



# VSG60A Vector Signal Generator Product Manual

## **Signal Hound VSG60A Product Manual**

Published 12/14/2023  
© 2023, Signal Hound, Inc.  
1502 SE Commerce Ave, Suite 101  
Battle Ground, WA USA  
Phone 360.313.7997

This information is being released into the public domain in accordance with the Export Administration  
Regulations 15 CFR 734

# Contents

- 1 Introduction ..... 1**
  - 1.1 System Requirements ..... 1
  - 1.2 Installation ..... 1
- 2 Understanding the Hardware ..... 2**
  - 2.1 External 10 MHz input ..... 3
  - 2.2 Trigger Output ..... 3
  - 2.3 Low Spur Mode (Digital Tuning)..... 3
  - 2.4 Linearity and compression ..... 4
  - 2.5 Improving VSWR, if flatness, mismatch uncertainty ..... 4
  - 2.6 Amplitude Control and switching ..... 4
  - 2.7 Hardware-Software interface..... 5
  - 2.8 Optimizing Performance ..... 5
- 3 Capabilities..... 6**
- 4 Calibration ..... 6**
- 5 Adjustments ..... 6**
  - 5.1 Timebase..... 6
- 6 VSG60A Specifications ..... 7**
  - 6.1 Inputs / Outputs ..... 9
  - 6.2 Mechanical / Environmental ..... 10
- 7 Warranty and Disclaimer ..... 10**
  - 7.1 Warranty ..... 10
  - 7.2 Warranty Service ..... 10
  - 7.3 Limitation of Warranty ..... 10
  - 7.4 Exclusive Remedies ..... 11
  - 7.5 Certification..... 11
  - 7.6 Credit Notice..... 11
- 8 Typical Performance ..... 11**
  - 8.1 EVM..... 11
  - 8.2 Typical SSB Phase Noise ..... 12
  - 8.3 Typical Amplitude Accuracy ..... 13
  - 8.4 Typical Carrier Feedthrough..... 13
  - 8.5 Typical Harmonics ..... 14
  - 8.6 Typical Flatness across 40 mhz channel ..... 14
  - 8.7 Typical other non-harmonic spurious ..... 15

## 1 Introduction

The Signal Hound VSG60A Vector Signal Generator offers mid-range performance and agility at an affordable price. Continuously streaming up to 40 MHz of bandwidth at up to 51.2 MSPS from a PC or laptop virtually eliminates I/Q pattern buffer size restrictions.

The VSG60A hardware features an agile low phase noise LO synthesizer, digital baseband oversampling with reconstruction filter, harmonic filters across the full frequency range, and a trigger output, timed to match the RF output, for integrating the VSG60A in to test systems.

I/Q phase, amplitude, and offset are corrected across RF frequency, baseband frequency, and temperature in our environmental chamber, and stored on the VSG60A. The software applies these corrections in real-time.

Commands to change frequency and amplitude are embedded in the same data stream from the PC as the I/Q data, giving the user precise timing across frequency and amplitude changes. The agile LO can change frequency and settle in 200  $\mu$ s and offers outstanding phase noise.

### 1.1 SYSTEM REQUIREMENTS

Supported operating systems

- Windows 10 (32/64-bit)
- Ubuntu 18.04 (64-bit)

Minimum system requirements

- Dual core Intel i5/i7 processor, 4<sup>th</sup> generation or later.
- The software will average less than 1GB of memory.
- USB 3.0 connectivity.

### 1.2 INSTALLATION

See the VSG60 software manual for installation directions.

## 2 Understanding the Hardware

At the heart of the VSG60A is pair of quadrature modulators, one for below 2 GHz, and one for above

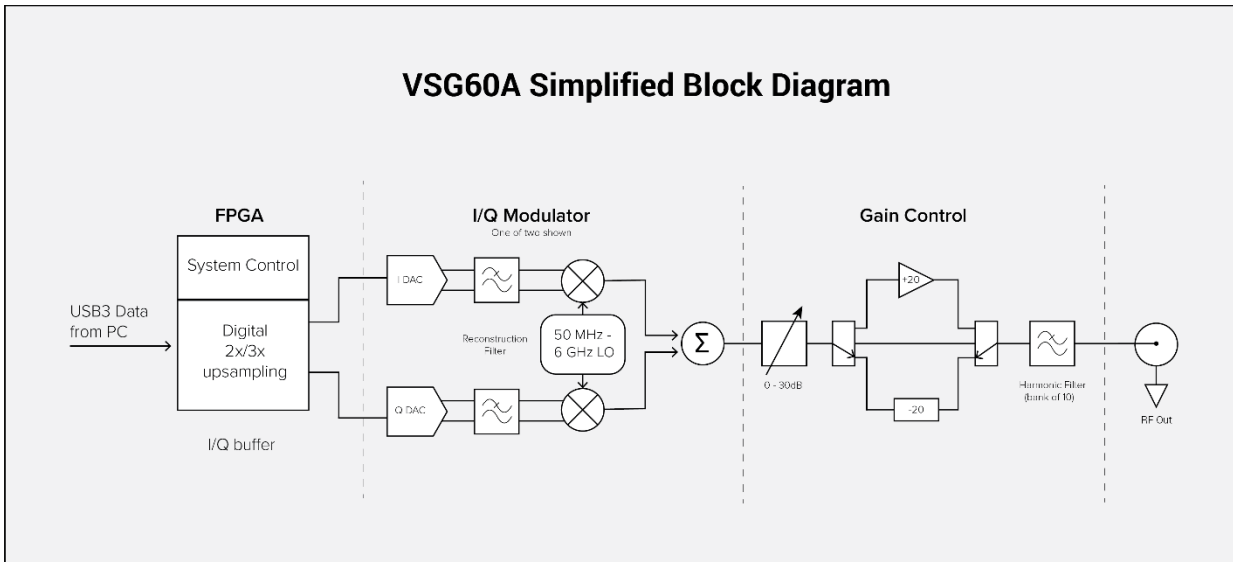

2 GHz (and a small segment around 800 MHz), driven by a dual channel DAC. The DAC clocks in I/Q samples at 66-102.4 MSPS. The data rate from the PC to the FPGA is 22-51.2 MSPS I/Q, so inside the FPGA we digitally up-sample by a factor of 2 or 3. This allows the use of a single optimized reconstruction filter for typically better than 60 dB rejection of any aliased baseband signals, and allows the PC to efficiently up-sample the user-selected baseband clock rate by a simple power of two.

The baseband clock is generated from a 2.4 to 2.8 GHz VCO and divided down to 66-102.4 MHz. Standard telecom symbol rates can be produced with 0 ppm additive error, and any symbol rate can be produced with less than 1 ppm error.

The local oscillator (LO) generates a low phase noise CW signal (typically -125 dBc/Hz at a 10 kHz offset from 1 GHz) for the I/Q modulators. Below 2 GHz, the LO runs at twice the RF frequency and is digitally divided into quadrature. Above 2 GHz, a polyphase filter generates the quadrature LO for the mixers. The LO switches frequencies in 200 microseconds for frequency-hopping applications. The LO has 1/6 Hz resolution when digital tuning is disabled, and better than 1  $\mu$ Hz when digital tuning is enabled. See the section on digital tuning for more information.

Both the baseband clock and LO are synthesized from a low phase noise 80 MHz clock, tied to either the internal 10 MHz voltage-controlled, temperature-compensated crystal oscillator (VCTCXO), or the user's external 10 MHz input.

From the modulators, up to 20 dB of gain or 50 dB of attenuation is applied, in 2 dB steps. The VSG60A software typically automatically selects the best setting based on output amplitude, but

manual control is available as well. Fine amplitude control is handled digitally, providing 0.01 dB resolution on the output amplitude.

Finally, a bank of harmonic filters reduces the amplitude of harmonics generated from the modulators and amplifiers, typically below -40 dBc.

The FPGA in the VSG60A can quickly switch between streaming I/Q and changing LO frequency or attenuator settings at precise intervals (200  $\mu$ s and 10  $\mu$ s, respectively), allowing the user to build signals that hop across the entire frequency range of the device. This makes the VSG60A a good choice for generating frequency hopping signals or signals that must cover a wide amplitude range.

## 2.1 EXTERNAL 10 MHZ INPUT

A low-jitter comparator provides low additive phase noise for an external 10 MHz reference input of 0 dBm to +13 dBm. When external reference is enabled, the internal 10 MHz VCTCXO is disabled and the external reference disciplines the 80 MHz VCXO directly. Inputs as low as -15 dBm will work, but phase noise degrades at lower amplitudes. A square wave provides the highest slew rate and therefore the best phase noise.

## 2.2 TRIGGER OUTPUT

The trigger output is a series-terminated 3.3V logic signal, meant to typically drive a high impedance load. The trigger output is synchronized with the RF output. Up to 1000 triggers per second can be output, with a user-selectable pulse width. This enables the VSG60A to be connected to other equipment in an automated testing environment.

## 2.3 LOW SPUR MODE (DIGITAL TUNING)

The LO uses a fractional-N PLL. This can lead to integer boundary spurs, as well as other spurious.

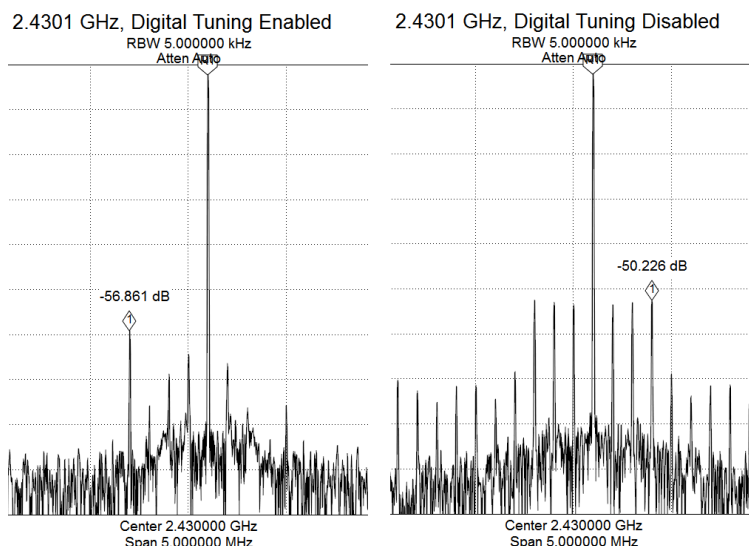

To mitigate these spurs, a low spur mode has been added, which is on by default. When low spur mode is enabled, the fractional-N PLL uses a very low denominator to keep the spurs at least 2 MHz away from the carrier and typically below -50 dBc above 3.7 GHz, and below -55 dBc below 3.7 GHz. This gives a coarse LO frequency, which is then digitally tuned to the exact requested frequency. The advantages of digital tuning are very low-level, predictable

fractional-N and integer boundary spurs, and nearly infinite tuning resolution. The disadvantage is that the hardware's I/Q offset is no longer centered in the modulation envelope.

For applications where digital tuning is not desirable, such as protocols that require the hardware I/Q offset to be centered, digital tuning should be disabled. This sets the fractional-N PLL for 1/6 Hz resolution, allowing 1 Hz steps and frequencies like 833 1/3 MHz with zero additive frequency error. Most frequencies in this mode will have fractional-N spurs below -50 dBc, but some frequencies will have close-in spurs that exceed this level.

### 2.4 LINEARITY AND COMPRESSION

To keep the VSG60A USB-powered, it was designed with modulators and amplifiers that strike a balance between linearity and power consumption. The best linearity is obtained at output levels of -10 dBm or lower, where 3<sup>rd</sup> order intermodulation products are typically below -50 dBc, and generally linearity is better at lower frequencies. For frequencies above 3 GHz at amplitudes above 0 dBm, compression and intermodulation distortion may become an issue for some signals. Above 4 GHz, a +10 dBm CW output may be compressed by about 1 dB in places, and compression at this level will significantly impair EVM. Applications requiring good linearity at high output power, especially at high frequencies, may require an external amplifier. An amplifier with a third order intercept 25 dB above the required output power will generally preserve the linearity of the VSG60A.

### 2.5 IMPROVING VSWR, IF FLATNESS, MISMATCH UNCERTAINTY

The VSG60A harmonic filters exhibit high VSWR at certain frequencies. When connecting to a high VSWR receiver or antenna, a 3 to 10 dB fixed SMA attenuator connected to the VSG60A output significantly reduces mismatch uncertainty and VSWR and improves the IF flatness for applications where this is a concern.

### 2.6 AMPLITUDE CONTROL AND SWITCHING

Internally, the VSG60A has 3 coarse gain settings, usually controlled by the API. High gain uses an amplifier with a 20-dB gain. Mid-gain is 0 dB (bypass both amplifier and attenuator). Low gain is a 20-dB attenuator. The amplifier is powered on for both high gain and mid gain but powered off for low gain. Additionally, there is a 0-30 dB step attenuator, calibrated in 2 dB steps. Fine amplitude control is accomplished digitally by scaling the I/Q data. The final amplitude state is "off", which powers down the I/Q modulators and amplifiers.

The VSG60A can switch amplitudes in 10 microseconds. This is a fixed delay to allow for switches, attenuators, and amplifiers to settle a bit. However, when switching directly from low gain amplitudes (such as -40 dBm) to high gain amplitudes (such as +5 dBm), the output amplifier must turn on and stabilize. The output power will be within 1 dB (0.6 dB typical) of its final power within 10 microseconds, but typically requires 5 milliseconds to stabilize to within 0.1 dB.

Please note that for ramping amplitude from low to high, 2 dB steps every millisecond for example, the amplifier is powered on but not used for a 20-dB range, giving plenty of time for the amplifier to fully stabilize before it is used. Also, if the amplitude is fully controlled with the I/Q data, this problem is avoided altogether.

### 2.7 HARDWARE-SOFTWARE INTERFACE

Other than up-sampling by 2 or 3 on the FPGA, all digital signal processing happens on the PC. The VSG60A software and API automatically adjust the signal amplitude, I/Q balance and DC offset to provide an accurate, clean, flat 40 MHz modulation bandwidth. A highly optimized FIR filter on the PC applies these corrections in real-time with minimal software overhead.

An array of correction constants across frequency and temperature is generated by running each VSG60A through an environmental chamber and storing this data to internal flash memory.

A state machine inside the FPGA processes I/Q data, triggers, frequency steps, and amplitude steps. This allows precise timing relationships between events such as frequency hops.

### 2.8 OPTIMIZING PERFORMANCE

#### Pulse Modulation

When using our user interface software, the “off” state can be optimized by changing the I/Q offset to minimize the LO feed-through until a spectrum analyzer, such as the SM200A, reads a minimum amplitude. Typically, 60 dB on/off ratio is possible using this method.

When using the API, two additional tricks are available. If the pulse will be sent to a receiver with 20 MHz bandwidth or less, converting the pulse to a 15-16 MHz offset tone will place the LO feed-through in the “off” state outside the 20 MHz bandwidth.

#### Spurious

The VSG60A uses a fractional-N synthesizer. If your application allows for some flexibility in frequency selection, sticking to even multiples of 4, 5, or 10 MHz for your center frequency will reduce or eliminate fractional-N spurs.

#### Bandwidth

For a 50 MSPS sample rate, digital filters in the FPGA begin to roll off just past an 18 MHz offset, and are down about 1 dB by 20 MHz offset from center. By keeping signal bandwidth to 72% or less of the I/Q sample rate, the VSG60A will maintain excellent flatness across the signal’s bandwidth. Please note that for sample rates below 25 MSPS, the API will up-sample the I/Q data, and there is no penalty for using a bandwidth up to 80% of the sample rate.



When using the API, the user is expected to keep the signal bandwidth confined to 80% of the sample rate. Violating this will result in spurious responses.

### 3 Capabilities

As a vector signal generator, the VSG60A can generate virtually any signal that fits within its 40 MHz bandwidth, limited only by the waveform generation software. The VSG60A ships with a powerful suite of software tools for generating both analog and digital modulation, adding impairments for receiver testing, or loading custom waveforms, all at no additional cost. A user-friendly application programming interface (API) is available for communicating with the VSG60A directly from your software application. See the VSG60A software and API manuals for more information.

### 4 Calibration

Our Field Calibration Software is available as a free download and may be used to calibrate the VSG60A. Check the Field Calibration software manual for required equipment.

### 5 Adjustments

Adjustments to the VSG60A are done in an environmental chamber at the Signal Hound production facility. Here, the timebase is initially adjusted, and the I/Q balance, DC offset, and output amplitude are adjusted across frequency and temperature. Additionally, the user can adjust the internal timebase as needed, and manually adjust the DC offset to null out the LO feedthrough, if the factory adjustment is insufficient for a particular task, such as improving the on/off ratio for pulse modulation.

#### 5.1 TIMEBASE

The 10 MHz internal timebase is a voltage-controlled, temperature-compensated crystal oscillator (VCTCXO) with a 16-bit DAC, providing sub-part per billion resolution. It is factory adjusted before shipping and may be software-adjusted in the field as needed. For a VSG60A operating at a stable temperature, periodic adjustments will typically keep the internal timebase to better than 0.1 ppm.

## 6 VSG60A Specifications

Unless otherwise noted, the specifications listed are under default conditions, digital tuning enabled.

Frequency		
Specified Range	All Modes	50 MHz to 6 GHz
Useable Range (typical)	All Modes	30 MHz to 6 GHz
Resolution	Digital Tuning Disabled	1/6 Hz
	Digital Tuning Enabled	< 1 $\mu$ Hz
LO Switch Time	Queued Hops	200 $\mu$ s
	Software-controlled	80 ms typical
Accuracy	Internal timebase, Aging	+/- 1 ppm/yr.
	Initial accuracy	+/- 1 ppm
I/Q Symbol Clock Range	All Modes	12.5 kHz to 51.2 MHz
I/Q Symbol Clock Accuracy	All Modes	+/- 1 ppm + timebase accuracy
	Commonly used symbol rates	0 ppm + timebase accuracy
I/Q Symbol Clock Switch Time	All modes	100 ms typical

## VSG60A Specifications | Timebase

Level		
Specified Range	CW Mode	-55 dBm to +7dBm
Useable range	All modes	-80 dBm to (+10 dBm – PAPR) <sup>1</sup>
Absolute level error	CW mode, -55 to +7 dBm	+/- 2.0 dB
Modulation Flatness	20 MHz BW, 1 GHz carrier	+/- 0.5 dB
	40 MHz BW, 1 GHz carrier	+/- 2.0 dB
Switching Time	All modes	10 $\mu$ s
Settling Time	< 20 dB step	<10 $\mu$ s typical to 0.1 dB
	> 20 dB step	<10 $\mu$ s typical to 1 dB 5 ms typical to 0.1 dB
Reverse Power	Damage Level	+20 dBm

<sup>1</sup>PAPR = Peak-to-Average Power Ratio

<b>Spectral Purity</b>		
Harmonics	50 MHz to 6 GHz, CW, 0 dBm	< -30 dBc
Image Response	50 MHz to 6 GHz, -10 dBm, 20 MHz modulation bandwidth	< -40 dBc
	50 MHz to 6 GHz, -10 dBm, 40 MHz modulation bandwidth	< -30 dBc
Carrier Feedthrough	50 MHz to 6 GHz, CW, 0 dBm	< -40 dBc
SSB Phase Noise	1 GHz CW, 0 dBm	
	10 kHz offset	< -120 dBc/Hz
	100 kHz offset	< -122 dBc/Hz
Other non-harmonic Spurious	Carrier 50 MHz to 6 GHz Digital tuning enabled Modulated with 1 MHz tone Level -10 dBm, Spurs measured to 1.7x center frequency	< -40 dBc
Error Vector Magnitude (EVM) (-10 dBm output power)	QPSK, 4 MS/s, 0.2RRC	
	< 3 GHz	< 1.2% (typ. 0.6%)
	3-6 GHz	< 1.8%
	QAM16, 4 MS/s, 0.2 RRC	
	< 3 GHz	< 1.0% (typ. 0.5%)
	3-6 GHz	< 1.7%
Adjacent Channel Power Ratio (RRC 0.2, -10 dBm)	1 GHz QAM16, 1 MS/s, 0.35 RC	< 0.5% (typ. 0.3%)
	QPSK 4 MS/s, 5 MHz channel	
	< 3 GHz	< -50 dBc (typ. -55 dBc)
	3-6 GHz	< -40 dBc (typ. -45 dBc)

## 6.1 INPUTS / OUTPUTS

<b>Data and Power</b>	(1) USB 3.0 port and (1) adjacent USB 2.0 or USB 3.0 port
<b>RF output</b>	SMA (F)
<b>External 10 MHz Input</b>	BNC (F), 0 to +13 dBm recommended
<b>Trigger Output</b>	BNC (F), 3.3V logic level

## **6.2 MECHANICAL / ENVIRONMENTAL**

<b>Power Requirements</b>	USB-powered, 4.5 – 5.25V, 6 watts typical.
<b>Operating temperature</b>	0 to 50 C
<b>Size</b>	8.63" x 3.19" x 1.19"
<b>Weight</b>	about 1 lb.

## **7 Warranty and Disclaimer**

©2013-2023 Signal Hound. All rights reserved.

Reproduction, adaptation, or translation without prior written permission is prohibited, except as allowed under the copyright laws.

### **7.1 WARRANTY**

The information contained in this manual is subject to change without notice. Signal Hound makes no warranty of any kind with regard to this material, including, but not limited to, the implied warranties or merchantability and fitness for a particular purpose. Signal Hound shall not be liable for errors contained herein or for incidental or consequential damages in connection with the furnishing, performance, or use of this material. This Signal Hound product has a warranty against defects in material and workmanship for a period of two years from date of shipment. During the warranty period, Signal Hound will, at its option, either repair or replace products that prove to be defective.

### **7.2 WARRANTY SERVICE**

For warranty service or repair, this product must be returned to Signal Hound. The Buyer shall pay shipping charges to Signal Hound and Signal Hound shall pay UPS Ground, or equivalent, shipping charges to return the product to the Buyer. However, the Buyer shall pay all shipping charges, duties, and taxes, to and from Signal Hound, for products returned from another country.

### **7.3 LIMITATION OF WARRANTY**

The foregoing warranty shall not apply to defects resulting from improper use by the Buyer, Buyer-supplied software or interfacing, unauthorized modification or misuse, operation outside of the environmental specifications for the product. No other warranty is expressed or implied. Signal Hound specifically disclaims the implied warranties or merchantability and fitness for a particular purpose.

## 7.4 EXCLUSIVE REMEDIES

The remedies provided herein are the Buyer's sole and exclusive remedies. Signal Hound shall not be liable for any direct, indirect, special, incidental, or consequential damages, whether based on contract, tort, or any other legal theory.

## 7.5 CERTIFICATION

Signal Hound certifies that, at the time of shipment, this product conformed to its published specifications.

## 7.6 CREDIT NOTICE

**Windows®** is a registered trademark of Microsoft Corporation in the United States and other countries.

**Intel® and Core™** are trademarks or registered trademarks of the Intel Corp. in the USA and/or other countries.

**Ubuntu®** is a registered trademark of Canonical, Ltd. in the United States and/or other countries.

## 8 Typical Performance

VSWR (typical, at tuned frequency)	
50 MHz – 1.6 GHz	< 1.62
1.6 GHz – 2.5 GHz	< 2.75
> 2.5 GHz	< 4.2

### 8.1 EVM

2.4 GHz, 1 MS/s QPSK, Raised cosine, alpha 0.35, -10 dBm: 0.24%; 0 dBm: 0.4%; +10 dBm: 1.1%

## 8.2 TYPICAL SSB PHASE NOISE

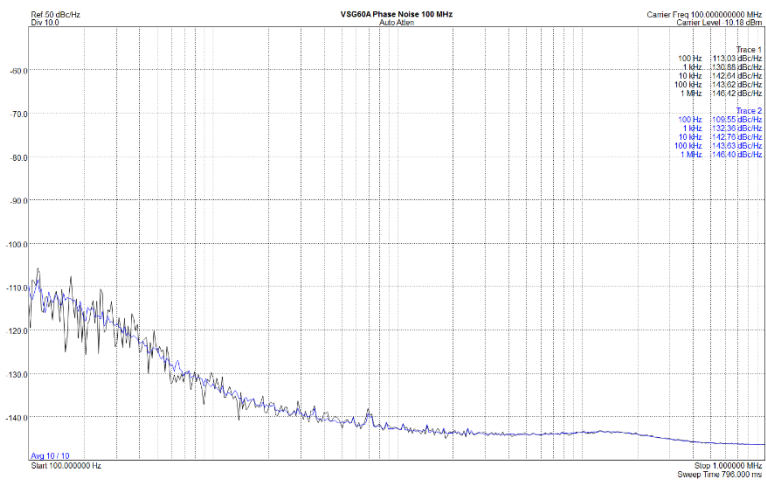
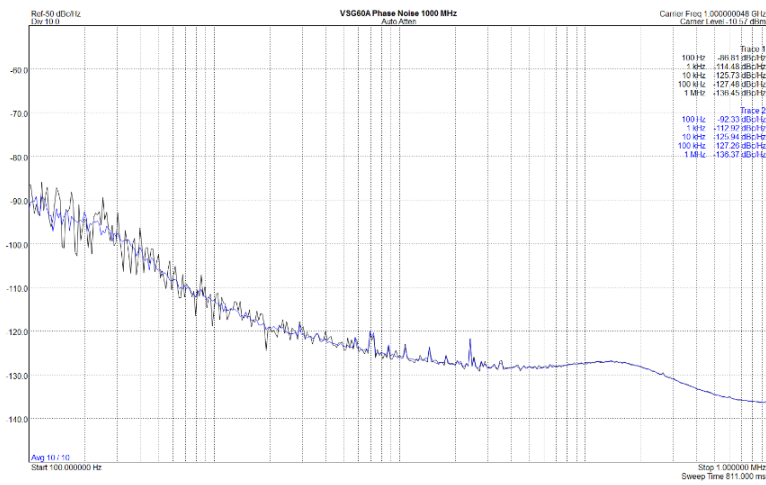
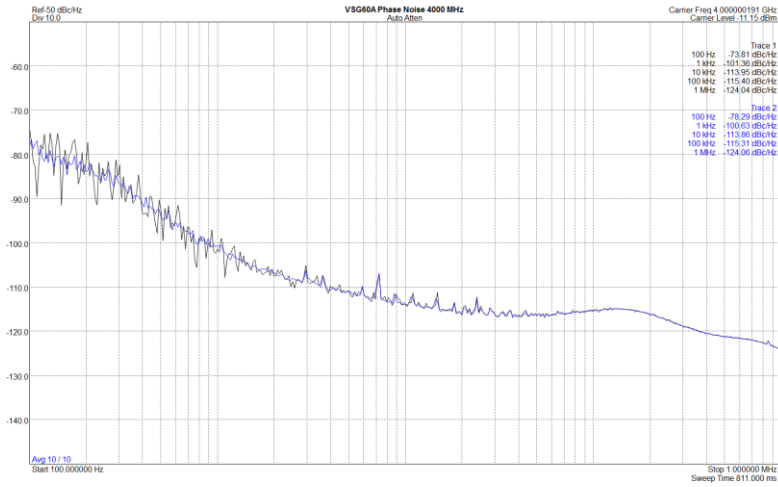

### 8.3 TYPICAL AMPLITUDE ACCURACY

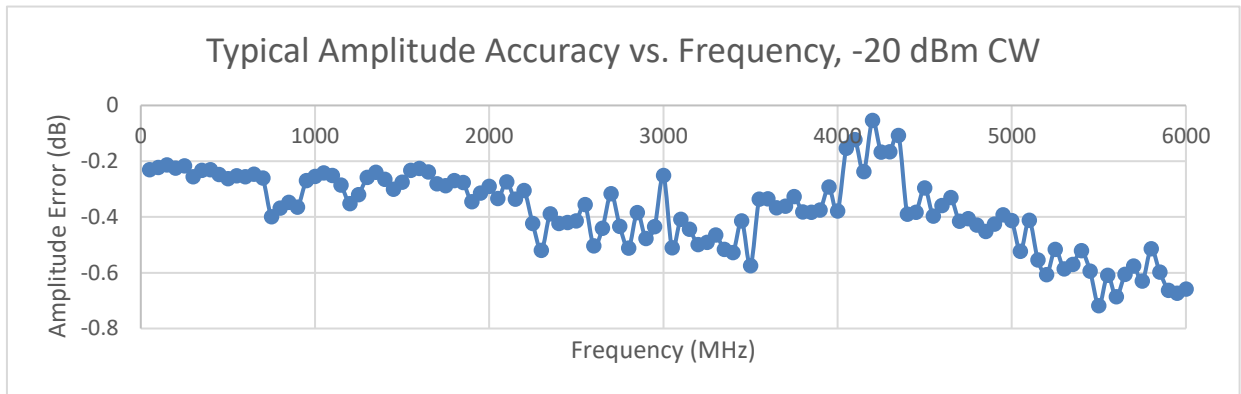

### 8.4 TYPICAL CARRIER FEEDTHROUGH

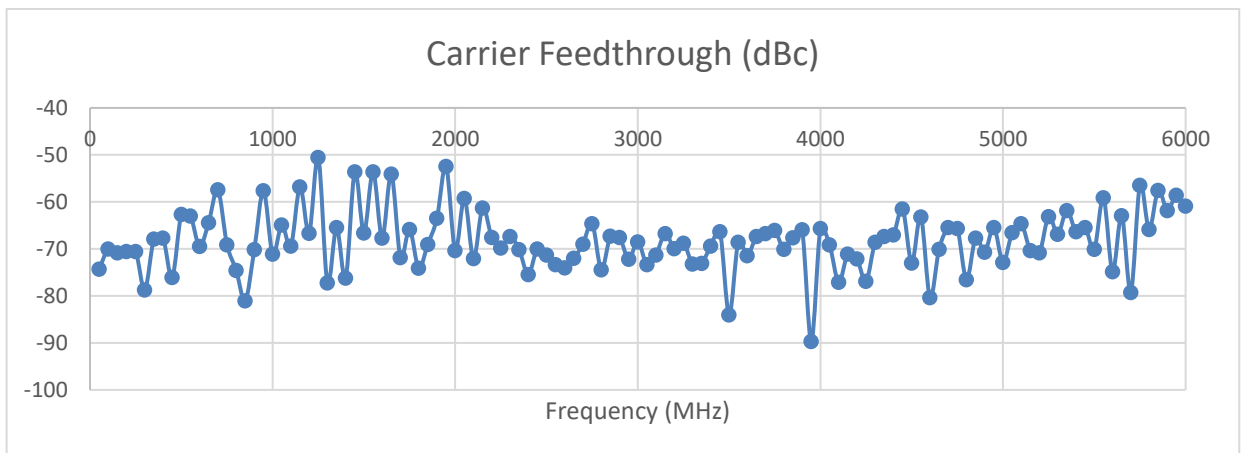



### 8.5 TYPICAL HARMONICS

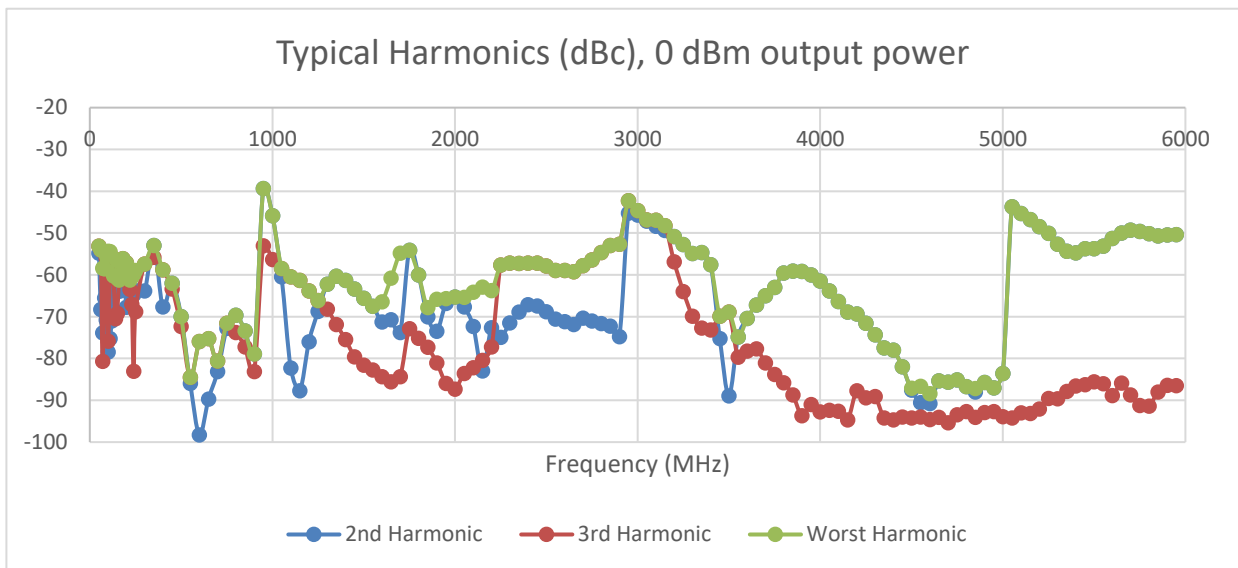

### 8.6 TYPICAL FLATNESS ACROSS 40 MHz CHANNEL

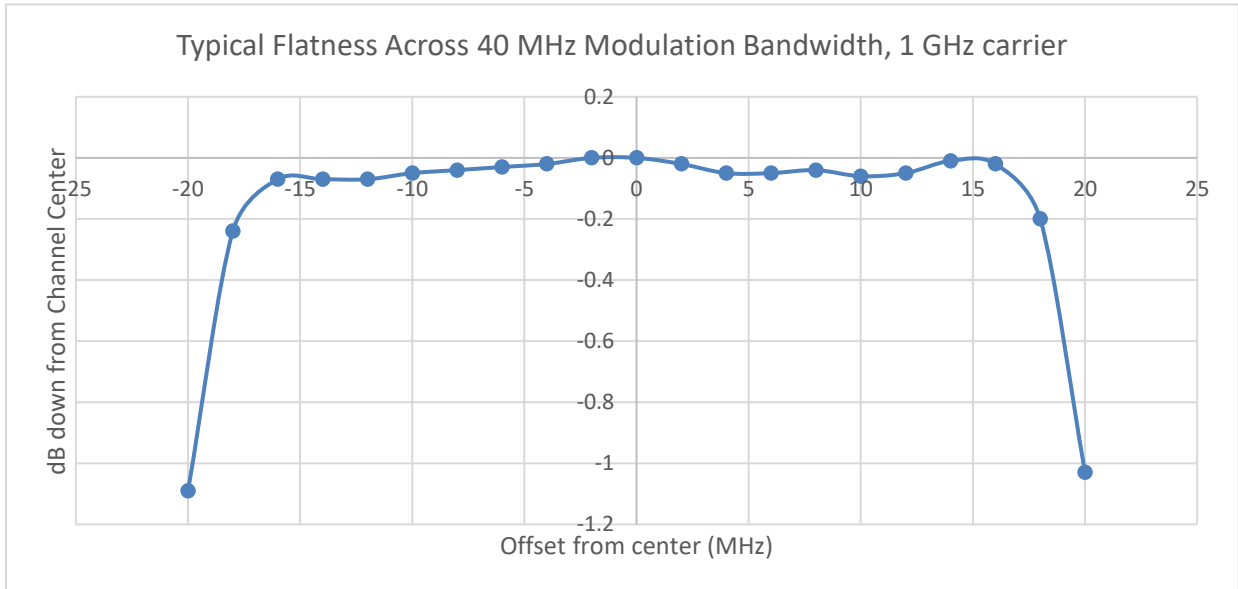

## 8.7 TYPICAL OTHER NON-HARMONIC SPURIOUS

