

Drawing(mm)

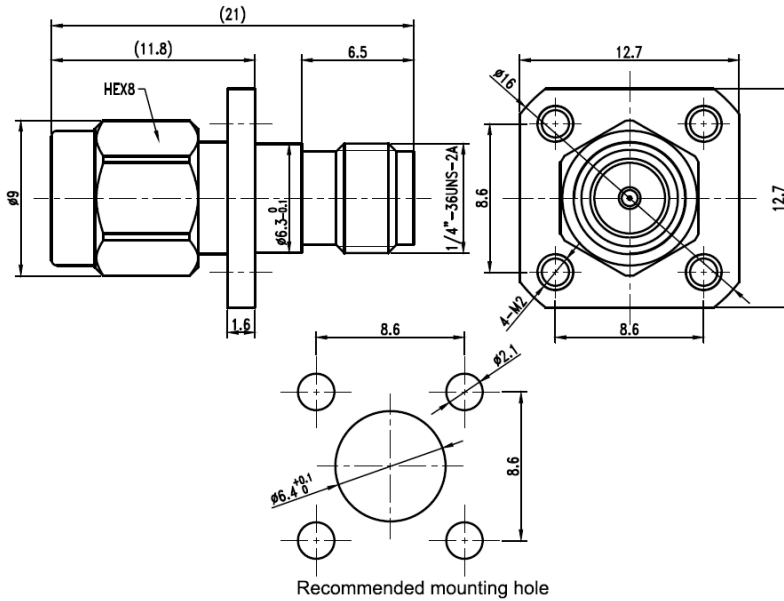

Electrical & Environmental

Impedance	50 ohm
Frequency Range	18 GHz
VSWR	1.15 max
Operating Temp	-55°C to +120°C
Interface	SMA per MIL-STD-348B

Material

Connector Body	Gold plated brass
Center Contact	Gold plated brass
Insulator	PTFE