

R&S®ZNA

Vector Network Analyzers

User Manual



1178646202
Version 29

ROHDE & SCHWARZ
Make ideas real



This document describes the following R&S®ZNA vector network analyzers:

- R&S®ZNA26, 10 MHz to 26.5 GHz, 2 test ports, 3.5 mm (m) connectors, order no. 1332.4500K22
- R&S®ZNA26, 10 MHz to 26.5 GHz, 4 test ports, 3.5 mm (m) connectors, order no. 1332.4500K24
- R&S®ZNA43, 10 MHz to 43.5 GHz, 2 test ports 2.92 mm, order no. 1332.4500K42
- R&S®ZNA43, 10 MHz to 43.5 GHz, 4 test ports 2.92 mm, order no. 1332.4500K44
- R&S®ZNA43, 10 MHz to 43.5 GHz, 2 test ports 2.4 mm, order no. 1332.4500K43
- R&S®ZNA43, 10 MHz to 43.5 GHz, 4 test ports 2.4 mm, order no. 1332.4500K45
- R&S®ZNA50, 10 MHz to 50 GHz, 2 test ports 2.4 mm, order no. 1332.4500K52
- R&S®ZNA50, 10 MHz to 50 GHz, 4 test ports 2.4 mm, order no. 1332.4500K54
- R&S®ZNA67, 10 MHz to 67 GHz, 2 test ports 1.85 mm, order no. 1332.4500K62
- R&S®ZNA67, 10 MHz to 67 GHz, 4 test ports 1.85 mm, order no. 1332.4500K64

Furthermore, it covers the vector network analyzer systems R&S®ZNA67EXT, with extended frequency range 10 MHz to 110 GHz and 1 mm external test sets:

- R&S®ZNA67EXT Variant 02, order no. 1352.1888K02, 2-port R&S®ZNA67, 2 standard power external test sets
- R&S®ZNA67EXT Variant 03, order no. 1352.1888K03, 4-port R&S®ZNA67, 2 standard power external test sets
- R&S®ZNA67EXT Variant 04, order no. 1352.1888K04, 4-port R&S®ZNA67, 4 standard power external test sets
- R&S®ZNA67EXT Variant 05, order no. 1352.1888K05, 2-port R&S®ZNA67, 2 high power external test sets
- R&S®ZNA67EXT Variant 06, order no. 1352.1888K06, 4-port R&S®ZNA67, 2 high power external test sets
- R&S®ZNA67EXT Variant 07, order no. 1352.1888K07, 4-port R&S®ZNA67, 4 high power external test sets

© 2023 Rohde & Schwarz GmbH & Co. KG
Muehldorfstr. 15, 81671 Muenchen, Germany
Phone: +49 89 41 29 - 0

Email: info@rohde-schwarz.com

Internet: www.rohde-schwarz.com

Subject to change – data without tolerance limits is not binding.

R&S® is a registered trademark of Rohde & Schwarz GmbH & Co. KG.

MIPI® marks and logos are service marks owned by MIPI Alliance, Inc. and any use of such marks by Rohde & Schwarz is under license.

All other trademarks are the properties of their respective owners.

1178.6462.02 | Version 29 | R&S®ZNA

Throughout this manual, products from Rohde & Schwarz are indicated without the ® symbol, i.e. R&S® is abbreviated as R&S.

Contents

1	Safety and regulatory information.....	15
1.1	Safety instructions.....	15
1.2	Warning messages in the documentation.....	17
1.3	Korea certification class A.....	18
2	Welcome to the R&S ZNA.....	19
2.1	What's new in firmware version 2.74.....	19
2.1.1	Firmware version 2.73.....	19
2.1.2	Firmware version 2.72.....	19
2.1.3	Firmware version 2.71.....	19
2.1.4	Firmware version 2.70.....	20
2.2	Documentation overview.....	21
2.2.1	Getting started manual.....	21
2.2.2	Getting started manual R&S ZNA67EXT.....	22
2.2.3	User manual and help.....	22
2.2.4	Service manual.....	22
2.2.5	Instrument security procedures.....	22
2.2.6	Printed safety instructions.....	22
2.2.7	Data sheets and brochures.....	22
2.2.8	Release notes and open source acknowledgment (OSA).....	23
2.2.9	Application notes, application cards, white papers, etc.....	23
3	Getting Started.....	24
3.1	Preparing for use.....	24
3.1.1	Lifting and carrying.....	24
3.1.2	Unpacking and checking.....	24
3.1.3	Choosing the operating site.....	24
3.1.4	Setting up the product.....	25
3.1.5	Considerations for test setup.....	27
3.1.6	Connecting the analyzer to the AC supply.....	28
3.1.7	Switching the instrument on and off.....	28
3.1.8	Standby and ready state.....	29
3.1.9	Windows operating system.....	30

3.1.10	Minimizing the VNA application.....	31
3.1.11	Connecting external accessories.....	32
3.2	Instrument tour.....	34
3.2.1	Front panel.....	35
3.2.2	Rear panel.....	41
3.3	Operating the instrument.....	43
3.3.1	Manual operation.....	43
3.3.2	Control elements of the application window.....	48
3.3.3	Touchscreen gestures.....	54
3.3.4	Working with dialogs.....	57
3.3.5	Handling diagrams, traces, and markers.....	58
3.3.6	Entering data.....	62
3.3.7	Scaling diagrams.....	66
3.4	Performing measurements.....	71
3.4.1	Transmission S-parameter measurement.....	71
3.4.2	Reflection S-parameter measurement.....	78
3.5	Getting started with R&S ZNA67EXT.....	79
3.5.1	Safety and regulatory information.....	79
3.5.2	Key features.....	81
3.5.3	Preparing for use.....	82
3.5.4	System tour.....	85
3.5.5	Putting the system into operation.....	92
3.5.6	Connecting the external test sets.....	93
3.5.7	Basic operation.....	99
4	Concepts and features.....	107
4.1	Basic concepts.....	107
4.1.1	Global (persistent) settings.....	107
4.1.2	Recall sets.....	108
4.1.3	Traces, channels and diagrams.....	108
4.1.4	Sweep control.....	110
4.1.5	Automatic level control.....	117
4.1.6	Power correction from pre-measurement.....	119
4.1.7	Data flow.....	120

4.2	Screen elements.....	124
4.2.1	Display elements of a diagram.....	124
4.2.2	Dialogs.....	136
4.2.3	Trace formats.....	140
4.3	Measurement results.....	149
4.3.1	S-parameters.....	149
4.3.2	Reference impedances.....	152
4.3.3	Impedance parameters.....	154
4.3.4	Admittance parameters.....	157
4.3.5	Wave quantities and ratios.....	158
4.3.6	Unbalance-balance conversion.....	161
4.3.7	Stability factors.....	166
4.3.8	Group delay.....	167
4.4	Operations on traces.....	168
4.4.1	Limit check.....	168
4.4.2	Trace files.....	176
4.5	Calibration.....	186
4.5.1	Calibration types.....	187
4.5.2	Calibration standards and calibration kits.....	199
4.5.3	Calibration pool.....	206
4.5.4	Calibration labels.....	206
4.5.5	Automatic calibration.....	206
4.5.6	Scalar power calibration.....	218
4.5.7	SMARTerCal.....	224
4.5.8	Parallel calibration of multiple channels.....	227
4.5.9	Joining calibrations.....	227
4.6	Offset parameters and de-/embedding.....	228
4.6.1	Offset parameters.....	228
4.6.2	Embedding and deembedding.....	234
4.7	Optional extensions and accessories.....	246
4.7.1	Spectrum analyzer mode.....	247
4.7.2	Time domain analysis.....	247
4.7.3	Frequency conversion measurements.....	261

4.7.4	Phase coherent source control.....	275
4.7.5	True differential mode.....	277
4.7.6	Pulsed measurements.....	279
4.7.7	Millimeter-wave converter support.....	281
4.7.8	Increased IF bandwidth 30 MHz.....	288
4.7.9	Frequency resolution 1 mHz.....	288
4.7.10	Continuous data recording.....	288
4.7.11	Noise figure measurement.....	289
4.7.12	Measurement uncertainty analysis.....	294
4.7.13	Security write protection.....	297
4.7.14	Continuous sweep up to 110 GHz (R&S ZNA67EXT only).....	297
4.7.15	Eazy de-embedding based on IEEE 370.....	298
4.7.16	In-situ de-embedding.....	299
4.7.17	Smart fixture de-embedding.....	300
4.7.18	Delta-L 4.0 PCB characterization.....	300
4.7.19	Health and usage monitoring service (HUMS).....	301
4.7.20	Internal 3rd and 4th source for 4-port R&S ZNA.....	302
4.7.21	Precision frequency reference.....	303
4.7.22	Second internal LO generator for 4-port R&S ZNA.....	303
4.7.23	Internal 2nd source and 2nd LO generator for 2-port R&S ZNA.....	303
4.7.24	Memory extension for data streaming.....	304
4.7.25	LO Out.....	305
4.7.26	RFFE GPIO interface.....	305
4.7.27	Direct generator/receiver access.....	306
4.7.28	Additional removable system drive.....	308
4.7.29	Source step attenuators.....	308
4.7.30	Direct IF access.....	308
4.7.31	Receiver step attenuators.....	309
4.7.32	Internal pulse modulators.....	309
4.7.33	Trigger board.....	309
4.7.34	Direct source monitor access.....	310
4.7.35	Internal combiner.....	311
4.7.36	Internal low noise preamplifier.....	312

4.7.37	Internal low power spur reduction amplifier.....	314
4.7.38	USB-to-IEC/IEEE adapter.....	316
4.7.39	External power meters.....	316
4.7.40	External generators.....	321
4.7.41	External switch matrices.....	323
4.7.42	Generic devices.....	331
4.7.43	External DLLs.....	332
4.7.44	Power added efficiency.....	334
4.7.45	R&S ZNXSIM.....	335
5	GUI reference.....	339
5.1	Function keys and softtools.....	339
5.2	Meas softtool.....	341
5.2.1	Measurement type.....	341
5.2.2	S-Params tab.....	344
5.2.3	Wave tab.....	357
5.2.4	Ratio Harmonics tab.....	361
5.2.5	Noise Figure tab.....	367
5.2.6	Intermodulation tab.....	380
5.2.7	Gain Compression tab.....	391
5.2.8	Time Domain tab.....	395
5.2.9	Time Gate tab.....	396
5.2.10	Power Sensor tab.....	396
5.2.11	Spectrum tab.....	397
5.2.12	External DLL tab.....	401
5.2.13	Scalar Mixer Meas tab.....	408
5.2.14	Vector Mixer Meas tab.....	414
5.2.15	Two Tone Group Dly tab (frequency-converting DUT).....	416
5.3	Format softtool.....	419
5.4	Scale softtool.....	425
5.4.1	Scale Values tab.....	425
5.4.2	Scale Coupling tab.....	428
5.4.3	Zoom tab.....	429
5.5	Traces softtool.....	431

5.5.1	Traces tab.....	431
5.5.2	Mem tab.....	437
5.5.3	All Mem All Data tab.....	439
5.5.4	Math tab.....	441
5.5.5	Time Domain tab.....	447
5.5.6	Time Gate tab.....	452
5.5.7	Distance to Fault tab.....	455
5.5.8	Trace Statistics tab.....	455
5.5.9	Smooth Shift Hold tab.....	462
5.5.10	Infinite Averaging tab.....	466
5.5.11	Trace Data tab.....	467
5.5.12	Linearity Deviation tab.....	475
5.6	Lines softtool.....	477
5.6.1	Limit Test tab.....	478
5.6.2	Ripple Test tab.....	487
5.6.3	Circle Test tab.....	492
5.6.4	Display Circle tab.....	496
5.6.5	Horiz. Line tab.....	497
5.7	Marker softtool.....	498
5.7.1	Markers tab.....	498
5.7.2	Marker Props tab.....	501
5.7.3	Marker Search tab.....	504
5.7.4	Multiple Peak tab.....	510
5.7.5	Target Search tab.....	512
5.7.6	Bandfilter tab.....	514
5.7.7	Set by Marker tab.....	518
5.7.8	Info Field tab.....	520
5.7.9	Marker Coupling tab.....	520
5.8	Stimulus softtool.....	522
5.8.1	Stimulus tab.....	522
5.8.2	Power tab.....	525
5.8.3	Time Domain X-Axis tab.....	533
5.9	Pwr Bw Avg softtool.....	535

5.9.1	Power tab.....	535
5.9.2	Bandwidth tab.....	535
5.9.3	Average tab.....	538
5.10	Sweep Softtool.....	539
5.10.1	Sweep Params tab.....	539
5.10.2	Wait Time Control tab.....	542
5.10.3	Sweep Type tab.....	546
5.10.4	Trigger tab.....	558
5.10.5	Sweep Control tab.....	565
5.11	Cal softtool.....	569
5.11.1	Start Cal tab.....	570
5.11.2	Cal Devices tab.....	612
5.11.3	Pwr Cal Settings tab.....	626
5.11.4	Use Cal tab.....	634
5.11.5	METAS Cal tab.....	642
5.12	Channel Config softtool.....	652
5.12.1	Channels tab.....	652
5.12.2	Port Config tab.....	667
5.12.3	Pwr Cal Settings tab.....	686
5.13	Mode softtool.....	686
5.13.1	Mode tab.....	686
5.13.2	Pulse Mod tab.....	691
5.13.3	Source Coherence tab.....	702
5.14	Offset Embed softtool.....	706
5.14.1	Offset Embed dock widget.....	706
5.14.2	Offset tab.....	716
5.14.3	One Way Loss tab.....	722
5.14.4	Single Ended tab.....	724
5.14.5	Fixture modeling dialog.....	727
5.14.6	Port Sets tab.....	742
5.14.7	Balanced tab.....	745
5.14.8	Ground Loop tab.....	748
5.14.9	Differential Match tab.....	751

5.14.10	Config tab.....	753
5.14.11	Deembed Assistant tab.....	754
5.14.12	Delta-L tab.....	764
5.15	File Print softtool.....	771
5.15.1	Recall sets tab.....	772
5.15.2	Favorites tab.....	776
5.15.3	Print tab.....	778
5.15.4	Printer Setup dialog.....	779
5.15.5	Trace Data tab.....	781
5.15.6	More tab.....	781
5.16	DUT softtool.....	782
5.16.1	DUT Centric Wizard.....	782
5.16.2	DUT Manager dialog.....	794
5.17	Applic softtool.....	797
5.17.1	External Tools application.....	798
5.17.2	TDR application.....	799
5.17.3	Distance to Fault application.....	830
5.18	Display softtool.....	838
5.18.1	Diagram tab.....	839
5.18.2	Split tab.....	842
5.18.3	Config tab.....	844
5.18.4	View Bar tab.....	852
5.18.5	Touchscreen tab.....	854
5.19	Setup softtool.....	854
5.19.1	Setup tab.....	854
5.19.2	Freq. Ref. tab.....	886
5.19.3	Remote Settings tab.....	888
5.19.4	Power Meter tab.....	890
5.19.5	Generator tab.....	896
5.19.6	Frequency Converter tab.....	901
5.19.7	Switch Matrix tab.....	908
5.19.8	Port Setup tab.....	918
5.19.9	Generic Device tab.....	921

5.19.10	Inline Cal System tab.....	926
5.20	Help softtool.....	927
5.21	Preset softtool.....	928
5.21.1	Select Preset tab.....	928
6	Remote control.....	931
6.1	Introduction to remote control.....	931
6.1.1	Remote control via USB.....	932
6.1.2	Starting a remote control session.....	932
6.1.3	GPIB Explorer.....	933
6.1.4	Switchover to remote control.....	935
6.1.5	Combining manual and remote control.....	938
6.2	Messages.....	939
6.2.1	Device messages (commands and device responses).....	939
6.2.2	SCPI command structure and syntax.....	939
6.2.3	SCPI parameters.....	943
6.3	Basic remote control concepts.....	945
6.3.1	Traces, channels, and diagram areas.....	945
6.3.2	Active traces in remote control.....	946
6.3.3	Initiating measurements, speed considerations.....	947
6.3.4	Addressing traces and channels.....	948
6.4	Command processing.....	949
6.4.1	Input unit.....	949
6.4.2	Command recognition.....	950
6.4.3	Data base and instrument hardware.....	950
6.4.4	Status reporting system.....	951
6.4.5	Output unit.....	951
6.4.6	Command sequence and command synchronization.....	951
6.5	Status reporting system.....	953
6.5.1	Overview of status registers.....	954
6.5.2	Structure of a SCPI status register.....	955
6.5.3	Contents of the status registers.....	957
6.5.4	Application of the status reporting system.....	963
6.5.5	Reset values of the status reporting system.....	966

7	Command reference.....	968
7.1	Special terms and notation.....	968
7.1.1	Upper- vs. lower-case.....	969
7.1.2	Special characters.....	969
7.1.3	Parameters.....	969
7.1.4	Numeric suffixes.....	969
7.2	Common commands.....	970
7.3	SCPI command reference.....	971
7.3.1	CALCulate commands.....	972
7.3.2	CONFigure commands.....	1202
7.3.3	CONTRol commands.....	1210
7.3.4	DIAGnostic commands.....	1230
7.3.5	DISPlay commands.....	1232
7.3.6	FORMat commands.....	1258
7.3.7	HCOPY commands.....	1259
7.3.8	INITiate commands.....	1265
7.3.9	INSTrument commands.....	1268
7.3.10	MEMory commands.....	1269
7.3.11	MMEMory commands.....	1271
7.3.12	OUTPut commands.....	1313
7.3.13	PROGram commands.....	1319
7.3.14	[SENSe:] commands.....	1322
7.3.15	SOURce commands.....	1521
7.3.16	STATus commands.....	1601
7.3.17	SYSTem commands.....	1604
7.3.18	TRACe commands.....	1650
7.3.19	TRIGger commands.....	1653
7.3.20	New commands for R&S ZNA.....	1662
7.4	HUMS and service date commands.....	1671
7.4.1	SNMP/REST commands.....	1672
7.4.2	System information commands.....	1675
7.4.3	Device tags commands.....	1685
7.4.4	Utilization commands.....	1686

7.4.5	Service date commands.....	1693
7.5	R&S ZVR/ZVABT compatible commands.....	1695
8	Programming examples.....	1722
8.1	Basic tasks.....	1722
8.1.1	Typical stages of a remote control program.....	1722
8.1.2	Channel, trace and diagram handling.....	1725
8.2	Condensed programming examples.....	1731
8.2.1	Path-independent remote control programs.....	1732
8.2.2	Trace and diagram handling.....	1732
8.2.3	Using markers.....	1741
8.2.4	Data handling.....	1743
8.2.5	Calibration.....	1747
8.2.6	Mixer measurement.....	1756
8.2.7	Two-tone group delay measurement (R&S ZNA-K9).....	1758
8.2.8	RFFE/GPIO interface programming.....	1759
8.2.9	Fixture modeling.....	1762
8.2.10	Noise figure measurement of an amplifier.....	1763
9	Error messages and troubleshooting.....	1766
9.1	Errors during firmware operation.....	1766
9.1.1	Asynchronous errors.....	1767
9.1.2	Errors during measurement.....	1767
9.2	Errors during firmware installation/update.....	1768
9.3	Collecting information for technical support.....	1768
9.4	Contacting customer support.....	1770
10	Transporting.....	1771
11	Maintenance, storage and disposal.....	1772
11.1	Replacing fuses (R&S ZNA67EXT only).....	1772
11.2	Recalibration and repair.....	1772
11.3	Cleaning.....	1772
11.4	Storage.....	1773
11.5	Disposal.....	1773
12	Annexes.....	1774

12.1	Administrative tasks.....	1774
12.1.1	Firmware installation.....	1774
12.1.2	Remote operation in a LAN.....	1775
12.2	System recovery.....	1779
12.3	Interfaces and connectors.....	1779
12.3.1	Rear panel connectors.....	1779
12.3.2	LAN interface.....	1781
12.3.3	GPIB interface.....	1782
12.3.4	RFFE - GPIO interface.....	1785
12.4	Showroom mode.....	1787
12.5	ENA emulation commands.....	1788
	Glossary: Frequently used terms.....	1796
	List of commands.....	1802
	Index.....	1835

1 Safety and regulatory information

The product documentation helps you use the product safely and efficiently. Follow the instructions provided here and in the following chapters.

Intended use

The product is intended for the development, production and verification of electronic components and devices in industrial, administrative, and laboratory environments. Use the product only for its designated purpose. Observe the operating conditions and performance limits stated in the data sheet.

Where do I find safety information?

Safety information is part of the product documentation. It warns you of potential dangers and gives instructions on how to prevent personal injury or damage caused by dangerous situations. Safety information is provided as follows:

- In [Chapter 1.1, "Safety instructions"](#), on page 15. The same information is provided in many languages as printed "Safety Instructions". The printed "Safety Instructions" are delivered with the product.
- Throughout the documentation, safety instructions are provided when you need to take care during setup or operation.

1.1 Safety instructions

Products from the Rohde & Schwarz group of companies are manufactured according to the highest technical standards. To use the products safely, follow the instructions provided here and in the product documentation. Keep the product documentation nearby and offer it to other users.

Use the product only for its intended use and within its performance limits. Intended use and limits are described in the product documentation such as the data sheet, manuals and the printed "Safety Instructions". If you are unsure about the appropriate use, contact Rohde & Schwarz customer service.

Using the product requires specialists or specially trained personnel. These users also need sound knowledge of at least one of the languages in which the user interfaces and the product documentation are available.

Never open the casing of the product. Only service personnel authorized by Rohde & Schwarz are allowed to repair the product. If any part of the product is damaged or broken, stop using the product. Contact Rohde & Schwarz customer service at <http://www.customersupport.rohde-schwarz.com>.

Lifting and carrying the product

The product is heavy. Do not move or carry the product by yourself. A single person can only carry a maximum of 18 kg safely depending on age, gender and physical condition. Look up the maximum weight in the data sheet. Use the product handles to

move or carry the product. Do not lift by the accessories mounted on the product. Accessories are not designed to carry the weight of the product.

To move the product safely, you can use lifting or transporting equipment such as lift trucks and forklifts. Follow the instructions provided by the equipment manufacturer.

Choosing the operating site

Only use the product indoors. The product casing is not waterproof. Water that enters can electrically connect the casing with live parts, which can lead to electric shock, serious personal injury or death if you touch the casing. If Rohde & Schwarz provides accessories designed for your product, e.g. a carrying bag, you can use the product outdoors.

Unless otherwise specified, you can operate the product up to an altitude of 2000 m above sea level. The product is suitable for pollution degree 2 environments where nonconductive contamination can occur. For more information on environmental conditions such as ambient temperature and humidity, see the data sheet.

Setting up the product

Always place the product on a stable, flat and level surface with the bottom of the product facing down. If the product is designed for different positions, secure the product so that it cannot fall over.

If the product has foldable feet, always fold the feet completely in or out to ensure stability. The feet can collapse if they are not folded out completely or if the product is moved without lifting it. The foldable feet are designed to carry the weight of the product, but not an extra load.

If stacking is possible, keep in mind that a stack of products can fall over and cause injury.

If you mount products in a rack, ensure that the rack has sufficient load capacity and stability. Observe the specifications of the rack manufacturer. Always install the products from the bottom shelf to the top shelf so that the rack stands securely. Secure the product so that it cannot fall off the rack.

Connecting to power

The product is an overvoltage category II product. Connect the product to a fixed installation used to supply energy-consuming equipment such as household appliances and similar loads. Keep in mind that electrically powered products have risks, such as electric shock, fire, personal injury or even death. Replace parts that are relevant to safety only by original parts, e.g. power cables or fuses.

Take the following measures for your safety:

- Before switching on the product, ensure that the voltage and frequency indicated on the product match the available power source. If the power adapter does not adjust automatically, set the correct value and check the rating of the fuse.
- Only use the power cable delivered with the product. It complies with country-specific safety requirements. Only insert the plug into an outlet with protective conductor terminal.





- Only use intact cables and route them carefully so that they cannot be damaged. Check the power cables regularly to ensure that they are undamaged. Also ensure that nobody can trip over loose cables.
- If you connect the product to an external power supply, use the one delivered with the product or recommended in the product documentation. The external power supply must conform to the country-specific regulations.
- Only connect the product to a power source with a fuse protection of maximum 20 A.
- Ensure that you can disconnect the product from the power source at any time. Pull the power plug to disconnect the product. The power plug must be easily accessible. If the product is integrated into a system that does not meet these requirements, provide an easily accessible circuit breaker at the system level.

Cleaning the product

Use a dry, lint-free cloth to clean the product. When cleaning, keep in mind that the casing is not waterproof. Do not use liquid cleaning agents.

Meaning of safety labels

Safety labels on the product warn against potential hazards.

	<p>Potential hazard</p> <p>Read the product documentation to avoid personal injury or product damage.</p>
	<p>Heavy product</p> <p>Be careful when lifting, moving or carrying the product. Carrying the product requires a sufficient number of persons or transport equipment.</p>
	<p>Electrical hazard</p> <p>Indicates live parts. Risk of electric shock, fire, personal injury or even death.</p>
	<p>Hot surface</p> <p>Do not touch. Risk of skin burns. Risk of fire.</p>
	<p>Protective conductor terminal</p> <p>Connect this terminal to a grounded external conductor or to protective ground. This connection protects you against electric shock if an electric problem occurs.</p>

1.2 Warning messages in the documentation

A warning message points out a risk or danger that you need to be aware of. The signal word indicates the severity of the safety hazard and how likely it will occur if you do not follow the safety precautions.

WARNING

Potentially hazardous situation. Could result in death or serious injury if not avoided.

NOTICE

Potential risks of damage. Could result in damage to the supported product or to other property.

1.3 Korea certification class A



이 기기는 업무용(A급) 전자파 적합기기로서 판매자 또는 사용자는 이 점을 주의하시기 바라며, 가정외의 지역에서 사용하는 것을 목적으로 합니다.

2 Welcome to the R&S ZNA

This manual is intended to provide you with all information that is necessary for setup, manual and remote control of the R&S ZNA.

We also invite you to find out what's new in the current revision of the software and learn how to make best use of our documentation and of the help system.

If you have any questions or comments, please contact your partners at Rohde & Schwarz and give us your feedback.

2.1 What's new in firmware version 2.74

This manual describes version 2.74 of the R&S ZNA firmware.

Compared to the previous version 2.73, firmware version 2.74 provides the following changes:

New functionality

- Firmware support of new 110 GHz VNA systems R&S ZNA67EXT
See [Chapter 3.5, "Getting started with R&S ZNA67EXT"](#), on page 79.

Firmware version

- ▶ To check your R&S ZNA firmware version, select "Help" > "About..." from the main menu.

2.1.1 Firmware version 2.73

Solved issues

- Since version 2.70, the firmware created and maintained log files
C:\ProgramData\Rohde-Schwarz\ZNA\Log\Ch<Ch>InitTimes.log
that grew with every initialization of channel <Ch>.
The creation of these files has been deactivated. You can safely delete them.

2.1.2 Firmware version 2.72

Modified functionality

- Fan test removed from self test

2.1.3 Firmware version 2.71

Modified functionality

- Power correction from pre-measurement: To prevent generators from oscillating, [convergence factors](#) > 1 are no longer allowed

2.1.4 Firmware version 2.70

New functionality

- Power correction from pre-measurement
See [Chapter 4.1.6, "Power correction from pre-measurement"](#), on page 119
- Time domain measurements (R&S ZNA-K2/K20): Time gates can be coupled within the same channel
See ["Time Gate Linking/Single Time Gate Linking"](#) on page 455
- New "Only Active Channel On" function to disable all channels except the active one
See ["Only Active Channel On"](#) on page 655
- Measurement uncertainty analysis (R&S ZNA-K50): Significance level can now be configured
See ["Significance"](#) on page 644

Modified functionality

- 1.0 mm cal kit "Demo Kit 1 mm" renamed to "General alternative kit"
Note: To remove the "Demo Kit 1 mm" (leftover from previous firmware versions), perform a factory preset.
- Spectrum analysis (R&S ZNA-K1): For spectrum channels, "IF Filter (analog)" is fixed to "Wideband", also when created using "Spectrum = Marker".
- Two-tone group delay measurements (R&S ZNA-K9): Mixer delay calibration integrated into standard calibration framework
 - New calibration types "Mixer Delay" and "UOSM Mixer Delay" in calibration GUI
 - New calibration types `MDElay` | `UMDElay` | `PUMDElay` for remote calibration
 - New remote command `[SENSe<Ch>:]CORRection:COLLect:AUTO:MDElay` for delay mixer calibration
 - Calibration-related controls removed from "Meas" > "Two Tone Group Dly" soft-tool tab
- R&S HUMS (R&S ZNA-K980) service updated to version 1.44
- "OSP320-4-8NC" matrix definition aligned with R&S ZNrun V2.62

New remote control features

- Additional commands for cal validation:
 - `CALCulate:CALValidate:AVERage[:STATe]`
 - `CALCulate:CALValidate:RESPonse:IMAGinary:LOWer|UPPer`
 - `CALCulate:CALValidate:RESPonse:REAL:LOWer|UPPer`
 - `CALCulate:CALValidate:RUN:RESult?`

Improvements

- "Simulation Noise" can be toggled from the menu bar
- Eye diagrams (R&S ZNA-K20: "Transfer Rate" can now be configured directly
See ["Symbol Rate/Transfer Rate"](#) on page 810
- Cal validation: The format of the validation diagrams can now be configured

See "[Preferences](#)" on page 612

Solved issues

- Cal kits containing weights could not be exported
- Time domain analysis R&S ZNA-K2:
 - Selecting a different time domain transform ("Type" selection on "Time Domain" tab) did not take effect
 - Changing the permittivity did not change the distance in TDR distance plots
- Distance to fault only worked for live traces
- HP8720 parser emulation: Acquisition of calibration data for calibration type "Trans Norm" was not initialized correctly
- If measurement data is available for a calibration, and the related setup was saved under a different name, then "Repeat Calibration" failed in the resulting recall set
- If measurement data is available for a calibration of channel no. x and this calibration was stored to the cal pool, then "Repeat Calibration" failed if the related cal pool calibration was applied to a channel no. y≠x
- Eye diagrams (R&S ZNA-K20): changing "Advanced Settings" did not take immediate effect
- "Delay" memory traces used the current stimulus axis instead of the stored one
- Internal combiner (R&S ZNAXx-B212/B213) in "Combiner Configuration" dialog: It was possible to select different receiver inputs for lower and upper tone
- A memory trace with "Math" could not be recalled correctly if the original trace was a wave
- *RST always triggered a factory preset before loading a user preset file

2.2 Documentation overview

This section provides an overview of the R&S ZNA user documentation. Unless specified otherwise, you find the documents at:

<https://www.rohde-schwarz.com/manual/ZNA>

2.2.1 Getting started manual

Introduces the R&S ZNA and describes how to set up and start working with the product. Includes basic operations, typical measurement examples, and general information, e.g. safety instructions, etc.

A printed version is delivered with the instrument. A PDF version is available for download on the Internet.

2.2.2 Getting started manual R&S ZNA67EXT

Getting started information on vector network analyzer systems R&S®ZNA67EXT is provided in a separate manual (order no. 1179.6295.02).

A printed version is delivered with each system. A PDF version is available for download on the Internet.

2.2.3 User manual and help

The user manual contains the description of all instrument modes and functions. It also provides an introduction to remote control, a complete description of the remote control commands with programming examples, and information on maintenance, instrument interfaces and error messages. Includes the contents of the getting started manual.

The contents of the user manual are available as help in the R&S ZNA. The help offers quick, context-sensitive access to the complete information for the instrument and its firmware.

The user manual is also available for download or for immediate display on the Internet.

2.2.4 Service manual

Describes the performance test for checking the rated specifications, module replacement and repair, firmware update, troubleshooting and fault elimination, and contains mechanical drawings and spare part lists.

The service manual is available for registered users on the global Rohde & Schwarz information system (GLORIS):

<https://gloris.rohde-schwarz.com>

2.2.5 Instrument security procedures

Deals with security issues when working with the R&S ZNA in secure areas. It is available for download on the internet.

2.2.6 Printed safety instructions

Provides safety information in many languages. The printed document is delivered with the product.

2.2.7 Data sheets and brochures

The data sheet contains the technical specifications of the R&S ZNA. It also lists the firmware applications and their order numbers, and optional accessories.

The brochure provides an overview of the instrument and deals with the specific characteristics.

See <https://www.rohde-schwarz.com/brochure-datasheet/ZNA>

2.2.8 Release notes and open source acknowledgment (OSA)

The release notes list new features, improvements and known issues of the current firmware version, and describe the firmware installation.

The software makes use of several valuable open source software packages. An open-source acknowledgment document provides verbatim license texts of the used open source software.

See <https://www.rohde-schwarz.com/firmware/ZNA>

2.2.9 Application notes, application cards, white papers, etc.

These documents deal with special applications or background information on particular topics.

See <https://www.rohde-schwarz.com/application/ZNA>

3 Getting Started

Note: the following chapters are identical to those in the printed R&S ZNA Getting Started manual.

For additional Getting Started information on the VNA system R&S ZNA67EXT see [Chapter 3.5, "Getting started with R&S ZNA67EXT"](#), on page 79.

• Preparing for use	24
• Instrument tour	34
• Operating the instrument	43
• Performing measurements	71
• Getting started with R&S ZNA67EXT	79

3.1 Preparing for use

Here, you can find basic information about setting up the product for the first time.

3.1.1 Lifting and carrying

The carrying handles are designed to lift or carry the instrument. Do not apply excessive external force to the handles.

See "[Lifting and carrying the product](#)" on page 15.

3.1.2 Unpacking and checking

1. Unpack the R&S ZNA carefully.
2. Retain the original packing material. Use it when transporting or shipping the R&S ZNA later.
3. Using the delivery notes, check the equipment for completeness.
4. Check the equipment for damage.

If the delivery is incomplete or equipment is damaged, contact Rohde & Schwarz.

3.1.3 Choosing the operating site

Specific operating conditions ensure proper operation and avoid damage to the product and connected devices. For information on environmental conditions such as ambient temperature and humidity, see the data sheet.

See also "[Choosing the operating site](#)" on page 16.

Electromagnetic compatibility classes

The electromagnetic compatibility (EMC) class indicates where you can operate the product. The EMC class of the product is given in the data sheet.

- Class B equipment is suitable for use in:
 - Residential environments
 - Environments that are directly connected to a low-voltage supply network that supplies residential buildings
- Class A equipment is intended for use in industrial environments. It can cause radio disturbances in residential environments due to possible conducted and radiated disturbances. It is therefore not suitable for class B environments. If class A equipment causes radio disturbances, take appropriate measures to eliminate them.

3.1.4 Setting up the product

See also:

- ["Setting up the product"](#) on page 16
- ["Intended use"](#) on page 15

3.1.4.1 Placing the product on a bench top

To place the product on a bench top

1. Place the product on a stable, flat and level surface. Ensure that the surface can support the weight of the product. For information on the weight, see the data sheet.
2. **WARNING!** A stack of products can fall over and cause injury. Never stack more than two products. Otherwise, mount them in a rack.

Stack as follows:

- All products must have the same dimensions (width and length).
- Do not exceed a total load of 50 kg placed on the product at the bottom of the stack.

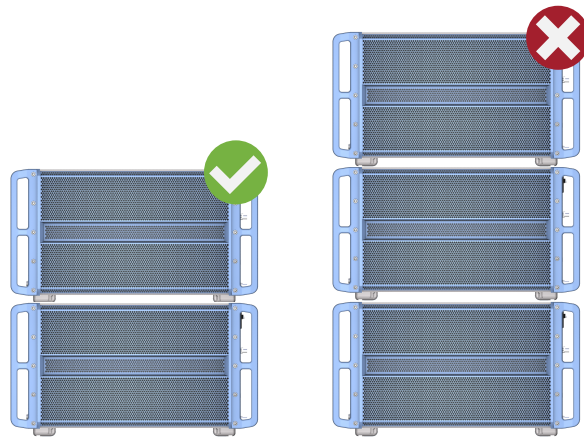

Left = Stacked correctly
Right = Stacked incorrectly, too many products

3. **NOTICE!** Overheating can damage the product.

Prevent overheating as follows:

- Keep a minimum distance of 10 cm between the fan openings of the product and any object in the vicinity.
- Do not place the product next to heat-generating equipment such as radiators or other products.

3.1.4.2 Mounting the product in a rack

To prepare the rack

1. Observe the requirements and instructions in "[Setting up the product](#)" on page 16.
2. **NOTICE!** Insufficient airflow can cause overheating and damage the product.
Design and implement an efficient ventilation concept for the rack.

To mount the R&S ZNA in a rack

1. Use an adapter kit to prepare the R&S ZNA for rack mounting.
 - a) Order the rack adapter kit R&S ZZA-KN6 (order number 1332.4498.02).
 - b) Mount the adapter kit. Follow the assembly instructions provided with the adapter kit.
2. Lift the R&S ZNA to shelf height.
3. Grab the handles and push the R&S ZNA onto the shelf until the rack brackets fit closely to the rack.
4. Tighten all screws in the rack brackets with a tightening torque of 1.2 Nm to secure the R&S ZNA in the rack.

To unmount the R&S ZNA from a rack

1. Loosen the screws at the rack brackets.
2. Remove the R&S ZNA from the rack.
3. If placing the R&S ZNA on a bench top again, unmount the adapter kit from the R&S ZNA. Follow the instructions provided with the adapter kit.

3.1.5 Considerations for test setup**Cable selection and electromagnetic interference (EMI)**

Electromagnetic interference (EMI) can affect the measurement results.

To suppress electromagnetic radiation during operation:

- Use high-quality shielded cables, for example, double-shielded RF and LAN cables.
- Always terminate open cable ends.
- Ensure that connected external devices comply with EMC regulations.

Regarding length and quality, the following requirements have to be met for cable that are directly connected to the R&S ZNA:

Table 3-1: Cable Requirements

Cable Type (Connector)	Requirement
RF cables (PORT 1, ..., PORT N)	Double shielded
BNC cables (various)	Double shielded
DB-25 (User Port)	Double shielded
Digital I/Q (External Handler IO, External Data Logger, Direct Control)	R&S order no. 1402.4990.00 only
GPIB	Standard cable
RFFE/GPIO	R&S ZN-Z25 (order no. 1334.3424.02) only
DisplayPort (Monitor)	Standard cable
DVI-D (Monitor)	2 ferrite cores
LAN	At least CAT6, S/FTP
PCIe	Standard cable
USB	Standard cables, length ≤ 3m

Signal input and output levels

Information on signal levels is provided in the data sheet. Keep the signal levels within the specified ranges to avoid damage to the product and connected devices.

Preventing electrostatic discharge (ESD)

Electrostatic discharge is most likely to occur when you connect or disconnect a DUT.

- ▶ **NOTICE!** Electrostatic discharge can damage the electronic components of the product and the device under test (DUT).

Ground yourself to prevent electrostatic discharge damage:

- a) Use a wrist strap and cord to connect yourself to ground.
- b) Use a conductive floor mat and heel strap combination.

During operation, if the firmware observes a serious unexpected disturbance (e.g. due to ESD), it resets all hardware components to ensure proper instrument functioning. It then restores the user settings to the state before the disturbance and indicates the foregone hardware reset by an "Hardware communication problem [...]" information popup.

3.1.6 Connecting the analyzer to the AC supply

For safety information, see "[Connecting to power](#)" on page 16.

The network analyzer is automatically adapted to the AC supply voltage, which must be in the range of 100 V to 240 V at 50 Hz to 60 Hz. A line frequency of 400 Hz is also supported.

The AC power connector is located in the upper part of the rear panel (see [Chapter 3.2.2, "Rear panel"](#), on page 41).

1. Plug the AC power cable into the AC power connector on the rear panel of the product. Only use the AC power cable delivered with the product.
2. Plug the AC power cable into a power outlet with ground contact.
The required ratings are listed next to the AC power connector and in the data sheet.
3. If necessary, also ground the product using the grounding terminal \perp .

The maximum power consumption and the typical power consumption of the individual analyzer models are listed in the data sheet.

3.1.7 Switching the instrument on and off

To switch on the R&S ZNA

1. Switch the AC power switch to position I (On).
The AC power switch is located in the upper part of the rear panel, above the mains connector; see [Chapter 3.2.2, "Rear panel"](#), on page 41.

After power-on, the analyzer automatically goes to standby or ready state, depending on the state of the standby toggle key at the front panel when the instrument was switched off last time.

2. If necessary, press the standby toggle key on the front panel to switch the instrument to ready state.

See [Chapter 3.1.8, "Standby and ready state"](#), on page 29

The instrument automatically performs a system check, boots the Windows® operating system and then starts the vector network analyzer (VNA) application. If it was terminated regularly, the VNA application restores all recall sets and instrument settings of the previous analyzer session.

To shut down the instrument

1. Press the standby toggle key.

Pressing the standby toggle key causes the instrument to save all loaded recall sets, to close the VNA application, to shut down Windows®, and to go to standby state (see [Chapter 3.1.8, "Standby and ready state"](#), on page 29).

Of course, you can also perform these steps manually, like in any Windows session.

2. If desired, set the AC power switch to position **O** (Off).

To disconnect from power

The R&S ZNA is in standby state.

1. **NOTICE!** Risk of data loss. If you disconnect the product from power when it is in the ready state, you can lose settings and data. Shut it down first.

Set the switch on the power supply to position [0].

The LED of the standby toggle key key is switched off.

2. Disconnect the R&S ZNA from the power source.



To guarantee the specified functionality, after turning off the R&S ZNA, you have to wait for at least 10 seconds before turning it on again. This rule applies to both the AC power off and the standby state.

3.1.8 Standby and ready state



The standby toggle key is located in the bottom-left corner of the front panel.

In standby state, the LED on the standby toggle key is orange, in ready state it is green. The standby power only supplies the power switch circuits and the optional high precision quartz (R&S ZNA-B4, "Precision Oven Quartz Frequency Reference"). In this state, it is safe to switch the AC power off and disconnect the instrument from the power supply. In ready state, all modules are power-supplied. When switched to ready state, the analyzer initiates its startup procedure.

Observe the instructions for startup and shutdown in [Chapter 3.1.7, "Switching the instrument on and off"](#), on page 28.

3.1.9 Windows operating system

The analyzer is equipped with a Windows® operating system which has been configured according to the instrument's features and needs. Changes in the system configuration can be necessary to:

- Establish a LAN connection
- Customize the properties of the external accessories connected to the analyzer
- Call up additional software tools

NOTICE

Modifications of the operating system

The operating system is adapted to the network analyzer. To avoid impairment of instrument functions, only change the settings described in this manual. Existing software must be modified only with update software released by Rohde & Schwarz. Likewise, only programs authorized by Rohde & Schwarz for use on the instrument must be executed.

All necessary settings can be accessed from the Windows "Start" menu, in particular from the "Control Panel". To open the "Start" menu, press the Windows key in the toolbar or on an external keyboard.



User accounts and password protection

The analyzer uses a user name and password as credentials for remote access. Two user accounts with different levels of access are available on the instrument:

- "instrument" is the default account with standard rights to change system settings. Use this account for normal operation of the analyzer.
- "Admin" is the account for administering the operating system. This account is required, for instance, if you wish to install programs on the analyzer.

In the factory configuration, "894129" is preset as a password for both users. To protect the analyzer from unauthorized access, it is recommended to change the preset passwords.

To switch from one user account to another, log off from Windows and then log on again. The "switch user" functionality is disabled on the R&S ZNA.

Service packs and updates

Microsoft regularly creates security updates and other patches to protect Windows-based operating systems. They are released through the Microsoft Update website and associated update server. Update instruments using Windows regularly, especially instruments that connect to a network.

Firewall settings

A firewall protects an instrument by preventing unauthorized users from gaining access to it through a network. Rohde & Schwarz highly recommends using the firewall on your instrument. Rohde & Schwarz instruments are shipped with the Windows firewall enabled. All ports and connections for remote control are enabled.

Note that changing firewall settings requires administrator rights.

Virus protection

Take appropriate steps to protect your instruments from infection. Use strong firewall settings and scan any removable storage device used with a Rohde & Schwarz instrument regularly. It is also recommended that you install anti-virus software on the instrument. Rohde & Schwarz does NOT recommend running anti-virus software in the background ("on-access" mode) on Windows-based instruments, due to potentially degrading instrument performance. However, Rohde & Schwarz does recommend running it during non-critical hours.

For details and recommendations, see the following Rohde & Schwarz white paper:

- [1EF96: Malware Protection Windows 10](#)

3.1.10 Minimizing the VNA application

With a minimized VNA application, you can access your analyzer's Windows® desktop or run other applications.

To exit the default full-screen mode of the VNA application, deselect System – [Display] > "View Bar" > "Title Bar Task Bar". Then use the standard Windows® titlebar functions to minimize/maximize/close the application window.

To start the VNA application with a minimized window

1. Right-click the Vector Network Analyzer shortcut icon on the desktop and open the "Properties" dialog.
2. In the "Shortcut" tab, select "Run: Minimized".

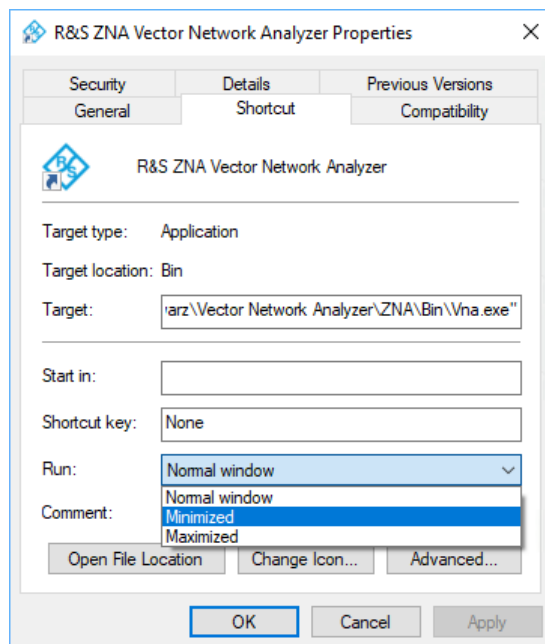

A software update restores the original shortcut properties.

3.1.11 Connecting external accessories

The analyzer's standard PC interfaces (Monitor, USB, LAN) can be used to connect various accessories:

- An external monitor displays the Windows® desktop plus the vector network analyzer (VNA) application windows.
- External keyboard and mouse simplify local control, in particular manual (GUI) operation of the VNA application.
- A printer can be used to create hard copies of the measurement diagrams and traces from within the VNA application.
- A LAN connection can be established to access the analyzer's mass storage or control the analyzer from an external PC.
- The R&S ZNA can also be remote controlled via USB.



External monitor, keyboard and mouse are not required for local operation. The R&S ZNA can be fully controlled by tapping the touchscreen.

3.1.11.1 Connecting a monitor



A standard monitor can be connected to the DVI-D connector of the R&S ZNA. No extra configuration is required.



The R&S ZNA also offers a DisplayPort.

3.1.11.2 Connecting a keyboard

A keyboard can be connected to any of the USB connectors. After being auto-detected by the operating system, it can safely be disconnected and reconnected even during measurements.

Keyboard configuration

The default input language is English – US. Select "Settings" > "Time & language" > "Region & language" from the Windows® Start menu to manage languages and keyboards.



To access Windows®, use the  button in the **toolbar** of the application window.

3.1.11.3 Connecting a mouse

A USB mouse can be connected to any of the USB connectors. After being auto-detected by the operating system, it can safely be disconnected and reconnected even during measurements.

Mouse configuration

Select "Settings" > "Devices" > "Mouse & touchpad" from the Windows® "Start" menu to configure the mouse properties.



To access Windows®, use the  button in the **toolbar** of the application window.

3.1.11.4 Connecting a printer

A printer can be connected to any of the USB connectors. After successful installation, it can safely be disconnected and reconnected even during measurements.

Before printing (System – [File Print] > "Print"), the analyzer checks whether a printer is connected and turned on and whether the appropriate printer driver is installed.

Printer driver installation

If necessary, the printer driver installation is initiated using the operating system's "Add Printer Wizard". The wizard is self-explanatory. A printer driver must be installed only once.

A great variety of printer drivers is available on the analyzer. To obtain the complete list, select "Settings" > "Devices" > "Printers & scanners" from the Windows® "Start" menu.



To access Windows®, use the  button in the **toolbar** of the application window.

You can load updated and improved driver versions or new drivers from an installation disk, USB memory stick or another external storage medium. Alternatively, if the analyzer is integrated in a network, you can install driver data stored in a network directory. In either case, use the "Add Printer" wizard to complete the installation.

Printer configuration

Use the "Printer Setup" dialog of the firmware (System – [File Print] > "Print" > "Print...") or the Windows® printer management to configure the printer properties and printing preferences.

3.1.11.5 Connecting a LAN cable

A LAN cable can be connected to the LAN connector on the rear panel of the analyzer. To establish a LAN connection, proceed as follows:

1. Refer to [Chapter 12.1.2.1, "Assigning an IP address"](#), on page 1775.
2. Connect a CAT6 or CAT7 LAN cable to the LAN port.

The LAN port of the analyzer is an auto-crossover Ethernet port. You can connect it to a network, but you can also set up a direct connection to a computer or another instrument. For both connection types, you can use either crossover or straight through (patch) cables.

The IP address information is displayed in the System – [Setup] > "Remote Settings" softtool tab.

3.1.11.6 Connecting a USB cable for remote control

The R&S ZNA can also be remote controlled via USB. To prepare for remote control operation, connect a suitable USB cable to the type B "USB Device" port on the rear panel of the instrument. With direct connection to a master device, a connecting cable A-B (plug type A onto plug type B) must be used.

For more information, refer to [Chapter 6.1, "Introduction to remote control"](#), on page 931.

3.2 Instrument tour

This chapter gives an overview of the control elements and connectors of the R&S ZNA and gives all information that is necessary to put the instrument into operation and connect external devices.

The meanings of the labels on the product are described in "[Meaning of safety labels](#)" on page 17.

3.2.1 Front panel

The front panel of a R&S ZNA consists of a large-scale capacitive touchscreen and the test port area below it.

Brief explanations on the controls and connectors can be found on the next pages.



3.2.1.1 Touchscreen

The touchscreen is split into two parts: the application window with diagrams and soft-tools on the left, and the control window with its (virtual) function keys and data entry controls on the right. User interaction is touch-only, i.e. all hardkeys commonly used in Rohde & Schwarz VNAs have been implemented in software.

Refer to the data sheet for the technical specifications of the touchscreen.

Application Window

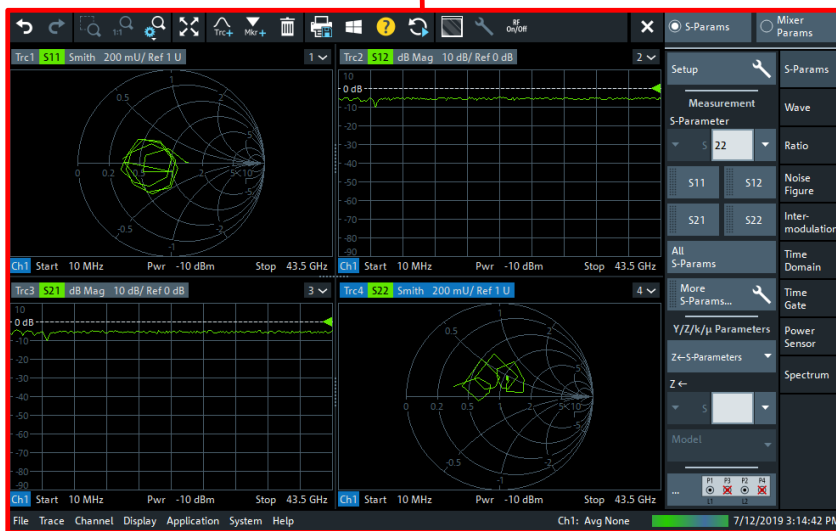

Control Window



Screen saver

The screen saver function of the operating system can be used to switch off the display if the analyzer receives no command for a selectable period of time. The display is switched on again when the touchscreen is touched.

Application window

The left part of the touchscreen is reserved for the application window.

The application window presents the measurement results, mostly in form of diagrams. The toolbar, softtools and menu bar give access to all instrument functions. For an introduction to touchscreen operation, refer to [Chapter 3.3.1, "Manual operation"](#), on page 43.

The following sections contain further useful information about manual control of the instrument.

- Refer to [Chapter 3.3, "Operating the instrument"](#), on page 43 to learn how to handle traces and diagrams, and how to use menus, keys and softtools.
- Refer to [Chapter 4.2.1, "Display elements of a diagram"](#), on page 124 to obtain information about the results in the diagram.
- Refer to [Chapter 5.18, "Display softtool"](#), on page 838 to learn how to customize the application window.

Control window: function keys

Most of the (virtual) keys in the upper part of the control window call up a related softtool of the analyzer GUI. Every softtool, in turn, provides access to a group of related settings and actions (see [Chapter 3.3.2.3, "Softtools"](#), on page 51).

Trace		
Meas	Format	Scale
Trace Config	Line	Marker

The Trace keys give access to all trace settings, to the limit check settings, and to the marker functions including marker search.

- [Meas]: select the measured and displayed quantity.
- [Format]: define how measured data (traces) are presented.
- [Scale]: define how traces are scaled.
- [Trace Config]: store traces to memory and perform mathematical operations on traces.
- [Line]: define limits for measurement results, visualize them in the diagrams and activate/deactivate the limit check.
- [Marker]: position markers on a trace, configure their properties and select the format of the numerical readout. Markers can also be used to locate specific points on the trace, define the sweep range, and scale the diagram.

Channel		
Pwr Bw Avg	Sweep	Cal
Channel Config	Mode	Offset Embed

The Channel keys give access to channel-related settings.

- [Pwr Bw Avg]: define the power of the internal signal source, the IF bandwidth, and the sweep average.
- [Sweep]: define the scope of measurement, including the sweep type and the number of measured sweeps.
- [Cal]: functions that are necessary to perform and manage calibrations.
- [Channel Config]: functions for channel management.
- [Mode]: set up channels for particular (non-standard) measurements.
- [Offset Embed]: functions for embedding and deembedding a DUT.

Stimulus	
Start	Stop
Center	Span

The Stimulus keys define the sweep range, depending on the sweep type.

- [Start]
- [Stop]
- [Center]
- [Span]

System		
File Print	DUT	Applic
Display	Setup	Preset

The System keys give access to (or provide) general system functions.

- [File Print]
 - Create, save or load recall sets.
 - Save or load trace data.
 - Send the contents of the active diagrams to a file, to the clipboard, or to an external printer (incl. content definition and printer setup).
- [DUT]: starting point for DUT-centric measurement setup.
 - Define DUTs to be measured (type, properties)
 - Choose the measurements to be performed on a selected DUT.

The analyzer firmware then helps you to set up the channels accordingly.

- [Applic]: external software tools and optional extensions of the analyzer firmware.
- [Display]: display settings and functions that activate, modify and arrange different diagrams.
- [Setup]: general system settings that are not restricted to a particular recall set.

- [Preset]: restores preset values.

Control window: data entry panel

The controls in the data entry panel are used to enter numbers, units, and characters. The appearance of the panel depends on the data type of the setting selected in the [Application window](#).



Figure 3-1: Data Entry panel

left = numeric value
right = string value

While most of the keys have their standard keyboard functionality, some keys and controls provide additional functionality:

- The [abc] and [123] keys switch between the numeric and the string keyboard.
- The wheel control at the right of the numerical data input panel increases and decreases numerical values, and scrolls within lists.
[Step Size] opens an input box to select the steps (in units of the current physical parameter) between two consecutive numerical values. The step size is also valid for value changes using the up and down keys. See also [Chapter 3.3.6.2, "Using the numeric editor"](#), on page 63.

3.2.1.2 Status LEDs



Multi-color LEDs, indicating various HW and FW states:

- **Ext. Ref.**
Indicates whether an external reference clock is used.
 - Off: the internal reference clock is used
 - Green: the R&S ZNA is synchronized to an external reference clock

- Yellow, flashing: the R&S ZNA is configured for external synchronization, but cannot lock on the external reference clock.
- **Cal.**
Indicates the calibration state of the active setup.
 - Off: none of the traces (in the active setup) has a valid calibration
 - Yellow: some of the traces have a valid calibration
 - Green: all the traces have a valid calibration
- **RF Interlock**
RF interlock mode is activated by “RF Off Control” BNC connector on the rear panel of the R&S ZNA (see [Chapter 3.2.2, "Rear panel"](#), on page 41. In this mode, RF sources are forced off.
 - If the connector is terminated (electrical short), the RF interlock mode is inactive and the LED is off (see picture below)
 - If the connector is open, the RF interlock state is active and the LED is on (red).



Figure 3-2: RF Off Control, terminated with attached Short

- **Remote**
Indicates whether a remote control (RC) connection is established.
 - Off: no RC connection established
 - Green: RC connection established
- **User Defined**
Persistent, user-defined state indicator. Can be set to off, green, green flashing, red, or red flashing

3.2.1.3 Standby key



The standby toggle switch is located in the bottom left corner of the front panel.

The key serves two main purposes:

- Toggle between standby and ready state; see [Chapter 3.1.8, "Standby and ready state"](#), on page 29.
- Shut down the instrument; see [Chapter 3.1.7, "Switching the instrument on and off"](#), on page 28.

3.2.1.4 Front panel connectors

The test ports and three USB connectors are located on the front panel of the R&S ZNA.

Test ports



Numbered connectors:

- 3.5 mm male for R&S ZNA26
- 2.92 mm (K) or 2.4 mm male for R&S ZNA43
- 2.4 mm male for R&S ZNA50
- 1.85 mm male for R&S ZNA67

The test ports serve as outputs for the RF stimulus signal and as inputs for the measured RF signals from the DUT (response signals).

- With a single test port, it is possible to generate a stimulus signal and measure the response signal in reflection. For a measurement example, refer to [Chapter 3.4.2, "Reflection S-parameter measurement"](#), on page 78.
- With more than one test port, it is possible to perform full two-port, 3-port, ... , or n-port measurements; see [Chapter 4.3.1, "S-parameters"](#), on page 149.



- Use a torque wrench when screwing RF cables on the test port connectors.
- See also [Chapter 3.1.5, "Considerations for test setup"](#), on page 27.

Connector usage

Two LEDs above each test port indicate the connector usage:

- Tx on: connector is used as a source port
- Rx on: connector is used as a receive port
- both LEDs on: connector is used as a bidirectional (source and receive) port

Direct generator and receiver access



Hardware option R&S ZNAXx-B16 provides direct access to the Ref, Source and Meas signal path for each test port of a R&S ZNAXx.

The connector type of the 3 connector pairs is 2.92 mm (f) for R&S ZNA26 and R&S ZNA43, and 1.85 mm (f) for R&S ZNA50 and R&S ZNA67.



See [Chapter 4.7.27, "Direct generator/receiver access"](#), on page 306.

USB connectors



The front panel offers three USB connectors of type A (master USB).

The USB ports can be used to connect external devices, e.g.:

- external PC accessories such as mouse or other pointing devices, a keyboard, printer or external storage device (USB stick, CD-ROM drive etc.)

- external measurement equipment such as calibration units, power meters, frequency converters, extension units, signal generators, or switch matrices

3.2.2 Rear panel

This section gives an overview of the rear panel elements of the network analyzer.

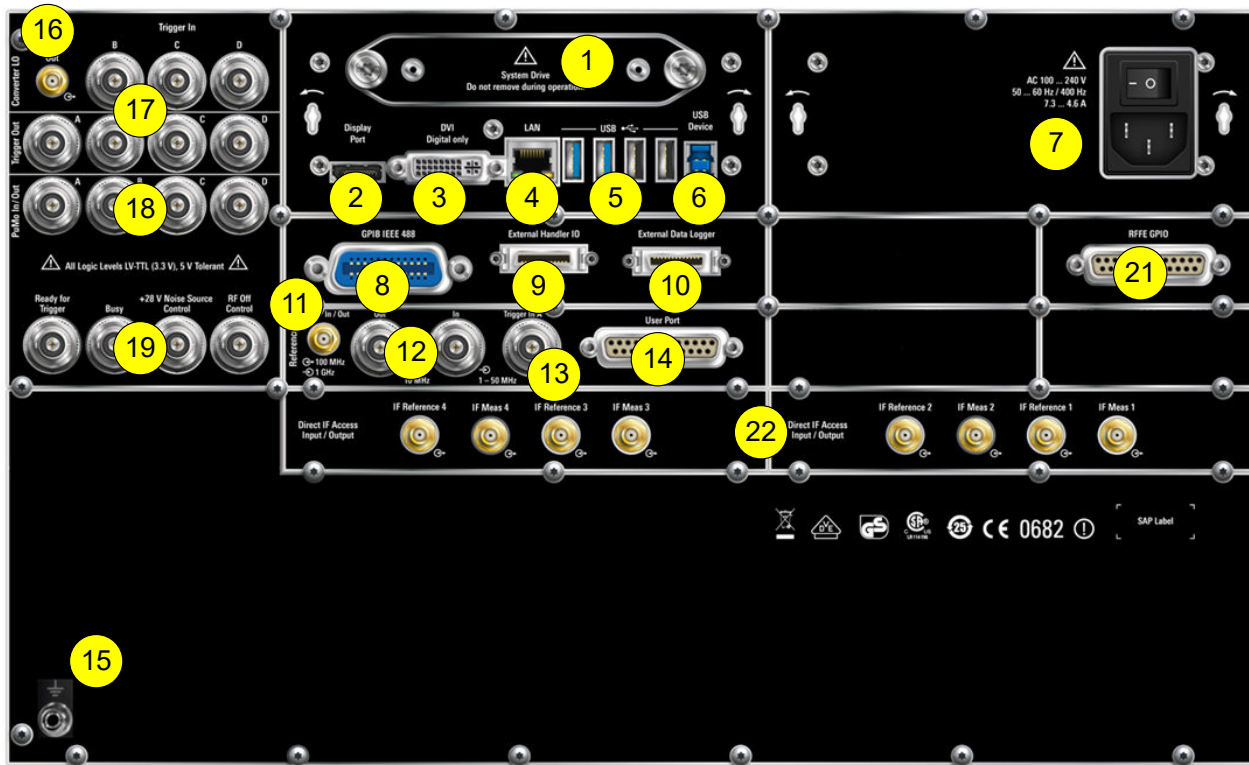

Table 3-2: Rear panel elements available on all instruments

Index	Label	Description
1	System Drive	Removable system drive of the R&S ZNA, containing all software (including the operating system and the VNA application) and data. No other drive is built in. Do not remove the system drive during operation. Option R&S ZNA-B19 provides an additional removable system drive (including operating system and firmware).
2	Display Port	External monitor connector (DisplayPort); see Chapter 3.1.11.1, "Connecting a monitor" , on page 32.
3	DVI Digital only	External monitor connector (DVI-D); see Chapter 3.1.11.1, "Connecting a monitor" , on page 32.
4	LAN	RJ-45 connector to integrate the instrument to a Local Area Network, primarily for remote control purposes; see Chapter 12.1.2.1, "Assigning an IP address" , on page 1775. See also Chapter 12.3.2, "LAN interface" , on page 1781.
5	USB	Type A USB host (master) connectors. Similar functionality as the USB connectors on the front panel (see "USB connectors" on page 40).

Index	Label	Description
6	USB Device	Type B USB device (slave) connector for remote control of the instrument (see Chapter 3.1.11.6, "Connecting a USB cable for remote control" , on page 34).
7	I/O	Power on/off switch, see Chapter 3.1.7, "Switching the instrument on and off" , on page 28
8	GPIB IEEE 488	GPIB bus connector according to standard IEEE 488 / IEC 625. See Chapter 12.3.3, "GPIB interface" , on page 1782.
9	External Handler IO	Used to connect an external Handler I/O (option R&S ZNBT-Z14), providing a Centronics 36 input/output connector. Not yet supported.
10	External Data Logger	Digital interface for data streaming. Requires "Data Streaming Memory" option R&S ZNA-B7 (not yet available).
11	(Reference) In/Out	SMA connector for external reference clock input or output. <ul style="list-style-type: none"> • Input: 100 MHz or 1 GHz • Output: 100 MHz
12	(Reference) In / (Reference) Out	BNC connectors for external reference clock input and output. <ul style="list-style-type: none"> • Input: 50 kHz to 100 MHz • Output: 10 MHz
13	Trigger In A	BNC connector for an incoming external trigger signal (LV-TTL 3.3 V, 5 V tolerant). The optional trigger board R&S ZNA-B91 provides three additional trigger inputs (and four trigger outputs).
14	User Port	25-pin D-Sub connector used as an input and output for other control signals (LV-TTL 3.3 V, 5 V tolerant). See Chapter 12.3.1.1, "User Port" , on page 1779.
15	(Ground connector)	The ground connector provides the ground of the analyzer's supply voltage. Use this connector for ESD protection; see "Preventing electrostatic discharge (ESD)" on page 28.

Table 3-3: Optional rear panel elements

Index	Label	Description
16	Converter LO	Hardware option R&S ZNA-B8 provides a local oscillator output that is particularly useful for driving mmWave converters. See Chapter 4.7.25, "LO Out" , on page 305.
17	Trigger In / Trigger Out	BNC connectors for incoming/outgoing trigger signals (LV-TTL 3.3 V, 5 V tolerant). Trigger inputs B to D and trigger outputs A to D are provided by the optional trigger board R&S ZNA-B91.
18	PuMo In/Out	BNC connectors for incoming/outgoing external pulse modulator control signals (LV-TTL 3.3 V, 5 V tolerant). Requires the optional trigger board R&S ZNA-B91.
19		BNC connectors for other incoming/outgoing control signals (LV-TTL 3.3 V, 5 V tolerant). <ul style="list-style-type: none"> • Ready for Trigger (outgoing) • Busy (outgoing) • +28 V Noise Source Control (outgoing) • RF Off Control (incoming) Requires the optional trigger board R&S ZNA-B91.

Index	Label	Description
21	RFFE GPIO	Option R&S ZNA-B15 provides 2 independent RF Front-End (RFFE) interfaces and 10 General Purpose Input/Output (GPIO) pins on a single connector (25 pins, female). The RFFE interfaces meet the MIPI® Alliance "System Power Management Interface Specification".
22	Direct IF Access Input / Output	Option R&S ZNA-B26 provides direct access to the IF signal paths.

3.3 Operating the instrument

The following sections describe the basics of manual operation, i.e. how to access instrument functions and settings via the analyzer GUI. Manual operation is particularly useful for getting to know the instrument and for trouble shooting.

Manual and remote control of the instrument

Manual control of the R&S ZNA is possible either via its touchscreen (without using a mouse and/or keyboard), via locally connected monitor + mouse + keyboard (see [Chapter 3.1.11, "Connecting external accessories"](#), on page 32), or via Remote Desktop (see also [Chapter 12.1.2, "Remote operation in a LAN"](#), on page 1775). Alternatively it can be remote-controlled via the GPIB interface or a LAN connection.

Manual operation and remote control are described to their full extent in the [GUI reference](#) and [Command reference](#) chapters, respectively. GUI functions and their related remote commands are linked bidirectionally. Background information is provided in the [Concepts and features](#) chapter.

3.3.1 Manual operation

The analyzer functions are accessible via several tabbed softtools, each presenting related functions and settings. The function keys on the control window open the most frequently used softtools (see ["Control window: function keys"](#) on page 36).

Manual operation via function keys and softtools provides touch-friendly access to the instrument functions and settings, avoiding complicated menu structures and long operating sequences. In general, this approach is recommended. However, sometimes the toolbar or an object's context menu can offer a shortcut. As a full-fledged alternative for manual operation via mouse and keyboard, also the menu bar provides access to all instrument functions and settings.

Trace			Stimulus		
Meas	Format	Scale	Start	Stop	
Trace Config	Line	Marker	Center	Span	
Channel			System		
Pwr Bw Avg	Sweep	Cal	File Print	DUT	Applic
Channel Config	Mode	Offset Embed	Display	Setup	Preset

Figure 3-3: Function Keys



Customizing the screen

The contents of the screen and the size and position of many display and control elements are not fixed. You can display or hide most elements. You can also drag and drop traces and info fields.

Using the Touchscreen

To access an instrument function:

1. Press a (virtual) key, e.g. the [Meas] key in the Trace section.
The corresponding softtool expands at the current docking position.

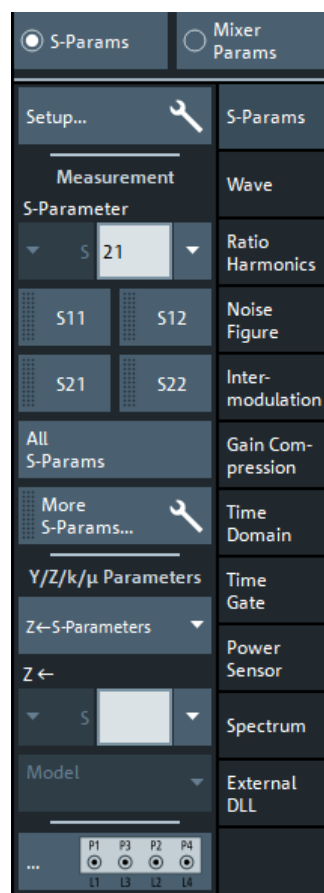

2. Make sure the "S-Params" radio button is selected.
3. Activate the desired softtool tab, e.g. "Wave".



4. Select a control element, e.g. "a1 Src Port 1".

The diagram immediately reflects your selection. The active trace shows the measurement results for the selected measured quantity.

A control element with three dots (e.g. System – [Setup] > "Setup" > "System Config...") opens a dialog, containing a group of related settings, a wizard or additional information.

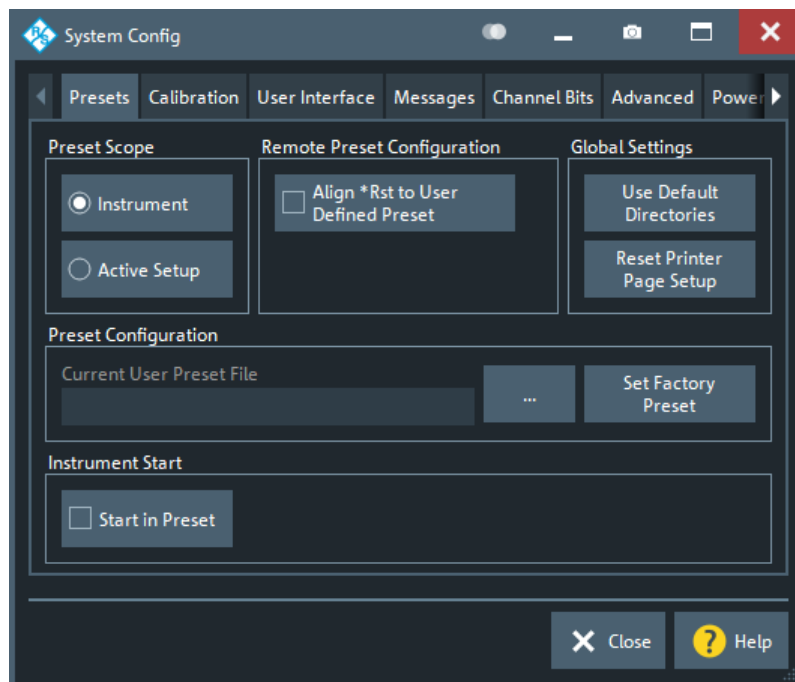

Using the menu bar

The menu bar at the bottom of the application screen provides alternative access to **all** instrument functions. To repeat the measured quantity selection described above,

- ▶ Select Trace – [Meas] > "S-Params" > "Wave" > "a1 Src Port 1".

The diagram immediately reflects your selection. The active trace shows the measurement results for the selected measured quantity. At the same time, the related softtool tab is opened.

Using context menus

Context menus are another alternative for quick access to instrument settings.

1. Touch and hold (right-click) the measured quantity section in the trace info for a couple of seconds until the context menu appears.

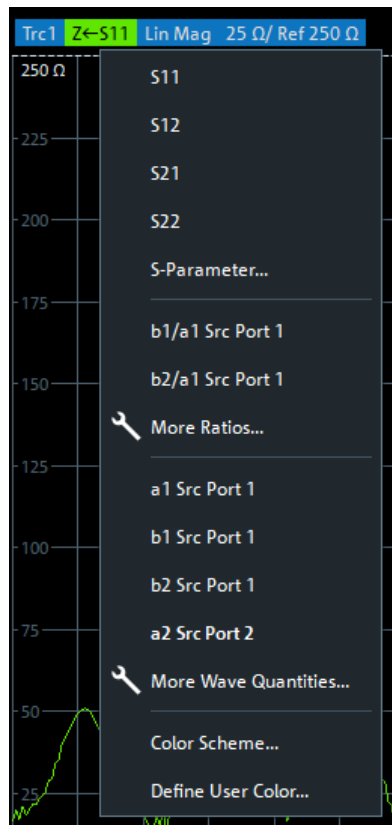

2. Select "a1 Src Port 2".

3.3.2 Control elements of the application window

The application window of the analyzer provides all control elements for the measurements and contains the diagrams for the results. There are several alternative ways for accessing an instrument function:

- Using a function key on the (virtual) hardkey panel to open the related softtool (recommended, provides all settings)
- Using the menus and submenus of the menu bar (alternative to the previous method)
- Using the context menus of certain display objects (for important actions in the context of this object)
- Using the icons in the toolbar above the diagram area (for frequent global actions)



These methods are described in more detail in the following sections.

For further reference:

- Refer to [Chapter 4.2.1, "Display elements of a diagram"](#), on page 124 to obtain information about the results in the diagram.
- Refer to [Chapter 5.18, "Display softtool"](#), on page 838 and learn how to customize the screen.

3.3.2.1 Title bar

By default, the analyzer GUI is shown in full screen mode, covering the whole screen and hiding the Windows taskbar. However, you can toggle the full screen mode using System – [Display] > "View Bar" > "Title and Task Bar On".

If full screen mode is switched off, the main application window of the vector network analyzer application provides a standard Windows® title bar.











3.3.2.2 Toolbar

The toolbar above the diagram area contains the most frequently used control elements of the user interface. All controls are also accessible via [Softtools](#).



The toolbar is divided into several icon groups, separated by vertical lines.

	<p>These icons represent the undo and redo actions that are also available via the menu bar items "System" > "Undo" / "Redo".</p> <p>Undo reverses the last action, redo reverses the last undo action (if possible).</p>
	<p>These icons control the zoom function (Trace – [Scale] > "Zoom").</p>
	<p>If multiple diagrams are configured, this icon toggles the "Maximize Diagram" action for the active diagram (System – [Display] > "Diagram" > "Maximize Diagram").</p>
	<p>These icons implement the following actions, from left to right:</p> <ul style="list-style-type: none"> • Add a clone of the active trace to the active diagram (single tap; same as Trace – [Trace Config] > "Traces" > "Add Trace") or to an arbitrary/new one (drag & drop the "Trc+" icon to the diagram area). • Add a new marker to the active diagram (single tap; similar to Trace – [Marker] > "Markers" > "Mkr<->") or to an arbitrary one (drag & drop the "Mkr+" icon). • Delete the active trace (single tap the trash icon), or an arbitrary trace (drag & drop its trace info field to the trash icon). Or delete all markers of a trace (drag & drop the marker info field to the trash icon).
	<p>These icons provide the following actions, from left to right:</p> <ul style="list-style-type: none"> • Print the current diagrams to a bitmap file (same as System – [File Print] > "Print" > "To File..."). By default, all diagrams are printed, no matter if displayed or not. However you can also choose to print only the active diagram (see System – [File Print] > "Print" > "Print..."). • Open the Windows® Start menu. • Open the context-sensitive help. • Restart the sweep in all channels (same as Channel – [Sweep] > "Sweep Control" > "Restart Sweep")
	<p>These icons provide the following actions, from left to right:</p> <ul style="list-style-type: none"> • Toggle advanced diagram area editing, which makes rearranging and/or deleting diagrams a breeze. • Toggle other measurements (except the active trace) OFF ON • Open the METAS Reconnection dialog This button is only visible if, option R&S ZNA-K50 "Measurement Uncertainty Analysis" is installed. It is only enabled, if a METAS calibration is active. • Open the channel setup dialog
	<p>These icons provide the following actions, from left to right:</p> <ul style="list-style-type: none"> • Open the ALC Config dialog This button is only visible while ALC (automatic level control) is enabled • Open the Source Coherence dialog This button is only visible while source coherence is enabled, which requires option R&S ZNA-K6. See Chapter 4.7.4, "Phase coherent source control", on page 275.
	<p>Switch off on all sources. This button is pinned to the right edge of the toolbar and is always visible</p>



You can hide the toolbar using System – [Display] > "View Bar".

3.3.2.3 Softtools

Softtools display groups of related settings as a tabbed panel. They can be opened via function keys, or via menu bar and context menu items.

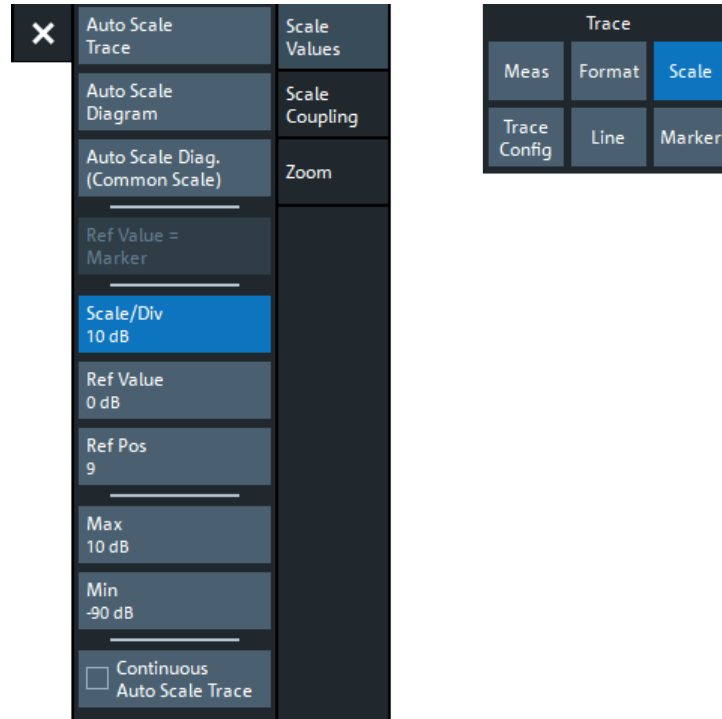

Figure 3-4: Scale softtool

A softtool is a tabbed panel with a close icon. When the softtool is closed, the close icon is replaced by a "hamburger" icon. The latter allows you to reopen the softtool.

Some controls on the softtool tabs allow you to read and modify settings (e.g. "Ref Value" in the screenshot above), some perform actions (e.g. "Auto Scale Trace"), while others open additional dialogs (button label ends with "...").

3.3.2.4 Menu bar

You can also access the analyzer functions via textual menus. The menu bar is located below the diagram area:

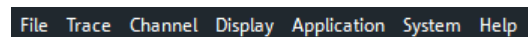

As in any Windows® application, menus can be controlled with the touchscreen or a mouse. A short tap (left mouse click) expands a menu or submenu. If a menu command has no submenu assigned, a short tap (left mouse click) opens a dialog or

directly activates the menu command. When a (sub)menu is selected, the R&S ZNA displays the corresponding softtool.

Overview of menu functions

- The "File" menu provides functions to handle recall sets and trace files, to print or save diagram content, and to shut down the VNA application.
- The "Trace" menu provides all trace settings, the limit check settings, and the marker functions including marker search.
- The "Channel" menu provides all channel settings and activates, modifies or stores different channels.
- The "Display" menu provides all display settings and the functions for activating, modifying and arranging different diagrams.
- The "Application" menu gives access to applications and tools that extend the functionality of the analyzer firmware.
- The "System" menu provides functions that can be used to return to a defined instrument state, reverse operations, access service functions and define various system-related settings.
- The "Help" menu provides assistance with the network analyzer and its operation.



You can toggle the visibility of the menu bar using System – [Display] > "View Bar" > "Menu Bar".

3.3.2.5 Menu structure

All menus show an analogous structure.

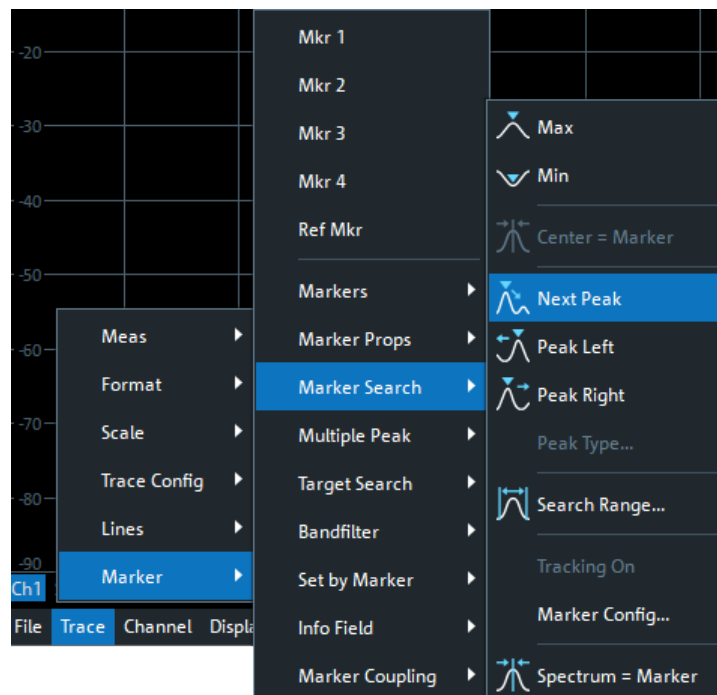

- A menu command with a right arrow expands a submenu with further related settings.
Example: "Marker" expands a submenu with marker-related properties.
- A menu command with three dots appended calls up a dialog providing several related settings.
Example: "Search Range" opens a dialog to define the search range for the marker search.
- A menu command with no arrow or dots initiates an immediate action.
Example: "Max" sets the active marker to the maximum of the active trace.

3.3.2.6 Hardkey panel

The (virtual) "Hard Key" panel displays the control window's function keys inside the main application window. For a short description of the function keys, refer to section ["Control window: function keys"](#) on page 36.

Trace	
Meas	Format
Scale	Trace Config
Line	Marker
Channel	
Channel Config	Sweep
Power Bw Avg	Mode
Cal	Offset Embed
System	
File Print	DUT
Display	Setup
Applic	Preset
Stimulus	
Start	Stop
Center	Span



The "Hard Key" panel is particularly useful if the analyzer is controlled from an external monitor or Remote Desktop.

For the R&S ZNA, it is hidden by default. In "Single Window Mode", it is visible (see [Chapter 3.3.6.1, "Dual-window mode vs. single-window mode"](#), on page 62).

You can display the "Hard Key" panel using one of the following methods:

- Select System – [Display] > "View Bar" > "Hard Key Panel".
- Select "Display"> "View Bar" > "Hard Key Panel On" from the menu bar.
- Select "Hard Key" from the context menu of the softtool panel.

3.3.2.7 Status bar

The status bar shows

- the active channel
- the current channel's sweep averaging counter (e.g. "Ch<i>: Avg 9/10"), or "Ch<i>: Avg None" if averaging is disabled
- the progress of the sweep
The progress bar also shows when the R&S ZNA prepares a sweep with new channel settings
(See [Chapter 4.1.4, "Sweep control"](#), on page 110)
- the "EXT REF" symbol, if an external reference clock is used for synchronization
(see ["Ext Frequency"](#) on page 887)
- a frequency converter symbol, if frequency converters are configured
(see [Chapter 5.19.6, "Frequency Converter tab"](#), on page 901)
- a symbol for redefined S-parameters, if the physical ports have been redefined
(see [Chapter 5.19.8.2, "Define Physical Ports dialog"](#), on page 919)
- the switch matrix status symbol, if a switch matrix is configured
(See [Chapter 4.7.41, "External switch matrices"](#), on page 323)
- the current date and time



Figure 3-5: R&S ZNA with frequency converters



Figure 3-6: R&S ZNA with switch matrix



The progress bar shows a moving color gradient if the current sweep is too fast to be monitored, e.g. because the number of sweep points is low. You can hide/show the status bar using System – [Display] > "View Bar" > "Status Bar".

3.3.3 Touchscreen gestures

A touchscreen allows you to interact with the software using various finger gestures on the screen. The basic gestures supported by the software and most applications are described here. Further actions using the same gestures may be possible.



Tapping

Touch the screen quickly, usually on a specific element.

You can tap most elements on the screen; in particular, any elements you can also click on with a mouse pointer.

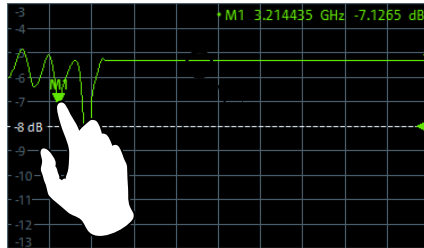
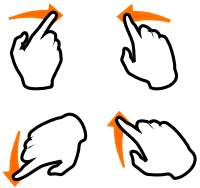

Figure 3-7: Tapping

Double-tapping

Tap the screen twice, in quick succession.

Double-tap a diagram to maximize it or to restore its original size.



Dragging

Move your finger from one position to another on the display, keeping your finger on the display the whole time.

By dragging your finger over a table or diagram you can pan the displayed area of the table or diagram to show results that were previously out of view.

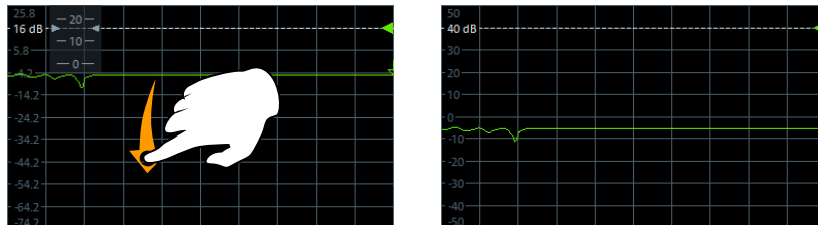
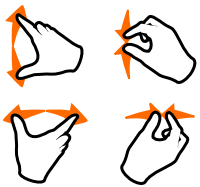

Figure 3-8: Dragging



Spreading and pinching two fingers

Move two fingers apart on the display (spread) or move two fingers together on the display (pinch).

These gestures take effect for diagrams only. The effect depends on the current zoom mode (see [Chapter 3.3.7, "Scaling diagrams"](#), on page 66).

- In graphical zoom mode, when you spread two fingers in the display, you graphically zoom in vertically.

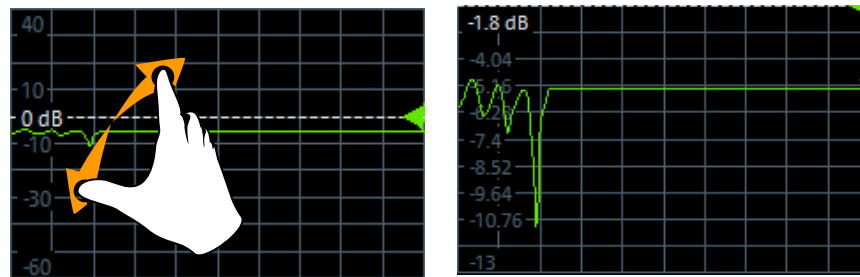

When you pinch two fingers in the display, you graphically zoom out vertically.

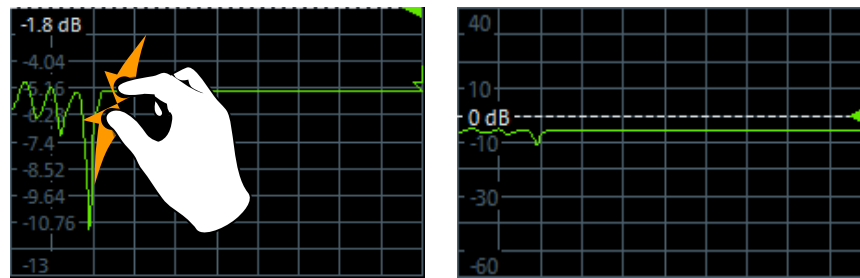

Figure 3-9: Pinching

While "Zoom Select" is active (toolbar icon or softtool button is toggled on), spreading and pinching is disabled. You can only select a rectangular area (using one finger) then.

- In stimulus zoom mode, spreading and pinching is disabled by default. Only while "Stim. Zoom Select" is active (toolbar icon or softtool button is toggled on), you can use spreading and pinching to modify the sweep area and/or the vertical scaling.

Mouse vs. touch actions

Any user interface elements that react to actions by a mouse pointer also react to finger gestures on the screen, and vice versa. The following touch actions correspond to mouse actions:

Table 3-4: Correlation of mouse and touch actions

Mouse operation	Touch operation
Click	Tap
Double-click	Double-tap
Click and hold	Touch and hold
Right-click	Touch, hold for 1 second and release
Drag&drop (= click and hold, then drag and release)	Touch, then drag and release
n.a. (Change hardware settings)	Spread and pinch two fingers
Mouse wheel to scroll up or down	Swipe
Dragging scrollbars to scroll up or down, left or right	Swipe
In (graphical) zoom mode only: dragging the borders of the displayed rectangle to change its size	Touch, then drag and release

Example:

You can scroll through a long table in conventional mouse operation by clicking in the table's scrollbar repeatedly. In touchscreen operation, you would scroll through the table by dragging the table up and down with your finger.

3.3.4 Working with dialogs

Dialogs provide groups of related settings and allow to make selections and enter data in an organized way. The settings are visualized, if possible. An example is shown below.

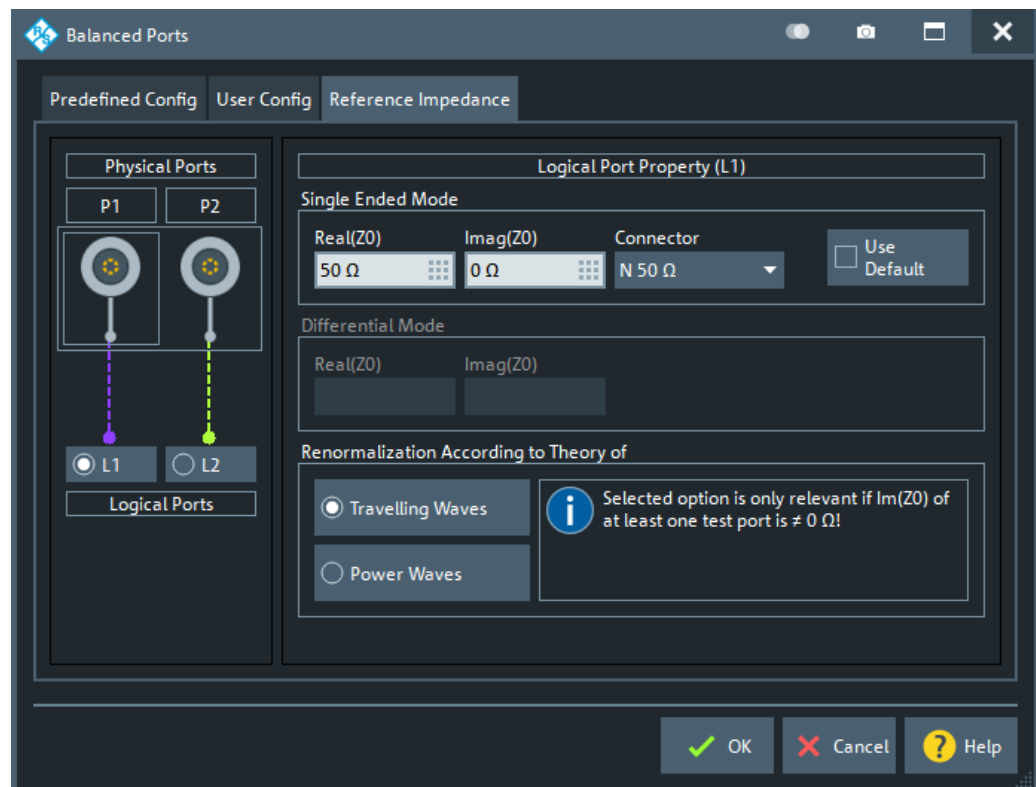

All dialogs are operated in a similar way.

- To open a dialog, select a softtool button with three dots appearing in its label (e.g. "Start... (Manual)").
- The title bar of each dialog contains some convenience functions:
 - Use the "Dialog Transparency" function to make the display elements behind the dialog visible.

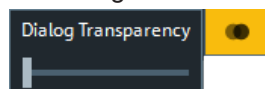

Note: The "Dialog Transparency" is a global setting, i.e. it applies to all dialogs.

- Use the  icon to create a screenshot of the dialog.
- Drag and drop the lower right corner of the dialog to modify its size.

- Some dialogs are subdivided into tabs, containing groups of related settings. Activate a tab to access those settings.

See also [Chapter 4.2.2.1, "Immediate vs. confirmed settings"](#), on page 136.



The Help system provides useful information about each dialog's specific settings. Select "Help" to open the Help.

3.3.5 Handling diagrams, traces, and markers

The analyzer displays measurement results as traces in rectangular diagrams. Markers are used to read specific numerical values and to search for points or regions on a trace. The following section presents some of the graphical tools the R&S ZNA provides for trace and marker handling.



For further reference

Refer to [Chapter 4, "Concepts and features"](#), on page 107 to learn more about traces, channels, and screen elements.

3.3.5.1 Adding new traces and diagrams

A new trace is required if you want to measure and display an additional quantity.

Typical scenario: The transmission coefficient S_{21} is measured as described in [Chapter 3.4.1, "Transmission S-parameter measurement"](#), on page 71. A trace is added to display the reflection coefficient S_{11} for comparison.



To create a trace:

1. Drag the "Trc+" icon from the toolbar into a diagram.

The diagram changes its color scheme and contents as shown below.

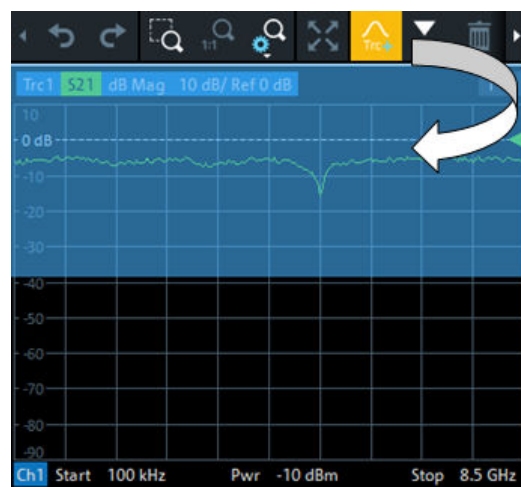

2. Select the adequate drop position, depending on whether you want to display the new trace in the existing diagram, or whether you want to add a new diagram. The highlighted area indicates the target diagram.

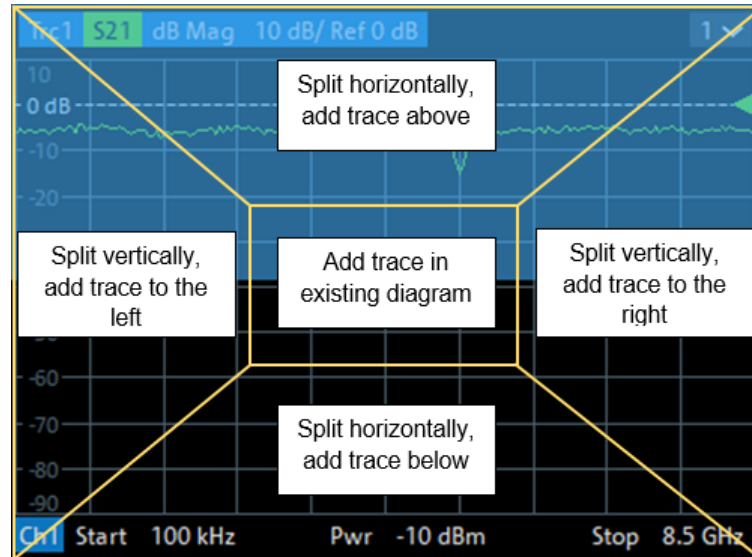

3. In the dialog box that is opened when you release the "New Trace" icon, select the S-parameter to be measured.
For a four-port analyzer:

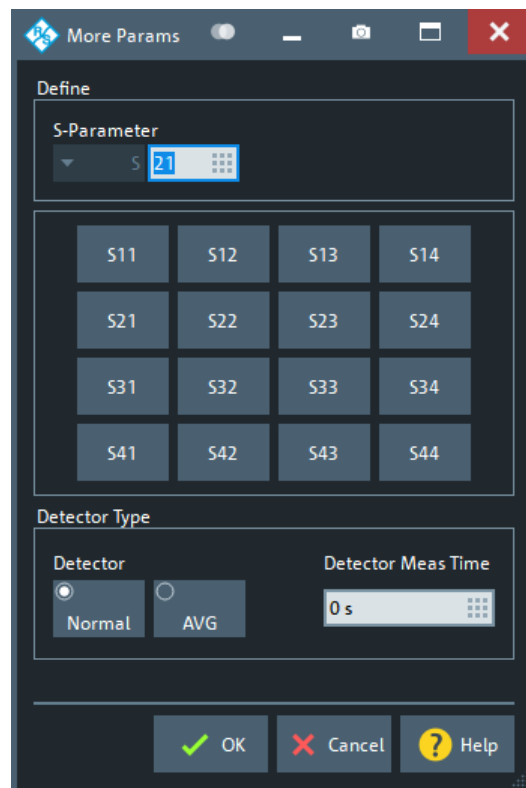

The R&S ZNA generates a new trace for the selected S-parameter.



Alternative control elements

To measure a different quantity, select Trace – [Meas]. Drag and drop a softkey representing a measured quantity to create a trace. Or simply select another softkey to change the measured quantity of the active trace.

Select Trace – [Trace Config] to access more trace handling functions. Select System – [Display] to access more diagram handling functions.

3.3.5.2 Adding new markers

A marker is needed, for instance, to read a particular numerical trace value.



To add a new marker:

- Drag and drop the "New Marker" icon from the toolbar to the desired position in the target diagram.

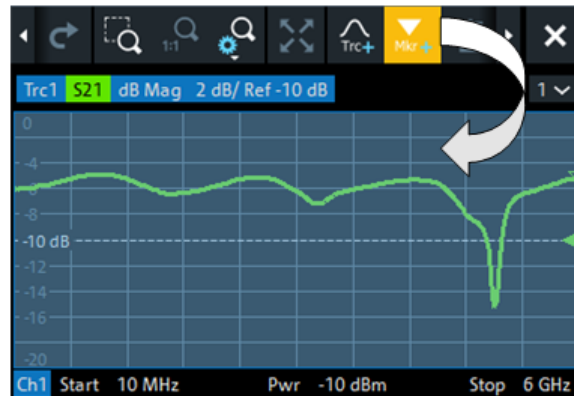

The marker appears on the target diagram's active trace. The marker info field displays the stimulus value (x-axis value) and response value (y-axis value) at the marker position. The response value varies as the analyzer continues performing sweeps.

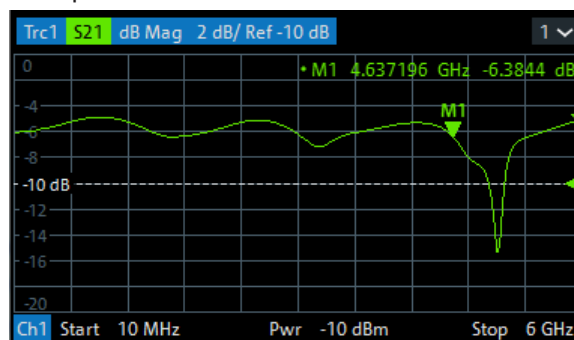



Active trace, alternative control elements

The trace line of the active trace in the upper part of the diagram is highlighted. If the diagram contains several traces, first activate the target trace, then add the marker.

The Trace – [Marker] softtool provides more functions for marker handling. In particular, any marker offered in the "Markers" tab can be positioned on the active trace using drag & drop.

3.3.5.3 Deleting display elements



Markers, traces, diagrams, and other display elements are most conveniently deleted using the "Delete" icon in the toolbar above the diagram area.

- To delete a single marker, drag it into vertical direction to release it from the trace and drop it onto the "Delete" icon.
To delete a set of markers, drag and drop their marker info field onto the "Delete" icon.
Deleting a marker and its info field also disables the associated marker function.
- To delete a trace, drag and drop its trace line onto the "Delete" icon. The active trace can also be deleted by tapping/clicking the "Delete" icon.
Note however, that the last remaining trace cannot be deleted.
- To delete a diagram, drag and drop its diagram number label onto the "Delete" icon.
Note however, that the last remaining diagram cannot be deleted.
- To delete a channel, drag and drop all associated traces onto the "Delete" icon.
Note however, that the last remaining channel cannot be deleted.
- To hide the limit lines and disable the limit check, drag and drop the PASS / FAIL message onto the "Delete" icon. The limit line itself is not deleted; you can re-use it any time.

The context menu of some display elements also provides the "Delete" function.



Undo function

If you happen to delete a display element unintentionally, you can restore it using the "Undo" toolbar icon.

3.3.5.4 Using drag and drop

You can drag and drop many of the R&S ZNA's control and display elements to change their size and position. The drag and drop functionality is often more convenient to use than the equivalent buttons of the softtool panels. The following table gives an overview.

Table 3-5: Drag and drop functionality for various screen elements

Screen element	Action	Drag and drop...
Diagram	Create	See Chapter 3.3.5.1, "Adding new traces and diagrams" , on page 58
	Resize	Separator between adjacent diagrams

Screen element	Action	Drag and drop...
	Delete	See Chapter 3.3.5.3, "Deleting display elements" , on page 61
Trace	Create	See Chapter 3.3.5.1, "Adding new traces and diagrams" , on page 58
	Move vertically	Reference line marker (right diagram edge)
	Move into other or new diagram	Trace line
	Delete	See Chapter 3.3.5.3, "Deleting display elements" , on page 61
	Reset / suspend graphic zoom	"Zoom" element in additional trace line --> "Delete" icon; see Chapter 3.3.7.1, "Using the graphical zoom" , on page 66
Marker	Create	See Chapter 3.3.5.2, "Adding new markers" , on page 60
	Move horizontally	Marker symbol
	Delete	Marker or marker info field --> "Delete" icon; see Chapter 3.3.5.3, "Deleting display elements" , on page 61
Marker info field	Add	See Chapter 3.3.5.2, "Adding new markers" , on page 60
	Move within diagram	Marker info field (move to one of several pre-defined positions)
	Delete	See Chapter 3.3.5.3, "Deleting display elements" , on page 61

3.3.6 Entering data

The analyzer provides dialogs with various types of input fields where you can enter numeric values and character data. Data entry with a mouse and an external keyboard is a standard procedure known from other Windows® applications. However, there are various other ways to enter data.

3.3.6.1 Dual-window mode vs. single-window mode

In dual-window mode (default), both the application window and the control window are shown. Whenever you select an editable value, a suitable editor is displayed in the data entry part of the control window.



See "Control window: data entry panel" on page 38.

In **single-window mode** (System – [Display] > "Config" > "Single Window Mode") only the application window is shown, with its virtual **Hardkey panel** enabled. The values can be edited in place, either using an external keyboard or by calling the VNA's numeric editor or on-screen keyboard (see [Chapter 3.3.6.2, "Using the numeric editor"](#), on page 63, or [Chapter 3.3.6.3, "Using the analyzer's on-screen keyboard"](#), on page 64).

3.3.6.2 Using the numeric editor

The "Numeric Editor" is a tool for convenient entry and modification of numeric values. It is available for all numeric input fields in the analyzer GUI.

The numeric editor is particularly useful in single-window mode. In dual-window mode, a suitable editor is automatically displayed: whenever an editable value is selected in the main window or a dialog, the data entry part of the control window is adjusted accordingly. Hence in dual-window mode there is typically no need to open the numeric editor.

Operation with touchscreen or mouse:

1. Double-tap (double-click) a numeric input field in a dialog or on a softtool to open the numeric editor.

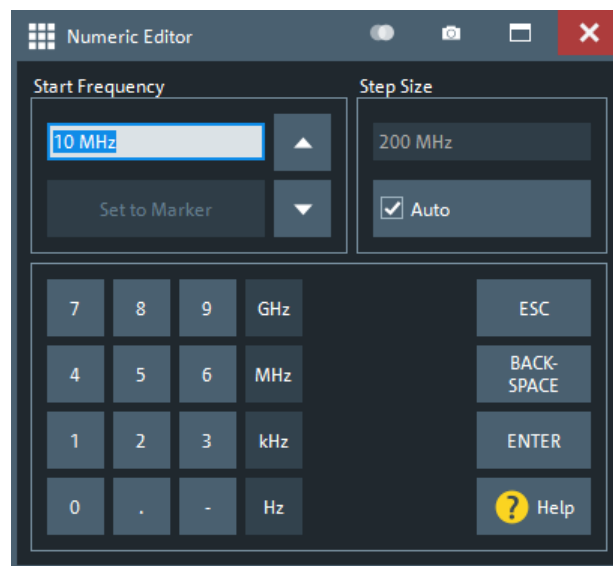

2. Use the buttons in the numeric keypad to compose the numeric input value.
3. If desired, select a "Step Size" and use the cursor up/down buttons to increment/decrement the current value. If a marker is active, you can also set the numeric value to the current marker value ("Set to Marker").
4. After completing the input string, select "ENTER" to apply your selection and close the numeric editor.



[Step Size] key

In dual-window mode, if a numeric input field is active, the [Step Size] key in the data entry panel opens a dialog containing the "Step Size" panel of the numeric editor. Select the adequate step size for efficient operation of the on-screen wheel (and mouse wheel).

3.3.6.3 Using the analyzer's on-screen keyboard

The on-screen "Keyboard" allows you to enter characters, in particular letters, without an external keyboard. It is available for all text input fields in the analyzer GUI.

The on-screen keyboard is particularly useful in single-window mode. In dual-window mode, a suitable editor is automatically displayed: whenever an editable value is selected in the main window or a dialog, the data entry part of the control window is adjusted accordingly. Hence in dual-window mode there is typically no need to open the on-screen keyboard.

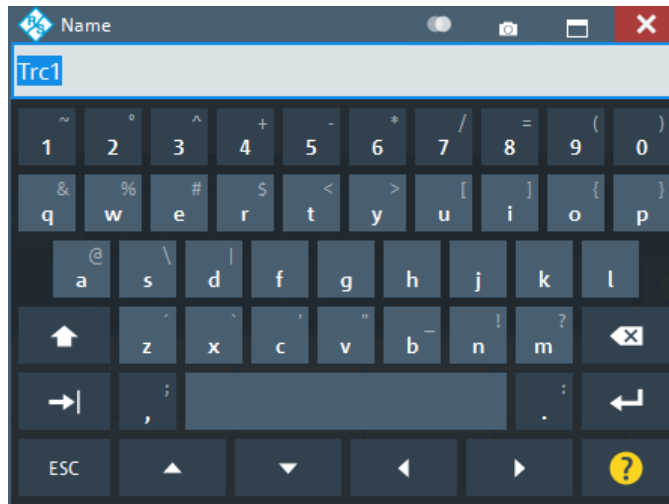

For the following procedure, we assume single-window mode.

1. Activate a character data input field in a softtool or a dialog.
2. Double-tap/click the input field to open the on-screen keyboard.
3. Select character buttons to compose the input string.
4. Select "Enter" to apply your selection and close the keyboard.

3.3.6.4 Using the Windows® on-screen keyboard

The Windows® on-screen keyboard allows you to enter characters, in particular letters, even if an input field cannot call up the analyzer's own on-screen keyboard. Examples are input fields in standard Windows® dialogs.

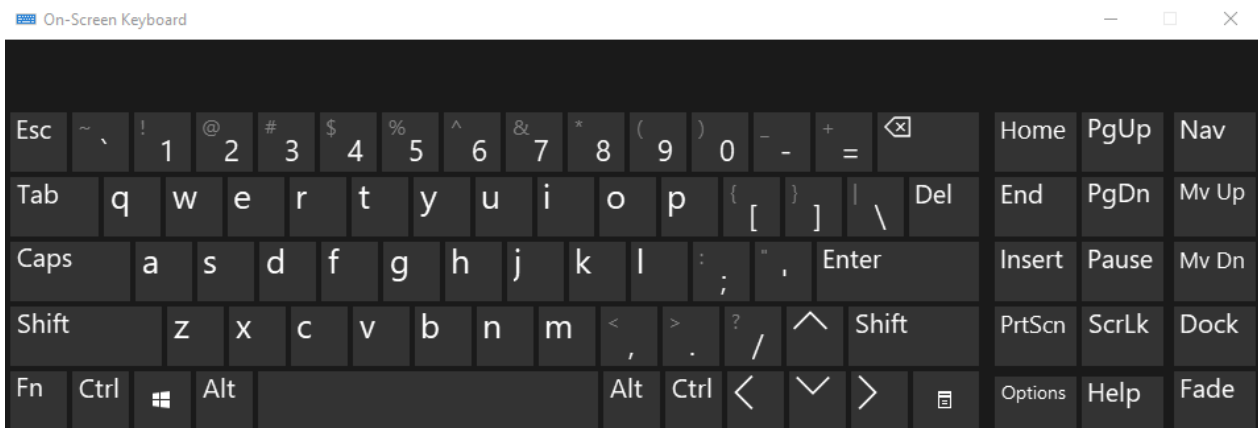

Figure 3-10: Windows 10 on-screen keyboard

To call up the on-screen keyboard:

1. Open the System – [Applic] softtool.

2. Select "External Tools"
3. Select "Screen Keyboard".

3.3.7 Scaling diagrams

The analyzer provides various tools for customizing the diagrams and for setting the sweep range. Choose the method that is most convenient for you.

3.3.7.1 Using the graphical zoom

The graphical zoom function magnifies a rectangular portion of the diagram (zoom window) to fill the entire diagram area. The sweep points are not affected.



The graphical zoom function is only supported for cartesian trace formats. For (inverted) Smith and polar diagrams, it is not available.



To activate the graphical zoom:

- Select the "Zoom Config" icon in the toolbar above the diagram area and make sure that the graphical zoom mode is active:

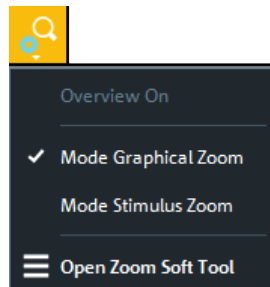

- Select the "Zoom Select" toggle button in the toolbar above the diagram area.



The icon changes its background color from black to blue.

- In the active diagram area, select an appropriate rectangular area.

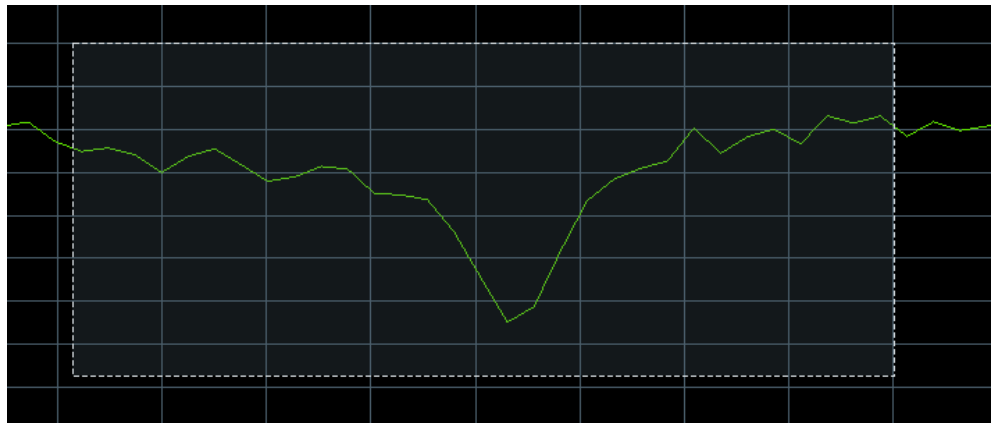

The zoomed view shows the selected rectangle, scaled in both horizontal and vertical direction. In general, the zoom window covers only a part of the sweep range; the horizontal distance between the sweep points increases. The reduced display range is indicated in an additional zoom line in the channel info area.

Ch1	Start	1 GHz	Pwr	-10 dBm	Stop	6 GHz
	Start	3.92 GHz	Zoom	Trc1	Stop	5.96 GHz



Use the "Zoom Reset" icon to restore the original diagram. Alternatively, you can drag and drop the "Zoom" label from the additional channel info line onto the  toolbar button.



Alternative settings

- The Trace – [Scale] > "Zoom" softtool tab allows you to define the displayed zoom range numerically. It can also be opened from the menu of the "Zoom Config" toolbar icon.
- If the active diagram is graphically zoomed, "Overview On" in the "Zoom" softtool tab toggles an overview. The upper part of the diagram then shows a small version of the unzoomed diagram. You can move the zoomed part of the trace by moving the rectangular area in the overview.

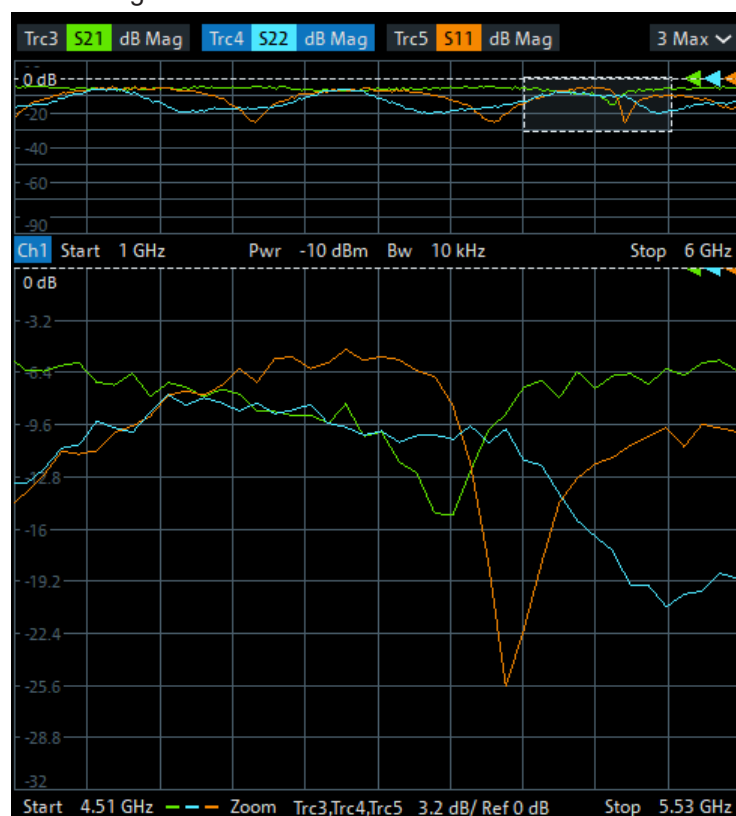

- To zoom the stimulus range (keeping the number of sweep points constant), use the "Zoom Config" toolbar icon and select "Mode Stimulus Zoom". Then use the "Zoom Select" icon to narrow the sweep range and adjust the vertical scaling.

Refer to the R&S ZNA Help or User Manual for details.

3.3.7.2 Setting the sweep range

The sweep range for all related channels is displayed in the channel info area at the bottom of each diagram:

Ch1	Start	10 MHz	—	Pwr	-10 dBm	Bw	10 kHz	Stop	4 GHz
Ch2	Start	1 GHz	—	Pwr	-10 dBm	Bw	10 kHz	Stop	6 GHz
Ch3	Start	5 GHz	—	Pwr	-10 dBm	Bw	10 kHz	Stop	8.5 GHz
Trc4	Start	-1 ns	—	Time Domain				Stop	4 ns

To change the sweep range of the active channel, use one of the following methods:

- Use the [Start], [Stop], [Center], and [Span] function keys from the Stimulus section.
- Double-tap (with a mouse: double-click) the "Start" or "Stop" label in the channel list.
- Tap and hold (with a mouse: right-click) the "Start" or "Stop" label in the channel list and select "Start Frequency", "Stop Frequency", "Center Frequency", or "Frequency Span" from the context menu.
- Select "Start Frequency", "Stop Frequency", "Center Frequency", "Span Frequency" from the "Channel" > "Stimulus" menu.
- Use the "Set by Marker" functions (Trace – [Marker] > "Set by Marker"; see [Chapter 3.3.7.6, "Set by marker"](#), on page 69).

3.3.7.3 Reference value and position

The analyzer provides three parameters for changing the scale of the vertical (response) axis:

- Changing the "Ref Value" or "Ref Pos" shifts the trace in vertical direction and adjusts the labels of the vertical axis. "Ref Value" also works for radial diagrams.
- Changing the "Scale/Div" modifies the value of the vertical or radial diagram divisions and thus the entire range of response values displayed.

The "Scale/Div" and the "Ref Value" are indicated in the scale section of the trace info. In the example below, a "Scale/Div" of 10 dB and a "Ref Value" of 0 dB is used.

Trc1 S21 dB Mag 10 dB/Ref 0 dB Math

To change such a scale parameter, use one of the following methods:

- Open the Trace – [Scale] > "Scale Values" softtool tab and proceed from there.
- Tap and hold (with a mouse: right-click) the scale section in the trace info and select a setting from the context menu.
- Select a setting from the "Trace" > "Scale" menu.
- Use "Set by Marker" functions (Trace – [Marker] > "Set by Marker"; see [Chapter 3.3.7.6, "Set by marker"](#), on page 69).

3.3.7.4 Auto scale

The "Auto Scale" function adjusts the scale divisions and the reference value so that the entire trace fits into the diagram. To access "Auto Scale", use one of the following methods:

- Open the Trace – [Scale] > "Scale Values" softtool tab and select "Auto Scale Trace" or "Auto Scale Diagram".
- Tap and hold (with a mouse: right-click) the scale section in the trace info and select "Auto Scale Trace" from the context menu.
- Select "Auto Scale Trace" or "Auto Scale Diagram" from the "Trace" > "Scale" menu.

3.3.7.5 Circular diagrams

The radial scale of a circular diagram ("Polar", "Smith" or "Inverted Smith") can be changed with a single linear parameter, the "Ref Value". The reference value defines the radius of the outer circumference.

- Increasing the "Ref Value" scales down the polar diagram.
- Decreasing the "Ref Value" magnifies the polar diagram.

The "Ref Value" is indicated in the scale section of the trace info.

A screenshot of a trace information box. The text inside the box is 'Trc1 S21 Polar 400 mU / Ref 2 U'. The 'S21' part is highlighted in green, and the 'Polar' part is highlighted in blue.

To change the "Ref Value" setting, use one of the following methods:

- Locate it on the Trace – [Scale] > "Scale Values" softtool tab.
- Tap and hold (with a mouse: right-click) the scale section in the trace info and select the parameter from the context menu.
- Select the parameter from the "Trace" > "Scale" menu.
- Use the "Set by Marker" functions; see [Chapter 3.3.7.6, "Set by marker"](#), on page 69.

3.3.7.6 Set by marker

The "Set by Marker" functions are a convenient tool for scaling (in particular: magnifying) diagrams without entering explicit numeric values. You simply place a marker to a trace point and use the marker values to change the sweep range or move the trace relative to the vertical axis. The touchscreen or a mouse makes it easier to activate (touch/click) or move (drag and drop) markers.

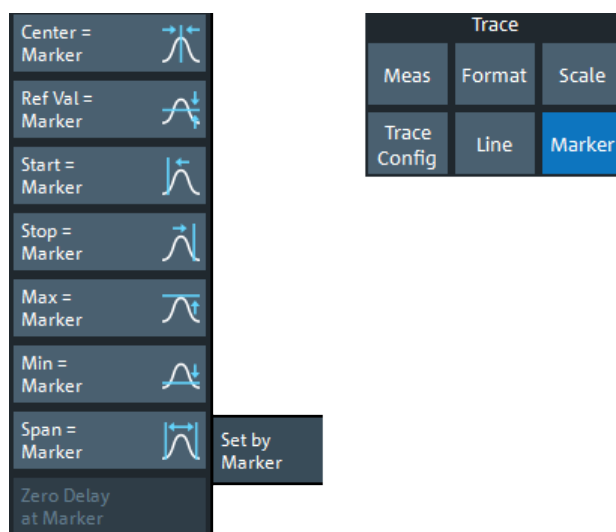

To set the sweep range using markers, use one of the following methods.

Set "Start" and "Stop" values in the diagram:

1. Create two normal markers, e.g. the markers "Mkr 1" (default label "M1") and "Mkr 2" (default label "M2").
See [Chapter 3.3.5.2, "Adding new markers"](#), on page 60.
2. Place "M1" to the start value of the desired sweep range and tap Trace – [Marker] > "Set by Marker" > "Start = Marker".
3. Place "M2" to the stop value of the desired sweep range and tap Trace – [Marker] > "Set by Marker" > "Stop = Marker".

Use a definite "Span:"

1. Create a marker.
2. Enable "Delta Mode" for this marker.
The analyzer automatically creates an additional reference marker.
3. Place the reference marker to the start value of the desired sweep range.
4. Set the value of the delta marker to the desired sweep range and tap Trace – [Marker] > "Set by Marker" > "Span = Marker".

To move the trace in vertical direction, proceed as follows:

1. Create a normal marker, e.g. the marker "Mkr 1" (default label "M1").
2. Place "M1" to a particular trace point, e.g. use the "Marker Search" functions to locate a maximum or minimum on the trace.
3. Select Trace – [Marker] > "Set by Marker" > "Max = Marker" to move the trace towards the upper diagram edge, leaving the values of the vertical divisions ("Scale/Div") and the overall vertical scale unchanged. Analogously, select "Min =

Marker" to move the trace towards the lower diagram edge, or select "Ref Val = Marker" to move the trace towards the "Ref Value".



You can also use marker values in the "Numeric Editor"; see [Chapter 3.3.6.2, "Using the numeric editor"](#), on page 63.

3.3.7.7 Enlarging a diagram

The analyzer provides different tools for customizing the contents and size of the diagrams:

- Select  from the toolbar to maximize the active diagram. Or, equivalently, select System – [Display] > "Diagram" > "Maximize Diagram". If enabled the active diagram is always maximized.
- The "Menu Bar", the "Status Bar", the "Hard Key Panel", and the "Title Bar" can be hidden to gain space for the diagrams (System – [Display] > "View Bar").
- The System – [Display] > "Config" softtool tab defines optional display elements for the interior of the diagrams.

Use the context menu of the diagram, the System – [Display] key or the "Display" menu to access the display settings.

3.4 Performing measurements

This chapter takes you through a sample session with a R&S ZNA network analyzer and describes basic operation tasks.



Prerequisite

The instrument is set up, connected to the mains system, and started up as described in [Chapter 3.1, "Preparing for use"](#), on page 24.

3.4.1 Transmission S-parameter measurement

In a transmission measurement, the analyzer transmits a stimulus signal to the input port of the device under test (DUT) and measures the transmitted wave at the DUT's output port. The trace settings allow you to select the measured quantities and display formats, depending on what you want to learn from the data. A minimum of two analyzer test ports are required for transmission measurements.

In the following example, the analyzer is set up for a two-port transmission measurement. A frequency sweep range is selected, the instrument is calibrated and the measurement result is analyzed using various display formats.

3.4.1.1 Connecting the instrument for transmission measurements

To prepare a transmission measurement, you have to connect your DUT (which for simplicity we assume to have appropriate connectors) in-between a pair of analyzer test ports. It is recommended that you preset the R&S ZNA to start from a well-defined instrument state.

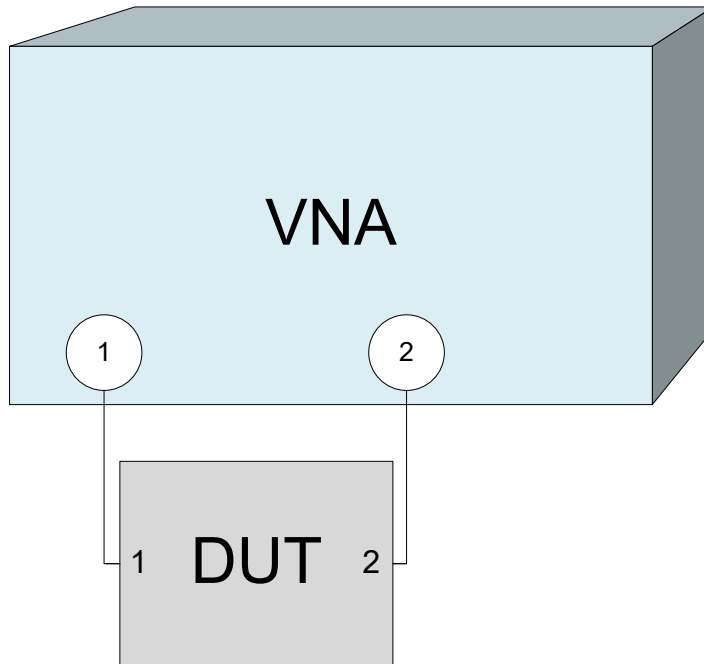

1. Connect the DUT between test ports 1 and 2 of the network analyzer as shown above.
2. Use the [Preset] key to restore a well-defined instrument state.

The analyzer is now set to its default state. The default measured quantity is the transmission S-parameter S_{21} .

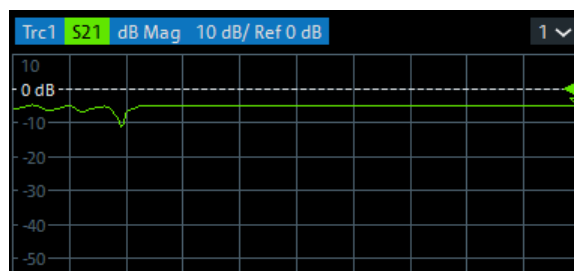

Select Trace – [Trace Config] and use the control elements in the "Traces" softtool tab if you wish to create additional traces and diagrams.

3.4.1.2 Selecting the sweep range and other parameters

After a system preset the display shows a diagram with a dB magnitude scale, and the S-parameter S_{21} is selected as a measured quantity. This S-parameter is the forward transmission coefficient of the DUT. It is defined as the ratio of the transmitted wave at the DUT's output port (port no. 2) to the incident wave at the DUT's input port (port no. 1).

The R&S ZNA automatically adjusts its internal source and receiver to the selected measured quantities: For an S_{21} measurement, a stimulus signal (termed a_1) is transmitted at the analyzer port no. 1; the transmitted wave (termed b_2) is measured at port 2. The stimulus signal from the analyzer port no. 2 is not needed except for some calibration types.

By default the sweep range is set to the frequency range of the analyzer, which can be unsuitable for your DUT. The following procedure shows you how to configure a smaller sweep range.

1. Select Stimulus – [Start] and set the "Start Frequency" to the lowest frequency you want to measure (e.g. 1.77 GHz).
2. In the "Stop Frequency" input field, enter the highest frequency you want to measure (e.g. 2.5 GHz).
3. Select Trace – [Scale] > "Scale Values" and activate the "Auto Scale Trace" function. The analyzer adjusts the scale of the diagram to fit in the entire S_{21} trace, leaving an appropriate display margin.

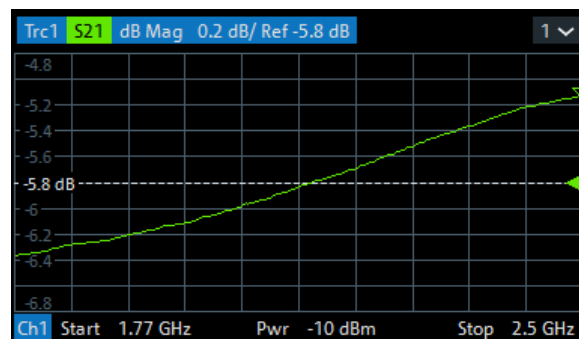

Tip: Refer to [Chapter 3.3.7, "Scaling diagrams"](#), on page 66 to learn more about the different methods and tools for diagram scaling.

3.4.1.3 Calibrating the instrument

Calibration (system error correction) is the process of eliminating systematic, reproducible errors from the measurement results. E.g., in the current test setup, the connecting cables between the analyzer ports and the DUT introduce an attenuation and a phase shift of the waves. Both effects impair the accuracy of the S-parameter measurement.

The analyzer provides a wide range of sophisticated calibration methods for all types of measurements. The calibration method to select depends on the expected system

errors, the accuracy requirements of the measurement, on the test setup and on the types of calibration standards available.

The following example requires a calibration kit with a male Through standard with known transmission characteristics for the related test port connector type and gender. With a single Through, it is possible to perform a transmission normalization, compensating for a frequency-dependent attenuation and phase shift in the signal paths.

Due to the R&S ZNA's calibration wizard, calibration is a straightforward, guided process.

1. Replace the DUT by the Through standard of your calibration kit. Make sure to disconnect all calibration units.
2. Select Channel – [Cal] > "Configure/Start Calibration..." to open the calibration setup dialog.
3. "Delete" all except the first row in the "Cal Settings" table. If the table is empty, use "Add" to create a calibration setup.

Cal. Settings								+ Add	✖ Delete
	Port1	Port3	Port2	Port4	Common Port	Calibration	Cal Kit Port 1		
1	<input checked="" type="checkbox"/>	<input type="checkbox"/>	<input checked="" type="checkbox"/>	<input type="checkbox"/>		UOSM	3.5 mm Ideal Kit	3.5 mm	

4. Tap on the "Calibration" cell of the first row in the "Cal Settings" table to open the "Define Calibration" dialog.
5. Select port 1 (P1) and port 2 (P2) and the calibration type "Trans Norm".

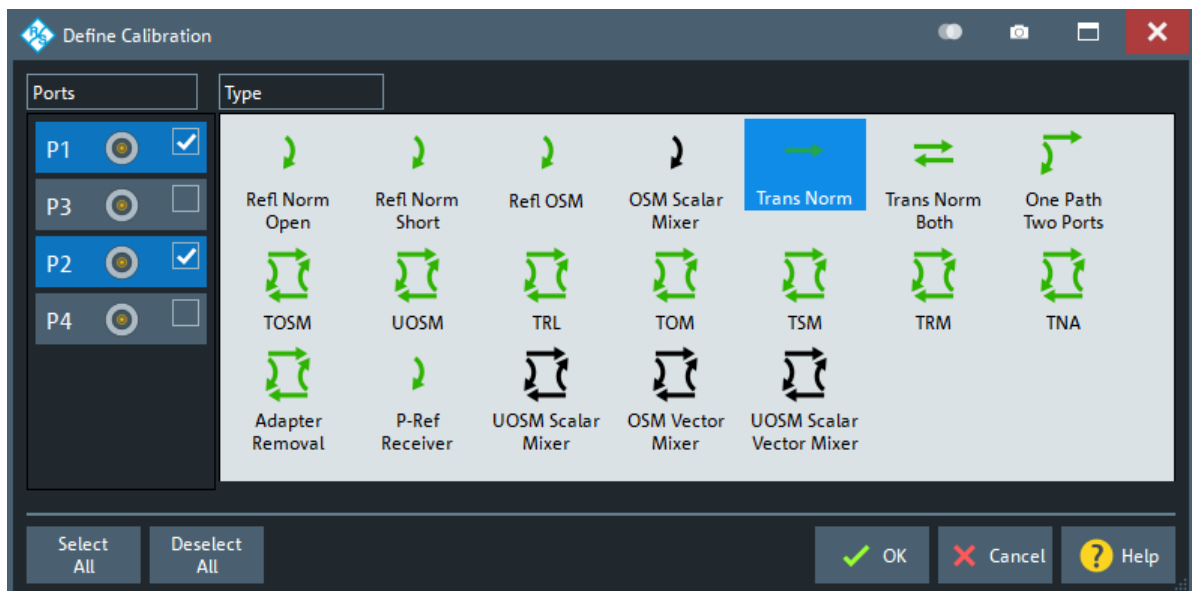

6. Select "OK" to apply your settings and return to the calibration setup dialog "Calibration Setting" wizard.

7. Select the test port connector type and gender (here: N 50 Ω , female, corresponding to a male Through standard), and the calibration kit (here: R&S ZV-Z121).

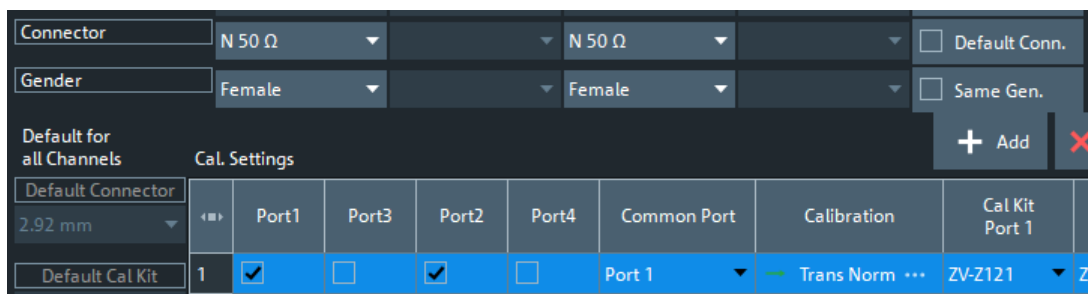

8. Tap "Start Cal".
9. The calibration dock widget indicates the standard measurements that make up a "Trans Norm" calibration. Select "Through (mm)" to initiate the measurement of the connected Through standard. Measuring the isolation between ports 1 and 2 is optional. Skip it for now.



The analyzer performs a calibration sweep for the measured quantity S_{21} . The magnitude and phase of the result is displayed in two diagrams, together with the expected typical result for a Through standard. The similarity of real and expected traces indicates that the Through standard has been properly connected. After the R&S ZNA has completed the calibration sweep and calculated the correction data, the "Apply" button is enabled.

10. Select "Apply" to close the wizard.

The system error correction is calculated and applied to the current channel. A "Cal" label appears in the trace list.

To proceed with the measurement, remove the Through standard and connect the DUT again.

3.4.1.4 Evaluating data

The analyzer provides various tools to optimize the display and analyze the measurement data. For instance, you can use markers to determine maxima and minima on the trace, and change the display format to obtain information about the group delay of the transmitted wave.

1. Select Trace – [Marker] > "Markers" > "Mkr 1".

This places marker "M1" to its default position (center of the sweep range). A marker symbol (triangle) appears on the trace, a marker info field in the upper right corner of the diagram. The marker info field displays the stimulus value (frequency) and response value (magnitude of the transmission coefficient converted to a dB value) at the marker position.

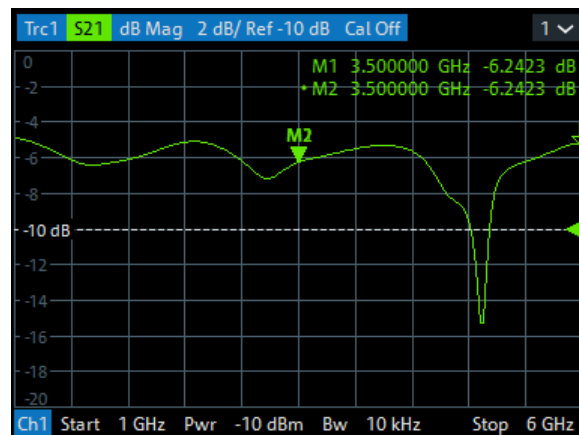

2. Select Trace – [Marker], activate the "Marker Search" softtool tab and activate "Min" search.
The marker jumps to the absolute minimum of the curve in the entire sweep range. The marker info field shows the coordinates of the new marker position.
3. Select Trace – [Format] and choose the "Delay" of the transmission coefficient as displayed quantity.
The group delay represents the propagation time of the wave through the DUT; it is displayed in a Cartesian diagram. The marker info field shows the frequency and group delay at the marker position.

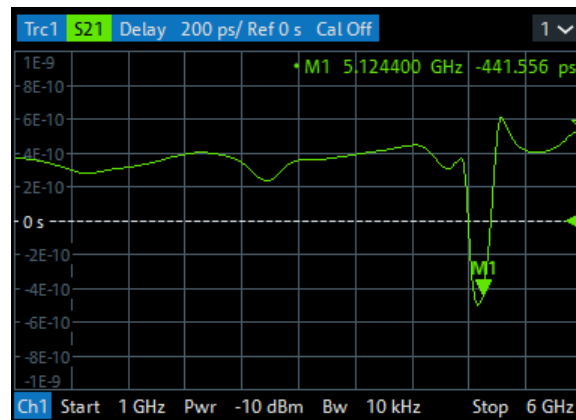

Refer to [Chapter 4.2.3, "Trace formats"](#), on page 140 to learn more about the diagram properties.

3.4.1.5 Saving and printing data

The analyzer provides standard functions for saving measurement settings and for saving or printing the results. You can use these functions as if you were working on a standard PC. Moreover you can export your trace data to an ASCII file and reuse it in a later session or in an external application.



Data transfer is made easier if external accessories are connected to the analyzer or if the instrument is integrated into a LAN. Refer to [Chapter 3.1.11, "Connecting external accessories"](#), on page 32, and [Chapter 12.1.2, "Remote operation in a LAN"](#), on page 1775 to obtain information about the necessary steps.

1. Activate the System – [File Print] > "Trace Data" softtool tab.
2. In the "Trace Data" softtool tab, select "Export" – "ASCII..." to open the "Export Data - ASCII Files" dialog.
3. In the "Export Data - ASCII Files" dialog:
 - a) Select a file location ("Look in:").
 - b) Enter a file name ("File name:").
 - c) Select "Save".

The analyzer writes the data of the active trace to an ASCII file and closes the dialog.

4. Activate the "Print" softtool tab (System – [File Print] > "Print") .
5. In the "Print" softtool tab, select "Print" to print the diagram area or "To Clipboard" to copy it to the Windows clipboard.
6. Select System – [File Print] > "Recall Sets" > "Save..." to open the "Save" dialog for recall sets.

7. In the "Save" dialog:
 - a) Select a file location ("Look in:").
 - b) Enter a name for the recall set file ("File name:").
 - c) Select "Save".

The analyzer saves the active recall set, containing channel, stimulus and trace settings, to a `znxml` file. This recall set can be restored in a later session.

3.4.2 Reflection S-parameter measurement

In a reflection measurement, the analyzer transmits a stimulus signal to the input port of the device under test (DUT) and measures the reflected wave. Different trace formats allow you to express and display the results, depending on what you want to learn from the data. Only one analyzer test port is required for reflection measurements.

In principle, a reflection measurement involves the same steps as a transmission measurement. Note the following differences:

- The basic test setup for reflection measurements involves a single DUT and analyzer port. For instance, you can connect the input of your DUT to port 1 of the analyzer as shown below.

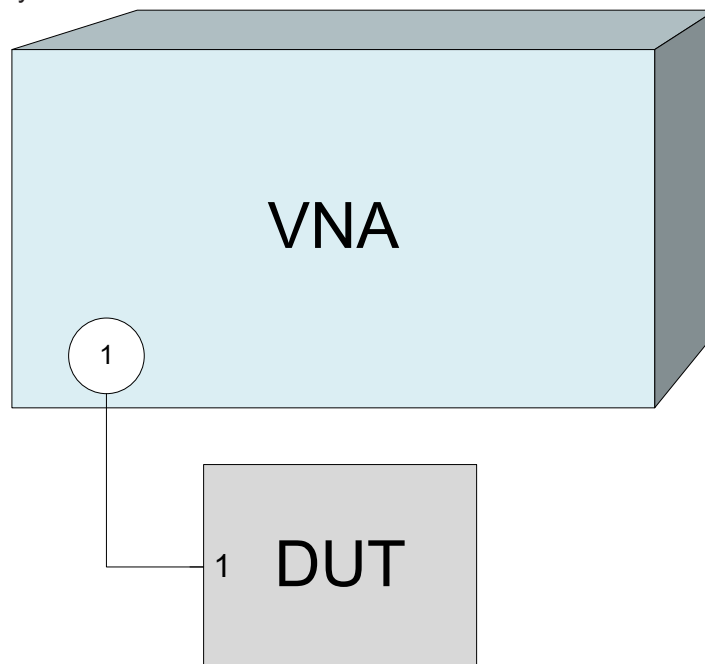

You can also use the basic transmission test setup, e.g. if you want to measure reflection and transmission parameters in parallel.

- The analyzer provides special calibration types for reflection measurements. Use the calibration wizard and select an appropriate type. A full n -port calibration (TOSM, UOSM, TNA ...) corrects the system errors for all transmission and reflection S-parameters.

- Some of the trace formats are particularly suited for reflection measurements. For instance, you can display the measured reflection coefficient S_{11} in a Smith chart to obtain the complex input impedance at port 1.

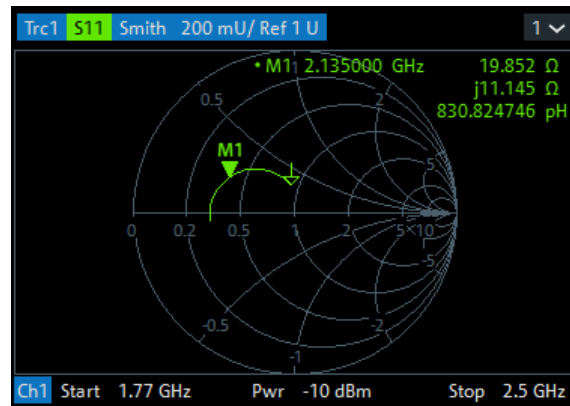

Proceed as described in [Chapter 3.1.7, "Switching the instrument on and off"](#), on page 28 to shut down your analyzer.

3.5 Getting started with R&S ZNA67EXT

This section provides getting started information on the R&S ZNA67EXT family of 110 GHz VNA systems. These systems are based on:

- A vector network analyzer R&S®ZNA67, order no. 1332.4500Kyy, either with two ports (yy=62) or with four ports (yy=64).
- Two or four external test sets, each consisting of:
 - A frequency converter R&S®ZVA-Z110, WM-2540 (WR10), order no. 1352.1642.yy, either standard power (yy=40) or high power (yy=50)
 - A diplexer R&S®ZVA-ZD110, order no. 1314.4002.zz, either with connectors on the left side (zz=12) or on the right side (zz=18)
- [Safety and regulatory information](#)..... 79
- [Key features](#)..... 81
- [Preparing for use](#)..... 82
- [System tour](#)..... 85
- [Putting the system into operation](#)..... 92
- [Connecting the external test sets](#)..... 93
- [Basic operation](#)..... 99

3.5.1 Safety and regulatory information

The product documentation helps you use the product safely and efficiently. Follow the instructions provided here and in the following chapters.

Intended use

Rohde & Schwarz vector network analyzers and millimeterwave converters R&S ZNA67EXT are intended for the development, production and verification of electronic components and devices in industrial, administrative, and laboratory environments. Only use them for their designated purpose. Observe the operating conditions and performance limits stated in the data sheet.

Where do I find safety information?

Safety information is part of the product documentation. It warns you of potential dangers and gives instructions on how to prevent personal injury or damage caused by dangerous situations. Safety information is provided as follows:



- Multilingual safety information is provided in the printed Getting Started guide of the R&S ZNA67EXT, and delivered with the system's R&S ZNA67.
- Throughout the documentation, safety instructions are provided when you need to take care during setup or operation.

3.5.1.1 Labels on the external test sets

Labels on the frequency converters and diplexers inform about:

- Product and environment safety
- Identification of the product

Table 3-6: Labels regarding product and environment safety

	<p>Labeling in line with EN 50419 for disposal of electrical and electronic equipment after the product has come to the end of its service life. For more information, see "Disposing electrical and electronic equipment" on page 1773.</p>
	<p>Take care when handling electrostatic sensitive devices.</p>

3.5.1.2 Warning messages in the documentation

A warning message points out a risk or danger that you need to be aware of. The signal word indicates the severity of the safety hazard and how likely it will occur if you do not follow the safety precautions.

NOTICE

Potential risks of damage. Could result in damage to the supported product or to other property.

3.5.2 Key features

The 1.0 mm VNA system R&S ZNA67EXT can sweep through a frequency range from 10 MHz to 110 GHz continuously. It supports two different measurement modes:

- Measurements with internal test sets cover a frequency range between 10 MHz and 67 GHz.
The R&S ZNA67EXT is based on a vector network analyzer R&S ZNA67. Connect the DUT to any of the test ports of the R&S ZNA and measure its properties as described in the R&S ZNA user manual (see <https://www.rohde-schwarz.com/manual/ZNA>) or help system.
- Measurements with external test sets cover an extended frequency range between 10 MHz and 110 GHz. The DUT is connected to the 1 mm connectors at the front of the diplexers R&S ZVA-ZD110. This measurement mode is described in the present manual.

This manual describes the external test sets and their connection to the DUT and to the R&S ZNA. A typical measurement example is presented in [Chapter 3.5.7, "Basic operation"](#), on page 99.



The measurement mode of each VNA port is selected in the [Converter Configuration dialog](#).

- "Converter Type" > "None": internal test sets
- "Converter Type" > "ZNA67EXT-TS": external test sets
- Selecting another "Converter Type" allows you to measure within the selected converter's frequency range.

Operation with external test sets

The external test sets enable a frequency range between 10 MHz and 110 GHz. The analyzer combines two different measurement methods to achieve this extended range.

- At frequencies below approx. 67 GHz (i.e. in "low frequency" mode), the frequency converter in the external test set is bypassed. The source signal of the respective analyzer port is directly fed to the 1 mm test port connector of the diplexer. The network analyzer measures the a-waves and b-waves from the Ref Out and Meas Out on the diplexer, respectively. The RF connectors LO IN, RF IN, REF OUT, and MEAS OUT on the connector panel of the converter are not used.
- To achieve frequencies above approx. 67 GHz (i.e. to measure in "high frequency" mode), the frequency converter in the external test set is used. The source signal of the respective analyzer port is fed to the frequency converter, and the converted signal is routed to the 1 mm test port connector of the diplexer. The frequency converter uses frequency multipliers to transform the source signal into a high-frequency stimulus signal. A local oscillator (LO) signal from the Converter LO output of the analyzer (R&S ZNA-B8) is used for down-conversion of the reference and measurement channels. If more than one converter is used, a power divider feeds the LO signal to the converters. This test setup ensures a stable phase relationship between the LO IN signals of the converters.

The analyzer measures the a-waves from REF OUT and the b-waves from MEAS OUT on the converters. The RF connectors REF OUT, MEAS OUT on the rear panel of the diplexers are not used.

The network analyzer automatically switches between low frequency and high frequency mode, depending on the stimulus frequency; see "[H/L SWITCH](#)" on page 90. There is no need to change the test setup and cabling.

3.5.3 Preparing for use

Here, you can find basic information about setting up the product for the first time.

3.5.3.1 Unpacking and checking

When you receive your VNA system, please take the following steps:

1. Unpack the contents from the cardboard shipping boxes.
2. Retain the original packing material. Use it when transporting or shipping the product later.
3. Using the delivery notes, check the equipment for completeness. The shipment must include the items listed in [Table 3-7](#).
4. Follow the instructions given in the "Preparing for use" chapter of the R&S ZNA's Getting Started guide.
5. Remove the protective caps from the 1 mm test ports at the front of the diplexer elements. Carefully inspect the converters and diplexers. If you notice any damage, immediately notify the shipping company.

Table 3-7: Shipment of VNA system R&S ZNA67EXT, order no. 1352.1888Kxx (Variants xx = 02, ..., 07)

	Variant 02	Variant 05	Variant 03	Variant 06	Variant 04	Variant 07
VNA R&S ZNA67, 1.85 mm order no. 1332.4500Kyy Shipment: see R&S ZNA Getting Started ¹	2-port (variant 62)	4-port (variant 64)				
Converter R&S ZVA-Z110, WM-2540 (WR10) order no. 1352.1642.yy ^{2,3,4}	2 x std. power (variant 40)	2 x high power (variant 50)	2 x std. power (variant 40)	2 x high power (variant 50)	4 x std. power (variant 40)	4 x high power (variant 50)
Diplexer R&S ZVA-ZD110 order no. 1314.4002.yy ^{2,4,5}	1 x left (variant 12), 1 x right (variant 18)				2 x left (variant 12), 2 x right (variant 18) ⁵	
Torque wrench for diplexer test port	1 x R&S ZN-ZTW variant 12, 1 mm, 0.34 Nm, order no. 1328.8534.12					
LO power divider SMA (f) 27 GHz + angled SMA adapters (m/f) R&S ZV-Z1218 (order no. 1314.5380.00)	1 x 1:2 R&S ZV-Z1227 (order no. 1307.0886.02) + 2 adapters				1 x 1:4 R&S ZV-Z1228 (order no. 3626.4937.02) + 4 adapters	
H/L SWITCH control cable	1 x for control of 2 diplexers, 2.5 m, order no. 1312.6643.00				1 x for control of 4 diplexers, 2.5 m, order no. 1352.1688.00	
VNA R&S ZNA67EXT Getting Started (this document)	1 x					

1: For mandatory options, see [Chapter 3.5.4.1, "Vector network analyzer R&S ZNA67"](#), on page 85.

2: The converters are pre-mounted to the diplexers.

3: Each converter is delivered with an external 9 V DC power supply, and with IF cables R&S CABLE EXT REF and R&S CABLE EXT MEAS.

4: The required RF and LO cables are not part of the standard delivery. They can be ordered separately, see ["Cable sets \(optional\)"](#) on page 98.

5: With cable deflectors premounted to the "outer" diplexer



RF and LO cables between VNA test ports and diplexers are not part of the standard delivery. See ["Cable sets \(optional\)"](#) on page 98.

3.5.3.2 Choosing the operating site

Specific operating conditions ensure proper operation and avoid damage to the product and connected devices. For information on environmental conditions such as ambient temperature and humidity, see data sheet.

3.5.3.3 Adjusting the feet of the test set

The frequency converter can be used with three or four feet attached to the bottom side. If possible, use three feet: two in front and one in the middle of the rear.



Figure 3-11: Setup with one rear foot (left) and two rear feet (right)

Two additional feet support the diplexer. Typically, the external test set can be aligned as follows:

1. Screw the diplexer feet and the front feet into the instrument as far as possible.
2. Use the rear foot to align the entire test set parallel to the surface of the bench top.
3. When you connect a DUT in-between two test sets (see [Chapter 3.5.7.6, "Mounting a DUT"](#), on page 106), use the diplexer feet for further alignment.

3.5.3.4 Considerations for test setup

Cable selection and electromagnetic interference (EMI)

Electromagnetic interference (EMI) can affect the measurement results.

To suppress electromagnetic radiation during operation:

- Use high-quality shielded RF cables.
- Always terminate open cable ends.

Signal input and output levels

Information on signal levels is provided in the data sheet. Keep the signal levels within the specified ranges to avoid damage to the product and connected devices.

Preventing electrostatic discharge (ESD)

Electrostatic discharge is most likely to occur when you connect or disconnect a DUT.

- ▶ **NOTICE!** Electrostatic discharge can damage the electronic components of the product and the device under test (DUT).

Ground yourself to prevent electrostatic discharge damage:

- a) Use a wrist strap and cord to connect yourself to ground.
- b) Use a conductive floor mat and heel strap combination.

3.5.4 System tour

3.5.4.1 Vector network analyzer R&S ZNA67

The VNA system R&S ZNA67EXT is based on a two- or four-port vector network analyzer R&S ZNA67, order no. 1332.4500Kyy, either with two ports (yy=62) or with four ports (yy=64), and equipped with:

- Dedicated LO output connector (HW option R&S ZNA-B8)
See [Chapter 4.7.25, "LO Out"](#), on page 305.
- Direct generator/receiver access (HW option R&S ZNA67-B16)
See [Chapter 4.7.27, "Direct generator/receiver access"](#), on page 306.
- Direct IF access (HW option R&S ZNA-B26)
See [Chapter 4.7.30, "Direct IF access"](#), on page 308.
- Receiver step attenuators R&S ZNA67-B3y at all test ports
See [Chapter 4.7.31, "Receiver step attenuators"](#), on page 309.
- SW option R&S ZNA-K8 "Frequency converter control"
See [Chapter 4.7.7, "Millimeter-wave converter support"](#), on page 281.
- SW option R&S ZNA67-K110 "Continuous Sweep up to 110 GHz for R&S ZNA67"
See [Chapter 4.7.14, "Continuous sweep up to 110 GHz \(R&S ZNA67EXT only\)"](#), on page 297.



SW option R&S ZNA67-K110 is only available with the R&S ZNA67EXT. It cannot be installed on a regular R&S ZNA67.

3.5.4.2 Frequency converters

The R&S ZNA67EXT is delivered with two or four fully assembled external test sets, as described in [Chapter 3.5.4.3, "Diplexers"](#), on page 88. The open connectors of the converter are described in the following sections.

Rear panel

The rear panel of the frequency converter provides the connectors and control elements shown below.

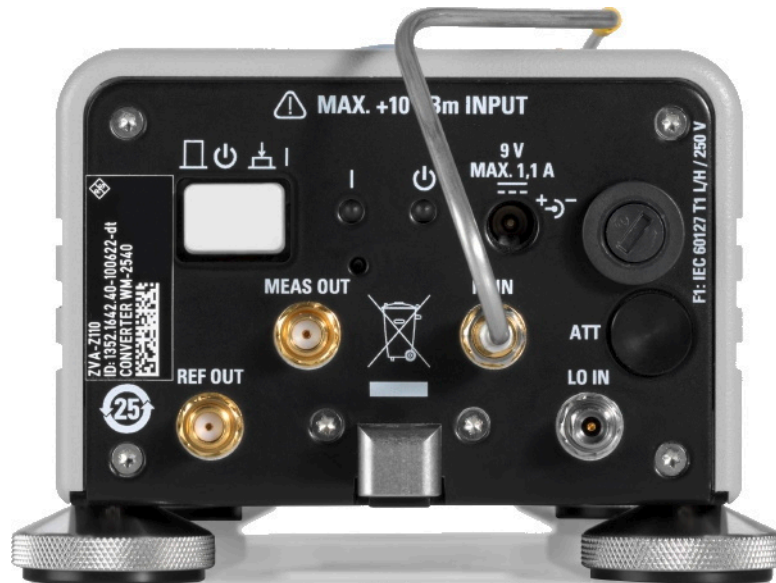

Figure 3-12: Rear view of the frequency converter

The connectors are described in the following sections.

Standby switch

The standby toggle switch connects (ready state) or disconnects (standby state) the internal modules of the frequency converter from the power supply. In standby state also the output connector for the diplexer power supply (see [Figure 3-14](#)) is disconnected.



Figure 3-13: Standby switch and LEDs

A green light-emitting diode (LED) next to the switch indicates that the instrument is in ready state. An orange LED further to the right indicates that the instrument is in standby state. These LEDs are only lit when the converter is properly connected to the power supply and the fuse of the instrument is intact.

Power supply connector



To supply the frequency converter, connect the external DC power supply provided with the converter to the 9 V / 1.1 A DC input. For details, see [Chapter 3.5.6.4, "DC power supply"](#), on page 99.

Always switch the instrument to standby state before removing the power supply.

NOTICE

Risk of instrument damage

The input voltage and current must not exceed the maximum values according to the rear panel labeling or the data sheet.

Always use the DC power supply included in the delivery to power your frequency converter.

Fuse holder



A fuse of type IEC60127 T1 L/H protects the frequency converter from excess input voltages at the power supply connector. A fuse of different type protects the diplexer (see ["Fuse panel"](#) on page 92).

For fuse replacement, see [Chapter 11, "Maintenance, storage and disposal"](#), on page 1772.

RF input



Two 3.5 mm input connectors, only used in high frequency mode:

- RF IN receives the RF source signal from the diplexer. A semi-rigid cable connects RF IN to the RF HIGH OUT connector on the top side of the diplexer.
- LO IN receives the local oscillator signal from the R&S ZNA67 network analyzer.

The complete RF connection of the external test set is described in [Chapter 3.5.6, "Connecting the external test sets"](#), on page 93.

NOTICE

Risk of instrument damage

The RF input power at the connectors RF IN and LO IN must not exceed the maximum values quoted in the data sheet. The maximum values are below the maximum RF source power of the network analyzer. The "ZNA67EXT-TS" converter type configuration ensures compatible source powers.

Before you connect your external test set to the network analyzer, always select the "ZNA67EXT-TS" converter type for the respective converter port in the "Frequency Converter" dialog (see [Chapter 3.5.7.2, "Converter configuration"](#), on page 100).

IF output



Two SMA output connectors, only used in high frequency mode:

- MEAS OUT provides the measured signal (b-wave) to the R&S ZNA67EXT67 network analyzer.
- REF OUT provides the reference signal (a-wave) to the R&S ZNA67EXT67 network analyzer. IF Reference and IF Meas

REF OUT and MEAS OUT must be connected to the corresponding IF Reference and IF Meas connectors at the [Chapter 3.2.2, "Rear panel"](#), on page 41 of the R&S ZNA. The complete RF connection of the external test set is described in [Chapter 3.5.6.2, "RF and LO cabling"](#), on page 96.

3.5.4.3 Diplexers

The R&S ZNA67EXT is delivered with two or four fully assembled external test sets, each consisting of a frequency converter R&S ZVA-Z110 and a diplexer R&S ZVA-ZD110.



Figure 3-14: Connection between frequency converter and diplexer (var. 18)

The connection of the diplexer and the frequency converter includes conducting lines for waves and power supply:

- The RF High Out connector on the top side of the diplexer is connected to RF IN on the rear panel of the converter using a semi-rigid RF cable.
- The waveguide connector on the top side of the diplexer is connected to the waveguide flange of the converter.
- The connection underneath the waveguide flange ensures the power supply of the diplexer.

An additional metal clamp at the bottom ensures mechanical stability.

Left vs. right model variant

The diplexer R&S ZVA-ZD110 is available in a left variant and a right variant.

- The left variant (Var 12) is designed for the left side of the standard arrangement **with two external test sets**. Its connector panel is located on the left side of the diplexer, i.e. it is oriented towards the VNA.
The RF High Out and H/L SWITCH switch connectors are located on the top left and top right, respectively.
- The right diplexer variant (Var 18) is designed for the right side of the standard arrangement with two test sets. Its connector panel is located on the right of the diplexer, i.e. it is oriented towards the VNA.

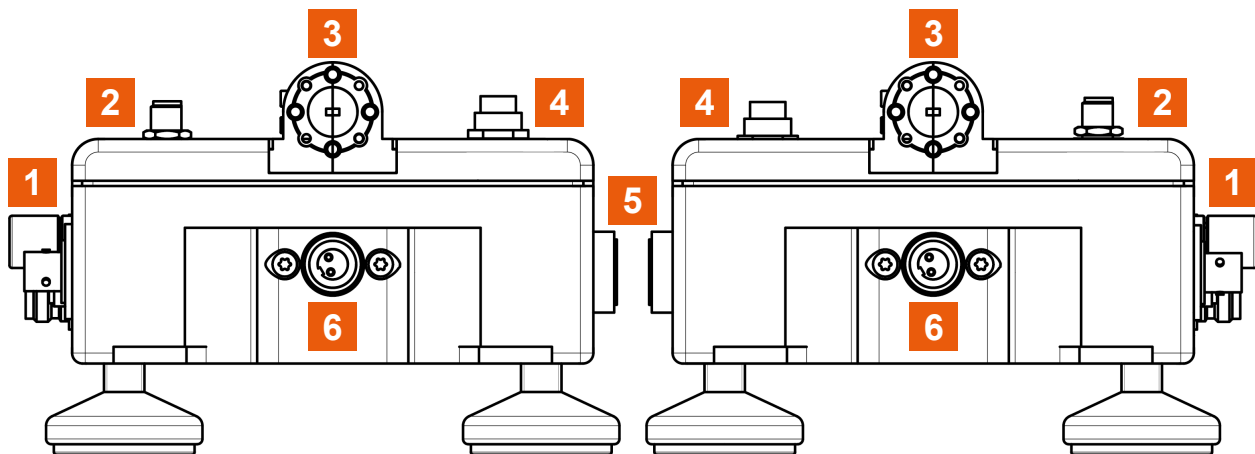

Figure 3-15: Left vs. right model variant (rear view)

- Left = Left variant (Var 12)
 Right = Right variant (Var 18)
 1 = Connector panel
 2 = RF High Out connector
 3 = Waveguide connector
 4 = H/L SWITCH
 5 = Fuse panel
 6 = Power supply connector

RF High Out, waveguide, and power supply connector can also be seen and are described below [Figure 3-14](#).

Standard arrangement with 4 external test sets

With four external test sets, using 2 times the left diplexer variant (Var 12) on the left side would be impractical. If their 1 mm connectors must be placed close to each other, e.g. for on-wafer probing, the RF cables connected to the [connector panel](#) of the outer test set would have to be bent unduly to bypass the inner test set. Same problem with 2 times Var 18 (right) on the right side.

For this reason, the R&S ZNA67EXT with four external test sets uses a Var 18 diplexer for the outer left test set, and a Var 12 diplexer for the outer right test.

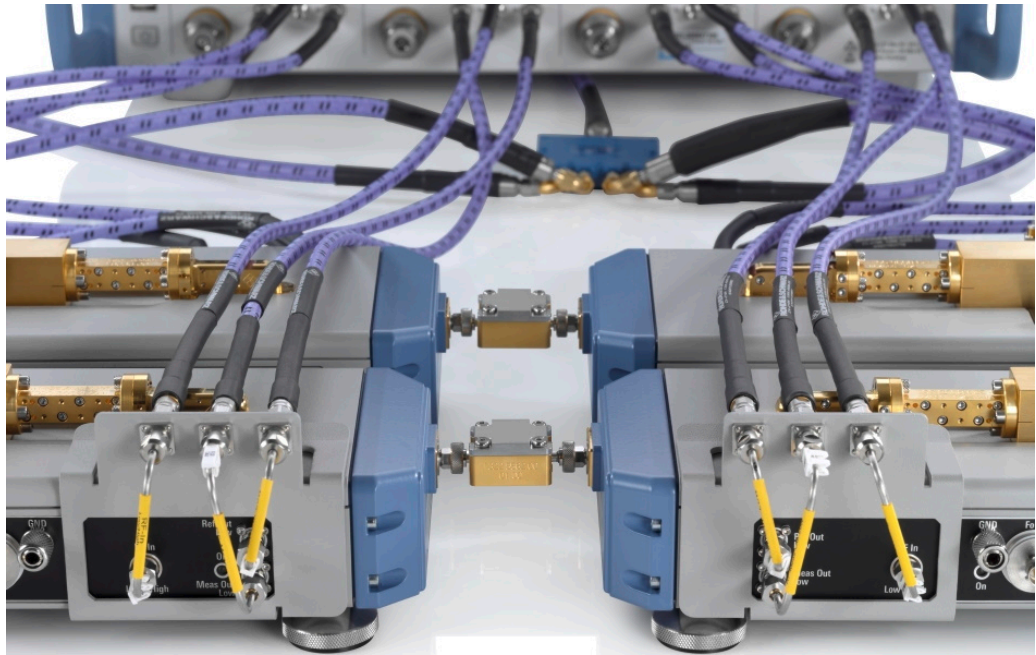

Figure 3-16: Standard arrangement for 4 external test sets

For both outer test sets, a cable deflector is mounted on the connector panel. Semi-rigid cables redirect the corresponding RF connectors towards the VNA.

Test port



1 mm (m) connector on the front side of the diplexer, serves as an output for RF stimulus signals and as an input for the measured RF signals from the DUT (response signals).

- With a single external test set, you can generate a stimulus signal and measure the reflected response signal.
- With $n = 2, 3, 4$ external test sets, a full n -port measurement is possible.

NOTICE

Maximum input level, mechanical damage

Do not exceed the damage level at the test port according to the data sheet, especially when using active DUTs or external amplifiers.

To avoid mechanical damage when connecting devices to the 1 mm connector, always use the torque wrench supplied with the R&S ZNA67EXT. See [Table 3-7](#).

H/L SWITCH

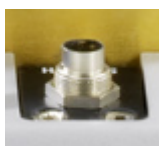

The H/L SWITCH connectors on the top side of each diplexer are input connectors for the User Port signals from the R&S ZNA67; see [Chapter 3.5.6.3, "Diplexer control"](#), on page 98. They allow the VNA firmware to switch the diplexer from low to high frequency mode and vice versa.

A suitable cable is shipped with the VNA system.

Connector panel

The connector panel of the diplexer provides input and output connectors for RF signals and a DC input. Connectors labeled Low are used in low frequency mode only; see ["Operation with external test sets"](#) on page 81.



Figure 3-17: Connector panel of R&S ZVA-ZD110 Var 18



The picture above shows the connector panel of the "right" diplexer variant (Var 18). For the "left" variant (Var 12), the horizontal order of the connectors is exactly opposite.

- The Sense and Force tri-axial BNC female connectors and the 4 mm GND socket implement the bias tee. Bias is applied via the Force input, which is protected by an exchangeable fuse (see ["Fuse panel"](#) on page 92). The Sense output is connected to the bias tee via a 1 kΩ resistor, which allows measuring the bias voltage close to the DUT without the uncertainty caused by a voltage drop on a long bias line.
- RF In Low / High is a 1.85 mm female connector, which receives the RF source signal from the R&S ZNA67EXT network analyzer unit. This connector is used in low frequency and in high frequency mode.
- Ref Out Low is a 1.85 mm female connector, which provides the reference signal (a-wave) in low frequency mode.
- Meas Out Low is a 1.85 mm female connector, which provides the measured signal (b-wave) in low frequency mode.

RF In, Ref Out, and Meas Out are connected to the corresponding direct access connectors of the related VNA port. The complete RF and IF connection of the external test set is described in [Chapter 3.5.6, "Connecting the external test sets"](#), on page 93.

NOTICE

Maximum input power at RF IN

The RF input power at the RF IN connector must not exceed the maximum value quoted in the data sheet. The maximum value is below the maximum RF source power of the network analyzer. The "ZNA67EXT-TS" converter type ensures compatible source powers.

Before you connect your external test set to the network analyzer, always select the "ZNA67EXT-TS" converter type for the related port using the "Converter Configuration" dialog (see [Chapter 3.5.7.2, "Converter configuration"](#), on page 100).

NOTICE**Maximum input voltage at FORCE and EMI suppression**

The maximum nominal input voltage and current for the FORCE bias input connector must not exceed the value quoted in the data sheet. Use a double-shielded cable and terminate open cable ends with 50 Ω to ensure successful control of electromagnetic radiation during operation.

The LED labeled ON lights when the diplexer is properly power-supplied. If the LED does not light, check the following:

- The power connection between the diplexer and the converter must be in place (see [Figure 3-14](#)).
- The converter must be power-supplied and switched on.
- The fuse at the converter must be intact.

Fuse panel

The other side panel of the diplexer gives access to the bias fuse. Furthermore, it holds the type label and visualizes the power supply from the converter (premounted).

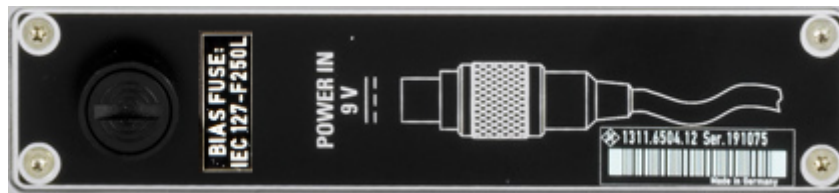

Figure 3-18: Fuse panel R&S ZVA-ZD110 Var 12

A fuse of type IEC 127-F250L protects the diplexer from excess input current at the Force connector (see [Figure 3-17](#)). A fuse of different type protects the frequency converter (see "[Fuse holder](#)" on page 87).

For fuse replacement, see [Chapter 11, "Maintenance, storage and disposal"](#), on page 1772.



- The picture above shows the fuse panel of the "left" diplexer variant (Var 12). For the "right" variant (Var 18), the horizontal order is exactly opposite.
- The bias tee functionality is provided by Sense, Force and GND on the connector panel, see [Figure 3-17](#).

3.5.5 Putting the system into operation

The initial setup of the R&S ZNA67EXT is described in the general R&S ZNA [Getting Started](#). This section gives additional information related to operation with external test sets.

3.5.5.1 Configure the external test sets in the analyzer firmware

Before connecting the RF cables, make sure that the converter configuration is set up correctly on the R&S ZNA (see [Chapter 3.5.7.2, "Converter configuration"](#), on page 100).

3.5.5.2 Connect the external test sets

Each of the external test sets must be connected to the R&S ZNA, the power supply and the DUT. Please refer to the following sections for details.

- H/L SWITCH (control connection): [Chapter 3.5.6.3, "Diplexer control"](#), on page 98
- RF and IF connections: See [Chapter 3.5.6.2, "RF and LO cabling"](#), on page 96
- Power supply: See [Chapter 3.5.6.4, "DC power supply"](#), on page 99
- DUT (usually connected after calibration): See [Chapter 3.5.7.6, "Mounting a DUT"](#), on page 106

3.5.5.3 Switch on the external test sets

The standby toggle switch is located at the rear panel (see ["Standby switch"](#) on page 86). To switch the external test set to ready state, press the key. The green LED next to the switch must be lit now.

After switching the external test set to the ready state, a warm-up time of one hour is required to ensure accurate measurements. The instrument is only warmed-up in ready state, not in standby state.

3.5.6 Connecting the external test sets

The R&S ZNA67EXT is delivered with fully assembled external test sets, each consisting of a diplexer R&S ZVA-ZD110 and a frequency converter R&S ZVA-Z110. The "internal" connection between the diplexers and frequency converters is described in [Chapter 3.5.4.3, "Diplexers"](#), on page 88.

System component information

A label on the rear panel of the network analyzer shows the diplexer and converter units with their position. The label contains the following information.

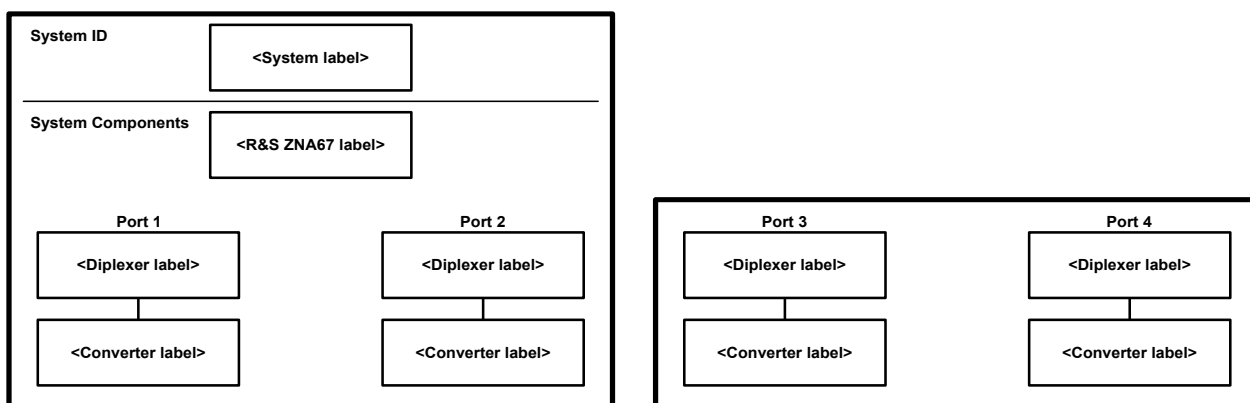

Figure 3-19: System component information



Compliance with rated specifications

Compliance with the rated specifications requires a system setup according to the rear panel labeling at the R&S ZNA67. If you interchange the delivered test sets, or if you use test sets from other R&S ZNA67EXT VNA systems, the rated specifications cannot be guaranteed.

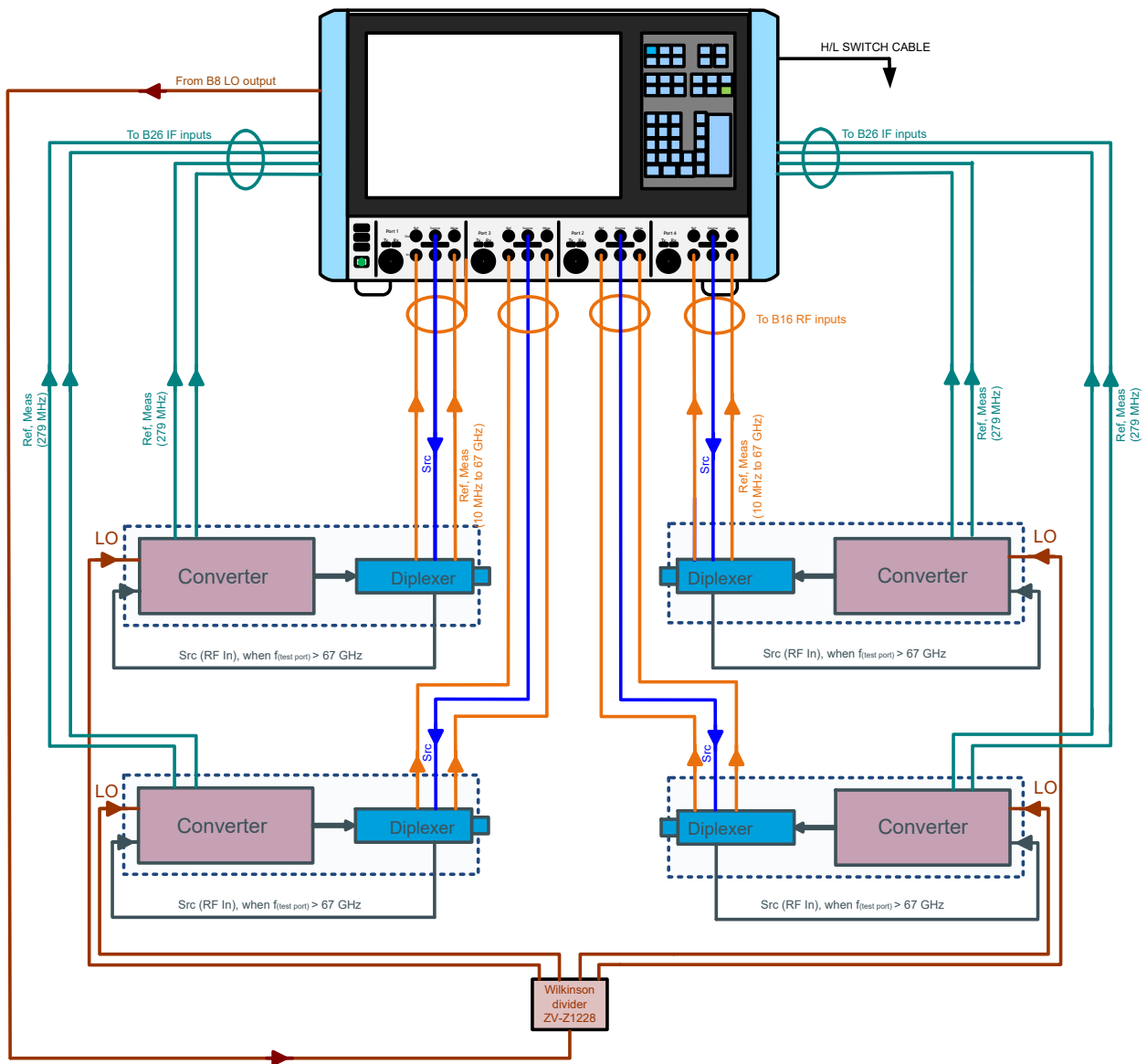

Figure 3-20: Test set connections (4 external test sets)

The following figure shows the cabling of external test set p.

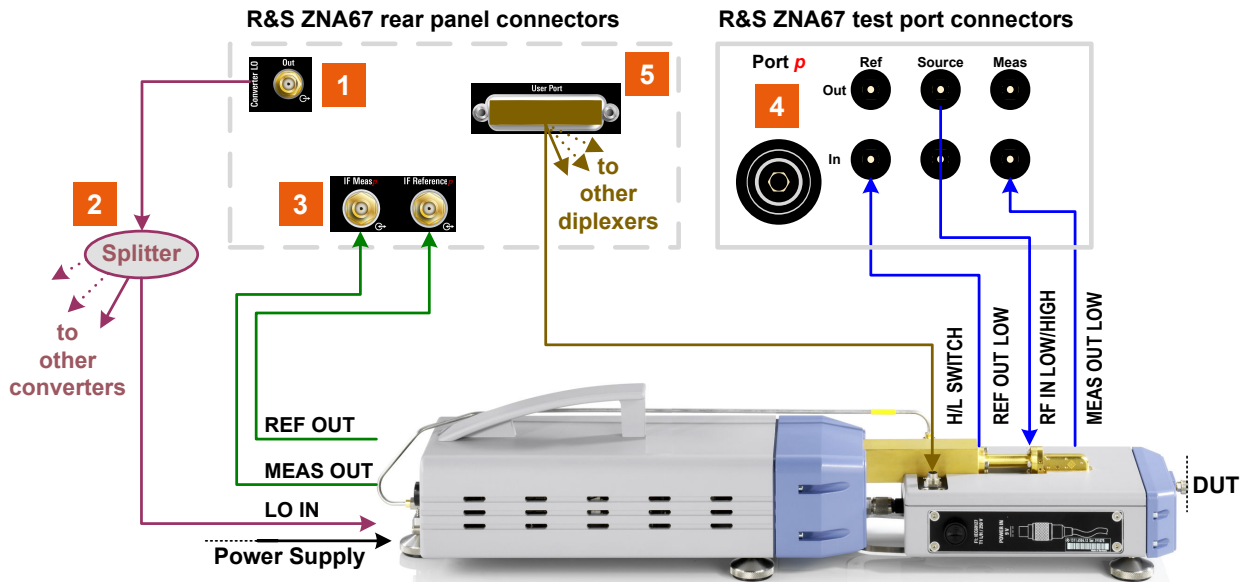

Figure 3-21: Connections of external test set p

- 1 = Converter LO output (R&S ZNA-B8)
- 2 = Splitter
- 3 = Direct IF access for port p (R&S ZNA-B26)
- 4 = RF port p with direct source/recveiver access (R&S ZNA67-B16)
- 5 = User port with H/L SWITCH control cable

For the connectors on the R&S ZNA, see Chapter 3.2, "Instrument tour", on page 34.

3.5.6.1 IF cabling

The required IF cables are included in the delivery of the test sets.

Table 3-8: IF connections for converters

Connections	Cable	Used at frequencies
Converter <i>p</i> REF OUT to R&S ZNA67 IF Reference <i>p</i>	R&S CABLE EXT REF, 1.55 m order no. 1307.8770.00	HIGH
Converter <i>p</i> MEAS OUT to R&S ZNA67 IF Meas <i>p</i>	R&S CABLE EXT MEAS, 1.55 m order no. 1307.8764.00	

3.5.6.2 RF and LO cabling

The following RF and LO connections must be established for each external test set.

Table 3-9: RF and LO connections

R&S ZNA67 connector	Ext. test set connector	Used at frequencies
Port <i>p</i> Source Out	Diplexer <i>p</i> RF IN	LOW / HIGH
Port <i>p</i> Ref In	Diplexer <i>p</i> REF OUT	LOW
Port <i>p</i> Meas In	Diplexer <i>p</i> MEAS OUT	LOW

R&S ZNA67 connector	Ext. test set connector	Used at frequencies
Conv LO Out	Converter p LO IN via power divider	HIGH
$p = 1, 2$ for systems with 2 external test sets		
$p = 1, \dots, 4$ for systems with 4 external test sets		



Some of the RF connections are only used while the network analyzer operates in the low frequency range (below approx. 67 GHz) or in the high frequency range (above approx. 67 GHz). However, to ensure full flexibility and maximum accuracy, it is recommended to establish all RF connections.

To get accurate measurement results, use high-quality cables with low attenuation and excellent phase stability. Rohde&Schwarz offers suitable cable sets from GORE®, see "[Cable sets \(optional\)](#)" on page 98.

NOTICE

RF input power

The RF input power at the connectors RF IN and LO IN of the converters must not exceed the maximum values quoted in the data sheet. Because these maximum values are below the maximum RF source power of the R&S ZNA, the R&S ZNA has to be configured carefully, before establishing these connections. Selecting the "ZNA67EXT-TS" converter type ensures compatible source powers (see [Chapter 3.5.7.2, "Converter configuration"](#), on page 100).

Proceed as follows:

1. Ensure that the converter is in standby state or disconnected from the power supply (see "[Standby switch](#)" on page 86).
2. Make sure to select the "ZNA67EXT-TS" converter type for each converter port of the VNA (see [Chapter 3.5.7.2, "Converter configuration"](#), on page 100).
3. Connect the RF input and output connectors of the diplexers and the frequency converters as shown in [Figure 3-21](#).

Repeat this procedure whenever you are not sure whether a suitable converter configuration is already active. Switching the VNA off and on preserves the converter configuration.



Converter configurations can be saved and loaded via the graphical user interface of the R&S ZNA.

("Save Converter Topology..."/"Load Converter Topology..." on the [Frequency Converter tab](#))

Cable sets (optional)

The required RF and LO cables listed in [Table 3-9](#) are **not** part of the standard delivery. However, it is recommended to order the suitable cable set for 2 or 4 external test sets together with your R&S ZNA67EXT VNA system.

Currently, Rohde & Schwarz offers cable sets R&S ZN-ZCASGO manufactured by GORE®:

- Variant 02, order no. 1352.1659.02 for 2 external test sets
- Variant 04, order no. 1352.1659.04 for 4 external test sets

Table 3-10: Cable set R&S ZN-ZCASGO

Connection	Cable type	# in Var 02	# in Var 04
<ul style="list-style-type: none"> • R&S ZNA67 port p Source Out to diplexer p RF IN • Diplexer p REF OUT to R&S ZNA67 port p Ref In • Diplexer p MEAS OUT to R&S ZNA67 port p Meas In 	R&S ZV-Z196, 67 GHz, order no. 1306.4736.00 1.85 mm (m) / 1.85 mm (m), 61 cm	x 6 $p = 1, 2$	
	R&S ZV-Z196, 67 GHz, order no. 1306.4807.00 1.85 mm (m) / 1.85 mm (m), 91 cm	–	x 6 $p = 3, 4$ (outer test sets)
R&S ZNA67 Conv LO Out to LO power divider	R&S ZV-Z195 26.5 GHz 2.92 mm (m) / 2.92 mm (m), 91 cm	x 1	
LO power divider (+ Adapters R&S ZV-Z1218) to converter p LO IN	R&S ZV-Z193, 26.5 GHz 3.5 mm (m) / 3.5 mm (m), 152 cm	x 2 $p = 1, 2$	x 4 $p = 1, \dots, 4$

Tightening RF cables

Tightening RF cables too strongly, can damage cables and connectors. Loose tightening can result in inaccurate measurement results.

Therefore always use an appropriate torque wrench, suitable for the type of connector. Rohde & Schwarz offers an optional 5/16" torque wrench that fits for SMA, 3.5 mm, 2.92 mm and 1.85 mm connectors (R&S ZN-ZTW variant 35). Similar wrenches are available for other sizes of spanner, too. For ordering information, see the R&S ZN-ZTW data sheet or product brochure.

3.5.6.3 Diplexer control

Switchover between low frequency and high frequency mode is automatically controlled from the R&S ZNA67EXT network analyzer unit. Use the "H/L Switch" cable to connect the User Port connector on the rear panel of the analyzer to the H/L SWITCH connectors on the top side of the diplexers.

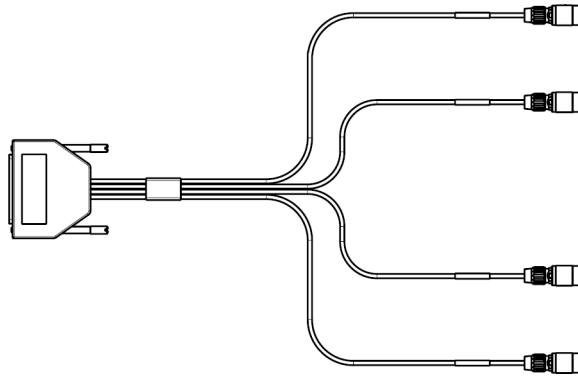

Figure 3-22: H/L SWITCH cable for 4 test sets

The H/L SWITCH cable is supplied with the R&S ZNA67EXT. The cable end labeled H/L SWITCH PORT p is intended for the diplexer connected to analyzer port no. p . The H/L switch mechanism is controlled by drive port bit no. p (pin 15 + p) of the USER CONTROL connector.

For a detailed description of the connector, see [Chapter 12.3.1.1, "User Port"](#), on page 1779.



Low frequency mode

In low frequency mode, the control cable is not needed – even if the DUT is connected to the 1 mm test port connectors of the diplexers.

3.5.6.4 DC power supply

An external DC power supply with country-specific AC cable is provided with each of the external test sets. Connect the power supply to the 9 V / 1.1 A DC input at the rear panel of the frequency converter (see ["Power supply connector"](#) on page 87) and to a power outlet. The power supply supports input AC voltages between 100 V and 240 V and frequencies between 47 Hz and 63 Hz.

A lit LED next to the standby switch indicates that the power supply operates appropriately. If neither of the two LEDs is lit, check the fuse of the instrument (see [Chapter 11, "Maintenance, storage and disposal"](#), on page 1772).

3.5.7 Basic operation

This chapter describes how to configure the standard setup with two external test sets, for 2-port transmission measurements.



On delivery, the R&S ZNA67EXT is already preconfigured for the number of external tests sets included in the ordered VNA system variant. A preset does not affect the converter configuration.

After a factory reset, however, the R&S ZNA67 comes up with its regular VNA setup, without frequency converter configuration.

To put the VNA system into operation, follow the steps described in [Chapter 3.5.5, "Putting the system into operation"](#), on page 92.

Configuration and measurement steps

Configuring the measurement setup and measuring the DUT involves the following steps:

1. Configuring the converters in the R&S ZNA firmware
See [Chapter 3.5.7.2, "Converter configuration"](#), on page 100
2. Establishing the required connections between the R&S ZNA and the test sets
See [Chapter 3.5.6, "Connecting the external test sets"](#), on page 93
3. Power calibration (optional for S parameter measurements)
See [Chapter 3.5.7.4, "Scalar power calibration and leveling \(optional\)"](#), on page 102
4. System error correction, using a suitable calibration kit
See [Chapter 3.5.7.5, "System error correction"](#), on page 105
5. Connecting the DUT
See [Chapter 3.5.7.6, "Mounting a DUT"](#), on page 106
6. Measuring the DUT
See [Chapter 3.5.7.7, "Measurement"](#), on page 106

3.5.7.1 Required equipment

The cabling of the external test sets is described in [Chapter 3.5.6, "Connecting the external test sets"](#), on page 93.

To calibrate the measurement setup, the following equipment is required:

- For power calibration and leveling at the 1 mm port of the external test set, a power meter that covers the measured frequency range, such as the thermal power sensor R&S NRP110T.
(for the latter an additional 1 mm f/f adapter is required)
- Suitable adapters for scalar power calibration of the LO IN and RF IN signals at the external test set
- For system error correction, a 1 mm calibration kit that covers the measured frequency range, e.g the R&S ZV-Z210

3.5.7.2 Converter configuration

Convenient converter configuration is provided with software option R&S ZNA-K8, which is already preinstalled on your R&S ZNA.

1. At the graphical user interface of the R&S ZNA, open the "Converter Configuration" dialog (System – [Setup] key > "Frequency Converter" tab > "Frequency Converter ...").



"Converter 1" is the converter connected to VNA port 1, "Converter 2" the converter connected to VNA port 2.

2. In the "Converter Configuration" dialog, configure the standard setup with two converters:
 - a) For both converter ports, set "Converter Type" to "ZNA67EXT-TS"
The firmware automatically fixes "IF Input" to "Rear & Dir" (rear IF access for high, direct access for low frequencies).
 - b) In the combo box above the "Splitter 1" symbol, select "Conv. LO" as LO source.
 - c) For both converter ports, select "Splitter 1" as the source for the "Local" port.

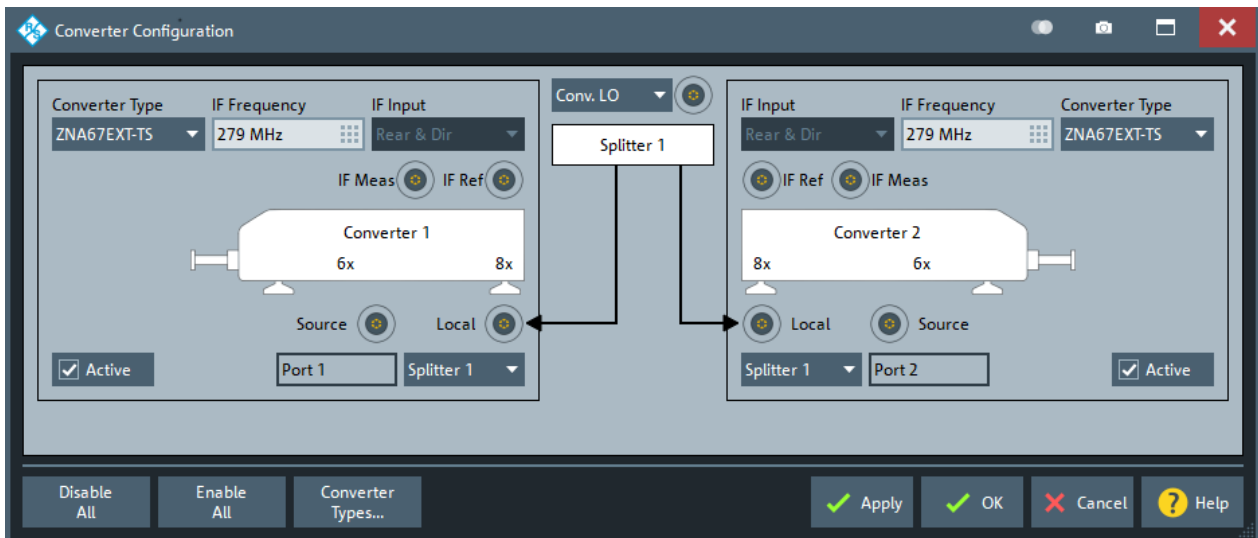

Figure 3-23: Standard setup with two external test sets

3. Select "OK" to apply the converter configuration and close the dialog.

The R&S ZNA now sets the involved ports to their maximum frequency range (10 MHz to 110 GHz). It sets the related [receiver step attenuators](#) to 0 dB, activates [low phase noise](#) mode and deactivates [automatic level control](#). In addition, the firmware adjusts the source power levels according to the properties of the "Rear & Dir" signal paths and the configured cable and splitter losses.



Converter configurations can be saved and loaded via the graphical user interface of the R&S ZNA.

("Save Converter Topology..."/"Load Converter Topology..." on the [Frequency Converter tab](#))

Cable and splitter losses

Check the cable and splitter losses:

1. Open the "Default Cable and Splitter Losses" dialog (System – [Setup] key > "Frequency Converter" tab > "Default Cable and Splitter Losses ...").
2. Adjust "Cable & Splitter Loss" and "Slope", if your cables and splitter losses deviate significantly from the default settings, which fit for cable sets R&S ZCASGO.

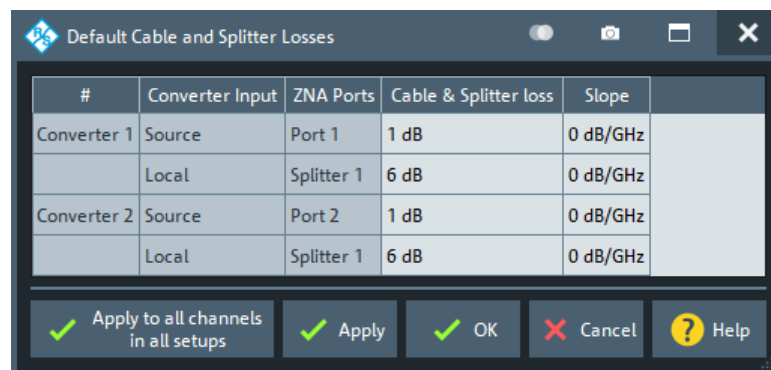

3. Select "OK" to apply your settings and close the dialog.

The resulting frequency and source power levels can be viewed – and tweaked – in the [Port Settings dialog](#).

3.5.7.3 Establishing the RF and IF connections

Refer to [Chapter 3.5.6.2, "RF and LO cabling"](#), on page 96.

3.5.7.4 Scalar power calibration and leveling (optional)

For standard S parameter measurements which do not require precise power levels at the DUT, a power calibration is not required.

To take control of the converter input and output levels, proceed as follows:

1. At the graphical user interface of the R&S ZNA, run the scalar power calibration wizard (Channel – [Cal] key > "Start Cal" tab > "Scalar Power Cal ...")
2. On the first page of the wizard, you can perform source flatness calibrations at the converter inputs.



Perform a source flatness calibration, if the configured values for cable and splitter losses cannot describe the actual ones with sufficient accuracy (sum deviation > 2 dB). See [step 2](#) in [step 2](#).

3. The second page of the wizard offers several calibration types:



- a) "Ref. Receiver"

To perform a reference receiver calibration, connect a power meter with suitable frequency range to the 1 mm port of the respective external test set. During the calibration, the R&S ZNA performs a frequency sweep and uses the power meter readings to correct the readings of the related reference receiver (transfer calibration). We recommend using the Rohde&Schwarz thermal power meter R&S NRP110T.

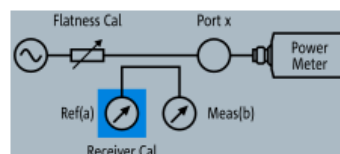

With the default power calibration method of the R&S ZNA, subsequent measurement receiver and source flatness calibrations rely on an existing reference receiver calibration. For output power leveling, an existing reference receiver calibration of the respective port is a prerequisite.

b) "Meas. Receiver"

A measurement receiver calibration adjusts the power readings at the receive port, by default based on an existing reference receiver calibration.

With an existing reference receiver calibration for port 1, to calibrate the measurement receiver of port 1, connect an Open to the 1 mm port of converter 1 and select port 1 as source.

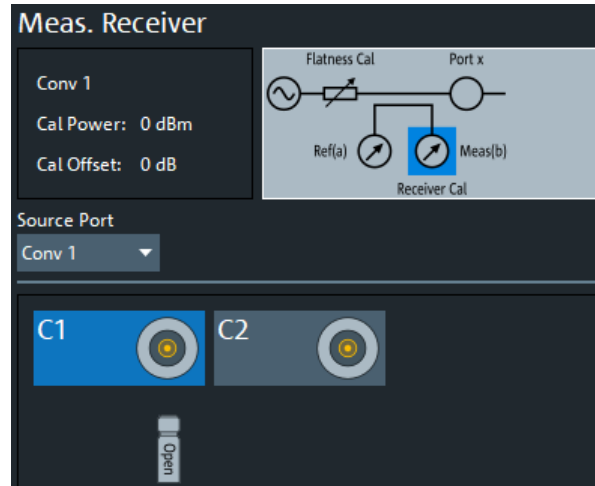

To calibrate the measurement receiver of port 2, connect the 1 mm ports of the test sets directly, and again use port 1 as source.

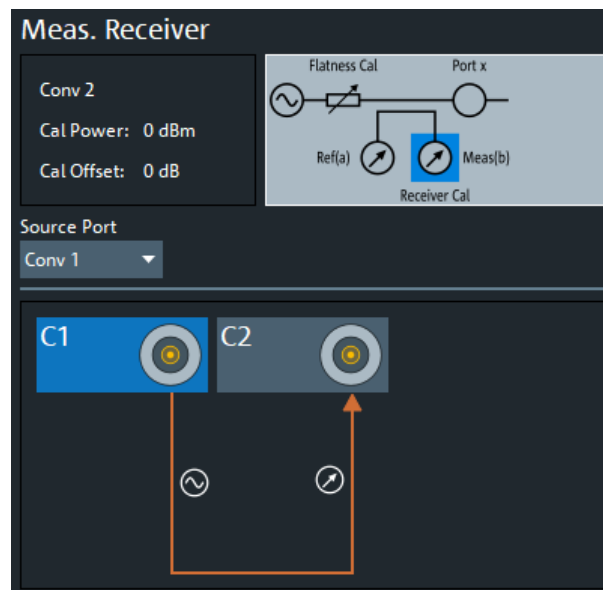

c) "Leveling Table (Global)"

Perform leveling if you want the power levels at the waveguide port to be constant over frequency. Also perform leveling if you want to have frequency-independent, variable, known absolute power levels at the waveguide port. The latter is necessary for power sweeps, but also for [automatic level control](#) (ALC). Use ALC for measurements that require precise power levels at the 1 mm port, in particular for measuring non-linear characteristics of a DUT (compression, intermodulation, spectrum...).

Based on an existing reference receiver calibration, the leveling procedure records the output power on a two-dimensional power/frequency grid. The VNA firmware then uses Interpolation to determine the appropriate RF IN level for the desired output level at a given frequency.

The screenshot displays the 'Leveling Table (Global)' configuration window. On the left, a block diagram shows a signal source connected to a leveling block, which then splits to a reference receiver (Ref(a)) and a measurement receiver (Meas(b)). The measurement receiver is connected to Port x, which is connected to a DUT. The configuration parameters are as follows:

Parameter	Value
Start Frequency	10 MHz
Stop Frequency	110 GHz
Number of Points	201
Min Power	-40 dBm
Max Power	20 dBm
Power Step Size	1 dB
ALC Step Size	<input checked="" type="checkbox"/>

d) "Source Flatness"

Based on an existing reference receiver calibration, the R&S ZNA varies the frequency and adjusts its source power so that the reference receiver readings correspond to the desired output power at the waveguide port of the converter.

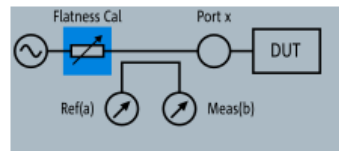

For operation with external test sets, make sure that the [convergence factor](#) is 0.3 or lower.

If leveling data is available for a port, a source flatness calibration is not necessary unless you want to achieve a higher precision at a particular frequency. To get even higher precision within the whole frequency range, use the [automatic level control](#) (ALC) feature of the R&S ZNA. Note that ALC at a converter port requires leveling data for this port.

3.5.7.5 System error correction

For precise S-parameter measurements, a system error correction is recommended. System error correction requires a calibration kit that is suitable for the measured frequency range. For the R&S ZNA67EXT we recommend the 1 mm calibration kit R&S ZV-Z210. The standards in these calibration kits allow for OSM, TOSM, UOSM and TOM calibrations.

The characteristic data of a particular R&S ZV-Z210 is stored on a USB stick shipped with the kit, and must be installed manually, before the kit can be used.



With an additional reference receiver calibration at one of the converter ports, a full n -port system error correction at $n > 1$ converter ports of the same waveguide band can be extended to a SMARTerCal. A SMARTerCal enables (relative) phase *and* (absolute) power accurate measurements of all involved a- and b-waves.

Refer to the documentation of your calibration kit and to [Chapter 4.5, "Calibration"](#), on page 186 for more information.

3.5.7.6 Mounting a DUT

The DUT must be screwed to the 1 mm test port connector at the front of the diplexer. A tight connection is essential to ensure precise calibration and measurement results. Depending on the connectors of the DUT, possibly additional adapters are required.

For n -port measurements, n external test sets must be connected to one DUT. Use the adjustable feet of the test sets to align the DUT accurately.

3.5.7.7 Measurement

After power calibration and system error correction, mount the DUT (see [Chapter 3.5.7.6, "Mounting a DUT"](#), on page 106).

Measurements involving converters can be performed like other measurements. All measured quantities (S parameters, wave quantities, ratios etc.) are available. Power sweeps and [automatic level control](#) can only be activated, if leveling data are available (see [Chapter 3.5.7.4, "Scalar power calibration and leveling \(optional\)"](#), on page 102).

The [Port Settings dialog](#) dialog shows the frequency and power sweep ranges of all implied signals, including RF IN, LO IN and IF output.



- After power-up, a warm-up time of one hour is required to ensure accurate measurements.
- Measurement results can be degraded if the setup is exposed to an electromagnetic field at the IF frequency (default: 279 MHz).
- For pulsed signals, the default IF frequency of 279 MHz cannot be used, because a narrow-band filter is applied at this frequency. Use the "Converter Configuration" dialog to select an IF frequency in the direct path between 30 kHz and 30 MHz instead (see [Figure 3-23](#)).
- If a power splitter is used and the phases of S_{ij} and S_{ji} deviate or drift by equal magnitude, but opposite sign, check the phase stability of the LO paths of the converters.

4 Concepts and features

The following chapter provides an overview of the analyzer's capabilities and their use. It contains a description of the basic concepts that the analyzer uses to organize, process and display measurement data. Also included are descriptions of the screen contents, possible measured quantities, calibration methods and typical test setups.

For a systematic explanation of all softtools, functions and parameters refer to [Chapter 5, "GUI reference"](#), on page 339.

4.1 Basic concepts

The analyzer provides various functions to perform a particular measurement and to customize and optimize the evaluation of results. To ensure that the instrument resources are easily accessible and that user-defined configurations can be conveniently implemented, stored and reused, the instrument uses a hierarchy of structures:

- Global resources can be used for all measurements, irrespective of the current measurement session.
- A recall set comprises a set of diagrams together with the underlying system, channel, trace and display settings. It can be saved to a recall set file and later recalled.
- The diagrams show traces which are assigned to channels. See [Chapter 4.1.3, "Traces, channels and diagrams"](#), on page 108.

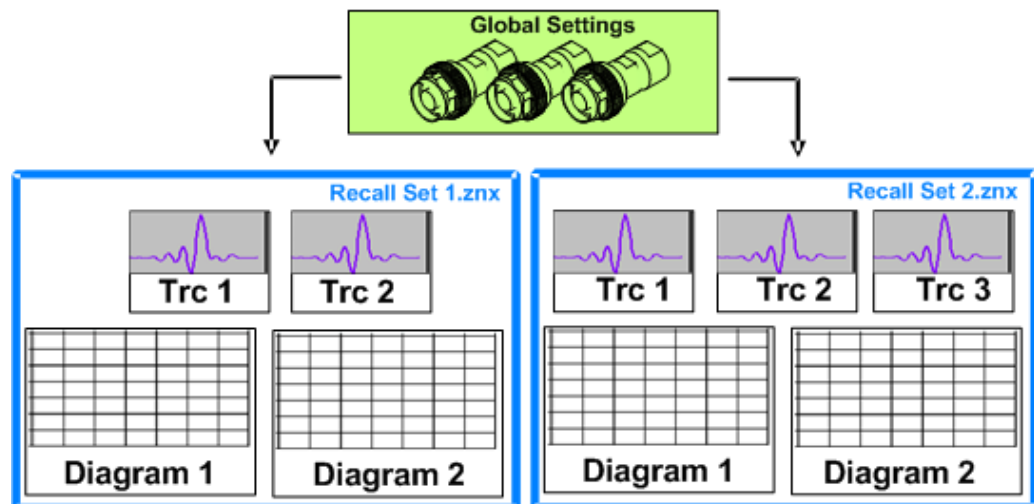

4.1.1 Global (persistent) settings

The analyzer manages global settings that apply to all measurements, irrespective of the current measurement setup. The following list contains examples of global settings:

- Calibration kits
- Connector types

- Cal pool data including system error correction and power correction data
- Directories for trace data, limit lines, calibration data etc.
- Color schemes and printer settings
- System configurations, to be accessed via System – [Setup].
- External power meter, generator, switch matrix, and generic device configurations

Global settings are not part of a recall set nor are they affected by a [Preset] of the analyzer. Many of them can be "Reset" in the "System Config" dialog.

Some settings are session-specific, i.e. they are initialized to default when a new measurement session is started (session settings).

4.1.2 Recall sets

A recall set comprises a set of diagrams together with the underlying system, channel, trace and display settings. The R&S ZNA can handle multiple recall sets in parallel, each of them displayed in a separate tab.



A recall set can be saved to a recall set file (*.znxml | *.znx) and reopened at a later point in time or at another instrument. Use the "Recall Sets" tab of the System – [File Print] softtool to organize recall sets.



A recall set only contains setup instructions, i.e. information on how to measure, how to process the measurement results, and how to display the processed results. It does **not** contain any trace or result data.

4.1.3 Traces, channels and diagrams

The analyzer arranges, displays or stores the measured data in traces which are assigned to channels and displayed in diagrams. To understand the functions of the instrument and quickly find the appropriate settings, it is important to understand the exact meaning of the three terms.

- A trace is a set of data points that can be displayed together in a diagram. The trace settings specify the mathematical operations used to obtain traces from the measured or stored data and to display them.
- A channel contains hardware-related settings which specify how the network analyzer collects data.
- A diagram is a rectangular portion of the screen which is used to display traces. Diagrams belonging to the same recall set are arranged in a common tab. The settings for diagrams are described in [Chapter 4.2.1, "Display elements of a diagram"](#), on page 124.

A diagram can contain a practically unlimited number of traces, assigned to different channels. Diagrams and channels are independent from each other.

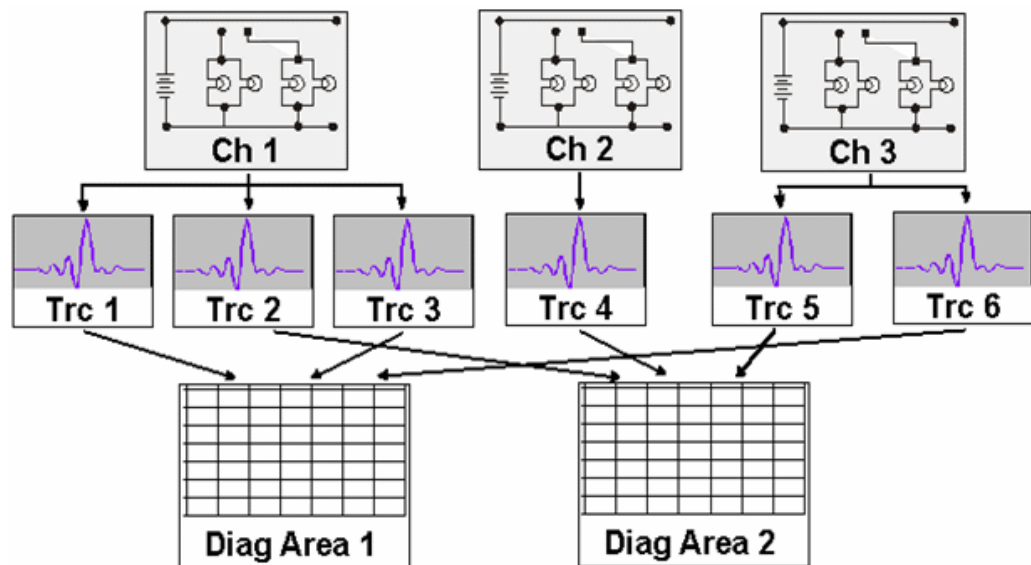

4.1.3.1 Trace settings

The trace settings specify the mathematical operations used to obtain traces from the measured or stored data. They can be divided into several main groups:

- Selection of the measured quantity (S-parameters, wave quantities, ratios, impedances,...)
- Conversion into the appropriate display format and selection of the diagram type
- Scaling of the diagram and selection of the traces associated to the same channel
- Readout and search of particular values on the trace by means of markers
- Limit check

The trace settings can be accessed via the keys in the Trace section of the (virtual) key panel. They complement the [Channel settings](#) accessible via the Stimulus and Channel sections.

Each trace is assigned to a channel. The channel settings apply to all traces of the channel.

4.1.3.2 Channel settings

A channel contains hardware-related settings which specify how the network analyzer collects data. The channel settings can be divided into three main groups:

- Description of the test setup (power of the internal source, IF filter bandwidth, port configuration, receiver step attenuators, ...)
- Control of the measurement process (sweep, trigger, averaging, ...)
- Correction data (calibration, offset, ...)

The channel settings can be accessed via the Stimulus and Channel sections of the (virtual) key panel.

4.1.3.3 Active and inactive traces and channels

A window can display several diagrams simultaneously, each with a variable number of traces. One of these traces is active at each time. The **active trace** is highlighted in the trace list on top of the active diagram (Trc4 in the figure below):

Trc1	S11	Smith	200 mU/ Ref 1 U	Trc2	S12	dB Mag	10 dB/ Ref 0 dB	1	▼
Trc3	S21	dB Mag	10 dB/ Ref 0 dB	Trc4	S22	Smith	200 mU/ Ref 1 U		

When a trace is selected in the diagram area, it becomes the **active trace**. If a previously inactive area is selected as the active area, the trace that was active last time when the area was active again becomes the active trace.

The **active channel** is the channel which belongs to the active trace. The channels of all traces in a diagram are listed at the bottom of the diagram, together with the "Stimulus" values and the display colors of all traces. The active channel is highlighted.

Ch1	Start	5 kHz	—	Pwr	-10 dBm	Bw	10 kHz	Stop	6 GHz
Ch2	Freq	1 GHz	—	Pwr	-10 dBm	Bw	10 kHz	Stop	201
Ch3	Freq	1 GHz	—	Pwr	-10 dBm	Bw	10 kHz	Stop	1 s
Ch4	Start	5 kHz	—	Pwr	-10 dBm	Bw	10 kHz	Stop	6 GHz
Trc4	Start	-1 ns	—	Time	Domain			Stop	4 ns

Channels with no traces are not indicated in the diagrams but can be accessed via the "Channel Manager" dialog.



In manual control, there is always exactly one active trace, irrespective of the number of channels and traces defined. In remote control, each channel contains an active trace.

See also [Chapter 6.3, "Basic remote control concepts"](#), on page 945.

4.1.4 Sweep control

A sweep is a series of consecutive measurements taken over a specified sequence of stimulus values. It represents the basic measurement cycle of the analyzer.

The analyzer can perform:

- sweeps at constant power but variable frequency (frequency sweeps)
- sweeps at constant frequency but variable power (power sweeps)
- sweeps at constant power and frequency that are repeated in time (Time/CW Mode sweeps)

The sweeps are further specified by the number of measurement points and the total measurement time.



The optional [True differential mode](#) introduces additional amplitude and phase imbalance sweeps.

By default, sweeps are repeated continuously. Alternatively, a measurement can also consist of a single sweep or of a specified number of sweeps.



After changing the channel settings or selecting another measured quantity, the analyzer needs some time to initialize the new sweep. This preparation period increases with the number of points and the number of partial measurements involved. It is indicated in the status bar:

Ch1: Avg None **Preparing** 3/20/2018 10:31:16 AM

All analyzer settings can still be changed during sweep initialization. If necessary, the analyzer terminates the current initialization and starts a new preparation period.

During the first sweep after a change of the channel settings, the analyzer displays an asterisk symbol in the status bar.

Ch1: Avg None ★ Ch1 P2 **40%** 3/20/2018 10:30:57 AM

4.1.4.1 Partial measurements and driving mode

Depending on the measurement task and the measured quantities, the measurement at each sweep point can consist of one or several "partial measurements" with definite hardware settings.

- If a single S-parameter is measured (e.g. the reflection coefficient S_{11}), the analyzer can operate at fixed hardware settings. In particular, a fixed source port and receive port is used. Each sweep point requires a single partial measurement. See also [Chapter 4.3.1, "S-parameters"](#), on page 149.
- For a complete two-port S-parameter measurement (e.g. S_{11} , S_{21} , S_{12} , S_{22}) the analyzer needs to interchange the roles of the source and receive ports. Each sweep point requires two partial measurements.

To improve the accuracy, it is possible to insert a delay time before each partial measurement.

In the default **"Alternated"** driving mode, the R&S ZNA performs a partial measurement at all sweep points (partial sweep) before the hardware settings are changed. The next partial measurement is carried out in an additional sweep. In the **"Chopped"** driving mode, the order is reversed, i.e. the measurement proceeds sweep point per sweep point, with varying hardware settings.

See Channel – [Channel Config] > "Mode" > "Driving Mode".

Advantages of alternated and chopped driving mode

If the settling time between sweep points is smaller than the settling time between hardware settings (which is generally true), then the "Alternated" mode is faster than the "Chopped" mode. On the other hand, the "Chopped" mode builds up traces sweep point per sweep point, whereas in the "Alternated" mode you have to wait for the last partial sweep.



Use the "Alternated" mode to increase the accuracy of measurements on DUTs with long level settling times (e.g. quartzes, SAW filters). To measure DUTs with short settling times and obtain a trace from the beginning of the sweep, use "Chopped" mode. In "Auto" mode, the analyzer optimizes the display update: Fast sweeps are performed in "Alternated" mode, slower sweeps in "Chopped" mode.

As an alternative to activating the "Alternated" mode, it is possible to insert a measurement delay before each partial measurement and thus improve the accuracy.

However, the delay slows down the measurement.

Relation to trigger settings

In triggered measurements, "Alternated" has no effect if the triggered measurement sequence is identical to a single sweep point. The following table shows how the analyzer performs a sweep comprising m sweep points, assuming that each of them requires n partial measurements.

Triggered Meas. Sequence	"Alternated" mode	"Chopped" mode
Sweep	Trigger event starts n partial sweeps over all sweep points.	Trigger event starts m complete measurements at consecutive sweep points.
Sweep Segment	Trigger event starts n partial sweeps over the next segment.	Trigger event starts complete measurements at all consecutive sweep points in the segment.
Point	All partial measurements of each sweep point are carried out one after another.	All partial measurements of each sweep point are carried out one after another.
Partial Measurement	Each partial measurement is carried out for all sweep points.	All partial measurements of each sweep point are carried out one after another

4.1.4.2 Parallel measurements on multiple DUTs

The support for parallel measurements on multiple DUTs depends on the analyzer type:

- For a 2-port R&S ZNA without second source, this feature is **not** available (see [Chapter 4.7.23, "Internal 2nd source and 2nd LO generator for 2-port R&S ZNA"](#), on page 303).
- For a 4-port R&S ZNA, VNA ports 1 and 2 can measure one DUT, while port 3 and port 4 can measure another one (using the same stimulus settings). To reduce "crosstalk" between the DUTs, a frequency offset can be applied between the corresponding port groups (see ["Parallel Measurements with Frequency Offset"](#) on page 113)



- Parallel [Frequency Conversion Measurements](#) require identical conversion settings for all port groups
- Parallel [Intermodulation Measurements](#) are **not** supported
- Parallel measurements are **not** possible if [External switch matrices](#) are used

Parallel Measurements with Frequency Offset

When performing parallel measurements, it is possible to specify a minimum frequency offset between the port groups. This is particularly useful for situations where "Cross-talk" between different DUTs would otherwise make the simultaneous measurement impossible (e.g. in wafer prober applications).

Example:

Consider a linear frequency sweep with 101 points from 100 MHz to 200 MHz resulting in a frequency step size of 1 MHz. When two port groups are defined and a minimum frequency offset of 1 MHz is specified, a parallel measurement with frequency offset is performed internally as follows:

- In the first measurement step, no measurements for port group 1 will be performed; measurements for port group 2 will be performed at 100 MHz.
- In the second measurement step measurements for port group 1 will be performed at 100 MHz; measurements for port group 2 will be performed at 101 MHz.
- In the third measurement step measurements for port group 1 will be performed at 101 MHz; measurements for port group 2 will be performed at 102 MHz.
- ...
- In the 101st measurement step measurements for port group 1 will be performed at 199 MHz; measurements for port group 2 will be performed at 200 MHz.
- Finally, in the 102nd measurement step measurements for port group 1 will be performed at 200 MHz; no measurements for port group 2 will be performed.

Parallel measurement with frequency offset is transparent to the user: All port groups will be measured in the requested frequency range. The results are available in the same form as if they were obtained in separate measurements without frequency offset.



Please note that in parallel measurement with frequency offset the firmware uses a modified IF as compared to measurements not using this mode. Because this modified IF requires a special calibration, it is essential to perform the [Calibration](#) with the same Frequency Offset settings as for the actual measurement; otherwise the calibration is turned off (see "[Cal Off label](#)" on page 187).

4.1.4.3 Stimulus and sweep types

The function of the Stimulus keys [Start], [Stop], [Center] and [Span] depends on the sweep type.

Table 4-1: Function of Stimulus keys

Sweep type	[Start](unit)	[Stop] (unit)	[Center] (unit)	[Span] (unit)
"Lin Freq"	"Start Frequency" (Hz)	"Stop Frequency" (Hz)	"Center Frequency" (Hz)	"Span Frequency" (Hz)
"Log Freq"	"Start Frequency" (Hz)	"Stop Frequency" (Hz)	–	–
"Segmented"	–	–	–	–
"Power"	"Start Power" (dBm)	"Stop Power" (dBm)	"CW Frequency" (Hz)	"CW Frequency" (Hz)
"CW Mode"	"CW Frequency" (Hz)	"Number of Points" (-)	"CW Frequency" (Hz)	"CW Frequency" (Hz)
"Time"	"CW Frequency" (Hz)	"Stop Time" (s)	"CW Frequency" (Hz)	"CW Frequency" (Hz)
"Amplitude Imbalance" ^{*)}	"Imb Start Power" (dBm)	"Imb Stop Power" (dBm)	–	–
"Phase Imbalance" ^{*)}	"Imb Start Phase" (deg)	"Imb Stop Phase" (deg)	–	–

^{*)} Available in [True differential mode](#) only

The ranges of numerical values must be compatible with the instrument model. The conditions for the stimulus range depend on the sweep type:

- **"Lin Freq" / "Log Freq" / "Segmented"**
 - For "Lin Freq" and "Log Freq" sweeps, if the number of sweep points is greater than 1, the stop frequency must be greater than the start frequency and the span must be ≥ 1 Hz. If a stop frequency smaller or equal than the current start frequency is set, then the start frequency is adjusted and vice versa.
 - For "Segmented" sweeps, the start and stop frequency in a sweep segment must not be different. So with a segmented sweep you can measure n_1 points at frequency f_1 (in segment 1), n_2 points at frequency f_2 (in segment 2) etc.
- **"Power"**

Start and stop power are both entered in absolute units (dBm). Start and stop power must be different; the stop power must be larger than the start power. If a stop power smaller than the start power is set, then the start power is adjusted automatically and vice versa.

The power corresponds to the actual source power at the test ports (channel base power P_b). After a port power calibration, this source power is available at the calibrated reference plane.
- **"CW Mode"**

The stimulus keys define the fixed stimulus frequency ("CW Frequency") and the "Number of Points" of the measurement. The other sweep parameters (e.g. the "Sweep Time") are set via Channel – [Sweep] > "Sweep Params".
- **"Time"**

The stimulus keys define the fixed stimulus frequency ("CW Frequency") and the total sweep time ("Stop Time") of the measurement. The other sweep parameters (e.g. the "Number of Points") are set via Channel – [Sweep] > "Sweep Params". The sweep time is entered in seconds and must be positive.
- **"Amplitude Imbalance"**

This sweep mode is available in [True differential mode](#) only.

Both "Imb Start Power" and "Imb Stop Power" must be in the range between -150 dBm and 100 dBm. The analyzer generates a balanced signal with configurable frequency and power, however, the amplitude of one signal component or the relative phase of the two components is varied according to this range.

- **"Phase Imbalance"**

This sweep mode is available in [True differential mode](#) only.

Both "Imb Start Phase" and "Imb Stop Phase" must be in the range between -180° dBm and 180°. The analyzer generates a balanced signal with configurable frequency and power, however, the relative phase of the two components is varied according to this range.



The selected sweep range applies to all source and receive ports of the analyzer.

In arbitrary mode (with option R&S ZNA-K4), you can define port-specific frequencies and powers; see [Chapter 5.12.2.2, "Port Settings dialog"](#), on page 668.

4.1.4.4 Wait time control

Equipped with several sources and receivers, and operating in various sweep and measurement modes, the synchronization of a VNA's sub-modules is essential to ensure reliable and reproducible results. To ensure proper synchronization and reproducible measurements, with sources and receivers in settled states, the R&S ZNA FW applies different algorithms to calculate the required wait times in a channel.

Although these wait time algorithms are designed for certain measurement tasks, they are still general and try to balance the conflicting targets of measurement precision and speed. Depending on the measurements to be performed, there can be some room for optimization, especially if for your application speed is more important than accuracy, or vice versa. The wait time control feature of the R&S ZNA allows you to shift the balance towards your primary target, and to observe the detrimental effects on the secondary one.

Wait time control algorithms

The task of calculating "suitable" wait times has to consider many aspects and their dependencies. The overall time the VNA requires to prepare for the next measurement depends on:

- The current and target HW settings (frequency, power, filters etc.)
- The current and target HW usage (generators/synthesizers, step attenuators, internal switches etc.)
- Channel and sweep state (certain channel/sweep events require extra preparation time)

Because the wait times also depend on the accuracy that is required for a particular measurement, the FW distinguishes between three wait time control algorithms:

1. **Mono-frequent:** Calculates wait times that are suitable for mono-frequent measurements.

2. **Frequency-converting:** Calculates wait times that are suitable for measurements on frequency-converting DUTs.
See [Chapter 4.7.3, "Frequency conversion measurements"](#), on page 261.
3. **Slow:** Calculates wait times that are suitable for measurements using external equipment (e.g. power sensors).



Typically, the algorithm for "mono-frequent"/"slow" measurements results in the shortest/longest overall wait times. Frequency-converting measurements rely on the relative power between the ports and hence require higher precision than mono-frequent measurements. So the wait times calculated with this algorithm are typically higher.

But as the wait times also depend on other channel settings, this is not always true.

Automatic vs. manual wait time control

By default, the R&S ZNA automatically selects the appropriate algorithm based on the channel's measurements. However, you can also pick one of the available algorithms and observe the effect on the overall measurement speed and precision. Depending on your channel setup and primary focus (speed vs. precision), selecting another algorithm can be beneficial.

Among other things, the selected [wait time control algorithm](#) determines wait times for the following channel and sweep events:

- Channel begin (channel initialization)
- First point of a channel or after a drive port change
- First point of a segment in a segmented frequency sweep
- First point of a (power) subsweep in a two-dimensional gain compression sweep
- Other sweep points

The calculated wait times depend on the selected algorithm and can be point-specific. In **manual mode**, you can overwrite them with user-defined (fixed) ones, or enforce user-defined lower and/or upper limits.



- Manual settings are particularly useful for applications that require predictable and stable times between measurement points, e.g. antenna measurements.
- Manual settings are for experts only. They can significantly degrade the measurement quality and even make the measurement unstable.
See ["Evaluation of measurement speed and precision"](#) on page 116.

Evaluation of measurement speed and precision

A timing info field presents speed-related information for the current channel:

i	Wait Time	: 321.600 μ s	X
	Measurement Time	: 000.000 s	
	First Point Wait Time	: 002.000 ms	
	SweepRetrace Time	: 072.882 ms	
	SweepCycle Time	: 073.204 ms	
	Avg of Cycle Times	: 079.530 ms	
	Max of Sweep Cycle Time	: 110.279 ms	
	Min of Sweep Cycle Time	: 060.669 ms	
	BusyTime	: 073.658 ms	

Table 4-2: Timing info

"Ch<no>"	The channel ID
"Wait Time"	The total wait time in the measurement
"Measurement Time"	The total time for the measurement, including the wait time
"First Point Wait Time"	The wait time before the first point
"Sweep Retrace Time"	The time between the completion of the measurement and the start of the next measurement. During this time, the HW is idle and the FW finalizes the computation of the last sweep.
"Sweep Cycle Time"	Sum of measurement time and sweep retrace time
"Avg Sweep Cycle Time"	The average of the sweep cycle times since "Show Sweep Timing" is active.
"Max Sweep Cycle Time"	The maximum of the sweep cycle times since "Show Sweep Timing" is active.
"Min Sweep Cycle Time"	The minimum of the sweep cycle times since "Show Sweep Timing" is active.
"Busy Time"	Sum of the sweep cycle times of all channels since "Show Sweep Timing" is active for at least one channel

To evaluate the measurement precision, proceed as follows:

1. Use automatic wait time control to create [memory traces](#) of your measurement results.
2. Compare these memory traces to traces obtained with alternative wait time control

4.1.5 Automatic level control

Automatic level control (ALC) keeps the level of generated waves (source level) at a constant value, irrespective of the DUT's input impedance. The measurement speed is slightly reduced.

Control loop parameters

The analyzer uses a proportional-integral (PI) controller as a feedback controller for ALC. PI controllers provide two control parameters:

- The proportional gain K_p controls the change of the controller output in response to the current error value. If the value is too high, the ALC can become unstable. If it is too low, the ALC possibly does not respond sufficiently to errors and become too slow.

- The integration time T_i controls the change of the controller output based on the integral of the error over time. If the value is high, the ALC becomes slower. If it is too low, the ALC can overshoot and thus become unstable.
The proportional and integration terms are summed to calculate the controller output, so there is a tradeoff between the two terms.
 $T_{control}$ is the (maximum) time the level control is performed – per sweep point. After it has elapsed, the VNA proceeds with the measurement. $T_{control}$ cannot be set by the user.
The control parameters can be set manually, or selected automatically by the analyzer. With automatic ALC parameter setting, the control parameters are determined by the selected ALC bandwidth as shown in the following table.

ALC IF band-width	IF filter (analog): normal			IF filter (analog): wideband, narrowband		
	K_r (dB)	T_i (ms)	$T_{control}$ (ms)	K_r (dB)	T_i (ms)	$T_{control}$ (ms)
20 Hz	0.225	9.5	112.5	0.225	9.5	105.57
30 Hz	0.29	7.5	62.345	0.275	7	60.495
50 Hz	0.3	4.5	36.155	0.275	4.5	48.075
100 Hz	0.34	2.5	29.6	0.6	3.5	26.6
200 Hz	0.85	2.5	20.12	0.0043	0.03	20
500 Hz	1.2	2	13.955	0.65	0.75	5.167
1 kHz	0.8	0.5	3.835	0.3	0.25	1.9
10 kHz	0.66	0.042	0.35	0.3	0.025	0.215
100 kHz	0.11	0.0014	0.04	0.315	0.003	0.031
1 MHz	–	–	–	0.177	.001475	0.04

For some test scenarios, an adjustment of the ALC parameters (loop tuning) can improve the stability and speed of the ALC.

ALC pre-measurement

Since firmware version 2.30 the ALC measurements are performed separately, before the user-requested measurements with their corresponding source settings. The ALC measurements are done one after the other, until all sources have a precise level.

The new pre-measurement allows you to use ALC also for mixer, intermodulation, and group delay measurements. It also induces a more predictable behavior for pulsed measurements and higher precision for phase coherent source signals.

ALC optimization

To reduce the overall measurement time, the ALC pre-measurements can also be performed in a speed-optimized way. By default this optimization is done if a single source is using ALC, but **not** if pulsed or phase coherent source signals are generated.

ALC deembedding

This feature allows the ALC to consider the configured [offset](#) or single-ended [deembedding network](#). The target power then refers to the DUT port instead of the calibration plane.

ALC with mmWave converters

Loop tuning is particularly beneficial for frequency converters R&S ZC500, R&S ZC750, and R&S ZC1100.

To use ALC with mm-wave converters, suitable [leveling data](#) is required. The leveling data must use a step size of 1 dB, which can be enforced with the [ALC Step Size](#) setting.

4.1.6 Power correction from pre-measurement

The "power correction from pre-measurement" feature is an alternative to [ALC](#). It uses power values measured in the previous sweep or in several dedicated correction sweeps to adjust the power in the current sweep. In contrast to ALC, which requires additional time during each sweep, the power correction from pre-measurement does not change the time required per point.

Core applications are pulsed stimuli, with pulses too short to run ALC, even in a separate pulse.

Correction logic

- Similar to ALC, a particular wave (port and REF/MEAS) can be selected for correction
- The start value is the power defined by the user, including the [source flatness calibration](#), if available
- The firmware calculates the power of the calibrated wave and compares it to its nominal value. If it observes a (significant) deviation, it adjusts the HW settings for the next measurement.
- The pre-measurement sweep is done with the same settings as the measurement sweep



- Power correction from pre-measurement cannot be combined with ALC.
- During calibration, power correction from pre-measurement is temporarily disabled.

Pre-measurement mode

There are two pre-measurement modes:

- **"Continuous"**: The correction is applied from one sweep to the next. It integrates seamlessly into the standard processing, but can lead to frequently changing HW settings.

- **"Once"**: At the initial start of the measurement, the firmware runs a user-defined number of pre-measurement sweeps. Subsequent sweeps are run with the derived, constant HW settings



In "Once" mode, during the pre-measurement averaging is (temporarily) disabled.

4.1.7 Data flow

The analyzer processes the raw measurement data in a sequence of stages to obtain the displayed trace. The following subsections give an overview.

4.1.7.1 Channel data flow

The diagram below illustrates the data processing stages for the entire channel. All stages are configurable.

Note that the channel data flow for S-parameters (and quantities derived from S-parameters such as impedances, admittances, stability factors) differs from the channel data flow for wave quantities (and derived quantities such as ratios).

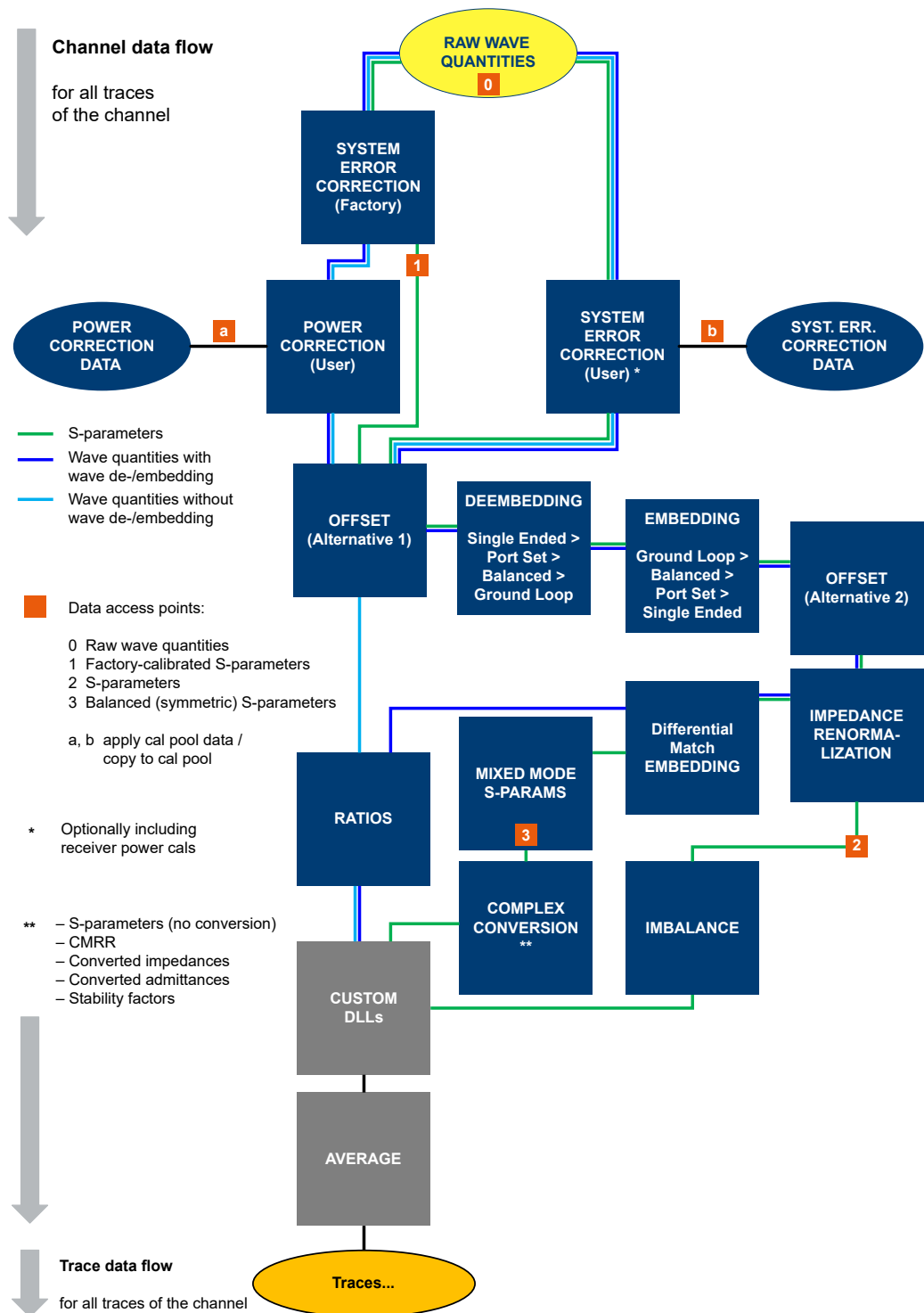

Figure 4-1: Channel data flow

Wave de-/embedding

In its original implementation, de-/embedding was calculated on the S-parameter branch of the channel calculation chain. After applying factory calibration and/or user

calibration on the measured wave quantities, intermediate results were transformed to the S-parameter domain. Before each **de-/embedding** step, the S-parameters were transformed to conductance (~ wave quantities), and vice versa afterwards.

The new "wave de-/embedding" remains in the wave quantity (~conductance) domain and calculates all de-/embedding steps in one multiplication step, without unnecessary matrix inversions. With "wave de-/embedding", the computation time does not depend on the number of embedding and/or de-embedding steps but is constant.

4.1.7.2 Trace data flow

The diagram below illustrates the processing stages the channel measurement data run through for each individual trace. Again, all stages are configurable.

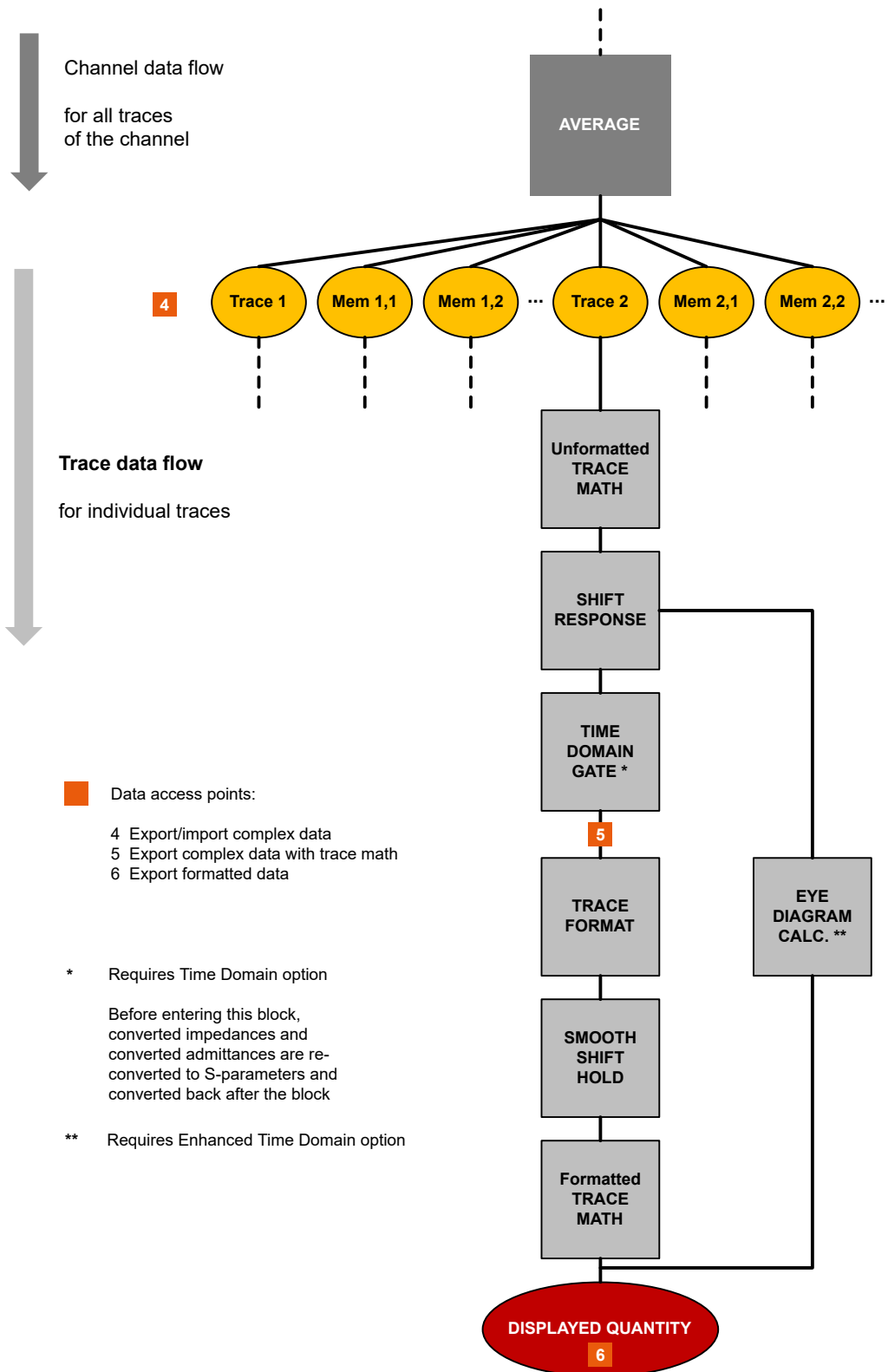

4.2 Screen elements

This section describes manual operation of the analyzer, including trace settings, markers and diagrams. For a description of the different quantities measured by the instrument, refer to [Chapter 4.3, "Measurement results"](#), on page 149.

4.2.1 Display elements of a diagram

The central part of the screen is occupied by one or more diagrams.

A diagram is simply a rectangular portion of the screen used to display traces. Diagrams are independent of trace and channel settings. A diagram can contain a practically unlimited number of traces which can be assigned to different channels.

Most diagram settings are arranged in the "Display" softtool (key System – [Display]). To assign traces and channels to diagrams, use the control elements on the "Traces" > "Traces" and "Channel Config" > "Channels" softtool tabs (keys Trace – [Trace Config] and Channel – [Channel Config]).

Diagrams can contain:

- A title (optional)
- The diagram number (or label)
- Measurement results, in particular traces and marker values (optional)
- An indication of the basic channel and trace settings
- Context menus providing settings which are related to a particular display element
- Error messages



The examples in this section have been taken from Cartesian diagrams. All other diagram types provide the same display elements.

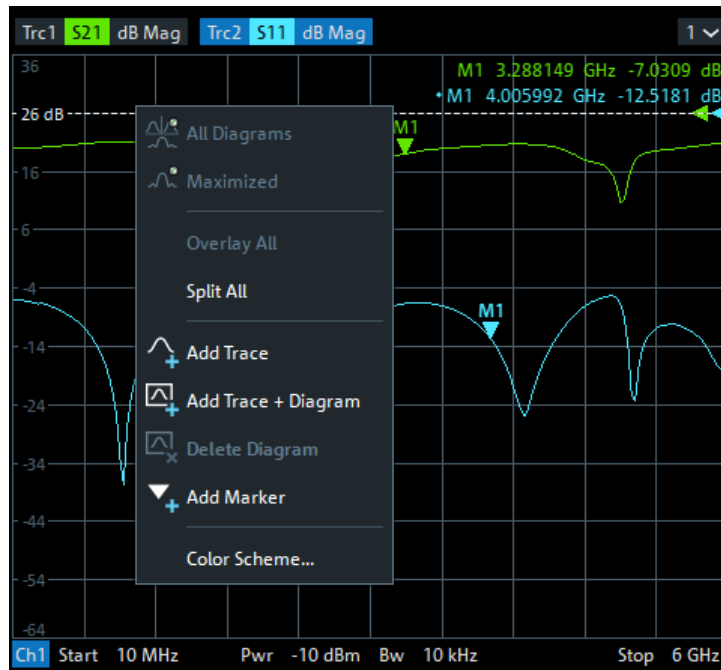

4.2.1.1 Title

An optional title across the top of the diagram can be used for a brief description of the diagram contents.

S-Parameter Measurement



Select System – [Display] > "Diagram" > "Title" to enter the diagram title and "Show Title" to display or hide it.

4.2.1.2 Traces

A trace is a set of data points displayed together in the diagram. The individual data points are connected so that each trace forms a continuous line.

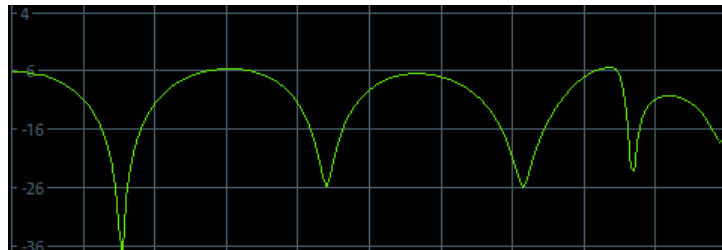

The trace can be complemented by the following display elements, plotted with the same color:

- Reference value (for all traces): The reference value is indicated with a triangle at the right edge of the diagram and a dashed, horizontal line. The value and position

of the triangle can be changed to modify the diagram scale and shift the trace vertically.

- Measured quantity (for the active trace): The measured quantity is indicated in the trace list; see ["Trace list and trace settings"](#) on page 126.

A trace can be either a data trace, a memory trace, or a mathematical trace; see ["Trace types"](#) on page 126.

Trace types

The analyzer uses traces to display the current measurement result in a diagram. It is also capable of storing traces to the memory, recalling stored traces, and defining mathematical relations between different traces. There are three basic trace types:

- Data traces show the current measurement data and are continuously updated as the measurement goes on. Data traces are dynamic traces.
- Memory traces are generated by storing the data trace to the memory. They represent the state of the data trace at the moment when it was stored. Memory traces are static traces which can be stored to a file and recalled.
- Mathematical traces are calculated according to a mathematical relation between constants and the data or memory traces of the active recall set. A mathematical trace that is based on the active data trace is dynamic.

It is possible to generate an unlimited number of memory traces from a data trace and display them together. Markers and marker functions are available for all trace types.



The type of each trace in a diagram is indicated in the trace list: "MEM<no>" at the beginning of the trace name indicates a memory trace (with default naming), Math at the end of the trace label indicates a mathematical trace. You can also hide a trace ("Invisible") without deleting it.

Trc1	S11	dB Mag	10 dB/Ref 0 dB	Ch1	Math	Mem5[Trc1]	S11	dB Mag	10 dB/Ref 0 dB	Ch1
Trc5	S21	dB Mag	10 dB/Ref 0 dB	Ch2	Invisible					

Trace list and trace settings

The main properties of all traces assigned to the diagram are displayed in the trace list in the upper part of the diagram.

Trc1	S11	dB Mag	10 dB/Ref 0 dB	Ch1	Math	Mem5[Trc1]	S11	dB Mag	10 dB/Ref 0 dB	Ch1
Trc5	S21	dB Mag	10 dB/Ref 0 dB	Ch2	Invisible					

Each line in the trace list describes a single trace. The active trace is highlighted ("Trc5" in the example above). The lines are divided into several sections with the following contents (from left to right):

- The **trace name** appears in the first section. The default names for new traces are Trc<n> with n automatically selected. A "Mem..." at the beginning of the trace name indicates a memory trace (default naming). To change the trace names, open the "Trace Manager" from any trace name segment's context menu.
- The **measured quantity** (e.g. an S-parameter or a ratio) appears on a colored background. The source port for wave quantities and ratios is indicated in brackets.

- The **format** section shows how the measured data is presented in the graphical display. Use the context menu of the format section to change the format of the related trace.
- The next sections show the value of the vertical or radial diagram divisions ("Scale Div.") and the reference value ("Ref").
- The **channel** section shows the channel that each trace is assigned to. It is omitted if the all traces in the diagram are assigned to the same channel.
- The **type** section indicates "Invisible" if a trace is hidden and Math if the trace is a mathematical trace. "Gat" indicates that a time gate is active for the trace. Use the "Mem Math" and "Traces" tabs of the "Traces" softtool to display and hide data and memory traces, and to define mathematical traces.



- The respective section's context menu (except for the type section) provides access to the most common related tasks.
- If the size of the diagram is too small, some of the sections are hidden. Enlarge or maximize the diagram to display all sections.

Example:

The following context menu is assigned to the measured quantity section in the trace list:

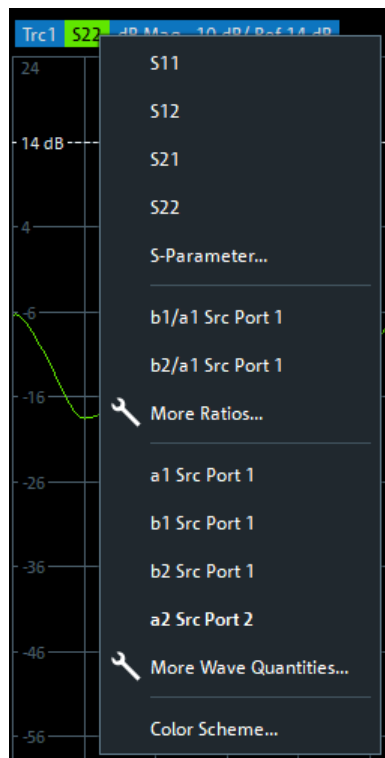

A label "Cal Off" appears at the end of the trace line if the system error correction no longer applies to the trace.

4.2.1.3 Markers

Markers are tools for numerical readout of measured data and for selecting points on the trace, or, in general, in the diagram area. A marker is displayed with a symbol (e.g. a triangle, a crossbar or a line) on the trace, which can be a data trace or a memory trace. At the same time, the coordinates are displayed in a marker info field or in a table. Each marker can be defined as a normal marker (M), reference marker (R), or delta marker (Δ M).

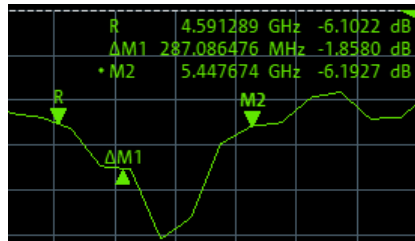

- A normal marker ("M1, M2...") determines the coordinates of a measurement point on the trace.
- The reference marker ("R") defines the reference value for all delta markers.
- A delta marker ("DeltaM1, DeltaM2...") indicates the coordinates relative to the reference marker.

A special set of markers M1 to M4 is provided for bandfilter search mode.

The most common tasks to be performed with markers can be achieved using the "Marker" menu functions:

- Determine the coordinates of a measurement point on the trace. In polar diagrams where no x-axis is displayed, markers can be used to retrieve the stimulus value of specific points.
- Determine the difference between two trace points or the relative measurement result ("Delta Mode").
- Convert a complex measurement result into other formats.

Markers also play an important role in performing the following advanced tasks:

- Change the sweep range and the diagram scale ("Marker Function").
- Search for specific points on the trace ("Marker Search", "Target Search", "Bandfilter").

Activating and moving markers

To activate a marker, either select the marker symbol itself or the corresponding line in the marker info field.

To move the active marker on the trace, use one of the following methods:

- Drag the marker symbol to the desired position (Cartesian diagrams only).
- Activate the "Markers" tab of the "Marker" softtool (Trace – [Marker]) and enter the related stimulus value numerically.
- Use the functions on the "Marker Search" softtool tab to move the marker to a specific position.



If the marker position is adjusted using the roll key, the mouse or the cursor keys, it always remains within the sweep range. If set explicitly by entering a numeric value, the marker position can be outside the sweep range. In this case, the marker symbol is automatically positioned to the start or stop value of the sweep range, whichever is closer.

Marker info field

The coordinates of all markers defined in a diagram can be displayed in the info field, which by default is located in the upper right corner.

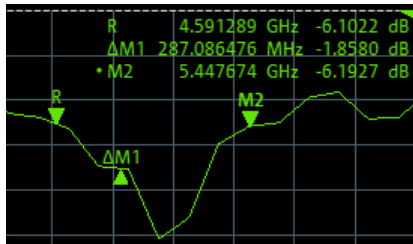

The info field contains the following information:

- "M1, M2..." denote the marker numbers. Markers are displayed with the same color as the associated trace.
- The marker coordinates are expressed in one of the marker formats selected via Trace – [Marker] > "Marker Props" > "Marker Format". The formats of the markers assigned to a trace are independent of each other and of the trace format settings. For harmonics traces, the label shows a "H<order>" below the x-axis frequency
- The active marker has a dot placed in front of the marker line.
- "R" denotes the reference marker. A "Δ" sign placed in front of the marker line indicates that the marker is in delta mode.

Open the context menu of the marker info field to access frequently used marker settings.

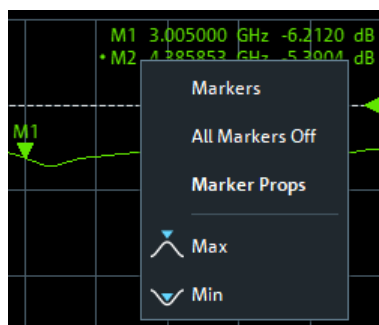

Customizing the marker info field

To change the position, appearance or contents of the marker info field, use one of the following methods:

- The info field can be moved to several positions in the upper and lower part of the active diagram. Drag & drop it to the desired position.

- To change the format of the active marker, select [TRACE] > "Marker" > "Marker Properties" > "Marker Format".
- To express the coordinates of the active marker relative to the reference marker, activate the delta mode [TRACE] > "Marker" > "Marker Properties" > "Delta Mode".



Info Table

If you wish to reserve the full diagram space for traces, you can drag & drop the marker info field to the info table.

M1	Trc1	5.130001	GHz	-15.6388	dB	Bandstop	Trc1	Ref to Max	Track
M2	Trc1	4.718891	GHz	-7.3323	dB	Bandwidth		535.657892	MHz
M3	Trc1	5.254549	GHz	-7.3323	dB	Center		4.979523	GHz
M4	Trc1	4.979523	GHz	-9.5924	dB	Lower Edge		4.718891	GHz
						Upper Edge		5.254549	GHz
						Quality Factor (3dB)		9.296	U
						Loss		15.6388	dB

The info table is hidden by default. To display it, open the "Display" softtool (System – [Display]), activate its "Config" tab and select "Info Table" – "Show".

Marker format

Marker values can be formatted according to the current trace format, according to the default marker format of the related trace (Trace > [Format] > "Format" > "Dflt Marker Frmt"), or formatted individually (Trace > [Marker] > "Marker Props" > "Marker Format").

The available marker formats are defined for all measured quantities and trace formats (see [Chapter 4.2.3.3, "Measured quantities and trace formats"](#), on page 148). Essentially, a marker format is simply a conversion between points on a complex-valued trace (the raw measurement data) and the respective target format. This must be kept in mind when interpreting the results and physical units displayed.

The following table describes how a complex marker value $z = x + jy$ is converted. It makes use of the polar representation $z = x + jy = |z| e^{j\varphi(z)}$, where

$$|z| = (x^2 + y^2)^{1/2} \text{ and } \varphi(z) = \arctan(y/x)$$

Table 4-3: Marker formats

Marker Format	Description	Formula
Default	<ul style="list-style-type: none"> • For an individual marker, this means that the marker is formatted according to the default marker format of the related trace. • For a trace's default marker format, this means that the default format is (dynamically) adjusted according to the selected trace format. 	–
Lin Mag	Magnitude of z, unconverted	$ z = \sqrt{x^2 + y^2}$
dB Mag	Magnitude of z in dB	$\text{dB Mag}(z) = 20 * \log z \text{ dB}$
Phase	Phase of z	$\varphi(z) = \arctan(y/x)$
Delay	Group delay, neg. derivative of the phase response ¹⁾	$-\text{d}\varphi(z) / \text{d}\omega$, where ω denotes the stimulus frequency

Marker Format	Description	Formula
Real	Real part of z	$\text{Re}(z) = x$
Imag	Imaginary part of z	$\text{Im}(z) = y$
SWR	(Voltage) Standing Wave Ratio	$\text{SWR} = (1 + z) / (1 - z)$
dB Mag Phase	Magnitude of z in dB and phase in two lines	$20 * \log z \text{ dB arctan} (\text{Im}(z) / \text{Re}(z))$
Lin Mag Phase	Magnitude of z (unconverted) and phase in two lines	$ z \text{ arctan} (\text{Im}(z) / \text{Re}(z))$
Real Imag	Real and imaginary part of z in two lines	x y
R + j X or R + j X series ^{***)}	(Series) impedance: Unnormalized (series) resistance, reactance, and either inductance or capacitance, in three lines (Smith diagram)	R_s X_s L_s or C_s ^{**)}
R + j X parallel ^{****)}	Parallel impedance: Unnormalized parallel resistance, reactance, and either inductance or capacitance, in three lines (Smith diagram)	R_p X_p L_p or C_p ^{**)}
G + j B or G + j B series ^{***)}	(Series) admittance: Unnormalized (series) conductance, susceptance, and either inductance or capacitance, in three lines (Inverted Smith diagram)	G_s B_s L_s or C_s ^{**)}
G + j B parallel ^{****)}	Parallel admittance: Unnormalized parallel conductance, susceptance, and either inductance or capacitance in three lines (Inverted Smith diagram)	G_p B_p L_p or C_p ^{**)}
Imp Mag or IMP Mag series ^{***)}	Magnitude of (series) impedance ^{**)}	$ Z_s = (R_s^2 + X_s^2)^{1/2}$
Imp Mag paral- lel ^{****)}	Magnitude of parallel impedance ^{**)}	$ Z_p = (R_p^2 + X_p^2)^{1/2}$
Adm Mag or Adm Mag series ^{***)}	Magnitude of (series) admittance ^{**)}	$ Y_s = (G_s^2 + B_s^2)^{1/2}$
Adm Mag paral- lel ^{****)}	Magnitude of parallel admittance ^{**)}	$ Y_p = (G_p^2 + B_p^2)^{1/2}$
Index	Index of the current sweep point	–
Noise	Noise power density measured at the marker position (1 Hz bandwidth).	Cum On, Feel the Noize ...

^{*)} The delay aperture is defined in the [Trace Config] > "Format" softtool.

^{**)} An impedance Z is represented as $Z = R + jX$, the corresponding admittance as $Y = 1/Z = G + jB$. For $X \geq 0$, we have an inductance $L = X/\omega$, for $X < 0$ we have a capacitance $C = 1/(\omega X)$, where ω denotes the stimulus frequency.

****)Only available for transmission measurements (see [Chapter 4.3.3.1, "Converted impedances"](#), on page 154)

Marker coupling

It connects the markers of a set of traces.

Marker coupling allows you to compare different measurement results (assigned to different traces) at the same stimulus value. It connects the markers of a set of traces.

Marker coupling can be enabled:

- either for all traces in the active recall set that have the same stimulus variable as the active trace
- or for all traces in a channel
- or for all traces in a diagram that have the same stimulus variable as the active trace

When marker coupling is enabled, the same markers are activated for all related traces: if a marker was active for some related trace, then it is activated for all related traces.

While marker coupling is active, the marker sets of the related traces are always kept in sync, i.e.:

- If a marker is added to (removed from) one of the related traces, it is also added to (removed from) the other related traces.
- If a marker is moved to a particular stimulus value for one of the related traces, then it is moved to this stimulus value for all related traces.
If the new stimulus value is outside a trace's sweep range, the marker value is invalid for this trace. The corresponding info field only displays the stimulus value.



Only one kind of marker coupling can be enabled. For instance it is not possible to couple markers per channel and per diagram at the same time.

Basic marker search functions

The search functions are tools for searching measurement data according to specific criteria. A search consists of analyzing the measurement points of the current trace (or of a user-defined subrange termed the "Search Range") to find one of the following:

- Absolute or relative (local) maxima and minima (peak search).
- Trace points with a specific response value (target search).
- Trace segments with a shape that is characteristic for bandpass or bandstop filters (bandfilter search); see ["Bandfilter search"](#) on page 133.

When the search is activated, the active marker is moved to the (next) point that meets the search criteria. If the trace contains no markers, a marker M1 is created and used for the search. The search result is displayed in the marker info field. If no search result can be found, the marker remains at its original position.

Some search functions can be activated repeatedly to find all possible search results. Moreover the analyzer provides a "Tracking" mode where the search is repeated after each sweep.

Multiple peak search

Multiple peak search allows you to find multiple local minima/maxima at once. Markers 1 to 10 are assigned to the peaks detected from the start frequency towards the stop frequency. Multiple peak search uses its own search and tracking settings; search and tracking settings for standard marker search are ignored.

Bandfilter search

In a bandfilter search, the R&S ZNA locates trace segments with a bandpass or bandstop shape and determines characteristic filter parameters.

Bandpass and bandstop regions can be described with the same parameter set:

- A bandpass region contains a local maximum around which the magnitude of the trace falls off by more than a specified value.
- A bandstop region contains a local minimum around which the magnitude of the trace increases by more than a specified value.

The analyzer locates bandpass and bandstop regions and determines their position ("Center" frequency) and shape ("Bandwidth", "Lower Edge" and "Upper Edge", quality factor. For a meaningful definition of the bandwidth factor, the trace format must be "dB Mag".

Bandstop	Ref to Max	Track
Bandwidth	473.584123	MHz
Center	5.008818	GHz
Lower Edge	4.777620	GHz
Upper Edge	5.251205	GHz
Quality Factor (3dB)	10.576	U
Loss	14.9467	dB

The info field contains the following search results:

- "Bandwidth" is the n-dB bandwidth of the bandpass/bandstop region, where n is a selectable bandwidth factor. The bandwidth is equal to the difference between the lower and the upper band edge frequency.
- "Center" is calculated as the geometric or arithmetic mean of the lower band edge frequency f_{LBE} and the upper band edge frequency f_{UBE} :

$$f_{Center} = \sqrt{f_{LBE} * f_{UBE}} \quad (\text{geometric mean}) \text{ or}$$

$$f_{Center} = 1/2 (f_{LBE} + f_{UBE}) \quad (\text{arithmetic mean})$$

The arithmetic mean is always higher than the geometric mean. The values are close if the bandwidth is small compared to the geometric mean of the band edges.
- "Lower Edge" is the closest frequency below the maximum (or minimum), where the trace value is equal to the maximum (minimum) value minus (plus) n dB.
- "Upper Edge" is the closest frequency above the maximum (or minimum), where the trace value is equal to the maximum (minimum) value minus (plus) n dB.
- The "Quality Factor (3 dB)" is the ratio between the "Center" frequency and the 3-dB "Bandwidth"; it does not depend on the selected bandwidth factor.
- The "Quality Factor (BW)" is the ratio between the "Center" frequency and the "Bandwidth" displayed above. This result is available only if the selected bandwidth factor is different from 3 dB.

- "Loss" is the loss of the filter at its maximum (or minimum) and is equal to the response value of marker no. 1. For an ideal bandpass filter, the loss is zero (0 dB), for an ideal bandstop filter it is $-\infty$ dB.

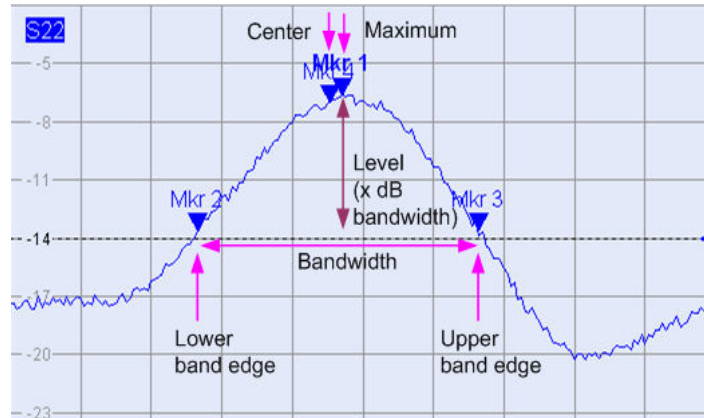

4.2.1.4 Channel list and channel settings

The main properties of all channels assigned to the traces in the diagram are displayed in the channel list below the diagram.

Ch1	Start	5 kHz	—	Pwr	-10 dBm	Bw	10 kHz	Stop	6 GHz
Ch2	Freq	1 GHz	—	Pwr	-10 dBm	Bw	10 kHz	Stop	201
Ch3	Freq	1 GHz	—	Pwr	-10 dBm	Bw	10 kHz	Stop	1 s
Ch4	Start	5 kHz	—	Pwr	-10 dBm	Bw	10 kHz	Stop	6 GHz
Trc4	Start	-1 ns	—	Time	Domain			Stop	4 ns

Each line in the channel list describes a single channel. The channel of the active trace is highlighted. The lines are divided into several sections with the following contents (from left to right):

- The "Channel Name" appears in the first section. The default names for new channels are Ch<n> with an automatically assigned number <n>. If a time domain transform is active, the R&S ZNA displays an additional line to indicate the stimulus range of the displayed time-domain trace. Open the "Channel Manager" from the name segment's context menu to change the channel name.
- The **measurement mode identifier** section (optional) indicates a special test mode of the channel, e.g. the measurement at arbitrary port frequencies ("Arb Port n").
- **Start** indicates the lowest value of the sweep variable (e.g. the lowest frequency measured), corresponding to the left edge of a Cartesian diagram.
- The **color legend** shows the display color of all traces assigned to the channel. The colors are different, so the number of colors is equal to the numbers of traces assigned to the channel.
- The values behind the color legend show the **constant stimulus value**, which is either the power of the internal signal source (for frequency sweeps and time

sweeps) or the CW frequency (for power sweeps), and the measurement bandwidth ("BW").

- **Stop** indicates the highest value of the sweep variable (e.g. the highest frequency measured), corresponding to the right edge of a Cartesian diagram.



Open a segment's context menu to access common related tasks.

Example:

The following context menu is assigned to the channel name section:

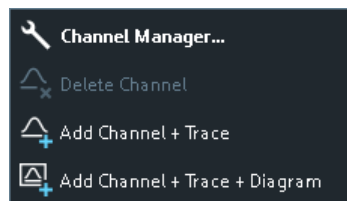

The settings in the context menus correspond to the most common functions in the Channel – [Channel Config] > "Channels" softtool tab, the "Stimulus" softtool (opened via Stimulus keys), the Channel – [Sweep] > "Sweep Params" softtool tab, and the Channel – [Pwr Bw Avg] softtool.

4.2.1.5 Context menus

To provide access to the most common tasks and speed up the operation, the analyzer offers context menus (right-click menus) for the following display elements:

- Diagram
- Marker info field
- Trace list (separate context menus for trace name section, measured quantity section, format section, scale section, and channel section)
- Channel list (separate context menus for channel name section, sweep range section, additional parameter section)

To open a context menu associated with a display element, tap and hold the element for some seconds. Right-click the display element if you are using a mouse.

Example:

The following context menu is assigned to the channel name section in the channel list:

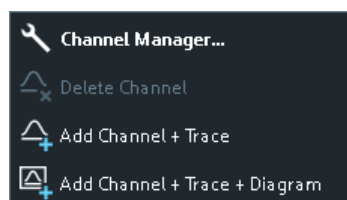

The functions of the context menu can also be called using the menu bar or the related softtool panels. Use whatever method is most convenient.

4.2.2 Dialogs

Dialogs provide groups of related settings and allow to make selections and enter data in an organized way. All softkeys with three dots behind their labeling (as in "Balanced Ports...") call up a dialog. The dialogs of the analyzer have an analogous structure and several common control elements.

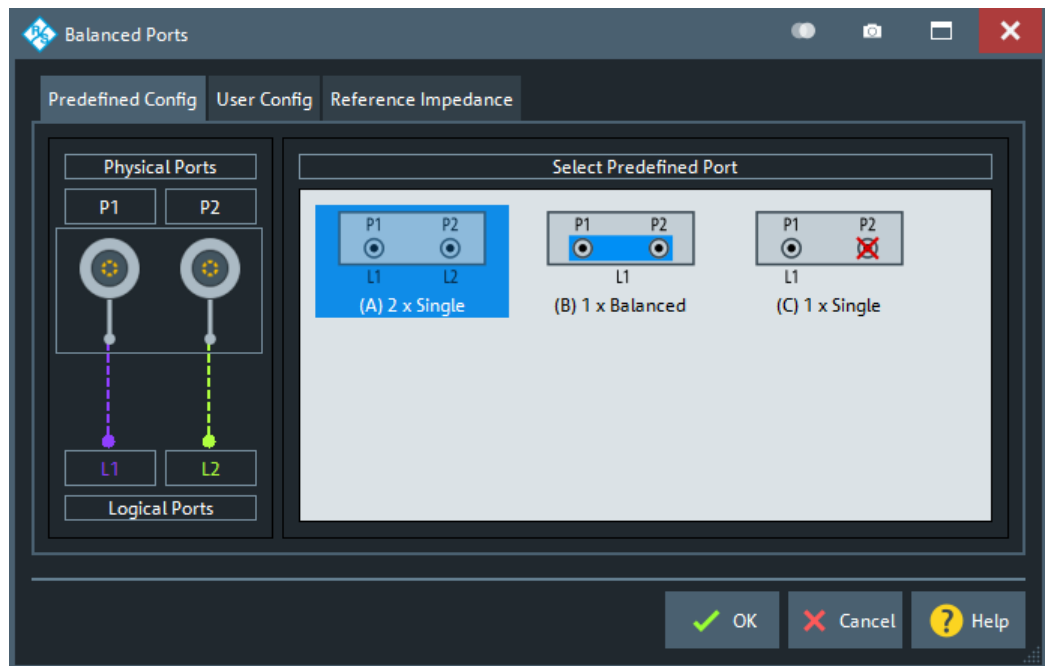

Dialogs are controlled in the usual way. For an introduction, refer to [Chapter 3.3.4, "Working with dialogs"](#), on page 57.

4.2.2.1 Immediate vs. confirmed settings

In some dialogs settings take effect immediately, so that the effect on the measurement is observable while the dialog is still open. This behavior is particularly useful when a numeric value is incremented or decremented, or when display elements are added or removed.

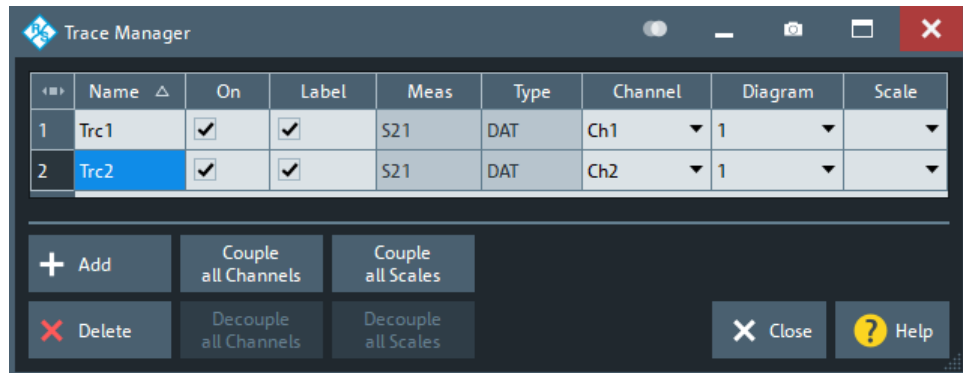

In most dialogs, however, it is possible to cancel an erroneous input before it takes effect. The settings in such dialogs must be confirmed explicitly.

The two types of dialogs are easy to distinguish:

- Dialogs with immediate settings provide a "Close" button but no "OK" button.
Example: "Trace Manager" dialog
- Dialogs with confirmed settings provide both an "OK" button and a "Cancel" button.
Example: "Balanced Ports" dialog



Immediate settings can be undone using the "Undo" toolbar icon.

4.2.2.2 Common dialogs

Open Dialog

The "Open File" dialog is used to open various file types (cal kit data, limit lines, sweep segment lists, ...).

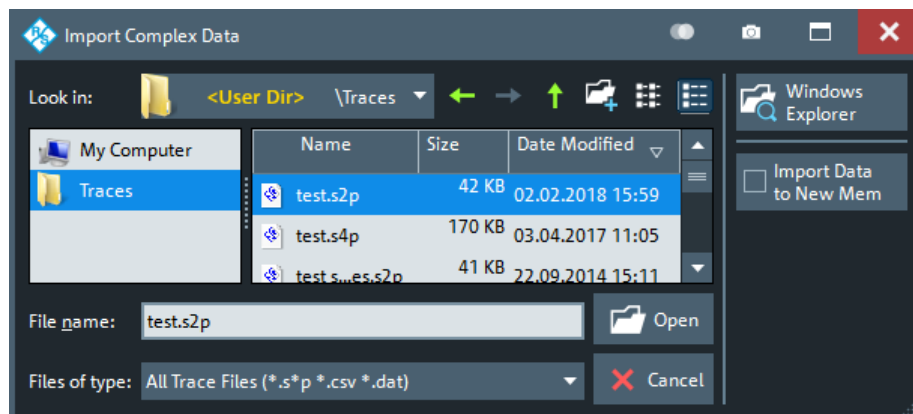

Depending on the context, the dialog is displayed with different caption, default directory ("Traces" in the above screenshot), and file type filters. Context-specific options ("Import Data to New Mem" in the above screenshot) are accessible via controls in the section below the "Windows Explorer" button.

- "Look in:" specifies the directory to be listed. The icons to the right of the pull-down list are provided for easy navigation in the file system (place the cursor on the icons to obtain "Whats this" help).
- "Windows Explorer" opens the selected directory in the Windows Explorer.
- "File name" specifies a filename to save the current data. The analyzer adds the extension in the "Files of type" field.
- "Files of type" filters the displayed files by type.
- "Open" opens selected file and closes the dialog.
- "Cancel" closes the dialog without opening a file.

Tip: Dialog properties (e.g. the current directory) are remembered when the dialog is closed. To restore default directories, select "Use Default Directories" in the [Presets tab](#) of the "System Config" dialog.

Save Dialog

The "Save" dialog is used to store various data types (e.g. cal kit data, limit lines, sweep segment lists, ...).

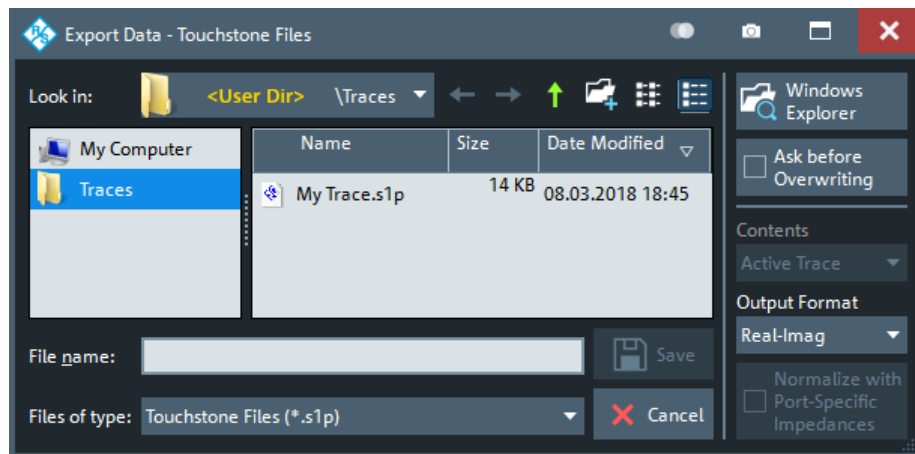

Depending on the context, the dialog is displayed with different caption, default directory ("Traces" in the above screenshot), and file types. Context-specific options (e.g. "Output Format" in the dialog above) are accessible via controls in the section below the "Ask Before Overwriting" toggle button.

- "Look in" specifies the drive and directory in which the data is stored. The icons to the right of the pull-down list are provided for easy navigation in the file system (place the cursor on the icons to obtain "Whats this" help).
- "File name" specifies a filename to save the current data. The analyzer adds the extension in the "Files of type" field.
- "Files of type" selects a particular file type for the created file.
- "Save" saves the data in the selected file and directory and closes the dialog.
- "Cancel" closes the dialog without saving the data.
- "Windows Explorer" opens the selected directory in Windows Explorer.
- If "Ask Before Overwriting" is enabled, overwriting an existing file has to be confirmed.

Tip: Dialog properties (e.g. the current directory) are remembered when the dialog is closed. To restore default directories, select "Use Default Directories" in the [Presets tab](#) of the "System Config" dialog.

4.2.2.3 Multi-channel setup dialog

Depending on the desired DUT and measurement type, the measurement channel has to be prepared in a particular way. The multi-channel setup dialog was invented to make this task as easy as possible.

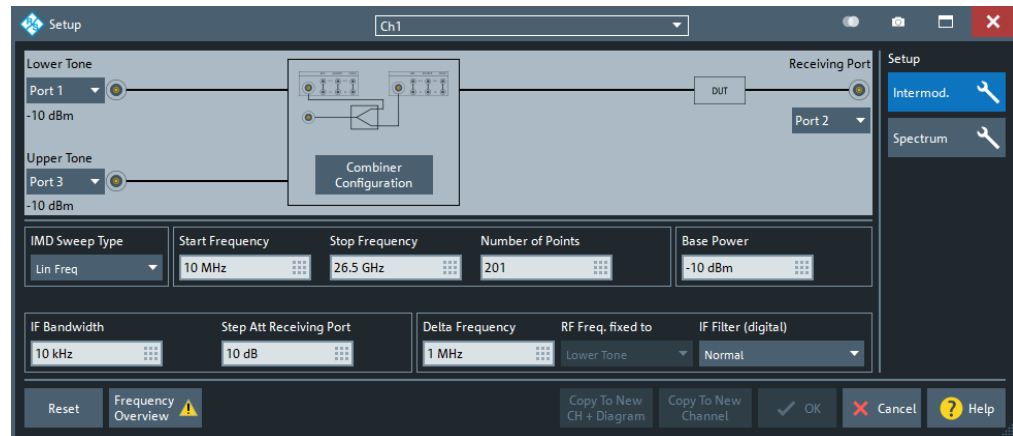

Figure 4-2: Multi-channel setup dialog

The buttons in the optional "Setup" part on the right allow you to switch between different measurement modes. The available measurement modes depend on the available options, e.g. intermodulation measurements require option R&S ZNA-K4 and spectrum measurements require option R&S ZNA-K1.

The controls in the vertical center of the dialog (to the left of the "Setup" part) allow you to set up the selected measurement mode. From top to bottom:

- generator and receiver ports
- signal path (direct access, combiners etc.)
- sweep parameters
- measurement logic
- measurement-specific channel settings

The channel selector in the title bar and the channel-related buttons in the lower part of the dialog ("Copy to New Channel", "Copy to New Ch + Diagram" allow you to select the target channels.

- On "OK", the channel selected in the title bar of the dialog is prepared for the measurement.
- Using "Copy to New Channel" or "Copy to New Ch + Diagram" it is possible create a channel and prepare the channel for the measurement in one go.



"OK", "Copy to New Channel" and "Copy to New Ch + Diagram" are only active, if the configured measurement setup is valid. Error and warning messages are displayed to point out possible configuration problems.

The info or warning icon overlaid on the "Frequency Overview" button indicates whether the resulting source and receiver frequencies are valid. Open the related dia-

log to find out more about the resulting frequency ranges and possible frequency range violations:

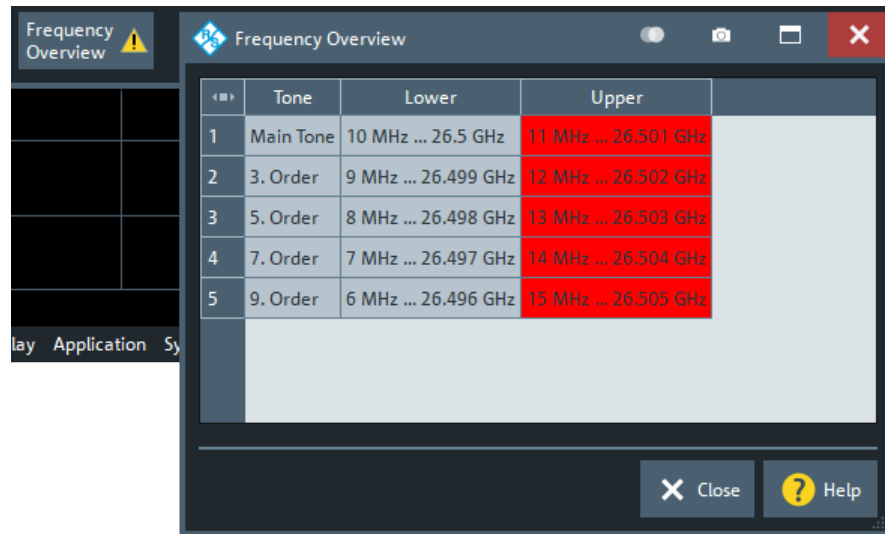

	Tone	Lower	Upper
1	Main Tone	10 MHz ... 26.5 GHz	11 MHz ... 26.501 GHz
2	3. Order	9 MHz ... 26.499 GHz	12 MHz ... 26.502 GHz
3	5. Order	8 MHz ... 26.498 GHz	13 MHz ... 26.503 GHz
4	7. Order	7 MHz ... 26.497 GHz	14 MHz ... 26.504 GHz
5	9. Order	6 MHz ... 26.496 GHz	15 MHz ... 26.505 GHz

After the channel configuration is applied, the related setup dialog and mode can be recalled at any time using the wrench icon in the main toolbar. When reopened, the "Reset" button in the lower left corner allows you to unwind subsequent modifications that were not yet applied.

4.2.3 Trace formats

A trace format defines how a trace is represented in a diagram.

The R&S ZNA supports the following trace formats:

- **Cartesian trace formats** "dB Mag", "Phase", "SWR", "Unwr Phase", "Lin Mag", "Log Mag", "Real", "Imag" and "Delay".
- Complex trace formats "Polar", "Smith" and "Inv Smith"



The VNA firmware allows arbitrary combinations of trace formats and measured quantities. However, to extract useful information from the measured data, it is important to select a trace format which is appropriate for the analysis of a particular measured quantity; see [Chapter 4.2.3.3, "Measured quantities and trace formats"](#), on page 148.

4.2.3.1 Cartesian trace formats

Cartesian trace formats assign a scalar response to the stimulus value (frequency, power, or time). The response can be calculated from the measured quantity at the related stimulus value, but it can also be the result of some mathematical transformation of the original (unformatted) trace.

Diagram representation

When a Cartesian trace is assigned to a diagram, the stimulus variable appears on the horizontal axis (x-axis), the response values appear on the vertical axis (y-axis).

Graph Scaling

- Except for the "Log Mag" format, the y-axis scale is always linear.
- The x-axis scaling depends on the sweep type of the channel to which the trace is assigned:
 - For sweep types "Lin Freq", "Power", "CW Mode" and "Time" it is scaled linearly.
 - For sweep type "Log Freq", it is scaled logarithmically.

The resulting linear or lin-log grid is plotted with the formatted trace.

The following examples show "dB Mag" Cartesian traces for the same measured quantity and sweep range, but with "Lin Freq" and "Log Freq" sweep types.

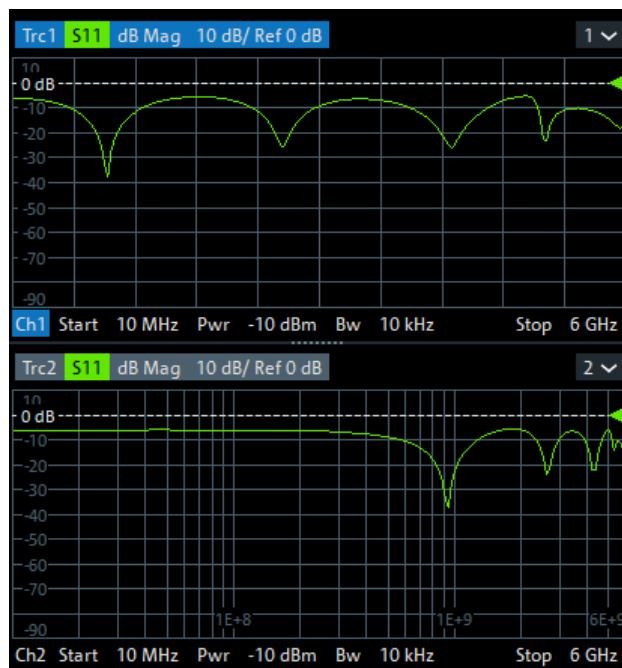

Figure 4-3: S11 trace in dB Mag format: sweep type Lin Freq (top) and Log Freq (bottom)

Conversion of complex to real quantities

The following table shows how "real" response values are calculated from complex measurement values $z = x + jy$ (where x , y , z are functions of the sweep variable). The formulas also hold for real measurement values ($y = 0$).

Trace Format	Description	Formula
"dB Mag"	Magnitude of z in dB	$\text{dB Mag}(z) = 20 * \log z \text{ dB}$
"Phase"	Phase of z	$\varphi(z) = \arctan(y/x)$
"SWR"	(Voltage) Standing Wave Ratio	$\text{SWR} = (1 + z) / (1 - z)$

Trace Format	Description	Formula
"Lin Mag"	Magnitude of z, unconverted	$ z = \sqrt{x^2 + y^2}$
"Real"	Real part of z	$\text{Re}(z) = x$
"Imag"	Imaginary part of z	$\text{Im}(z) = y$
"Delay"	Group delay, neg. derivative of the phase response	$-\text{d} \varphi (z) / \text{d} \Omega \quad (\Omega = 2\pi * f)$



An extended range of formats and conversion formulas is available for markers. To convert any point on a trace, create a marker and select the appropriate marker format. Marker and trace formats can be selected independently.

4.2.3.2 Complex trace formats

Complex trace formats assign a complex response to the stimulus value (frequency, power, or time).

In diagrams, the response values are always represented as points in the two-dimensional complex plane:

- The complex 0 is located at the center of the diagram.
- The real part is drawn in horizontal direction, the imaginary part in vertical direction.

Result values for consecutive stimulus values are interconnected by straight lines, so the trace is represented as a polygonal chain in the complex plane.

The stimulus axis is not visible. However, the stimulus value for a given trace point can be displayed using a marker.

The difference between the different complex trace formats ([Polar](#), [Smith](#) and [Inv Smith](#)) is the coordinate system that is used for the representation of the response values and that is graphically overlaid to the formatted trace.

Polar

For "Polar" traces the complex response values are represented in polar coordinates: magnitude and phase.

In a diagram the grid lines overlaid to the trace correspond to points of equal magnitude and phase:

- Points with equal magnitude are located on circles around the complex 0 that is located at the center of the diagram.
- Points with the equal phase are located on straight lines originating at the center.

The following example shows a polar diagram with a marker used to display a pair of stimulus and response values.

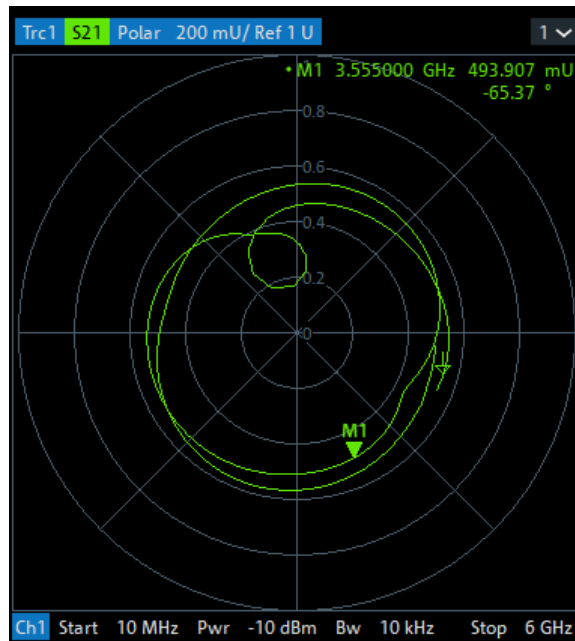

Example: Reflection coefficients in polar diagrams

If the measured quantity is a complex reflection coefficient (S_{11} , S_{22} etc.), then the center of the polar diagram corresponds to a perfect load Z_0 at the input test port of the DUT (no reflection, matched input). The outer circumference ($|S_{ii}| = 1$) represents a totally reflected signal.

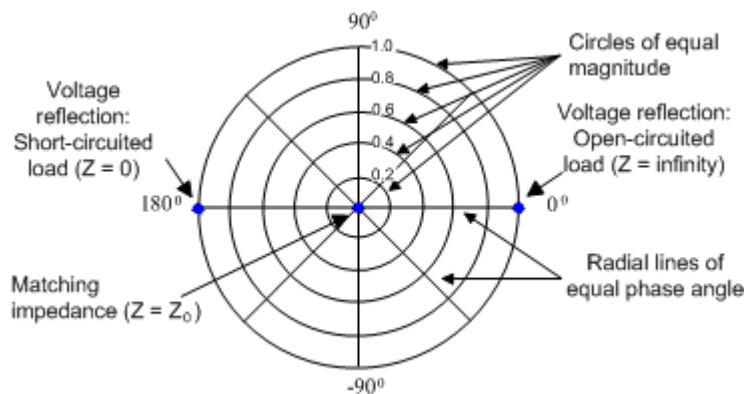

Examples for definite magnitudes and phase angles:

- The magnitude of the reflection coefficient of an open circuit ($Z = \text{infinity}$, $I = 0$) is one, its phase is zero.
- The magnitude of the reflection coefficient of a short circuit ($Z = 0$, $U = 0$) is one, its phase is -180 deg.

Smith

For "Smith" traces the response values are interpreted as reflection coefficients S_{ii} and represented in terms of their corresponding complex impedance $Z(S_{ii}) = R(S_{ii}) + j X(S_{ii})$.

In a diagram, the grid lines overlaid to a "Smith" trace correspond to points of equal resistance R and reactance X :

- Points with the same resistance are located on circles.
- Points with the same reactance produce arcs.

The following example shows a Smith chart with a marker used to display the stimulus value, the complex impedance $Z = R + j X$ and the equivalent inductance L .

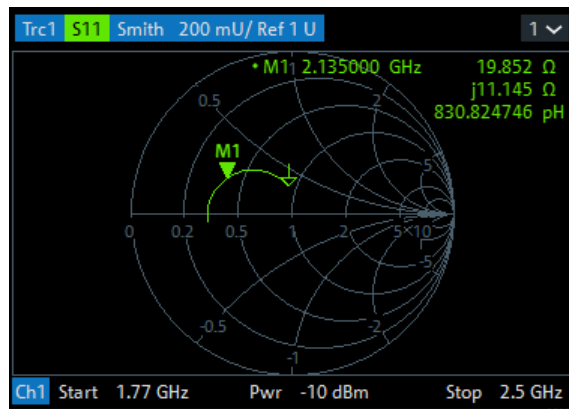

Smith chart construction

In a Smith chart, the impedance plane is reshaped so that the area with positive resistance is mapped into a unit circle.

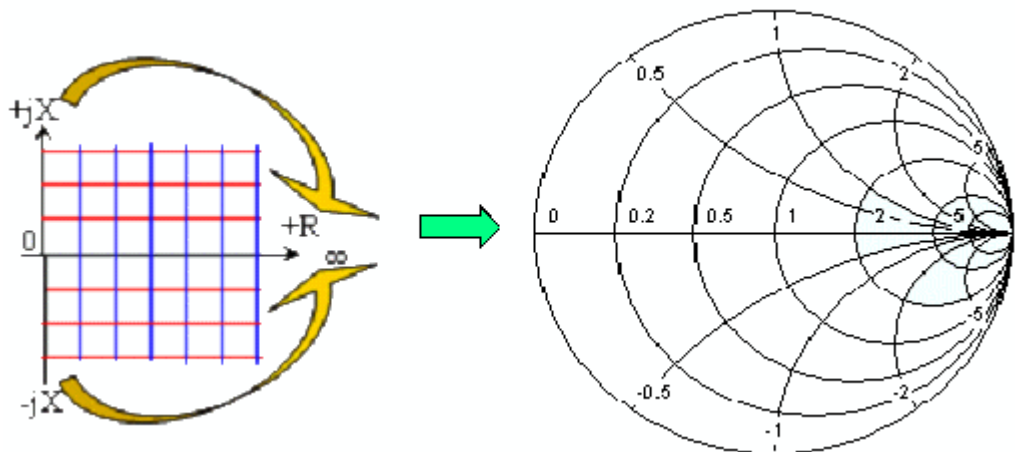

The basic properties of the Smith chart follow from this construction:

- The central horizontal axis corresponds to zero reactance (real impedance). The center of the diagram represents $Z/Z_0 = 1$ which is the reference impedance of the system (zero reflection). At the left and right intersection points between the horizontal axis and the outer circle, the impedance is zero (short) and infinity (open).
- The outer circle corresponds to zero resistance (purely imaginary impedance). Points outside the outer circle indicate an active component.
- The upper and lower half of the diagram correspond to positive (inductive) and negative (capacitive) reactive components of the impedance, respectively.

Example: Reflection coefficients in the Smith chart

If the measured quantity is a complex reflection coefficient Γ (e.g. S_{11} , S_{22}), then the unit Smith chart can be used to read the normalized impedance of the DUT. The coordinates in the normalized impedance plane and in the reflection coefficient plane are related as follows (see also: definition of matched-circuit (converted) impedances):

$$Z/Z_0 = \frac{1 + \Gamma}{1 - \Gamma}$$

From this equation, it is easy to relate the real and imaginary components of the complex resistance to the real and imaginary parts of Γ :

$$R = \text{Re}(Z/Z_0) = \frac{1 - \text{Re}(\Gamma)^2 - \text{Im}(\Gamma)^2}{[1 - \text{Re}(\Gamma)]^2 + \text{Im}(\Gamma)^2}$$

$$X = \text{Im}(Z/Z_0) = \frac{2 \text{Im}(\Gamma)}{[1 - \text{Re}(\Gamma)]^2 + \text{Im}(\Gamma)^2}$$

According to the two equations above, the graphical representation in a Smith chart has the following properties:

- Real reflection coefficients are mapped to real impedances (resistances).
- The center of the Γ plane ($\Gamma = 0$) is mapped to the reference impedance Z_0 , whereas the circle with $|\Gamma| = 1$ is mapped to the imaginary axis of the Z plane.
- The circles for the points of equal resistance are centered on the real axis and intersect at $Z = \text{infinity}$. The arcs for the points of equal reactance also belong to circles intersecting at $Z = \text{infinity}$ (open circuit point $(1, 0)$), centered on a straight vertical line.

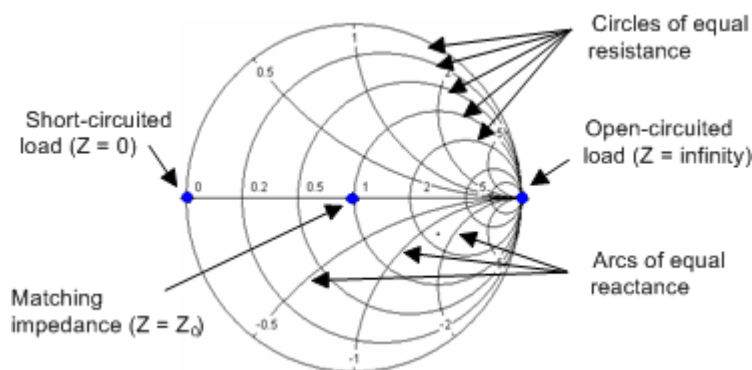

Examples for special points in the Smith chart:

- The magnitude of the reflection coefficient of an open circuit ($Z = \text{infinity}$, $\Gamma = 0$) is one, its phase is zero.
- The magnitude of the reflection coefficient of a short circuit ($Z = 0$, $\Gamma = 0$) is one, its phase is -180 deg.

Inv Smith

For "Inv Smith" formatted traces, the response values are interpreted as complex reflection coefficients S_{ii} and represented in terms of their corresponding complex admittance $Y(S_{ii}) = G(S_{ii}) + j B(S_{ii})$.

In a diagram, the grid lines overlaid to a "Smith" trace correspond to points of equal conductance G and susceptance B :

- Points with the same conductance are located on circles.
- Points with the same susceptance produce arcs.

The following example shows an inverted Smith chart with a marker used to display the stimulus value, the complex admittance $Y = G + j B$ and the equivalent inductance L .

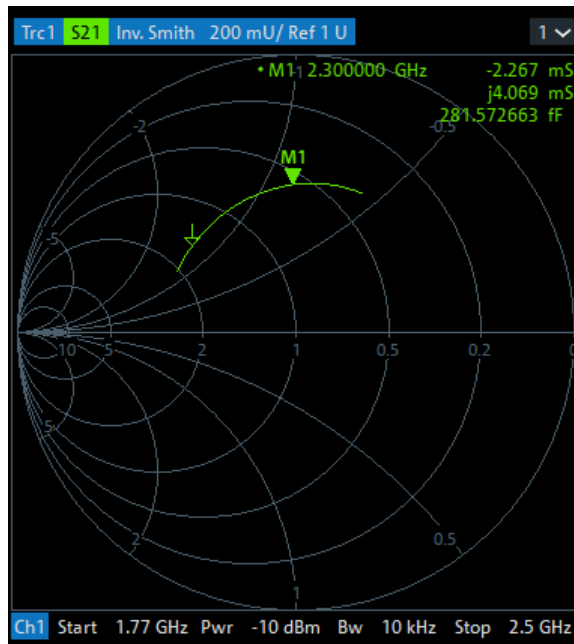

Inverted Smith chart construction

The inverted Smith chart is point-symmetric to the Smith chart:

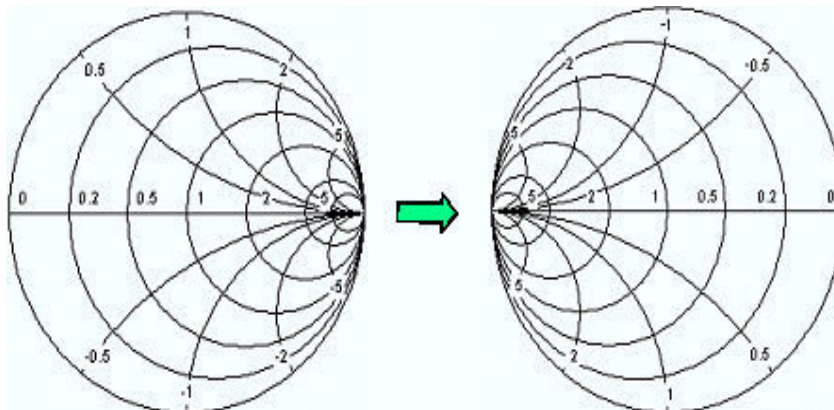

The basic properties of the inverted Smith chart follow from this construction:

- The central horizontal axis corresponds to zero susceptance (real admittance). The center of the diagram represents $Y/Y_0 = 1$, where Y_0 is the reference admittance of the system (zero reflection). At the left and right intersection points between the horizontal axis and the outer circle, the admittance is infinity (short) and zero (open).
- The outer circle corresponds to zero conductance (purely imaginary admittance). Points outside the outer circle indicate an active component.
- The upper and lower half of the diagram correspond to negative (inductive) and positive (capacitive) susceptive components of the admittance, respectively.

Example: Reflection coefficients in the inverted Smith chart

If the measured quantity is a complex reflection coefficient Γ (e.g. S_{11} , S_{22}), then the inverted Smith chart can be used to read the normalized admittance of the DUT. The coordinates in the normalized admittance plane and in the reflection coefficient plane are related as follows (see also: definition of matched-circuit (converted) admittances):

$$Y/Y_0 = \frac{1 - \Gamma}{1 + \Gamma}$$

From this equation, it is easy to relate the real and imaginary components of the complex admittance to the real and imaginary parts of Γ :

$$G = \text{Re}(Y/Y_0) = \frac{1 - \text{Re}(\Gamma)^2 - \text{Im}(\Gamma)^2}{[1 + \text{Re}(\Gamma)]^2 + \text{Im}(\Gamma)^2}$$

$$B = \text{Im}(Y/Y_0) = \frac{-2 \text{Im}(\Gamma)}{[1 + \text{Re}(\Gamma)]^2 + \text{Im}(\Gamma)^2}$$

According to the two equations above, the graphical representation in an inverted Smith chart has the following properties:

- Real reflection coefficients are mapped to real admittances (conductances).
- The center of the Γ plane ($\Gamma = 0$) is mapped to the reference admittance Y_0 , whereas the circle with $|\Gamma| = 1$ is mapped to the imaginary axis of the Y plane.
- The circles for the points of equal conductance are centered on the real axis and intersect at $Y = \text{infinity}$. The arcs for the points of equal susceptance also belong to circles intersecting at $Y = \text{infinity}$ (short circuit point $(-1, 0)$), centered on a straight vertical line.

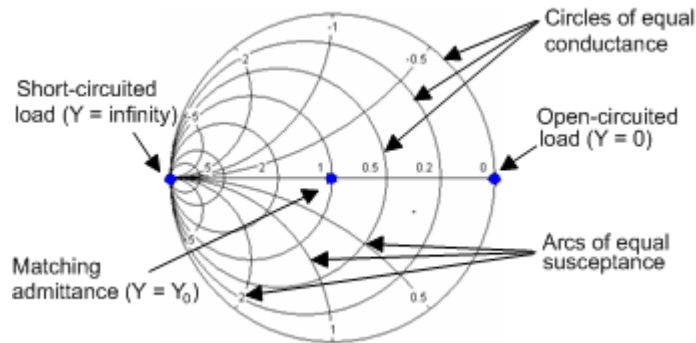

Examples for special points in the inverted Smith chart:

- The magnitude of the reflection coefficient of a short circuit ($Y = \text{infinity}$, $U = 0$) is one, its phase is -180 deg.
- The magnitude of the reflection coefficient of an open circuit ($Y = 0$, $I = 0$) is one, its phase is zero.

4.2.3.3 Measured quantities and trace formats

The analyzer allows any combination of a display format and a measured quantity. The following rules can help to avoid inappropriate formats and find the format that is ideally suited to the measurement task.

- All formats are suitable for the analysis of reflection coefficients S_{ij} . The formats "SWR", "Smith" and "Inv Smith" lose their original meaning (standing wave ratio, normalized impedance or admittance) if they are used for transmission S-parameters, ratios and other quantities.
- For complex "Impedances", "Admittances", "Z-parameters", and "Y-parameters" generally a Cartesian format or the polar format is suitable.
- For the real valued [Stability factors](#), one of the Cartesian formats "Lin Mag" or "Real" should be used. In complex formats, real numbers represent complex numbers with zero imaginary part.

The following table gives an overview of recommended display formats.

	Complex dimensionless quantities: S-parameters and ratios	Complex quantities with dimensions: Wave quantities, Z-parameters, Y-parameters, impedances, admittances	Real quantities:
Lin Mag	ON	ON (default for Z-parameters, Y-parameters, impedances, admittances)	ON (default)
dB Mag	ON (default)	ON (default for wave quantities)	–
Phase	ON	ON	–
Real	ON	ON	ON
Imag	ON	ON	–
Unwrapped Phase	ON	ON	–

	Complex dimensionless quantities: S-parameters and ratios	Complex quantities with dimensions: Wave quantities, Z-parameters, Y-parameters, impedances, admittances	Real quantities:
Smith	ON (reflection coefficients S_{ii})	–	–
Polar	ON	–	–
Inverted Smith	ON (reflection coefficients S_{ii})	–	–
SWR	ON (reflection coefficients S_{ii})	–	–
Delay	ON (transmission coefficients S_{ij})	–	–

The default formats are activated automatically when the measured quantity is changed.

4.3 Measurement results

This section gives an overview of the measurement results of the network analyzer and the meaning of the different measured quantities. All quantities can be selected in the "Meas" softtool (function key Trace – [Meas]).

4.3.1 S-parameters

S-parameters are the basic measured quantities of a network analyzer. They describe how the DUT modifies a signal that is transmitted or reflected in forward or reverse direction. For a 2-port measurement, the signal flow is as follows.

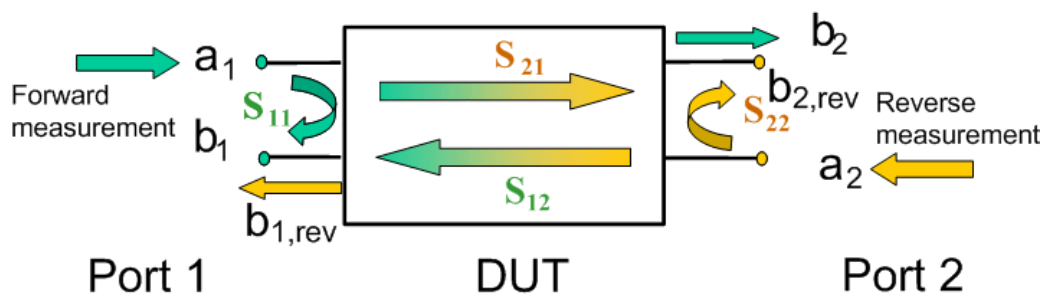

The figure above is sufficient for the definition of S-parameters but does not necessarily show the complete signal flow. In fact, if the source and load ports are not ideally matched, part of the transmitted waves are reflected off the receiver ports. An additional a_2 contribution occurs in forward measurements, and an a_1 contribution occurs in reverse measurements. The 7-term calibration types Txx take these additional contributions into account.

The scattering matrix links the incident waves a_1 , a_2 to the outgoing waves b_1 , b_2 according to the following linear equation:

$$\begin{bmatrix} b_1 \\ b_2 \end{bmatrix} = \begin{bmatrix} S_{11} & S_{12} \\ S_{21} & S_{22} \end{bmatrix} \begin{bmatrix} a_1 \\ a_2 \end{bmatrix}$$

Meaning of 2-port S-parameters

The four 2-port S-parameters can be interpreted as follows:

- S_{11} is the reflection coefficient of DUT port 1, i.e. the ratio between outgoing wave b_1 and incident wave a_1 in a forward measurement with matched DUT port 2:
 $S_{11} = b_1 / a_1$, if $|a_1| > 0$ and $a_2 = 0$
- S_{21} is the forward transmission coefficient, defined as the ratio between outgoing wave b_2 and incident wave a_1 in a forward measurement with matched DUT port 2:
 $S_{21} = b_2 / a_1$, if $|a_1| > 0$ and $a_2 = 0$
- S_{12} is the reverse transmission coefficient, defined as the ratio between outgoing wave b_1 and incident wave a_2 in a forward measurement with matched DUT port 1:
 $S_{12} = b_1 / a_2$, if $|a_2| > 0$ and $a_1 = 0$
- S_{22} is the reflection coefficient of port 2, i.e. the ratio between outgoing wave b_2 and incident wave a_2 in a forward measurement with matched DUT port 1:
 $S_{22} = b_2 / a_2$, if $|a_2| > 0$ and $a_1 = 0$

Meaning of squared amplitudes

The squared amplitudes of the incident and outgoing waves and of the matrix elements have a simple meaning:

Table 4-4: Squared S-parameters

$ a_i ^2$	Available incident power (= the power provided by a generator with a source impedance equal to the reference impedance Z_0) at DUT port $i=1,2$
$ b_i ^2$	Reflected power at DUT port $i=1,2$
$10 \log S_{ii} ^2 = 20 \log S_{ii} $	Reflection loss at DUT port $i=1,2$
$10 \log S_{21} ^2 = 20 \log S_{21} $	Insertion loss of forward transmission
$10 \log S_{12} ^2 = 20 \log S_{12} $	Insertion loss of reverse transmission

4.3.1.1 Multiport S-parameters

The multiport S-parameters extend the standard 2-port S-parameters to a larger number of incident and outgoing waves. For a 4-port DUT,

$$\begin{bmatrix} b_1 \\ b_2 \\ b_3 \\ b_4 \end{bmatrix} = \begin{bmatrix} S_{11} & S_{12} & S_{13} & S_{14} \\ S_{21} & S_{22} & S_{23} & S_{24} \\ S_{31} & S_{32} & S_{33} & S_{34} \\ S_{41} & S_{42} & S_{43} & S_{44} \end{bmatrix} \begin{bmatrix} a_1 \\ a_2 \\ a_3 \\ a_4 \end{bmatrix}$$

where again a_i ($i = 1$ to 4) denote the incident, b_i ($i = 1$ to 4) denote the outgoing waves, and the S-parameters are expressed as S_{ij} ($i, j = 1$ to 4).

The indices of the S-parameters described so far number the output and input ports of a DUT; the parameters are referred to as single-ended S-parameters. The S-parameter description can also be used to differentiate between different propagation modes of the waves at the output and input ports. This results in the so-called mixed mode S-parameters. The analyzer measures either single-ended or mixed mode S-parameters.

4.3.1.2 Redefined S-parameters

The analyzer firmware allows you to redefine the physical VNA ports, simply by specifying:

- a reference receiver ("a wave")
- a measurement receiver ("b wave")
- a generator ("Source" VNA or external generator port)

As a consequence, the measured S-parameters and other measured quantities are also redefined.



- The receivers and generators can be freely assigned, but without reusing the same (original) physical port in different (redefined) ports. See [Chapter 5.19.8.2, "Define Physical Ports dialog"](#), on page 919.
- Redefined physical ports are global, persistent settings, i.e. they are valid for all recall sets. A [Preset] does not reset the physical port configuration.
- Redefining physical ports causes a factory reset. The factory reset deletes all switch matrix RF connections.

Redefining physical ports can be used to insert external components (e.g. external signal separating devices, power amplifiers etc.) into the signal path. This allows you to develop custom measurements, e.g. to test high-power devices and extend the dynamic range.

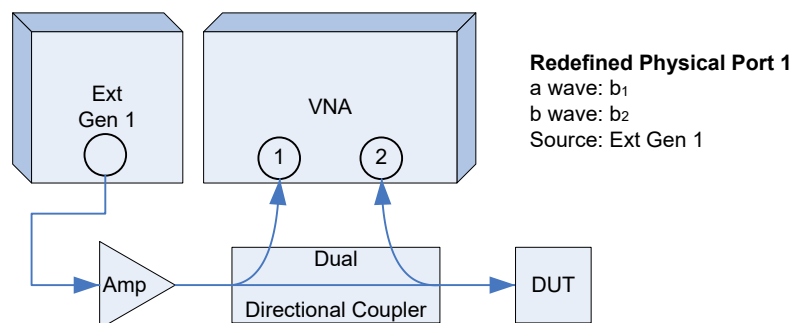

Figure 4-4: Redefined physical port 1 (port 2 not used)

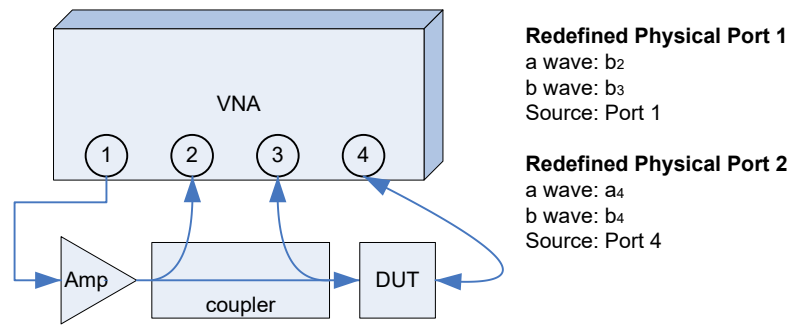

Figure 4-5: Two redefined ports

NOTICE

High Signal Power

When dealing with external signal amplification, make sure that:

- the signals fed to the analyzer are within the allowed range
- during calibration the calibration standards meet the requirements in terms of their power handling capacity

Attenuator pads can be used to adapt the power levels.

4.3.2 Reference impedances

Changing the reference impedances of the analyzer ports is often referred to as renormalization of port impedances. Renormalization means that the measurement results measured at 50 Ω (75 Ω) are converted into results at arbitrary port impedance.

- Renormalization of the physical port impedances affects, e.g., S-parameters and wave quantities in "Power" representation.
- Renormalization of the balanced port impedances affects all measured quantities that the analyzer provides for balanced ports.

The default reference impedance of a physical port is equal to the reference impedance of the connector type assigned to the port (50 Ω or 75 Ω). It can be defined as a complex value. For balanced ports, it is possible to define separate complex reference impedances for differential and for common mode.

The default values for the balanced port reference impedances are derived from the default reference impedance of the physical analyzer ports ($Z_0 = 50 \Omega$):

- The default value for the differential mode is $Z_{0d} = 100 \Omega = 2 \cdot Z_0$.
- The default value for the common mode is $Z_{0c} = 25 \Omega = Z_0/2$

Renormalization can be based on two alternative waveguide circuit theories whose conversion formulas may yield different results if the reference impedance of at least one test port has a non-zero imaginary part.

Conversion formula for wave quantities and S-parameters

Renormalization transforms the "raw" S-matrix S_0 for the default reference impedances Z_{0i} (with physical port number index $i = 1, 2, \dots, n$) into a "renormalized" S-matrix S_1 for the modified reference impedances Z_{1i} . In terms of raw and renormalized wave quantities a_{0i} , b_{0i} and a_{1i} , b_{1i} , S_0 and S_1 are defined as follows:

$$\begin{pmatrix} b_{01} \\ b_{02} \\ \dots \\ b_{0n} \end{pmatrix} = S_0 \cdot \begin{pmatrix} a_{01} \\ a_{02} \\ \dots \\ a_{0n} \end{pmatrix}; \quad \begin{pmatrix} b_{11} \\ b_{12} \\ \dots \\ b_{1n} \end{pmatrix} = S_1 \cdot \begin{pmatrix} a_{11} \\ a_{12} \\ \dots \\ a_{1n} \end{pmatrix}.$$

The renormalized wave quantities (a_1 and b_1) and the S-matrix S_1 can be calculated from S_0 and the reference impedances Z_{0i} , Z_{1i} according to two alternative waveguide circuit theories.

1. Traveling waves

In the model of Marks and Williams ("A General Waveguide Circuit Theory"), the wave quantities a and b are transformed as follows:

$$\begin{pmatrix} a_{1i} \\ b_{1i} \end{pmatrix} = \frac{1}{2Z_{0i}} \left| \frac{Z_{0i}}{Z_{1i}} \right| \sqrt{\frac{\operatorname{Re}(Z_{1i})}{\operatorname{Re}(Z_{0i})}} \cdot \begin{pmatrix} Z_{0i} + Z_{1i} & Z_{0i} - Z_{1i} \\ Z_{0i} - Z_{1i} & Z_{0i} + Z_{1i} \end{pmatrix} \cdot \begin{pmatrix} a_{0i} \\ b_{0i} \end{pmatrix}$$

The renormalized S-matrix S_1 is calculated as:

$$S_1 = P^{-1}(S_0 - \gamma)(E - \gamma S_0)^{-1} P$$

with the unit matrix E and two additional matrices with the elements

$$\gamma_{ii} = \frac{Z_{1i} - Z_{0i}}{Z_{1i} + Z_{0i}}$$

$$P_{ii} = \frac{Z_{0i}}{Z_{0i} + Z_{1i}} \left| \frac{Z_{1i}}{Z_{0i}} \right| \sqrt{\frac{\operatorname{Re}(Z_{0i})}{\operatorname{Re}(Z_{1i})}}$$

2. Power waves

In the model of Kurokawa ("Power Waves and the Scattering Matrix"), the wave quantities a and b are transformed as follows:

$$\begin{pmatrix} a_{1i} \\ b_{1i} \end{pmatrix} = \frac{1}{2\sqrt{\operatorname{Re}(Z_{0i})\operatorname{Re}(Z_{1i})}} \cdot \begin{pmatrix} \overline{Z_{0i}} + Z_{1i} & Z_{0i} - \overline{Z_{1i}} \\ \overline{Z_{0i}} - \overline{Z_{1i}} & Z_{0i} + Z_{1i} \end{pmatrix} \cdot \begin{pmatrix} a_{0i} \\ b_{0i} \end{pmatrix}$$

The renormalized S-matrix S_1 is calculated as:

$$S_1 = A^{-1}(S_0 - \overline{\Gamma})(E - \Gamma S_0)^{-1} \overline{A}$$

with the unit matrix E and two additional matrices with the elements

$$\Gamma_{ii} = \frac{Z_{li} - Z_{0i}}{Z_{li} + Z_{0i}}$$

$$A_{ii} = \frac{1 - \overline{\Gamma_{ii}}}{|1 - \Gamma_{ii}|} \sqrt{|1 - \Gamma_{ii} \overline{\Gamma_{ii}}|}$$

4.3.3 Impedance parameters

An impedance is the complex ratio between a voltage and a current. The analyzer provides two independent sets of impedance parameters:

- Converted impedances (each impedance parameter is obtained from a single S-parameter)
- Z-parameters (complete description of an n-port DUT)

4.3.3.1 Converted impedances

The converted impedance parameters Z_{ij} ($1 \leq i, j \leq n$) describe the input impedances of an n-port DUT with fully matched outputs. The analyzer converts a single measured S-parameter S_{ij} to determine the corresponding converted impedance, under the assumption that each of the other ports is terminated with its respective reference impedance Z_{0k} (matched-circuit parameters). As a result, converted impedances cannot completely describe general n-port DUTs.



The extension of the impedances to more ports and mixed mode measurements is analogous to S-parameters. Z_{dd44} is the differential mode input impedance at port 4 of a DUT that is terminated at its other ports with the reference impedance Z_0 .

The [Converted admittances](#) are defined as the inverse of the converted impedances.

Reflection impedance

The converted impedance Z_{ii} ($1 \leq i \leq n$) describes the input impedance at port i of the DUT.

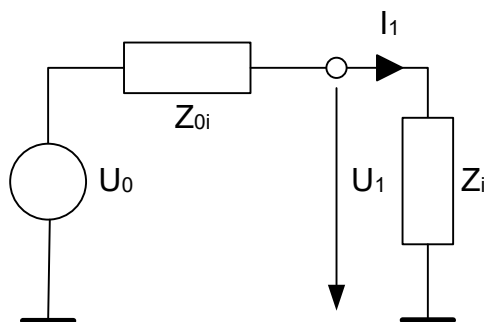

Example:

For a 2-port DUT that is terminated at its output with the reference impedance Z_{02} , Z_{11} is the input impedance (matched-circuit impedance measured in a forward reflection measurement).

A converted impedance Z_{11} completely describes a one-port DUT.

The calculation formula of the converted reflection impedances Z_{ii} depends on the waveguide circuit theory according to which [Reference impedances](#) are calculated.

Table 4-5: Calculation of Converted Reflection Impedances

Traveling Waves	Power Waves
$Z_{ii} = Z_{0i} \frac{1 + S_{ii}}{1 - S_{ii}}$	$Z_{ii} = \frac{\overline{Z_{0i}} + S_{ii} Z_{0i}}{1 - S_{ii}}$

Series transmission impedance

A two-port transmission parameter Z_{ij} ($i \neq j$) can describe a pure serial impedance between the two ports.

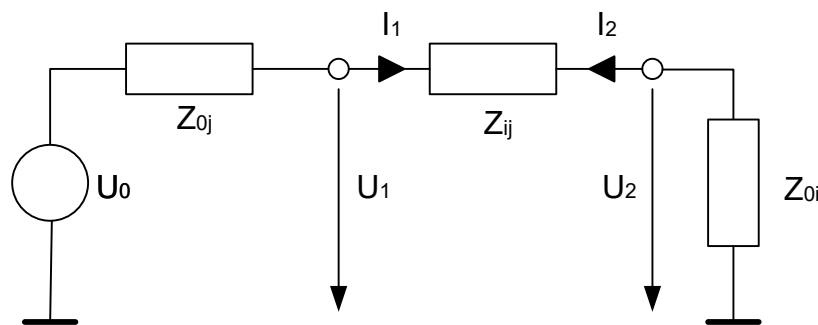

The calculation formula of a converted serial transmission impedance Z_{ij} depends on the waveguide circuit theory according to which [Reference impedances](#) are calculated.

Table 4-6: Calculation of Converted Series Transmission Impedances

Traveling Waves	Power Waves
$Z = 2e^{j\varphi(Z_{0i})} \sqrt{\left \frac{\text{Re}(Z_{0i})}{\text{Re}(Z_{0j})} \right } \frac{ Z_{0j} }{S_{ij}} - (Z_{0i} + Z_{0j})$	$Z = 2 \text{sgn}(\text{Re}(Z_{0i})) \frac{\sqrt{ \text{Re}(Z_{0i})\text{Re}(Z_{0j}) }}{S_{ij}} - (Z_{0i} + Z_{0j})$

Parallel transmission impedance

A two-port transmission parameter Z_{ij} ($i \neq j$) can also describe a parallel impedance between the two ports.

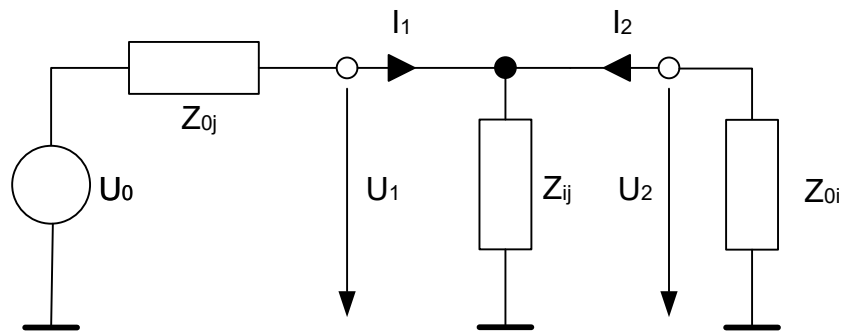

The calculation formula of a converted parallel transmission impedance Z_{ij} depends on the waveguide circuit theory according to which [Reference impedances](#) are calculated.

Table 4-7: Calculation of Converted Parallel Transmission Impedances

Traveling Waves	Power Waves
$Z = \frac{Z_{0i}Z_{0j}S_{ij}}{2 \left(Z_{0i} \left \frac{Z_{0j}}{Z_{0i}} \right \sqrt{\left \frac{\text{Re}(Z_{0i})}{\text{Re}(Z_{0j})} \right } - S_{ij} \frac{Z_{0i}+Z_{0j}}{2} \right)}$	$Z = \frac{Z_{0j}S_{ij}}{\sqrt{\left \frac{\text{Re}(Z_{0j})}{\text{Re}(Z_{0i})} \right } (1 + e^{-2\varphi(Z_{0i})}) - S_{ij} \left(1 + \frac{Z_{0j}}{Z_{0i}} \right)}$

4.3.3.2 Z-parameters

The Z-parameters describe the impedances of a DUT with open output ports (impedance = 0). The analyzer provides the full set of Z-parameters including the transfer impedances (i.e. the complete nxn Z-matrix for an n port DUT).

This means that Z-parameters can be used as an alternative to S-parameters (or Y-parameters) to characterize a linear n-port network completely.

2-port Z-parameters

In analogy to S-parameters, Z-parameters are expressed as Z_{ij} , where i denotes the measured and j the stimulated port.

The Z-parameters for a two-port are based on a circuit model that can be expressed with two linear equations:

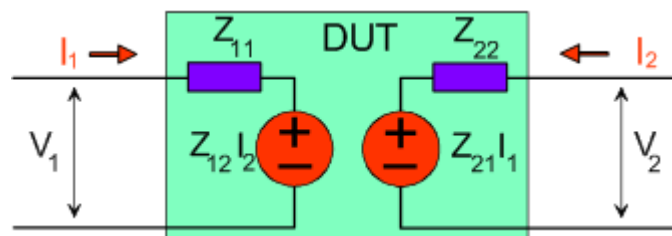

$$V_1 = Z_{11}I_1 + Z_{12}I_2$$

$$V_2 = Z_{21}I_1 + Z_{22}I_2$$

Meaning of Z-parameters

The four 2-port Z-parameters can be interpreted as follows:

- Z_{11} is the input impedance, defined as the ratio of the voltage V_1 to the current I_1 , measured at port 1 (forward measurement with open output, $I_2 = 0$).
- Z_{21} is the forward transfer impedance, defined as the ratio of the voltage V_2 to the current I_1 (forward measurement with open output, $I_2 = 0$).
- Z_{12} is the reverse transfer impedance, defined as the ratio of the voltage V_1 to the current I_2 (reverse measurement with open input, $I_1 = 0$).
- Z_{22} is the output impedance, defined as the ratio of the voltage V_2 to the current I_2 , measured at port 2 (reverse measurement with open input, $I_1 = 0$).

Z-parameters can be easily extended to describe circuits with more than two ports or several modes of propagation.

4.3.4 Admittance parameters

An admittance is the complex ratio between a current and a voltage. The analyzer provides two independent sets of admittance parameters:

- Converted admittances (each admittance parameter is obtained from a single S-parameter)
- Y-parameters (complete description of the n-port DUT)

4.3.4.1 Converted admittances

The converted admittance parameters describe the input admittances of a DUT with fully matched outputs. The converted admittances are the inverse of the [Converted impedances](#).

4.3.4.2 Y-parameters

The Y-parameters describe the admittances of a DUT with output ports terminated in a short circuit (voltage = 0). The analyzer provides the full set of Y-parameters including the transfer admittances (i.e. the complete $n \times n$ Y-matrix for an n port DUT).

This means that Y-parameters can be used as an alternative to S-parameters (or Z-parameters) to characterize a linear n -port network completely.

2-port Y-parameters

In analogy to S-parameters, Y-parameters are expressed as $Y_{\langle out \rangle \langle in \rangle}$, where $\langle out \rangle$ and $\langle in \rangle$ denote the output and input port numbers of the DUT. In analogy to Z-parameters, the Y-parameters for a two-port are based on a circuit model that can be expressed with two linear equations:

$$I_1 = Y_{11}V_1 + Y_{12}V_2$$

$$I_2 = Y_{21}V_1 + Y_{22}V_2$$

Meaning of Y-parameters

The four 2-port Y-parameters can be interpreted as follows:

- Y_{11} is the input admittance, defined as the ratio of the current I_1 to the voltage V_1 , measured at port 1 (forward measurement with output terminated in a short circuit, $V_2 = 0$).
- Y_{21} is the forward transfer admittance, defined as the ratio of the current I_2 to the voltage V_1 (forward measurement with output terminated in a short circuit, $V_2 = 0$).
- Y_{12} is the reverse transfer admittance, defined as the ratio of the current I_1 to the voltage V_2 (reverse measurement with input terminated in a short circuit, $V_1 = 0$).
- Y_{22} is the output admittance, defined as the ratio of the current I_2 to the voltage V_2 , measured at port 2 (reverse measurement with input terminated in a short circuit, $V_1 = 0$).

Y-parameters can be easily extended to describe circuits with more than two ports or several modes of propagation.

4.3.5 Wave quantities and ratios

The elements of the S-, Z- and Y-matrices represent fixed ratios of complex wave amplitudes. As long as the assumption of linearity holds, the S-, Z- and Y-parameters are independent of the source power.

The network analyzer provides two additional sets of measurement parameters which have an unambiguous meaning even if the DUT is measured outside its linear range:

- *Wave quantities* provide the power of any of the transmitted or received waves.
- *Ratios* provide the complex ratio of any combination of transmitted or received wave quantities.



In contrast to S-, Z- and Y-parameters, wave quantities and ratios are not system-error corrected.

To increase the accuracy or to correct a possible attenuation in the source signal path, it is recommended to perform a power calibration (see [Chapter 4.5.6, "Scalar power calibration"](#), on page 218).

4.3.5.1 Wave quantities

A wave quantity measurement provides the power of any of the transmitted or received waves. The power can be displayed in voltage units (e.g. V or dBmV) or equivalent power units (e.g. W or dBm).



Examples for using wave quantities

The wave quantities provide the power at the different receive ports of the analyzer. This is different from an S-parameter measurement, where the absolute power of a linear device is canceled. Wave quantities are therefore suitable for the following measurement tasks:

- Analysis of nonlinearities of the DUT.
- Use of the analyzer as a selective power meter.
To increase the accuracy or to correct a possible attenuation in the source signal path, it is recommended to perform a power calibration (see [Chapter 4.5.6, "Scalar power calibration"](#), on page 218).

The notation for wave quantities is as follows:

- " a_i Src Port j " denotes the wave incoming at DUT port i , when DUT port j is stimulated.
 a_i is detected at the reference receiver of the VNA port connected to DUT port i .
- " b_i Src Port j " denotes the wave outgoing at DUT port i , when DUT port j is stimulated.
 b_i is detected at the measurement receiver of the VNA port connected to DUT port i .

In a standard forward S-parameter measurement, a_1 Src Port 1 is the incident wave and b_1 Src Port 1 is the reflected wave at DUT port 1.

4.3.5.2 Ratios

A ratio measurement provides the complex ratio of any combination of transmitted or received wave amplitudes. Ratios complement the S-parameter measurements, where only ratios of the form b_i/a_j (ratios between outgoing and incoming waves at the DUT ports) are considered.



Examples for using ratios

A measurement of ratios is particularly suitable for the following test scenarios:

- The test setup or some of its components (e.g. active components or non-reciprocal devices) do not allow a system error correction so that a complete S-parameter measurement is not possible.
- The test setup contains frequency-converting components so that the transmitted and the received waves are at different frequencies.
- A ratio of two arbitrary waves that is not an element of the S-matrix (e.g. a ratio of the form a_i/a_j) is needed.

The notation for ratios is similar to the notation for wave quantities (see [Chapter 4.3.5.1, "Wave quantities"](#), on page 158). Given a source port k , any ratio between wave quantities " a_i Src Port k " and " b_j Src Port k " can be measured.

Examples:

- " b_2/a_1 Src Port 1" is the ratio of the outgoing wave at DUT port 2 and the incident wave at DUT port 1 (i.e. DUT port 1 ist stimulated). This corresponds to the forward transmission coefficient S_{21} .
- " b_1/a_1 Src Port 1" is the ratio of the outgoing wave at DUT port 1 and the incident wave at DUT port 1 (i.e. DUT port 1 ist stimulated). This corresponds to the forward reflection coefficient S_{11} .

4.3.5.3 Detector settings

The "Detector" settings select the algorithm that is used to calculate the displayed measurement points from the raw data. The "Detector" can be selected in the More Params, "More Wave Quantities", and More Ratios dialogs.



Figure 4-6: More Wave Quantities dialog

The following detectors are available:

- **"Normal"** selects the default detector mode where each valid measurement point is displayed without modification. The analyzer then proceeds to the next sweep

point. Normal detector mode ensures that the measurement is performed at maximum speed and that a meaningful complex result is obtained.

- **"AVG"** collects all valid results at each sweep point during the "Detector Meas Time" set in the More Params, "More Wave Quantities", and More Ratios dialog and calculates the complex arithmetic mean value of these results. Averaging tends to remove statistical fluctuations (e.g. noise contributions) from the measured signal.
The AVG detector is also used for [Noise figure measurement](#).
- **RMS** collects all valid results at each sweep point during the "Detector Meas Time" set in the "More Wave Quantities" or More Ratios dialog and calculates the root mean square (RMS) of the linear magnitude of these results. Note that the phase is not evaluated in this process so that complex conversions (e. g. the calculation of real and imaginary values) do not really make sense.
- **Peak** collects all valid results at each sweep point during the "Detector Meas Time" set in the "More Wave Quantities" or More Ratios dialog and selects the result with the maximum magnitude (maximum power) as the measurement point. Note that the phase is not evaluated in this process so that complex conversions (e. g. the calculation of real and imaginary values) do not really make sense.



Combining different detectors

The detector setting in the More Ratios menu applies to both the numerator and the denominator wave quantity. To allow for different detector settings, measure the numerator and denominator wave quantities individually and use trace functions to calculate the ratio. A possible application is the comparison of different detector settings for a particular trace.



Error Messages

The analyzer generates a warning if the selected measurement time for the "AVG..." detectors is too long. At the same time, bit no. 15 in the `...INTEGRITY:HARDWARE` status register is set. Reduce the measurement time and/or reduce the IF bandwidth until the warning disappears. A warning also appears if the measurement time for the "AVG..." detectors is too short. Increase the measurement time and/or increase the IF bandwidth until the warning disappears.

4.3.6 Unbalance-balance conversion

Unbalance-balance conversion is the simulation of one or more unbalance-balance transformers (baluns) integrated in the measurement circuit. It converts the DUT ports from an unbalanced state into a balanced state and virtually separates the differential and common mode signals. The analyzer measures the unbalanced state but converts the results and calculates mixed mode parameters, e.g. mixed mode S-parameters. No physical transformer is needed.

To perform balanced measurements, a pair of physical analyzer ports is combined to form a logical port. The balanced port of the DUT is directly connected to the analyzer ports. For a two-port analyzer, a single balanced port can be defined.

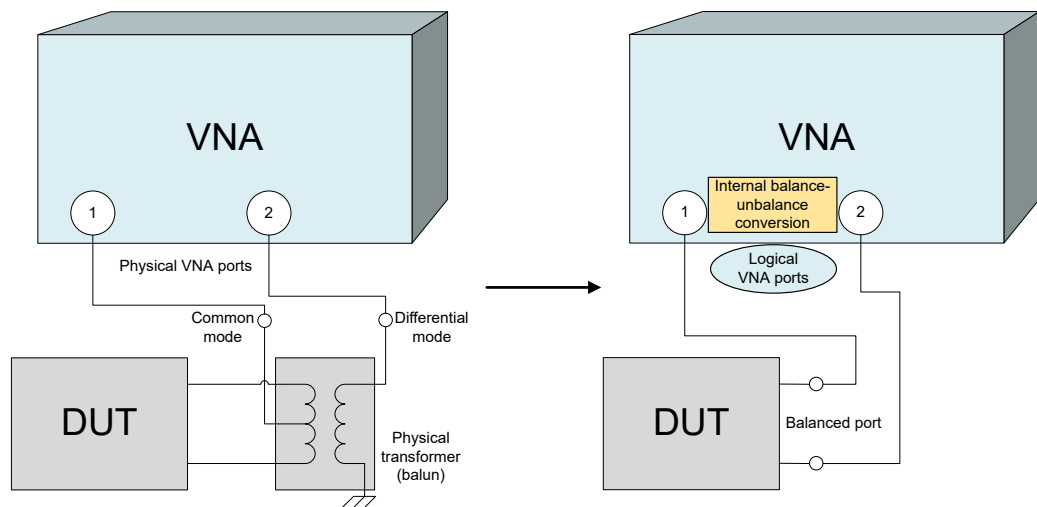

Unbalance-balance conversion avoids the disadvantages of real transformers:

- There is no need to fabricate test fixtures with integrated baluns for each type of DUT.
- The measurement is not impaired by the non-ideal characteristics of the balun (e.g. error tolerances, limited frequency range).
- Calibration can be performed at the DUT's ports. If necessary (e.g. to compensate for the effect of a test fixture), it is possible to shift the calibration plane using length offset parameters.
- Differential and common mode parameters can be evaluated with a single test setup.

4.3.6.1 Balanced port configurations

Defining a balanced logical port requires two physical ports.

The physical ports (on the VNA and connected [External switch matrices](#)) are equivalent and can be freely combined to balanced (logical) ports. Moreover, it is possible to assign arbitrary, independent reference impedance values to each unbalanced port and to the differential and common mode of each logical port.

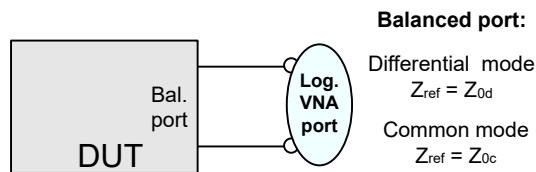
Example:**2 physical ports:** Reflection measurements on 1 balanced port**3 physical ports:** Reflection and transmission measurements on 1 balanced port**Single-ended (unbalanced) port**

$Z_{ref} = Z_{connector}$

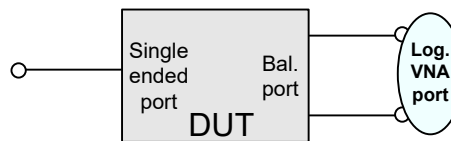
**4 physical ports:** Reflection and transmission measurements on 1 or 2 balanced ports**Single-ended (unbalanced) ports**

$Z_{ref1} = Z_{connector1}$

$Z_{ref2} = Z_{connector2}$

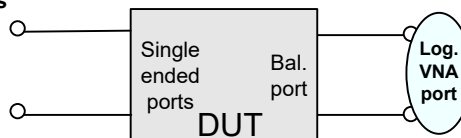
**Balanced port:**Differential mode
 $Z_{ref} = Z_{0d}$ Common mode
 $Z_{ref} = Z_{0c}$ 

A balanced port configuration is defined in two steps: First, select the pairs of physical ports that you want to combine to form balanced ports. Second, define the two reference impedances for the differential and common mode at each balanced port. Both steps can be done in a single "Balanced Ports" dialog.

Depending on the test setup, the analyzer provides different types of mixed mode parameters; refer to the following sections for details.

4.3.6.2 Mixed-mode parameters

Mixed mode parameters are an extension of normal mode parameters (e.g. S-parameters, impedances and admittances) for balanced measurements. The analyzer can measure mixed mode parameters once a balanced port configuration is selected.

Mixed mode parameters are used to distinguish the following three port modes:

- s: Single-ended (for unbalanced ports)
- d: Differential mode (for balanced ports)
- c: Common mode (for balanced ports)

The notation of a general S-parameter is $S_{\langle\text{mout}\rangle\langle\text{min}\rangle\langle\text{out}\rangle\langle\text{in}\rangle}$, where $\langle\text{mout}\rangle$ and $\langle\text{min}\rangle$ denote the output and input port modes, $\langle\text{out}\rangle$ and $\langle\text{in}\rangle$ denote the output and input port numbers.

Meaning of 2-port mixed mode S-parameters

The mixed mode 2-port S-parameters can be interpreted as follows:

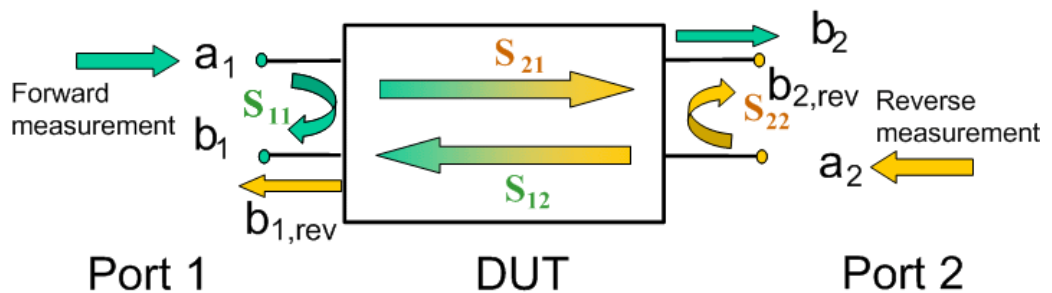

- $S_{\langle\text{mout}\rangle\langle\text{min}\rangle 11}$ is the mixed mode input reflection coefficient, defined as the ratio of the wave quantities b_1 (mode mout) to a_1 (mode min), measured at PORT 1 (forward measurement with matched output and $a_2 = 0$).
- $S_{\langle\text{mout}\rangle\langle\text{min}\rangle 21}$ is the mixed mode forward transmission coefficient, defined as the ratio of the wave quantities b_2 (mode mout) to a_1 (mode min) (forward measurement with matched output and $a_2 = 0$).
- $S_{\langle\text{mout}\rangle\langle\text{min}\rangle 12}$ is the mixed mode reverse transmission coefficient, defined as the ratio of the wave quantities b_1 (mode mout) (reverse measurement with matched input, b_1' in the figure above and $a_1 = 0$) to a_2 (mode min).
- $S_{\langle\text{mout}\rangle\langle\text{min}\rangle 22}$ is the mixed mode output reflection coefficient, defined as the ratio of the wave quantities b_2 (mode mout) (reverse measurement with matched input, b_2' in the figure above and $a_1 = 0$) to a_2 (mode min), measured at PORT 2.

If $\langle\text{mout}\rangle$ is different from $\langle\text{min}\rangle$, the S-parameters are called mode conversion factors.

Mixed-mode parameters for different test setups

Which types of mixed mode parameter are available depends on the measured device and the port configuration of the analyzer. With 4 physical test ports (on the VNA and connected [External switch matrices](#)), the following examples of mixed mode parameters can be measured.

1. DUT with only single-ended ports: No balanced port definition necessary, the analyzer provides single-ended multiport parameters.
2. DUT with one balanced port: Only reflection and mode conversion measurements with differential and common mode parameters.

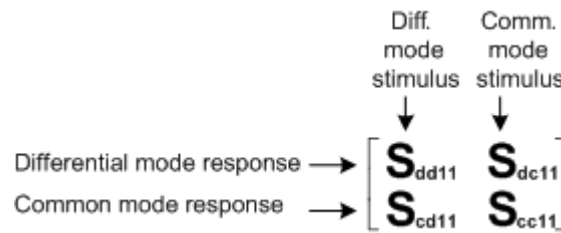

3. DUT with one balanced and one single-ended port.

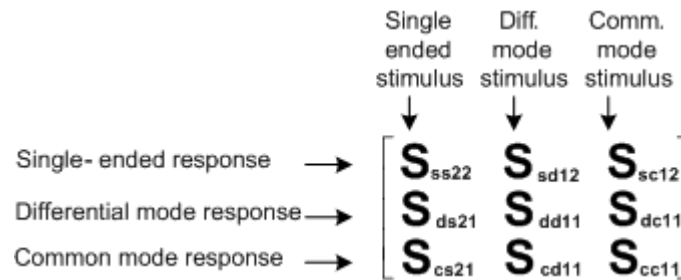

4. DUT with two balanced ports or one balanced and two single-ended ports. Both device types are fully characterized by 4x4 mixed mode S-matrices.

4.3.6.3 Imbalance and common mode rejection

An ideal unbalance-balance transformer (balun) converts an unbalanced signal into a balanced one and vice versa. When it is driven with an unbalanced signal at its physical port 1 (= single-ended logical port 1), unbalanced signals with equal amplitude and opposite phase appear at physical ports 2 and 4 (forming balanced logical port 2). This means that the ratio $-S_{21}/S_{41}$ of the physical transmission coefficients of an ideal balun equals 1. This ratio is called **imbalance**; it is a measure for the deviation of the balun from ideality. The general definition of the transmission imbalance between two different ports (at least one of them balanced) is given below.

For a DUT with two balanced ports (e.g. an amplifier), the ratio between the (wanted) differential mode power gain and the (unwanted) common mode power gain is called **common-mode rejection ratio** (CMRR). It can be calculated as $|S_{dd21}|/|S_{cc21}|$ (see [Chapter 4.3.6.2, "Mixed-mode parameters"](#), on page 163). The general definition of the complex CMRR between two ports (at least one of them balanced) is given below.



Imbalance and common-mode rejection ratio can only be measured if more than 2 test ports are available on the VNA and connected [switch matrices](#).

General Definition

In general, imbalance and CMRR are quantities with two numeric indices, indicating the logical output port and the logical input port of the DUT during the measurement ($\text{Imb}_{\langle \text{out} \rangle \langle \text{in} \rangle}$, $\text{CMRR}_{\langle \text{out} \rangle \langle \text{in} \rangle}$).

- DUT with single-ended logical port i and balanced logical port j :

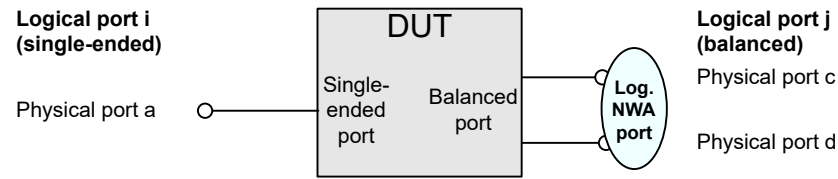

- $\text{Imb}_{ji} = -S_{ca}/S_{da}$ and $\text{Imb}_{ij} = -S_{ac}/S_{ad}$
- $\text{CMRR}_{ji} = S_{dsji}/S_{csji}$ and $\text{CMRR}_{ij} = S_{sdij}/S_{scij}$

- DUT with balanced logical ports i and j:

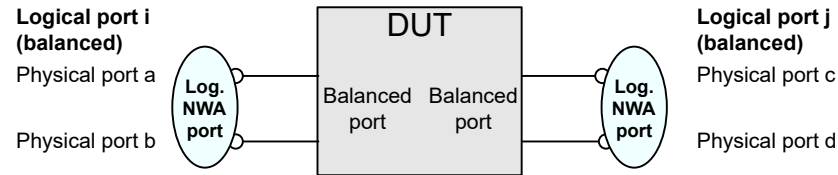

- $\text{Imb}_{ji} = -(S_{ca} - S_{cb}) / (S_{da} - S_{db})$, for $i \neq j$
- $\text{CMRR}_{ji} = S_{ddji} / S_{ccji}$

Differential Imbalance

A (differential) imbalance can also be calculated if the second balanced DUT port is connected to two single-ended logical ports:

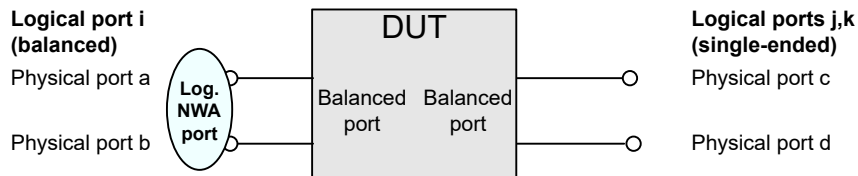

$$\text{Imb}_{jk-i} = -(S_{ca} - S_{da}) / (S_{cb} - S_{db})$$

$$\text{Imb}_{i-jk} = -(S_{ac} - S_{ad}) / (S_{bc} - S_{bd})$$

4.3.7 Stability factors

The stability factors K , μ_1 and μ_2 are real functions of the (complex) S-parameters, defined as follows:

$$K := \frac{1 - |S_{11}|^2 - |S_{22}|^2 + |S_{11} \cdot S_{22} - S_{12} \cdot S_{21}|^2}{2 \cdot |S_{12} \cdot S_{21}|}$$

$$\mu_1 := \frac{1 - |S_{11}|^2}{|S_{22} - \overline{S_{11}} \cdot (S_{11} \cdot S_{22} - S_{12} \cdot S_{21})| + |S_{12} \cdot S_{21}|}$$

$$\mu_2 := \frac{1 - |S_{22}|^2}{|S_{11} - \overline{S_{22}} \cdot (S_{11} \cdot S_{22} - S_{12} \cdot S_{21})| + |S_{12} \cdot S_{21}|}$$

where \overline{S} denotes the complex conjugate of S.

Stability factors are calculated as functions of the frequency or another stimulus parameter. They provide criteria for linear stability of two-ports such as amplifiers. A linear circuit is said to be unconditionally stable if no combination of passive source or load can cause the circuit to oscillate.

- The K-factor provides a necessary condition for unconditional stability: A circuit is unconditionally stable if $K > 1$ and an additional condition is met. The additional condition can be tested with the stability factors μ_1 and μ_2 .
- The μ_1 and μ_2 factors both provide a necessary and sufficient condition for unconditional stability: The conditions $\mu_1 > 1$ or $\mu_2 > 1$ are both equivalent to unconditional stability. This means that μ_1 and μ_2 provide direct insight into the degree of stability or potential instability of linear circuits.

References: Marion Lee Edwards and Jeffrey H. Sinsky, "A New Criterion for Linear 2-Port Stability Using a Single Geometrically Derived Parameter", IEEE Trans. MTT, vol. 40, No. 12, pp. 2303-2311, Dec. 1992.

4.3.8 Group delay

The group delay τ_g represents the propagation time of wave through a device. τ_g is a real quantity and is calculated as the negative of the derivative of its phase response. A non-dispersive DUT shows a linear phase response, which produces a constant delay (a constant ratio of phase difference to frequency difference).

The group delay is defined as:

$$\tau_g = -\frac{d\phi_{rad}}{d\omega} = -\frac{d\phi_{deg}}{360^\circ df}$$

where

Φ_{rad} , Φ_{deg} = phase response in radians or degrees

ω = angular velocity in radians/s

f = frequency in Hz

In practice, the analyzer calculates an approximation to the derivative of the phase response, taking a small frequency interval Δf and determining the corresponding phase change $\Delta\Phi$. The group delay is computed as

$$\tau_{g,meas} = -\frac{\Delta\phi_{deg}}{360^\circ \cdot \Delta f}$$

where $\Delta\Phi/\Delta f$ is the slope of the regression line through the frequency points of aperture Δf .

Δf must be adjusted to the conditions of the measurement, e.g. it must be reduced if phase slope fluctuates significantly over frequency. Otherwise group delay variations are flattened out.

Note that the input value "Aperture Points" does not define the number of frequency points, but the number of frequency steps between the points. I.e. "Aperture Points" is

always the number of frequency points involved minus 1. If "Aperture Points" is an odd number, the part of the aperture towards lower frequencies contains one more frequency step than the part towards larger frequencies.

If the group delay is constant over the considered frequency range (non-dispersive DUT, e.g. a cable), then τ_g and $\tau_{g,meas}$ are identical and:

$$\tau_g = \frac{d(360^\circ f \cdot \Delta t)}{360^\circ d f} = \Delta t = \frac{L_{mech} \cdot \sqrt{\epsilon}}{c}$$

where Δt is the propagation time of the wave across the DUT, which often can be expressed in terms of its mechanical length L_{mech} , the permittivity ϵ , and the velocity of light c . The product $L_{mech} \cdot \sqrt{\epsilon}$ is termed the electrical length of the DUT and is always larger or equal than the mechanical length ($\epsilon > 1$ for all dielectrics and $\epsilon = 1$ for the vacuum).

4.4 Operations on traces

The R&S ZNA can perform more complex operations on the measured traces. Some of the operations, e.g. the time domain transform, require additional software options; see [Chapter 4.7, "Optional extensions and accessories"](#), on page 246.

The R&S ZNA can also check whether the measured values comply with specified limits and export trace data, using different file formats.

4.4.1 Limit check

A limit line restricts the allowed range for some or all points of a trace, i.e. for a certain range of stimulus values. Typically, limit lines are used to check whether a DUT conforms to the rated specifications (conformance testing).

- An upper limit line defines the maximum allowed values for the related stimulus range.
- A lower limit line defines the minimum allowed values for the related stimulus range.
- A ripple limit defines the maximum difference between the largest and the smallest response value for the related stimulus range. A ripple limit test is suitable, e.g., to check whether the passband ripple of a filter is within acceptable limits, irrespective of the actual transmitted power in the passband.
- A circle limit defines the acceptable values as a circular area within a complex diagram.

A limit check compares the measurement results to the limit lines, and displays a pass/fail indication.

An acoustic warning and a TTL signal at the rear panel User Port (for test automation) can be generated in addition, if a limit is violated.

Upper and lower limit lines are both defined as a combination of segments with a linear or logarithmic dependence between the measured quantity and the sweep variable (stimulus variable). Similar to this segmentation, ripple limits can be defined in several ranges. The limit lines (except circle limits) can be stored to a file and recalled. Data or memory traces can be used to define the segments of an upper or lower limit line. Moreover it is possible to modify the upper and lower limit lines globally by adding an offset to the stimulus or response values.

4.4.1.1 Rules for limit line definition

The analyzer places few restrictions on the definition of limit line segments.

The following rules ensure a maximum of flexibility:

- Segments do not have to be sorted in ascending or descending order (e.g. the "Start Stimulus" value of segment no. n does not have to be smaller than the "Start Stimulus" value of segment no. n+1).
- Overlapping segments are allowed. The limit check in the overlapping area is related to the tighter limit (the pass test involves a logical AND operation).
- Gaps between segments are allowed and equivalent to switching off an intermediate limit line segment.
- Limit lines can be partially or entirely outside the sweep range, however, the limits are only checked at the measurement points.

The following figure shows a limit line consisting of 3 upper and 2 lower limit line segments. To pass the limit check, the trace must be confined to the shaded area.

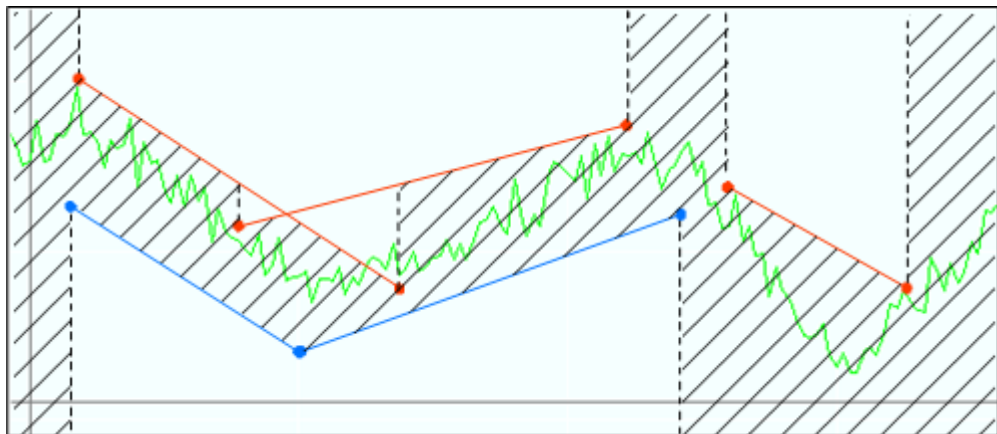

As a consequence of the limit line rules, a DUT always passes the limit check if no limit lines are defined.



Formula-defined limit lines

A limit line doesn't have to be straight. You can also use a custom formula to define it.

When the sweep axis is changed from linear frequency sweep to logarithmic sweeps, straight limit lines are transformed into exponential curves. The sweep points are redistributed along the x-axis, so the number of failed points can change.

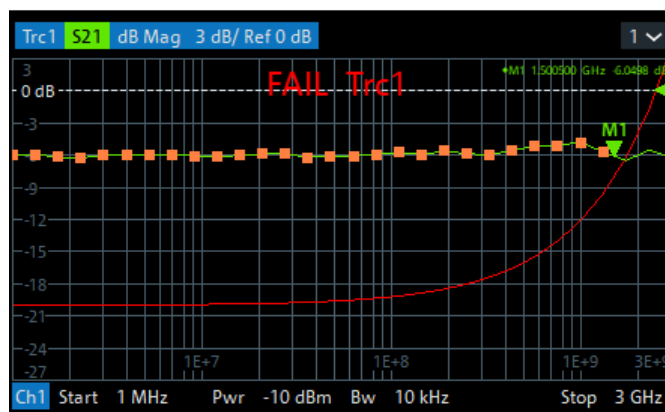
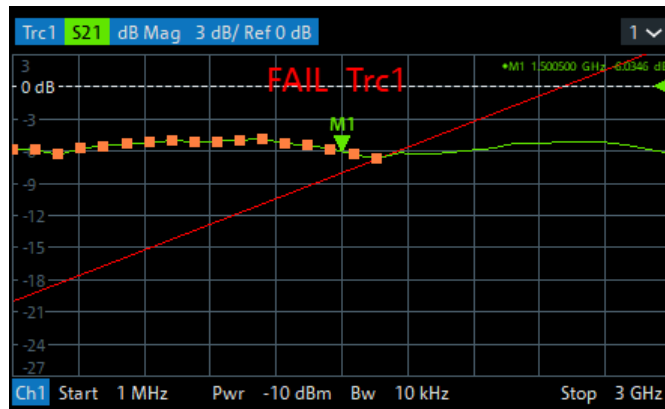

Logarithmic interpolation

The analyzer offers a logarithmic interpolation mode that allows you to carry over the limit line definition to logarithmic sweeps.

While "Show Limit Line" is active, the diagrams display all limit line segments.

Exception: In a segmented frequency sweep with point-based x-axis, gaps between the segments are minimized. To facilitate the interpretation, the R&S ZNA displays only the limit line segments which provide the limit check criterion (the "tighter" limit line at each point). In the example below, this rule results in a single, continuous lower limit line.

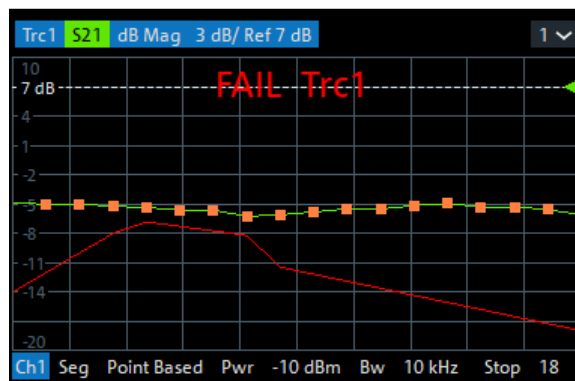
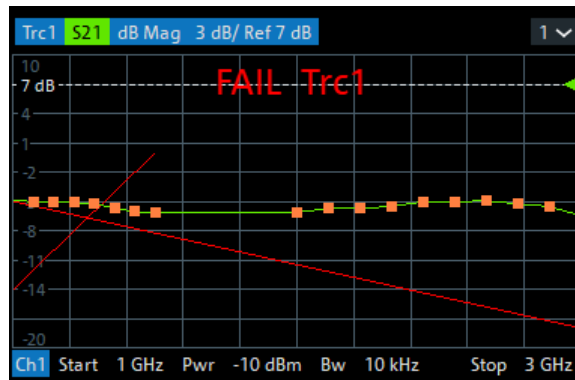

4.4.1.2 Rules for ripple test definition

The analyzer places few restrictions on the definition of ripple limit ranges.

The following rules ensure a maximum of flexibility:

- Ranges do not have to be sorted in ascending or descending order (e.g. the "Start Stimulus" value of range no. n does not have to be smaller than the "Start Stimulus" value of range no. n+1).
- Overlapping ranges are allowed. The limit check in the overlapping area is related to the tighter limit (the pass test involves a logical AND operation).
- Gaps between ranges are allowed and equivalent to switching off an intermediate ripple limit range.
- Ripple limit ranges can be partially or entirely outside the sweep range, however, the limits are only checked at the measurement points.

The following figure shows a ripple limit test involving 3 active ranges.

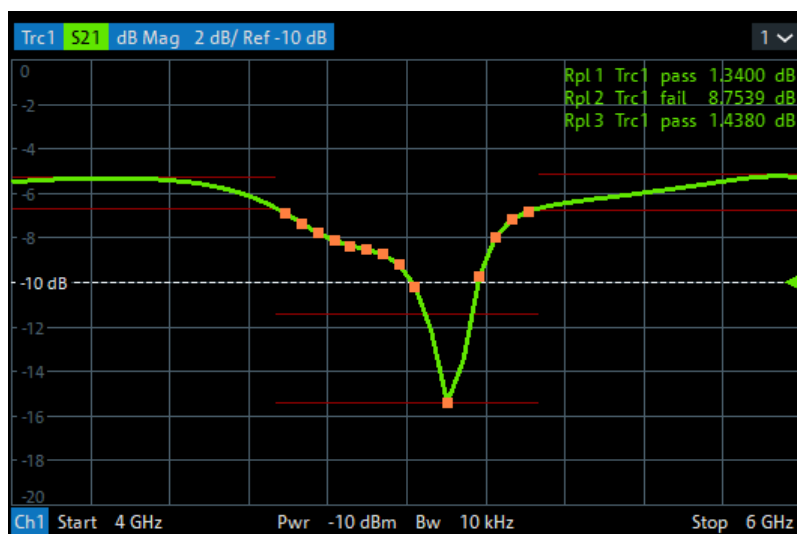

The limit line rules for logarithmic sweeps and segmented frequency sweeps with point-based x-axis also apply to ripple limit lines (see [Chapter 4.4.1.1, "Rules for limit line definition"](#), on page 169).

4.4.1.3 Circle limits

A circle limit is a special type of **upper** limit line which is defined by its center coordinate in the diagram and its radius. Depending on the diagram type, circle limit can serve different purposes:

- With a circle limit line centered on the origin of a polar diagram, you can check whether the magnitude of the measurement results exceeds a limit, defined by the radius of the limit line.

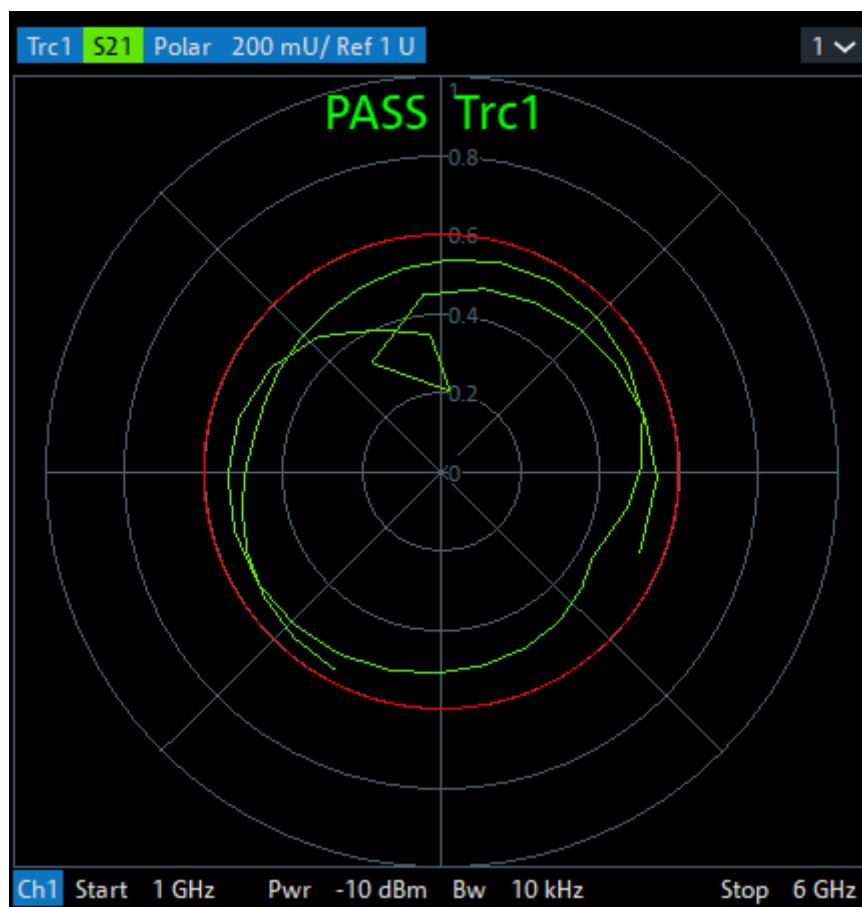

- With a circle limit line adjusted to the right border of a Smith diagram ($Z = \text{infinity}$), you can check whether the imaginary part of the impedance ($\text{Im}(Z)$, reactance) falls below a limit.

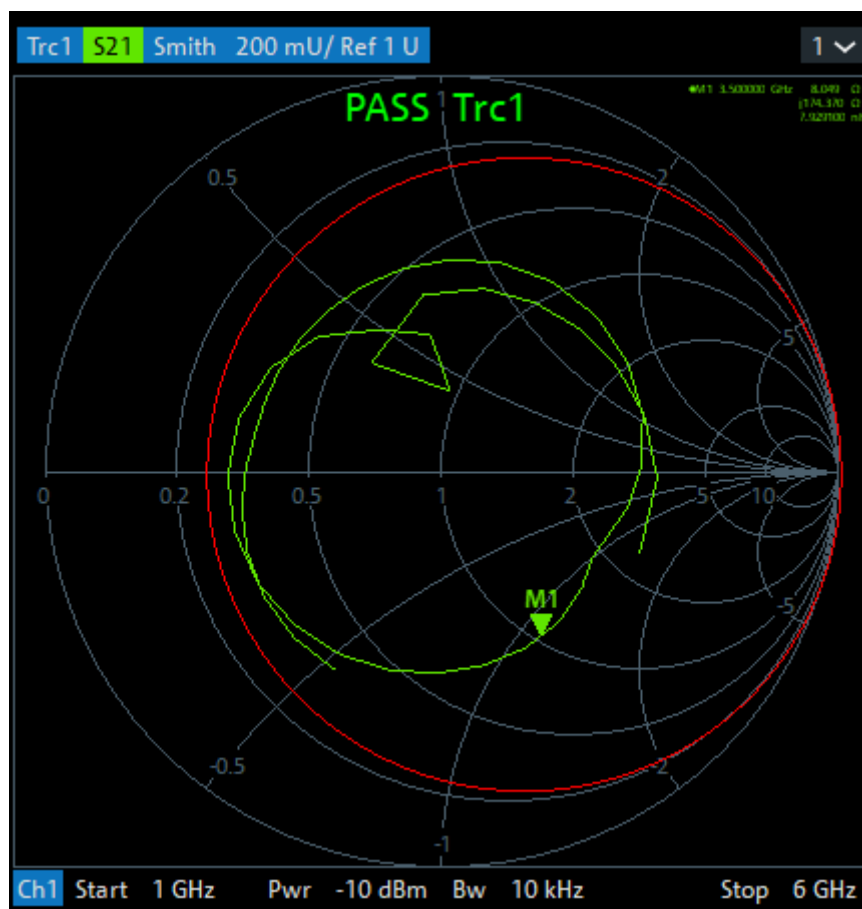

- With a circle limit line centered on the left border of an inverted Smith diagram ($Y = \infty$), you can check whether the imaginary part of the admittance ($\text{Im}(Y)$, susceptance) falls below a limit.

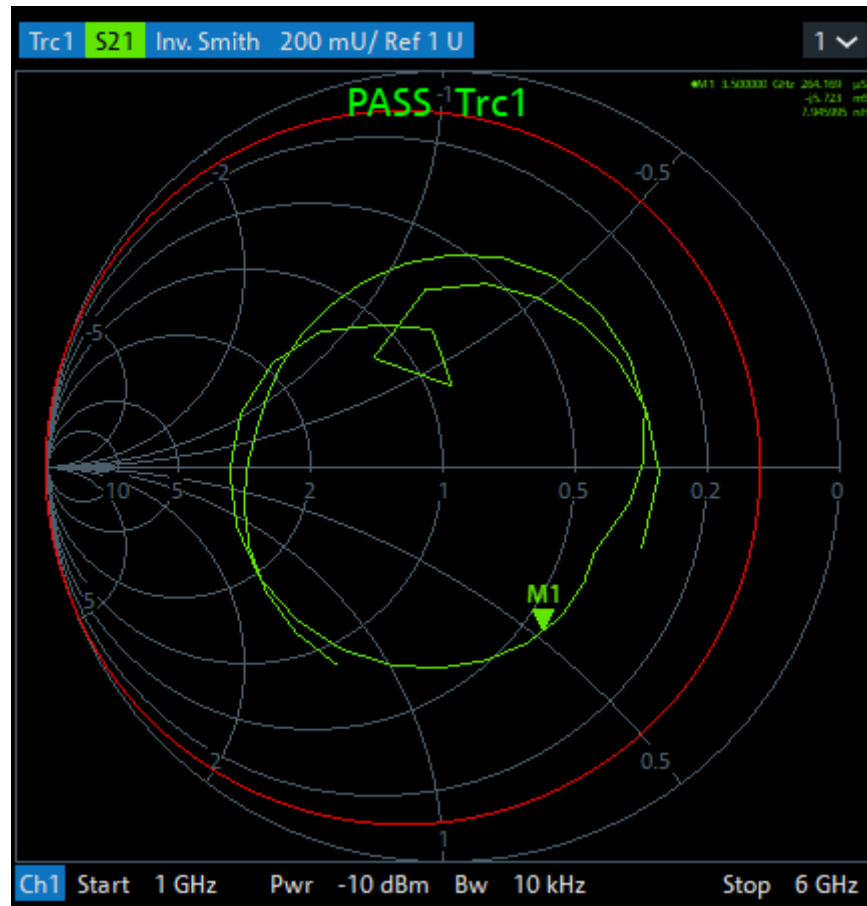

4.4.1.4 File format for limit lines

The analyzer uses a simple ASCII format to export limit line data. By default, the limit line file has the extension *.limit and is stored in the directory shown in the "Save Limit Line" and "Recall Limit Line" dialogs. The file starts with a preamble containing the channel and trace name and the header of the segment list. The following lines contain the entries of all editable columns of the list.

Example of a limit line file

The limit line:

	Type	Start Stimulus	Stop Stimulus	Start Response	Stop Response
1	Upper	9 kHz	8.5 GHz	0 dB	0 dB
2	Lower	9 kHz	6 GHz	-20 dB	-10 dB
3	Off	6 GHz	8.5 GHz	-10 dB	-10 dB

is described by the limit line file:

```
# Version 1.00
#
# Channel 1
# Trace 1
en:Type,start_stimulus[MHz],stop_stimulus[MHz],start_Response[dB],stop_Response[dB],
Upper,8.999999999999999E-003,8.500000000000000E+003,0.000000000000000E+000,0.000000000000000E+000,
Lower,8.999999999999999E-003,6.000000000000000E+003,-2.000000000000000E+001,-1.000000000000000E+001,
Off,6.000000000000000E+003,8.500000000000000E+003,-1.000000000000000E+001,-1.000000000000000E+001,
```



Compatibility with other instruments

The VNAs of the R&S ZNx and R&S ZVx families use the same file format. Limit line files can be interchanged without restriction.

4.4.1.5 File format for ripple limits

The analyzer uses a simple ASCII format to export ripple limits. By default, the ripple limit file has the extension *.ripple and is stored in the directory shown in the "Save Ripple Limits" and "Recall Ripple Limits" dialogs. The file starts with a preamble containing the channel and trace name and the header of the range list. The following lines contain the entries of all editable columns of the list.

Example of a ripple limit file

The ripple limit list:

	Range On/Off	Start Stimulus	Stop Stimulus	Ripple Limit
1	<input checked="" type="checkbox"/>	3 GHz	5 GHz	12 dB
2	<input checked="" type="checkbox"/>	4.5 GHz	5.5 GHz	5 dB
3	<input type="checkbox"/>	5.5 GHz	6 GHz	4.3826 dB

is described by the ripple limit file:

```
# Version 1.00
#
# Channel 1
# Trace 1
bo:Range on/off,start_stimulus[MHz],stop_stimulus[MHz],Ripple Limit[dB],
true,3.000000000000000E+003,5.000000000000000E+003,1.200000000000000E+001,
true,4.500000000000000E+003,5.500000000000000E+003,5.000000000000000E+000,
false,5.500000000000000E+003,6.000000000000000E+003,4.382581058243317E+000,
```



Compatibility with other instruments

The VNAs of the R&S ZNx and R&S ZVx families use the same file format. Ripple limit files can be interchanged without restriction.

4.4.2 Trace files

The R&S ZNA can store one or several data or memory traces to a file or load a memory trace from a file.

Trace files are ASCII files with selectable file format. The analyzer provides several types of trace files:

- Touchstone (*.s<n>p) files

- ASCII ("*.csv") files
- Matlab ("*.dat") files are ASCII files which can be imported and processed in Matlab.

The trace file formats complement each other; see [Chapter 4.4.2.3, "Finding the best file format"](#), on page 185.



- When exporting traces to a file, it is recommended to set the analyzer to single sweep mode (Channel – [Sweep] > "Sweep Control" > "All Channels on Hold"). This mode ensures that a complete sweep is exported.
- The number of decimal places of stimulus and data values in export files is configurable.

4.4.2.1 Touchstone files

The Touchstone file format is a standard for the transfer of frequency-dependent network data. Based on information from Agilent Corporation (the originator of Touchstone), formal specifications were produced by the EIA/IBIS Open Forum.

- [Touchstone File Format Specification Rev 1.1](#)
- [Touchstone File Format Specification Version 2.0](#)

The R&S ZNA supports Touchstone file versions 1.1 and 2.0.

By convention, Touchstone files use file extensions `.snp`, where `n` is the number of network ports. The following displays an `s1p` export file in "Version 1.1 (ZNx)" format:

```

1 # HZ S RI R 50.00
2 ! Rohde & Schwarz Vector Network Analyzer
3 ! Rohde-Schwarz,ZNA26-4Port,1332450024100005,2.20
4 ! Created: UTC 12/24/2020, 5:20:26 PM
5 ! My Comment
6 ! freq[Hz] re:S11 im:S11
1.0000000000000000E7 5.067533850669861E-1 -4.535870999097824E-2
1.4245000000000000E8 4.869025051593781E-1 -1.263110041618347E-1
...

```

1 = option line
2 = VNA identification comment
3 = timestamp comment
4 = user-defined comment
5 = network data table header comment
6 = network data table

General syntax rules

Among others, the following general syntax rules apply:

- Touchstone files are ASCII files, 8-bit encoded using ISO/IEC 8859-1:1998. Only the graphical characters 0x20 to 0x7E, the tab character 0x09, and the three line termination sequences LF (0x0A), CR+LF (0x0D + 0x0A), and CR (0x0Dh) are allowed.
- Touchstone files are case-insensitive.

- Blank lines are permitted.

Option line

Each Touchstone file must contain an option line with the following structure:

```
# <frequency unit> <parameter> <data format> R <reference
resistance>
```

- # indicates the beginning of the option line
- <frequency unit> can be either Hz, kHz, MHz or GHz. Default is GHz. The R&S ZNA always uses HZ for exported data.
- <parameter> specifies what kind of network parameter data is contained in the file. Default is S for S-parameters, which is the only parameter type the R&S ZNA supports.
- <data format> specifies how the complex network parameter data are formatted. Possible values are RI for "Real-Imag", MA for "Lin Mag-Phase", and DB for "dB Mag-Phase". Default is MA.
According to the Touchstone file standards, dB Mag = $20 \times \log_{10} \text{Mag}$, and the phase is always represented in degrees.
During data export, the analyzer allows you to select the suitable <data format>.
- <reference resistance> specifies the impedance system underlying the network data, given as a real, positive resistance. Its value is given in Ω (default 50). During export, if the impedances of all involved ports are identical, the analyzer sets the <reference resistance> to the real part of this impedance. Otherwise it sets it to 50.

With the exception of the opening # symbol and the value following R, option line parameters can appear in any order. If a parameter is missing, the default value is assumed.

Comments

Comments can be used for any kind of documentation purpose, e.g. to describe the network parameter data and how they were generated.

Syntactically, comments are preceded by an exclamation mark and terminated by a line termination sequence (see "[General syntax rules](#)" on page 177). They can appear anywhere in the file, either on a separate line, or after the parsed content of a line. Any number of comment lines can be inserted.

The content of the comments is not standardized in any way. The following sections describe the comments the R&S ZNA inserts into a Touchstone file during export.



During import, the R&S ZNA ignores all comments.

VNA identification

These comment lines identify the VNA that was used to generate the file.

```
! Rohde & Schwarz Vector Network Analyzer
! Rohde-Schwarz,ZNA26-4Port,1332450024100005,2.20
```

The first line is fixed, the second reflects the configurable identification string of the instrument.

Timestamp

The timestamp comment line reflects the time at which the Touchstone file was created. For "Version 1.1 (ZNx)" export format, it is represented as Coordinated Universal Time (UTC):

```
! Created: UTC 12/24/2020, 5:20:26 PM
```

The other export formats "Version 1.1" and "Version 2.0" use local time (Greenwich Mean Time + offset):

```
! Created: GMT+1 2020-12-24 18:20:26
```

Renormalization information

If, during export, the S-parameter data were renormalized with port-specific impedances, these impedances are written to the output file as a comment. In case the port-specific impedances are different, a note points out that the impedance system underlying the data is not interpreted correctly during import:

```
! The following Port Impedance Renormalization has been used when saving the data.
! PortZ Port1:100+j0 Port2:50+j0
!
! Note: The Port Impedances differ from the reference impedance of this file.
!       While reading the file the reference impedance value of the option line above
!       is always used.
```

For more information, see ["Renormalization of S-parameters"](#) on page 184.



For the "Version 2.0" export format, the port impedances are currently not written to the renormalization information comment. Instead, the real parts of the port impedances appear as arguments of the `[Reference] keyword`.

Network data table header

These comment lines indicate the content of the [Network parameter data](#) table right below it.

As the first column of the data table is always designated to the frequency points, the first table header comment always starts with `! freq[Hz]`.

- **"Version 1.1 (ZNx)" export format**

For this format, the header explicitly specifies the exported parameters and their data format. The port numbers of single-ended S-parameters in the header are the "real" (physical) port numbers:

```
! freq[Hz] re:S22 im:S22 re:S12 im:S12 re:S21 im:S21 re:
S11 im:S11
```

Up to port reordering, which is possible via "snp free config" export and via logical port assignment, the order in which the parameter data occur is the one described in the Touchstone 1.1 standard. See ["Network parameter data"](#) on page 182.

If balanced (and mixed mode) parameters are exported, the assigned logical port numbers are used:

```
! freq[Hz] re:Sdd11 im:Sdd22 re:Scd22 im:Scd22 re:Sdc22 im:
Sdc22 re:Sc22 im:Sc22
```

- **"Version 1.1" and "Version 2.0" export formats**

These export formats always use single-ended identifiers S_{ij} and port numbers 1 to n in the table header.

```
! freq[Hz] S11[Re] S11[Im] ...
```

The mapping between nominal (single-ended) and actual – possibly balanced – ports is given in the [port assignments](#) comments.

Port assignments (Version 1.1 and Version 2.0)

For export format "Version 1.1 (ZNX)", the assignments are given in the [Network data table header](#) comment lines. For export formats "Version 1.1" and "Version 2.0", they are declared in a dedicated comments section:

```
! Port Assignments:
! Nominal Port -> Actual Test Port
! -----
!   1 -> 2
!   2 -> 1
```

For balanced ports, the port assignment looks like in the following example:

```
! Port Assignments:
! Nominal Port -> Actual Test Port
! -----
!   1 -> D1,2
!   2 -> C1,2
```

The "s1p Active Trace" export, which allows to dump an arbitrary S-parameter trace to an s1p file, explicitly mentions the exported parameter:

```
! Trace info:
! Nominal Param -> Actual Exported Buffer
! -----
! S11 -> S21
```

User comment

The analyzer's trace export function allows you to insert a custom comment line into the export file.

```
! My Comment
```

Keywords (version 2.0 only)

Keywords are enclosed in square brackets, “[” and “]”, and start at the beginning of a line. Arguments after keywords (if any) are separated from the closing bracket and from each other by at least one blank (or tab).

[Keyword] argument1 argument2 ...



Keywords are new in Touchstone standard version 2.0. They are not allowed in version 1.1 files.

The purpose of the keywords is to give more details about the file contents in a standardized way. During "Version 2.0" export, the R&S ZNA writes the following keywords to the generated Touchstone file:

Keyword	Example	Description
[Version]	[Version] 2.0	Specification version, typically the first line in the file Currently only 2.0 is allowed
[Number of Ports]	[Number of Ports] 2	The <i>n</i> in the generated <i>snp</i> file. Except for the "s1p Active Trace" export, <i>n</i> equals the number of physical ports involved in the export.
[Two-Port Data Order]	[Two-Port Data Order] 21_12	Specifies the data order in <i>s2p</i> files. <ul style="list-style-type: none"> • 21_12 indicates data order f N11 N21 N12 N22 • 12_21 indicates data order f N11 N12 N21 N22 (see "Data arrangement" on page 182) The R&S ZNA generates <i>s2p</i> files with fixed data order 21_12 (according to the TS1.1 standard).
[Number of Frequencies]	[Number of Frequencies] 201	Number of exported frequency sweep points; can also be derived from the Network parameter data block.
[Reference]	[Reference] 50 75	If the exported S-parameter data were renormalized with port-specific impedances, the real parts of these impedances are listed as arguments of the [Reference] keyword. Overrides the common reference impedance of the "Option line" on page 178 Note: currently ignored during import
[Mixed-Mode Order]	[Mixed-Mode Order] D1,2 C1,2	Required if a balanced port is involved. In the example to the left, nominal port 1 is the differential mode and nominal port 2 is the common mode of balanced port (1,2). Conveys the same information as the Port assignments (Version 1.1 and Version 2.0) comment
[Network Data]	[Network Data] ! no args	Marks the begin of the Network parameter data block
[End]	[End] ! no args	Marks the end of the network parameter data section and is typically placed in the last line of the export file

For details and more keywords, see the Touchstone File Format Specification Version 2.0 (http://www.ibis.org/touchstone_ver2.0/touchstone_ver2_0.pdf).



During import, the R&S ZNA currently only considers the [Two-Port Data Order].

Network parameter data

The network parameter data section contains one block of network parameters per frequency point. Each block is preceded by a frequency value, i.e. the first entry in the first (or only) data line of a data block is a frequency value. The complex network parameter data is formatted as pairs of values. The following general rules apply

- Individual entries in a network data line are separated by whitespace
- In version 1.1 files, no more than four parameters are allowed per network data line. No restriction exists on the number of data pairs on a line in version 2.0 files.
- The network data blocks are arranged in ascending order of frequency



For segmented sweeps, the R&S ZNA makes an exception to the strict "ascending order" principle. During export, the segments are always kept together, which can result in downward "frequency jumps" at segment borders.

Data arrangement

During export, for each block the R&S ZNA arranges the frequency value f and network parameter data $(N_{i,j})_{1 \leq i,j \leq n}$ as described in the Touchstone 1.1 standard.

- **n = 1**
f N11
- **n = 2**
f N11 N21 N12 N22
- **n = 3, 4**
f N11 N12 N13
N21 N22 N13
N31 N32 N33

Similar matrix arrangement for $n=4$.

- **n > 4**
For $n > 4$, the "max. four parameters per data line" restriction applies. It is overcome by wrapping the matrix rows at multiples of four network parameter values.
For $n = 9$:

```
f N11 N12 N13 N14
  N15 N16 N17 N18
  N19
  N21 ...
  N95 N96 N97 N98
  N99
f N11 N12 N13 N14
  N15 N16 N17 N18
  N19
  N21 ...
  N95 N96 N97 N98
  N99
```

The data blocks are arranged in ascending order of frequency.



The "snp Free Config" export mode allows you to define

- the set of (physical) ports whose S-parameters shall be exported and
- the order in which they are exported

The examples above represent the simple scenario with consecutive ports {1,...,n} and natural ordering.

Data format

Frequencies are represented as single positive numbers, network parameter data as pairs of numbers. The `<frequency unit>` and `<data format>` are specified in the [Option line](#). Numbers can be represented as decimal integers or floating point numbers, with "." used as decimal separator. Scientific notation is allowed (e.g., `1.2345e-12`). No minimum or maximum limits are placed on numerical precision.

For Touchstone export, the R&S ZNA uses the normalized scientific notation, with a significand (mantissa) of length 17 (+1 for the minus sign) and an exponent with maximum length 2 (+1 for the minus sign).

```
1.0000000000000000e+09    -2.375070438098596e-01    -4.533104459856211e-01
1.0100000000000000e+09    -3.132740349817996e-01    -5.874596585157938e-01
1.0200000000000000e+09    -3.062444919836442e-01    -4.587379501906624e-01
```

Conditions for Touchstone file export

- One-port Touchstone files with data from a single trace
Typically, Touchstone files contain a complete set of S-parameter traces of an n-port network. The only exceptions are `s1p` files created from arbitrary S-parameter traces using the "s1p Active Trace" export function in the [Trace Data tab](#) or the remote command `MMEMoRy:STORe:TRACe`.
- Touchstone files containing S-matrices
 - For a one-port Touchstone file, the reflection coefficient for the specified port (S_{ii} for port i) must be measured. If a full one-port (Refl OSM) or a full n-port (TOSM, ...) calibration is available for the specified port, it is possible to export the data even when the trace is not displayed.
 - For a multiport Touchstone file `*.s<n>p`, either a full multiport system error correction or a complete set of n^2 S-parameter traces must be available. If the port configuration contains balanced ports, the exported Touchstone file contains the converted single-ended S-parameters unless you enable "Balanced Params" during export.
 - Export of balanced (symmetric) S-parameters must be enabled. If you want to export balanced S-parameters, make sure that all these parameters are measured, and that for each involved balanced port both physical ports are part of the export.

This type of export can be initiated from the GUI by using the "s<n>p Port ..." or "snp Free Config. ..." functions of the [Trace Data tab](#) or by the remote command `MMEMoRy:STORe:TRACe:PORTs` on page 1312.

Renormalization of S-parameters

Renormalization means that the S-parameters at connector impedances are converted to S-parameters at certain target impedances.

During Touchstone export, the S-parameters can be renormalized in two ways:

- **Common target impedance**
The `<reference resistance>` of the [Option line](#) is taken as common target impedance and the data is renormalized to the common target impedance, regardless of the reference impedances of the involved ports.
If the impedances of all involved ports are identical, the analyzer sets the `<reference resistance>` in the [Option line](#) to the real part of this impedance. Otherwise it sets it to 50 (Ω).
- **Port-specific Reference impedances**
In this case, the reference impedances of the individual ports are used for the renormalization and these impedances are documented in the [Renormalization information](#) comment. If the port-specific reference impedances are different, an additional warning is added to this comment, indicating that the option line contains a non-matching reference resistance.
Note that when reimporting this type of file into standard applications (including the R&S ZNA itself), the `<reference resistance>` of the Touchstone option line is used and the impedance system underlying the data is not interpreted correctly.

4.4.2.2 ASCII (*.csv) files

An ASCII file contains a header and the actual trace data:

```
freq;reTrc1_S21;imTrc1_S21;reMem2[Trc1]_S21;imMem2[Trc1]_S21;
300000.000000;0.000000;0.000000;0.000000;0.000000;
40499497.487437;0.000000;0.000000;0.000000;0.000000;
80698994.974874;0.494927;-0.065174;0.500833;-0.074866;
120898492.462312;0.497959;-0.111724;0.488029;-0.107375;
...
```

The header consists of the following data elements:

- `<Stimulus>` stimulus variable: freq for Frequency sweep, power for Power sweep, time for Time sweep, trigger for CW Mode sweep.
- `<reTrace1>` first response value of first trace: re`<Trace_Name>`, mag`<Trace_Name>` or db`<Trace_Name>` for output format Re/Im, lin. Mag-Phase or dB Mag-Phase, respectively. The data format for export files can be selected in the Export Data dialog.
- `<imTrace1>` second response value of first trace: im`<Trace_Name>` for output format Re/Im, ang`<Trace_Name>` for output formats lin. Mag-Phase or dB Mag-Phase. The data format for export files can be selected in the Export Data dialog.
- `<reTrace2>` first response value of second trace: re`<Trace_Name>`, mag`<Trace_Name>` or db`<Trace_Name>` for output format Re/Im, lin. Mag-Phase

or dB Mag-Phase, respectively. The data format for export files can be selected in the Export Data dialog.

- `<imTrace2>...` second response value of second trace: `im<Trace_Name>` for output format Re/Im, `ang<Trace_Name>` for output formats lin. Mag-Phase or dB Mag-Phase. The data format for export files can be selected in the Export Data dialog. first response value of second trace. HZ / KHZ / MHZ / GHZ allowed for imported files. The analyzer always uses HZ for exported data. second response value of first trace: `im<Trace_Name>` for output format Re/Im, `ang<Trace_Name>` for output formats lin. Mag-Phase or dB Mag-Phase. The data format for export files can be selected in the Export Data dialog.

The trace data is arranged as described in the header. Different values are separated by semicolons, commas or other characters, depending on the selected "Decimal Separator" in the "Export ... Data" dialogs. A semicolon is inserted before the end of each line.

The stimulus values are arranged in ascending order.

4.4.2.3 Finding the best file format

The file format depends on how you want to use the exported data.

Use a [Touchstone](#) file format to export S-parameter data traces to a file that can be evaluated with applications such as Keysight's Advanced Design System (the former Microwave Design System), and to convert mixed mode parameters back to single-ended parameters. The data must be acquired in a frequency sweep. Note the "[Conditions for Touchstone file export](#)" on page 183.



Touchstone files cannot be used to export mathematical traces.

Use the [ASCII \(*.csv\)](#) format if you want to do one of the following:

- Import the created file into a spreadsheet application such as Microsoft Excel.
- Export an arbitrary number of traces, multiple traces with the same parameter or memory traces.
- Export traces acquired in a power sweep or CW sweep.
- Export time domain traces
- Use export options.

Use the **Matlab (*.dat)** format if you want to import and process the trace data in Matlab.

4.5 Calibration

Calibration or system error correction is the process of eliminating systematic, reproducible errors from the measurement results (S-parameters and derived quantities; see [Chapter 4.1.7, "Data flow"](#), on page 120). The process involves the following stages:

Calibration or system error correction is the process of eliminating systematic, reproducible errors from the measurement results (S-parameters and derived quantities). The process involves the following stages:

1. A set of calibration standards is selected and measured over the required sweep range.
For many calibration types, the magnitude and phase response of each calibration standard (i.e. its S-parameters if no system errors occur) must be known within the entire sweep range. In some calibration procedures (TRL, TNA, TRM), part of the characteristics of the standards can be auto-determined due to implicit redundancy (self-calibration).
2. The analyzer compares the measurement data of the standards with their known, ideal response. The difference is used to calculate the system errors using a particular error model (calibration type) and derive a set of system error correction data.
3. The system error correction data is used to correct the measurement results of a DUT that is measured instead of the standards.

Calibration is always channel-specific because it depends on the hardware settings, in particular on the sweep range. This means that a system error correction data set is stored with the calibrated channel.

The analyzer provides a wide range of sophisticated calibration methods for all types of measurements. Which calibration method is selected depends on the expected system errors, the accuracy requirements of the measurement, on the test setup and on the types of calibration standards available.

Due to the analyzer's calibration wizard, calibration is a straightforward, menu-guided process. Moreover, it is possible to perform the entire calibration process automatically using a Calibration Unit (e.g. R&S ZN-Z5x or R&S ZN-Z15x).



The system error correction data determined in a calibration procedure are stored on the analyzer. You can read these correction data using the remote control command `[SENSe<Ch>:]CORRection:CDATa`. You can also replace the correction data of the analyzer by your own correction data sets.



Cal Off label

A label "Cal Off" appears in the trace line if the system error correction no longer applies to the trace:

Trc1 S21 dB Mag 10 dB/ Ref 0 dB Cal Off

This can happen for one of the following reasons:

- The sweep range is outside the calibrated frequency range.
- The channel calibration is not sufficient for the measured quantity (e.g. a one-port calibration has been performed, but the measured quantity is a transmission parameter).
- There is a mismatch between the current Frequency Offset settings and the Frequency Offset settings that were used during calibration (see ["Parallel Measurements with Frequency Offset"](#) on page 113)
- The system error correction has been switched off deliberately ("User Cal Active" is disabled).

The analyzer provides other labels to indicate the status of the current calibration; see [Chapter 4.5.4, "Calibration labels"](#), on page 206.



Calibration and port de-/activation

The analyzer firmware automatically activates/deactivates ports during/after a (successful) calibration:

- Calibrated ports that were previously disabled, are automatically enabled as single-ended logical ports.
- An uncalibrated port that is not used by a measurement (i.e. the port is not required by any trace of the related channel) is disabled.

4.5.1 Calibration types

The analyzer provides a wide range of calibration types for one, two or more ports. The calibration types differ in the number and types of standards used, the error terms, i.e. the type of systematic errors corrected and the general accuracy. The following table gives an overview.

Table 4-8: Overview of calibration types

Calibration Type	Standards	Parameters	Error Terms	General Accuracy	Application
Reflection Normalization	Open or Short	S_{ii} for Port i	Reflection tracking	Low to medium	Reflection measurements on any port.
Transmission Normalization	Through	S_{ij} for port pair (i,j) , $i \neq j$	Transmission tracking	Medium	Transmission measurements in any direction and between any combination of ports.

Calibration Type	Standards	Parameters	Error Terms	General Accuracy	Application
Reflection OSM	Open, Short, Match ¹⁾	S_{ii} for Port i	Reflection tracking, Source match Directivity,	High	Reflection measurements on any port.
One Path Two Ports	Open, Short, Match ¹⁾ (at source port), Through ²⁾ between the source port and all target ports	S_{tj} for fixed source port j and target ports t	Reflection tracking, Source match, Directivity, Transmission tracking	Medium to high	Unidirectional transmission measurements in any direction and between any combination of ports.
TOSM or UOSM (n-port)	Open, Short, Match ¹⁾ (at each port), Through ²⁾ (between all port pairs)	All	Reflection tracking, Source match, Directivity, Load match, Transmission tracking,	High	Reflection and transmission measurements; classical 12-term error correction model.
Adapter Removal (2-port)	Open, Short, Match ¹⁾ (at each port), Through	All Reflection parameters with and without adapter	Reflection tracking, Source match, Directivity, Load match, Transmission tracking,	High	Reflection and transmission measurements; classical 12-term error correction model.
TOM (n-port)	Open, Match (at both ports), Through (between all port pairs)	All	Reflection tracking, Source match, Directivity, Load match, Transmission tracking	High	Reflection and transmission measurements.
TSM (n-port)	Short, Match (at both ports), Through (between all port pairs)	All	Reflection tracking, Source match, Directivity, Load match, Transmission tracking	High	Reflection and transmission measurements.
TRM (n-port)	Reflect (equal at both ports), Match, Through (between all port pairs)	All	Reflection tracking, Source match, Directivity, Load match, Transmission tracking	High	Reflection and transmission measurements, especially in test fixtures.

Calibration Type	Standards	Parameters	Error Terms	General Accuracy	Application
TRL (n-port)	Reflect (at both ports), Through, Line1, other Lines (optional), combina- tion with TRM (optional)	All	Reflection tracking, Source match, Directivity, Load match, Transmission track- ing	High, high directiv- ity	Reflection and transmission mea- surements, espe- cially for planar cir- cuits. Limited band- width.
TNA (n-port)	Through, Attenua- tion, Symmetric network	All	Reflection tracking, Source match, Directivity, Load match, Transmission track- ing	High, lowest requirements on standards	Reflection and transmission mea- surements, espe- cially for planar cir- cuits.
OSM Scalar Mixer	Open, Short, Match ¹⁾ (at each port)	All except transmis- sion phases	Reflection tracking, source match, directivity	Low, improves with complementary ref- erence receiver cali- bration	Scalar mixer mea- surements , if no through is available
UOSM Scalar Mixer	Open, Short, Match ¹⁾ (at each port), Through	All except transmis- sion phases/delays	Reflection tracking, source match, directivity, load match, transmis- sion tracking	Medium, high with complementary ref- erence receiver cali- bration	Scalar mixer mea- surements, if no phases/delays are required
OSM Vector Mixer	Open, Short, Match ¹⁾ (at each port), Calibration Mixer	All except feed- throughs	Reflection tracking, source match, directivity	Medium, high for transmission pha- ses/delays	Vector mixer mea- surements , if no through is available or only transmission phases/delays are measured
UOSM Scalar Vec- tor Mixer	Open, Short, Match ¹⁾ (at each port), Through, Cal- ibration Mixer	All	Reflection tracking, source match, directivity, load match, transmis- sion tracking	High	Scalar and vector mixer measure- ments

¹⁾ Or any other 3 known one-port standards. To be used in a guided calibration, the known standards must be declared to be Open, Short, and Match irrespective of their properties.

²⁾ Or any other known two-port standard. To be used in a guided calibration, the known standard must be declared to be Through, irrespective of its properties.



The calibration type must be selected in accordance with the test setup. Select the calibration type for which you can obtain or design the most accurate standards and for which you can measure the required parameters with best accuracy.

- [Normalization \(reflection, transmission\)](#)..... 190
- [Reflection OSM calibration](#)..... 190
- [One Path Two Ports Calibration](#)..... 191
- [TOSM and UOSM calibration](#)..... 191
- [Adapter removal](#)..... 192
- [TOM calibration](#)..... 194
- [TSM calibration](#)..... 194

• TRM calibration.....	194
• TRL calibration.....	195
• TNA calibration.....	197
• Full n-Port calibration with reduced number of Through connections.....	197
• Complementary isolation measurement.....	198
• Mixer calibrations.....	199

4.5.1.1 Normalization (reflection, transmission)

A normalization is the simplest calibration type since it requires the measurement of only one standard for each calibrated S-parameter:

- One-port (reflection) S-parameters (S_{11} , S_{22} , ...) are calibrated with an Open or a Short standard providing the reflection tracking error term.
- Two-port (transmission) S-parameters (S_{12} , S_{21} , ...) are calibrated with a Through standard providing the transmission tracking error term.

Normalization means that the measured S-parameter at each sweep point is divided by the corresponding S-parameter of the standard. A normalization eliminates the frequency-dependent attenuation and phase shift in the measurement path (reflection or transmission tracking error). It does not compensate for directivity or mismatch errors. This limits the accuracy of a normalization.



- Manual reflection normalizations offer [Complementary Match standard measurements](#)
- Manual transmission normalizations support [Complementary isolation measurement](#) (optional).

Complementary Match standard measurements

For reflection normalizations, the mandatory Open or Short measurements can be complemented by optional Match measurements. Additionally, measuring a Match standard allows you to eliminate errors due to the directivity of the internal couplers, which improves the accuracy of reflection measurements on well-matched DUTs (high return loss).



For reflection measurements on DUTs with low return loss, accuracy may be degraded compared to a simple reflection normalization.

4.5.1.2 Reflection OSM calibration

A reflection OSM (full one-port) calibration requires a Short, an Open and a Match standard to be connected to a single test port. The three standard measurements are used to derive all three reflection error terms:

- The Short and Open standards are used to derive the source match and the reflection tracking error terms.
- The Match standard is used to derive the directivity error.

A reflection OSM calibration is more accurate than a normalization but is only applicable for reflection measurements.

4.5.1.3 One Path Two Ports Calibration

A one path two ports calibration combines a reflection OSM (full one-port) calibration with a transmission normalization. The fully calibrated port is termed the node port. This calibration type requires a Short, an Open and a Match standard to be connected to a single test port plus a Through standard between this calibrated source port and the other load ports. The four standard measurements are used to derive the following error terms:

- The Short and Open standards are used to derive the source match and the reflection tracking error terms at the source port.
- The Match standard is used to derive the directivity error at the source port.
- The Through standard provides the transmission tracking error terms.

For calibration of two ports, a one-path two-port calibration requires only four standards to be connected (instead of 7 for a full two-port TOSM calibration). It is suitable when only the forward (e.g. S_{11} and S_{21}) or reverse S-parameters (e.g. S_{22} and S_{12}) are needed, and if the DUT is well matched, especially at the load port.

A one-path two-port calibration is also the best calibration method for test setups with unidirectional signal flow, e.g. a pulsed measurement using an external generator.

4.5.1.4 TOSM and UOSM calibration

TOSM

A TOSM (Through – Open – Short – Match) calibration requires the same standards as the one path two ports calibration, however, all measurements are performed in the forward and reverse direction. TOSM is also referred to as SOLT (Short – Open – Load = Match – Through) calibration. The four standards are used to derive 6 error terms for each signal direction:

- In addition to the source match and reflection tracking error terms provided by the one-path two-port calibration, TOSM also provides the load match.
- The directivity error is determined at all source ports.
- The transmission tracking is determined for each direction.

TOSM calibration is provided for arbitrary n-port measurements ($n > 1$). The number of required standard measurements and of error terms increases as shown in the following table.

Number of ports	Number of standards to be connected	Number of standard measurements	Number of error terms ^{*)}
2	$2 * 3$ $+1 = 7$	$2 * 3$ $+2 * 1 = 8$	$2 * 3$ $+ 2 * 2 = 10$
3	$3 * 3$ $+ 2 + 1 = 12$	$3 * 3$ $+2 * (2 + 1) = 15$	$3 * 3$ $+ 2 * 2 * 3 = 21$
4	$4 * 3$ $+3 + 2 + 1 = 18$	$4 * 3$ $+2 * (3 + 2 + 1) = 24$	$4 * 3$ $+ 2 * 2 * 6 = 36$

^{*)} No isolation terms are available.

An Open, Through and Match measurement is required at each port; in addition, for a full TOSM, a Through must be measured for every directed port pair. Therefore the total number of standard measurements for an n-port TOSM calibration is $3n + n(n-1) = n(n+2)$. However, this number can be significantly decreased without losing too much precision (see [Chapter 4.5.1.11, "Full n-Port calibration with reduced number of Through connections"](#), on page 197)

The analyzer automatically performs each through measurement in both directions, so the number of connected standards is smaller than the number of measurements.



Manual TOSM calibration supports [Complementary isolation measurement](#) (optional).

UOSM: TOSM with unknown Through

The analyzer can perform a TOSM calibration with any 2-port network serving as through connection, as long as it fulfills the reciprocity condition $S_{21} = S_{12}$. The modified TOSM calibration is referred to as UOSM (Unknown through – Open – Short – Match) calibration. It can be selected as follows:

- If different connector types are assigned to the test ports, the analyzer automatically replaces TOSM by UOSM.
[The network analyzer supports different connector types at its test ports to measure DUTs with different port connectors; see also [Chapter 4.5.1.5, "Adapter removal"](#), on page 192.]
- If the same connector types are used but an appropriate Through standard is not defined, the analyzer also replaces TOSM by UOSM.
- UOSM can be selected explicitly in the "Calibration Setting" dialog.

After acquiring the calibration sweep data for the unknown through, the analyzer automatically determines its delay time/transmission phase.

4.5.1.5 Adapter removal

Many DUTs use different connector types on their RF ports (e.g. port 1: N-type connector, female; port 2: PC 3.5-type connector, female).



DUTs of this sort are also known as **noninsertable devices**.

A suitable calibration kit is then required for each of the different connector types. The kit must include, as a minimum, the standards that are used for one-port calibration. The through-connection between test ports with different connector types must be made using **adapters**.

The problem here is that unlike Through standards, adapters are usually not characterized, i.e. their delay time/transmission phase is unknown.

If the adapter fulfills the reciprocity condition $S_{21} = S_{12}$, it can serve as **Unknown** through in an **UOSM** calibration (see "[UOSM: TOSM with unknown Through](#)" on page 192).

Adapter Removal is an extension of the **2-port UOSM** calibration. It requires two additional reflection OSM calibrations with the adapter successively connected to port 1 and port 2.

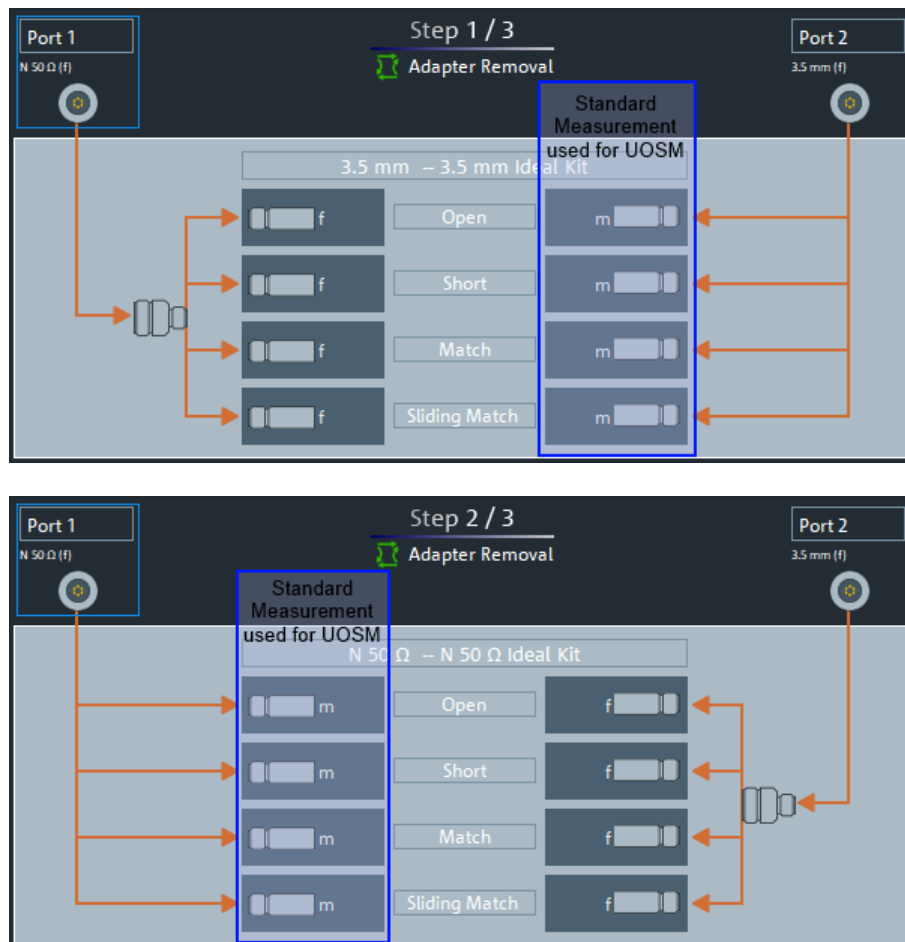

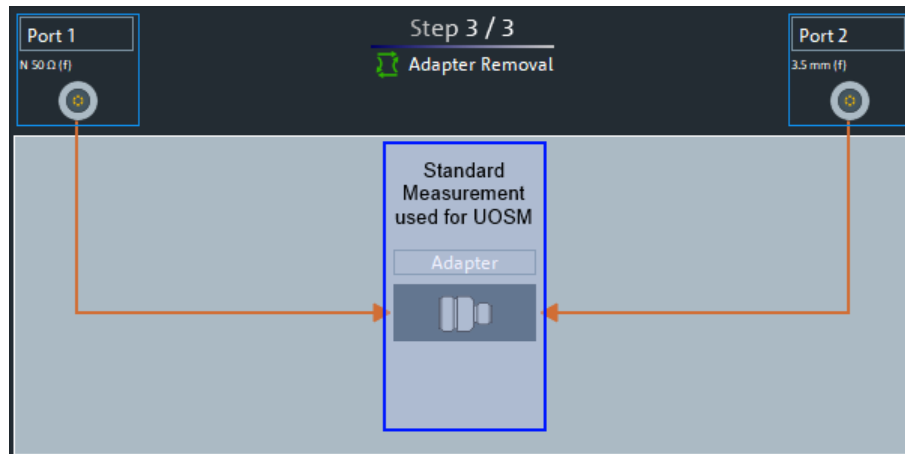

Figure 4-7: Adapter Removal vs. UOSM

The obtained adapter characteristics are mathematically removed from the obtained error coefficients. Uncertainties arising from a non-ideal characterization of the unknown through almost cancel, whereas they add up in the UOSM technique. As a consequence, Adapter Removal will provide more accurate results.



- Adapter Removal is not defined for more than 2 ports. However, with "Multiple Calibrations per Channel" enabled, multiple (disjoint) port pairs can be calibrated using Adapter Removal.
- Currently Adapter Removal is not supported with [Automatic calibration](#).

4.5.1.6 TOM calibration

A TOM (Through – Open – Match) calibration requires a low-reflection, low-loss Through standard with an electrical length that can be different from zero, an Open, and a Match. The characteristics of all standards must be fully known; the Match can have non-ideal characteristics.

4.5.1.7 TSM calibration

A TSM (Through – Short – Match) calibration requires a low-reflection, low-loss Through standard with an electrical length that can be different from zero, a Short, and a Match. The characteristics of all standards must be fully known; the Match can have non-ideal characteristics.

TSM calibration can replace TOM calibration if no appropriate Open standard is available, especially in the high frequency domain.

4.5.1.8 TRM calibration

A TRM (Through – Reflect – Match) calibration requires a low-reflection, low-loss Through standard with an electrical length that can be different from zero, a Reflect, and a Match. The magnitude of the reflection coefficient of the Reflect standard can be

unknown but must be nonzero; its phase must be roughly known (90 deg). The magnitude and phase of the reflection coefficient must be the same at both test ports.

TRM calibration is especially useful for DUTs in test fixtures.

4.5.1.9 TRL calibration

A TRL (Through – Reflect – Line) calibration requires the two-port standards Through and Line, which are both assumed to be ideally matched. The Through must be lossless, and its length must be exactly known. The length of the Line standard must be known approximately.

Furthermore, a reflecting one-port standard (Reflect) is needed. The magnitude of the reflection coefficient of the Reflect standard can be unknown but must be nonzero; its phase must be roughly known (90 deg). The magnitude and phase of the reflection coefficient must be the same at both test ports.

TRL calibration is especially useful for DUTs in planar line technology (e.g. test fixtures, on-wafer measurements) where it is difficult to design and connect accurately modeled Open, Short or Match standards.

If TRL is not practicable, TNA can be an alternative.

TRL with several Lines and with TRM

The system of equations that have to be solved for the error terms exhibits singularities whenever the length difference ΔL between the Through and the Line is an integer multiple of half of the wave length:

$$\Delta L \neq n \frac{\lambda}{2}$$

As a rule, singularities are avoided with sufficient accuracy if the phase shift resulting from the (electric) length difference between the Through and the Line standard is between 20° and 160° . This corresponds to a ratio of 1:8 for the start and stop frequency of the calibrated sweep range.



To shift the calibrated sweep range to smaller or larger frequencies, you can use a longer or shorter Line. To extend the calibrated range, use one of the following methods:

- Perform TRL calibration with two or three different Line standards. With an appropriate length of the Lines, the ratio for the start and stop frequency of the calibrated sweep range can increase to approx. 1:64 (for 2 lines) or 1:512 (for 3 lines).
- In the low-frequency domain where TRL becomes inaccurate, replace TRL by TRM calibration. See "[Low-frequency extension with TRM](#)" on page 197.

The methods can be combined or used separately. The list of measured standards in the calibration step for TRL calibration is extended if the calibration kit in use contains the necessary standards:

- A 2-line (3-line) calibration requires two (three) different Lines of matching gender. The lines must be measured between any combination of two ports.

- A TRM extension at low frequencies requires either a Match or a Sliding Match standard. The standard must be measured at each port.

The complete list of measured standards for a two-port calibration is shown below.

- For a **TRL calibration with 1 Line**, the Reflect standard at both ports, the Through, and one Line standard must be measured.
- For a **TRL calibration with 2 Lines**, a second Line standard must be measured in addition.
- For a TRM extension, the Reflect and Match standards at both ports (and the Through) must be measured. See also [Chapter 4.5.2.3, "Sliding Match standards"](#), on page 203.

The TRL calibration is valid when the standards for a TRL calibration with 1 line have been measured. The TRL extensions are applied automatically if the necessary standards have been measured.

P1	P2	P1 P2
N 50 Ω (f) N 50 Ω Ideal Kit	N 50 Ω (f) N 50 Ω Ideal Kit	N 50 Ω (f) N 50 Ω Ideal Kit
M Match (m)	M Match (m)	T Through (mm)
Sliding Match (m)	Sliding Match (m)	L Line 1 (mm)
R Reflect (m)	R Reflect (m)	L Line 2 (mm)
		L Line 3 (mm)

Example: TRL calibration with two and three Lines

If several Lines with different lengths are measured, the analyzer automatically divides the calibrated range into segments. The calibration data of the longest line is applied to the lowest segment, the calibration data of the shortest line to the highest segment.

The calibration sweep segments for two Lines with electric lengths l_{long} and l_{short} ($l_{\text{long}} > l_{\text{short}}$) are obtained as follows (the Through standard is assumed to be of length l_{thr}):

- The longer Line can be used up to a frequency f_{long} where its transmission phase is equal to 160 deg. This frequency is equal to

$$f_{\text{long}} = 4 \cdot c_0 / [9 \cdot (l_{\text{long}} - l_{\text{thr}})].$$
- The shorter Line can be used from a frequency f_{short} where its transmission phase is equal to 20 deg. This frequency is equal to

$$f_{\text{short}} = c_0 / [18 \cdot (l_{\text{short}} - l_{\text{thr}})].$$
- The border between the two frequency segments f_{div} is calculated as the geometric mean of f_{long} and f_{short} , i.e.

$$f_{\text{div}} = \text{sqrt}(f_{\text{long}} \cdot f_{\text{short}}).$$

The formulas are also applied if $f_{\text{long}} < f_{\text{short}}$.

For a TRL calibration using three Lines with different length, the allowed frequency ranges are calculated in an analogous manner to obtain three (ideally overlapping) frequency ranges. The borders between two adjacent frequency ranges are calculated as the geometric mean of the frequency limits f_{long} and f_{short} of the two ranges.



A second or third Line in the list does not mean that you have to measure two or three Line standards. If the calibrated frequency range is small enough, the calibration is valid when the analyzer has acquired correction data for a single Line standard.

The Match and Sliding Match standards are not necessary for TRL calibration. However, they must be measured if TRL is combined with TRM calibration.

Low-frequency extension with TRM

TRL calibration becomes inaccurate if the electrical length difference between Line and Through standard corresponds to a phase shift below 20° . In practice, TRL is only practicable above a threshold frequency $c_0/[18 \cdot (l_{\text{long}} - l_{\text{thr}})]$, where l_{long} denotes the longest electrical length of the used Line standards, and l_{thr} the electrical length of the Through. The analyzer assumes $l_{\text{thr}} \ll l_{\text{long}}$ and uses $c_0/(18 \cdot l_{\text{long}})$ as the frequency threshold.

E.g., for a line with $l_{\text{long}} = 16.666$ cm, the threshold frequency is 100 MHz.

At frequencies below this threshold frequency, TRL calculation is automatically replaced by TRM calculation, if the necessary Match data have been acquired.

Accuracy conditions for the Lines

The length error of the Line, converted into a transmission phase error, must be below the minimum difference to the singularity points 0 deg or 180 deg multiplied by two. Suppose that an approximately known Line standard causes a transmission phase 30 deg at the start frequency and of 160 deg at the stop frequency of the sweep. Its length error must cause a phase difference below $(180 \text{ deg} - 160 \text{ deg}) \cdot 2 = 40 \text{ deg}$.

4.5.1.10 TNA calibration

A TNA (Through – Network – Attenuation) calibration requires two-port standards only. Again, the Through standard must be ideally matched and lossless. The Symmetric Network must have the same properties as the Reflect standard used for a TRL calibration. I.e., the magnitude of its reflection coefficient can be unknown but must be nonzero. Its phase must be roughly known (± 90 deg). The magnitude and phase of the reflection coefficient must be the same at both test ports. The Attenuation standard must be well matched on both sides and cause an attenuation different from 0 dB; the exact value of the transmission coefficient is not important.

As with TRL, TNA calibration is especially useful for planar DUTs. If TNA is not practicable, TRL can be an alternative.

4.5.1.11 Full n-Port calibration with reduced number of Through connections

The analyzer can calculate the error terms for a full n-port calibration after n-1 Through measurements, if the measured Throughs connect all ports to be calibrated. The correction values for the unmeasured Throughs can then be calculated from the measured ones.

To establish a sufficient set of Through connections, you can select an arbitrary test port as the "center" and measure all Through connections to this test port ("star-shaped calibration"). You can also connect all ports in increasing order, e.g. 1→2, 2→3, 3→4 ...

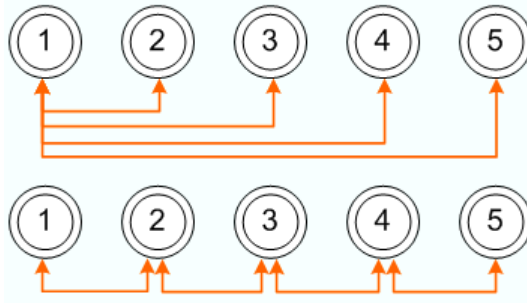

[For the mathematically inclined: the graph constructed from the calibration ports as nodes and the measured Throughs as edges must be connected.]



If an external switch matrix is configured and you want to calibrate three or more test ports that are all on the **same submatrix**, then an extra Through measurement is required: Complement the minimum set of $n-1$ Throughs (as explained above) by an additional Through at a port pair that is connected by a "chain of throughs" of length 2 (e.g. between ports 2 and 4 in the examples above).

See [Chapter 4.7.41, "External switch matrices"](#), on page 323 for background information on switch matrices and their submatrices.

Compared to the full number of $n(n-1)/2$ Through connections, the time and effort is significantly reduced, in particular if n is large.

The "Reduced Through" logic is implemented for all full n -port calibration types.

- During manual calibration, you can apply the calibration when a sufficient set of Through connections have been measured. However, you can measure additional Through connections to improve the accuracy.
- If [Multiple port assignments](#) are required, an [Automatic calibration](#) always proposes a minimum number of port assignments. However, for each port assignment all possible through connections are measured by default. If you want to apply the "Reduced Through" logic also for each port assignment, you can activate it in the system configuration.

4.5.1.12 Complementary isolation measurement

For each port pair in a manual transmission normalization or TOSM calibration, the Through measurement can be complemented by an isolation measurement. This measurement accounts for possible crosstalk between the related test ports (e.g. on a test fixture).

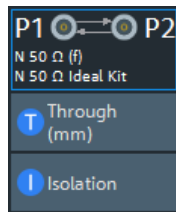

If isolation is measured, the corrected transmission coefficient of the DUT is calculated as:

$$(Transmission\ coefficient\ DUT - Isolation) / (Transmission\ coefficient\ Through - Isolation)$$

There is no dedicated physical standard for isolation measurement; it is recommended to terminate the test ports suitably (e.g. with 50 Ω loads).

4.5.1.13 Mixer calibrations

All "(U)OSM Scalar/Vector Mixer" calibrations mentioned in [Table 4-8](#) are based on the [Reflection OSM calibration](#) or the [UOSM Calibration](#).

A **scalar** mixer calibration basically ensures that all required frequencies for the mixer measurements are calibrated. A **vector** mixer calibration requires an additional frequency converting calibration standard, a so-called "Calibration Mixer". Such a Calibration Mixer must be reciprocal, to establish the frequency converting phase relation between two ports.

The properties of the Calibration Mixer and the corresponding calibration measurement steps can be configured in the "[Mixer/IMD/Harmonics tab](#)" on page 590 of the calibration setup dialog (Channel – [Cal] > "Start Cal" tab > "Configure/Start Calibration ...").

#	Use Power	Port Power	M. Source Att.	Power Result	LO Multiplier
LO	<input type="checkbox"/>		0 dB		1

4.5.2 Calibration standards and calibration kits

A calibration kit is a set of physical calibration standards for a particular connector type. The magnitude and phase response of the calibration standards (i.e. their S-parameters) must be known or predictable within a given frequency range.

The standards are grouped into several types (Open, Through, Match,...) corresponding to the different input quantities for the analyzer's error models. The standard type also determines the equivalent circuit model used to describe its properties. The circuit model depends on several parameters that are stored in the cal kit file associated with the calibration kit.

As an alternative to using circuit models, it is possible to describe the standards with S-parameter tables stored in a file.

The analyzer provides many predefined cal kits but can also import cal kit files and create kits:

- A selection of predefined kits is available for all connector types. The parameters of these kits are displayed in the "View / Modify Cal Kit Standards" dialog, however, it is not possible to change or delete the kits.
- Imported and user-defined kits can be changed in the "Calibration Kits" dialog and its various subdialogs.

Calibration kits and connector types are global resources; the parameters are stored independently and are available irrespective of the current recall set.

4.5.2.1 Calibration standard types

The following table gives an overview of the different standards and their circuit models (offset and load models).

Table 4-9: Calibration standard types

Standard Type	Characteristics	Ideal Standard	Offset Model	Load Model
Open	Open circuit (one-port)	$\infty \Omega$	<input checked="" type="checkbox"/>	<input checked="" type="checkbox"/>
Short	Short circuit (one-port)	0Ω	<input checked="" type="checkbox"/>	<input checked="" type="checkbox"/>
Offset short	Short circuit with added electrical length offset, for waveguide calibration (one-port)	0Ω	<input checked="" type="checkbox"/>	<input checked="" type="checkbox"/>
Match	Matched broadband termination (one-port)	Z_0 (characteristic impedance of the connector type)	<input checked="" type="checkbox"/>	<input checked="" type="checkbox"/>
Sliding match	One-port standard consisting of an air line with a movable, low-reflection load element (sliding load)	–	–	–
Reflect	Unknown mismatched standard (one-port)	$\infty \Omega$	<input checked="" type="checkbox"/>	<input checked="" type="checkbox"/>
Through	Through-connection with minimum loss (two-port)	–	<input checked="" type="checkbox"/>	–
Line1, Line 2	Line(s) for TRL calibration with minimum loss (two-port)	–	<input checked="" type="checkbox"/>	–
Attenuation	Fully matched standard in both directions (two-port; the reflection factor at both ports is zero)	–	–	–
Symm. network	Unknown mismatched reflection-symmetric standard (two-port)	–	<input checked="" type="checkbox"/>	<input checked="" type="checkbox"/>

Offset parameters

The offset parameters have the following physical meaning:

- The *delay* is the propagation time of a wave traveling through the standard. The *electrical length* is equal to the delay times the speed of light in the vacuum. It is a measure for the length of transmission line between the standard and the actual calibration plane. For a waveguide with permittivity ϵ_r and mechanical length L_{mech} , the following relations hold:

$$\text{Delay} = \frac{L_{mech} \cdot \sqrt{\epsilon_r}}{c}; \quad \text{Electrical Length} = L_{mech} \cdot \sqrt{\epsilon_r}$$

The default delay is 0 s, the default step width is 1 ns, corresponding to a step width of 299.792 mm for the electrical length. The relations hold for one-port and 2-port standards.

- Z_0 is the characteristic impedance of the standard. If the standard is terminated with Z_0 , then its input impedance is also equal to Z_0 . Z_0 is not necessarily equal to the reference impedance of the system (depending on the connector type) or the terminal impedance of the standard. The characteristic impedance of the standard is only used in the context of calibration.

The default characteristic impedance is equal to the reference impedance of the system.

- The *loss* is the energy loss along the transmission line due to the skin effect. For resistive lines and at RF frequencies, the loss is approximately proportional to the square root of the frequency.

In Keysight mode, the *offset loss* is expressed in units of Ω/s at a frequency of 1 GHz. The following formula holds for two-port standards:

$$\text{Offset Loss} / [\Omega / s] = \frac{\text{Loss} / [dB] \cdot Z_0 / [\Omega]}{4.3429 / [dB] \cdot \text{delay} / [s]}$$

The conversion formula for one-port standards has an additional factor $\frac{1}{2}$ on the right-hand side. The reason for this factor is that the Loss in dB accounts for the attenuation along the forward **and** the reverse path. It does not depend on how often the wave actually propagates through the line, whereas the offset loss is proportional to the attenuation of the line.

To determine an offset loss value experimentally, measure the delay in seconds and the loss in dB at 1 GHz and use the formula above.

The default loss or offset loss is zero.



The impedance for waveguides is frequency-dependent. If a waveguide line type is selected in the "Cal Connector Types" dialog, the "Char. Imp." field is disabled and indicates "varies" instead of a definite impedance value. Moreover no loss or offset loss can be set.

Offset parameters and standard types

Offset parameters are used to describe all types of standards except the Sliding Match and the Attenuation.

- The Sliding Match is a one-port standard with variable load parameters (sliding load) and unspecified length. The reference impedance is fixed and equal to the characteristic impedance of the connector type. No load and offset parameters need to be set.
- The Attenuation is a two-port standard which is fully matched in both directions (the reflection factor at both ports is zero). No load and offset parameters need to be set.

Load parameters and standard types

Load parameters are used to describe all types of standards except a Through, a Sliding Match, a Line, and an Attenuation.

- The Through standard is a through-connection between two ports with minimum loss which is taken into account by the offset parameters.
- The Sliding Match is a one-port standard with variable load parameters (sliding load), so there is no fixed load model.
- The Line standard is a line of variable length with minimum loss which is taken into account by the offset parameters.
- The Attenuation is a two-port standard which is fully matched in both directions (the reflection factor at both ports is zero). No load and offset parameters need to be set.

4.5.2.2 Cal kit parameter types

The analyzer uses three types of parameters to describe the calibration standards. The parameter type is the same for all standards in a kit and therefore appended to the kit name:

- **Universal** parameters (no suffix) describe calibration kit models with highly standardized components so that the parameters are valid for all calibration kits of the model.
- **Typical** parameters (suffix "typical") approximately describe a calibration kit model. To correct for deviations between the standards, each kit of the model is individually measured and delivered with an additional, kit-specific parameter set. Therefore each typical parameter set "<kit_name> typical" is complemented by an additional parameter set "<kit_name>" containing optimized parameters for an individual kit.
- **Ideal** parameters (suffix "Ideal Kit") describe an idealized calibration kit for each connector type; see below.



Make sure to use universal or individual parameter sets if you need to obtain high-precision results. The precision of the calibration kit parameters determines the accuracy of the system error correction and of the measurements. The R&S ZNA displays a warning if you use a typical or ideal parameter set to calibrate a channel.

Calibration kits can be obtained as network analyzer accessories; refer to the data sheet for the relevant ordering information. The name of all parameter sets is equal to the name of the corresponding calibration kit model.

Ideal parameters

All ideal kits contain the standards listed below.

Table 4-10: Ideal standard parameters

Standard (Gender)	R (Load)	Electrical Length (Offset)
Open (f, m)	$\infty \Omega$	0 mm (Delay: 0 s)
Short (f, m)	0 Ω	0 mm
Offset Short (f, m)	0 Ω	10 mm

Standard (Gender)	R (Load)	Electrical Length (Offset)
Match (f, m)	Z_0 (characteristic impedance of the connector type)	0 mm
Sliding Match (f, m)	–	0 mm
Reflect (f, m)	$\infty \Omega$	0 mm
Through (ff, mm, mf)	–	0 mm
Line (ff, mm, mf)	–	10 mm
Attenuation (ff, mm, mf)	–	0 mm
Symm. Network (ff, mm, mf)	–	0 mm

The following additional parameters are used:

- Characteristic impedance: Z_0 (characteristic impedance of the connector type)
- Loss: 0 dB / sqrt(GHz) or (0 GΩ / s) in Keysight mode
- All inductance and capacitance parameters are set to zero.

4.5.2.3 Sliding Match standards

The Sliding Match is a one-port standard consisting of an air line with a movable, low-reflection load element (sliding load). This standard is used because a no perfect Match is available over a wide frequency range. However, a series of measurements at a given frequency with equal mismatch and varying phase yields reflection factors that are located on a circle in the Smith chart. The center of this circle corresponds to perfect match. The network analyzer determines and further corrects this match point following I. Kása's circle-fitting algorithm.

To obtain the reflection coefficient for a perfectly matched calibration standard, the Sliding Match must be measured at least at 3 positions which should be unequally spaced to avoid overlapping data points. Increasing the number of positions to 4 to 6 can improve the accuracy. Moreover, using the predefined load positions of the standard is recommended.

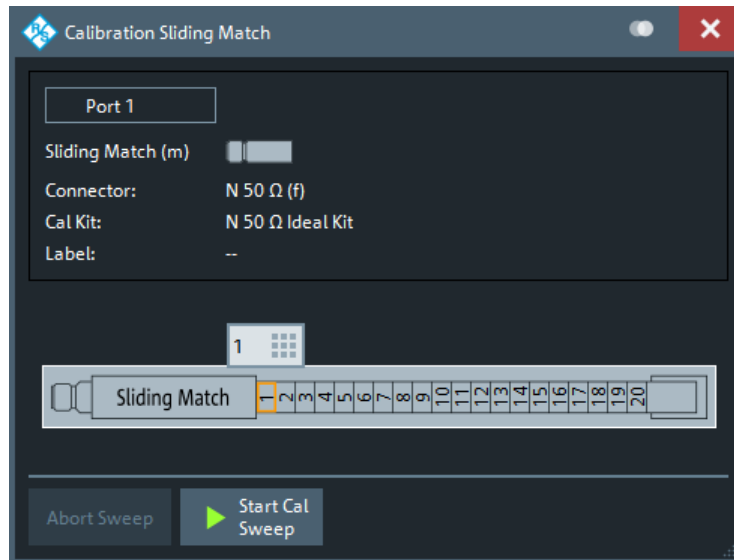

Figure 4-8: Sliding Match: GUI representation

A calibration is valid (and can be applied to the calibrated channel) if either the Match or three positions of the Sliding Match have been measured. However, it is often desirable to acquire calibration data from both standards.



The R&S ZNA can acquire correction data for up to 20 positions.

The analyzer combines the data in an appropriate manner:

- The Match results are used up to the lower edge of the specified frequency range of the Sliding Match (Min Freq).
- The Sliding Match results are used for frequencies above the Min Freq. In general, the Sliding Match provides better results than the Match within its specified frequency range.

4.5.2.4 Cal kit Files

Calibration kit files can be used to store the parameters of a particular calibration kit, to reload the data and to exchange calibration kits from one network analyzer to another.

Cal kit file contents

Cal kit files are independent of the current recall set and contain the following information:

- Name and label of the calibration kit
- Connector type including all connector type parameters (name, polarity, offset model, reference impedance)
- Type, gender and label of all standards in the kit together with the circuit model parameters (offsets, load) or S-parameter tables (.s<n>p file) that are necessary to determine its magnitude and phase response.

By default cal kit files are stored in the

C:\Users\Public\Documents\Rohde-Schwarz\ZNA\Calibration directory.

- To **export** cal kit data, the analyzer uses a specific binary file format *.calkit.
- Three different **import** file formats are supported: R&S ZVA-specific binary cal kit files (*.calkit), R&S ZVR-specific binary cal kit files (*.ck), cal kit files in Keysight-specific ASCII formats (*.csv, *.prn).



Importing older R&S ZVR cal kit files

On loading some older R&S ZVR-specific *.ck files, e.g. the R&S ZV-Z23 cal kit file, the R&S ZNA generates the message "File does not comply with instrument calibration kit file format". The files must be converted using an R&S ZVR network analyzer equipped with a firmware version V3.52 or later.

Proceed as follows:

- On the R&S ZVR, press "CAL > CAL KITS > MODIFY KITS > INSTALL NEW KIT" to import the *.ck file.
- Press "CREATE INST FILE" in the same submenu to export the *.ck file in a R&S ZNA-compatible format.
- Import the converted file into the R&S ZNA.

*.csv cal kit files: VNA Cal Kit Manager V2.1

The VNA Cal Kit Manager is a free, Windows®-based software tool intended to import, edit, and export *.csv cal kit files. The software is available for download at <http://na.support.keysight.com/vnahelp/products.html>. The decimal separator used by the VNA Cal Kit Manager V2.1 depends on the language version of the Windows® operating system: Cal kit files generated on an English operating system contain dots, the ones generated on a German system contain commas.

The network analyzer expects the dot as a separator and displays an error message when a *.csv file with commas is loaded. Please install the VNA Cal Kit Manager V2.1 on an appropriate (e.g. English) Windows® version to avoid trouble.

*.prn cal kit files: PNA Cal Kit Editor

The network analyzer can import and process cal kit files created with the PNA Cal Kit Editor. The files use the extension *.prn; the data format is identical to the *.csv format. The software is available for download at <http://na.support.keysight.com/pna/apps/#calkiteditor>.

The decimal separator used by the PNA Cal Kit Editor depends on the language version of the Windows® operating system: Cal kit files generated on an English operating system contain dots, the ones generated on a German system contain commas.

The network analyzer expects the dot as a separator and displays an error message when a *.prn file with commas is loaded. Please install the PNA Cal Kit Editor on an appropriate (e.g. English) Windows® version to avoid trouble.

4.5.3 Calibration pool

The calibration "Pool" is a collection of correction data sets (cal groups) that the analyzer stores in a common directory

C:\Users\Public\Documents\Rohde-Schwarz\ZNA\Calibration\Data. Cal groups in the pool can be applied to different channels and recall sets. Each cal group is stored in a separate file named <CalGroup_name>.cal. The cal group name can be changed in the "Calibration Manager" dialog.

One of the available cal groups can be set as "Preset User Cal", i.e. the user correction data that should be restored after a user-defined preset.

If a new channel is created, the channel calibration of the active channel is also applied to the new channel. See also [Calibration labels](#).

4.5.4 Calibration labels

The following labels in the trace list inform you about the status or type of the current system error correction.

Table 4-11: Calibration labels (system error correction)

Label	Meaning
Cal	The system error correction is applied without interpolation. This means that a set of measured correction data is available at each sweep point.
Cal int	The system error correction is applied, however, the correction data for at least one sweep point is interpolated from the measured values. This means that the channel settings have been changed so that a current sweep point is different from the calibrated sweep points. It is not possible to disable interpolation.
Cal Off	The system error correction is no longer applied (e.g. "User Cal Active" is disabled). See also " Cal Off label " on page 187.

4.5.5 Automatic calibration

A calibration unit is an integrated solution for automatic system error correction of vector network analyzers. Rohde & Schwarz offers a wide range of calibration units for different frequency ranges and connector types. The connector types of the calibration unit should be selected according to the connector types of the DUT.

The calibration units contain calibration standards that are electronically switched when a calibration is performed. The calibration kit data for the internal standards is also stored in the calibration unit, so that the analyzer can calculate the error terms and apply the calibration without any further input.



Advantages of automatic calibration

Automatic calibration is faster and more secure than manual calibration, because:

- There is no need to connect several standards manually. The number of connections to be performed quickly increases with the number of ports.
- Invalid calibrations due to operator errors (e.g. wrong standards or improper connections) are almost excluded.
- No need to handle calibration kit data.
- The internal standards do not wear out because they are switched electronically.

Limitations of automatic calibration

Calibration units do not contain characterized Through standards, so calibration types TOM, TSM, TRM, TRL, TNA are not available.

4.5.5.1 Connecting the calibration unit

The calibration units provide the following connectors:

- USB type B connector at the rear, which is used to power-supply and control the unit. A USB cable for connection to the network analyzer is provided with the calibration unit.

- RF connectors, which are connected to the test ports. For all Rohde & Schwarz calibration units except a customized R&S ZN-Z51, the connector types are equal for all ports.

To connect the unit,

1. Switch on and power up your network analyzer.
2. To protect your equipment against ESD damage, use the wrist strap and grounding cord supplied with the instrument and connect yourself to the GND connector at the front panel.
3. Connect the USB type A connector of the USB cable to any of the USB type A connectors of the analyzer. Connect the USB type B connector of the USB cable to the USB type B connector of the calibration unit.
4. Wait until the operating system has recognized and initialized the new hardware. When the unit is connected for the first time, this may take longer than in normal use.

The unit is ready to be used, see [Chapter 4.5.5.2, "Performing an automatic calibration"](#), on page 208.

**Recommended use**

- The calibration unit is intended for direct connection to R&S ZNA network analyzers following the procedure described above. You can also connect the unit before switching on the analyzer. Do not connect the unit to other USB hosts, e.g. a PC, or insert any USB hubs between the analyzer and the unit, as this may damage the unit or the host.
- You can connect several calibration units to the different USB ports of the analyzer. You can also connect cal units and other devices (mouse, USB memory stick etc.) simultaneously.
- An unused calibration unit may remain connected to the USB port while the network analyzer is performing measurements. It must be disconnected during a firmware update.
- It is safe to connect or disconnect the calibration unit while the network analyzer is operating. Never connect or disconnect the unit while data is being transferred between the analyzer and the unit. Never connect the unit during a firmware update.

4.5.5.2 Performing an automatic calibration

After connection and initialization of the calibration unit, define an automatic calibration in the calibration setup dialog; see [Chapter 5.11.1.4, "Calibration setup dialog"](#), on page 582), Then perform the automatic calibration of the related test ports using the calibration wizard; see [Chapter 5.11.1.3, "Calibration wizard"](#), on page 573. The wizard indicates the required port (re-)connections.



The assignment between the analyzer ports and the cal unit ports can be detected automatically. If auto-detection fails (e.g. because of a high attenuation in the signal path), you can either enter the port assignment manually or connect matching port numbers and select "Default Port Assignment".

When finished, remove the test cables from the unit, connect your DUT instead and perform calibrated measurements.



Accuracy considerations

To ensure an accurate calibration, please observe the following items:

- Unused ports of the calibration unit must be terminated with a 50 Ω match.
- No adapters must be inserted between the calibration unit and the test ports of the analyzer.
- Allow for a sufficient warm-up time before starting the calibration. Refer to the specifications of the calibration unit for details.
- To ensure best accuracy, the analyzer automatically reduces the source power to -10 dBm. If the test setup contains a large attenuation, deactivate "Auto Power Setting for Cal Unit" in the "Calibration" tab of the "System Config" dialog. Ensure an input power of -10 dBm at the ports of the calibration unit (please also refer to the specifications of the calibration unit).

NOTICE

Maximum RF input power

The maximum RF input power of the calibration unit is beyond the RF output power range of the analyzer, so there is no risk of damage if the device is directly connected to the test ports. If you use an external power amplifier, make sure that the maximum RF input power of the calibration unit quoted in the data sheet is never exceeded.

The available calibration types depend on the number of ports to be calibrated. For a single calibrated port, the reflection calibration types are available ("Refl Norm Open", "Refl Norm Short", "Refl OSM").

For $n > 1$ ports to be calibrated, the analyzer provides the following additional calibration types:

- A full n -port (TOSM or UOSM) calibration for n calibrated ports.
- n full one-port calibrations.
- $(n - 1)$ one path two port calibrations for n calibrated ports (all possible 2-port combinations from the "Node Port" to any other port). The node port is the source port for each one path two port calibration (fully calibrated port).
- $(n - 1)$ transmission normalizations (bidirectional, forward or reverse) for n calibrated ports (all possible 2-port combinations from the first port to any other port). "Forward" transmission normalization means that the signal direction is from the ports with the lower numbers to the port with the higher numbers.

Example:

Select ports no. 1, 2, 3. A forward transmission normalization calibrates the S-parameters S_{21} , S_{31} , and S_{32} . A reverse transmission normalization calibrates the S-parameters S_{12} , S_{13} , and S_{23} . A bidirectional transmission normalization calibrates all six transmission S-parameters.

4.5.5.3 Characterization of calibration units

Each calibration unit is delivered with factory characterization data which ensure an accurate calibration for all standard applications. For specific modifications of the test setup, e.g. the connection of additional adapters to a calibration unit, a modified set of characterization data (suitable for the cal unit with adapters) may be desirable. The R&S ZNA provides a characterization wizard which you can use to generate your own characterization data sets for (modified) R&S cal units. The characterization data can be stored in the cal unit and used for automatic calibration whenever needed.

A cal unit characterization can be performed in a frequency sweep. The network analyzer must be properly calibrated, with the reference plane at the input ports of the (modified) cal unit to be characterized.

The procedure involves the following steps:

1. Perform a calibration of your network analyzer, using the test setup and the calibration type you wish to perform with your calibration unit.
2. Connect the calibration unit to the network analyzer.
3. Access the "Characterize Cal Unit" dialog (Channel – [Cal] > "Cal Devices" > "Characterize Cal Unit...") and select "Start Characterization...".
4. Step through the "Characterization" wizard, following the instructions in the dialogs.

Dependency between calibration types and characterization data

A cal unit characterization provides full one-port (OSM) data at the selected ports plus two-port (Through) data between any pair of selected ports. The measurement of Through data is optional, however, it is required for some calibration types. The following table gives an overview.

Calibration type	Characterization data required
Refl Norm Open Refl Norm Short Refl OSM UOSM TOSM	OSM CalPort 1, OSM CalPort2 ... (all calibrated ports)
Trans Norm Both Trans Norm Forward One Path Two Ports	OSM CalPort 1, OSM CalPort2 ... (all calibrated ports), Through (between all pairs of ports)

4.5.5.4 Inline calibration

Any disturbance of the measurement setup after the calibration process inevitably produces errors. If a massive system error correction is required, e.g. if long RF cables with high damping are used, those disturbances can lead to inaccurate and unreproducible measurement results. Especially in remote scenarios, such as measurements in a thermal vacuum chamber (TVAC), a recalibration using traditional calibration kits or calibration units is a costly and time consuming process.

The Rohde & Schwarz inline calibration system (ICS) R&S ZN-Z3x allows recalibrating a running measurement setup without mechanically changing it. For each DUT port, an inline calibration unit (ICU) is inserted between the corresponding VNA test port and the DUT. The ICU remains within the signal path throughout the measurement (low-loss through path) and, on request of the VNA, performs a full one-port calibration (OSM) in-situ.

For n-port measurements with $n > 2$, an initial n-port calibration of the test setup has to be done.



Figure 4-9: ICU R&S ZN-Z32

Control connections are established via a central Inline Calibration Controller (ICC) with:

- 2 CAN bus interfaces for connecting the ICUs
- USB and LAN interface for remote control (from the R&S ZNA or a standard Windows PC)

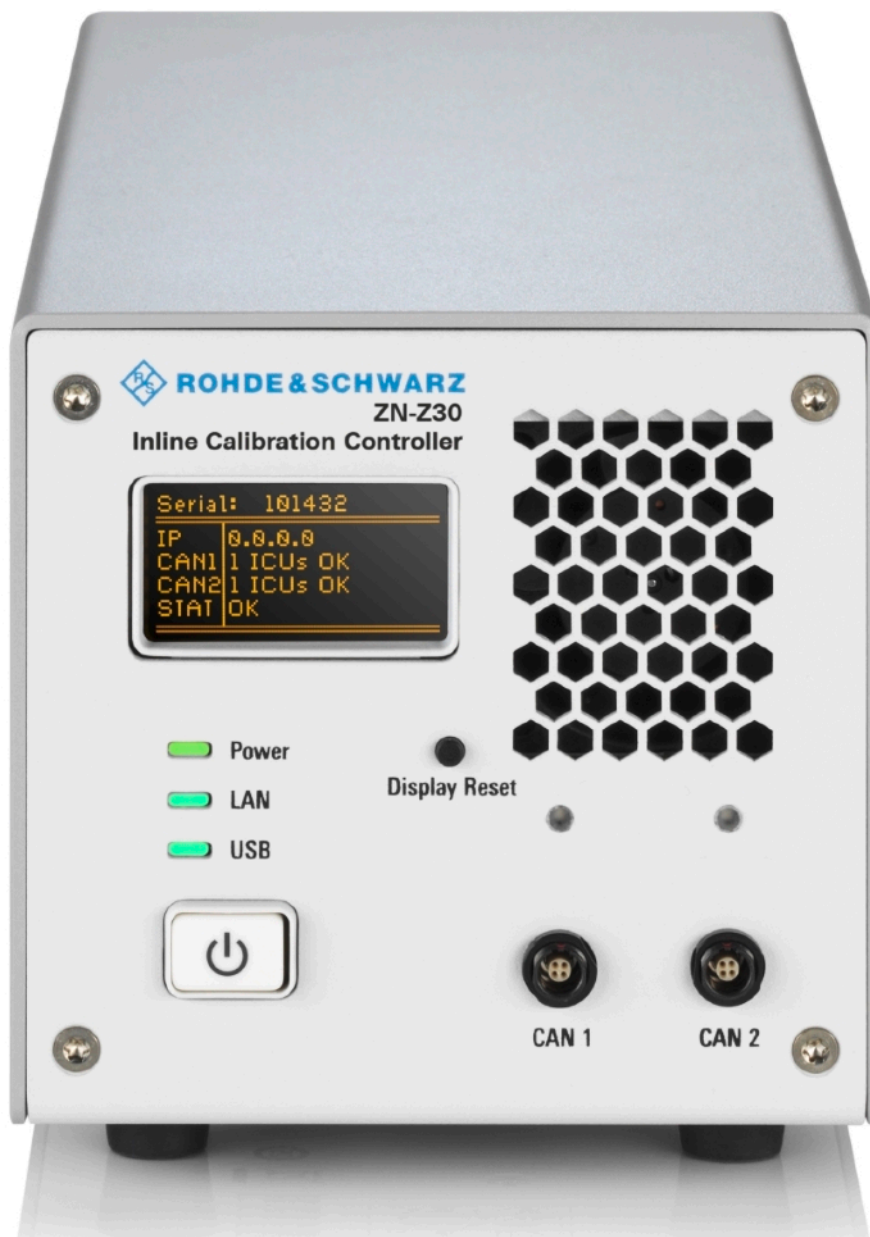

Figure 4-10: ICC R&S ZN-Z30

For more information, see the R&S ZN-Z3x product pages at https://www.rohde-schwarz.com/product/NetworkAnalyzer_Acc_ZN3.

Firmware integration

The control connection between R&S ZNA and ICC is established via USB. After the VNA firmware has detected the ICC, it requests information about connected ICUs from the ICC.



Because the ICC does not support hot plugging of ICUs, connect the ICUs to the ICC before connecting the ICC to the R&S ZNA.

The VNA firmware supports:

- Pulling characterization data for the connected ICUs from the ICC
- Interpolation of factory ICU characterization data to match the current ICU temperature
- Performing user characterizations of ICUs:
 - Embedding the Through standard of the ICU into its Open, Short, and Match standards
 - Storing the resulting characterization on the ICU
- Performing full n-port system calibrations using n ICUs
- Performing system (re-)calibrations



- The characterization and calibration functionality for standard calibration units is also used for ICUs.
- Embedding the Through into the ICU's OSM standards is necessary, because the ICU remains in situ. For this reason, during ICU characterizations the Through measurement is mandatory.

Workflow

1. Configure the ICS as required, connecting all the ICUs to the ICC via CAN bus.
2. Connect the ICC to the VNA via USB.
3. Perform user characterizations of the connected ICUs (optional).
 - a) Attach the cabling/adapters that are required to connect both ports of an ICU to the VNA.
 - b) Calibrate this setup using a manual calibration kit or a calibration unit – without connecting the ICUs
 - c) Connect the ICUs and proceed with the user characterization.
4. Perform an initial (automatic) calibration of your test setup.
 - a) Select the ICS as calibration unit.
 - b) Assign the correct ICUs to the related ports.
 - c) Select suitable characterization data for each ICU.
 - d) For factory characterizations, activate temperature compensation (optional).
 - e) Start the calibration.

f) Step 1: OSM

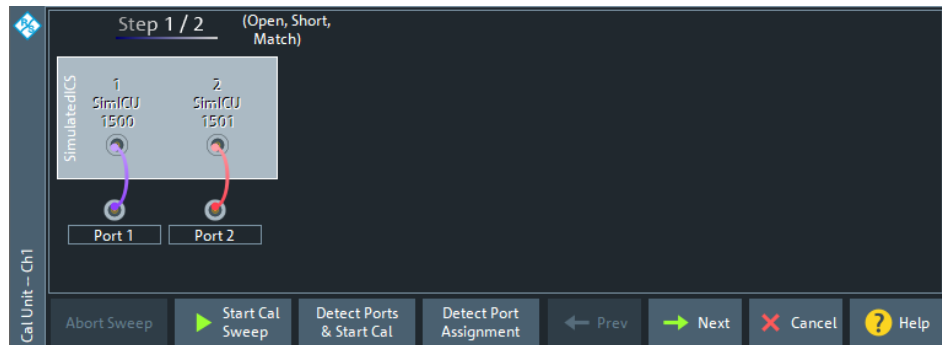

g) Step 2: Unknown Through

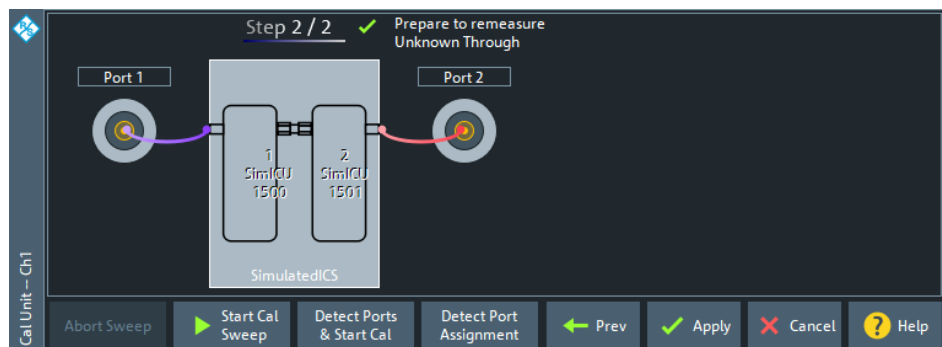

5. Connect the DUT to the calibrated setup and perform the required measurements.
6. Refresh the calibration in situ, whenever required.
 - a) Restart the calibration.
 - b) Perform OSM measurements.
 - c) Skip Through measurements.

4.5.5.5 Calibration validation

This feature allows you to validate the active channel calibration against the expected result from a stored characterization. It requires an R&S calibration unit.



- Cal validation works with 2- and 4-port calibration units.
- Currently, cal validation is limited to automatic calibrations. Furthermore, the same calibration unit has to be used for calibration and validation.

Calibration validation provides an automated, single-click (basic) mode, and an advanced mode for detailed validation and adjustment of limit tolerances, reporting, and SCPI automation.

Basic mode

When "Cal Validation" is launched for the first time, it runs in basic mode. In this mode, the R&S ZNA automatically detects the instrument ports connected to the cal unit, and

only validates connected ports. Thus, if a 2-port cal unit is connected to a 4-port calibrated channel, only the two connected instrument ports are validated against the cal unit.

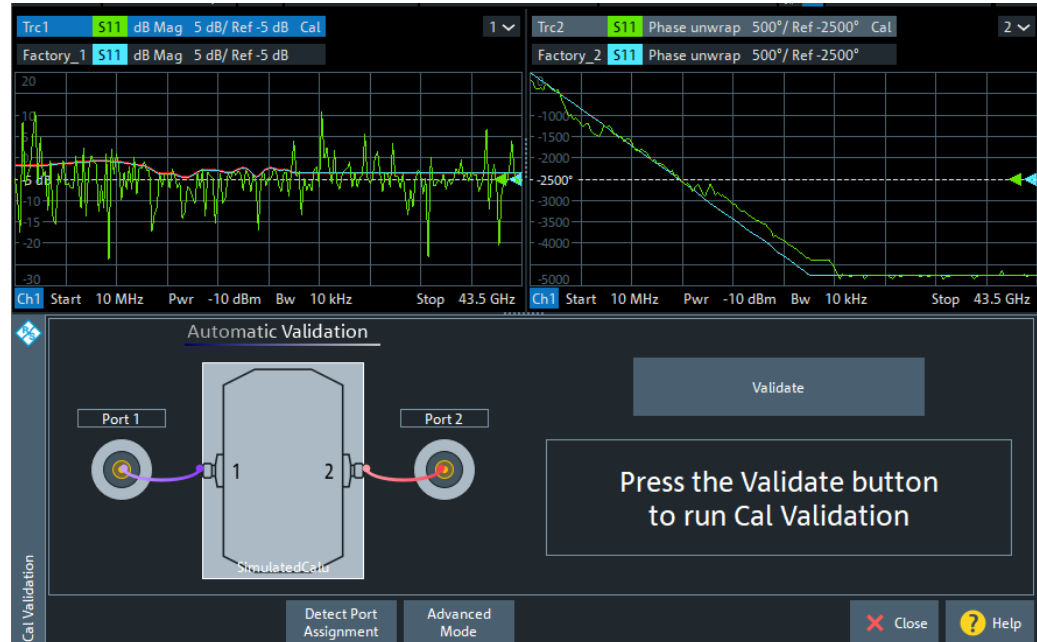

The validation logic proceeds through the connected ports $p \in \{1, \dots, 4\}$ in ascending order, measuring S_{pp} for the Open, Short and Match standard. It then compares the measured S_{pp} values with the corresponding reflection S parameters of the cal unit's factory characterization. The on-screen feedback indicates success ("PASS", failure ("FAIL") or provides a warning about undetected ports.

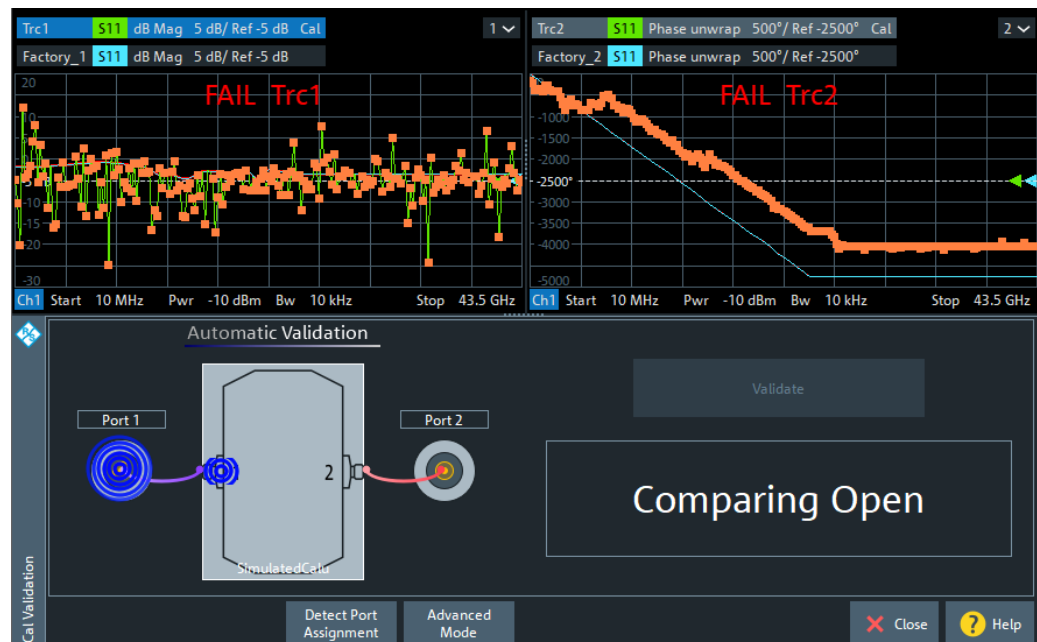

For a channel with more calibrated ports than cal unit ports available, you can change the port assignments and rerun the automated validation. Or you can switch to advanced mode and validate each port manually.

Advanced mode

In advanced mode you can configure the validation settings (reference characterization, deviation limits) and run or rerun particular measurements (reflection at port p with connected Open, Short or Match).

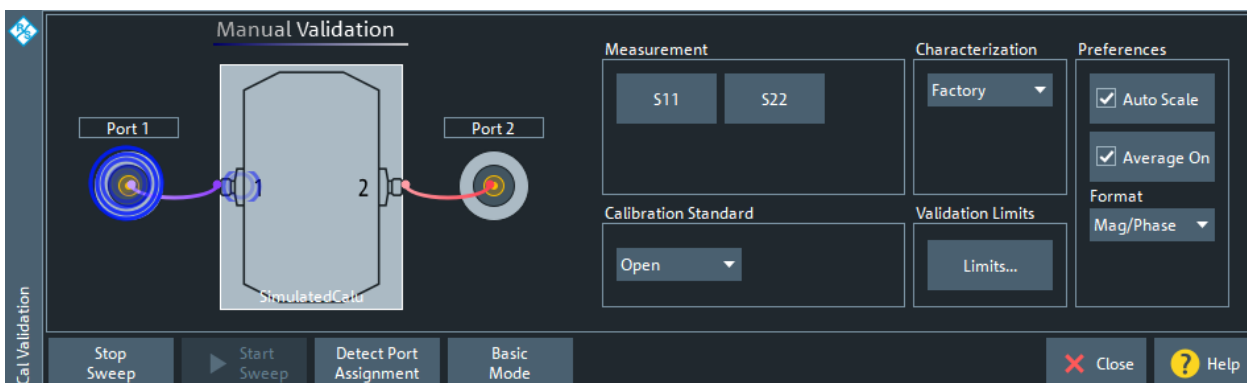

4.5.5.6 Multiple port assignments

With multiple port assignments, you can calibrate port groups of any size, no matter how many ports your calibration unit (or cal unit characterization) has. For example, you can use a 2-port calibration unit to perform a full 4-port calibration.



The multiple port assignment method considerably extends the range of applications of the calibration units. However, the method entails some loss of convenience because you have to reconnect the calibration unit between the different calibration stages (assignments). It can also cause a loss of accuracy because only a subset of all possible through connections is measured.

To calibrate n test ports with an m -port calibration unit ($m < n$), the calibration unit has to be connected at least n/m times. Each connection is described by its "port assignment", i.e. the mapping of calibration unit ports to test ports. Then for each assignment an automatic calibration is performed. Finally the analyzer combines the calibration data and calculates the required n -port error terms.

This calculation is possible if and only if:

- The port assignments "cover" the calibrated test ports
- The overlap between assignments allows a(n ordered) "chain of measured through connections" between any (ordered) pair of test ports requiring a Through measurement

For full n -port calibrations, to calculate the correction terms for those test port pairs that are not covered by a single assignment, the R&S ZNA applies the "reduced through" logic. See [Chapter 4.5.1.11, "Full n-Port calibration with reduced number of Through"](#)

[connections](#)", on page 197. Depending on the calibration type, a "minimal" valid and complete solution can be described as follows:

Calibration type	Minimal solution	Default solution (minimal)
Full One Port	Each calibrated test port must appear in exactly one port assignment.	Subdivide the n test ports into groups of m ports with increasing port numbers. Create a separate port assignment for each group.
One Path Two Port	<ul style="list-style-type: none"> The node port must be included in all port assignments Each of the n-1 other calibrated test ports must appear in exactly one port assignment <p><i>Additional condition:</i> The calibration unit port assigned to the node port must be the same in all assignments. This condition minimizes the number of port reconnections between the calibration stages.</p>	<p>Assign the node port to port 1 of the calibration unit. Subdivide the remaining n-1 test ports into groups of m-1 ports and create a separate port assignment for each group.</p> <p>Leave port 1 of the calibration unit connected to the node port and connect the remaining ports of each port group to the remaining ports of the calibration unit.</p>
Full n-Port	<ul style="list-style-type: none"> the two generic conditions stated above (with "unordered Throughgs") the number of assignments must be as small as possible <p><i>Additional condition:</i> The cal unit port assigned to a given test port must be the same in all assignments. Again, this condition minimizes the number of port reconnections between the calibration stages.</p>	<p>Same as for One Path Two Port calibrations, using the test port with the lowest number as "node port".</p> <p>(Every other calibrated port could serve as "node port")</p>

Among the minimal ones, the "star-shaped" solutions with fixed (but arbitrary) "node port" are also optimal w.r.t. the (average) length of the "Chain of Throughgs" and hence the accuracy of the calculated Throughgs. Additional port assignments can improve the accuracy, if they add more measured through connections.



For full n-port calibrations, an extra assignment is required if:

- An external switch matrix is used
- You want to calibrate 3 or more test ports of the **same submatrix**
- Only 2 cal unit ports are available

Starting with the minimal solution (as explained above), create an additional 2-port assignment for a pair of ports that was previously not covered by a single, but by two assignments.

See [Chapter 4.7.41, "External switch matrices"](#), on page 323 for background information on switch matrices and their submatrices.

Example:

The following examples show minimal port assignments for a Full 9-Port calibration using a four-port calibration unit:

Table 4-12: Full 9-port calibrations: star-shaped optimum solution

Test Port	Assignment 1	Assignment 2	Assignment 3
1	Cal Unit Port 1	Cal Unit Port 1	Cal Unit Port 1
2	Cal Unit Port 2	-	-
3	Cal Unit Port 3	-	-
4	Cal Unit Port 4	-	-
5	-	Cal Unit Port 2	-
6	-	Cal Unit Port 3	-
7	-	Cal Unit Port 4	-
8	-	-	Cal Unit Port 2
9	-	-	Cal Unit Port 3

Table 4-13: Full 9-port calibrations: line-shaped optimum solution

Test Port	Assignment 1	Assignment 2	Assignment 3
1	Cal Unit Port 1	-	-
2	Cal Unit Port 2	-	-
3	Cal Unit Port 3	-	-
4	Cal Unit Port 4	Cal Unit Port 4	-
5	-	Cal Unit Port 1	-
6	-	Cal Unit Port 2	-
7	-	Cal Unit Port 3	Cal Unit Port 3
8	-	-	Cal Unit Port 1
9	-	-	Cal Unit Port 2

4.5.6 Scalar power calibration

The purpose of a scalar power calibration is to ensure accurate source power levels and power readings at a particular position (calibration plane) in the test setup. Scalar power calibration is different from the system error correction described in [Chapter 4.5, "Calibration"](#), on page 186.

A power calibration is required for accurate measurement of wave quantities or ratios (see section [Chapter 4.1.7, "Data flow"](#), on page 120). For best accuracy, choose a calibration method according to the table below.



Calibration of S-parameters

S-parameters are not affected by a scalar power calibration. S-parameters are ratios of incident and outgoing waves: for linear DUTs, they do not depend on the absolute power. For measurements on non-linear DUTs, a SMARTerCal is recommended.

A SMARTerCal is also appropriate for frequency conversion measurements. For detailed information, refer to [Chapter 4.5.7, "SMARTerCal"](#), on page 224.

Table 4-14: Recommended calibration methods for various measurements

Measurement	System error correction	Scalar Power calibration	SMARTerCal
S-parameter meas. on linear DUTs	Yes	Not necessary	Not necessary
S-parameter meas. on non-linear DUTs	Not possible --> Use SMARTerCal	Yes Power (source) and meas. receiver, supported in combination with SMARTerCal	Yes ¹⁾
Meas. of wave quantities or ratios on linear DUTs	Not possible --> Use SMARTerCal	Not necessary	Yes
Meas. of wave quantities or ratios on non-linear DUTs	Not possible --> Use SMARTerCal	Yes Power (source) and meas. receiver, supported in combination with SMARTerCal	Yes
Power sweep, e.g. for compression point measurement	Yes	Power (source): Yes Meas. receiver: not necessary	Not necessary
Frequency conversion measurements on linear DUTs	Not possible --> Use SMARTerCal	Not necessary	Yes
Frequency conversion measurements on non-linear DUTs	Not possible --> Use SMARTerCal	Yes Power (source) and meas. receiver, supported in combination with SMARTerCal	Yes

In general, a power calibration involves two stages:

- Source power calibration:** An external power meter is connected to the calibration plane. The analyzer uses the power meter readings to calibrate its reference receiver. Subsequently, it modifies its source power so that the calibrated reference receiver reading corresponds to the desired source power value (flatness calibration).

Tip: It is also possible to perform the source (flatness) calibration using the power meter (without previously calibrating the reference receiver). This is particularly suitable if a source and a reference receiver from different VNA ports are combined via [Direct generator/receiver access](#) (and [redefined physical ports](#)).
- Measurement receiver calibration:** The analyzer uses the calibrated source signal to adjust the power reading at the receive port.

4.5.6.1 Source power calibration

A source power calibration ensures accurate power levels of the generated waves at an arbitrary calibration plane in the measurement path. Typically the calibration plane corresponds to the input of the DUT.

In a frequency sweep, the power at the calibration plane is maintained at a constant "Cal Power" value. The source power calibration eliminates frequency response errors in the signal path between the source and the calibration plane. It is possible to introduce an arbitrary attenuation or gain into the signal path so that the cal power is not restricted to the power range of the source. A typical application for a power calibration in a frequency sweep is the measurement of the gain of an amplifier across a frequency range but at a fixed input power.

In a power sweep, the power calibration ensures that the power at the calibration plane is either constant or a linear function of the stimulus power. A typical application for a power calibration in a power sweep is the measurement of the gain of an amplifier across a power range but at a fixed frequency. The correction data acquired in a frequency or power sweep is re-used if a "Time" or "CW Mode" sweep is activated.

Calibration procedure

The source power calibration requires an external power meter, to be connected via GPIB bus, USB or LAN interface. The power sensor can be connected directly at the calibration plane or to any other point in the test setup where the signal power is known to be proportional to the power at the calibration plane.

By default, the source power calibration involves several steps:

1. **Reference receiver calibration:** The analyzer performs a first calibration sweep at the source power that is likely to produce the target power ("Cal Power") at the calibration plane. A known attenuation or gain at the source port and in the signal path between the source port and the calibration plane can be specified:

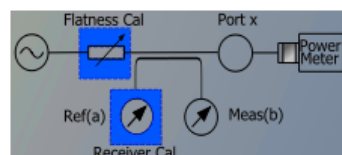

The power which the external power meter measured at the calibration plane is displayed in the calibration sweep diagram, together with the reference receiver reading. The firmware uses the difference between the two traces to correct the reference receiver reading.

2. **Internal source power flatness calibration:** In the following steps, the calibrated reference receiver is used to adjust the source power. To this end, the R&S ZNA performs a series of calibration sweeps at varying source power until the number of "Total Readings" is reached or until the deviation between the calibrated reference receiver power and the cal power is below a specified "Tolerance". The external power meter is no longer used for these repeated calibration sweeps; everything is

based on the previously calibrated reference receiver. This speeds up the calibration procedure but does not impair its accuracy.

Tip: It is also possible to perform the source (flatness) calibration using a power meter (without previously calibrating the reference receiver).

3. After the flatness calibration, the R&S ZNA performs an additional verification sweep to demonstrate the accuracy of the calibration.

After the source power calibration, one can expect the power at the calibration plane to be within the range of uncertainty of the power meter. The reference receiver reading corresponds to the calibrated source power. After a change of the sweep points or sweep range, the analyzer interpolates or extrapolates the calibration data; see [Chapter 4.5.6.3, "Power calibration labels"](#), on page 222.

4.5.6.2 Measurement receiver calibration

A measurement receiver calibration ensures that the power readings at a specified receive port of the analyzer (b-waves) agree with the source power level calibrated at an arbitrary calibration plane. Typically, the calibration plane is at the input of the receiver so that the calibration eliminates frequency response errors in the calibrated receiver.

In contrast, the reference receiver calibration ensures correct power readings for the generated waves (a-waves).

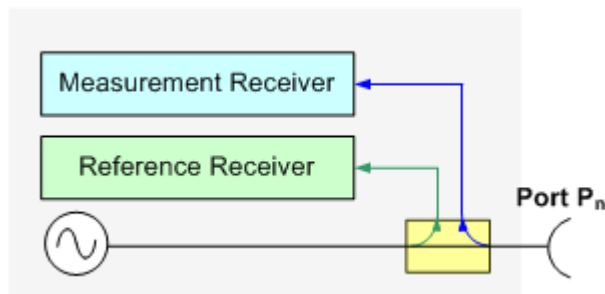

A measurement receiver calibration generally improves the accuracy of power (wave quantity) measurements. The correction data acquired in a frequency or power sweep is re-used if a "Time" or "CW Mode" sweep is activated.

Calibration procedure

The measurement receiver calibration is based on a received wave b_n with known power. The calibration involves a connection to a (previously source power-calibrated) source port.

The received wave to calibrate can be generated by a different analyzer port P_m ($m \neq n$) or by an external generator. Alternatively, it is possible to connect an Open or Short standard to port P_n : The measurement receiver is calibrated using the reflected wave a_n .

The measurement receiver calibration involves a single calibration sweep. The calibration sweep is performed with current channel settings but with a maximum IF band-

width of 10 kHz. Smaller IF bandwidths are maintained during the calibration sweep; larger bandwidths are restored after the sweep. The analyzer measures the power at each sweep point, compares the result with the nominal power of the source, and compiles a correction table.

At the end of the calibration sweep, a checkmark symbol next to the calibrated source indicates the status of the measurement receiver calibration. After a change of the sweep points or sweep range, the analyzer interpolates or extrapolates the calibration data.

4.5.6.3 Power calibration labels

Power calibration labels in the trace list for wave quantities and ratios inform you about the status and type of the current scalar power calibration. The labels appear in the following instances:

- For a-waves, if a source power calibration is available.
- For b-waves, if a measurement receiver power calibration is available.
- For ratios between a- and b-waves, if both a source power and a measurement receiver power calibration is available.



Calibration of S-parameters

S-parameters and derived quantities (e.g. impedances, admittances, stability factors) are assumed to be linear; otherwise they must be corrected by a SMARTerCal.

Therefore, a scalar power calibration is not applied to S-parameters and derived quantities; no power calibration labels appear in the trace list.

Table 4-15: Power calibration labels

Label	Meaning
PCal	A scalar power calibration is available and applied without interpolation or extrapolation (see below). This means that a set of measured correction data is available at each sweep point.
PCai	The power calibration is applied, however, the correction data for at least one sweep point is interpolated from the measured values. This means that the channel settings have been changed so that a current sweep point is different from the calibrated sweep points. It is not possible to disable interpolation.
PCao	The power calibration is applied, however, the source power (channel base power) was out of tolerance.
PCax	The power calibration is applied, however the calibration data is extrapolated. The current stimulus range exceeds the calibrated stimulus range. The power calibration data of the first calibrated sweep point is used for all smaller stimulus values; the power calibration data of the last calibrated sweep point is used for all larger stimulus values.
PCa< j o x> S	Like PCa< j o x>, but only a source flatness calibration is available
PCa< j o x> R	Like PCa< j o x>, but only a receiver calibration is available
PCal Off	The power calibration is no longer applied (e.g. deliberately turned off in the "Calibration > Use Cal " softtool panel).

A lower label in the list has priority over the higher labels (e.g. if the power calibration is interpolated and the source power is changed, then the label PCao is displayed).

Interpolation and extrapolation

The analyzer can interpolate and extrapolate power correction data so that a source or receiver power calibration can be reused after a change of the frequency sweep range:

- At new sweep points within the calibrated sweep range, interpolation is applied to calculate the correction data. A label "PCai" in the trace list indicates an interpolated power calibration.
- At new sweep points outside the calibrated sweep range, the correction values are extrapolated: Sweep points below the lowest calibrated frequency are assigned the correction value of the lowest frequency. Sweep points above the highest calibrated frequency are assigned the correction value of the highest frequency. A label "PCax" in the trace list indicates an extrapolated power calibration.

4.5.6.4 Extended test setups

The power calibration data can be modified to account for an additional two-port device in the test setup. The known transmission coefficients of the two-port can be entered manually or automatically (Channel – [Cal] > "Pwr Cal Settings" > "Transm. Coefficients..."). The R&S ZNA supports two different test scenarios.

A: Two-port at DUT (during measurement)

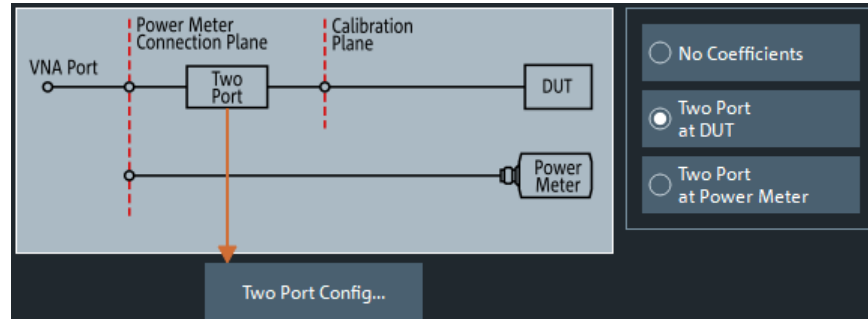

Test and measurement procedure:

1. Perform the calibration without the additional two-port. During the calibration, the analyzer decreases the power sensor values by the 2-port transmission coefficients to move the calibration plane of the power calibration towards the input of the DUT. The calibration plane corresponds to the output of the 2-port which is placed in-between the network analyzer port and the DUT.
2. Perform the measurement with the additional two-port.

Practical example: On-wafer measurements. The power sensor cannot be directly connected to the input of the DUT. The transmission coefficients of the wafer probe are used for the power meter correction.

B: Two-port at power meter (during calibration)

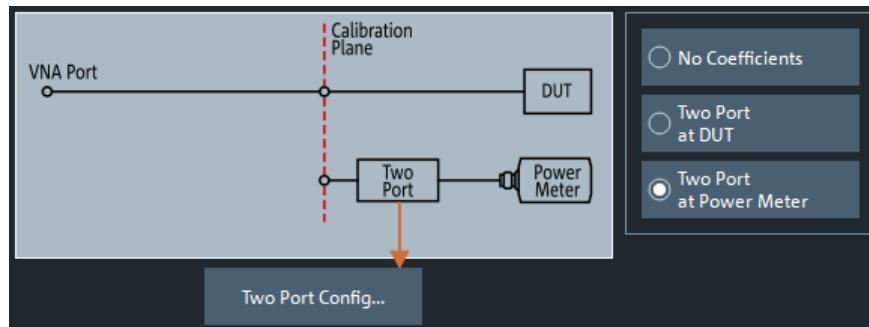

Test and measurement procedure:

1. Perform the calibration with the additional two-port between the analyzer port and the power sensor. During the calibration, the analyzer increases the power sensor values by the 2-port transmission coefficients to move the calibration plane of the power calibration towards the input of the DUT. The calibration plane corresponds to the input of the additional 2-port.
2. Perform the measurement without the additional two-port.

Practical example: An adapter or attenuator with known attenuation is needed to connect the power sensor to the test port of the network analyzer. The transmission coefficients of the adapter are used for the power meter correction.

4.5.7 SMARTerCal

A SMARTerCal (smarter calibration) is a combination of a "One Path Two Ports" or a full n-port system error correction (TOSM, UOSM, Adapter Removal, TRL, TNA ...) for two or more ports with a (scalar) receiver power calibration at a **single** port. The two calibration methods serve different purposes:

- The system error correction requires a set of calibration standards; it provides vector error-corrected S-parameters. For equal port frequencies, the n-port calibration types provide the full set of error terms. For frequency conversion measurements, a source match correction and (optional) load match correction is calculated.
- The receiver power calibration requires an external power meter; it corrects the power readings of the reference and measurement receivers according to the measured absolute power at the calibration plane. This does **not** include a readjustment of the actual source power (flatness calibration).

Example: Channel base power: -10 dBm; the test setup involves a 3-dB attenuation between the source port and the calibration plane. After the power calibration is applied, the analyzer indicates an output power (a-wave) of -13 dBm, although the actual source power remains at -10 dBm.

The SMARTerCal is also applied to ratios and wave quantities. For measurements on linear DUTs, SMARTerCal is sufficient. Non-linear measurements can be further improved by a combination of a SMARTerCal plus a scalar power calibration. See [Combining SMARTerCal with scalar power calibration](#).

For an overview of measurements and recommended calibration methods refer to [Table 4-14](#).

4.5.7.1 Calibration procedure

A SMARTerCal is a fully menu-guided process which is performed like a regular system error correction. The calibration wizard defines the calibrated ports and the calibration type; it also initiates the calibration sweeps for all calibration standards. The calibration sweep for the external power meter is performed in analogy to a sweep for a one-port calibration standard. However, the analyzer uses the "Reference Receiver Cal Power" setting from the scalar power calibration. The order of the system error correction and power calibration sweeps is arbitrary; ensure that you always connect the proper equipment.

The R&S ZNA also supports a SMARTerCal based on the calibration units. The calibration units provide the n-port system error correction data (TOSM or UOSM); a subsequent power calibration sweep completes the calibration.

4.5.7.2 Calibration types

The names of the SMARTerCal calibration types consist of a prefix "P" (indicating the additional power calibration) plus the system error correction type. The R&S ZNA supports the SMARTerCal equivalent of all full n-port system error corrections; an overview is shown below.

Table 4-16: SMARTerCal calibration types

SMARTerCal Type	Based on ...	Manual calibration	Calibration unit
P-Ref Receiver (Calibrate All only)	= reference receiver (scalar power) calibration	<input checked="" type="checkbox"/>	<input type="checkbox"/>
P-Ref1 Norm Open	Ref1 Norm Open	<input checked="" type="checkbox"/>	<input checked="" type="checkbox"/>
P-Ref1 Norm Short	Ref1 Norm Short	<input checked="" type="checkbox"/>	<input checked="" type="checkbox"/>
P-Ref1 Norm OSM	OSM	<input checked="" type="checkbox"/>	<input checked="" type="checkbox"/>
P-Trans Norm	Trans Norm	<input checked="" type="checkbox"/>	<input checked="" type="checkbox"/>
P-Trans Norm Both	Trans Norm Both	<input checked="" type="checkbox"/>	<input checked="" type="checkbox"/>
P-One Path Two Ports	One Path Two Ports	<input checked="" type="checkbox"/>	<input checked="" type="checkbox"/>
PTOSM	TOSM	<input checked="" type="checkbox"/>	<input checked="" type="checkbox"/>
PUOSM	UOSM	<input checked="" type="checkbox"/>	<input checked="" type="checkbox"/>
PTRL	TRL	<input checked="" type="checkbox"/>	<input type="checkbox"/>
PTOM	TOM	<input checked="" type="checkbox"/>	<input type="checkbox"/>
PTSM	TSM	<input checked="" type="checkbox"/>	<input type="checkbox"/>
PTRM	TRM	<input checked="" type="checkbox"/>	<input type="checkbox"/>

SMARTerCal Type	Based on ...	Manual calibration	Calibration unit
PTNA	TNA	<input checked="" type="checkbox"/>	<input type="checkbox"/>
P-Adapter Removal	Adapter Removal	<input checked="" type="checkbox"/>	<input type="checkbox"/>

The selection criteria for the SMARTerCal calibration types are identical to the criteria for system error corrections. For an overview, refer to [Chapter 4.5.1, "Calibration types"](#), on page 187.

4.5.7.3 Combining SMARTerCal with scalar power calibration

As described in [Chapter 4.5.7, "SMARTerCal"](#), on page 224, the power meter results of a SMARTerCal are only used to calibrate the receivers of the R&S ZNA. To obtain definite source power levels, you can combine the SMARTerCal with an additional scalar source power calibration.

The scalar source power calibration and the SMARTerCal can be performed in any order. As a result of the combined calibration, the R&S ZNA measures vector error-corrected S-parameters; the scalar power correction is applied to wave quantities and ratios. Notice that this provides different values, e.g., of S_{21} and the ratio b_2/a_1 . The flatness calibration step of the scalar source calibration ensures accurate input powers at the DUT.

A combined SMARTerCal and scalar power calibration is also appropriate for frequency conversion measurements on non-linear DUTs. For linear measurements, where the actual input power at the DUT is not critical, a SMARTerCal is sufficient.

4.5.7.4 Calibration labels

The status and type of the SMARTerCal is indicated in the trace list, in analogy to a system error correction (see [Chapter 4.5.4, "Calibration labels"](#), on page 206). The calibration labels for a SMARTerCal consist of a prefix "S" plus the system error correction labels.

Table 4-17: Calibration labels (SMARTerCal)

Label	Meaning
SCal	The SMARTer Cal is applied without interpolation. This means that a set of measured correction data is available at each sweep point.
SCal int	The SMARTer Cal is applied, however, the correction data for at least one sweep point is interpolated from the measured values. This means that the channel settings have been changed so that a current sweep point is different from the calibrated sweep points. It is not possible to disable interpolation.
Cal Off	The SMARTer Cal is no longer applied (e.g. "User Cal Active" is disabled). See also "Cal Off label" on page 187.

The receiver power calibration included in the SMARTerCal is not indicated separately. If a SMARTerCal is combined with an additional scalar source power calibration (see [Chapter 4.5.7.3, "Combining SMARTerCal with scalar power calibration"](#), on page 226),

the trace list may contain an addition power calibration label according to [Chapter 4.5.6.3, "Power calibration labels"](#), on page 222.

Trcl a1(P1) Lin Mag 100 µW/ Ref 1 mW Cal Off PCal

4.5.8 Parallel calibration of multiple channels

If multiple channels are configured in the active recall set, clearly they can be calibrated one after the other, but this can be inefficient in terms of necessary reconnections of calibration standards (or calibration units).

The R&S ZNA offers multiple possibilities to calibrate several channels in parallel:

- The **"Calibrate All"** function supports parallel calibration of multiple channels. For each channel and port set, a different calibration, and even multiple calibrations can be configured. During the calibration phase, the number of connections of cal standards/cal devices is minimized.
For some measurement/channel setup dialogs, when the measurement configuration is applied, a default calibration configuration for the involved channels and ports is created.
"Calibrate All" supports all [Chapter 4.5.1, "Calibration types"](#), on page 187 calibration types –excluding scalar power calibration. Use a suitable [SMARTerCal](#) instead.
- Calibrate multiple channels in one go, using the same calibration type on the same ports for all channels
In this case, for each port to be calibrated the same calibration standards have to be connected. After connecting one of these standards, a calibration sweep has to be performed for each channel.
This simple mode of parallel calibration is supported from the analyzer GUI ("Calibrate all Channels" checkbox in all calibration wizards) and via remote control (see [\[SENSe:\]CORRection:COLLect:CHANnels:ALL](#) on page 1376).
- Calibrate a subset of the available channels, possibly using different ports and calibration types, using **remote control**.
In this case, for each port to be calibrated a different set of calibration standards might be required. For each of these standards only a subset of the available channels might have to be swept. See [\[SENSe:\]CORRection:COLLect:CHANnels:MCTypes](#) on page 1377.
This advanced mode of parallel calibration is available via **remote control only**.

4.5.9 Joining calibrations

The "JoinCal" functionality of the analyzer firmware allows you to join two calibrations from an active channel or the calibration pool. The resulting calibration can replace one of the joined calibrations, can be stored in a new channel, or added to the calibration pool.

- **Frequency range join**
Joins calibrations of the same port set, but with different overlapping frequency ranges. The resulting calibration is of the same kind and applies to the same port set, but covers the joint frequency range.

- **Port set join**

Joins calibrations with the same frequency range, but with different port sets. The resulting calibration is of the same kind and covers the same frequency range, but applies to the joint port set

Calibrations on additional frequency axes in the *second* input calibration are copied to the output calibration.

4.6 Offset parameters and de-/embedding

The R&S ZNA functionality described in this section complements the calibration, compensating for the effect of known transmission lines or matching networks between the calibrated reference plane and the DUT.

4.6.1 Offset parameters

Offset parameters compensate for the known length and loss of a (non-dispersive and perfectly matched) transmission line between the calibrated reference plane and the DUT.

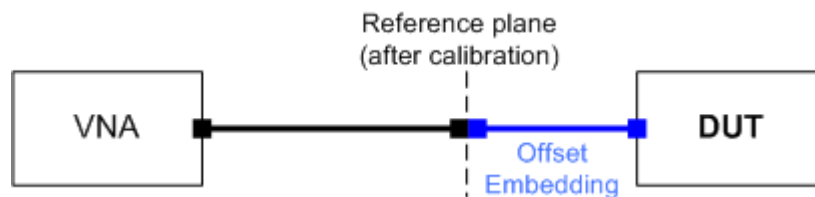

The analyzer can also auto-determine length and loss parameters, assuming that the actual values should minimize the group delay and loss across a configurable frequency range.

4.6.1.1 Definition of offset parameters

The *delay* is the propagation time of a wave traveling through the transmission line. The *electrical length* is equal to the delay times the speed of light in the vacuum. It is a measure for the length of the transmission line between the standard and the actual calibration plane. For a line with permittivity ϵ_r and *mechanical length* L_{mech} the delay and the electrical length are calculated as follows:

$$Delay = \frac{L_{mech} \cdot \sqrt{\epsilon_r}}{c}; \quad Electrical\ Length = L_{mech} \cdot \sqrt{\epsilon_r}$$

For a non-dispersive DUT, the delay defined above is constant over the considered frequency range and equal to the negative derivative of the phase response for the frequency (see mathematical relations). The length offset parameters compensate for a constant delay, which is equivalent to a linear phase response.

4.6.1.2 Definition of loss parameters

The loss is the attenuation a wave experiences when traveling through the transmission line. In logarithmic representation, it can be modeled as the sum of a constant and a frequency-dependent part, where the frequency dependence is due to the skin effect.

In the limit case, where the length of the transmission line is considered to be "almost zero", the loss is considered constant:

$$Loss(f) = Loss_{DC}$$

Otherwise, if the loss at DC and one additional frequency f_1 is known (or measured), the loss at frequency f is approximated by:

$$Loss(f) = Loss_{DC} + (Loss(f_1) - Loss_{DC}) \cdot \sqrt{\frac{f}{f_1}}$$

If in addition the loss at a second frequency f_2 is known (or measured), then the loss can be approximated by:

$$Loss(f) = Loss_{DC} + (Loss(f_1) - Loss_{DC}) \cdot \left(\frac{f}{f_1}\right)^b, \text{ where } b = \frac{\log_{10}\left(\left|\frac{Loss(f_1)}{Loss(f_2)}\right|\right)}{\log_{10}\left(\frac{f_1}{f_2}\right)}$$

In practice, the frequency-dependent part is often dominant, so that $Loss_{DC}$ can be set to zero. Experimentally, the loss value at DC can be determined in a separate measurement at a very low frequency ($f \rightarrow 0$).

4.6.1.3 Auto Length

The "Auto Length" function adds an electrical length offset to the active trace's receive port, such that the residual delay of the active trace (defined as the negative derivative of the phase response) is minimized across a configurable frequency range. If "Delay" is the selected trace format, the entire trace is shifted in vertical direction and centered on zero. In phase format, the "Auto Length" corrected trace shows the deviation from linear phase.

Length and delay measurement, related settings

"Auto Length" is suited for length and delay measurements on transmission lines.

1. Connect a (non-dispersive) cable to a single analyzer port no. n and measure the reflection factor S_{nn} .
2. In the Channel – [Offset Embed] > "Offset" softtool tab, select "Auto Length".

The delay is displayed in the "Delay" field, the cable length (depending on the "Velocity Factor") in the "Mech. Length" field.

It is also possible to determine cable lengths using a transmission measurement. Note that "Auto Length" always provides the **single** cable length and the delay for propagation in **one** direction.

The analyzer provides alternative ways for delay measurements:

1. Measure the reflection factor and select Trace – [Format] > "Delay".

This yields the delay for propagation in forward and reverse direction and should be approx. twice the "Auto Length" result. For transmission measurements, both results should be approx. equal.

2. Measure the reflection factor and select Trace – [Format] > "Phase". Place a marker to the trace and activate Trace – [Trace Config] > "Trace Statistics" > "Phase/EI Length".

This yields the delay in one direction and should be approx. equal to the "Auto Length" result.

The measurement results using trace formats and trace statistics functions depend on the selected delay aperture and evaluation range. "Auto Length" is particularly accurate because it uses all sweep points. For non-dispersive cables, aperture and evaluation range effects are expected to vanish.

Use Trace – [Marker] > "Set by Marker" > Zero Delay at Marker to set the delay at a special trace point to zero.

Preconditions for Auto Length, effect on measured quantities and exceptions

"Auto Length" is enabled if the measured quantity contains the necessary phase information as a function of frequency, and if the interpretation of the results is unambiguous:

- A frequency sweep must be active.
- The measured quantity must be an S-parameter, ratio, wave quantity, a converted impedance or a converted admittance.

The effect of "Auto Length" on S-parameters, wave quantities and ratios is to eliminate a linear phase response as described above. The magnitude of the measured quantity is not affected. Converted admittances or impedances are calculated from the corresponding "Auto Length" corrected S-parameters. Y-parameters, Z-parameters and stability factors are not derived from a single S-parameter, therefore "Auto Length" is disabled.

Auto Length for logical ports

The "Auto Length" function can be used for balanced port configurations as well. If the active test port is a logical port, then the same length offset must be assigned to both physical ports that are combined to form the logical port. If different length offsets have been assigned to the physical ports before, they are both corrected by the same amount.

4.6.1.4 Auto Length and Loss

The "Auto Length and Loss" function determines all offset parameters at the active trace's receive port such that the residual group delay of the active trace (defined as the negative derivative of the phase response) is minimized **and** the measured loss is minimized as far as possible across a configurable frequency range.

"Auto Length and Loss" involves a two-step procedure:

- An "Auto Length" correction modifies the phase of the measured quantity, minimizing the residual group delay. The magnitude of the measured quantity is not affected.
- The automatic loss correction modifies the magnitude of the measured quantity, leaving the (auto length-corrected) phase unchanged.

Preconditions for Auto Length and Loss, effect on measured quantities and exceptions

"Auto Length and Loss" is enabled if the measured quantity contains the necessary phase information as a function of the frequency, and if the interpretation of the results is unambiguous:

- A frequency sweep must be active.
- The measured quantity must be an S-parameter, ratio, wave quantity, a converted impedance or a converted admittance.

The effect of "Auto Length and Loss" on S-parameters, wave quantities and ratios is to eliminate a linear phase response and account for a loss as described above. Converted admittances or impedances are calculated from the corresponding "Auto Length and Loss" corrected S-parameters. Y-parameters, Z-parameters and stability factors are not derived from a single S-parameter, therefore "Auto Length and Loss" is disabled.

Calculation of loss parameters

The loss is assumed to be given in terms of the DC loss $Loss_{DC}$, the reference frequency f_{ref} , and the loss at the reference frequency $Loss(f_{ref})$. The formula used in the Auto Loss algorithm is similar to the formula for manual entry of the loss parameters (see [Chapter 4.6.1.2, "Definition of loss parameters"](#), on page 229).

The result is calculated according to the following rules:

- The reference frequency f_{ref} is kept at its previously defined value (default: 1 GHz).
- The DC loss c is zero except for wave quantities and for S-parameters and ratios with maximum dB magnitude larger than -0.01 dB.
- "Auto Length and Loss" for a wave quantity centers the corrected dB magnitude as close as possible around 0 dBm.
- "Auto Length and Loss" for S-parameters and ratios centers the corrected dB magnitude as close as possible around 0 dB.

The resulting offset parameters are displayed in the Channel – [Offset Embed] > "Offset" softtool tab.

Auto Length and Loss for balanced ports

The "Auto Length and Loss" function can be used for balanced port configurations as well. If the active test port is a balanced (logical) port, then the same offset parameters must be assigned to both physical ports that are combined to form the logical port. If different offset parameters have been assigned to the physical ports before, they are both corrected by the same amount.

4.6.1.5 Fixture Compensation

"Fixture Compensation" is an automated length offset and loss compensation for test fixtures. The analyzer performs a one-port reflection measurement at each port, assuming the inner contacts of the test fixtures to be terminated with an open or short circuit.

"Fixture Compensation" complements a previous system error correction and replaces a possible manual length offset and loss correction. For maximum accuracy, it is recommended to place the reference plane as close as possible towards the outer test fixture connectors using a full n-port calibration. The "Fixture Compensation" is then carried out in a second step, it only has to compensate for the effect of the test fixture connections.

The following features can further improve the accuracy of the fixture compensation:

- "Direct Compensation" provides a frequency-dependent transmission factor (instead of a global electrical length and loss).
- "Open and Short" causes the analyzer to calculate the correction data from two subsequent sweeps. The results are averaged to compensate for errors due to non-ideal terminations.

Auto Length and Loss vs. Direct Compensation

"Auto Length and Loss" compensation is a descriptive correction type: The effects of the test fixture connection are traced back to quantities that are commonly used to characterize transmission lines.

Use this correction type if your test fixture connections have suitable properties in the considered frequency range:

- The electrical length is approximately constant.
- The loss varies due to the skin effect.

"Direct Compensation" provides a frequency-dependent transmission factor. The phase of the transmission factor is calculated from the square root of the measured reflection factor, assuming a reciprocal test fixture. The sign ambiguity of this calculated transmission factor is resolved by a comparison with the phase obtained in an Auto Length calculation. This compensation type is recommended for test fixture connections that do not have the properties described above.

A "Direct Compensation" resets the offset parameters to zero.

Open/Short vs. Open and Short compensation

A non-ideal "Open" or "Short" termination of the test fixture connections during fixture compensation impairs subsequent measurements, causing an artificial ripple in the measured reflection factor of the DUT. If you observe this effect, an "Open and Short" compensation may improve the accuracy.

"Open and Short" compensation is more time-consuming because it requires two consecutive fixture compensation sweeps for each port, the first with an open, the second with a short circuit. The analyzer automatically calculates suitable averages from both fixture compensation sweeps to compensate for the inaccuracies of the individual "Open and Short" compensations.

4.6.1.6 Application and effect of offset parameters

Offset and loss parameters can be particularly useful if the reference plane of the calibration cannot be placed directly at the DUT ports, e.g. because the DUT has non-coaxial ports and can only be measured in a test fixture. Offset parameters can also help to avoid a new complete system error correction if a cable with known properties has to be included in the test setup.

- A positive length offset moves the reference plane of the port towards the DUT, which is equivalent to deembedding the DUT by numerically removing a (perfectly matched) transmission line at that port.
- A negative offset moves the reference plane away from the DUT, which is equivalent to embedding the DUT by numerically adding a (perfectly matched) transmission line at that port.

The offset parameters are also suited for length and delay measurements; see [Chapter 4.6.1.3, "Auto Length"](#), on page 229. In contrast to the embedding/deembedding functions (see [Chapter 4.6.2, "Embedding and deembedding"](#), on page 234) the parameters cannot compensate for a possible mismatch in the test setup.

Each offset parameter is assigned to a particular port. The delay parameters affect the phase of all measured quantities related to this port; the loss parameters affect their magnitude. An offset at port 1 affects the S-parameters S_{11} , S_{21} , S_{12} , S_{31} ... Some quantities (like the Z-parameters) depend on the whole of all S-parameters, so they are all more or less affected when one S-parameter changes due to the addition of an offset length.



To account for the propagation in both directions, the phase shift of a reflection parameter due to a given length offset is twice the phase shift of a transmission parameter. If, at a frequency of 300 MHz, the electrical length is increased by 250 mm ($\lambda/4$), then the phase of S_{21} increases by 90 deg, whereas the phase of S_{11} increases by 180 deg.

Equivalent relations hold for the loss.

If the trace is displayed in "Delay" format, changing the offset parameters simply shifts the whole trace in vertical direction.

The sign of the phase shift is determined as follows:

- A positive offset parameter causes a positive phase shift of the measured parameter and therefore reduces the calculated group delay.
- A negative offset parameter causes a negative phase shift of the measured parameter and therefore increases the calculated group delay.

4.6.1.7 Offset parameters for balanced ports

The offset parameters can be used for balanced port configurations:

- Offset parameters must be assigned to both physical ports of a logical port.
- "Auto Length" corrects the length offset of both physical ports of a logical port by the same amount.

4.6.2 Embedding and deembedding

The R&S ZNA allows you to define virtual networks to be added to/removed from the measurement circuit for a DUT with single ended or balanced ports. This concept is referred to as embedding/deembedding.

The embedding/deembedding function has the following characteristics:

- Embedding and deembedding can be combined with balanced port conversion: the (de-)embedding function is available for single ended and balanced ports.
- A combination of four-port and two-port networks (not necessarily both) can be applied to balanced ports; two-port networks can be applied to single ended ports.
- A combination of four-port and two-port networks can be applied to any pair of single-ended ports. Moreover it is possible to combine several port pairs in an arbitrary order (port pair de-/embedding).
- Single-ended and/or balanced port (de-)embedding can be combined with ground loop (de-)embedding. A ground loop models the effect of a non-ideal ground connection of the DUT.
- Transformation networks can be defined by a set of S-parameters stored in a Touchstone file or by an equivalent circuit with lumped elements.
- The same networks are available for embedding and deembedding.

4.6.2.1 Embedding a DUT

To be integrated in application circuits, high-impedance components like Surface Acoustic Wave (SAW) filters are often combined with a matching network. To obtain the characteristics of a component with an added matching network, both must be integrated in the measurement circuit of the network analyzer.

The idea of virtual embedding is to simulate the matching network and avoid using physical circuitry so that the analyzer ports can be directly connected to the input and output ports of the DUT. The matching circuit is taken into account numerically. The analyzer measures the DUT alone but provides the characteristics of the DUT, including the desired matching circuit.

This method provides a number of advantages:

- The measurement uncertainty is not impaired by the tolerances of real test fixtures.
- There is no need to fabricate test fixtures with integrated matching circuits for each type of DUT.
- Calibration can be performed at the DUT's ports. If necessary, (e.g. for compensating for the effect of a test fixture) it is possible to shift the calibration plane using length offset parameters.

4.6.2.2 Deembedding a DUT

Deembedding and embedding are inverse operations: A deembedding problem is given if an arbitrary real network connected to the DUT is to be virtually removed to obtain the characteristics of the DUT alone. Deembedding is typically used for DUTs which are not directly accessible because they are inseparably connected to other components, e.g. for MMICs in a package or connectors soldered to an adapter board.

To be numerically removed, the real network must be described by a set of S-parameters or by an equivalent circuit of lumped elements. Deembedding the DUT effectively extends the calibration plane towards the DUT ports, enabling a realistic evaluation of the DUT without the distorting network. Deembedding can be combined with length offset parameters; see [Chapter 4.6.1, "Offset parameters"](#), on page 228.

The simplest case of single port deembedding can be depicted as follows:

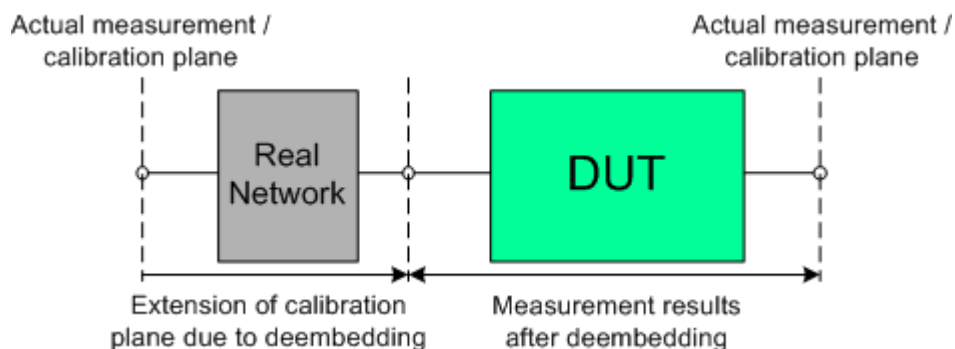

4.6.2.3 Circuit models for 2-port networks

The lumped element 2-port transformation networks for (de-)embedding consist of the following two basic circuit blocks:

- a capacitor connected in parallel with a resistor
- an inductor connected in series with a resistor

The 2-port transformation networks comprise all possible combinations of 2 basic blocks, where either one block represents a serial and the other a shunt element or both represent shunt elements. In the default setting the resistors are not effective, since the serial resistances are set to 0Ω , the shunt resistances are set to $10 \text{ M}\Omega$ and the shunt inductances are set to 0 Siemens .

The first network is defined by its S-parameters stored in an imported two-port Touchstone file (*.s2p). No additional parameters are required.

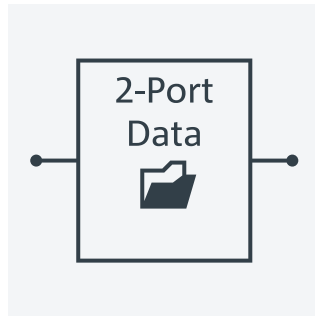

The following networks are composed of a serial capacitance C or inductance L (as seen from the test port), followed by a shunt L or C. They are named `Serial C`, `Shunt L / Serial L`, `Shunt C / Serial C`, `Shunt C / Serial L`, `Shunt L`.

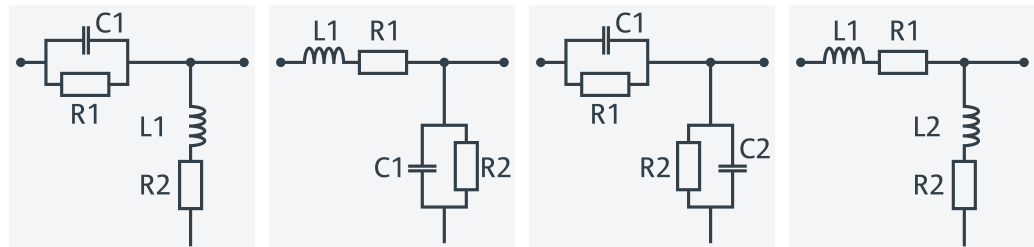

The following networks are composed of a shunt C or L (as seen from the analyzer port), followed by a serial C or L. They are named `Shunt C`, `Serial L / Shunt L`, `Serial C / Shunt C`, `Serial C / Shunt L`, `Serial L`.

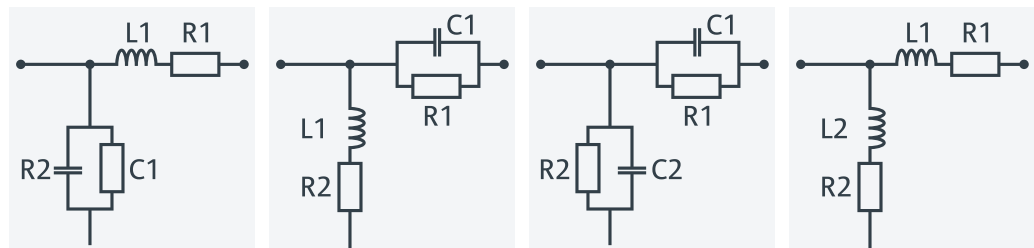

At the GUI, the "capacitance C<i>" in parallel with resistance R<i>" circuit blocks can be replaced by equivalent "capacitance C<i>" in parallel with conductance G<i>" circuit blocks.

In addition, there is also a `Shunt L`, `Shunt C` circuit model available, where the shunt C is defined as a capacitance C in parallel with a conductance G:

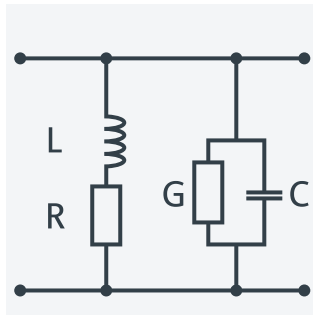

4.6.2.4 Circuit models for 4-port networks

The lumped element 4-port transformation networks for (de-)embedding consist of the following two basic circuit blocks:

- A capacitor C connected in parallel with a resistor.
- An inductor L connected in series with a resistor.

The transformation networks comprise various combinations of 3 basic circuit blocks, where two blocks represent serial elements, the third a shunt element. In the default setting the resistors are not effective, since the serial R_s are set to $0\ \Omega$, the shunt R_s are set to $10\ \text{M}\Omega$. Moreover, the serial elements can be replaced by imported 2-port S-parameters, or the entire transformation network can be described by imported 4-port S-parameters.

The first network is defined by its S-parameters stored in an imported four-port Touchstone file (* .s4p). No additional parameters are required.

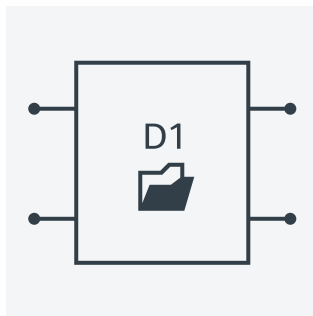

The following networks are composed of a shunt C or L and two serial elements, described by imported 2-port S-parameters. They are named Serial 2-port, Shunt C / Serial 2-port, Shunt L / Shunt L, Serial 2-port / Shunt C, Serial 2-port.

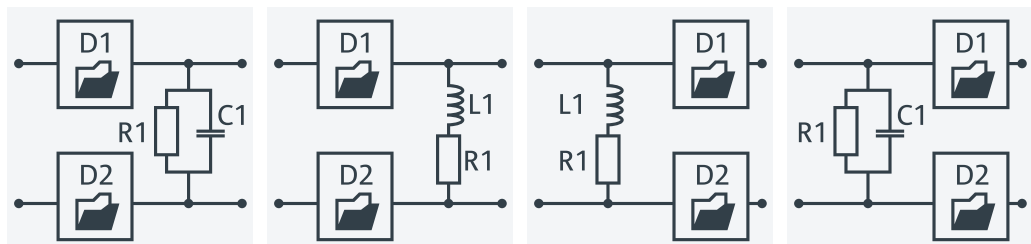

The following networks are composed of two serial Cs or Ls (as seen from the analyzer test port), followed by a shunt C or L. They are named *Serial Cs*, *Shunt L / Serial Ls*, *Shunt C / Serial Cs*, *Shunt C / Serial Ls*, *Shunt L*.

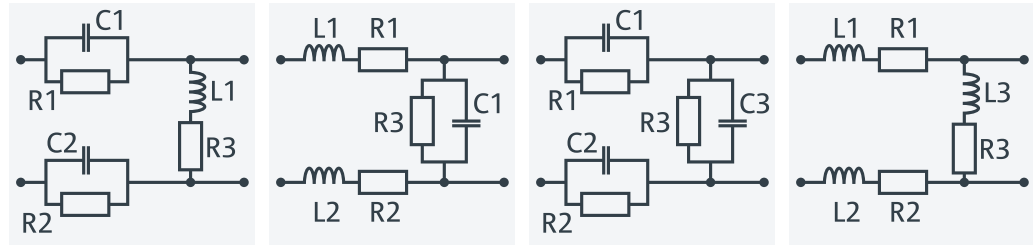

The following networks are composed of a shunt C or L (as seen from the analyzer test port), followed by two serial Cs or Ls. They are named *Shunt L*, *Serial Cs / Shunt C*, *Serial Ls / Shunt C*, *Serial Cs / Shunt L*, *Serial Ls*.

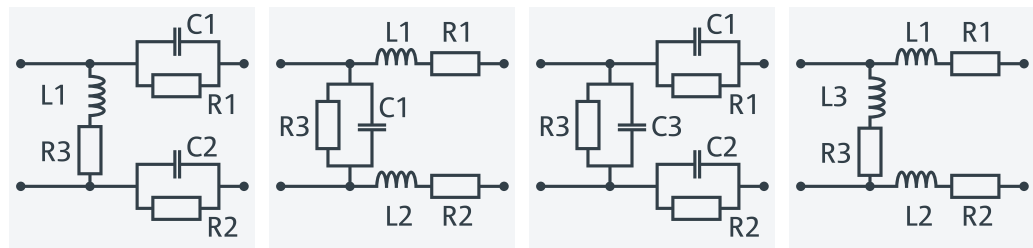

Since FW version 1.93, the "capacitance C<i>" in parallel with resistance R<i>" circuit blocks can alternatively be represented as "capacitance C<i>" in parallel with conductance G<i>" circuit blocks.

4.6.2.5 Port pair de-/embedding

Port pair de-/embedding extends the functionality of balanced port de-/embedding to pairs of single-ended physical ports. The analyzer uses the 4-port transformation networks known from balanced port de-/embedding, however, each transformation network is assigned to an arbitrary pair of (single-ended) physical ports.

A simple circuit which can be modeled using port pair (de-)embedding is a circuit (e.g. a resistance) between two ports of a DUT. To obtain the circuit in the following figure, select port pair 1,2 and the *Serial Ls*, *Shunt L* transformation network with all inductances set to zero ($L1 = L2 = L3 = 0 \text{ H}$) and $R1 = R2 = 0 \text{ } \Omega$.

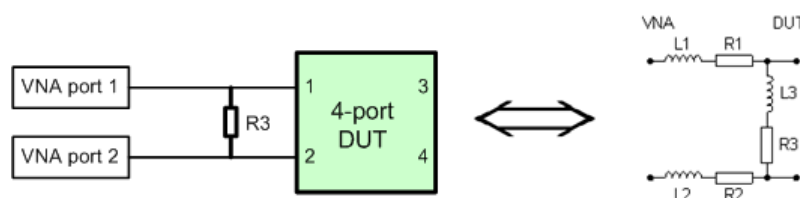

To model a general (de-)embedding network for ports 1 and 2, select port pair 1, 2 and a 4-Port Touchstone file.

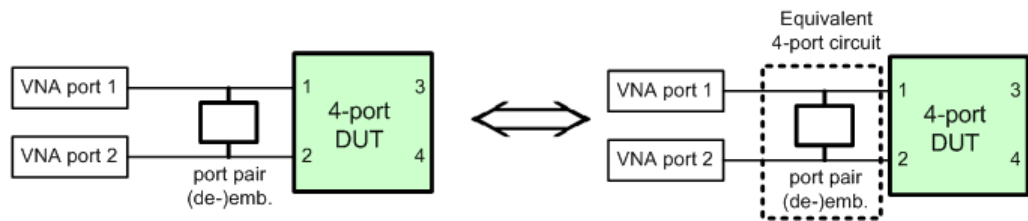

The two port pair (de-)embedding networks in the figure below are based on port pairs 1, 2 and 1, 3 with appropriate sets of 4-port S-parameters.

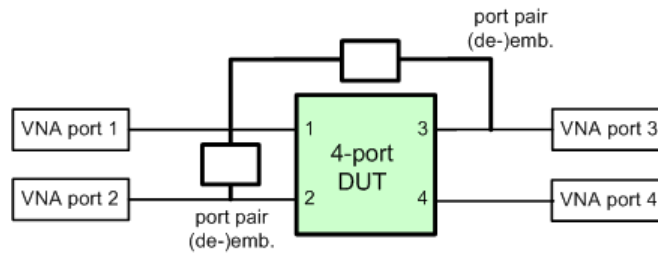

The R&S ZNA FW handles Port Pair De-/Embedding as a special case of [Port set de-/embedding](#).

4.6.2.6 Port set de-/embedding

The port set de-/embedding feature allows de-/embedding a linear 2m-port network connecting m physical VNA ports to m physical DUT ports ($m \geq 2$).

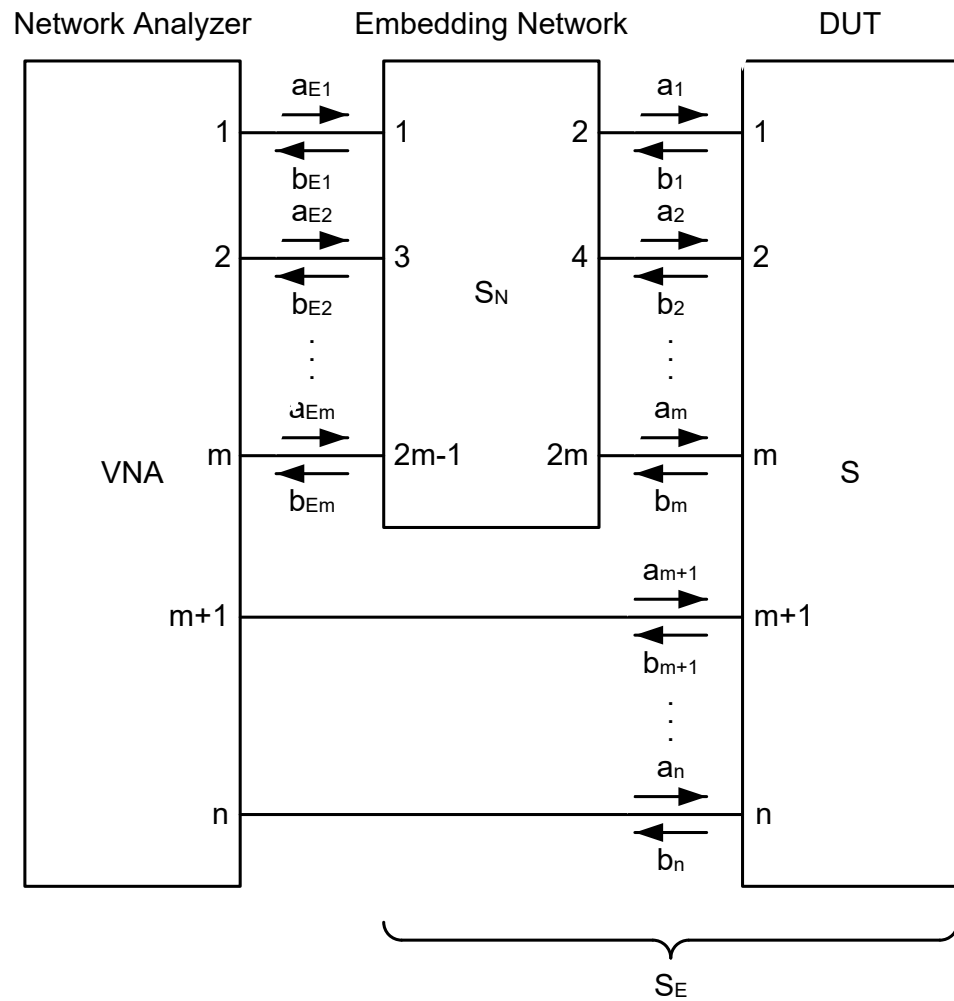
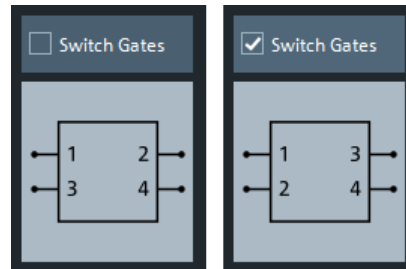

Figure 4-11: Port Set De-/Embedding

As shown in section [Combining Several de-/embedding networks](#), port set deembedding is calculated after single-ended deembedding, and the port set embedding step precedes single ended embedding. It is possible to combine a sequence of port sets for deembedding (embedding), each port set having its own transformation network. The effect of port set de-/embedding depends on the port sets themselves but also on their order. The same physical ports can be used repeatedly in different port sets; it is also possible to use the same port set repeatedly.



- For port pairs (i.e. for $m=2$), the de-/embedding network can be defined either via lumped element model (possibly in combination with s2p Touchstone files) or via a s4p Touchstone file, see [Chapter 4.6.2.5, "Port pair de-/embedding"](#), on page 238. For $m>2$, there are no predefined lumped element models available; the de-/embedding network has to be defined via a $s<2m>p$ Touchstone file.
- In case the port number conventions of the loaded Touchstone file differ from the numbering scheme depicted in [Figure 4-11](#), it is possible to "Switch Gates". The analyzer interchanges the port numbers when loading the file.



4.6.2.7 Ground loop de-/embedding

A ground loop models the effect of a non-ideal ground connection of the DUT causing a difference in potential between the analyzer's and the DUT's ground reference. A typical and often unavoidable source of ground loops is the parasitic inductance of the ground contacts.

In contrast to the 2-port de-/embedding networks, the ground loop represents a single-wire connection that can be described by a one-port S-matrix. On the other hand, the ground loop de-/embedding algorithm for an n -port DUT involves matrix operations which are based on the complete uncorrected single-ended $n \times n$ S-matrix.

The Ground Loop De-/Embedding can be specified via Touchstone s1p file or by parametrizing one of the lumped element models "Shunt L", "Shunt C".

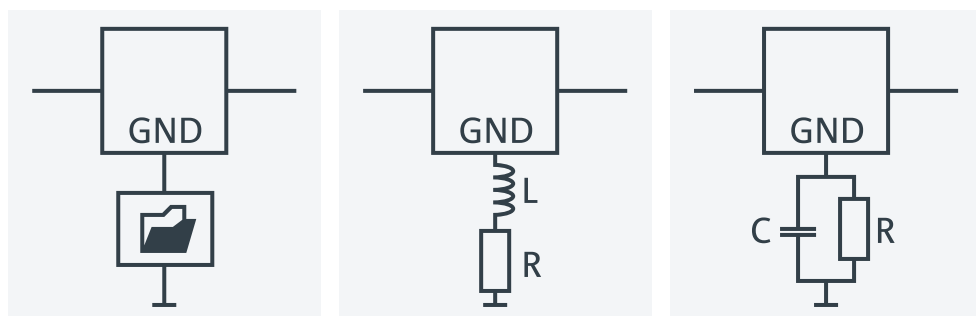

4.6.2.8 Differential match embedding

Differential Match Embedding allows you to simulate the characteristics of balanced DUT ports whose differential mode is balance-unbalance converted and then connected to a port-specific matching circuit.

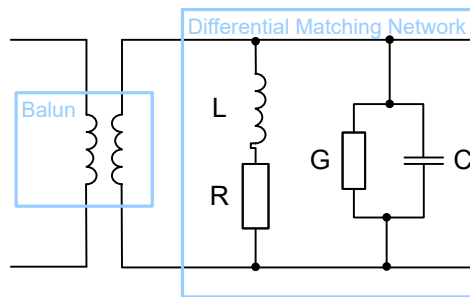

In contrast to standard balanced embedding (4-port), the matching circuit is only applied to the differential mode port (2-port). It can be specified via a Touchstone s2p file or by parametrizing a lumped "Shunt L, Shunt C" element model.

4.6.2.9 Fixture modeling and deembedding

When performing tasks such as verifying digital high-speed signal structures on printed circuit boards (PCBs), measurements have to be carried out on certain layers without the effects of probes, probe pads, vias, lead-ins and lead-outs. This requires the use of accurate deembedding algorithms to calculate and remove these effects from the measurements, leaving only the result for the area of interest.

Instead of asking the user to define the fixture by parametrizing one of the given lumped circuit models or by "somehow" providing a suitable `snp` file, the firmware of the R&S ZNA now also provides integration for third-party tools that model the test fixture from measured data:

- AtaiTec's [In-situ de-embedding \(ISD\)](#)
- PacketMicro's [Smart fixture de-embedding \(SFD\)](#)
- [Eazy de-embedding based on IEEE 370](#)

The tools are integrated into the deembedding functionality of the R&S ZNA firmware. More fixture modeling tools may be added in future firmware releases.

Test Setup

The setup below shows an example for verifying the high-speed differential signal lines on a PCB.

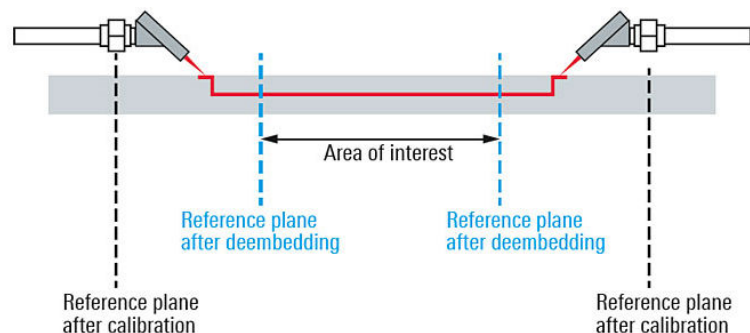

Fixture Modeling Process

For all supported tools, the fixture modeling proceeds as follows:

1. Perform a calibration to the fixture connectors.
2. Measure one or more PCB test coupons for the related fixture.
The results are independent of a particular DUT. Hence they can be reused for subsequent measurements using the same test fixture.
3. Measure the total structure, i.e. the DUT with the fixture.
4. Run the selected third-party tool to calculate the fixture deembedding files.

After a final confirmation, the calculated deembedding files (s_{2p} for single-ended ports, s_{4p} for balanced ports) are used for deembedding the DUT at the respective logical port(s).

Test Coupons

The test fixture consists of a set of lead-ins.

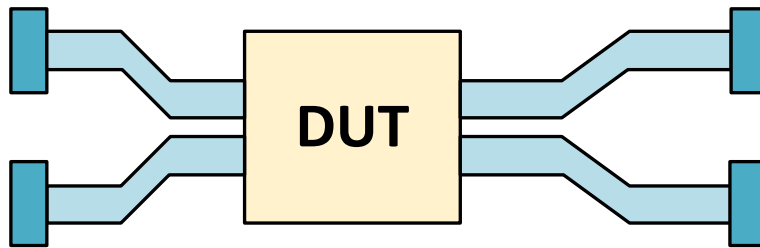

Figure 4-12: DUT with Test Fixture (balanced)

The fixture modeling tools require test coupons for the lead-ins to the DUT and that are either representing a Through, an Open or a Short. If the lead-ins "on the left" and "on the right" side of the DUT ("lead-outs") are not symmetric, different test coupons for the lead-ins and lead-outs are required.

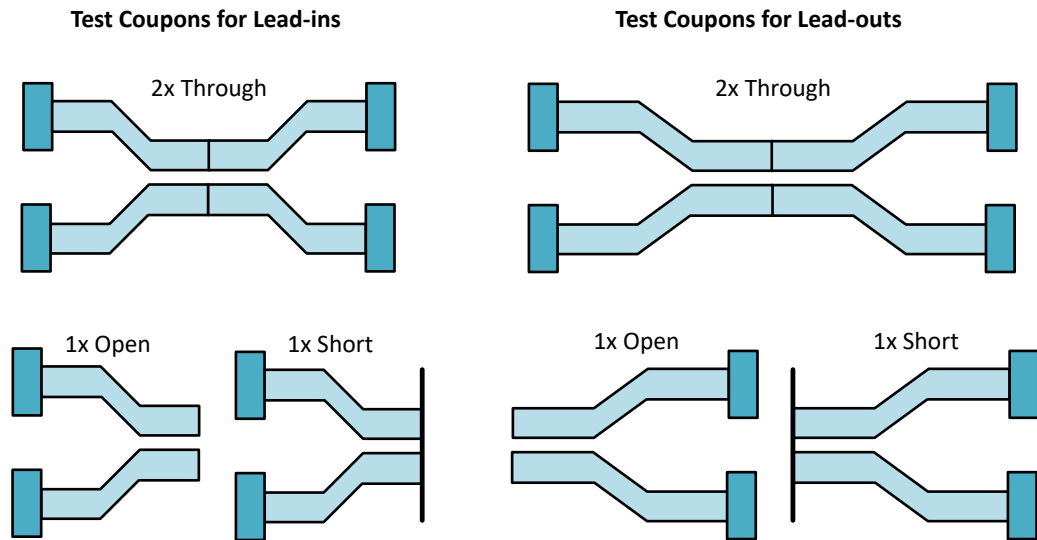

Figure 4-13: Test Coupons (balanced)

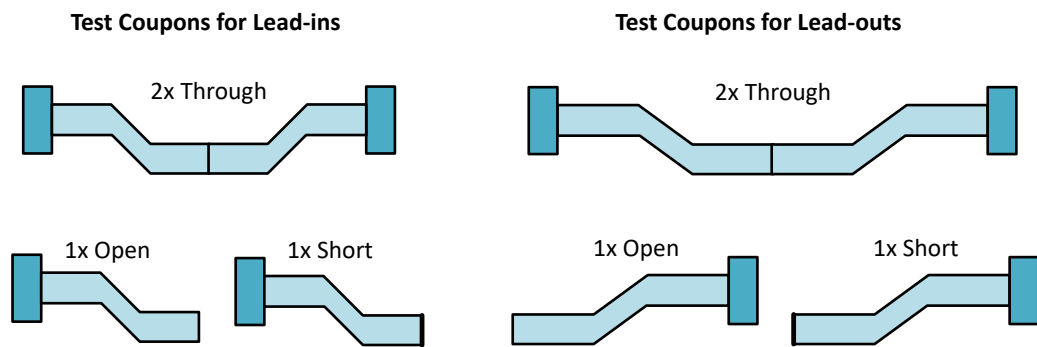

Figure 4-14: Test Coupons (single-ended)

4.6.2.10 Combining Several de-/embedding networks

The R&S ZNA allows you to select a combination of networks to be numerically added/removed at different layers

- 2-port networks at single ended physical ports
- 4-port networks at pairs of single ended physical ports
- 4-port networks at balanced logical ports
- 1-port ground loop networks
- 2-port differential match embedding networks at balanced logical ports

The different steps for deembedding and embedding are carried out in the following order:

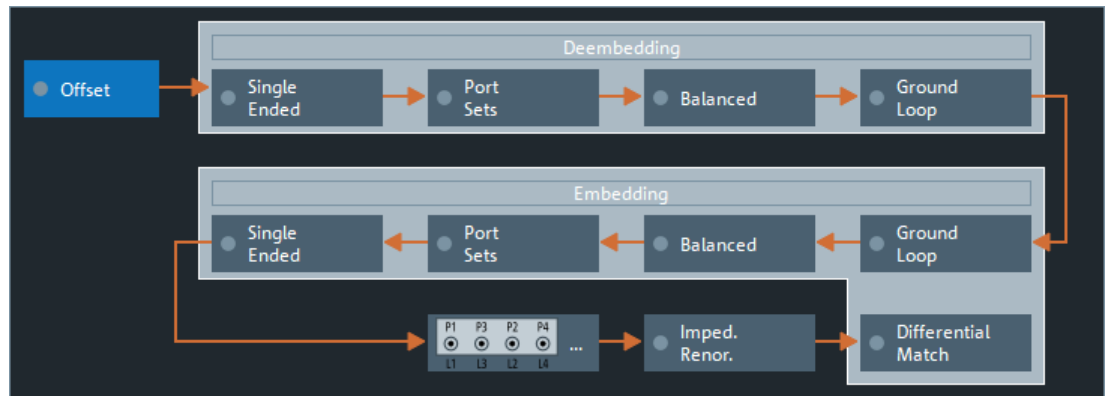
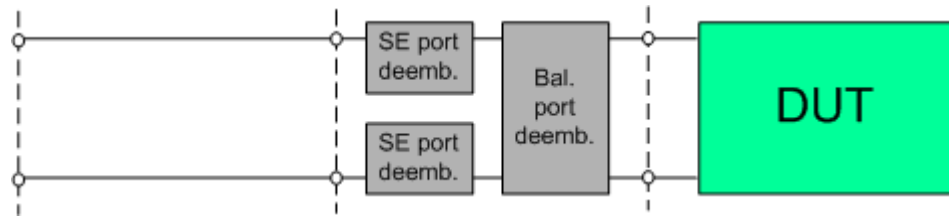

Figure 4-15: De-/Embedding calculation flow

This means that the real networks are removed before virtual networks are added.

The (de-)embedding steps are carried out in the following order:

1. Single Ended Deembedding: every physical port can be deembedded from a single 2-port network
2. Port Set Deembedding: every port set can be deembedded from one or more 4-, 6- or 8-port networks. There is no restriction on the sequence of port pairs and deembedding networks.
3. Balanced Deembedding: every balanced logical port can be deembedded from a single 4-port network
4. Ground Loop Deembedding: the DUT's ground connection can be deembedded from a single 1-port network
5. Ground Loop Embedding: the DUT's ground connection can be embedded in a single 1-port network
6. Balanced Embedding: every balanced logical port can be embedded in a single 4-port network
7. Port Set Embedding: every port set can be embedded in one or more 4-, 6- or 8-port networks. There is no restriction on the sequence of port pairs and embedding networks.
8. Single Ended Embedding: every physical port can be embedded in a single 2-port network
9. Differential Match Embedding: the differential mode of a balanced logical port can be embedded in a single 2-port network
1. Initial situation: DUT embedded in 2-port and 4-port networks (only 1 port shown)



2. Single ended deembedding

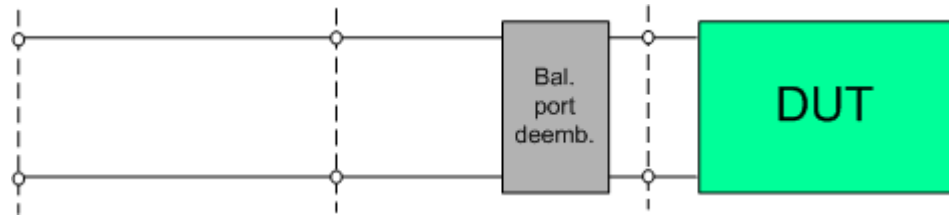

3. Balanced port deembedding



4. Balanced port embedding



5. Single ended port embedding



4.7 Optional extensions and accessories

The instrument can be upgraded with various software and hardware options, providing enhanced flexibility and an extended measurement functionality. The equipped options are listed in the "Options" tab of the [Info dialog](#) (System – [Setup] > "Setup" > "Info...").

For a complete list of options, accessories, and extras refer to the product brochure or to the "Options" section of the R&S ZNA product pages on the Internet.

The following sections provide an introduction to the software and hardware options described in this documentation. The use of external power meters, generators, switch matrices and generic devices does not require any additional hardware or software options; it is described at the end of the chapter.

4.7.1 Spectrum analyzer mode

Option R&S ZNA-K1

Option R&S ZNA-K1 enables spectrum analysis measurements on all receivers of the R&S ZNA (measurement receiver or reference receiver).

Up to 4 spectra can be measured in parallel, if the motherboard of the R&S ZNA has a product index 8 or higher (see the [Hardware tab](#)). Motherboards with product index < 8 do not support parallel spectrum measurements.



To find out the motherboard product index of your R&S ZNA, go to the [Hardware tab](#) of the "Info" dialog. Scroll to the "MB_MPM" row of the "Assemblies" table, and look at the first number in the "Product Index" column.

For more information on spectrum mode measurements and channel setups, see the description of the [Spectrum tab](#) and the [Spectrum Setup dialog](#).



- If a R&S ZNA50 or R&S ZNA67 is equipped with the [Internal low noise preamplifier](#) option variant B312, or the [Internal low power spur reduction amplifier](#) option variant B511, then option R&S ZNA-K1 is not available.
- Before firmware version 2.40, only measurement receivers were available for spectrum measurements, and parallel spectrum measurements were not possible at all.

4.7.2 Time domain analysis

Option R&S ZNA-K2

The network analyzer measures and displays complex S-parameters and other quantities as a function of the frequency. The measurement results can be filtered and mathematically transformed to obtain the time domain representation, which often gives a clearer insight into the characteristics of the DUT.

Time domain transforms can be calculated in band pass or low pass mode. For the latter, the analyzer offers the impulse and step response as two alternative transformation types. A wide selection of windows can be used to optimize the time domain response and suppress side lobes due to the finite sweep range. Moreover, it is possible to elimi-

nate unwanted responses using a time gate and transform the gated result back into the frequency domain.

For a detailed discussion of the time domain transformation including many examples, refer to the application note 1EP83 which is available on the R&S internet at <http://www.rohde-schwarz.com/apnotes/1EP83>.

Trace selection

Select a reflection parameter S_{ij} to perform a time domain reflectometry (TDR) measurement, e.g. to detect cable faults. To measure the impedance of a network, you can select a **converted impedance parameter** $Z \leftarrow S_{ij}$.

Select a transmission parameter S_{ij} ($i \neq j$) to perform a time domain transmission (TDT) measurement, e.g. for measuring antennas.



- For TDR traces and if distance is used as the x axis, the x value indicates the **one-way** path to the reflection.
- To export time domain traces, you have to use **formatted values** (ASCII, Matlab) must be used. See [Chapter 4.4.2.3, "Finding the best file format"](#), on page 185.

4.7.2.1 Chirp z-transformation

The Chirp z-transformation that the analyzer uses to compute the time domain response is an extension of the (inverse) Fast Fourier Transform (FFT). Compared to the FFT, the number of sweep points is arbitrary (not necessarily an integer power of 2), but the computation time is increased by approx. a factor of 2. This increased computation time is usually negligible compared to the sweep times of the analyzer.

The following properties of the Chirp z-transformation are relevant for the analyzer settings:

- The frequency points must be equidistant.
- The time domain response is repeated after a time interval which is equal to $\Delta t = 1 / \Delta f$, where Δf is the spacing between two consecutive sweep points in the frequency domain. For a sweep span of 4 GHz and 201 equidistant sweep points, $\Delta f = 4 \text{ GHz} / 200 = 2 \cdot 10^7 \text{ Hz}$, so that $\Delta t = 50 \text{ ns}$. Δt is termed measurement range (in time domain) or unambiguous range.

Additional constraints apply if the selected Chirp z-transformation is a lowpass transformation.

4.7.2.2 Band pass and low pass mode

The analyzer provides two different types of time domain transforms:

- **Band pass mode:** The time domain transform is based on the measurement results obtained in the sweep range between any set of positive start and stop values. The sweep points must be equidistant. No assumption is made about the measurement point at zero frequency (DC value). The time domain result is complex, with an undetermined phase depending on the delay of the signal.

- Low pass mode: The measurement results are continued towards $f = 0$ (DC value) and mirrored at the frequency origin so that the effective sweep range (and thus the response resolution) is more than doubled. Together with the DC value, the condition of equidistant sweep points implies that the frequency grid must be harmonic. Due to the symmetry of the trace in the frequency domain, the time domain result is harmonic.
See also [Chapter 4.7.2.4, "Harmonic grid"](#), on page 250.
Two different types of response are available in low pass mode; see below.

Table 4-18: Comparison of band pass and low pass modes

Transform type	Band pass	Low pass
Advantages	Easiest to use: works with any set of equidistant sweep points	Higher response resolution (doubled) Includes information about DC value Real result Impulse and step response
Restrictions	No step response Undetermined phase	Needs harmonic grid
Use for...	Scalar measurements where the phase is not needed DUTs that do not operate down to $f = 0$ (e.g. pass band or high pass filters)	Scalar measurements where the sign is of interest DUTs with known DC value

Impulse and step response

In low pass mode, the analyzer can calculate two different types of responses:

- The impulse response corresponds to the response of a DUT that is stimulated with a short pulse.
- The step response corresponds to the response of a DUT that is stimulated with a voltage waveform that transitions from zero to unity.

The two alternative responses are mathematically equivalent; the step response can be obtained by integrating the impulse response:

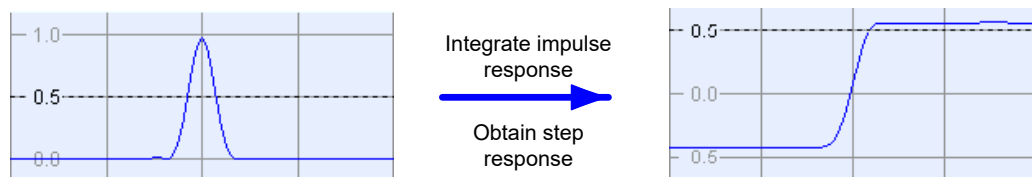

The step response is recommended for impedance measurements and for the analysis of discontinuities (especially inductive and capacitive discontinuities). The impulse response has an unambiguous magnitude and is therefore recommended for most other applications.

4.7.2.3 Windows in the frequency domain

The finite sweep range in a frequency domain measurement with the discontinuous transitions at the start and stop frequency broadens the impulses and causes side

lobes (ringing) in the time domain response. The windows offered in the "Define Transform" dialog can reduce this effect and optimize the time domain response. The windows have the following characteristics:

Table 4-19: Properties of frequency windows

Window	Side lobe suppression	Relative impulse width	Best for...
No Profiling (Rectangle)	13 dB	1	–
Low First Side lobe (Hamming)	43 dB	1.4	Response resolution: separation of closely spaced responses with comparable amplitude
Normal Profile (Hann)	32 dB	1.6	Good compromise between pulse width and side lobe suppression
Steep Falloff (Bohman)	46 dB	1.9	Dynamic range: separation of distant responses with different amplitude
Arbitrary Side lobes (Dolph-Chebyshev)	User defined between 10 dB and 120 dB	1.2 (at 32 dB side lobe suppression)	Adjustment to individual needs; tradeoff between side lobe suppression and impulse width

4.7.2.4 Harmonic grid

A harmonic grid is formed by a set of equidistant frequency points f_i ($i = 1 \dots n$) with spacing Δf and the additional condition that $f_1 = \Delta f$. In other words, all frequencies f_i are set to harmonics of the start frequency f_1 .

If a harmonic grid, including the DC value ($f = 0$), is mirrored to the negative frequency range, the result is again an equidistant grid.

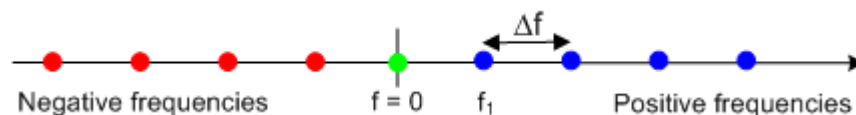

The point symmetry with respect to the DC value makes harmonic grids suitable for lowpass time domain transformations.

Visualization of the harmonic grid algorithms

The R&S ZNA provides three different algorithms for harmonic grid calculation. The three harmonic grids have the following characteristics:

- Keep "Stop Frequency and Number of Points" means that the stop frequency and the number of sweep points is maintained. The sweep points are redistributed across the range between the minimum frequency of the analyzer and the stop frequency; the step width can be increased.

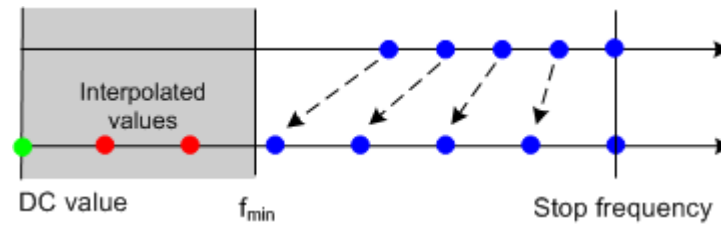

- Keep "Frequency Gap and Number of Points" means that the number of sweep points and their relative spacing is maintained. If the start frequency of the sweep is sufficiently above the f_{min} , the entire set of sweep points is shifted towards lower frequencies so that the stop frequency is decreased.

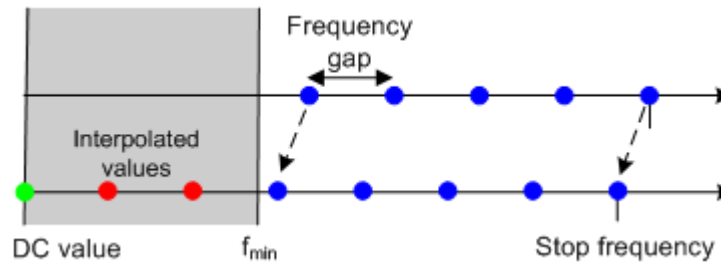

If the start frequency of the sweep is close to f_{min} , then the sweep points can have to be shifted towards higher frequencies. If the last sweep point of the calculated harmonic grid exceeds the maximum frequency of the analyzer, then an error message is displayed, and another harmonic grid algorithm must be used.

- Keep "Stop Frequency and Approximate Frequency Gap" means that the stop frequency is maintained and the number of sweep points is increased until the range between f_{min} and the stop frequency is filled. The frequency gap is approximately maintained.

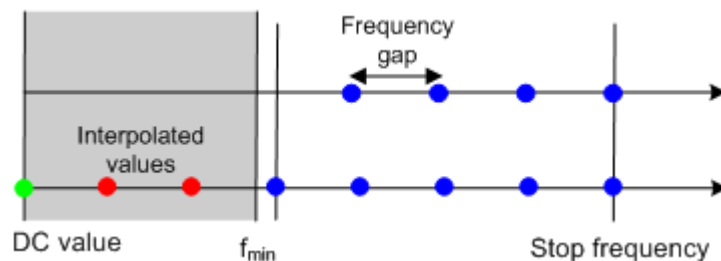

The figures above are schematic and do not comply with the conditions placed on the number of sweep points and interpolated/extrapolated values.



The harmonic grids cannot be calculated for any set of sweep points. If the minimum number of sweep points is smaller than 5, then the interpolation/extrapolation algorithm for additional sweep points does not work. The same is true if the number of sweep points or stop frequency exceeds the upper limit. Besides, the ratio between the sweep range and the interpolation range between $f = 0$ and $f = f_{min}$ must be large enough to ensure accurate results. If the sweep range for the harmonic grid exceeds the frequency range of the current system error correction, a warning is displayed.

Finding the appropriate algorithm

The three types of harmonic grids have different advantages and drawbacks. Note that for a bandpass transformation the grid parameters have the following effect:

- A wider sweep range (i.e. a larger bandwidth) increases the time domain resolution.
- A smaller frequency gap extends the unambiguous range.
- A larger number of points increases the sweep time.

With default analyzer settings, the differences between the grid types are small. The following table helps you find the appropriate grid.

Table 4-20: Properties of grid types

Grid type: Keep	Sweep time	Time domain resolution	Unambiguous range	Algorithm fails if...
Stop freq. and no. of points	➡	⬆	⬇	–
Freq. gap and no. of points	➡	➡	➡	Stop frequency beyond upper frequency limit
Stop freq. and approx. freq. gap	⬆	⬆	➡	Number of sweep points beyond limit

4.7.2.5 Time gates

A time gate is used to eliminate unwanted responses that appear on the time domain transform. An active time gate acts on the trace in time domain and in frequency domain representation.

The properties of the time gates are analogous to the properties of the frequency domain windows. The following table gives an overview:

Table 4-21: Properties of time gates

Window	Side lobe suppression	Passband ripple	Best for...
Steepest Edges (Rectangle)	13 dB	0.547 dB	Eliminate small distortions in the vicinity of the useful signal, if demands on amplitude accuracy are low
Steep Edges (Hamming)	43 dB	0.019 dB	Good compromise between edge steepness and side lobe suppression
Normal Gate (Hann)	32 dB	0.032 dB	Good compromise between edge steepness and side lobe suppression
Maximum Flatness (Bohman)	46 dB	0 dB	Maximum attenuation of responses outside the gate span
Arbitrary Gate Shape (Dolph-Chebyshev)	User defined between 10 dB and 120 dB	0.071 dB	Adjustment to individual needs; tradeoff between side lobe suppression and edge steepness

Time-gated frequency domain trace

The trace in the frequency domain depends on the state of the "Time Gate":

- If the gate is disabled, the frequency domain (FD) trace corresponds to the measured sweep results before the time-domain transformation.
- If the gate is enabled, the displayed frequency domain trace is calculated from the time domain (TD) trace which is gated and transformed back into the frequency domain.

The analyzer uses fixed "No Profiling (Rectangle)" window settings to transform the measured trace into time domain. The TD trace is gated using the selected time gate. The gated trace is transformed back into frequency domain using a "No Profiling (Rectangle)" window.

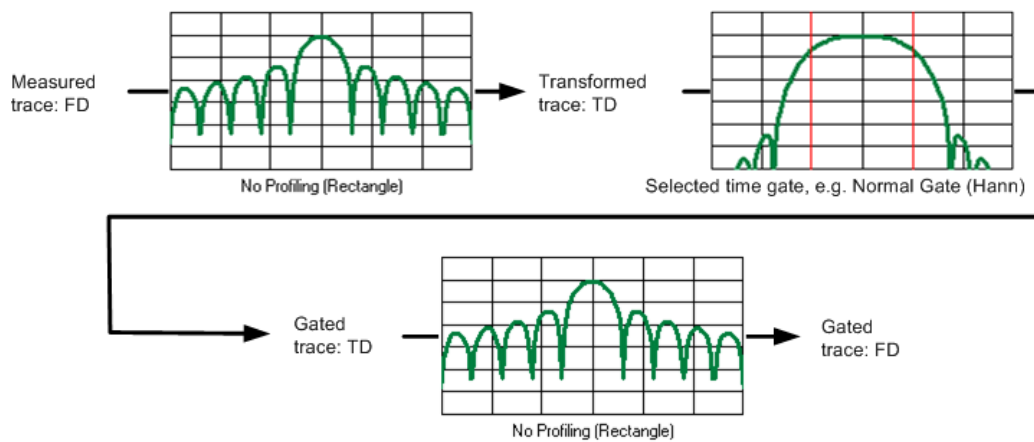

The shape, width and position of the time gate affect the gated frequency domain trace. The window type selection in the "Define Transform" dialog is ignored. The selected window is used again when the TD trace is displayed ("Time Domain: On").

The rectangular "No Profiling (Rectangle)" windows minimize numerical inaccuracies near the boundaries of the measured frequency span. In the limit where the effect of the time gate vanishes (e.g. a gate of type "Notch" and a very small width), the time gated trace is equal to the original measured trace.

4.7.2.6 Time domain S_{VSWR} measurements

The vector network analyzer R&S ZNA with time domain option K2 supports TD site VSWR measurements.



For the frequency range 1 GHz to 18 GHz, this method of S_{VSWR} measurement is proposed in standard ANSI C63.25.

Hence a R&S ZNA equipped with time domain option K2 supports TD site VSWR measurements in accordance with ANSI C63.25.

EMC Test Site Validation

EMC test sites for radiated emission measurements rely on free-space conditions to minimize the influence of reflections on the received signal. Practically, near free-space conditions are achieved by shielded enclosures fully lined with RF absorbing material. *Site validation* determines deviations from free-space conditions that must meet the acceptance criterion for making EMC compliance measurements in a FAR (= fully anechoic room). It is performed by measuring the *site voltage standing-wave ratio* (S_{VSWR}), which is the ratio of maximum received signal to minimum received signal, caused by interference between direct (intended) and reflected signals.

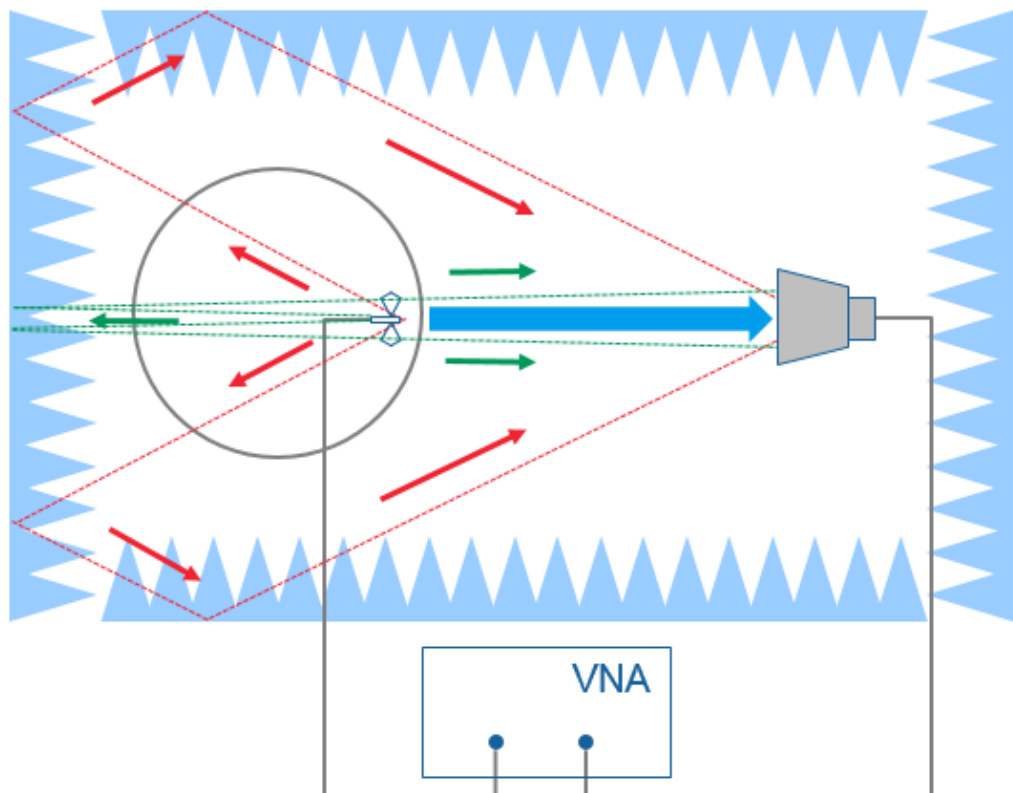

blue arrow = direct signal
red and green arrows = reflected signal

TD S_{VSWR} Calculation

The ANSI time-domain method relies on a complex transmission measurement (S_{21}) using a vector network analyzer (VNA).

A time-domain transformation of the frequency domain data shows the impulse response between the two antennas. Since the direct antenna-to-antenna response is related to the shortest distance, the earliest impulse is the direct antenna response. Reflections from the test site are from farther distance away, thus come at later time. It is therefore possible to separate the direct antenna response $S_{21, \text{direct}}$ from reflections $S_{21, \text{reflected}}$ by using time gating and to calculate

$$\text{TD } S_{VSWR} = (1+r) / (1-r) ,$$

where $r = S_{21,reflected} / S_{21,direct}$.

Measurement Procedure for ANSI C63.25

See the Rohde & Schwarz Application Card "Fast validation of EMC Test Sites above 1 GHz with Time-domain S_{VSWR} ", published on the Rohde & Schwarz internet site.

4.7.2.7 Distance-to-fault measurements

Option R&S ZNA-K2 also offers a special distance-to-fault measurement that allows you to locate faults and discontinuities on cables and transmission lines.

Faults produce peaks on the impulse response (in the time domain) that is calculated from the measured reflection S-parameter trace via inverse Fourier transformation. The distance between the reference plane and the fault can then be calculated from the propagation time, accounting for the electrical properties of the transmission line. Moreover it is possible to define the peaks to be considered as being caused by a fault.

The following example shows the reflection at the end of a faultless open cable connected to test port 2. A full one-port calibration ensures that the distance is measured from the test port position (reference plane = distance zero). The horizontal position of marker "M2" corresponds to the cable length of 1417 mm, the additional peak at position "M1" is due to a bad connection between the cable and the test port.

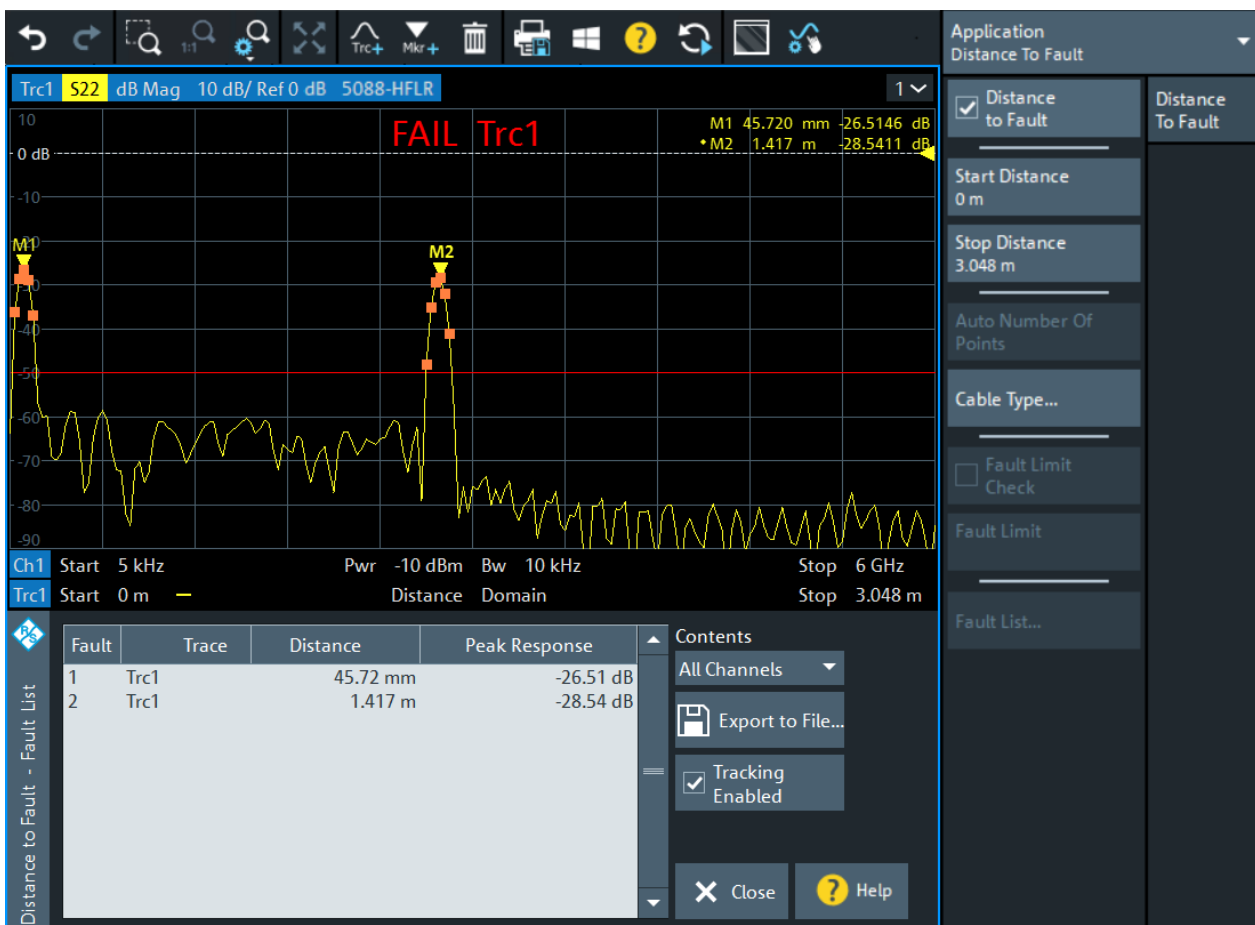

Adjust the frequency sweep to the length of the transmission line and the expected distance to fault:

- The maximum distance that can be measured is proportional to the number of sweep points. The larger the number of sweep points, the longer the maximum distance between the calibrated reference plane and the fault to be located.
- The maximum distance that can be measured is inversely proportional to the frequency span. The smaller the frequency span, the longer the maximum distance between the calibrated reference plane and the fault to be located. However, a smaller frequency span comes at the cost of a coarser distance resolution.

The R&S ZNA can automatically determine a suitable number of sweep points for a given maximum distance to fault ("Auto Number of Points"). Moreover it is possible to define which of the peaks are considered as being due to a fault, and to draw up and export a list of the detected faults.

4.7.2.8 Extended time domain analysis

Option R&S ZNA-K20

Option K20 extends the basic Time Domain representation capabilities of option K2 by signal integrity testing functionality in the time domain.

Simulated Eye Diagram

With the impulse response calculated from the measured S parameters using the inverse Fourier transform, it is possible to predict the system response to arbitrary time domain signals by calculating the convolution of the input signal with the impulse response.

With option R&S ZNA-K20, the R&S ZNA firmware implements a "virtual" signal generator that is able to generate multilevel PAM signals (NRZ, PAM-4, PAM-8, PAM-16), including a simulated low pass behavior. The simulated eye diagram using the DUT's measured S parameters gives an extensive overview regarding the signal integrity of the system.

Further building blocks for pre-emphasis, jitter, noise and equalization allow you to synthesize effects of transmitter and receiver parts in the transmission system.

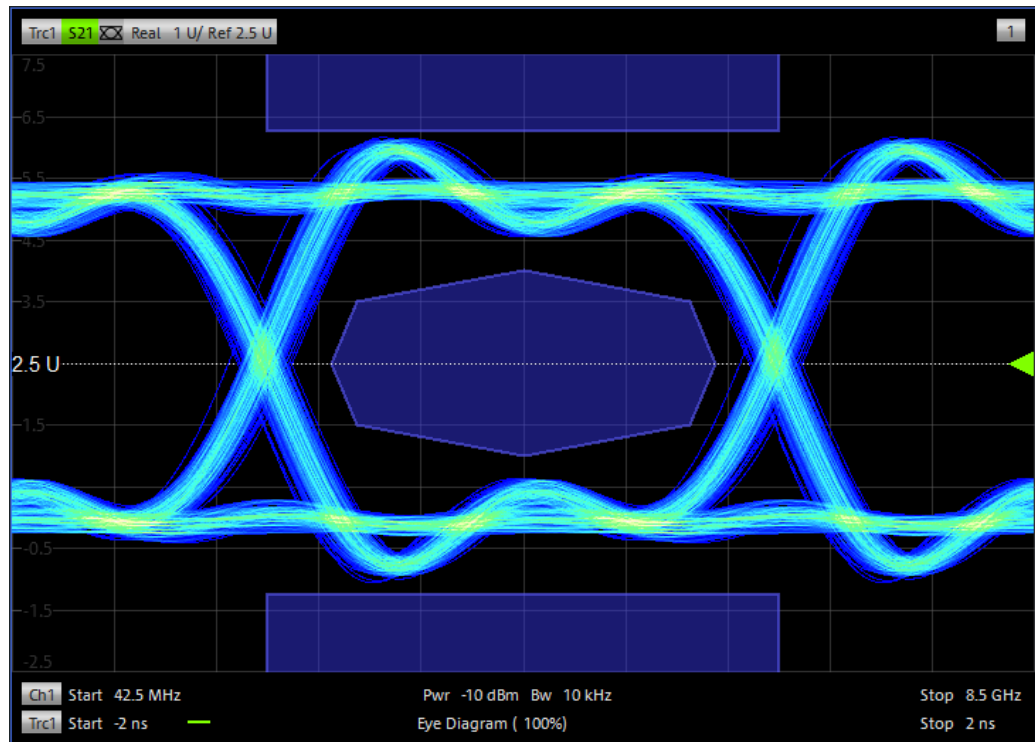

Figure 4-16: Eye Diagram (NRZ modulated)

The measurement proceeds as follows:

1. The analyzer performs a frequency sweep.
2. The impulse response is calculated based on the results of the preceding frequency sweep.
3. With the impulse response calculated in [step 2](#),
 - a) the eye diagram is simulated.
 - b) the [Eye Diagram Results](#) are calculated.
 - c) the [Eye Mask Test](#) is evaluated (if enabled).
4. In continuous sweep mode, go back to [step 2](#)



- The simulation progress is shown in the channel list below the eye diagram
- In continuous sweep mode, the analyzer keeps on sweeping while the eye diagram is being simulated and evaluated

Eye Diagram Results

The properties of the simulated eye diagram can be displayed as an info field or exported to an ASCII file.

Trc1	
Eye Minimum	-3.106 V
Eye Maximum	3.106 V
Eye Base	-2.810 V
Eye Top	2.810 V
Eye Mean	0.000 V
Eye Amplitude	5.621 V
Trc1	
Bit Period	10.000 ns
Rise Time	125.000 ps
Fall Time	125.000 ps
Jitter Pk-Pk	50.125 ps
Jitter RMS	0.000 s
Duty Cycle Dist	25.063 ps
Duty Cycle Pct	0.251 %
Crossing Percent	50.000 %
Opening Factor	1.000
SNR	-----

Figure 4-17: Eye Diagram Result Info Field

The following results are available:

- Eye Minimum and Eye Maximum**
 These values represent the minimum and maximum outputs of the eye diagram processing. These values include any over- and under-shoots seen during the symbol transitions.
- Eye Base, Eye Top, Eye Mean, and Eye Amplitude**
 "Eye Base" and "Eye Top" represent the averaged voltages observed for the low and high voltage bits, respectively. "Eye Mean" is the average of "Eye Top" and "Eye Base", "Eye Amplitude" is the difference between "Eye Top" and "Eye Base".
- Eye Height**
 This result indicates the effects of noise in reducing the vertical eye opening. It is defined as $(\text{"Eye Top"} - 3\sigma_{\text{Top}}) - (\text{"Eye Base"} + 3\sigma_{\text{Base}})$, where σ_{Top} and σ_{Base} denote the standard deviations of the observed high and low voltage levels, respectively.
- Eye Width**
 This result indicates the effects of jitter in reducing the horizontal eye opening. It is defined as $\text{"Bit Period"} - 2 \cdot 3 \cdot \text{"Jitter RMS"}$.
- Bit Period**
 The inverse of the data rate.
- Rise Time and Fall Time**
 The time it takes the rising (falling) edge of the eye to go from x% (y%) of the "Eye Amplitude" to y% (x%) of the "Eye Amplitude" ($0 \leq x \leq y \leq 100$, typically $x=10$ and $y=90$).
- Jitter Pk-Pk/RMS**
 These values measure the excursion of the 50% point of the rising edge in the horizontal (time) direction: "Jitter Pk-Pk" is the distance between the peak values; "Jitter RMS" is the RMS value of the excursions.
- Duty Cycle Dist/Pct**
 These values measure the time separation between the rising and falling edge at the 50% level of the eye diagram. "Duty Cycle Dist" is the absolute distance, "Duty Cycle Pct" gives the same value as a percentage of the "Bit Period".
- Crossing Percent**

The Crossing Height is the height above "Eye Base" where the rising and falling edges cross, "Crossing Percent" gives the same value as a percentage of the "Eye Amplitude".

- **Opening Factor**
This result is a measure of the effects of amplitude noise on the vertical eye opening. Accordingly, it is equal to $(\text{"Eye Top"} - \sigma_{\text{Top}}) - (\text{"Eye Base"} + \sigma_{\text{Base}}) / \text{"Eye Amplitude"}$
- **SNR**
Relates the "Eye Amplitude" to the noise level. Accordingly, it is equal to $\text{"Eye Amplitude"} / (\sigma_{\text{Top}} + \sigma_{\text{Base}})$



Eye diagram results are only available for NRZ modulated signals.

Eye Mask Test

Furthermore, the eye diagram simulation allows to perform tests against a user-defined eye mask:

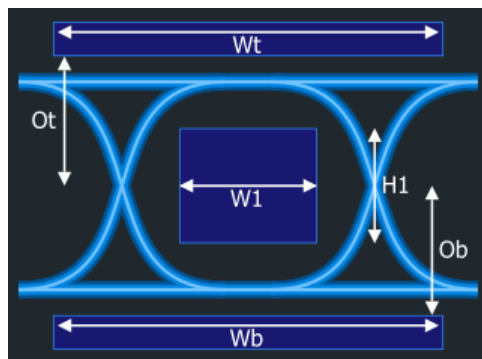

Figure 4-18: User-defined Eye Mask



Eye mask tests are only available for NRZ modulated signals.

Rise Time Measurement

From the measured S parameters, the step responses can also be calculated using the inverse Fourier transform. The rise time is the time the step response takes to rise from x% to y% ($0 \leq x \leq y \leq 100$) of the resulting step size, typically from 10% to 90%.

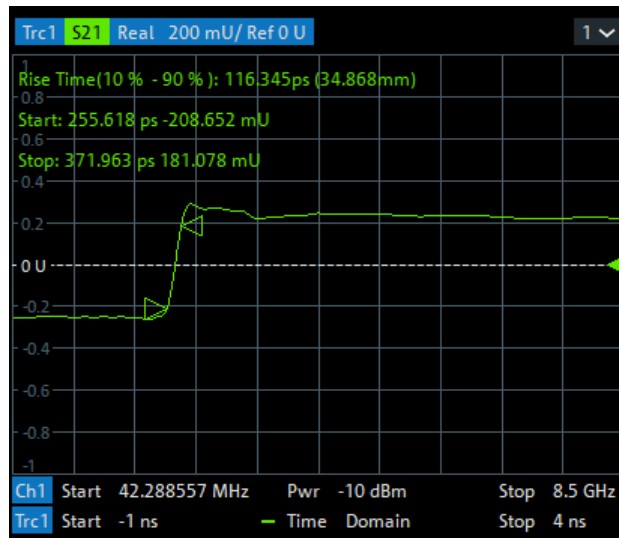

Figure 4-19: Rise Time Measurement

Skew Measurement

The skew measurement allows you to compare the step responses calculated from different traces measured on the same analyzer channel. The skew is calculated as the "delta time" (or length) at user defined percentage of the step size.

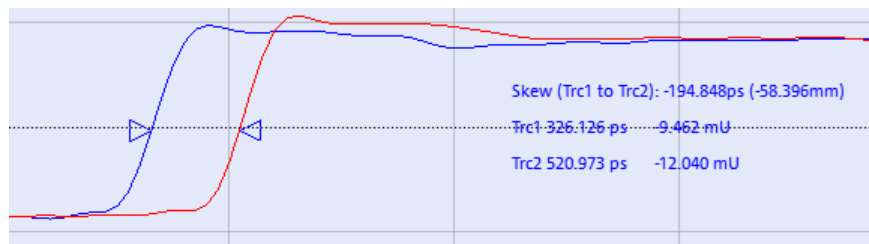

Figure 4-20: Skew measurement

For instance, this can be used to evaluate the quality of a balanced transmission line ("intra-pair skew").



Limit Test

Testing against a user-defined skew limit is also supported.

DUT-centric setup

As far as possible the required settings are related to time domain properties of the DUT, which might be more intuitive for users of digital oscilloscopes that are not familiar with vector network analyzers.

The Automatic Harmonic Grid from the option R&S ZNA-K2 "Time domain Analysis" is used to ease setting up the frequency grid for all measurements provided by the option R&S ZNA-K20.

4.7.3 Frequency conversion measurements

Option R&S ZNA-K4

With option R&S ZNA-K4, the port frequencies can be configured independently. Those arbitrary port settings represent a major extension to the analyzer's measurement functionality; in particular they allow you to measure frequency-converting DUTs.



The source and receive frequencies of the ports are always equal.

The following figure shows a transmission measurement on a mixer.

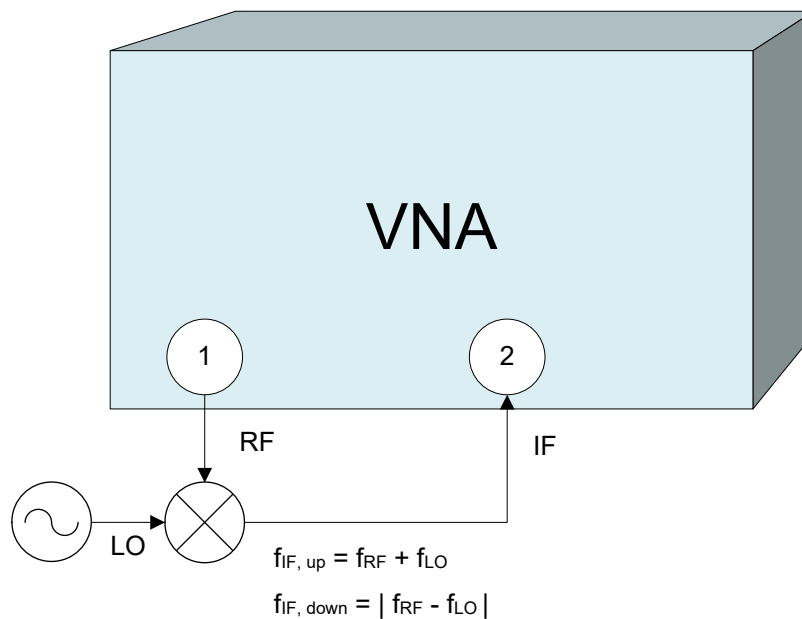

In this example, the transmission parameter S_{21} corresponds to the mixer's conversion gain.

Before measuring, the port frequencies must be set appropriately. In the port configuration table (Channel – [Channel Config] > "Port Config" > "Port Settings..." > "Arb Frequency"), the (source) frequency of Port 1 is set to the desired RF frequency (here: the channel base frequency/sweep range f_b). An external generator provides a fixed stimulus signal at 1 GHz. To measure the up-converted IF signal, the (receive) frequency at Port 2 is set to $f_b + 1$ GHz.

#	Info	RF Off	Gen	Freq. Conversion	Frequency Result
Port 1	VNA Model	<input type="checkbox"/>		f_b ...	3 GHz ... 6 GHz
Port 2	VNA Model	<input type="checkbox"/>		$f_b + 1$ GHz ...	4 GHz ... 7 GHz
Gen 1	SMBV100A	<input type="checkbox"/>	<input checked="" type="checkbox"/>	1 GHz ...	1 GHz ... 1 GHz

Independent source powers for Port 1 and Gen1 can be configured in addition, if so desired.



Internal Second Source

For a 4-port R&S ZNA, a second internal source is available and hence the mixer measurements outlined above (and many other measurements) can be performed without an additional external generator. The limited source connectivity can be overcome with option R&S ZNA-B3 (see [Chapter 4.7.20, "Internal 3rd and 4th source for 4-port R&S ZNA"](#), on page 302).

Similarly, a 2-port R&S ZNA with [Internal 2nd source and 2nd LO generator for 2-port R&S ZNA](#) and [LO Out](#) can perform mixer measurements without an additional external generator.

4.7.3.1 Calibration options

In arbitrary mode, the R&S ZNA automatically calibrates the source and receive frequency ranges of all ports, according to the frequency conversion settings in the "Port Settings" dialog or in dedicated configuration dialogs.

- SMARTerCal is the recommended calibration method for frequency conversion measurements.
- For measurements on non-linear DUTs, an additional scalar power calibration is recommended; for details refer to [Chapter 4.5.7, "SMARTerCal"](#), on page 224.
- A load match correction (optional) involves an additional reverse sweep. It can provide a significant improvement of the transmission S-parameter measurements if the load ports are poorly matched.

Select the appropriate correction type according to your accuracy and speed requirements. Notice that none of the correction types provide the phase information for transmission S-parameters.

4.7.3.2 Intermodulation measurements

The intermodulation measurement is automatically enabled with option R&S ZNA-K4.

The "Intermodulation" tab of the [Meas] softtool gives access to the measurement configuration and selection of results (see [Chapter 5.2.6, "Intermodulation tab"](#), on page 380).



If [external switch matrices](#) are used, intermodulation measurements are not supported.

An intermodulation measurement is performed with two RF signals of equal power but different frequencies termed the upper and lower tone. The purpose of the measurement is to test the properties of a DUT that is supplied with a signal that covers a frequency band, typically a modulated RF channel. To simulate this scenario, the frequency difference ("tone distance") between the upper and lower signal is chosen to be small compared to the frequencies of the two tones:

$$f_L \approx f_U \text{ or } \Delta f = f_U - f_L \ll f_L$$

A nonlinear behavior of the DUT causes emissions at frequencies which correspond to sums and differences of the upper and lower tone frequencies and their integer multiples. These intermodulation products can be near the upper and lower tone frequencies, as long as their order is odd.

The analyzer measures the intermodulation products of k^{th} order IM_k (where $k = 3, 5, 7, 9$) at the lower tone frequency minus $(k - 1)/2$ times the tone distance and at the upper tone frequency plus $(k - 1)/2$ times the tone distance; see also "[Intermodulation measurement results](#)" on page 267.

For a two-port R&S ZNA without [Internal 2nd source and 2nd LO generator for 2-port R&S ZNA](#), a test setup with an external generator and an external combiner is required.

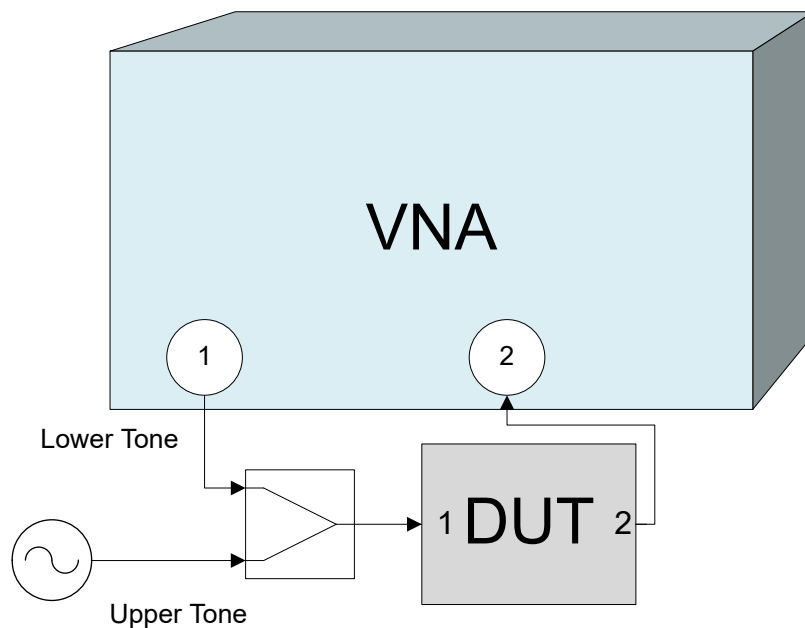

The lower tone signal is generated at port 1, the upper tone is provided by the external generator. Both signals are combined externally and fed to the DUT input. The intermodulation quantities can be measured at the DUT output (transmitted wave b2). It is possible to interchange the ports no. 1 and 2.



For a two-port R&S ZNA with [Internal 2nd source and 2nd LO generator for 2-port R&S ZNA](#), an external generator is not required. The two sources can be combined [internally](#) or externally. However, with two ports the upper tone source port is identical to the receive port.

For a 4-port R&S ZNA, you can use any combination of analyzer ports that are supplied by different internal sources to generate the lower and upper tones. In the following example, port 3 replaces the external generator.

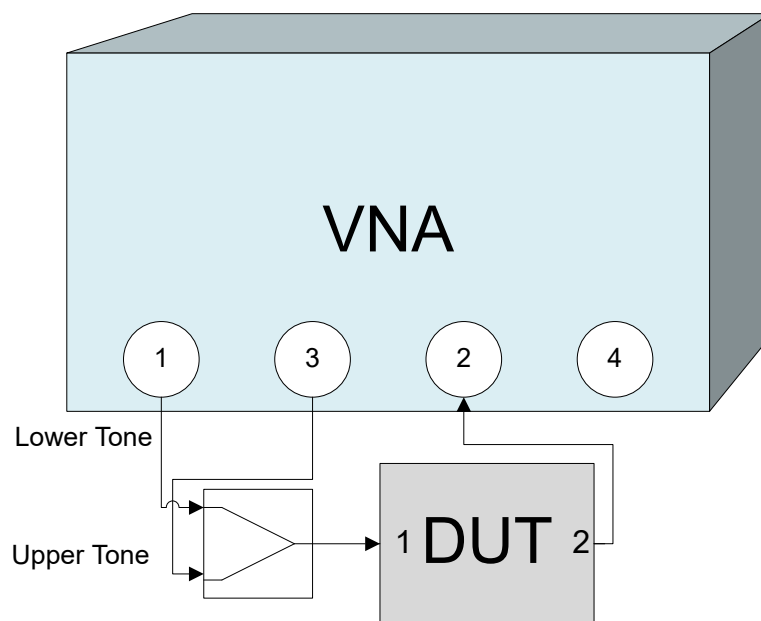

Operation with more than one source is *not* supported, if [External switch matrices](#) are part of the RF connection configuration.

The intermodulation distortion measurement can be extended to frequency-converting DUTs. E.g., it is possible to feed the two-tone source signal to the RF input of a mixer and measure the intermodulation distortion of the IF output signal, after conversion with an additional LO signal.

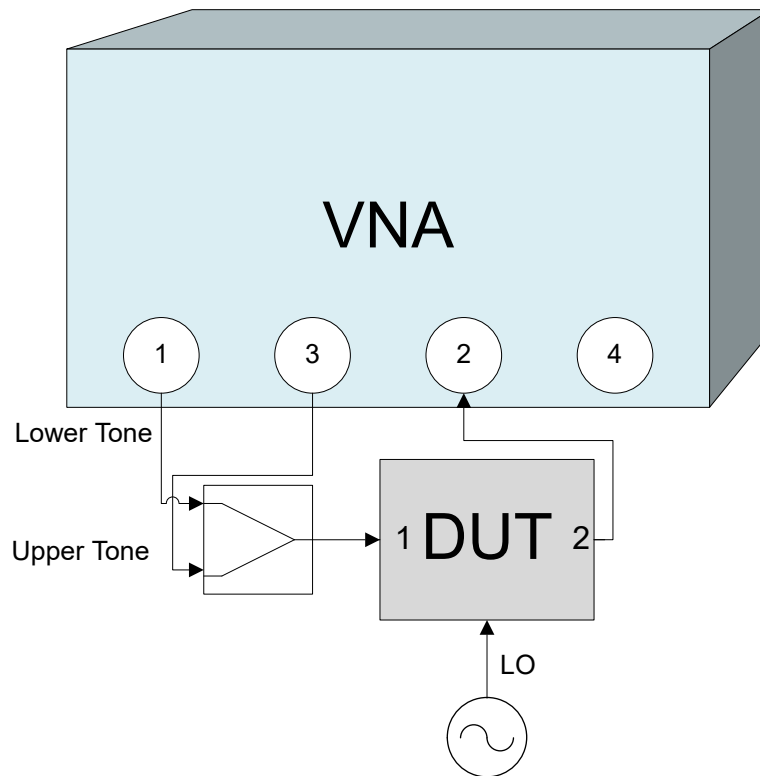

For a 4-port R&S ZNA with four sources, the mixer's LO signal can also be provided by the VNA.

Two-tone generation and combination

To generate a two-tone signal, two independent RF signal sources are required.



On a two-port R&S ZNAxx, two internal sources are only available with option R&S ZNAxx-B52 [Internal 2nd source and 2nd LO generator for 2-port R&S ZNA](#).

For a R&S ZNA that is not equipped with [Internal combiner](#) or with [Direct generator/receiver access](#) (R&S ZNAxx-B16), lower and upper tone must be combined from the RF ports on the analyzer and connected external generators. An external combiner is required.

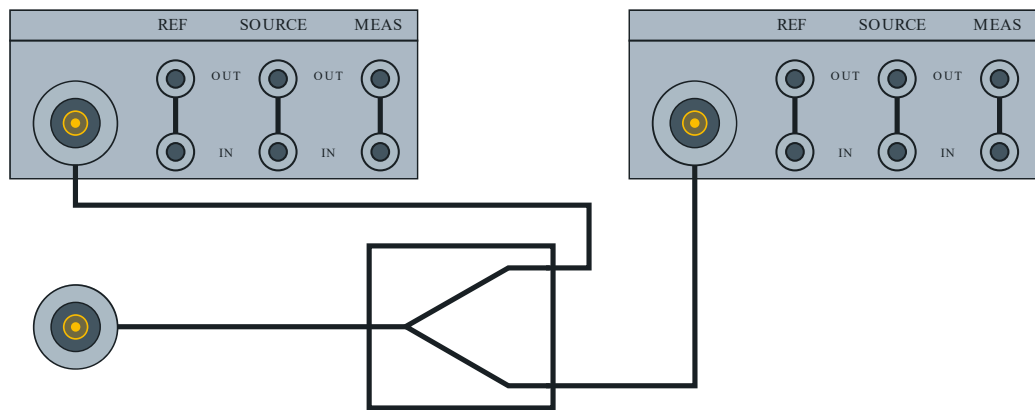

Figure 4-21: RF ports, external combiner



The lower-tone port must be a VNA port, the upper-tone port can be an external generator port.

If equipped, the internal combiner is the preferred signal combination option:

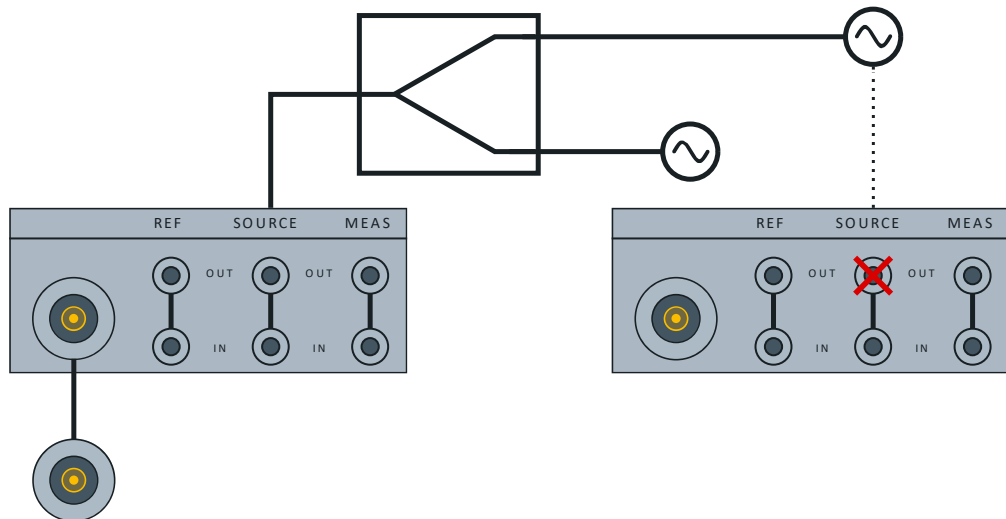

Figure 4-22: Internal combiner

For a 2-port instrument the tones are generated at VNA ports 1 and 2, the combined signal is output to port 1.

For a 4-port instrument, the tones must be generated at VNA ports 1 and 3, the combined signal is output to port 1.

For a R&S ZNA that is equipped with option R&S ZNAXx-B16, Direct Generator/Receiver Access but not with an internal combiner, the following test setup is recommended:

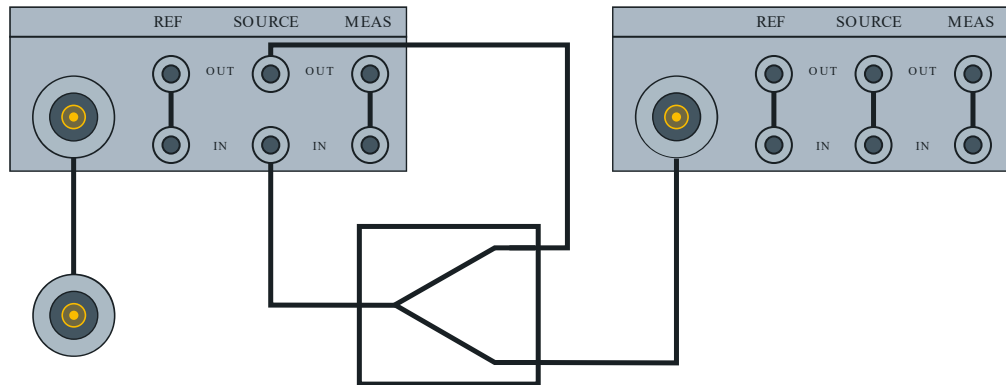

Figure 4-23: Direct access to lower-tone port, external combiner

The lower tone is generated at a VNA port, the upper tone is also provided by the analyzer (4-port models only) or by an external generator. The signals are combined externally and fed to the SOURCE IN connector at the lower tone port. Thus the superimposed signals are available at the lower tone port and can be fed to the DUT input. The IF output signal is measured at another VNA port.

As an alternative to the test setup with external combiner, you can also combine the two tones using the coupler in the test set of the upper-tone port:

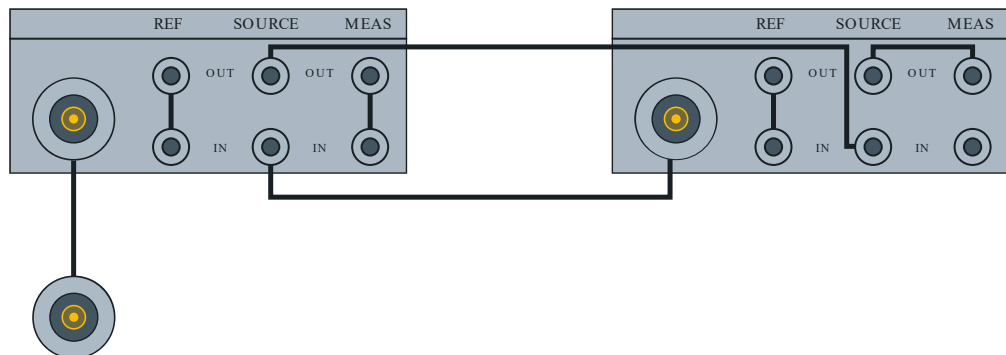

Figure 4-24: Direct access to both ports, coupler as combiner



With frequency converters, only external combination of the converter RF out signals is supported. For all measurements involving two-tone stimuli and a receiving converter port (intermodulation, two-tone group delay), a 4-port R&S ZNA is required.

Intermodulation measurement results

The intermodulation measurement provides two different types of results:

- In the swept measurement, the analyzer performs a frequency or power sweep of the two-tone stimulus signal and displays the selected intermodulation quantities as a function of the lower-tone frequency or power.

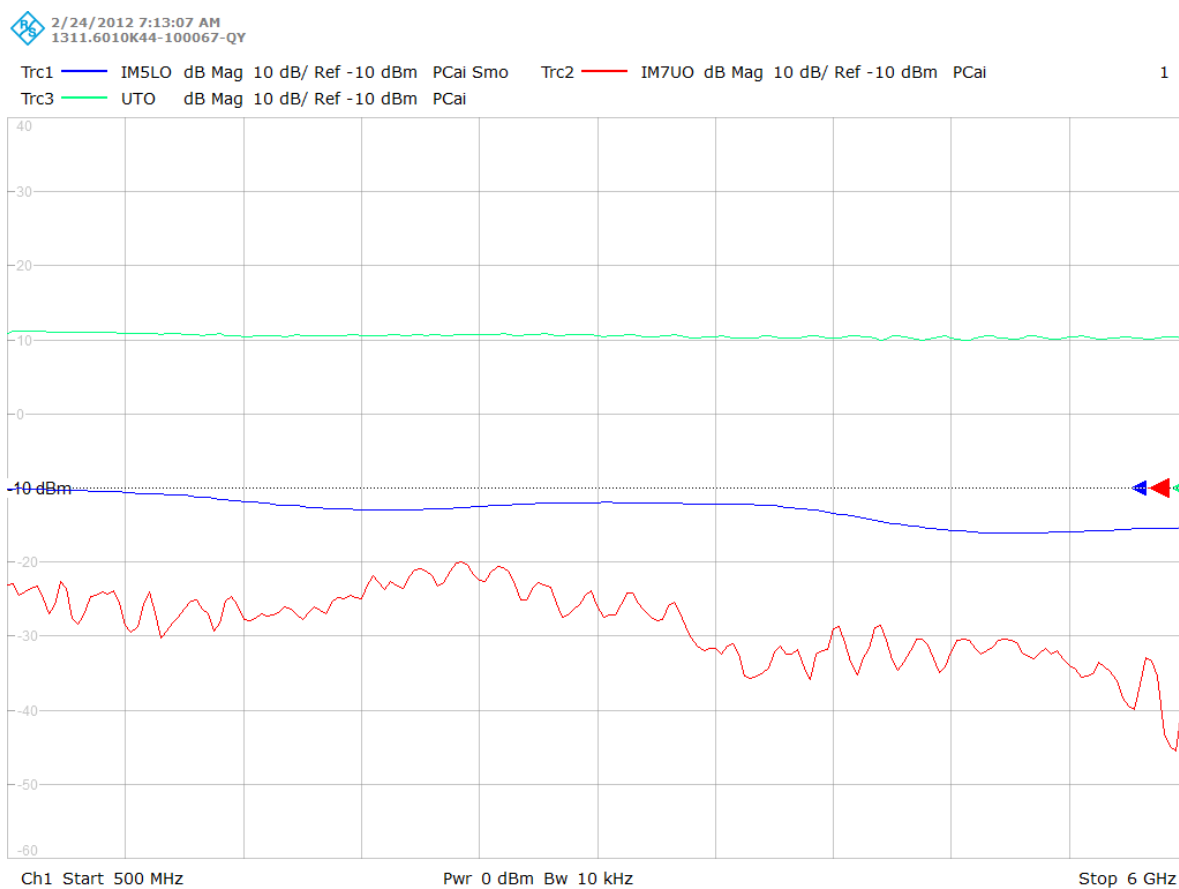

- In the intermodulation spectrum measurement ("CW Mode Spectrum"), the frequency and power of the lower and upper tones is kept constant. The analyzer displays all intermodulation products near the signals up to a selectable order.

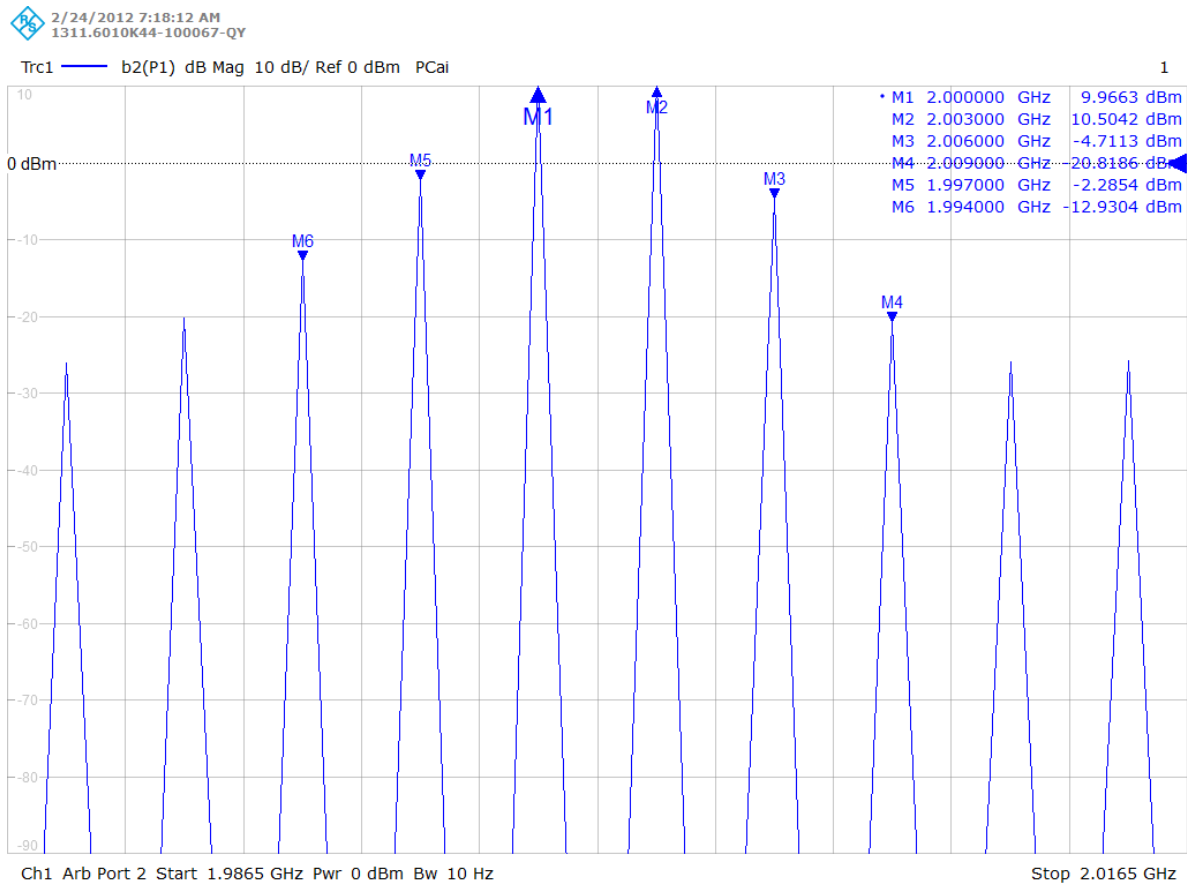

Intermodulation quantities

A nonlinear DUT that is supplied with a two-tone signal with the lower/upper frequencies f_L and f_U causes emissions at frequencies which correspond to sums and differences of the upper and lower tone frequencies and their integer multiples:

$$f_U - f_L, f_U + f_L, 2*f_U - f_L, 2*f_U + f_L, f_U + 2*f_L, 2*f_L - f_U \dots$$

The order of these intermodulation products is defined by the number of f_L and f_U terms. The analyzer measures the intermodulation products of k^{th} order IM_k (where $k = 3, 5, 7, 9$) at the lower tone frequency minus $(k - 1)/2$ times the tone distance and at the upper tone frequency plus $(k - 1)/2$ times the tone distance. Intermodulation products can be measured at the DUT output (transmitted wave b_n).

The intermodulation suppression $IM_{k_{rel}}$ is the ratio of the power of an intermodulation product to the power of the lower tone fundamental wave in dB, measured at the DUT output.

For each intermodulation product, an output intercept point $IP_{k_{out}}$ is defined as follows:

$$IP_{k_{out}} = P_{L_{out}} - IM_{k_{rel}} / (k - 1)$$

In this formula, $P_{L_{out}}$ denotes the lower tone power in dBm, measured at the DUT output. In analogy, the input intercept point $IP_{k_{in}}$ is defined as:

$$IPk_{in} = P_{L, in} - IMk_{rel} / (k - 1)$$

The intermodulation suppression generally decreases with increasing stimulus power. The intercept point is equal to the lower tone power for which the intermodulation suppression would reach 0 dB. Output and input intercept point differ by the attenuation of the lower tone signal upon transmission through the DUT. The intercept point is a mathematical concept. For most DUTs, it is beyond the nominal power operating range.



Filter settings

Intermodulation measurements require frequency-selective filter settings. When an intermodulation result is selected, the analyzer checks whether the IF bandwidth of the active channel is 1/100 of the distance between the upper and the lower tone ("Tone Distance") or less. If not, the analyzer displays a tooltip.

Selectivity is automatically set to high, but can be changed manually.

4.7.3.3 Harmonics measurements

Harmonics are signals at an integer multiple of the fundamental frequency. The fundamental is the first harmonic, the Nth harmonic is N times the frequency of the fundamental. The production of harmonic frequencies by an electronic system, when a signal is applied at the input, is known as harmonic distortion.

Harmonic distortion measurements can be performed irrespective of the sweep type: A frequency sweep yields the harmonics as a function of the frequency, a power sweep yields the power-dependent harmonics at fixed frequency.

Apart from absolute and relative harmonic power measurements, it is also possible to measure the total harmonic power, defined as:

$$THD_F(N) = \frac{\sqrt{\sum_{i=2}^N |U_i^2|}}{|U_1|}$$

Equation 4-1: Fundamental THD of order N

$$THD_R(N) = \frac{\sqrt{\sum_{i=2}^N |U_i^2|}}{\sum_{i=1}^N |U_i^2|} = \frac{THD_F(N)}{\sqrt{1 + (THD_F(N))^2}}$$

Equation 4-2: Root mean square THD of order N

Harmonic power calibration

Due to the different frequency ranges of the input and output signals, the harmonic power calibration must be performed in two steps. For a test setup where the DUT's input signal (fundamental signal) is provided by analyzer port 1 and where the harmonic is analyzed at port 2, the following test setups are required

1. Source power calibration of the fundamental signal and the harmonic frequency ranges

A power sensor is connected to port 1. The source power is calibrated over the selected sweep ranges. The correction data for all calibration sweeps is stored.

- Receiver power calibration for the selected harmonics.
No external device is needed. The receiver (port 2) is calibrated at the harmonic frequency using the source signal from port 1, calibrated in the first step.

4.7.3.4 Scalar mixer measurements

Scalar Mixer measurements are included in option R&S ZNA-K4.

RF mixers convert an RF signal at one frequency into a signal at another frequency. The frequency that is to be shifted is applied at the RF input. The frequency shifting signal (from a local oscillator, LO) is applied to the RF mixer's LO port, resulting in an output signal at the mixer's Intermediate Frequency (IF) port. For a given RF signal, an ideal mixer would produce only two IF outputs: one at the frequency sum of the RF and LO ($IF = RF + LO$), and another at the frequency difference between the RF and LO ($IF = |RF - LO|$). Filtering can be used to select one of these IF outputs and reject the unwanted one.



Meaning of S-parameters

The frequency-converting property of the mixer (i.e. the fact that incident and transmitted waves are at different frequencies) causes a loss of phase information. While a scalar measurement is active, the reverse transmission parameter S_{12} is unavailable; the magnitude of the forward transmission parameter S_{21} describes the conversion gain. The conversion gain measurement can be improved by a source match correction (included in the SMARTerCal) and a load match correction (optional). The phase information, including the group delay, is meaningless.

The phase or group delay of mixers can be analyzed in a vector mixer measurement.

In the scalar mixer mode the analyzer provides the following functionality:

- Configuration of the RF and LO signals and measurement of the generated IF signal.
- System error correction and power calibration of the signal sources and of the IF receiver. A SMARTerCal is recommended for this purpose; see [Chapter 4.7.3.1, "Calibration options"](#), on page 262.
- The mixer mode can be used to test important performance parameters of RF mixers such as frequency ranges, conversion loss, compression, and isolation.

Two-stage mixer measurements

The scalar mixer measurement is also suited for measuring a system of two mixers with frequency multipliers at their RF and LO inputs. The RF and LO input frequencies of the first mixer are both multiplied by an integer fraction; the converted output signal f_{int} is fed to the second mixer, together with the multiplied second LO signal. The analyzer measures the output signal of the second mixer at its IF input port. The general test setup is shown below; the mixer system under test (MUT) is enclosed in a blue rectangle.

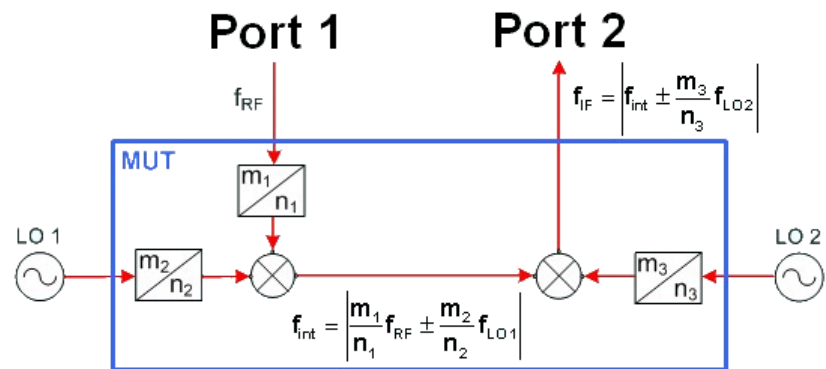

The figure above also shows the possible output frequencies of the two mixers. The actual values of f_{int} and f_{IF} depend on the RF and LO frequencies and of the measured conversion (lower sideband or upper sideband with up- or down-conversion). The analyzer automatically calculates all frequencies and sets its receiver according to the settings made.

A test setup with two mixers requires 3 independent source ports plus one receive port. Only a 4-port R&S ZNA with [four internal sources](#) (option R&S ZNAff-B3) does not require external generators.

A standard mixer measurement with a single mixer stage and no frequency multipliers corresponds to the figure above with the second mixer and LO 2 omitted and $m_1 = n_1 = m_2 = n_2 = 1$.

Mixer diagrams

The mixer signal diagrams show the parameters of the mixer input signals (RF, LO) and of the mixing product (IF signal, output).

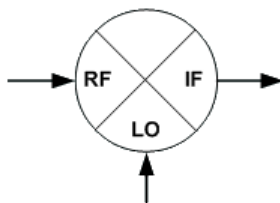

- The RF signal is the stimulus signal that the analyzer generates with the current channel settings. After a reset, the frequency and power of the RF signal is as defined in the Channel – Stimulus menu. The RF signal parameters can be changed in the "Power" and "Frequencies" dialogs.
- The Local Oscillator (LO) signal is an additional RF signal that is either generated by the network analyzer (at one of the ports that are not used for the RF and IF signals) or by an external generator. A test setup with two mixers involves two independent LO signals at both mixers.
- The IF signal is the mixer output signal (mixing product), which is at one of the following conversion frequencies: $\text{IF} = \text{LO} + \text{RF}$ or $\text{IF} = |\text{LO} - \text{RF}|$, i.e. $\text{LO} - \text{RF}$ (for $\text{LO} > \text{RF}$) or $\text{IF} = \text{RF} - \text{LO}$ (for $\text{RF} > \text{LO}$). The IF frequency is selected in the "Fre-

quencies" dialog. A test setup with two mixers involves two independent conversion settings.

The signal description above, with the swept RF signal and the LO signal at a fixed frequency, corresponds to the default configuration. In the "Frequencies" dialog, you can select any of the signals as a "Sweep/CW" signal. You can set the frequency range for this signal via "Start/Stop" or "CW Frequency". A second signal is at a "Fixed" frequency, and the third at the calculated sum or difference frequency ("Auto").

The labeling of the complete diagrams depends on the sweep type.

- The following mixer signal diagram corresponds to a **frequency sweep**:

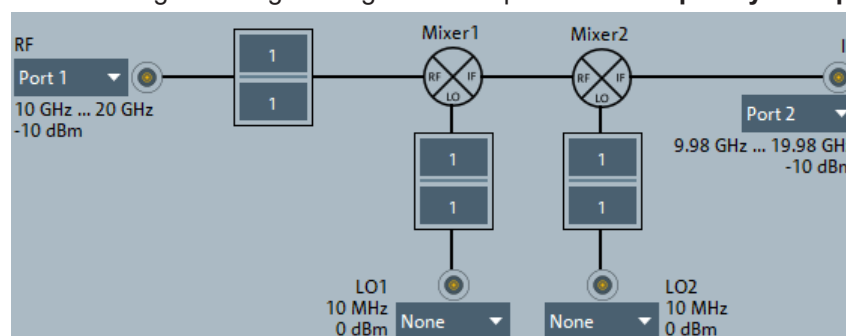

- RF signal (left side): Analyzer port number (e.g. Port 1), frequency sweep range (or fixed frequency, if the LO signal is swept), CW power, frequency conversion settings (1 / 1 denotes no conversion).
- LO signals (1 or 2, from below): Signal source (analyzer port or external generator), fixed power and frequency (or frequency sweep range, if the RF signal is at fixed frequency), frequency conversion settings.
- IF signal (right side): Analyzer port number (e.g. Port 2), frequency range = (sweep range + LO) or |sweep range – LO|, expected fixed power.

- The following mixer signal diagram corresponds to a **power sweep**:

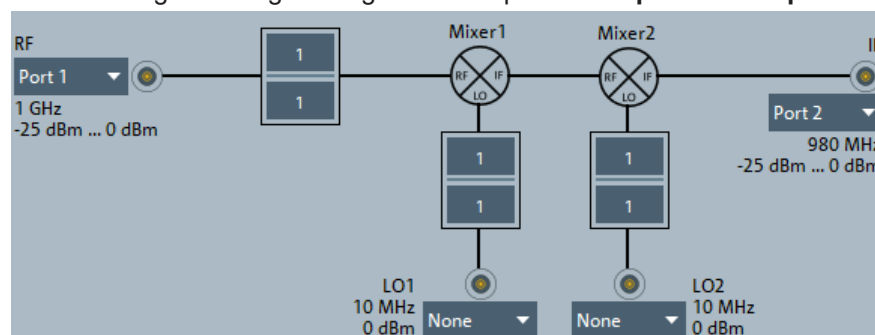

- RF signal (left side): Analyzer port number (e.g. Port 1), power sweep range or fixed power, CW frequency, frequency conversion settings (1 / 1 denotes no conversion).
- LO signals (1 or 2, from below): Signal source (analyzer port or external generator), fixed power or power sweep range, CW frequency, frequency conversion settings.
- IF signal (right side): Analyzer port number (e.g. Port 2), fixed frequency = (RF + LO) or |RF – LO|, expected power range.

- The following mixer signal diagram corresponds to a **Time or CW mode sweep**:

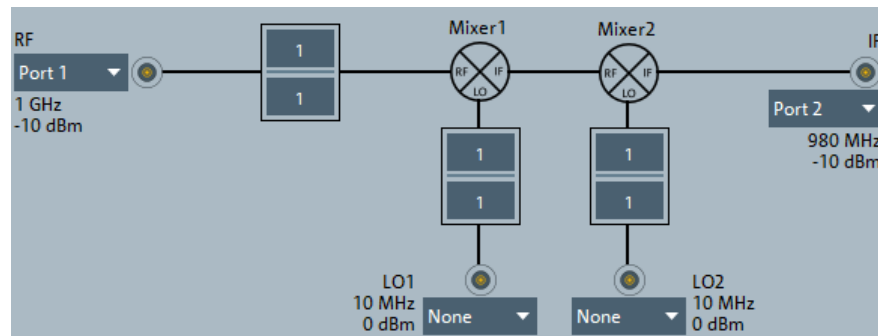

- RF signal (left side): Analyzer port number (e.g. Port 1), fixed power, CW frequency, frequency conversion settings (1 / 1 denotes no conversion).
- LO signals (1 or 2, from below): Signal source (analyzer port or external generator), fixed power, CW frequency, frequency conversion settings.
- IF signal (right side): Analyzer port number (e.g. Port 2), fixed frequency = (RF + LO) or $|RF - LO|$, expected fixed power.



The ports in the mixer signal diagrams are physical ports. To measure mixers with differential inputs, define a logical port configuration and enter one of the physical ports that belong to the logical port. The analyzer implicitly accounts for the logical port settings.

4.7.3.5 Vector mixer measurements

Option R&S ZNA-K5

Option R&S ZNA-K5 enables measurement of the parameters of an external mixer including phase, e.g. the complex conversion loss or reflection coefficients.

In contrast to [Scalar mixer measurements](#) (with option R&S ZNA-K4), vector mixer measurements provide magnitude **and** phase information, including group delay, about the mixer under test (MUT).



Option R&S ZNA-K5 requires option R&S ZNA-K4.

4.7.3.6 Embedded LO mixer group delay measurements

Option R&S ZNA-K9

Option R&S ZNA-K9 enables measuring a mixer's absolute and relative group delay.

The mixer delay measurement is an extension of the scalar mixer measurement. The network analyzer generates a two-tone RF signal as a mixer input signal and meas-

ures the converted IF signal at the mixer output. The mixer delay is derived from the relative phases of the two-tone signals at the mixer input and the mixer output.

Compared to conventional measurement methods, the mixer delay measurement offers several additional advantages:

- A network analyzer with standard functionality is sufficient.
- Easy calibration using a calibration mixer.
- PUOSM calibration (for high gain DUTs)



- See also "[Two-tone generation and combination](#)" on page 265.
- Option R&S ZNA-K9 requires the [Frequency conversion measurements](#) option R&S ZNA-K4.
- If [external switch matrices](#) are used, embedded LO mixer group delay measurements are not supported.

A 4-port R&S ZNA or a 2-port R&S ZNA with [Internal 2nd source and 2nd LO generator for 2-port R&S ZNA](#) is recommended, because of the second internal source. A dedicated cable set for this measurement is provided with accessory R&S ZNAXx-Z9.

Group Delay Calculation w/o LO Access

The group delay τ_g of a circuit is defined as the negative derivative of its phase response. Hence, for two tones with phases Φ_1 and Φ_2 and a frequency difference ("aperture") Δf :

$$\tau_g = -\frac{d\phi_{deg}}{360^\circ df} \approx -\frac{d\Delta\phi_{deg}}{360^\circ \Delta f} = -\frac{\Delta\phi_2 - \Delta\phi_1}{360^\circ \Delta f} = -\frac{(\phi_2^{out} - \phi_2^{in}) - (\phi_1^{out} - \phi_1^{in})}{360^\circ \Delta f} = \frac{\Delta\phi^{out} - \Delta\phi^{in}}{360^\circ \Delta f}$$

$\Delta\phi^{in}$ and $\Delta\phi^{out}$ are the phase differences of the two tones at the input and output of the DUT, respectively.

The phase difference of the source signal $\Delta\phi^{in}$ and the aperture Δf are known quantities. $\Delta\phi^{out}$ depends on the DUT and can be measured. As a phase difference, $\Delta\phi^{out}$ is stable against variations of the LO frequency, because those will affect both signals in the same way. This means that the mixer delay measurement does not require any synchronization between the analyzer and the LO signal, even if the LO shows a noticeable frequency drift.

4.7.4 Phase coherent source control

R&S ZNA-K6

With option R&S ZNA-K6, a R&S ZNA with two or more sources can generate signals with defined phase. Typical application examples are measurements on balanced DUTs or the supply of antenna arrays which are designed for a well-defined radiation pattern.



- For a two-port R&S ZNA, hardware option R&S ZNA-B52 is required. See [Chapter 4.7.23, "Internal 2nd source and 2nd LO generator for 2-port R&S ZNA"](#), on page 303.
- With option R&S ZNA-K4, phase coherent signals can be generated at arbitrary amplitudes and frequencies.

Defined coherence mode requires an analyzer with at least two independent internal sources. It is compatible with arbitrary single-ended or balanced port configurations. It can also be used for frequency conversion measurements.

The source ports and the properties of the coherent signals are all defined in the "Source Coherence" dialog. After a system error correction, the coherent signals with the selected properties are available at the calibrated reference plane.



Prerequisites for accurate phase control

- Source coherence mode relies on wave correction. A consistent system error correction is essential for accurate coherent waves at the reference planes. You should always perform a full n-port calibration (TOSM, UOSM or one of the Txx calibration types) of all physical ports involved and change the reference impedances, if they differ from the default settings. A subsequent source power calibration is recommended.
The system error correction applies to all a- and b-waves of the n calibrated ports, not only to waves with a defined phase. You can also use offset parameters in order to move the reference plane where the analyzer provides an accurate coherent signal.
- The defined phases are established during a pre measurement per sweep point and source coherent port, which significantly slows down the sweep.

4.7.4.1 Amplitude Imbalance and Phase Imbalance Sweep

Since firmware version 2.40, amplitude and phase imbalance sweeps are no longer limited to [True differential mode](#), but are also available in source coherence mode.

In source coherence mode, during an amplitude or phase imbalance sweep, all source signals are coherent.

- During an amplitude imbalance sweep, the driving port operates at its port-specific phase and performs a power sweep within a configurable, port-independent delta range relative to its nominal port power.
- During a phase imbalance sweep, the driving port operates at its port-specific power and performs a phase sweep within a configurable delta range relative to its port-specific phase.

Generator ports operate in CW mode, at their port-specific nominal power and phase.

4.7.5 True differential mode

Option R&S ZNA-K61

Differential transmission lines and circuits are widely used, because their characteristics give them a lower susceptibility to electromagnetic interference. Linear balanced devices can be tested with sufficient accuracy using the [virtual differential mode](#), where the vector network analyzer generates unbalanced stimulus signals and uses a mathematical transformation to convert unbalanced wave quantities into balanced S-parameters. A different behavior is expected for nonlinear balanced devices, where the transmission characteristics of the DUT may depend on how closely the stimulus signal matches real operating conditions.

In *true differential mode*, a R&S ZNA with two or more internal sources generates true differential and common mode stimuli at arbitrary reference planes in the test setup and determines mixed-mode S-parameters, wave quantities and ratios. It can also perform true differential measurements on [frequency-converting DUTs](#) or to use true differential mode in combination with external frequency converters. Moreover the true differential mode provides two additional sweep types, the [Amplitude Imbalance and Phase Imbalance Sweep](#).



- Like the virtual differential mode, the true differential mode requires a port configuration with at least one balanced port. However, in true differential mode a balanced source port requires independent sources for the constituent physical ports.
 - On a 2-port R&S ZNA, the optional internal second source is required. See [Chapter 4.7.23, "Internal 2nd source and 2nd LO generator for 2-port R&S ZNA"](#), on page 303.
 - To have two balanced ports, a 4-port R&S ZNA with 4 sources is required. See [Chapter 4.7.20, "Internal 3rd and 4th source for 4-port R&S ZNA"](#), on page 302.
- Because true differential mode is a special kind of [Phase coherent source control](#), option R&S ZNA-K6 is a prerequisite for option R&S ZNA-K61. The [Prerequisites for accurate phase control](#) also apply to true differential mode

4.7.5.1 Virtual vs. true differential mode

The analyzer uses different stimulus signals and different mathematical methods to obtain results in normal, virtual differential, or true differential mode. The following table gives an overview.

Normal (unbalanced) mode	Measurement of wave quantities and S-parameters for unbalanced ports. Unbalanced stimulus signals.
Virtual differential mode	Precondition: At least one balanced port is defined. Measurement of unbalanced wave quantities using unbalanced stimulus signals. Unbalanced system error correction. Conversion of unbalanced wave quantities into balanced and mixed-mode S-parameters with possible renormalization of port impedances.
True Differential Mode	Precondition: At least one balanced port is defined, whose constituent ports are driven by two independent sources. Measurement of unbalanced wave quantities using balanced stimulus signals (differential and common mode). System error correction and conversion of unbalanced into balanced wave quantities. Calculation of balanced and mixed-mode S-parameters with possible renormalization of port impedances.

True differential mode relies on wave correction. A consistent system error correction is essential for accurate balanced waves at the reference planes and accurate measurement results. Perform a full n-port calibration (TOSM, UOSM or one of the Txx calibration types) of all physical ports involved in the true differential measurement and change the differential and common mode reference impedances, if they differ from the default settings. A subsequent source power calibration is recommended.



You can also use [Offset parameters and de-/embedding](#) to move the reference plane where the analyzer provides an accurate differential or common mode signal.

4.7.5.2 Amplitude imbalance and phase imbalance sweep

In true differential mode, you can select a single balanced (logical) port L^1 to behave "imbalanced", either w.r.t. magnitude or w.r.t. phase. During an amplitude or phase imbalance sweep, the analyzer generates a balanced CW signal at L^1 , but sweeps the power or phase of one of its constituent physical ports within a configurable range.



Since firmware version 2.40, amplitude and phase imbalance sweeps are no longer limited to true differential mode, but are also available in [source coherence mode](#).

Imbalance Compensation of a-Waves

Since the mixed-mode S-parameters of a linear balanced DUT depend only on the DUT itself, they are independent of the [amplitude or phase imbalance](#) of the stimulus signal. For example, S_{dd21} of a differential amplifier in phase imbalance sweep does not reveal the amplitude reduction of the differential output signal caused by unequal lengths of the balanced input line conductors. This length asymmetry corresponds to a phase imbalance increasing over frequency. To see the effect of such a phase or amplitude imbalance, modified S-parameters are required. The modification is done in such a way that, if for example the imbalance of port 1 is swept, the imbalance of the a-wave of port 1 is compensated before the S-parameters are calculated.

The effect of the compensation is a constant amplitude of the differential or common mode stimulus wave of port 1 over the imbalance sweep range. This reflects the situation of the user applying a stimulus signal of known nominal amplitude to the DUT, but

getting at the output only the amplified differential contents in this signal, which depends on the imbalance. Usually, S-parameters of balanced devices measured with active imbalance compensation will exhibit a maximum or minimum at zero imbalance.

The imbalance compensation is not only performed for mixed-mode S-parameters, but also for the imbalance-swept a wave itself when it is selected as a measured quantity, as well as for ratios including that wave.

4.7.5.3 True differential mode on frequency-converting DUTs

True differential mode can be combined with [frequency-converting measurement modes](#). For this type of measurements, a consistent calibration is particularly important.

4.7.5.4 True differential mode with frequency converters

If the [frequency converter mode](#) is combined with true differential mode, the analyzer generates a true differential or common mode stimulus signal at a calibrated reference plane which is located after two frequency converter ports. To achieve this, two frequency converters with independent sources are combined to form a balanced converter port. The frequency converters must provide the RF drive signal simultaneously so that a third, independent LO signal is required.

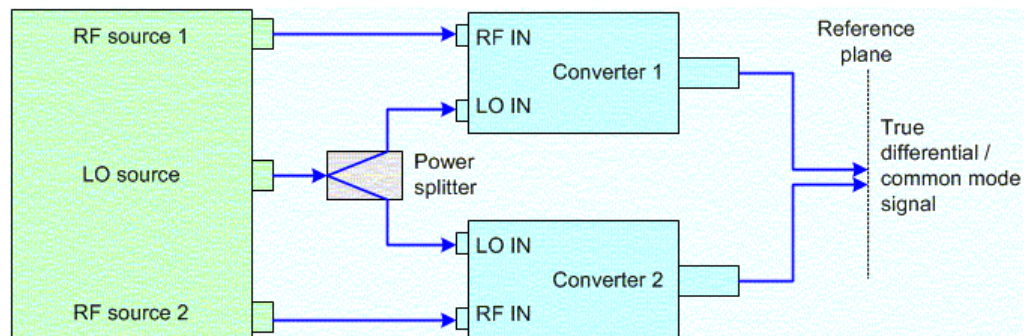

Depending on the network analyzer type and the number of independent sources available, different test setups are possible.

4.7.6 Pulsed measurements

Option R&S ZNA-K7

Measurements on pulsed RF signals are required in many areas of RF and microwave technology. Pulsed signals are used in mobile phone applications and radar systems, and amplifiers are typically designed for pulsed rather than continuous wave (CW) conditions.

The analyzer performs pulsed measurements in analogy to a time sweep (i.e. at constant receiver frequency), but with a much higher sampling rate. Option R&S ZNA-K7

provides configuration of the internal pulse modulators and pulse profile measurements. The measurement bandwidth can be increased up to 50 MHz.



- Option R&S ZNA-K7 requires the [Increased IF bandwidth 30 MHz](#) option R&S ZNA-K17.

For better time resolution, pulse profile measurements use the [Memory extension for data streaming](#) option R&S ZNA-B7, if available.

4.7.6.1 Live pulse analysis with R&S VSE

The [R&S VSE](#) vector signal explorer software brings the experience and power of Rohde & Schwarz signal analysis to a desktop PC. Its "Pulse measurements application" (option [R&S VSE-K6](#)) can analyze parameters such as pulse duration, pulse period, pulse rise and fall times, power drop across a pulse, and intrapulse phase modulation, and produces a trend analysis over many pulses.

The R&S ZNA can push pulse profile measurement data to a running R&S VSE instance for further (live!) analysis.

Requirements

- R&S ZNA:
 - FW V2.20 or higher
 - with option R&S ZNA-K7 "Pulsed measurements"
- R&S VSE:
 - basic or enterprise edition (licensed separately)
 - running on the R&S ZNA or on a PC that is reachable via LAN
 - V1.90 or higher
 - with option R&S VSE-K6 "Pulse measurements application"

Limitations

- only b-waves can be pushed to the R&S VSE
- only a single b-wave can be pushed to the R&S VSE at a time
- the sweep duration must be 50 μ s or higher

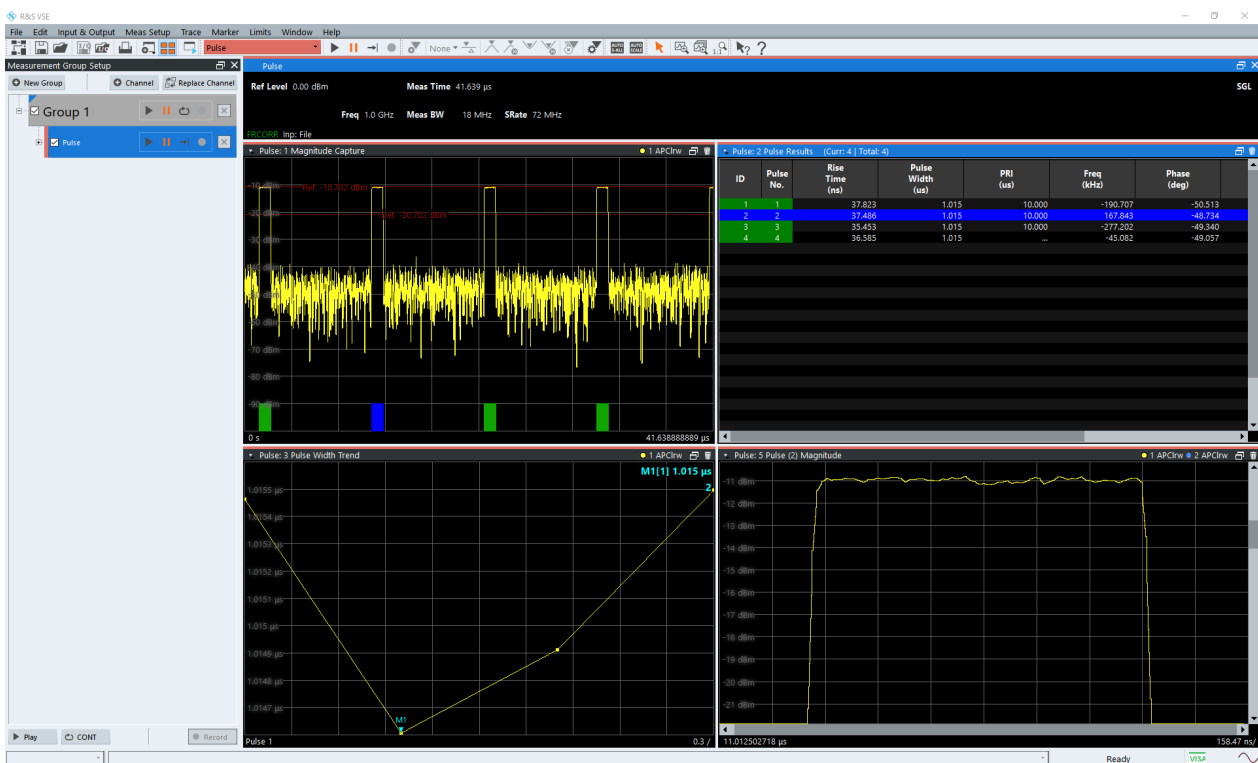

Figure 4-25: R&S VSE with pulse measurement application (option R&S VSE-K6)

How to configure

1. On the target R&S VSE, prepare the required analysis windows (see the related [user manuals](#))
2. On the R&S ZNA
 - a) prepare and run a "Pulse Profile" sweep
 - b) create a trace for the b-wave to be measured
 - c) set up and establish a VISA connection to the target R&S VSE
 - d) start pushing data to the target R&S VSE

4.7.7 Millimeter-wave converter support

Option R&S ZNA-K8

Software option R&S ZNA-K8 adds convenient support of connected millimeter wave converters to the R&S ZNA firmware. It requires R&S ZNAXx-B16 ([Direct generator/receiver access](#)) or R&S ZNA-B26 ([Direct IF access](#)).



On a R&S ZNA67EXT, this hardware option is preinstalled.

Measurements at frequencies beyond the analyzer's operating range (mm-wave measurements) are achieved by combining a frequency-converting measurement with an external test set (standalone frequency converter, or combined with a diplexer in case of R&S ZNA67EXT). The frequency converters use frequency multipliers to transform the RF source signal from one of the network analyzer ports into a high-frequency stimulus signal. A dual directional coupler separates the reference and measurement channels from the waveguide test port. A local oscillator (LO) signal is used for down-converting the reference and measurement channels. The LO signal can be provided by the optional **LO Out**, or by an analyzer or external generator port. The down-converted reference and measurement signals are fed to the respective B16 or B26 ports.



Figure 4-26: Frequency converter cabling: front connection



On a R&S ZNA67EXT, this option is preinstalled.

Rohde & Schwarz offers dedicated frequency converter types for various mm-wave bands. The frequency converter R&S ZC110, for example, extends the frequency range of R&S ZNA network analyzers to a W-band range between 75 GHz and 110 GHz. The test ports of the frequency converters and the connecting elements are rectangular waveguides, whose dimensions are according to EIA WR-10, equivalent to RCSR WG-27.

Refer to the Getting Started guide and the specifications supplied with your converter for detailed information about the frequency range and the waveguide type of your converter model.



Controlling the electronic attenuator of legacy converters R&S ZVA-Z90E and R&S ZVA-Z110E is **not** supported.

4.7.7.1 Leveling

Introduction

The "Leveling" functionality of the vector network analyzer can be used to linearize the output power of a connected mm-wave converter over a wide range of power levels and frequencies. Based on an existing reference receiver calibration, it records the converter's power transfer function and creates a data set which compensates for the converter's nonlinearities. Leveling enables converter output power sweeps of up to 70 dB and thus is particularly beneficial for intercept or compression point measurements.



- Before firmware version 2.40, the leveling functionality was provided by the separate R&S Converter Leveling Tool. This tool is no longer required and can no longer be used with the R&S ZNA.
- Best leveling results are obtained for frequency converters R&S ZCxxx, R&S ZVA-Z110 Var.03, and R&S ZVA-Z90. Other frequency converters have limited ability to control the RF output power via the RF input power and therefore generally do not allow for effective power correction over wide frequency and power ranges.
- Controlling the electronic attenuator of an E-type converter is not supported by the R&S ZNA. However, E-type converters can also be used with their default (unattenuated) output power.

Without leveling data (default or recorded), the measurement is performed at fixed RF source and LO power. No power sweep is possible. To reduce the actual output power of the converters (e.g. for measuring wave quantities or testing compression effects), turn the adjusting knob on top of the converters clockwise. You will see an effect on the output power within the last 2 mm of the adjustable range.



Although the leveling functionality is enabled with option R&S ZNA-K8 and is designed for converter ports, it can also be used for regular VNA ports.

Leveling procedure

The purpose of frequency converter leveling is to determine the nominal RF input power P_{RF-In} at the converter input that is required to generate a particular RF converter output power P_{RF-Out} at (output) frequency f .

To this end, the RF output power is measured on a "leveling grid", i.e. at equidistant RF input power levels $P_{RF-In,i}$ and frequencies f_j . Two-dimensional interpolation is then used to obtain the appropriate input level for the desired output level at a given frequency. Selecting smaller step sizes can improve the interpolation accuracy, at the cost of an increased leveling duration.

Frequency converter leveling can be performed via the standard [Power Cal wizard](#). For each frequency converter port, the leveling procedure consists of the following steps:

1. **Source flatness calibration** (optional)

To improve the accuracy of P_{RF-In} , it is recommended to perform complementary source flatness calibrations at the related analyzer ports (including the cables connecting the analyzer port to the RF Input of the frequency converter).

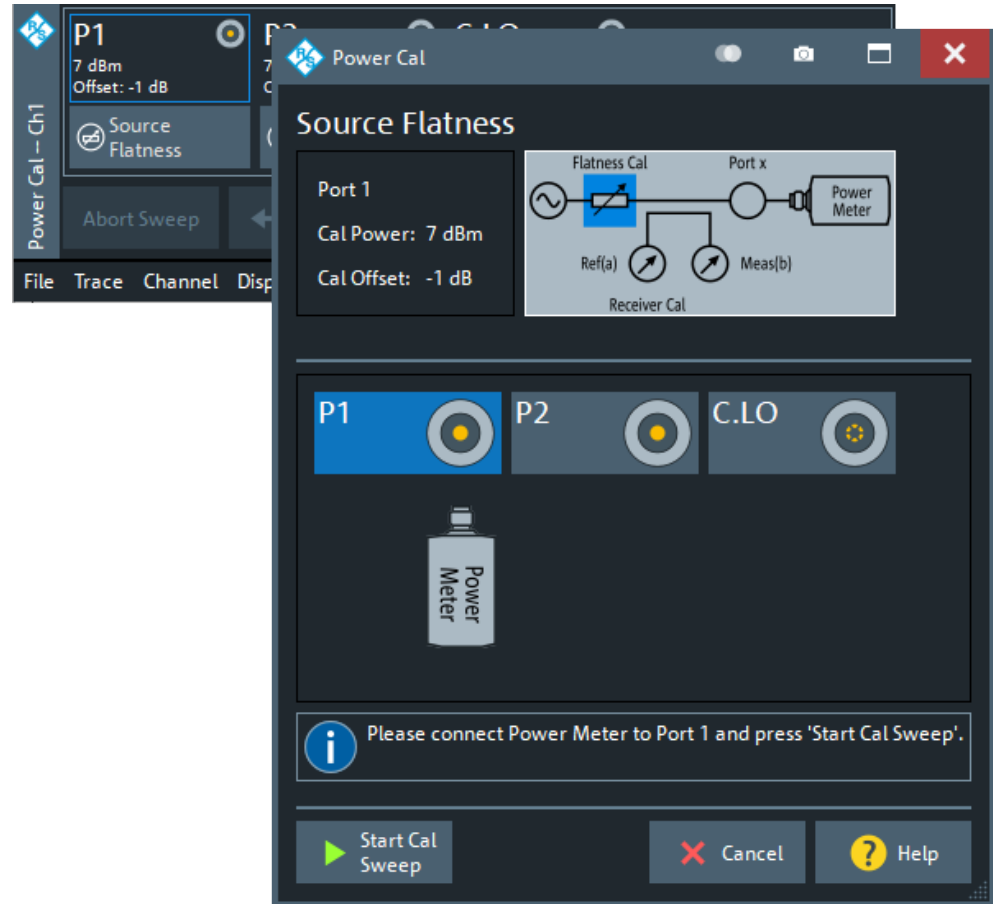

2. Reference receiver calibration

During this step, connect a power meter to the test port of the respective frequency converter. The calibration consists of a single frequency sweep f_1, \dots, f_n during which $P_{RF-Out}(f_j)$ and $P_{REF}(f_j)$ are recorded, where $P_{REF}(f_j)$ denotes the power measured by the VNA reference receiver.



The sweep is performed at the frequency converter's maximum RF level, which is typically advantageous w.r.t. measurement time and accuracy at the power meter. For the subsequent steps, the correction factors $c(f_j) = P_{\text{RF-Out}}(f_j) - P_{\text{REF}}(f_j)$ (on logarithmic scale) are assumed to be independent of the input power level $P_{\text{RF-In}}$.

3. RF input power calibration

This is the actual leveling step, i.e. for each point on the leveling grid, the RF output power $P_{\text{RF-Out}}(P_{\text{RF-In}, i}, f_j)$ is determined.

However, during this step it is sufficient to measure the reference receiver power $P_{\text{REF}}(P_{\text{RF-In}, i}, f_j)$, which can be performed much faster and with a much higher dynamic range compared to measuring the RF output power using a power meter. With the correction factors $c(f_j)$ obtained in step 1, the RF output power can then be calculated as $P_{\text{RF-Out}}(P_{\text{RF-In}, i}, f_j) = c(f_j) + P_{\text{REF}}(P_{\text{RF-In}, i}, f_j)$ (on logarithmic scale). The power meter is no longer required.

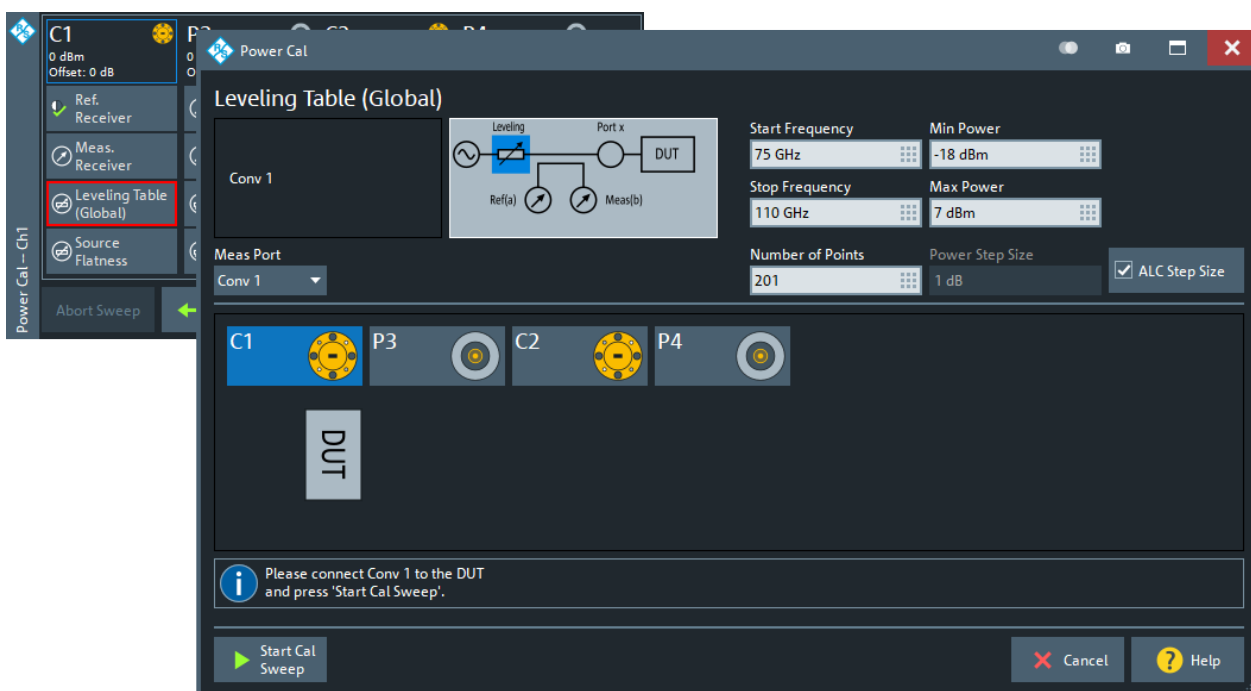

After you have finished the leveling procedure and have applied the scalar power calibration, the created leveling datasets are automatically activated. They can be deactivated or reactivated in the [Leveling Datasets dialog](#).

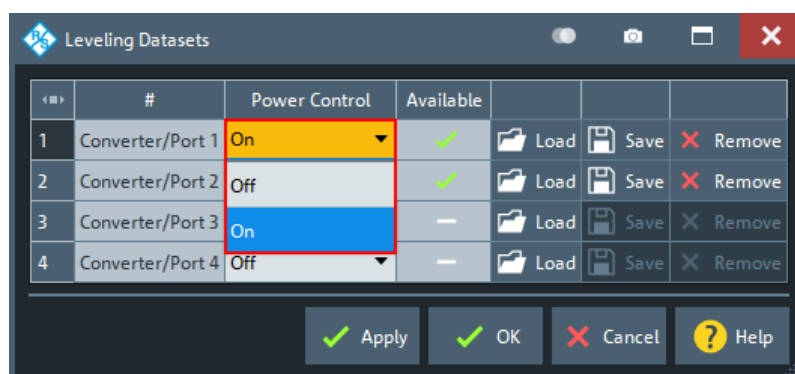

Although leveling is performed in the standard power cal wizard, the created leveling dataset is applied to all channels in the current recall set. A "Preset" does not affect the leveling dataset and whether or not it is used for power control.

4.7.7.2 System error correction

S-parameters are to be measured, an additional system error calibration is recommended after power calibration. Measurements with frequency converters require a special waveguide calibration kit for system error correction. Rohde & Schwarz offers these, e.g. the calibration kits R&S ZV-WRxx. The standards in the calibration kits allow all

one-port and two-port calibration types supported by the network analyzer except for TNA. Refer to the documentation of the calibration kit for details.

The R&S ZCxxx converters conform to standard IEEE 1785. The designation of their waveguide sizes is WM-xxx. The waveguide dimensions are identical to the former WRyy sizes between the 75 – 110 GHz and the 220 – 330 bands. In order to allow for the use of the ZV-WRyy kits for the calibration of a R&S ZCxxx converter, these kits have additionally been pre-defined in the VNA firmware for the WM-xxx connector types.

For some high-frequency converter types (e.g. R&S ZC500) each calibration sweep of the system error correction is performed twice. The first sweep is named Preparation Sweep; a tooltip below the calibration sweep diagram indicates an ongoing preparation sweep.

4.7.7.3 Measurement

After power calibration and system error correction, the mm-wave measurement can be performed like any other network analyzer measurement. The port configuration settings (together with the stimulus settings) determine the sweep range of the converted signals (i.e the input and output frequencies at the DUT ports). All measured quantities (S-parameters, wave quantities, ratios etc.) and other trace settings are available.

Generally, a measurement with a mm-wave converter involves the following steps:

1. R&S ZCxxx series: connect the converter to the VNA via USB. The analyzer firmware automatically identifies the converter and reads the factory leveling data.
2. Configure the RF connections between analyzer ports and converters
3. Connect the frequency converters
4. Perform a system error correction using a suitable waveguide calibration kit
5. Connect the DUT and measure it

For converters whose output power can be controlled by varying the input power, the following additional steps can be performed:

- [Leveling](#)
- Power settings



To enable n-port converter measurements on an n-port R&S ZNA, you can use the **LO Out** connector at the rear panel of the R&S ZNA as common LO drive port.

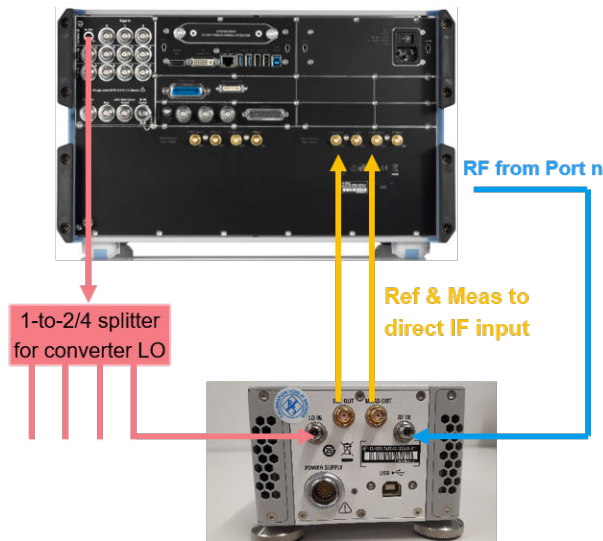

4.7.8 Increased IF bandwidth 30 MHz

Option R&S ZNA-K17

This software option increases the maximum measurement bandwidth (IF bandwidth) of a R&S ZNA from 1.5 MHz to 30 MHz.

4.7.9 Frequency resolution 1 mHz

Option R&S ZNA-K19

This software option improves the frequency resolution of a R&S ZNA to 1 mHz.

4.7.10 Continuous data recording

Option R&S ZNA-K28

Option R&S ZNA-K28 offers a "controlled timing" feature, which guarantees constant measurement times per sweep point, as long as no settings are changed by the user.



- Controlled timing is limited to setups with a single channel.
- Controlled timing is not compatible with:
 - ALC
 - spectrum measurements
 - two-dimensional compression point measurements
 - phase coherent and true differential signal generation
 - external devices control via USB or LAN (power meters, generators)
 - RFFE usage

4.7.11 Noise figure measurement

Option R&S ZNA-K30

Software option R&S ZNA-K30 allows you to measure the noise figure of a 2-port DUT, operating in its linear range.

4.7.11.1 Introduction

Noise figure (or *noise factor*, if the linear representation is chosen) is an important figure of merit for system designers and eventually determines the overall system performance of a receiver.

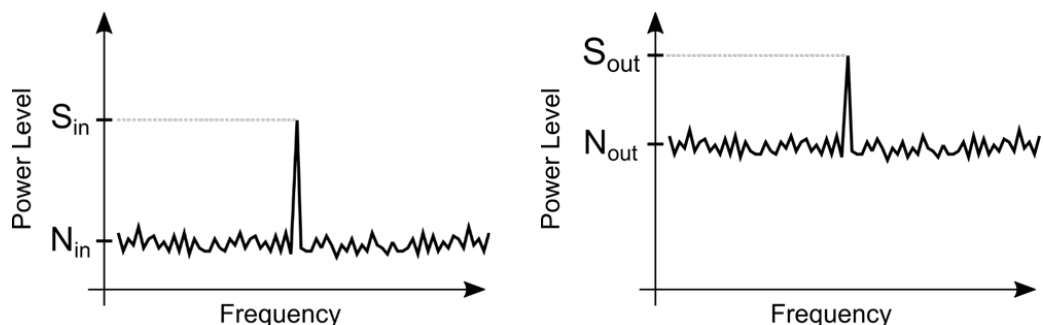

Figure 4-27: Exemplary spectrum for a single tone excitation (left = DUT input; right = DUT output)

The general definition of the noise factor F_D is the ratio of the signal to noise ratio (SNR) at the input, to the SNR at the output of a DUT. In other words, it describes the degradation of the SNR from the input to the output of a DUT.

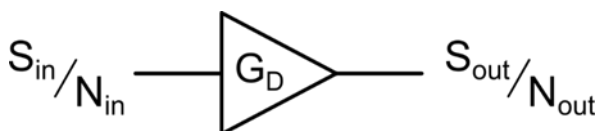

Figure 4-28: Schematic showing the signal and noise powers relevant for noise figure calculations

Based on this formulation the equation can be written in linear terms as:

$$F_D = \frac{SNR_{in}}{SNR_{out}} = \frac{S_{in}/N_{in}}{S_{out}/N_{out}} = \frac{S_{in}N_{out}}{S_{out}N_{in}} = \frac{N_{out}}{G_D N_{in}}$$

S_{in} and S_{out} denote the signal power at the input and output of the DUT, respectively. N_{in} and N_{out} represent the noise present at the input of the DUT and at the output of the DUT, respectively. The gain G_D of the DUT is defined by the ratio of the output signal power to the input signal power:

$$G_D = \frac{S_{out}}{S_{in}}$$

The resulting formula for the noise factor F_D shows that the calculation depends on precise knowledge of:

- the noise that is present at the input of the DUT,
- the noise present at the output of the DUT
- the gain of the DUT

These quantities must be measured during the different steps of a noise figure measurement. In a post-processing step, these individual measurements are then used to calculate the noise figure of the DUT.



Typically, the noise factor F_D is displayed in decibel which is then called the noise figure $NF_D = 10 \log F_D$. Noise figure and noise factor are used interchangeably throughout this manual.

4.7.11.2 Algorithmic implementation

Cold source method

Historically, the noise figure of DUTs was measured using the Y-factor method with a noise figure analyzer or with a spectrum analyzer. Because these measurement instruments had no internal sources, they used an external broadband noise source (switched on and off) to measure the noise and the gain of the DUT.

Nowadays, with the use of modern network analyzers, there is no need for an additional noise source and the Y-factor method. Instead, the so-called cold source method is utilized, which uses broadly available and highly accurate power meters for calibration. The noise emitting from the DUT is measured with switched off internal VNA source and a matched termination at the DUT input (typically a VNA port). The gain of the DUT is measured with an active source and the calibrated VNA receivers.

Equivalent circuit

The internal calculations are performed in the noise temperature representation.

Compared to calculations using noise factors (or noise figures), this method can easily account for different physical temperatures of the involved components. Furthermore, with noise temperatures there is no need to apply correction factors, if the compo-

nents are on a different temperature than the reference temperature T_0 ($= 290$ K). The equivalent circuit, which is internally used for the calculation of the DUT noise factor F_D , is shown in Figure 4-29. G_{ext} comprises the total external loss (net gain) between the R&S ZNA port and the calibration plane, including connecting cables, additional external attenuators, adapters, etc.

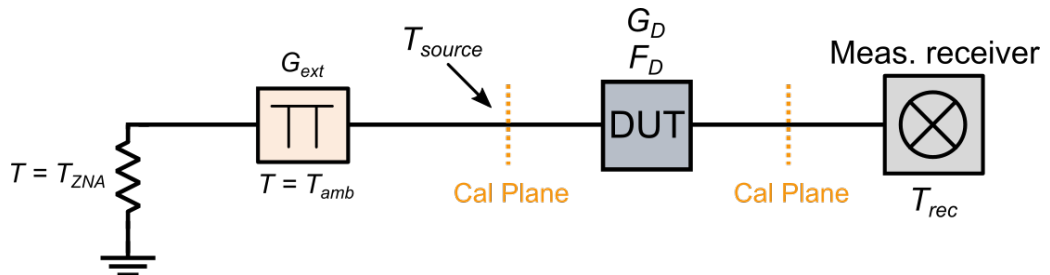

Figure 4-29: Equivalent circuit used for the calculation of the DUT noise factor



A noise temperature T is converted into the corresponding noise factor F using the equation:

$$F = 1 + \frac{T}{T_0}$$

Source noise temperature

As already mentioned, it is important to have precise knowledge of the noise present at the input of the DUT. The input noise temperature T_{Source} is derived from the internal temperature of the R&S ZNA (typically around 38 °C) and the ambient temperature T_{amb} of the measurement environment. The ambient temperature is by default chosen to 296 kelvins, which is close to a typical laboratory temperature of 23 °C. However, for precise measurements the ambient temperature can be adjusted to the actual room temperature (see "Advanced Settings" on page 373).

To calculate the effective noise temperature T_{Source} at the DUT input, the external attenuation (net gain) must be considered. Depending on the total external attenuation, the "hot" internal temperature of the R&S ZNA is suppressed:

$$T_{Source} = T_{amb} + G_{ext}(T_{VNA} - T_{amb})$$

T_{VNA} represents the internal temperature of the R&S ZNA and G_{ext} is the external net gain (cables, additional external attenuators, adapters, etc.) connected during calibration and measurement. The external net gain is automatically determined during calibration.

Receiver noise temperature

The noise present at the output of the DUT cannot be measured directly. In fact, the measured noise is always the sum of the noise emitting from the DUT and the noise present in the receiver. An additional step is required during calibration to characterize the noise of the receiver.

For the receiver NF calibration, a well matched 50 Ω load connected to the receiving port and the noise power is measured. The model used for the receiver noise calibration is shown in Figure 4-30 and depicts the matched load (at ambient temperature) directly connected to the receiver.

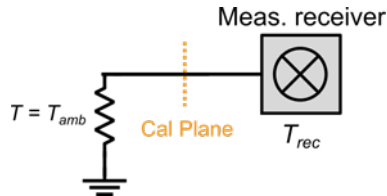

Figure 4-30: Model used for the receiver noise calibration

Using the model above, it is possible to calculate the receiver noise temperature T_{rec} using the following formula:

$$T_{rec} = \frac{N_{M,rec}}{kB} - T_{amb}$$

In this formula, $N_{M,rec}$ is the measured noise power during calibration, k is the Boltzmann constant (1.38064852e-23 J/K), and B is the equivalent noise bandwidth of the used IF filter.



The equivalent noise bandwidth represents the cumulated normalized filter response. In other words, it is the bandwidth of a rectangular filter which has the same integrated noise power as the real filter. The calculation is done by the following equation:

$$B = \frac{1}{2\pi} \int_0^{\infty} \left| \frac{H(j\omega)}{H_{max}} \right| d\omega$$

where $H(j\omega)$ is the magnitude of the IF filter, H_{max} is the maximum value of $H(j\omega)$.

DUT noise figure

Amplifier (non-frequency-converting DUTs)

The calculation of the noise figure (NF) of a non-frequency-converting DUT requires a calibrated NF channel in the R&S ZNA setup. During calibration, important system parameters such as **Source noise temperature** and **Receiver noise temperature** are determined. The final noise factor F_D is then calculated using the following equation:

$$F_D = \frac{\frac{N_{DUT,meas}}{kB} - T_{rec}}{G_D T_0} - \frac{T_{source} - T_0}{T_0}$$

where

- $N_{DUT,meas}$ is the noise power measured with the DUT connected to the VNA
- T_{rec} and T_{source} are the source and receiver noise temperature, respectively, determined during calibration

- G_D is the measured gain of the DUT
- $T_0 = 290$ K is the reference temperature

Frequency-converting DUTs

Due to the existence of image (receive) bands, the noise figure of a frequency-converting DUT is calculated slightly different than the noise figure of a non-frequency-converting DUT. The noise factor F_D of a frequency translating DUT is calculated using the following formula:

$$F_D = \frac{N_{DUT,meas} - T_{rec}}{G_{D,RF} T_0} - \frac{T_{source,RF} - T_0}{T_0} - \frac{G_{D,IM}}{G_{D,RF}} \left(\frac{T_{source,IM} - T_0}{T_0} \right)$$

where

- $N_{DUT,meas}$ is the noise power measured with the DUT connected to the VNA
- T_{rec} is the receiver noise temperature, determined during calibration
- $T_{source,RF}$ and $T_{source,IM}$ are the noise temperatures at DUT input, at the RF and the image frequency, respectively
- $G_{D,RF}$ and $G_{D,IM}$ represent the gain of the DUT, measured at the RF and the image frequency, respectively
- $T_0 = 290$ K is the reference temperature



Due to the small error introduced by the image band, image band correction is by default deactivated. However, under [Advanced Settings](#) it can be activated. With active image band correction, additional measurements are required to determine the gain $G_{D,IM}$ and the source noise temperature $T_{source,IM}$.

Sideband correction

Typically, VNA receivers do not have any preselection filters within their signal paths. However, due to their architecture, they exhibit additional receiving windows at higher-order harmonics of the local oscillator frequency. Frequencies in these higher-order sidebands are down-converted to the same IF frequency as the intended RF frequency. Without additional measurements, these sideband contributions cannot be separated from the contribution of the intended RF frequency band.

For typical network analyzer measurements with an active driving signal (S-parameters, intermodulation, compression, ...), unsuppressed higher-order sidebands are not an issue. Also for noise figure measurements on narrowband devices with less than an octave bandwidth and an out-of-band suppression of more than 30 dB, they do not impose significant measurement errors. But for noise figure measurements on a broadband DUT with several octaves of bandwidth (e.g. a distributed amplifier), they certainly cannot be ignored.

Noise figure option R&S ZNA-K30 uses a patented algorithm to remove the error introduced by the higher-order sidebands, and to calculate the true NF of a DUT. Based on additional measurements during calibration and measurement phase, the imperfect receiver response is corrected mathematically.

Noise power spectral density

The noise power spectral density, or noise density for short, is calculated as

$$\text{NPSD} = \text{ND} = N_{\text{meas, corr}} / B$$

where $N_{\text{meas, corr}}$ denotes the measured sideband-corrected noise power, and B the equivalent noise bandwidth (see "Receiver noise temperature" on page 291). $N_{\text{meas, corr}}$ is basically independent of what is currently connected to the test ports, so no distinction between calibration and DUT is required.

4.7.12 Measurement uncertainty analysis

Option R&S ZNA-K50/R&S ZNA-K50P

Measurement uncertainty analysis is available if option R&S ZNA-K50 and METAS VNA Tools (version 2.2.6 or higher) are installed on the instrument.



Option R&S ZNA-K50P offers the same functionality as option R&S ZNA-K50, but comes with METAS VNA Tools preinstalled. It can be shipped with new instruments or installed at Rohde&Schwarz service.

The purpose of the METAS VNA Tools software is to compute uncertainties of S-parameter measurements. After registration, you can download it from the VNA Tools Internet site (<https://www.metas.ch/vnatools>).



- The uncertainty analysis of the METAS VNA Tools is limited to S-parameter measurements. Uncertainty analysis of wave quantities is not supported.
- The uncertainty calculations are in line with EURAMET Calibration Guide No. 12 Version 3.0 (03/2018).
- If [external switch matrices](#) are used, measurement uncertainty analysis is **not supported**.

METAS Calibration

The VNA firmware directly interacts with the DLLs of the METAS VNA Tools. During a "METAS Calibration", the VNA firmware collects all data that are required to set up a METAS VNA Tools project. After the "METAS Calibration" [METAS calibration](#) is completed, the analyzer is ready for real-time uncertainty analysis: after each sweep it passes the raw (uncalibrated) S-parameters to the VNA tools and receives the calibrated S-parameters plus uncertainties (95% confidence ellipse in the complex plane) in return.

The calibrated S-parameter traces plus their uncertainty bands can be displayed in magnitude, phase, real and imaginary [trace formats](#). The display of uncertainties in complex diagrams (polar, Smith) is not supported.

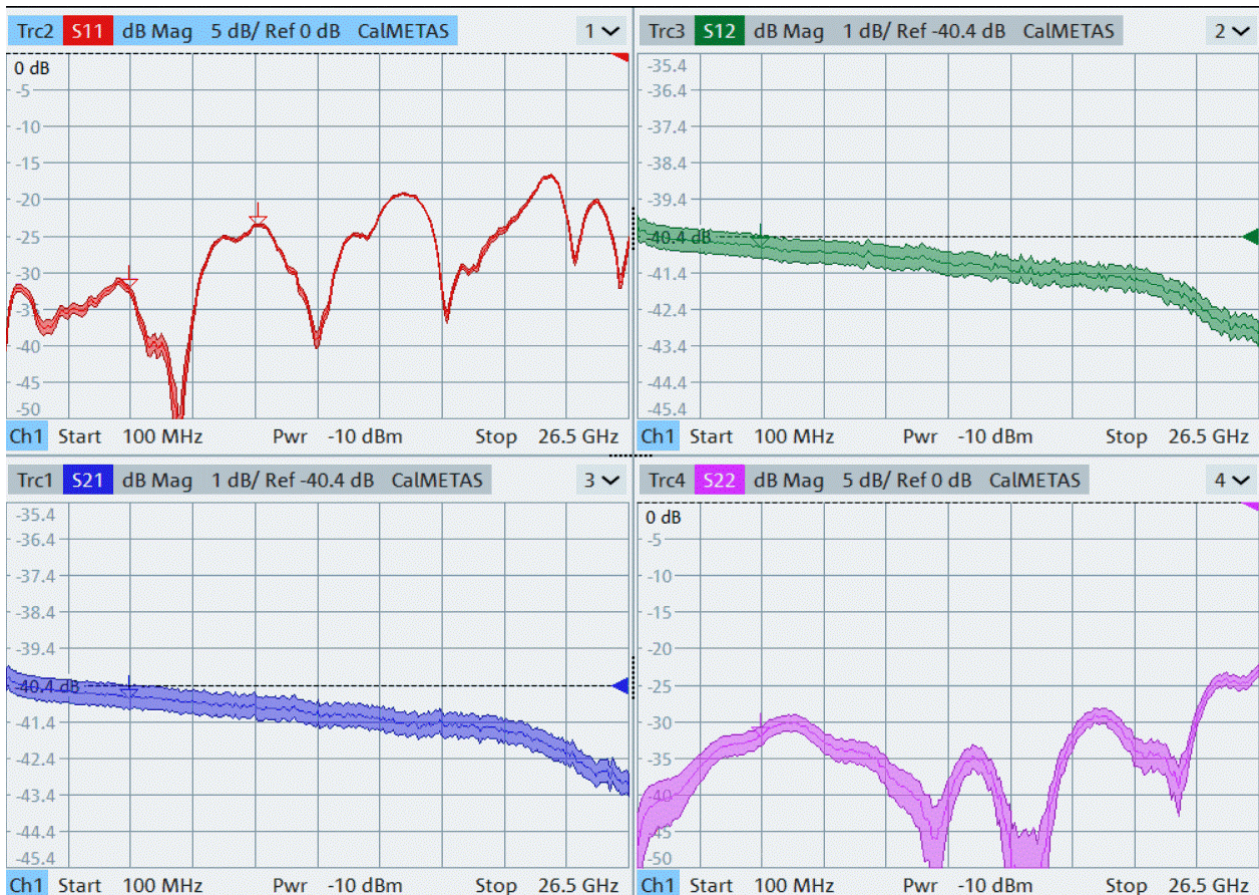

Figure 4-31: S-parameter measurements with uncertainty bands

Required input data for METAS VNA Tools:

- METAS VNA model (noise floor, trace noise, receiver linearity, drift)
This model is provided by the analyzer firmware.
- Connector types
Part of the uncertainty calculation is the number of reconnections between calibrated ports and calibration standards or DUT. METAS VNA Tools provides "repeatability models" for various connector types.
- METAS cable model
As cables (and cable movements) contribute to the measurement uncertainty, the magnitude and phase stability of the cables must be considered. The VNA firmware uses the cable models available in the local METAS VNA Tools installation. You can add your cable models using its graphical user interface. Cable models that ship with the VNA firmware are automatically added to the METAS database.
- Calibration standard characterizations with uncertainties
Standard cal kit data does not contain information about the uncertainty of the characterization. However, to get meaningful results, these uncertainties must be considered and hence a "characterization with uncertainties" must be used. Rohde&Schwarz calibration kits with accredited calibrations (ACA) include uncertainties.
- Channel setup (IF bandwidth, power, ...) and calibration data

Required to calculate the calibrated S-parameters and their uncertainties. If relevant settings are changed on the VNA, these changes are also propagated to the METAS VNA Tools.

- **Measured S-parameters (uncalibrated)**
The raw ("uncalibrated") data are handed over to the METAS VNA Tools after every sweep for real-time correction and uncertainty analysis.



Only a single VNA channel can be METAS calibrated at a time.

Verification

To get precise information about the absolute measurement uncertainty after calibration, you can use verification standards, which are DUTs precisely characterized by the manufacturer. Verification kits, which include multiple standards, deliver the most accurate results for the measurement uncertainty.

Verification kits R&S ZV-Z4xx from Rohde&Schwarz contain a male and a female offset short, a male and a female mismatch, an attenuator and a stepped through. These verification standards differ substantially from the conventional calibration standards – Open, Short and Match – because they have different impedances. They are characterized in steps of 250 MHz and specified together with their measurement uncertainties. Characterization and uncertainties are accredited by the DAkks (Germany's national accreditation body).

The VNA firmware compares the uncertainties calculated by the METAS VNA Tools with the accredited uncertainties and presents both uncertainty bands graphically. To pass verification, the calculated band must be within the accredited band for the specific standard.

Cal kits and verification kits with uncertainties

Cal kits and verification kits with uncertainties have to be provided as *.zip or *.scolv files. The comprised standards must be provided as *.sdatb, *.sdatcv, or *.calstd files. The standard filenames must convey information about the file content:

- **Standard type**
 - **Cal kit:** open, short, load, match, through, sliding load, or sliding match
 - **Verification kit:** offset short, mismatch, airline, mismatch airline, att, attenuator, or stepped thru
- **Gender:** (f), (m), _f_, _m_, female, male, (fm), _fm_, ...
If gender information is not found, the standard is assumed sexless.

4.7.13 Security write protection

R&S ZNA-K51

With software option R&S ZNA-K51 "Security Write Protection" (SWP), the firmware can be run in write-protected mode, i.e. all data that would otherwise be written to the C: drive of your VNA are kept in RAM instead. After a restart of the instrument, these data are gone without a trace.

RAM usage is limited to 1 GByte. When 90% (900 GByte) is used, a warning is displayed requesting you to reboot the instrument. When 100% is reached, the reboot is performed automatically.

Option R&S ZNA-K51 is delivered as a separate installer, which has to be run on the R&S ZNA and requires administrative privileges. The installed service runs in the background and can be accessed via the Windows system tray.

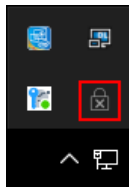
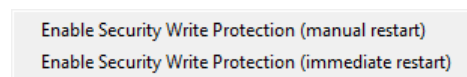

Figure 4-32: R&S ZNA-K51: system tray icon (SWP inactive)

For standard Windows users, SWP is disabled. To enable it, right-click the system tray icon and select one of the available actions:



For details see the R&S ZNA-K51 user manual that is installed with the software.

4.7.14 Continuous sweep up to 110 GHz (R&S ZNA67EXT only)

R&S ZNA67-K110

This software option is preinstalled on a R&S ZNA67 shipped with a VNA system R&S ZNA67EXT. It enables continuous sweeps in the full range between 10 MHz and 110 GHz.



Software option R&S ZNA67-K110 is not available for regular R&S ZNA67.

4.7.15 Eazy de-embedding based on IEEE 370

Option R&S ZNA-K210

EaZy deembedding (EZD) is an implementation of the IEEE algorithm for generating deembedding files from a symmetrical 2x thru measurement.

Option R&S ZNA-K210 allows you to model a test fixture using the EZD fixture modeling tool and to deembed selected ports using the generated touchstone files.

The EZD fixture modeling proceeds in the following steps:

1. Measure one or more test coupons for the related fixture.
2. Run the EZD tool to calculate the Touchstone files modeling the test fixture.

The calculated `sNp` files can then be used to deembed the DUT at selected ports.

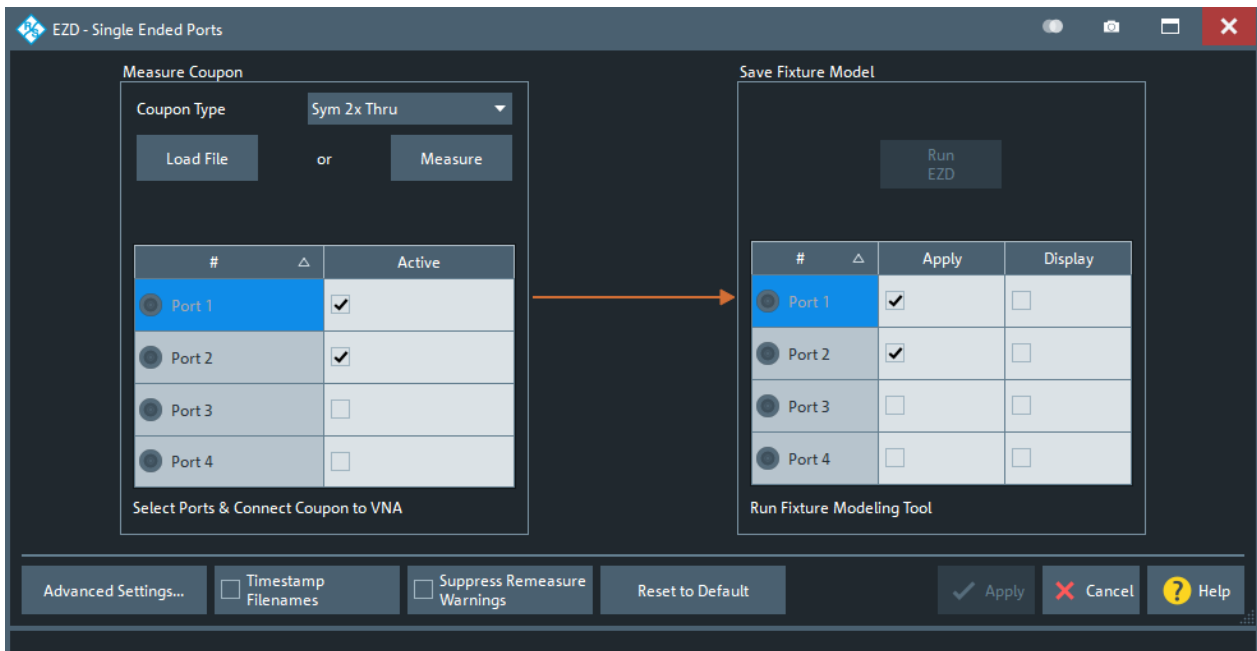

Figure 4-33: Fixture modeling: EZD – Single Ended Ports dialog

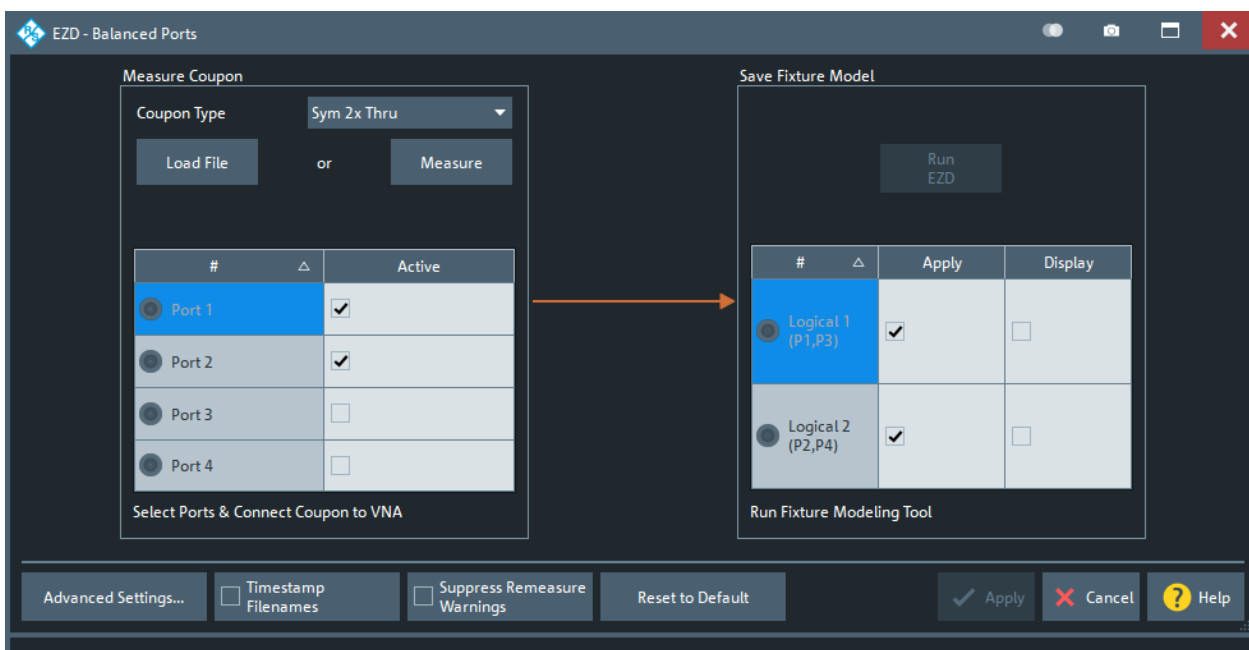

Figure 4-34: Fixture modeling: EZD – Balanced Ports dialog



- For general information about fixture de-embedding, see [Chapter 4.6.2.9, "Fixture modeling and deembedding"](#), on page 242.
- Option R&S ZNA-K210 can be ordered with a new instrument or retrofitted at Rohde&Schwarz service.

4.7.16 In-situ de-embedding

Option R&S ZNA-K220

This option offers a pre-installed or service-retrofitted version of AtaiTec's *In Situ De-Embedding* (ISD) tool for fixture de-embedding.

The tool is integrated into the de-embedding functionality of the analyzer firmware.



- For general information about fixture de-embedding, see [Chapter 4.6.2.9, "Fixture modeling and deembedding"](#), on page 242.
- For detailed information about the ISD tool, see the product pages at <http://atai-tec.com/products/isd/>

Tips for using ISD

The ISD User's Guide offers the following guidelines to get the most out of ISD:

1. The Touchstone files must have enough number of points.

The minimum required is at least two points for every 90 degree phase angle change in insertion loss (or 8 points per wavelength).

2. The "2x Thru's" return loss must be smaller than its insertion loss.
3. The "2x Thru's" insertion loss must be relatively linear, with a few wavelengths at the highest frequency.
4. Use a 4-port "2x Thru" if strong far-end crosstalk (FEXT) is present.
5. Use a *complete* DUT w. fixture file for extraction.

Source: "In Situ De-Embedding (ISD) User's Guide" – November 11, 2018

4.7.17 Smart fixture de-embedding

Option R&S ZNA-K230

This option offers a pre-installed or service-retrofitted version of PacketMicro's *Smart Fixture De-embedding* (SFD) for fixture de-embedding.

The tool is integrated into the de-embedding functionality of the analyzer firmware.



- For general information about fixture de-embedding, see [Chapter 4.6.2.9, "Fixture modeling and deembedding"](#), on page 242.
- For detailed information about the SFD tool, see the product pages at <https://www.packetmicro.com/Products/sfd-tool.html>.

4.7.18 Delta-L 4.0 PCB characterization

Option R&S ZNA-K231

Delta-L is a de-embedding methodology developed by Intel Corporation and is used for de-embedding strip lines that include vias. Delta-L calculates the loss of PCB interconnects and can be performed on single-ended or balanced interconnects.

The objective of Delta-L is to determine an insertion loss measurement defined on two or more coupon lines of differing lengths. This ratio of insertion loss in dB/inch can be applied to any trace length with similar vias.



For background information, see

- <https://www.intel.com/content/dam/www/public/us/en/documents/guides/delta-l-plus-methodology-for-electrical-characterization-guide.pdf>
- <https://ieeexplore.ieee.org/document/7048423>

The R&S ZNA uses the Clear Signal Solutions AITT-DL implementation of the Delta-L v4.0 algorithms (see <https://clearsig.com/clearsig/tools/#Delta>). It allows you to perform:

- 1L (one line/length) analysis
Typically used for high-volume manufacturing (relative comparison)
- 2L analysis
Typically used for board-quality validation (removes the test fixture impact)
- 3L analysis
Typically used for material characterization (best accuracy, self-validation of results).



Figure 4-35: Test coupons for 1L, 2L and 3L measurements



Option R&S ZNA-K231 can be ordered with a new instrument or retrofitted at Rohde&Schwarz service.

4.7.19 Health and usage monitoring service (HUMS)

Option R&S ZNA-K980

The R&S ZNA comes with a health and utilization monitoring system (HUMS) providing information about the R&S ZNA. Aim is to increase the overall utilization, to avoid downtime and to increase the overall security level of a fleet of instruments.

HUMS provides, for example, information about:

- Health status
- Characteristics (device footprint)
- Operation system / security patches
- Usage of options
- Calibration and service information

Interfaces and protocols

The HUMS installation on the R&S ZNA includes an SNMP agent and a REST service with HTTP endpoints. So you can access the health and usage information via LAN, using the SNMP protocol or the REST protocol. Accessing the data does not interfere with remote control via SCPI commands or with measurement execution.

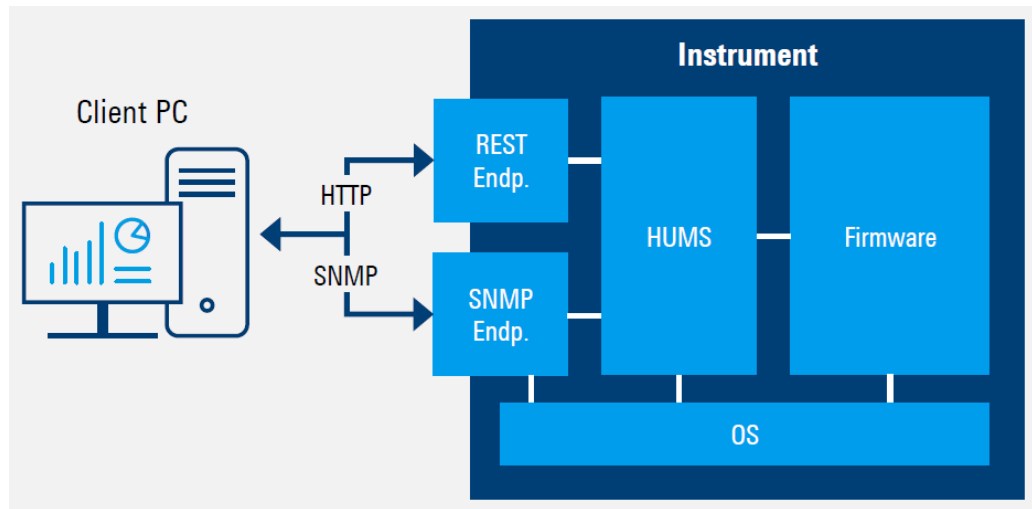

Reference information for both protocols is available on the R&S ZNA at the address <http://<instrument>/api/hums/v1/documents?name=<interface>>.

For *<instrument>*, enter the hostname or the IP address of your instrument, as for access to the GUI.

For *<interface>* = *snmp*, you get a `.zip` file containing the MIB files for SNMP. For *<interface>* = *rest*, you get a web page with the OpenAPI specification of the REST API.

For further information about the HUMS service itself, see the R&S HUMS user manual.

4.7.20 Internal 3rd and 4th source for 4-port R&S ZNA

R&S ZNAxx-B3

A four-port R&S ZNA has at least two internal sources. With two internal sources (default), the physical ports of a four-port VNA are split into groups $P1 = \{1,2\}$ and $P2 = \{3,4\}$ such that source 1 can only drive ports in $P1$ and source 2 can only drive ports in $P2$. Independent signals require the source ports to reside in different port groups. For example, you cannot use VNA ports 1 and 2 as independent source ports.

Hardware option **R&S ZNAxx-B3** expands a four-port network analyzer R&S ZNAxx with a third and fourth internal source. With four independent internal sources, a wide range of [Frequency conversion measurements](#) can be performed, without the need for additional (external) generators.

4.7.21 Precision frequency reference

Option R&S ZNA-B4

An optional OCXO improves the static frequency accuracy of the R&S ZNA. For details, refer to the data sheet.

4.7.22 Second internal LO generator for 4-port R&S ZNA

Option R&S ZNA-B5

For 4-port R&S ZNA, hardware option R&S ZNA-B5 provides a second internal LO that enables parallel measurement of a- and b-waves in frequency converting measurements.

The frequency range of the internal LO generators (1st and 2nd) is 10 MHz to 26.5 GHz.



- For 2-port R&S ZNA, option R&S ZNAxx-B52 offers a second internal RF source **and** a second internal LO. See [Chapter 4.7.23, "Internal 2nd source and 2nd LO generator for 2-port R&S ZNA"](#), on page 303.
- If the R&S ZNA is equipped with a second internal LO generator and an [LO Out](#), then the second internal LO generator is connected to the LO Out.

4.7.23 Internal 2nd source and 2nd LO generator for 2-port R&S ZNA

Option R&S ZNAxx-B52

Without additional HW options, a two-port R&S ZNAxx is equipped with a single internal source. This source can drive a single port at a time. Hardware option R&S ZNAxx-B52 provides a second internal RF source **and** a second internal LO.

The frequency range of the second internal RF source corresponds to the frequency range of the related R&S ZNA. The frequency range of the LO generators (1st and 2nd) is 10 MHz to 26.5 GHz.



- If the R&S ZNA is equipped with a second internal LO and an [LO Out](#), then the second internal LO is connected to the LO Out.
- For 4-port R&S ZNAxx, option R&S ZNAxx-B5 offers a second internal LO. See [Chapter 4.7.22, "Second internal LO generator for 4-port R&S ZNA"](#), on page 303.

With two independent internal RF sources (and the [Internal combiner](#)), the R&S ZNA can generate (and combine) two-tone stimuli without the need for an additional generator (and combiner). Using [Direct generator/receiver access](#), the upper-tone port can serve as receiving port in intermodulation and two-tone group delay measurements. And, with two independent internal RF sources the R&S ZNA can generate [phase coherent](#) or [true differential](#) source signals.

The additional second LO source enables measurements with two frequency converters, and many additional [Frequency conversion measurements](#) without the need for additional (external) generators. The LO Out (option R&S ZNA-B8) can also serve as additional source.

4.7.24 Memory extension for data streaming

R&S ZNA-B7

Hardware option R&S ZNA-B7 comprises an additional memory board, that is exclusively used for buffering data of the measurement and reference receivers. Compared to the standard memory, the buffering speed is twice as high.

This high-speed memory is particularly useful for [Pulsed measurements](#), because a high time resolution requires a high IF bandwidth and hence a large amount of data to be buffered. The "Pulse Profile" sweep type uses the R&S ZNA-B7, if available.

The doubled memory speed also doubles the number of wave quantities that can be measured simultaneously at a given bandwidth. The following table presents optimum values.

IF BW (MHz)	Time resolution (ns)	Simultaneously measured wave quantities			
		2	4	8	16
0.1	552	✓	✓	✓	✓
0.15	368	✓	✓	✓	with B7
1	48	✓	✓	✓	with B7
1.5	32	✓	✓	✓	with B7
2	24	✓	✓	with B7	
10	16	✓	✓	with B7	
15	16	✓	✓	with B7	
20	8	✓	with B7		
30	8	✓	with B7		

The number of wave quantities that are required to measure a certain quantity, depends on the setup and the calibration. E.g., a calibrated gain measurement with "One Path Two Ports" calibration requires the simultaneous measurement of three wave quantities.



To retrofit the memory extension board, the R&S ZNA must be sent to Rohde & Schwarz Service.

4.7.25 LO Out

R&S ZNA-B8

Hardware option R&S ZNA-B8 provides a dedicated [Rear panel](#) local oscillator output port.

This port is particularly useful for driving millimeter wave converters. If you use a power splitter to connect the LO Out of the R&S ZNA to the LO In ports of the converters, then it is possible to measure n converter ports with an n-port R&S ZNA, without the need for an external generator.



On a R&S ZNA67EXT, this hardware option is preinstalled.



If the R&S ZNA is equipped with a second internal LO generator, then the second internal LO generator is connected to the LO Out.

4.7.26 RFFE GPIO interface

Option R&S ZNA-B15

The trend in mobile radio communication is towards higher scale of integration of external components such as filters, switches, low noise and power amplifiers. The requirement for test and measurement equipment is to make it possible to control those components directly from the instrument without the need of additional external tools, e.g. a USB to RFFE adapter.

For these kinds of applications, Rohde & Schwarz has developed an RFFE-GPIO extension board for the R&S ZNA. This board is equipped with a 25-pin female connector interface providing 2 independent RF Front-End (RFFE) interfaces according to the MIPI® Alliance "System Power Management Interface Specification" and 10 General Purpose Input/Output (GPIO) pins. RFFE command execution and GPIO voltage settings can be synchronized with the sweep (sweep sequencer functionality); however, RFFE read is not supported in sweep sequencer mode.

Variants

The following variants of the RFFE-GPIO extension board are available:

- R&S ZNA-B15 variant **02**, order number 1332.4575.**02**
- R&S ZNA-B15 variant **03**, order number 1332.4575.**03**, including current and voltage measurements for all RFFE and GPIO pins

Information about the voltage and current levels is available in [Chapter 12.3.4, "RFFE - GPIO interface"](#), on page 1785.



There is no need to perform any kind of calibration or alignment of the extension board. The analyzer firmware automatically detects and supports it. The controlled devices can be hot-plugged.

NOTICE

Risk of board and instrument damage

Please **turn off the R&S ZNA** before mounting an internal RFFE-GPIO extension board R&S ZNA-B15. A hot plug installation is not supported and can damage board and instrument.

Current and voltage measurements (variant 03 only)

For test purposes, variant 03 of the R&S ZNA-B15 can apply constant, pin-specific output voltages not only to the GPIO pins but also to the individual RFFE pins. Furthermore it can measure the (resulting) voltages/currents at these pins using suitable shunt resistances. The firmware takes 500 samples per millisecond (and pin) and calculates the average voltages/currents over the configured measurement time.

RFFE Cable with adapters (R&S ZN-Z25)

A 2m ribbon cable for connecting a DUT to the RFFE GPIO interface – along with a set of adapters – is shipped with each RFFE GPIO extension board. It splits the 25-pin connector of the RFFE GPIO interface to four 10-pin socket connectors. The adapters provide several different pin configurations.



This interface cable/adaptor kit can also be ordered separately from Rohde & Schwarz (R&S ZN-Z25, order no. 1334.3424.02). For a detailed pin description, see the R&S ZN-Z25 data sheet.

4.7.27 Direct generator/receiver access

R&S ZNAxx-B16

Hardware option R&S ZNAxx-B16 provides direct access to the Ref, Source and Meas signal path for each test port of an analyzer R&S ZNAxx.

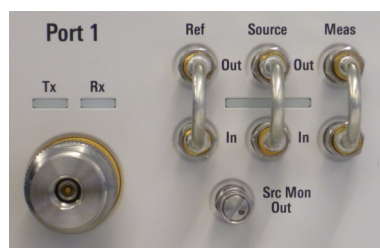

The corresponding connectors are located on the front panel, beneath the related test port (see [Chapter 3.2.1, "Front panel"](#), on page 35).

- The Source Out signal comes from the internal RF signal source. The Source In signal goes to the test port.
- The Ref Out signal comes from the coupler and provides the reference signal. The Ref In signal goes to the reference receiver.
- The Meas Out signal comes from the coupler and provides the received signal (to be measured). The Meas In signal goes to the receiver input for the measured signal.

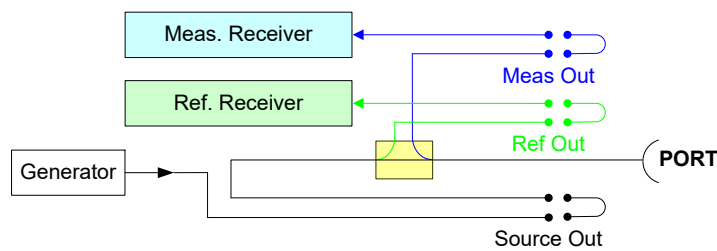

Direct generator/receiver access can be used to insert external components such as amplifiers, attenuators or external signal separating devices into the signal path. E.g., a power amplifier can be inserted between Source Out and Source In to boost the test port power. In this sense, direct access enables custom measurements, e.g. to test high-power devices or to extend the dynamic range.

If no external components are connected, each Out/In loop must be closed using a jumper.



On a R&S ZNA67EXT, hardware option R&S ZNA67-B16 is preinstalled.

Reverse Coupler Configuration

The reverse coupler configuration is obtained by a simple reconnection of the direct generator/receiver access jumpers.

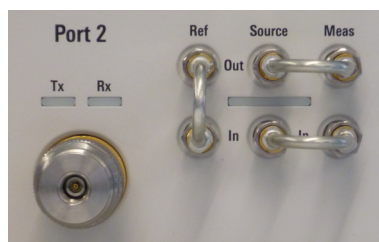

By inverting the signal routing of RF out and measurement path, the sensitivity of the measurement receiver is increased by 10 dB to 20 dB .

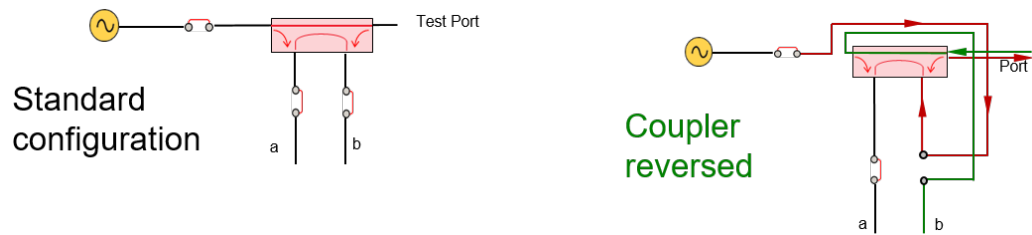

Figure 4-36: Standard vs. reverse coupler configuration



Make sure not to overdrive the measurement receiver, when using the reversed coupler configuration. Its compression point is reduced by 10 dB to 20 dB, compared to the standard configuration. Furthermore the source power level of the test port is reduced by 10 dB.

4.7.28 Additional removable system drive

Option R&S ZNA-B19

Option R&S ZNA-B19 provides an additional removable system drive for the R&S ZNA, including operating system and VNA firmware.

4.7.29 Source step attenuators

Option R&S ZNAxx-B21|B22|B23|B24

Hardware option R&S ZNAxx-B2y provides a mechanical source step attenuator for physical port y of a R&S ZNAxx.

Attenuation can be set from 0 to 70 dB, in steps of 10 dB.

4.7.30 Direct IF access

Option R&S ZNA-B26

Hardware option R&S ZNA-B26 enables direct access to the IF signal path of the R&S ZNA via [Rear panel](#) connectors IF Reference <i></i> and IF Meas <i></i>.

- Switchable, 1 GHz analog bandwidth
- System extension with external digitizer (spectrum analyzer, scope)
- Beneficial for antenna measurement systems



On a R&S ZNA67EXT, this hardware option is preinstalled.

4.7.31 Receiver step attenuators

Options R&S ZNAxx-B3y

Receiver step attenuators are used to adjust the received signal levels to the input level range of the analyzer to avoid damage to the instrument, e.g. if the DUT is a power amplifier.

Hardware option R&S ZNAxx-B3y provides a receiver step attenuator for physical port y of a R&S ZNAxx. The attenuation values can be set between 0 dB and 35 dB (in 5 dB steps); see "[Receiver Step Att.](#)" on page 527.



On a R&S ZNA67EXT, hardware options R&S ZNA67-B3y are preinstalled.

4.7.32 Internal pulse modulators

Option R&S ZNAxx-B4y

Software-enabled hardware option R&S ZNAxx-B4y provides an internal pulse modulator for physical port y of a R&S ZNAxx.

Switch times are limited to 1 μ s or higher.

4.7.33 Trigger board

Option R&S ZNA-B91

Hardware option R&S ZNA-B91 adds the following BNC connectors to the [Chapter 3.2.2, "Rear panel"](#), on page 41 of the R&S ZNA:

- 3 trigger in, 4 trigger out
- 4 external pulse modulator control signals (I/O switchable)
- busy and ready for trigger indication
- +28 V noise source control
- RF OFF control input

All logic levels are LV-TTL 3.3 V, 5 V tolerant.

4.7.34 Direct source monitor access

R&S ZNAxx-B161/B163/U161/U163

For instruments that are equipped with [Source step attenuators](#), the direct source monitor options give access to the unattenuated generator signals of port 1 and 3. The signal does not have to pass the respective source step attenuator, which is particularly useful for measurements requiring a low stimulus power, such as high gain (converter) measurements. Taking the "attenuated" signal as the reference signal would result in noisy results, so it is recommended to use the monitor signal as the reference signal in this case.

- Option R&S ZNAxx-B161 provides direct access for port 1 of a R&S ZNAxx.
- Option R&S ZNAxx-B163 is available for 4-port models only. It provides direct access for port 1 **and** port 3.

Direct source monitor access is only available for instruments with [Direct generator/receiver access](#). The unattenuated source signal is available via monitor ports below the respective direct-access connectors. Simply by rejumping the direct-access ports from "Ref Out → Ref In" to "Src Mon Out → Ref In", the monitor signal can be used as the reference signal:

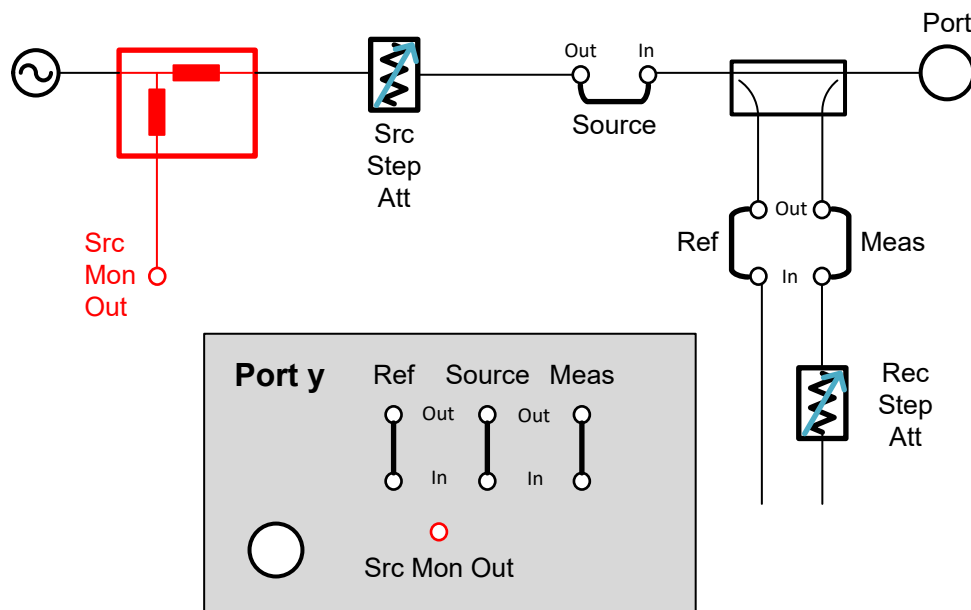

Figure 4-37: Standard B16 jumpering

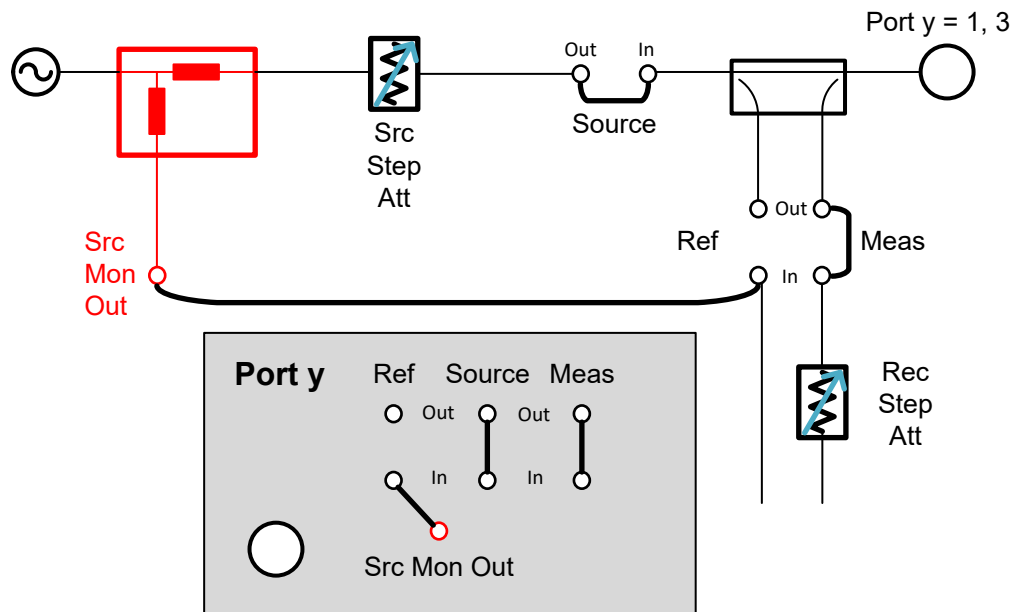

Figure 4-38: B16 jumpering for direct source monitoring



- Options R&S ZNAXx-B161/163 are only available with hardware option R&S ZNAXx-B16 (see [Chapter 4.7.27, "Direct generator/receiver access"](#), on page 306). Furthermore:
 - R&S ZNAXx-B161 requires R&S ZNAXx-B21
 - R&S ZNAXx-B163 requires R&S ZNAXx-B21 **and** R&S ZNAXx-B23 (see [Chapter 4.7.29, "Source step attenuators"](#), on page 308)
- Upgrade kits R&S ZNAXx-U161/U163 are available to retrofit direct source monitor access, with the same logic and prerequisites as for options R&S ZNAXx-B161/163. The R&S ZNA must be sent to Rohde & Schwarz service though.

4.7.35 Internal combiner

Options R&S ZNAXx-B212/B213

On a **2-port** R&S ZNAXx with hardware option R&S ZNAXx-B212, the source signals generated at physical ports **1** and **2** can be internally combined and routed to port 1.

On a **4-port** R&S ZNAXx with hardware option R&S ZNAXx-B213, the source signals generated at physical ports **1** and **3** can be internally combined and routed to port 1.

No external combiner or additional cabling is needed. The performance loss of [using the coupler as combiner](#) is avoided.

An internal combiner is particularly useful for [Intermodulation measurements](#) and [Embedded LO mixer group delay measurements](#), that require a two-tone signal.

It is possible to switch the combiner on or off between channels.



- Two-tone signals are *not* supported, if [External switch matrices](#) are part of the RF connection configuration.
- On a 2-port R&S ZNAxx, option R&S ZNAxx-B212 requires a second internal source.
See [Chapter 4.7.23, "Internal 2nd source and 2nd LO generator for 2-port R&S ZNA"](#), on page 303.
- On a **4-port** R&S ZNAxx, option R&S ZNAxx-B213 requires R&S ZNAxx-B21 and R&S ZNAxx-B23, i.e. source step attenuators at ports **1** and **3**.
On a **2-port** R&S ZNAxx, option R&S ZNAxx-B212 only requires R&S ZNAxx-B21.
See [Chapter 4.7.29, "Source step attenuators"](#), on page 308.
- To retrofit the internal combiner, the R&S ZNA must be sent to Rohde & Schwarz service.

4.7.36 Internal low noise preamplifier

Hardware options R&S ZNAxx-B302, R&S ZNA50-B312, R&S ZNA67-B312

Each of these hardware options provide an internal low noise pre-amplifier (LNA) at receive port 2 of a R&S ZNAxx, which is installed in parallel to the [receiver step attenuator](#). The LNA can apply a power gain of 20 dB, 25 dB, or 30 dB.



- R&S ZNA50/67-B302 is subject to **export control restrictions**.
R&S ZNA50/67-B312 is **not** subject to export control restrictions, but if this HW option is installed, the spectrum analysis software option R&S ZNA-K1 is blocked.
- Both R&S ZNAxx-B302 and R&S ZNA50/67-B312 require:
 - [Direct generator/receiver access](#) (option R&S ZNAxx-B16)
 - A receiver step attenuator at port 2 (option R&S ZNAxx-B32)

The internal LNA reduces the noise figure of the receiver at port 2 of the R&S ZNA, improving the quality of its [Chapter 4.7.11, "Noise figure measurement"](#), on page 289.

A schematic of the internal circuitry is shown in [Figure 4-39](#).

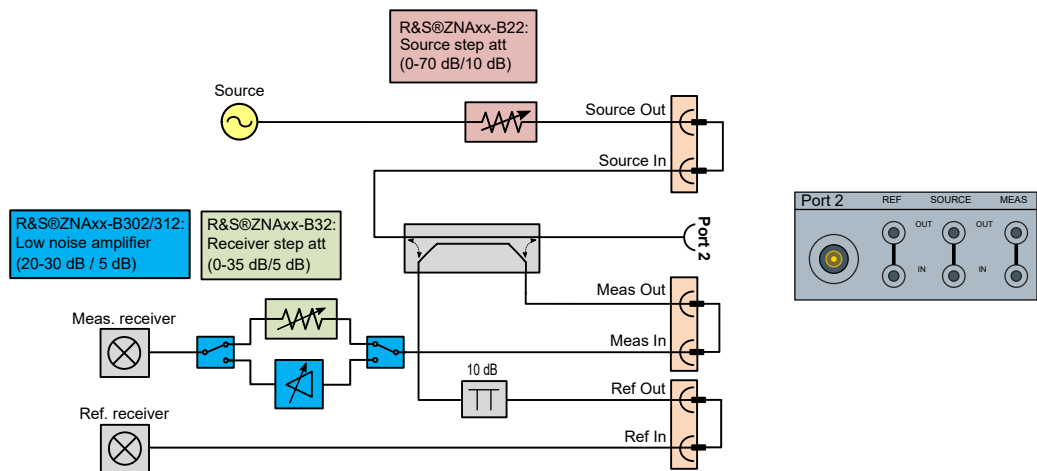

Figure 4-39: LNA circuitry: standard

For optimum receiver noise performance, it is recommended to use the [Direct generator/receiver access](#) in the reversed coupler configuration, as shown in [Figure 4-40](#).

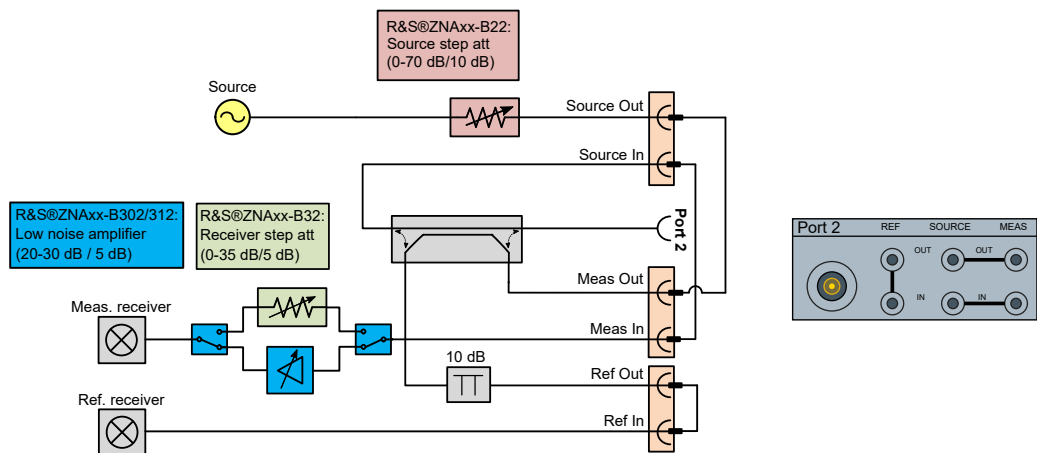

Figure 4-40: LNA circuitry: direct access with reversed coupler configuration

This configuration changes the connection of the source and the receiver at the coupler, as can be clearly seen in the simplified schematic in [Figure 4-41](#). The LNA and the cascaded receiver are therefore directly connected to the port without coupling loss, which further improves the overall receiver noise figure.

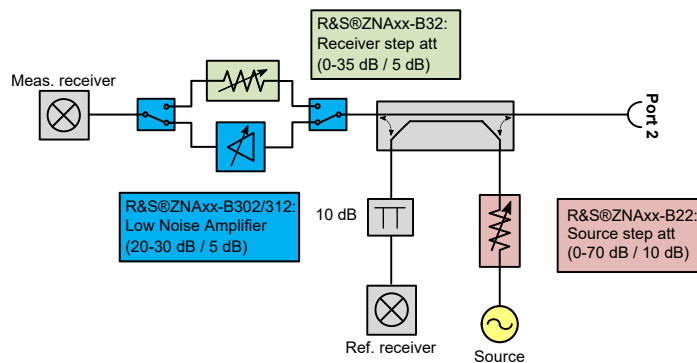

Figure 4-41: LNA circuitry: reversed coupler configuration (simplified)



Reversing the coupler and activating the LNA at port 2 lowers the 0.1 dB compression point to approximately -40 dBm. Choosing a lower gain of the LNA improves the compression point.

4.7.37 Internal low power spur reduction amplifier

Hardware options R&S ZNAxx-B501, R&S ZNA50-B511, R&S ZNA67-B511

The purpose of these options is to lower the local oscillator (LO) leakage at port 1, which is required for properly measuring high gain DUTs (> 60 dB) or DUTs with low input compression. To suppress the LO leakage, it adds a 30 dB switchable low noise amplifier (LNA) to the receiving path of port 1.

The LNA is located after the [receiver step attenuator](#), which can be freely set and therefore allows you to optimize the input compression and noise behavior at this measurement receiver. See [Figure 4-42](#).



- R&S ZNA50/67-B501 is subject to **export control restrictions**. R&S ZNA50/67-B511 is **not** subject to export control restrictions, but if this HW option is installed, the spectrum analysis software option R&S ZNA-K1 is blocked.
- The R&S ZNAxx must be equipped with a receiver step attenuator at port 1 (option R&S ZNAxx-B31)

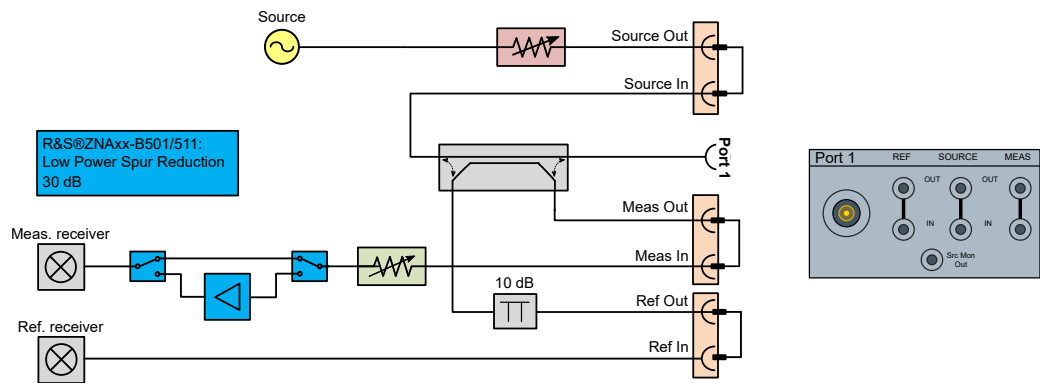

Figure 4-42: Internal Low Power Spur Reduction Amplifier circuitry: standard

To suppress the overall LO leakage at the port further, it is recommended to use the [Direct source monitor access](#) at port 1 (option R&S ZNAxx-B161). This configuration suppresses the LO leakage of the reference receiver. A full schematic showing the internal configuration is shown in [Figure 4-43](#).

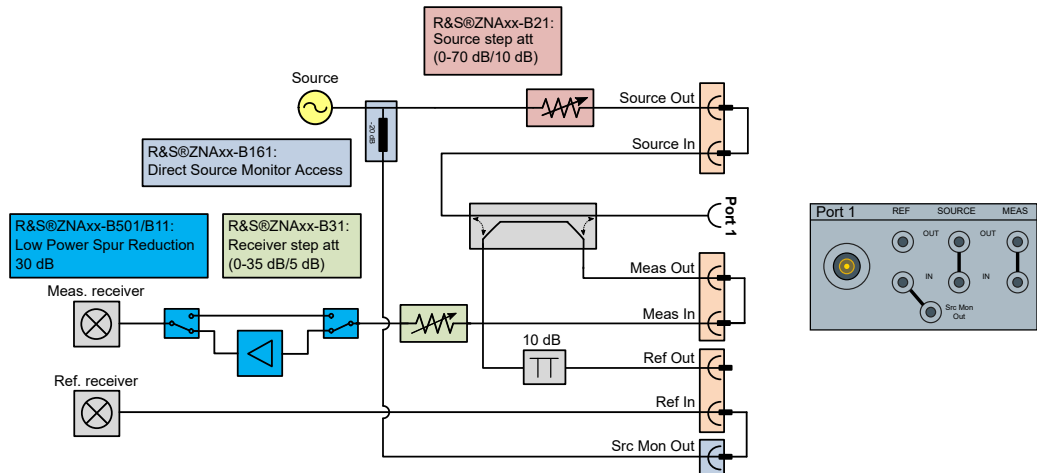

Figure 4-43: Internal Low Power Spur Reduction Amplifier with Direct Source Monitor Access

A simplified schematic showing only the relevant components for operation with only minor LO leakage is shown in [Figure 4-44](#).

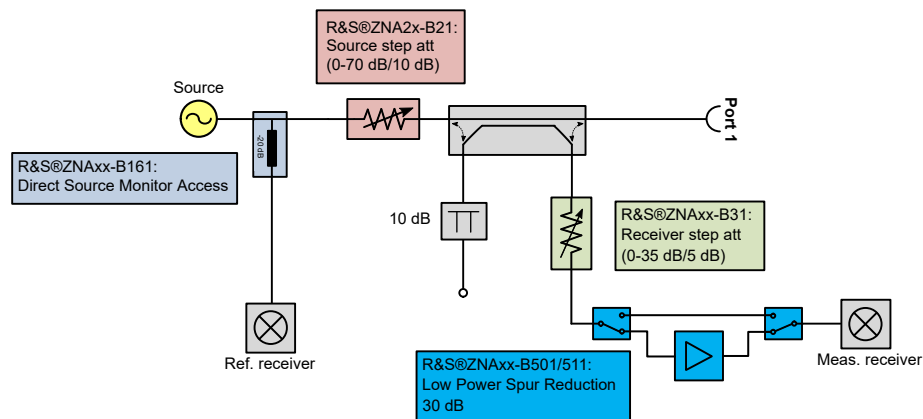

Figure 4-44: Internal Low Power Spur Reduction Amplifier with Direct Source Monitor Access (simplified)

4.7.38 USB-to-IEC/IEEE adapter

R&S ZVAB-B44

Hardware option R&S ZVAB-B44 (order no. 1302.5544.03) comprises an adapter and driver software for controlling external devices via IEEE 488 / IEC 625 (GPIB). The driver software is installed on the network analyzer. Connect the USB port of the adapter to any of the master USB connectors on the front or rear panel of the analyzer. Connect the GPIB port of the adapter to the external device.

This hardware option is required, if you want to use GPIB for two purposes at the same time:

- to control the R&S ZNA from an external controller (via the built-in GPIB bus connector)
- to control external devices from the R&S ZNA (via the adapter)



To get the adapter to work, you have to install the NI VISA library on the R&S ZNA.

4.7.39 External power meters

The connection of an external power meter to the R&S ZNA can serve different purposes.

- Extended measurement functionality: Each external power meter represents an additional receive port. External power meters increase the number of RF input signals of a DUT that the analyzer can measure simultaneously. They can also provide accurate results for signals at inaccurate or unknown frequencies. A typical example is a mixer measurement with an unknown LO signal (and therefore unknown IF output frequency).

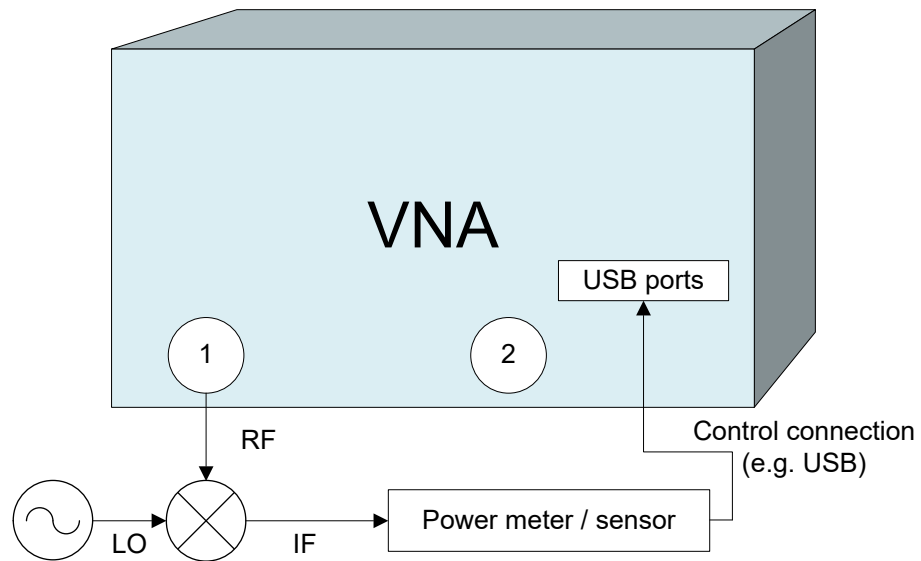

- Power calibration: An external power meter can measure the exact signal power at an arbitrary point in the test setup (reference plane) and thus provide the reference values for a power calibration. A typical example is a source power calibration for an arbitrary analyzer port.

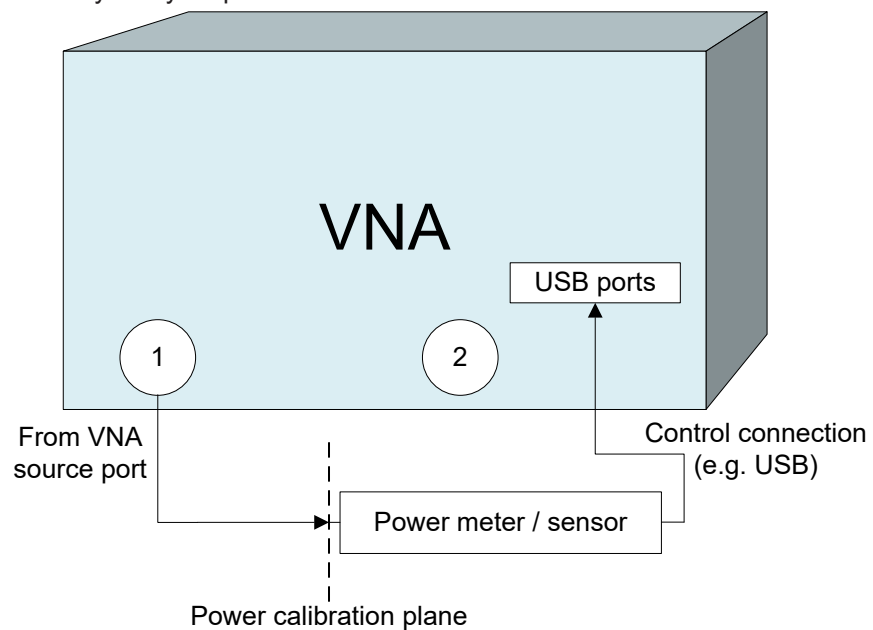

External power meters must be configured with their connection type and device address before they are available as additional receivers (System – [Setup] > "External Devices" > "Power Meters"). Configured power meters appear in many control elements of the R&S ZNA, e.g. in the port configuration and in the power calibration dialogs.

4.7.39.1 Zeroing

Zeroing calibrates the external power meter by adjusting its reading at zero signal power. For this purpose, the RF cable between the analyzer and the power sensor must be disconnected (see tips below!). R&S power sensors and power meters automatically detect the presence of any significant input power. This aborts zeroing and generates an error message. Zeroing can take a few seconds, depending on the power meter model; refer to the documentation of your external power meter for more information.



Repeat zeroing

- During warm-up after switching on or connecting the instrument
- After a substantial change of the ambient temperature
- After fastening the power meter to an RF connector at high temperature
- After several hours of operation
- When low-power signals are to be measured, e.g. less than 10 dB above the lower measurement limit.

A reset of the network analyzer does not affect the last zeroing result.

4.7.39.2 Power meters for mm-waves

The R&S ZNA supports the following power meters that are particularly suitable for [mm-wave converters](#).

- R&S NRP110T or its predecessor R&S NRP-Z58 for frequencies up to 110 GHz



Figure 4-45: R&S NRP110T

This power meter is equipped with a 1mm coax connector, so a suitable WRxx to 1 mm adapter is required. For details concerning its usage, see the R&S NRPxxT(N) or R&S NRP-Z Power Sensors User Manual.

- [VDI Erickson power meters PM5 and PM4](#) for frequencies above 110 GHz

VDI Erickson power meters PM5 and PM4

For frequencies above 110 GHz, VDI Erickson power meters PM5 or PM4 can be used.



The power meter's sensor head is equipped with a WR10 waveguide connector, so depending on the frequency converter model a suitable WRxx to WR10 waveguide taper is required. For details concerning its usage, see the respective PMx manual that is available from the VDI Erickson power meter product pages (<http://vadiodes.com/index.php/en/products/power-meters-erickson>).

Control connection

The control units of the PMx power meters are connected to the R&S ZNA via USB. The PM5 control unit is equipped with a USB interface, for the PM4 an additional USB-to-RS232 adapter is required. The PM5 can be auto-configured, the PM4 has to be configured manually.



The required USB-to-RS232 adapter is not delivered with the PM4. Presumably, an adapter-specific driver must be installed on the R&S ZNA.

After installing the required drivers and connecting the PM4 to the R&S ZNA, you can find a new virtual COM port in the "Ports (COM & LPT)" section of your Windows "Device Manager":

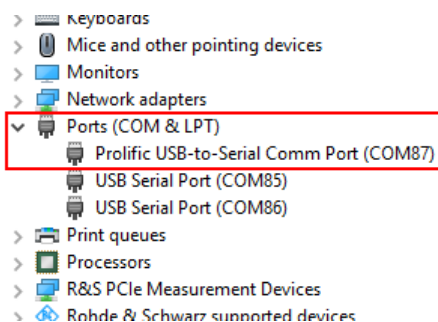

In the above screenshot, a converter cable with prolific chipset was used.



If you are in doubt about the related COM port, disconnect the PM4 and see which port will disappear and appear after reconnecting.

When configuring the PM4 in the External Power Meters dialog, the "Raw Serial" interface must be used, and the related COM port ("COM87" in our example) must be entered as "Address" parameter.

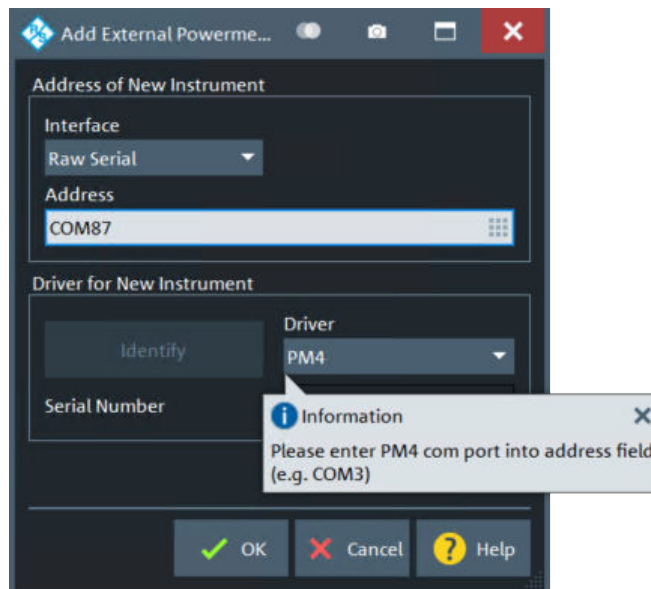

Ranging

For power meters PMx, setting the power range remotely is **not** supported by the R&S ZNA firmware.

Adjust the range switch of the PMx so that the maximum RF output power of the frequency converter is within the selected power range. See the data sheet of the related converter type and the suitable PMx manual for details.

Zeroing

To increase calibration accuracy – in particular for low measurement ranges – zeroing the PMx power meter is recommended. Zeroing is also recommended before a reference receiver calibration.

After mounting the sensor head to the frequency converter, allow sufficient thermal settling time (1 hour is recommended). After the system has reached thermal equilibrium, switch off the converter's RF output power by selecting Channel – [Pwr Bw Avg] > "Power" > "RF Off All Channels" on the R&S ZNA. Press the [ZERO] button on the front panel of the PMx. After that, reactivate the converter's output power by deselecting "RF Off All Channels".



For the PM5, zeroing can also be done from the analyzer GUI (Trace – [Meas] > "Power Sensor" > "Auto Zero". For the PM4, "Auto Zero" is not supported.

4.7.40 External generators

The connection of an external generator to the R&S ZNA can serve different purposes.

- Extended measurement functionality: Each external generator represents an additional source port. External generators increase the number of RF input signals for the DUT. A typical example is a mixer measurement with a 2-port analyzer, where an external generator provides the LO input signal.

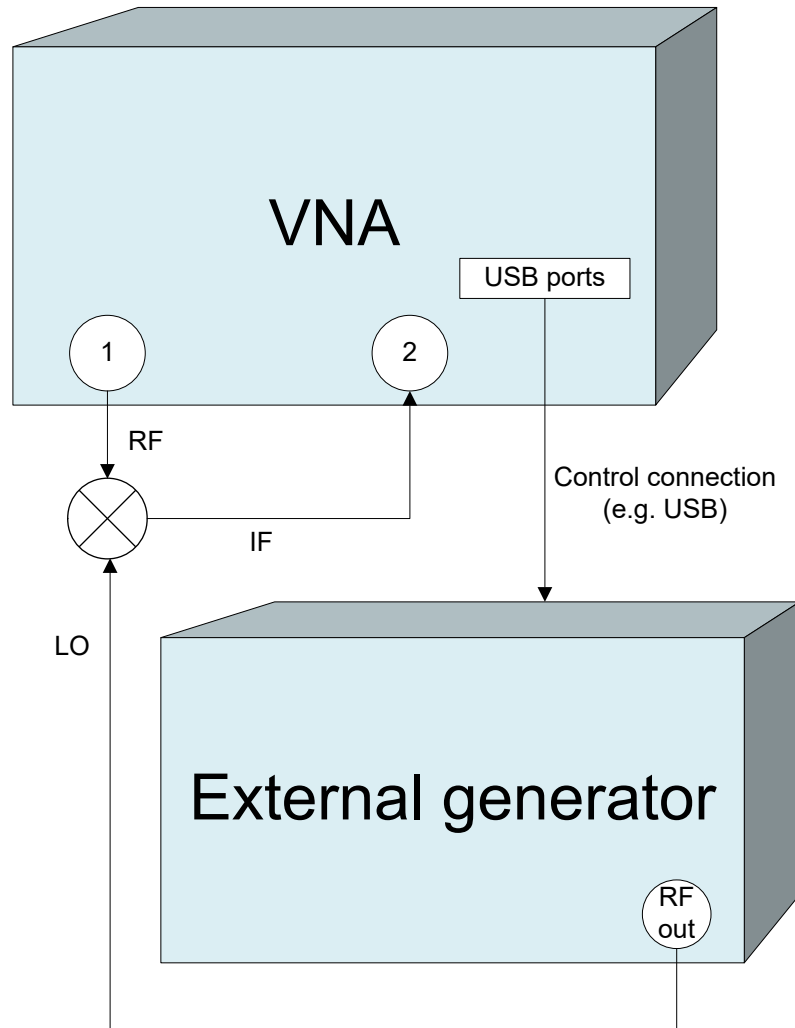

- Power calibration: An external generator can provide the reference signal for a source or receiver calibration. A typical example is a receiver power calibration using a measured wave b_1 .

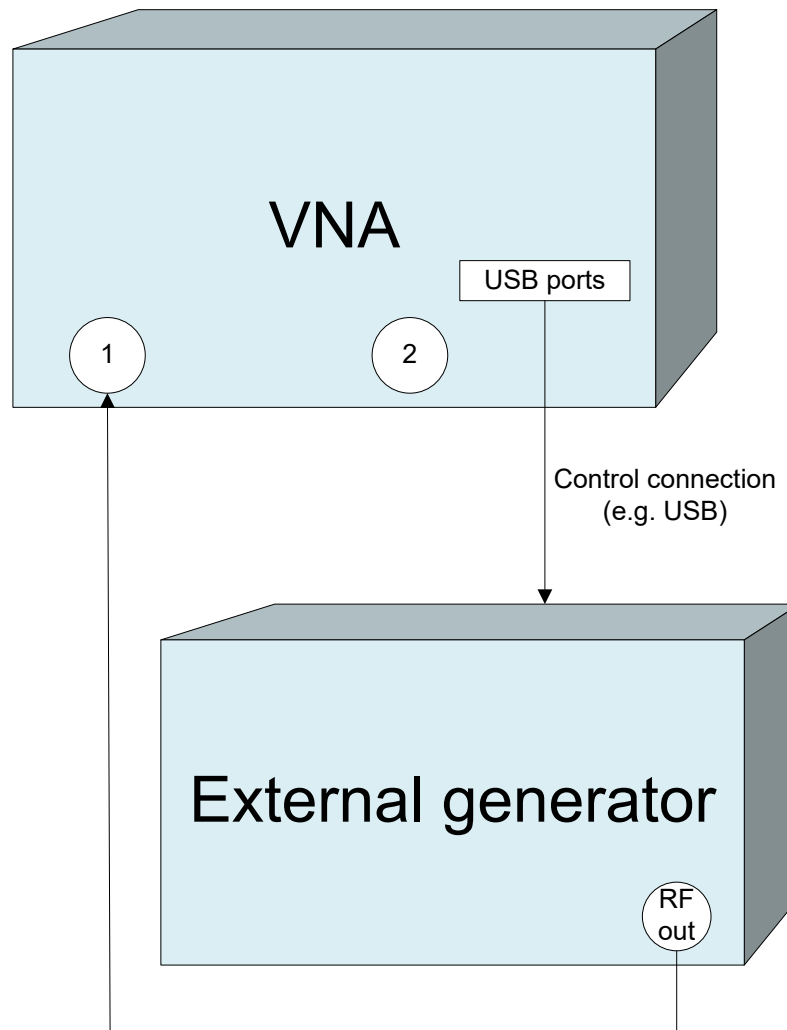

External generators must be configured in the System – [Setup] softtool before they are available as additional sources. Configured generators appear in many control elements of the R&S ZNA, e.g. in the "More Ratios", "More Wave Quantities", port configuration and power calibration dialogs.

Reference frequency

To ensure frequency accuracy and frequency stability in a test setup where different devices represent the signal sources and receivers, it is advisable to use a common reference frequency. Accurate frequencies are particularly important if external generators are used for measurements with narrow measurement bandwidths.

A common reference frequency can be established in different ways:

- Use the analyzer as master device: Set the analyzer to "Internal" frequency reference (System – [Setup] > "Freq. Ref." > "Internal") and operate all other devices in external reference mode using the reference clock signal from the Reference Out connector on the analyzer's rear panel.

- Use another device as master: Set the analyzer to "External" frequency reference and synchronize it (and all other devices) to the master's reference clock signal, fed in at the Reference In connector on the analyzer's rear panel.

Fast sweep mode and conditions

In list mode the external generator steps through a predefined list of frequencies or signal powers. This mode can be used to accelerate the measurements involving external generators. If "Fast Sweep" is activated in the "External Generators" dialog, the analyzer compiles a list of the stimulus values (frequencies and powers) in all channels and transfers it to the generator. The list is automatically updated and retransferred whenever the channel settings are changed.

The analyzer uses a trigger handshake mechanism in order to control the generator's list mode:

- The generator sends an EXT GEN BLANK signal to pin no. 22 of the User Port connector on the rear panel of the analyzer to show that it is ready to step to the next frequency or power value in the list.
- The analyzer transmits an EXT GEN TRG signal at pin no. 21 of the User Port connector in order to switch the generator to the next point in the list. Afterwards the analyzer waits for the next EXT GEN BLANK signal.

If the User Port connection is interrupted during the measurement, the sweep is halted. It is continued after a "Restart Sweep".



If the number of sweep points exceeds the maximum number of entries in the list (depending on the generator type), the analyzer must interrupt the sweep in order to send a new list and complete the stimulus information. This generally slows down the measurement.

Measurement process for external generators

The measurement process for **external generators** "Gen 1", "Gen2" ... differs from the measurement process for internal source ports:

- An external generator always represents a permanent signal source that is switched on for all partial measurements.
- The external source is measured in the first partial measurement where an internal source is active. This means that no separate partial measurement for the external generator signal is needed. If no internal source is needed at all, the external source is measured in the first partial measurement.

4.7.41 External switch matrices

4.7.41.1 Overview

From the perspective of the VNA, the purpose of a switch matrix is to extend the number of test ports. I.e. it converts an N-port network analyzer into an N'-port network analyzer ($N' > N$) without modifying the instrument itself. The increased number of test

ports can reduce or even eliminate the manual reconnections of the DUT, resulting in a higher measurement speed, reliability and repeatability.

Starting with version 2.60, the firmware of the R&S ZNA is able to control switch matrices from Rohde & Schwarz directly. For example, a 4-port R&S ZNA26 in combination with two R&S ZN-Z85 can work as a multi-port network analyzer with up to 48 ports, seamlessly performing the required matrix switching operations. However, the frequency range of the switch matrix is limited to 20 GHz.



While it is allowed to connect multiple matrices to a R&S ZNA, matrix cascading is **not** supported.

An N-port analyzer is always limited to measuring N signals simultaneously. I.e. even though the DUT is fully connected to the switch matrix, you cannot measure all its b-waves simultaneously. For example, consider a DUT with 6 unbalanced ports, connected to a 2-port analyzer via a 2x6 matrix (e.g. a R&S ZN-Z8x base unit without extensions). For each stimulus port, 5 sweeps are required to measure the resulting b-waves, $6 \cdot 5 = 30$ sweeps in total.

Furthermore, each additional sweep requires at least one matrix switching procedure. This procedure involves command processing and physical switching and hence can take some time to complete. For mechanical switches (such as R&S ZV-Z81 variant 66), in particular, switching is slow and causes mechanical wear. To optimize the measurement setup w.r.t. speed and resources, the characteristics of the available switch matrices have to be accounted for.

4.7.41.2 Matrix setup and operation

Setting up a switch matrix at the R&S ZNA firmware typically involves the following steps:

1. Establish the physical connection via the appropriate management interface (USB or LAN).
2. Register the matrix (as managed object).
3. Define the RF configuration:
 - a) Configure the matrix-VNA-connections according to the existing (or planned) physical connections between VNA test ports and matrix VNA ports.
 - b) Assign the matrix test ports and the remaining VNA ports (i.e. the VNA ports not connected to a matrix VNA port) to DUT test ports.

After this initial setup, the R&S ZNA takes control of the attached matrices: it allows you to configure the test ports and dynamically establishes the required matrix routes according to the current measurement task.



To make a measurement, set up a channel where all unused logical ports are disabled.

Switch matrices are global resources: their configuration is not part of a recall set. However, a recall set contains information about the required matrices and their RF connections. At the time the recall set is loaded, the R&S ZNA checks whether the same matrix setup is still active. If not, a wizard guides the user through the matrix configuration.

4.7.41.3 RF connections and matrix connectivity

Depending on the design of the switch matrix and the RF connections between VNA and matrix, the following limitations can occur:

- Certain matrix test ports are not available for measurements
- Certain transmission measurements are not possible

Example:

The 4x24 extension of switch matrix R&S ZN-Z84 consists of 2 separate 2x12 submatrices. Matrix VNA ports of the "left" submatrix cannot be connected to the test ports of the "right" submatrix and vice versa. If none of the two VNA ports of a submatrix is connected to the VNA, then obviously you cannot use the test ports of this submatrix for measurements.

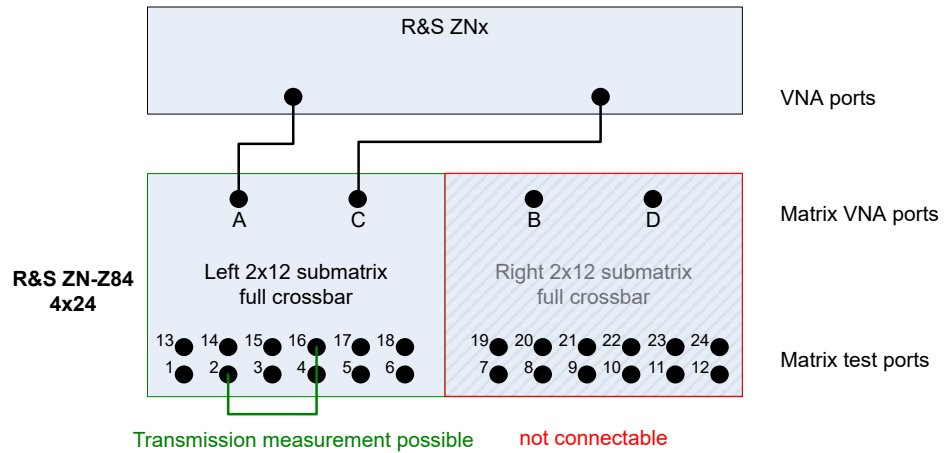

Figure 4-46: Unconnected right submatrix

With the same extension type, connecting one of two submatrix VNA ports enables reflection measurements for the corresponding matrix test ports. However, as long as a second connection between the VNA and this submatrix is missing, "intra-submatrix" transmission measurements are still impossible.

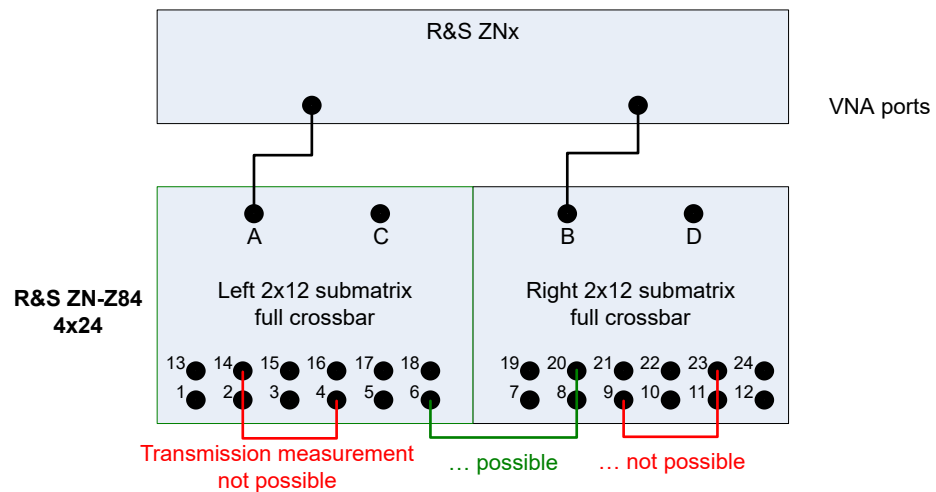

Figure 4-47: Partially connected submatrices

Basically the same argument holds true for variant 16 of switch matrix ZV-Z82, which consists of 4 separate 1x4 submatrices and that allows "inter-" but no "intra-submatrix" transmission measurements.

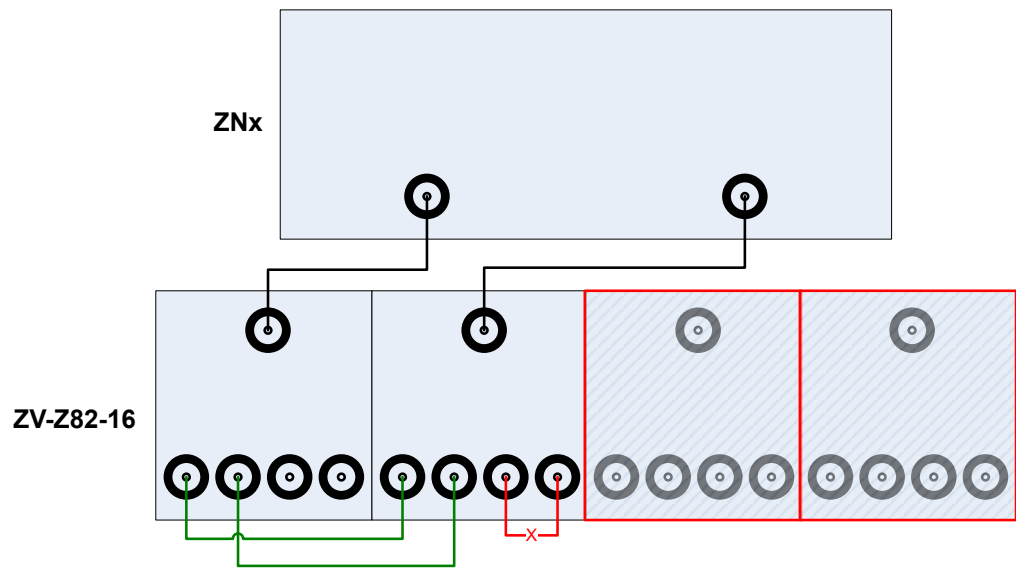

Figure 4-48: ZV-Z82-16: limited connectivity

4.7.41.4 Multiple paths: precision vs. speed

A switch matrix can offer multiple routes to a given matrix test port. Hence, measurements can be performed using different physical paths, where a *path* consists of the traversed VNA connections and matrix routes.

These paths can have different characteristics - in particular if the corresponding matrix routes differ in the number of semiconductor or mechanical switching functions that have to be traversed.

Example:

For switch matrix ZV-Z82-09, every test port can be reached via two different routes, traversing either one or two semiconductor switches:

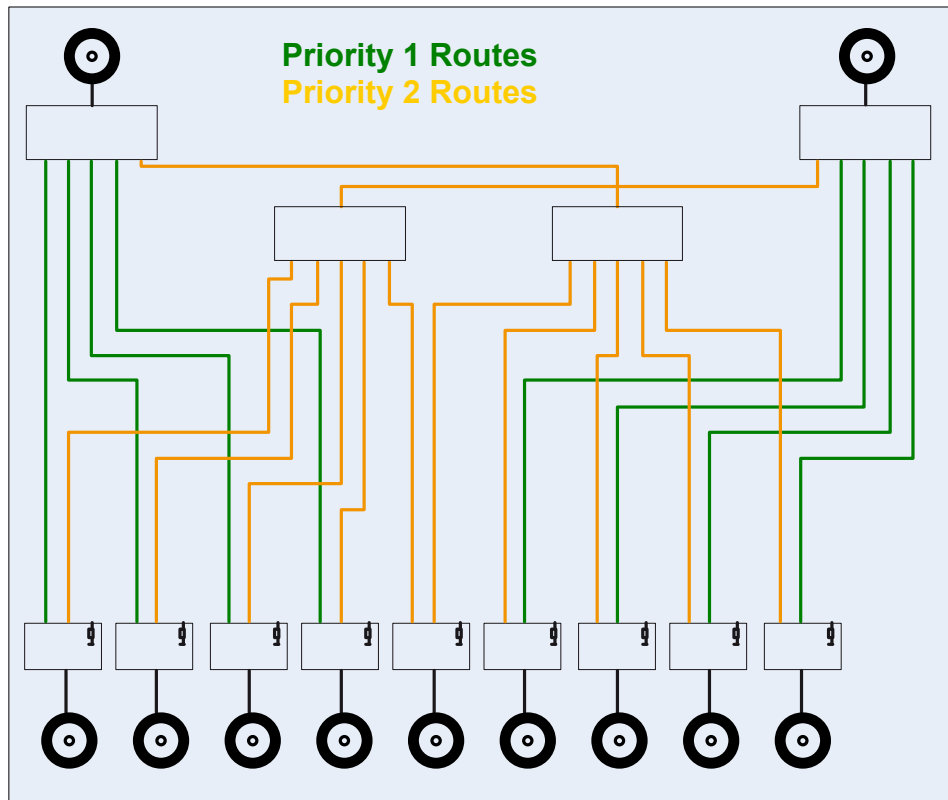

Figure 4-49: ZV-Z81 Routes and priorities

Example:

For an R&S ZN-Z8x, each route traverses exactly one of the equipped 2x6 modules. The overall route quality is determined by the number of solid state switches traversed on this 2x6 module:

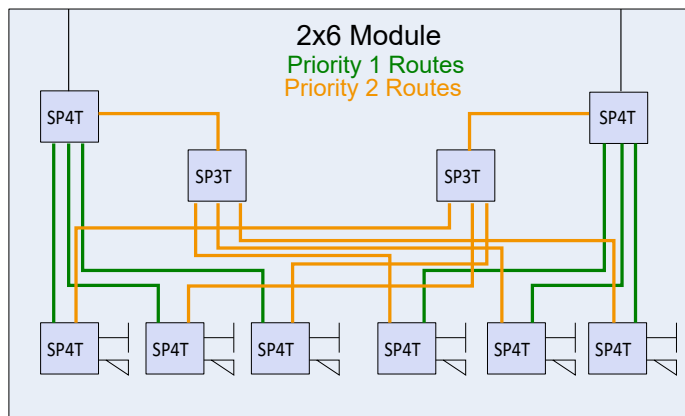

Figure 4-50: Routes and priorities



See the data sheet of the respective switch matrix for details on the available routes.

For every supported switch matrix, the available routes are prioritized according to the number of switches they traverse (the rectangles in [Figure 4-49](#)).

- To obtain highest measurement *precision*, the driving port uses the "best possible" (highest priority) route. On the other hand this can cause additional matrix switching procedures and hence can result in a reduced measurement speed.
- If the focus is on measurement *speed*, the number of matrix switching procedures is minimized, disregarding a possible loss in measurement precision.

The R&S ZNA allows you to select which optimization should be performed.

4.7.41.5 Multiple paths and calibration



With switch matrices, a signal loss of up to 25 dB is possible, so (full) calibration is a must! For a high number of test ports, manual calibration is time-consuming and error-prone, so automatic calibration (with auto-detection) is recommended.

During calibration, correction data are determined for all possible paths from the VNA to the related test ports. For the currently supported matrices a maximum of 2 paths per test port are available, resulting in a maximum of

- 2 paths per reflection measurement

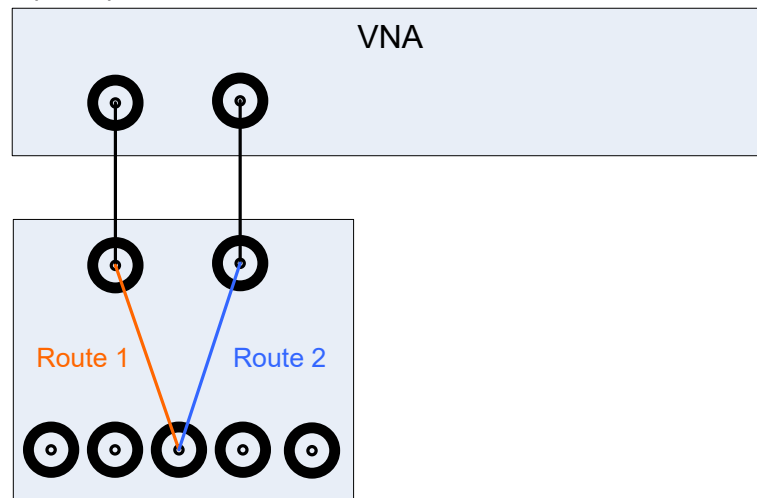

- 2 paths per transmission measurement for a 2-port VNA:

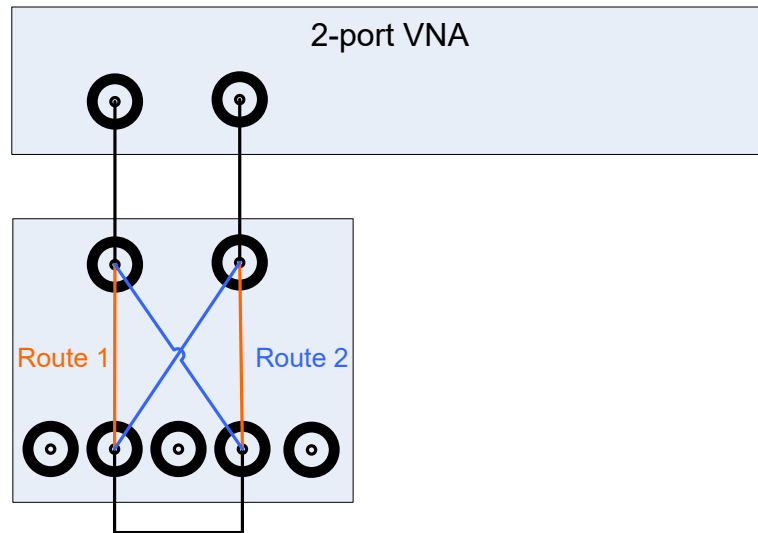

- 4 paths per transmission measurement for an N-port VNA with $N \geq 4$

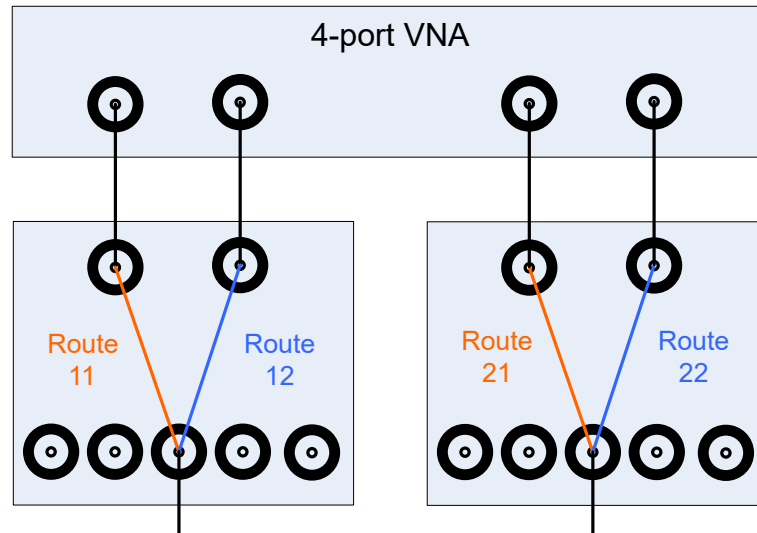

This kind of "multipath calibration" offers the following additional benefit:

During manual calibration, the measured reflection/transmission coefficients are presented as memory traces – one per path. By comparing these traces, it should be possible to track down hardware problems (cables, connectors, matrix, ...) already during calibration.

4.7.41.6 Cable sets R&S ZN-Z85ZNAC

Dedicated semi-rigid cable sets are available to connect the R&S ZNA to a switch matrix R&S ZN-Z85.

Table 4-22: Semi-rigid cable sets R&S ZN-Z85ZNAC

	Cable type	2-port VNA	4-port VNA
R&S ZNA26/43	2.92 mm (f) to 2.92 mm (m)	1339.4006.02 *	6-port matrices: 1339.4006.04 ** 12-port matrices: 1339.4006.06 ***
R&S ZNA50/67	1.85 mm (f) to 2.92 mm (m)	1339.4006.03 *	6-port matrices: 1339.4006.05 ** 12-port matrices: 1339.4006.07 ***
<p>* Supports:</p> <ul style="list-style-type: none"> • P1 ↔ Port A • P2 ↔ Port B or P2 ↔ Port C <p>** Supports:</p> <ul style="list-style-type: none"> • P1 ↔ Port A • P3 ↔ Port B or P2 ↔ Port B <p>*** Supports:</p> <ul style="list-style-type: none"> • P1 ↔ Port A • P3 ↔ Port C and P2 ↔ Port B, or P3 ↔ Port B and P2 ↔ Port C • P4 ↔ Port D 			

4.7.42 Generic devices

The Generic Devices functionality allows you to control VISA-capable external devices from the VNA that are a priori unknown to the analyzer firmware. Different device settings can be applied for each channel (sequencer functionality).



The firmware support of the R&S ZVAX-TRM extension unit is based on the generic devices functionality.

A generic device's control interface is declared in one or more device configuration files, using the popular [JavaScript Object Notation](#) (*.json file format). The following top-level keys are supported:

- "Header"
The "Header" object describes the content of the config file. Currently only its "File Format" key-value pair is evaluated and only the value 1.0 is accepted.
- "Device Identification"
The "Device Identification" object describes the device properties the analyzer firmware has to consider when interacting with the device. Currently only its "Settling Time" key-value pair is evaluated. It describes the time (number of seconds) the firmware must wait after sending a command sequence to the device.
- "Commands"
The "Commands" array defines possible commands (or rather command sequences) the analyzer firmware can send to the device.
Each command (sequence) is specified by:
 - A "Command Name" (string value), identifying the command
 - A Command List array whose members (JSON objects {"Command": "<Device command>"}) represent the individual commands to be sent to the device.



The "Command Name" value must be unique within a configuration file. It is used to select the respective command sequence at the GUI or via remote control.

Example: Generic Device Configuration

```
{
  "Header":
  {
    "File Format": 1.0
  },
  "Device Identification":
  {
    "Settling Time": 0.03
  },
  "Commands":
  [
    { "Command Name": "MySetting1",
      "Command List":
      [
        { "Command": "My:Device:Command 1" },
        { "Command": "My:Device:Command 2" }
      ]
    },
    { "Command Name": "MySetting2",
      "Command List":
      [
        { "Command": "My:Device:Command 1" }
      ]
    }
  ]
}
```



An identical "Settling Time" is used for all command sequences within a device configuration file. If certain command sequences require a significantly longer/shorter settling time, it is recommended to declare them in a separate config file.

4.7.43 External DLLs

The R&S ZNA firmware provides a plug-in interface that allows you to extend the VNA firmware with custom functionality (measurements, device control, ...).

The plug-in interface allows the external software to interact with the firmware before and after a change of the:

- channel
- drive port
- sweep segment
- sweep point

The plug-in then can perform arbitrary actions and eventually return data to the VNA firmware:

- as custom traces
- as input values for math functions for the calculation of other traces



To calculate a custom trace, the plug-in can make use of all data access points in the channel calculation chain. See [Chapter 4.1.7.1, "Channel data flow"](#), on page 120).

Furthermore, it can communicate with other processes / peripherals that are not part of the VNA firmware or host OS.

4.7.43.1 Basic use case

A basic use case is the integration of a power supply into an arbitrary VNA sweep.

Suppose that you want to test an amplifier with various bias settings. To do so, you can perform a CW sweep to measure S-parameters with different gate voltages applied to the amplifier at each sweep point.

With one power supply channel connected to the amplifier's gate, and another channel connected to the amplifier's drain, the measurement could proceed as follows:

1. At the beginning of the sweep, the power supply is initialized (e.g. voltage setting and current limit for each power supply channel) and then switched ON.
2. At the beginning of each sweep point, the plugin sets the power supply gate voltage to the next value.
3. At the end of each sweep point, the plugin reports the power supply reading of the gate voltage and drain current to the VNA. These readings are displayed in dedicated traces.
4. At the end of the sweep, the power supply is switched OFF.

4.7.43.2 Technology

The plug-in interface is a traditional C style DLL interface. Suitable DLLs can be compiled using different platforms, such as C or MATLAB. A plug-in is installed in the firmware as a *.zip file, containing the external DLL and, possibly, additional files to be kept with the DLL.

An SDK for external DLLs is provided with the analyzer firmware on the Rohde&Schwarz internet pages.



For details, see the HTML help topics that are distributed with the plugin SDK.

Interactions of the external DLL with analyzer firmware and external devices are synchronized with the measurement. Synchronization is done via callbacks from the FW, at so-called interrupts. At an interrupt, the measurement takes a break and waits

for the FW to continue. During an interrupt, the plugin can access external devices and return results to the FW.

The VNA firmware can abort the processing in the external DLL at any time, e.g. on a [Preset].

The DLL can handle certain trace types that must be uniquely named within the DLL. A naming scheme for traces allows the firmware (and hence the user) to request a particular trace.



If an external DLL is configured for permanent use, it performs a particular task (such as switching the state of a DUT or controlling external devices) without providing data.

4.7.43.3 Trace calculation in the channel calculation chain

To enable the calculation of trace results using data from external DLLs, a dedicated calculation step for external DLLs is inserted directly before the averaging step in the calculation chain (see [Chapter 4.1.7, "Data flow"](#), on page 120).

This position allows maximum flexibility, because:

- The trace calculation chain is limited to one input for one output
- The position allows the plugin to use the results of the averaging step, and the trace data is calculated in the same way as for other calculation steps
- All internal measurement types can be used as input for the new calculation step



The new calculation step is only enabled if a plugin is installed (and active), and a custom trace is requested.

The new calculation step serves all active external DLLs. When custom traces are requested, the firmware asks the related DLLs which input traces they need to calculate "their" traces. During the calculation, the requested inputs are provided to the DLL, which then calculates its requested traces.

Due to its position, all internal trace types are allowed as inputs. External types are also allowed if no circular dependency is created between them.

4.7.44 Power added efficiency

The Power Added Efficiency (PAE) is the ratio of the added RF power generated by an active two-port device (e.g. an amplifier) to the supplied DC power P_{DC} . The added RF power can be expressed as the difference between the power of the outgoing wave b_m at the output of the DUT and the power of the incident wave a_n at the input of the DUT; hence:

$$PAE = \frac{|b_m|^2 - |a_n|^2}{P_{DC}}$$

Positive PAE values indicate a gain in the RF power, negative values an attenuation. The PAE is always smaller than 1.

The PAE measurement is based on the standard test setup for forward S-parameter measurements on a 2-port DUT. An additional measurement to determine the supplied power P_{DC} is required.

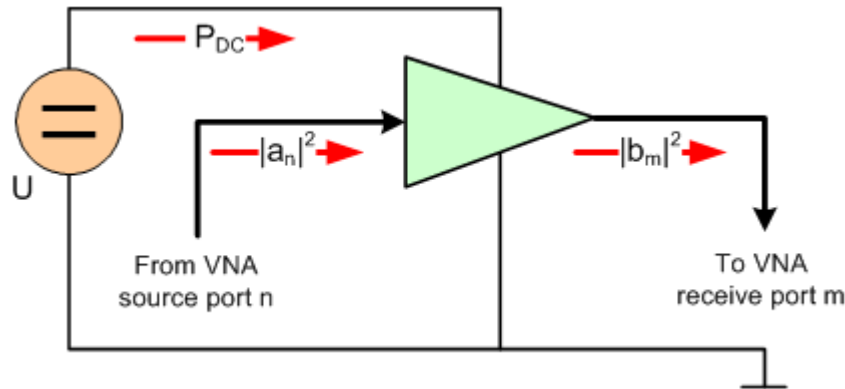

DC power measurement

For the R&S ZNA an external power supply is required to measure P_{DC} .

4.7.45 R&S ZNXSIM

With the R&S ZNXSIM PC simulation, you can have all the functions of an R&S ZNA, R&S ZNB, R&S ZNB or R&S ZND on your desktop. Always accessible, even when you do not have access to the hardware.

The same software that runs on the instrument (firmware) is used to run the simulation.

- The R&S ZNA firmware simulates all available R&S ZNA models. It can be installed in parallel with an R&S ZNB or R&S ZND firmware, but only one of them can be run at a time.
- The R&S ZNB firmware simulates all R&S ZNB, R&S ZNBT, and R&S ZND models. It also comprises the documentation for all these instruments.
- The R&S ZND firmware also simulates all R&S ZNB and R&S ZNBT models, but only comprises the R&S ZND docs.

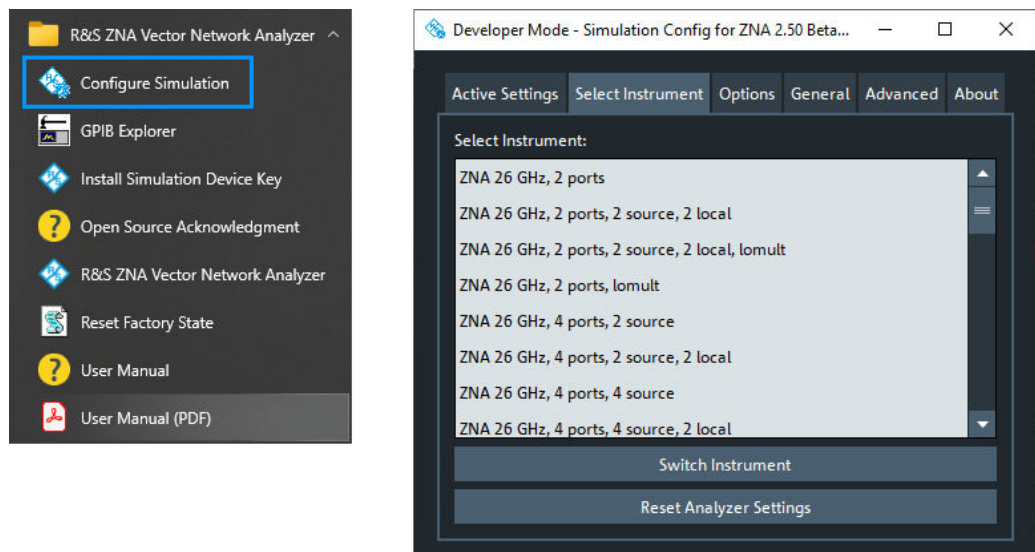

Figure 4-51: Instrument selection



For information on installation and licensing, see the R&S ZNXSIM Getting Started manual available at <https://www.rohde-schwarz.com/manual/ZNXSIM>.

4.7.45.1 Simulation data

The firmware simulation displays traces. To this end, it loads simulation data from file, by default from

```
C:\Program Files\Rohde-Schwarz\Vector Network Analyzer\ZNA\
Resources\Simulation\Measurements\
InputBufferGroupSimulation.s4p.
```

This **Touchstone** file contains the 16 S-parameter traces of a 4-port network (4x4 S-matrix), measured at 1193 points in the frequency range from 0 GHz to 70 GHz. The S-Matrix "simulates" a linear network (DUT) connected to VNA ports 1 to 4.

For 2-port VNAs, the left upper 2x2 submatrix is used.

For instruments with $N \geq 4$ ports (on the VNA and connected switch matrices), the firmware replicates the loaded S-matrix $[N/4]^2$ times, and uses the left upper $N \times N$ matrix:

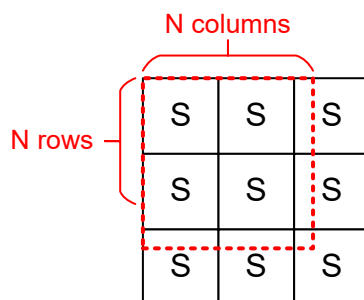

Figure 4-52: S-matrix replication

By default, the firmware simulation applies `InputBufferGroupSimulation.s4p` to all channels in all setups.

For each setup in the firmware simulation, you have two possibilities to define and refine the simulated DUT.

1. Load setup-specific simulation data from file.
For the related setup, they take precedence over the default simulation data.
If the number of physical test ports is larger than the "rank" of the S matrix the firmware loads from the specified file (N for `sNP` files), the previously mentioned [replication logic](#) applies.
2. Load channel-specific simulation data from file.
For the related channel, they take precedence over the data of the setup-specific and default simulation data.
Again, the previously mentioned replication logic applies.



To determine S_{ij} at a channel frequency, the firmware interpolates between the two "closest" frequencies of the S-parameter trace ultimately loaded for S_{ij} .

4.7.45.2 Simulation noise

The firmware simulation allows you to add noise to the simulated data, i.e. a random small value added to the simulation data loaded from file. This random value changes every sweep and every sweep point in time, with the effect of seeing more "realistic" fluctuating traces, in particular in continuous sweep mode.

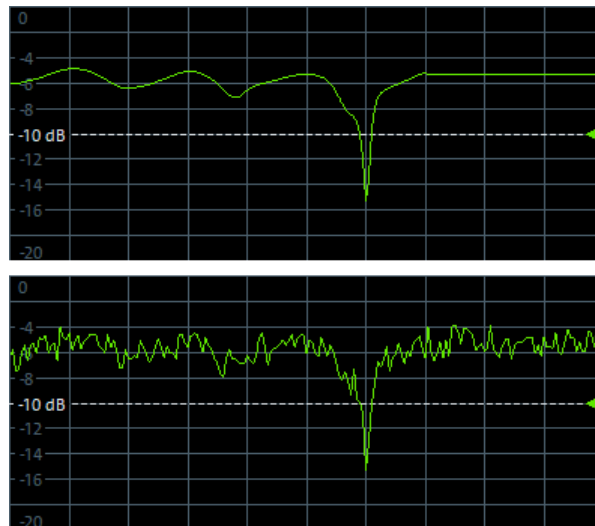

Figure 4-53: Simulation noise



- Since version 2.60 of the analyzer firmware, simulation noise can be activated or deactivated from the analyzer GUI.
See [Chapter 5.15.6, "More tab"](#), on page 781.
- Make sure to deactivate "Simulation Noise" before exporting traces to file (see [Chapter 4.4.2, "Trace files"](#), on page 176). Otherwise the exported results comprise an "artificial" random component.

5 GUI reference

This chapter describes the Graphical User Interface (GUI) of the analyzer.

The most convenient way to access the GUI functions is via [Softtools](#). Hence the GUI reference is structured accordingly.

The softtools, in turn, can be opened in the following ways:

- via the [function keys](#) in the control window
- via the keys on the virtual [Chapter 3.3.2.6, "Hardkey panel"](#), on page 53
- via the items in the main menu

For details, see [Chapter 5.1, "Function keys and softtools"](#), on page 339.

In case a GUI function can also be performed via remote control, one or more links at the end of the function description point to the related remote control commands.



For a general overview of the analyzer's capabilities and their use, refer to [Chapter 4, "Concepts and features"](#), on page 107.

5.1 Function keys and softtools

Most of the [function keys](#) in the control window serve as "openers" for an associated softtool in the analyzer GUI.

By default, the following "opener logic" is applied:

- If the associated softtool is not displayed, pressing the key
 - opens the associated softtool
 - activates its first enabled tab (default) or the last used tab (see ["Use Default Tab for Hardkey"](#) on page 862)
 - activates the first enabled input control on this tab (if any)
- If the associated softtool is already displayed, pressing the hardkey
 - activates the next enabled tab on the associated softtool (cyclically)
 - activates the first enabled input control on this tab (if any)

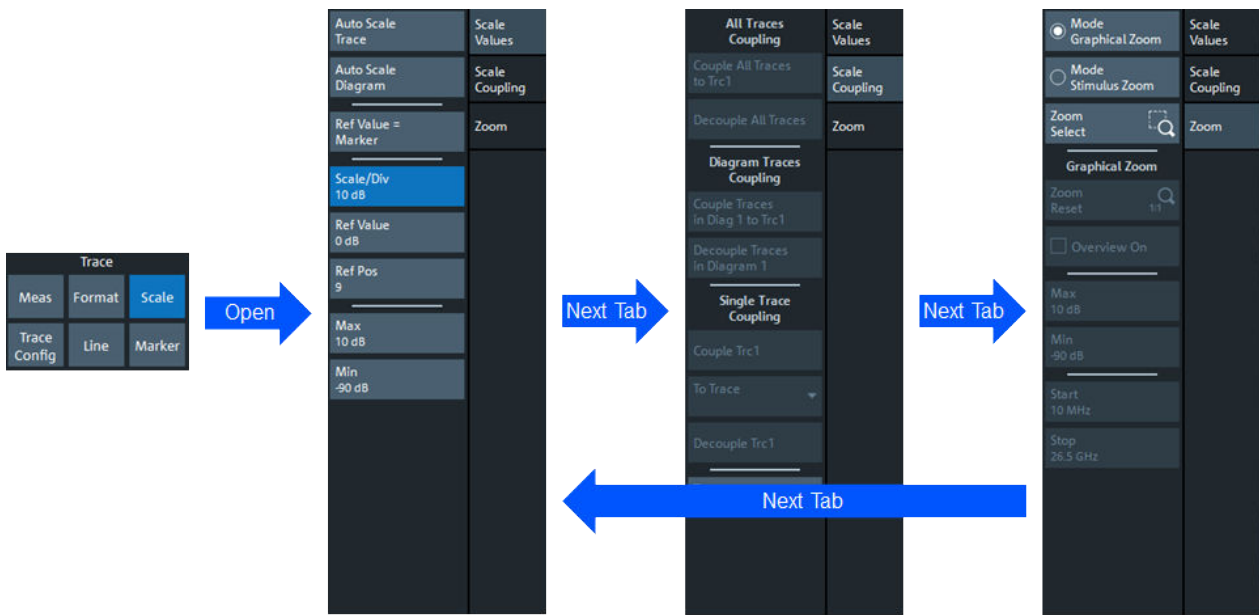

Table 5-1: Function keys and softtools

Function Key	Keyboard Shortcut	Related Softtool	Action
Trace – [Meas]	Alt + Shift + A	Meas softtool	default
Trace – [Format]	Alt + Shift + B	Format softtool	default
Trace – [Scale]	Alt + Shift + C	Scale softtool	default
Trace – [Trace Config]	Alt + Shift + D	Traces softtool	default
Trace – [Line]	Alt + Shift + E	Lines softtool	default
Trace – [Marker]	Alt + Shift + G	Marker softtool	default
Stimulus – [Start]	Alt + Shift + J	Stimulus softtool	Selects an input control corresponding to the start, stop, center or span of the active channel's current sweep type. Activates the corresponding tab on the "Stimulus" softtool.
Stimulus – [Stop]	Alt + Shift + K		
Stimulus – [Center]	Alt + Shift + F		
Stimulus – [Span]	Alt + Shift + H		
Channel – [Pwr Bw Avg]	Alt + Shift + L	Pwr Bw Avg softtool	default
Channel – [Sweep]	Alt + Shift + M	Sweep Softtool	default
Channel – [Cal]	Alt + Shift + P	Cal softtool	default
Channel – [Chan- nel Config]	Alt + Shift + O	Channel Config softtool	default
Channel – [Mode]	Alt + Shift + R	Mode softtool	default
Channel – [Off- set Embed]	Alt + Shift + Q	Offset Embed softtool	default
System – [File Print]	Ctrl + O	File Print softtool	default
System – [DUT]	Ctrl + P	DUT softtool	default

Function Key	Keyboard Shortcut	Related Softtool	Action
System – [Applic]	Ctrl + N	Applic softtool	default
System – [Display]	Ctrl + S	Display softtool	default
System – [Setup]	Ctrl + T	Setup softtool	default
System – [Preset]	Ctrl + U	Preset softtool	default + preset (normal or user-defined)

5.2 Meas softtool

The "Meas" softtool allows you to select the quantities to be measured and displayed.

A fundamental distinction is made between frequency converting and non-frequency converting DUTs (see [Chapter 5.2.1, "Measurement type"](#), on page 341).

Access: Trace – [Meas]



Background information

For a detailed description of all measurement results of the R&S ZNA, refer to [Chapter 4.3, "Measurement results"](#), on page 149.



Efficient trace handling

To select a result and display it as a trace, you can simply drag and drop the corresponding button into a diagram area. See also [Chapter 3.3.5, "Handling diagrams, traces, and markers"](#), on page 58.

Port activation on demand

If a requested result involves disabled ports, but could be calculated if those ports were configured as single-ended ports with "logical port number = physical port number", then the required logical port configuration is performed automatically.

For example, with P1 assigned to L1 and P2 disabled, S21 could be measured if P2 would be assigned to L2.

5.2.1 Measurement type

The R&S ZNA allows you to select between measurements on a non-frequency-converting DUT ("S-Params") or a frequency-converting DUT ("Mixer Params").



Measurements on frequency-converting DUTs require option R&S ZNA-K4.

Because some of the measurements are only available for either the one or the other type of DUT, the tabs in the "Meas" softtool are adjusted according to the one selected.

Depending on the desired DUT and measurement, the measurement channel has to be prepared in a particular way. A dedicated multi-channel setup dialog guides you through the channel configuration (see [Chapter 4.2.2.3, "Multi-channel setup dialog"](#), on page 139).

S-Params (Non-Frequency Converting DUTs)

The "Meas" softtool for non-frequency converting DUTs provides the following tabs:

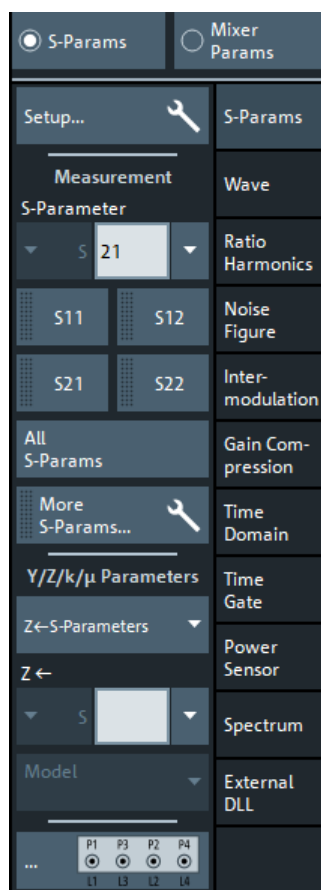

Table 5-2: Meas softtool for S-Params Measurements

"Meas" softtool tab	Channel Mode	Required Software Option
S-Params tab	S-Params	-
Wave tab		
Ratio Harmonics tab	S-Params	The "Harmonics" part requires R&S ZNA-K4
Noise Figure tab	Noise Figure	R&S ZNA-K30
Intermodulation tab	Intermodulation	R&S ZNA-K4
Gain Compression tab	Amplifier Compression	-
Time Domain tab	-	R&S ZNA-K2
Time Gate tab		

"Meas" softtool tab	Channel Mode	Required Software Option
Power Sensor tab	-	-
Spectrum tab	Spectrum	R&S ZNA-K1
External DLL tab		-

Mixer Params (Frequency Converting DUTs)

All frequency converting measurements require software option R&S ZNA-K4 (see [Chapter 4.7.3, "Frequency conversion measurements"](#), on page 261). If this option is not available, the "Mixer Params" measurement type and the corresponding tabs are not available.

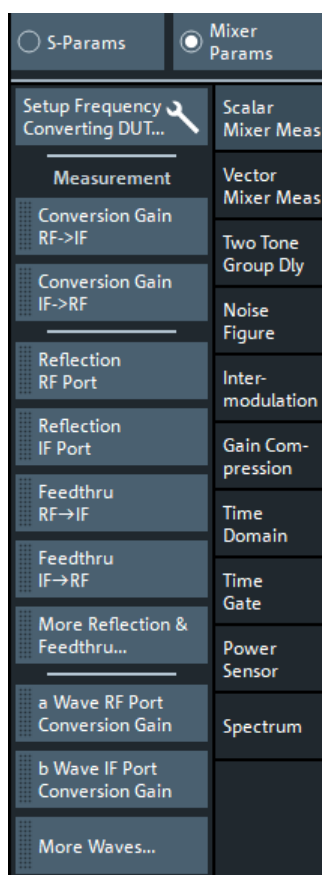

Table 5-3: Meas softtool for Mixer Params Measurements

"Meas" softtool tab	Channel Mode	Required Software Option (in addition to R&S ZNA-K4)
Scalar Mixer Meas tab	Scalar mixer measurements	-
Vector Mixer Meas tab	Vector mixer measurements	R&S ZNA-K5
Two Tone Group Dly tab (frequency-converting DUT)	Embedded LO mixer group delay measurements	R&S ZNA-K9
Noise Figure tab	Noise figure measurement	R&S ZNA-K30

"Meas" softtool tab	Channel Mode	Required Software Option (in addition to R&S ZNA-K4)
Intermodulation tab	Intermodulation measurements (frequency converting)	-
Gain Compression tab	Converter compression	
Time Domain tab	Time domain analysis	R&S ZNA-K2
Time Gate tab		
Power Sensor tab	-	-
Spectrum tab	Spectrum analyzer mode	R&S ZNA-K1

5.2.2 S-Params tab

The "S-Params" tab gives access to measurements that are typically used to characterize passive, non-frequency converting DUTs. S-parameters are the basic measured quantities of a network analyzer. They describe how the DUT modifies a signal that is transmitted or reflected in forward or reverse direction. S-parameters, and similarly Y- and Z-parameters, fully characterize a linear DUT.



Background information

Refer to:

- [Chapter 4.3.1, "S-parameters"](#), on page 149
- [Chapter 4.3.3, "Impedance parameters"](#), on page 154
- [Chapter 4.3.3.1, "Converted impedances"](#), on page 154
- [Chapter 4.3.3.2, "Z-parameters"](#), on page 156
- [Chapter 4.3.4, "Admittance parameters"](#), on page 157
- [Chapter 4.3.4.1, "Converted admittances"](#), on page 157
- [Chapter 4.3.4.2, "Y-parameters"](#), on page 157
- [Chapter 4.3.6.3, "Imbalance and common mode rejection"](#), on page 165
- [Chapter 4.3.7, "Stability factors"](#), on page 166

5.2.2.1 Controls on the S-Params tab

The appearance of the "S-Params" tab depends on whether the R&S ZNA is equipped with the [Frequency conversion measurements](#) option R&S ZNA-K4.



Setup

Opens the [S-Params setup dialog](#).

S-Parameter (selector)

Selects an [S-parameters](#) as a measured quantity for the active trace.

Single-ended (unbalanced) S-parameters are referred to as S<out>< in>, where <out> and <in> denote the output and input **logical** port numbers, respectively.

If entered manually, <out> and <in> must be expressed using the same number of digits. I.e. for <out>=10 and <in>=9 you can specify S<out>< in> as S1009 or S010009, but not as S109.

In presence of balanced ports, standard S-parameters are defined in the form S<m_out><m_in><out><in>, where output mode <m_out> and input mode <m_in> can be one of:

- d (differential, balanced)
- c (common, balanced)
- s (single-ended, unbalanced)

It is also possible to display "raw" single-ended S-parameters within the same channel: after setting the S-Parameter type to "S" any pair of (used) **physical** ports can be selected.

Remote command:

```
CALCulate<Ch>:PARAmeter:MEASure
CALCulate<Ch>:PARAmeter:MEASure:SENDEd
CALCulate<Ch>:PARAmeter:SDEFine
CALCulate<Ch>:PARAmeter:SDEFine:SENDEd
```

S<out><in>

Selects one of the four elements of the standard 2-port [S-parameters](#) as a measured quantity for the active trace.

Remote command:

```
CALCulate<Ch>:PARAmeter:MEASure "<Trace_Name>", "S11" | "S12" |
"S21" | "S22"
CALCulate<Ch>:PARAmeter:SDEFine "<Trace_Name>", "S11" | "S12" |
"S21" | "S22"
```

All S-Params

With the active logical ports distributed to m DUTs with n_1, \dots, n_m ports, respectively, the analyzer creates $n_1^2 + \dots + n_m^2$ diagrams and displays the full set of [S-parameters](#), one in each diagram. The diagrams are arranged as an $n \times n$ grid.

If "All S-Params" would result in more than 100 diagrams being created, it is disabled.

Remote command:

```
CALCulate<Ch>:PARAmeter:SDEFine
CALCulate<Ch>:PARAmeter:DEFine:SGRoup
```

More S-Params...

Opens a dialog that allows to select an arbitrary S-parameter as measured quantity, along with a suitable [Detector](#). See [Chapter 5.2.2.3, "More S-Params dialog"](#), on page 350.

Y/Z/k/ μ -Parameters

Allows you to select other measurement results that are typically used to characterize a linear DUT. All these results can be calculated from the DUT's S-parameters.

If entered manually, the logical port numbers must be expressed using the same number of digits. I.e. for $\text{<out>}=10$ and $\text{<in>}=9$ you can specify S<out>< in> as S1009 or S010009, but not as S109.

Z ← S-Parameters ← Y/Z/k/ μ -Parameters

Allows you to select a converted impedance as measured quantity.

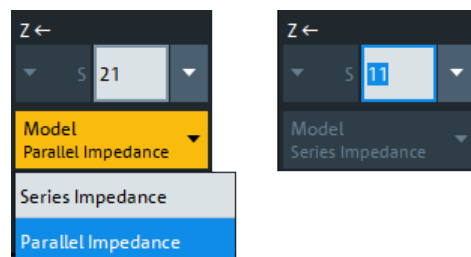

A converted impedance is calculated from the corresponding S-parameter, which can be selected in the pull-down lists below "Z ←". In case a transmission parameter is selected, you can choose between a [series](#) and a [parallel](#) impedance calculation.

For background information, see [Chapter 4.3.3.1, "Converted impedances"](#), on page 154.

Remote command:

```
CALCulate<Ch>:PARAmeter:MEASure "<Trace_Name>", "Z-S11" |
"Z-S12" | "Z-S12SER" | "Z-S12PAR" ...
```

```
CALCulate<Ch>:PARAmeter:SDEFine "<Trace_Name>", "Z-S11" |
"Z-S12" | "Z-S12SER" | "Z-S12PAR" | ...
```

Y ← S-Parameters ← Y/Z/k/μ-Parameters

Allows you to select a converted admittance as measured quantity.

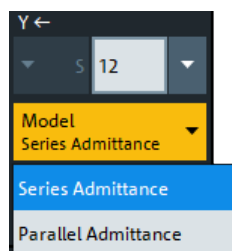

A converted admittance is calculated from the corresponding S-parameter, which can be selected in the pull-down lists below "Y ←". In case a transmission parameter is selected, you can choose between a series and a parallel admittance calculation.

For background information, see [Chapter 4.3.4.1, "Converted admittances"](#), on page 157.

Remote command:

```
CALCulate<Ch>:PARAmeter:MEASure "<Trace_Name>", "Y-S11" |
"Y-S12" | "Y-S12SER" | "Y-S12PAR" ...
```

```
CALCulate<Ch>:PARAmeter:SDEFine "<Trace_Name>", "Y-S11" |
"Y-S12" | "Y-S12SER" | "Y-S12PAR" | ...
```

Y/Z-Parameters ← Y/Z/k/μ-Parameters

Allows you to select an admittance (Y-) or impedance (Z-) parameter as measured quantity. Both Y- and Z-parameters can serve as an alternative to S-parameters for characterizing a linear n-port network.



In absence of balanced ports, Y- and Z-parameters are expressed as $Y/Z_{<i><j>}$, where $<i>$ and $<j>$ denote logical ports numbers. Otherwise they are expressed as $Y/Z_{<m_j><m_j> <i><j>}$, where $<m_j>$ and $<m_j>$ denote the port modes of the related logical ports $<i>$ and $<j>$.

For background information, see [Chapter 4.3.4.2, "Y-parameters"](#), on page 157 or [Chapter 4.3.3.2, "Z-parameters"](#), on page 156.

Remote command:

```
CALCulate<Ch>:PARAmeter:MEASure "<Trace_Name>", "Y11" |
"Z11" ...
CALCulate<Ch>:PARAmeter:SDEFine "<Trace_Name>", "Y11" |
"Z11" ...
```

Imbalance/CMRR ← Y/Z/k/μ-Parameters

Allows you to select an imbalance or common mode rejection ratio (CMRR) parameter as measured quantity. These measurements are only available if at least one balanced port is active.

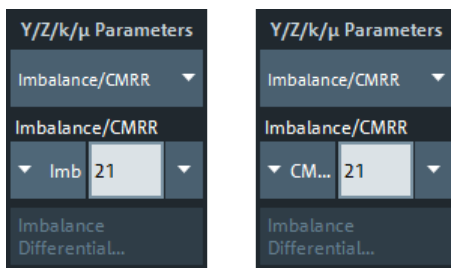

These parameters are expressed as "Imb_{<out><in>}" or "CMRR_{<out><in>}", where <out> and <in> denote logical port numbers.

For background information, see [Chapter 4.3.6.3, "Imbalance and common mode rejection"](#), on page 165.

The "Imbalance Differential..." dialog opener button is only enabled, if a balanced and two single-ended logical ports are configured in the [Balanced Ports dialog](#). See [Imbalance Differential dialog](#).

Remote command:

```
CALCulate<Ch>:PARAmeter:MEASure "<Trace_Name>", "IMB21" |
"IMB12" | "CMRR11" | "CMRR21" | "CMRR12" ...
CALCulate<Ch>:PARAmeter:SDEFine "<Trace_Name>", "IMB21" |
"IMB12" | "CMRR11" | "CMRR21" | "CMRR12" ...
```

Stability ← Y/Z/k/μ-Parameters

Allows you to select one of the three two-port stability factors K, μ_1 or μ_2 as measured quantities.

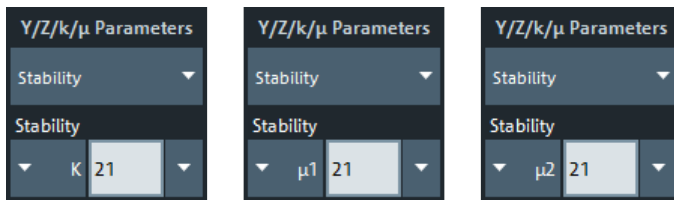

The stability factor calculation is based on 2-port reflection **and** transmission S-parameters so that the input and output port numbers must be different. The pull-down list contains all possible physical (single-ended) port combinations. For an analyzer with n ports, provides n·(n-1) stability parameters.

Stability parameters are expressed as " $K_{\langle out \rangle \langle in \rangle}$ ", " $\mu 1_{\langle out \rangle \langle in \rangle}$ ", and " $\mu 2_{\langle out \rangle \langle in \rangle}$ ", where $\langle out \rangle$ and $\langle in \rangle$ denote logical port numbers.

A typical application of stability factors is to assess the stability of an amplifier. Stability factors cannot be calculated in balanced port configurations. For background information, see [Chapter 4.3.7, "Stability factors"](#), on page 166.

Remote command:

```
CALCulate<Ch>:PARAMeter:MEASure "<Trace_Name>", "KFAC21" |
"MU121" | "MU221" | ...
CALCulate<Ch>:PARAMeter:SDEFine "<Trace_Name>", "KFAC21" |
"MU121" | "MU221" | ...
```

Balanced Ports...

Opens a dialog that allows you to enable/disable physical ports and to define logical ports (balanced or unbalanced) in the active channel. See [Chapter 5.2.2.5, "Balanced Ports dialog"](#), on page 352.

Note: If either multiple DUTs are configured (see [Chapter 5.12.2.3, "Define Parallel Measurement dialog"](#), on page 682) or the "Fixture Simulator" is disabled for the related channel (see ["Fixture Simulator"](#) on page 655), the "Balanced Ports..." button is inactive (grayed out).

5.2.2.2 S-Params setup dialog

The "S-Params" setup dialog is an instance of the [Multi-channel setup dialog](#). It allows you to set up one or more channels for standard non-frequency converting measurements (S-parameters, waves, ratios).

Access: Trace – [Meas] > "S-Params" | "Wave" | "Ratio" > "Setup"

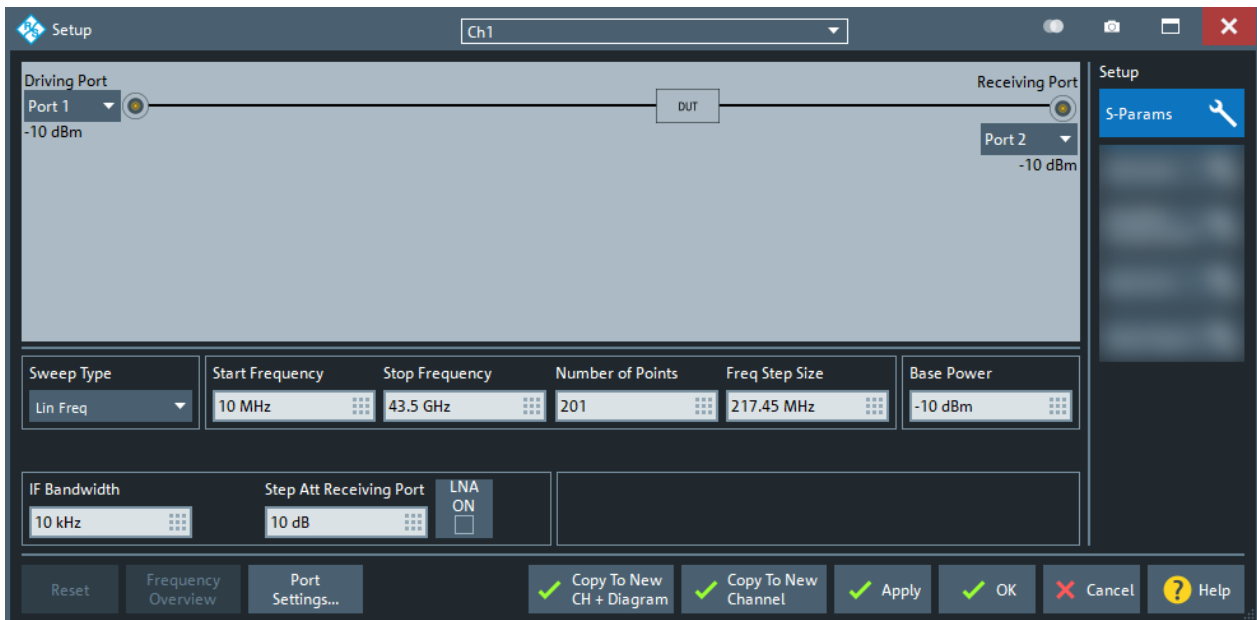

5.2.2.3 More S-Params dialog

Allows to select an arbitrary S-parameter as measured quantity, along with a suitable [Detector](#).

Access: Trace – [Meas] > "S-Params" > "More S-Params..."

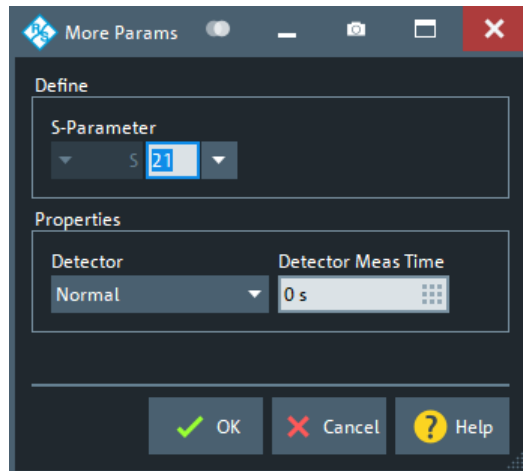

S-Parameter

See ["S-Parameter \(selector\)"](#) on page 345.

Detector

Selects the algorithm that is used to calculate the results points from the raw measurement data.

For details refer to [Chapter 4.3.5.3, "Detector settings"](#), on page 160.

Remote command:

```
CALCulate<Ch>:PARAmeter:MEASure
CALCulate<Ch>:PARAmeter:SDEFine
[SENSe<Ch>:]SWEep:DETector:TIME
```

5.2.2.4 Imbalance Differential dialog

Allows you to measure the differential mode imbalance of a DUT with balanced input and output ports, connected to a balanced and two single-ended logical ports at the VNA.

Access: Trace – [Meas] > "S-Params" > "Y/Z/k/ μ -Parameters": "Imbalance/CMRR" > "Imbalance Differential..."

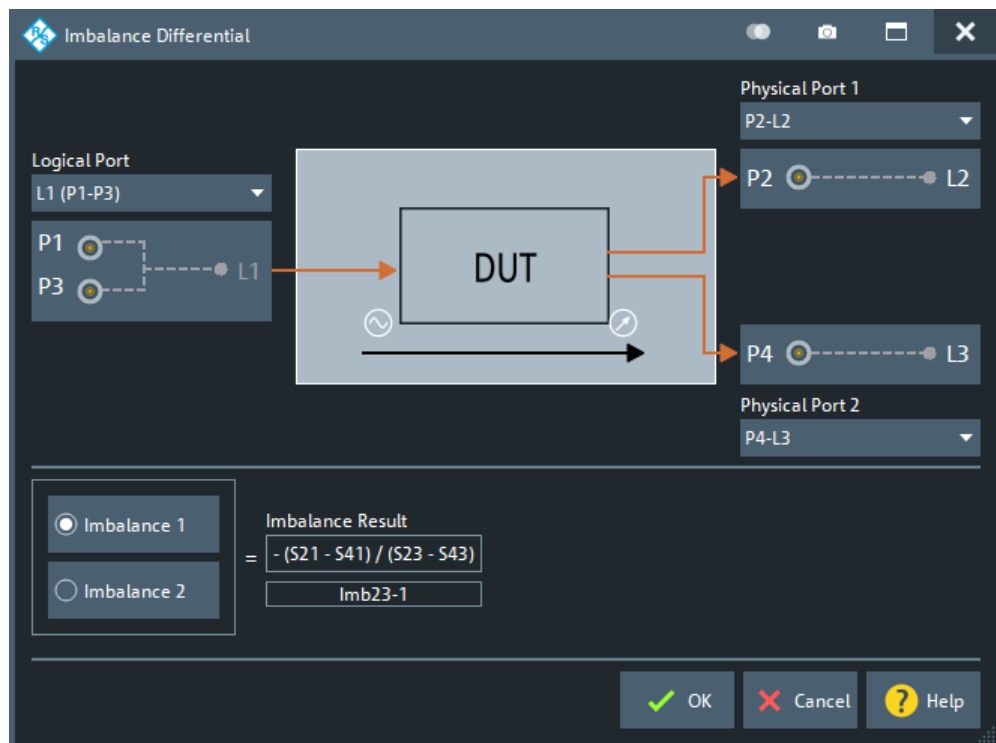

This dialog can only be opened, if a balanced and two single-ended logical ports are configured in the [Balanced Ports dialog](#).

- The **Logical Port** on the left represents the balanced test port: any (active) balanced logical port can be selected
- Physical Port 1 and Physical Port 2 represent the two single-ended test ports: any two (active) single-ended logical ports can be selected
- The part below allows you to select the signal direction and hence the "Imbalance Result" to be calculated.

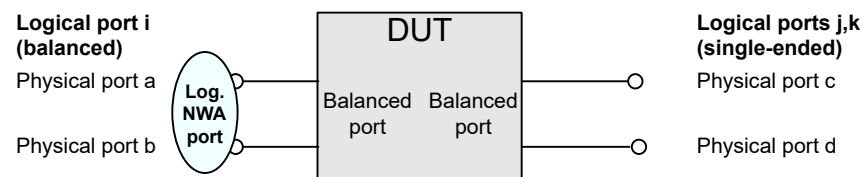

Imbalance 1 / Imbalance 2

Imbalance 1 selects the balanced logical port *i* as the input, the single-ended logical ports *j* and *k* as the output and calculates the following imbalance parameter:

$$\text{Imb}_{jk-i} = -(S_{ca} - S_{da}) / (S_{cb} - S_{db})$$

Imbalance 2 selects the balanced logical port *i* as the output, the single-ended logical ports *j* and *k* as the input and calculates the following imbalance parameter:

$$\text{Imb}_{i-jk} = -(S_{ac} - S_{ad}) / (S_{bc} - S_{bd})$$

Remote command:

```
CALCulate<Ch>:PARAmeter:MEASure "<Trace_Name>", "IMB<i>-<j><k>"
| "IMB<j><k>-<i>"
```

```
CALCulate<Ch>:PARAmeter:SDEFine "<Trace_Name>", "IMB<i>-<j><k>"
| "IMB<j><k>-<i>"
```

5.2.2.5 Balanced Ports dialog

The "Balanced Ports" dialog allows you to enable/disable physical ports and to define logical ports (balanced or unbalanced) in the active channel.

Access: Channel – [Channel Config] > "Port Config" > "Balanced Ports..."



Background information

Refer to the following sections:

- [Chapter 4.3.6, "Unbalance-balance conversion"](#), on page 161
- [Chapter 4.3.6.1, "Balanced port configurations"](#), on page 162
- [Chapter 4.3.2, "Reference impedances"](#), on page 152
- [Chapter 4.7.5, "True differential mode"](#), on page 277

Predefined Config tab

The "Predefined Config" tab of the "Balanced Ports" dialog provides the most commonly used logical port configurations of the analyzer.



This tab is hidden if a switch matrix is configured.

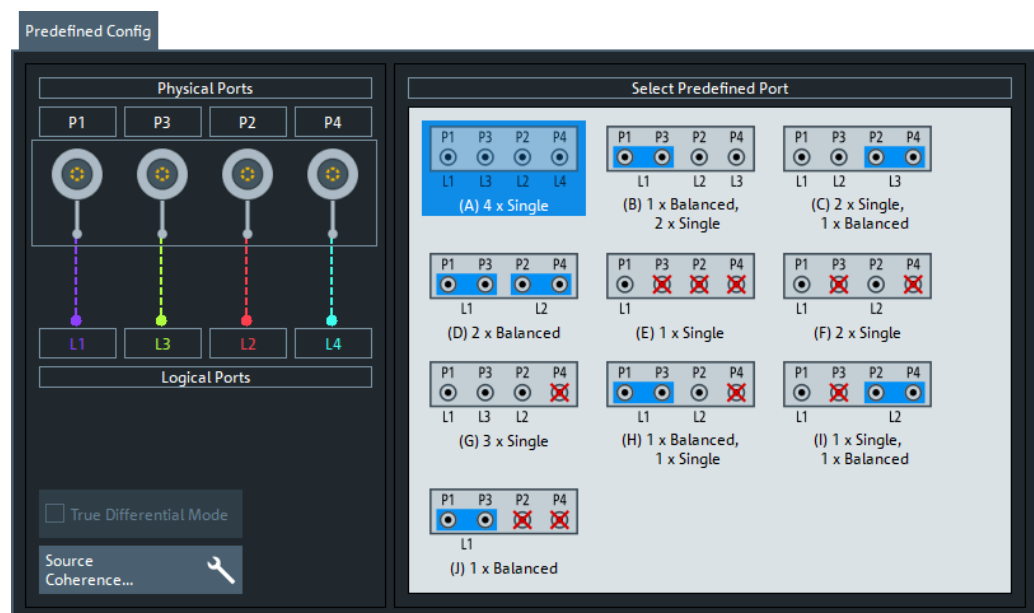

The port configurations are arranged in the list to the right. The resulting port assignment is shown on the left-hand side of the "Predefined Config" tab.

- For a single-ended port, the diagram shows a single line between the physical test port and the logical port.
- For a balanced port, two physical ports are combined to form a single logical port.
- For unused ports, the physical port is crossed out; no logical port number is assigned.

Select Predefined Port

Allows you to select from a set of predefined logical port configurations.

The available configurations depend on the number of analyzer ports.

Remote command:

```
SOURce<Ch>:LPORt<LogPt>
SOURce<Ch>:LPORt<LogPt>:CLEar
```

True Differential Mode

Activates/deactivates True Differential Mode

This checkbox is only visible if [True differential mode](#) option R&S ZNA-K61 is available.

It is enabled, if at least one balanced port is configured, whose physical ports are fed by independent sources (see [Chapter 4.7.20, "Internal 3rd and 4th source for 4-port R&S ZNA"](#), on page 302). In case the balanced port is made up of frequency converter ports, [Power Control](#) must be active for both of them.

Use the "Source Coherence..." button to open the [Source Coherence dialog](#) dialog, which allows you to configure the TruDi-specific sweep types.

Remote command:

```
SOURce<Ch>:TDIF [ :STATe ]
```

Source Coherence...

Opens the dialog of the same name, which allows you to configure and enable source coherence and to configure the true differential mode sweep types "Phase Imbalance" and "Amplitude Imbalance".

See [Chapter 5.13.3.2, "Source Coherence dialog"](#), on page 703.

Logical Port Config tab

The "Logical Port Config" tab of the "Balanced Ports" dialog allows you to configure logical ports (balanced or unbalanced) and to disable unused physical ports in the active channel.



This tab is only visible if a switch matrix is configured).

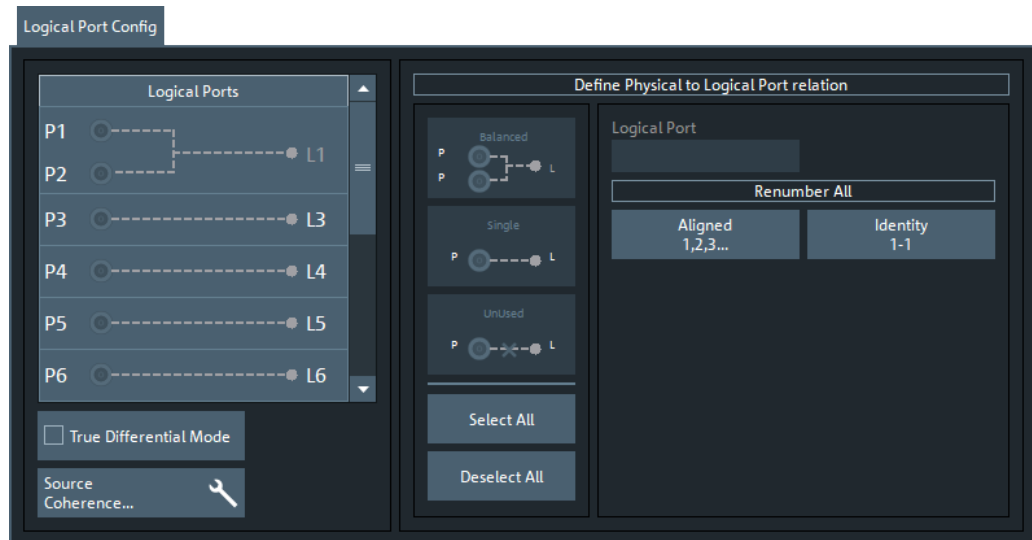

For [True Differential Mode](#) and [Source Coherence...](#) see their description in the "Pre-defined Config" tab.

Define Physical to Logical Port Relation

Allows you to define balanced, single-ended, and unused ports and provides functions for (re)numbering the resulting logical ports.

In principle, it is possible to combine any pair of two physical analyzer ports into a balanced port. With n test ports a maximum of $n/2$ (n even) or $(n - 1)/2$ (n odd) logical ports is supported.

- To define a balanced port, select two physical ports and tap "Balanced".
- To dissolve balanced ports, select them and tap "Single".
- To exclude logical ports from the measurement, select them and tap "Unused".
- To assign a number to a logical port, select it and enter a new "Logical Port" number in the corresponding field
- To number the logical ports in line with the physical ports, select "Identity 1-1"
For balanced ports, the lower of the two physical port numbers is selected.
- To number the logical ports consecutively from top to bottom, select "Aligned 1,2,3..."

Remote command:

```
SOURce<Ch>:LPORt<LogPt>
```

```
SOURce<Ch>:LPORt<LogPt>:CLEAr
```

User Config tab

The "User Config" tab of the "Balanced Ports" dialog defines a new balanced port configuration.



If a switch matrix is configured, this tab is replaced by the [Logical Port Config tab](#) tab.

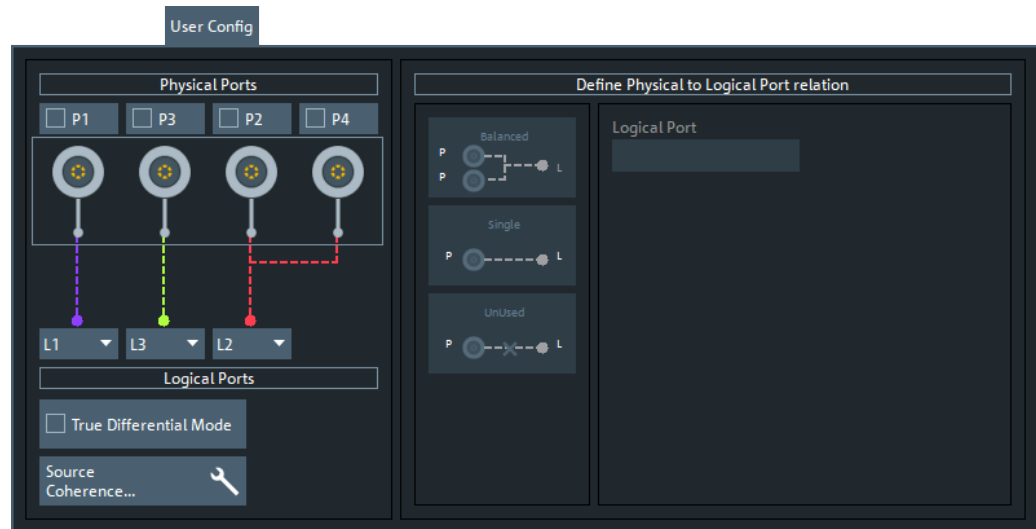

For [True Differential Mode](#) and [Source Coherence...](#) see their description in the "Pre-defined Config" tab.

Physical Ports / Logical Ports

Allows you to renumber logical ports.

Remote command:

```
SOURce<Ch>:LPORt<LogPt>
```

```
SOURce<Ch>:LPORt<LogPt>:CLEAr
```

Define Physical to Logical Port Relation

Allows you to define balanced, single-ended, and unused ports. In principle, it is possible to combine any pair of two physical ports into a balanced port.

- To define a balanced port, select two physical ports and tap "Balanced".
- To dissolve a balanced port, select it and tap "Single".
- To exclude a physical port from the measurement, select the port and tap "Unused".

Furthermore, provides functions for renumbering the logical ports.

Remote command:

```
SOURce<Ch>:LPORt<LogPt>
```

```
SOURce<Ch>:LPORt<LogPt>:CLEAr
```

Reference Impedance tab

The "Reference Impedance" tab of the "Balanced Ports" dialog allows you to define (or redefine) the impedances of the logical ports.



Background information

Refer to [Chapter 4.3.2, "Reference impedances"](#), on page 152.

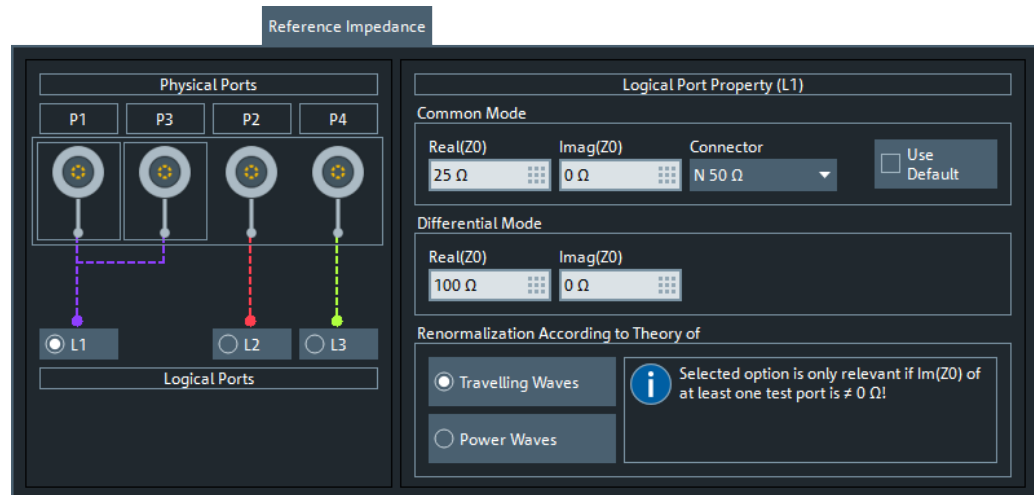
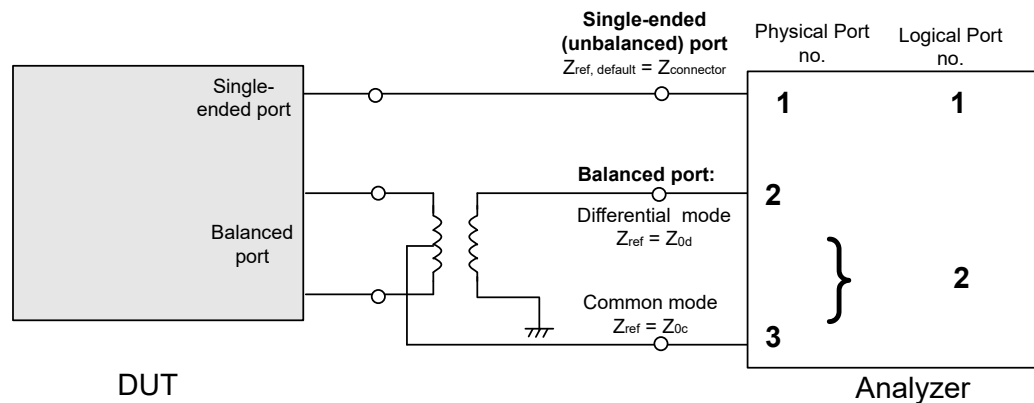

Figure 5-1: Reference Impedance Tab (4 physical ports)

By default, the reference impedance of a physical port is set to the reference impedance of the connector type assigned to the port. However, it can be defined as an arbitrary complex value (renormalization of port impedances). By changing the reference impedance, it is possible to convert the measured values at 50 Ω (75 Ω) into values at arbitrary port impedances.

For balanced ports, it is possible to define separate complex reference impedances for differential and for common mode.



Single Ended Mode / Common Mode / Differential Mode

Defines arbitrary reference impedances.

"Single Ended Mode" is available for single-ended logical ports only, "Common Mode" and "Differential Mode" impedances for balanced ports only.

The default values for the balanced port reference impedances are derived from the (real) default reference impedance $Z_0 = 50 \Omega$ of the (single-ended) physical analyzer ports:

- The default value for the differential mode is $Z_{0d} = 100 \Omega = 2 \cdot Z_0$.
- The default value for the common mode is $Z_{0c} = 25 \Omega = Z_0/2$.

Remote command:

```
[SENSe<Ch>:] PORT<PhyPt>: ZREference  
[SENSe<Ch>:] LPORT<LogPt>: ZCOMmon  
[SENSe<Ch>:] LPORT<LogPt>: ZDIFferent
```

Connector

Allows you to specify the connector type of the related physical port.

Remote command:

```
[SENSe<Ch>:] CORRection: COLLect: CONNectiOn<PhyPt>
```

Use Default

Allows you to toggle between default and renormalized port impedance (or impedances) for the selected logical port and connector type.

Remote command:

```
[SENSe<Ch>:] LPORT<LogPt>: ZDEFault [:STATe]
```

Renormalization According to Theory of

Selects the waveguide circuit theory for renormalization. The conversion formulas of these theories only differ if the reference impedance of at least one test port has a non-zero imaginary part.

Refer to [Chapter 4.3.2, "Reference impedances"](#), on page 152.

Remote command:

```
CALCulate<Chn>: TRANsform: IMPedance: RNORmal
```

5.2.3 Wave tab

Selects wave quantities as measured quantities.



Background information

Refer to [Chapter 4.3.5, "Wave quantities and ratios"](#), on page 158.

5.2.3.1 Controls on the Wave tab



The "Setup" button opens the [S-Params setup dialog](#).

The "More Wave Quantities..." button opens the [More Wave Quantities](#) dialog which allows to select an arbitrary [wave quantity](#), e.g. for different source ports or higher port numbers.

a<i> Source Port <i>, b<j> Source Port <i>

Selects one of the standard 2-port [wave quantities](#) a_i , b_j for different source ports.

The predefined wave quantities are obtained with different source ports. "a1 Source Port 1", "b1 Source Port 1" and "b1 Source Port 2" are measured at Port 1 of the analyzer. "a2 Source Port 2, b2 Source Port 1" and "b2 Source Port 2" are measured at Port 2 of the analyzer.

- "a1 Source Port 1" is the wave transmitted at physical port 1. In a standard S-parameter measurement, this wave is fed to the input port (port 1) of the DUT (forward measurement).
- "b1 Source Port 1" is the wave received at physical port 1. In a standard S-parameter measurement, this wave is reflected at port 1 of the DUT (forward measurement).
- "b2 Source Port 1" is the wave received at physical port 2. In a standard S-parameter measurement, this wave is transmitted at port 2 of the DUT (forward measurement).
- "a2 Source Port 2" is the wave transmitted at physical port 2. In a standard S-parameter measurement, this wave is fed to the output port (port 2) of the DUT (reverse measurement).

- "b1 Source Port 2" is the wave received at physical port 1. In a standard S-parameter measurement, this wave is transmitted at port 2 of the DUT (reverse measurement).
- "b2 Source Port 2" is the wave received at physical port 2. In a standard S-parameter measurement, this wave is fed to the output port (port 2) of the DUT (reverse measurement).

Tip: In the trace list, the source port is indicated in brackets. For example, "a1(P1)" denotes the wave a_1 with source port 1.

The analyzer can also measure arbitrary wave quantities for other source ports; see [Chapter 5.2.3.2, "More Wave Quantities dialog"](#), on page 359.

Remote command:

```
CALCulate<Ch>:PARAmeter:MEASure "<Trace_Name>", "A1" | ...
```

```
CALCulate<Ch>:PARAmeter:SDEFine "<Trace_Name>", "A1" | ...
```

Wave Correction

Determines whether measured quantities that are calculated based on wave quantities are system error corrected in the active channel.

This applies to wave quantities themselves, but also to ratios, harmonics, and intermodulation products.

If checked (default), the "best available" calibration is applied, with the following precedence:

- Scalar power calibration
- User system error correction
- Factory system error correction

Note:

- Only a single calibration is applied.
- If "Wave Correction" is turned off, no calibration is applied for these measured quantities at all.

Remote command:

```
[SENSe<Ch>:]CORRection:EWAVE[:STATe]
```

5.2.3.2 More Wave Quantities dialog

The "More Wave Quantities" dialog provides arbitrary wave quantities with arbitrary source ports as measured quantities. All wave quantities can be calculated with different detector settings.

Access: Trace – [Meas] > "Wave" > "More Wave Quantities..."



Background information

Refer to the following sections:

- [Chapter 4.3.5.1, "Wave quantities"](#), on page 158
- [Chapter 4.3.5.2, "Ratios"](#), on page 159



The notation for wave quantities follows the usual scheme of the vector network analyzer:

- The a-waves are the outgoing/transmitted waves at the analyzer's test ports.
- The b-waves are the incoming/measured waves.
- The source port for the stimulus signal must be specified in addition.
- The port number range covers all test ports of the analyzer.

Define

The controls in this section of the dialog allow you to set the "Wave" type, the "Receiving Port" and the "Source Port".

The latter is only available, if no external source is used (see ["Use Generator as Source"](#) on page 360).

Remote command:

```
CALCulate<Ch>:PARAMeter:MEASure "<Trace_Name>", "A1" ...
```

```
CALCulate<Ch>:PARAMeter:SDEfine "<Trace_Name>", "A1" ...
```

Use Generator as Source

If checked, the "Generator" combo lists the configured external generators and the "Source Port" group of the [Define](#) section is disabled

To configure external generators, use the "External Generators" dialog. See [Chapter 4.7.40, "External generators"](#), on page 321.

Properties

Allows you to select the measurement detector and the display unit for the selected wave quantity.

Detector ← Properties

Selects the algorithm that is used to calculate the results points from the raw measurement data.

For details refer to [Chapter 4.3.5.3, "Detector settings"](#), on page 160.

Remote command:

```
CALCulate<Ch>:PARAmeter:MEASure
CALCulate<Ch>:PARAmeter:SDEFine
[SENSe<Ch>:]SWEep:DETEctor:TIME
```

Display unit ← Properties

Selects the physical unit of the displayed trace. It is possible to display the measured "Voltage" V or to convert it into a power value P according to the formula

$$P = V^2 / \operatorname{Re}(Z_0).$$

Z_0 denotes the reference impedance of the source port (for wave quantities a_n) or of the receive port (for wave quantities b_n). The reference impedances are defined in the "Balanced Ports" dialog; see [Chapter 5.2.2.5, "Balanced Ports dialog"](#), on page 352.

Remote command:

```
CALCulate<Chn>:FORMat:WQUType
```

5.2.4 Ratio | Harmonics tab

The "Ratio | Harmonics" tab gives access to two types of measured quantities:

- Ratios of wave quantities
- Harmonics, i.e. arbitrary harmonics, ratios between harmonics and the fundamental wave, and total harmonic distortion (THD)
To this end, the source remains at the fundamental frequency whereas the receiver is set to n times the fundamental frequency.

Access: Trace – [Meas] > "S-Params" > "Harmoniocs"



The "Setup" button opens the [S-Params setup dialog](#).



Background information

Refer to

- [Chapter 4.3.5, "Wave quantities and ratios"](#), on page 158
- [Chapter 4.7.3.3, "Harmonics measurements"](#), on page 270

5.2.4.1 Ratio measurements

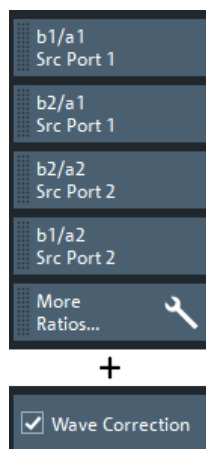

The "More Ratios..." button opens the [More Ratios](#) dialog which allows to select an arbitrary [ratio](#) of wave quantities.

"Wave Correction" applies to wave quantity, ratio and harmonics measurements. The corresponding checkbox is also shown on the "Wave" tab (see ["Wave Correction"](#) on page 359).

b<i>/ a<j> Source Port <j>

Selects predefined complex [ratios](#) of the standard 2-port wave quantities a_1 , a_2 , b_1 , and b_2 .

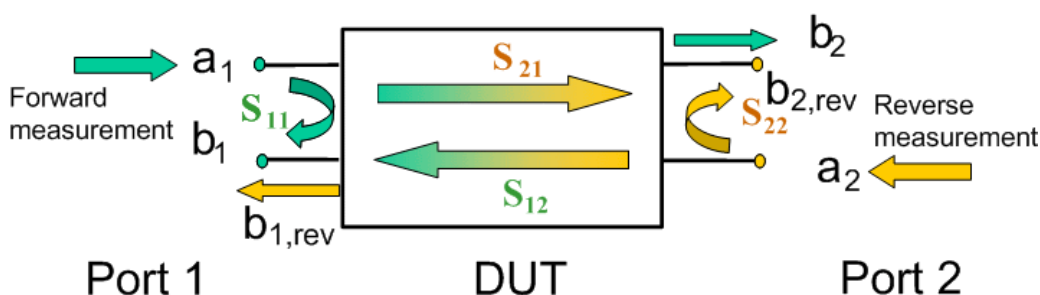

The predefined wave quantities can all be obtained with the same test setup, where a 2-port DUT is connected between the analyzer ports 1 and 2. The stimulus signal is provided by the analyzer port 1 or 2 ("Source Port").

The predefined wave quantities correspond to the 2-port S-parameters:

- "b1/a1 Source Port 1" is the ratio of the wave quantities b_1 and a_1 , measured at port 1. This ratio corresponds to the S-parameter S_{11} (input reflection coefficient).
- "b2/a1 Source Port 1" is the ratio of the wave quantities b_2 and a_1 and corresponds to the S-parameter S_{21} (forward transmission coefficient).
- "b2/a2 Source Port 2" is the ratio of the wave quantities b_2 and a_2 , measured at port 2. This ratio corresponds to the S-parameter S_{22} (output reflection coefficient).
- "b1/a2 Source Port 2" is the ratio of the wave quantities b_1 and a_2 and corresponds to the S-parameter S_{12} (reverse transmission coefficient).

The analyzer can also measure arbitrary ratios for other source ports; see [Chapter 5.2.4.2, "More Ratios dialog"](#), on page 363.

Tip: In the trace list, the source port is indicated in brackets. "b2/a1(P1)" denotes the ratio b_2/a_1 with source port 1.

Remote command:

```
CALCulate<Ch>:PARAMeter:MEASure "<Trace_Name>", "B2/A1" | ...
CALCulate<Ch>:PARAMeter:SDEFine "<Trace_Name>", "B2/A1" | ...
```

5.2.4.2 More Ratios dialog

The More Ratios dialog allows you to select arbitrary ratios between wave quantities b_i , a_j as measured quantity. The ratios can be calculated with arbitrary source port and different detector settings.

Access: Trace – [Meas] > "Ratio" > "More Ratios..."



Background information

Refer to the following sections:

- [Chapter 4.3.5.1, "Wave quantities"](#), on page 158
- [Chapter 4.3.5.2, "Ratios"](#), on page 159

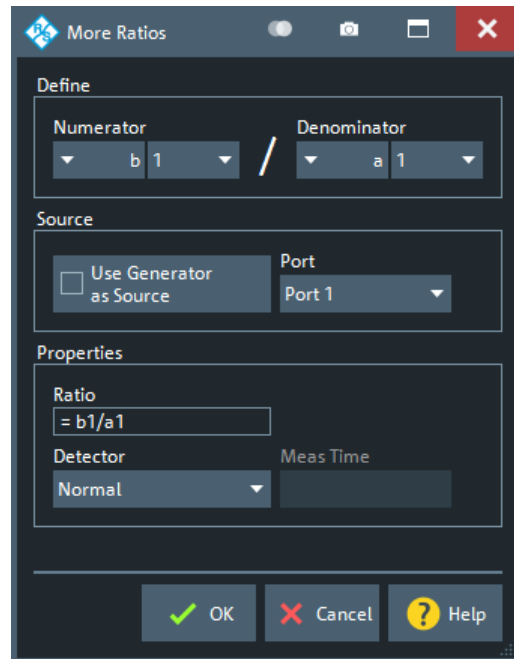

The notation for ratios follows the usual scheme of the vector network analyzer:

- The a-waves are the outgoing/transmitted waves at the analyzer's test ports.
- The b-waves are the incoming/measured waves.
- The source port for the stimulus signal must be specified in addition.
- The port number range covers all test ports of the analyzer.

Numerator

Selects the type (left pull-down list) and the port number assignment (right pull-down list) of the wave that forms the numerator of the [ratio](#).

Remote command:

```
CALCulate<Ch>:PARAMeter:MEASure "<Trace_Name>", "B2/A1" | ...
```

```
CALCulate<Ch>:PARAMeter:SDEFine "<Trace_Name>", "B2/A1" | ...
```

Denominator

Selects the type (left pull-down list) and the port number assignment (right pull-down list) of the wave that forms the denominator of the [ratio](#).

Remote command:

```
CALCulate<Ch>:PARAMeter:MEASure "<Trace_Name>", "B2/A1" | ...
```

```
CALCulate<Ch>:PARAMeter:SDEFine "<Trace_Name>", "B2/A1" | ...
```

Use Generator as Source

If selected, the "Port" control lists the external generators. Otherwise it lists the analyzer ports.

External generators must be configured explicitly in the "External Generators" dialog before they appear in the list. See also [Chapter 4.7.40, "External generators"](#), on page 321.

Port

Allows you to select the source for the stimulus signal.

- "None", "Port <Pt>", or "Conv <Pt>", if [Use Generator as Source](#) is not checked
- "Gen <i>" if "Use Generator as Source" is checked

Remote command:

```
CALCulate<Ch>:PARAmeter:MEASure "<Trace_Name>", "<Ratio>"
CALCulate<Ch>:PARAmeter:SDEFine "<Trace_Name>", "<Ratio>"
```

Detector

Selects the algorithm that is used to calculate the results points from the raw measurement data.

For details refer to [Chapter 4.3.5.3, "Detector settings"](#), on page 160.

Remote command:

```
CALCulate<Ch>:PARAmeter:MEASure
CALCulate<Ch>:PARAmeter:SDEFine
[SENSe<Ch>:]SWEep:DETEctor:TIME
```

5.2.4.3 Harmonics measurements

Harmonics measurements require option R&S ZNA-K4, see ([Chapter 4.7.3.4, "Scalar mixer measurements"](#), on page 271).

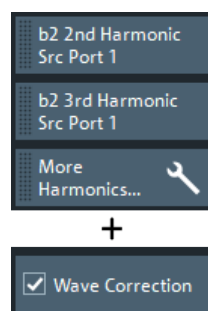

"More Harmonics..." opens the [More Harmonics dialog](#) that allows you to select from the full range of direct and relative harmonics measurements.

"Wave Correction" applies to wave quantity, ratio and harmonics measurements. The corresponding checkbox is also shown on the "Wave" tab (see ["Wave Correction"](#) on page 359).

b2 2nd Harmonic Src Port 1

Power of the outgoing wave at port 2, measured at 2 times the frequency of the wave generated at port 1.

Remote command:

```
CALCulate<Ch>:PARAmeter:MEASure '<TraceName>', 'h2b2 (p1)'
```

```
CALCulate<Ch>:PARAmeter:SDEFine '<TraceName>', 'h2b2 (p1)'
```

...

b2 3rd Harmonic Src Port 1

Power of the outgoing wave at port 2, measured at 2 times the frequency of the wave generated at port 1

Remote command:

```
CALCulate<Ch>:PARAmeter:MEASure '<TraceName>', 'h3b2 (p1)'
```

```
CALCulate<Ch>:PARAmeter:SDEFine '<TraceName>', 'h3b2 (p1)'
```

...

5.2.4.4 More Harmonics dialog

The controls in the "More Harmonics" dialog allow you to select and configure arbitrary harmonics measurements in the current channel.

Access: Trace – [Meas] > "S-Params" > "Harmonics" > "More Harmonics..."

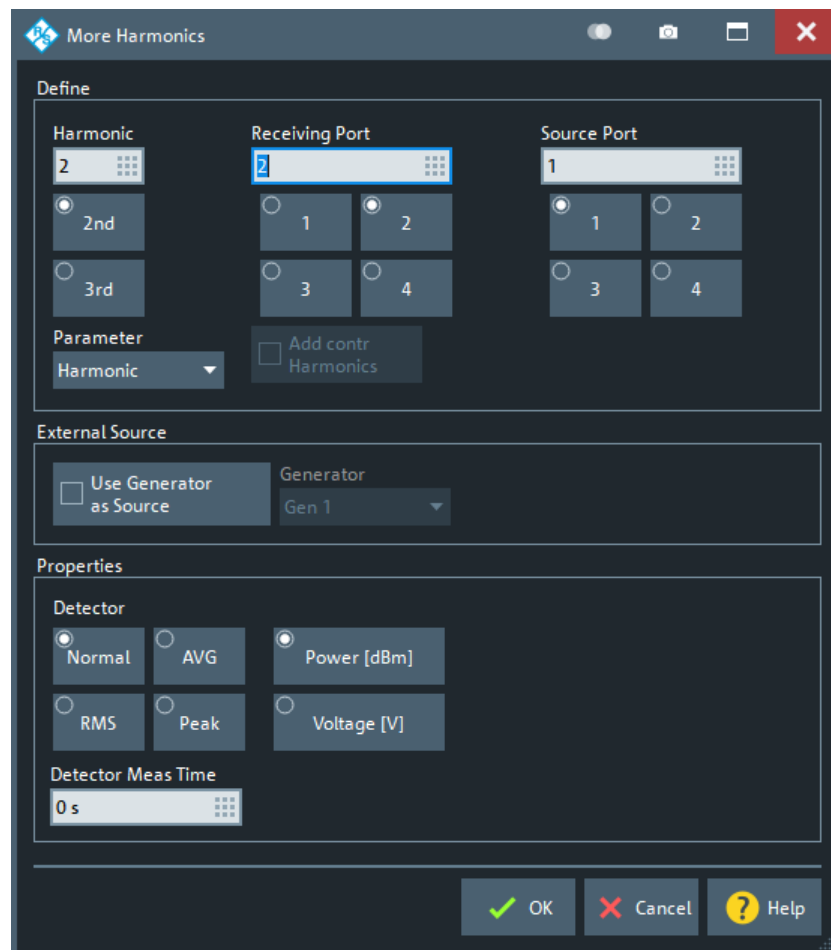

Define

Selects the harmonic to be measured.

A "Frequency out of range" warning is displayed the harmonic frequency to be measured exceeds the frequency range of the analyzer. The harmonic traces are truncated at the maximum receiver frequency.

- "Parameter" The following types of results are provided.
- "Harmonic": The signal received at the Nth harmonic of the stimulus signal is measured. The result is displayed as a wave quantity but can be modified and converted using the functions in the "Trace" softtool.
 - "Relative": The Nth harmonic is divided by the 1st harmonic (fundamental). This result is also called the Nth harmonic distortion factor.
 - "THD_F" and "THD_R": The fundamental and root mean square total harmonic distortion

See [Chapter 4.7.3.3, "Harmonics measurements"](#), on page 270

"Harmonic" The Harmonic order can be set in the range between 2 (2nd harmonic) and 100.

"Receiving Port" The receive port measures the signal at n times the fundamental frequency where n is the harmonic order.

"Source Port" The source port provides the stimulus signal at the fundamental frequency.

Remote command:

```
CALCulate<Ch>:PARAmeter:MEASure '<TraceName>',
'h<Harmonic>b<Receiving Port>(p<Source Port>)[R|THDF|THDR]'
CALCulate<Ch>:PARAmeter:SDEFine '<TraceName>',
'h<Harmonic>b<Receiving Port>(p<Source Port>)[R|THDF|THDR]'
...
```

Properties

See ["Properties"](#) on page 361.

5.2.5 Noise Figure tab

Noise figure measurements are available for both non-frequency converting and frequency converting DUTs.



The noise figure measurement is provided with software option R&S ZNA-K30. If this option is not installed, the "Noise Figure" tab is not available.

For background information, see [Chapter 4.7.11, "Noise figure measurement"](#), on page 289.

Access: Trace – [Meas] > "Noise Figure"

5.2.5.1 Controls on the Noise Figure tab

The controls on the "Noise Figure" tab allow you to set up a noise figure (NF) measurement and give access to the related measured quantities.

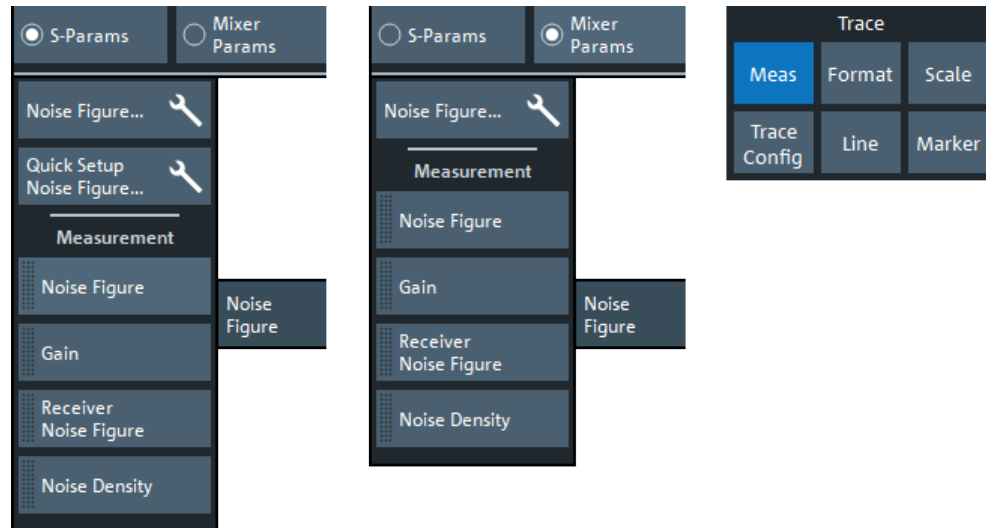

Noise Figure (tool button)

Opens the [Noise figure setup dialog](#), which allows you to set up the NF measurement.

Quick Setup Noise Figure (tool button)

Opens the [NF quickset dialog](#), which allows you to swiftly set up a NF measurement. The dialog provides guidance in terms of optimized measurement configuration and calculates the required measurement and calibration settings, such as source power and detector times.

If [external switch matrices](#) are used, the NF quickset functionality is not available and hence this button is disabled.

Noise Figure/Gain/Receiver Noise Figure/Noise Density

These draggable buttons select the noise figure parameters to be measured in the active channel.

"Noise Figure" Selects the calculated noise figure of the DUT

"Gain" This button selects the measured gain of the DUT, as used for the noise figure calculation.

Note that in NF channels, the gain is calculated as the ratio between b-wave and a-wave, *without* mismatch correction. Therefore it is *not* identical to a vector corrected S-parameter measurement (e.g. S21).

"Receiver Noise Figure" Selects the receiver noise figure determined during NF calibration.

"Noise Density" Selects the receiver noise density as measured quantity.

Remote command:

"Noise Figure":

```
CALCulate<Ch>:PARAmeter:MEASure <TraceName>, 'NF12' | 'NF13'
| ... | 'NF21' | 'NF23' | ...
```

```
CALCulate<Ch>:PARAmeter:SDEFine <TraceName>, 'NF12' | 'NF13'
| ... | 'NF21' | 'NF23' | ...
```

"Gain":

```
CALCulate<Ch>:PARAmeter:MEASure <TraceName>, 'b1/a2 (P2)' |
'b1/a3 (P3)' | ... | 'b2/a1 (P1)' | 'b2/a3 (P3)' | ...
```

```
CALCulate<Ch>:PARAmeter:SDEFine <TraceName>, 'b1/a2 (P2)' |
'b1/a3 (P3)' | ... | 'b2/a1 (P1)' | 'b2/a3 (P3)' | ...
```

"Receiver Noise Figure":

```
CALCulate<Ch>:PARAmeter:MEASure <TraceName>, 'NF1R' | 'NF2R'
| ...
```

```
CALCulate<Ch>:PARAmeter:SDEFine <TraceName>, 'NF1R' | 'NF2R'
| ...
```

```
CALCulate<Ch>:PARAmeter:MEASure <TraceName>, 'ND1' | 'ND2' | ...
```

```
CALCulate<Ch>:PARAmeter:SDEFine <TraceName>, 'ND1' | 'ND2' | ...
```

5.2.5.2 Noise figure setup dialog

The NF "Setup" dialog is an instance of the [Multi-channel setup dialog](#). It allows you to set up a noise figure (NF) measurement.

Access: [Noise Figure tab](#) ("S-Params") > "Noise Figure" tool button

The noise figure specific parameters in the lower part of the dialog are identical for non-frequency-converting and frequency-converting measurements.

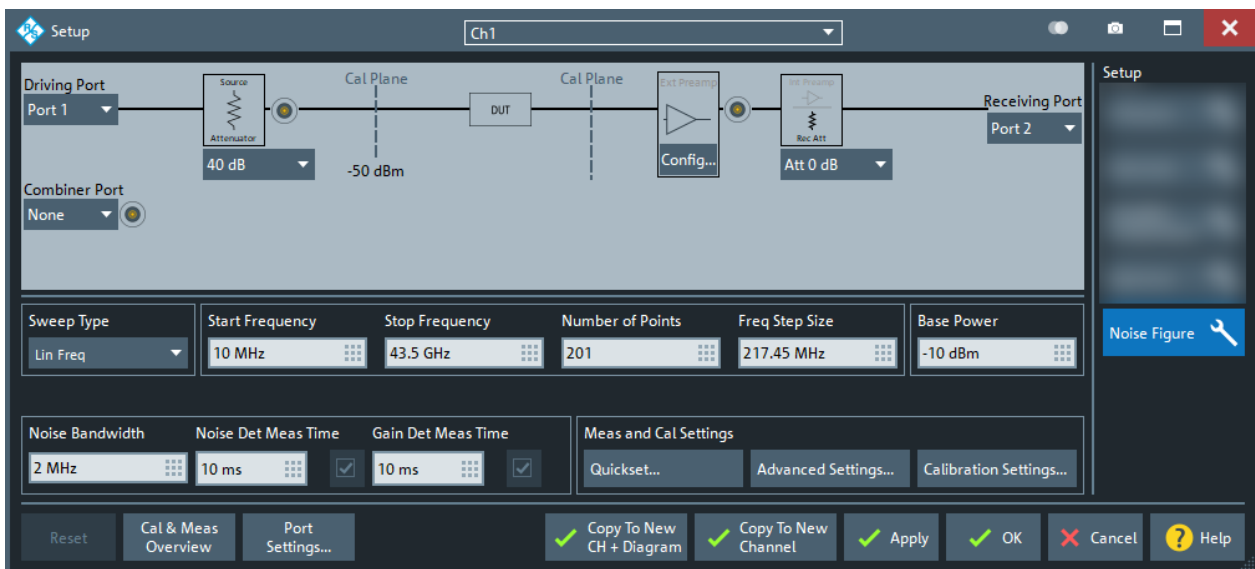

Figure 5-2: NF Setup dialog: non-frequency-converting

The frequency conversion settings in the frequency-converting variant of the dialog are identical to the settings in the [Scalar Mixer Meas setup dialog](#).

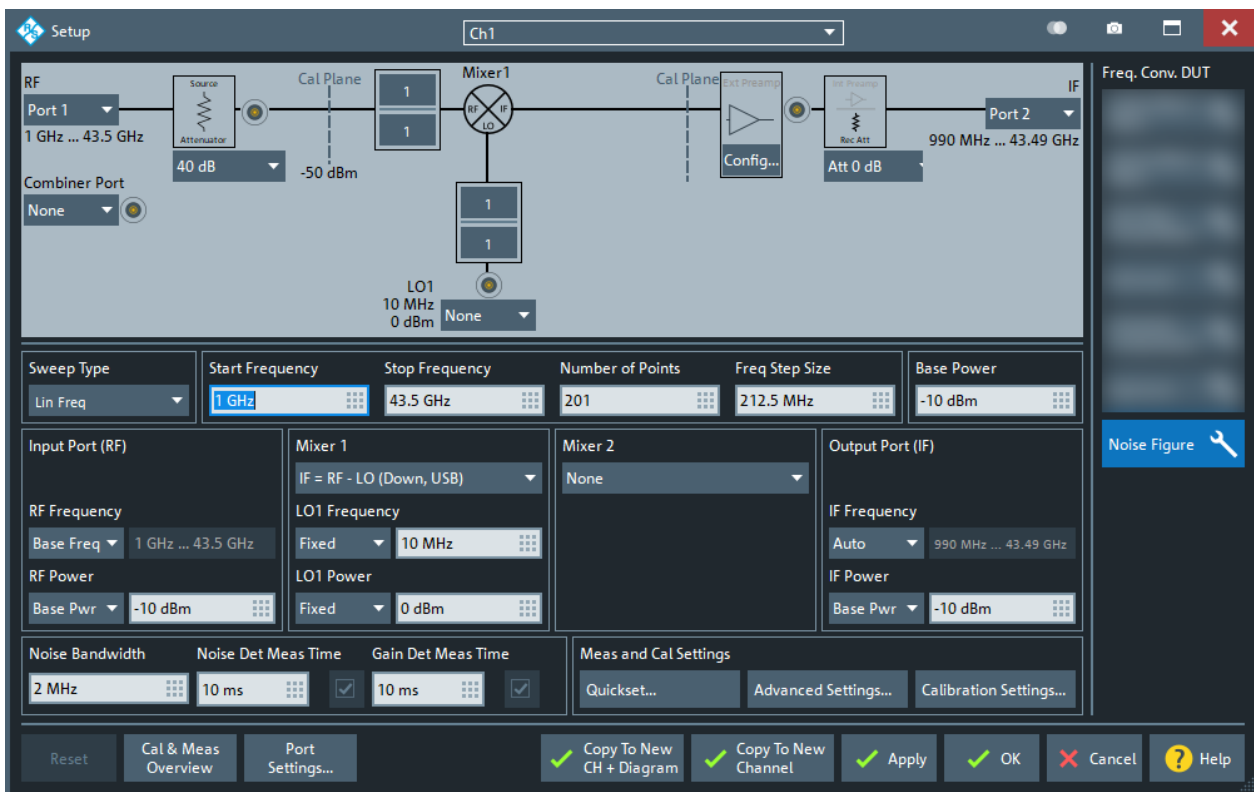

Figure 5-3: NF Setup dialog: frequency-converting

Driving Port (RF) / Receiving Port (IF)

Allows you to select the driving port (the RF port for frequency-converting DUTs) and the receiving port (the IF port) for the noise figure measurement. It is recommended to use a driving port which is equipped with a [source step attenuator](#) to suppress to internal noise of the VNA.

Remote command:

```
[SENSe<Ch>:]NFIFigure:DEFine
```

Source Attenuator

For a precise noise figure measurement, it is necessary to suppress to internal noise of the VNA. To this end, set the source step attenuator to a value of at least 40 dB.

Remote command:

See [Source Step Att.](#)

Combiner Port

If an internal or external combiner is used to create a two-tone signal, not only the driving port, but also the port generating the second tone must use a [source step attenuator](#) of at least 40 dB.

Remote command:

See [Source Step Att.](#)

Cal Plane

The power levels shown at the calibration plane are only valid after a source flatness calibration was performed.

Ext Preamp Config

In this dialog, different configurations using an external preamplifier can be set.

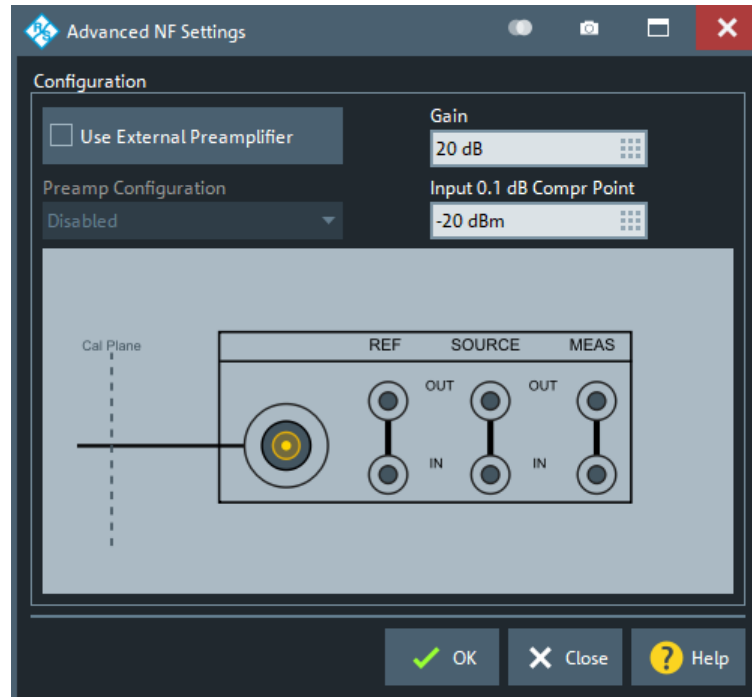

Depending on the chosen configuration, only applicable calibration types are recommended.

Int Preamp / Rec Att

Allows you to choose whether the internal [receiver step attenuator](#) or [preamplifier](#) is used. For typical DUTs, it is recommended to use either the internal preamplifier or a receiver step attenuator setting of 0 dB.

Remote command:

Receiver step attenuator: see [Receiver Step Att.](#)

Internal preamplifier: see [Receiver Step Att.](#)

Noise Bandwidth

Sets the bandwidth used for the NF measurement and calibration. Since the receiver has no image band suppression, the noise bandwidth roughly equals two times the filter bandwidth (due to reception on both sidebands).

Important for the resulting trace noise is the product of the noise bandwidth and the chosen [noise detector measurement time](#). Therefore, a larger noise bandwidth allows you to use a shorter measurement time or vice versa. However, due to the receiver architecture, a larger noise bandwidth also requires a higher intermediate frequency, which can influence the accuracy of measurements of narrowband DUTs.

Remote command:

See [Bandwidth](#)

Noise Det Meas Time

For measuring the noise power, the root-mean-square (RMS) of each measurement sample is calculated. The noise detector measurement time sets the detector time at each measurement point for the [RMS detector](#), allowing to choose how many RMS values are used at each frequency. A longer detector time and therefore a higher number of RMS values results in a closer estimation of the real noise power.

"Auto" means that the value is set from the [NF quickset dialog](#). Use the checkbox to the right to enable the input field and set its value manually.

Remote command:

```
[SENSe<Ch>:]NFIGure:NTIME
```

Gain Det Meas Time

Sets the detector time at each measurement point for the [AVG detector](#), which is used for the measurement of the DUT gain. Using the AVG detector allows you to remove statistical fluctuations from the measurement and therefore achieves a more accurate result.

"Auto" means that the value is set from the [NF quickset dialog](#). Use the checkbox to the right to enable the input field and set its value manually.

Remote command:

```
[SENSe<Ch>:]NFIGure:GTIME
```

Cal & Meas Overview

Opens the "Cal & Meas Overview" dialog, which displays all settings related to NF calibration and measurement.

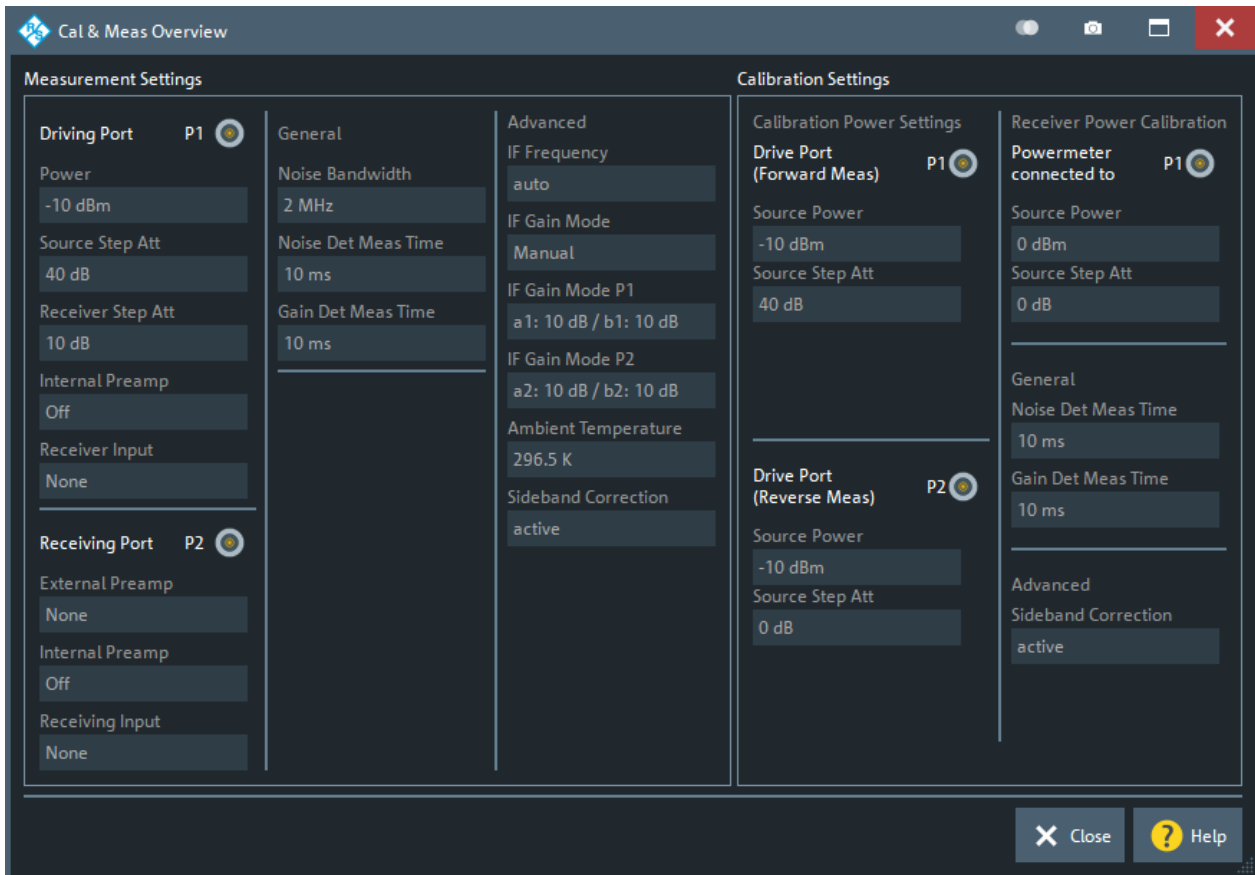

Figure 5-4: NF setup: Cal & Meas Overview dialog

With all relevant settings displayed on one page, you can check if NF calibration and measurement are set up properly without browsing through various dialogs.

Quickset

Opens the [NF quickset dialog](#) that guides you through to setup of a noise figure (NF) measurement.

If [external switch matrices](#) are used, the NF quickset functionality is not available and hence this button is disabled.

Advanced Settings

Opens the "Advanced NF Settings" dialog, which allows to perform expert settings for NF calibration and measurement.

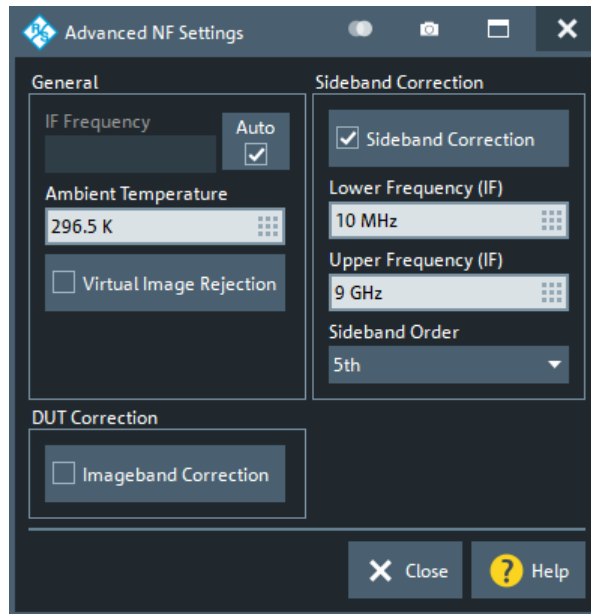

General > IF Frequency ← Advanced Settings

For typical applications, the IF frequency is chosen automatically and depends on the chosen [Noise Bandwidth](#) and the measurement frequency. However, for certain measurements it can be preferable to choose a different IF frequency. The manually chosen IF frequency is applied over the full measurement frequency range.

Remote command:

```
[SENSe<Ch>:]NFIGure:IFConst
[SENSe<Ch>:]NFIGure:IFConst:STATE
```

General > Ambient Temperature ← Advanced Settings

The ambient temperature is used for precise calculation of the source noise temperature at the input of the DUT. The external attenuation (cables, adapters, attenuators, etc.) is assumed to have a physical temperature equal to the ambient temperature. See "[Source noise temperature](#)" on page 291 for a detailed description.

Remote command:

```
[SENSe<Ch>:]NFIGure:TEATtenuator
```

General > Virtual Image Rejection ← Advanced Settings

If "Virtual Image Rejection" is active, the firmware combines different measurements to remove the image band influence, which allows precise measurements of narrow spikes on "Noise Figure", "Gain" or "Noise Density" traces. By default it is disabled.

For segmented sweeps, virtual image rejection can be activated or deactivated per segment (see "[Optional Columns](#)" on page 557).

Remote command:

```
[SENSe<Ch>:]NFIGure:VIRejection[:STATE]
```

Sideband Correction ← Advanced Settings

In this section of the "Advanced NF Settings" dialog, you can compensate for the imperfect response of the VNA receivers. See ["Sideband correction"](#) on page 293 for a detailed description. However, the overall influence on the calculated NF does not only depend on the receivers but also on the DUT. Therefore, depending on the DUT, it can be advantageous to choose a higher sideband order and a higher upper frequency limit as chosen by default.

A general recommendation is to choose a 5th order sideband correction for frequencies starting below 1 GHz. For higher frequencies, the sideband order can be reduced. For frequencies starting above 20 GHz, the effect of parasitic sidebands is typically negligible.

Example 1: A broadband amplifier with a positive gain ranging from 500 MHz to 6 GHz typically requires sideband correction during a precise NF measurement. For such an amplifier, several higher-order sidebands of the VNA receiver are within its gain bandwidth. At a measurement frequency of 500 MHz, for example, the sidebands of the VNA receiver are at 1 GHz, 1.5 GHz, 2 GHz. These bands are within the gain bandwidth of the amplifier and therefore require sideband correction. Since the DUT does not have any gain above 6 GHz, the upper frequency of the sideband correction can be set close to this value (e.g. 7 GHz).

Example 2: A narrowband amplifier with a positive gain ranging from 2.3 GHz to 2.6 GHz typically requires no sideband correction for a precise NF measurement. For such an amplifier, the sidebands of the VNA receiver (4.6 GHz to 5.2 GHz for the 2nd sideband, 6.9 GHz to 7.8 GHz for the 3rd sideband) are not within its gain bandwidth.

Note: The sideband order can be decreased after calibration. This allows you to investigate the effect of the parasitic sidebands, and to increase the measurement speed, since less additional measurements are required.

Remote command:

```
[SENSe<Ch>:]NFIGure:HARMonic[:STATe]  
[SENSe<Ch>:]NFIGure:HARMonic[:MINFrequency]  
[SENSe<Ch>:]NFIGure:HARMonic[:MAXFrequency]  
[SENSe<Ch>:]NFIGure:HARMonic[:MAXimumorder]
```

DUT Correction ← Advanced Settings

Image band correction is only available for frequency converting DUTs. Using this function requires additional measurement to determine the gain and source noise temperature at the image band. The additional measurements are automatically carried out during calibration and measurement. See ["Frequency-converting DUTs"](#) on page 293 for details.

Remote command:

```
[SENSe<Ch>:]NFIGure:RFICorr
```

Calibration Settings

Opens the calibration setup dialog and activates its ["Noise Figure tab"](#) on page 594, where you can adjust calibration settings such as power levels and detector times.

5.2.5.3 NF quickset dialog

The "Quickset" dialog guides you through to setup of a noise figure (NF) measurement.

Access:

- [Noise Figure tab](#) ("S-Params") > "Quick Setup Noise Figure" tool button
- [Noise figure setup dialog](#) (non-frequency-converting) > "Quickset" tool button



If [external switch matrices](#) are used, the quickset functionality is not available and hence this dialog cannot be accessed.

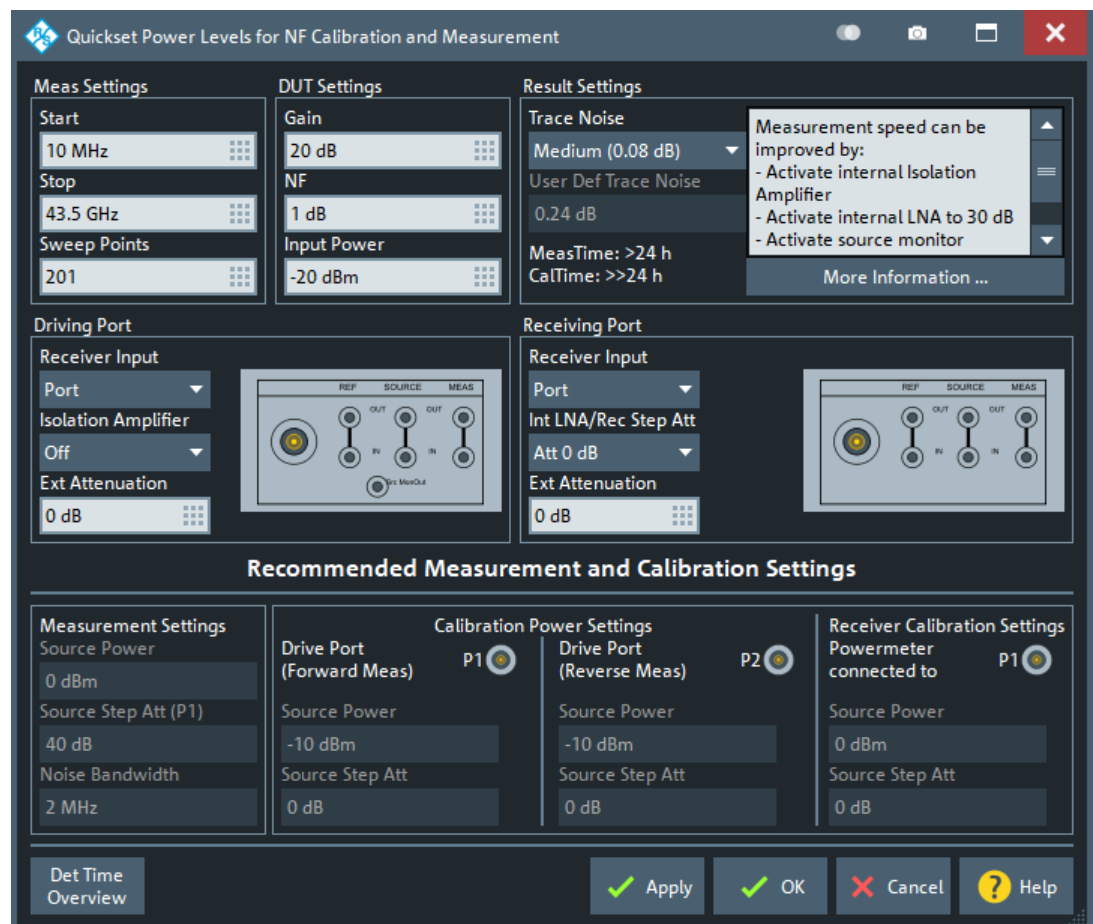

Figure 5-5: NF Quickset dialog

The dialog provides guidance in terms of optimized measurement configuration and calculates the required measurement and calibration settings, such as source power and detector times.

Meas Settings

The controls in the "Meas Settings" section allow you to enter the [start and stop frequency](#) of the NF measurement, and the [number of frequency sweep points](#).

Note: By default a linear frequency sweep is used for calculating the measurement frequencies. If a [logarithmic frequency sweep](#) is desired, select this sweep type in the [Noise figure setup dialog](#) before using "Quickset".

DUT Settings

The controls in the "DUT Settings" section allow you to enter approximate information on the DUT.

The specified "Gain" is used to calculate suitable power levels for measurement and calibration. To ensure linearity of the complete measurement chain (including the VNA receivers), set it to the maximum gain of the DUT.

The specified "NF" is used to calculate the intended trace noise in the [Result Settings](#).

Set the "Input Power" to a value in the linear region of the DUT. A good starting point is approximately 10 dB below the 0.1 dB input compression point of the DUT.

Remote command:

```
[SENSe<Ch>:]NFIGure:QSET:DUT:GAIN
[SENSe<Ch>:]NFIGure:QSET:DUT:ENFigure
[SENSe<Ch>:]NFIGure:QSET:DUT:POWer
```

Result Settings

In the "Result Settings" section, you can specify the trace noise of the NF measurement trace. Select a predefined value or enter a custom trace noise. The proposed value is based on the previously specified [DUT Settings](#).

Furthermore, the "Result Settings" section displays the required measurement time to achieve the user selected (or entered) trace noise for the NF measurement trace. This information is calculated based on the selected [Meas Settings](#) and the VNA characteristics. If the current configuration of the VNA can be optimized to achieve faster measurement times, the required steps for optimization are shown in the info box.

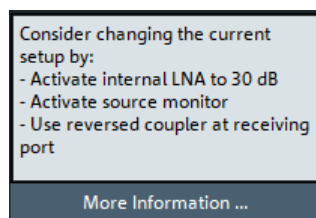

The recommended setup considers the achievable measurement time and the effort to reconfigure the R&S ZNA. The intention of the algorithm is to recommend a reasonably fast measurement, with minimum effort in terms of changing the [Direct generator/receiver access](#) and/or [Direct source monitor access](#) jumpering. Changing the jumper configuration can be advantageous for low source power levels (direct source monitor access at driving port), or to improve the receiver noise figure ([Reverse Coupler Configuration](#) at receiving port).

[More Information](#) opens an overview of the measurement times for all possible VNA configurations.

Remote command:

```
[SENSe<Ch>:]NFIGure:QSET:TNOise
```

More Information ← Result Settings

Opens a dialog that displays the calculated measurement time for the setup variants that are possible with the relevant VNA hardware ([Direct source monitor access](#), [Reverse Coupler Configuration](#), [Internal low noise preamplifier](#)), if equipped. The resulting measurement times are based on the VNA characteristics, and the [Meas Settings](#) and [DUT Settings](#) configured in the "Quickset" dialog. Modify these settings to achieve a reasonable measurement time.

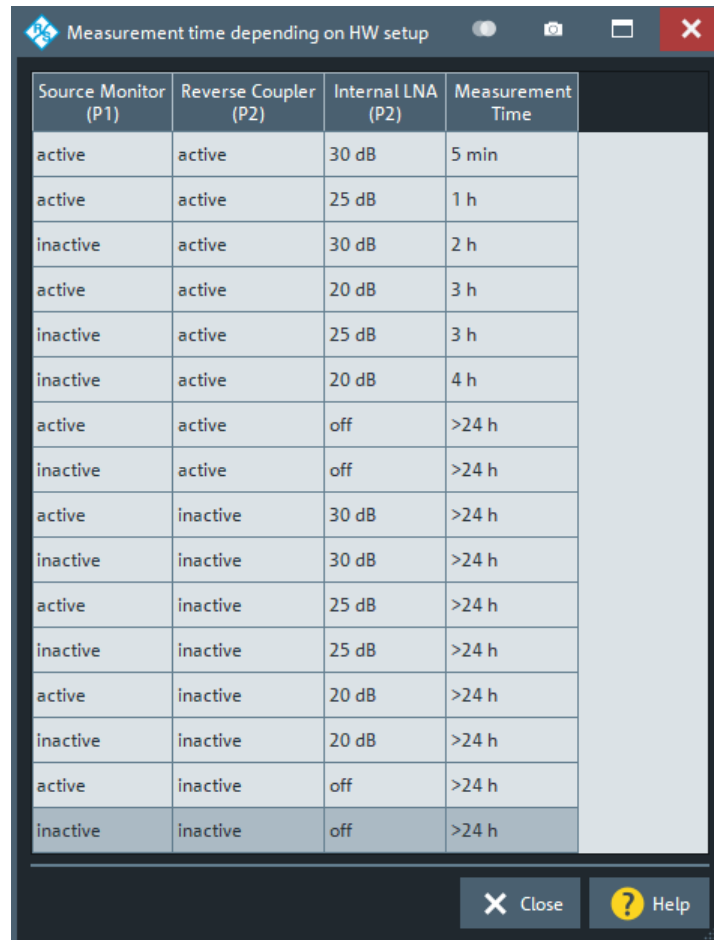

Source Monitor (P1)	Reverse Coupler (P2)	Internal LNA (P2)	Measurement Time
active	active	30 dB	5 min
active	active	25 dB	1 h
inactive	active	30 dB	2 h
active	active	20 dB	3 h
inactive	active	25 dB	3 h
inactive	active	20 dB	4 h
active	active	off	>24 h
inactive	active	off	>24 h
active	inactive	30 dB	>24 h
inactive	inactive	30 dB	>24 h
active	inactive	25 dB	>24 h
inactive	inactive	25 dB	>24 h
active	inactive	20 dB	>24 h
inactive	inactive	20 dB	>24 h
active	inactive	off	>24 h
inactive	inactive	off	>24 h

Driving Port

Allows you to evaluate the influence of the different front side [receiver inputs](#) and the ["Preamp. Gain"](#) on page 527 "b1" ("Isolation Amplifier") on the measurement time.

Setting the "Receiver Input" and "Isolation Amplifier" here is equal to activating it in the ["Input/Output tab"](#) on page 677 of the "Port Configuration" dialog or the [Power tab](#) of the "Pwr Bw Avg" softtool, respectively.

In addition, it is possible to specify an external attenuation at the driving port to let the "Quickset" logic choose the suitable source powers for calibration and measurement.

Remote command:

[\[SENSe<Ch>:\]NFIGure:QSET:ATTSource](#)

Receiving Port

For the receiving port, you can activate or deactivate the [Reverse Coupler Configuration](#) and the [Internal low noise preamplifier](#). The R&S ZNA immediately calculates the resulting measurement time and displays it in the [Result Settings](#) section.

In addition, it is possible to specify an external attenuation at the receiving port to let the "Quickset" logic choose the suitable source powers for calibration and measurement.

Remote command:

```
[SENSe<Ch>:]NFIGure:QSET:ATTReceiver
```

Det Time Overview

Opens the "Detector Time Overview" dialog, which shows an overview of the resulting detector times for each step of the calibration and measurement.

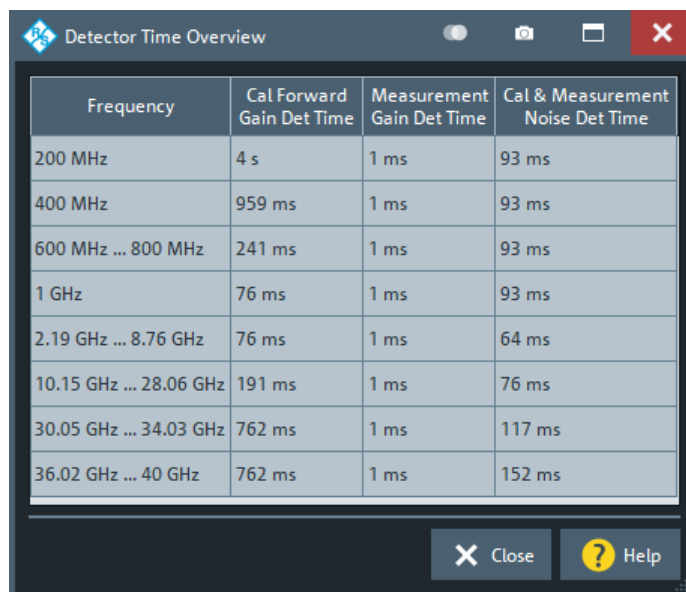

Frequency	Cal Forward Gain Det Time	Measurement Gain Det Time	Cal & Measurement Noise Det Time
200 MHz	4 s	1 ms	93 ms
400 MHz	959 ms	1 ms	93 ms
600 MHz ... 800 MHz	241 ms	1 ms	93 ms
1 GHz	76 ms	1 ms	93 ms
2.19 GHz ... 8.76 GHz	76 ms	1 ms	64 ms
10.15 GHz ... 28.06 GHz	191 ms	1 ms	76 ms
30.05 GHz ... 34.03 GHz	762 ms	1 ms	117 ms
36.02 GHz ... 40 GHz	762 ms	1 ms	152 ms

The detector times are calculated based on the VNA characteristics. They ensure that the selected trace noise is achieved over the intended frequency range, with minimum overall measurement time.

Recommended Measurement and Calibration Settings

This section gives an overview of the power settings that the Quickset function recommends for an ideal calibration and measurement, without compression of the DUT or the VNA receivers. Using "Apply" or "OK" these values are directly transferred into the corresponding measurement and calibration settings.

Apply/OK

Applies the settings of the quick NF setup. OK also closes the dialog.

Remote command:

```
[SENSe<Ch>:]NFIGure:QSET[:EXEC]
```

5.2.6 Intermodulation tab

Allows you to set up the channel for an intermodulation measurement, and to select intermodulation products and other results as measured quantities.

Intermodulation measurements require software option R&S ZNA-K4. They are available for both non-frequency converting and frequency converting DUTs.



Background information

Refer to the following sections:

- [Chapter 4.7.3.2, "Intermodulation measurements"](#), on page 262
- ["Intermodulation quantities"](#) on page 269



The labels for the intermodulation quantities in the trace list are identical to the parameters used for remote control; see `CALCulate<Ch>:PARAmeter:SDEFine`.

5.2.6.1 Controls on the Intermodulation tab

After a [Preset], most of the controls on the "Intermodulation" tab are disabled. They are enabled after the current channel has been set up for an intermodulation measurement (see ["Intermod"](#) on page 381).



If [external switch matrices](#) are used, intermodulation measurements are not supported and hence the controls on this tab are disabled.

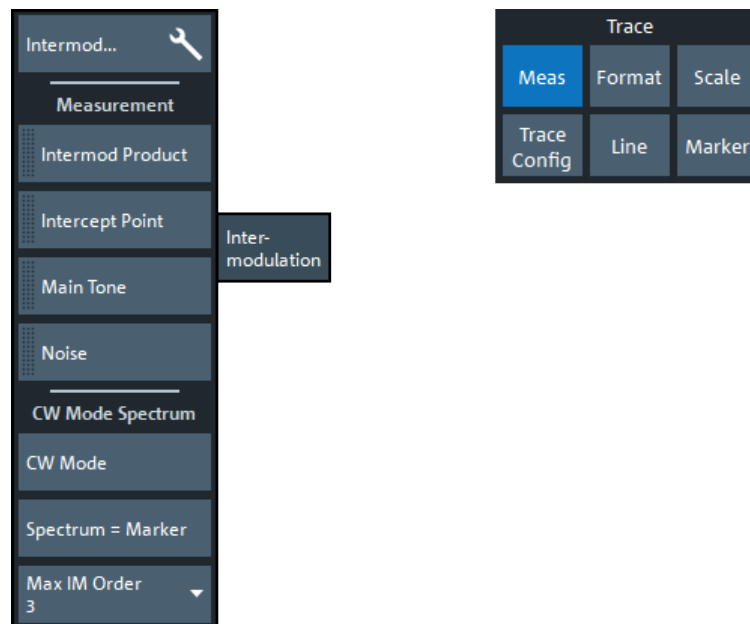

Intermod

The **"Intermod"** button opens the intermodulation setup dialog that allows you to set up the intermodulation measurement:

- [Non-frequency converting](#)
- [Frequency converting](#)

Intermod Product

After the intermodulation measurement has been set up (see ["Intermod"](#) on page 381) this button opens the intermodulation measurements dialog and activates the [Intermod Product tab](#).

Intercept Point

After the intermodulation measurement has been set up (see ["Intermod"](#) on page 381) this button opens the intermodulation measurements dialog and activates the [Intercept Point tab](#).

Main Tone

After the intermodulation measurement has been set up (see ["Intermod"](#) on page 381) this button opens the intermodulation measurements dialog and activates the [Main Tone tab](#).

Noise

"Noise" (at DUT output) is a measure for the noise level and therefore the dynamic range of the intermodulation measurement. The noise level is measured at the frequency of the lower tone minus half the tone distance.

Remote command:

```
CALCulate<Ch>:PARAmeter:MEASure
CALCulate<Ch>:PARAmeter:SDEFine
```

CW Mode Spectrum

In CW spectrum mode, the intermodulation measurement is performed at fixed frequency of the lower tone ("CW Frequency") and the upper tone ("CW Frequency" + "Tone Distance"). The analyzer displays intermodulation products up to a selectable order ("IM Order") around the lower and upper tone frequencies. The channel settings differ from the swept intermodulation measurement, therefore a new channel is created when the spectrum measurement is activated ("Add CW Mode").

The following example shows an intermodulation spectrum with the following settings:

- CW Frequency: 2 GHz (lower tone, position of marker M1)
- Tone Distance: 3 MHz (defines the upper tone, position of marker M2)
- Max. IM Order: 9.

From left to right, the peaks correspond to the following intermodulation products:

- lower IM9
- lower IM7
- lower IM5 (marker M6)
- lower IM3 (marker M5)
- lower tone (marker M1)
- upper tone (marker M2)
- upper IM3 (marker M3)
- upper IM5 (marker M4)

- upper IM7
- upper IM9

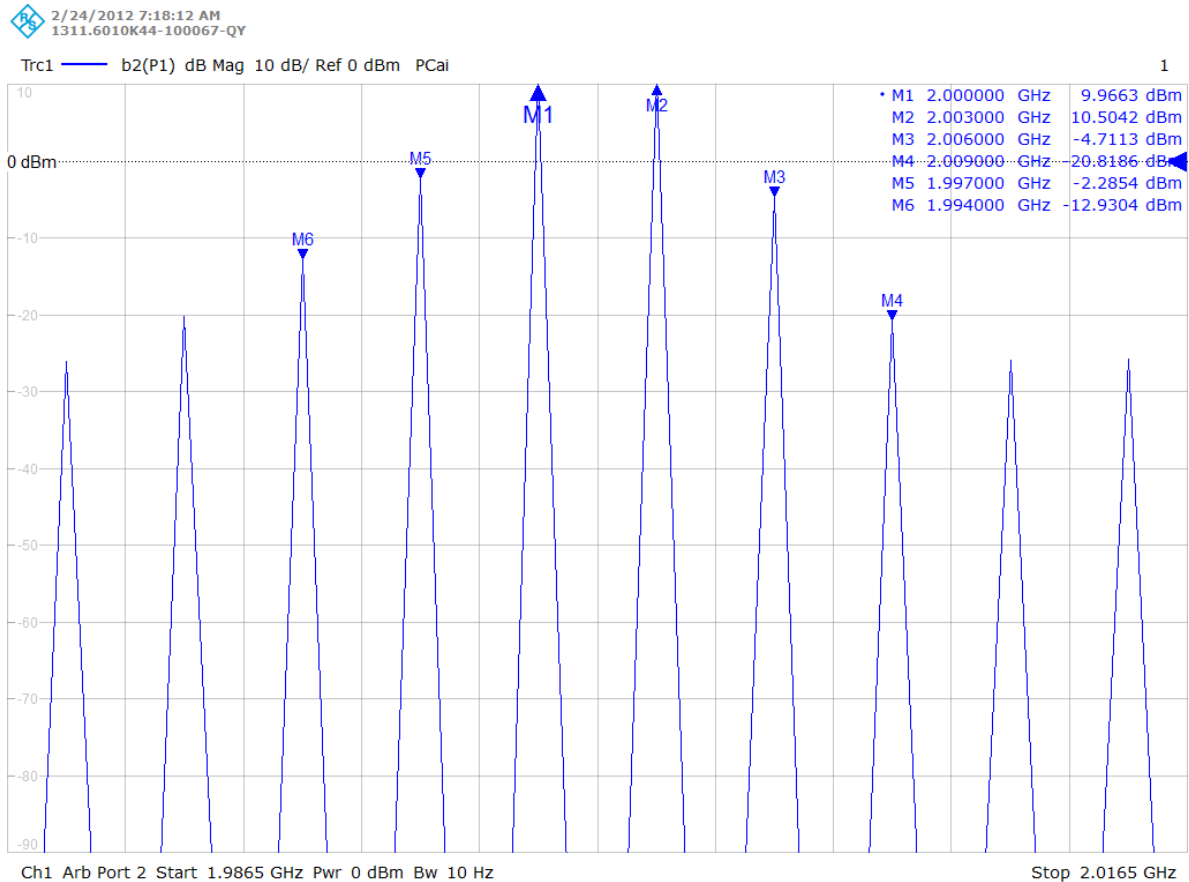

- "CW Mode"
Activates a new channel for the spectrum measurement. The "CW Frequency" plus half the "Tone Distance" defines the center of the diagram.
- "Spectrum = Marker"
This button is only available if the analyzer is equipped with software option R&S ZNA-K1; see "Spectrum = Marker" on page 506. If there is no marker in the active intermodulation trace, the center frequency of the related channel is used.
- "Max IM Order"
Defines the width of the spectrum measurement.

Remote command:

```
[SENSe<Ch>:]FREQuency[:CW]
[SENSe<Ch>:]FREQuency:IMODulation:MSPECTrum
[SENSe<Ch>:]FREQuency:IMODulation:SPECTrum:MORDER
[SENSe<Ch>:]FREQuency:IMODulation:SPECTrum[:STATe]
```

5.2.6.2 Intermodulation setup dialog

The intermodulation setup dialog is an instance of the [Multi-channel setup dialog](#). It allows you to set up one or more channels for intermodulation measurements on a non-frequency converting DUT.

Access: Trace – [Meas] ("Non-Frequency Converting") > "Intermodulation" > "Intermod."

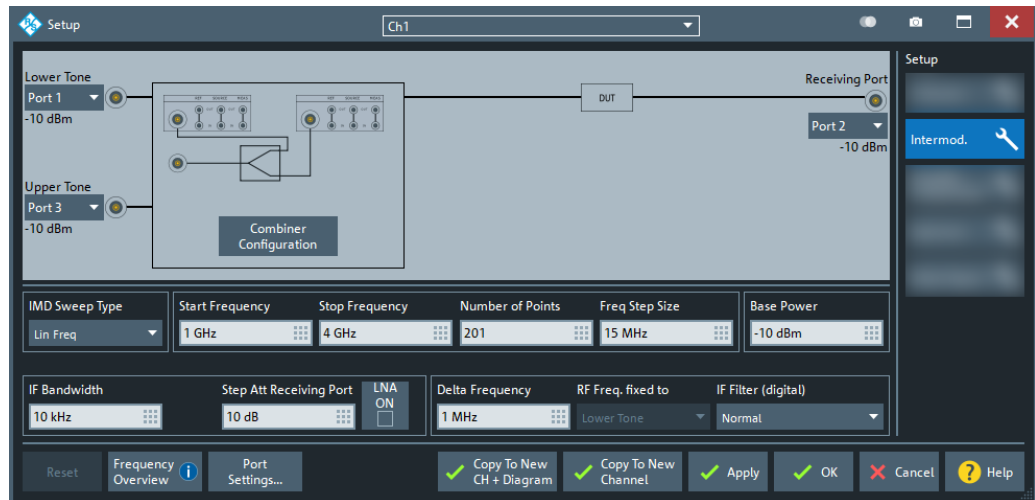

Figure 5-6: Intermodulation Setup Dialog (non-frequency converting DUT)

Port and signal path setup

The graphical part of the dialog allows you to define the related ports and the signal path.

Lower Tone

Selects an analyzer port as a source of the lower tone signal.

Remote command:

```
[SENSe<Ch>:]FREQuency:IMODulation:LTONE
```

Upper Tone

Selects an analyzer port or external generator as a source of the upper tone signal.

- For a 2-port R&S ZNA without [Internal 2nd source and 2nd LO generator for 2-port R&S ZNA](#), the upper tone must be provided by an [external generator](#).
- For a 4-port R&S ZNA, upper tone and lower tone must be provided by different sources. I.e. without the optional [Internal 3rd and 4th source for 4-port R&S ZNA](#), you cannot combine ports 1 and 2 or ports 3 and 4.

Remote command:

```
[SENSe<Ch>:]FREQuency:IMODulation:UTONE
```

Combiner Configuration

Opens the "Combiner Configuration" dialog that allows you to define the signal paths of the ports generating the two-tone signal. The lower tone port is always the one on the left.

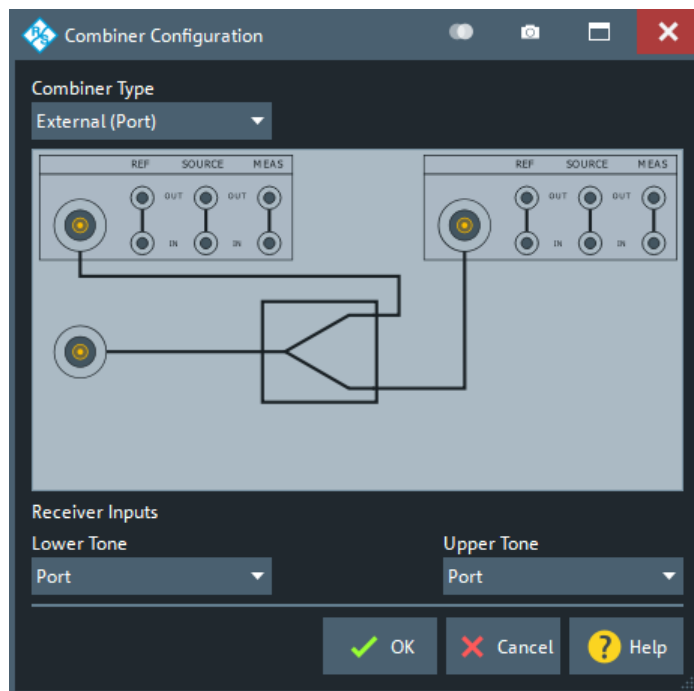

Combiner Type ← Combiner Configuration

Defines how the generated signals are combined.

"External (Port)" Use the signals of the test ports and combine them externally (see graphic above).
With this configuration, the two-tone signal is available at the output of the combiner. It allows you to measure intermodulation products at the DUT output, but not at the DUT input.

Note: With frequency converters, only external combination of the converter RF out signals is supported.

"External (Direct Access)" Use the signal from the source out (direct access) of the lower tone port and the signal from the upper tone port. Combine them externally, and feed the combined signal to the source in (direct access) of the lower tone port:

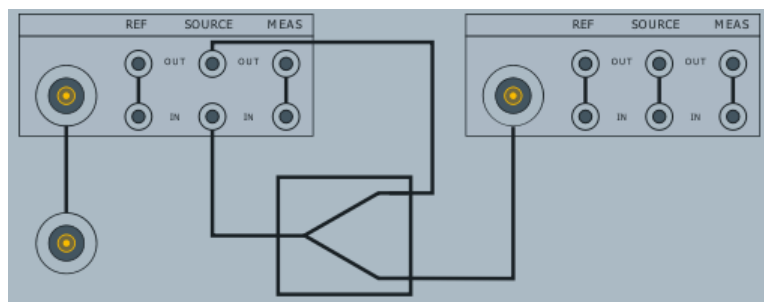

With this configuration, the two-tone signal is available at test port 1. The intermodulation quantities can be measured at the DUT input or at the DUT output.

"Use Coupler as Combiner"

This configuration does not require an external combiner, but provides a reduced dynamic range. It combines the signals of the lower tone and upper tone sources using the directional coupler of the upper tone port as combiner:

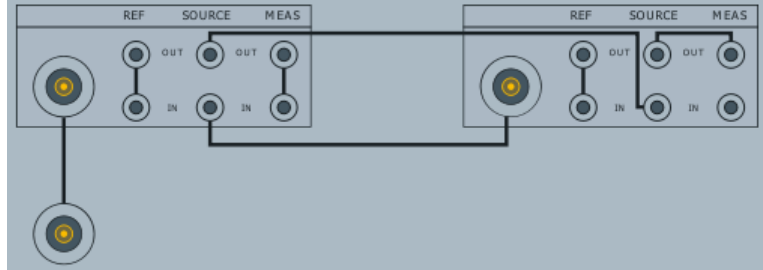

With this configuration, the two-tone signal is available at test port 1. The intermodulation quantities can be measured at the DUT input or at the DUT output.

"Internal"

If the R&S ZNA is equipped with an [Internal combiner](#) (R&S ZNAXx-B21y), then:

- For a 2-port instrument (with R&S ZNAXx-B212), the source signals of port 1 and port 2 can be combined internally
- For a 4-port instrument (with R&S ZNAXx-B213), the source signals of port 1 and port 3 can be combined internally

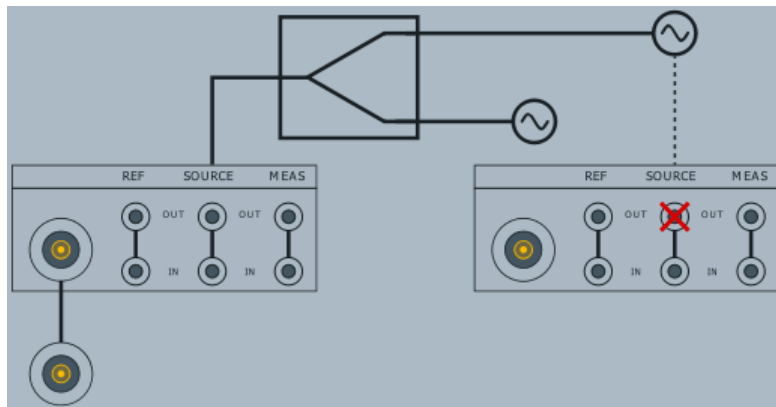

The combined signal is output to port 1.

Remote command:

`SOURce<Ch>:COMBiner`

Receiver Inputs ← Combiner Configuration

Defines the receiver signal paths for the lower- and upper-tone ports.

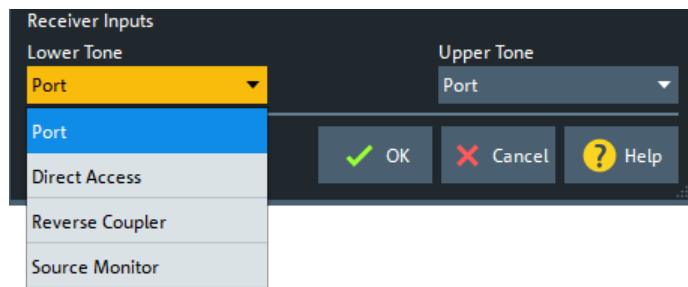
**Note:**

- Make sure to select the correct configuration, according to your cabling.
- If the [internal combiner](#) is used, lower- and upper-tone signals use the same path, and hence only "Lower Tone" can be selected.

See "[Receiver Input](#)" on page 678.

Receiving Port

Selects the receiving port for the signal from the output of the DUT.

Remote command:

```
[SENSe<Ch>:]FREQuency:IMODulation:RECeiver
```

Sweep and stimulus setup**IMD Sweep Type**

The intermodulation distortion measurement can be performed with three different sweep types. The sweep parameters to the right of the "IMD Sweep Type" selector change accordingly.

- | | |
|------------|----------------------------------------------------------------------------------------------------------------------------------------------------------------------------------------------------------------------------------------------------------------------------------------------------------------------------------------------------------------------------------------------------------------------------------------------------------------------------------------------------------------------------------------------------------------------------------------------------------------------------------------------------------------------------------------------------------------------------------------------------------------------------------------------------------------------------|
| "Lin Freq" | The channel is set to Lin Freq sweep type. The lower tone port sweeps with channel settings (see " Start Frequency/Stop Frequency/Number of Points/Freq Step Size/Base Power " on page 387), the upper tone in parallel with a given Delta Frequency . |
| "Power" | The channel is set to Power sweep type. The lower tone port sweeps with channel settings (see " Start Power/Stop Power/Number of Points/Fixed CW " on page 387), the upper tone in parallel with a given Delta Frequency . |
| "Delta F" | The channel performs a CW Mode sweep whose standard parameters can be set in the dialog (see " Start delta Freq./Stop delta Freq./Number of Points/Base Power/CW Frequency/CW fixed to " on page 387).
The frequency distance between lower tone and upper tone starts at "Start Delta Freq." and ends at "Stop Delta Freq." (grows or shrinks linearly). Either the lower tone or the upper tone remains at the configured CW Frequency ("CW fixed to": "Lower Tone"/"Upper Tone"). As a third possibility, the center between lower tone and upper tone can remain at the configured CW Frequency ("CW fixed to": "Center"). For the related parameters, see " Start delta Freq./Stop delta Freq./Number of Points/Base Power/CW Frequency/CW fixed to " on page 387. |

Start Frequency/Stop Frequency/Number of Points/Freq Step Size/Base Power

Standard parameters of a linear frequency sweep (see [Chapter 5.8, "Stimulus softtool"](#), on page 522).

Start Power/Stop Power/Number of Points/Fixed CW

Standard parameters of a power sweep (see [Chapter 5.8, "Stimulus softtool"](#), on page 522).

Delta Frequency

Defines the frequency difference between the upper and the lower tone for linear frequency and power sweeps. The tone distance is kept constant across the entire sweep.

Remote command:

```
[SENSe<Ch>:]FREQuency:IMODulation:TDIStance
```

Start delta Freq./Stop delta Freq./Number of Points/Base Power/CW Frequency/CW fixed to

Defines the lower tone and upper tone frequency sweeps for [IMD Sweep Type "Delta F"](#).

Additional channel settings**IF Bandwidth**

See ["Bandwidth"](#) on page 536.

Step Att Receiving Port

Only available if the selected [Receiving Port](#) is equipped with a receiver step attenuator (see [Chapter 4.7.31, "Receiver step attenuators"](#), on page 309).

Defines the [receiver step attenuation](#) at this port.

Frequency Overview dialog

The "Frequency Overview" dialog summarizes the resulting measured frequency ranges, according to the current setup of the related channel. Invalid frequency ranges (that are not covered by the analyzer's frequency range) are marked in red.

Access: "Frequency Overview" in various channel mode setup dialogs

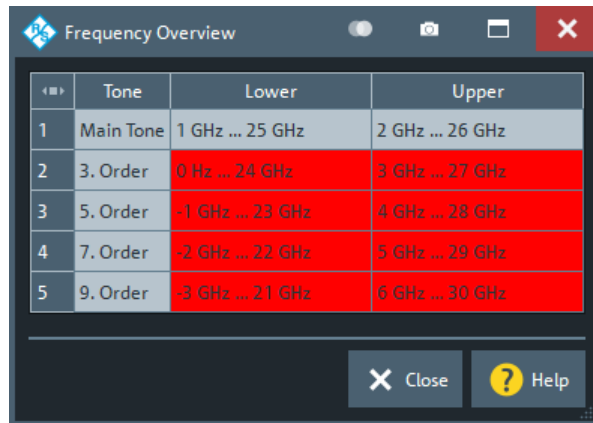

	Tone	Lower	Upper
1	Main Tone	1 GHz ... 25 GHz	2 GHz ... 26 GHz
2	3. Order	0 Hz ... 24 GHz	3 GHz ... 27 GHz
3	5. Order	-1 GHz ... 23 GHz	4 GHz ... 28 GHz
4	7. Order	-2 GHz ... 22 GHz	5 GHz ... 29 GHz
5	9. Order	-3 GHz ... 21 GHz	6 GHz ... 30 GHz

The settings in the channel mode setup dialog from which the "Frequency Overview" dialog was called cannot be applied unless all measured frequency ranges are valid.

5.2.6.3 Intermodulation setup dialog (frequency-converting)

The frequency converting intermodulation setup dialog is an instance of the [Multi-channel setup dialog](#). It allows you to set up one or more channels for an intermodulation measurement on a frequency converting DUT.

Access: Trace – [Meas] ("Frequency Converting") > "Intermodulation" > "Intermod."

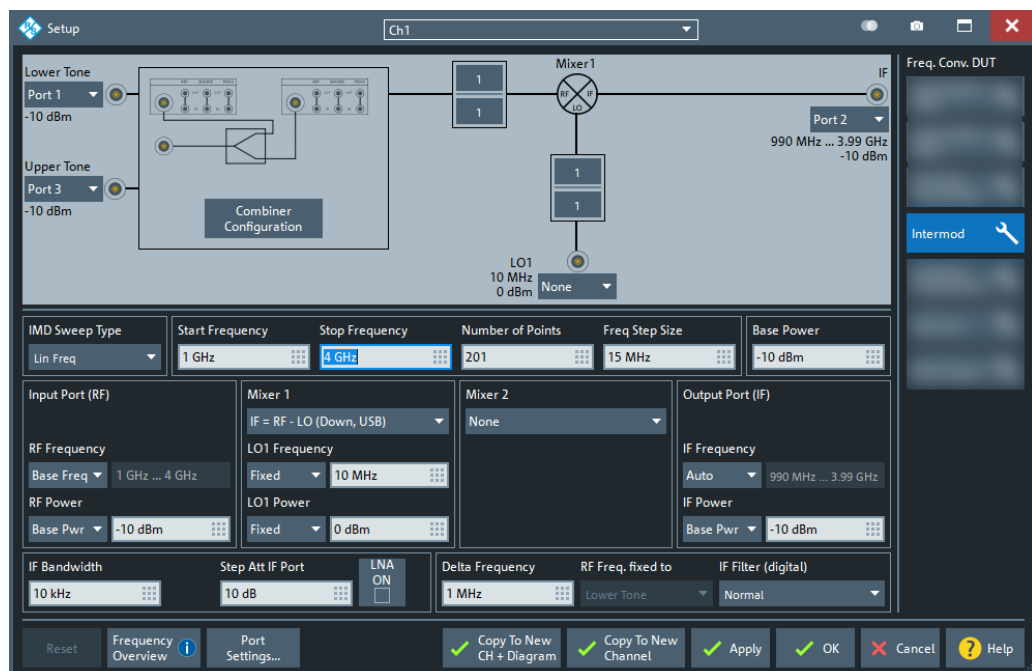

Figure 5-7: Intermodulation Setup Dialog (frequency converting DUT)

5.2.6.4 Intermodulation Measurements dialog

Allows you to select the measured quantities that are relevant for intermodulation measurements.

Access: Trace – [Meas] > "Intermodulation" > "Intermod Product" | "Intercept Point" | "Main Tone"



Background information

Refer to "[Intermodulation quantities](#)" on page 269.

Intermod Product tab

Allows you to select intermodulation products as measured quantities.

Access: Trace – [Meas] > "Intermodulation" > "Intermod Product"

Intermod Product							
Absolute				Relative			
3	IM3LO	IM3UO	IM3MO	IM3LOR	IM3UOR	IM3MOR	3
5	IM5LO	IM5UO	IM5MO	IM5LOR	IM5UOR	IM5MOR	5
7	IM7LO	IM7UO	IM7MO	IM7LOR	IM7UOR	IM7MOR	7
9	IM9LO	IM9UO	IM9MO	IM9LOR	IM9UOR	IM9MOR	9
	Lower	Upper	Major	Lower	Upper	Major	

IM<order><side>O

Absolute InterModulation product (displayed in dB units).

- **<order>** defines the order of the intermodulation product. Possible values are 3, 5, 7, or 9.
- **<side>** defines the position of the intermodulation product relative to the lower and upper tones.
 - **Upper** intermodulation products are measured at frequencies above the upper tone.
 - **Lower** intermodulation products are measured at frequencies below the lower tone.
 - **Major** denotes the lower or upper intermodulation product, whichever is larger. The major intermodulation product reveals the worst-case performance of the DUT.

Currently intermodulation products are always measured at DUT **O**utput.

Remote command:

`CALCulate<Ch>:PARAmeter:MEASure`

`CALCulate<Ch>:PARAmeter:SDEFine`

IM<order><side>OR

Relative intermodulation product at DUT output.

Same as [IM<order><side>O](#) but in this case the intermodulation product is displayed in dBc units relative to the measured lower tone level at the DUT output ("Lower Tone at DUT Out").

The relative result is often termed "intermodulation suppression".

Remote command:

```
CALCulate<Ch>:PARAmeter:MEASure
```

```
CALCulate<Ch>:PARAmeter:SDEFine
```

Intercept Point tab

Allows you to select intermodulation products as measured quantities.

Access: Trace – [Meas] > "Intermodulation" > "Intercept Point"

Intercept Point							
Output			Input				
3	IP3LO	IP3UO	IP3MO	IP3LI	IP3UI	IP3MI	3
5	IP5LO	IP5UO	IP5MO	IP5LI	IP5UI	IP5MI	5
7	IP7LO	IP7UO	IP7MO	IP7LI	IP7UI	IP7MI	7
9	IP9LO	IP9UO	IP9MO	IP9LI	IP9UI	IP9MI	9
	Lower	Upper	Major	Lower	Upper	Major	

IP<order><side><DUT port>

Intercept Point at DUT output

- **<order>** defines the order of the intercept point. Possible values are 3, 5, 7, or 9.
- **<side>** defines the position of the intercept point relative to the lower and upper tones.
 - The **Lower** intercept points are measured at frequencies below the lower tone.
 - The **Upper** intercept points are measured at frequencies above the upper tone.
 - The **Minor** intercept point denotes the lower or upper intercept point, whichever is **smaller**. It reveals the worst-case performance of the DUT.
- **<DUT port>** defines the reference port for the intercept point calculation. Possible values are **O** for the DUT output port and **I** for the DUT input port. Both values differ by the attenuation of the lower tone signal upon transmission through the DUT; see "[Intermodulation quantities](#)" on page 269.

Remote command:

```
CALCulate<Ch>:PARAmeter:MEASure
```

```
CALCulate<Ch>:PARAmeter:SDEFine
```

Main Tone tab

Allows you to select the upper/lower tone at DUT input/output as measured quantities.

Access: Trace – [Meas] > "Intermodulation" > "Main Tone"

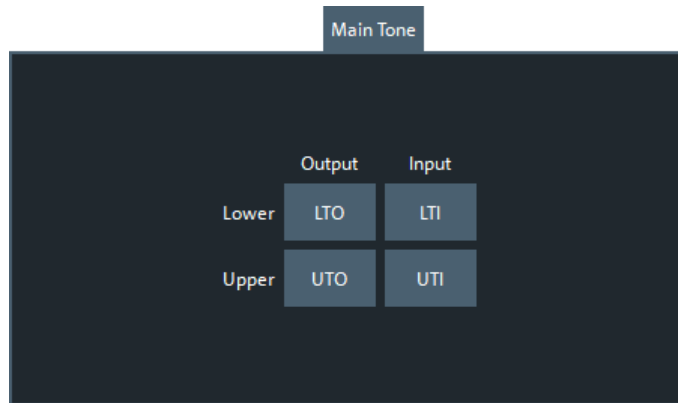

"Lower Tone at DUT Out" (**LTO**), "Lower Tone at DUT In" (**LTI**), "Upper Tone at DUT Out" (**UTO**), and "Upper Tone at DUT In" (**UTI**) are measurements of the two fundamental waves of the intermodulation measurement.

5.2.7 Gain Compression tab

Allows you to configure and perform compression point over frequency measurements. This softtool is available and has the same appearance for both frequency- and non frequency-converting DUTs.

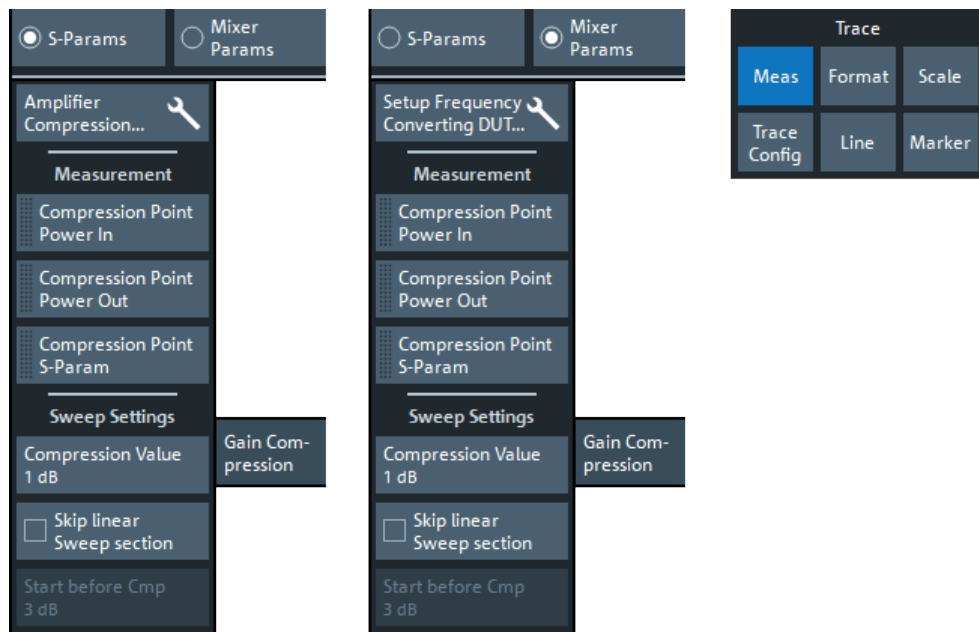

The gain compression measurement performs a power sweep (defined by [Start Power/ Stop Power](#) and [Power Points](#)) for a linear frequency grid (defined by [Start Frequency/ Stop Frequency](#), [Number of Points](#)). Given the configured [Compression Value](#), and with the (fixed) start power serving as reference point, the compression point (P_{Cmp} , $I_N(f)$, $S_{\text{Cmp}}(f)$) is determined for each grid frequency f .

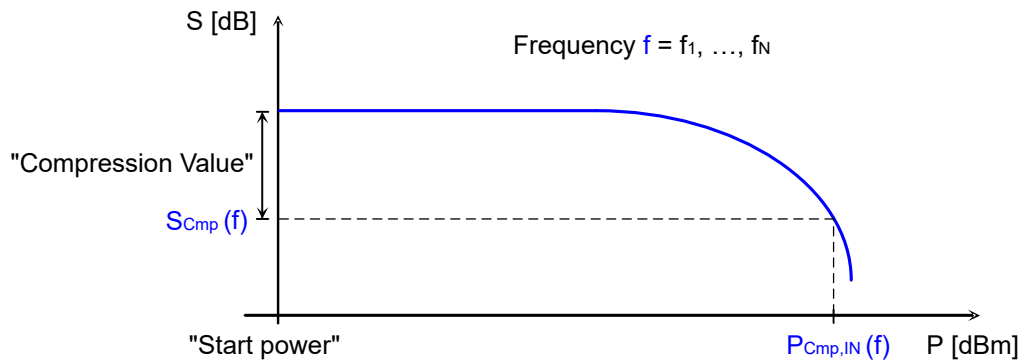

If a full 2-port calibration is used, the R&S ZNA also requires measurements in reverse direction, i.e. with the receiving port of the gain compression measurement operating as source port. In the current implementation, by default the same power sweeps are used for the reverse direction. If the resulting power levels are inadequate for your DUT, you have to configure a source power different from P_b for the receiving port of the gain compression measurement (see ["Channel Base Power"](#) on page 630).

Skipping the linear part

For all frequencies, the power sweep starts at the configured [start power](#), which serves as the reference for the compression point. The power sweep always stops when it reaches a point that falls below the configured [Compression Value](#). However, if the linear part is large compared to the compression part, a large part of the measurement time is wasted for irrelevant power points. If you enable [Skip Linear Sweep Section](#), then for frequency f_{n+1} the firmware skips all power sweep points between start power and $P_{Cmp,IN}(f_n) -$ ["Start Before Cmp"](#) on page 393.

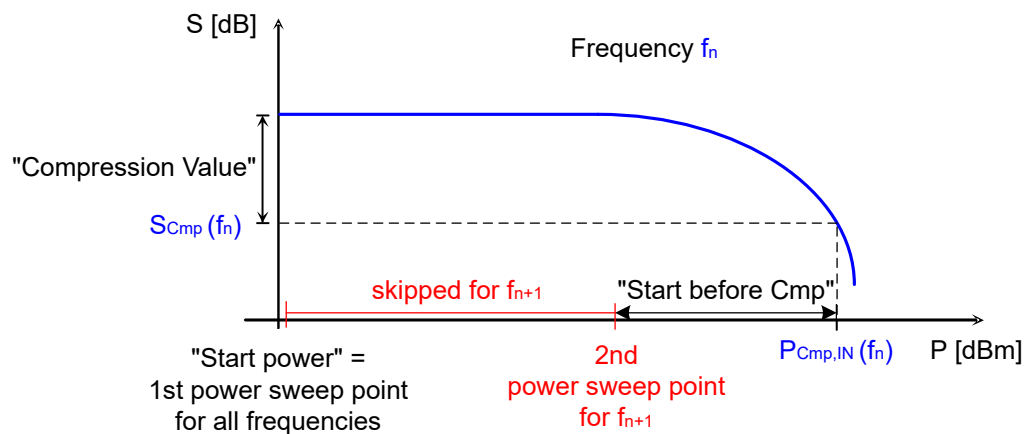

5.2.7.1 Controls on the Gain Compression tab

Amplifier Compression/Setup Frequency Converting DUT

Opens the [Multi-channel setup dialog](#) for gain compression measurements:

- See [Chapter 5.2.7.2, "Amplifier Compression setup dialog"](#), on page 394 for non-frequency converting DUTs
- See [Chapter 5.2.7.3, "Converter Compression setup dialog"](#), on page 395 for frequency-converting DUTs

Compression Point Power In / Compression Point Power Out / Compression Point S-Param

Selects the input power, output power, or transmission S-parameter value at the <x dB> compression point as the measured quantity, where <x dB> is the specified [Compression Value](#).

Remote command:

```
'CALCulate<Ch>:PARAmeter:MEASure '<TraceName>', 'CmpPtPin' |
'CmpPtPout' | 'CmpPtS'
CALCulate<Ch>:PARAmeter:SDEFine '<TraceName>', 'CmpPtPin' |
'CmpPtPout' | 'CmpPtS'
```

Compression Value

With a "Compression Value" of x, the gain compression measurement searches for the x dB compression points of the power sweeps.

The x dB compression point is defined as the stimulus level where the response value has dropped by x dB compared to the response value at [start power](#).

Remote command:

```
[SENSe<Ch>:]FREQuency:COMPression:POINt
```

Skip Linear Sweep Section

Activates/deactivates skipping "irrelevant" power sweep points, as described in ["Skipping the linear part"](#) on page 392.

Remote command:

```
[SENSe<Ch>:]FREQuency:COMPression:SKIP
```

Start Before Cmp

If [Skip Linear Sweep Section](#) is active, then for the next frequency, after measuring at [start power](#), the firmware continues the power sweep "Start Before Cmp" to the left of the "Compression Point Power In" determined for the previous frequency.

See ["Skipping the linear part"](#) on page 392.

Remote command:

```
[SENSe<Ch>:]FREQuency:COMPression:SKIP:OFFSet
```

5.2.7.2 Amplifier Compression setup dialog

The "Amplifier Compression" setup dialog is an instance of the [Multi-channel setup dialog](#). It allows you to set up one or more channels for compression point over frequency measurements on non-frequency converting DUTs.

Access: [Meas softtool](#) > "S-Params" > "Gain Compression" > "Amplifier Compression"

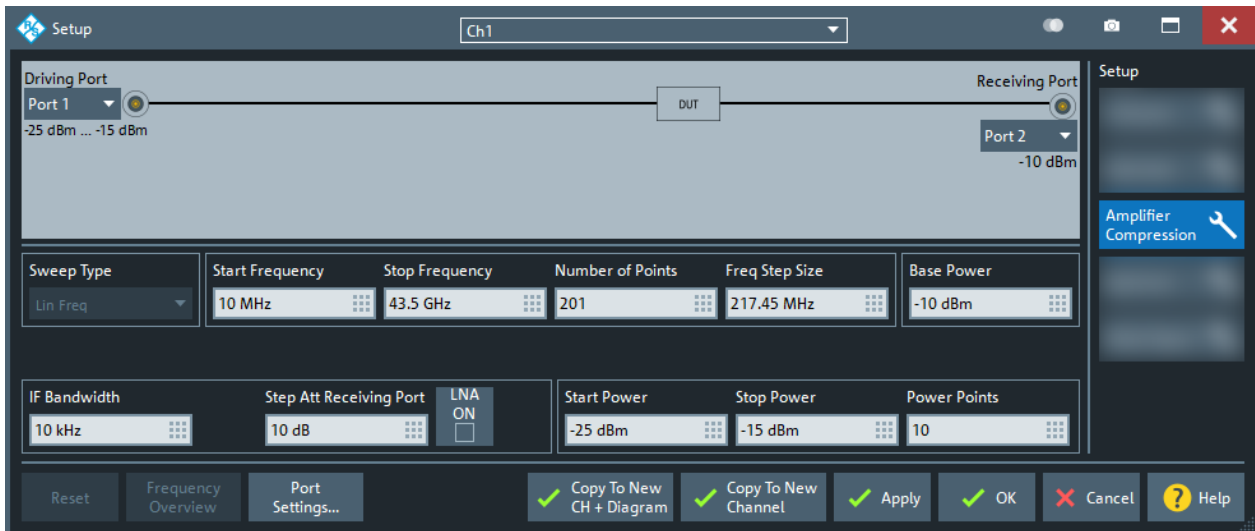

Figure 5-8: Amplifier Compression dialog

Driving Port/Receiving Port

Selects the driving and receiving port for the gain compression measurement.

Remote command:

```
[SENSe<Ch>:] FREQuency:COMPReSSION:SRCPort
[SENSe<Ch>:] FREQuency:COMPReSSION:RECEiver
```

Sweep Type

Compression measurement channels are set up for linear frequency sweeps. For each point on the (linear) frequency grid, the firmware performs a power sweep.

Start Frequency/Stop Frequency

See the corresponding controls on the [Stimulus tab](#).

Number of Points

See the corresponding controls on the [Sweep Params tab](#).

Base Power/IF Bandwidth/Step Att Receiving Port

See the corresponding controls on the [Pwr Bw Avg softtool](#).

Start Power/Stop Power

Defines the start and stop power for the power sweeps that are performed at each point on the linear frequency grid defined using [Start Frequency/Stop Frequency](#).

Remote command:

```
[SENSe<Ch>:] FREQuency:COMPReSSion:POWer:START
[SENSe<Ch>:] FREQuency:COMPReSSion:POWer:STOP
```

Power Points

Defines the number of points for the power sweeps at each point on the frequency grid defined using [Start Frequency/Stop Frequency](#).

Remote command:

```
[SENSe<Ch>:] FREQuency:COMPReSSion:POWer:POINTs
```

5.2.7.3 Converter Compression setup dialog

Similar to the [Amplifier Compression setup dialog](#), but with additional configuration possibilities for frequency converting DUTs.

Access: [Meas softtool](#) > "Mixer Params" > "Gain Compression" > "Setup Frequency Converting DUT"

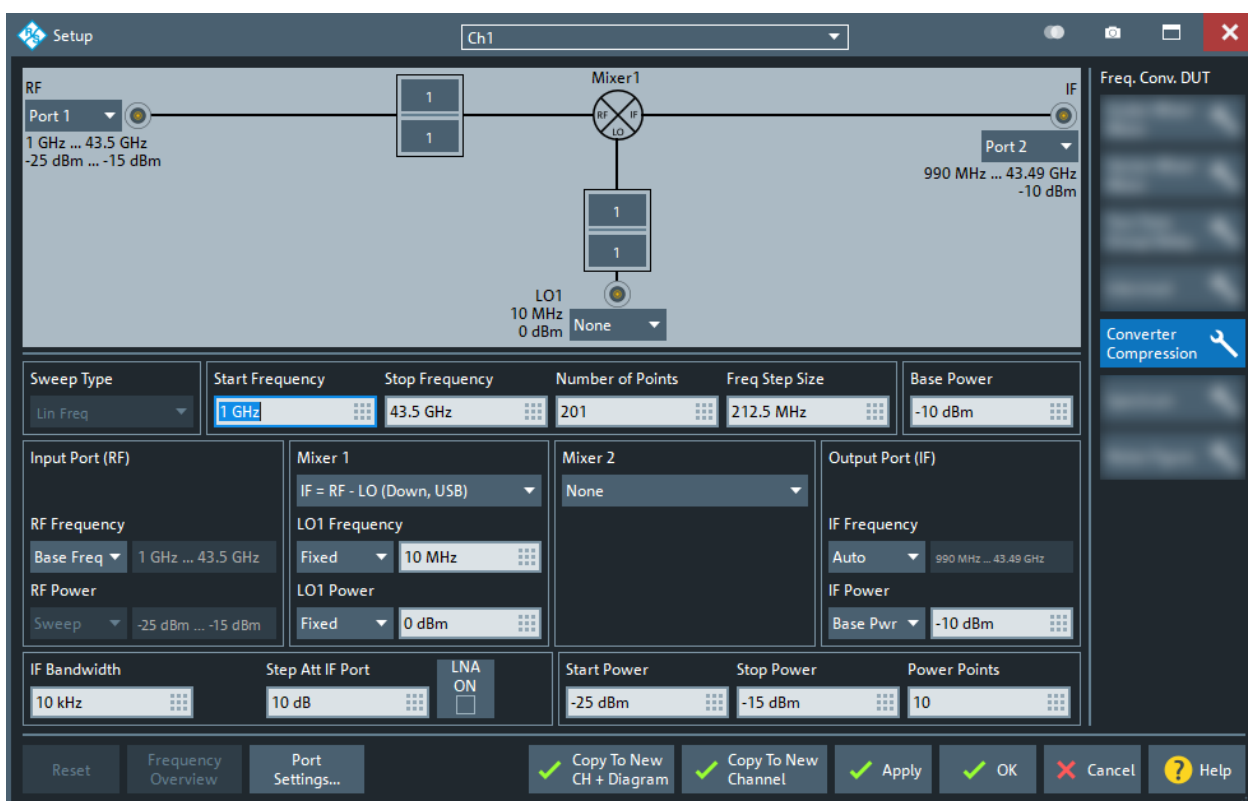

5.2.8 Time Domain tab

The "Time Domain" tab is enabled by software option R&S ZNA-K2. It mirrors the [Time Domain tab](#) of the Trace – [Trace Config] softtool.

5.2.9 Time Gate tab

The "Time Gate" tab is enabled by software option R&S ZNA-K2. It mirrors the [Time Gate tab](#) of the Trace – [Trace Config] softtool.

5.2.10 Power Sensor tab

Allows you to set up and perform measurements using external power sensors.



The standard test setup for a "Power Sensor" measurement involves one analyzer source port and a power sensor. The power sensor is connected to the VNA (e.g. to the analyzer's USB port) and provides scalar wave quantity results. See [Chapter 4.7.39, "External power meters"](#), on page 316.

Pmtr<i>

After a was connected, [configured](#), and [selected](#), you can use this button to create a power meter trace in one of the available diagrams or in a new one.

Remote command:

```
CALCulate<Ch>:PARAmeter:MEASure 'TraceName', 'PmtrD1 | ...
CALCulate<Ch>:PARAmeter:SDEFine 'TraceName', 'PmtrD1 | ...
```

Power Meter

Shows a list of all power meters that have been properly configured. See ["Configured Devices"](#) on page 893.

The bordered label below displays the type and serial number of the selected power meter.

Remote command:

```
CALCulate<Ch>:PARAmeter:MEASure 'TraceName', 'PmtrD1 | ...
CALCulate<Ch>:PARAmeter:SDEFine 'TraceName', 'PmtrD1 | ...
```

Auto Zero

Initiates an automatic zeroing procedure of the selected power meter.

The power meter must be disconnected from the RF power; see [Chapter 4.7.39.1, "Zeroing"](#), on page 318. A message indicates that zeroing is finished.

Remote command:

```
SYSTem:COMMunicate:RDEvice:PMETer<Pmtr>:AZERo
```

Source Port

Selects one of the available test ports of the analyzer as a source of the stimulus signal.

Remote command:

```
CALCulate<Ch>:PARAmeter:MEASure 'TraceName', 'PmtrD1 | ...  
CALCulate<Ch>:PARAmeter:SDEFine 'TraceName', 'PmtrD1 | ...
```

Show as

Selects the physical unit of the displayed trace. It is possible to display the measured "Voltage" V or convert it to a "Power" according to the formula

$$P = V^2/\text{Re}(Z_0).$$

Z_0 denotes the reference impedance of the source port. The reference impedances are defined in the "Balanced Ports" dialog (see [Chapter 5.2.2.5, "Balanced Ports dialog"](#), on page 352).

Remote command:

```
CALCulate<Chn>:FORMat:WQUType
```

Port Settings...

Opens the [Port Settings dialog](#).

5.2.11 Spectrum tab

The "Spectrum" tab allows you to set up spectrum measurements.



Spectrum measurements require software option R&S ZNA-K1. If this option is not installed, the "Spectrum" tab is hidden.

5.2.11.1 Controls on the Spectrum tab

The controls on the "Spectrum" tab allow you to select a port and one of its receivers, and to define how the spectrum trace is calculated. The sweep parameters and other channel settings are defined in the [Chapter 5.2.11.2, "Spectrum Setup dialog"](#), on page 400.



Spectrum Analysis...

Opens the [Spectrum Setup](#) dialog

Measurement

Selects the physical port for the spectrum measurement.

Drag one of the "Port" buttons to the diagram area to create a spectrum trace. Then select the "Receiver" on page 399 to be measured.

If [external switch matrices](#) are connected, ports 3 and higher can be selected using a combo-box instead of a button:

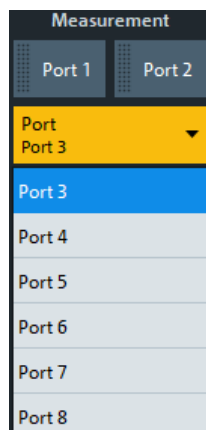

Remote command:

```
CALCulate<Ch>:PARAmeter:MEASure 'SA1' | 'SA1REF' | 'SA2' |
'SA2REF' ...
CALCulate<Ch>:PARAmeter:SDEFine 'SA1' | 'SA1REF' | 'SA2' |
'SA2REF' ...
```

Receiver

Selects which receiver of the current spectrum trace's **port** shall be measured.

Remote command:

```
CALCulate<Ch>:PARAmeter:MEASure 'SA1' | 'SA1REF' | 'SA2' |
'SA2REF' ...
CALCulate<Ch>:PARAmeter:SDEFine 'SA1' | 'SA1REF' | 'SA2' |
'SA2REF' ...
```

Trace Mode

Defines how the spectrum trace is smoothed and averaged.

- "Clear Write" Overwrite mode: the trace is overwritten by each sweep.
- "AVG" The pointwise arithmetic mean over several sweeps.
- "Min Hold" The minimum value is determined from several sweeps and displayed. The R&S ZNA saves the sweep result in the trace memory only if the new value is lower than the previous one.
- "Max Hold" The maximum value is determined over several sweeps and displayed. The R&S ZNA saves the sweep result in the trace memory only if the new value is greater than the previous one.

The different trace modes are implemented as a combination of the general purpose [Infinite Averaging](#) and [Hold](#) mode.

Trace mode	Infinite averaging	Hold mode
"Clear Write"	OFF	"Hold OFF"
"AVG"	ON	"Hold OFF"
"Min Hold"	OFF	"Min Hold"
"Max Hold"	OFF	"Max Hold"

Use [Reset History](#) to reset the averaging/minimization/maximization history.

Remote command:

Use the commands for [Infinite Averaging](#) and [Hold](#) according to the table above.

Reset History

Resets the trace calculation history for [Trace Mode](#) "AVG", "Min Hold", and "Max Hold".

Remote command:

```
"AVG": CALCulate<Chn>:IAverage[:STATe] OFF; IAAverage ON
"Min Hold": CALCulate<Chn>:PHOLD OFF; PHOLD MIN
"Max Hold": CALCulate<Chn>:PHOLD OFF; PHOLD MAX
```

Detector

The "Detector" defines how the measurement result for a particular sweep point is derived from the related sample values.

Maximum Peak	Determines the largest of all levels measured at the individual frequencies which are displayed in one sample point.
Minimum Peak	Determines the smallest of all levels measured at the individual frequencies which are displayed in one sample point.
RMS	Calculates the root mean square of all samples contained in a sweep point.
Average	Calculates the arithmetic mean of all samples contained in a sweep point.

Remote command:

```
[SENSe<Ch>:]SPECTrum:DETEctor
```

Image Rejection

Selects the image rejection strategy: the higher the number of data acquisitions, the better the image rejection.

"Off 1 acq." is recommended if you want to evaluate the [noise power ratioPower Ratio](#).

Remote command:

```
[SENSe<Ch>:]SPECTrum:IREJection
```

Increased Level Accuracy

Disables/enables zero padding.

By default zero padding is used to increase the level accuracy. Not using it can increase the measurement speed, in particular for multi-channel measurements (at the possible cost of a small decrease in level accuracy).

Remote command:

```
[SENSe<Ch>:]SPECTrum:ZPADing
```

Port Settings...

Opens the [Port Settings dialog](#).

5.2.11.2 Spectrum Setup dialog

Allows you to set up channels for the spectrum measurement. For spectrum measurements on frequency-converting DUTs, the "Spectrum Setup" dialog also comprises the mixer configuration.

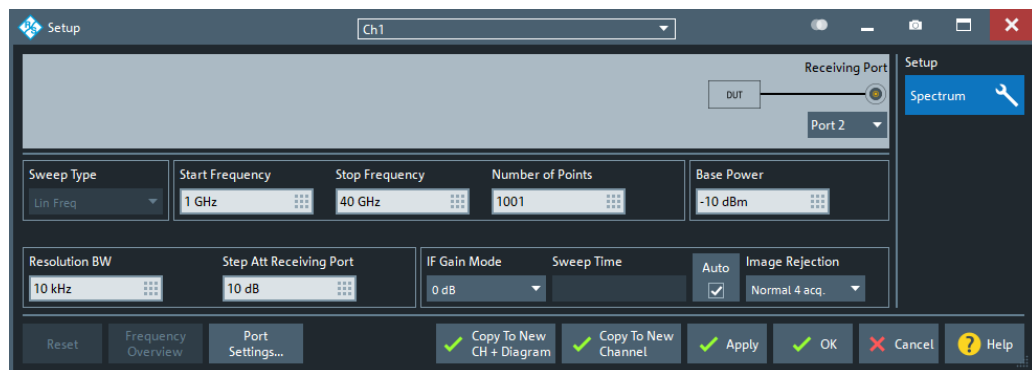

Figure 5-9: Spectrum Setup dialog (non frequency-converting DUT)



- Spectrum measurement channels always use the wideband signal path (see "[IF Filter \(analog\)](#)" on page 537).
- If you want the R&S ZNA to generate a stimulus signal while making the spectrum measurement, you have to configure a generator ("Source Gen") port in the [Port Settings dialog](#).

Sweep Type / ... / Base Power

Basic frequency sweep settings as defined in the [Stimulus tab](#) and [Sweep Params tab](#). In spectrum mode, the receiver is swept linearly.

Resolution BW

Sets the resolution bandwidth, see "[Bandwidth](#)" on page 536.

Step Att Receiving Port

Defines the (mechanical) attenuation at the receiving port (see "[Receiver Step Att.](#)" on page 527).

LNA ON/Preamp Gain

If you select port 2 as the "Receiving Port" and enable the [internal low noise amplifier](#) ("LNA ON"), you can specify a "Preamp Gain" instead of a [Step Att Receiving Port](#).

See [Chapter 5.8.2, "Power tab"](#), on page 525.

Sweep Time / Auto

Allows you to set a sweep time or use the minimum possible sweep time (see "[Sweep Time / Auto](#)" on page 541).

5.2.12 External DLL tab

The "External DLL" tab allows you to add/remove custom plug-ins to/from the firmware. It gives access to their configuration, tasks, and traces.



Background information

Refer to [Chapter 4.7.43, "External DLLs"](#), on page 332.

Access: Trace – [Meas] > "S-Params" mode > "External DLL"

5.2.12.1 Controls on the External DLL tab

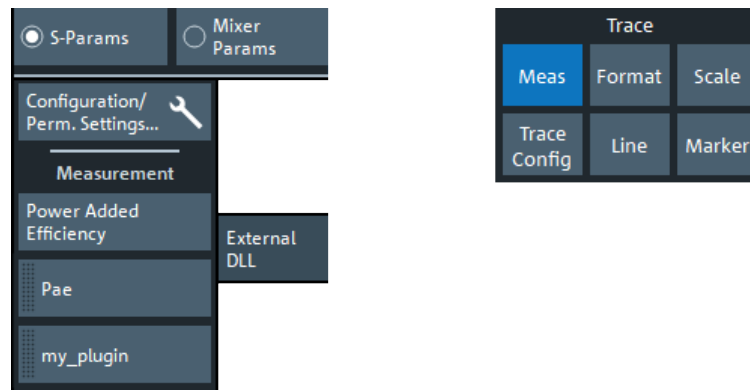

Configuration / Perm. Settings

Opens the [External DLL Configuration Dialog](#).

Measurement

The "Measurement" section gives access to the custom traces of the loaded plug-ins.

Each external DLL `<ext_dll_name>.dll` that provides at least one custom trace type, adds a measurement button "`<ext_dll_name>`" (with dotted left border) to the "Measurement" section of the "External DLL" tab. If neither the PAE plugin nor any custom external DLL is installed, the "Measurement" section is hidden.

Tapping (clicking) or dragging & dropping a measurement button to the diagram area, opens an additional [Trace Definition Dialog](#).

As usual, tapping (clicking) redefines the current trace while dragging & dropping creates a trace.

Power Added Efficiency ← Measurement

This button is part of the PAE plugin, which is pre-installed on instruments shipped with firmware V2.15 or higher, and that can be installed on any instrument running firmware V2.15 or higher. It opens the [Power Added Efficiency \(PAE\) dialog](#).

5.2.12.2 External DLL Configuration Dialog

In the "External DLL Configuration" dialog, you can add/remove [External DLLs](#) to/from the firmware. If a plugin requires interaction with an external device, you can define its address from here.



To add/remove external DLLs, the firmware has to be run as administrator.

(Close the analyzer GUI, tap and hold the "R&S ZNA Vector Network Analyzer" icon on the desktop and select "Run as administrator"

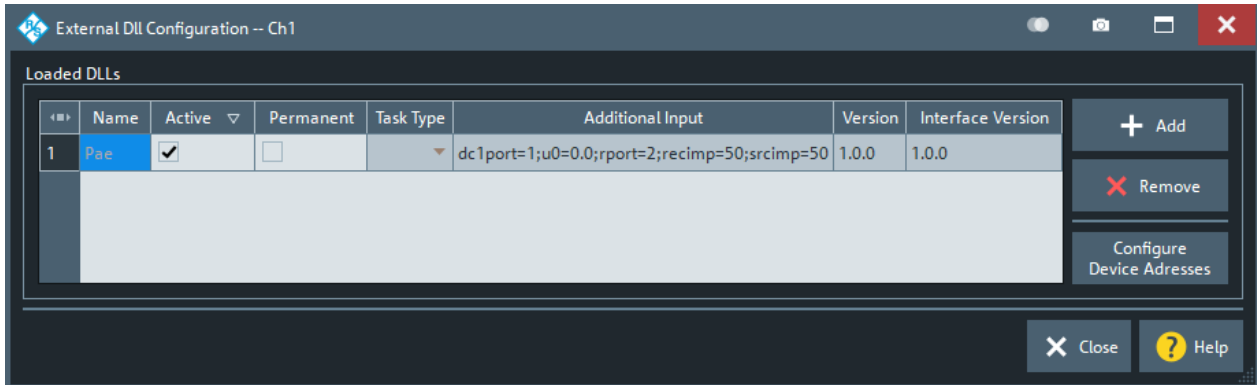

Loaded DLLs table

Displays the loaded plug-in DLLs and their configuration in the current channel.

Remote command:

`[SENSe:] CDLL:LIST?`

Active ← Loaded DLLs table

Allows you to de-/activate the respective plugin in the current channel. An active plugin can be used to [create traces](#) and/or can be made [Permanent](#).

Remote command:

`[SENSe<Ch>:] CDLL[: STATE]`

Permanent ← Loaded DLLs table

Defines the task that is selected via [Task Type](#) and further defined via "[Additional Input](#)" on page 403 as permanent.

A permanent task can interact with the firmware, even if it currently does not provide any traces, e.g. for synchronized control of an external device. In contrast to the trace mode, the permanent mode of operation is not restricted to a particular driving port.

Remote command:

`[SENSe<Ch>:] CDLL:PERManent[: STATE]`

Task Type ← Permanent ← Loaded DLLs table

Displays the task types implemented by the external DLL. This combo-box is only enabled, if the DLL is marked as permanent.

Remote command:

`[SENSe<Ch>:] CDLL:PERManent:TASK`

Additional Input ← Permanent ← Loaded DLLs table

Specifies additional input that further specifies the permanent task to be performed by the external DLL.

This string is processed by the external DLL, with DLL-specific syntax and semantics. If it is malformed or inappropriate for some reason, the firmware logs and displays the error messages that are returned by the DLL. See the docs of your DLL for details.

Remote command:

```
[SENSe<Ch>:]CDLL:PERManent:ADDitional
```

Version/Interface Version ← Loaded DLLs table

"Version" is purely informative. It reports the version of the DLL, as specified by its developer.

"Interface Version" is the version of the plug-in SDK that was used to compile the DLL (more precisely, the version of the interface `RsVnaCustomDllInterface.h` against which it was compiled). This version can change the DLL handling of the analyzer firmware.

Add / Remove

Allows you to add/remove custom plugins to/from the analyzer firmware.

In general, a plug-in is installed as a *.zip file, containing a DLL and, possibly, some additional files. The only exception is the [PAE plugin](#), which comes with its own Microsoft installer.

A plug-in is installed as a *.zip file, containing a DLL and, possibly, some additional files.

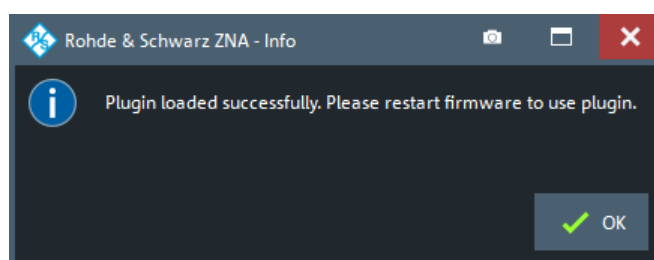
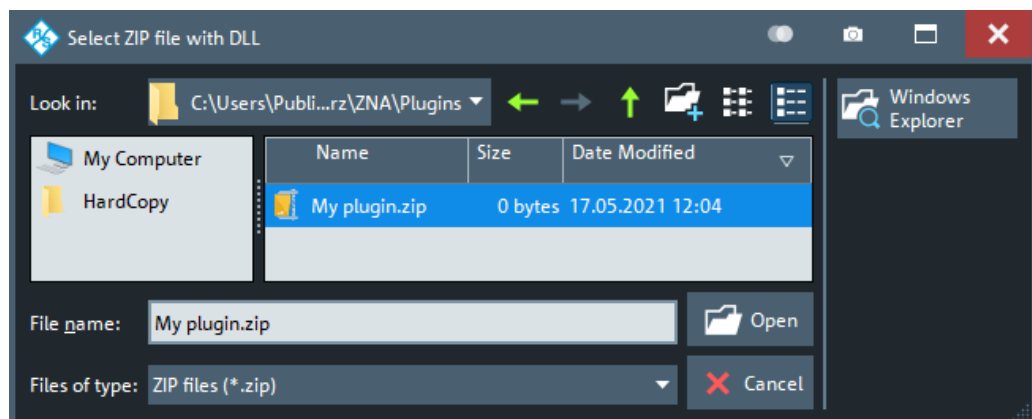

The firmware must be run as administrator to add or remove custom plugins. Once installed, standard user privileges are sufficient to use a plugin's functionality.

Remote command:

```
[SENSe:]CDLL:ADD
```

```
[SENSe:]CDLL:REMOve
```

Configure Device Address

Opens an additional dialog that allows you to specify the addresses of external devices the external DLL requires to complete its tasks. For each task type, a single device address can be configured.

The address syntax is DLL-specific: the DLL manages the connection to the external device. In the example below, the DLL expects a VISA resource string and the VNA operator indicates that the device is connected to (virtual) COM port 4.

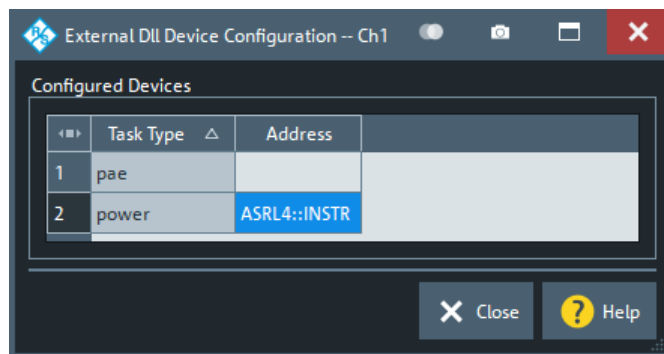

Remote command:

[SENSe<Ch>:] CDLL:TASK:ADDRess

5.2.12.3 Power Added Efficiency (PAE) dialog

The "Power Added Efficiency (PAE)" dialog configures the measurement of the PAE of an active 2-port device.



PAE plugin

- The PAE measurement is preinstalled on instruments shipped with FW V2.15 or higher. For older instruments, it is available as a separate installer that can be downloaded from the [R&S ZNA firmware page](#), and that is supported with FW V2.15 or higher.
- The PAE measurement requires an external power supply R&S HMP2030 that is connected to the R&S ZNA via USB.
- There are no dedicated remote commands for the PAE measurements. Instead, the measurement parameters are provided as:
 - trace definition parameter "Src Port" in the [Trace Definition Dialog](#)
 - "Additional Input" string in the [Trace Definition Dialog](#) and [External DLL Configuration Dialog](#) (for permanent tasks).

Access: Trace – [Meas] > "S-Params" > "External DLL" > "Power Added Efficiency"



Background information

Refer to section [Chapter 4.7.44, "Power added efficiency"](#), on page 334.

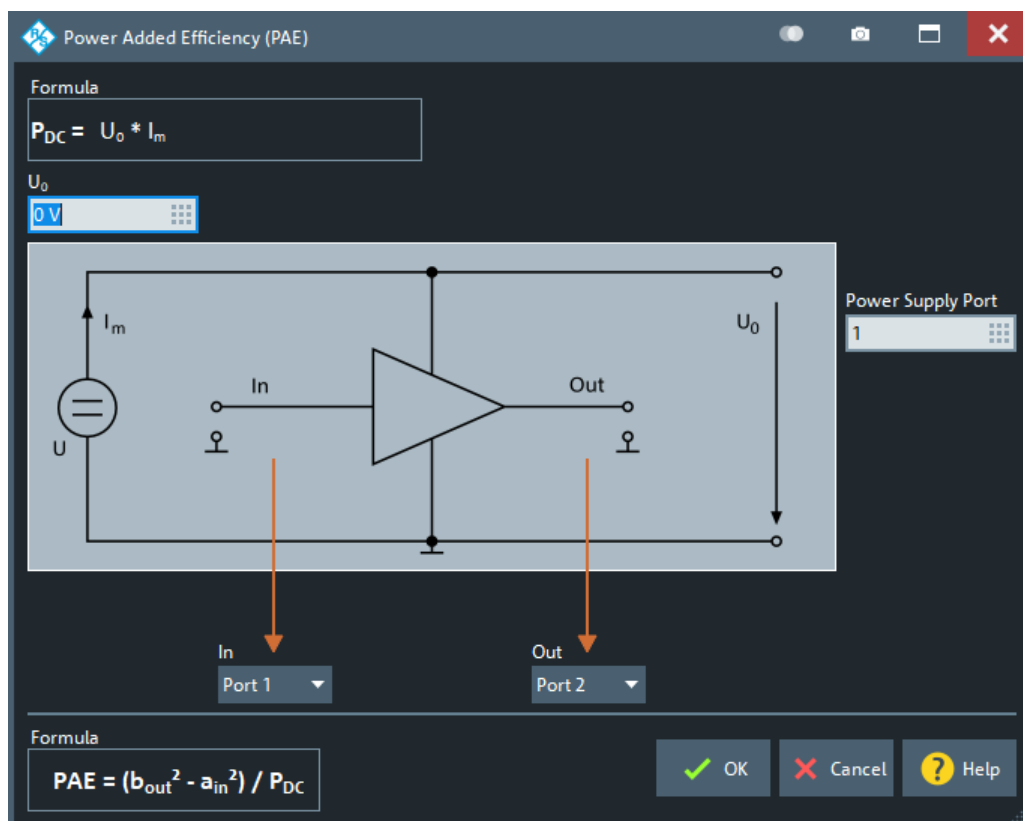

A PAE measurement involves the following steps:

1. Enter the measurement parameters.
2. Establish the test setup (including the RF connections of the DUT and the DC INPUT connections) as shown in the circuit diagram.
3. Close the "Power Added Efficiency (PAE)" dialog and observe the result in the measurement diagram.

The power supply R&S HMP2030 applies a configurable DC voltage U_0 between the DUT ports, and measures the resulting current I_m . With the resulting DC power $P_{DC} = U_0 I_m$, the power-added efficiency can be calculated as:

$$PAE = (b_{out}^2 - a_{in}^2) / P_{DC}$$

U_0

Defines the DC voltage to be applied by the power supply.

Remote command:

"Additional Input" `u0=<numeric value>;`

Power Supply Port

Defines the power supply port to be used.

Remote command:

"Additional Input" `dclport=<int value>;`

In/Out

Define the logical ports for the RF input and output signal, respectively.

Remote command:

"In" is specified as `<Src Port>` in the trace identifier (see [Define Trace](#))

"Out" is specified as "Additional Input" `rport=<int value>`;

5.2.12.4 Trace Definition Dialog

Specifies a custom trace that is provided by an external DLL.

Access: [External DLL tab](#) > "Measurement" section buttons

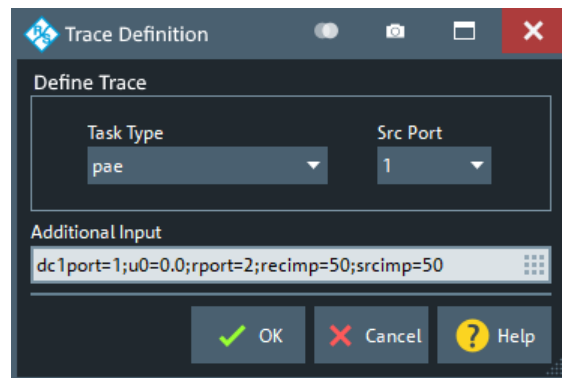

Figure 5-10: Trace Definition dialog

In the VNA firmware, the following string represents the measured quantity:

Cu(P<Src Port>)<lowercase_ext_dll_name>/<Task Type>/<Additional Input>

This string is displayed in the trace info and in the "Trace Manager". You can also use it to specify the corresponding `<Result>` in remote commands:

- `CALCulate<Ch>:PARAmeter:MEASure`
- `CALCulate<Ch>:PARAmeter:SDEFine`

Define Trace

Requests the external DLL, for which the [Trace Definition Dialog](#) was called, to calculate a particular trace.

- "Task Type" selects the task that is responsible for calculating this kind of trace
- The trace is calculated when "Src Port" is the (physical) driving port

In the [Figure 5-10](#), for example, the external DLL provides a task to calculate PAE (power added efficiency) traces. The user requests the PAE trace calculation while port 1 is the driving port.

"Task Type" and "Src Port" define the first part of the trace identifier:

Cu(P<Src Port>)<lowercase_ext_dll_name>/<Task Type>/<Additional Input>

If these selections are insufficient to fully specify the trace, [Additional Input](#) can be provided to the respective task.

Additional Input

For some task types, the basic information in "Define Trace" can be supplemented with "Additional Input". This string is processed by the external DLL, with DLL-specific syntax and semantics. If it is malformed or inappropriate for some reason, the firmware logs and displays the error messages that are returned by the DLL. See the docs of your DLL for details.

In [Figure 5-10](#), for example, the external DLL plugin is provided with additional information about the source and receive impedance (*recimp=50;srcimp=50*) to calculate the PAE trace correctly.

The "Additional Input" is the last part of the trace identifier:

```
Cu(P<Src Port>)<lowercase_ext_dll_name>/<Task Type>/<Additional Input>
```

5.2.13 Scalar Mixer Meas tab

Prepares [Scalar mixer measurements](#) on a frequency converting DUT and allows you to select the measured quantities for:

- Gain measurements
- Reflection feedthrough measurements
- Wave measurements



These measurements require software option R&S ZNA-K4. If this option is not installed, the "Scalar Mixer Meas" tab is not available.



Background information

Refer to [Chapter 4.7.3.4, "Scalar mixer measurements"](#), on page 271.



- The "Setup Frequency Converting DUT" button opens the [Scalar Mixer Meas setup dialog](#) that allows you to prepare one or more channels for [Scalar mixer measurements](#).
- The "More ..." buttons open the [Frequency Converting Measurements dialog](#) that offers all available measurement parameters for scalar mixer measurements.

5.2.13.1 Scalar Mixer Meas setup dialog

The "Scalar Mixer Meas" dialog is an example of a [Multi-channel setup dialog](#). It allows you to prepare one or more channels for [Scalar mixer measurements](#).

Access: Trace – [Meas] ("Mixer Params") > "Scalar Mixer Meas" > "Setup Frequency Converting DUT"



Background information

Refer to the following sections:

- [Chapter 4.2.2.3, "Multi-channel setup dialog"](#), on page 139
- [Chapter 4.7.3.4, "Scalar mixer measurements"](#), on page 271
- ["Two-stage mixer measurements"](#) on page 271

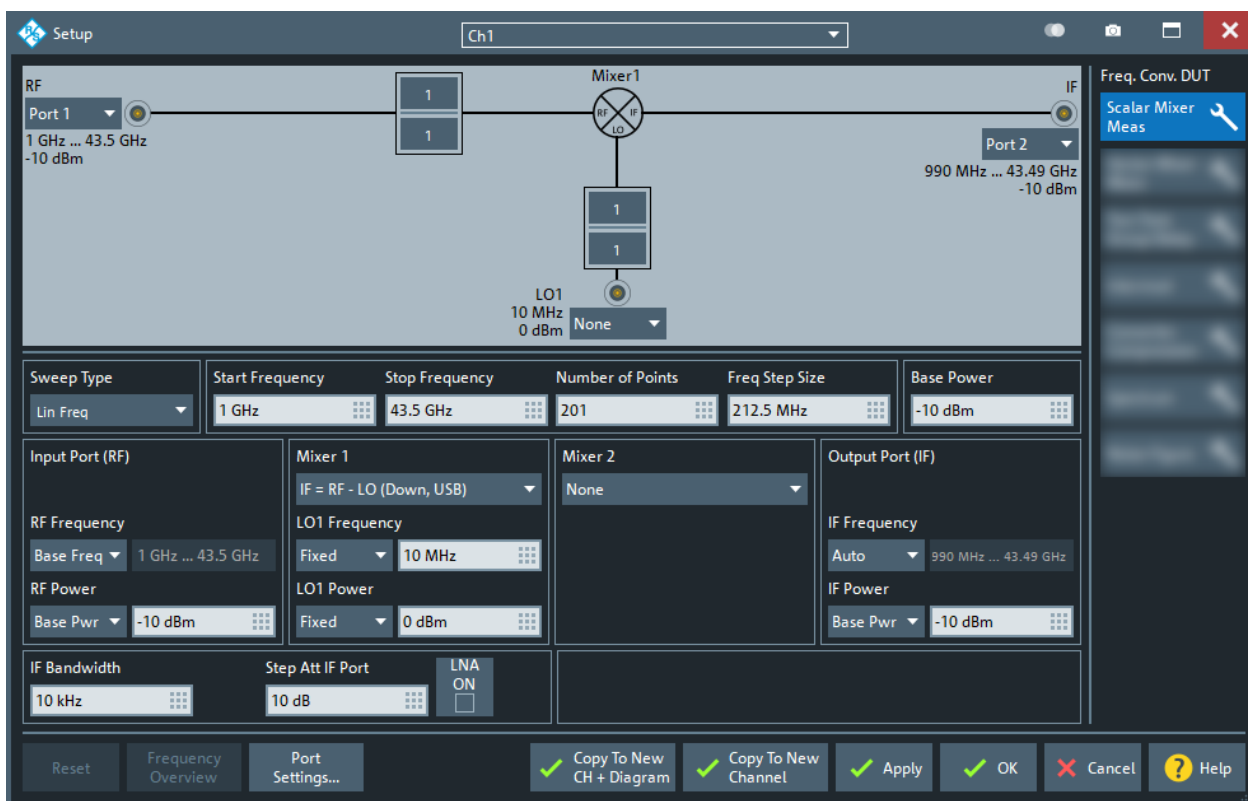

In its upper part, the dialog shows a diagram with the RF and LO signals, the mixing product (IF), and the current frequency and power ranges for all signals. The diagram is adjusted according to the "2nd Mixer" selection; see ["Two-stage mixer measurements"](#) on page 271.

The lower part of the dialog allows you to configure the mixer stages and to define sweep, stimulus and other channel settings.

Port selection

The port lists in the graphical part of the dialog contain all analyzer ports or external generators which can provide the RF signal and local oscillator (LO) signals.

Note: If [External switch matrices](#) are used, operation with more than one internal source RF is *not* supported. In this case, only the Converter LO port or an external generator can be used as local oscillator.

Generators must be configured explicitly in the [External Generators dialog](#) before they appear in the list. "None" means that the input signal at LO (if available) is not controlled by the analyzer.

Remote command:

```
[SENSe<Ch>:] FREQuency:CONVersion:MIXer:RFPort
[SENSe<Ch>:] FREQuency:CONVersion:MIXer:IFPort
[SENSe<Ch>:] FREQuency:CONVersion:MIXer:LOPort<Stg>
```

Multiplication factors

The fractional numbers in the graphical part of the dialog indicate the frequency conversion factors for the RF and LO signals.

The frequency-converting device is considered to be part of the mixer system under test (MUT). In the default configuration where the RF signal is swept and the LO signals are at fixed frequency, the conversion factors do not modify the analyzer's source signals (RF, LO 1, LO 2). They are used for the calculation of the IF frequency only.

Remote command:

```
[SENSe<Ch>:]FREQuency:CONVersion:MIXer:RFMultiplier
[SENSe<Ch>:]FREQuency:CONVersion:MIXer:LOMultiplier<Stg>
```

RF, IF and Mixer Stages

Input Port (RF) RF Frequency Base Freq ▾ 1 GHz ... 26.5 GHz RF Power Base Pwr ▾ -10 dBm	Mixer 1 IF = RF - LO (Down, USB) ▾ LO1 Frequency Fixed ▾ 10 MHz LO1 Power Fixed ▾ 0 dBm	Mixer 2 None ▾	Output Port (IF) IF Frequency Auto ▾ 990 MHz ... 26.49 GHz IF Power Base Pwr ▾ -10 dBm
------------------------------------------------------------------------------------------------------------	---------------------------------------------------------------------------------------------------------------	--------------------------	-----------------------------------------------------------------------------------------------------------

The table in the "Frequency" tab contains the following columns:

- The frequency selectors specify how the frequency for each signal is defined. One of the mixer input and output signals is at the analyzer's channel base frequency ("Base Freq"; the signal is swept if a frequency sweep is active; it is at fixed frequency (CW) for the other sweep types). One or two signals are at "Fixed" frequencies. The last frequency or frequency range is calculated automatically ("Auto"), depending on the other dialog settings.
- The power selectors specify how the power for each signal is defined. Each of the mixer input signals RF, LO 1, and LO 2 (if present, for) can be either at the analyzer's channel base power ("Base Pwr"; the signal is swept if a power sweep is active; it is at fixed power (CW) for the other sweep types) or at the "Fixed" power. The same applies to the IF signal.
- The conversion selectors of the two mixer stages determine the frequency of the IF signal.

The output signal (IF signal) of each mixer can be at the sum or at the difference of the RF and LO input frequencies.

- $IF = RF - LO$ means that the RF signal is down-converted (upper sideband). The analyzer automatically switches to $IF = LO - RF$ if the LO frequency is above the RF input frequency.
- $IF = LO - RF$ means that the LO signal is down-converted (lower sideband). The analyzer automatically switches to $IF = RF - LO$ if the RF input frequency is above the LO frequency.
- $IF = LO + RF$ means that the RF input signal is up-converted.

Use the "Port Settings" dialog to perform measurements at different mixer output frequencies (e.g. to analyze the isolation for $IF = RF$ or higher-order mixing products), see [Chapter 5.12.2.2, "Port Settings dialog"](#), on page 668.

- "Mixer 2" allows you to define a test setup including two mixers (instead of a single one); see [Two-stage mixer measurements](#). The signal diagram and the other control elements in the dialog are adjusted accordingly.

Remote command:

```
[SENSe<Ch>:]FREQuency:CONVersion:MIXer:FUNDamental
[SENSe<Ch>:]FREQuency:CONVersion:MIXer:MFFixed
SOURce<Ch>:FREQuency:CONVersion:MIXer:PMODE
```

```
SOURce<Ch>:FREQuency:CONVersion:MIXer:PMFixed
[SENSe<Ch>:]FREQuency:CONVersion:MIXer:TFREquency<Stg>
[SENSe<Ch>:]FREQuency:CONVersion:MIXer:STAGes
```

OK

Activates the scalar mixer mode and closes the dialog. A "Mix" label in the channel list indicates that a scalar mixer measurement is active.

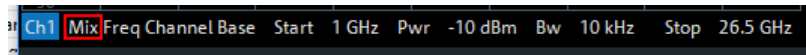

Remote command:

```
[SENSe<Ch>:]FREQuency:CONVersion
```

5.2.13.2 Frequency Converting Measurements dialog

The "Frequency Converting Measurements" dialog lets you select measurement parameters for mixer measurements.

Access:

- [Scalar Mixer Meas tab](#) > "More ..."
- [Vector Mixer Meas tab](#) > "More ..."

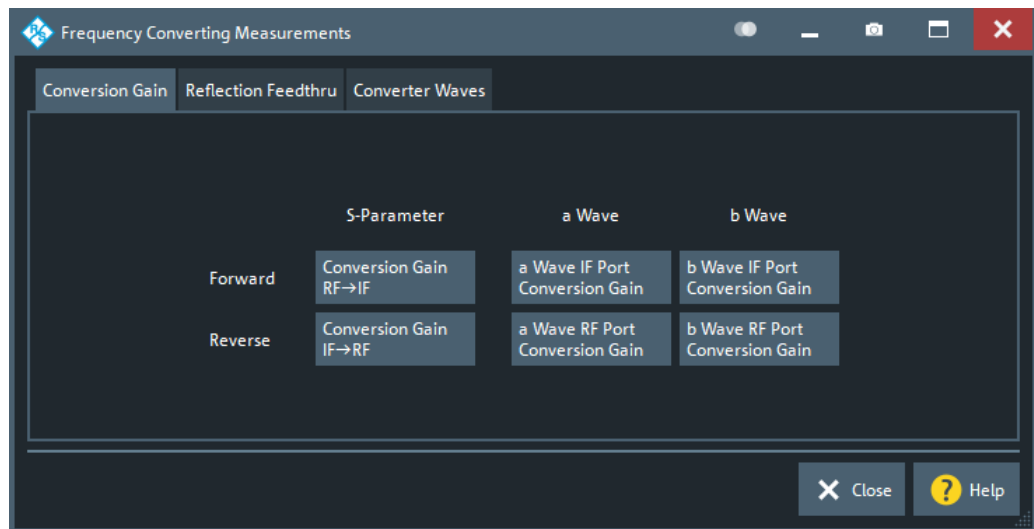

Figure 5-11: Frequency Converting Measurements dialog: scalar/vector mixer measurements

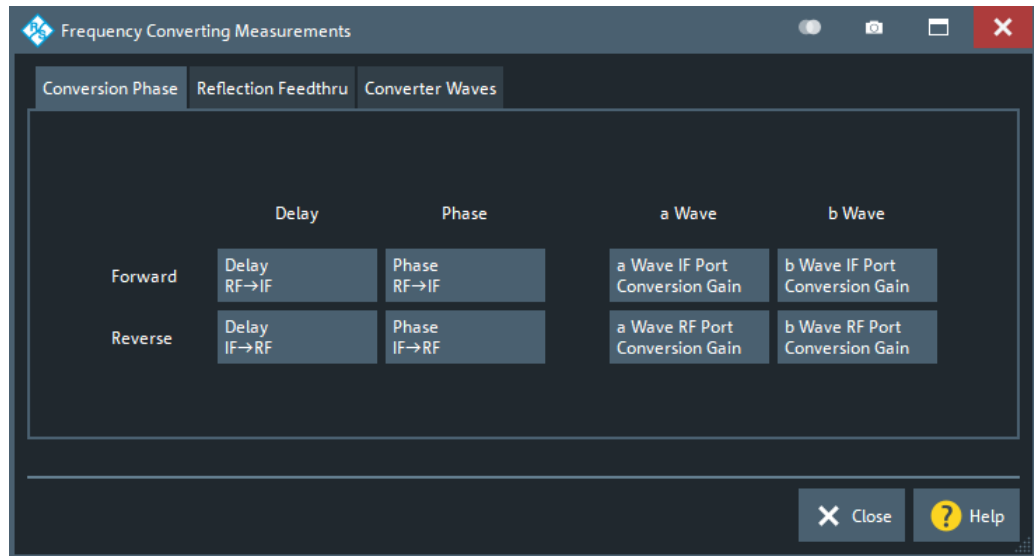
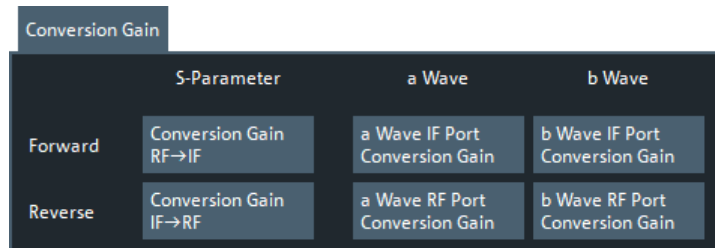

Figure 5-12: Frequency Converting Measurements dialog: vector mixer measurements

Conversion Gain/Conversion Phase tab

Conversion Gain tab (scalar/vector mixer measurements)

Offers the full set of gain measurement parameters for frequency-converting DUTs.



Conversion Phase tab (vector mixer measurements)

Offers the full set of phase measurement parameters for frequency-converting DUTs.

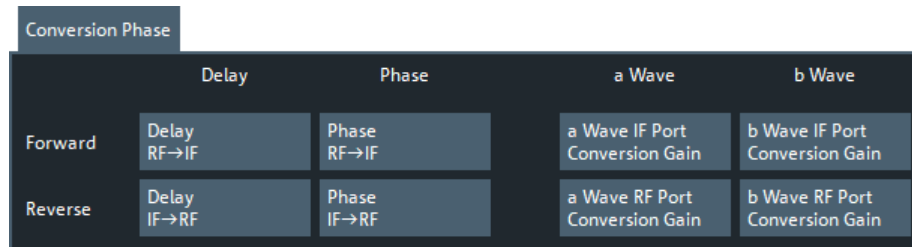

Reflection Feedthru tab

Offers the full set of reflection and feedthru measurement parameters for frequency-converting DUTs.

		Reflection Feedthru			
		b Wave at Port			
		RF	LO1	LO2	IF
a Wave Driving Port	RF	Reflection RF Port			Feedthru RF→IF
	LO1	Feedthru LO1→RF	Reflection LO1 Port		Feedthru LO1→IF
	LO2	Feedthru LO2→RF		Reflection LO2 Port	Feedthru LO2→IF
	IF	Feedthru IF→RF			Reflection IF Port

Converter Waves tab

Offers the full set of wave parameters for frequency-converting DUTs.

		Converter Waves				
		a Wave	b Wave at Port			
			RF	LO1	LO2	IF
Driving Port	RF	RF AWave	RF BWave	LO1 BWave(RF)	LO2 BWave(RF)	IF BWave(RF)
	LO1	LO1 AWave	RF BWave(LO1)	LO1 BWave	LO2 BWave(LO1)	IF BWave(LO1)
	LO2	LO2 AWave	RF BWave(LO2)	LO1 BWave(LO2)	LO2 BWave	IF BWave(LO2)
	IF	IF AWave	RF BWave(IF)	LO1 BWave(IF)	LO2 BWave(IF)	IF BWave

5.2.14 Vector Mixer Meas tab

Sets up the channel for phase measurements on a frequency converting DUT (a.k.a. vector mixer measurements), and lets you select the quantities to be measured.



These measurements require software option R&S ZNA-K5. If this option is not installed, the "Vector Mixer Meas" tab is not available.



Background information

Refer to [Chapter 4.7.3.5, "Vector mixer measurements"](#), on page 274.

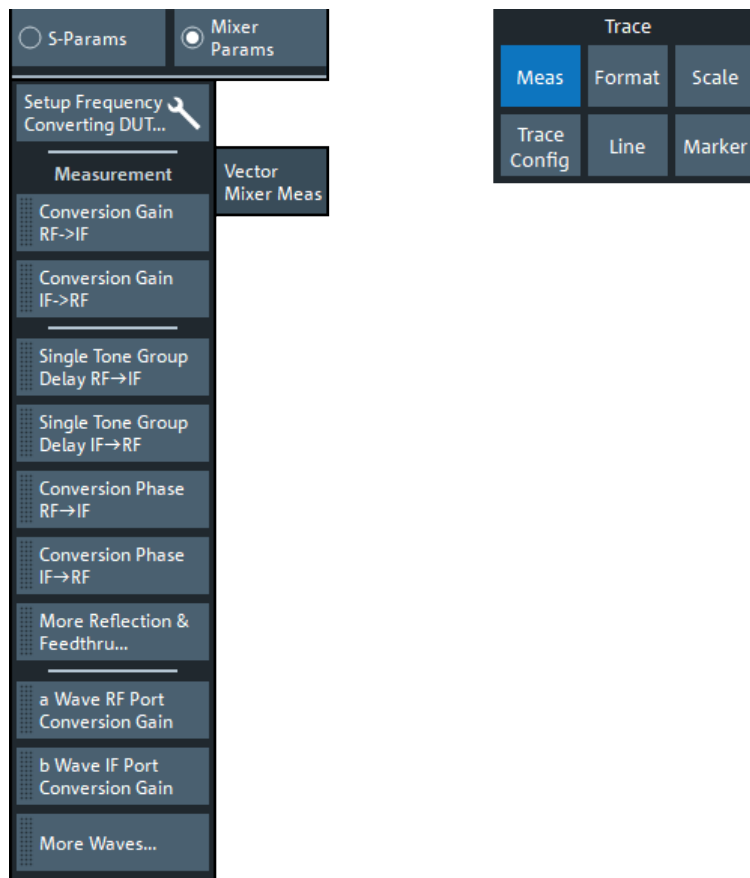

- The "Setup Frequency Converting DUT" button opens the [Vector Mixer Meas setup dialog](#) that allows you to prepare one or more channels for [Vector mixer measurements](#).
- The "More ..." buttons open the [Frequency Converting Measurements dialog](#) that offers all available measurement parameters for mixer measurements. "More Reflection & Feedthru..." opens the [vector mixer measurements](#) variant of the dialog, "More Waves" opens the [scalar mixer measurements](#) variant.

5.2.14.1 Vector Mixer Meas setup dialog

The "Vector Mixer Meas" dialog is an example of a [Multi-channel setup dialog](#). It allows you to prepare one or more channels for [Vector mixer measurements](#) (including group delay measurements).

Access: Trace – [Meas] ("Mixer Params") > "Vector Mixer Meas" > "Setup Frequency Converting DUT"

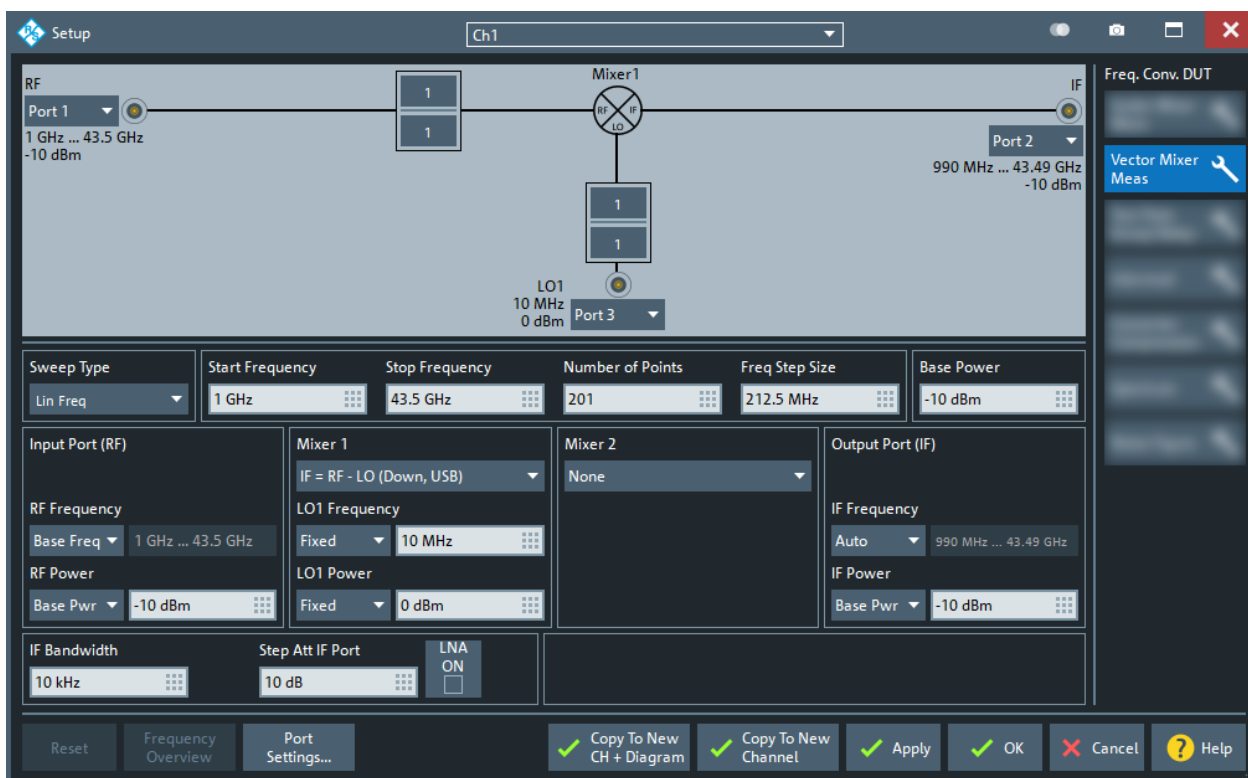

This dialog offers the same settings as the [Scalar Mixer Meas setup dialog](#). However, for vector mixer measurements the LO ports must be controlled by the analyzer.

5.2.15 Two Tone Group Dly tab (frequency-converting DUT)

Sets up the channel for a two-tone group delay measurement (a.k.a. mixer group delay measurement with embedded LO), and selects the measured quantities.



These measurements require software option R&S ZNA-K9. If this option is not installed, the "Two Tone Group Dly" tab is not available.



Background information

Refer to [Chapter 4.7.3.6, "Embedded LO mixer group delay measurements"](#), on page 274.

5.2.15.1 Controls on the Two Tone Group Dly tab



If [external switch matrices](#) are used, "Two Tone Group Dly" are not supported and hence the controls on this tab are disabled.

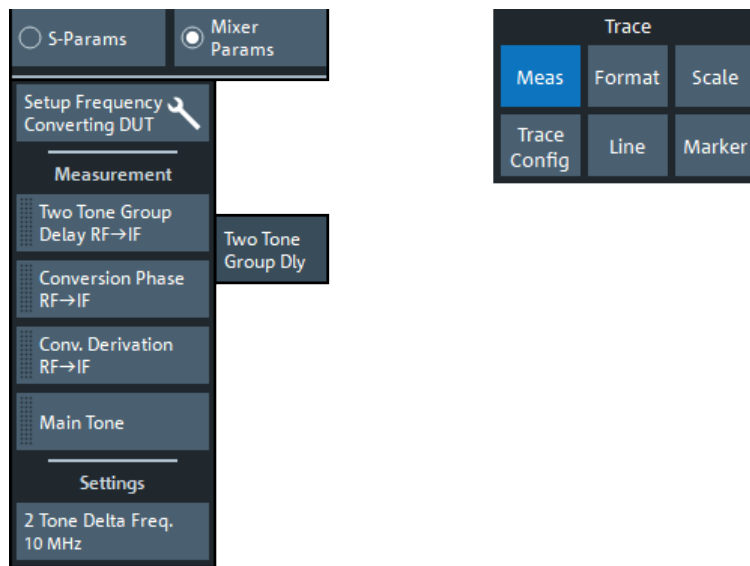

Setup Frequency Converting DUT

Opens the [Two Tone Group Delay](#) setup dialog.

Measurement

Allows you to select the quantities to be measured.

The "Main Tone" button opens a dialog for quantity selection:

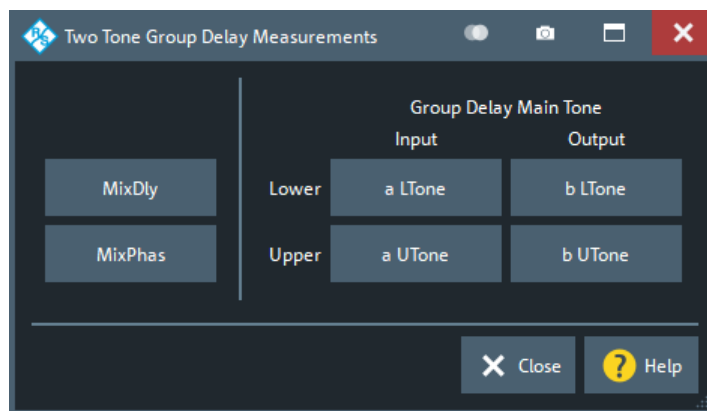

Remote command:

```
CALCulate<Ch>:PARAmeter:MEASure '<TraceName>', MixDly | MixPhas
| MixDeriv | Mix_a_LTone | Mix_a_UTone | Mix_b_LTone |
Mix_b_UTone
```

```
CALCulate<Ch>:PARAmeter:SDEFine '<TraceName>', MixDly | MixPhas
| MixDeriv | Mix_a_LTone | Mix_a_UTone | Mix_b_LTone |
Mix_b_UTone
```

2 Tone Delta Freq.

Allows you to select the frequency delta between upper tone and lower tone.

Remote command:

```
[SENSE<Ch>:] FREQuency:MDELay:APERture
```

5.2.15.2 Two Tone Group Delay setup dialog

The "Two Tone Group Delay" dialog is an example of a [Multi-channel setup dialog](#). It allows you to prepare one or more channels for [two-tone group delay measurements](#) (with or without embedded LO).

Access: Trace – [Meas] ("Mixer Params") > "Two Tone Group Dly" > "Setup Frequency Converting DUT"

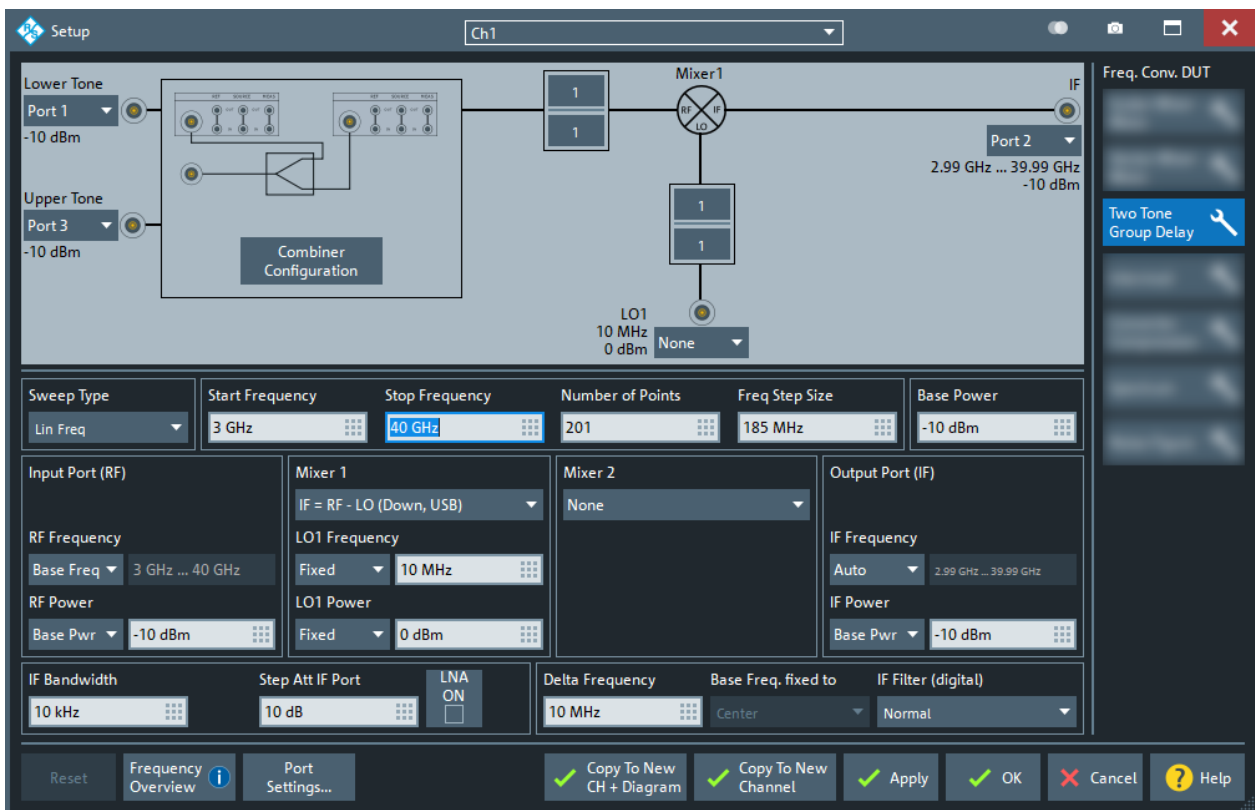

Lower Tone

Select the port that generates the lower tone of the two-tone signal.

Remote command:

`[SENSE<Ch>:] FREQUENCY:MDElay:LTONE`

Upper Tone

Select the port that generates the upper tone of the two-tone signal.

Remote command:

`[SENSe<Ch>:] FREQUENCY:MDElay:UTONE`

Combiner Configuration

See [Combiner Configuration](#).

IF

Select the receive port for the two-tone group delay measurement.

Remote command:

```
[SENSe<Ch>:] FREQuency:MDELay:RPORT
```

Delta Frequency

Selects the frequency delta between upper tone and lower tone.

Remote command:

```
[SENSe<Ch>:] FREQuency:MDELay:APERture
```

Apply/OK

Applies the settings and activates the group delay measurement mode for the channel selected in the title bar of the setup dialog.

Remote command:

```
[SENSe<Ch>:] FREQuency:MDELay:CONVersion
```

5.3 Format softtool

The "Format" softtool allows you to define how the measured data is presented in the diagram area.

Access: Trace – [Format]



Measured quantities and display formats

The analyzer allows arbitrary combinations of display formats and measured quantities (see [Chapter 5.2, "Meas softtool"](#), on page 341). Nevertheless, to extract useful information from the data, it is important to select a display format which is appropriate to the analysis of a particular measured quantity.

An extended range of formats is available for markers. To convert any point on a trace, create a marker and select the appropriate marker format (see ["Marker Format"](#) on page 502). Marker and trace formats can be applied independently.



Background information

Refer to the following sections:

- [Chapter 4.2.3, "Trace formats"](#), on page 140
- [Chapter 4.2.3.3, "Measured quantities and trace formats"](#), on page 148

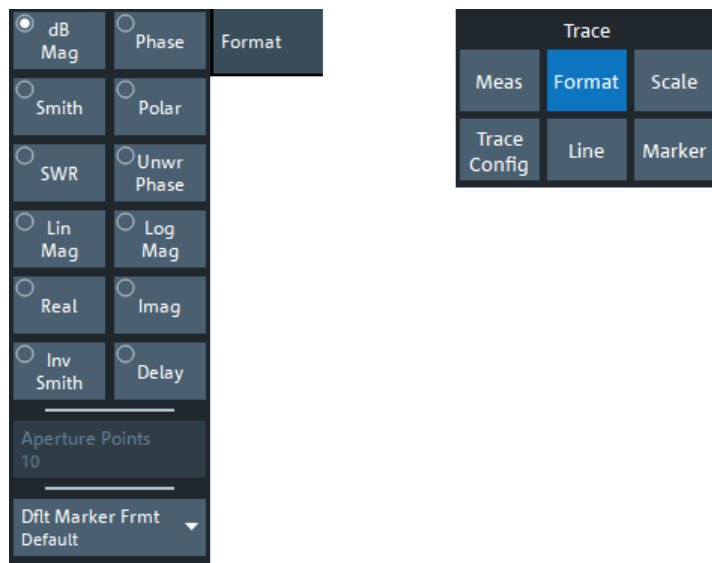

dB Mag

Selects a Cartesian diagram with a dB scale of the vertical axis to display the magnitude of the complex measured quantity.

Properties: The stimulus variable appears on the horizontal axis, scaled linearly. The magnitude of the complex quantity C , i.e. $|C| = \sqrt{\text{Re}(C)^2 + \text{Im}(C)^2}$, appears on the vertical axis, scaled in dB. The decibel conversion is calculated according to $\text{dB Mag}(C) = 20 * \log(|C|)$ dB.

Application: dB Mag is the default format for the complex, dimensionless S-parameters. The dB-scale is the natural scale for measurements related to power ratios (insertion loss, gain etc.).

Tip (alternative formats): The magnitude of each complex quantity can be displayed on a linear scale. It is possible to view the real and imaginary parts instead of the magnitude and phase. Both the magnitude and phase are displayed in the polar diagram.

Remote command:

`CALCulate<Chn>:FORMat MLOGarithmic`

Phase

Selects a Cartesian diagram with a linear vertical axis to display the phase of a complex measured quantity in the range between -180 degrees and $+180$ degrees.

Properties: The stimulus variable appears on the horizontal axis, scaled linearly. The phase of the complex quantity C , i.e. $\varphi(C) = \arctan(\text{Im}(C) / \text{Re}(C))$, appears on the vertical axis. $\varphi(C)$ is measured relative to the phase at the start of the sweep (reference phase = 0°). If $\varphi(C)$ exceeds $+180^\circ$ the curve jumps by -360° ; if it falls below -180° , the trace jumps by $+360^\circ$. The result is a trace with a typical sawtooth shape. The alternative "Unwr Phase" format avoids this behavior.

Application: Phase measurements, e.g. phase distortion, deviation from linearity.

Tip (alternative formats): The magnitude of each complex quantity can be displayed on a linear scale or on a logarithmic scale. It is possible to view the real and imaginary parts instead of the magnitude and phase. Both the magnitude and phase are displayed in the polar diagram. As an alternative to direct phase measurements, the analyzer provides the derivative of the phase response for a frequency sweep ([Delay](#)).

Remote command:

```
CALCulate<Chn>:FORMat PHASe
```

Smith

Selects a Smith chart to display a complex quantity, primarily a reflection S-parameter.

Properties: The Smith chart is a circular diagram obtained by mapping the positive complex semi-plane into a unit circle. Points with the same resistance are located on circles, points with the same reactance produce arcs. If the measured quantity is a complex reflection coefficient S_{ij} , then the unit Smith chart represents the normalized impedance. In contrast to the polar diagram, the scaling of the diagram is not linear.

Application: Reflection measurements; see example in "[Smith](#)" on page 143.

Tip: The axis for the sweep variable is lost in Smith charts but the marker functions easily provide the stimulus value of any measurement point. dB values for the magnitude and other conversions can be obtained by the "Marker Format" functions.

Remote command:

```
CALCulate<Chn>:FORMat SMITh
```

Polar

Selects a polar diagram to display a complex quantity, primarily an S-parameter or ratio.

Properties: The polar diagram shows the measured data (response values) in the complex plane with a horizontal real axis and a vertical imaginary axis. The magnitude of a complex value is determined by its distance from the center, its phase is given by the angle from the positive horizontal axis. In contrast to the Smith chart, the scaling of the axes is linear.

Application: Reflection or transmission measurements, see example in "[Polar](#)" on page 142.

Tip: The axis for the sweep variable is lost in polar diagrams but the marker functions easily provide the stimulus value of any measurement point. dB values for the magnitude and other conversions can be obtained by the "Marker Format" functions.

Remote command:

```
CALCulate<Chn>:FORMat POLar
```

SWR

Calculates the standing wave ratio (SWR) from the measured quantity (typically a reflection S-parameter) and displays it in a Cartesian diagram.

Properties: The SWR (or voltage standing wave ratio, VSWR) is a measure of the power reflected at the input of the DUT. It is calculated from the magnitude of the reflection coefficients S_{ij} (where i denotes the port number of the DUT) according to:

$$SWR = \frac{1 + |S_{ii}|}{1 - |S_{ii}|}$$

The superposition of incident and reflected wave on the transmission line connecting the analyzer and the DUT causes an interference pattern with variable envelope voltage. The SWR is the ratio of the maximum voltage to the minimum envelope voltage along the line.

Interpretation of the SWR

The superposition of the incident wave I and the reflected wave R on the transmission line connecting the analyzer and the DUT causes an interference pattern with variable envelope voltage. The SWR is the ratio of the maximum voltage to the minimum envelope voltage along the line:

$$SWR = V_{Max}/V_{Min} = (|V_I| + |V_R|) / (|V_I| - |V_R|) = (1 + |S_{ii}|) / (1 - |S_{ii}|)$$

Application: Reflection measurements with conversion of the complex S-parameter to a real SWR.

Remote command:

`CALCulate<Chn>:FORMat SWR`

Unwr Phase

Selects a Cartesian diagram with an arbitrarily scaled linear vertical axis to display the phase of the measured quantity.

Properties: The stimulus variable appears on the horizontal axis, scaled linearly. The phase of the complex quantity C, i.e. $\varphi(C) = \arctan(\text{Im}(C) / \text{Re}(C))$, appears on the vertical axis. $\varphi(C)$ is measured relative to the phase at the start of the sweep (reference phase = 0°). In contrast to the normal [Phase](#) format, the display range is not limited to values between -180° and +180°. This format avoids artificial jumps of the trace but can entail a relatively wide phase range if the sweep span is large.

Application: Phase measurements, e.g. phase distortion, deviation from linearity.

Tip: After changing to the "Unwr Phase" format, use the "Auto Scale Trace" function to rescale the vertical axis and view the entire trace (see ["Auto Scale Trace"](#) on page 427).

Remote command:

`CALCulate<Chn>:FORMat UPHase`

Lin Mag

Selects a Cartesian diagram with a linear vertical axis scale to display the magnitude of the measured quantity.

Properties: The stimulus variable appears on the horizontal axis, scaled linearly. The magnitude of the complex quantity C, i.e. $|C| = \sqrt{\text{Re}(C)^2 + \text{Im}(C)^2}$, appears on the vertical axis, also scaled linearly.

Application: Real measurement data (i.e. the stability factors and the DC voltages) are always displayed in a Lin Mag diagram.

Tip (alternative formats): The magnitude of each complex quantity can be displayed on a logarithmic scale. It is possible to view the real and imaginary parts instead of the magnitude and phase.

Remote command:

`CALCulate<Chn>:FORMat MLINear`

Log Mag

Selects a Cartesian diagram with a logarithmic (base 10) vertical axis scale to display the magnitude of the measured quantity.

Properties: The stimulus variable appears on the horizontal axis, scaled linearly. The magnitude of the complex quantity C , i.e. $|C| = \sqrt{\text{Re}(C)^2 + \text{Im}(C)^2}$, appears on the vertical axis, scaled logarithmically.

Application: Impedance measurements

Remote command:

`CALCulate<Chn>:FORMat LOGarithmic`

Real

Selects a Cartesian diagram to display the real part of a complex measured quantity.

Properties: The stimulus variable appears on the horizontal axis, scaled linearly. The real part $\text{Re}(C)$ of the complex quantity $C = \text{Re}(C) + j \text{Im}(C)$, appears on the vertical axis, also scaled linearly.

Application: The real part of an impedance corresponds to its resistive portion.

Tip (alternative formats): It is possible to view the magnitude and phase of a complex quantity instead of the real and imaginary part. The magnitude can be displayed on a linear scale or on a logarithmic scale. Both the real and imaginary parts are displayed in the polar diagram.

Remote command:

`CALCulate<Chn>:FORMat REAL`

Imag

Selects a Cartesian diagram to display the imaginary part of a complex measured quantity.

Properties: The stimulus variable appears on the horizontal axis, scaled linearly. The imaginary part $\text{Im}(C)$ of the complex quantity $C = \text{Re}(C) + j \text{Im}(C)$, appears on the vertical axis, also scaled linearly.

Application: The imaginary part of an impedance corresponds to its reactive portion. Positive (negative) values represent inductive (capacitive) reactance.

Tip (alternative formats): It is possible to view the magnitude and phase of a complex quantity instead of the real and imaginary part. The magnitude can be displayed on a linear scale or on a logarithmic scale. Both the real and imaginary parts are displayed in the polar diagram.

Remote command:

`CALCulate<Chn>:FORMat IMAGinary`

Inv Smith

Selects an inverted Smith chart to display a complex quantity, primarily a reflection S-parameter.

Properties: The inverted Smith chart is a circular diagram obtained by mapping the positive complex semi-plane into a unit circle. If the measured quantity is a complex reflection coefficient S_{ij} , then the unit inverted Smith chart represents the normalized admittance. In contrast to the polar diagram, the scaling of the diagram is not linear.

Application: Reflection measurements, see example in ["Inv Smith"](#) on page 146.

Tip: The axis for the sweep variable is lost in Smith charts but the marker functions easily provide the stimulus value of any measurement point. dB values for the magnitude and other conversions can be obtained by the "Marker Format" functions.

Remote command:

```
CALCulate<Chn>:FORMat ISMith
```

Delay

Calculates the (group) delay from the measured quantity (typically a transmission S-parameter) and displays it in a Cartesian diagram.

Properties: The group delay τ_g represents the propagation time of wave through a device. τ_g is a real quantity and is calculated as the negative of the derivative of its phase response. A non-dispersive DUT shows a linear phase response, which produces a constant delay (a constant ratio of phase difference to frequency difference).

For more information, refer to [Chapter 4.3.8, "Group delay"](#), on page 167.

Application: Transmission measurements, especially with the purpose of investigating deviations from linear phase response and phase distortions. To obtain the delay, a frequency sweep must be active.

Tip: The cables between the analyzer test ports and the DUT introduce an unwanted delay, which often can be assumed to be constant. Use the Zero Delay at Marker function, define a numeric length "Offset" or use the "Auto Length" function to compensate for this effect in the measurement results. To compensate for a frequency-dependent delay in the test setup, a system error correction is required.

Note: The delay for reflection factors corresponds to the transmission time in forward and reverse direction; see ["Length and delay measurement, related settings"](#) on page 229.

Remote command:

```
CALCulate<Chn>:FORMat GDElay
```

Aperture Points

Defines an aperture Δf for the (group) "Delay" calculation. The value is entered as number of sweep steps (= number of sweep points - 1).

For background information, see [Chapter 4.3.8, "Group delay"](#), on page 167.

Properties: The delay at each sweep point is computed as:

$$\tau_{g,meas} = -\frac{\Delta\phi_{deg}}{360^\circ \cdot \Delta f}$$

where the aperture Δf is a finite frequency interval around the sweep point f_0 and the analyzer measures the corresponding phase change $\Delta\Phi$, which is calculated via a linear regression algorithm over the frequency points of the aperture.

Application: The aperture must be adjusted to the conditions of the measurement. A small aperture increases the noise in the group delay; a large aperture tends to minimize the effects of noise and phase uncertainty, but at the expense of frequency resolution. Phase distortions (i.e. deviations from linear phase) which are narrower in frequency than the aperture tend to be smeared over and cannot be measured.

Remote command:

```
CALCulate<Chn>:GDAPerture:SCount
```

Dflt Marker Frmt

Defines the default marker format of the active trace. "Default" means formatted according to the selected trace format.

New markers are formatted with the trace's "Dflt Marker Frmt" ; existing markers are reformatted if (and only if) their [Marker Format](#) is set to (Trace) "Default".

For background information on marker formats, see "[Marker format](#)" on page 130.

Remote command:

```
CALCulate<Chn>:MARKer:DEFault:FORMat
```

5.4 Scale softtool

The "Scale" softtool allows you to define how the active trace is displayed in its current format.

Access: Trace – [Scale] key

5.4.1 Scale Values tab

Provides the functions for diagram scaling.



The "Scale Values" settings are closely related to the "Format" and "Display" settings.

The "Scale Values" settings depend on the current trace format (diagram type) because not all diagrams can be scaled in the same way:

- In Cartesian diagrams, all scale settings are available.
- In circular diagrams, no "Scale/Div", no "Ref Pos", and no "Max" and "Min" values can be defined.

The default scale is activated automatically when a display format (diagram type) is selected. Scale settings that are not compatible with the current display format are unavailable (grayed out).

Relations between the scaling parameters

The scaling parameters "Scale/Div", "Ref Value", "Ref Pos", "Max", and "Min" are coupled together in the following manner:

- $\text{"Max"} - \text{"Min"} = \text{"Scale/Div"} \cdot \langle \text{Number of graticule divisions} \rangle$
- $\text{"Max"} = \text{"Ref Value"}$ when "Ref Value" is 10
- $\text{"Min"} = \text{"Ref Value"}$ when "Ref Value" is 0



Alternatives to Scaling

There are several alternatives to manual trace/diagram scaling. Refer to the following sections:

- [Chapter 3.3.7, "Scaling diagrams"](#), on page 66
- [Chapter 3.3.3, "Touchscreen gestures"](#), on page 54 (zoom stimulus via spreading and pinching)
- [Chapter 5.8.1, "Stimulus tab"](#), on page 522

Auto Scale Trace

Adjusts the "Scale/Div" and the "Ref Value" to display the entire active trace in the diagram area, leaving an appropriate display margin.

- In Cartesian diagrams, the analyzer recalculates the values of the vertical divisions so that the trace fits onto approx. 80% of the vertical grid. The reference value is chosen to center the trace in the diagram.
- In circular diagrams ("Polar", "Smith", "Inv Smith"), the analyzer recalculates the values of the radial divisions so that the diagram is confined to approx. 80% of the outer circumference. The reference value is set to the value of the outer circumference.

Auto scale does not affect the stimulus values and the horizontal axis.

Remote command:

```
DISPlay[:WINDow<Wnd>]:TRACe<WndTr>:Y[:SCALe]:AUTO
```

Auto Scale Diagram

Adjusts the "Scale/Div" and the "Ref Value" to display all traces in the diagram area, leaving an appropriate display margin. All traces in the active diagram are scaled independently (see ["Auto Scale Trace"](#) on page 427), and irrespective of their channel assignment.

Auto Scale Diag. (Common Scale)

Similar to ["Auto Scale Diagram"](#) on page 427, but scales equally formatted traces together.

Ref Value = Marker

See ["Ref Val = Marker / Max = Marker / Min = Marker"](#) on page 519.

Scale/Div

Sets the value of the vertical diagram divisions in Cartesian diagrams.

"Scale/Div" corresponds to the increment between two consecutive grid lines. The unit depends on the display format: dB for display format "dB Mag", degrees for "Phase" and "Unwr Phase", ns for "Delay", U (units) for all other (dimensionless) formats.

"Scale/Div" is not available for circular diagrams ("Polar", "Smith", "Inv Smith").

Remote command:

```
DISPlay[:WINDow<Wnd>]:TRACe<WndTr>:Y[:SCALe]:PDIVision
```

Ref Value

Sets the reference line of a Cartesian diagram or the outer circumference of a circular diagram.

- In Cartesian diagrams "Ref Value" defines the value of the reference line, indicated by an arrowhead symbol at the right edge of the diagram area. The color of the symbol corresponds to the trace color. As the "Ref Value" is varied, the position of the reference line ("Ref Pos") is left unchanged, so that the current trace is shifted in vertical direction. The unit of the "Ref Value" depends on the display format: dB for display format "dB Mag", degrees for "Phase" and "Unwr Phase", ns for "Delay", U (units) for all other (dimensionless) formats.
- In circular diagrams ("Polar", "Smith", "Inv Smith"), "Ref Value" defines the value of the outer circumference. Changing "Ref Value" enlarges or scales down the diagram, leaving the center unchanged. The unit is U (units) for all circular diagrams.

Remote command:

```
DISPlay[:WINDow<Wnd>]:TRACe<WndTr>:Y[:SCALe]:RLEVel
```

Ref Pos

Defines the position of the reference line in a Cartesian diagram.

The reference line is indicated by an arrowhead symbol at the right edge of the diagram area. The color of the symbol corresponds to the trace color. "Ref Pos" is defined on a linear scale between 0 (bottom line of the diagram) and 10 (top line of the diagram). As the "Ref Pos" is varied, the value of the reference line ("Ref Value") is left unchanged, so the current trace is shifted together with the "Ref Pos".

"Ref Pos" is not available (grayed) for polar diagrams ("Polar", "Smith", "Inv Smith").

Remote command:

```
DISPlay[:WINDow<Wnd>]:TRACe<WndTr>:Y[:SCALe]:RPOSition
```

Max / Min

Define the upper and lower edge of a Cartesian diagram.

"Max" and "Min" are not available (grayed) for polar diagrams ("Polar", "Smith", "Inv Smith").

Remote command:

```
DISPlay[:WINDow<Wnd>]:TRACe<WndTr>:Y[:SCALe]:TOP
DISPlay[:WINDow<Wnd>]:TRACe<WndTr>:Y[:SCALe]:BOTTom
```

Continuous Auto Scale Trace

Similar to [Auto Scale Trace](#), but applies auto-scaling continuously, even during a running sweep.

Remote command:

n.a.

5.4.2 Scale Coupling tab

Selects common scale settings for all traces. The softkeys are available if the active recall set contains at least two traces, and if the active trace is not a reference trace ("To Trace").



Related settings

Refer to [Chapter 5.5.1.3, "Trace Manager dialog"](#), on page 435.

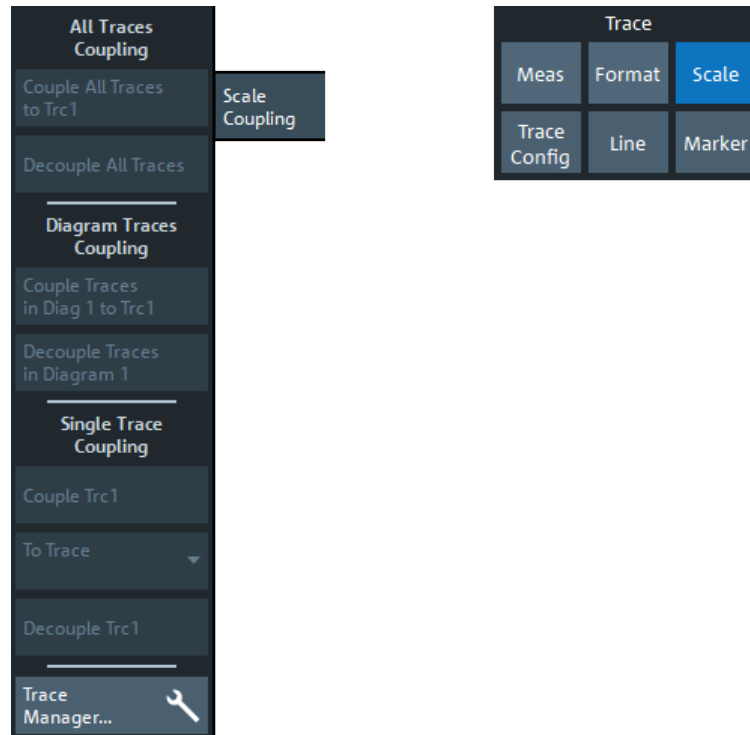

The "Trace Manager..." button opens the [Trace Manager dialog](#).

Couple All Traces / Couple Trc ... To Trace

Applies the scale settings of the reference trace ("To Trace") to all traces / to the active trace.

Remote command:

n/a

Decouple All Traces / Decouple Trc

Assigns independent scale settings to all traces / to the active trace.

Remote command:

n/a

5.4.3 Zoom tab

Provides graphical and stimulus zoom functions for cartesian diagrams.

The graphical zoom magnifies a (paraxial) rectangular portion of a diagram without modifying any sweep parameters. The stimulus zoom also magnifies the selected rectangle, but at the same time narrows the sweep range of the active channel to the rectangle's horizontal range.



Alternatives to Zooming

There are several alternatives to graphical/numerical zooming. Refer to the following sections:

- [Chapter 3.3.7, "Scaling diagrams"](#), on page 66
- [Chapter 5.4.1, "Scale Values tab"](#), on page 425
- [Chapter 3.3.3, "Touchscreen gestures"](#), on page 54 (zoom stimulus via spreading and pinching)
- [Chapter 5.8.1, "Stimulus tab"](#), on page 522

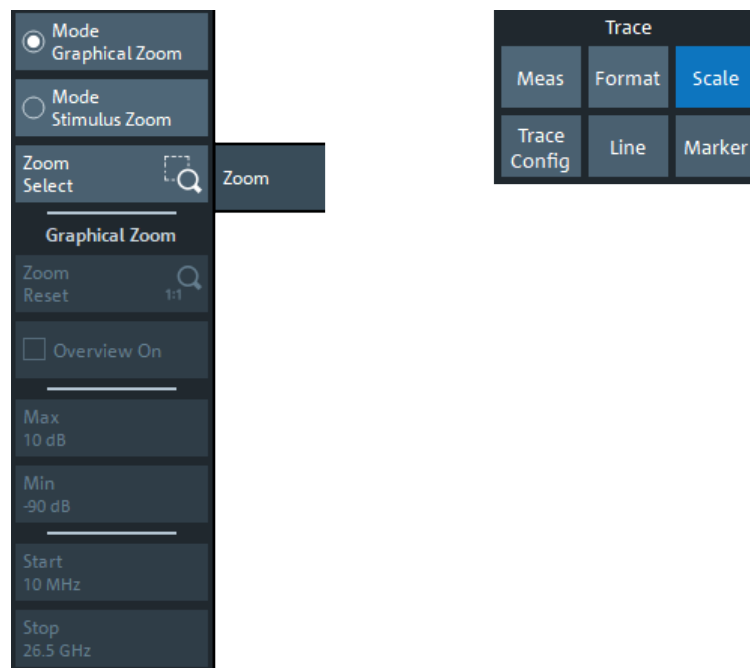

Mode Graphical Zoom/Mode Stimulus Zoom

Switches between graphical and stimulus zoom mode.

Use the [zoom selection button](#) to initiate the selection of a (paraxial) rectangular zoom area. Its label changes according to the selected zoom mode.

Remote command:

n.a.

Zoom Select/Stim. Zoom Select

Prepares the analyzer GUI for the selection of a (paraxial) rectangular zoom area.

The effect of the subsequent selection depends on the current [zoom mode](#) (as indicated on the button label):

- In "Mode Graphical Zoom" (button label "Zoom Select"), the selected rectangle is magnified without modifying any sweep parameters.
- In "Mode Stimulus Zoom" (button label "Stim. Zoom Select") the selected rectangle is magnified as well, but at the same time the sweep range of the active channel is narrowed to the rectangle's horizontal range.

You can define the zoom area using touchscreen or mouse. To modify the zoom window in graphical zoom mode, you can also use the numerical input fields "Max", "Min", "Start", and "Stop".

Remote command:

```
DISPlay[:WINDow<Wnd>]:TRACe<WndTr>:ZOOM[:STATe]
```

Zoom Reset

If a [graphical zoom](#) has been applied to the current diagram, this action resets the zoom area.

Remote command:

```
DISPlay[:WINDow<Wnd>]:TRACe<WndTr>:ZOOM[:STATe]
```

Overview On

If a [graphical zoom](#) has been applied to the active diagram (and has not been [reset](#), this button toggles the overview for this diagram.

The overview appears in the upper part of the diagram and shows the original diagram and the zoom area. You can move the zoomed part of the trace by moving the zoom area or use the numerical input fields "Max", "Min", "Start", "Stop" to do so.

Remote command:

```
DISPlay[:WINDow<Wnd>]:TRACe<WndTr>:ZOOM[:STATe]
```

Max / Min / Start / Stop

Defines the coordinates of the graphical zoom window for the active diagram. "Max" and "Min" define the response axis range, "Start" and "Stop" define the stimulus axis range.

The input fields are only enabled if a zoom area was selected before.

Remote command:

```
DISPlay[:WINDow<Wnd>]:TRACe<WndTr>:ZOOM:BOTTOm
```

```
DISPlay[:WINDow<Wnd>]:TRACe<WndTr>:ZOOM:START
```

```
DISPlay[:WINDow<Wnd>]:TRACe<WndTr>:ZOOM:STOP
```

```
DISPlay[:WINDow<Wnd>]:TRACe<WndTr>:ZOOM:TOP
```

5.5 Traces softtool

The "Traces" softtool provides functions for managing traces.

Access: Trace – [Trace Config]

5.5.1 Traces tab

Provides functions to handle traces and diagram areas, and assign traces to channels.



Related information

Refer to the following sections:

- [Chapter 4.1.3, "Traces, channels and diagrams"](#), on page 108
- [Chapter 3.3.5, "Handling diagrams, traces, and markers"](#), on page 58



In remote control, each channel can contain an active trace. The active remote traces and the active manual trace are independent of each other; see [Chapter 6.3.2, "Active traces in remote control"](#), on page 946.

5.5.1.1 Controls on the Traces tab

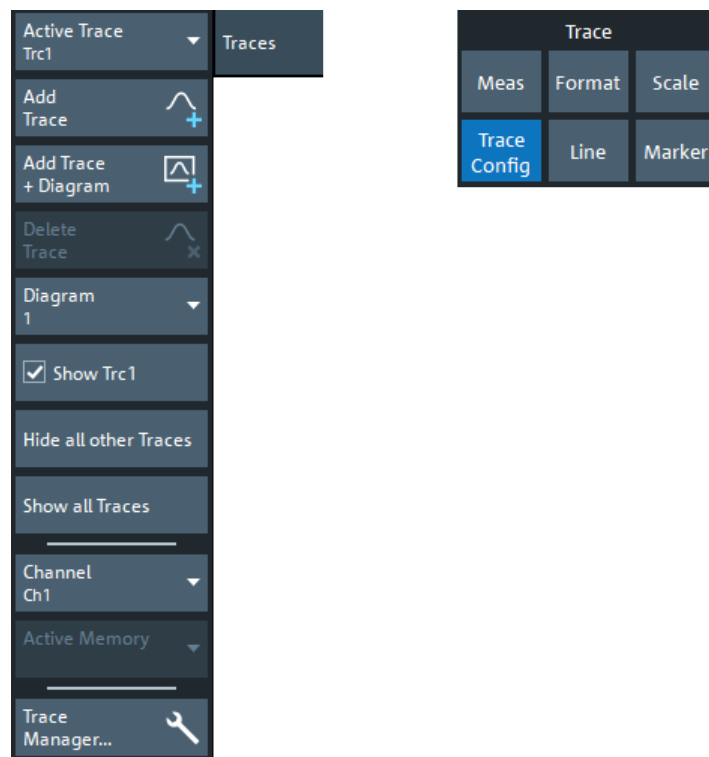

The "Trace Manager..." button opens the [Trace Manager dialog](#).

Active Trace

Selects an arbitrary trace of the active recall set as the active trace in its channel and diagram. At the same time, it sets the trace's diagram and channel as the active [Diagram / Channel](#).

Tip: You can also select an item in a trace list or a trace line in a diagram to make the related trace the active one.

This function is disabled if only one trace is defined.

Add Trace

Creates a trace in the active [Diagram / Channel](#) and makes it the [Active Trace](#).

The new trace is created with the settings of the former active trace, but displayed in another color. The former and the new active trace overlay each other. Change the reference position or select a different measurement for the new trace to separate them (see [Chapter 5.2, "Meas softtool"](#), on page 341).

The new trace is named "Trc<n>", where <n> is the largest of all existing trace numbers plus one. The name can be changed in the [Trace Manager dialog](#).

Remote command:

```
CALCulate<Ch>:PARAmeter:SDEFine
DISPlay[:WINDow<Wnd>]:TRACe<WndTr>:FEED
```

Add Trace + Diagram

Creates a trace in the active channel and assigns it to a new diagram. Otherwise behaves like [Add Trace](#).

Remote command:

```
CALCulate<Ch>:PARAmeter:SDEFine
DISPlay[:WINDow<Wnd>][:STATe] ON
DISPlay[:WINDow<Wnd>]:TRACe<WndTr>:FEED
```

Delete Trace

Deletes the active trace and removes it from the diagram area. If the active diagram contains only one trace, the diagram is also deleted.

"Delete Trace" is disabled if the active recall set contains only one trace. In manual control, each recall set must contain at least one diagram area with one channel and one trace.

Tips:

- You can also hide traces without actually deleting them: remove the corresponding "On" flags in the "Trace Manager" (see [Chapter 5.5.1.3, "Trace Manager dialog"](#), on page 435).
- Use the undo function to restore a trace that was unintentionally deleted.

Remote command:

```
CALCulate<Ch>:PARAmeter:DELeTe
CALCulate:PARAmeter:DELeTe:ALL
CALCulate<Ch>:PARAmeter:DELeTe:CALL
```

Diagram / Channel

Displays the active diagram and channel, i.e. the diagram and channel of the [Active Trace](#). Allows you to move the active trace to another diagram or channel.

Remote command:

```
DISPlay[:WINDow<Wnd>]:TRACe<WndTr>:FEED
```

Show <Trace Name> / Hide All Other Traces / Show All Traces

Configures the visibility of the traces in the active diagram:

- "Show <Trace Name>" toggles the visibility of the [Active Trace](#)
- "Hide All Other Traces" hides all traces of the active diagram – except the active one (which can be visible or not)
- "Show All Traces" makes all traces of the active diagram visible

Note:

- These actions can also be performed from the context menu of the trace name segment in the trace list (see [Chapter 4.2.1.4, "Channel list and channel settings"](#), on page 134).
- Use the "On" flags in the "Trace Manager" to show/hide arbitrary sets of traces (see [Chapter 5.5.1.3, "Trace Manager dialog"](#), on page 435).

5.5.1.2 New Trace dialog

The "Trc+" tool bar button allows you to create a trace in the active channel.

- Tap/click the "Trc+" button to duplicate the active trace (equivalent to [Add Trace](#)).
- Drag the respective button onto the diagram area to create the trace in any other existing diagram or in a new one.
After the button has been dropped, the "New Trace" dialog pops up and lets you select the quantity to be measured.

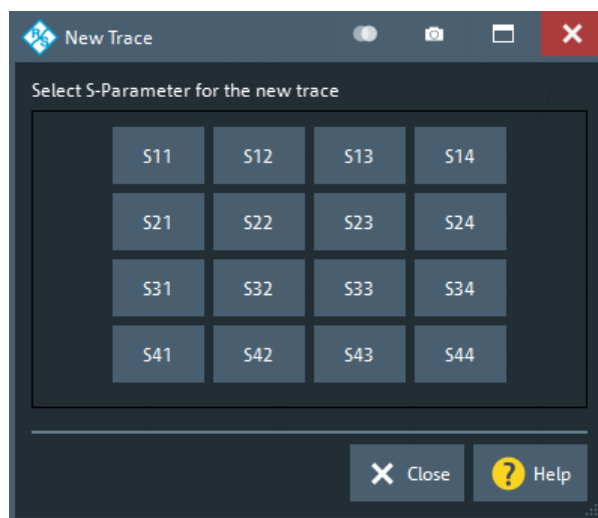

If the active channel is in a non-standard measurement mode, a different "New Trace" dialog is opened:

- Intermodulation: see [Chapter 5.2.6.4, "Intermodulation Measurements dialog"](#), on page 389
- Compression:

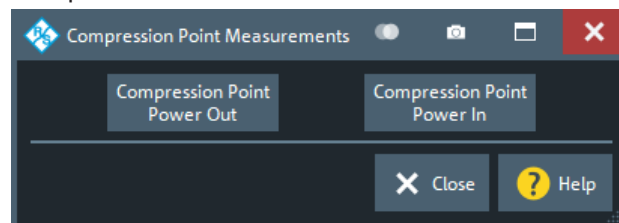

- Spectrum:

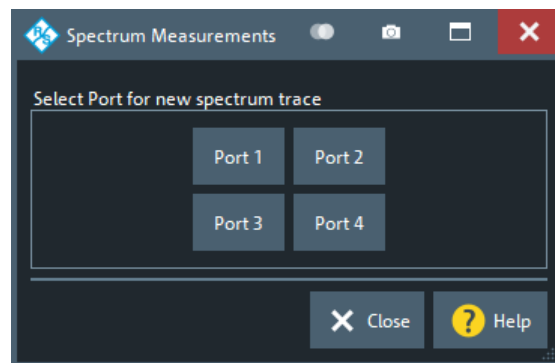

- Frequency Converting Measurements: see [Chapter 5.2.13.2, "Frequency Converting Measurements dialog"](#), on page 412
- Two Tone Group Delay Measurements: see ["Measurement"](#) on page 417

5.5.1.3 Trace Manager dialog

The "Trace Manager" dialog allows you to perform operations on traces.

Access: Trace – [Trace Config] > "Traces" > "Trace Manager..."

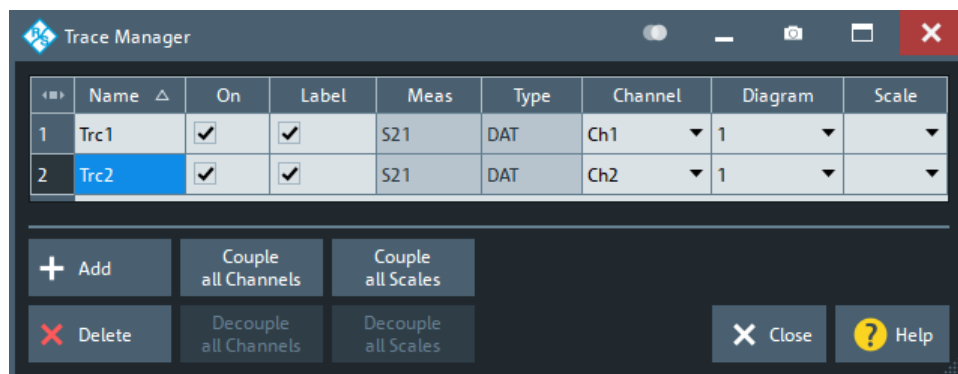

All existing traces of the current recall set are listed in a table with several editable (white) or non-editable (gray) columns.

Table Area

The table contains the following columns:

- "Name" indicates name of the related trace.
Trace names must be unambiguous across all channels and diagram areas in a recall set.
- "On" indicates and controls the visibility of the related trace.
- "Label" indicates and controls the visibility of the related trace label
- "Meas" indicates the measured parameter.
- "Type" indicates whether the trace is a data trace ("DAT"), displaying the current measurement data, or a memory trace ("MEM").
- "Channel" indicates and controls the channel to which the related trace is assigned. Data traces and their associated memory traces are always assigned to the same channel.

- "Diagram" indicates and controls the diagram area to which the related trace is assigned.
- "Scale" indicates and controls the scale coupling of the related trace. A trace's scaling can either be uncoupled ("Scale" empty) or coupled to another trace's scaling.

Rules for trace names

The analyzer can define mathematical relations between different traces and calculate new mathematical traces ("User Def Math"). The trace names are used as operands in the mathematical expressions and must be distinguished from the mathematical operators +, -, *, /, (,) etc., which places some restrictions on the syntax of trace names.

- The first character of a trace name can be one of the following:
 - an upper case letter from A to Z, or lower case letter from a to z
 - an underscore _
 - a square bracket [or]
- For all other characters of a trace name, the numbers 0 to 9 can be used in addition.

Note: The analyzer does not accept illegal or ambiguous trace names. If an illegal or ambiguous name is specified, the entry is denied.

Remote command:

```
CONFigure:TRACe:CATalog?
CONFigure:CHANnel<Ch>:TRACe:CATalog?
CONFigure:TRACe<Trc>:REName
CONFigure:CHANnel<Ch>:TRACe:REName
DISPlay[:WINDow<Wnd>]:TRACe<WndTr>:SHOW
DISPlay[:WINDow<Wnd>]:TRACe<WndTr>:LABel:SHOW
CONFigure:TRACe:WINDow:TRACe?
DISPlay[:WINDow<Wnd>]:TRACe<WndTr>:FEED
CONFigure:CHANnel<Ch>:NAME:ID?
```

Add

Creates a trace based on the [Active Trace](#). In particular, the trace is assigned to the channel and diagram of the active trace. However, its "Scale" coupling is not adopted.

The default names for new traces are "Trc<n>", where <n> is selected by the analyzer firmware to make trace names unambiguous.

Remote command:

```
CALCulate<Ch>:PARAmeter:SDEFine
```

Delete

Deletes the selected trace.

This button is disabled if the recall set contains only one trace: In manual control, each recall set must contain at least one diagram area with one channel and one trace.

Remote command:

```
CALCulate<Ch>:PARAmeter:DElete
```

Couple All Channels / Decouple All Channels

- "Couple All Channels" assigns all traces to the channel of the active trace, deleting all other (now unused) channels. The analyzer displays a confirmation dialog box before deleting the unused channels.
- "Decouple All Channels" makes sure that each data trace is assigned its own (independent) channel.
For data traces previously assigned to the same channel, new channels are created based on the original channel's settings. Data traces and their associated memory traces are assigned to the same channel.

Remote command:

n/a

Couple All Scales / Decouple All Scales

- "Couple All Scales" couples the scale settings of all traces to the scale settings of the active trace. The scale settings of the other traces are lost.
- "Decouple All Scales" applies independent scale settings to all traces.
If trace A is coupled to trace B, then B's scale settings are copied to A.

Remote command:

n/a

5.5.2 Mem tab

Stores traces to the memory.

**Background information**

Refer to "[Trace types](#)" on page 126.

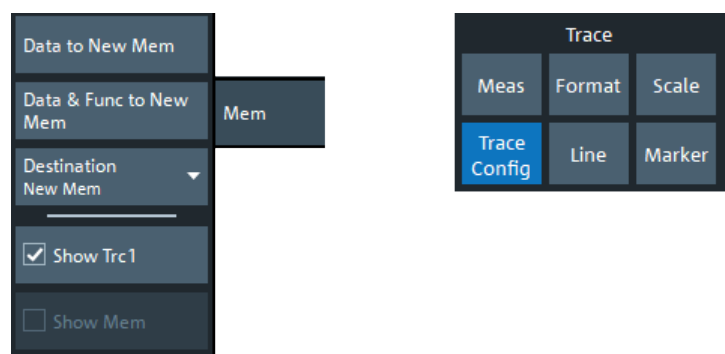
**Coupling of data and memory traces**

When a memory trace is generated from a data trace, it is displayed in the same diagram area and inherits all channel and trace settings from the data trace. The memory trace displayed in the active diagram; its properties are indicated in the trace list:



New memory traces are named "Mem<n>[<Data Trace>]", where:

- <n> counts all data and memory traces in the active recall set in chronological order
- <Data_Trace> is the name of the associated data trace

Trace names can be changed in the [Trace Manager dialog](#).

The following display settings of a data trace and the associated memory traces are **fully coupled**. Changing a property of one trace affects the properties of all other traces.

- All "Format" settings (see [Chapter 5.3, "Format softtool"](#), on page 419)
- All "Scale" settings (see [Chapter 5.4, "Scale softtool"](#), on page 425)

Selection of the measured quantity (using the [Meas softtool](#)) is possible for the data trace but disabled for the memory traces.

Channel settings made for a memory trace act on the associated data trace. Some of the channel settings for a data trace (e.g. the "Stimulus" range) also affect the display of the memory traces.



If, due to a change of the sweep type, the stimulus type of a data trace changes, all its memory traces are deleted.

Active Trace vs. Active Data Trace

In the context of memory traces we distinguish between the active trace and the active data trace.

- If the active trace is a memory trace, then the active data trace is the data trace to which the memory trace is associated.
- If the active trace is a data trace, then the active trace is also the active data trace.

Data to <Destination>

Stores the current state of the active data trace to the [Destination](#) memory trace. No trace functions are applied to the stored trace.

Tips:

- Use [Data & Func to <Destination>](#) to apply trace functions to the stored trace.
- You can also create memory traces using the [Import Complex Data dialog](#).
- It is not possible to store [Hold](#) traces to memory.
- For the relation between a data trace and its associated memory traces, see "[Coupling of data and memory traces](#)" on page 437.

Remote command:

```
CALCulate<Chn>:MATH:MEMorize
TRACe:COPY
```

Data & Func to <Destination>

Stores the current state of the active data trace – including trace functions – to the [Destination](#) memory trace.

Trace functions

The trace functions comprise the following mathematical operations:

- Active trace math on unformatted and formatted traces, as configured in the [Chapter 5.5.4, "Math tab"](#), on page 441.
- A shift of the data trace (see ["Shift Trace"](#) on page 465).

[Data to <Destination>](#) stores the raw trace without the trace functions, "Data & Func to <Destination>" stores the trace after it has been transformed using the trace functions.

For the relation between a data trace and its associated memory traces, see ["Coupling of data and memory traces"](#) on page 437.

Remote command:

```
CALCulate<Chn>:MATH:MEMorize
TRACE:COPY:MATH
```

Destination

Selects the destination for the [Data to <Destination>](#) and [Data & Func to <Destination>](#) operations.

The destination can be one of the following:

- An existing memory trace of the active data trace.
The existing memory trace is overwritten.
- "New Trace"
The data are copied to a new memory trace, associated to the current data trace.

Remote command:

n/a

Show <Active Data Trace>

Shows or hides the active data trace in the diagram.

Remote command:

```
DISPlay[:WINDow<Wnd>]:TRACe<WndTr>:SHOW
```

Show <Mem>

Shows or hides the active memory trace or the first memory trace of the active data trace.

If no memory trace is associated with the active data trace, "Show <Mem>" is disabled.

Remote command:

```
DISPlay[:WINDow<Wnd>]:TRACe<WndTr>:SHOW
```

5.5.3 All Mem All Data tab

Performs actions on all data or memory traces in the active recall set.



Background information

Refer to ["Trace types"](#) on page 126.

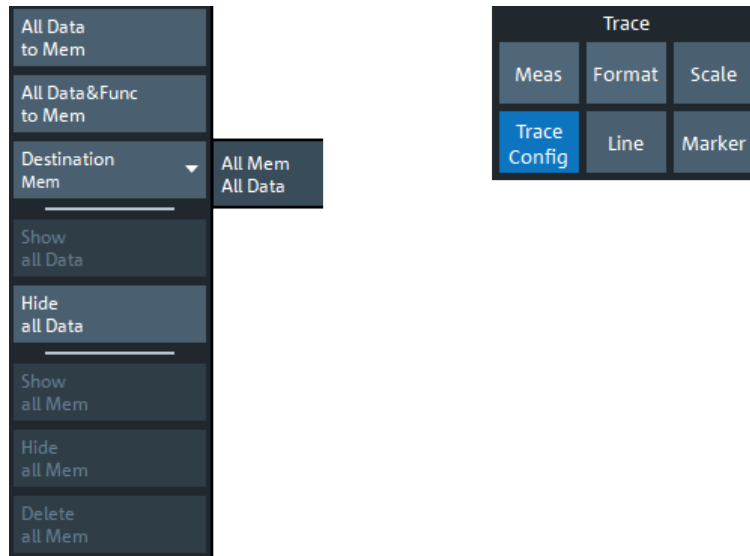

All Data to <Destination>

Stores the current data of all data traces in the active recall set to memory traces, in accordance with the [Destination](#) setting. No trace functions are applied to the stored traces.

Remote command:

`TRACe: COPY`

All Data & Func to <Destination>

Stores the current data of all data traces in the active recall set to memory traces, in accordance with the [Destination](#) setting. Trace functions are applied to the stored traces.

For information on trace functions, see "[Data & Func to <Destination>](#)" on page 438.

[All Data to <Destination>](#) stores the raw trace without the trace functions, "[All Data & Func to <Destination>](#)" stores the trace after it has been transformed using trace functions.

Remote command:

`CALCulate<Chn>: MATH: MEMorize`

Destination

Selects the destination for the [All Data to <Destination>](#) and [All Data & Func to <Destination>](#) functions, that operate on all data traces in the active recall set.

- **"Mem":**
For each data trace with associated memory traces, the current trace data are copied to the first associated memory trace, overwriting existing data. For data traces without associated memory trace, the current trace data are copied to a new memory trace, associated to this data trace.
- **"New":**
For each data trace, the current trace data are copied to a new memory trace, associated to this data trace.

New memory traces are named "Mem<n>[<Data_Trace>]" with <n> selected by the analyzer firmware to make trace names unique.

Remote command:

n/a

Show All Data / Hide All Data / Show All Mem / Hide All Mem

Displays or hides all data or memory traces in the active recall set. Hidden traces are not deleted.

Remote command:

```
DISPlay[:WINDow<Wnd>]:TRACe<WndTr>:SHOW
```

Delete All Mem

Deletes all memory traces in the active recall set.

Tips:

- Use the [Trace Manager dialog](#) to hide or delete arbitrary sets of traces.
- Use the UNDO function of the analyzer to restore a trace that was unintentionally deleted.

Remote command:

```
CALCulate:PARAmeter:DELeTe:MEMory
```

5.5.4 Math tab

Allows you to define mathematical operations on traces.



Background information

Refer to "[Trace types](#)" on page 126.

5.5.4.1 Controls on the Math tab



The "Define Math..." buttons in the "Complex Data" and "Formatted Data" sections both open the [User Def Math dialog](#), but with different scope:

- "Complex Data" > "Define Math..." defines mathematical operations on raw complex trace data.
- "Formatted Data" > "Define Math..." defines mathematical operations on formatted trace data.

Both can be combined.

Complex Data/Formatted Data

The controls in the "Complex Data" section define math operations on raw complex trace data, the controls in the "Formatted Data" section define math operations on formatted trace data.

"Complex Data" math is available in all firmware versions of all R&S ZNx vector network analyzers. "Formatted Data" math was added in version 1.80 of the R&S ZNA firmware.

Trace Math ← Complex Data/Formatted Data

Activates or deactivates the "Complex Data" and/or "Formatted Data" formula previously defined using [Data / <Mem>](#), [Data - <Mem>](#), or "Define Math..." (via [Chapter 5.5.4.2, "User Def Math dialog"](#), on page 443).

Trace math for unformatted and formatted trace data can be active at the same time.

Trace Math ← Complex Data/Formatted Data

Activates the mathematical mode, applying the last active mathematical relation to the active trace. The trace is replaced by the mathematical trace and Math is displayed in the trace list while the mathematical mode is active:

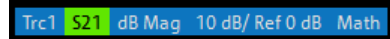

"Trace Math" is enabled if the active data trace fulfills the conditions for evaluating the mathematical relation. E.g., if no "User Defined" mathematical relation is defined, a memory trace must be coupled to the active data trace, so that the R&S ZNA can evaluate one of the relations "Data / <Mem>" or "Data - <Mem>".

Remote command:

```
CALCulate<Chn>:MATH:STATE
```

```
CALCulate<Chn>:MATH:FORMatted:STATE
```

Data / <Mem>, Data - <Mem> ← Complex Data/Formatted Data

Activates the mathematical mode with the corresponding trace mathematical operation. The division (subtraction) is calculated on a point-to-point basis: Each measurement point of the active trace is divided by (subtracted from) the corresponding measurement point of the memory trace. If the memory trace represents the result of a previous sweep with unchanged settings, the divided (subtracted) curve is typically centered at 1 / 0 dB (0). It shows the variation of the results in subsequent sweeps.

The result of the division is a mathematical trace and replaces the active data trace in the diagram area. The mathematical trace is updated as the measurement goes on and the analyzer provides new active trace data.

This function is disabled unless a memory trace is coupled to the active data trace. Trace coupling ensures that the two traces have the same number of points so that the mathematical trace is well-defined.

Remote command:

```
CALCulate<Chn>:MATH:FUNCTION
```

```
CALCulate<Chn>:MATH:FORMatted:FUNCTION
```

User Defined ← Complex Data/Formatted Data

Activates the mathematical mode and displays the mathematical trace defined using in the "User Def Math" dialog (see [Chapter 5.5.4.2, "User Def Math dialog"](#), on page 443).

The mathematical trace replaces the active data trace in the diagram area; it is updated as the measurement goes on and the analyzer provides new active trace data.

Remote command:

```
CALCulate<Chn>:MATH:STATE
```

5.5.4.2 User Def Math dialog

The "User Def Math" dialog defines a mathematical trace for the active trace. Each measurement point of the original trace is replaced by the corresponding point of the mathematical trace.

Access: Trace – [Trace Config] > Math > Complex Data/Formatted Data section > "Define Math..."

Depending on the section from where the dialog is opened, the calculation is either based on unformatted or formatted trace data.

Compatibility between traces in mathematical relations

Mathematical traces are either constant functions or functions of one or more data or memory traces. They are calculated on a point-to-point basis. Each trace point no. i of the mathematical trace is calculated from a set of constant values c_1, \dots, c_n plus the trace points $\text{Trc1}_i, \text{Trcm}_i$ of all traces 1 to m in the mathematical relation:

$$\text{Math}_i = \text{Fct.} (c_1, \dots, c_n, \text{Trc1}_i, \text{Trcm}_i), i = 1, \text{ no. of points}$$

Different traces can be used in the same mathematical relation provided that they contain the same number of points. The analyzer places no further restriction on the compatibility of traces, e.g. the sweep points of the traces do not have to be the same.

The number of points belongs to the channel settings. Coupled data and memory traces are always compatible because they have the same channel settings.



The analyzer processes only numeric values without units in the mathematical formulas. No consistency check for units is performed.

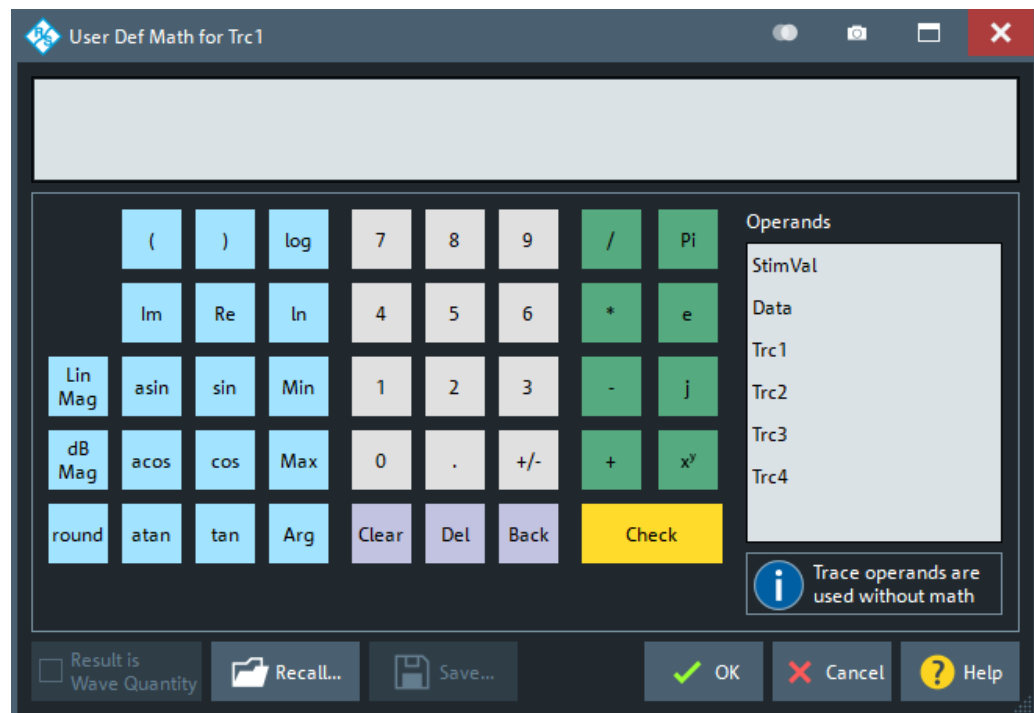

Expression builder

The mathematical expression appears in the upper part of the dialog. The operands and operators in the expression can be selected from a keyboard and the list of "Operands":

- The keyboard supports the entry of numeric values, constants, and mathematical functions. In addition to the numbers 0 to 9, the decimal point and the constants j (complex unit), π (approx. 3.14159) and e (approx. 2.71828), it contains the following buttons:
 - +/- changes the sign
 - The effect of the basic arithmetic operators ($/$, $*$, $-$, $+$) and the mathematical functions is described in [Table 5-4](#).
Products of numbers and constants may be entered in abbreviated form, e.g. $2e$ for $2*e$.
 - The Clear, Del, Back buttons are used to correct faulty entries.
 - Check performs a consistency check of the displayed mathematical expression and displays a message.
- "Operands" contains all data traces and memory traces of the active recall set.
 - Data and memory traces are identified by their trace names.
 - "Data" denotes the active data trace.
 - "Mem" is the memory trace associated with the active data trace (or the first created one, if several memory traces are associated with the active data trace).
 - "StimVal" is the array of stimulus values; see footnote for [Table 5-4](#).

The trace operands denote *unmodified* data and memory traces. Trace math and other trace functions ("Smoothing", "Hold", "Shift Trace" etc.) are not taken into account.

Table 5-4: Effect of the operators on a complex quantity $z = x + jy$.

$+$, $-$, $*$, $/$	Basic arithmetic operations
$()$	Grouping parts of an expression
Lin Mag	$ z = \sqrt{x^2 + y^2}$
dB Mag	$\text{dB Mag}(z) = 20 * \log z \text{ dB}$
round	x real \Rightarrow round(x) rounds x to the closest integer (away from zero for ties) x, y real \Rightarrow round($x+yj$) = round(x)+round(y) j
x^y	Exponential, e.g. z^2
Arg	Phase $\varphi(z) = \arctan(\text{Im}(z) / \text{Re}(z))$
Re, Im	x, y (Real and Imag)
log, ln	Common (base 10) or natural (base e) logarithm
Min, Max	Smaller or larger values of all points of two traces, e.g. Min(Trc1, Trc2)
StimVal *)	Stimulus value*)
tan, atan, sin, asin, cos, acos	Direct and inverse trigonometric functions.

*) The operand "StimVal" can be used for all sweep types. Please note that – as with all user math operands – only the numerical value without unit is processed in the user math formula.

- In frequency sweeps "StimVal" provides the stimulus frequency in Hz.
- In power sweeps, "StimVal" provides the voltage in V that results from the source power in dBm. To obtain the correct source power in dBm (for "dB Mag" trace format), [Result is Wave Quantity](#) must be enabled. Note that, due to the conversion into a dBm value, the source power depends on the reference impedance of the port associated with the measured wave quantity, to be set in the "Balanced Ports" dialog.
- In time sweeps, "StimVal" is the stimulus time in s.
- In CW mode sweeps, "StimVal" is the number of the point.

Remote command:

```
CALCulate<Chn>:MATH[:EXPRession]:SDEFine
```

```
CALCulate<Chn>:MATH:FORMatted[:EXPRession]:SDEFine
```

Result is Wave Quantity

"Result is Wave Quantity" controls the conversion and formatting of the mathematic expression.

This switch is available for **unformatted** trace data (Complex Data) only.

- If "Result is Wave Quantity" is enabled, the analyzer assumes that the result of the mathematical expression represents a voltage. Examples for voltage-type expressions are all terms proportional to a wave quantity (e.g. $1.1 * \text{Data}$, if a wave quantity is measured) or to a stimulus value of a power sweep.
If "Show as": "Power" is selected in the "More Wave Quantities" dialog, the result is converted into a linear power before the selected trace format is applied. Otherwise no conversion is performed, and "dB Mag" results are referenced to $1 \mu\text{V}$.
- If "Result is Wave Quantity" is disabled the analyzer assumes that the result of the mathematical expression is dimensionless. Examples for dimensionless expressions are all terms proportional to ratios of wave quantities, e.g. $\text{Data} / \text{Mem2}[\text{Trc1}]$.
The selected trace format is applied without previous conversion.

"Result is Wave Quantity" acts on the result of the mathematical expression only. Wave quantities and power sweep stimulus values always enter into the expression as voltages.

Effect of "Result is Wave Quantity"

In the [More Wave Quantities dialog](#), the "Show as" control element specifies whether wave quantities are displayed as voltages or equivalent powers, using the port impedances for a conversion between the two representations. "Result is Wave Quantity" is relevant for mathematical traces displayed in units of dBm ("Show as": "Power" and trace format "dB Mag"):

If "Result is Wave Quantity" is on (checked), the mathematical trace values $\langle W \rangle$ are interpreted as voltages and first converted into equivalent powers ($\langle W \rangle \rightarrow \langle P \rangle = \langle W \rangle^2 / \text{Re}(Z_0)$). Results in "dB Mag" format are calculated according to $\langle P \rangle_{\log} = 10 * \log(\langle P \rangle / 1\text{mW})$.

- If "Result is Wave Quantity" is off, the mathematical trace values $\langle W \rangle$ are interpreted as dimensionless quantities. Results in "dB Mag" format are calculated according to $\langle W \rangle_{\log} = 20 * \log(\langle W \rangle)$.

Example:

A mathematical trace value amounts to 1 (real value); the port impedance is 50 Ω. If "Result is Wave Quantity" is on, the analyzer assumes the trace value to be 1 V, which is converted into a linear power of 20 mW, corresponding to approx. 13 dBm. With "Result is Wave Quantity" off, the trace value 1 is directly converted into a logarithmic power of 0 dBm.

Tip: See also example for `CALCulate<Chn>:MATH:WUNit:STATe`.

Remote command:

```
CALCulate<Chn>:MATH:WUNit[:STATe]
```

Recall... / Save...

Recalls / saves a mathematical expression from / to a trace math string file. Trace math string files are ASCII files with the default extension `*.mth` and contain the mathematical expression as it is written in the "User Def Math" dialog. It is possible to change or create math string files using a text editor.

Remote command:

```
CALCulate<Chn>:MATH:WUNit[:STATe]
```

5.5.5 Time Domain tab

The "Time Domain" tab enables and configures the time domain representation of the measurement results.



Time domain analysis requires option R&S ZNA-K2. If this option is not installed, the "Time Domain" and [Time Gate tab](#) tabs are hidden.

**Background information**

Refer to [Chapter 4.7.2, "Time domain analysis"](#), on page 247.

For a comparison of the different transformation types and windows, and for application examples, please also refer to the application note 1EZ44_OE (<https://www.rohde-schwarz.com/appnote/1EZ44>).

5.5.5.1 Controls on the Time Domain tab

The contents of the "Time Domain" tab are also displayed on the "Meas" softtool for non-frequency converting DUTs.



"Low Pass Settings..." opens the [Low Pass Settings dialog](#).

Time Domain

Selects the time domain representation for the active diagram area. The softkey is enabled if a linear frequency sweep is active (see ["Lin Freq"](#) on page 546). The analyzer automatically quits time domain representation when a different sweep type is selected.

The time domain results are obtained by transforming the measured frequency sweep data into the time domain using an appropriate mathematical transformation type and frequency window ("Impulse Response"). The sweep range and the output power for the active channel is still displayed below the diagram; the displayed time interval is shown in a second line:

```
Ch1 Start 1 MHz Pwr -10 dBm Bw 10 kHz Stop 3 GHz
Trc1 Start -1 ns — Time Domain Stop 4 ns
```

Trace settings in time domain representation

While the time domain representation is active, the trace settings behave as follows:

- The "Start" and "Stop" settings in the "Time Gate" tab configure the time axis.
- All trace formats including the circular diagrams are available.
- Limit lines can be defined like the limit lines for time sweeps.
- The bandfilter search functions are available for the transformed trace.
- If marker coupling is active, then the markers in the time domain and in the frequency domain are coupled with each other.

The analyzer places no restriction on the measured quantities to be transformed into the time domain. Impedances and admittances are first converted back into the equivalent S-parameter, transformed, and restored after the transformation.

See also [Chapter 4.7.2.1, "Chirp z-transformation"](#), on page 248.

Remote command:

```
CALCulate<Chn>:TRANSform:TIME:STATe
```

Type

Selects a band pass or low pass time domain transform. See [Chapter 4.7.2.2, "Band pass and low pass mode"](#), on page 248.

To calculate a low pass transform, the sweep points must be on a harmonic grid. Otherwise the analyzer can only calculate an approximate result and generates a warning. "Low Pass Settings..." opens a dialog that allows to establish or change a harmonic grid (not available for memory traces). See [Chapter 5.5.5.2, "Low Pass Settings dialog"](#), on page 450.

For the "Low Pass Step" response transform, it is recommended to activate [Dynamic Bw at Low Frequencies](#). A dialog prompts you to do so:

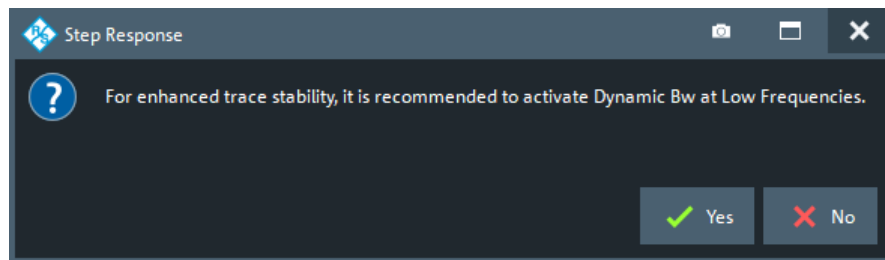

Remote command:

```
CALCulate<Chn>:TRANSform:TIME[:TYPE]
CALCulate<Chn>:TRANSform:TIME:STIMulus
```

Impulse Response

Selects a window type which the R&S ZNA uses to filter the trace in the frequency domain. The drop-down list shows the impulse response of a constant trace over a finite sweep range (i.e. a rectangular function) that was filtered using the different available window types. The selected window is applied to the active trace.

See also [Chapter 4.7.2.3, "Windows in the frequency domain"](#), on page 249.

Note: The frequency domain window is used to filter the trace before transforming it to the time domain. An independent "Time Gate" can be used after the transformation to eliminate unwanted responses (see [Chapter 5.5.6, "Time Gate tab"](#), on page 452).

The analyzer always uses a "No Profiling (Rectangle)" window to calculate the time-gated frequency domain trace, see ["Time-gated frequency domain trace"](#) on page 253.

Remote command:

```
CALCulate<Chn>:TRANSform:TIME:WINDow
```

Side Lobe Level

Defines the side lobe suppression for an "Arbitrary Sidelobes (Dolph-Chebyshev)" window. The entered value is the ratio of the power of the central lobe to the power of the first side lobe in dB.

Remote command:

```
CALCulate<Chn>:TRANSform:TIME:DCHebyshev
```

Resolution Enh.

Broadens the frequency range that the analyzer considers for the time domain transform by a linear factor. A factor of 1 means that the original sweep range and the measured sweep points are used; no additional assumptions are made. With higher resolution enhancement factors, the measurement data is extrapolated using a linear prediction method. As a result, the resolution in time domain can be improved.

The ideal resolution enhancement factor depends on the properties of the DUT. For distance to fault measurements on cables, set it to 1.

Remote command:

```
CALCulate<Chn>:TRANSform:TIME:RESolution:EFACtor
```

TD-VSWR

Enables time domain site VSWR measurements (see [Chapter 4.7.2.6, "Time domain \$S_{VSWR}\$ measurements"](#), on page 253).

Remote command:

```
CALCulate:TDVSwr[:STATE]
```

Gate Span

[Time domain \$S_{VSWR}\$ measurements](#) relies on a time gate that is centered at the antenna's direct response (plus ring-down time), separating the direct response from the indirect responses (reflections).

"Gate Span" is equivalent to the "Span" value on the [Time Gate tab](#).

This button is only enabled if [TD-VSWR](#) is active.

Remote command:

```
CALCulate<Chn>:FILTer[:GATE]:TIME:SPAN
```

Show Impulse Response...

To get an impression of the required [Gate Span](#), you can quickly create a trace displaying the impulse response of the active trace in a new diagram.

This button is only enabled if [TD-VSWR](#) is active.

5.5.5.2 Low Pass Settings dialog

The "Low Pass Settings" dialog defines the harmonic grid for low pass time domain transforms.

Access: Trace – [Trace Config] > "Time Domain" > "Low Pass Settings..."

**Background information**

Refer to [Chapter 4.7.2.4, "Harmonic grid"](#), on page 250.

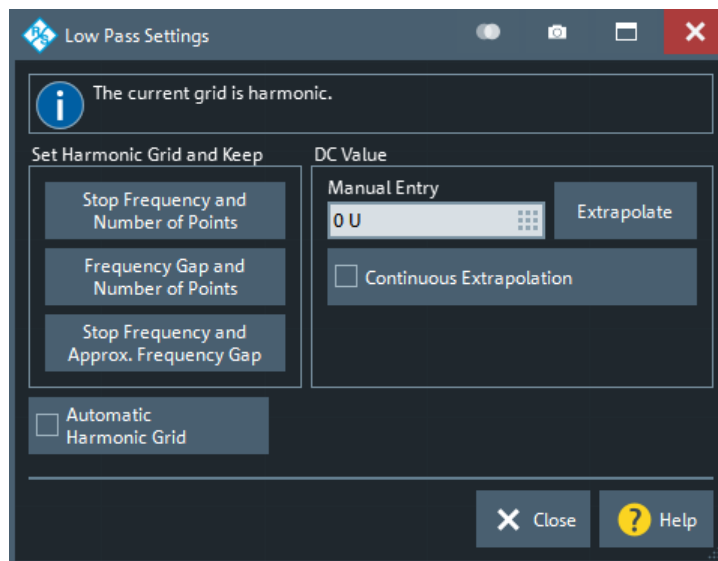

Is the Current Grid Harmonic?

The area at the top of the "Low Pass Settings" dialog indicates whether the current frequency grid is harmonic.

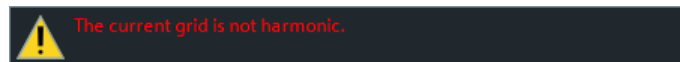

Remote command:

```
[SENSe<Ch>:]HARMonic?
```

Set Harmonic Grid and Keep

The three buttons provide alternative algorithms for calculation of a harmonic grid, based on the current sweep points.

- Keep "Stop Frequency and Number of Points" calculates a harmonic grid based on the current "Stop Frequency" (see ["Start Frequency / Stop Frequency / Center Frequency / Span Frequency"](#) on page 523) and the current number of sweep points (see ["Number of Points"](#) on page 540). This algorithm can increase the frequency gap (i.e. the [Freq Step Size](#)).
- Keep "Frequency Gap and Number of Points" calculates a harmonic grid based on the current "Stop Frequency" and the current frequency gap (i.e. the "Freq Step Size").
- Keep "Stop Frequency and Approximate Frequency Gap" calculates a harmonic grid based on the current "Stop Frequency", increasing the "Number of Points" in such a way that the frequency gap (i.e. the "Freq Step Size") remains approximately the same. This algorithm can increase the sweep time, due to the additional sweep points introduced.

The three grids can be calculated repeatedly in any order; the analyzer always starts from the original set of sweep points.

For more information, refer to [Chapter 4.7.2.4, "Harmonic grid"](#), on page 250.

Remote command:

```
CALCulate<Chn>:TRANSform:TIME:LPASs
```

Automatic Harmonic Grid

If enabled (default) the frequency grid is automatically kept harmonic.

Remote command:

```
[SENSe<Ch>:]HARMonic:AUTO
```

DC Value

The control elements in this section define the measurement result at zero frequency and in the interpolation/extrapolation range between $f = 0$ and $f = f_{\min}$. They are enabled after a harmonic grid has been established.

Defining the low frequency sweep points

After calculating a harmonic grid, the analyzer must determine the value of the measured quantity at grid points below the analyzer's minimum frequency f_{\min} .

The following figure shows a scenario where the harmonic grid was calculated with fixed "Stop Frequency and Number of Points". The DC value and the values at the two additional red points must be extrapolated or interpolated according to the values at the measured sweep points (blue dots).

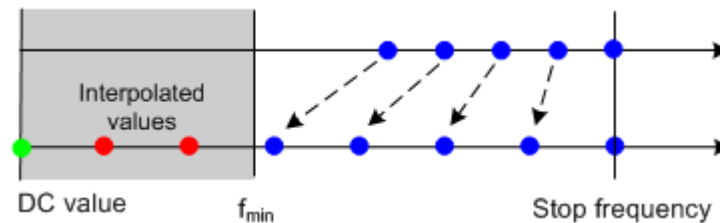

- If the properties of the DUT at $f = 0$ are sufficiently well known, then it is recommendable to enter the DC value manually ("Manual Entry").
Examples: At $f = 0$ the reflection factor of an open-ended cable is 1. It is -1 for a short-circuited cable and 0 for a cable with matched termination. If a cable with known termination is measured, enter these numbers as DC values.
- The "Extrapolate" button initiates an extrapolation of the measured trace towards $f = 0$ and overwrites the current DC value. This function can be used for a consistency check.
- "Continuous Extrapolation" initiates an extrapolation of the measured trace towards lower frequencies, so that the missing values (green and red dots) are obtained without any additional input. The extrapolation is repeated after each sweep.

After setting or extrapolating the DC value, the analyzer then calculates the remaining values (red dots) by linear interpolation of the magnitude and phase.

Remote command:

```
CALCulate<Chn>:TRANSform:TIME:LPASs:DCSParm
```

```
CALCulate<Chn>:TRANSform:TIME:LPASs:DCSParm:CONTinuous
```

```
CALCulate<Chn>:TRANSform:TIME:LPASs:DCSParm:EXTRApolate
```

```
CALCulate<Chn>:TRANSform:TIME:LPFRequency
```

5.5.6 Time Gate tab

Defines and activates a gate in the time domain. An active time gate acts on the trace in time domain and in frequency domain representation. In time domain representation,

you can use the time gate settings to eliminate unwanted responses in your signal. After switching back to the frequency domain, you will receive the frequency response of your DUT without the contribution of the unwanted responses. The time gate is independent of the frequency window used to filter the trace before transforming it to time domain.



Time domain analysis requires option R&S ZNA-K2. If this option is not installed, the [Time Domain tab](#) and "Time Gate" tabs are hidden.



Background information

Refer to [Chapter 4.7.2.5, "Time gates"](#), on page 252.

Trace		
Meas	Format	Scale
Trace Config	Line	Marker

Time Gate

Enables or disables the time gate for the time domain and frequency domain traces. "Gat" is displayed in the trace list while the time gate is active.

Trc1 S21 dB Mag 10 dB/ Ref 0 dB Gat

Remote command:

```
CALCulate<Chn>:FILTer[:GATE]:TIME:STATE
```

Axis Pair

"Start Stop" lets you define the time gate via its "Start" and "Stop", "Center Span" lets you define it via its "Center" and "Span" value (in time). The analyzer generates a warning if the (resulting) time span exceeds the unambiguous range which is given by $\Delta t = 1/\Delta f$, where Δf is the "Freq Step Size". Simply reduce the time span until the warning disappears.

Remote command:

```
CALCulate<Chn>:FILTer[:GATE]:TIME:CENTer
CALCulate<Chn>:FILTer[:GATE]:TIME:SPAN
CALCulate<Chn>:FILTer[:GATE]:TIME:START
CALCulate<Chn>:FILTer[:GATE]:TIME:STOP
```

Show Range Lines

Displays or hides two red lines indicating the start and stop of the time gate in a time domain diagram.

Remote command:

```
CALCulate<Chn>:FILTer[:GATE]:TIME:SHOW
```

Bandpass / Notch

The filter type defines what happens to the data in the specific time region.

- A "Bandpass" filter passes all information in the specified time region and rejects everything else.
- A "Notch" filter rejects all information in the specified time region and passes everything else.

Remote command:

```
CALCulate<Chn>:FILTer[:GATE]:TIME[:TYPE]
```

Shape

Selects a gate shape which the R&S ZNA uses to filter the trace in the time domain.

The drop-down list visualizes how the time gate will affect a constant function after transformation back into the frequency domain. The selected window is applied to the active trace. The two red vertical lines represent the "Start" and "Stop" values defining the size of the time gate.

See also [Chapter 4.7.2.5, "Time gates"](#), on page 252.

Remote command:

```
CALCulate<Chn>:FILTer[:GATE]:TIME:SHAPE
CALCulate<Chn>:FILTer[:GATE]:TIME:WINDOW
```

Side Lobe Level

Defines the side lobe suppression for an "Arbitrary Gate Shape (Dolph-Chebyshev)" gate. The entered value is the ratio of the power of the central lobe to the power of the first side lobe in dB.

Remote command:

```
CALCulate<Chn>:FILTer[:GATE]:TIME:DCHebyshev
```

Time Gate Linking/Single Time Gate Linking

Allows you to link the time gates of a channel's time domain traces, i.e. to align the time gate setting across linked (~coupled) traces.

"Time Gate Linking" links the time gates of all traces to the time gate of the active trace, "Single Time Gate Linking" links the time gate of the current trace to the time gate of the selected trace.

The controls in these sections are enabled, if the current channel contains at least one time domain trace,

Remote command:

```
CALCulate<Chn>:FILTer[:GATE]:TIME:LINK
```

5.5.7 Distance to Fault tab

This tab is only visible, if option R&S ZNA-K2 is installed on the R&S ZNA. It replicates the "Distance to Fault" tab of the "Distance to Fault" application. See [Chapter 5.17.3, "Distance to Fault application"](#), on page 830.

5.5.8 Trace Statistics tab

Evaluates statistical and phase information of the entire trace or of a specific evaluation range and calculates the x-dB compression point.

5.5.8.1 Controls on the Trace Statistics tab



The "Evaluation Range..." button opens the "Evaluation Range" dialog (see [Chapter 5.5.8.2, "Evaluation Range dialog"](#), on page 461).

The "Decimal Places..." button opens the "System Config" dialog to define the (maximum) number of fractional digits for setting values and measurement results. See also ["User Interface tab"](#) on page 860..

Min/Max/Peak-Peak, Mean/Std Dev/RMS

The upper two softkeys in the "Trace Statistics" tab display or hide groups of statistical results. The values are based on all response values of the trace in the selected evaluation range ("Evaluation Range...").

Statistics (S21)	
Min	-15.1576 dB
Max	-4.2206 dB
Pk-Pk	10.9370 dB
Mean	-5.9004 dB
Std Dev	1.2777 dB
Rms	-5.7588 dB

Suppose that the trace in the evaluation range contains n stimulus values x_i and n corresponding response values y_i (measurement points). The statistical values are obtained as follows:

- "Min" and "Max" are the largest and the smallest of all response values y_i .
- "Pk-Pk" is the peak-to-peak value and is equal to the difference "Max"–"Min"

- "Mean" is the arithmetic mean value of all response values:

$$Mean = \frac{1}{n} \sum_{i=1}^n y_i$$

- "Std Dev" is the standard deviation of all response values:

$$Std.Dev. = \sqrt{\frac{1}{n} \sum_{i=1}^n (y_i - \frac{1}{n} \sum_{i=1}^n y_i)^2}$$

- "RMS" is the root mean square (effective value) of all response values:

$$RMS = \sqrt{\frac{1}{n} \sum_{i=1}^n |y_i|^2}$$

Note: To calculate the "Min", "Max", "Pk-Pk" and the "Std Dev" values, the analyzer uses formatted response values y_i (see trace formats). Consequently, the mean value and the standard deviation of a trace depend on the selected trace format. In contrast, the "RMS" calculation is based on linear, unformatted values. The physical unit for unformatted wave quantities is 1 Volt. The RMS value has zero phase. The selected trace format is applied to the unformatted RMS value, which means that the RMS result of a trace does depend on the trace format.

Remote command:

```
CALCulate<Chn>:STATistics:MMPTpeak[:STATe]
CALCulate<Chn>:STATistics:MSTDdev[:STATe]
CALCulate<Chn>:STATistics:RMS[:STATe]
CALCulate<Chn>:STATistics:RESult?
CALCulate<Chn>:STATistics[:STATe]
CALCulate<Chn>:STATistics[:STATe]:AREA
```

Format

This setting determines how [Min/Max/Peak-Peak](#), [Mean/Std Dev/RMS](#) for complex-valued traces (Smith, Polar) are calculated:

- "ZVAB": the results are based on unformatted wave quantities (voltages)
- "R + jX": the results are based on the impedance values R and X
- "G + jB": the results are based on the admittance values G and B

In the two latter cases, the "RMS" value is not displayed.

Remote command:

```
CALCulate<Chn>:STATistics:FORMat
```

Phase/EI Length

Displays or hides the phase delay ("Phs Dly") and the electrical length ("EI Len") of the trace in the selected evaluation range ("Evaluation Range..."). The parameters are only available for trace formats that contain phase information, i.e. for the formats "Phase", "Unwr Phase", and the polar diagram formats "Polar", "Smith", "Inv Smith" (see [Chapter 5.3, "Format softtool"](#), on page 419). Moreover, the sweep type must be a frequency sweep, and the evaluation range must contain at least 3 measurement points.

```
Statistics (S21)
Phs Dly  340.800 ps
EI Len   102.169 mm
```

The phase parameters are obtained from an approximation to the derivative of the phase in the selected evaluation range.

- "Phs Dly" is the phase delay, which is an approximation to the group delay and calculated as follows:

$$PD = -\frac{\Delta\phi_{deg}}{360^\circ \cdot \Delta f}$$

where Δf is the width of the evaluation range and $\Delta\Phi$ is the corresponding phase change. See also note on transmission and reflection parameters below.

- "El Len" is the electrical length, which is the product of the phase delay times the speed of light in the vacuum.

If no dispersion occurs, the phase delay is equal to the group delay. For more information, refer to [Chapter 4.3.8, "Group delay"](#), on page 167.

Note: To account for the propagation in both directions, delay and electrical length of a reflection parameter are only half the delay and electrical length of a transmission parameter. The formula for PD above is for transmission parameters. See the section on "Length and delay measurement" in [Chapter 4.6.1.3, "Auto Length"](#), on page 229.

Tip: The phase evaluation can cause misleading results if the evaluation range contains a 360 deg phase jump. The trace format "Unwr Phase" avoids this behavior.

Remote command:

```
CALCulate<Chn>:STATistics:EPDelay[:STATe]
CALCulate<Chn>:STATistics:RESult?
CALCulate<Chn>:STATistics[:STATe]
```

Flatness/Gain/Slope

Displays or hides trace parameters that the analyzer calculates for the selected evaluation range ("Evaluation Range...").

```
Statistics (S21)
Gain      -5.1494 dB
Slope     0.6164 dB
Flatness  3.9478 dB
```

Suppose that A and B denote the trace points at the beginning and at the end of the evaluation range, respectively.

- "Gain" is the larger of the two stimulus values of points A and B.
- "Slope" is the difference of the stimulus values of point B minus point A.
- "Flatness" is a measure of the deviation of the trace in the evaluation range from linearity. The analyzer calculates the difference trace between the active trace and the straight line between points A and B. The flatness is the difference between the largest and the smallest response value of this difference trace.

Remote command:

```
CALCulate<Chn>:STATistics:SFlatness[:STATe]
CALCulate<Chn>:STATistics:RESult?
CALCulate<Chn>:STATistics[:STATe]
CALCulate<Chn>:STATistics[:STATe]:AREA
```

Power Ratio

Activates the noise power ratio statistics for spectrum traces.

Statistics	(S/A2)
Ref. Power Density	-6.358 dBm/Hz
Eval. Power Density	-6.358 dBm/Hz
Power Ratio	0.0000 dB

This checkbox is only available if the [spectrum analysis](#) option R&S ZNA-K1 is installed. It is only enabled if the active channel is in spectrum analysis mode.

Deactivate [Image Rejection](#) for realistic results.

Remote command:

```
CALCulate<Chn>:STATistics:PRATio[:STATE]
```

```
CALCulate<Chn>:STATistics:PRATio:RESult?
```

Compr. Point / Compr. Val.

Displays or hides all results related to the x dB (or x degrees) compression point of the trace, where x is the selected compression value. To obtain valid compression point results, a power sweep must be active, and the trace format must be dB or phase.

For dB traces, the x dB compression point of an S parameter or ratio is defined as the stimulus level where the response value has dropped by x dB compared to the response value at small stimulus signal levels ("small signal value"). For phase traces, the x degree compression point of an S parameter or ratio is defined as the stimulus level where the phase value has dropped by x° compared to the phase value at small stimulus signal levels. By default, the analyzer uses the value at the "First Point" of the selected evaluation range ("Evaluation Range...") as an approximation for the small signal value. However, you may also choose a different [Reference Value](#).

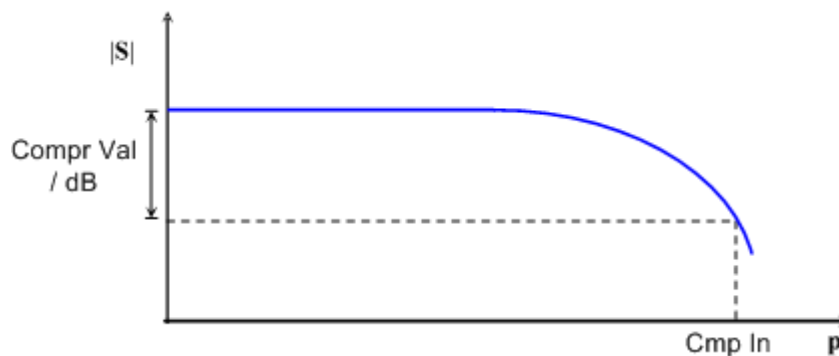

The compression point is a measure for the upper edge of the linearity range of a DUT. It is close to the highest input signal level for which the DUT shows a linear response, so that the magnitude of all S-parameters remains constant).

Statistics (S21)	Statistics (S21)
Cmp In -24.6907 dBm	Cmp In -24.9548 dBm
Cmp Out -35.3765 dBm	Cmp Out -116.29 °

- "Cmp In" is the stimulus level at the compression point in units of dBm. "Cmp In" always corresponds to the driving port level (e.g. the level from port no. j, if a transmission parameter S_{ij} is measured).
- For dB formatted traces, "Cmp Out" is the sum of the stimulus level "Cmp In" and the magnitude of the measured response value at the compression point. The magnitude of a transmission S-parameter S_{ij} is a measure for the attenuation (or gain) of the DUT, hence: "Cmp Out" = "Cmp In" + <Attenuation>.

For phase formatted traces, "Cmp Out" is the response value at the compression point.

The info field shows invalid results ('---') if the wrong sweep type or trace format is selected, or if no compression point with the configured properties was found.

Remote command:

```
CALCulate<Chn>:STATistics:NLINear:COMP[:STATe]
CALCulate<Chn>:STATistics:NLINear:COMP:LEVel
CALCulate<Chn>:STATistics:NLINear:COMP:PHASe
CALCulate<Chn>:STATistics:NLINear:COMP:RESult?
CALCulate<Chn>:STATistics[:STATe]:AREA
```

Reference Value

This control is only available if [compression point](#) statistics are calculated. It selects the reference value ("small signal value") for the compression point calculation.

"First Point" (default)	uses the value at the first point of the selected evaluation range as the reference value (see Chapter 5.5.8.2, "Evaluation Range dialog" , on page 461)
"Selected Marker"	uses the value at a selectable marker as the reference value (see "Selected Marker" on page 460)
"Range"	uses the average value in a configurable "Ref. Range" on page 460 as the reference value
"Defined Value"	allows to specify the reference value manually (see "Defined Value" on page 461)

Remote command:

```
CALCulate<Chn>:STATistics:NLINear:COMP:REFerence
```

Selected Marker

This button is only visible if "Selected Marker" is used as [Reference Value](#). It allows you to select the marker whose value shall be used as the reference ("small signal value") for the compression point calculation.

Remote command:

```
CALCulate<Chn>:STATistics:NLINear:COMP:RMARker
```

Ref. Range

This button is visible if either:

- [Compression point](#) statistics are calculated and "Range" is used as [Reference Value](#)
- The current channel is in spectrum analysis mode

It opens the "Reference Range" dialog that allows you to configure the sweep range whose average value shall be used as the reference ("small signal value") for the compression point calculation or as the reference power for the [Power Ratio](#) calculation.

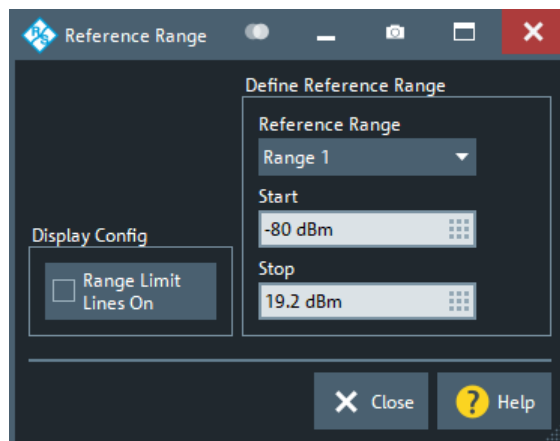

Remote command:

Compression point statistics:

```
CALCulate<Chn>:STATistics:NLINear:COMP:RDOMain:USER
CALCulate<Chn>:STATistics:NLINear:COMP:RDOMain:USER:START
CALCulate<Chn>:STATistics:NLINear:COMP:RDOMain:USER:STOP
CALCulate<Chn>:STATistics:NLINear:COMP:RDOMain:USER:SHOW
```

Power ratio statistics (spectrum analysis) :

```
CALCulate<Chn>:STATistics:RDOMain:USER
CALCulate<Chn>:STATistics:RDOMain:USER:START
CALCulate<Chn>:STATistics:RDOMain:USER:STOP
CALCulate<Chn>:STATistics:RDOMain:USER:SHOW
```

Defined Value

This setting is only visible if "Defined Value" is used as [Reference Value](#). It manually defines the reference value ("small signal value") for the compression point calculation.

Remote command:

```
CALCulate<Chn>:STATistics:NLINear:COMP:RLEVEL
CALCulate<Chn>:STATistics:NLINear:COMP:RPHASE
```

5.5.8.2 Evaluation Range dialog

The "Evaluation Range" dialog defines the range for various trace evaluation operations (trace statistics, offset, loss and fixture compensation calculations). The evaluation range is a continuous interval of the sweep variable.

Access:

- Trace – [Trace Config] > "Trace Statistics" > "Evaluation Range..."
- Channel – [Offset Embed] > "Offset" > "Evaluation Range..."
- ...

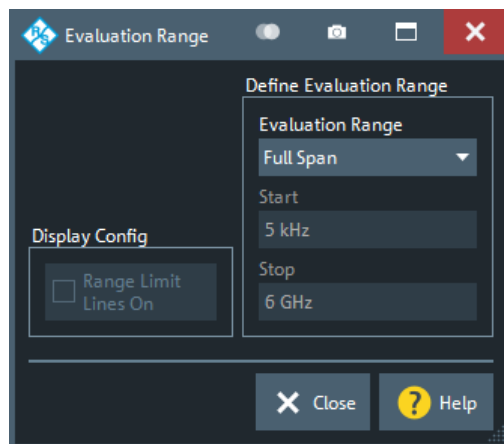

Evaluation Range

Selects a predefined evaluation range. Up to 10 different ranges are available for each recall set. "Full Span" means that the search range is equal to the entire sweep range. The trace statistics functions consider all measurement points with stimulus values x_i between the "Start" and "Stop" value of the evaluation range:

"Start" $\leq x_i \leq$ "Stop"

The evaluation ranges are defined similar to the marker search ranges. For more information, see [Chapter 5.7.3.2, "Search Range dialog"](#), on page 506.

Note: A restricted evaluation range is indicated in the "Trace Statistics" info field.

Statistics (S21)	Range 1)
Min	-7.6453 dB
Max	-4.1692 dB
Pk-Pk	3.4761 dB

Remote command:

```
CALCulate<Chn>:STATistics:DOMain:USER
CALCulate<Chn>:STATistics:DOMain:USER:START
CALCulate<Chn>:STATistics:DOMain:USER:STOP
```

Range Limit Lines On

Displays or hides the range limit lines in the diagram area. Range limit lines are two vertical lines at the Start and Stop values of the active evaluation range ("Range 1" to "Range 10").

Remote command:

```
CALCulate<Chn>:STATistics:DOMain:USER:SHOW
```

5.5.9 Smooth Shift Hold tab

Provides various functions to modify the entire measured trace.



- The analyzer can export the raw complex (unformatted) data or formatted data. The unformatted data are independent of all "Smooth Shift Hold" settings; see ["Formatted Values"](#) on page 472.
- For complex traces, if marker format and trace format do not coincide, the marker values are calculated before [Smoothing](#) and [Hold](#) are applied. In this case, the displayed marker values may not behave as expected.



Smoothing

Activates the smoothing function for the active trace, which can be a data or a memory trace.

With smoothing active, the trace value at each sweep point is replaced by the arithmetic mean of the trace values at the sweep point itself, and at neighboring sweep points (symmetrically, to the left and to the right). The number of trace values to be averaged is defined by the [Aperture](#) and can be adjusted according to the properties of the trace.

Smoothing operates on the formatted trace and does not significantly increase the measurement time.

Tip: The sweep average is an alternative method of compensating for random effects on the trace by averaging consecutive traces. Compared to smoothing, the sweep average requires a longer measurement time but does not have the drawback of averaging out quick variations of the measured values.

See [Chapter 5.9.3, "Average tab"](#), on page 538.

Remote command:

```
CALCulate<Chn>:SMOothing[:STATe]
```

Aperture

Defines how many trace values are averaged to smooth the trace if [Smoothing](#) is switched on.

An "Aperture" of a % means that the value at sweep point $n \in \{1, \dots, N\}$ is replaced by the arithmetic mean of the values at sweep points

$$\max \{ 1, \lceil n - a/100 \cdot N/2 \rceil \}, \dots, \min \{ N, \lfloor n + a/100 \cdot N/2 \rfloor \},$$

where N is the number of points of the sweep (or sweep segment for segmented sweeps).

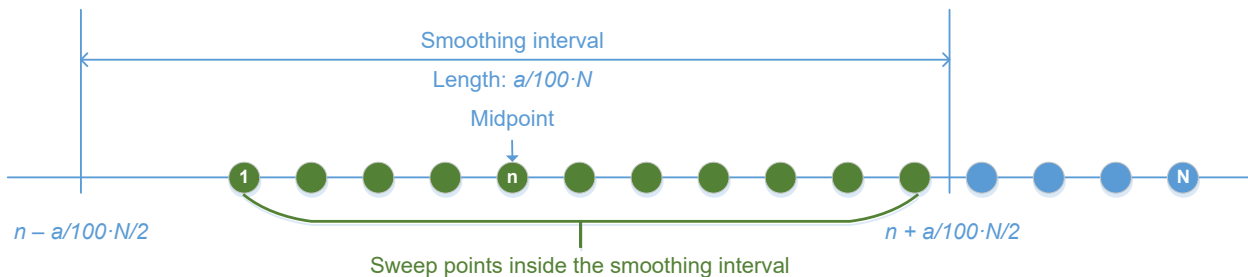

The range definition above takes border cases and rounding into account.

Tips: Finding the appropriate aperture

A large smoothing aperture enhances the smoothing effect but can hide quick variations of the measured values and thus produce misleading results.

To avoid errors, observe the following recommendations.

- Start with a small aperture and increase it only as long as you are certain that the trace is still correctly reproduced.
- Select a smoothing aperture that is small compared to the width of the observed structures (e.g. the resonance peaks of a filter). If necessary, restrict the sweep range or switch smoothing off to analyze narrow structures.

Remote command:

```
CALCulate<Chn>:SMOothing:APERTure
```

Hold

Selects the "Max Hold" (peak hold) or "Min Hold" function for the active trace, or disables both functions ("Hold Off"). With enabled "Max Hold" or "Min Hold" function, the displayed trace shows the maximum or minimum values that the analyzer acquired since the start of the measurement. The "Max Hold" and "Min Hold" traces are real; they are based on the magnitude of the trace values (the phase values are discarded).

The "Hold" process can be restarted any time using "Restart" (current trace) or "Restart All" (all traces in the active recall set). The "Hold" process is also restarted automatically when the channel or trace settings are changed so that the previous measurement results are no longer compatible.

Note: A memory trace is unformatted by definition. Therefore, a "to memory" operation on a "Hold" trace actually stores the last measured trace data instead of the current "Max Hold" or "Min Hold" values.

Remote command:

`CALCulate<Chn>:PHOLd`

Shift Trace

Functions for shifting the active trace in horizontal and vertical direction.

Stimulus ← Shift Trace

Shifts the active trace in horizontal direction, leaving the positions of all markers unchanged. The unit of the offset value depends on the sweep type.

Note:

A "Stimulus" shift can be used in cartesian and in complex diagrams. The visible effect depends on the diagram type:

- In cartesian diagrams, the trace is shifted relative to the markers and the x-axis.
- In complex diagrams, the trace is not affected.

Remote command:

`DISPlay[:WINDow<Wnd>]:TRACe<WndTr>:X:OFFSet`

Mag / Phase / Real / Imag ← Shift Trace

Modifies the active trace by adding and/or multiplying complex constants.

The trace points are modified according to the following formula:

$$M_{new} = M_{old} \cdot 10^{<Magnitude>/20 \text{ dB}} a \cdot e^{j \cdot <Phase>/180^\circ} + <Real> + j <Imag>$$

The formula and the different constants are adjusted to the different display formats of a trace:

- The "Mag" factor shifts a dB Mag trace in vertical direction, leaving the phase of a complex parameter unchanged.
- The "Phase" factor rotates a trace that is displayed in a polar diagram around the origin, leaving the magnitude unchanged.
- The "Real" value shifts a real trace in vertical direction, leaving the imaginary part unchanged.
- The "Imag" value shifts an imaginary trace in vertical direction, leaving the real part unchanged.

Tip: Shifting the trace by constant values is a simple case of trace mathematics. Use the "User Def Math" dialog to define more complicated mathematical operations (see [Chapter 5.5.4.2, "User Def Math dialog"](#), on page 443).

Remote command:

`DISPlay[:WINDow<Wnd>]:TRACe<WndTr>:Y:OFFSet`

Shift Reset

Resets the static shifting, defined using [Stimulus](#) and [Mag / Phase / Real / Imag](#), respectively.

Tracking Mode/Ref Sweep Point

Allows you to take the trace value at a selected sweep point as the reference point for a dynamic shift of the active trace.

With a raw complex trace value $z = \text{Re}(z) + j \cdot \text{Im}(z) = |z| e^{j \cdot \varphi(z)}$ and a raw complex value $z_r = \text{Re}(z_r) + j \cdot \text{Im}(z_r) = |z_r| e^{j \cdot \varphi(z_r)}$ at the reference point (for the current sweep), the dynamically shifted trace value $\text{Dyn_Shift}(z)$ is calculated as follows:

"Amplitude"	$\text{Dyn_Shift}(z) = z / z_r $
"Phase"	$\text{Dyn_Shift}(z) = z e^{-j \cdot \varphi(z_r)}$
"Real"	$\text{Dyn_Shift}(z) = z - \text{Re}(z_r)$
"Imag"	$\text{Dyn_Shift}(z) = z - \text{Im}(z_r)$
"Complex"	$\text{Dyn_Shift}(z) = z - z_r$

Remote command:

n.a.

5.5.10 Infinite Averaging tab

The controls on the "Infinite Averaging" tab allow you configure infinite averaging for the active trace.

Infinite averaging means the average at a sweep point is taken over all trace values at this sweep point since the previous restart of the averaging cycle.

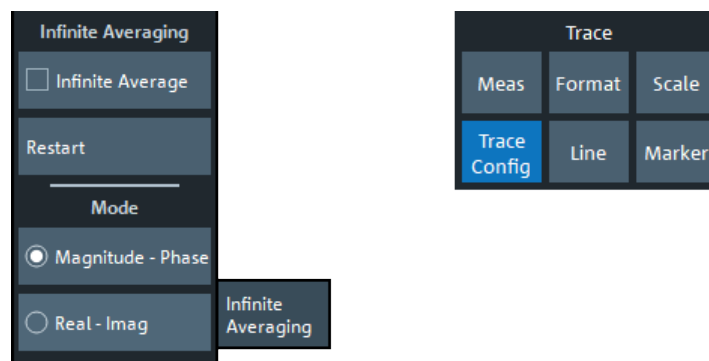
**Infinite Average/Restart**

"Infinite Average" enables or disables "Infinite Averaging" (default: disabled), "Restart" starts a new averaging cycle.

Remote command:

`CALCulate<Chn>: IAVerage [: STATE]`

Mode

Selects the quantities to be averaged.

"Magnitude - Phase"	Perform averaging of magnitude and phase (default) of the complex trace value.
Real - Imag	Perform averaging of the real and imaginary part of the complex trace value (i.e. over the complex value itself).

Remote command:

`CALCulate<Chn>:IAverage:MODE`

5.5.11 Trace Data tab

Stores one or several data or memory traces to a file or loads a memory trace from a file.



Background information

Refer to [Chapter 4.4.2, "Trace files"](#), on page 176.



All buttons on the "Trace Data" tab serve as "openers" for related dialogs:

- "Import..." calls up a dialog to load a memory trace from a trace file; see [Chapter 5.5.11.1, "Import Complex Data dialog"](#), on page 468.
- The buttons in the "Export snp Files" section call up a dialog to store data or memory traces to a trace file of the corresponding content and file format; see [Chapter 5.5.11.2, "Export Data - <File Type> dialog"](#), on page 469.
- "snp Free Config..." opens a dialog to define the port assignment for the created Touchstone (*.s<n>p) file. See [Chapter 5.5.11.4, "Select Ports dialog"](#), on page 474.



Exporting data from the firmware simulation

When working with the firmware simulation [R&S ZNXSIM](#), make sure to deactivate "Simulation Noise" before exporting traces to file. Otherwise the exported results comprise an "artificial" random component.

Since version 2.60 of the analyzer firmware, [Simulation Noise](#) can be activated or deactivated from the analyzer GUI.

5.5.11.1 Import Complex Data dialog

The "Import Complex Data" dialog loads a memory trace from a trace file. Trace files are ASCII files with selectable file format. The loaded trace data is used to generate a memory trace which is coupled to the active data trace.

Access: Trace – [Trace Config] > "Trace Data" > "Import..."



Background information

Refer to [Chapter 4.4.2, "Trace files"](#), on page 176.

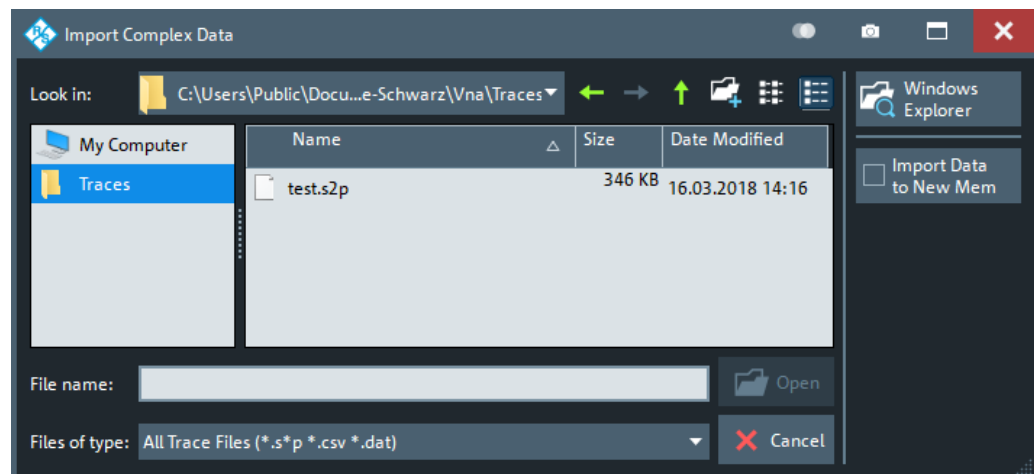

On loading data from a trace file with several traces, the analyzer displays a dialog to select one or more of the traces stored in the file (see [Chapter 5.5.11.3, "Select Parameter dialog"](#), on page 473). E.g., for an * .s2p Touchstone file, the box offers all four 2-port S-parameters (see [Chapter 4.4.2.1, "Touchstone files"](#), on page 177).

Coupling between the imported memory trace and the active data trace implies that the stimulus values of the imported data and of the active trace must be compatible. Compatibility means that the "Sweep Type" of the two traces must match; the position and number of the sweep points do not have to be the same.

The analyzer checks for compatibility before importing data. The "Select Parameter" box remains empty if the selected file contains no compatible data.

"Import Complex Data" is a standard "Open File" dialog with an additional button.

Import Data to New Mem

Specifies whether the loaded data overwrite an existing memory trace, if available (box unchecked), or whether they are used to generate a new memory trace (box checked).

If the box is unchecked and the active trace is a memory trace, then this memory trace will be overwritten. If the box is unchecked and the active trace is a data trace, then the data trace's last created memory trace will be overwritten (or a new memory trace will be created, in case there was previously no memory trace assigned to this data trace).

Remote command:

`MMEMoRY:LOAD:TRACe`

5.5.11.2 Export Data - <File Type> dialog

The "Export Data - <File Type>" dialog stores data or memory traces to a trace file. Trace files are ASCII files with selectable file format.

Access:

- Trace – [Trace Config] > "Trace Data" > "Export snp Files" – ...
- Trace – [Trace Config] > "Trace Data" > "Export" – ...

Data export can serve many purposes, e.g.:

- To process and evaluate measurement data in an external application.
- To store measurement data and reimport it in a future measurement session.



Background information

Refer to the following sections:

- [Chapter 4.4.2, "Trace files"](#), on page 176.
- [Chapter 4.4.2.3, "Finding the best file format"](#), on page 185

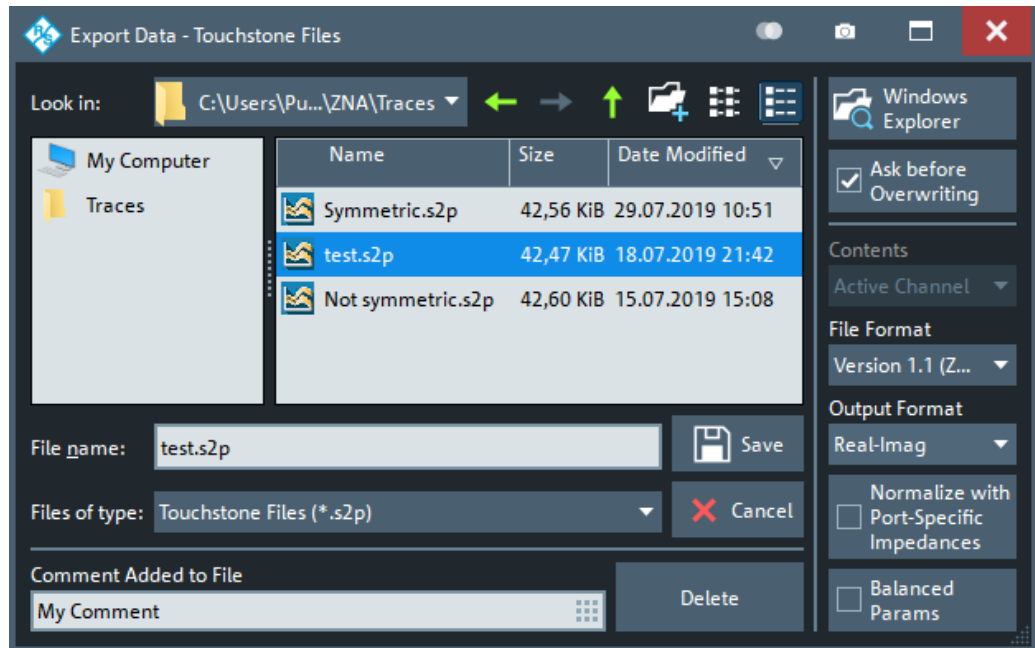

Figure 5-13: Touchstone file export

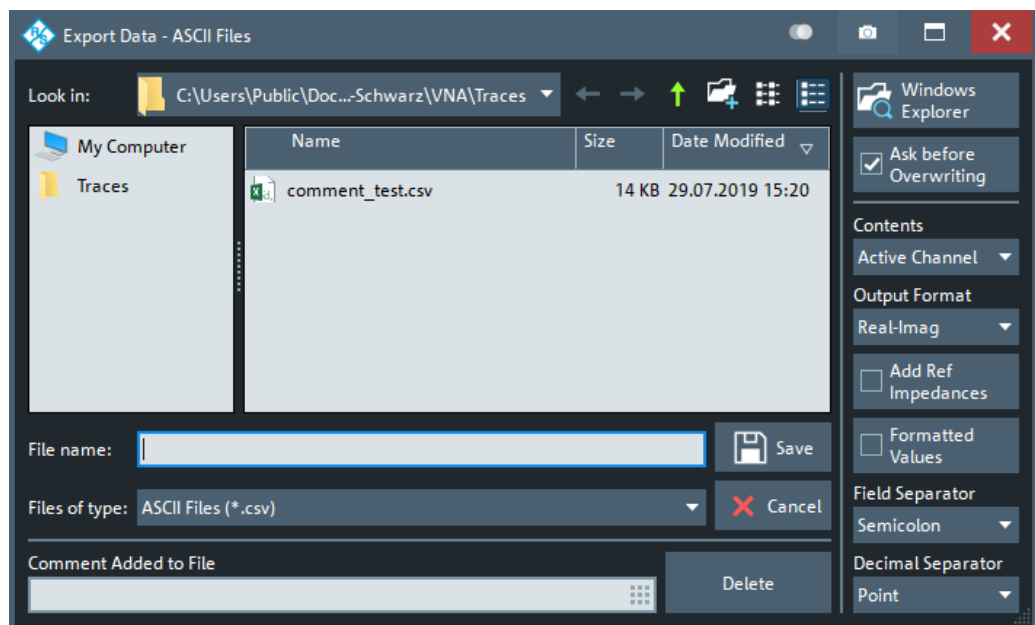

Figure 5-14: ASCII Trace files export

The "Export Data - <File Type>" dialog is a standard "Save File" dialog with several additional buttons to specify the export options. Many options depend on the selected export file format ("Files of type"). The displayed controls change accordingly.

The export options are remembered when the dialog is closed.

Ask Before Overwriting

Activates a message box to be displayed before an older trace file with the same file name and directory is overwritten.

Contents

For ASCII (*.csv) and Matlab (*.dat) export, you can include the active trace, all traces of the active channel (including memory traces), or all traces in all channels.

For Touchstone file export, it is possible to export the traces of the active channel or of all channels. Consider "[Conditions for Touchstone file export](#)" on page 183.

In both cases, the R&S ZNA creates one file per channel.

File Format

Selects the Touchstone file format to be generated. See [Chapter 4.4.2.1, "Touchstone files"](#), on page 177.

Remote command:

`MMEMory:STORe:TRACe:OPTion:FORMat`

Output Format

Selects the format of the exported raw, complex measurement values. The exported values can be represented by the real and imaginary parts, the linear magnitude and phase, or dB magnitude and phase; see also "[Formatted Values](#)" on page 472.

Export of [Formatted Values](#) is not available for Touchstone files.

Normalize with Port-Specific Impedances

For Touchstone file export only. If checked, the firmware renormalizes the exported S-parameters according to the port-specific reference impedances instead of a common target impedance of 50 Ω (see "[Renormalization of S-parameters](#)" on page 184).

Note however, that during import the firmware always assumes a common reference impedance of 50 Ω .

Balanced Params

For Touchstone file export only: activates/deactivates the export of balanced (and mixed-mode) S-parameters.

Note:

- Please consider "[Conditions for Touchstone file export](#)" on page 183. In particular: if only one port of a balanced port is selected, then the export fails.
- In contrast to single-ended S-parameters, balanced S-parameters are always normalized.

Remote command:

`MMEMory:STORe:TRACe:OPTion:BALanced`

Decimal Places

Opens a dialog that allows you to specify the number of decimal places for stimulus and data values in all supported trace data files (Touchstone, ASCII, MatLab).

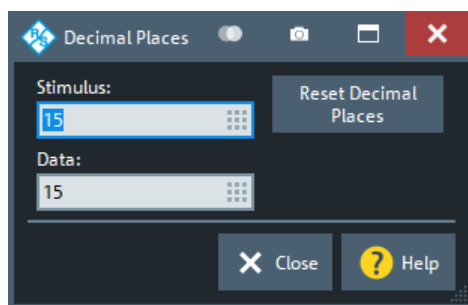

The allowed range is 1 (minimum precision) to 15 (maximum precision). "Reset Decimal Places" resets these numbers to their respective defaults, which is 15 in both cases.

Note: In the current implementation of the Touchstone file export, only the "Version 1.1 (ZNX)" [File Format](#) file format supports independent settings for stimulus and data values. For the "Version 1.1" and "Version 2.0" formats the "Data" number of digits is used for both stimulus and data values.

Remote command:

`MMEMory:STORe:TRACe:OPTion:DECimals:STIMulus`

`MMEMory:STORe:TRACe:OPTion:DECimals:DATA`

Add Ref Impedances

For ASCII (*.csv) or Matlab (*.dat) files only: Includes the reference impedances Z_0 for all analyzer ports in the file header.

Formatted Values

For ASCII (*.csv) or Matlab (*.dat) files only: Selects the format for the exported trace data.

- Check box cleared (off):** Export the raw complex (unformatted) measurement values, represented by the real and imaginary parts, the linear magnitude and phase, or dB magnitude and phase.

The exported complex trace values are the values at the beginning of the trace data flow. None of the following stages (trace mathematics, shift, time domain gate, trace formatting and smoothing) affects the exported data. "Save" writes the raw stimulus values (frequency/power/time, according to the sweep type) and the raw, complex measurement points to a file.

The exported complex trace values are the values at the beginning of the trace data flow. None of the following stages (trace mathematics, shift, time domain gate, trace formatting and smoothing) affects the exported data. "Save" writes the raw stimulus values (frequency/power/time, according to the sweep type) and the raw, complex measurement points to a file. See [Chapter 4.1.7, "Data flow"](#), on page 120.

Export of complex data is available for all trace file types.
- Check box selected (on):** Export the values as they are displayed in the diagram, e.g. export the dB magnitude, if trace format "dB Mag" is selected. The trace file does not necessarily contain the full (complex) information about the trace. For trace formats involving Cartesian diagrams ("dB Mag", "Real", "Imag"...), the stimulus value and a single real response value is exported. For circular diagrams, both the real and imaginary part of the response value is exported.

The trace values are the fully processed values as they appear in the diagram area. They correspond to the results in the marker info field. All possible stages of the trace data flow (e.g. trace formats, trace mathematics, time domain transform, shift, smoothing) are considered. Some trace functions (e.g. time scale, shift stimulus) also affect the stimulus values.

Export of formatted data is not available for Touchstone files.

Field Separator

For ASCII (*.csv) file export, this property defines the separator the analyzer uses to separate different numbers in each line of the file. For Matlab (*.dat) export, always "Comma" is used.

Decimal Separator

For ASCII (*.csv) files only: Selects either the "Point" or the "Comma" (if needed to process the exported data with an external application) as a separator for decimal numbers.

Save

Stores the trace data, according to the selected options.

Tip: Note the conditions described in ["Conditions for Touchstone file export"](#) on page 183.

Remote command:

`MMEemory:STORe:TRACe:PORTs`

`MMEemory:STORe:TRACe`

`MMEemory:STORe:TRACe:CHANnel`

Comment Added to File

Defines a comment to be added to the exported trace data file.

If empty (←"Delete"), no comment is added.

Remote command:

`MMEemory:STORe:TRACe:OPTion:COMMent`

5.5.11.3 Select Parameter dialog

The "Select Parameter" dialog provides a selection of measurement results (e.g. S-parameters) or traces, e.g. for trace import, import of power correction coefficients, limit line import.

Access: The dialog may be called from several dialogs, for example on pressing "Open" in the [Import Complex Data dialog](#).

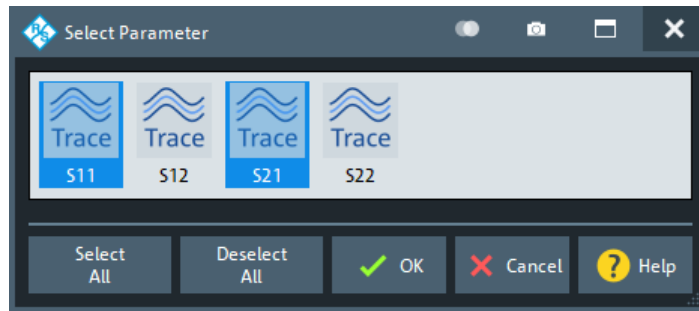

Select All / Deselect All

During trace data import, selects/deselects all traces contained in the opened trace file.

Auto Distribute

Available for trace data import only.

If checked, a selected trace S_{ij} is imported as a memory trace for all data traces in the current recall set that are measuring S_{ij} .

Remote command:

`MMEMoRY:LOAD:TRACe:AUTO`

5.5.11.4 Select Ports dialog

The "Select Ports" dialog defines the port assignment for the created Touchstone (*.s<n>p) file.

Access: Trace – [Trace Config] > "Trace Data" > "snp Free Config..."



Touchstone files and file export

Note the conditions described in "[Conditions for Touchstone file export](#)" on page 183.

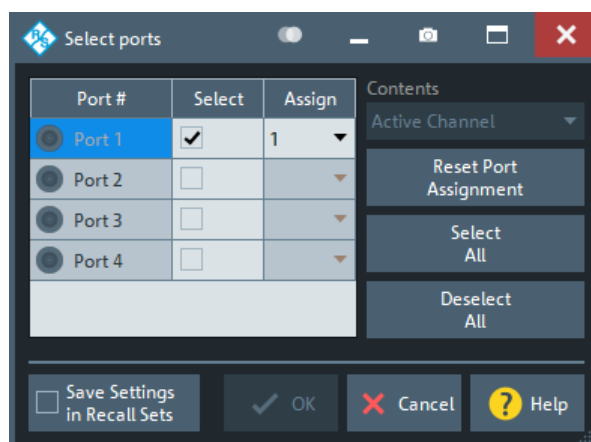



Checks and Messages in the Dialog

After each port or channel selection, the R&S ZNA checks the channel data for compatibility with the trace export conditions. If data from "All Channels" are exported, every channel must contain a compatible set of traces; see "[Conditions for Touchstone file export](#)" on page 183.

The "OK" button is available only if no error message is displayed in the dialog.

Select / Select All / Deselect All

Selects the ports to be considered for the S-parameter export.

Example: With ports 1 and 2 selected, S-parameters S_{11} , S_{12} , S_{21} and S_{22} are exported.

Remote command:

```
MMEMory:STORe:TRACe:PORTs
```

Assign

Selects the port number assignment in the created *.s<n>p file. By default, analyzer and *.s<n>p port numbers are identical. You can interchange the port assignment to change the order of the S-parameters in the created Touchstone file. Each of the analyzer port numbers must be assigned to one *.s<n>p port number.

Active Channel / All Channels

Selects data export for the active channel or for all channels.

Reset Port Assignments

Restores the identity between original and assigned port number.

Save Settings in Recall Set

The "Select Ports" dialog preserves the selected and assigned port numbers. By default (unchecked), these settings are global, i.e. they are identical for each recall set and are not affected by a [Preset]. However you can also choose to preserve specific settings for the current recall set (checked).

Note however that the settings are not persisted unless the "Select Ports" dialog is closed using "OK".

5.5.12 Linearity Deviation tab

Allows you to set up and activate a linearity deviation view for the active trace.



Instead of the trace itself, the linearity deviation view displays the deviation of the trace values from a linear function of the current sweep variable sv:

$$\text{LinDev_Tr}(sv) = \text{Tr}(sv) - (\text{Constant} + \text{Slope} \cdot sv)$$

"Constant" and "Slope" can either be specified or obtained from a linear regression of the original trace. The latter makes sense if you want to verify linearity but currently do not care if the trace values are close to a particular target line.



"Linearity Deviation" is only available for cartesian trace formats.

On

Activates/deactivates the linearity deviation calculation using the current **Constant** and **Slope** values. When activated, the trace statistics info field is shown and populated with the following (additional) lines:

- Lin Deviation On
- Slope <value><Y-scale unit (per X scale unit)>
- Constant <value> <Y-scale unit>

Note that if both **Slope** and **Constant** are zero (default), the linearity deviation view simply reproduces the original trace.

Remote command:

```
CALCulate<Chn>:LDEVIation:MODE
```

Auto Linearity Deviation

Turns linearity deviation calculation **On** and (re)calculates **Constant** and **Slope** using linear regression.

Remote command:

```
CALCulate<Chn>:LDEVIation:AUTO ONCE
```

Tracking

Similar to **Auto Linearity Deviation** but recalculates **Constant** and **Slope** for every sweep.

This checkbox is only enabled if linearity deviation is turned **On**.

Remote command:

```
CALCulate<Chn>:LDEVIation:MODE
```

Slope

Slope of the linear function to which the trace is compared.

Remote command:

```
CALCulate<Chn>:LDEVIation:SLOPe
```

El. Length

The electrical length is available for "Phase" traces and frequency sweeps only.

In this case, **Slope** can be interpreted as a constant group delay τ and we have the identity:

$$-\text{"Slope"}/360^\circ = \tau = 10^6 \cdot \text{"El. Length"}/c$$

with "Slope" given in **°/MHz** (degrees per megahertz) and with the speed of light $c = 299792458$ m/s. Hence the "Slope" determines the "El. Length" and vice versa.

Remote command:

```
CALCulate<Chn>:LDEVIation:ELENgth
```

Constant

Y intercept of the linear function to which the trace is compared.

Remote command:

```
CALCulate<Chn>:LDEVIation:CONStant
```

Reset Values

Sets **Constant** and **Slope** to zero, which effectively disables linearity deviation calculation.

Remote command:

```
CALCulate<Chn>:LDEVIation:SLOPe 0
CALCulate<Chn>:LDEVIation:CONStant 0
```

5.6 Lines softtool

The "Lines" softtool allows you to define limits for the measurement results, visualize them in the diagrams and activate/deactivate the limit check. The analyzer provides upper, lower, ripple and circle limits. In addition, the "Lines" softtool provides functions to limit complex diagrams to a user-defined "Display Circle" and to add user-defined horizontal lines to cartesian diagrams.

Access: Trace – [Line] key



Background information

Refer to [Chapter 4.4.1, "Limit check"](#), on page 168.

5.6.1 Limit Test tab

Defines limit lines for the measurement results (upper and lower limits), visualizes them in the diagrams and activates/deactivates the limit check.

Limit lines are available for all cartesian diagram types; "dB Mag" limits can also be checked in complex diagrams (Smith, Polar).



Background information

Refer to [Chapter 4.4.1, "Limit check"](#), on page 168.

5.6.1.1 Controls on the Limit Test tab



The "Define Limit Line..." button opens the "Define Limit Lines" dialog (see [Chapter 5.6.1.2, "Define Limit Lines dialog"](#), on page 482).

Show Limit Line

Shows or hides the limit line associated with the active trace in a Cartesian diagram area.

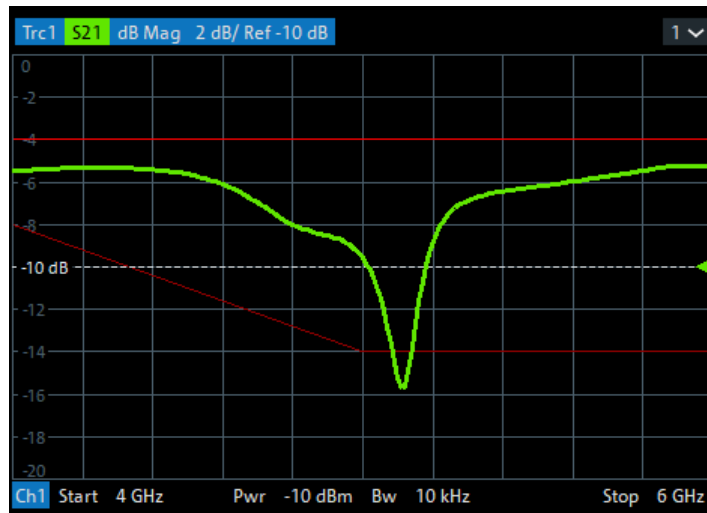

The limit line colors are defined in the [Define User Color Scheme dialog](#) (System > [Display] > "Config" > "Define User Color..."). You can choose between various options:

- Display upper and lower limit lines with different colors.
- Assign the same color to traces and associated limit lines.
- Assign different colors to limit line segments with disabled limit check.

Note: Displaying the limit line and limit check are independent of each other: Hiding the limit line does not switch off the limit check.

Remote command:

`CALCulate<Chn>:LIMit:DISPlay[:STATE]`

Limit Check

Enables/disables the limit check for the active trace. If enabled, an additional info field is displayed in the diagram, indicating the "PASS" or "FAIL" state.

Limit violations are marked with squares, whose color is defined in the [Define User Color Scheme dialog](#) ("Limit Fail Trace Color").

An [acoustic signal](#) and a [TTL signal](#) indicating pass or fail can be generated in addition.

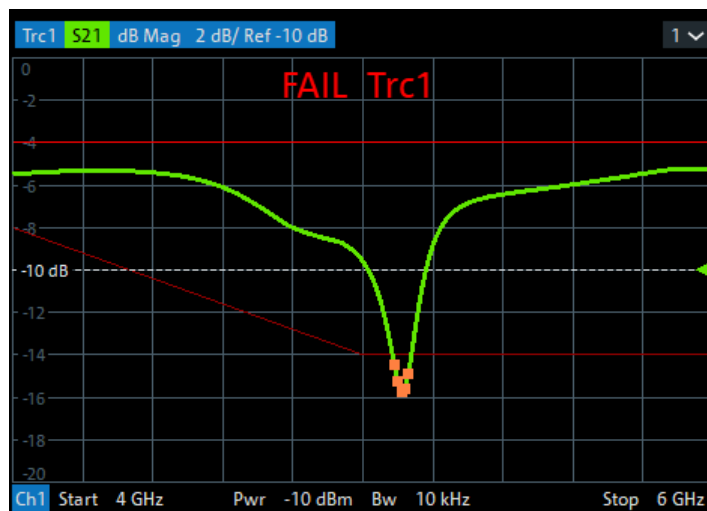

The "Limit Fail Trace Color" and the appearance of the limit fail symbols are defined in the [Define User Color Scheme dialog](#) ("Display" > "Config" > "Define User Color...").

Note:

- Limit check and display of limit lines are independent of each other:
 - The limit lines can be displayed, no matter if the limit check is enabled.
 - If "Limit Check" is enabled, the limits are checked, no matter if the limit lines are displayed.
 - The limit check can even be enabled, if no limit lines are defined. In this case, the info field displays "No limit defined!" and the limit check always passes.
- Limit lines are defined for a particular trace format. However, the limit check is performed irrespective of the current trace format. The info field indicates the correct "PASS"/"FAIL" state and limit violations are visualized on the trace (if any).

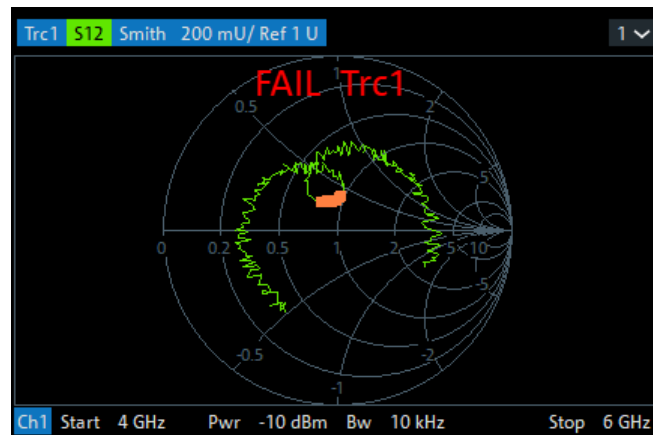

Figure 5-15: Limit line violations in complex trace formats

Remote command:

```
CALCulate<Chn>:LIMit:STATe
CALCulate<Chn>:LIMit:LOWer:STATe
CALCulate<Chn>:LIMit:UPPer:STATe
CALCulate<Chn>:LIMit:FAIL?
CALCulate:LIMit:FAIL:ALL?
CALCulate<Chn>:LIMit:STATe:AREA
CALCulate:LIMit:POINTs:LOWer?
CALCulate:LIMit:POINTs:UPPer?
```

Limit Fail Beep

Activates or deactivates the fail beep. The fail beep is a low-tone acoustic signal that is generated each time the analyzer detects an exceeded limit. No fail beep can be generated if the limit check is switched off.

Note: The R&S ZNA does not have a built-in audio device and loudspeaker. To hear sounds, connect a USB audio device to the instrument or operate it via remote desktop.

Remote command:

```
CALCulate<Chn>:LIMit:SOUNd[:STATe]
```

Clear Test

Resets the limit check results.

Remote command:

`CALCulate<Chn>:LIMit:CLEar`

Global Check

Activates or deactivates the global limit check including upper/lower limits and ripple limits. The global limit check is a composite limit check over all traces of the current recall set. The result of the global check appears in a popup box whenever "Global Check" is selected.



- "PASS" represents pass for all traces with enabled limit check. A trace without limit lines or with disabled individual limit check always passes the global check.
- "FAIL" means that the limit check for one or more traces failed.

Remote command:

`CALCulate:CLIMits:FAIL?`

TTL1 Pass / TTL2 Pass

Assigns the active trace to the low-voltage (3.3 V) TTL output signals at the User Port (see [Chapter 12.3.1.1, "User Port"](#), on page 1779).

Monitoring a single trace

If "TTL1 Pass" ("TTL2 Pass") is selected and the trace passes all active limit checks, then the TTL signal is applied to pin 13 (pin 14) of the User Port. If one of the limit checks fails, then no TTL signal is generated.

Monitoring several traces

If a channel contains several traces, is possible to assign each of them to any TTL output. The assignment divides the traces of the channel into four groups:

- Not assigned to signal 1 or signal 2
- Assigned to signal 1, but not to signal 2
- Assigned to signal 2, but not to signal 1
- Assigned to both signals

If several traces are assigned to a pass/fail signal, then the TTL signal is only generated if all traces are within their respective limits. It is switched off if one trace exceeds those limits.

Application: Graduated quality check

The two pass/fail signals can be used to distinguish three quality levels of a DUT. The test is performed on two identical traces Trc1 and Trc2 within the same channel. Trc1

is configured with a tighter, Trc2 with a looser set of limit lines. For Trc1 "TTL1 Pass" is enabled, for Trc2 "TTL2 Pass".

- TTL1: signal
If Trc1 passes (and so does Trc2), the quality of the DUT is good.
- TTL1: no signal, TTL2: signal
If Trc1 fails but Trc2 passes, the quality of the DUT is still sufficient.
- TTL1: no signal, TTL2: no signal
If both Trc1 and Trc2 fail, the quality is poor.

Instead of using two traces, it is possible to consider two groups of traces that are assigned to "TTL1 Pass" and "TTL2 Pass", respectively.

Remote command:

```
CALCulate<Chn>:LIMit:TTLout<Pt>[:STATe]
```

Shift Lines

By setting the "Stimulus" and "Response" values it is possible to shift a previously defined limit line in x and y direction, respectively, without having to redefine the constituent line segments.

Remote command:

```
CALCulate<Chn>:LIMit:CONTRol:SHIFt
```

```
CALCulate<Chn>:LIMit:UPPer:SHIFt
```

```
CALCulate<Chn>:LIMit:LOWer:SHIFt
```

5.6.1.2 Define Limit Lines dialog

The "Define Limit Lines" dialog defines the limit lines for the active trace on a segment-by-segment basis. For each segment, the limit is defined as a line connecting two points (with linear or logarithmic "Interpolation"), or as a user-defined formula.

Access: Trace – [Line] > "Limit Test" > "Define Limit Line..."



Background information

Refer to [Chapter 4.4.1, "Limit check"](#), on page 168.



When you switch to a different [sweep type](#), existing limit lines are preserved. With a different sweep variable, however, the limit lines cannot be [displayed](#) and the corresponding [limit check](#) cannot be executed.

If you want to define limit lines for the new sweep variable, you first have to [delete all](#) existing limit lines for the old sweep variable.

Controls on the Define Limit Lines dialog

The "Define Limit Lines" dialog contains a table to edit the individual segments of the limit lines. The buttons below the table extend or shorten the segment list.

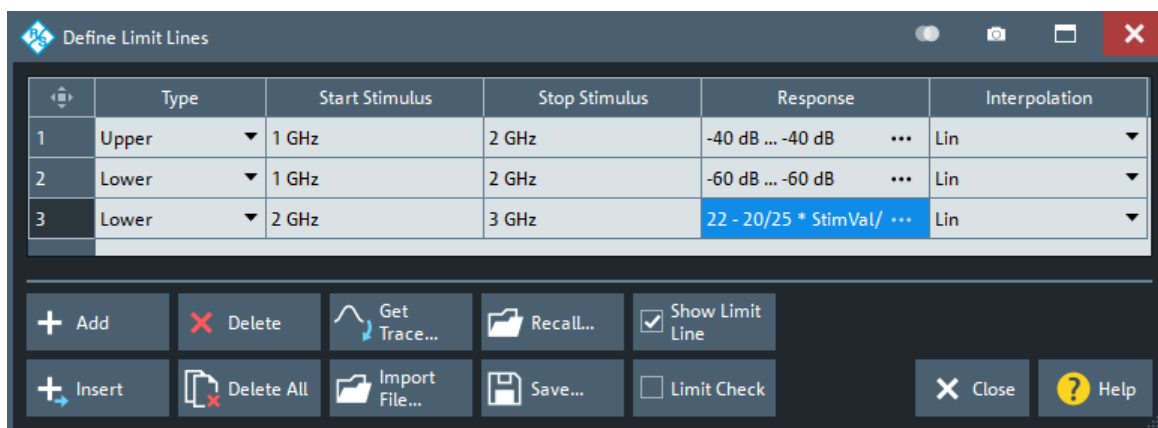

Creating limit lines with minimum effort

Choose one of the following methods to create and handle limit lines efficiently:

- To define limit lines with only a few segments, select "Add" and edit each segment in the [Segment List](#) individually.
- Select a data or memory trace as a limit line ("Import Trace...") or import a trace stored in a file ("Import File...").
- Save your limit lines to a file so you can reuse or modify them later sessions ("Save Limit Line...", "Recall Limit Line...").

Segment List

Defines the individual limit line segments.

The table contains an automatically assigned current number for each segment plus the following editable columns:

- "Type" indicates whether the segment belongs to an "Upper" or a "Lower" limit line, or if the limit check at the segment is switched "Off". Switching off the limit check does not delete the segment but changes its screen color.
- "Start Stimulus" is the stimulus (x-axis) value of the first point of the segment.
- "Stop Stimulus" is the stimulus (x-axis) value of the last point of the segment.
- "Response"
 - For a limit line segment that is defined as linear functions of the stimulus, "Response" displays the y-axis values at the start and stop stimulus (x-axis) values.
 - For formula-defined line segments, it displays the formula.

Tap the "Response" field to open the [Response dialog](#) that offers the full range of configuration possibilities.

- "Interpolation" determines whether the limit line segment is interpolated linearly or logarithmically. The latter is possibly more suitable for logarithmic sweeps.

Remote command:

```
CALCulate<Chn>:LIMit:SEGMENT:COUNT?
CALCulate<Chn>:LIMit:SEGMENT<Seg>:TYPE
CALCulate<Chn>:LIMit:SEGMENT<Seg>:STIMulus:START
CALCulate<Chn>:LIMit:SEGMENT<Seg>:STIMulus:STOP
CALCulate<Chn>:LIMit:SEGMENT<Seg>:AMPLitude:START
```

```

CALCulate<Chn>:LIMit:SEGment<Seg>:AMPLitude:STOP
CALCulate<Chn>:LIMit:CONTRol[:DATA]
CALCulate<Chn>:LIMit:CONTRol:SHIFt
CALCulate<Chn>:LIMit:DATA
CALCulate<Chn>:LIMit:LOWer[:DATA]
CALCulate<Chn>:LIMit:LOWer:SHIFt
CALCulate<Chn>:LIMit:UPPer[:DATA]
CALCulate<Chn>:LIMit:UPPer:FEED
CALCulate<Chn>:LIMit:SEGment<Seg>:INTerpol

```

Add / Insert / Delete / Delete All

The first four buttons below the segment list extend or shorten the list. The analyzer places no restriction on the number of segments in a limit line.

- "Add" adds a new segment to the end of the list. The new segment extends from the "Stop Stimulus" value of the last segment to the end of the sweep range. Its response values are equal to the "Stop Response" value of the last segment.
- "Insert" adds a new segment before the active segment (marked by a blue background in the first column of the segment list). The new segment extends from the "Stop Stimulus" value of the segment before the active segment to the "Start Stimulus" value of the active segment. Its response values are equal to the "Start Response" value of the active segment. The segment numbers in the list are adapted.
If no segment is active, "Insert" is equivalent to "Add".
- "Delete" removes the selected segment from the list.
- "Delete All" clears the entire segment list so it is possible to define or load a new limit line.

Remote command:

```
CALCulate<Chn>:LIMit:DELeTe:ALL
```

Recall... / Save...

The buttons open an "Open File" or "Save File" dialog, which allows you to load a limit line from a limit line file or store the current limit line configuration to a limit line file.

A limit line file (*.limit) is a text file whose content describes a limit line configuration. See [Chapter 4.4.1.4, "File format for limit lines"](#), on page 175.

Remote command:

```
MMEMory:LOAD:LIMit
```

```
MMEMory:STORe:LIMit
```

Get Trace... / Import File...

- "Get Trace..." opens a dialog to load a limit line from a data or memory trace in the active recall set.

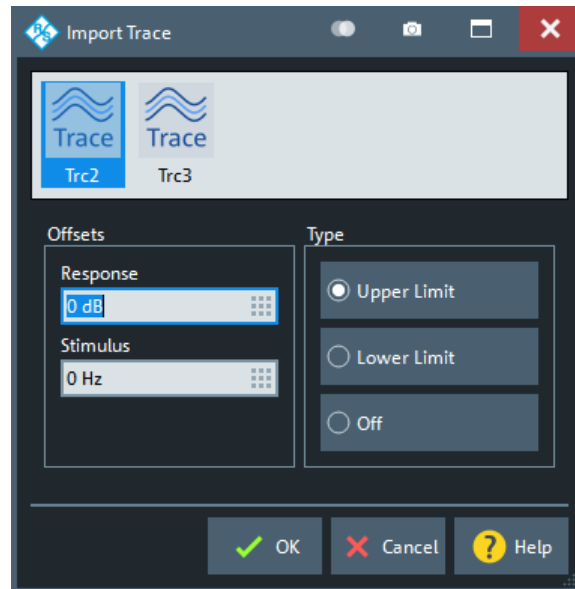

The active trace must be cartesian and the "Format" of the imported trace must be the same as the "Format" of the active trace.

- "Import File..." opens a dialog to load a limit line from a trace file (see [Chapter 5.5.11, "Trace Data tab"](#), on page 467).

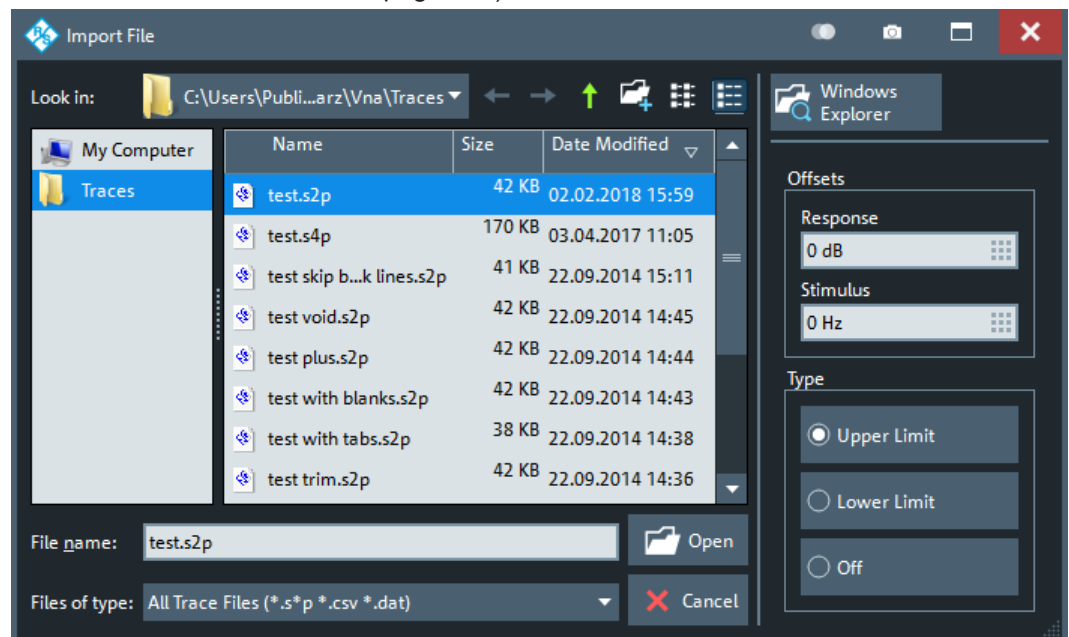

In case the selected file contains more than one trace, another popup dialog lets you select the adequate one:

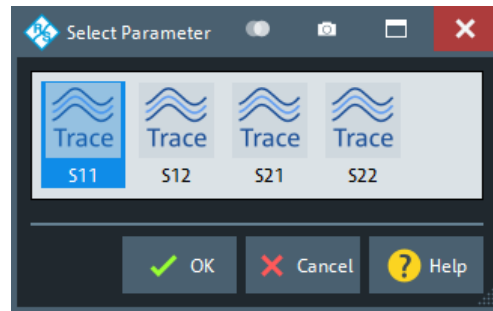

Imported traces are polygonal curves with n points and $n - 1$, where n is the "Number of Points" of the imported trace (see [Chapter 5.10.1, "Sweep Params tab"](#), on page 539). The $n - 1$ segments are appended to the current segment table for further editing. Existing limit line segments are not overwritten.

Both import dialogs contain the following file import settings:

- "Offsets" contains two input fields to define constant offset values for all imported segments. The "Response" offset shifts all segments in vertical direction, the "Stimulus" offset shifts them in horizontal direction. The offsets are added to the start and stop values of all segments.
- "Type" defines whether the imported segments belong to the "Upper" or "Lower" limit line. A third option is to import the segments but disable the limit check ("Off").

Remote command:

`CALCulate<Chn>:LIMit:LOWer:FEED`

`CALCulate<Chn>:LIMit:UPPer:FEED`

Response dialog

The "Response" dialog allows you to configure the limit line segment in detail.

Access: [Define Limit Lines dialog](#) > "Response" cells

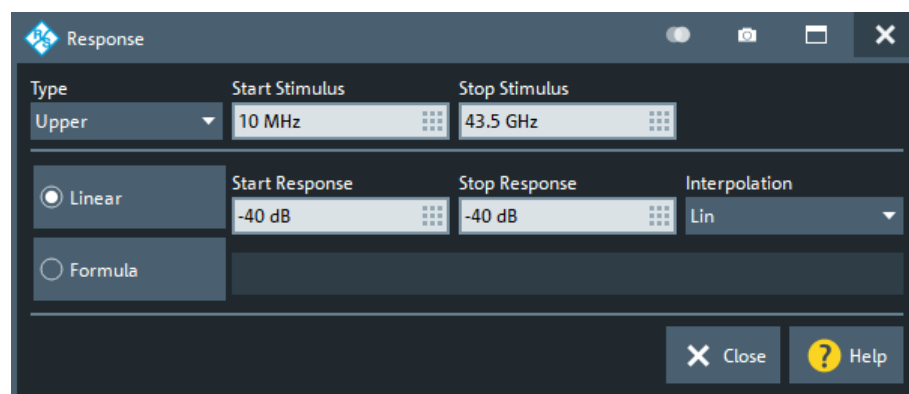

For convenience, "Type", "Start Stimulus", "Stop Stimulus", and "Interpolation" are repeated from the [Segment List](#) of the "Define Limit Lines" dialog.

Linear/Formula

Allows you to decide how to define the line segment.

- "Linear": Define the line segment as a straight line, connecting the endpoints ("Start Stimulus", "Start Response") and ("Stop Stimulus", "Stop Response").

- In this case, you can also decide whether linear or logarithmic [interpolation](#) is used.
- "Formula": Define the line segment by a custom formula.
You can enter the formula in the text field to the right of the "Formula" button, or Tap and hold the text field to open the [User Def Math dialog](#).

Remote command:

```
CALCulate<Chn>:LIMit:SEGment<Seg>:FORMula:STATe
```

```
CALCulate<Chn>:LIMit:SEGment<Seg>:FORMula
```

5.6.2 Ripple Test tab

Defines ripple limits for the measurement results, visualizes them in the diagrams and activates/deactivates the ripple limit check.

A ripple test is a special type of limit test where the **difference** between response values in certain stimulus ranges must not exceed configurable limits (ripple limits).

Ripple limits can be defined for cartesian trace formats only and are limited to the trace format they were configured for. If another format is selected, the ripple limit lines are hidden and the limit check is temporarily disabled.



Background information

Refer to [Chapter 4.4.1, "Limit check"](#), on page 168.

5.6.2.1 Controls on the Ripple Test tab

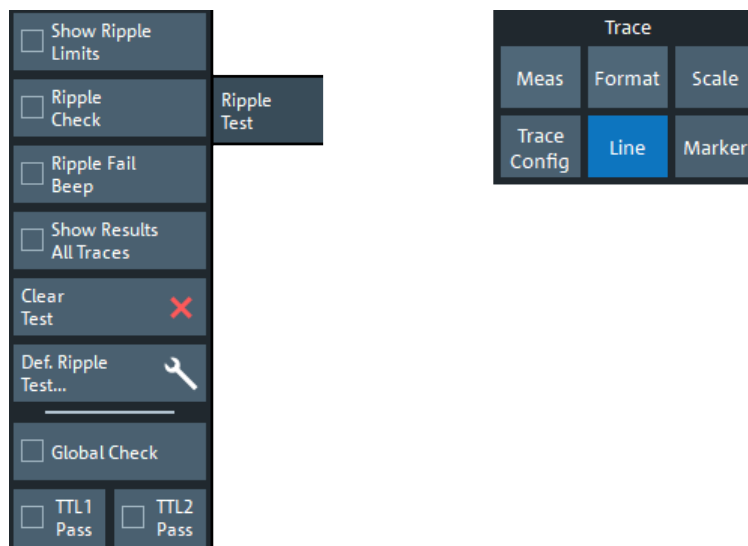

The "Def. Ripple Test..." button opens the "Define Ripple Test" dialog (see [Chapter 5.6.2.2, "Define Ripple Test dialog"](#), on page 490).

Show Ripple Limits

Shows or hides the ripple limit lines associated with the active trace in a Cartesian diagram area. The vertical positions of the ripple lines are recalculated after each sweep; only their stimulus range and distance (the ripple limit) are fixed.

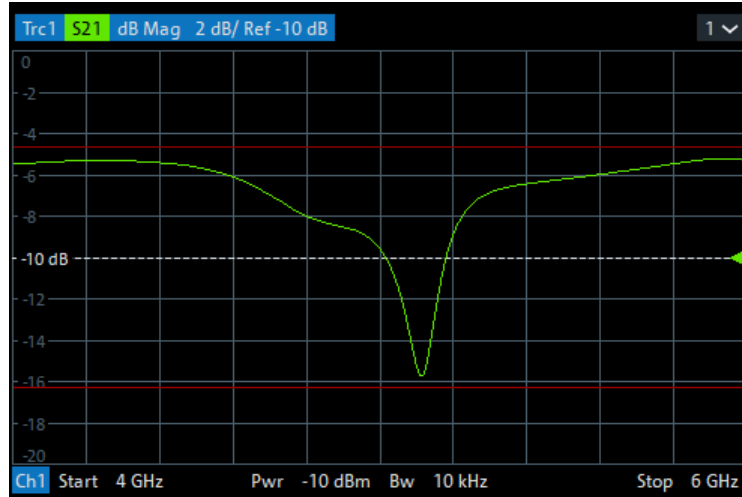

Note: Limit line display and limit check are independent of each other: Hiding the limit line does not switch off the limit check.

Remote command:

```
CALCulate<Chn>:RIPple:DISPlay[:STATE]
```

Ripple Check

Switches the ripple limit check of the active trace on or off. When the limit check is switched on, a movable info field shows the pass/fail information and the measured ripple in each ripple limit range.

Limit violations are marked with squares, whose color is defined in the [Define User Color Scheme dialog](#) ("Limit Fail Trace Color").

An [acoustic signal](#) and a [TTL signal](#) indicating pass or fail can be generated in addition.

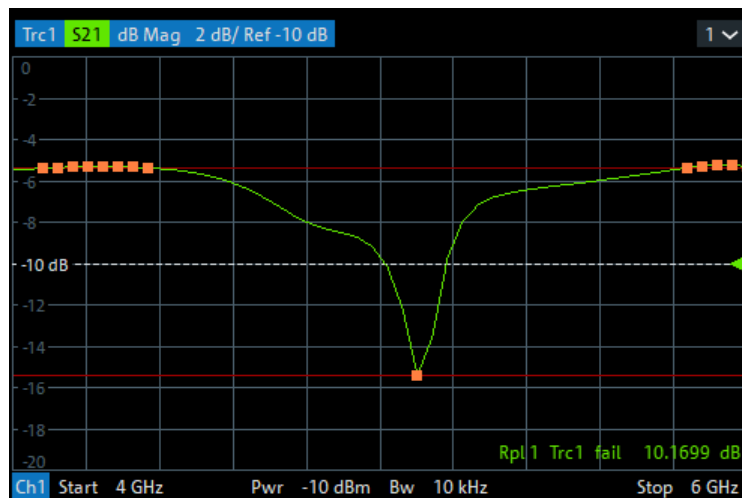

Note:

- Ripple check and display of limit lines are independent of each other:
 - The ripple limits can be displayed, no matter if the ripple check is enabled.
 - If "Ripple Check" is enabled, the ripple limits are checked, no matter if they are displayed.
 - The ripple check can even be enabled, if no limit lines are defined. In this case, the info field displays "No ripple defined!" and the limit check always passes.
- For each trace, ripple limits can only be set for a single cartesian trace format. If another trace format is selected, the ripple limit lines are hidden and the ripple check is suspended.

Remote command:

```
CALCulate<Chn>:RIPPlE:STATe
CALCulate<Chn>:RIPPlE:FAIL?
CALCulate:RIPPlE:FAIL:ALL?
CALCulate<Chn>:RIPPlE:SEGMENT<Seg>:RESult?
CALCulate<Chn>:RIPPlE:STATe:AREA
```

Ripple Fail Beep

Activates or deactivates the fail beep. The fail beep is a low-tone acoustic signal that is generated each time the analyzer detects an exceeded ripple limit. No fail beep can be generated if the ripple limit check is switched off.

Note: The R&S ZNA does not have a built-in audio device and loudspeaker. To hear sounds, connect a USB audio device to the instrument or operate it via remote desktop.

Remote command:

```
CALCulate<Chn>:RIPPlE:SOUNd[:STATe]
```

Show Results All Traces

Defines the visibility of ripple info fields in the active recall set.

- If disabled, only the ripple info field of the active trace is displayed (in case it has ripple check enabled).
- If enabled, ripple info fields are displayed for all traces with ripple check enabled.

Remote command:

```
CALCulate:RIPPlE:DISPlay:RESult:ALL[:STATe]
```

Clear Test

Resets the limit check results.

Remote command:

```
CALCulate<Chn>:RIPPlE:CLear
```

Global Check

See "[Global Check](#)" on page 481.

TTL1 Pass / TTL2 Pass

See "[TTL1 Pass / TTL2 Pass](#)" on page 481.

5.6.2.2 Define Ripple Test dialog

The "Define Ripple Test" dialog defines the ripple limits for the active trace on a range-by-range basis. A separate ripple limit can be assigned to each range.

Access: Trace – [Line] > "Ripple Test" > "Def. Ripple Test..."



Defining ripple limits with minimum effort

Choose one of the following methods to create and handle ripple limit ranges efficiently:

- To configure a limit test with only a few ranges, use "Add" and edit each range in the table individually.
- Use the "Align All" button to create non-overlapping, contiguous ranges of equal width.
- Save your ripple ranges to a file so you can reuse or modify them in later sessions ("Save Ripple Test...", "Recall Ripple Test...").



Background information

Refer to [Chapter 4.4.1, "Limit check"](#), on page 168.

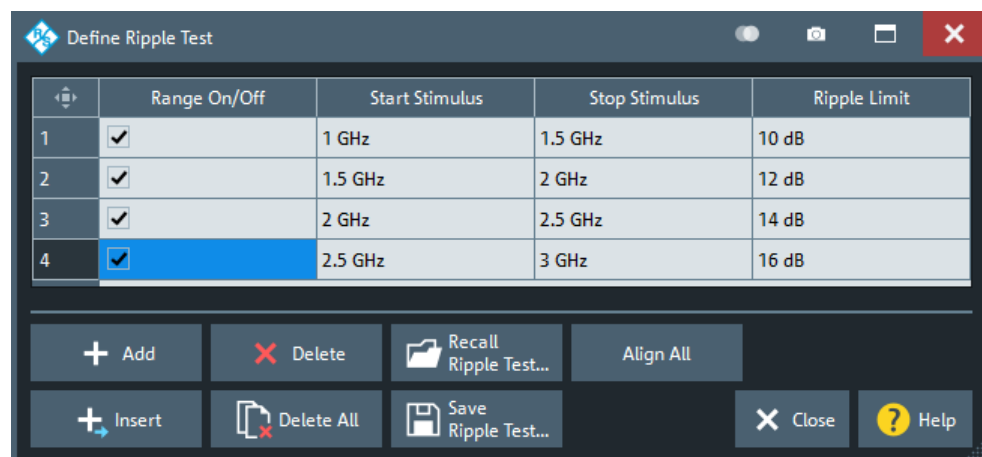

The "Define Ripple Test" dialog contains a table to edit the individual ranges of the ripple check ranges. The buttons below the table extend, shorten, or reorder the range list and save/recall ripple test data.

Range List

Defines the individual ripple limit ranges.

The table contains an automatically assigned current number for each range plus the following editable columns:

- "Range On/Off" enables or disables the ripple limit check in each range. Disabling the ripple limit check does not delete the range but hides the entry in the info field.
- "Start Stimulus" is the smallest stimulus (x-axis) value of the range.
- "Stop Stimulus" is the largest stimulus (x-axis) value of the range.

- "Ripple Limit" is the maximum allowed difference between the largest and the smallest trace value in the range.

The ripple limit range is displayed as two parallel, horizontal lines in the diagram. "Stop Stimulus" - "Start Stimulus" is the length of both lines (if the range is within the sweep range); "Ripple Limit" is their vertical distance. See [Chapter 4.4.1.2, "Rules for ripple test definition"](#), on page 171.

Remote command:

```
CALCulate<Chn>:RIPple:SEGment<Seg>[:STATe]
CALCulate<Chn>:RIPple:SEGment<Seg>:STIMulus:START
CALCulate<Chn>:RIPple:SEGment<Seg>:STIMulus:STOP
CALCulate<Chn>:RIPple:SEGment<Seg>:LIMit
CALCulate<Chn>:RIPple:SEGment:COUNT?
```

Add / Insert / Delete / Delete All / Align All

The first four buttons below the range list extend, shorten, or reorder the list.

- "Add" adds a new range to the list. The new range is inserted after the previously selected range. The current range numbers are adapted; the start and stop stimulus values are set so that an overlap is avoided. Moreover, the ripple limit is estimated according to the measured ripple of the trace in the created range. The analyzer places no restriction on the number of ranges assigned to each trace.
- "Insert" adds a new range before the active range (marked by a blue background in the first column of the range list). The new range extends from the "Stop Stimulus" value of the range before the active range to the "Start Stimulus" value of the active range. Its ripple limit is estimated according to the measured ripple of the trace in the created range. The range numbers in the list are adapted. If no range is active, "Insert" is equivalent to "Add".
- "Delete" removes the selected range from the list.
- "Delete All" clears the entire range list so it is possible to define or load a new ripple limit line.
- "Align All" redefines existing sweep ranges such that they cover the overall sweep range and have (almost) equal width. The ripple limits are estimated according to the measured ripple of the trace in the created ranges.

Remote command:

```
CALCulate<Chn>:RIPple:CONTRol:DOMain
CALCulate<Chn>:RIPple:DATA
CALCulate<Chn>:RIPple:DELeTe:ALL
```

Recall Ripple Test.../Save Ripple Test...

The buttons open an Open/Save File dialog to load a ripple limit line from a ripple limit file or store the current ripple limit configuration to a file.

Ripple limit files are ASCII files with the default extension *.ripple and a special file format. See [Chapter 4.4.1.5, "File format for ripple limits"](#), on page 176.

Remote command:

```
MMEMory:LOAD:RIPple
MMEMory:STORe:RIPple
```

5.6.3 Circle Test tab

Defines circular limit lines for complex trace formats ("Polar", "Smith", "Inv Smith"), visualizes them in the diagram and activates/deactivates the circle limit check.

Most of the control elements in the "Circle Test" tab are disabled if the active trace has a cartesian format.



Background information

Refer to [Chapter 4.4.1.3, "Circle limits"](#), on page 172.

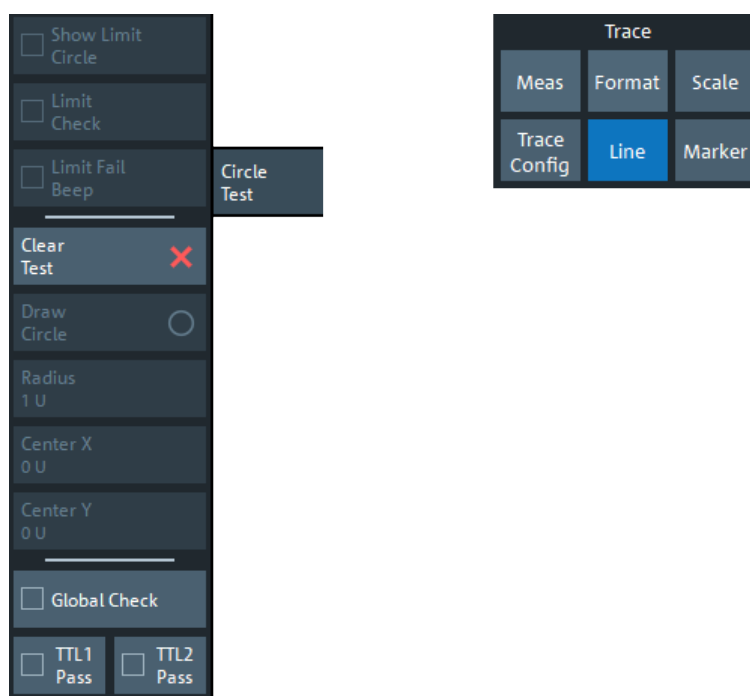

Show Limit Circle

Shows or hides the limit line associated with the active trace in a polar diagram area.

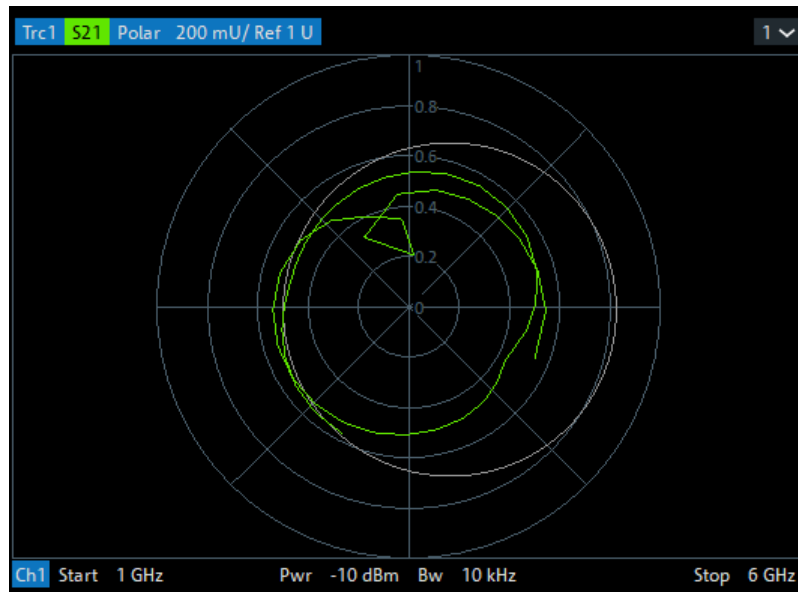

The limit line colors are defined in the "Define User Color Scheme" dialog (see [Chapter 5.18.3.2, "Define User Color Scheme dialog"](#), on page 847). You can choose between various options:

- Assign the same color to traces and associated limit lines.
- Assign different colors to limit line segments with disabled limit check.

Note: Limit line display and limit check are independent of each other: Hiding the limit line does not switch off the limit check.

Remote command:

```
CALCulate<Chn>:LIMit:CIRCle:DISPlay[:STATe]
```

Limit Check

Switches the limit check of the active trace on or off. When the limit check is switched on, a movable "PASS" or "FAIL" message is displayed in the diagram.

Limit violations are marked with squares, whose color is defined in the [Define User Color Scheme dialog](#) ("Limit Fail Trace Color").

An [acoustic signal](#) and a [TTL signal](#) indicating pass or fail can be generated in addition.

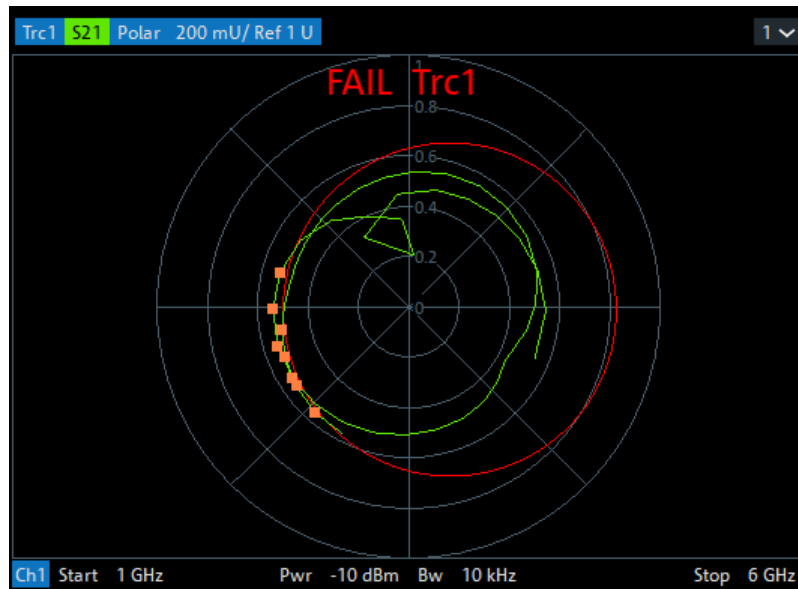

The appearance of the limit fail symbols is defined in the "Define User Color Scheme" dialog (see [Chapter 5.18.3.2, "Define User Color Scheme dialog"](#), on page 847). You can choose between various options:

- Change the trace color between failed measurement points.
- Show or hide the colored squares.

Note:

- Circle limit check and display of limit circles are independent of each other:
 - The limit circles can be displayed, no matter if the circle limit check is enabled.
 - If "Limit Check" is enabled, the ripple limits are checked, no matter if they are displayed.
- If result evaluation is limited to a user-defined [display circle](#), the [Chapter 5.6.3, "Circle Test tab"](#), on page 492 is only performed inside this display circle.
- The circle limits can only be checked if the trace format is complex. While a cartesian format is active, the limit circles are hidden and the circle limit check is suspended.
- If the limit check for (cartesian) [limit lines](#) is enabled, it is also evaluated in complex diagrams.

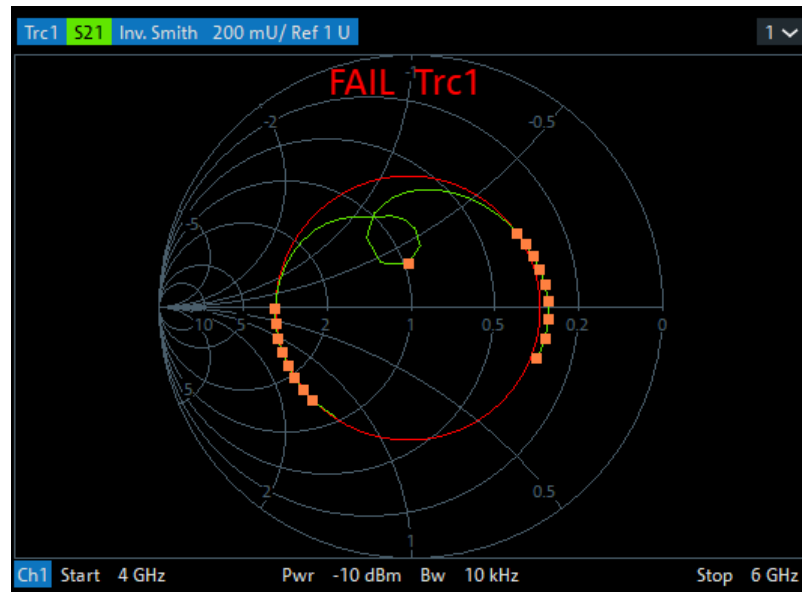

Figure 5-16: Simultaneous dB Mag limit line and circle check

Remote command:

```
CALCulate<Chn>:LIMit:CIRCle[:STATe]
CALCulate<Chn>:LIMit:CIRCle:FAIL?
CALCulate:LIMit:CIRCle:FAIL:ALL?
```

Limit Fail Beep

Activates or deactivates the fail beep. The fail beep is a low-tone acoustic signal that is generated each time the analyzer detects an exceeded limit. No fail beep can be generated if the limit check is switched off.

Note: The R&S ZNA does not have a built-in audio device and loudspeaker. To hear sounds, connect a USB audio device to the instrument or operate it via remote desktop.

Remote command:

```
CALCulate<Chn>:LIMit:CIRCle:SOUND[:STATe]
```

Clear Test

Resets the limit check results.

Remote command:

```
CALCulate<Chn>:LIMit:CIRCle:CLEar
```

Draw Circle

Activates touchscreen or mouse operation; tap the diagram at one border of the limit circle and draw the circle to the required size and position.

Remote command:

n/a

Radius / Center X / Center Y

Defines the limit circle by its radius and its center on the X-axis and Y-axis.

Remote command:

`CALCulate<Chn>:LIMit:CIRClE:DATA`

Global Check

See "Global Check" on page 481.

TTL1 Pass / TTL2 Pass

See "TTL1 Pass / TTL2 Pass" on page 481.

5.6.4 Display Circle tab

The "Display Circle" functionality allows you to limit results in complex trace formats (Smith, Polar) to a user-defined circle. In particular, while the trace format is complex, line and circle limit checks are only performed inside the display circle.



Most of the controls on this tab are only active, if the active trace is displayed in a complex format.

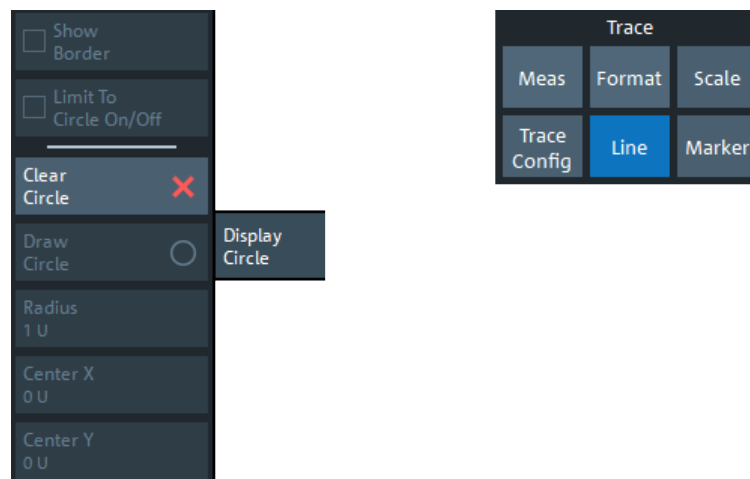

Show Border

If enabled, the border of the Display Circle is shown whenever the related trace is displayed in complex format.

The border color can be modified by a user-defined color scheme ([Element](#) "Vertical Range Lines").

Remote command:

`CALCulate<Chn>:LIMit:DCIRcle:DISPlay[:STATe]`

Limit to Circle On/Off

If enabled, only trace points within the configured "Display Circle" are shown, whenever the related trace is displayed in complex format. At the same time, the active limit tests (line, circle) are restricted to the configured "Display Circle".

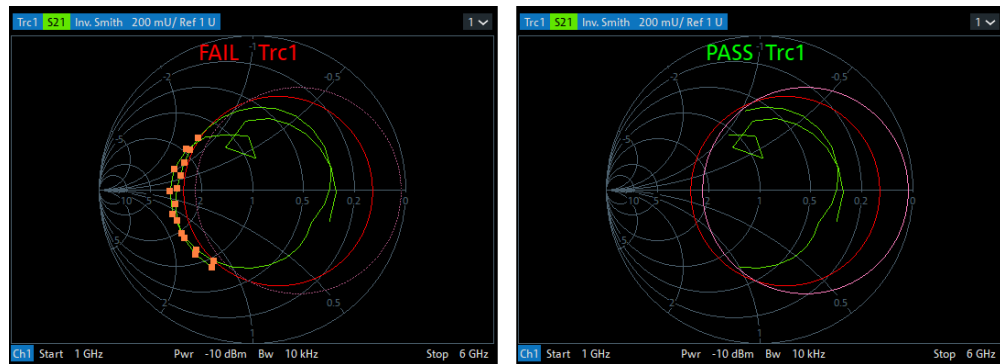

left ("FAIL") = "Circle Test" enabled, but not limited to "Display Circle"
 right ("PASS") = "Circle Test" enabled, but limited to "Display Circle"

Remote command:

```
CALCulate<Chn>:LIMit:DCIRcle[:STATe]
```

Clear Circle

Resets the "Display Circle" to its default configuration (unit circle; show border: off; limit to circle: off)

Remote command:

```
CALCulate<Chn>:LIMit:DCIRcle:CLEar
```

Draw Circle / Radius, Center X, Center Y

Defines the Display Circle – either by drawing it in the diagram area or by providing its radius and center.

Remote command:

```
CALCulate<Chn>:LIMit:DCIRcle:DATA
```

5.6.5 Horiz. Line tab

Shows or hides a horizontal line associated to the active trace in a cartesian diagram area. The line can be moved to particular trace points to retrieve the response values. It also shows which parts of a trace are above or below a definite response value.



- The controls on this tab are only active if the active trace is displayed in cartesian format.
- If another trace format is selected, the line (position) is deleted.

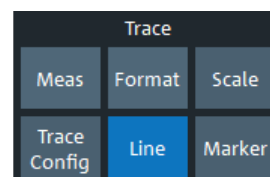
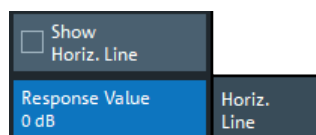

Show Horiz. Line

Displays or hides the horizontal line.

Remote command:

`CALCulate<Chn>:DLINe:STATe`

Response Value

Defines/shows the response value of the horizontal line.

Tip: Use the R&S ZNA's drag and drop functionality to move the horizontal line to a particular position. The response value appears in the numeric entry field.

Remote command:

`CALCulate<Chn>:DLINe`

5.7 Marker softtool

The "Marker" softtool allows you to position markers on a trace and to define their properties. Markers are also convenient tools for searching special points on traces and for scaling diagrams.

Access: Trace – [Marker]

**Background information**

Refer to the following sections:

- [Chapter 4.2.1.3, "Markers"](#), on page 128
- [Chapter 3.3.7.6, "Set by marker"](#), on page 69

5.7.1 Markers tab

Creates markers and configures their properties. Markers are available for all trace formats.

A first marker labeled "M1" is automatically created when the [Marker] key is pressed. The "Mkr 1" ... "Mkr 10" and "Ref Mkr" softkeys enable the corresponding markers.

"Add Marker" adds a new marker.

**Related information**

Refer to the following sections:

- [Chapter 4.2.1.3, "Markers"](#), on page 128
- [Chapter 3.3.5, "Handling diagrams, traces, and markers"](#), on page 58

**Mkr <i> Stimulus / Ref Mkr Stimulus**

Gets/sets the stimulus value of the active marker.

Remote command:

```
CALCulate<Chn>:MARKer<Mk>:X
```

```
CALCulate<Chn>:MARKer<Mk>:REFerence:X
```

Mkr <i> Arb. Response / Ref Mkr Arb. Response

Gets/sets the response value (Y position) of an "Arbitrary" marker (see ["Marker Mode"](#) on page 502).

Remote command:

```
CALCulate<Chn>:MARKer<Mk>:Y
```

```
CALCulate<Chn>:MARKer<Mk>:REFerence:Y
```

On

Enables/disables the active marker.

Markers remember their "Marker Props" while disabled (see [Chapter 5.7.2, "Marker Props tab"](#), on page 501). The marker properties are definitely lost when the associated trace is deleted.

Remote command:

```
CALCulate<Chn>:MARKer<Mk>[:STATe]
```

```
CALCulate<Chn>:MARKer<Mk>:REFerence[:STATe]
```

All Off

Disables all markers of the active trace.

Markers remember their "Marker Props" while disabled (see [Chapter 5.7.2, "Marker Props tab"](#), on page 501). The marker properties are definitely lost when the associated trace is deleted.

Tip: To disable a single marker, drag it into vertical direction to release it from the trace and drop it onto the "Delete" icon.

Remote command:

```
CALCulate<Chn>:MARKer<Mk>:AOFF
```

Delta Mode

Enables/disables the "Delta Mode" for the active marker. At the same time, enables the [Ref Mkr](#).

This function is inactive if the reference marker is the active marker.

Remote command:

```
CALCulate<Chn>:MARKer<Mk>:DELTA [:STATe]
```

Mkr 1 ... Mkr 10

Creates the markers numbered 1 to 10 and assigns them to the active trace. When a marker is created, a triangle labeled "M<i>" is positioned on the trace and the marker coordinates are displayed in the movable info field.

The stimulus position of an active marker can be entered in the "Mkr <i> Stimulus" entry field. The default position is the center of the sweep range. You can also drag and drop markers in a diagram to change their X position.

If the [Marker Mode](#) is "Arbitrary", also the response value (Y position) can be changed.

See also "[Activating and moving markers](#)" on page 128.

Remote command:

```
CALCulate<Chn>:MARKer<Mk> [:STATe]
CALCulate<Chn>:MARKer<Mk>:Y
CALCulate<Chn>:MARKer [:STATe] :AREA
```

Ref Mkr

Creates a reference marker and assigns it to the active trace. When a marker is created, a triangle labeled "R" is positioned on the trace and the marker coordinates are displayed in the info field.

The stimulus position of the active reference marker can be entered in the "Ref Marker Stimulus" entry field. The default position is the start of the sweep range or the position of the last active marker.

The reference marker defines the reference value for all markers that are in "Delta Mode".

Remote command:

```
CALCulate<Chn>:MARKer<Mk>:REFerence [:STATe]
CALCulate<Chn>:MARKer<Mk>:REFerence:Y
```

Add Marker

Adds a new marker to the active trace. Uses the next "free" marker number

Coupled Markers

Activates or deactivates [Marker coupling](#). The label indicates the selected [Coupling Type](#):

"Coupling Type"	Label
"All"	"Coupled Markers"
"Channel"	"Coupled Markers in <name of active channel>"
"Diagram"	"Coupled Markers in <name of active diagram>"

Coupling also works if [Tracking](#) is enabled for *Marker <m>* in **one** trace. The *Marker <m>* of the other traces then follow the movements of the tracked marker. The same holds true for the reference marker.

Remote command:

```
CALCulate:MARKer:COUPled[:STATe]
```

5.7.2 Marker Props tab

Modifies the properties of a marker created previously (see [Chapter 5.7.1, "Markers tab"](#), on page 498). The functions (except "Export Markers...") are unavailable if the active trace contains no markers.



Marker Name

Assigns a (new) name to the active marker. Marker names can contain letters, numbers, blanks and special characters.

Remote command:

```
CALCulate<Chn>:MARKer<Mk>:NAME
```

```
CALCulate<Chn>:MARKer<Mk>:REFerence:NAME
```

Marker Format

Defines the formatting of the active marker in the movable marker info field.

For background information on marker formats, see "[Marker format](#)" on page 130.

"Default" means that the marker is formatted according to the related trace's [Dfit Marker Frmt](#) .

In "Arbitrary" [Marker Mode](#), if the transformation between trace format and marker format requires a concrete stimulus value, some result values in the marker info field can be unavailable. Those values are displayed as a sequence of dashes (-----).

Remote command:

```
CALCulate<Chn>:MARKer<Mk>:FORMat
```

```
CALCulate<Chn>:MARKer<Mk>:REFerence:FORMat
```

Marker Style

Defines how the selected marker is displayed on the screen.

Remote command:

n/a

Discrete

Discrete mode means that a marker can be set to discrete sweep points only. If discrete mode is switched off, the marker can be positioned on any point of the trace, and its response values are obtained by interpolation.

Remote command:

```
CALCulate<Chn>:MARKer<Mk>:MODE
```

```
CALCulate<Chn>:MARKer<Mk>:REFerence:MODE
```

Marker Mode

Determines if and how the marker's position is adjusted and if and how it can be moved in the diagram area.

Normal: If [Tracking](#) is enabled, the marker's stimulus value is updated automatically with every sweep, otherwise it is constant. The marker position is adjusted to the corresponding response value, i.e. the marker is always positioned on the trace.

If in the current trace format the X axis represents the stimulus, the marker can be moved horizontally. At the same time, the marker's stimulus and response values are adjusted, i.e. its vertical position automatically follows the trace.

Fixed: freezes the marker at the position determined by the current stimulus and response value. Tracking is disabled. The stimulus and response values are stored with the marker; they are not adjusted to subsequent sweeps or trace format changes.

If in the current trace format the X axis represents the stimulus, the marker can be moved horizontally. Moving the marker adjusts the markers's stimulus value, but its response value remains fixed.

Arbitrary: freezes the marker at the position determined by the current stimulus and response value. Tracking is disabled. The marker stores the stimulus value and – in addition – its X and Y coordinates in the current [Marker Format](#).

The marker can be moved freely inside the diagram, directly adjusting its X and Y coordinates. If in the current trace format the X axis represents the stimulus, the marker's stimulus value is adjusted accordingly. Otherwise the marker's stimulus value remains unchanged and is not shown in the [Marker info field](#). Switching between trace formats resets the marker position to the response value at the marker's stimulus value, i.e. the marker snaps to the trace.

Remote command:

```
CALCulate<Chn>:MARKer<Mk>:TYPE
```

```
CALCulate<Chn>:MARKer<Mk>:REFerence:TYPE
```

Marker Info

Displays the marker coordinates above the marker symbol.

Remote command:

n/a

Ref Mkr -> Mkr

Places the reference marker to the position of the active marker. "Ref. Mkr -> Mkr" is not active if the active marker is a reference marker.

Remote command:

n/a

Export Markers

Calls up a "Save As"... dialog to store the current marker values to a marker file.

The analyzer uses a simple ASCII format to export marker values. By default, the marker file extension is *.txt. The file contains all traces in the active recall set together with their names and measured quantities. Below each trace, the file shows a list of all markers with their names, stimulus and response values.

The following example of a marker file describes a recall set with two traces, "Trc1" and its memory trace "Mem2[Trc1]". "Trc1" has a reference marker "R" and three normal markers "M1, M2, M3" assigned, the memory trace has no markers.

```
Trc1 S21
R 869.01766 MHz -4.751 dB
M1 5.621400 GHz 1.351 dB
M2 3.380996 GHz -6.043 dB
M3 1.928122 GHz -4.700 dB

Mem2 [Trc1] S21
No Markers
```

Remote command:

```
MMEMoRY:STORe:MARKer
```

Decimal Places...

Opens the "User Interface" tab of the "System Config" dialog, which allows to define the (maximum) number of decimal digits for different units. See ["User Interface tab"](#) on page 860.

5.7.3 Marker Search tab

Provides "Marker Search" functions that move the active marker to a (local) maximum or minimum of the active trace.

The search operation can be restricted to a configurable range of stimulus values ("Search Range..."). By default, the search range is equal to the entire sweep range.

If necessary, the active marker is enabled to indicate the search result.



Background information

Refer to "[Basic marker search functions](#)" on page 132.

5.7.3.1 Controls on the Marker Search tab



Max / Min

Sets the active marker to the absolute maximum or minimum in the search range, i.e. to the largest or smallest of all response values. If a complex trace format (e.g. a polar diagram) is active, the marker is set to the measurement point with the maximum or minimum magnitude.

"Max" and "Min" also overwrite the current "Search Mode" (--> "Search Min" and "Search Max") and the "Peak Type" for the peak search functions.

Remote command:

```
CALCulate<Chn>:MARKer<Mk>:FUNction:EXECute MINimum | MAXimum
CALCulate<Chn>:MARKer<Mk>:REFerence:FUNction:EXECute MINimum |
MAXimum
CALCulate<Chn>:MARKer<Mk>:FUNction:RESult?
CALCulate<Chn>:MARKer<Mk>:REFerence:FUNction:RESult?
```

Center = Marker

See "[Center = Marker / Start = Marker / Stop = Marker / Span = Marker](#)" on page 519.

Next Peak

Sets the active marker to the next local maximum or minimum in the search range, depending on the selected [Peak Type](#).

Remote command:

```
CALCulate<Chn>:MARKer<Mk>:FUNction:EXECute NPEak
CALCulate<Chn>:MARKer<Mk>:REFerence:FUNction:EXECute NPEak
CALCulate<Chn>:MARKer<Mk>:FUNction:RESult?
CALCulate<Chn>:MARKer<Mk>:REFerence:FUNction:RESult?
```

Peak Left / Peak Right

Sets the active marker to the next local maximum or minimum to the left or right of the current marker position, depending on the selected [Peak Type](#).

Remote command:

```
CALCulate<Chn>:MARKer<Mk>:FUNction:EXECute LPEak | RPEak
CALCulate<Chn>:MARKer<Mk>:REFerence:FUNction:EXECute LPEak |
RPEak
CALCulate<Chn>:MARKer<Mk>:FUNction:RESult?
CALCulate<Chn>:MARKer<Mk>:REFerence:FUNction:RESult?
```

Peak Type

Defines the peak type to be searched for using [Next Peak](#) and "Next Peak", [Peak Left / Peak Right](#):

- If "Max" is active, then the marker is set to the next maximum. The next maximum is the maximum with the largest response value that is below the current marker response value.
- If "Min" is active, then the marker is set to the next minimum. The next minimum is the minimum with the smallest response value that is above the current marker response value.
- If "Min or Max" is active, then the marker is set to the next minimum or maximum, whichever has the smallest distance from the current marker response value.

Remote command:

```
CALCulate<Chn>:MARKer<Mk>:FUNction:EXECute LPEak | RPEak
CALCulate<Chn>:MARKer<Mk>:REFerence:FUNction:EXECute LPEak |
RPEak
```

Search Range...

Opens the [Search Range dialog](#).

Tracking

Enables/disables tracking of the active marker for the current [Search Mode](#), which causes the marker to be updated after each sweep (or after each sweep point in case of "Sweep Progress").

Among the available search modes, the tracking functionality only makes sense for:

- "Min" and "Max", where such an update typically causes the marker to change both its horizontal and vertical position and
- "Target Search", where typically only the horizontal position changes
- "Sweep Progress" for long duration sweeps

Define an adequate "Search Range" to restrict the search to the adequate frequency or power interval (see [Chapter 5.7.3.2, "Search Range dialog"](#), on page 506).

Note: Tracking for bandfilter search can be activated separately, see ["Tracking"](#) on page 518.

Remote command:

```
CALCulate<Chn>:MARKer<Mk>:SEARch:TRACking
```

```
CALCulate<Chn>:MARKer<Mk>:REFerence:SEARch:TRACking
```

Marker Config...

Opens the [Marker Config dialog](#).

Spectrum = Marker

This button is only available if the analyzer is equipped with software option R&S ZNA-K1 (see). It is only enabled if there is at least one marker on the active trace.

In this case it performs the following actions:

- Create a channel
- Sets its center to the active marker's position
- Set its span to 10 times the (previously) active channel's [Bandwidth](#)
- Switch the channel to spectrum mode ([wideband signal path](#))

Remote command:

```
CALCulate<Chn>:MARKer<Mk>:FUNCTion:SPECTrum
```

5.7.3.2 Search Range dialog

The "Search Range" dialog confines the "Marker Search" and "Target Search" for the selected marker to a subrange of the sweep. The search range is a continuous interval of the sweep variable.

Access:

- Trace – [Marker] > "Marker Search" > "Search Range..."
- Trace – [Marker] > "Target Search" > "Search Range..."

If [Tracking](#) is active, the assigned "Search Range" applies to all sweeps and can be used to achieve uniqueness in "Min", "Max" or "Target Search".

See also [Chapter 5.5.8, "Trace Statistics tab"](#), on page 455.

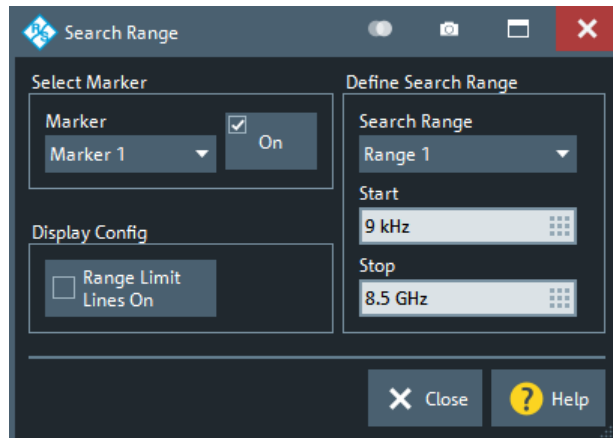

It is possible to define search ranges for each recall set and assign them to the corresponding markers and the reference marker.

Select Marker

Selects the reference marker or one of the numbered markers that can be assigned to the trace. If a numbered marker does not exist, it is created when "On" is checked. A created marker is displayed in the center of the search range.

Search Range

Selects the "Search Range" to be assigned to the selected marker. "Full Span" means that the "Search Range" is equal to the sweep range. Besides, it is possible to store up to 10 customized search ranges.

The "Search Range"s are bordered by the "Start" and "Stop" values. "Start" must be smaller than "Stop", otherwise the second value is automatically adjusted.

"Search Range" properties

The 10 search ranges are valid for the entire recall set. Each of them can be assigned to any marker in the recall set, irrespective of the trace and channel that the marker belongs to.

The default search range of any new marker is "Full Span". The analyzer provides the greatest flexibility in defining search ranges. In particular, two search ranges can overlap or even be identical. The search is confined to the part of the search range that belongs to the sweep range.

The following example shows how "Search Range"s can be used to search a trace for several local maxima.

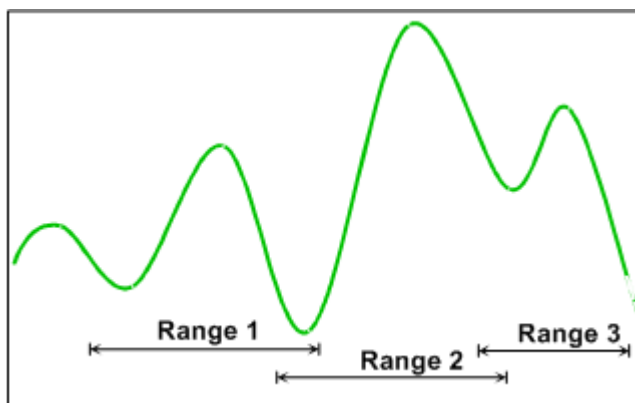

Note: The marker Search Ranges are identical to the evaluation ranges for trace statistics. For more information, see [Chapter 5.5.8.2, "Evaluation Range dialog"](#), on page 461.

Remote command:

```
CALCulate<Chn>:MARKer<Mk>:FUNction:DOMain:USER[:RANGE]
CALCulate<Chn>:MARKer<Mk>:REFerence:FUNction:DOMain:USER[:RANGE]
CALCulate<Chn>:MARKer<Mk>:FUNction:DOMain:USER:START
CALCulate<Chn>:MARKer<Mk>:REFerence:FUNction:DOMain:USER:START
CALCulate<Chn>:MARKer<Mk>:FUNction:DOMain:USER:STOP
CALCulate<Chn>:MARKer<Mk>:REFerence:FUNction:DOMain:USER:STOP
```

Range Limit Lines On

Displays or hides the range limit lines in the diagram area. Range limit lines are two vertical lines at the Start and Stop values of the active search range ("Range 1" to "Range 10").

The line color can be modified by a user-defined color scheme ([Element "Vertical Range Lines"](#)).

Remote command:

```
CALCulate<Chn>:MARKer<Mk>:FUNction:DOMain:USER:SHOW
CALCulate<Chn>:MARKer<Mk>:REFerence:FUNction:DOMain:USER:SHOW
```

5.7.3.3 Marker Config dialog

The "Marker Config" dialog allows you to configure the peak searches for the active trace and all its markers.

Access:

- Trace – [Marker] > "Marker Search" > "Marker Config..."
- Trace – [Marker] > "Multiple Peak" > "Marker Config..."

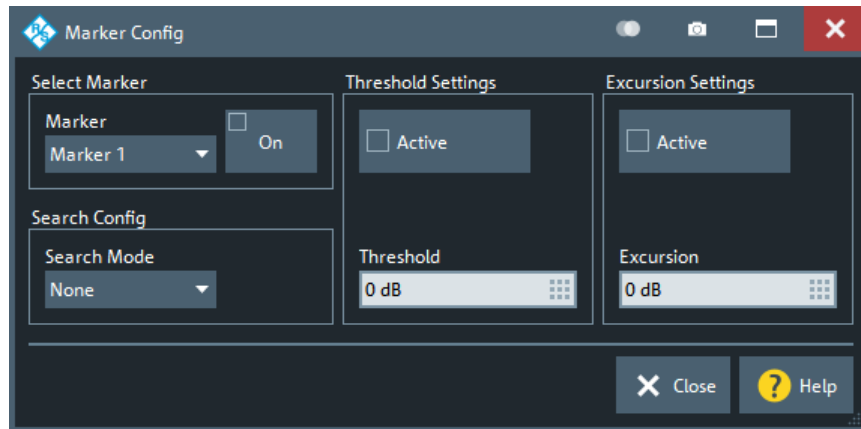

Select Marker

Allows you to select the related marker and to activate or deactivate it.

Remote command:

```
CALCulate<Chn>:MARKer<Mk>[:STATe]
```

Search Config

Allows you to select the [Target Search Mode](#) of the selected marker.

Remote command:

```
CALCulate<Chn>:MARKer<Mk>:FUNCTION:EXECute
```

```
CALCulate<Chn>:MARKer<Mk>:REFERENCE:FUNCTION:EXECute
```

Threshold Settings

Defines a threshold for (single) peak searches and activates it.

If "Active", only maxima above and minima below the configured "Threshold" are considered.

The unit is derived from the active trace format and cannot be modified. Changing the trace format resets the "Threshold" to a format-specific default value.

Remote command:

```
CALCulate<Chn>:MARKer<Mk>:THReshold
```

```
CALCulate<Chn>:MARKer<Mk>:REFERENCE:THReshold
```

```
CALCulate<Chn>:MARKer<Mk>:THReshold:STATE
```

```
CALCulate<Chn>:MARKer<Mk>:REFERENCE:THReshold:STATE
```

Excursion Settings

Defines a minimum excursion for peak searches and activates it.

If "Active", only peaks with an excursion above the configured "Excursion" value are considered. By definition, the excursion of a peak is the smaller of the absolute differences in measured values from the adjoining peaks of opposite polarity.

The unit is derived from the active trace format and cannot be modified. Changing the trace format resets the "Excursion" to a format-specific default value.

For spectrum channels (R&S ZNA-K1), peak searches use an excursion of 6 dBm per default.

Remote command:

```
CALCulate<Chn>:MARKer<Mk>:EXCursion
CALCulate<Chn>:MARKer<Mk>:REFerence:EXCursion
CALCulate<Chn>:MARKer<Mk>:EXCursion:STATe
CALCulate<Chn>:MARKer<Mk>:REFerence:EXCursion:STATe
```

5.7.4 Multiple Peak tab

"Multiple Peak" search allows you to find multiple local minima/maxima at once.



Background information

Refer to "[Basic marker search functions](#)" on page 132.

5.7.4.1 Controls on the Multiple Peak tab



Max / Min

Sets up to 10 markers to the highest maxima or lowest minima in the configured [Eval Range](#). If a complex trace format is active (e.g. a polar diagram), the markers are set to the measurement points with the maximum or minimum magnitude.

The required markers are created/deleted as needed.

Remote command:

```
CALCulate<Chn>:MARKer<Mk>:FUNction:EXECute MMAXimum | MMINimum
CALCulate<Chn>:MARKer<Mk>:REFerence:FUNction:EXECute MMAXimum |
MMINimum
CALCulate<Chn>:MARKer<Mk>:FUNction:RESult?
CALCulate<Chn>:MARKer<Mk>:REFerence:FUNction:RESult?
```

Eval Range

Opens the [Evaluation Range dialog](#) that allows you to set the domain for the multiple peak search. A modified domain takes effect the next time [Max / Min](#) is used.

Tracking

Enables or disables tracking for "Multiple Peak" search. If enabled, a new multiple peak search is performed for each sweep (creating/deleting markers as needed).

Define an [Eval Range](#) to restrict the search to the adequate frequency or power interval.

Remote command:

```
CALCulate<Chn>:MARKer<Mk>:SEARch:TRACking
```

Marker Config...

Opens the [Multiple Marker Config dialog](#).

All Markers Off

See ["All Off"](#) on page 499.

5.7.4.2 Multiple Marker Config dialog

The "Multiple Marker Config" dialog allows you to configure the multiple peak searches for the active trace.

Access: Trace – [Marker] > "Multiple Peak" > "Marker Config..."

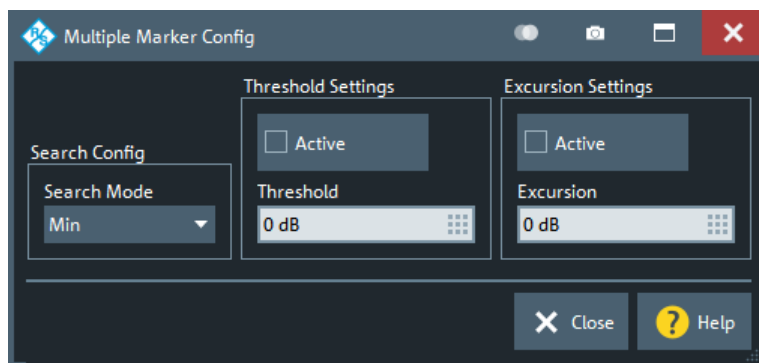
**Search Config**

Same as selecting [Max / Min](#).

Remote command:

```
CALCulate<Chn>:MARKer<Mk>:FUNctIon:EXECute MMAXimum | MMINimum  
CALCulate<Chn>:MARKer<Mk>:REFerence:FUNctIon:EXECute MMAXimum |  
MMINimum
```

Threshold Settings

Defines a threshold for multiple peak searches and activates it.

If "Active", only maxima above and minima below the configured "Threshold" are considered.

The unit is derived from the active trace format and cannot be modified. Changing the trace format resets the "Threshold" to a format-specific default value.

Remote command:

```
CALCulate<Chn>:MARKer:MPEak:THReshold
CALCulate<Chn>:MARKer:MPEak:THReshold:STate
```

Excursion Settings

Defines a minimum excursion for multiple peak searches and activates it.

If "Active", only peaks with an excursion above the configured "Excursion" value are considered. By definition, the excursion of a peak is the smaller of the absolute differences in measured values from the adjoining peaks of opposite polarity.

The unit is derived from the active trace format and cannot be modified. Changing the trace format resets the "Excursion" to a format-specific default value.

Remote command:

```
CALCulate<Chn>:MARKer:MPEak:EXCursion
CALCulate<Chn>:MARKer:MPEak:EXCursion:STate
```

5.7.5 Target Search tab

The "Target Search" functions use markers to locate trace points with a specific response value ("Target Value"). The functions are unavailable if the active trace contains no markers (e.g. after "All Markers Off").

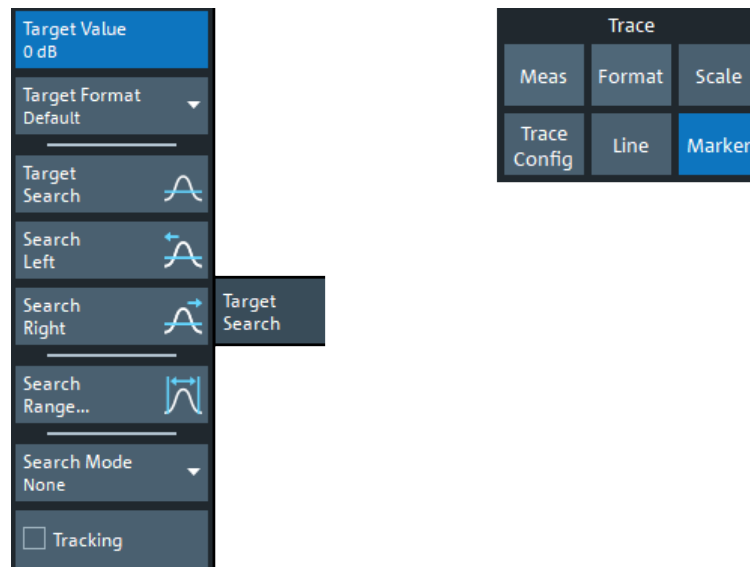

Some of the "Target Search" functions are equal to other marker search functions. Refer to the following sections:

- [Chapter 5.7.3.2, "Search Range dialog"](#), on page 506
- ["Tracking"](#) on page 506

Target Value

Specifies the target value for the search.

The VNA software allows you to specify the target value in different formats (see [Target Format](#) below). For example, you can search for a particular phase value in a Smith chart.

Remote command:

```
CALCulate<Chn>:MARKer<Mk>:TARGet
```

```
CALCulate<Chn>:MARKer<Mk>:REFerence:TARGet
```

Target Format

Selects the format that is used to specify the [Target Value](#).

The selected target format applies to the current marker only: each marker can have a different target format. The table below gives an overview on how a complex target value $z = x + jy$ is converted.

Target Format	Description	Formula
"Lin Mag"	Magnitude of z, unconverted.	$ z = \sqrt{x^2 + y^2}$
"dB Mag"	Magnitude of z [dB]	$\text{Mag}(z) = 20 \log z \text{ dB}$
"Phase"	Phase of z [°]	$\varphi(z) = \arctan(y/x)$
"Phase unwrap"	Unwrapped phase of z comprising the complete number of 360° phase rotations [°]	$\Phi(z) = \varphi(z) + 2k \cdot 360^\circ$
"Real"	Real part of z	$\text{Re}(z) = x$
"Imag"	Imaginary part of z	$\text{Im}(z) = y$
"SWR"	(Voltage) Standing Wave Ratio	$\text{SWR} = (1 + z) / (1 - z)$
"Default"	Identical to trace format. Note: the Smith and Polar traces use "Lin Mag" as the default format for target value.	-

Remote command:

```
CALCulate<Chn>:MARKer<Mk>:SEARch:FORMat
```

```
CALCulate<Chn>:MARKer<Mk>:REFerence:SEARch:FORMat
```

Target Search

Activates the search and sets the active marker to the defined target value. If the target value occurs at several stimulus values, the marker is placed to the search result with the smallest stimulus value. The other measurement points with the same target value can be located using the "Search Right" function.

If the target is not found (e.g. because the active trace does not contain the target value), then the active marker is not moved away from its original position.

Remote command:

```
CALCulate<Chn>:MARKer<Mk>:FUNctioN:EXECute TARGet
```

```
CALCulate<Chn>:MARKer<Mk>:REFerence:FUNctioN:EXECute TARGet
```

```
CALCulate<Chn>:MARKer<Mk>:FUNctioN:RESult?
```

```
CALCulate<Chn>:MARKer<Mk>:REFerence:FUNctioN:RESult?
```

Search Left/Search Right

Searches the [Target Value](#) to the left/right of the active marker's stimulus value within the current search range (see [Chapter 5.7.3.2, "Search Range dialog"](#), on page 506).

If the search is successful, the active marker is moved to the next smaller/larger stimulus value with this target value. Use "Search Left"/"Search Right" repeatedly to locate the other ones.

Remote command:

```
CALCulate<Chn>:MARKer<Mk>:FUNction:EXECute LTARget
CALCulate<Chn>:MARKer<Mk>:REFerence:FUNction:EXECute LTARget
CALCulate<Chn>:MARKer<Mk>:FUNction:RESult?
CALCulate<Chn>:MARKer<Mk>:REFerence:FUNction:RESult?
```

Search Mode

Displays and sets the current marker search mode.

Select one of the predefined max, min, peak, or target searches or select "Sweep Progress" to track the position of the sweep cursor.

Remote command:

```
CALCulate<Chn>:MARKer<Mk>:FUNction:EXECute
CALCulate<Chn>:MARKer<Mk>:REFerence:FUNction:EXECute
```

5.7.6 Bandfilter tab

"Bandfilter" search allows you to search for trace segments with a bandpass or band-stop shape, and determine characteristic filter parameters.

**Background information**

Refer to ["Bandfilter search"](#) on page 133.

Bandfilter for arbitrary scalar traces

"Bandfilter" search can be used for a broad range of measured quantities (see [Chapter 5.2, "Meas softtool"](#), on page 341). To obtain real filter parameters, the trace format must be "dB Mag", the measured quantity must be a transmission S-parameter and a frequency sweep must be performed. However, for other formats, measured quantities or sweep types, the "Bandfilter" functions can still be useful to analyze general trace properties.

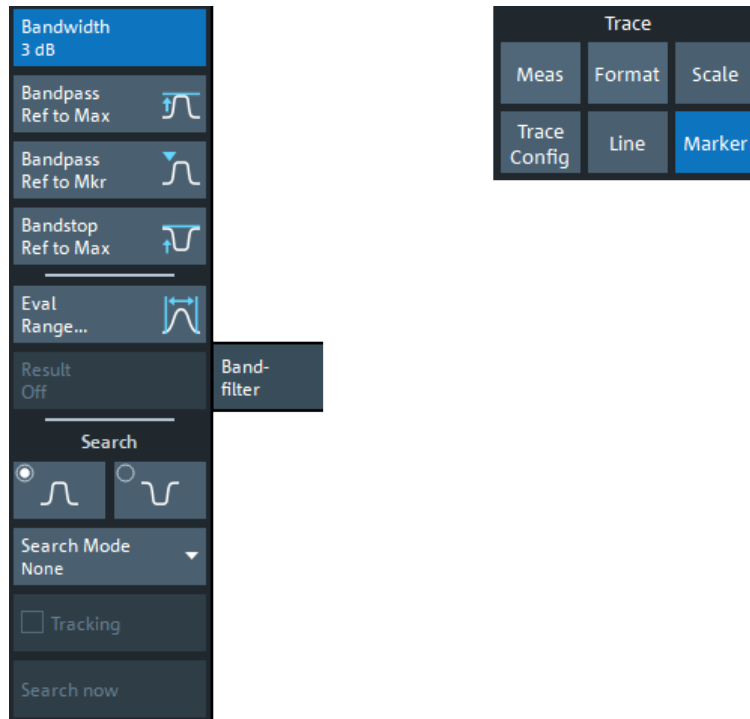

The "Eval Range..." button opens the "Evaluation Range" dialog that allows you to narrow the "Bandfilter" search to a particular stimulus range. See [Evaluation Range dialog](#).

Bandwidth

Specifies the minimum excursion of the bandpass and bandstop peaks.

- A bandpass peak must fall off on both sides by the specified <Bandwidth> value to be considered a valid peak.
- A bandstop peak must be <Bandwidth> below the maximum level in the search range (bandpass value) to be considered a valid peak.

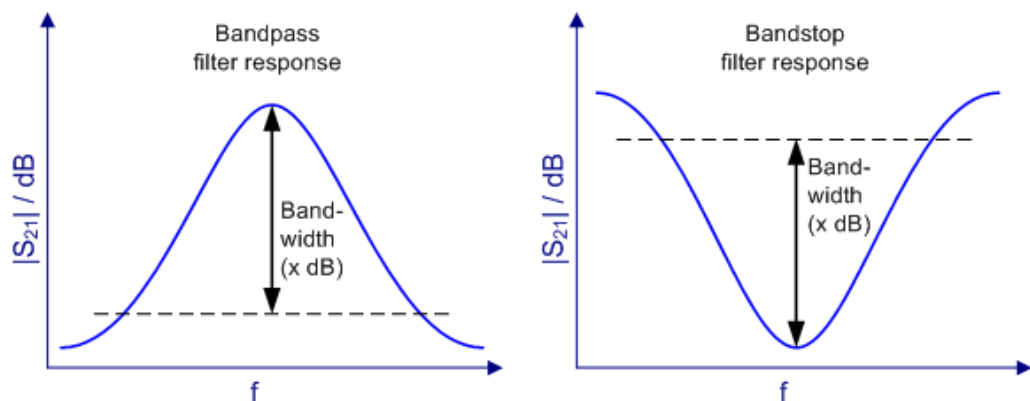

Remote command:

`CALCulate<Chn>:MARKer<Mk>:BWIDth`

Bandpass Ref to Max

Activates the search for a bandpass region on the active trace and activates [Tracking](#). The located bandpass region is the tallest peak in the search range with a minimum excursion as specified by the "Bandwidth" parameter.

If "Bandpass Ref to Max" is selected, the analyzer uses (or creates) the four markers "M1" to "M4" to locate the **bandpass region**.

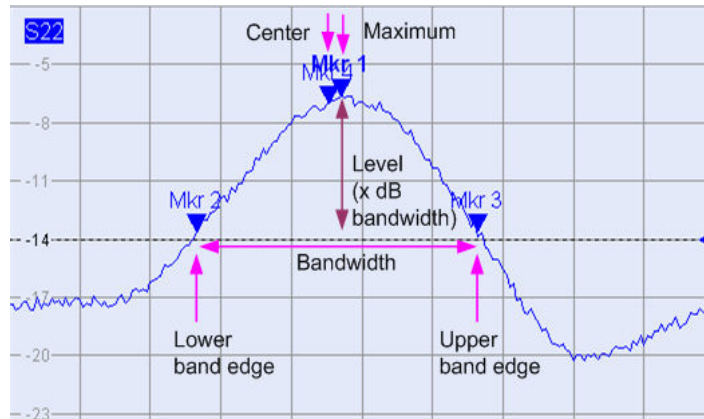

- "M1" indicates the maximum of the peak ("Max").
- "M2" indicates the point on the left edge of the peak where the trace value is equal to the maximum minus the bandwidth factor ("Lower Edge").
- "M3" indicates the point on the right edge of the peak where the trace value is equal to the maximum minus the bandwidth factor ("Upper Edge").
- "M4" indicates the center of the peak. Depending on a system setting, the center is either calculated as the geometric or the arithmetic mean of the "Lower Edge" and "Upper Edge" frequencies (see ["Geometric Calculation of Bandfilter Center"](#) on page 866).

The search results are displayed in the movable "Bandfilter" info field.

Remote command:

```
CALCulate<Chn>:MARKer<Mk>:FUNction:BWIDth:MODE BPASS
CALCulate<Chn>:MARKer<Mk>:FUNction:EXECute BFILter
CALCulate<Chn>:MARKer:SEARch:BFILter:RESult[:STATE]:AREA
```

Bandpass Ref to Mkr

Activates the search for a bandpass region on the active trace and activates [Tracking](#), starting at the position of the active marker. A bandpass region is the closest peak in the evaluation range that has a minimum excursion as specified by the "Bandwidth" parameter.

In contrast to a "Bandpass Ref to Max", the "Bandpass Ref to Mkr" does not change the position of the active markers. The search results are displayed in the movable "Bandfilter" info field.

Remote command:

```
CALCulate<Chn>:MARKer<Mk>:FUNction:BWIDth:MODE BPRMarker
CALCulate<Chn>:MARKer<Mk>:FUNction:EXECute BFILter
```

Bandstop Ref to Max

Activates the search for a bandstop region on the active trace and activates [Tracking](#). A bandstop region is the lowest peak (local minimum) in the search range, whose level is at least <Bandwidth> below the maximum (passband value).

If "Bandstop Ref to Max" is selected, the analyzer uses (or creates) the four markers "M1" to "M4" to locate the **bandstop region**.

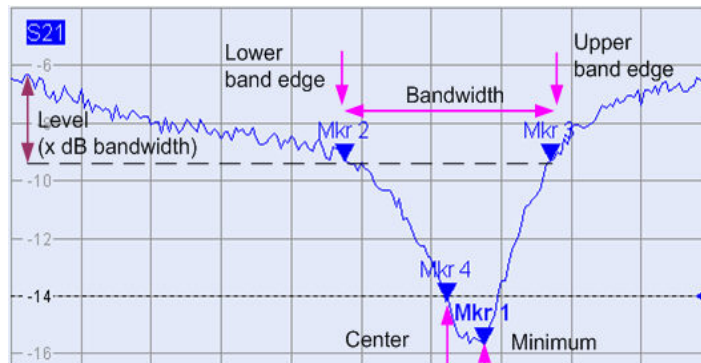

- "M1" indicates the minimum of the peak ("Min").
- "M2" indicates the "Lower Edge" of the bandstop, i.e. the point on the left edge of the peak where the trace value is equal to the maximum in the search range (passband value) minus the specified [Bandwidth](#).
- "M3" indicates the "Upper Edge" of the bandstop, i.e. the point on the right edge of the peak where the trace value is equal to the maximum in the search range (passband value) minus the specified "Bandwidth".
- "M4" indicates the center of the peak. Depending on a system setting, the center is either calculated as the geometric or the arithmetic mean of the "Lower Edge" and "Upper Edge" positions (see ["Geometric Calculation of Bandfilter Center"](#) on page 866).

The search results are displayed in the movable "Bandfilter" info field.

Remote command:

```
CALCulate<Chn>:MARKer<Mk>:FUNction:BWIDth:MODE BStOp
CALCulate<Chn>:MARKer<Mk>:FUNction:EXECute BFILter
```

Result Off

Hides the movable info field with the results of a bandpass or a bandstop search and disables [Tracking](#). The info field is displayed again (and tracking re-enabled) when a new "Bandfilter" search is performed.

Remote command:

```
CALCulate<Chn>:MARKer:SEARch:BFILter:RESult[:STATe]
```

Search (Bandpass or Bandstop) / Search Mode

Enables a bandpass or bandstop search (left/right icon) for an arbitrary search mode. The search modes have the following effect:

- "Ref to Max": The bandpass (bandstop) is the tallest (lowest peak) in the search range. For a detailed description, refer to ["Bandpass Ref to Max"](#) on page 516 and ["Bandstop Ref to Max"](#) on page 517.

- "Ref to Marker": The bandpass (bandstop) is the tallest (lowest) peak in the search range. The response value for the lower and upper band edges is calculated as the response value at the active marker position plus (minus) the [Bandwidth](#). To be valid, the peak must be above (below) the response value for the band edges.
- "Absolute Level:" The bandpass (bandstop) is the tallest (lowest) peak in the search range. To be valid, the peak must be above (below) $-$ "Bandwidth". The Lower Band Edge and Upper Band Edge values are given by the frequencies where the trace is equal to $-$ "Bandwidth".
- "None": "Bandfilter" search switched off, result off.

Remote command:

```
CALCulate<Chn>:MARKer<Mk>:FUNction:BWIDth:MODE
```

Tracking

Causes the active "Bandfilter" search to be repeated after each sweep: When tracking mode is active, the markers typically change their horizontal and vertical positions as the measurement proceeds.

Tracking mode properties

Tracking modes are available for all search modes. The tracking modes for minimum/maximum/peak search and target search are coupled; tracking for "Bandfilter" search can be activated separately. Tracking is activated automatically when one of the "Bandfilter" search modes is selected.

Remote command:

"Bandfilter" tracking and marker/target search tracking are controlled with the same command:

```
CALCulate<Chn>:MARKer<Mk>:SEARch:TRACking
```

5.7.7 Set by Marker tab

The "Set by Marker" functions use the active marker to define the sweep range, scale the diagram and introduce an electrical length offset. The functions are unavailable if the active trace contains no markers (e.g. after "All Markers Off").



Examples

Refer to [Chapter 3.3.7.6, "Set by marker"](#), on page 69.

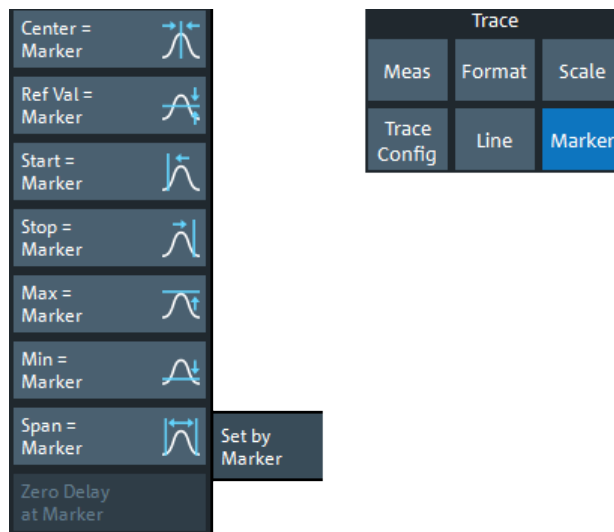

Center = Marker / Start = Marker / Stop = Marker / Span = Marker

The following functions use the stimulus value of the active marker to define the sweep range.

- "Center = Marker" sets the center of the sweep range equal to the stimulus value of the active marker, leaving the span unchanged. The active marker appears in the center of the diagram.
- "Start = Marker" sets the beginning (start) of the sweep range equal to the stimulus value of the active marker, leaving the end (stop) value unchanged. The active marker appears at the left edge of the diagram.
- "Stop = Marker" sets the end (stop) of the sweep range equal to the stimulus value of the active marker, leaving the beginning (start) unchanged. The active marker appears at the right edge of the diagram.
- "Span = Marker" is only available for frequency sweeps (linear or logarithmic). It is enabled if the active marker is in [Delta Mode](#). "Span = Marker" adjusts the sweep span to the range between the active delta marker and the reference marker.

Remote command:

```
CALCulate<Chn>:MARKer<Mk>:FUNction:CENTer
CALCulate<Chn>:MARKer<Mk>:REFerence:FUNction:CENTer
CALCulate<Chn>:MARKer<Mk>:FUNction:START
CALCulate<Chn>:MARKer<Mk>:REFerence:FUNction:START
CALCulate<Chn>:MARKer<Mk>:FUNction:STOP
CALCulate<Chn>:MARKer<Mk>:REFerence:FUNction:STOP
CALCulate<Chn>:MARKer<Mk>:FUNction:SPAN
```

Ref Val = Marker / Max = Marker / Min = Marker

The following functions use the response value of the active marker to scale the y-axis of the diagram:

- "Ref Val = Marker" sets the reference value equal to the response value of the active marker, leaving the values of the vertical divisions ("Scale / Div") unchanged.
- "Max = Marker" sets the upper edge of the diagram equal to the response value of the active marker, leaving the values of the vertical divisions ("Scale / Div") unchanged.

- "Min = Marker" sets the lower edge of the diagram equal to the response value of the active marker, leaving the values of the vertical divisions ("Scale / Div") unchanged.

Remote command:

n/a

Zero Delay at Marker

This function is available for [Delay](#) traces only. It shifts the trace in vertical direction so that the delay at the marker position becomes zero. Mathematically, it modifies the measurement results by subtracting the delay at the current marker position.

The delay represents the propagation time of the wave. Hence "Zero Delay at Marker" performs an electrical length compensation, by adding or subtracting a simulated lossless transmission line of variable length to or from the test port. This shift of the reference plane must be carried out on the "Delay" trace, but has an impact on all trace formats.

A standard application of "Zero Delay at Marker" is correction of the constant delay caused by the interconnecting cables between the analyzer test ports and the DUT (line stretch).

Note: "Zero Delay at Marker" modifies the "Offset" parameters and therefore influences the entire channel.

Remote command:

n/a

5.7.8 Info Field tab

Displays or hides the marker info field and selects its contents. The functions are self-explanatory.



Background information

Refer to "[Marker info field](#)" on page 129

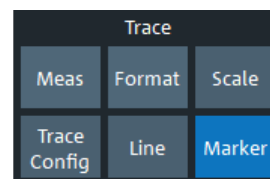
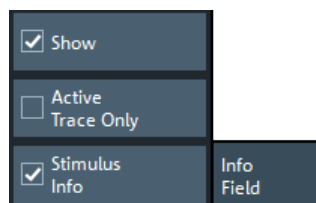

5.7.9 Marker Coupling tab

Allows you to set up and control marker coupling.



Background information

Refer to "[Marker coupling](#)" on page 132.

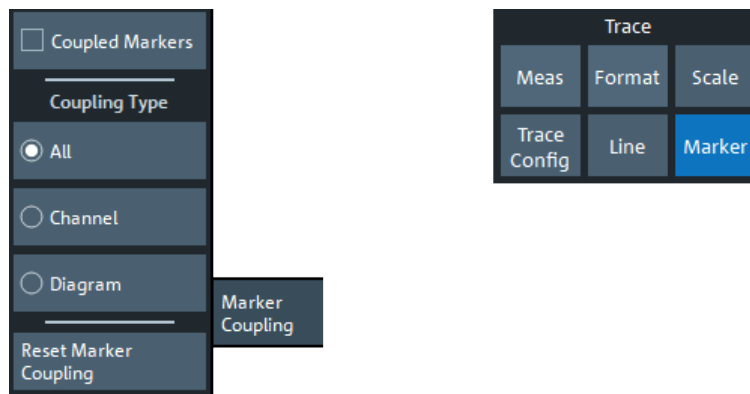

Coupled Markers

Activates or deactivates [Marker coupling](#). The label indicates the selected [Coupling Type](#):

"Coupling Type"	Label
"All"	"Coupled Markers"
"Channel"	"Coupled Markers in <name of active channel>"
"Diagram"	"Coupled Markers in <name of active diagram>"

Coupling also works if [Tracking](#) is enabled for *Marker <m>* in **one** trace. The *Marker <m>* of the other traces then follow the movements of the tracked marker. The same holds true for the reference marker.

Remote command:

`CALCulate:MARKer:COUPled[:STATE]`

Coupling Type

Determines the set of traces whose markers are coupled to the markers of the active trace when [marker coupling](#) is enabled.

- **"All"**: marker coupling applies to all traces in the active recall set that have the same stimulus variable as the active trace
- **"Channel"**: marker coupling applies to all traces in the active channel
- **"Diagram"**: marker coupling applies to all traces in the active diagram that have the same stimulus variable as the active trace

The selected "Coupling Type" applies to all marker coupling relations in the current recall set. Changing the "Coupling Type" automatically disables marker coupling throughout the recall set.

Remote command:

`CALCulate:MARKer:COUPled:TYPE`

Reset Marker Coupling

Convenience function for disabling [marker coupling](#) and setting the [Coupling Type](#) to "All" (default).

Remote command:

```
CALCulate:MARKer:COUPled[:STATe] OFF
```

```
CALCulate:MARKer:COUPled:TYPE ALL
```

5.8 Stimulus softtool

On the "Stimulus" softtool, you can access to the stimulus parameters of the active channel. If the active trace is represented in [Time Domain](#), it also allows you to configure the "observation interval".

Access: Stimulus – [Start] | [Stop] | [Center] | [Span] key



- While in Cartesian diagrams the x-axis represents the stimulus values, in polar and Smith diagrams this direct relation is lost. In any case, a marker can be used to display the stimulus value of a given trace point. For "Time Domain" traces, points in the "observation interval" are interpreted as stimulus values.
- All stimulus settings except the "Time Domain X-Axis" settings are channel settings. "Time Domain X-Axis" applies to the active (time domain) trace only.



Background information

Refer to the following sections:

- [Chapter 4.1.3, "Traces, channels and diagrams"](#), on page 108
- [Chapter 3.3.7.2, "Setting the sweep range"](#), on page 68
- [Chapter 3.3.7.6, "Set by marker"](#), on page 69

5.8.1 Stimulus tab

Defines the sweep range in the current channel, depending on the sweep type.



Related Settings

Refer to the following sections:

- [Chapter 4.1.4.3, "Stimulus and sweep types"](#), on page 113
- [Chapter 5.10.3, "Sweep Type tab"](#), on page 546

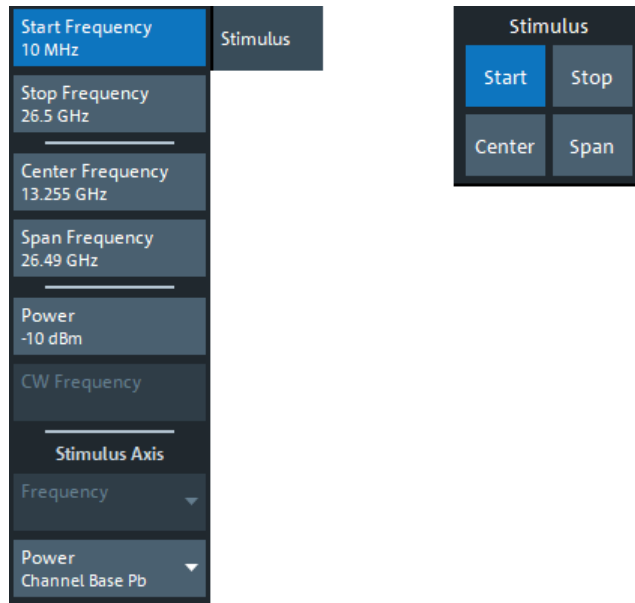

The following "Stimulus" settings are also available on the "Power" tab:

- [Power](#)
- [Start Power / Stop Power](#)

Start Frequency / Stop Frequency / Center Frequency / Span Frequency

Defines the sweep range for non-segmented frequency sweeps.

For a [Lin Freq](#) sweep, setting "Start Frequency" and "Stop Frequency" or "Center Frequency" and "Span Frequency" are alternatives.

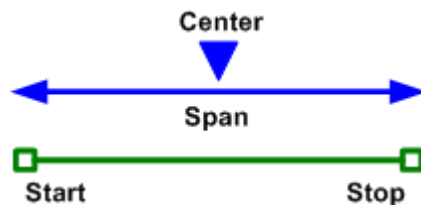

For a [Log Freq](#) only "Start Frequency" and "Stop Frequency" can be set.

Note: For segmented frequency sweeps the start and stop frequencies and the number of sweep points are defined per segment. See [Chapter 5.10.3.2, "Define Segments dialog"](#), on page 553.

Remote command:

```
[SENSe<Ch>:] FREQuency: START
```

```
[SENSe<Ch>:] FREQuency: STOP
```

```
[SENSe<Ch>:] FREQuency: CENTer
```

```
[SENSe<Ch>:] FREQuency: SPAN
```

```
SYSTem: FREQuency? (query frequency range of the network analyzer)
```

Start Power / Stop Power

Defines the sweep range for [Power](#) sweeps.

Remote command:

```
SOURce<Ch>:POWer<PhyPt>:START
SOURce<Ch>:POWer<PhyPt>:STOP
```

Number of Points

Sets the total number of measurement points for [CW Mode](#) sweeps.

This value can also be set on the "Sweep Params" tab of the "Sweep" softtool (see ["Number of Points"](#) on page 540).

Remote command:

```
[SENSe<Ch>:]SWEep:POINTs
```

Stop Time

Defines the sweep range for [Pulse Profile](#) or [Time](#) sweeps.

Remote command:

```
[SENSe<Ch>:]SWEep:TIME
```

Imb Start Phase, Imb Stop Phase / Imb Start Power, Imb Stop Power

Defines the sweep range for ["Phase Imbalance/ Amplitude Imbalance"](#) on page 551 sweeps.

Remote command:

```
SOURce<Ch>:TDIF:IMBalance:PHASe:START
SOURce<Ch>:TDIF:IMBalance:PHASe:STOP
SOURce<Ch>:TDIF:IMBalance:AMPLitude:START
SOURce<Ch>:TDIF:IMBalance:AMPLitude:STOP
```

CW Frequency

Sets the fixed frequency for [Power](#), [CW Mode](#), and [Time](#) sweeps.

The "CW Frequency" is also used as the channel base frequency for frequency-converting measurements; see [Chapter 4.7.3, "Frequency conversion measurements"](#), on page 261.

Remote command:

```
[SENSe<Ch>:]FREQuency:FIXed
[SENSe<Ch>:]FREQuency[:CW]
SOURce<Ch>:FREQuency<PhyPt>:FIXed
SOURce<Ch>:FREQuency<PhyPt>[:CW]
```

Stimulus Axis – Frequency / Power

Selects the channel base frequency (power) or the frequency (power) of a particular port as the stimulus axis in all diagrams of the active recall set. The selected stimulus axis is displayed in the channel line. Select the axis according to your port configuration and measurement results.

Example:

Port 1 provides the RF input signal for a mixer; the IF output signal is measured at Port 2. The port frequency of Port 1 is equal to the channel base frequency f_b , the port frequency of Port 2 is set to the IF frequency $f_b + f_{LO}$. To view the received wave b_2 over the entire IF frequency range, select port 2 as a frequency stimulus axis.

The lists include external generator and power meter ports. The "Frequency" list is disabled while the frequency conversion is switched off.

Remote command:

[SENSe<Ch>:] SWEep:AXIS:FREQuency

[SENSe<Ch>:] SWEep:AXIS:POWEr

5.8.2 Power tab

The "Power" tab provides settings related to transmit and receive power. It is also displayed on the "Pwr Bw Avg" softtool.

5.8.2.1 Controls on the Power tab



left = R&S ZNA with 4 physical ports

right = R&S ZNA with > 4 physical ports on the VNA and connected switch matrices

If an [external switch matrix](#) is used, then most of the controls on the "Power" tab are hidden. If available, the corresponding functionality can be configured in the [Arbitrary Power tab](#) of the [Chapter 5.12.2.2, "Port Settings dialog"](#), on page 668.

For power sweeps, the [Start Power / Stop Power](#) can be set on the [Stimulus tab](#) of the "Stimulus" softtool.

Some of the buttons on the "Power" tab open related dialogs.

- "Power Config...": see [Chapter 5.8.2.2, "Power Config dialog"](#), on page 527
- "ALC Config...": see [Chapter 5.8.2.3, "ALC Config dialog"](#), on page 527
- "Cal Premeas Config...": see [Chapter 5.8.2.4, "Cal Premeas Config dialog"](#), on page 531

Power

Determines the output power at the test ports for the sweep types "Lin Freq", "Log Freq", "CW Mode", and "Time". Also determines the default output power for "Segmented" sweeps, where the output power can be set per segment.

The setting has no effect for [Power](#) sweeps, where the source power is varied over a continuous range.

Remote command:

```
SOURce<Ch>:POWER<PhyPt>[:LEVel] [:IMMediate] [:AMPLitude]
```

Source Step Att.

This section is only available if the R&S ZNA is equipped with mechanical source step attenuators (see [Chapter 4.7.29, "Source step attenuators"](#), on page 308).

Attenuation can be set from 0 to 70 dB, in steps of 10 dB.

If an [external switch matrix](#) is used, this section is also hidden. The "Source Step Att." functionality can be configured in the [Arbitrary Power tab](#) of the [Chapter 5.12.2.2, "Port Settings dialog"](#), on page 668.

Remote command:

```
SOURce<Ch>:POWER<PhyPt>:ATTenuation
```

ALC On

Enables/disables automatic level control (ALC) for the current channel.

If mm-wave converters are involved in the setup, the VNA firmware checks whether suitable leveling data are active. Otherwise a warning message is displayed and ALC remains disabled (although the checkbox is checked).

Use [Power Cal dialog – Leveling Table](#) to create a leveling dataset and [Leveling Data-sets dialog](#) to activate it. For background information see ["ALC with mmWave converters"](#) on page 119.

Remote command:

```
SOURce<Ch>:POWER:ALC:CSTate
```

RF Off All Channels

"RF Off All Channels" switches the internal power source for all channels off (if checked) or on. Switching off the RF power helps to prevent overheating of a connected DUT while no measurement results are taken.

Tip: Switching off the internal RF sources while an external generator is used can improve the measurement accuracy. "RF Off All Channels" also deactivates external generators, so you have to use the settings in the "Arb Frequency" tab of the [Port Settings dialog](#) (with option R&S ZNA-K4).

Remote command:

```
OUTPut<Ch> [:STATe]
```

Receiver Step Att.

Defines an attenuation factor for the received waves at each analyzer port. At least one receiver step attenuator must be installed to use this feature; see [Chapter 4.7.31, "Receiver step attenuators"](#), on page 309.

Receiver step attenuators are used to adapt the received signal level to the input level range of the analyzer. They protect the instrument from being overloaded or damaged, e.g. if the DUT is a power amplifier.

Attenuation factors are port- and channel-specific. Possible values are 0 dB to 35 dB in steps of 5 dB. The analyzer rounds any entered value below the maximum attenuation to the closest step.

Note: Receiver step attenuators are optional hardware (see [Chapter 4.7.31, "Receiver step attenuators"](#), on page 309).

If an [external switch matrix](#) is used, this functionality can be configured in the [Receiver Level tab](#) of the [Chapter 5.12.2.2, "Port Settings dialog"](#), on page 668.

Remote command:

```
[SENSe<Ch>:] POWer:ATTenuation
```

Preamp. Gain

Sets the gain of the [Internal low power spur reduction amplifier](#) (b1) and the [Internal low noise preamplifier](#) (b2)

If an [external switch matrix](#) is used, "Preamp. Gain" is **not** available.

Remote command:

```
[SENSe<Ch>:] PAMPlifier2 [:STATe]
```

```
[SENSe<Ch>:] PAMPlifier2 [:VALue]
```

5.8.2.2 Power Config dialog

Except for the ALC settings, which are covered in the [ALC Config dialog](#), the "Power Config" dialog offers the same settings as the [Arbitrary Power tab](#) of the [Chapter 5.12.2.2, "Port Settings dialog"](#), on page 668.

5.8.2.3 ALC Config dialog

Enables and configures automatic level control (ALC) for the current channel.

Access:

- Channel – [Pwr Bw Avg] > "Power" > "ALC Config..."
- [Port Settings dialog](#) > "Arbitrary Power" tab > "ALC Params" column



Background information

See [Chapter 4.1.5, "Automatic level control"](#), on page 117.

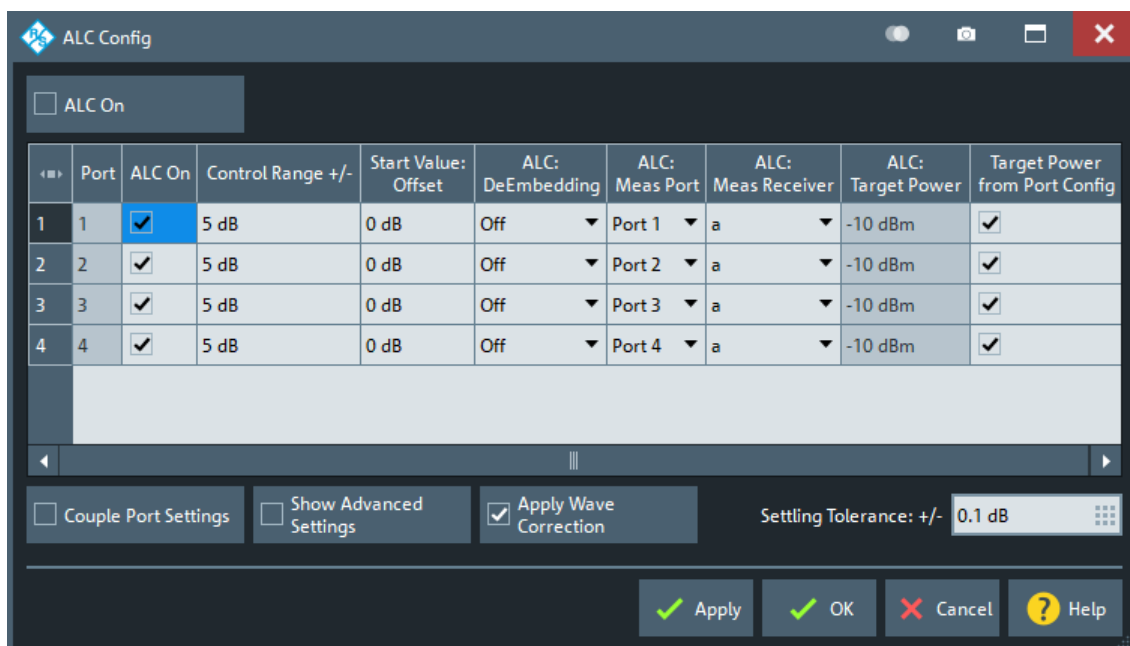

Initially, the "ALC Config" dialog only displays basic settings. For full details, enable [Show Advanced Settings](#).

ALC On

Enables/disables automatic level control (ALC) for the current channel.

If mm-wave converters are involved in the setup, the VNA firmware checks whether suitable leveling data are active. Otherwise a warning message is displayed and ALC remains disabled (although the checkbox is checked).

Use [Power Cal dialog – Leveling Table](#) to create a leveling dataset and [Leveling Data-sets dialog](#) to activate it. For background information see "[ALC with mmWave converters](#)" on page 119.

Remote command:

```
SOURce<Ch>:POWer:ALC:CStAtE
```

ALC On (table area)

Enables or disables ALC for the respective port.

Remote command:

```
SOURce<Ch>:POWer<Pt>:ALC[:STATe]
```

Control Range +/-

"Control Range +/-" is the maximum change of the source signal level due to the ALC.

A value of 5 dB (default) means that the source signal level can be adjusted in a 10 dB wide symmetric range around the start value. A value of 0 dB effectively disables the ALC. With a wider control range, the ALC can compensate for larger attenuation/gain factors. A narrow control range is often sufficient if the source power is relatively well known, e.g. from a previous power calibration.

Possible [Port Power Limits](#) are ignored while the ALC loop is active. Therefore, to protect sensitive DUTs from excess input levels, a narrower control range (smaller value) can be required. A warning in the lower left corner of the "ALC Config" dialog points out the potential hazard.

Remote command:

```
SOURce<Ch>:POWer<Pt>:ALC:RANGe
```

Start Value: Offset

A positive/negative offset Increases/decreases the source signal level before the ALC loop is started. An appropriate value can speed up the ALC.

Note that the offset direction has been reversed in firmware version 2.20, i.e. before FW V2.20 a positive/negative offset decreased/increased the source signal level before the ALC loop is started.

Remote command:

```
SOURce<Ch>:POWer<Pt>:ALC:SOFFset
```

ALC Deembedding

See "[ALC deembedding](#)" on page 119.

"Offset"	Use the configured offset .
Deembed	Use the configured single-ended deembedding network.
"Off" (default)	Do not use the configured offset or the single-ended deembedding network.

Remote command:

```
SOURce<Ch>:POWer<Pt>:ALC:VNETwork
```

ALC: Meas Port/ALC: Meas Receiver

Defines the received signal to be used for ALC, i.e. whose power the R&S ZNA tries to keep at a particular target level.

Note: If the related port is used as the upper- or lower-tone port in a two-tone scenario and the internal combiner is used, then the firmware automatically selects a1 when ALC is enabled.

Remote command:

```
SOURce<Ch>:POWer<Pt>:ALC:RECeiver
```

ALC: Target Power/Target Power from Port Config

Defines the target level, the ALC tries to keep at the selected [receiver](#).

By default, this "ALC: Target Power" is automatically set to the power level defined in the [port configuration](#). However, you can uncheck "Target Power from Port Config", apply this setting, and specify "ALC: Target Power" in the respective column.

Remote command:

```
SOURce<Ch>:POWer<Pt>:ALC:TPOWer
SOURce<Ch>:POWer<Pt>:ALC:TPOWer:DEFault
```

Couple Port Settings

Enforces identical ALC settings for the individual ports (except [ALC On \(table area\)](#)). If disabled, different settings can be made for the individual ports.

Remote command:

`SOURce<Ch>:POWER<Pt>:ALC:COUPLE`

Apply Wave Correction

See "Wave Correction" on page 359.

Remote command:

`[SENSe<Ch>:]CORRection:EWAVE[:STATe]`

Settling Tolerance

Defines the maximum variation of the source signal level after the ALC has settled.

The "Settling Tolerance" has an impact on the [ALC Path IF Bandwidth](#) in "Auto" mode: other things being equal, the smaller the "Settling Tolerance" the smaller the auto-selected filter bandwidth.

Remote command:

`SOURce<Ch>:POWER:ALC:STOLerance`

Show Advanced Settings

Shows or hides advanced ALC settings:

								ALC Optimize
								Auto
Clamp	ALC Path IF Bandwidth	ALC: DeEmbedding	Control Loop Parameters: Coefficients	Control Loop Parameters: Kr	Control Loop Parameters: Ti	Control Loop Parameters: Control Time	Control Loop Parameters: Auto Settling	
<input checked="" type="checkbox"/>	Auto	Off	Auto				<input type="checkbox"/>	
<input checked="" type="checkbox"/>	Auto	Off	Auto				<input type="checkbox"/>	
<input checked="" type="checkbox"/>	Auto	Off	Auto				<input type="checkbox"/>	
<input checked="" type="checkbox"/>	Auto	Off	Auto				<input type="checkbox"/>	

ALC Optimize ← Show Advanced Settings

Enables/configures [ALC optimization](#).

"Auto" (default) The firmware decides whether speed optimization is performed.

"On" Optimization active

"Off" Optimization inactive

Remote command:

`SOURce<Ch>:POWER<Pt>:ALC:OPTimize`

Clamp ← Show Advanced Settings

Suspends the ALC mechanism while the analyzer acquires measurement data. The automatic level adjustment during the measurement is controlled via "Clamp" and [Control Range +/-](#).

Remote command:

`SOURce<Ch>:POWER<Pt>:ALC:CLAMP`

ALC Path IF Bandwidth ← Show Advanced Settings

Selects the bandwidth in the ALC control loop.

Values above 100 kHz are only available on the [wideband](#) signal path. The 7 MHz filter was introduced in firmware version 2.40 to improve convergence speed, which allows shorter pulses with ALC.

"Auto" means, the analyzer selects the appropriate IF bandwidth, depending on the source frequency and level.

If the [Control Loop Parameters](#) are determined automatically, then the "ALC Path IF Bandwidth" also affects the resulting "Control Loop Parameters".

Remote command:

```
SOURce<Ch>:POWER:ALC:AUBW
```

```
SOURce<Ch>:POWER:ALC:BANDwidth
```

Control Loop Parameters ← Show Advanced Settings

Defines the tuning coefficients of the proportional-integral (PI) controller the analyzer uses as a feedback controller for ALC; see "[Control loop parameters](#)" on page 117.

By default the parameters are selected by the analyzer firmware ("Coefficients" = "Auto"). With automatic selection of the [ALC Path IF Bandwidth](#), this option is the only one. If "ALC Path IF Bandwidth" is set manually, it is also possible to vary the proportional gain "Kr", the integration time "Ti", and the "Control Time" manually.

The latter specifies the maximum duration of the control loop phase, per measurement point. With "Auto Settling" enabled, the firmware exits the control loop when the convergence criteria are met, and does not wait until the "Control Time" has elapsed.

Remote command:

```
SOURce<Ch>:POWER<Pt>:ALC:PIParameter
```

```
SOURce<Ch>:POWER<Pt>:ALC:PIParameter:GAIN
```

```
SOURce<Ch>:POWER<Pt>:ALC:PIParameter:ITIME
```

```
SOURce<Ch>:POWER:ALC:PIParameter:CTIME
```

```
SOURce<Ch>:POWER:ALC:PIParameter:ASETtling
```

5.8.2.4 Cal Premeas Config dialog

Enables and configures calibration (i.e. power correction) from previous measurements.

Access: Channel – [Pwr Bw Avg] > "Power" > "Cal Premeas Config..."

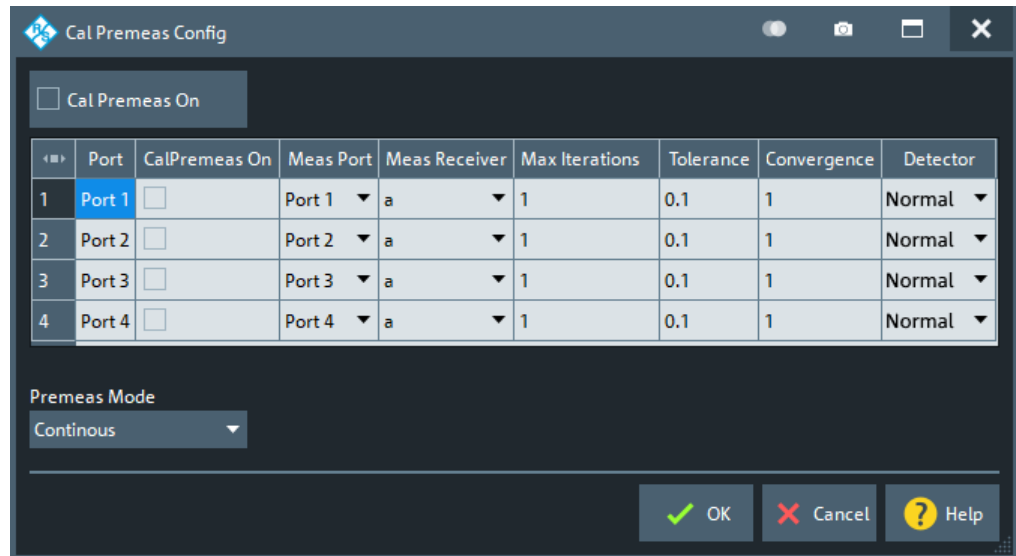

Cal Premeas On

Activates/deactivates power correction from previous measurements for the current channel.

Remote command:

`SOURce<Ch>:POWER:CPremeas:CStAtE`

Cal Premeas On (table area)

Enables or disables power correction from previous measurements for the respective port.

Only takes effect, if [Cal Premeas On](#) is active for the current channel.

Remote command:

`SOURce<Ch>:POWER<Pt>:CPremeas[:STATe]`

Meas Port/Meas Receiver (table area)

Defines the received signal to be used for power correction from previous measurements, i.e. whose power the R&S ZNA tries to keep at the level defined in the [port configuration](#).

Remote command:

`SOURce<Ch>:POWER<Pt>:CPremeas:RECeiver`

Max Iterations/Tolerance/Convergence (table area)

Defines the parameters for [Premeas Mode](#) "Once".

In general, cal premeas uses the convergence logic of a flatness cal. See "[Flatness Cal – Max Iterations](#)" on page 628, "[Flatness Cal – Tolerance](#)" on page 628, "[Flatness Cal – Convergence](#)" on page 628.

However, to prevent the generators from oscillating, for cal premeas convergence factors >1 are not allowed.

Remote command:

```
SOURce<Ch>:POWer<Pt>:CPRe meas:NREadings  
SOURce<Ch>:POWer<Pt>:CPRe meas:NTOLerance  
SOURce<Ch>:POWer<Pt>:CPRe meas:CFACTOR
```

Detector (table area)

Selects the detector to be used during the calibration pre-measurement. See [Chapter 4.3.5.3, "Detector settings"](#), on page 160.

Remote command:

```
SOURce<Ch>:POWer<Pt>:CPRe meas:DETECTOR
```

Premeas Mode

Defines how the firmware performs calibration pre-measurements in the current channel:

- | | |
|------------------------|---------------------------------------------------------------------------------------------------------------------------------------------------------------------------------------|
| "Continuous" (default) | The correction is applied continuously, from one sweep to the next. |
| "Once" | The correction is applied once, at the initial start of the measurement. The Max Iterations/Tolerance/Convergence (table area) settings define the convergence logic. |

Remote command:

```
SOURce<Ch>:POWer:CPRe meas:MODE
```

5.8.3 Time Domain X-Axis tab

If the active trace is a time domain trace, these settings define its stimulus axis.



Time domain analysis requires option R&S ZNA-K2. If this option is not installed, the "Time Domain X-Axis" tab is hidden.



Related information

Refer to the following sections:

- [Chapter 4.7.2, "Time domain analysis"](#), on page 247
- [Chapter 5.5.5, "Time Domain tab"](#), on page 447

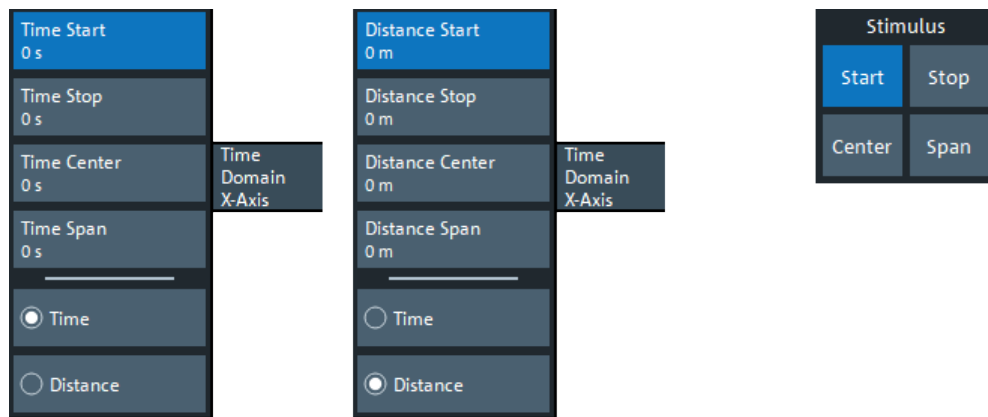

Figure 5-17: Stimulus > Time Domain X-Axis softtool tab

left = Time representation
right = Distance representation

Time Start / Time Stop / Time Center / Time Span

Defines the display range for the time domain trace in time representation (see "Time / Distance" on page 535).

- "Time Start" is the lowest displayed time and corresponds to the left edge of the Cartesian diagram.
- "Time Stop" is the highest displayed time and corresponds to the right edge of the Cartesian diagram.
- "Time Center" corresponds to the center of the Cartesian diagram, i.e. $(\text{"Time Start"} + \text{"Time Stop"})/2$.
- "Time Span" corresponds to the diagram width, i.e. $(\text{"Time Stop"} - \text{"Time Start"})$.

"Time Start" and "Time Stop" or "Time Center" and "Time Span" are alternative settings.

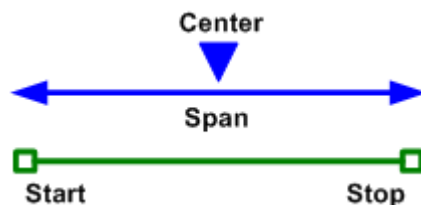

Remote command:

```
CALCulate<Chn>:TRANSform:TIME:START
CALCulate<Chn>:TRANSform:TIME:STOP
CALCulate<Chn>:TRANSform:TIME:CENTer
CALCulate<Chn>:TRANSform:TIME:SPAN
```

Distance Start / Distance Stop / Distance Center / Distance Span

Defines the display range for the time domain trace in distance representation (see "Time / Distance" on page 535).

"Distance Start" and "Distance Stop" or "Distance Center" and "Distance Span" are alternative settings.

Remote command:

n.a.

See [Time Start / Time Stop / Time Center / Time Span](#).

Time / Distance

"Time" and "Distance" switch over between the x-axis scaling in time units or distance units.

The interpretation of time and distance depends on the measurement type. For reflection measurements (S-parameters S_{ii} or ratios with equal port indices), the time axis represents the propagation time of a signal from the source to the DUT and back. For transmission measurement, it represents the propagation time from the source through the device to the receiver.

The distance between the source and the DUT is calculated from the propagation time, the velocity of light in the vacuum, and the velocity factor of the receiving port:

- $Distance = \langle Time \rangle * c_0 * \langle Velocity Factor \rangle$ for transmission measurements
- $Distance = 1/2 * \langle Time \rangle * c_0 * \langle Velocity Factor \rangle$ for reflection measurements. The factor 1/2 accounts for the return trip from the DUT to the receiver.

The velocity factor of the receiving port can be defined using Channel – [Offset Embed] > "Offset" (see [Chapter 5.14.2.1, "Controls on the Offset tab"](#), on page 717).

Remote command:

`CALCulate<Chn>:TRANSform:TIME:XAXis`

5.9 Pwr Bw Avg softtool

The "Pwr Bw Avg" softtool allows you to configure the signal power, to set up the IF signal processing, and to configure the averaging logic.

Access: Channel – [Pwr Bw Avg] key

5.9.1 Power tab

The "Power" tab allows you to configure the signal power. It is identical to the "Stimulus" > "Power" tab; see [Chapter 5.8.2, "Power tab"](#), on page 525.

5.9.2 Bandwidth tab

Sets the measurement bandwidth and the shape of the digital and analog IF filters for the active channel.

A system error correction (calibration) remains valid when the filter settings are changed.



Optimizing the filter settings

A small bandwidth and a high selectivity of the digital IF filter suppress the noise level around the measurement frequency, and thus increase the dynamic range. However, the measurement time increases with smaller filter bandwidths and high selectivity. For small bandwidths, the filter settling time, which is inversely proportional to the bandwidth, is responsible for the predominant part of the measurement time.

The characteristics of the high selectivity filter make it particularly suitable for isolating unexpected spurious responses or known mixer products.



Segmented sweeps

In segmented frequency sweeps, the filter settings can be selected independently for each segment. See [Chapter 5.10.3.2, "Define Segments dialog"](#), on page 553.

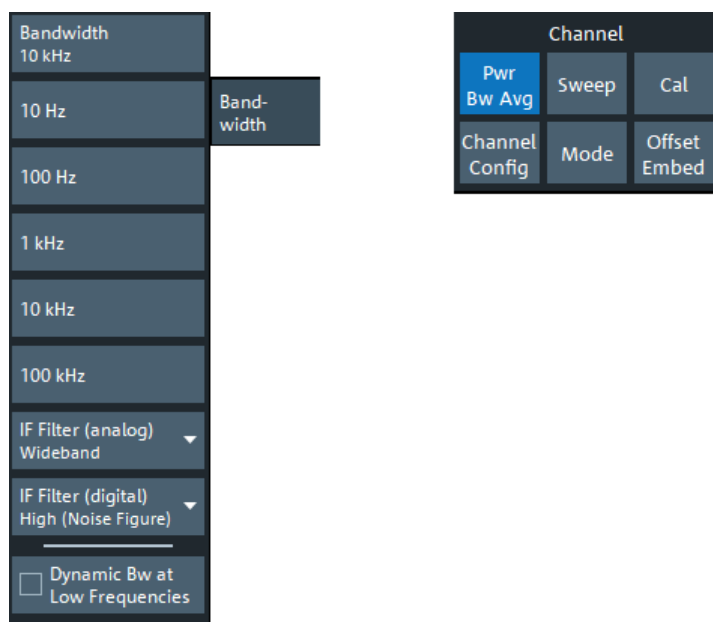

Bandwidth

"Bandwidth" the measurement bandwidth of the IF filter. Within the value range, the entered value is rounded up to $1 \cdot 10^n$ Hz, $1.5 \cdot 10^n$ Hz, $2 \cdot 10^n$ Hz, $3 \cdot 10^n$ Hz, $5 \cdot 10^n$ Hz, $7 \cdot 10^n$ Hz ($n \geq 0$). Values exceeding the maximum bandwidth are rounded down.

The bandwidth range is 1 Hz to 1.5 MHz. Option R&S ZNA-K17 enables measurement bandwidths up to 30 MHz (see [Chapter 4.7.8, "Increased IF bandwidth 30 MHz"](#), on page 288). Bandwidths above 1.5 MHz are only available for the wideband signal path (see ["IF Filter \(analog\)"](#) on page 537).

For **spectrum measurement channels**, the **resolution bandwidth (RBW)** is set instead of the IF bandwidth. The label changes accordingly. Currently the RBW is limited to 1.5 MHz, no matter if option R&S ZNA-K17 is installed.

Remote command:

```
[SENSe<Ch>:]BANDwidth[:RESolution]
```

```
[SENSe<Ch>:]BWIDth[:RESolution]
```

IF Filter (analog)

Selects the analog IF signal path.

- "Normal" Standard high precision path
- "Wideband" Wideband path with 50 MHz lowpass filter
- "Narrowband" Narrowband path with 10.7 MHz bandpass filter

For a VNA system R&S ZNA67EXT, selecting the "IF Filter (analog)"

Cannot be selected if the analyzer uses [Direct IF access](#) as [Receiver Input](#), in which case you can select a [Rear Input Path](#).

Exception: For a VNA system R&S ZNA67EXT, the "IF Filter (analog)" setting determines both the low-band path (frequencies below ~67 GHz via [Direct generator/receiver access](#)) and the high band path (frequencies above ~67 GHz via [Direct IF access](#)).

"IF Filter (analog)"	Low band signal path	High band signal path
"Normal"	Standard high precision path	Wideband path ("BP_279M")
"Wideband"	Wideband path	Wideband path
"Narrowband"	Narrowband path	Narrowband path ("LP_60M")

Note that if you select "Narrowband" for a R&S ZNA67EXT, you have to reduce the IF frequency down to 30 MHz or lower.

Remote command:

```
[SENSe<Ch>:]IFPath
```

IF Filter (digital)

Selects the shape of the digital IF filter:

- "Normal" selectivity filters provide a short settling time (recommended for fast measurements).
- "High Selectivity" filters have steep edges and the longer settling times. This filter type is suitable for isolating adjacent signals which are separated by a small frequency spacing.

Remote command:

```
[SENSe<Ch>:]BANDwidth[:RESolution]:SElect
[SENSe<Ch>:]BWIDth[:RESolution]:SElect
```

Dynamic Bw at Low Frequencies

If "Dynamic Bw at Low Frequencies" is enabled, then at receiver frequencies below 500 MHz the analyzer reduces the selected IF [Bandwidth](#) by a frequency-dependent (dynamic) factor. The bandwidth reduction reduces the trace noise at small frequencies and improves the accuracy of the time domain transform.

Remote command:

```
[SENSe<Ch>:]BANDwidth[:RESolution]:DREDuction
```

5.9.3 Average tab

Defines the number of consecutive sweeps to be averaged and enables/disables the sweep average.



Effects of sweep averaging, alternative settings

An average over several sweeps reduces the influence of random effects in the measurement and therefore minimizes the noise level. The effect increases with the average factor, however, obtaining an averaged result requires several sweeps and therefore increases the measurement time.

Smoothing is an alternative method of compensating for random effects on the trace by averaging adjacent measurement points. Compared to the sweep average, smoothing does not significantly increase the measurement time but can eliminate narrow peaks and thus produce misleading results.

The sweep average is not frequency selective. To eliminate a spurious signal near the measurement frequency, alternative techniques (e.g. a smaller filter bandwidth) must be used.



The average factor is also valid for calibration sweeps. The calculation of system correction data is based on the averaged trace.

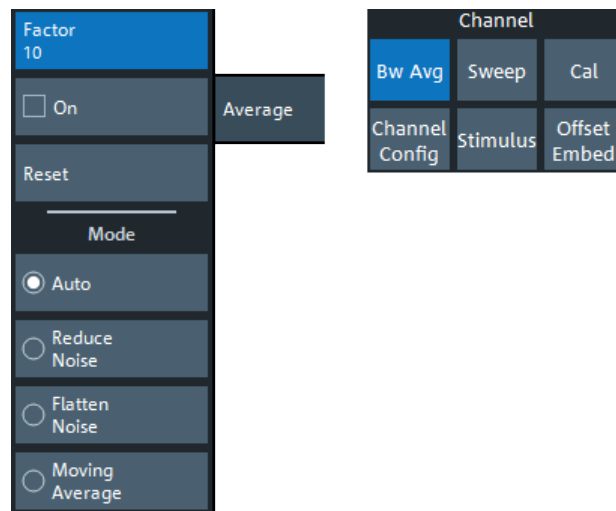

Factor / On / Reset

"Factor" defines the number of averaged traces, "On" enables or disables the sweep average, "Reset" starts a new average cycle. The average cycle is also restarted when the [averaging mode](#) is changed.

Remote command:

```
[SENSe<Ch>:] AVERAge: COUNT
[SENSe<Ch>:] AVERAge [ : STATE]
[SENSe<Ch>:] AVERAge: CLear
```

Mode

Selects one of the following averaging algorithms:

- **"Auto"**: Automatic selection between **"Reduce Noise"** and **"Flatten Noise"** mode, depending on the trace type.
- **"Reduce Noise"**: Cumulative moving averages of the real and imaginary parts of each measurement result, provides the most effective noise suppression for the "Real" and "Imag" formats and for polar diagrams.
- **"Flatten Noise"**: Cumulative moving averages of the (linear) magnitude and phase values, provides the most effective noise suppression for the "dB Mag", "Phase", "Unwr. Phase", and "Lin Mag" formats.
- **"Moving Average"**: Simple moving averages of the real and imaginary parts of each measurement result; similar to "Reduce Noise", but with finite history.

Changing the mode resets the average cycle.

Note: For frequency conversion measurements, always "Flatten Noise" is used.

Remote command:

[SENSe<Ch>:] AVERage:MODE

5.10 Sweep Softtool

The "Sweep" softtool allows you to define the scope of the measurement in the active channel.

The available settings comprise the sweep type (with related parameters), the trigger conditions, and the periodicity of the measurement.

Access: Channel – [Sweep] key

**Background information**

Refer to the following sections:

- [Chapter 4.1.4, "Sweep control"](#), on page 110
- [Chapter 4.1.4.3, "Stimulus and sweep types"](#), on page 113

5.10.1 Sweep Params tab

Allows you to define the scope and timing of the measurement in the active channel.

**Segmented sweeps**

In "Segmented" linear frequency sweeps, the sweep parameters can be set independently for each segment. See [Chapter 5.10.3.2, "Define Segments dialog"](#), on page 553.



System error correction

In general, the system error correction is no longer valid after a change of the sweep parameters. The status of the calibration is shown in the trace list. If the number of points is changed, the analyzer interpolates the correction data. The calibration label "Cal Int" is displayed. See also [Chapter 4.5.4, "Calibration labels"](#), on page 206.

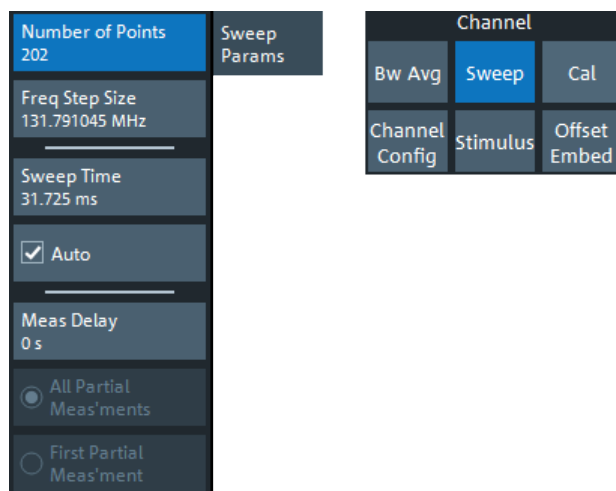

Number of Points

Sets the total number of measurement points per sweep. The minimum number of points is 1 (measurement at a single frequency/power/time value), the maximum is 100,001.

Together with the sweep range defined in the [Stimulus tab](#) of the "Stimulus" softtool, this parameter defines the grid of sweep points. The step width between two consecutive sweep points is constant on a linear scale (sweep types "Lin Freq", "Time" and "CW Mode") or on a logarithmic scale (sweep types "Log Freq" and "Power").

The sweep points for linear frequency sweeps can also be defined using the [Freq Step Size](#).

Tip: Measurement time and screen resolution

Increasing the number of sweep points improves the resolution of the trace but increases the measurement time. The overall measurement time is composed of the hardware settling time at the beginning of the sweep plus the sum of the measurement times at each individual sweep point. Hence the measurement time increases roughly linearly with the number of points.

See also [Chapter 4.1.4, "Sweep control"](#), on page 110.

Remote command:

```
[SENSe<Ch>:] SWEEp: POINTs
```

Freq Step Size

Sets the distance between two consecutive sweep points of a linear frequency sweep.

For linear frequency sweeps the step size is an alternative to the [Number of Points](#) setting:

- If the sweep range is defined via "Start Frequency" and "Stop Frequency", both the "Stop Frequency" value and the "Number of Points" can vary as the "Freq Step Size" is changed. The "Stop Frequency" value is changed as little as possible so that the condition $\text{"Freq Step Size"} = (\text{"Stop Frequency"} - \text{"Start Frequency"}) / (\text{"Number of Points"} - 1)$ can be fulfilled. Changing the "Start Frequency" and "Stop Frequency" modifies the "Freq Step Size".
- If the sweep range is defined via "Center Frequency" and "Span Frequency", both the "Span Frequency" value and the "Number of Points" can vary as the "Freq Step Size" is changed. The "Span Frequency" is reduced as little as possible so that the condition $\text{"Freq Step Size"} = \text{"Span Frequency"} / (\text{"Number of Points"} - 1)$ can be fulfilled. Changing the "Span Frequency" modifies the "Freq Step Size".

Note:

- This setting is valid for linear frequency sweeps only. It does not apply to logarithmic and segmented sweeps, power, time or CW mode sweeps.
- Decreasing the "Freq Step Size" generally increases the measurement time.

Remote command:

`[SENSe<Ch>:] SWEep:STEP`

Sweep Time / Auto

Varies the measurement time for a sweep or delays the start of each sweep.

- "Sweep Time" is the total measurement time for the sweep. The minimum possible sweep time is equal to the estimated value in "Auto" mode. Setting a larger sweep time is equivalent to defining a [Meas Delay](#) before each partial measurement.
- "Auto" minimizes the sweep time. The [Meas Delay](#) is set to 0 s. "Sweep Time" indicates the estimated sweep time, depending on the current measurement settings. The "Sweep Time" and "Meas Delay" values are maintained until changed explicitly if "Auto" is switched off.

If a time sweep is active, "Sweep Time" cannot be modified. The analyzer uses the previously defined sweep time settings.

Remote command:

`[SENSe<Ch>:] SWEep:TIME`

`[SENSe<Ch>:] SWEep:TIME:AUTO`

Meas Delay

Adds a delay time before the start of every partial measurement. See [Chapter 4.1.4.1, "Partial measurements and driving mode"](#), on page 111 .

"Meas Delay" is not available while a "Time" or "CW Mode" sweep is active.

As an alternative to increasing the delay (and thus the total sweep time), it is possible to select "Alternated" driving mode; see ["Driving Mode"](#) on page 687.

Remote command:

`[SENSe<Ch>:] SWEep:DWELL`

All Partial Meas'ments / First Partial Meas'ment

If [Meas Delay](#) is set to a value > 0, this setting allows you to define how the measurement delay is applied:

- If "All Partial Meas'ments" is selected, the delay time is added before each partial measurement. For a complete 2-port S-parameter measurement, the delay must be added twice per sweep point.
- If "First Partial Meas'ment" is selected, the delay time is added once per sweep point only, irrespective of the measured quantities and the number of partial measurements. The sweep time increases by the measurement delay times the number of sweep points.

Tip: A delay time before the start of each partial measurement increases the accuracy, in particular for measurements on DUTs with long settling times (e.g. quartz oscillators, SAW filters). Select "First Partial Meas'ment" if the DUT does not require an additional settling time due to the interchange of source and receive ports.

Remote command:

```
[SENSe<Ch>:]SWEep:DWELl:IPoint
```

5.10.2 Wait Time Control tab



Background information

See [Chapter 4.1.4.4, "Wait time control"](#), on page 115.

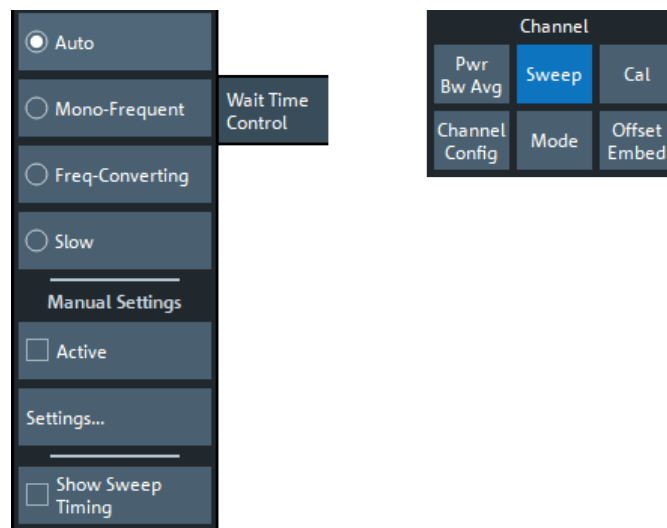

5.10.2.1 Controls on the Wait Time Control tab

Here you can determine how the R&S ZNA calculates various HW settling wait times ([Auto](#) | ... | [Slow](#)), overwrite or limit certain wait times ([Manual](#)), and observe the effect of your settings on measurement speed [Show Sweep Timing](#).

Auto | ... | Slow

The R&S ZNA firmware implements three algorithms for calculating hardware settling wait times (see ["Wait time control algorithms"](#) on page 115). Choose one of these algorithms, or let the R&S ZNA decide which one to use ("Auto" = default).

Calculated wait times are point-specific and not constant. In [controlled timing mode](#), however, this is a must. To achieve constant wait times, the firmware chooses the maximum wait time calculated for the measurement points as the constant wait time.

In [manual mode](#) mode, you can overwrite or limit the calculated values.

Remote command:

```
[SENSe<Ch>:] SWEEp:TIME:MODE
```

Manual

"Active" allows you to activate or deactivate manual wait time control, "Settings..." opens a dialog that allows you to define manual wait times (see [Chapter 5.10.2.2, "Manual Wait Time Settings dialog"](#), on page 543).

Remote command:

```
[SENSe<Ch>:] SWEEp:CTIMing:MODE
```

Show Sweep Timing

Show/hides the sweep timing info box.



Ch 1	
Wait Time	: 000.000 s
Measurement Time	: 160.001 ms
First Point Wait Time	: 002.000 ms
SweepRetrace Time	: 048.012 s
SweepCycle Time	: 048.172 s
Avg of Cycle Times	: 022.164 s
Max of Sweep Cycle Time	: 048.683 s
Min of Sweep Cycle Time	: 804.914 ms
BusyTime	: 048.172 s

See [Table 4-2](#).

Note: The firmware does not display the sweep timing info box, if the display of instrument messages is blocked (see ["Show Instrument Messages"](#) on page 864).

Remote command:

```
[SENSe<Ch>:] SWEEp:CTIMing:VISualize
```

5.10.2.2 Manual Wait Time Settings dialog

Allows you to activate and configure manual wait times for different channel/sweep events. By selectively activating manual values for certain events, you can also configure a mixture of calculated and manual wait times.



In [controlled timing mode](#), the firmware chooses the maximum **total** wait time calculated or set for the measurement points as the constant wait time. For the first point in a channel, the total wait time comprises the calculated wait time for channel initialization ([Channel Begin](#)), which cannot be set in controlled timing mode.

Access: Channel – [Sweep] > "Wait Time Control" tab > "Manual Settings" section > "Settings..."



Active

Activates or deactivates manual wait time control for the current channel. Same functionality as the "Active" checkbox on the [Wait Time Control tab](#).

If checked, you can activate and configure manual wait times for various channel and sweep events.

Remote command:

```
[SENSe<Ch>:] SWEEp:CTIMing:MODE
```

Channel Begin

Allows you to activate and specify manual wait times for the begin of the current channel. A distinction is made between:

- "same" – the current channel is the first one to be swept, or the same as the previously swept one
- "other" – the current channel is different from the previously swept one

Manual wait times for "same" and "other" can be activated separately, and different minimum wait times can be specified. The (common) lower limit for the minimum wait times is determined by certain HW properties and enforced by the analyzer firmware.

This setting is **not** available in [controlled timing mode](#).

Remote command:

"same":

```
[SENSe<Ch>:] SWEEp:CTIMing:CHANnel:MODE
```

```
[SENSe<Ch>:] SWEEp:CTIMing:CHANnel
```

"other":

```
[SENSe<Ch>:] SWEEp:CTIMing:OCHannel:MODE
```

```
[SENSe<Ch>:] SWEEp:CTIMing:OCHannel
```

First Point of Ch / Drive Port Change

Activates or deactivates manual wait times for the current channel's first point, and its points following a drive port change. Minimum and maximum wait times can be activated and specified separately. They are valid for both channel event types.

Remote command:

Minimum wait time:

```
[SENSe<Ch>:] SWEEp:CTIMing:PORT:MIN:MODE
```

```
[SENSe<Ch>:] SWEEp:CTIMing:PORT:MIN
```

Maximum wait time:

```
[SENSe<Ch>:] SWEEp:CTIMing:PORT:MAX:MODE
```

```
[SENSe<Ch>:] SWEEp:CTIMing:PORT:MAX
```

First Point of Segments

Separately activates and specifies exact manual wait times for:

- The first point of a segment, if the current channel performs a segmented frequency sweep
- The first point of each (power) subsweep, if the current channel performs a two-dimensional gain compression sweep

Only applies to those points that are not [First Point of Ch / Drive Port Change](#).

Remote command:

Segmented frequency sweep:

```
[SENSe<Ch>:] SWEEp:CTIMing:SEGment:MODE
```

```
[SENSe<Ch>:] SWEEp:CTIMing:SEGment
```

2-dimensional gain compression measurements:

```
[SENSe<Ch>:] SWEEp:CTIMing:COMPression:MODE
```

```
[SENSe<Ch>:] SWEEp:CTIMing:COMPression
```

All Points

Activates and specifies manual wait times for other sweep points.

- "Auto" deactivates manual settings
- "User Def" allows you to specify an exact value
- "Limited" allows you to specify an allowed range

Remote command:

```
[SENSe<Ch>:] SWEEp:CTIMing:STIME:MODE
```

```
[SENSe<Ch>:] SWEEp:CTIMing:STIME
```

```
[SENSe<Ch>:] SWEEp:CTIMing:STIME:MIN
```

```
[SENSe<Ch>:] SWEEp:CTIMing:STIME:MAX
```

5.10.3 Sweep Type tab

Defines the sweep variable (frequency/power/time), the position of the sweep points across the sweep range, and some aspects of sweep execution.

5.10.3.1 Controls on the Sweep Type tab

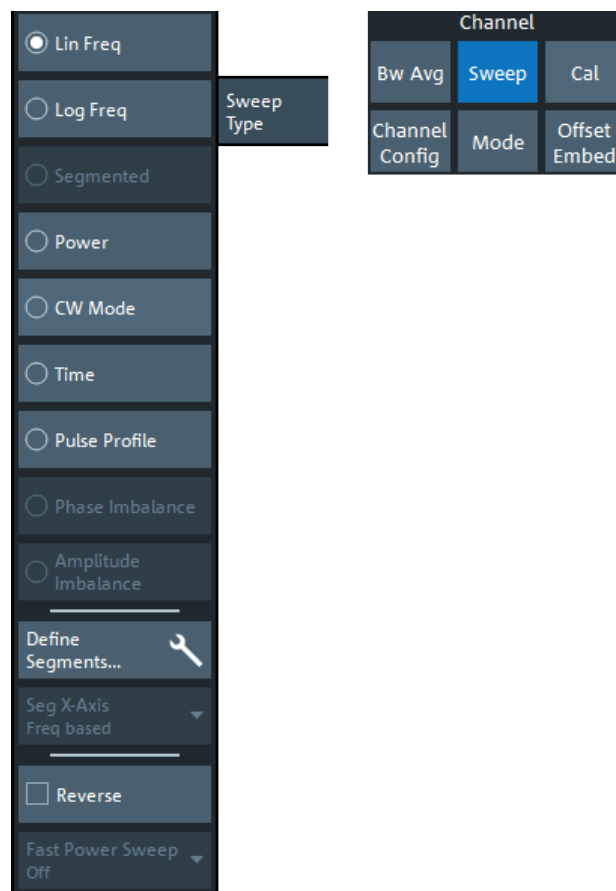

Lin Freq

In a linear frequency sweep, the stimulus frequency is swept in equidistant steps over the continuous frequency range. The frequency range (sweep range) and the internal generator power can be specified in the "Stimulus" settings (see [Chapter 5.8.1, "Stimulus tab"](#), on page 522). The step width between two consecutive sweep points is constant and given by $\frac{\text{Span}}{(n - 1)}$ where n is the specified "Number of Points" ($n > 1$).

"Lin Freq" is the default sweep type. In a Cartesian diagram, the measurement result is displayed as a trace over a linear frequency scale (as known, e.g., from spectrum analyzers). The following example shows a "Lin Freq" sweep with the forward transmission parameter S_{21} as measured quantity, and a "dB Mag" scaled y-axis.

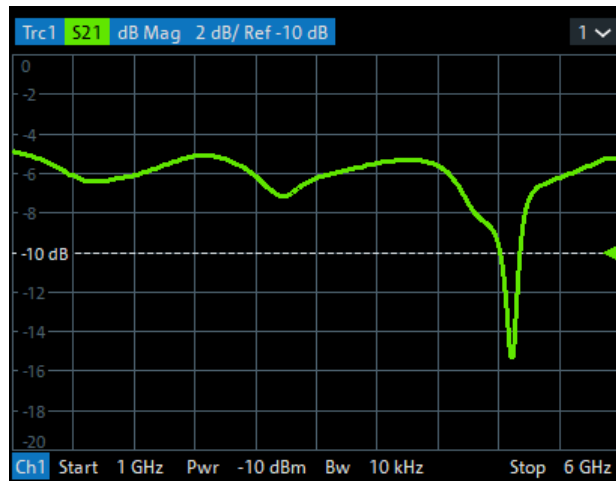

Remote command:

```
[SENSe<Ch>:] SWEEP:TYPE LINear
```

Log Freq

In a "Log Freq" sweep, the stimulus frequency is swept on a logarithmic scale over the continuous frequency range. The frequency range (sweep range) and the internal generator power can be specified in the "Stimulus" settings (see [Chapter 5.8.1, "Stimulus tab"](#), on page 522). The sweep points are calculated from the "Span" and the specified "Number of Points" ($n > 1$) with the condition that the step width is constant on the logarithmic scale.

"Log Freq" sweeps are suitable for the analysis of a DUT over a large frequency range, e.g. over several octaves. In a Cartesian diagram, the measurement result is displayed as a trace over a logarithmic frequency scale. The following example shows a "Log Freq" sweep with the forward transmission parameter S_{21} as measured quantity, and a "dB Mag" scaled y-axis.

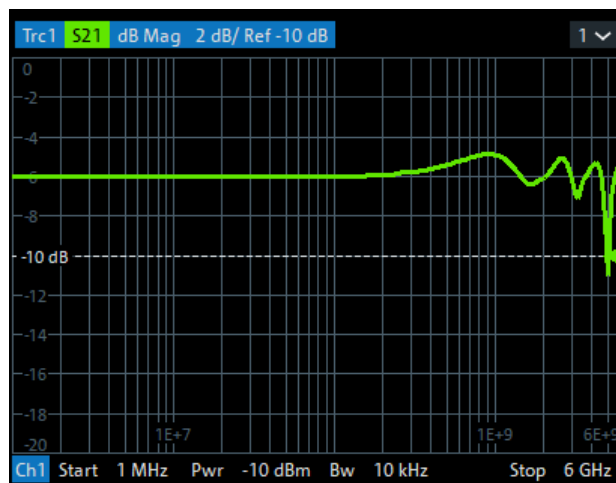

Tip: In "Log Freq" representation, limit lines and ripple limit lines appear as exponential curves; see [Chapter 4.4.1.1, "Rules for limit line definition"](#), on page 169.

Remote command:

```
[SENSe<Ch>:] SWEEP:TYPE LOGarithmic
```

Segmented

In a "Segmented" (linear) frequency sweep, the sweep range can be composed of several continuous frequency sub-ranges or single frequency points. The sub-ranges are termed sweep segments and are defined in the [Define Segments dialog](#).

Sweep segments can overlap. The segment list must contain at least 2 distinct frequency points before a segmented frequency sweep can be started.

Instrument settings such as the internal generator power, the measurement (IF) bandwidth, and the frequency band of the local oscillator can be set independently for the individual segments.

Due to this flexibility, segmented frequency sweeps are suitable for any detailed analysis of a DUT at specified frequencies. In a Cartesian diagram, the measurement result is displayed as a trace over a linear frequency scale ranging from the lowest to the highest frequency point of all segments. The following example shows a segmented frequency sweep with 2 segments. The forward transmission parameter S_{21} is measured, and a "dB Mag" scaled y-axis is used. In the frequency range between the sweep segments, the trace is displayed as a straight line.

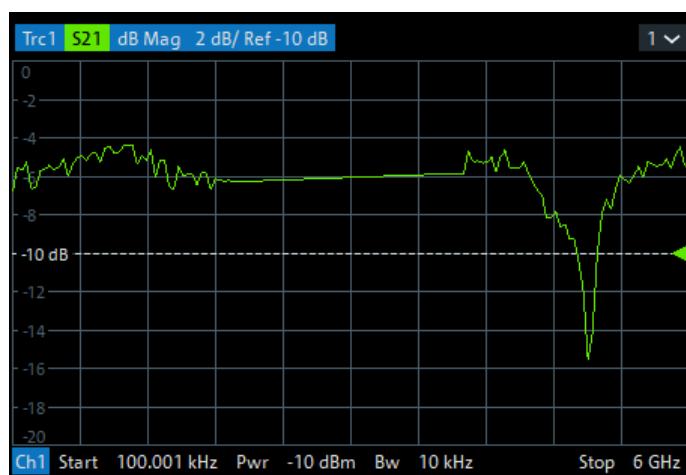

Tip: You can change to point based x-axis to improve the display of a segmented frequency sweep (see ["Seg X-Axis"](#) on page 551).

Remote command:

```
[SENSe<Ch>:] SWEEP:TYPE SEGMENT
```

Power

In a "Power" sweep, the internal generator power is swept in dB-linear, equidistant steps over a continuous power range. The generator power range (sweep range) and the fixed frequency can be specified in the "Stimulus" settings (see [Chapter 5.8.1, "Stimulus tab"](#), on page 522).

"Power" sweeps are particularly suitable for the analysis of non-linear effects (saturation, compression) on active and passive DUTs (e.g. power amplifiers, mixers).

In a Cartesian diagram, the measurement result is displayed as a trace over a dB-linear power scale. The following example shows a "Power" sweep in the source power range between -25 dBm and 0 dBm, performed at a CW frequency of 1 GHz.

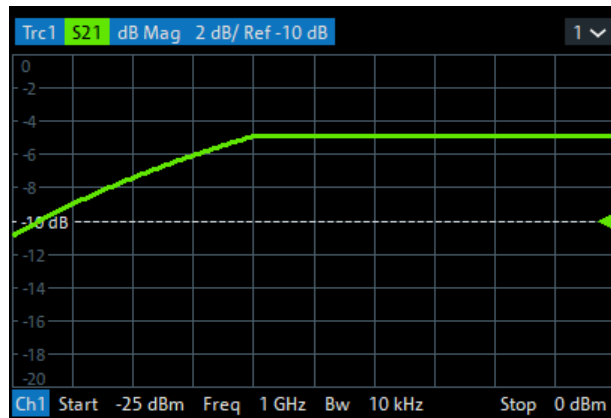

Any generator power calibration or attenuation of the active source step attenuators is included.

Remote command:

```
[SENSe<Ch>:] SWEp:TYPE PWEr
```

CW Mode

"CW Mode" sweeps, like [Time](#) sweeps, are performed at constant frequency and stimulus power, which can be specified in the "Stimulus" settings (see [Chapter 5.8.1, "Stimulus tab"](#), on page 522).

The measurement is triggered according to the current trigger settings (see [Chapter 5.10.4, "Trigger tab"](#), on page 558). Each trigger event triggers the first partial measurement of a measurement point. The time interval between two consecutive measurements depends on the trigger settings and the sweep parameters (especially the number of points). Any trigger mode is allowed.

A "CW Mode" sweep corresponds to the analysis of a signal over the time with a time scale and resolution that is determined by the trigger events. In a Cartesian diagram, the measurement result is displayed as a trace over a linear time scale (like, e.g., in an oscilloscope). The diagram is similar to the "Time" diagram. The following example shows a "CW Mode" sweep with a DUT that does not markedly change its transmission characteristics over the time.

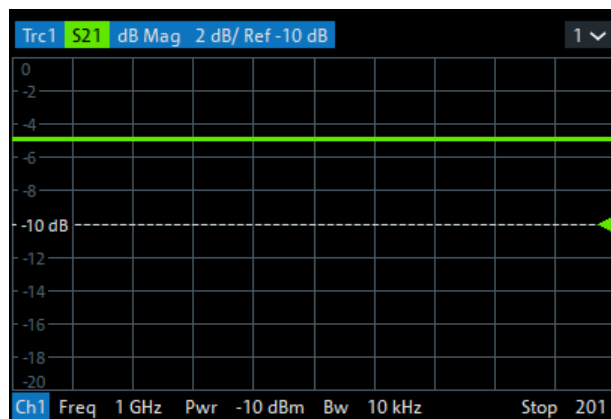

Tip: Sweep time

The time interval between two consecutive trigger pulses must not be smaller than the minimum measurement time per measurement point. See ["Sweep Time / Auto"](#) on page 541.

Remote command:

```
[SENSe<Ch>:] SWEep:TYPE POINT
```

Time

"Time" sweeps, like [CW Mode](#) sweeps, are performed at constant frequency and stimulus power, which can be specified in the "Stimulus" settings (see [Chapter 5.8.1, "Stimulus tab"](#), on page 522). A single sweep extends over a specified period of time, defined via the "Stop Time" setting. The time intervals between two consecutive sweep points are calculated according to "Stop Time"/(n - 1) where n is the selected [Number of Points](#).

A "Time" sweep corresponds to the analysis of a signal over the time; the function of the analyzer is analogous to an oscilloscope. In a Cartesian diagram, the measurement result is displayed as a trace over a linear time scale. The following example shows a "Time" sweep with a DUT that does not markedly change its transmission characteristics over the time.

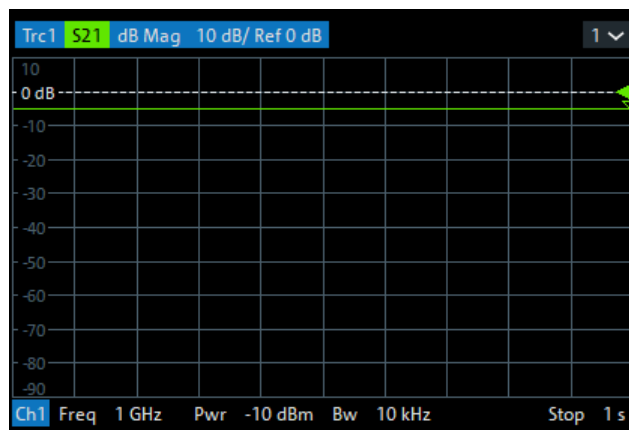

Tip: Sweep time

The minimum sweep time depends on the number of measurement points, the measurement bandwidth, the delay time before each partial measurement and the number of partial measurements required for each measurement point. The analyzer estimates this time, based on the current measurement settings.

If the "Stop Time" is smaller than the estimated minimum sweep time, the entered value is increased automatically.

Equidistance of sweep points

The analyzer tries to keep the time intervals between any two consecutive time sweep points equal: The time sweep samples are equidistant. Equidistance also holds for sweeps which range over several channels.

Remote command:

```
[SENSe<Ch>:] SWEep:TYPE CW
```

Pulse Profile

This sweep type is only available, if the R&S ZNA is equipped with software option R&S ZNA-K7 [Pulsed measurements](#).

Activates the pulse profile sweep defined in the [Pulse Modulation dialog](#).

Remote command:

```
[SENSe<Ch>:]SWEep:TYPE PULSe
```

Phase Imbalance/ Amplitude Imbalance

These sweep types are only available, if the R&S ZNA is equipped with software option R&S ZNA-K6 [Phase coherent source control](#). They can only be activated if [source coherence](#) or [True Differential Mode](#) is active.

Remote command:

```
[SENSe<Ch>:]SWEep:TYPEIPHase | IAMplitude
```

Define Segments...

Opens the [Define Segments dialog](#) that allows to set up the channel for a [Segmented](#) frequency sweep.

Seg X-Axis

Scales the x-axis for a segmented frequency sweep:

- In "Freq based" mode, the x-axis covers the frequency ranges of all sweep segments, including possible gaps between the segments. Equal frequency spacings correspond to equal distances on the x-axis.
- In "Point based" mode, the x-axis shows all sweep points with equal spacings. Gaps between sweep segments are minimized; no diagram space is "wasted" on unused frequency ranges. Point-based mode is indicated in the channel line.

The example below shows a segmented frequency sweep with two segments. The first segment ranges from 1 GHz to 1.4 GHz; the second segment from 2 GHz to 3 GHz. Both segments contain 11 sweep points. In point-based mode (lower diagram), all sweep points are equidistant.

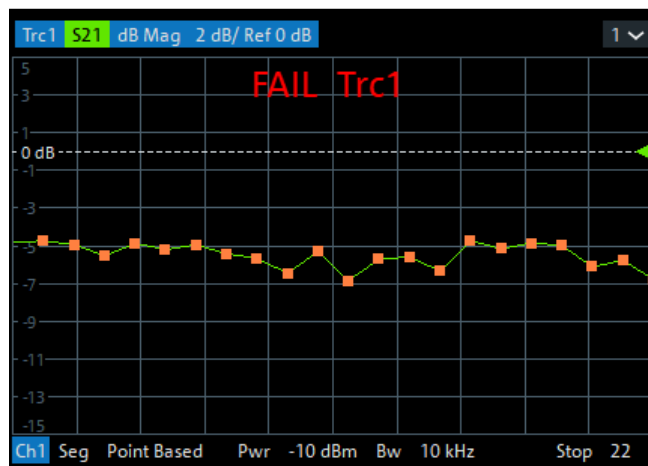
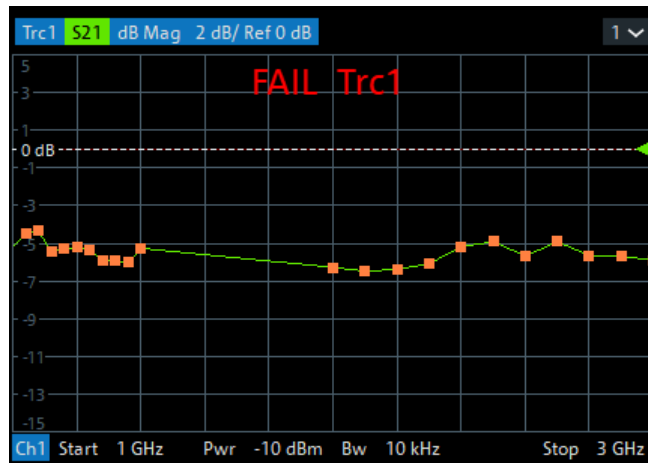

Tip: Overlapping limit line and ripple limit line segments are not displayed when a point-based x-axis is active; see [Chapter 4.4.1.1, "Rules for limit line definition"](#), on page 169.

Remote command:

`[SENSe<Ch>:] FREQuency:SEGMENT:AXIS`

Reverse

Reverses the direction of the sweep.

Remote command:

`[SENSe<Ch>:] SWEEP:REVERSE`

Fast Power Sweep

This control is only enabled, if sweep type [Power](#) is selected.

The alternative power sweep methods are most suitable for compression measurements on frequency-converting DUTs with embedded (and drifting) LO. For this kind of measurements, "Track LO" alone does not help, because not only the frequency, but also the phase can vary between sweep points, which makes power level measurements unreliable.

Off Regular power sweep (stepped mode). For each sweep point, measurement takes place after the power level has settled.

- "On" In this mode, the power level is swept continuously and linearly from "Start Power" to "Stop Power" (swept mode, faster). For each sweep point, measurement takes place over a range of power levels. Assuming the phase drifts linearly during the sweep time, the phase can be removed from the measurement results.
- "Pulsed" In this mode, for each sweep point the analyzer performs an additional measurement at the "Start Power", i.e. the power is rapidly switched between the stimulus power and the "Start Power". By comparing the different "Start Power" measurements, the (uncompressed) phase at each sweep point can be estimated and removed from the measurement. While this method does not make an assumption on the phase drift, it assumes that the DUT can cope with rapid power level changes.

Remote command:

`[SENSe<Ch>:] SWEep:FPOWer`

5.10.3.2 Define Segments dialog

The "Define Segments" dialog defines all channel settings for a [Segmented](#) frequency sweep and imports or exports segmented sweep settings.

Access: Channel – [Sweep] > "Sweep Type" > "Define Segments..."

The dialog contains a table to edit the individual segments of the sweep range. Use the [Displayed Columns dialog](#) to select the columns to be displayed and edited.



- Sweep segments are allowed to overlap.
- In contrast to standard frequency sweeps, the start and stop frequency in a sweep segment do not have to be different. So with a segmented sweep you can measure n_1 points at frequency f_1 (in segment 1), n_2 points at frequency f_2 (in segment 2) etc.

Controls in the Define Segments dialog

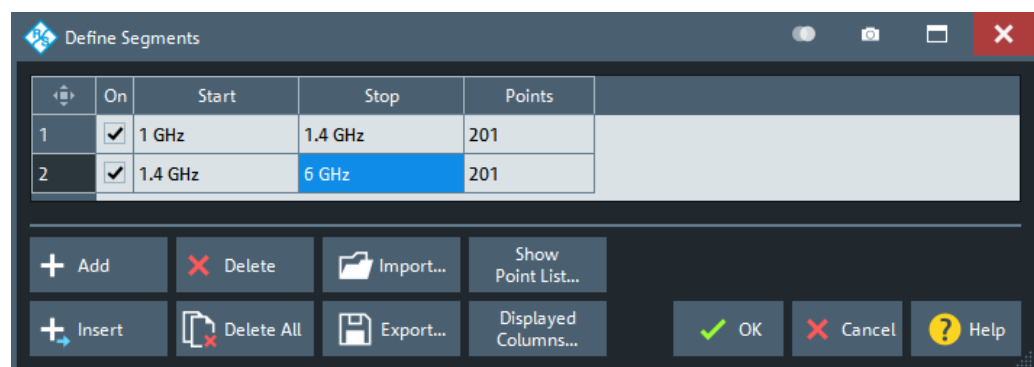

Table Columns

The table in the upper part of the "Define Segments" dialog contains an automatically assigned current number for each segment plus the following editable or non-editable columns:

- "On" provides check boxes to activate or deactivate each individual segment. Sweep points in inactive segments are not measured and not listed in the "Point List".
- "Start" is the stimulus (x-axis) value of the first point of the segment.
- "Stop" is the stimulus (x-axis) value of the last point of the segment.
- "Points" is the number of sweep points in the segment. A single segment can consist of only one point. If "Points" is set to 1, then the "Stop" frequency is set equal to the "Start" frequency.

Note: Displayed Columns and Segment-specific Measurement Settings

The remaining columns allow you to replace channel-wide measurement settings by segment-specific ones. These columns are only displayed – and the corresponding segment-specific values are only applied – if they are selected in the [Displayed Columns dialog](#).

Note: Limitations for overlapping segments

When overlapping sweep segments are created, the marker functions, trace evaluation functions, trace search functions and band filter functions are still available. It is possible, however, that these tools show an unexpected behavior when used in overlapping sweep segments. The reason is that the assignment of markers to traces in overlapping segments is ambiguous. If you want to analyze a particular segment using markers, turn "Off" all sweep segments that overlap with this segment.

Remote command:

```
[SENSe<Ch>:] SEGMENT:COUNT?
[SENSe<Ch>:] SEGMENT<Seg>[:STATe]
[SENSe<Ch>:] SEGMENT<Seg>:FREQUENCY:START
[SENSe<Ch>:] SEGMENT<Seg>:FREQUENCY:STOP
[SENSe<Ch>:] SEGMENT<Seg>:FREQUENCY:CENTER?
[SENSe<Ch>:] SEGMENT<Seg>:FREQUENCY:SPAN?
[SENSe<Ch>:] SEGMENT<Seg>:SWEeP:POINTs
```

Add / Insert / Delete / Delete All

The four buttons below the segment list extend or shorten the list.

- "Add" adds a new segment to the end of the list. The added segment covers a possible frequency gap between the preceding segment and the upper frequency limit of the analyzer. The "Start" frequency of the new segment is set equal to the "Stop" frequency of the preceding segment. The "Stop" frequency is equal to the upper frequency limit. The number of points is the same as the number of points of the preceding segment.
- "Insert" inserts a new segment before the active segment. The segment numbers of all segments after the new segment are incremented by one. The new segment covers a possible frequency gap between the two adjacent segments. A new segment which is inserted before segment no. 1 starts at the lower frequency limit of the analyzer. The number of points is the same as the number of points of the next segment.
- "Delete" removes the selected segment from the list.

- "Delete All" clears the entire segment list so it is possible to define or load a new segmented sweep range.

Remote command:

```
[SENSe<Ch>:] SEGMENT<Seg>:ADD
[SENSe<Ch>:] SEGMENT<Seg>:INSert
[SENSe<Ch>:] SEGMENT<Seg>:DELete [:DUMMy]
[SENSe<Ch>:] SEGMENT<Seg>:DELete:ALL
```

Show Point List...

Opens a list of all active sweep points and their channel settings. All columns except "Point", "Segment" and "Frequency" are displayed only if they are explicitly selected; see "Displayed Columns dialog" on page 556.

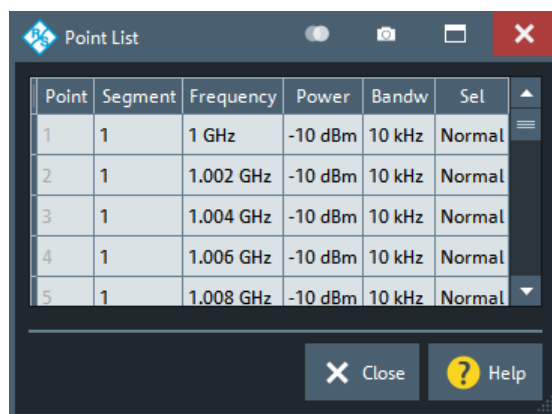

Figure 5-18: Point List

Import.../ Export...

The buttons open standard dialogs to import/export sweep segment settings to/from an ASCII file (*.SegList).

- "Import..." replaces the current segment list by a sweep segment list loaded from a *.SegList file.
- "Export..." stores the current sweep segments settings to a *.SegList file.

Sweep segment files

The analyzer uses a simple ASCII format to export sweep segment data. By default, the sweep segment file extension is *.SegList. The file starts with two comment lines containing the version and a third line reproducing the header of the segment list. The following lines contain the entries of all columns of the segment list, including the "Displayed Columns" that are configured in the "Define Segments" dialog.

Example:

The segmented sweep range

	Name	On	Start	Stop	Points	Pwr (Pb)	Bandw
1	Low	<input checked="" type="checkbox"/>	1 GHz	2 GHz	11	-10 dBm	10 kHz
2	High	<input checked="" type="checkbox"/>	2 GHz	3 GHz	11	-10 dBm	10 kHz

is described by the following sweep segment file:

```
# Version 1.00
#
bo:State,str:Name,Start Frequency[MHz],Stop Frequency[MHz],int:No of Points,Source Power [dBm],IF Bandwidth[Hz]
true,Low,1.000000000000000E+003,2.000000000000000E+003,11,-1.000000000000000E+001,1.000000000000000E+004,Normal
true,High,2.000000000000000E+003,3.000000000000000E+003,11,-1.000000000000000E+001,1.000000000000000E+004,Normal
```

Note: The *.SegList file actually contains more columns listing all channel settings of the individual sweep segments. The headings of the additional columns are *IF Bandwidth [Hz]*, *en:IF Selectivity*, *en:IF Sideband*, *Meas Delay [μs]*, *bo:Sweep Time Auto*, *en:Frq Sweep Mode*.

Remote command:

`MMEMemory:LOAD:SEGment`

`MMEMemory:STORe:SEGment`

Displayed Columns dialog

The "Displayed Columns" dialog allows you to select the channel settings that can be defined per sweep segment. These settings are displayed in the [Define Segments dialog](#) and in the "Point List" (opened via [Show Point List...](#)).

Access: [Define Segments dialog](#) > "Displayed Columns..."

All segment-specific settings can be modified in the "Define Segments" dialog. By default, the first sweep segment is created with the channel settings defined for unsegmented sweep types. When any further sweep segment created, it uses the channel settings of the previously active segment.

**Related information**

Refer to the following sections:

- [Chapter 5.10.3.2, "Define Segments dialog"](#), on page 553
- ["Show Point List..."](#) on page 555

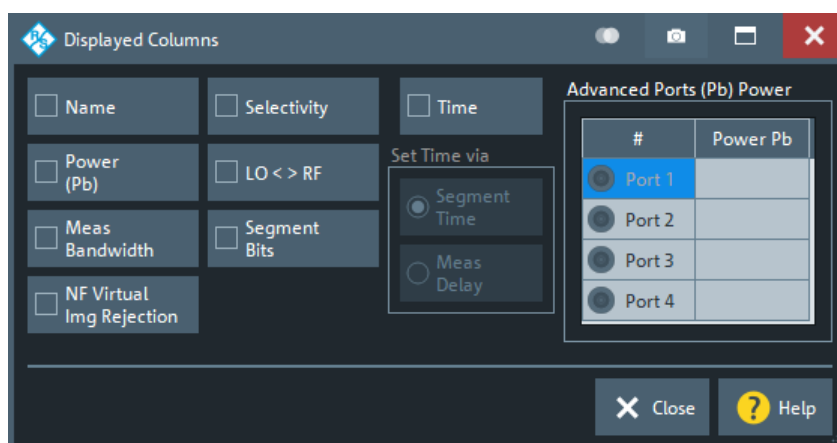

Optional Columns

Each selected (checked) option adds a column to the segment list and the point list.

- "Name" allows you to assign a name to each segment. A segment name is a string that is allowed to contain letters, numbers and special characters.
- "Power (Pb)" allows you to define the internal source power (channel base power) for each individual sweep segment. See ["Power"](#) on page 526.

If checked, you have the possibility to define port-specific power levels by selecting the related ports in the "Advanced Ports (Pb) Power" table. Unselected ports are driven with the segment-specific power.

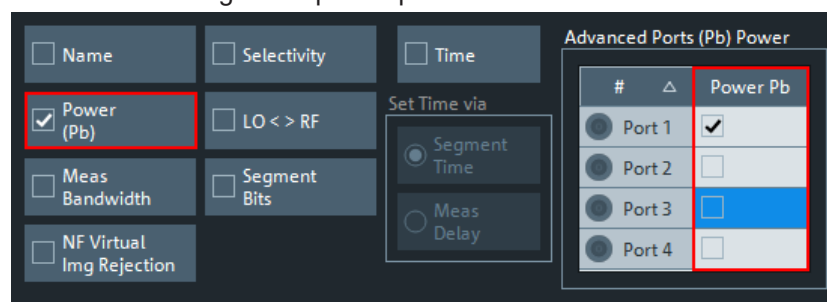

- "Meas Bandwidth" defines the IF filter bandwidth for each individual sweep segment. See ["Bandwidth"](#) on page 536.
- "NF Virtual Img Rejection" allows you to activate or deactivate virtual image rejection for individual sweep segments in noise figure channels. If the column is hidden, the channel-wide [virtual image rejection](#) setting is used. Enabling "NF Virtual Img Rejection" only takes effect if the channel is configured for [Noise figure measurement](#), and if either "Noise Figure", "Gain" or "Noise Density" are measured.
- "Selectivity" defines the selectivity of the IF filter used for each sweep segment. See ["IF Filter \(digital\) "](#) on page 537.
- "LO < > RF" allows you to define segment-specific "Image Suppr." settings; see ["Image Suppr."](#) on page 687.
- "Segment Bits" enables the definition of a segment-dependent 4-bit binary value to control four independent output signals at the User Port connector (lines 16, 17, 18, 19; see [Chapter 12.3.1.1, "User Port"](#), on page 1779). The output signals are 3.3 V TTL signals which can be used to differentiate between up to 16 independent analyzer states.

For an application example, refer to the detailed remote control description (`OUTPut<Ch>:UPORt:SEGMENT<Seg>[:VALue]`).

Setting the segment bits does not change the analyzer state.

- "Time" defines the sweep time for each segment. The default configuration for a new segment is equal to the sweep time setting for unsegmented sweeps; see ["Sweep Time / Auto"](#) on page 541.

When "Time" is checked, two new columns appear in the table. The first column is titled "Segment Time" or "Meas Delay", depending on the selected radio button below the "Time" checkbox. The second column is titled "Auto" and is used to activate automatic sweep time setting.

"Segment Time" is the total measurement time for the sweep segment. The minimum segment sweep time to be set is equal to the estimated value in "Auto" mode. "Meas Delay" sets a delay time allowing the DUT to settle before the hardware settings of the analyzer are changed and a new partial measurement is started.

Changing the "Meas Delay" modifies the "Segment Time" and vice versa.

"Auto" minimizes the sweep time. If "Auto" is selected for a segment, the columns "Segment Time" or "Meas Delay" (in the "Define Segments" dialog cannot be edited). "Segment Time" indicates the estimated sweep time, depending on the current measurement settings, the "Meas Delay" is 0 s. The segment sweep time and point delay values are maintained until changed explicitly if "Auto" is switched off.

Remote command:

```
[SENSe<Ch>:] SEGMENT:POWER[:LEVel]:CONTRol
[SENSe<Ch>:] SEGMENT<Seg>:POWER[:LEVel]
[SENSe<Ch>:] SEGMENT<Seg>:BWIDth[:RESolution]:CONTRol
[SENSe<Ch>:] SEGMENT<Seg>:BWIDth[:RESolution]
[SENSe<Ch>:] SEGMENT:NFIGure:VIREjection:STATE:CONTRol on page 1488
[SENSe<Ch>:] SEGMENT<Seg>:NFIGure:VIREjection[:STATE] on page 1488
[SENSe<Ch>:] SEGMENT<Seg>:BWIDth[:RESolution]:SELEct
[SENSe<Ch>:] SEGMENT<Seg>:BWIDth[:RESolution]:SELEct:CONTRol
[SENSe<Ch>:] SEGMENT<Seg>:DEFine
[SENSe<Ch>:] SEGMENT<Seg>:DEFine:SELEct
[SENSe<Ch>:] SEGMENT<Seg>:INSert
[SENSe<Ch>:] SEGMENT<Seg>:INSert:SELEct
[SENSe<Ch>:] SEGMENT<Seg>:PORT<PortId>[:STATE]
[SENSe<Ch>:] SEGMENT<Seg>:PORT<PortId>:POWER[:LEVel]
[SENSe<Ch>:] SEGMENT<Seg>:SWEep:DWELl
[SENSe<Ch>:] SEGMENT<Seg>:SWEep:DWELl:CONTRol
[SENSe<Ch>:] SEGMENT<Seg>:SWEep:TIME
[SENSe<Ch>:] SEGMENT<Seg>:SWEep:TIME:CONTRol
[SENSe<Ch>:] SEGMENT<Seg>:SWEep:TIME:SUM?
OUTPut<Ch>:UPORt:SEGMENT<Seg>:STATE
OUTPut<Ch>:UPORt:SEGMENT<Seg>[:VALue]
CONTRol:AUXiliary:C[:DATA]
```

5.10.4 Trigger tab

Selects the source of the trigger signal and provides additional trigger settings.

Trigger system of the analyzer

The trigger system is used to synchronize the analyzer's actions with events that can be provided by an internal or external signal or user-generated ("Manual Trigger"). Triggered measurements are an alternative to the default mode ("FreeRun", "Continuous" sweep), where the measurement is continuously repeated without fixed time reference.

Any trigger event can start an entire sweep or a part of it. Moreover, it is possible to switch off the RF source between consecutive triggered measurement sequences, and to define a delay between trigger events and the measurement sequences.



Background information

Refer to [Chapter 4.1.4.1, "Partial measurements and driving mode"](#), on page 111.

Output trigger

If the R&S ZNA is equipped with the Trigger Board option R&S ZNA-K91, it provides four configurable output trigger signals that can be used to synchronize external devices with the measurement. These signals are available at the rear panel connectors Trigger Out A to D.

5.10.4.1 Controls on the Trigger tab



The trigger settings are also valid for calibration sweeps. Hence, in external trigger mode, the external trigger signal must be available during the system error correction, too. To start the calibration sweeps without delay, use the "FreeRun" trigger type.

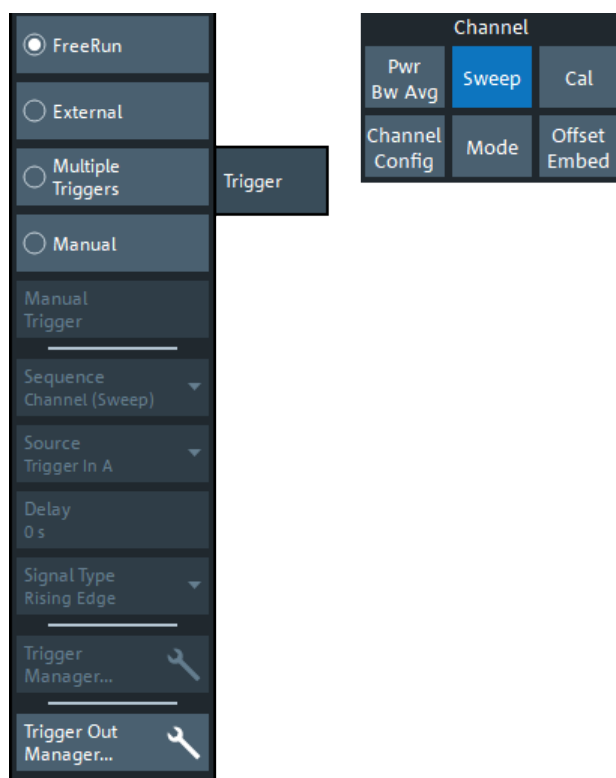

The following buttons in the "Trigger" tab open related dialogs:

- **"Trigger Manager...":** [Trigger Manager dialog](#)
- **"Trigger Out Manager...":** [Trigger Out Manager dialog](#)

FreeRun / External / Manual / Multiple Triggers

These four buttons select the trigger source:

- In "FreeRun" mode, a new measurement is started immediately without waiting for a trigger event and without fixed time reference. The remaining trigger settings are not valid.
"FreeRun" means that a measurement in "Continuous" sweep mode is repeated as fast as possible.
- In "External" trigger mode, the measurement is triggered by an external 5 V TTL signal, applied to one of the following rear panel connectors:
 - BNC connectors Trigger In A to D (requires trigger board R&S ZNA-B91)
 - Pin 2 of the User Port connector
 See ["Source"](#) on page 562. For detailed specifications of the trigger signals, refer to [Chapter 12.3.1.1, "User Port"](#), on page 1779.
The "External" trigger mode can be configured using the [Sequence](#), [Delay](#) and [Signal Type](#) settings.
- In "Manual" trigger mode, the trigger signal is generated by the "Manual Trigger" button.
- If "Multiple Triggers" is active, the trigger sources for different triggered measurement sequences, the trigger slope, and the trigger delay can be selected individually using the [Trigger Manager dialog](#).

In particular, it is possible to use different external trigger sources.

Remote command:

```
TRIGger<Ch>[:SEquence]:SOURce EXTernal
```

Manual Trigger

Generates the trigger event for "Manual" trigger mode and is disabled unless this mode is active.

Remote command:

```
TRIGger<Ch>[:SEquence]:SOURce MANual
```

*TRG

Sequence

Selects the measurement cycle or sequence of actions to be triggered in "External" or "Manual" mode.

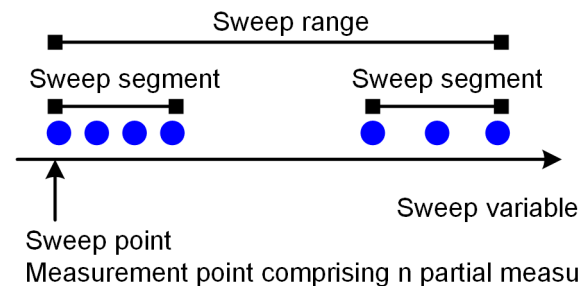

- "Sweep" means that each trigger event starts an entire sweep, according to the current sweep configuration.
- "Point" means that each trigger event starts the measurement at the next sweep point.
- "Partial Measurement" means that each trigger event starts the next partial measurement at the current or at the next sweep point. If every sweep point only requires a single partial measurement, this option is equivalent to "Point". See also [Chapter 4.1.4.1, "Partial measurements and driving mode"](#), on page 111.
- "Segment" means that each trigger event starts the next sweep segment within the current sweep. If a sweep type other than [Segmented](#) is active, this option is equivalent to "Sweep".

Relation with other sweep settings

Some sweep settings are logically incompatible with a particular selection of the triggered measurement sequence:

- If a [Time](#) sweep is performed, the sequence is always a sweep.
- "Alternated" [Driving Mode](#) only makes sense if the triggered measurement sequence comprises more than one sweep point. If "Point" or "Partial Measurement" is selected, "Alternated" mode is switched off and vice versa.

Note: The trigger events must be adjusted to the triggered measurement sequence. If the analyzer receives a trigger event while the last sequence is still running, the R&S ZNA skips the trigger event and generates a message.

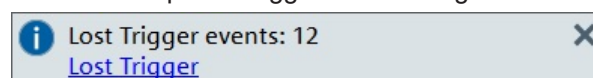

If it observes lost trigger events, the analyzer increments a dedicated counter and records the events in a dedicated log, which is updated after every sweep. Use the clickable link in the message popup to open the [Lost Trigger tab](#) of the system "Info" dialog, which displays the lost trigger event log. From there you can also clear the log (and reset the counter at the same time).

Remote command:

```
TRIGger<Ch>[:SEquence]:LINK
TRIGger[:SEquence]:LTRigger:COUNT?
```

Source

In [FreeRun / External / Manual / Multiple Triggers](#) External trigger mode, this setting selects one of the possible external trigger sources. Trigger In A and pin 2 of the User Port connector are equivalent.

Remote command:

```
TRIGger<Ch>[:SEquence]:EINPut
```

Delay

Specifies a delay time between the trigger event and the start of the next measurement sequence.

The specified "Delay" must be zero or positive, so that the trigger event precedes the start of the measurement (post-trigger).

If "Multiple Triggers" is active, the "Delay" can be selected individually using the [Trigger Manager dialog](#).

Remote command:

```
TRIGger<Ch>[:SEquence]:HOLDoff
```

Signal Type

Specifies the "External" trigger mode in detail.

- **"Rising Edge"/"Falling Edge"** means that the rising/falling slope of every external trigger pulse can trigger a single measurement sequence.
- **"Active High"/"Active Low"** means that the analyzer measures in "FreeRun" mode as long as the external trigger signal is high/low. The measurement is discontinued when the trigger signal changes to low/high.

Remote command:

```
TRIGger<Ch>[:SEquence]:SLOPe
```

5.10.4.2 Trigger Manager dialog

The "Trigger Manager" dialog defines individual trigger sources and delays for the triggered measurement sequences. The dialog is available and its settings are valid if the analyzer is configured for "Multiple Triggers" (see ["FreeRun / External / Manual / Multiple Triggers"](#) on page 560).

Access: Channel – [Sweep] > "Trigger" > "Trigger Manager..."



Background information

Refer to [Chapter 4.1.4.1, "Partial measurements and driving mode"](#), on page 111.

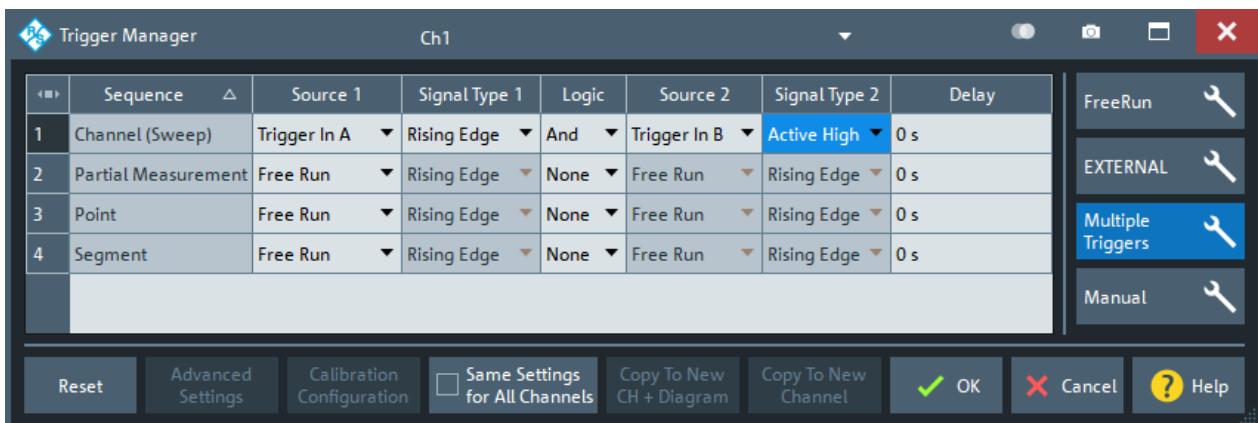

Figure 5-19: Example of a multiple trigger configuration

The table in the "Trigger Manager" dialog contains several editable (white) or non-editable (gray) columns. All settings are analogous to the general trigger settings in the [Trigger tab](#). Refer to the following sections:

- ["Sequence"](#) on page 561
- ["Source"](#) on page 562
- ["FreeRun / External / Manual / Multiple Triggers"](#) on page 560
- ["Signal Type"](#) on page 562
- ["Delay"](#) on page 562

... /Logic/ ...

The table defines all settings related to "Multiple Triggers". For all measurement sequences it is possible to select (and configure) the related trigger logic:

- no trigger required ("Free Run")
- a single trigger source with configurable [Signal Type](#)
- a logical combination of two trigger sources, each with configurable "Signal Type"

Remote command:

```
TRIGger<Ch>[:SEquence]:MULTiple:SOURce<inp>
TRIGger<Ch>[:SEquence]:MULTiple:LOGic
TRIGger<Ch>[:SEquence]:MULTiple:SLOPe<Num>
TRIGger<Ch>[:SEquence]:MULTiple:HOLDoff
```

5.10.4.3 Trigger Out Manager dialog

Defines if and how the channel-specific sweep sequence is indicated at the Trigger Out interfaces.

Access: Channel – [Sweep] > "Trigger" > "Trigger Out Manager..."

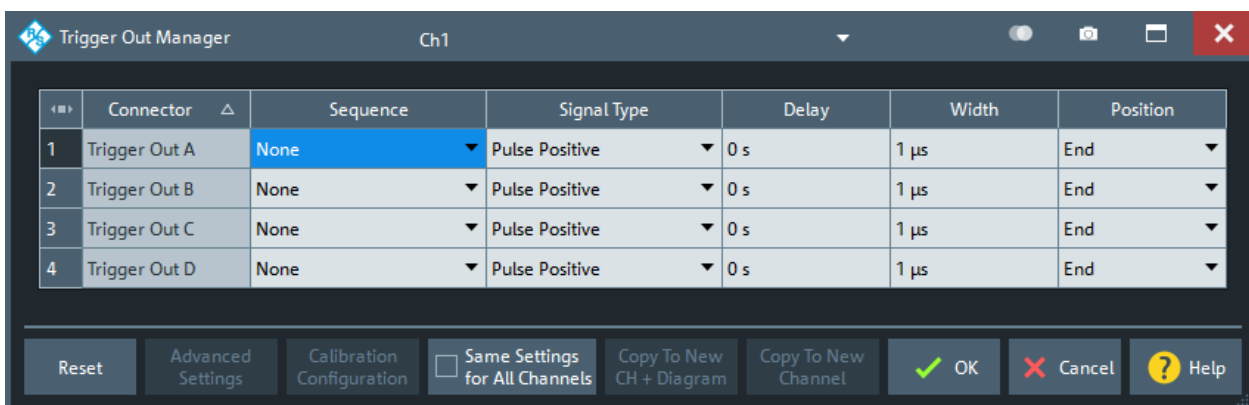

Trigger Out connectors A to D are provided by the optional [Trigger board](#). If this hardware option is not installed, it is not possible to generate outgoing trigger signals. In particular, the "Trigger Out Manager" dialog is not available in this case.

Sequence

Selects the sequence to be indicated at the related Trigger Out "Connector". Trigger out signals can be generated for every sweep, segment, partial measurement, and sweep point.

Furthermore, trigger out signals can be generated for the data acquisition phases and for the start of pulse generator pulses.

Remote command:

```
TRIGger:CHANnel<Ch>:AUXiliary<n>:INTerval
```

Signal Type

Defines how the selected [Sequence](#) is indicated at the related Trigger Out "Connector":

- using pulses with positive or negative polarity ("Pulse Positive", "Pulse Negative")
- sending the high voltage level in active state and the low level otherwise ("Active High"), or vice versa ("Active Low").

Note that pulse generator pulses cannot be indicated using high and low voltage levels.

Remote command:

```
TRIGger:CHANnel<Ch>:AUXiliary<n>:STYPe
```

Delay

Specifies the delay of the trigger signal relative to the selected [Sequence](#).

If pulses are used as trigger out signals, the delay is defined relative to the start or end of the sweep event (see "[Position](#)" on page 565 and "[Sequence](#)" on page 564)

Remote command:

```
TRIGger:CHANnel<Ch>:AUXiliary<n>:DELay
```

Width

If pulses are used as trigger out signals (see "[Signal Type](#)" on page 564), this parameter specifies the pulse width.

Remote command:

`TRIGger:CHANnel<Ch>:AUXiliary<n>:DURation`

Position

If pulses are used as trigger out signals (see ["Signal Type"](#) on page 564), the pulses can either indicate the "Start" or "End" position of the related sweep event (see ["Sequence"](#) on page 564). Choose the suitable position setting according to the action to be triggered.

Note that for the "Pulse Generator" [Sequence](#) only the "Start" position can be used.

Remote command:

`TRIGger:CHANnel<Ch>:AUXiliary<n>:POSition`

5.10.5 Sweep Control tab

Allows you to control the sweep execution.



The availability of certain settings depends on the selected [Remote Language](#).

5.10.5.1 Controls on the Sweep Control tab

Channel		
Bw Avg	Sweep	Cal
Channel Config	Stimulus	Offset Embed

Continuous / Single

Activate either continuous (default) or single sweep mode.

- In "Continuous" sweep mode, the analyzer measures the related channel (or channels) continuously, repeating the current sweep over and over.

- In "Single" sweep mode, the measurement is stopped after the configured number of **sweeps**.

Restart Sweep initiates a new measurement cycle.

For the DEFAULT **Remote Language**, this setting applies to the active channel only. Use **All Channels Continuous/All Channels on Hold** to select a common sweep mode for all channels.

For remote languages other than DEFAULT, this setting applies to all channels.

Remote command:

```
INITiate<Ch>:CONTinuous
```

See also:

```
CONFigure:CHANnel<Ch>:MEASure[:STATe]
```

```
CONFigure:CHANnel:MEASure:ALL[:STATe]
```

Controlled Timing

Activates/deactivates the controlled timing mode, which is provided by **Continuous data recording** option R&S ZNA-K28.

Note: This checkbox is only available if option R&S ZNA-K28 is installed. It is only enabled if the current setup contains a single channel.

You can control the wait times from the **Wait Time Control tab**.

Remote command:

```
INITiate<Ch>:CTIMing
```

Sweeps/Memory Size

"Sweeps" defines the number of sweeps to be performed (and buffered) in "Single" sweep mode (see **"Continuous / Single"** on page 565). In "Continuous" sweep mode, and if **Controlled Timing** is inactive, it is not available (grayed out).

In "Continuous" sweep mode, if sweep control is active, the label changes to **"Memory Size"**, indicating how many sweeps are buffered (ring buffer).

For **remote languages** other than DEFAULT, the "Sweeps" setting is disabled. You can define the number of sweeps in the **Restart Manager dialog**.

Remote command:

```
[SENSe<Ch>:]SWEep:COUNT
```

```
[SENSe:]SWEep:COUNT:ALL
```

Restart Sweep

Stops the current measurement cycle and starts a new one.

For the DEFAULT **Remote Language**, the effect of this command depends on the **sweep modes** of the active channel, and the restart behavior defined in the **Restart Manager dialog**:

	"Sweep Active Channel"	"Sweep All Channels"
Active channel in "Continuous" sweep mode	The "Continuous" sweep mode channels are swept cyclically, the "Single" sweep channels are on hold.	First the "Single" sweep mode channels are swept one after the other, each with its channel-specific number of "Sweeps". Then the "Continuous" sweep mode channels are sweep cyclically.
Active channel in "Single" sweep mode	First the active channel is swept with its channel-specific number of "Sweeps". Then the "Continuous" sweep mode channels are sweep cyclically.	

For remote languages other than DEFAULT, the effect of the "Restart Sweep" command is determined by the selected (common) sweep mode and restart behavior:

	"Sweep Active Channel"	"Sweep All Channels"
All channels in "Continuous" sweep mode	The channels are swept cyclically	
All channels in "Single" sweep mode	The active channel is swept "Sweeps" times. All other channels are on hold	The channels are swept one after the other, each of them "Sweeps" times.

Remote command:

```
INITiate<Ch>[:IMMEDIATE] [:DUMMY]
INITiate[:IMMEDIATE]:ALL
```

Restart Manager...

Opens the [Restart Manager dialog](#).

All Channels Continuous/All Channels on Hold

Selects a common [sweep mode](#) for all channels of the active recall set.

- "All Channels Continuous": all channels are set to "Continuous" sweep mode
- "All Channels on Hold": all channels are set to "Single" sweep mode.

[Restart Sweep](#) initiates a new measurement cycle.

These actions are only available for the DEFAULT [Remote Language](#)). For other remote languages, the [Continuous / Single](#) setting applies to all channels and the "All Channels Continuous"/"All Channels on Hold" buttons are greyed out;

Remote command:

```
INITiate:CONTinuous:ALL
```

Sweep Controller

Activates/deactivates the (resizable) "Sweep Info" dialog, which displays the current sweep stage. The "Sweep Info" dialog is particularly useful for long duration sweeps that are executed in single sweep mode: by observing the dialog, it is easy to realize when the sweep is done.

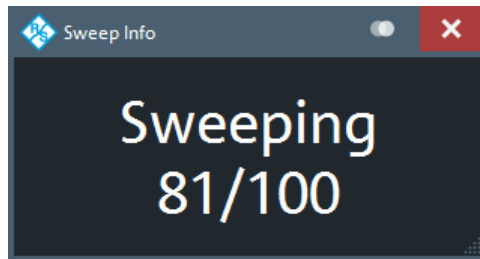

The possible sweep stages and how they are displayed partly depend on the selected sweep mode (see "[Continuous / Single](#)" on page 565):

Sweep stage	Sweep controller display	
	in "Continuous" sweep mode	in "Single" sweep mode
No ongoing sweep	<i>Idle</i>	<i>Idle</i>
Sweep is being prepared	<i>Preparing</i>	<i>Preparing</i>
Ongoing sweep ¹⁾	<i>Continuous</i>	<i>Sweeping</i> if #Sweeps = 1
		<i>Sweeping m/n</i> if n = #Sweeps > 1
Measurement results are being calculated	<i>Continuous calculation</i>	<i>Calculation</i>
¹⁾ The VNA is sweeping or waits for a trigger signal.		

5.10.5.2 Restart Manager dialog

The "Restart Manager" dialog defines the [Restart Sweep](#) behavior in "Single" sweep mode.

Access: Channel – [Sweep] > "Sweep Control" > "Restart Manager..."



Related information

Refer to [Chapter 4.1.4, "Sweep control"](#), on page 110.

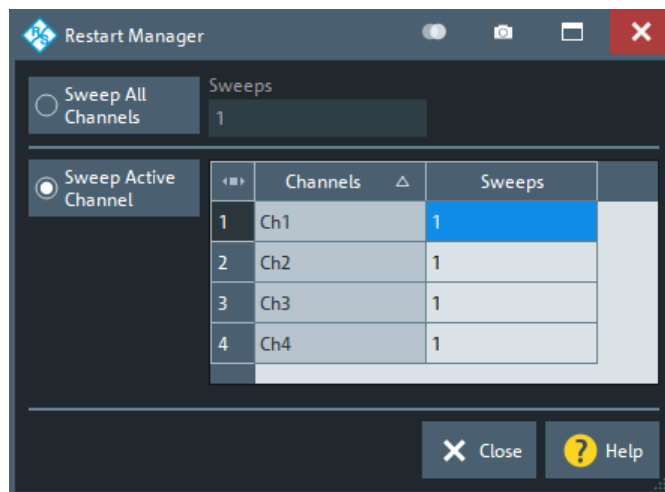

Sweep All Channels/Sweeps

If you select "Sweep All Channels", [Restart Sweep](#) restarts the sweep in all channels of the active recall set.

For the DEFAULT [Remote Language](#), the number of sweeps in single sweep mode is channel-specific and can be defined in the table below the separator line. The "Sweeps" column reflects the [Sweeps](#) settings of the individual channels. The "Sweeps" setting above the separator line is unused and disabled.

For remote languages other than DEFAULT, the "Sweeps" setting above the separator line defines the common number of sweeps that are executed on each channel in single sweep mode. The table below the separator line is unused and disabled.

Tip: In remote control, it is possible to retrieve the results acquired in any of the sweeps within a single sweep group.

Remote command:

```
INITiate[:IMMediate]:ALL
INITiate<Ch>[:IMMediate]:SCOPE ALL
[SENSe<Ch>:]SWEep:COUNT
```

Sweep Active Channel/Sweeps (table)

If you select "Sweep Active Channel", then in single sweep mode [Restart Sweep](#) only restarts the sweep in the active channel.

The "Sweeps" column reflects the [Sweeps](#) settings of the individual channels.

Remote command:

```
INITiate<Ch>[:IMMediate]:SCOPE SINGLE
[SENSe<Ch>:]SWEep:COUNT
```

5.11 Cal softtool

The "Cal" softtool provides all functions related to system error calibration, scalar power calibration, and "SMARTerCal".

Access: Channel – [Cal]

5.11.1 Start Cal tab

The "Start Cal" tab provides access to all functions for automatic or manual calibration. Calibration of the R&S ZNA is a fully guided process.



Background information

Refer to the following sections:

- [Chapter 4.5, "Calibration"](#), on page 186
- [Chapter 4.5.5, "Automatic calibration"](#), on page 206
- [Chapter 4.5.6, "Scalar power calibration"](#), on page 218
- [Chapter 4.5.7, "SMARTerCal"](#), on page 224
- [Chapter 4.1.7, "Data flow"](#), on page 120

5.11.1.1 Measurement modes and default calibration setup

When you open the [Calibration wizard](#), the [Calibration setup dialog](#), or the [Calibrate All dialog](#) for the first time, the analyzer determines the preferred calibration setup based on:

- the channel's (or channels') measurement mode (or modes)
- the channel's traces
- whether a power meter is connected

The channel's (or channels') calibration setup is either written to the recall set automatically, or you are asked to select between several reasonable setups (non-"Quick Start" actions only).

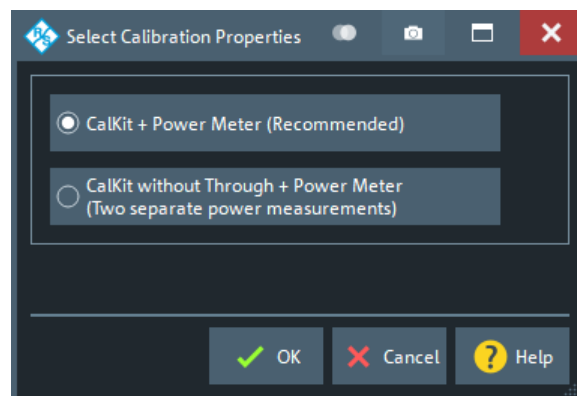

Figure 5-20: Select Calibration Properties dialog: scalar mixer measurements



For the standard mode a calibration unit is used, if connected.

Measurement mode	Traces	Power meter	Calibration setup
Standard	only one-port	–	OSM
		✓	POSM
	at least one two-port	–	UOSM
		✓	PUOSM
Spectrum (R&S ZNA-K1)		✓ (required)	POSM
Scalar mixer (R&S ZNA-K4)		✓ (required)	1x (P)UOSM Scalar Mixer or 2x (P)OSM Scalar Mixer* (see screenshot above)
IMD (R&S ZNA-K4)		✓ (required)	"P-Ref Receiver" for UT and LT port, if on VNA, and "P-Trans Norm" between UT and IF port
Vector mixer (R&S ZNA-K5)			"PUOSM Scalar Vector Mixer" or "UOSM Vector Mixer"
* automatically selected if frequency converters are involved			

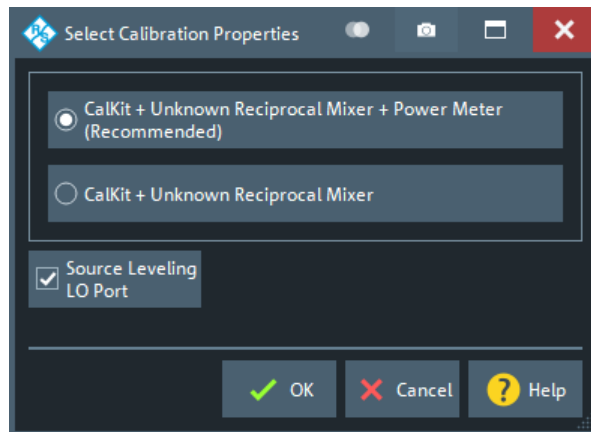
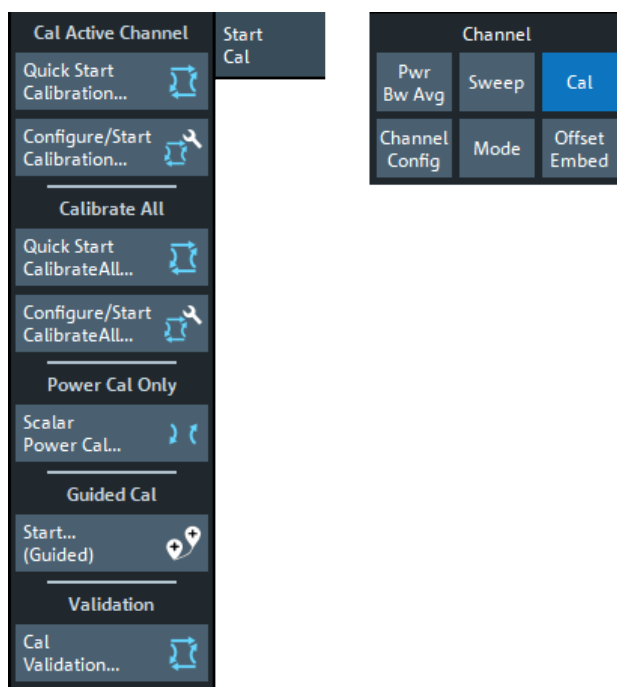

Figure 5-21: Select Calibration Properties dialog: vector mixer measurements

5.11.1.2 Controls on the Start Cal tab



All controls on the "Start Cal" are buttons and each of them opens a dialog or dock widget wizard. The buttons are grouped in three sections.

- "Cal Active Channel" section

The main purpose of the buttons in this section is to calibrate the current channel.

- "Quick Start Calibration..." immediately starts the calibration of the current channel, using its current calibration configuration. Opens the [calibration wizard](#) that guides you through the calibration data acquisition.
- "Configure/Start Calibration..." opens the [calibration setup dialog](#), which allows you to configure the calibration setup of the current channel, and to start the calibration. You can also switch to another channel and configure/start this channel's calibration (see [Chapter 4.2.2.3, "Multi-channel setup dialog"](#), on page 139).

- "Calibrate All" section

The main purpose of the buttons in this section is to perform complex multi-channel calibrations in an efficient way.

- "Quick Start Calibrate All..." immediately starts the calibration, using a previously configured subset of the available calibration setups, or all available calibration setups. Opens the [calibration wizard](#) that guides you through the calibration data acquisition.
- "Configure/Start Calibrate All..." opens the [Calibrate All dialog](#) that allows you to configure calibration setups for an arbitrary set of channels and to enable/disable a subset of the configured calibration setups. Finally you can acquire calibration data for the enabled calibration setups in an efficient way.

- "Power Cal Only" section
The "Scalar Power Cal" button opens the [Power Cal wizard](#), which allows you to perform "Ref. Receiver", "Meas. Receiver" and scalar source power ("Source Flatness") calibrations for the current channel.

Guided Calibration...

Use "Start... (Guided)" to open the [Guided Calibration wizard](#) that allows you to configure and run a set of calibrations efficiently.

Cal Validation ...

Opens the [Cal Validation dock widget](#) that allows you to set up and run a [Calibration validation](#).

5.11.1.3 Calibration wizard

Guides you through the acquisition of calibration data (system error correction and power correction).

Access:

- Channel – [Cal] > "Start Cal" > "Cal Active Channel" – "Quick Start Calibration"
- [Calibration setup dialog](#) > "Start Cal"
- Channel – [Cal] > "Start Cal" > "Calibrate All" – "Quick Start Calibrate All"
- [Calibrate All dialog](#) > "Start Cal"

If accessed via "Quick Start Calibration" or the calibration setup dialog, a single channel is calibrated. If accessed via "Quick Start Calibrate All" or the "Calibrate All" dialog, possibly multiple channels are calibrated. Depending on the calibration setup, the calibration can also involve several power calibration steps.

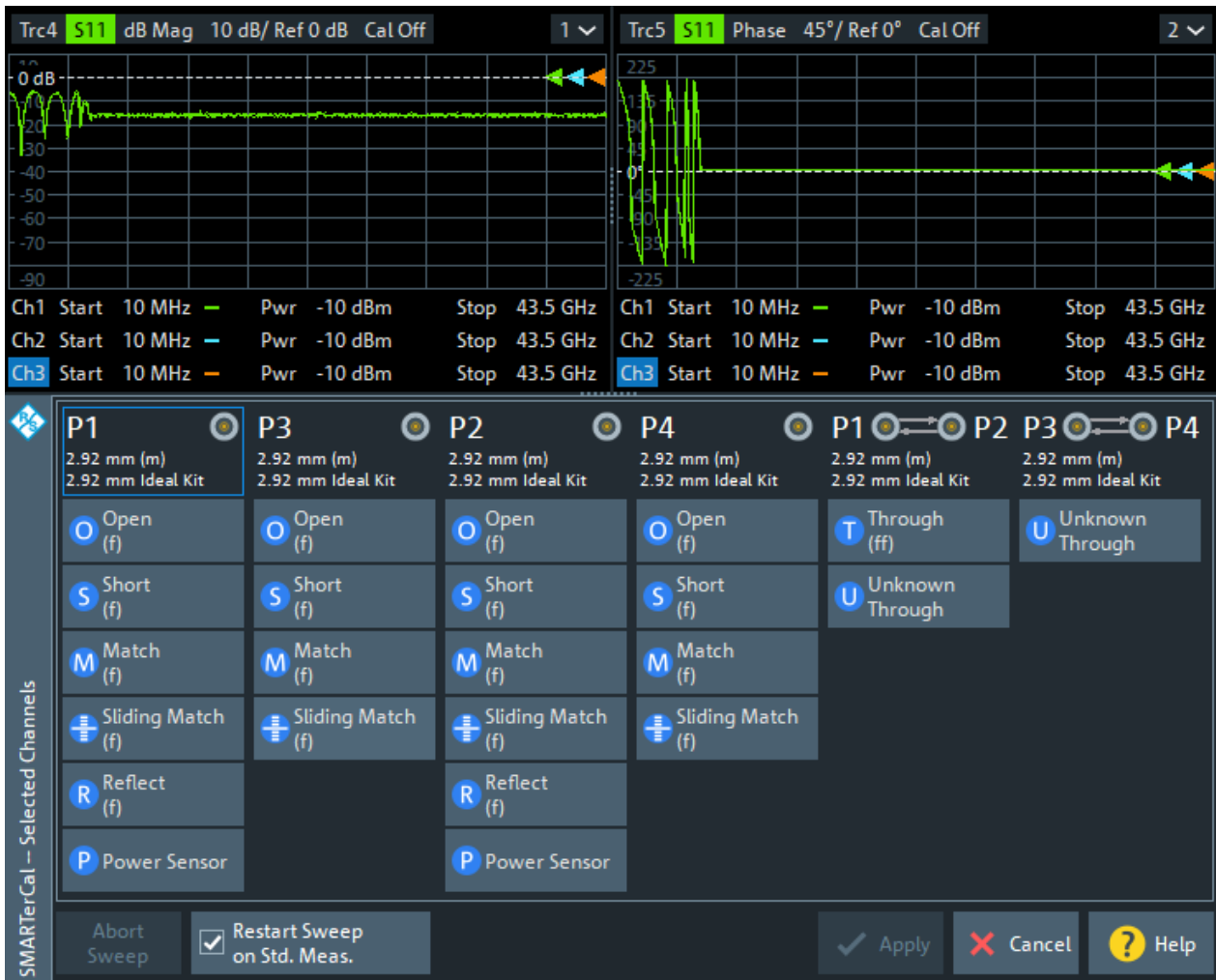

For complex calibrations, the wizard proceeds in several steps ("Next"/"Back" buttons at the bottom of the dock widget). On "Apply", the R&S ZNA calculates the system error corrections and/or power corrections from the acquired data and applies the result to the related channels.



The "Reduced Through" logic and the powerful "Calibrate All" function help you to keep the number of calibration sweeps and the number of calibration standard/unit reconnections as small as possible (see [Chapter 4.5.1.11, "Full n-Port calibration with reduced number of Through connections"](#), on page 197).



Background and related information

- Refer to [Chapter 4.5, "Calibration"](#), on page 186 for background information
- For the description of the source flatness and source power cal steps, see the description of the [Power Cal wizard](#).
- If the calibration setup for a calibrated channel is not changed and sweep data are available from previous calibrations, the existing system error correction can be optimized without repeating the measurement of all standards.
- When you apply the new calibration, the current calibration is replaced and discarded.
To persist the current calibration, you can transfer it to the calibration "Pool" using the [Calibration Manager dialog](#).
- The active system error correction data can be read (and modified) using the remote control command `[SENSe<Ch>:]CORRection:CDATa`.
If [external switch matrices](#) are involved, use `[SENSe<Ch>:]CORRection:SMATrix:CDATa` instead.

Manual calibrations

If you want to perform a manual calibration, the calibration wizard allows you to acquire error correction data for every required port (pair) and calibration standard, where "required" depends on the selected ports and calibration type.

During the calibration data acquisition phase, the lower part of the screen displays the operation keys (or visualizations of the current actions, if the calibration is performed via remote control).



Background information

- Refer to [Chapter 4.5.2, "Calibration standards and calibration kits"](#), on page 199.
- Refer to [Chapter 4.5.7, "SMARTerCal"](#), on page 224

Calibration sweep diagrams

During the calibration, the upper part of the screen displays the calibration sweep diagrams (magnitude and phase), each with a live and a memory trace.

- The live traces present a live measurement of the port or port connection selected in the lower part of the screen. They allow you to monitor the response when connecting a calibration standard. The traces are switched automatically when a calibration sweep is performed for a different port or port connection.
- The memory traces represent the data acquired during the previous calibration sweep. They are updated every time a calibration sweep is completed. If no calibration sweep has been performed yet, no memory traces are shown.
In the example below, the memory traces display the previously measured response of a one-port standard connected to port 1.

Both live and memory traces represent raw S-parameters, i.e. the corresponding wave ratio without wave correction.



Power Sweep Diagrams

Power sweep traces are displayed during the "Power" calibration sweeps of a SMARTerCal.

Start Cal Sweep

The dock widget below the diagrams shows the calibrated ports and standards and visualizes the measurement progress.

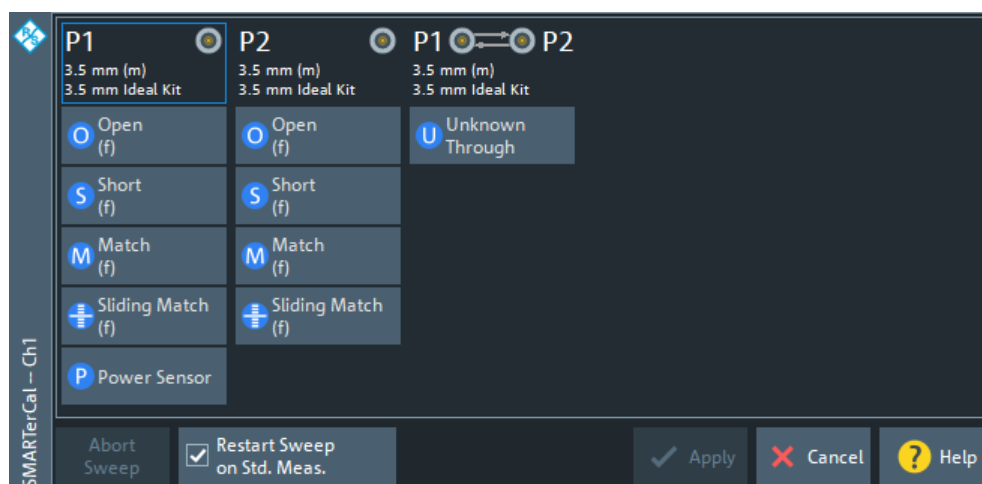

Use the buttons representing the calibration standards to start the corresponding calibration sweeps.

If "Show Cal Kit Label" is enabled on the [Calibration tab](#) of the "System Config" dialog, an additional "Calibration Info" dialog is displayed. In this case, the cal sweep is started from this dialog.

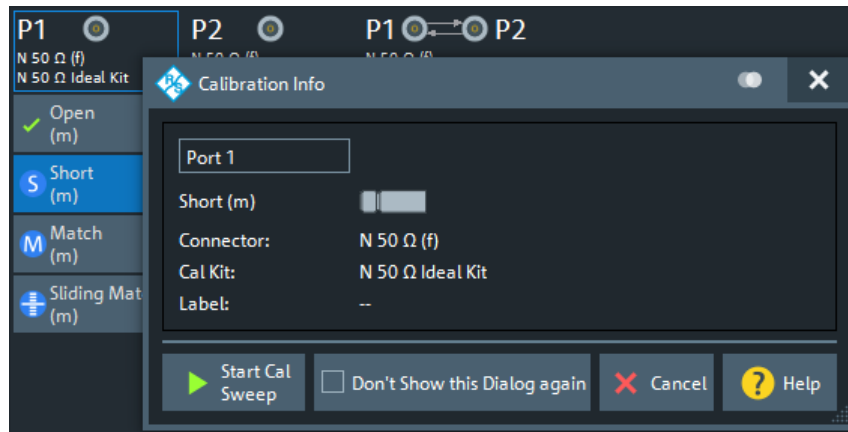

For SMARTerCals, an additional receiver power calibration at one of the ports is required:

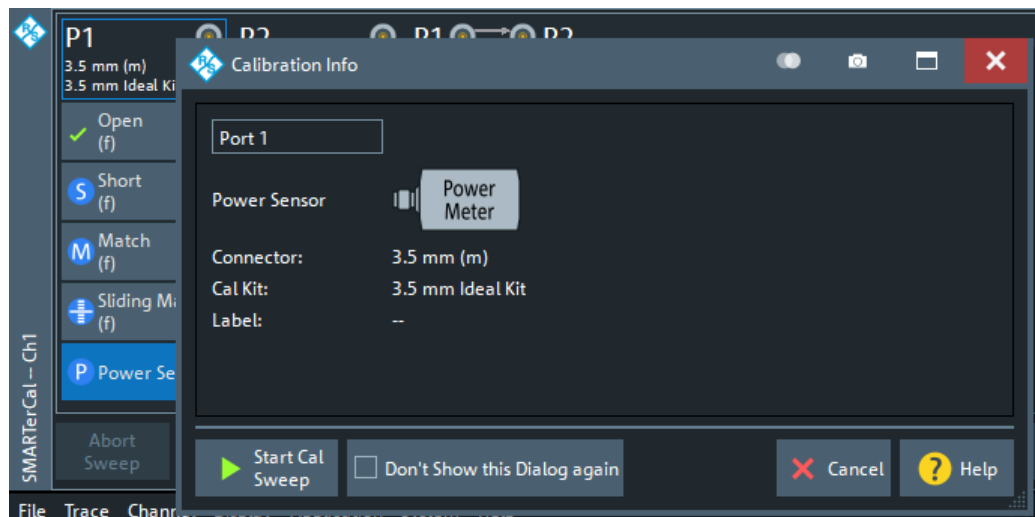

"Don't Show this Dialog Again" has the same effect as disabling "Show Cal Kit Label".

A green checkmark indicates that the calibration data of a standard has been acquired successfully. A green checkmark after the port symbol indicates that the minimum number of calibration measurements for the port has been performed.

Tip:

- For a TRL calibration, at least one line standard must be measured between any pair of calibrated ports. See [Chapter 4.5.1.9, "TRL calibration"](#), on page 195.
- If the selected calibration kit comprises a Sliding Match, then for every required Match measurement either the Match or at least three positions of the Sliding Match must be measured. See [Chapter 4.5.2.3, "Sliding Match standards"](#), on page 203.

Remote command:

`[SENSE<Ch>:]CORRection:COLLect[:ACQuire]:SElected`

See also: `[SENSE<Ch>:]CORRection:COLLect:LOAD:SElected`

Restart Sweep on Std. Meas.

If this function is active, a new standard measurement initiates a new sweep, starting at the beginning ("Start") of the sweep range: The sweep points for the calibration sweep are in ascending order, like for an ordinary measurement.

If "Restart Sweep on Std. Meas." is inactive, the new standard measurement is started at the current sweep point; the current sweep is continued as a calibration sweep.

Note:

This function has a secondary effect in IDLE mode (i.e. while the calibration sweep is NOT running):

- If active, only the selected trace is refreshed.
- If inactive, the R&S ZNA permanently refreshes all traces of all diagrams which can put a heavy load on the connected switch matrices (if any).

Hence it is recommended (and default) to activate it, in particular if one of the matrices uses *mechanical* switches (that wear off apart from making noise).

Apply

Is enabled when sufficient data have been acquired for the calibrated ports and standards and for the power meter. The button starts the calculation of the calibration data and closes the calibration wizard. The current instrument settings are stored with the correction data.

To avoid incompatibilities, older calibration data is deleted unless it has been transferred into the "Cal Pool" using the "Calibration Manager".

Note: Checks during the calculation of correction data

Incompatibilities between the selected calibration type, the standards and the channel settings can cause the calibration to be inaccurate. The analyzer auto-detects potential sources of errors and displays appropriate, self-explanatory notice boxes.

Remote command:

```
[SENSe<Ch>:]CORRection:COLLect:SAVE:SELEcted[:DUMMy]
[SENSe<Ch>:]CORRection:COLLect:SAVE:SELEcted:DEFault
[SENSe<Ch>:]CORRection:COLLect:DELeTe
[SENSe<Chn>:]CORRection:SState?
[SENSe<Ch>:]CORRection:STIMulus?
[SENSe<Ch>:]CORRection:STIMulus:PORT<PhyPt>?
```

Automatic calibrations

The calibration wizard can also guide you through a calibration using a calibration unit (plus a power meter for SMARTer Cals).

**Background information**

- Refer to [Chapter 4.5.5, "Automatic calibration"](#), on page 206
- Refer to [Chapter 4.5.7, "SMARTerCal"](#), on page 224

1. For each port assignment:
 - a) Connect the calibration unit to the related set of test ports.
 - b) Perform an automatic system error correction.

The upper part of the "Cal Unit" screen displays the calibration sweep diagrams for the currently measured S-parameter. The lower part visualizes the active port assignment and the measurement progress.

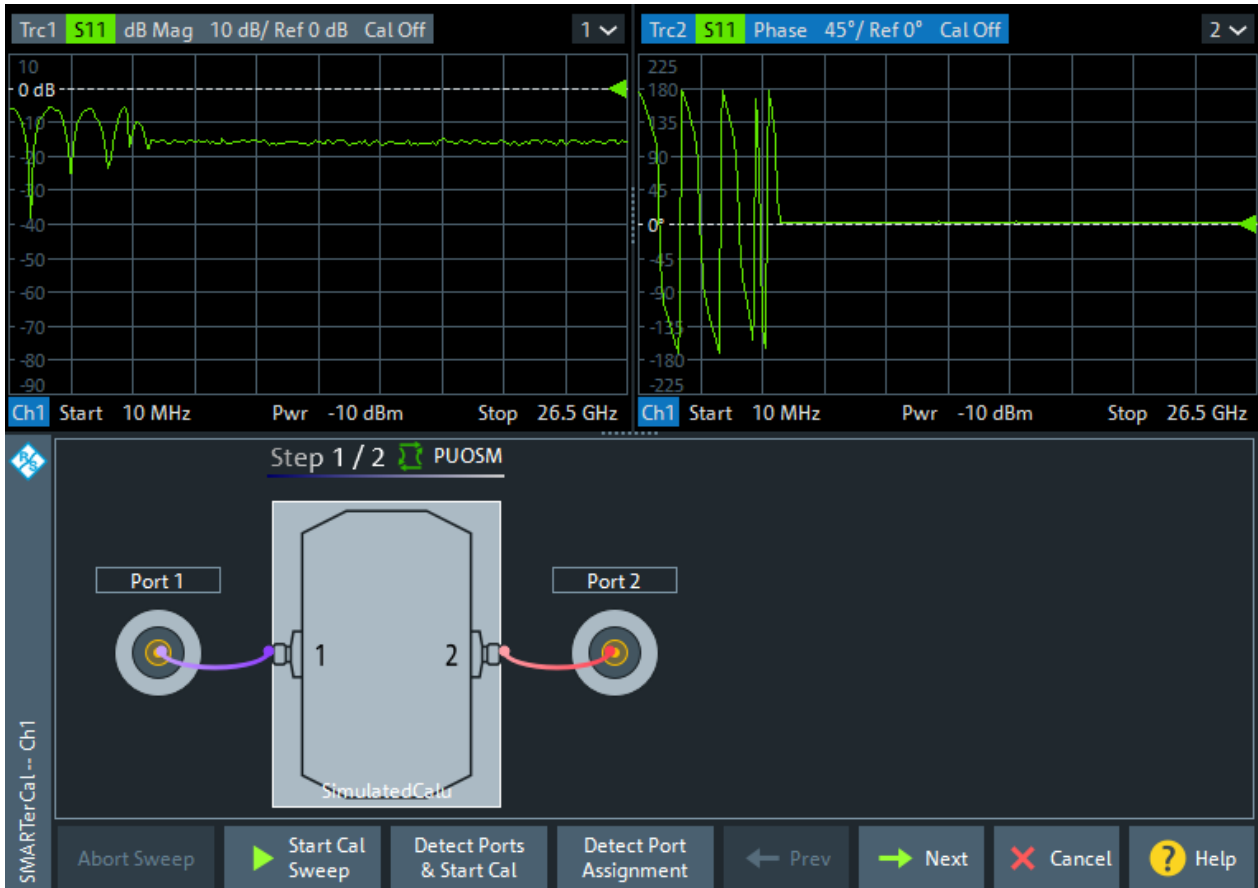

Figure 5-22: Automatic calibration: standard cal unit

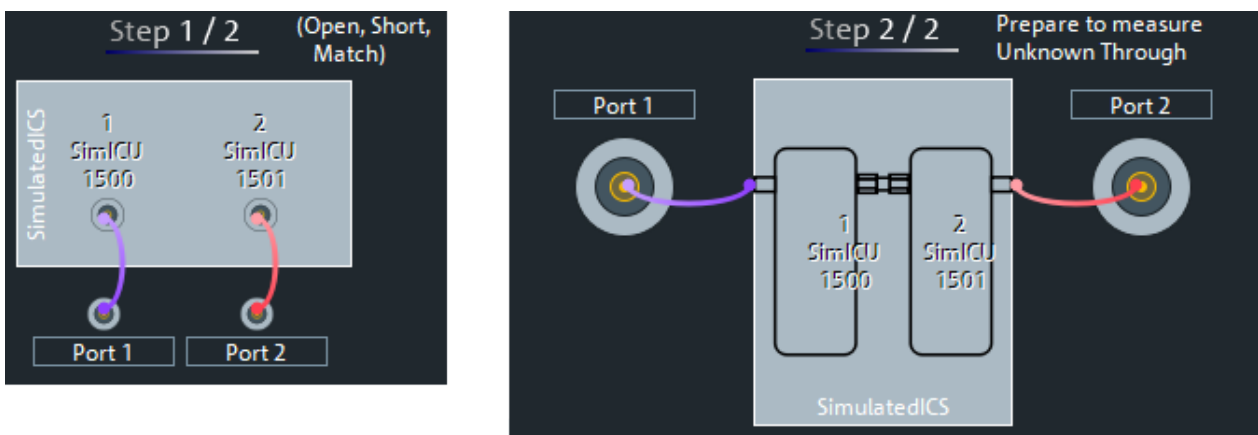
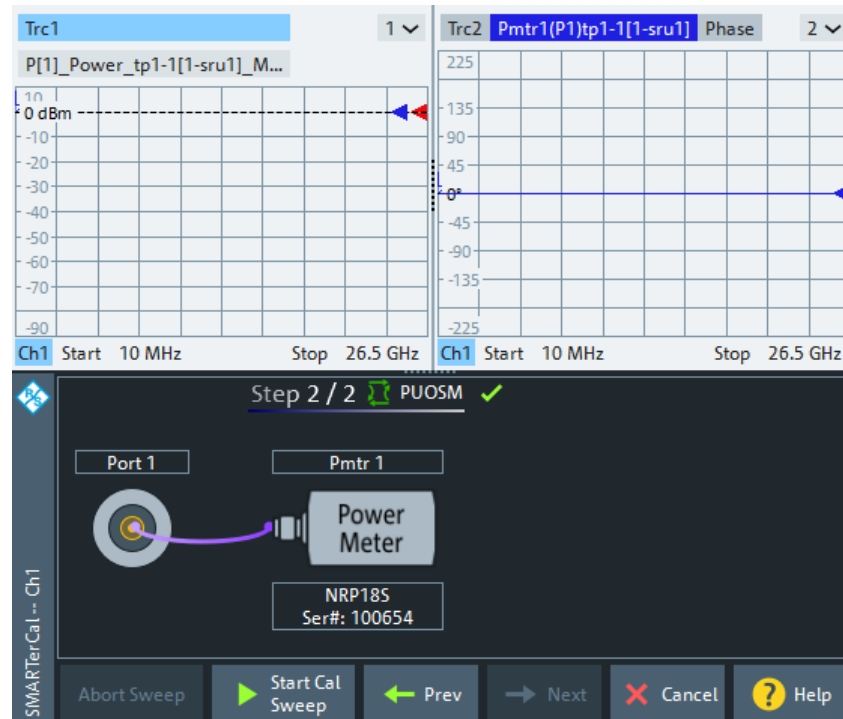

Figure 5-23: Automatic calibration: inline calibration system

2. When you perform a SMARterCal, in a final step:
 - a) Replace the calibration unit by the power meter.

b) Start the power calibration sweep.

The upper part of the screen displays power trace diagrams and the lower part displays the power meter connection.



Calibration Sweep Diagrams

During the calibration, the upper part of the screen displays the calibration sweep diagrams (magnitude and phase), each with a live and a memory trace.

- The live traces present a live measurement of the port or port connection selected in the lower part of the screen. They allow you to monitor the response when connecting a calibration standard. The traces are switched automatically when a calibration sweep is performed.
- The memory traces represent data acquired during the previous calibration sweep. They are updated with every completed calibration standard measurement of a calibration sweep. If no calibration sweep has been performed yet, no memory traces are shown.

In the example below, the memory traces show the result of the Unknown Through measurement between port 1 and 2, acquired during the previous cal sweep.

If switch matrices are involved, a sweep is performed for every possible signal path and for each of these paths a separate S-parameter trace is shown (see [Chapter 4.7.41.5, "Multiple paths and calibration"](#), on page 329).

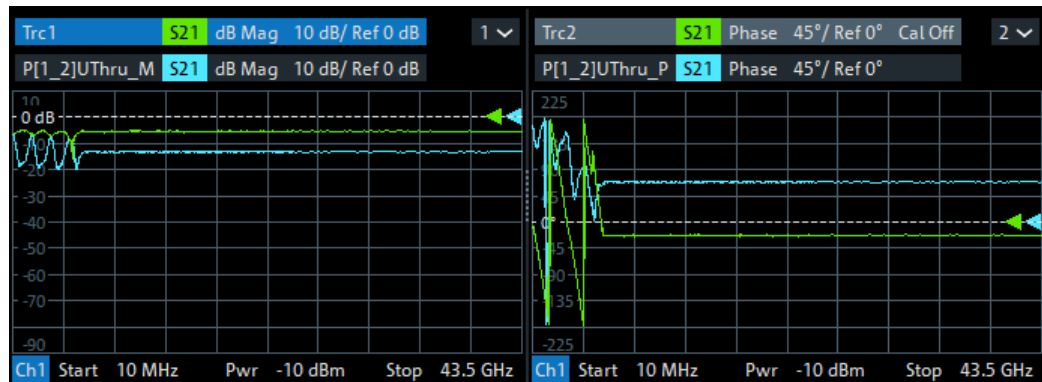

If switch matrices are involved, the label also indicates:

- which VNA port b is switched to the input port j and
- which VNA port a is switched to the output port i

Instead of a single S_{ij} trace we have multiple traces $S_{jvat/vbtj}$. E.g., "S21v1t1v3t2" means that S21 is measured with VNA port 1 connected to the input port and VNA port 3 connected to the output port.

Power Sweep Diagrams

Power sweep traces are displayed during the "Power" calibration sweeps of a SMARTerCal.

Start Cal Sweep / Abort Sweep

Starts the calibration sweep for the related port assignment or aborts it.

Note: The power calibration sweep is performed at the "Reference Receiver Cal Power" level specified in the [Cal Power Config dialog](#).

Remote command:

```
[SENSe<Ch>:]CORRection:COLLect:AUTO:ASSignment<Asg>:ACQuire
[SENSe<Ch>:]CORRection:COLLect:AUTO:POWer
```

Detect Ports & Start Cal

Performs the "Detect Port Assignment" and "Start Cal Sweep" functions, one after the other.

Detect Port Assignment

Starts a procedure by which the R&S ZNA (with a little help from the attached calibration unit) auto-detects the connected ports. The automatic assignment replaces the configured one.

In case auto-detection fails

- an error report is shown as a warning dialog
- the undetected port connections are marked with warning signs
- the calibration can be invalid

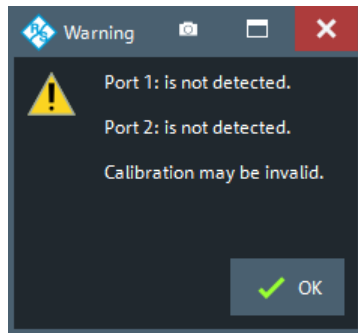

Remote command:

```
[SENSe:]CORRection:COLLect:AUTO:PORTs:CONNectioN?
```

Apply

This button is enabled when sufficient data have been acquired for the calibrated ports. The button starts the calculation of the calibration data and closes the calibration wizard.

The results are applied to the related channels. The current instrument settings are stored with the correction data.

To avoid incompatibilities, older calibration data is deleted unless it has been transferred into the calibration "Pool" using the [Calibration Manager dialog](#).

Note: Checks during the calculation of correction data

Incompatibilities between the selected calibration type, the standards and the channel settings can cause the calibration to be inaccurate. The analyzer auto-detects potential sources of errors and displays appropriate, self-explanatory notice boxes.

Remote command:

```
[SENSe<Ch>:]CORRection:COLLect:AUTO
[SENSe<Ch>:]CORRection:COLLect:AUTO:TYPE
[SENSe<Ch>:]CORRection:COLLect:AUTO:PORTs
[SENSe<Ch>:]CORRection:COLLect:AUTO:PORTs:TYPE
[SENSe<Ch>:]CORRection:COLLect:AUTO:SAVE
[SENSe<Ch>:]CORRection:COLLect:AUTO:POWer
```

5.11.1.4 Calibration setup dialog

Allows you to configure the calibration setup of the available channels.

Access:

- Channel – [Cal] > "Start Cal" > "Cal Active Channel" – "Configure/Start Calibration"
- [Calibrate All dialog](#) > "Add + Modify"

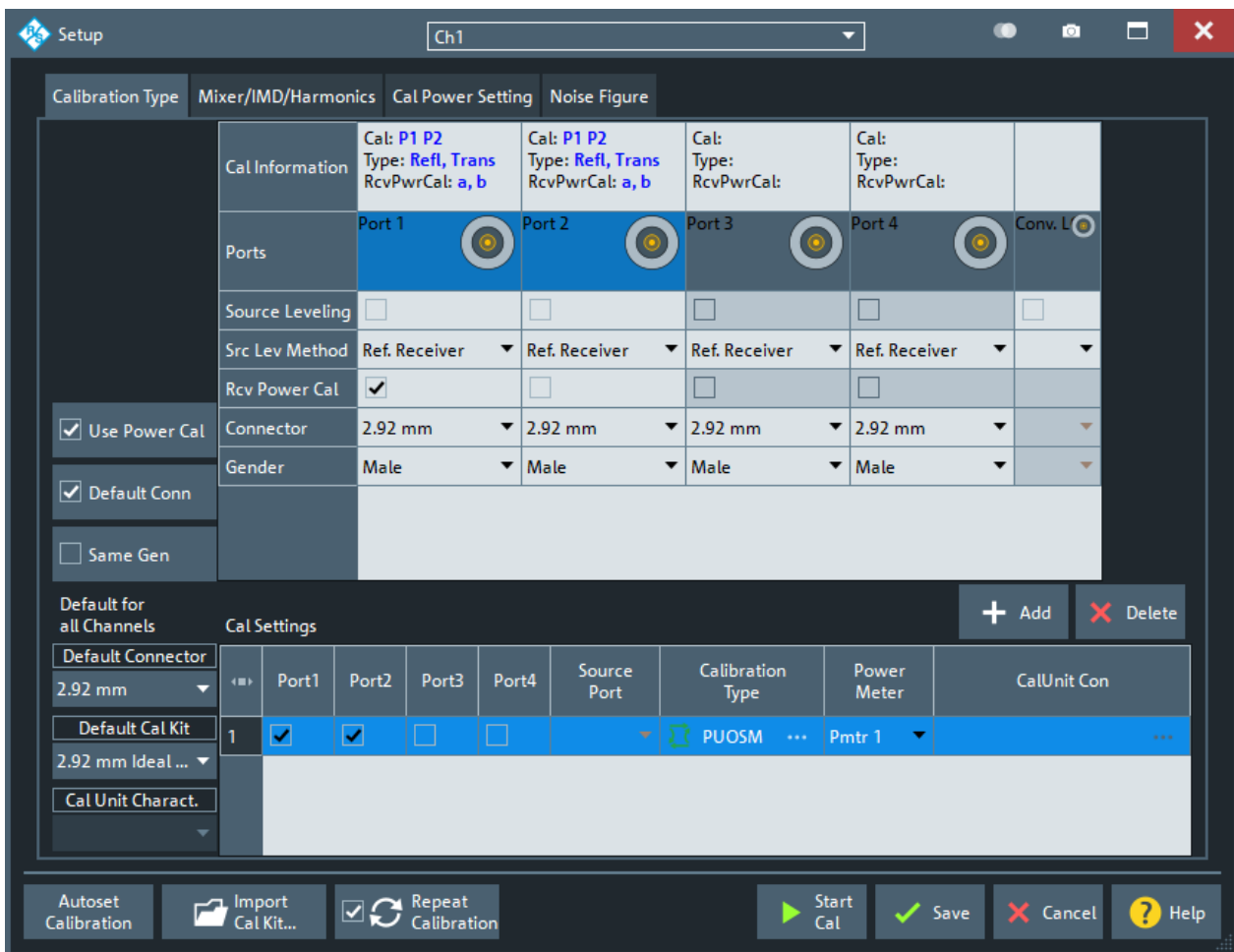

Messages in the dialog

An information message (or error message) is displayed if one of the following happens:

- One of the selected calibration kits is described by ideal kit parameters or typical values.
- One of the selected calibration kits does not contain all standards that are required for the chosen calibration type.
- Different connector types are defined at the ports but the selected calibration type requires uniform connectors.
- A cal kit standard, cal unit or power meter does not cover the entire calibrated frequency range.
- A combination of cal units and cal kits is configured in a channel

Calibration Type tab

The "Calibration Type" tab allows you to configure the calibration setup (i.e. a set of calibration definitions) for the channel selected in the title area of the calibration setup dialog.

Use Power Cal

If checked, you can select the power calibrations to be performed together with the system error correction.

The default setting and the selected power calcs depend on the active channel mode. E.g., for a standard (S-parameter) channel a [SMARTerCal](#) is proposed if a power meter is available.

Source Leveling/Src. Lev. Method

Adds a [Source power calibration](#) of the related port to the current calibration definition, which comes in handy for SMARTer calibrations (see [Chapter 4.5.7.3, "Combining SMARTerCal with scalar power calibration"](#), on page 226).

When you run the [Calibration wizard](#), an additional [source flatness calibration](#) step is performed.

"Src. Lev. Method" is equivalent to "Pwr Cal Method" on the "Power Cal Settings" tab (see ["Flatness Cal – Pwr Cal Method"](#) on page 628).

Remote command:

```
SOURce:POWer:CORRection:COLLect:METhod
```

Connector / Gender

Defines the connector types and genders of the ports to be calibrated. For symmetric (sexless) connector types (e.g. 7 mm / PC7), "Gender" is unavailable.

If "Default Conn." is active, the "Default Connector" is set in the "Default for all Channels" section (to the left of the [Cal. Settings](#) table). If "Same Gen." is active, the genders at all ports are always adjusted to the current selection.

User-defined connectors can be added or removed in the [Cal Connector Types dialog](#).

Remote command:

```
[SENSe<Ch>:]CORRection:COLLect:CONNection<PhyPt>
[SENSe<Ch>:]CORRection:COLLect:SCONNection<PhyPt>
[SENSe<Ch>:]CORRection:CONNection
[SENSe<Ch>:]CORRection:CONNection:CATalog?
[SENSe<Ch>:]CORRection:CONNection:DElete
```

Add

Use "Add" to add a calibration definition to the selected channel. The default calibration type depends on the channel's measurement mode.

Delete

Select a row in the [Cal. Settings](#) table and "Delete" the corresponding calibration definition.

Cal. Settings

The "Cal. Settings" table displays the calibration definitions of the current channel. The available columns depend on the available calibration devices.

<=>	Port1	Port2	Port3	Port4	Source Port	Calibration Type	Power Meter	Cal Kit Port 1	Cal Kit Port 2	Characterization	CalUnit Con
1	<input checked="" type="checkbox"/>	<input checked="" type="checkbox"/>	<input type="checkbox"/>	<input type="checkbox"/>		PUOSM ...	Pmtr 1	SimulatedCalu	SimulatedCalu	Factory	...

Figure 5-24: Cal settings for standard calibration units

<=>	Port1	Port2	Port3	Port4	Source Port	Calibration Type	Power Meter	Cal Kit Port 1	Cal Kit Port 2	Characterization	CalUnit Con	Temperature Compensation	Characterization for ICUs
1	<input checked="" type="checkbox"/>	<input checked="" type="checkbox"/>	<input type="checkbox"/>	<input type="checkbox"/>		PUOSM ...	Pmtr 1	SimulatedICS	SimulatedICS		...	<input type="checkbox"/>	...

Figure 5-25: Cal settings for inline calibration systems

Note: Currently, for each channel either manual calibrations, automatic calibrations, or inline calibration systems are allowed.

Port <i> ← Cal. Settings

Tick the checkboxes in the "Port <i>" columns to select the ports to be calibrated in the corresponding calibration.

Note: Calibration and port de-/activation.

The analyzer firmware automatically activates/deactivates ports during/after a (successful) calibration:

- Calibrated ports that were previously disabled, are automatically enabled as single-ended logical ports.
- An uncalibrated port that is not used by a measurement (i.e. the port is not required by any trace of the related channel) is disabled.

Source Port ← Cal. Settings

Source port for unidirectional n-port calibrations such as "One Path Two Ports" or "Trans Norm".

Remote command:

First test port in various autocal definition commands such as `[SENSe<Ch>:]CORRection:COLLect:AUTO:TYPE`

Common Port ← Cal. Settings

This column is only available if "Use Reduced Number of Through" on page 859 is activated in the "Calibration" tab of the "System Config" dialog.

For full n-port automatic calibrations, it defines the port that must appear in each port assignment, and that are as the "center" of all Through measurements.

Remote command:

`[SENSe<Ch>:]CORRection:COLLect:AUTO:CPORt`

Calibration Type ← Cal. Settings

Displays the calibration type.

Tap the table cell to open the "Define Calibration" dialog that lets you choose calibrated ports and type of the calibration definition. The available calibration types depend on the channel mode of the active channel.

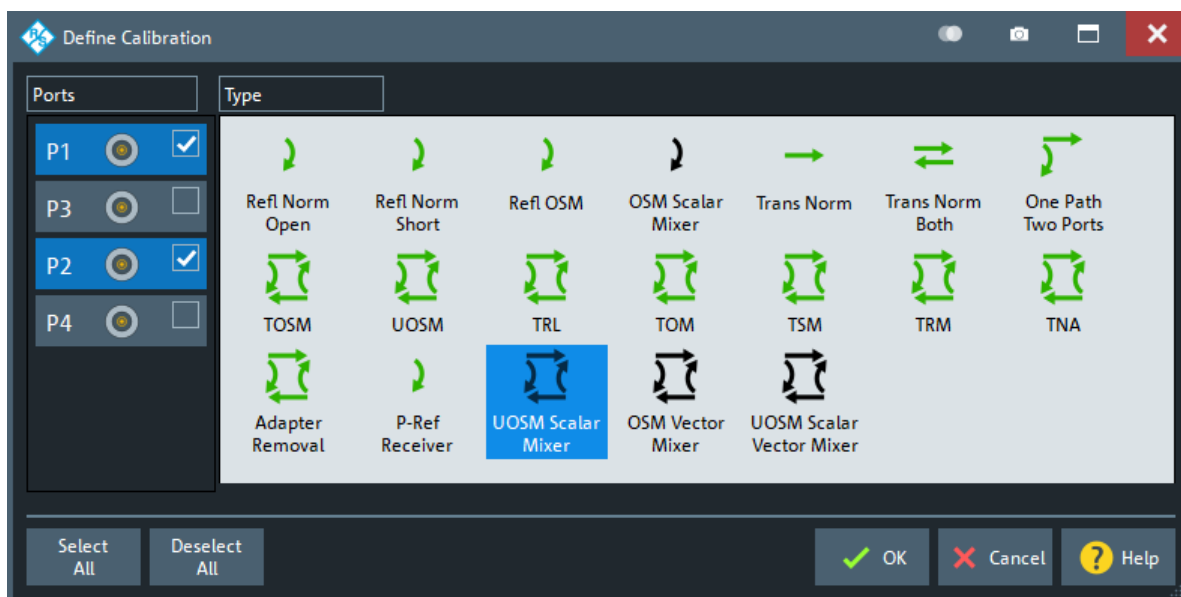

Figure 5-26: Define Calibration dialog: manual calibration

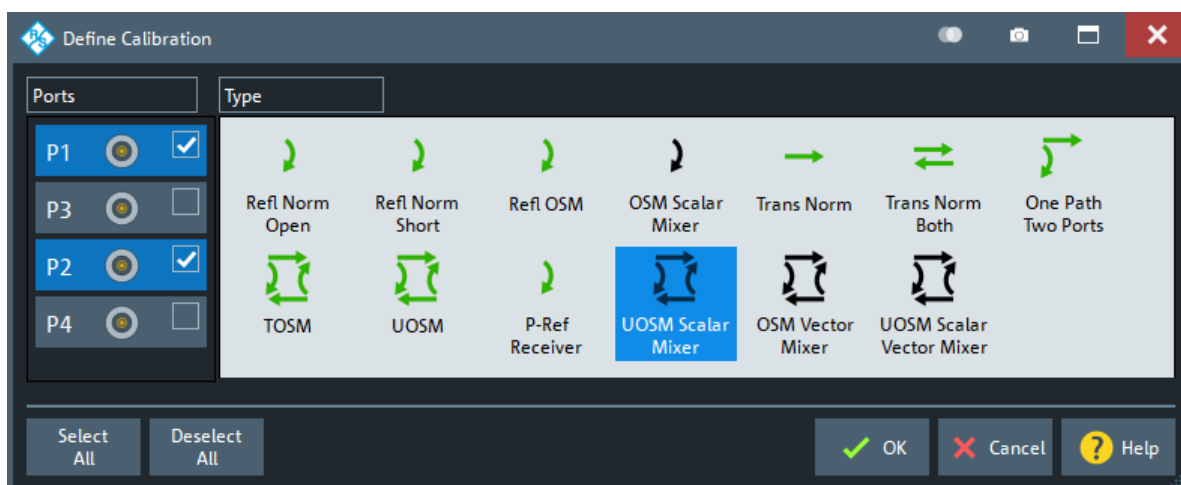

Figure 5-27: Define Calibration dialog: automatic calibration

The green arrow symbols give a preview of the type and the number of calibration sweeps involved:

- Curved arrows (example: "Refl Norm Open") denote one or more reflection measurements at each port.
Reflection calibration types can be used for any set of test ports: reflection calibrations are repeated for each port.
- Straight, horizontal arrows (example: "Trans Norm") denote one or more transmission measurements between each pair of two ports.
Transmission calibration types require at least two physical ports. For unidirectional transmission calibration types ("Trans Norm", "One Path Two Ports"), the ("**Source**" port) must be specified in addition.
- The full n-port calibration types ($n > 1$, e.g. "TOSM") are symbolized by a closed square symbol. The number of arrows increases the complexity but can also improve the accuracy of the calibration.

For an overview, refer to [Table 4-8](#).

Remote command:

Manual calibration

```
[SENSe<Ch>:]CORRection:COLLect:METhod:DEFine
```

```
[SENSe<Ch>:]CORRection:COLLect:AUTO:TYPE
```

Automatic calibration

```
[SENSe<Ch>:]CORRection:COLLect:AUTO:PORTs:TYPE
```

```
[SENSe<Ch>:]CORRection:COLLect:AUTO:CONFigure
```

Power Meter ← Cal. Settings

Shows a list of all power meters that have been properly configured and are available for the scalar source power calibration of a single source port. The last configured power meter is selected by default. See ["Configured Devices"](#) on page 893.

Remote command:

```
[SENSe:]CORRection:COLLect:PMETer:ID
```

Cal Kit Port <i> ← Cal. Settings

For each physical port covered by the selected calibration definition, you can select a cal kit, cal unit, or inline calibration system. The drop-down list contains the kits for the selected connector type and the connected calibration units.

The assignment of a calibration kit or unit to a [connector type](#) must be the same for all physical ports covered by the calibration definition. If a calibration kit is changed, the R&S ZNA automatically assigns the new kit to all ports with the same connector type.

Use [Import Cal Kit...](#) to add new kits to the list.

Remote command:

```
[SENSe:]CORRection:CKIT:SElect
```

Characterization ← Cal. Settings

Displays all characterizations that are stored in the active cal unit. The "Factory" characterization is available for all calibration units; it ensures an accurate calibration for all standard applications. To account for modifications of the cal unit such as the connection of additional adapters, you can generate modified sets of characterization data using the cal unit characterization wizard. See [Chapter 5.11.2.3, "Characterize Cal Unit dialog"](#), on page 621. By default, the R&S ZNA uses the last generated cal unit characterization.

For an inline calibration system, each connected inline calibration unit has its own set of characterizations:

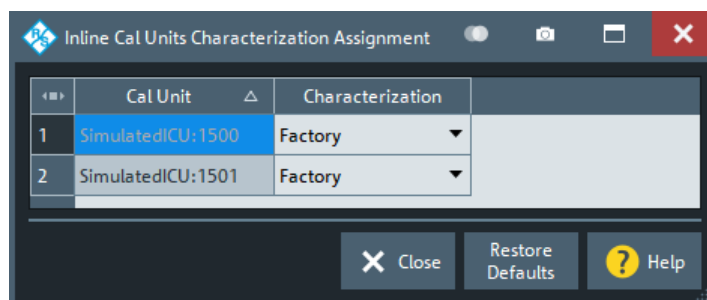

Tip: If the characterization wizard is password-protected, the "Characterization" button is unavailable. Use this functionality to prevent inadvertent activation of inappropriate characterizations. See ["Authentication"](#) on page 622.

See also [Chapter 4.5.5.3, "Characterization of calibration units"](#), on page 210.

Remote command:

```
[SENSe<Ch>:]CORRection:COLLect:AUTO:CONFigure
SYSTem:COMMunicate:RDEvice:AKAL:CKIT
SYSTem:COMMunicate:RDEvice:AKAL:CKIT:CATalog?
SYSTem:COMMunicate:RDEvice:AKAL:CKIT:STANdard:CATalog?
SYSTem:COMMunicate:RDEvice:AKAL:SDATA?
```

Query further cal unit properties:

```
SYSTem:COMMunicate:RDEvice:AKAL:DATE?
SYSTem:COMMunicate:RDEvice:AKAL:FRANge?
SYSTem:COMMunicate:RDEvice:AKAL:PORTs?
SYSTem:COMMunicate:RDEvice:AKAL:WARMup[:STATe]?
```

CalUnit Con ← Cal. Settings

Opens the "Calibration Unit" dialog that allows you to define the port assignments for an automatic calibration.

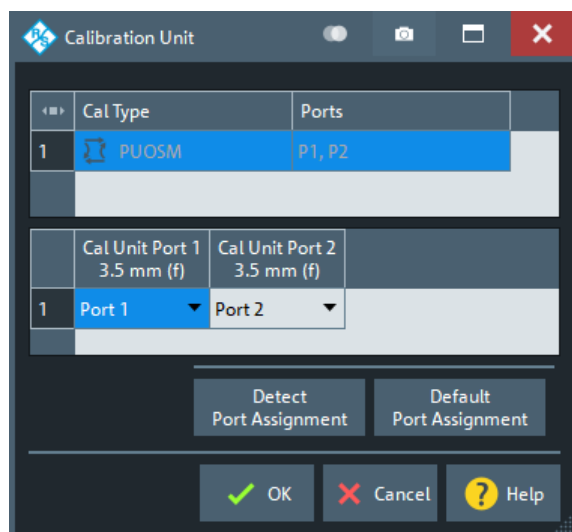

The R&S ZNA always proposes an optimum solution (minimum number of assignments) that also minimizes the physical port reconnections required between calibration stages. For user-modified assignments, it provides assistive information indicating insufficient, or redundant entries.

The test port connectors are automatically set according to the connector type of the selected calibration unit port.

"Detect Port Assignment" starts a procedure by which the R&S ZNA (with a little help from the attached calibration unit) auto-detects the connected ports. The automatic assignment replaces the configured one.

In case auto-detection fails:

- An error report is shown as a warning dialog
- The undetected port connections are marked with warning signs

- The calibration can be invalid

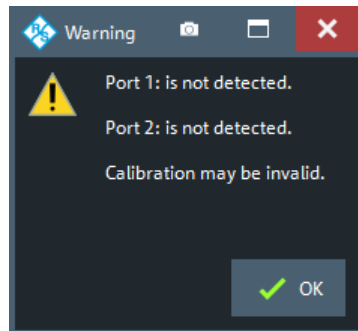

"Default Port Assignment" restores the default port assignments.

Remote command:

```
[SENSe<Ch>:]CORRection:COLLect:AUTO:ASSignment<Asg>:DEFine
[SENSe<Ch>:]CORRection:COLLect:AUTO:ASSignment<Asg>:DEFine:TPORT
[SENSe<Ch>:]CORRection:COLLect:AUTO:ASSignment:COUNT?
```

"Detect Port Assignment"

```
[SENSe:]CORRection:COLLect:AUTO:PORTs:CONNECTION?
```

"Default Port Assignment"

```
[SENSe<Ch>:]CORRection:COLLect:AUTO:ASSignment:DEFine:DEFAULT
[SENSe<Ch>:]CORRection:COLLect:AUTO:ASSignment:DEFine:TPORT:
DEFAULT
```

Temperature Compensation ← Cal. Settings

Available for inline calibration systems (ICS) only. Applies to all inline calibration units (ICUs) that are connected to the ICS and that are used with factory characterization data.

If checked, the R&S ZNA firmware adjusts the factory characterization data according to the ICU temperatures.

Remote command:

```
[SENSe<Ch>:]CORRection:COLLect:AUTO:TEMPcomp
```

Autoset Calibration

Resets the calibration to its default for the current channel mode.

Remote command:

n.a.

Repeat Cal

If checked, measurement data of the active calibration are reused (if available), which allows the calibration to be repeated without repeating all measurements.

Remote command:

```
[SENSe<Ch>:]CORRection:COLLect:AUTO:REPEAT
```

Import Cal Kit...

Opens the "Import Calibration Kit" dialog that allows you to import a cal kit file. For background information, see [Chapter 4.5.2.4, "Cal kit Files"](#), on page 204.

Remote command:

`MMEMoRY:LOAD:CKIT`

Mixer/IMD/Harmonics tab

Defines channel-specific settings for mixer and intermodulation (IMD) measurements.

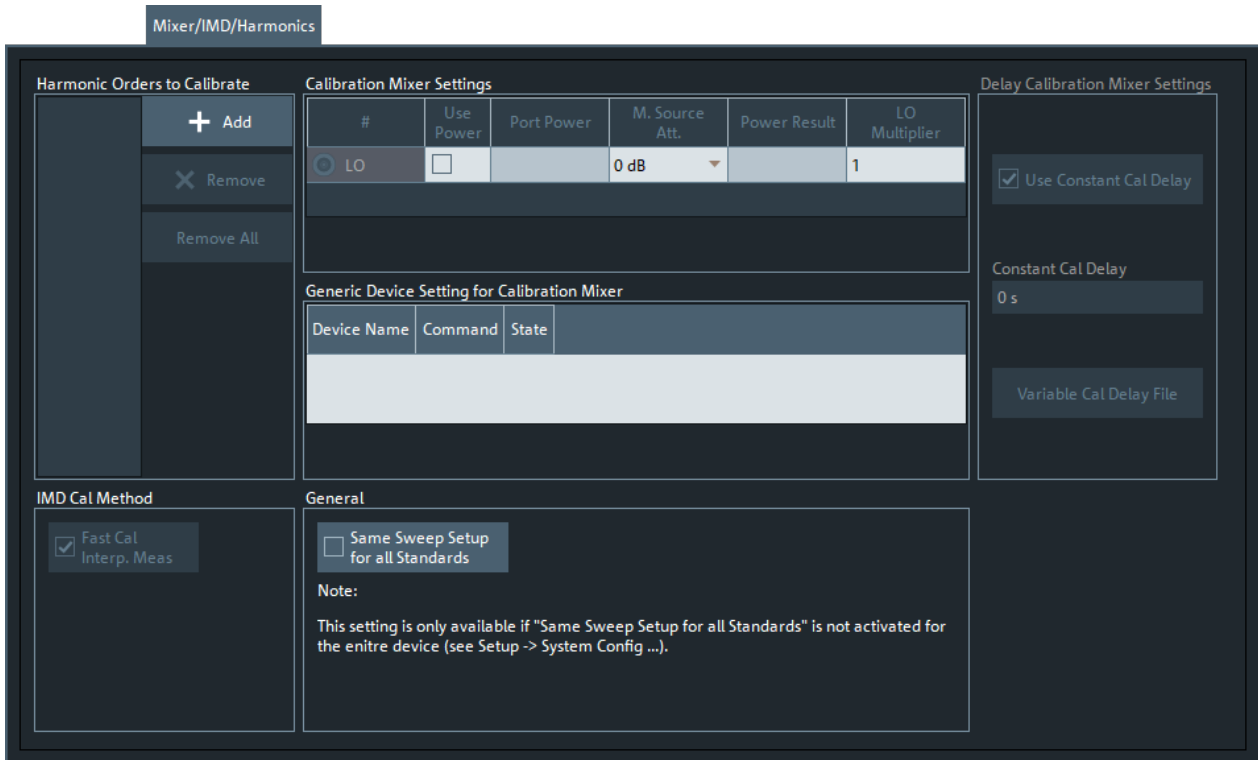

Harmonic Orders to Calibrate

If a harmonics measurement is active in the current channel, this section allows you to specify the harmonic orders to be calibrated in the current channel.

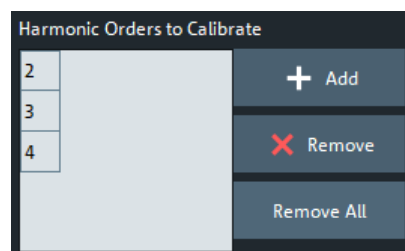

By default, the firmware selects all harmonic orders that are relevant for an existing harmonics trace in this channel.

Remote command:

```
[SENSe<Ch>:]CORRection:ADVanced:HARMonic:ORDeR?
[SENSe<Ch>:]CORRection:ADVanced:HARMonic:ORDeR:ADD
[SENSe<Ch>:]CORRection:ADVanced:HARMonic:ORDeR:REMOve
SOURce<Ch>:POWeR<PhyPt>:CORRection:HARMonic[:ACQuire]
[SENSe<Ch>:]CORRection:POWeR<PhyPt>:HARMonic:ACQuire
```

IMD Cal Method>Fast Cal Interp. Meas

This checkbox is enabled, if the channel is configured for an intermodulation (IMD) measurement.

To avoid interpolation of calibration data, which causes problems during the measurement, it is preferable to increase the number of sweep points during the calibration. However, the number of sweep points that are required to avoid interpolation can be large, and hence the calibration can take some time to complete.

Keep "Fast Cal Interp. Meas" checked to stick to the faster calibration method that does not increase the number of sweep points and uses interpolation if necessary.

Remote command:

`SOURce<Ch>:POWer:CORRection:IMODulation:MEtHod`

Calibration Mixer Settings

Defines the properties of the calibration mixer and the related calibration. The table is enabled, if the channel is configured for a mixer measurement.

Calibration Mixer Settings					
#	Use Power	Port Power	M. Source Att.	Power Result	LO Multiplier
LO	<input type="checkbox"/>		0 dB		1

Generic Device Setting for Calibration Mixer

Allows you to execute a command on a previously configured [generic device](#) before the calibration mixer step of a calibration.

Generic Device Setting for Calibration Mixer		
Device Name	Command	State
GenericDevice::TCPIP0::test::INSTR		!
	MySetting1	
	MySetting2	

This setting can be used, for example, to insert the calibration mixer into the signal path using an external switching unit such as the R&S OSP.

Remote command:

`[SENSe<Ch>:]GDEvice:MSLEct`

General>Same Sweep Setup for all Standards

Enables the [Same Sweep Setup for All Standards](#) logic for the current channel (instead globally).

Note that noise figure calibrations require individual setups, and hence this setting is ignored.

Remote command:

`[SENSe<Ch>:]CORRection:COLLect:CHANnels:CSEtup`

Delay Calibration Mixer Settings

The controls in this section are only active, if the current channel is set up for mixer delay measurements (Chapter 5.2.15, "Two Tone Group Dly tab (frequency-converting DUT)", on page 416). They allow you to configure the properties of a mixer delay calibration.

Use Constant Cal Delay ← Delay Calibration Mixer Settings

If checked, you can specify a [Constant Cal Delay](#). Otherwise you can use the [Variable Cal Delay File](#) button to pick a CSV file with delay data for the reference mixer.

Remote command:

```
[SENSe<Ch>:] FREQuency:MDElay:CDMode
```

Constant Cal Delay ← Delay Calibration Mixer Settings

If [Use Constant Cal Delay](#) is checked, you can enter a constant calibration delay.

Remote command:

```
[SENSe<Ch>:] FREQuency:MDElay:CDElay
```

Variable Cal Delay File ← Delay Calibration Mixer Settings

This button is only enabled, if [Use Constant Cal Delay](#) is unchecked. It allows you to load delay data for the reference mixer from a CSV file.

Remote command:

```
MMEMory:LOAD:MDAData
```

Cal. Power Settings tab

The "Cal Power Setting" tab collects all calibration-related power settings that were previously distributed across several softtool tabs and dialogs.

Cal Power Setting

Ports	Port 1 RF	Port 2 IF	Port 3	Port 4	Conv. LO
Source Power	-10 dBm	-10 dBm	-10 dBm	-10 dBm	-10 dBm
Source Step Att	0 dB <input type="checkbox"/>	0 dB <input type="checkbox"/>	0 dB <input type="checkbox"/>	0 dB <input type="checkbox"/>	
ZNA Port Power	-10 dBm	-10 dBm	-10 dBm	-10 dBm	
Cal Power Offset	0 dB	0 dB	0 dB	0 dB	
Cal Power	-10 dBm <input type="checkbox"/>	-10 dBm <input type="checkbox"/>	-10 dBm <input type="checkbox"/>	-10 dBm <input type="checkbox"/>	0 dBm <input type="checkbox"/>
PreAmp Gain	Off <input type="checkbox"/>	Off <input type="checkbox"/>			
Receiver Step Att	10 dB <input type="checkbox"/>	10 dB <input type="checkbox"/>	10 dB <input type="checkbox"/>	10 dB <input type="checkbox"/>	

Power Cal Settings for Source Flatness

Max Iterations	Tolerance	Convergence
10 <input type="checkbox"/>	0.1 dB <input type="checkbox"/>	1 <input type="checkbox"/>

Reference Receiver Cal Power

<input checked="" type="checkbox"/> Use Cal Power for Port	Source Power	Source Step Att	Transmission Coefficients Power
------------------------------------------------------------	--------------	-----------------	---------------------------------

Source Power

See ["Power"](#) on page 526.

Source Step Att

Source step attenuator setting used during calibration, if activated.

Remote command:

```
[SENSe<Ch>:]CORRection:ADVanced:SOURce<PhyPt>:ATTenuator
[SENSe<Ch>:]CORRection:ADVanced:SOURce<PhyPt>:ATTenuator:STaTe
```

ZNA Port Power

"Power Result", as displayed in the [port settings dialog](#).

Cal Power Offset

For power calibrations only: Specifies a gain (positive values) or an attenuation (negative values) in the signal path between the source port and the calibrated reference plane. With a "Cal Power Offset" of n dB, the target power at the reference plane (cal power) is equal to the actual output power at the port plus n dB. The "Cal Power Offset" has no impact on the source power.

Example: Use of an amplifier in the signal path

Assume that a DUT requires a constant input power of +25 dBm, and that the measurement path contains an amplifier with a 30 dB gain. After a reset of the analyzer, the channel power P_b is -10 dBm. Select a "Port Power Offset" of +5 dB at the calibrated source port and a "Cal Power Offset" of +30 dB. Then the source power calibration ensures that the constant input power of +25 dBm is maintained across the entire sweep range. The actual output power of the analyzer is -5 dBm.

Notice that a power calibration with an appropriate "Cal Power Offset" can prevent excess input levels at the DUT.

Remote command:

```
SOURce<Ch>:POWer<PhyPt>:CORRection:LEVel:OFFSet
SOURce<Ch>:POWer<PhyPt>:CORRection:GENerator<Gen>:LEVel:OFFSet
```

Cal Power

Port power used during calibration, if activated.

Remote command:

```
[SENSe<Ch>:]CORRection:ADVanced:POWer<PhyPt>
[SENSe<Ch>:]CORRection:ADVanced:POWer<PhyPt>:STaTe
```

Preamp Gain

Preamplifier gain used during calibration, if activated.

Only available if the R&S ZNA is equipped with optional preamplifiers.

- Port 1: see [Chapter 4.7.37, "Internal low power spur reduction amplifier"](#), on page 314
- Port 2: [Chapter 4.7.36, "Internal low noise preamplifier"](#), on page 312

Remote command:

```
[SENSe<Ch>:]CORRection:ADVanced:SENSe<PhyPt>:PREamp
[SENSe<Ch>:]CORRection:ADVanced:SENSe<PhyPt>:PREamp:STATe
```

Receiver Step Att

Receiver step attenuation used during calibration, if activated.

Only available for ports that are equipped with receiver step attenuators (see [Chapter 4.7.31, "Receiver step attenuators"](#), on page 309).

Remote command:

```
[SENSe<Ch>:]CORRection:ADVanced:SENSe<PhyPt>:PREamp
[SENSe<Ch>:]CORRection:ADVanced:SENSe<PhyPt>:PREamp:STATe
```

Parameter Source Flatness

Specifies the parameters of a source flatness calibration. See [Chapter 5.11.3, "Pwr Cal Settings tab"](#), on page 626.

Reference Receiver Cal Power

See ["Reference Receiver Cal Power"](#) on page 631.

Noise Figure tab

In this tab, you can adjust noise figure calibration settings such as power levels and detector times.

Noise Figure

Calibration Power Settings	Ref Receiver Cal Power	General
<p>Drive Port (Forward Meas) P1</p> <p>Source Power: -10 dBm</p> <p>Source Step Att: 40 dB <input type="checkbox"/></p> <p>ZNA Port Power: -50 dBm <input type="checkbox"/></p> <p>Src Power Thru Meas: -50 dBm <input type="checkbox"/></p>	<p><input checked="" type="checkbox"/> Use Port Power Result</p> <p>Source Power: [input field]</p> <p>Source Attenuation: [input field]</p>	<p>Noise Det Meas Time: 10 ms <input checked="" type="checkbox"/></p> <p>Gain Det Meas Time: 10 ms <input checked="" type="checkbox"/></p>
<p>Drive Port (Reverse Meas) P2</p> <p>Source Power: -10 dBm</p> <p>Source Step Att: 0 dB <input type="checkbox"/></p> <p>ZNA Port Power: -10 dBm <input type="checkbox"/></p>		

The **Quickset** functionality in the **Noise figure setup dialog** automatically chooses suitable calibration settings. Manual configuration requires carefully chosen power levels, depending on the active **receiver step attenuator** and **internal preamplifier** configuration.

For a noise figure measurement, the power level at the test port input must not exceed the values given in the table below.

Table 5-5: Max. power level

	Receiving port coupler	
	standard	reversed
Receiver Step Att. = 10 dB	10 dBm	0 dBm
"Receiver Step Att." = 0 dB	0 dBm	-10 dBm
"Receiver Step Att." on page 527 = 20 dB	-20 dBm	-30 dBm
"Preamp. Gain" = 25 dB	-25 dBm	-35 dBm
"Preamp. Gain" = 30 dB	-30 dBm	-40 dBm

Choose a source power between -10 dBm and 0 dBm for reference receiver calibration, to ensure a high-quality calibration.

Values entered for "Calibration Power Settings" and "Ref Receiver Cal Power" are mirrored to the "Cal Power Settings" and vice versa. The detector times determine the trace noise during measurement of the calibration standards and the receiver noise measurement. Generally, a higher detector time results in a better measurement result. However, a certain trade-off to the overall calibration and measurement time has to be found.



If different power levels are configured for the cal standard and/or power meter steps, the power level is reduced to the respective minimum before every calibration step.

Src Power Thru Meas

Source power for Through measurements during NF calibration.

Remote command:

```
SOURce<Ch>:NFIGure:CALibration:TPOWer
SOURce<Ch>:NFIGure:CALibration:TPOWer:STATE
```

Noise Det Meas Time

Defines the detector time of the RMS detector which is used for the noise measurement during a noise figure calibration in channel <Ch>.

Remote command:

```
[SENSe<Ch>:]NFIGure:CALibration:NTIME
```

Gain Det Meas Time

Defines the detector time of the AVG detector which is used for the gain measurement during a noise figure calibration in channel <Ch>.

Remote command:

```
[SENSe<Ch>:]NFIGure:CALibration:GTIME
```

5.11.1.5 Power Cal wizard

The "Power Cal" wizard displays a single screen, showing the current source and receive ports. It allows you to perform "Ref. Receiver", "Meas. Receiver" and scalar source power ("Source Flatness") calibrations, based on the current power calibration settings (see [Chapter 5.11.3, "Pwr Cal Settings tab"](#), on page 626).

Access: Channel – [Cal] > "Start Cal" > "Power Cal..."

Screen elements



From top to bottom, the screen consists of the following elements.

Calibration Sweep Diagram

The calibration sweep diagram in the upper part of the screen shows the progress of the calibration and the accuracy of a completed calibration ("Verification"). The diagram is scaled in "dB Mag" format.

The diagram title indicates the ongoing calibration type and reading. The traces in the diagram vary according to the calibration stage.

While no calibration is performed, or during a source power calibration ("Power"), the following traces are displayed:

- A limit line (double horizontal) represents the target power of the source power calibration ("Cal Power").
- "Pmtr<n>" shows the reading of the power meter <n> in use. This trace is only shown during the first calibration sweeps; the following sweeps are based on the reference receiver result.
- "a<m>(P<m>)" shows the source power reading of the analyzer (wave quantity, reference receiver) at the calibrated source port P<m>.

After a successful power calibration, the trace "a<m>(P<m>)" must be close to the "Cal Power".

During a measurement receiver calibration ("Meas. Receiver"), the following traces are displayed:

- The trace "a<m>(P<m>)" shows the (previously calibrated) power at the calibrated reference plane (source port P<m>).
- The trace "b<n>(P<n>)" shows the current power reading of the analyzer at the calibrated receive port P<n> (source port P<m>).

After successful measurement receiver calibration, the "b<n>(P<n>)" trace must be close to the "a<m>(P<m>)" trace. Due to the previous power calibration, both traces must be close to the cal power.

Remote command:

```
SOURce<Ch>:POWer<PhyPt>:CORRection[:ACQuire]:VERification:
RESult?
```

Port Overview

Shows all source ports together with the possible power calibrations.

For each analyzer port P1 ... PN, a "Ref. Receiver", a "Meas. Receiver" and a "Source Flatness" calibration can be performed.

- If a "SMARTerCal" is active, additional receiver power calibrations are not allowed and the R&S ZNA only offers the possibility to perform "Source Flatness" calibrations of the related test ports:

P1	P3	P2	P4
-10 dBm Offset: 0 dB	-10 dBm Offset: 0 dB	-10 dBm Offset: 0 dB	-10 dBm Offset: 0 dB
Source Flatness	Ref. Receiver	Source Flatness	Ref. Receiver
	Meas. Receiver		Meas. Receiver
	Source Flatness		Source Flatness

See [Chapter 4.5.7.3, "Combining SMARTerCal with scalar power calibration"](#), on page 226 for details.

- If external generators are configured, they appear as additional source ports G1 ... Gm in the port overview. A source power (flatness) calibration is available at each generator port.
- If the optional [LO Out](#) is equipped and **not** configured as LO source for millimeter wave converters, it appears as an additional "C.LO" port.

Only a source flatness calibration can be performed, and this calibration can only be done using a power meter (irrespective of the selected [Power Cal Method](#)).

- If option R&S ZNA is available and frequency converters are configured, additional source flatness calibrations can be performed for the analyzer ports driving the converters' RF IN and LO IN ports.

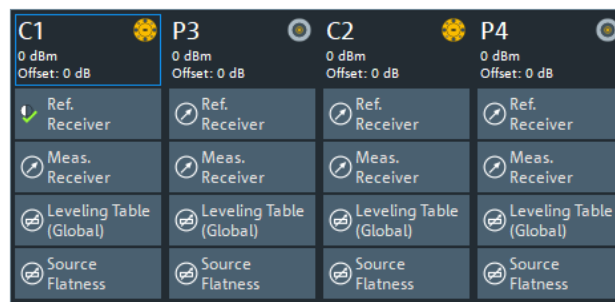
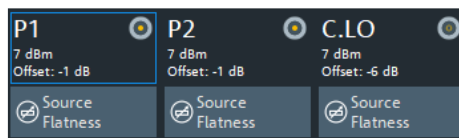
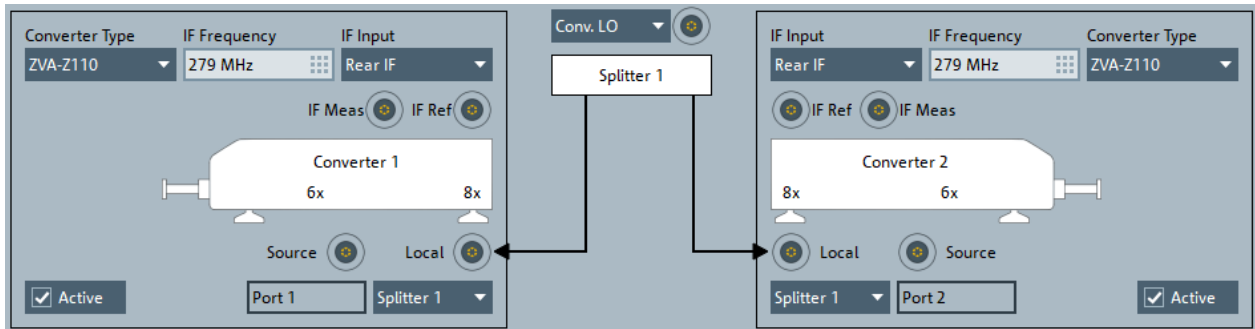

In the converter configuration above, P1 and P2 drive the RF IN ports of converter 1 and 2, respectively, and the Converter LO port drives the LO IN ports of both converters.

Since firmware version 2.40, the "Leveling Table" buttons give access to the converter leveling functionality that previously required a separate software.

Select a "Ref. Receiver" or "Meas. Receiver", "Leveling Table", or "Source Flatness" symbol to start the related calibration. See ["Power Cal dialog – Ref. Receiver"](#) on page 599, ["Power Cal dialog – Meas. Receiver"](#) on page 600, ["Power Cal dialog – Source Flatness"](#) on page 604, and ["Power Cal dialog – Leveling Table"](#) on page 602.

A green checkmark ✓ indicates that the calibration data has been acquired successfully. A half circle overlay ◐ indicates that only the respective port frequencies are covered (see ["Calibrate Only Port Frequency"](#) on page 600).

Remote command:

```
SOURce<Ch>:POWer:CORRection[:ACQuire]
[SENSe<Ch>:]CORRection:POWer<PhyPt>:ACQuire
SOURce<Ch>:POWer:CORRection:DATA:PARAmeter<Wv>?
```

`SOURce<Ch>:POWer<PhyPt>:CORRection:DATA:PARAmeter<Wv>:COUNT?`
`SOURce<Ch>:POWer<PhyPt>:CORRection:UPORt:STATe` on page 1577

Apply

Is enabled when a new set of power calibration data has been acquired. The button applies all available power calibrations to the active channel, aborts the verification sweeps, and closes the port overview section.

The power calibration state is indicated in the trace list, see [Chapter 4.5.6.3, "Power calibration labels"](#), on page 222. Use the functions in the [Chapter 5.11.4, "Use Cal tab"](#), on page 634 to activate, deactivate, or store power calibrations.

Remote command:

```
SOURce<Ch>:POWer:CORRection[:ACQuire]
[SENSe<Ch>:]CORRection:POWer<PhyPt>:ACQuire
SOURce<Ch>:POWer:CORRection:DATA
SOURce<Ch>:POWer:CORRection:DATA:PORT<PhyPt>
[SENSe<Chn>:]CORRection:PState?
```

Power Cal dialog – Ref. Receiver

In Ref. Receiver mode, the "Power Cal" dialog guides you through a reference receiver calibration.

The selected source port is displayed with its cal power settings (see [Chapter 5.11.3.2, "Cal Power Config dialog"](#), on page 629). A circuit diagram visualizes the connectivity. A power meter must be connected to the calibrated source port.

Access: [Power Cal wizard](#) > Ref. Receiver



Background information

Refer to [Chapter 4.5.6.1, "Source power calibration"](#), on page 220.

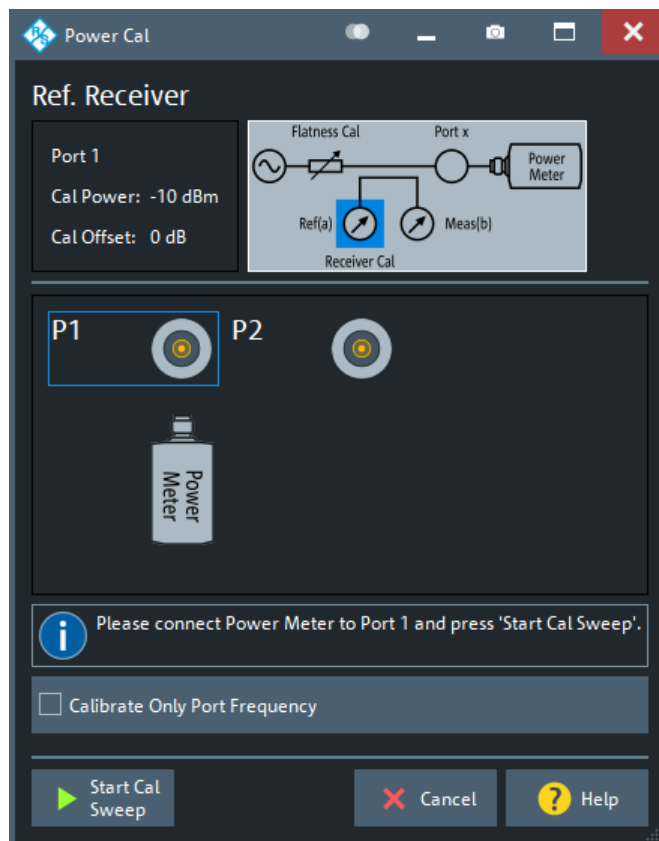

Start Cal Sweep

Starts the calibration sweeps for the selected port and power calibration settings and closes the dialog. The calibration is performed as described in "[Calibration procedure](#)" on page 220.

Open the [Pwr Cal Settings](#) tab if you wish to modify the calibration procedure.

Remote command:

```
SOURce<Ch>:POWER:CORRection[:ACQuire]
```

```
SOURce<Ch>:POWER<PhyPt>:CORRection:COLLect[:ACQuire]
```

Calibrate Only Port Frequency

For [Frequency conversion measurements](#), by default the reference receivers are calibrated for all resulting frequencies – even if they are currently not relevant for some ports. Using this switch, you can limit the calibrated frequencies to those frequencies that are required for the related port, which results in shorter calibration times.

Power Cal dialog – Meas. Receiver

In "Meas. Receiver" mode, the "Power Cal" dialog guides you through the calibration of a measurement receiver. To ensure accurate source signal powers, a source power calibration must be performed before the measurement receiver calibration.



Background information

Refer to [Chapter 4.5.6.2, "Measurement receiver calibration"](#), on page 221.

Access: [Power Cal wizard](#) > "Meas. Receiver"

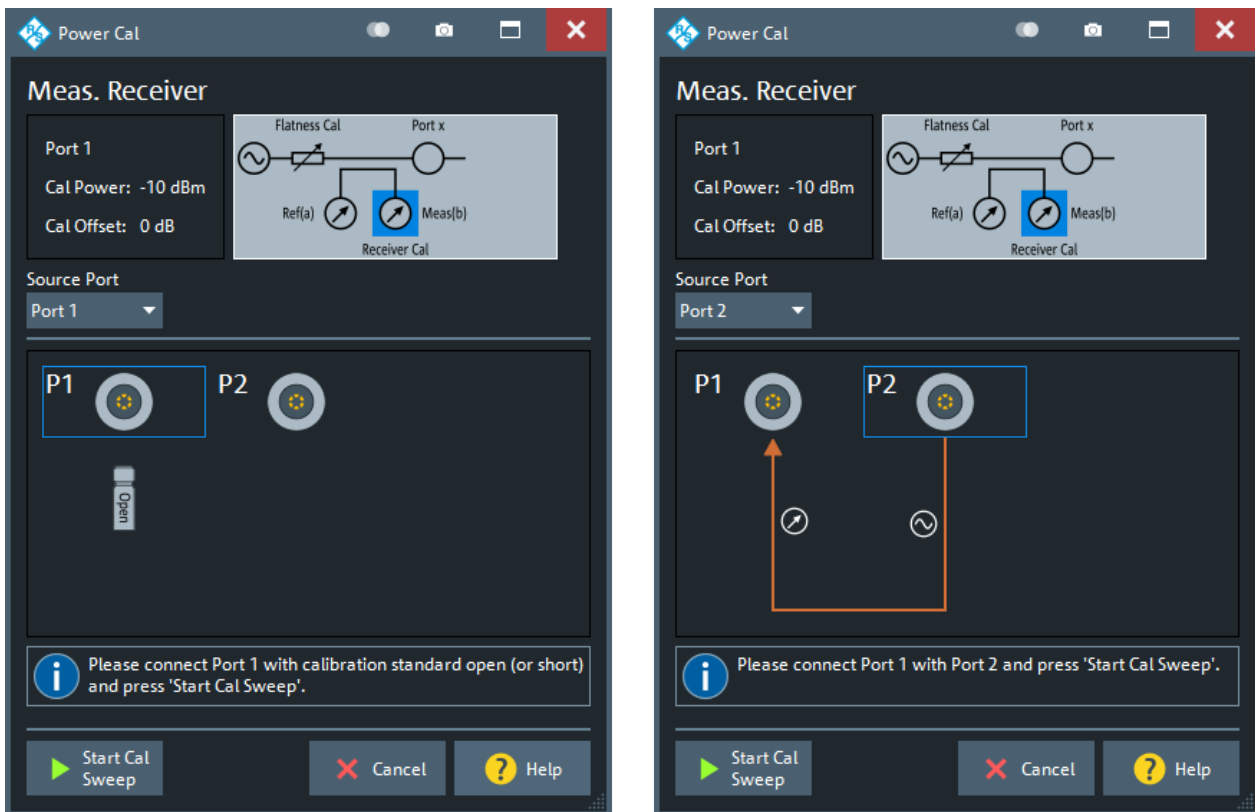

left: = source and meas. port identical
right = source and meas. port different

Port Overview

The dialog shows all receiver ports of the network analyzer. The selected port is displayed with the current cal power settings (see [Chapter 5.11.3.2, "Cal Power Config dialog"](#), on page 629); moreover, a circuit diagram visualizes the purpose of the measurement receiver calibration.

"Source Port" defines the type of measurement receiver calibration:

- If the source port is equal to the calibrated port, the measurement receiver is calibrated by the wave that is reflected back by a connected Open or Short standard. Connect the Open or Short standard to the calibrated port; no additional external test setup is required.
- If the source port and the calibrated port are different, the measurement receiver is calibrated by the wave generated at the source port. Connect the source port to the calibrated port, including any external devices that you used for the source power calibration.

For the source port, a source power calibration must be active.

Remote command:

```
[SENSe<Ch>:]CORRection:POWer<PhyPt>:ACquire
```

Start Cal Sweep

Start the calibration sweep for the selected port and power calibration settings and close the dialog. The calibration is performed as described in "[Calibration procedure](#)" on page 221. No additional calibration settings are needed.

Remote command:

```
[SENSe<Ch>:]CORRection:POWer<PhyPt>:ACQuire  
[SENSe<Ch>:]CORRection:POWer:DATA  
[SENSe<Ch>:]CORRection:POWer:DATA:PORT<PhyPt>
```

Power Cal dialog – Leveling Table

In "Leveling Table" mode, the "Power Cal" dialog guides you through the source power leveling of a single port.

The dialog shows the selected source port and allows you to define the leveling grid for the current channel. A circuit diagram visualizes the setup.



- The leveling function and the "Leveling Table" variant of the "Power Cal" dialog are only available if option R&S ZNA-K8 is installed. Their main focus is to enable source power control for mm-wave converter ports. However, leveling can also be done for "normal" VNA ports.
- Leveling requires an existing [reference receiver](#) on the related port.
- Although leveling is performed in the standard power cal wizard, the created leveling dataset is applied to all channels in the current recall set. A "Preset" does not affect the leveling dataset and whether or not it is used for power control.



Background information

Refer to [Chapter 4.7.7.1, "Leveling"](#), on page 283.

Access: [Power Cal wizard](#) > "Leveling Table"

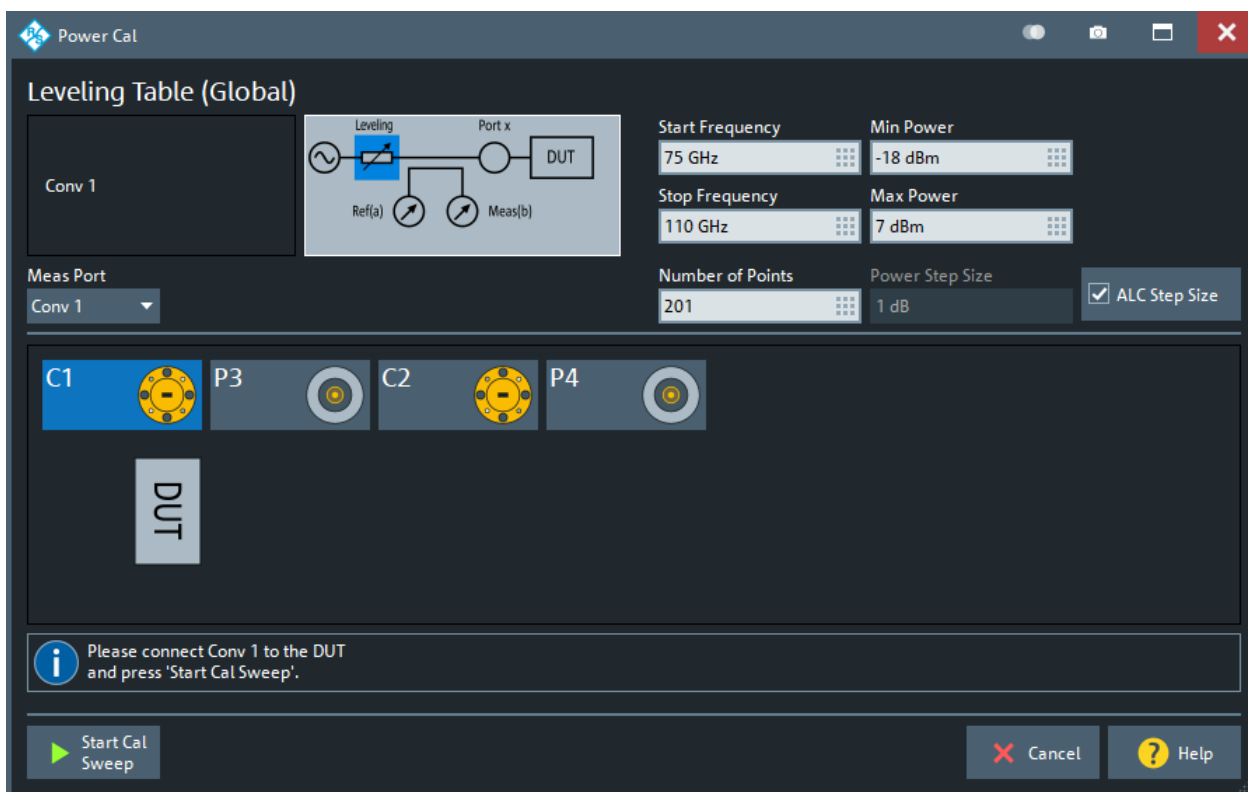

Start Frequency/Stop Frequency

Defines the start and stop frequency of the leveling grid.

By default the vector network analyzer uses the standard frequency range of the selected "Meas Port".

Remote command:

```
SOURce<Ch>:POWER<PhyPt>:CORRection:SLEVeling:FREQuency:START
SOURce:POWER<PhyPt>:CORRection:SLEVeling:FREQuency:STOP
```

Number of Points

Defines the number of frequency sweep points of the leveling grid.

By default the R&S ZNA uses 201 sweep points. The higher the number of "Sweep Points", the more accurate the leveling, but also the longer it takes to create the leveling table). The number of sweep points is limited to 100001.

Remote command:

```
SOURce:POWER<PhyPt>:CORRection:SLEVeling:FREQuency:POINTs
```

Start Power/Stop Power

Defines the start and stop (source) power of the leveling grid.

Remote command:

```
SOURce<Ch>:POWER<PhyPt>:CORRection:SLEVeling:POWER:START
SOURce:POWER<PhyPt>:CORRection:SLEVeling:POWER:STOP
```

Power Step Size

Defines the (source) power step size of the leveling grid..

The value can be decreased down to 0.1 dB, but is only recommended for converters with extremely steep power transfer characteristics. If **ALC Step Size** is checked, the value is set to 1 dB and disabled.

Remote command:

```
SOURce:POWer<PhyPt>:CORRection:SLEVeling:POWer:STEP
```

ALC Step Size

If checked, **Power Step Size** is fixed to 1 dB and the corresponding input field is disabled. With this

Remote command:

```
SOURce:POWer<PhyPt>:CORRection:SLEVeling:POWer:ALC
```

Start Cal Sweep

Start the RF input power calibration sweeps for the selected port and settings and close the dialog. See step 3 of the [Leveling procedure](#).

Remote command:

```
SOURce:POWer<PhyPt>:CORRection:SLEVeling[:ACQuire]
```

Power Cal dialog – Source Flatness

In "Source Flatness" mode, the "Power Cal" dialog guides you through a source power calibration of a single port.

The dialog shows the selected source port with its current cal power settings (see [Chapter 5.11.3.2, "Cal Power Config dialog"](#), on page 629).

A circuit diagram visualizes the calibration setup, which depend on the selected [Pwr Cal Method](#).

- "Ref. Receiver": connect a DUT or a Match to the related source port
- "Power Meter": connect a power meter to the related source port

Access: [Power Cal wizard](#) > "Source Flatness"



Background information

Refer to [Chapter 4.5.6.1, "Source power calibration"](#), on page 220 and [Chapter 4.5.7.3, "Combining SMARTerCal with scalar power calibration"](#), on page 226.

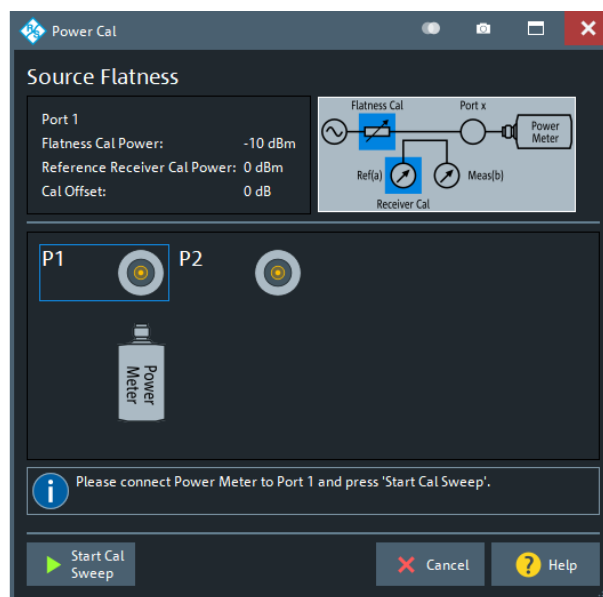
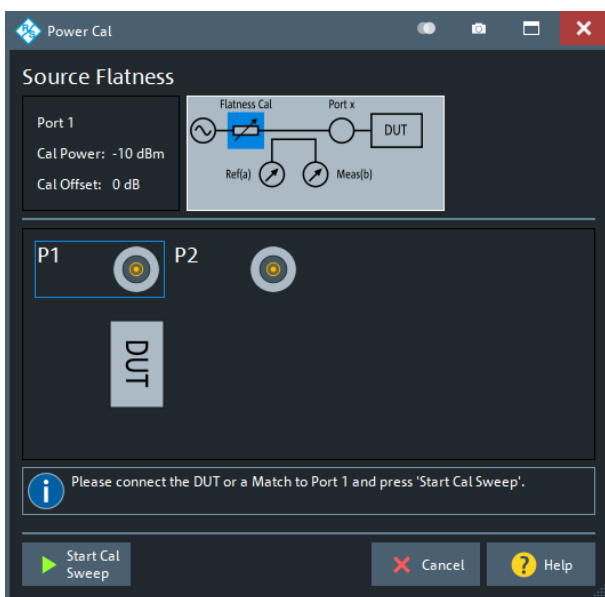

left = "Ref. Receiver" [Pwr Cal Method](#)
 right = "Power Meter" [Pwr Cal Method](#)

Start Cal Sweep

Start the calibration sweeps for the selected port and power calibration settings and close the dialog. The calibration is performed as described in ["Calibration procedure"](#) on page 220.

Use the [Pwr Cal Settings tab](#) "Pwr Cal Settings" to modify the calibration procedure.

Remote command:

`SOURce<Ch>:POWER:CORRection[:ACQuire]`

`SOURce<Ch>:POWER<PhyPt>:CORRection:COLLect[:ACQuire]`

5.11.1.6 Calibrate All dialog

The "Calibrate All" dialog guides you through the setup of complex calibration scenarios, where the set of calibrations to be performed for each port group and channel is freely configurable. The calibration configuration is persisted and can be recalled.



Background and related information

See [Chapter 4.5.8, "Parallel calibration of multiple channels"](#), on page 227.

Access: Channel – [Cal] > "Start Cal" > "Calibrate All" – "Configure + Start..."

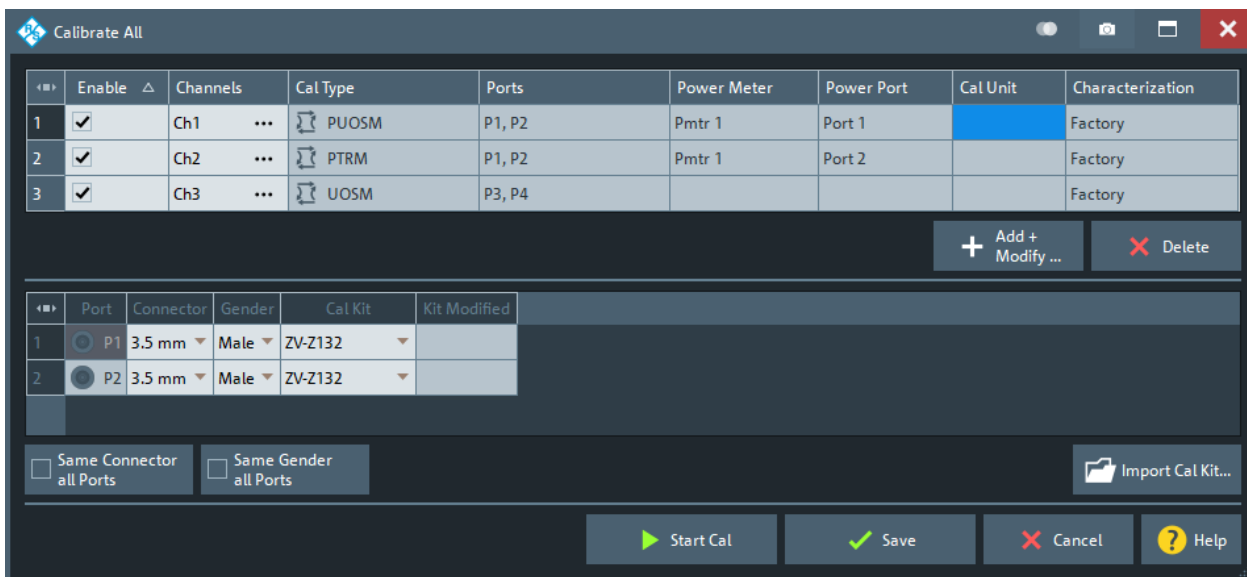

Calibration definition table

The upper half of the "Calibrate All" dialog shows the calibration definitions of all channels. Each row contains a single calibration definition for one channel.

Enable	Channels	Cal Type	Ports	Power Meter	Power Port	Cal Unit	Characterization
<input checked="" type="checkbox"/>	Ch1	PUOSM	P1, P2	Pmtr 1	Port 1		Factory
<input checked="" type="checkbox"/>	Ch2	PTRM	P1, P2	Pmtr 1	Port 2		Factory
<input checked="" type="checkbox"/>	Ch3	UOSM	P3, P4				Factory

Tap the [Add + Modify](#) button to open the [Calibration setup dialog](#), which allows you to add calibration definitions or modify them. Existing definitions can be selectively [deleted](#).

Use the checkboxes in the "Enable" column to enable/disable the related calibration definition. Use the ellipsis button in the "Channels" column to assign the related calibration definition (also) to other channels.

Add + Modify

Opens the [Calibration setup dialog](#) that allows you to add calibration definitions and modify existing ones.

Delete

Deletes the calibration definition that is selected in the ["Calibration definition table"](#) on page 606.

Port table

The table in the lower half of the dialog displays the port configuration of the item selected in the row in the [Calibration definition table](#):

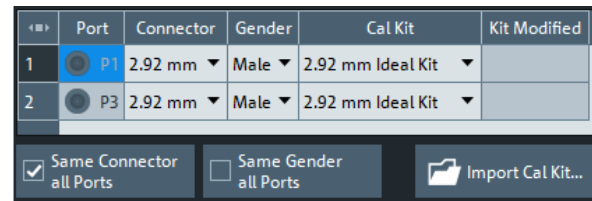
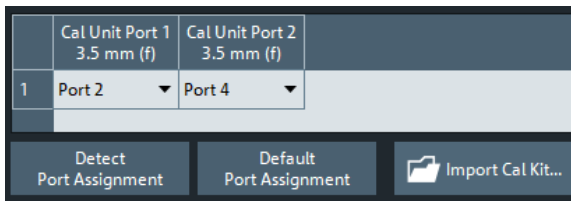

- For an automatic calibration (left), it displays the port assignment.
- For a manual calibration (right), it displays the ports with their connector, gender and cal kit.
For a given port, these values are shared among the related manual channel calibration definitions.

The buttons "Same Connector all Ports", "Same Gender all Ports" and "Import Cal Kit..." provide the functionality known from the [Calibration setup dialog](#).

Start Cal

Saves the calibration definitions to the current setup. Then enters the [Calibration wizard](#) to acquire data for all involved channels, ports and standards.

Note: In the current implementation, "Start Cal" is disabled if both manual and automatic calibration definitions are enabled in the [Calibration definition table](#).

Save/Cancel

Saves the channel calibration definitions to the current setup or discards unsaved modifications.

5.11.1.7 Guided Calibration wizard

The "Guided Calibration" wizard lets you calibrate a set of channels using the calibration methods the firmware proposes for the related measurements.



If a calibration unit is connected, it is automatically used.

Access: Channel – [Cal] > "Start Cal" > "Start... (Guided)"

Step 1: channel selection

See [Chapter 5.11.1.8, "Channel Selection for Calibration dialog"](#), on page 609. The channel selection is shown, even if the active recall set contains only one channel.

Step 2: calibration settings

Defines power settings that apply to all subsequent calibrations and allows you to select some optional calibration steps.

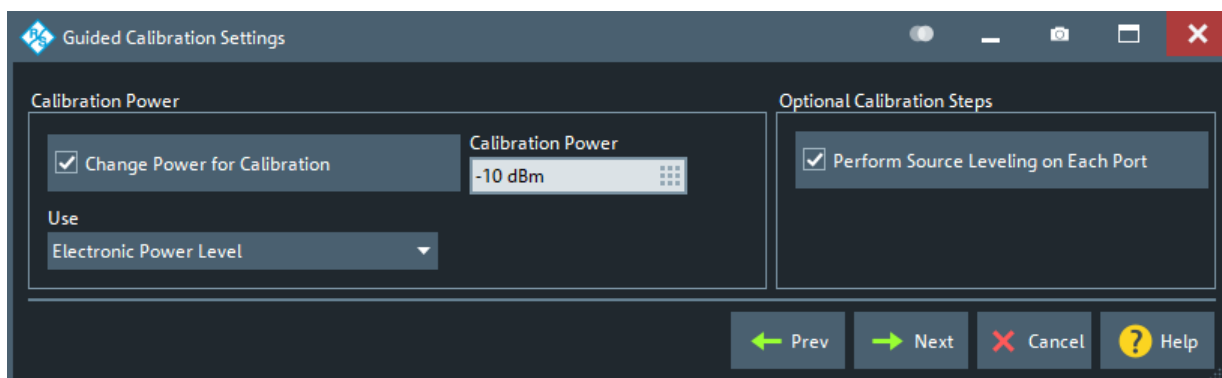

Step 3: ports and calibration types

In step 3 the "Guided Calibration" wizards repeatedly calls the [Chapter 5.11.1.3, "Calibration wizard"](#), on page 573.

During the calibration phase, a progress bar below the active calibration wizard's dock widget indicates the overall progress of the guided calibration.



After all required calibration steps were performed, the "Guided Calibration" wizards asks you to connect your DUT to the VNA as you have specified in the "DUT/VNA Connections step".

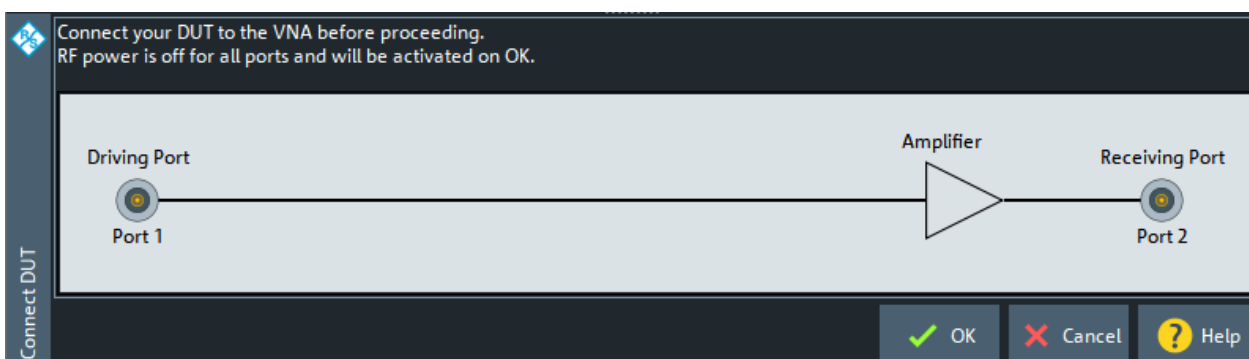

RF power will be switched off for all ports until you proceed with "OK", which will terminate the "Guided Calibration" wizard.

If you cancel one of those wizards, you are asked if you want to skip just the current calibration, or end the guided calibration as a whole.

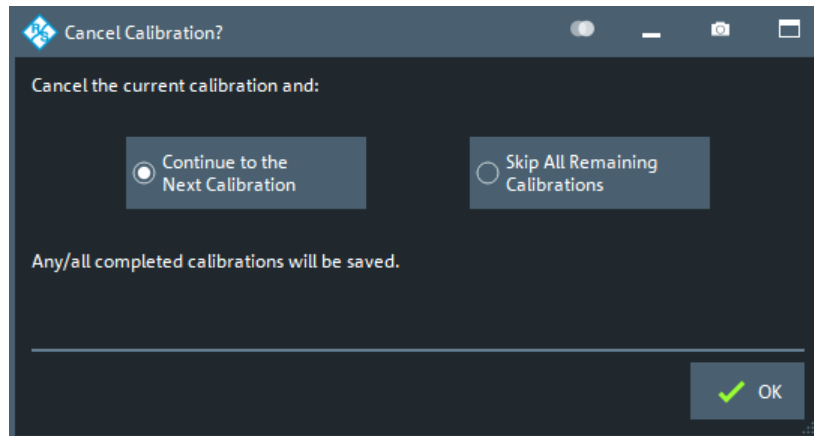

Data of completed calibrations are saved, data of incomplete calibrations are discarded.

5.11.1.8 Channel Selection for Calibration dialog

If you initiate a guided calibration and there is more than one channel in the current recall set, you are prompted to select the channels to be calibrated:

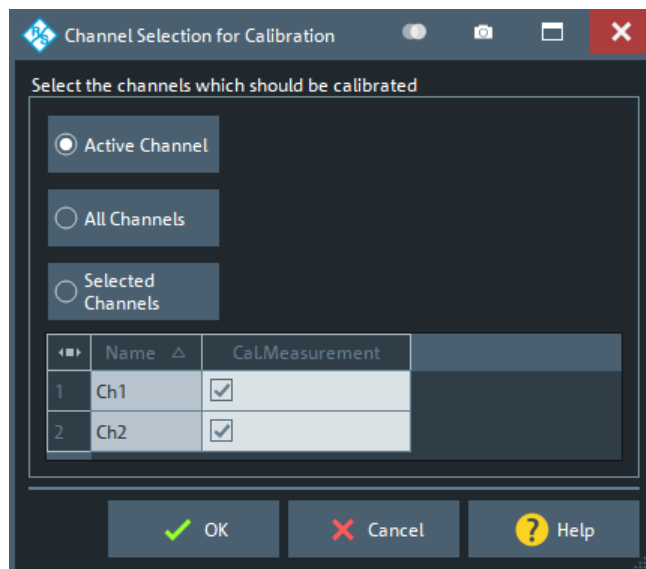

Use

- "Active Channel" if you only want to calibrate the active channel
- "All Channels" if you want to calibrate all channels in the current recall set
- "Selected Channels" if you want to calibrate only certain channels

5.11.1.9 Cal Validation dock widget

The controls on the "Cal Validation" dock widget allow you to set up and run a [Calibration validation](#) in [basic](#) or [advanced](#) mode.

Basic mode

In basic mode, the validation runs automatically, with autodetected ports and the settings specified in [Advanced mode](#) (default settings after a system [Preset]).

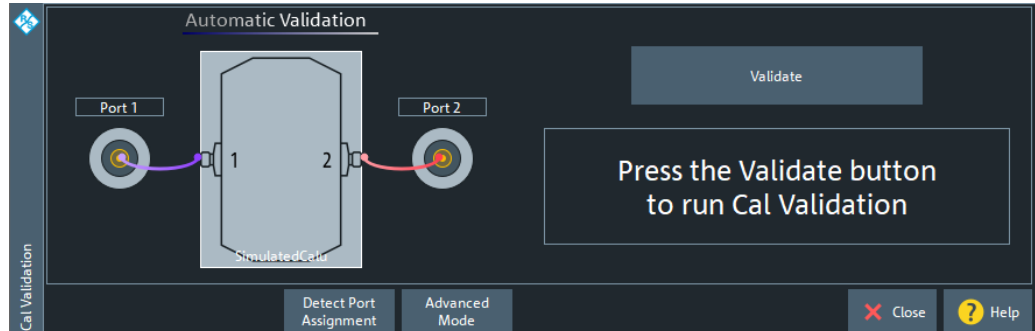

Use "Detect Port Assignment" to detect the current port assignment (after reconnecting the calibration unit).



Manual port assignment is not supported.

Validate

Runs the validation for the current port assignment. The validation proceeds through the connected ports $p \in \{1, \dots, 4\}$ in ascending order, measuring S_{pp} for the Open, Short and Match standard.

- "PASS": all measured reflection parameters are within the specified [Validation Limits](#), compared to the selected reference [characterization](#).
- "FAIL" otherwise.

[In this case, the validation stops at the first failed reflection measurement.]

Remote command:

```
CALCulate:CALValidate:RUN
CALCulate:CALValidate:RUN:RESult?
```

Advanced Mode

Switches to [Advanced mode](#).

Advanced mode

In advanced mode you can configure the validation settings ([Characterization](#), [Validation Limits](#)) and run or rerun particular measurements ([Measurement](#), "[Calibration Standard](#)" on page 611).

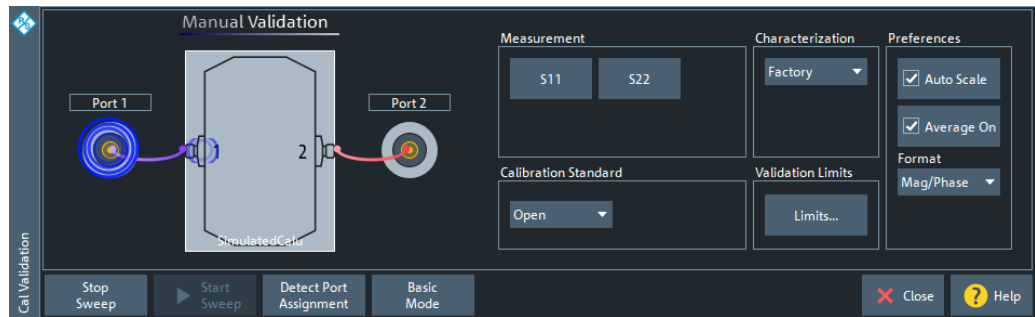

Use "Detect Port Assignment" to detect the current port assignment (after reconnecting the calibration unit).

Measurement

Selects the measurement to be performed in advanced mode and runs it

Characterization

Selects the calibration unit characterization to be used for the validation.

By default the factory characterization is used.

Remote command:

`CALCulate:CALValidate:CHARacteriza`

Calibration Standard

Selects the calibration standard to be measured in advanced mode.

Validation Limits

The "Limits..." button opens the "Cal Validation Limits" dialog that allows you to specify the maximum tolerable deviations from the corresponding S-parameters of the selected reference [characterization](#).

	Name	dB Mag Lower	dB Mag Upper	Phase Lower	Phase Upper
1	S11	-0.2 dB	0.2 dB	-2°	2°
2	S22	-0.2 dB	0.2 dB	-2°	2°
3	S33	-0.2 dB	0.2 dB	-2°	2°
4	S44	-0.2 dB	0.2 dB	-2°	2°

Defaults are ± 0.2 dB for magnitude and $\pm 2^\circ$ for phase deviations.

Remote command:

`CALCulate:CALValidate:RESPonse:MAGNitude:LOWer`

`CALCulate:CALValidate:RESPonse:MAGNitude:UPPer`

`CALCulate:CALValidate:RESPonse:PHASe:LOWer`

`CALCulate:CALValidate:RESPonse:PHASe:UPPer`

`CALCulate:CALValidate:RESPonse:REAL:LOWer`

```
CALCulate:CALValidate:RESPonse:REAL:UPPer
CALCulate:CALValidate:RESPonse:IMAGinary:LOWer
CALCulate:CALValidate:RESPonse:IMAGinary:UPPer
CALCulate:CALValidate:RESPonse:PRESet
```

Preferences

Allows you to configure the behavior of the validation diagrams and traces.

Unchecking "Auto Scale" prevents the traces from scaling as the measurement and/or standard changes. Unchecking "Average On" turns off averaging.

"Format" selects the traces to be displayed.

Remote command:

```
CALCulate:CALValidate:AVERage[:STATe]
CALCulate:CALValidate:FORMat
```

Basic Mode

Switches to [Basic mode](#)

5.11.2 Cal Devices tab

Provides access to all functions for calibration kit management and cal unit characterization.



Background information

Refer to the following sections:

- [Chapter 4.5.2, "Calibration standards and calibration kits"](#), on page 199
- [Chapter 4.5.5.3, "Characterization of calibration units"](#), on page 210

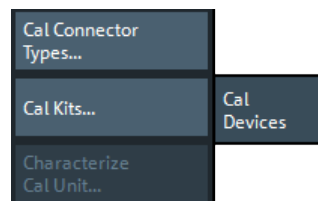

The buttons in the "Cal Devices" tab open the following dialogs:

- **"Cal Connector Types..."**: See [Chapter 5.11.2.1, "Cal Connector Types dialog"](#), on page 613
- **"Cal Kits..."**: See [Chapter 5.11.2.2, "Calibration Kits dialog"](#), on page 615
- **"Characterize Cal Unit..."**: See [Chapter 5.11.2.3, "Characterize Cal Unit dialog"](#), on page 621

5.11.2.1 Cal Connector Types dialog

The "Cal Connector Types" dialog displays and modifies the list of available connector types. Cal connector types must be selected in accordance with the connectors of the measured DUT.

Access: Channel – [Cal] > "Cal Connector Types..."

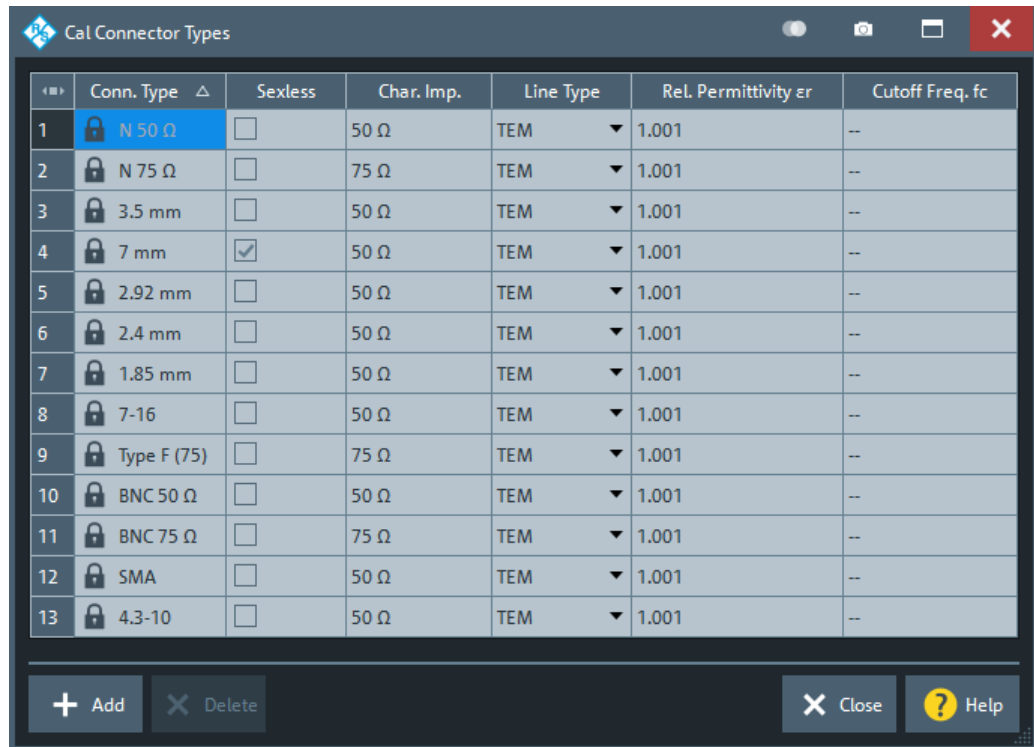

The list shows the available connector types with their name ("Conn. Type") and polarity ("Sexless"). The remaining columns in the list are described below.



Storing connector type settings

Calibration kits and connector types are global resources; the parameters are stored independently and available for all recall sets. The connector type settings are always stored together with the associated calibration kit parameters. The [Calibration Kits dialog](#) provides buttons to export and import cal kit and connector settings.



After assigning a calibration kit to a user-defined connector type, you can still change its name, offset model and reference impedance. If you switch between sexed and sexless, all kits assigned to the connector type are deleted.

Char. Imp.

The characteristic impedance or reference impedance ("Char. Imp.") Z_0 for the connectors is a critical value that has an impact on various parameter conversions. Z_0 enters into:

- The calculation of the S-parameters for the calibration standards associated with the connector type, if they are derived from a circuit model (see ["View / Modify Cal Kit Standards dialog"](#) on page 619).
- The calculation of the (default) reference impedances for balanced ports (see ["Reference Impedance tab"](#) on page 355).
- The calculation of impedance and admittance parameters (see [Chapter 4.3.3, "Impedance parameters"](#), on page 154 and [Chapter 4.3.4, "Admittance parameters"](#), on page 157).

Remote command:

```
[SENSe<Ch>:]CORRection:CONNection
```

Line Type / Rel. Permittivity ϵ_r / Cutoff Freq. f_c

"Line Type" describes the wave propagation mode (offset model) in the transmission lines of the standards associated with the connector type.

- If the calibration kit standards contain lines with transverse electric propagation mode (TEM, e.g. coax cables), then the "Rel. Permittivity ϵ_r " of the dielectric can be defined. The default permittivity is the value for air. TEM-type lines have no cutoff frequency.
- If the calibration kit standards contain waveguides, then the lowest frequency where a wave propagation is possible ("Cutoff Freq. f_c ") can be defined. The default cutoff frequency is 0 Hz (propagation at all frequencies). No relative permittivity is needed for waveguides.

Note: The impedance for waveguides is frequency-dependent. If a waveguide line type is selected, various dialogs indicate "varies" instead of a definite impedance value.

Impact of line type parameters

The line type parameters are used for the calculation of the S-parameters for the calibration standards associated with the connector type, if they are derived from a circuit model (see ["View / Modify Cal Kit Standards dialog"](#) on page 619).

- For TEM-type lines, the relative permittivity ϵ_r is needed for the conversion of a ZVR-type "Loss" (in units of dB/sqrt(GHz)) into a Keysight-type "Offset Loss" (in units of G Ω /s) and vice versa (see ["View / Modify Cal Kit Standards dialog"](#) on page 619). The "Electrical Length" and "Delay" values in the [View / Modify Cal Kit Standards dialog](#) are directly entered and therefore independent of ϵ_r .
- For waveguides, the low frequency cutoff frequency f_c is important because no wave propagation is possible at frequencies below f_c . If a standard is measured to acquire calibration data, the analyzer checks the low frequency cutoff. If the start frequency of the sweep range is below f_c , an error message is generated.

The offset model parameters are not used except in the context of calibration. The offset parameter definitions are based on independent ϵ_r values; see [Chapter 5.14.2, "Offset tab"](#), on page 716.

Remote command:

```
[SENSe<Ch>:]CORRection:CONNection
```

Add / Delete

Adds or deletes a user-defined connector type. The parameters of a user-defined connector type can be modified in the table.

Note: Deleted/Missing Connector Types.

- Deleting a connector type also deletes all calibration or adapter kits assigned to it.
- Deleting a connector type that is used by a loaded recall set resets the affected ports to the instrument's connector type and gender.
- A setup can only be loaded if all its connector types (identified by their names) are configured at the target instrument.

Remote command:

```
[SENSe<Ch>:]CORRection:CONNection
```

```
[SENSe<Ch>:]CORRection:CONNection:CATalog?
```

```
[SENSe<Ch>:]CORRection:CONNection:DELeTe
```

5.11.2.2 Calibration Kits dialog

The "Calibration Kits" dialog shows the available calibration kits for the different connector types. It is also used for cal kit and cal kit file management.

Access: Channel – [Cal] > "Cal Devices" > "Cal Kits..."



Related information

Refer to the following sections:

- See also [Chapter 4.5.2, "Calibration standards and calibration kits"](#), on page 199
- [Chapter 4.5.2.4, "Cal kit Files"](#), on page 204
- [Chapter 4.5.2.2, "Cal kit parameter types"](#), on page 202
- [Chapter 5.11.2.1, "Cal Connector Types dialog"](#), on page 613

The contents of the "Available Cal Kits" table vary, depending on the selected "Connector Type". The table can also contain kits with ideal or typical parameter values; see [Cal kit parameter types](#). The "Keysight Model" is an optional scheme to characterize the offset parameters of the standards; see ["Offset Parameters"](#) on page 620.



Cal kit labels

Assigning a "Label" to user-defined calibration kits is optional. However, the label is displayed in many dialogs and can provide useful information about the kit, e.g. its serial number. It is even possible to assign several calibration kits with the same name, distinguished by their label, to a common connector type. See also [Chapter 7.3.14.7, "\[SENSe:\]CORRection:CKIT... with Labels"](#), on page 1349.

Controls in the Calibration Kits dialog

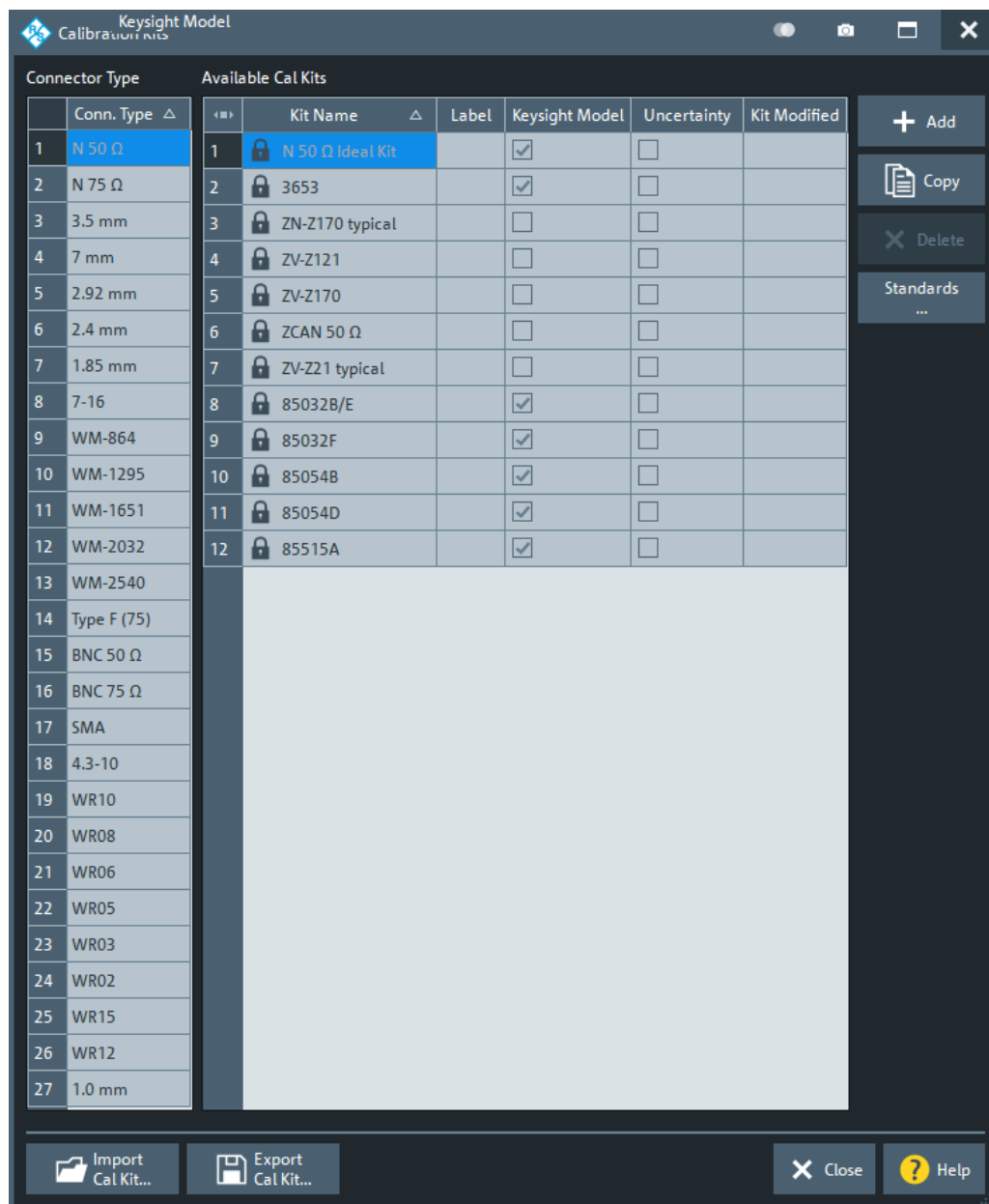

Connector Type

The "Connector Type" table displays the available cal kit connector types. Select a row in this table to get the list of [Available Cal Kits](#).

Remote command:

```
[SENSe<Ch>:]CORRection:CONNection:CATalog?
```

Available Cal Kits

Displays the cal kits for the selected [Connector Type](#)

If option K50 "Measurement Uncertainty Analysis" is installed, the "KitModified" column is replaced by an "Uncertainty" column, indicating whether the kits contains uncertainty information for all its calibration standards.

Remote command:

```
[SENSe:]CORRection:CKIT:CATalog?
```

Add / Copy / Delete / Standards...

The buttons in the right part of the dialog are used to manage calibration kits:

- "Add" creates a cal kit file for the selected connector type.
- "Copy" creates a cal kit file based on the contents of an existing cal kit file.
- "Delete" deletes an imported or user-defined cal kit file.
- "Standards..." opens the "Kit Standards" dialog, which shows the contents of the cal kit file. For user-defined or imported kits, you can modify the contents. See "[Kit Standards dialog](#)" on page 617.

Remote command:

The following commands create and modify calibration kits:

```
[SENSe:]CORRection:CKIT:<ConnType>:SElect
```

```
[SENSe:]CORRection:CKIT:<ConnType>:LSElect
```

```
[SENSe:]CORRection:CKIT:DMODE
```

```
[SENSe:]CORRection:CKIT:DElete
```

Query connector types and calibration kits:

```
[SENSe<Ch>:]CORRection:CONNection:CATalog?
```

```
[SENSe:]CORRection:CKIT:CATalog?
```

Import Cal Kit... / Export Cal Kit...

The buttons below the "Connector Type" list are used to store cal kit data to a file and to reload previously stored cal kit files. By default, calibration kit files are stored in the C:\Users\Public\Documents\Rohde-Schwarz\ZNA\Calibration directory; see [Chapter 4.5.2.4, "Cal kit Files"](#), on page 204.

Remote command:

```
MMEMoRY:LOAD:CKIT
```

```
MMEMoRY:STORe:CKIT
```

Kit Standards dialog

The "Kit Standards" dialog shows the calibration standards in a selected calibration kit. It is also used to modify the contents of a user-defined kit.



Related information

Refer to the following sections:

- [Chapter 4.5.2.4, "Cal kit Files"](#), on page 204
- [Chapter 5.11.2.2, "Calibration Kits dialog"](#), on page 615
- [Chapter 4.5.2.1, "Calibration standard types"](#), on page 200

Access: [Calibration Kits dialog](#) > "Standards..."

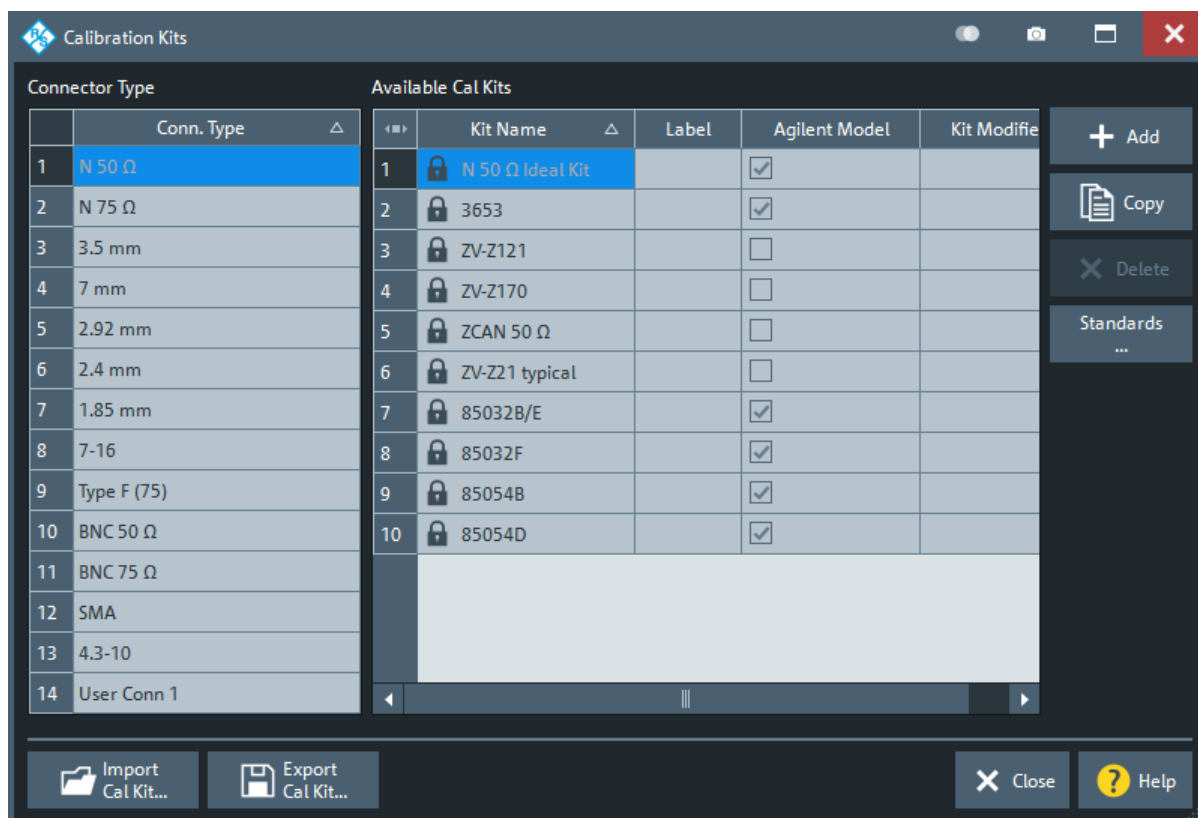

One port and two port standards are listed in two separate tables. Most of the buttons on the right side are available only if the "Kit Standards" dialog was opened for a user-defined calibration kit.

One Port Standards / Two Port Standards

The standard tables contain the following information:

- "Type" and "Gender" describe the calibration standard type; for an overview see [Chapter 4.5.2.1, "Calibration standard types"](#), on page 200.
- "Label" is a user defined name of the standard. The label can help you identify a standard or distinguish different standards with similar parameters.
- "Min Freq" and "Max Freq" define the rated frequency range of the standard. During calibration, the analyzer checks whether the sweep range is within the validity range of all measured standards and possibly generates a warning.
- ".s1p File" and ".s2p File" define whether the characteristics of the standard are described by a Touchstone file rather than by a circuit model from which the R&S ZNA can calculate the S-parameters. See ["Read .s1p File... / Read .s2p File..."](#) on page 619 and ["View / Modify Cal Kit Standards dialog"](#) on page 619.
- "Port" defines whether the standard can be connected to any analyzer port or to just one port (for one-port standards) or a pair of ports (for two-port standards). Standards with unrestricted port assignment ("any") are stored with their gender. When a connector type and calibration kit is selected for the calibration, the analyzer checks whether the kit contains the required standard types and whether the standards have the right gender.

Standards with restricted port assignment are always assumed to have the gender that is appropriate for the calibrated port. The **port assignment** is stored in the cal-

ibration kit file, instead of the gender. During the calibration, the analyzer checks whether the cal kit contains the necessary standard types for the required ports.

Remote command:

```
[SENSe:]CORRection:CKIT:<StandardType>
[SENSe:]CORRection:CKIT:<ConnType>:SELEct
```

Add / Copy... / Delete / View / Modify...

The buttons in the right part of the dialog are used to manage standards:

- "Add" adds a new standard to the calibration kit. The properties of the standard can be edited in the table.
- "Copy..." creates a standard based on the properties of an existing standard.
- "Delete" deletes the selected standard.
- "View / Modify..." opens the "View / Modify Cal Kit Standards" dialog. This dialog shows the circuit model for the selected standard. For user-defined standard, you can modify the circuit model parameters. See "[View / Modify Cal Kit Standards dialog](#)" on page 619.

Remote command:

```
[SENSe:]CORRection:CKIT:<StandardType>
[SENSe:]CORRection:CKIT:<StandardType>:WLAbel
```

Read .s1p File... / Read .s2p File...

Opens a file selection dialog where you can select a Touchstone file containing the reflection or transmission S-parameters for the standard. The R&S ZNA uses the imported S-parameters rather than the circuit model to characterize the standard, if ".s1p File"/".s2p File" is checked in the standard table. The appropriate file type (*.s1p for one-port standards and *.s2p for two-port standards) is selected automatically.

Remote command:

```
MMEMoRY:LOAD:CKIT:SDATa
```

View / Modify Cal Kit Standards dialog

The "View / Modify Cal Kit Standards" dialog shows the circuit model for a selected calibration standard. It is also used to define or edit the circuit model (offset and load) parameters for a user-defined standard.



Related information

Refer to the following sections:

- [Chapter 4.5.2.4, "Cal kit Files"](#), on page 204
- ["Kit Standards dialog"](#) on page 617
- [Chapter 4.5.2.1, "Calibration standard types"](#), on page 200

Access: [Kit Standards dialog](#) > "View / Modify..."

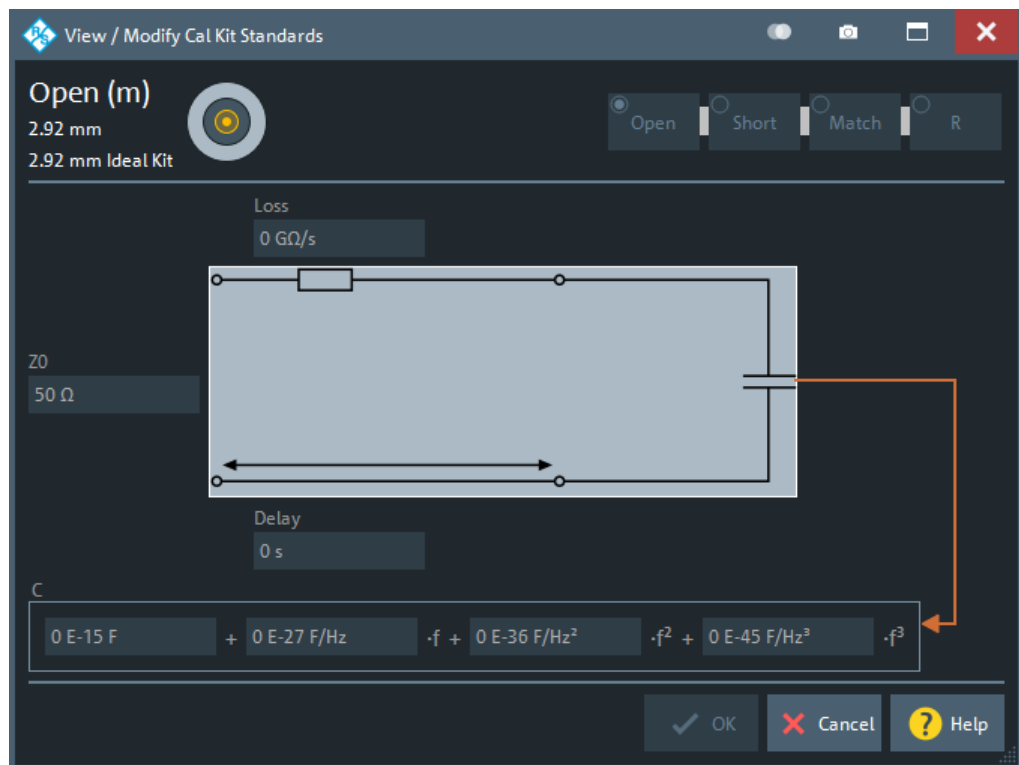

The diagram in the "View / Modify Cal Kit Standards" dialog depends on the standard type for which the dialog was opened. Moreover, it is possible to modify the circuit model using the buttons in the upper right of the dialog.

Offset Parameters

The entries in the upper part of the "View / Modify Cal Kit Standards" dialog specify the offset parameters for the transmission lines of the selected calibration standard.

The offset parameters depend on whether the circuit model is defined as "Keysight Model" (see [Chapter 5.11.2.1, "Cal Connector Types dialog"](#), on page 613):

- In a "Keysight Model", a calibration standard is characterized by its "Delay" (in s), its characteristic impedance "Z0" (in Ω) and its "Offset Loss" (in $\text{G}\Omega/\text{s}$).
- Otherwise the standard is characterized by the R&S ZVR-compatible parameters "Electrical Length" (in m), "Char. Imp." (in Ω) and "Loss" (in $\text{dB}/\sqrt{\text{GHz}}$). The loss is zero and not editable as long as the electrical length is zero.

Both parameter sets are closely related. The "Electrical Length" is proportional to the "Delay"; "Z0" corresponds to the "Char. Imp.". Moreover the analyzer converts a Keysight-type "Offset Loss" into a R&S ZVR-type "Loss" and vice versa using the "Rel. Permittivity ϵ_r " for the selected connector type.

See also description of the offset parameters in [Chapter 4.5.2.1, "Calibration standard types"](#), on page 200.

Remote command:

```
[SENSe:]CORRection:CKIT:<StandardType>
```

Load Parameters

The entries in the lower part of the "View / Modify Cal Kit Standards" dialog specify the load parameters for a particular calibration standard describing its terminal impedance.

The circuit model for the load consists of capacitance C which is connected in parallel to an inductance L and a resistance R, both connected in series.

- R is the constant resistive contribution. It is possible to select:
 - "Open" for $\infty \Omega$ (so that the inductance coefficients are irrelevant)
 - "Short" for 0Ω
 - "Match" for the reference impedance of the current connector type
 - any resistance "R"
- The fringing capacitance C and the residual inductance L are both assumed to be frequency-dependent and approximated by the first four terms of the Taylor series around $f = 0$ Hz.

See also description of the load parameters for the different standard types in [Chapter 4.5.2.1, "Calibration standard types"](#), on page 200.

Remote command:

```
[SENSe:]CORRection:CKIT:<StandardType>
```

5.11.2.3 Characterize Cal Unit dialog

The "Characterize Cal Unit" dialog displays the properties of the connected cal units, provides control elements for characterization file management, and starts the characterization wizard.

Access: Channel – [Cal] > "Cal Devices" > "Characterize Cal Unit..."



Background information

Refer to [Chapter 4.5.5.3, "Characterization of calibration units"](#), on page 210.



A cal unit characterization can be performed in a frequency sweep. The "Characterize Cal Unit" dialog is unavailable while a "Power", "CW Mode", or "Time" sweep is active. The analyzer always uses a fixed source power of -10 dBm to acquire the characterization data.

Controls in the Characterize Cal Unit dialog

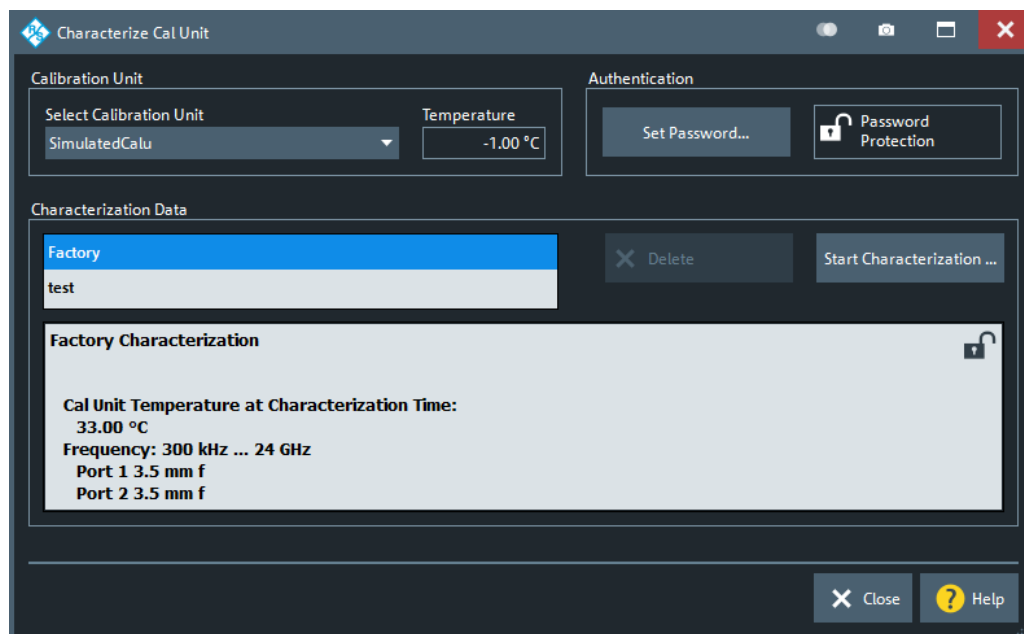

Calibration Unit

Displays the connected calibration units. The R&S ZNA auto-detects all calibration units which are connected to one of its USB ports. If several cal units are connected, one of them must be selected for characterization (active cal unit).

Remote command:

```
SYSTem:COMMunicate:RDEvice:AKAL:ADDRESS:ALL?  
SYSTem:COMMunicate:RDEvice:AKAL:ADDRESS
```

Authentication

Allows you to set a password to protect the characterization dialog and the [Characterization wizard](#) from unauthorized access and operation. "Set Password..." opens a dialog to enter the password and activate password protection at the next time the "Set Password" dialog is opened. Enter an empty string (no password) to deactivate password protection.

Tip: A password also blocks a switchover of the active characterization during calibration; see ["Characterization"](#) on page 587.

Remote command:

```
[SENSe:]CORRection:COLLect:AUTO:CKIT:PASSword
```

Characterization Data

Displays all characterizations which are stored on the active cal unit. The "Factory" characterization is available for all calibration units; it ensures an accurate calibration for all standard applications. Characterizations stored on an SD card (inserted at the cal unit) are prefixed with "SD:".

Tip: Characterizations stored on an SD card (inserted at the cal unit) are prefixed with "SD:".

The properties of the selected characterization are shown below the list. "Delete" deletes the selected characterization file; "Start Characterization..." opens the [Characterization wizard](#) to create a characterization.

Remote command:

```
SYSTem:COMMunicate:RDEvice:AKAL:CKIT:CATalog?  
SYSTem:COMMunicate:RDEvice:AKAL:CKIT:STANdard:CATalog?  
SYSTem:COMMunicate:RDEvice:AKAL:SDATa?
```

Characterization wizard

The "Characterization" wizard guides you through the automatic characterization of a calibration unit.

Access: [Characterization wizard](#) > "Start Characterization..."

The guided characterization consists of the following steps:

1. **"Characterization"**: Select the characterized ports and cal unit standards to initiate the characterization sweeps.
2. **"Save Characterization Data"**: Save the characterization data to the calibration unit.

Step 1: Characterization

Selects the calibration type and the characterized cal unit ports and initiates the necessary characterization sweeps.



Characterization procedure

To acquire accurate characterization data, the test setup must be properly calibrated before you start the characterization wizard. Use the calibration type that you wish to perform with your new cal unit characterization; see [Chapter 4.5.5.3, "Characterization of calibration units"](#), on page 210.

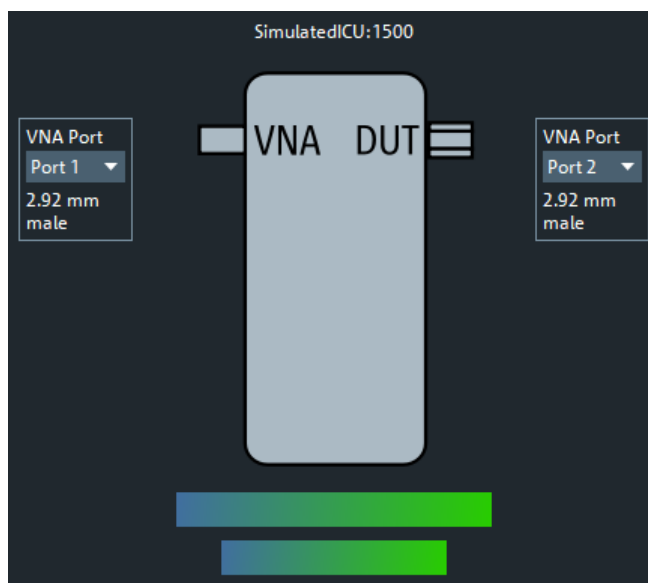

Figure 5-28: Characterization of inline calibration units

Test Port Assignment

Defines the assignment between test ports and cal unit ports. In the default "Manual" assignment, VNA ports and cal unit port numbers match. If you decide to use a different assignment, you can auto-detect the actual assignment ("Automatic") or select the analyzer port numbers manually. Auto-detection can fail, e.g., because of a high attenuation in the signal path.

Remote command:

```
[SENSe<Ch>:]CORRection:COLLect:AUTO  
[SENSe<Ch>:]CORRection:COLLect:AUTO:PORTs  
[SENSe:]CORRection:COLLect:AUTO:PORTs:CONNectiOn?  
[SENSe:]CORRection:COLLect:AUTO:CKIT:PORTs
```

Take OSM / Take All OSM and Through

"Take OSM" starts a calibration sweep for the related port. "Take All OSM and Through" initiates a series of calibration sweeps; the R&S ZNA acquires a full set of one-port and two-port data. The latter is required for the transmission normalizations and for a "One Path Two Ports" calibration; see "[Dependency between calibration types and characterization data](#)" on page 210.

Remote command:

```
[SENSe<Ch>:]CORRection:COLLect:AUTO  
[SENSe<Ch>:]CORRection:COLLect:AUTO:PORTs  
[SENSe:]CORRection:COLLect:AUTO:PORTs:CONNectiOn?
```

Next

Proceeds to [Step 2: Save Characterization Data](#) . Next is available when the R&S ZNA has acquired characterization data for a single port.

Step 2: Save Characterization Data

Saves the characterization data to the calibration unit.

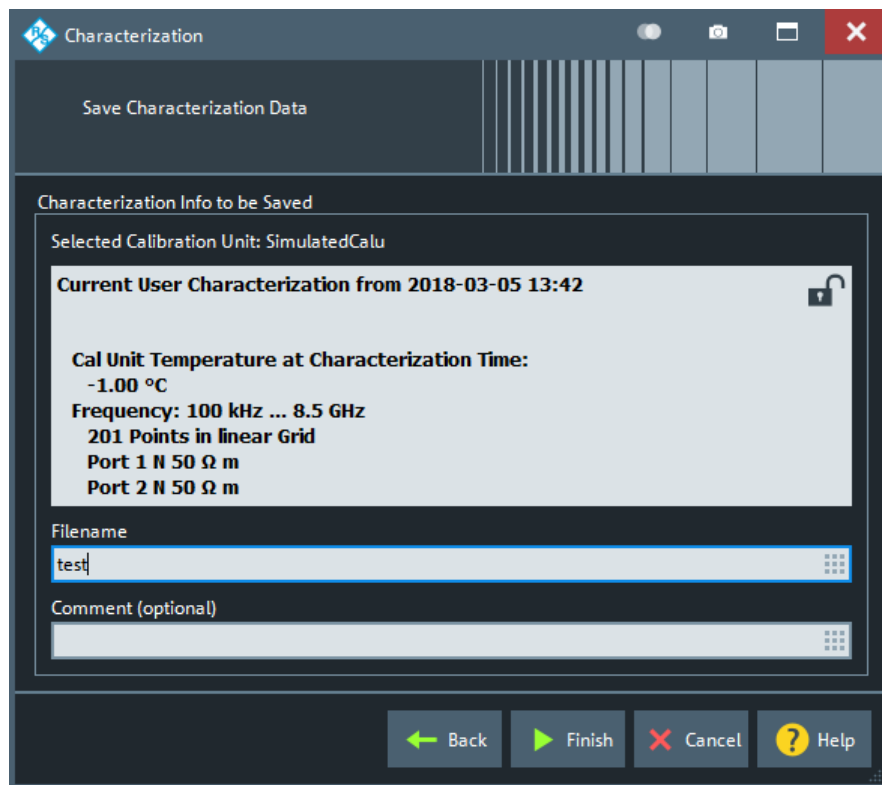

Figure 5-29: Save Characterization Data

Save File to SD Card

For all calibration units, characterization data can be saved to the calibration unit's internal flash memory. For some calibration units (e.g. the new models R&S ZN-Z5x and R&S ZN-Z15x), they can also be saved to an SD card inserted at the calibration unit. Activate this checkbox to save the characterization data to the SD card.

Tip: If the characterized calibration unit does not have an SD card slot, the checkbox is hidden. If the calibration unit has an SD card slot but the SD card is not accessible, the checkbox is grayed out.

File name / Comment (Optional)

Selects a filename to reference the characterization data set in the "Characterize Cal Unit" and "Calibration Unit" dialogs and a comment, to be written into the characterization file. A filename is required before you can "Finish" the characterization wizard and store the data.

Remote command:

```
[SENSe:]CORRection:COLLect:AUTO:CKIT
```

5.11.3 Pwr Cal Settings tab

Gives access to all functions for power meter and power calibration data handling (transmission coefficients). Power calibration of the R&S ZNA is a fully menu-guided process.



Efficient power calibration procedure

- For standard applications, open the "Start Cal" tab and select "Scalar Power Cal" – "Power Cal..." to perform the necessary calibration sweeps with default power calibration settings. You do not need any of the buttons in the "Pwr Cal Settings" tab.
- Select "Cal Power..." if you use an amplifier between the source port and the DUT.
- Select "Transm. Coefficients..." if you want to modify the power calibration procedure.



Background information

Refer to [Chapter 4.5.6, "Scalar power calibration"](#), on page 218.

5.11.3.1 Controls on the Pwr Cal Settings tab

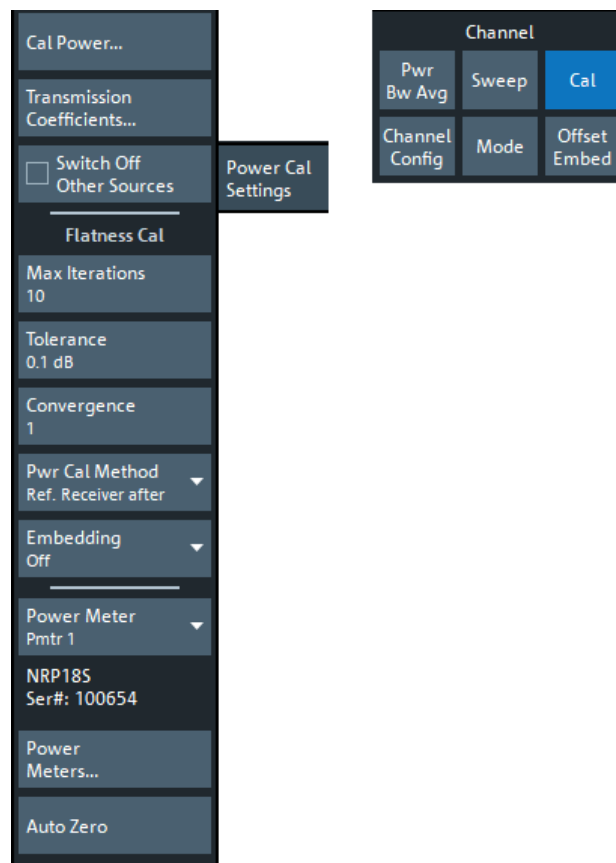

Some buttons serve as openers for additional dialogs:

- "Cal Power...": see [Chapter 5.11.3.2, "Cal Power Config dialog"](#), on page 629
- "Transm. Coefficients...": see [Chapter 5.11.3.3, "Power Meter Transmission Coefficients dialog"](#), on page 632
- "Power Meters...": see [Chapter 4.7.39, "External power meters"](#), on page 316

Switch Off Other Sources

Ensures that the power at all sources except the calibrated source is switched off during the calibration. Recommended, if the measurement involves a combination of different signals.

Remote command:

```
SOURce<Ch>:POWer:CORRection:OSources[:STATe]
```

Flatness Cal – Max Iterations

Sets a limit for the number of calibration sweeps. See also ["Calibration procedure"](#) on page 220.

Remote command:

```
SOURce:POWer:CORRection:NREadings
SOURce:POWer:CORRection:COLLect:AVERage[:COUNT]
```

Flatness Cal – Tolerance

Defines the maximum deviation of the measured power from the cal power. The calibration procedure is stopped if "Max Iterations" is reached or if the measured power is within the "Tolerance".

Remote command:

```
SOURce:POWer:CORRection:COLLect:AVERage:NTOLerance
```

Flatness Cal – Convergence

Modifies the amount of power correction for each of the flatness calibration sweeps. The power correction in each sweep, as controlled by the calibrated reference receiver (a-wave receiver), is multiplied by the selected convergence factor. With a convergence factor larger (smaller) than 1, the source power correction after each flatness calibration step is larger (smaller) than the measured deviation from the desired power.

For analyzer test ports, a convergence factor 1 is appropriate. Convergence factors different from 1 may be indicated for external generator ports which show a nonlinear behavior. In general, it is recommendable to start the calibration with a convergence factor 1 and choose smaller values (0.8 ... 0.4) in case that the iteration fails. Inappropriate convergence factors can slow down the flatness calibration or even prevent convergence.

Remote command:

```
SOURce:POWer:CORRection:COLLect:CFACTOR
```

Flatness Cal – Pwr Cal Method

Defines how power calibrations are performed.

"Ref. Receiver after"	Use a power meter for the calibration of the reference receiver, and the calibrated reference receiver for the flatness calibration.
"Power Meter only"	Use a power meter for the calibration of the reference receiver <i>and</i> the flatness calibration.
"Ref. Receiver only"	Perform a flatness calibration using the reference receiver. Do not recalibrate the reference receiver; use the best available reference receiver calibration instead.

For external generators and the optional [Chapter 4.7.25, "LO Out"](#), on page 305 port, a power meter must be used.

"Ref. Receiver after" is the default behavior.

Remote command:

```
SOURce:POWer:CORRection:COLLect:METhod
```

Embedding

Defines whether the source flatness cal uses the configured offset de-/embedding to get the power values at the DUT (instead of the calibrated reference plane).

This setting applies to all ports and channels. Default is "Off" (no offset or de-/embedding used).

Remote command:

```
SOURce:POWer:CORRection:COLLect:VNETworks
```

Power Meter

Shows a list of all power meters that have been properly configured and are available for the power calibration of a source port. The last configured power meter is selected by default. See ["Configured Devices"](#) on page 893.

Remote command:

```
SOURce:POWer:CORRection:PMETer:ID
```

Auto Zero

Initiates an automatic zeroing procedure of the selected power meter.

The power meter must be disconnected from the RF power; see [Chapter 4.7.39.1, "Zeroing"](#), on page 318. A message indicates that zeroing is finished.

Remote command:

```
SYSTem:COMMunicate:RDEvice:PMETer<Pmtr>:AZERo
```

5.11.3.2 Cal Power Config dialog

The "Cal Power Config" dialog adjusts the target power for the power calibration (cal power) and defines the target power for the reference receiver calibration. These settings are particularly important for test setups involving external attenuators or amplifiers.

Access: Channel – [Cal] > "Pwr Cal Settings" > "Cal Power..."



Related information

The settings in the "Cal Power Config" dialog are also used to define port-specific source powers in arbitrary mode; refer to ["Arbitrary Power tab"](#) on page 674.

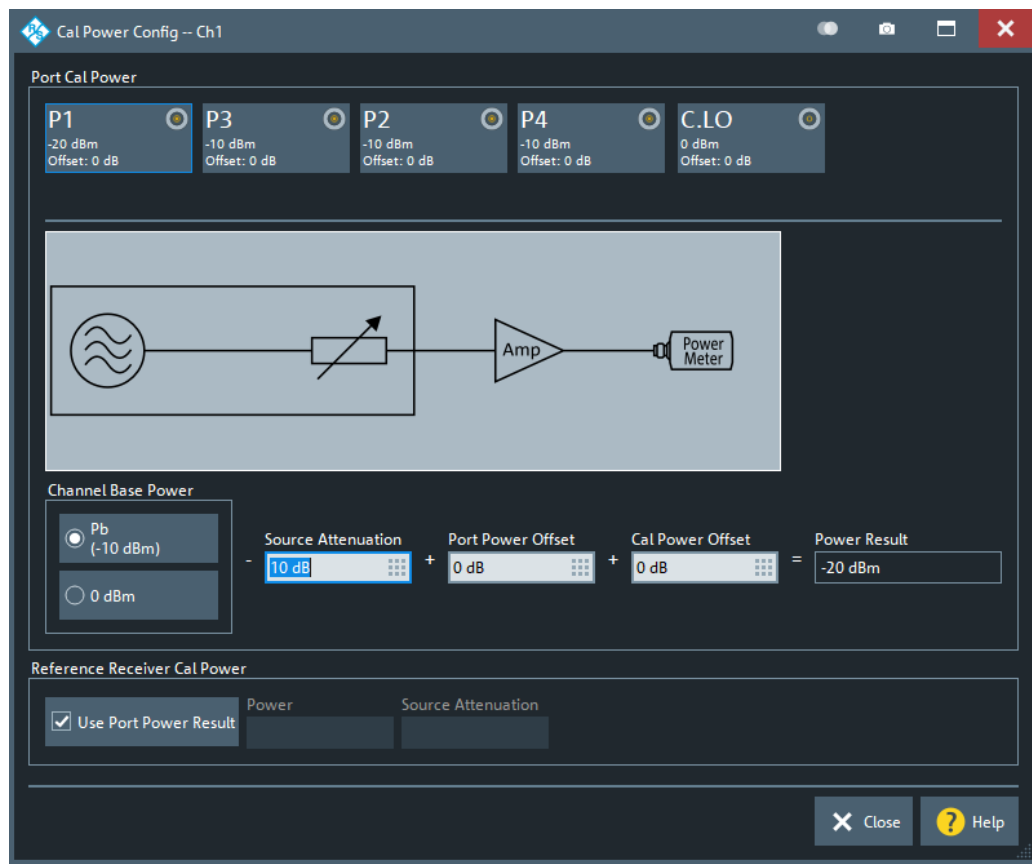

The diagram in the center of the dialog visualizes the settings and results below.

Port Cal Power

Allows you to define (port-specific) power levels for source power calibrations.

Port Overview ← Port Cal Power

The dialog shows all source ports of the network analyzer. Each port is displayed with the current "Power Result" at the input of the DUT (in dBm) and offset (i.e. the "Cal Power Offset" in dB).

Configured external generators ("G1" ...) and the Converter LO are included in the source port overview.

Remote command:

```
SOURCE<Ch>:POWER<PhyPt>[:LEVEL][:IMMEDIATE]:OFFSET
SOURCE<Ch>:POWER<PhyPt>:CORRECTION:LEVEL:OFFSET
```

Channel Base Power ← Port Cal Power

Allows you to select between the channel base power P_b and a fixed value of 0 dBm.

If frequency converters are configured, the "Channel Base Power" at the RF IN port can also show "varies", which either indicates that [leveling data](#) are used or that a source flatness calibration at the converter port is active. In the former case, the combo-box is disabled. In the latter case, you can alternatively select P_b or 0 dBm, which deactivates the source flatness cal, or select "varies" to reactivate it.

Remote command:

```
SOURce<Ch>:POWer<PhyPt>[:LEVel] [:IMMediate]:OFFSet
SOURce<Ch>:RLO:PABSolut
```

Source Attenuation ← Port Cal Power

See "Source Step Att." on page 526-

Port Power Offset ← Port Cal Power

Defines a port-specific offset to the [Channel Base Power](#). The actual output power at the port is equal to the "Channel Base Power" plus the "Port Power Offset".

If P_b is selected as "Channel Base Power", then for a power sweep the actual port power varies across the sweep. Otherwise the port power is constant.

Remote command:

```
SOURce<Ch>:POWer<PhyPt>[:LEVel] [:IMMediate]:OFFSet
SOURce<Ch>:RLO:POFFset
SOURce<Ch>:POWer<PhyPt>:GENerator<Gen>:OFFSet
SOURce<Ch>:POWer<PhyPt>:CONVerter:OFFSet
```

Cal Power Offset ← Port Cal Power

For power calibrations only: Specifies a gain (positive values) or an attenuation (negative values) in the signal path between the source port and the calibrated reference plane. With a "Cal Power Offset" of n dB, the target power at the reference plane (cal power) is equal to the actual output power at the port plus n dB. The "Cal Power Offset" has no impact on the source power.

Example: Use of an amplifier in the signal path

Assume that a DUT requires a constant input power of +25 dBm, and that the measurement path contains an amplifier with a 30 dB gain. After a reset of the analyzer, the channel power P_b is -10 dBm. Select a "Port Power Offset" of +5 dB at the calibrated source port and a "Cal Power Offset" of +30 dB. Then the source power calibration ensures that the constant input power of +25 dBm is maintained across the entire sweep range. The actual output power of the analyzer is -5 dBm.

Notice that a power calibration with an appropriate "Cal Power Offset" can prevent excess input levels at the DUT.

Remote command:

```
SOURce<Ch>:POWer<PhyPt>:CORRection:LEVel:OFFSet
SOURce<Ch>:POWer<PhyPt>:CORRection:GENerator<Gen>:LEVel:OFFSet
```

Reference Receiver Cal Power

Defines the source power and step attenuation settings the R&S ZNA uses to perform the first calibration sweep of the source power calibration.

In this first sweep, the power meter reading is used to calibrate the reference receiver of the calibrated port. The following calibration sweeps are based solely on the reference receiver (see "[Calibration procedure](#)" on page 221).

By default, the "Reference Receiver Cal Power" is set to the resulting [Port Cal Power](#). However, the accuracy of the source power calibration depends on the power meter's measurement accuracy. Therefore it is advantageous to select a "Reference Receiver Cal Power" at which the power meter provides maximum accuracy.

The "Reference Receiver Cal Power" is also used for the power calibration step in a SMARTerCal; see [Chapter 4.5.7, "SMARTerCal"](#), on page 224.

Note: Risk of damage due to high power settings. If an external device (e.g. an amplifier) is connected between the calibrated test port and the power meter, ensure that the "Reference Receiver Cal Power" does not exceed its maximum input power.

Remote command:

```
SOURce:POWer:CORRection:PSElect
```

```
SOURce:POWer:CORRection:PPOWer
```

```
SOURce:POWer:CORRection:PPOWer:PATTenuation
```

5.11.3.3 Power Meter Transmission Coefficients dialog

The power calibration is taken at another reference plane compared to the system error correction. This happens, e.g., in on-wafer measurements, but also at more trivial things like using a simple attenuator to connect the power meter to the measurement system.

Two scenarios have to be considered:

- A two-port connected to the DUT which is not present during power calibration (e.g. an on-wafer probe)
- A two-port connected to the power Meter during the power calibration (e.g. an adapter)

The "Power Meter Transmission Coefficients" dialog allows you to modify the results of a scalar power calibration to account for these two-ports.

Access: Channel – [Cal] > "Pwr Cal Settings" > "Transm. Coefficients..."



Background information

Refer to [Chapter 4.5.6.4, "Extended test setups"](#), on page 223.

Controls in the Power Meter Transmission Coefficients dialog

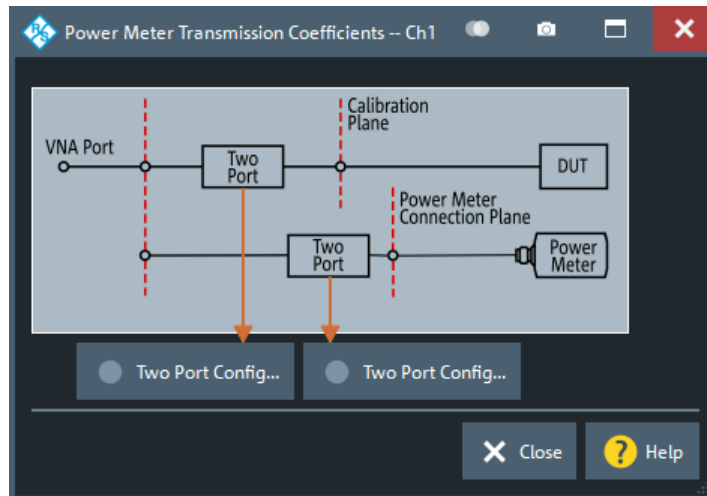

Two Port Config...

These buttons open the "Two Port Configuration" dialog that allows you to define the transmission coefficients of additional two-port devices between VNA and DUT (during the measurement), and between VNA and power meter (during power calibration). See ["Two Port Configuration dialog"](#) on page 633.

Remote command:

`SOURce:POWer:CORRection:TCoefficient[:STATE]`

Deprecated: `SOURce<Ch>:POWer<PhyPt>:CORRection:TCoefficient:CALibration`

Two Port Configuration dialog

The "Two Port Configuration" dialog defines the transmission characteristics of an additional two-port in the calibrated frequency range.

Access: [Power Meter Transmission Coefficients dialog](#) > "Two Port Config..."

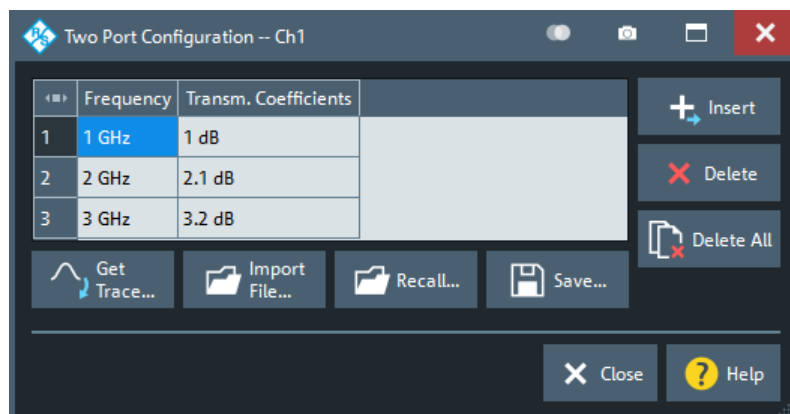

Frequency / Transm. Coefficients: Insert, Delete, Delete All

The required two-port information is a list of transmission coefficients at different frequency values (power loss list). The buttons in the dialog provide different ways of creating and modifying the list. Use "Insert", "Delete", "Delete All" to edit the list manually.

In a power, time or CW mode sweep, one point at the fixed CW frequency is sufficient. In a frequency sweep, it is possible to enter several coefficients to account for a frequency-dependent attenuation. Transmission coefficients are interpolated between the frequency points and extrapolated, if necessary.

If no transmission coefficient is defined at all, the R&S ZNA assumes a 0 dB attenuation across the entire frequency range. This assumption is equivalent to an ideal through connection or selecting "No Coefficients" in the [Power Meter Transmission Coefficients dialog](#).

Remote command:

```
SOURce:POWer:CORRection:TCOefficient:INSert<ListNo>
SOURce:POWer:CORRection:TCOefficient:DEFine<ListNo>
SOURce:POWer:CORRection:TCOefficient:COUNT?
SOURce:POWer:CORRection:TCOefficient:DELeTe<ListNo>[:DUMMY]
SOURce:POWer:CORRection:TCOefficient:DELeTe:ALL
```

Get Trace...

Opens a selection box containing all traces in the active recall set. The "dB Mag" values of the selected trace are used to define the transmission coefficients. Notice that if you combine different channels with different sweep points, the analyzer possibly has to interpolate or extrapolate the transmission coefficients.

Remote command:

```
SOURce:POWer:CORRection:TCOefficient:FEED
```

Import File...

Imports the transmission coefficients from a trace file. The imported file must be either in Touchstone (*.s<n>p) or in *.csv format; see also [Chapter 4.4.2, "Trace files"](#), on page 176.

Remote command:

```
MMEMorY:LOAD:CORRection:TCOefficient<Ch>
```

Recall... / Save...

You can save the displayed power loss list to a power meter correction list file with extension (*.pmc1) and reload it in later sessions.

Remote command:

```
MMEMorY:LOAD:CORRection:TCOefficient<Ch>
MMEMorY:STORe:CORRection:TCOefficient<Ch>
```

5.11.4 Use Cal tab

Provides access to functions for activating, deactivating and managing calibrations.



Background information

Refer to the following sections:

- [Chapter 4.5, "Calibration"](#), on page 186

5.11.4.1 Controls on the Use Cal tab



User Cal Active

Activates or deactivates the system error correction in the active channel. "User Cal Active" is available only if a valid system error correction is available for the active channel; see "Channel State" in [Chapter 5.11.4.3, "Calibration Manager dialog"](#), on page 638.

Note: A label "Cal Off" appears behind the trace list if the system error correction is switched off; see also [Chapter 4.5.4, "Calibration labels"](#), on page 206. The calibration status of each channel and trace appears in the setup information ("Setup" > "Info..." > "Setup").

Remote command:

```
[SENSe<Ch>:]CORRection[:STATe]
```

Load Match Correction

Load match correction prevents a possible impairment of the transmission S-parameter measurements due to the influence of the waves reflected at the receive (load) ports. It is performed as follows:

- The correction is based on the system error corrected a- and b-waves of the source and load ports. An appropriate calibration is a prerequisite for the load match correction; see [Chapter 4.7.3.1, "Calibration options"](#), on page 262.
- A reverse sweep is automatically performed during the measurement.
- The correction is calculated under the assumption that the reverse transmission factor is zero (e.g. $S_{12}=0$ if S_{21} is measured).

Load match correction can provide a significant improvement of the transmission S-parameter measurements if the load ports are poorly matched. With sufficiently matched load ports, you can disable the correction to gain speed.

Note: Disable the load match correction if your test setup or DUT is not suited for reverse sweeps or if you want to gain speed.

Remote command:

```
[SENSe<Ch>:]FREQuency:CONVersion:GAIN:LMCorrection
```

Scalar Power Cal – All Power Cals On / All Power Cals Off

Activates or deactivates all scalar power calibrations in the active channel. "All Power Cals On" is only available if a valid power calibration is available for the active channel, but not active; see "Channel State" in [Chapter 5.11.4.3, "Calibration Manager dialog"](#), on page 638.

Note: A label "PCal Off" appears behind the trace list of a wave quantity or a ratio if the power calibration is switched off; see also [Chapter 4.5.6.3, "Power calibration labels"](#), on page 222. The calibration status of each channel and trace appears in the setup information (see ["Setup tab"](#) on page 875).

Remote command:

```
[SENSe<Ch>:]CORRection:PCAL
```

Active Power Cals...

Opens the [Active Power Cals dialog](#)

Power Leveling

This section is only available if the R&S ZNA is equipped with option R&S ZNA-K8 (see [Chapter 4.7.7, "Millimeter-wave converter support"](#), on page 281). The "Leveling Dataset Usage" button opens the [Leveling Datasets dialog](#) that allows you to configure the usage of the available leveling datasets.

Manage Cals – Recall Last Cal Set

Loads and activates the recall set for which the last calibration was performed. If the last calibrated setup is already active, nothing is changed. The calibrated setups are automatically stored in the

```
C:\Users\Public\Documents\Rohde-Schwarz\ZNA\Calibration\
RecallSets
```

 directory. A message box pops up if the directory is empty, e.g. because no calibration was performed yet.

Remote command:

n/a

Manage Cals – Cal Manager...

Opens the [Calibration Manager dialog](#)

Manage Cals – Remove all Cal Data

This button cleans the active channel's existing calibration data and also removes links to the calibration pool.

Remote command:

```
[SENSe<Ch>:]CORRection:DELeTe
```

Manage Cals – Join Calibration...

Opens the [JoinCal dialog](#)

5.11.4.2 Active Power Cals dialog

The "Active Power Cals" dialog shows the power calibrations that are compatible with the active channel configuration. It allows you to enable or disable the available power calibrations.

Access: Channel – [Cal] > "Use Cal" > "Active Power Cals..."



All possible power calibrations can be performed from the [Power Cal wizard](#).

Port Overview

Shows all source ports together with their possible power calibrations. Unavailable calibrations (i.e. calibrations that have not been performed yet) are grayed out.

If external generators are configured, they appear as additional source ports G1 ... Gm in the port overview. A source power calibration is available at each generator port.

If the optional [LO Out](#) is equipped and **not** configured as LO source for millimeter wave converters, it appears as "C.LO" port with a possible "Source Flatness" cal.

If frequency converters are configured, additional source flatness calibrations can be performed for the analyzer ports driving the converters' RF IN and LO IN ports.

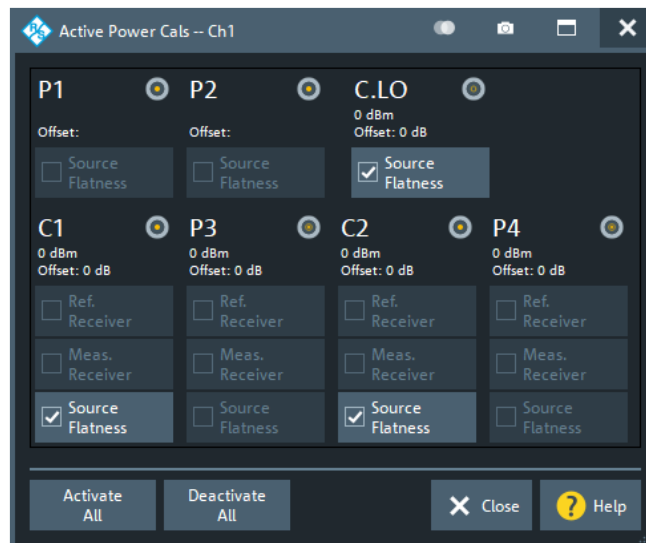
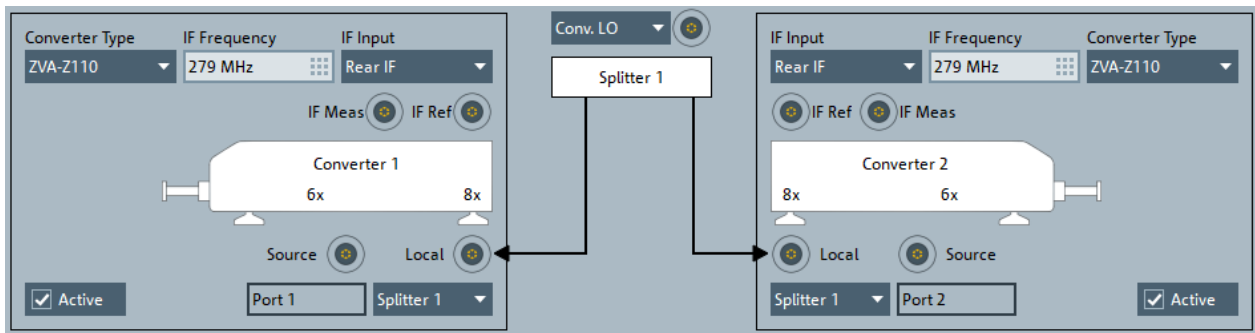

In the converter configuration above, P1 and P2 drive the RF IN ports of converter 1 and 2, respectively, and the Converter LO port drives the LO IN ports of both converters.

If the source flatness calibration at the converter port is enabled, then the flatness cal at the RF IN port is disabled (and grayed out). However, the source flatness cals at the converter RF in or out ports are only used, if the converter port is **not** configured to use [leveling data](#).

Remote command:

```
SOURce<Ch>:POWer<PhyPt>:CORRection:STATe
SOURce<Ch>:POWer:CORRection:GENerator<Gen>[:STATe]
[SENSe<Ch>:]CORRection:POWer<PhyPt>[:STATe]
[SENSe<Ch>:]CORRection:PCAL
```

5.11.4.3 Calibration Manager dialog

The "Calibration Manager" dialog stores user correction data to the cal pool and assigns stored correction data to channels.

See [Chapter 4.5.3, "Calibration pool"](#), on page 206 for background information.

Access: Channel – [Cal] > "Use Cal" > "Cal Manager..."

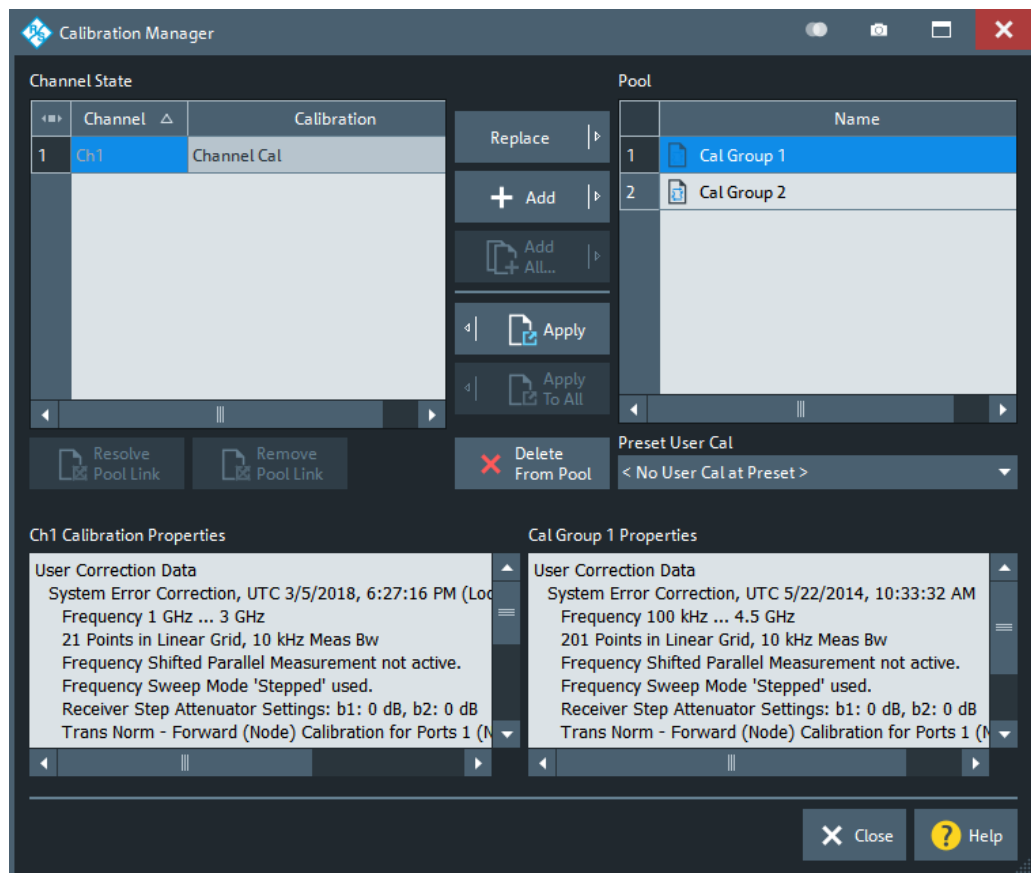

Channel State

The "Channel State" table shows all channels in the active recall set together with their current calibration. Channels can use either the active channel calibration (if available), a previously stored user correction data or the factory system error correction (indicated as '--').

Remote command:

n/a

Add / Add All... / Replace / Apply / Apply to All

The buttons between the tables are used to modify the calibration pool and apply calibration data sets (cal groups) to channels:

- "Add" copies the correction data of the selected channel to the cal pool, generating a new pool member (cal group).
- "Add All..." copies the correction data of all channels to the cal pool, generating new pool members (cal groups).
- "Replace" overwrites a cal group with new correction data.
- "Apply" assigns the selected cal group to the selected channel.
- "Apply to All" assigns the selected cal group to all channels in the "Channel State" table.

For channels that are linked to a "Cal Group" (using "Apply" or "Apply to All"), a new calibration overwrites the cal group data and hence affects all channels that are also linked to this cal group. An "Overwrite Warning" is displayed in this case. To continue with the calibration, confirm by using button "Overwrite Current File?" or "[Resolve Pool Link / Remove Pool Link](#)" on page 640.

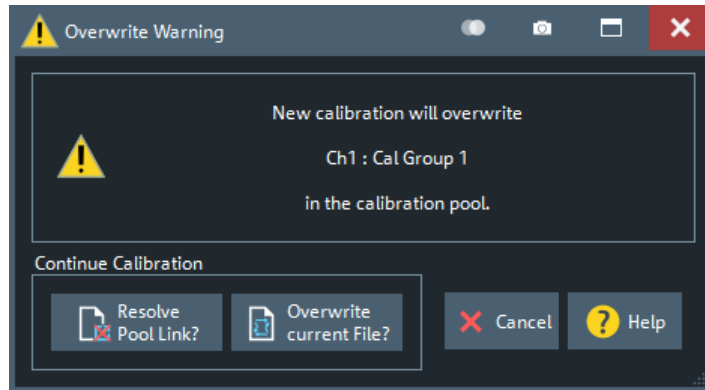

Remote command:

```
MMEMory:STORe:CORRection
MMEMory:LOAD:CORRection
MMEMory:LOAD:CORRection:MERGe
```

Pool / Delete from Pool

The "Pool" table shows all correction data sets `<CalGroup_name>.cal` in the directory `C:\Users\Public\Documents\Rohde-Schwarz\ZNA\Calibration\Data`. The name of a pool data set can be modified directly in the corresponding table cell.

"Delete from Pool" deletes a cal group file from the pool. **Note** however, that calibrations being used in any of the opened recall sets cannot be deleted.

Remote command:

```
MMEMory:DELeTe:CORRection
```

Preset User Cal

Selects a cal group from the pool that is activated during a user-defined preset.

A "Preset User Cal" is particularly useful for scenarios involving [External switch matrices](#), because with switch matrices user correction is indispensable.

Remote command:

```
SYSTem:PRESet:USER:CAL
```

Resolve Pool Link / Remove Pool Link

Deletes a link between the selected channel and a "Cal Group" (previously created using "Apply" or "Apply to All"). With "Resolve Pool Link", the cal group data are still used as a channel calibration ("Channel Cal") for this channel. With "Remove Pool Link" the channel calibration is removed.

Remote command:

```
MMEMory:LOAD:CORRection:RESolve
```

Ch<n> Calibration Properties/Cal Group <n> Properties

Displays the basic channel settings and the properties of the system error correction and the power correction for the channel (calibration group) selected in the "Channel State" ("Pool") table.

"Ch<n> Calibration Properties" also indicates settings mismatches (between the selected channel and the channel setup that was used during calibration) that lead to a "Cal Off". Currently this indication is limited to settings related to Parallel Measurements with [Frequency Offset](#).

In addition, it is stated whether sweep data are available for the selected calibration.

Remote command:

```
[SENSe<Ch>:]CORRection:DATE?
```

```
[SENSe<Ch>:]CORRection:DATA:PARAmeter<Sfk>?
```

```
[SENSe<Ch>:]CORRection:DATA:PARAmeter<Sfk>:PORT<PhyPt>?
```

```
[SENSe<Ch>:]CORRection:DATA:PARAmeter:COUNT?
```

```
[SENSe<Chn>:]CORRection:SState?
```

5.11.4.4 JoinCal dialog

Allows you to join existing calibrations.

Access: Channel – [Cal] > "Use Cal" > "JoinCal"



Background information

See [Chapter 4.5.9, "Joining calibrations"](#), on page 227.

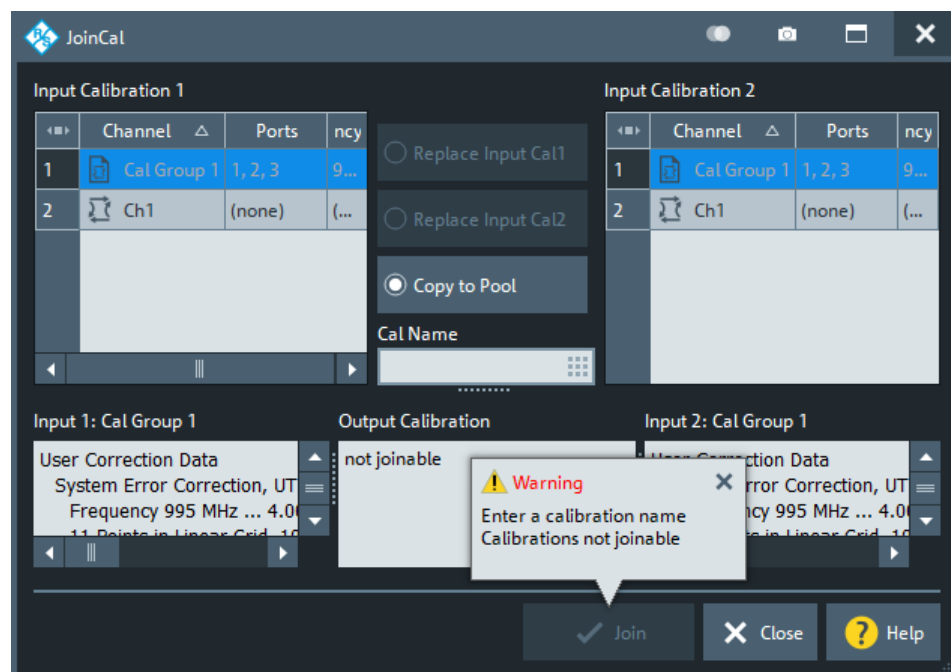

Input Calibration1/Input Calibration2/Cal Name

Select the input calibrations to be joined, and specify a name for the resulting calibration

Remote command:

`SYSTem:CORRection:JOINcal`

5.11.5 METAS Cal tab

The controls on the "METAS Cal" tab allow you to set up the instrument for real-time measurement uncertainty analysis. It is only visible if option R&S ZNA-K50 and METAS VNA Tools (version 2.2.3 or higher) are installed on the instrument.



For background information, see [Chapter 4.7.12, "Measurement uncertainty analysis"](#), on page 294.



- If [external switch matrices](#) are used, measurement uncertainty analysis is not supported and hence the controls on this tab are disabled.
- METAS calibration and verification is not fully supported via remote control. Some actions must be performed from the VNA GUI.

5.11.5.1 Controls on the METAS Cal tab (option K50)

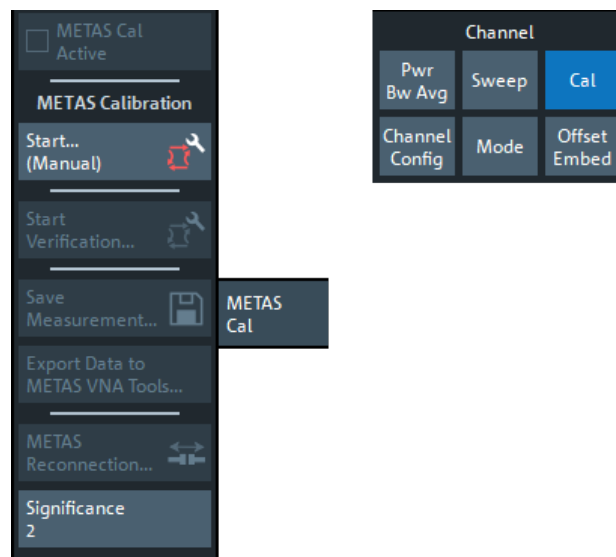

METAS Cal Active

After a successful METAS calibration, this checkbox enables or disables the uncertainty calculation for the related channel.

- If enabled, measurement results and uncertainties are calculated by METAS VNA Tools.
- If disabled, the VNA calculates the measurement results based on standard system error correction data (without uncertainties)

Remote command:

```
[SENSe<Ch>:]CORRection:METAs[:STATE]
```

METAS Calibration – Start... (Manual)

Opens the [METAS Calibration \(Manual\) dialog](#). A successful METAS calibration is [activated](#) immediately.

METAS calibration using calibration units is not supported.

Start Verification

While a METAS calibration is [active](#), this button opens the [METAS Verification dialog](#).

Save Measurement

Allows you to save the current measurement results to the temporary METAS VNA Tools project that is created under the hood during the [METAS calibration](#). This project can be saved using the [Export Data to METAS VNA Tools](#) function.

Opens the "Measurement Filename" dialog that lets you specify a prefix for the name of the generated file. A timestamp of the related measurement is always appended.

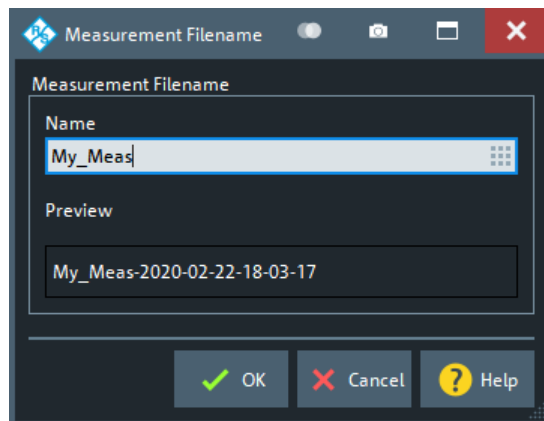

If no measurement data are available, the firmware displays a message box instead of the "Measurement Filename" dialog:

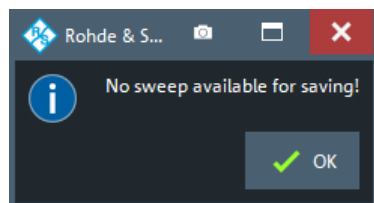

Export Data to METAS VNA Tools

Saves the current state of the METAS VNA Tools project that is created with the METAS calibration.

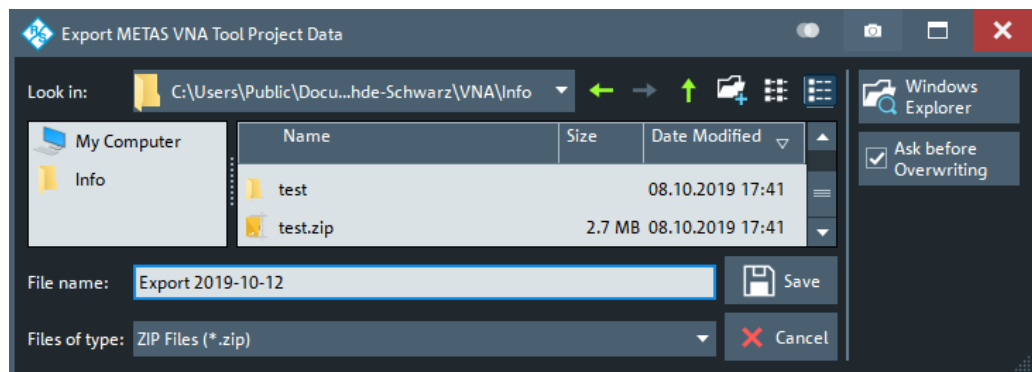

The exported ZIP file also contains the characterizations of the standards that were used for calibration and verification. The characterization data are kept as static resources in the METAS VNA Tools database. In summary, the exported ZIP file includes everything that is required to perform an offline analysis using any METAS VNA Tools installation, not only the one on the VNA.

Note: The exported file can be directly unzipped to the METAS VNA Tools user data folder (default: `C:\Users\Public\Documents\Metas.Vna.Tools`). After (re-)opening the METAS VNA Tools, the exported project and its associated static data are available for offline analysis.

METAS Reconnection

Opens the [METAS Reconnection dialog](#).

This button is only enabled, if a METAS cal is active.

Significance

Defines the width of the [uncertainty band](#), expressed as multiples of the standard deviation.

Default is 2 (95% confidence interval).

Remote command:

```
[SENSe<Ch>:]CORRection:METAs:UNCertainty
```

5.11.5.2 METAS Calibration (Manual) dialog

This dialog allows you to set up and perform a [METAS Calibration](#) of the active channel.

Access: Channel – [Cal] > "METAS Cal" > METAS Calibration – "Start (Manual)"



Only a single VNA channel can be METAS calibrated at a time. If you have a METAS calibration for another channel (no matter in which recall set), this METAS calibration is deleted when you apply the new one.

Step 1: Ports and Type

In step 1, choose the ports to be calibrated and the calibration type to be performed.

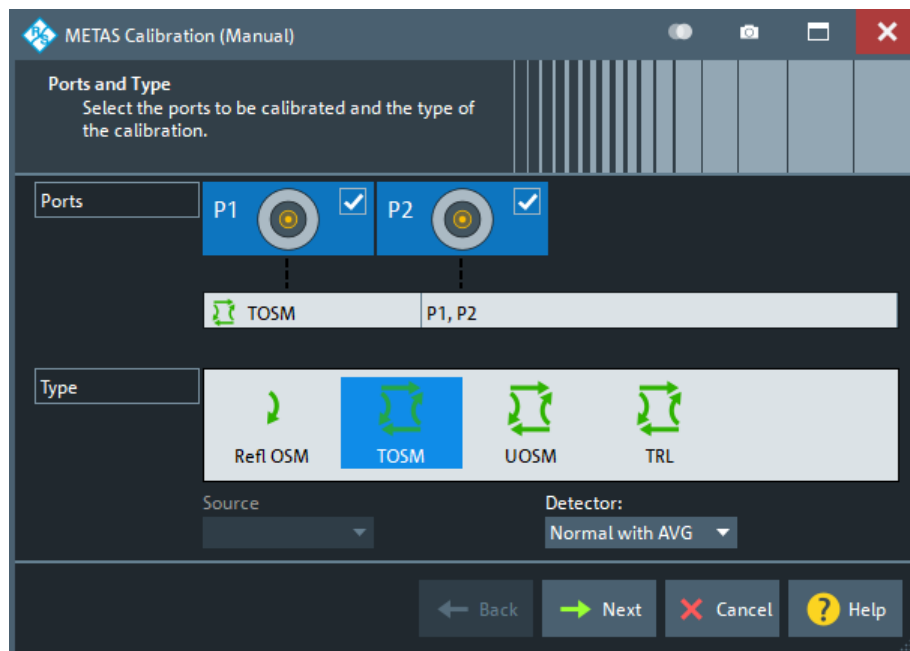

Only calibration types supported by METAS VNA Tools are available.

Ports

Selects the test ports to be calibrated.

Note: Calibration and port de-/activation.

The analyzer firmware automatically activates/deactivates ports during/after a (successful) calibration:

- Calibrated ports that were previously disabled, are automatically enabled as single-ended logical ports.
- An uncalibrated port that is not used by a measurement (i.e. the port is not required by any trace of the related channel) is disabled.

Remote command:

The port parameters in many calibration commands define the calibrated ports.

Type

Selects the calibration type.

Remote command:

```
[SENSe<Ch>:]CORRection:COLLect:METHod:DEFine <CalName>, MTOSm |
MUOSm | MOSM | MTRL, ...
```

Detector

Selects the detector type the analyzer uses during the calibration.

"AVG" The average detector eliminates noise contributions which are superimposed on the measured signal.

If an S-parameter, wave quantity or ratio is measured with a "Detector" on page 350 other than "Normal", AVG is selected by default. The "AVG" detector is used for [Noise figure measurement](#).

The "Normal" detector is recommended for all other applications.

"Normal"/"Normal with AVG" The sample detector without/with (automatic) averaging. This is the default detector for all other channels, if [Auto Averaging](#) is disabled/enabled.

Remote command:

```
[SENSe<Ch>:]CORRection:COLLect:DETEctor
```

```
[SENSe:]CORRection:COLLect:AVERAge
```

Step 2: Connectors and Cal Kits



Connector/Gender

Specifies the connector and gender of the ports selected in [Step 1: Ports and Type](#).

Note that METAS compatible file formats do not contain information about the related connector type, so you have to make sure to choose a suitable [Cal Kit](#).

Remote command:

see [Connector / Gender](#)

Cable

Allows you to specify which cables are connected to the related ports.

The cable models are read from the METAS VNA Tools database. Additional cable models can be added on a project-specific basis.

Remote command:

```
[SENSe:]CORRection:METAs:CABLE:CATalog?
```

```
[SENSe<Ch>:]CORRection:METAs:CABLE:TYPE
```

Cal Kit/Uncertainty

Allows you to specify the cal kits to be used for the selected ports. For meaningful uncertainty calculations, use a cal kit that is characterized with uncertainties.

Regular cal kits (without uncertainties) are also offered for selection. For these cal kits, zero uncertainty is assumed, which results in an unrealistic METAS calibration quality.

The "Uncertainty" checkbox indicates whether the selected characterization actually comprises uncertainties.

Remote command:

```
[SENSe:]CORRection:CKIT:SELEct
```

Same Connector All Ports / Same Gender All Ports

Assigns the same connector type or gender to all selected physical ports. For some multi-port calibration types, the port connector types must be equal, e.g. because they require a Through standard with known characteristics.

Remote command:

```
[SENSe<Ch>:]CORRection:COLLect:CONNection:PORTs
[SENSe<Ch>:]CORRection:COLLect:CONNection:GENDErs
```

Import Cal Kit...

Opens the "Import Calibration Standards with Uncertainties" dialog, that allows you to import cal kits with (or without) uncertainties.

A "CalKit with Uncertainties" can be one of the following:

- a zip file containing calibration standard characterizations in a format supported by METAS VNA Tools (sdatb, sdatx, sdatcv, calstd)
- a scolcv file

See the document "Data Formats" on the METAS VNA Tools internet page (<https://www.metas.ch/metas/en/home/fabe/hochfrequenz/vna-tools.html>, section "VNA Tools Documentation").

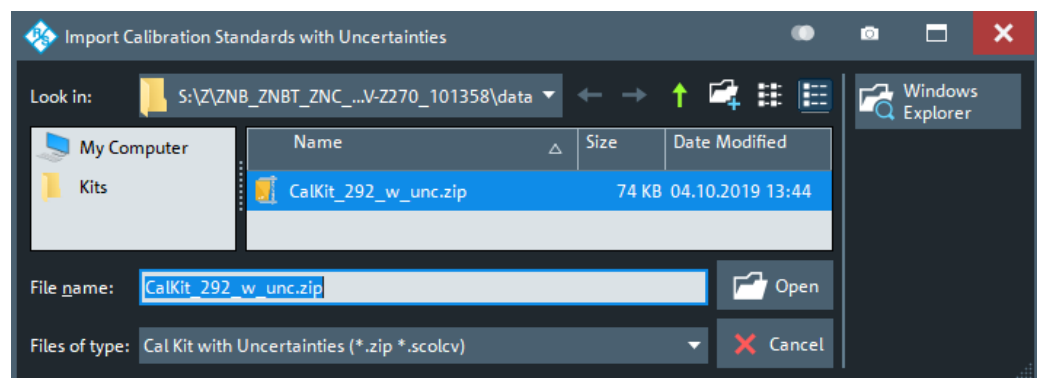

The imported cal kit is assigned to the selected **Connector** type; the name of the ZIP file is used as the cal kit name.

The name of a characterization file inside the zip container must indicate

- the standard type (Open, Short, Load, Match, Line, Reflect, Through, Sliding Load, Sliding Match)

and, if applicable, its gender (f, m, ff, fm, mf, mm).

Imported cal kits with uncertainties are preserved and added to the [Cal Kit](#) selection combo-box. There and in the [Calibration Kits dialog](#), they appear with an "Uncertainty" flag.

Start

Proceeds to [Step 3: Calibration](#). If the configuration is not plausible, a warning is displayed:

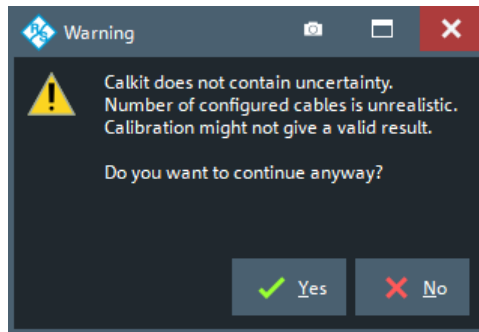

Step 3: Calibration

In step 3, the calibration is performed. The procedure is the same as for regular calibrations of the selected type (see [Chapter 5.11.1.3, "Calibration wizard"](#), on page 573).

On "Apply", the raw calibration data are transferred to METAS VNA Tools, which take over the calculation of measurement results and uncertainties: [METAS Cal Active](#) is enabled automatically.

In parallel to the "METAS Calibration", a regular VNA calibration without uncertainties is created. This calibration can be activated if "METAS Cal Active" is unchecked.

5.11.5.3 METAS Verification dialog

This dialog allows you to set up and perform a [Verification](#) of a [METAS Calibration](#).

For background information see "[Verification](#)" on page 296.

Access: Channel – [Cal] > "METAS Cal" > "Start Verification"

Step 1: Verification Kit

Allows you to select the verification kit to be used. All other settings are taken from the active [METAS calibration](#) and cannot be changed.

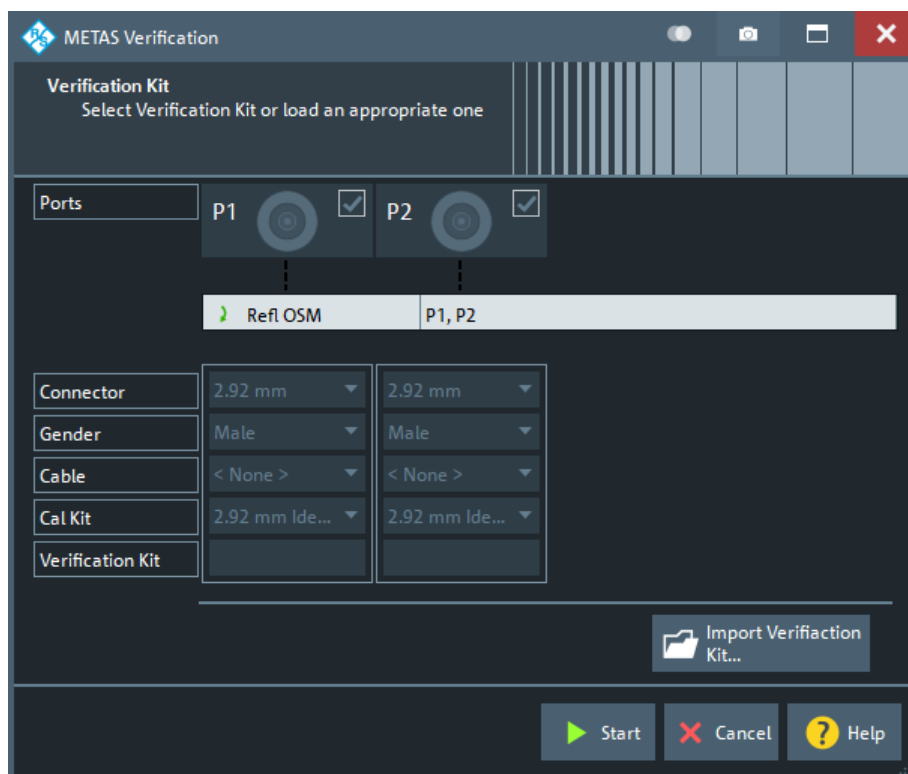

Verification Kit

Allows you to specify the verification kits to be used for the related ports.

Verification standards are characterized individually, including uncertainties. So initially no verification kits are defined. Use [Import Verification Kit...](#) to import your verification kit.

Import Verification Kit...

Opens the "Import Verification Standards with Uncertainties" dialog.

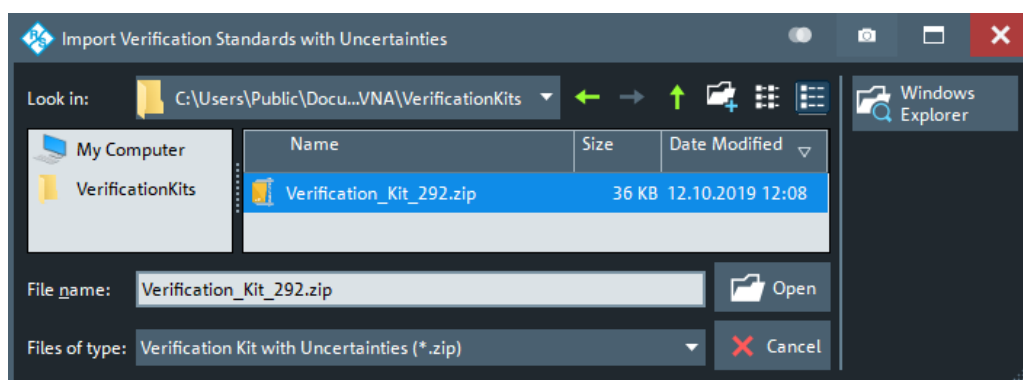

A "Verification Kit with Uncertainties" is a ZIP file containing verification standard characterizations in a format supported by METAS VNA Tools (sdatb, sdatx, sdatcv). See the document "Data Formats" on the METAS VNA Tools internet page (<https://www.metas.ch/metas/en/home/fabe/hochfrequenz/vna-tools.html>, section "VNA Tools" > "Installer and Documentation").

The imported verification kit is assigned to the selected [Connector](#) type; the name of the ZIP file is used as the verification kit name.

The name of a characterization file inside the zip container must indicate

- the standard type (offset short, mismatch, 20 dB Att, 40/50 dB Att, airline, mismatch airline, att, attenuator, stepped thru)
- and, if applicable, its gender (f, m, fm, ff, mf, mm).

Imported verification kits with uncertainties are preserved and added to the [Verification Kit](#) selection combo-box.

Step 2: METAS Verification

Step 2 allows you to perform the verification.

By selecting a button representing a verification standard, the required measurements are performed. The raw measurement data are handed over to METAS VNA Tools that returns the calibrated results and uncertainties and the pass/fail states of the respective verifications. The latter are indicated on the trace fields to the right of the verification standard buttons (red = failed).

The verification standard buttons indicate the verification states of the respective verification standards ("V" = not verified yet, "✓" = passed, "X" = failed). Use the [Collapse](#) button to toggle a condensed view focusing on these verification states.

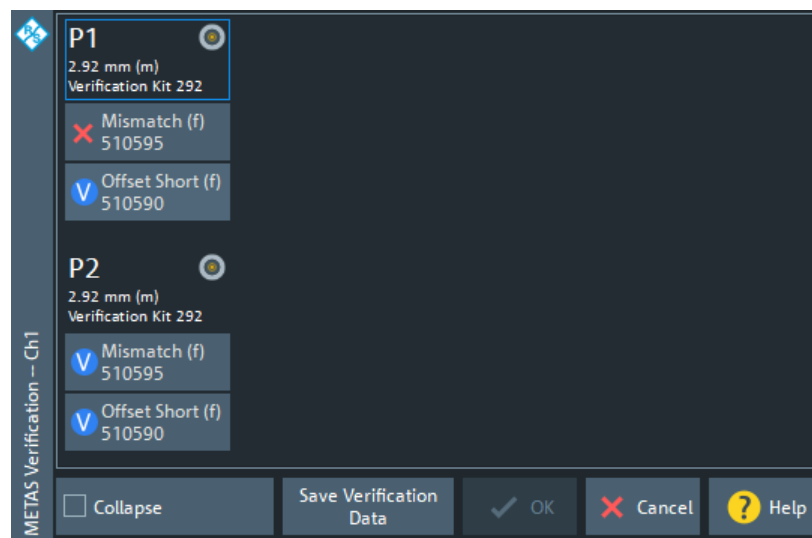

Collapse

In collapsed state, the "METAS Verification" dock widget presents a condensed view, focusing on the verification results for the available verification standards.

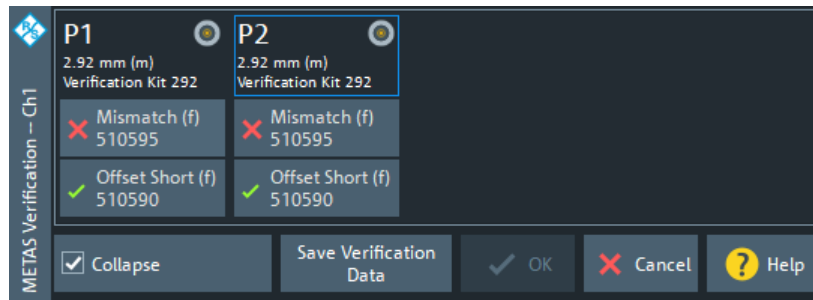

Save Verification Data

Same as [Export Data to METAS VNA Tools](#). The exported ZIP file now also contains the METAS verification configuration, and the verification measurement data obtained so far.

5.11.5.4 METAS Reconnection dialog

While a METAS calibration is active, you can notify the METAS VNA Tools about additional reconnections and/or cable movements. The latter is only applicable if cables were configured during the setup of the METAS calibration.

Access:  main toolbar icon or

Channel – [Cal] > "METAS Cal" > "METAS Reconnection"

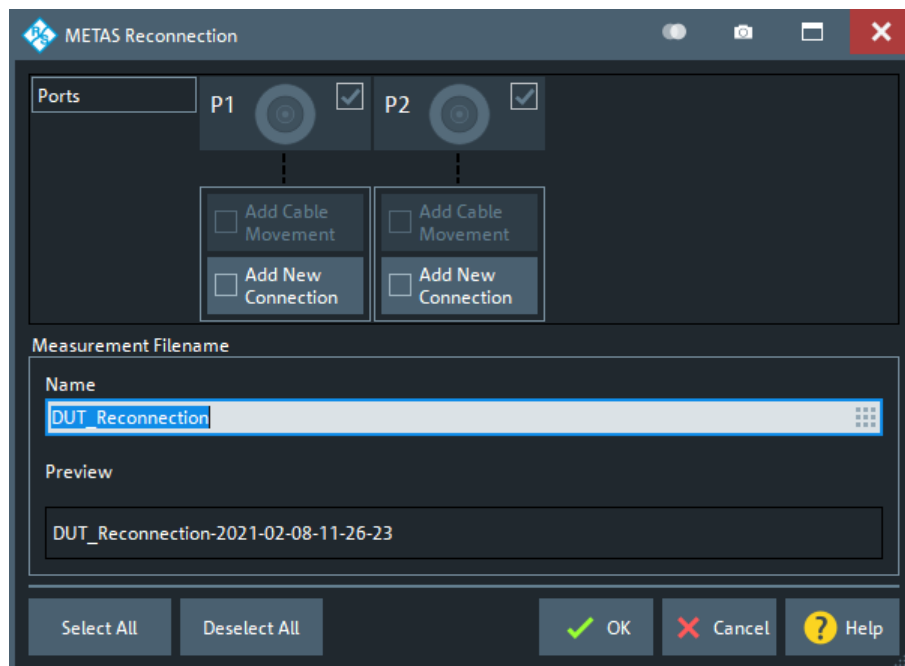

Both reconnections and cable movements contribute to the overall measurement uncertainty. In the METAS VNA Tools project created during the [METAS calibration](#), these events are registered in the so-called measurement journal. In addition, the results measured immediately after the event report are persisted in the project.

The effect of a reconnection depends on the selected [connector](#), the effect of a cable movement depends on the selected [cable](#) (on their respective models, to be precise).

For the METAS calibration, the VNA firmware reports the minimum possible number of reconnections (depending on the selected calibration type) and no cable movements. All other events of these types must be reported manually, using the "METAS Reconnection" dialog.

Add New Connection/Add Cable Movement

While a METAS calibration is active, these buttons notify the METAS VNA Tools about additional connector reconnections and/or cable movements. The latter is only applicable if cables were configured during the setup of the METAS calibration.

Remote command:

```
[SENSe<Ch>:]CORRection:METAs:CABLe:REConnection  
[SENSe<Ch>:]CORRection:METAs:CABLe:MOVement
```

Measurement Filename

Allows you to configure the name of the measurement data file generated with the measurement journal entry. For uniqueness, a timestamp is always appended.

5.12 Channel Config softtool

The "Channel Config" functions select, create and delete channels, configure the source and receive ports of the R&S ZNA, and optimize the measurement process.

Access: Channel – [Channel Config] key

5.12.1 Channels tab

Allows you to create and delete channels, to modify the channel state, and to select a channel as the active channel.



You can monitor the channel activity using the `OUTPut<Ch>:UPORt[:VALue]` command and the output signals at pins 8 to 11 of the User Port connector.



Background information

Refer to [Chapter 4.1.3.3, "Active and inactive traces and channels"](#), on page 110.

5.12.1.1 Controls on the Channels tab

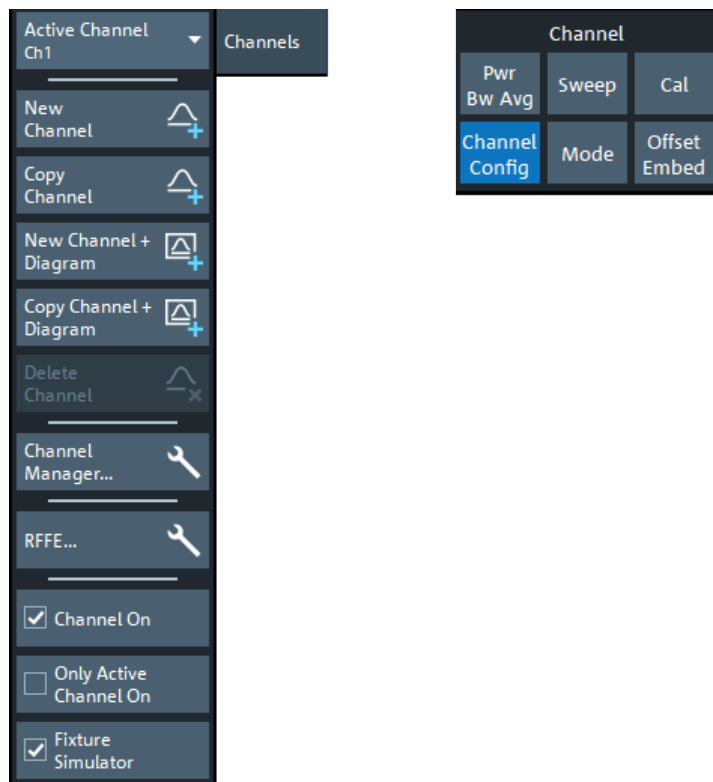

The buttons in the "Channels" tab open the following dialogs:

- "Channel Manager...": see [Chapter 5.12.1.2, "Channel Manager dialog"](#), on page 655
- "RFFE...": see [Chapter 5.12.1.3, "RFFE Config dialog for R&S ZN-B15/-Z15 Var. 03"](#), on page 656

Active Channel

Selects an arbitrary channel of the active recall set as the active channel. This function is disabled if the current recall set contains only one channel.

If one or several traces are assigned to the selected channel, one of these traces becomes the active trace.

The order of all channels in a recall set is given by the channels' creation time. By default, the channels are named Ch1, Ch2, ... so that Ch<n – 1> precedes Ch<n>. This order is always maintained, even if channels are renamed, invisible (because no traces are assigned to them) or distributed over several diagram areas.

Tip: You can also select a line in the channel list to activate the corresponding channel.

Remote command:

The numeric suffix <Ch> appended to the first-level mnemonic of a command selects a channel as the active channel.

New Channel

Creates a channel and a trace with default settings, and assigns the new trace to the active diagram area.

The new channel is named Ch<n>, where <n> is the largest of all existing channel numbers plus one. The name can be changed in the "Channel Manager" dialog.

Tips:

- To create a channel and a trace with default settings and to display the trace in a *new* diagram area, use [New Channel + Diagram](#).
- Use [Add Trace](#) to create a trace in the *active* channel.

Remote command:

```
CONFigure:CHANnel<Ch>[:STATe] ON
CALCulate<Ch>:PARAmeter:SDEFine
DISPlay[:WINDow<Wnd>]:TRACe<WndTr>:FEED
CONFigure:TRACe<Trc>:CHANnel:NAME?
CONFigure:TRACe<Trc>:CHANnel:NAME:ID?
```

Copy Channel

Copies the active channel with all its settings (including a possible channel calibration) and traces. The new traces are displayed in the active diagram area.

The new channel is named Ch<n>, where <n> is the largest of all existing channel numbers plus one. The name can be changed in the "Channel Manager" dialog.

Tips: Use [Copy Channel + Diagram](#) to display the copied traces in a *new* diagram area.

Remote command:

```
CONFigure:CHANnel<Ch>[:STATe] ON
CALCulate<Ch>:PARAmeter:SDEFine
DISPlay[:WINDow<Wnd>]:TRACe<WndTr>:FEED
CONFigure:TRACe<Trc>:CHANnel:NAME?
CONFigure:TRACe<Trc>:CHANnel:NAME:ID?
```

New Channel + Diagram

Creates a channel and a trace with default settings, and assigns the created trace to a new diagram area.

The new channel is named Ch<n>, where <n> is the largest of all existing channel numbers plus one. The name can be changed in the "Channel Manager" dialog.

Tip: To create a channel and a trace with default settings and to display the trace in the *active* diagram area, use [New Channel](#).

Copy Channel + Diagram

Copies the active channel with all its settings (including a possible channel calibration) and traces, and displays the created traces in a new diagram area.

The new channel is named Ch<n>, where <n> is the largest of all existing channel numbers plus one. The name can be changed in the "Channel Manager" dialog.

Tips: Use [Copy Channel](#) to display the new traces in an *existing* diagram area.

Delete Channel

Deletes the current channel including all the traces assigned to it and removes all display elements related to the channel from the diagram area. "Delete Channel" is disabled if the recall set contains only one channel: In manual control, each recall set must contain at least one diagram area with one channel and one trace.

Tips: Use the "Undo" function to restore a channel that was unintentionally deleted.

Remote command:

```
CONFigure:CHANnel<Ch>[:STATe] OFF
```

Channel On

Toggles the measurement state of the active channel.

Remote command:

```
CONFigure:CHANnel<Ch>:MEASure[:STATe]
```

Only Active Channel On

If checked, only the active channel is measured; all other channels are switched off temporarily and dynamically.

Temporarily means: If "Only Active Channel On" is unchecked, then all channels return to their original [Channel On](#) state.

Dynamically means: If another channel becomes the active one, the firmware adjusts the temporary ON/OFF state accordingly.

Remote command:

```
CONFigure:CHANnel:MEASure:ACTive[:STATe]
```

Fixture Simulator

The "Fixture Simulator" switch deactivates or activates the configured deembedding, embedding, balanced ports, and port impedance settings for the selected channel.

When "Fixture Simulator" is **deactivated**:

- All balanced ports are resolved to single ended ports
- All port impedances are set to default
- All de/embeddings are disabled

At the GUI, the "Balanced Ports" dialog and the de/embedding tabs and dock widgets are disabled. Related remote commands generate an error.

When "Fixture Simulator" is **reactivated**, the situation before the deactivation is restored.

Note: The "Offset" and "One Way Loss" settings are **not** affected by the "Fixture Simulator" switch. Use the "All Compensation Off"/"All Compensation On" functions of the "Fixture Compensation" dialog to de/activate these compensations as well (see [Chapter 5.14.2.2, "Fixture Compensation dialog"](#), on page 719).

Remote command:

```
CALCulate<Ch>:TRANSform:VNETworks:FSIMulator[:STATe]
```

5.12.1.2 Channel Manager dialog

The "Channel Manager" dialog allows you to rename channels and to change their measurement state and sweep mode.

Access: Channel – [Channel Config] > "Channels" > "Channel Manager..."



Background information

Refer to [Chapter 4.1.3.3, "Active and inactive traces and channels"](#), on page 110.

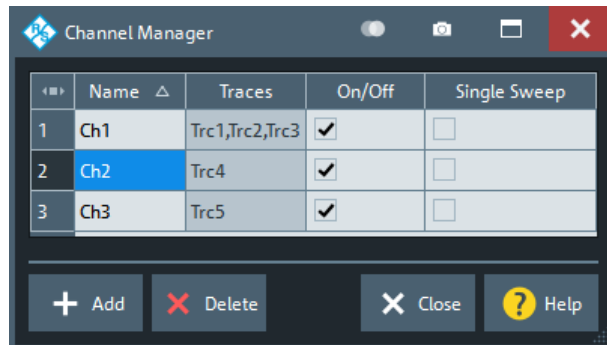

Channel table

The rows and columns of the channel table represent the existing channels (rows) together with certain editable (white) or non-editable (gray) properties (columns).

- "Name" indicates the name of the related channel.
- "Traces" indicates the names of all traces assigned to the related channel.
- "On/Off" toggles the measurement state of the related channel.
- "Single Sweep" toggles between "Continuous" and "Single" sweep mode (see ["Continuous / Single"](#) on page 565).

Remote command:

```
CONFigure:CHANnel:CATalog?
CONFigure:CHANnel<Ch>:NAME
CONFigure:CHANnel<Ch>:NAME:ID?
CONFigure:CHANnel<Ch>:MEASure[:STATe]
INITiate<Ch>:CONTinuous
```

Add / Delete

The buttons below the channel table add and delete channels.

- "Add" adds a new channel to the list. The new channel is named Ch<n>, where <n> is the largest of all existing channel numbers plus one.
- "Delete" deletes the channel selected in the table. This button is disabled if the setup contains only one channel: In manual control, each setup must contain at least one diagram area with one channel and one trace.

Remote command:

```
CONFigure:CHANnel<Ch>[:STATe]
```

5.12.1.3 RFFE Config dialog for R&S ZN-B15/-Z15 Var. 03

Controls the channel-specific setup of the two RFFE bus interfaces and GPIO ports provided by **variant 03** of the RFFE GPIO extension board R&S ZNA-B15.

Access: Channel – [Channel Config] > "Channels" > "RFFE..."

Seq.	CLK	VIO	VLow	VHigh	RFFE Command	Send
<input checked="" type="checkbox"/>	31.25 kHz	0 V	0 V	0 V	SA=? CMD=?? DATA=...	SEND ►
<input type="checkbox"/>	31.25 kHz	0 V	0 V	0 V	SA=? CMD=?? DATA=...	SEND ►

TEST	Output Voltage	Range	Shunt	Voltage	Current
RFFE 1 Data	0 V	20 mA	10 Ω	0 V	0 A
RFFE 1 Clock	0 V	20 mA	10 Ω	0 V	0 A
RFFE 1 VIO	0 V	20 mA	10 Ω	0 V	0 A
RFFE 2 Data	0 V	20 mA	10 Ω	0 V	0 A
RFFE 2 Clock	0 V	20 mA	10 Ω	0 V	0 A
RFFE 2 VIO	0 V	20 mA	10 Ω	0 V	0 A



Background information

Refer to [Chapter 4.7.26, "RFFE GPIO interface"](#), on page 305.

For more details about the voltage range, clock frequency ranges and their steps sizes, refer to [Chapter 12.3.4, "RFFE - GPIO interface"](#), on page 1785.

RFFE tab

The "RFFE" tab is divided into two parts:

- The upper part gives access to the RFFE interface settings and allows manual command execution and result display (see ["Basic RFFE interface settings and command execution"](#) on page 659)
- The lower part allows you to define and apply test voltages and to execute voltage and current measurements on the RFFE pins (see ["GPIO voltage and current measurements"](#) on page 663)

The "Set" button activates the "Output Voltage" and "Range" ("Shunt" resistance) settings. The "Meas" button starts the voltage and current measurements.

RFFE

	Seq.	CLK	VIO	VLow	VHigh	RFFE Command	Send
RFFE1	<input checked="" type="checkbox"/>	31.25 kHz	0 V	0 V	0 V	SA=? CMD=?? DATA=...	... SEND ▶
RFFE2	<input type="checkbox"/>	31.25 kHz	0 V	0 V	0 V	SA=? CMD=?? DATA=...	... SEND ▶

Measurement

TEST		Output Voltage	Range	Shunt	Voltage	Current
RFFE 1	Data	0 V	20 mA	10 Ω	0 V	0 A
RFFE 1	Clock	0 V	20 mA	10 Ω	0 V	0 A
RFFE 1	VIO	0 V	20 mA	10 Ω	0 V	0 A
RFFE 2	Data	0 V	20 mA	10 Ω	0 V	0 A
RFFE 2	Clock	0 V	20 mA	10 Ω	0 V	0 A
RFFE 2	VIO	0 V	20 mA	10 Ω	0 V	0 A

▶ Set

▶ Start Meas

Sweep Sequencer tab

Gives access to the "Sweep Sequencer" functionality, see [Chapter 5.12.1.6, "Sweep Sequencer"](#), on page 665.

GPIOs tab

The "GPIOs" tab is split into two parts:

- The left part of the table area (up to column "Output Voltage") allows you to define and apply the GPIO pin voltages (see ["Basic GPIO configuration"](#) on page 662).
- The right part allows you to define and execute voltage and current measurements on the GPIO pins (see ["GPIO voltage and current measurements"](#) on page 663)

The "Apply" button activates both the "Output Voltage" and "Range" ("Shunt" resistance) settings. The "Meas" button starts the voltage and current measurements.

GPIOs

Measurement							
#	Seq.	Output Voltage	Range	Shunt	Voltage	Current	
1	<input type="checkbox"/>	0 V	20 mA	10 Ω	0 V	0 A	
2	<input type="checkbox"/>	0 V	20 mA	10 Ω	0 V	0 A	
3	<input type="checkbox"/>	0 V	20 mA	10 Ω	0 V	0 A	
4	<input type="checkbox"/>	0 V	20 mA	10 Ω	0 V	0 A	
5	<input type="checkbox"/>	0 V	20 mA	10 Ω	0 V	0 A	
6	<input type="checkbox"/>	0 V	20 mA	10 Ω	0 V	0 A	
7	<input type="checkbox"/>	0 V	20 mA	10 Ω	0 V	0 A	
8	<input type="checkbox"/>	0 V	20 mA	10 Ω	0 V	0 A	
9	<input type="checkbox"/>	0 V	100 mA	1 Ω	0 V	0 A	
10	<input type="checkbox"/>	0 V	100 mA	1 Ω	0 V	0 A	

5.12.1.4 RFFE interface configuration

Access: [RFFE tab](#) of the "RFFE Config" dialog

Basic RFFE interface settings and command execution

The RFFE config table gives access to the channel-specific setup of the two RFFE bus interfaces RFFE1 and RFFE2.

If at least one of the RFFE commands reads back values, an additional result area is shown below the table. For each of these read-back commands, it displays the respective read count or, after the command was sent, the last received response (if successfully read).

	Seq.	CLK	VIO	VLow	VHigh	RFFE Command	Send
RFFE1	<input checked="" type="checkbox"/>	31.25 kHz	0 V	0 V	0 V	SA=1 CMD=01	... SEND
RFFE2	<input checked="" type="checkbox"/>	31.25 kHz	0 V	0 V	0 V	SA=1 CMD=02 DATA=45AF	... SEND

RFFE2 Read Count: 2 byte long.

Seq.

Enables/disables the corresponding RFFE interface in the Sweep Sequencer (see [Chapter 5.12.1.6, "Sweep Sequencer"](#), on page 665).

Remote command:

```
CONTrol<Ch>:RFFE<Bus>:SETTings[:STATe]
```

CLK, VIO, VLow, VHigh

These columns give access to the physical properties of the RFFE interfaces: clock rate ("CLK"), supply voltage ("VIO") and the voltage levels of the data signal SDATA ("VLow") and clock signal SCLK ("VHigh").

Remote command:

```
CONTrol<Ch>:RFFE<Bus>:SETTings:FREQuency
CONTrol<Ch>:RFFE<Bus>:SETTings:VOLTage:IO
CONTrol<Ch>:RFFE<Bus>:SETTings:VOLTage:LOW
CONTrol<Ch>:RFFE<Bus>:SETTings:VOLTage:HIGh
```

RFFE Command

The ellipsis buttons in these columns open a dialog that allows to define the RFFE command to be sent.

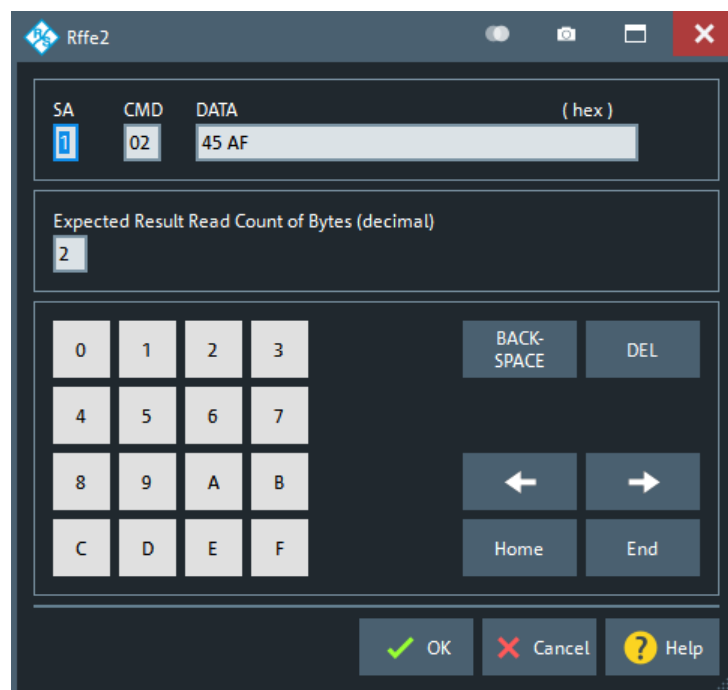

In this dialog, enter the following parameters (according to the device to be controlled):

- "SA": a slave address between 0 and 15 as 1 hex digit
- "CMD": a command number between 0 and 255 as 2 hex digits
- "DATA": the data part, 0 bytes to 17 bytes (hex digit **pairs**)
- "Expected Result Read Count of Bytes (decimal)": The number of bytes to be read back after the command was sent (max. 16). If set to 0, the command is a pure write command.

In Sweep Sequencer mode, this section is hidden.

For details and background information, see the "MIPI Alliance Specification for RF Front-End Control Interface".

Remote command:

```
CONTrol<Ch>:RFFE<Bus>:COMMand:DATA
```

SEND

Use the "SEND" button to send the previously defined command, e.g. before starting the sweep for the related channel.

On a R&S ZN-B15/Z15 **var. 03**, before the command is executed the related shunt resistance is set to its minimum possible value.

Remote command:

`CONTrol<Ch>:RFFE<Bus>:COMManD:SEND` (write-only) or

`CONTrol<Ch>:RFFE<Bus>:COMManD:SEND? <BytesToRead>` (with read-back)

RFFE interface voltage and current measurements

Defines the voltage and current measurements on the RFFE pins.

		Measurement				
TEST		Output Voltage	Range	Shunt	Voltage	Current
RFFE 1	Data	0 V	20 mA	10 Ω	0 V	0 A
RFFE 1	Clock	0 V	20 mA	10 Ω	0 V	0 A
RFFE 1	VIO	0 V	20 mA	10 Ω	0 V	0 A
RFFE 2	Data	0 V	20 mA	10 Ω	0 V	0 A
RFFE 2	Clock	0 V	20 mA	10 Ω	0 V	0 A
RFFE 2	VIO	0 V	20 mA	10 Ω	0 V	0 A



- The measurement parameters are channel-specific. However only one configuration can be measured at a time.
- Voltage and current measurements on the RFFE and GPIO pins are only possible with **Var. 03** of the extension board R&S ZN-B15/Z15 (part number 1323.9355.03 or 1325.5905.03).

Output Voltage

Defines the output voltages for the voltage/current measurements on the RFFE pins.

Note: The Data and Clock pins always use the same output voltages; their values cannot be set independently.

The "Output Voltage" and **Range / Shunt** settings do not take effect until **Set** is pressed.

Remote command:

`CONTrol<Ch>:RFFE<Bus>:TEST:DATA`

`CONTrol<Ch>:RFFE<Bus>:TEST:CLOCK`

`CONTrol<Ch>:RFFE<Bus>:TEST:VIO`

Range / Shunt

Defines the current range for the voltage and current measurement on the respective RFFE pin. The analyzer firmware automatically selects a suitable shunt resistance.

The **Output Voltage** and "Range" / "Shunt" settings do not take effect until **Set** is pressed.

Remote command:

```
CONTrol<Ch>:RFFE<Bus>:TEST:CLOCK:RANGe
CONTrol<Ch>:RFFE<Bus>:TEST:CLOCK:SHUNt?
CONTrol<Ch>:RFFE<Bus>:TEST:DATA:RANGe
CONTrol<Ch>:RFFE<Bus>:TEST:DATA:SHUNt?
CONTrol<Ch>:RFFE<Bus>:TEST:VIO:RANGe
CONTrol<Ch>:RFFE<Bus>:TEST:VIO:SHUNt?
```

Set

Use the "Set" button to apply all RFFE configuration changes and to activate the configured voltage and [Range / Shunt](#) settings on the RFFE pins.

Remote command:

```
CONTrol<Ch>:RFFE:TEST:OUTPut
```

Start Meas

Starts the voltage and current measurement.

Note that "Start Meas" does not automatically activate the "Output Voltage" and "Range" / "Shunt" settings of the current channel. Use [Set](#) to activate them manually.

The measurement (=sampling) time can only be set via remote command. It is not channel-specific and applies to RFFE and GPIO measurements.

Remote command:

```
CONTrol<Ch>:RFFE:TEST:SENSe:TRIGger
CONTrol<Ch>:RFFE:TEST:TIME
```

Voltage, Current

Results of the voltage/current measurements on the related RFFE pins.

Remote command:

```
CONTrol:RFFE<Bus>:TEST:DATA:VOLTage?
CONTrol:RFFE<Bus>:TEST:CLOCK:VOLTage?
CONTrol:RFFE<Bus>:TEST:VIO:VOLTage?
CONTrol:RFFE<Bus>:TEST:DATA:CURRent?
CONTrol:RFFE<Bus>:TEST:CLOCK:CURRent?
CONTrol:RFFE<Bus>:TEST:VIO:CURRent?
```

5.12.1.5 GPIO configuration

Access: [GPIOs tab](#) of the "RFFE Config" dialog

Basic GPIO configuration

The (left part of the) GPIO config table gives access to the channel-specific GPIO voltage settings.

	#	Seq.	Output Voltage	Range	Shunt
1	GPIO 1	<input checked="" type="checkbox"/>	0 V	20 mA	10 Ω
2	GPIO 2	<input type="checkbox"/>	0 V	20 mA	10 Ω
3	GPIO 3	<input type="checkbox"/>	0 V	20 mA	10 Ω
4	GPIO 4	<input type="checkbox"/>	0 V	20 mA	10 Ω
5	GPIO 5	<input type="checkbox"/>	0 V	20 mA	10 Ω
6	GPIO 6	<input type="checkbox"/>	0 V	20 mA	10 Ω
7	GPIO 7	<input type="checkbox"/>	0 V	20 mA	10 Ω
8	GPIO 8	<input type="checkbox"/>	0 V	20 mA	10 Ω
9	GPIO 9	<input type="checkbox"/>	0 V	100 mA	1 Ω
10	GPIO 10	<input type="checkbox"/>	0 V	100 mA	1 Ω

 Apply

Figure 5-30: Basic GPIO Configuration for HW Var. 03

Seq.

Enables/disables the corresponding GPIO pin in the Sweep Sequencer (see [Chapter 5.12.1.6, "Sweep Sequencer"](#), on page 665).

Remote command:

```
CONTrol<Ch>:GPIO<Port>[:STATe]
```

Voltage / Output Voltage

Sets the (default) voltage of the respective GPIO pin for R&S ZN-B15/-Z15 Var. 02 / Var. 03.

Remote command:

```
CONTrol<Ch>:GPIO<Port>:VOLTage[:DEFault]
```

Apply

Use the "Apply" button to activate the configured voltage (and [Range / Shunt](#)) settings to the GPIO pins.

Remote command:

```
CONTrol<Ch>:GPIO:VOLTage:OUTPut
```

GPIO voltage and current measurements

Defines and executes the voltage and current measurements on the GPIO pins.

Measurement							
#	Seq.	Output Voltage	Range	Shunt	Voltage	Current	
1	GPIO 1	0V	20 mA	10 Ω	0 V	0 A	
2	GPIO 2	0V	20 mA	10 Ω	0 V	0 A	
3	GPIO 3	0V	20 mA	10 Ω	0 V	0 A	
4	GPIO 4	0V	20 mA	10 Ω	0 V	0 A	
5	GPIO 5	0V	20 mA	10 Ω	0 V	0 A	
6	GPIO 6	0V	20 mA	10 Ω	0 V	0 A	
7	GPIO 7	0V	20 mA	10 Ω	0 V	0 A	
8	GPIO 8	0V	20 mA	10 Ω	0 V	0 A	
9	GPIO 9	0V	100 mA	1 Ω	0 V	0 A	
10	GPIO 10	0V	100 mA	1 Ω	0 V	0 A	

▶ Apply
→ Meas



- The measurement parameters are channel-specific. However only one configuration can be measured at a time.
- Voltage and current measurements on the RFFE and GPIO pins are only possible with **Var. 03** of the extension board R&S ZN-B15/-Z15 (part number 1323.9355.03 or 1325.5905.03).
The high-resistance configuration of GPIO pins 9 and 10 requires FPGA version 6.1.0 or higher. For older versions of the R&S ZN-B15/Z15 Var. 03, pins 9 and 10 have the same current range as pins 1 to 8 (see "[Range / Shunt](#)" on page 664). To check for an equipped RFFE/GPIO interface's part number and "Product Index" version, see the [Hardware tab](#) of the "Info" dialog.

Range / Shunt

"Range" defines an upper bound of the current to be measured on the respective GPIO pin. The analyzer firmware automatically selects a suitable shunt resistance.

Possible ranges for ports 1 to 8 are $\{ 2 \cdot 10^n \mu\text{A} \mid n=1, \dots, 5 \}$.

For a R&S ZN-B15/Z15 Var. 03 with FPGA version 6.1.0 or higher, Pins 9 and 10 can be configured as follows:

- 0 A "high resistance" range (shunt resistance 100 MΩ)
- 100 mA range (shunt resistance 1 Ω)

For older versions, pins 9 and 10 have the same current range as pins 1 to 8.

The [Voltage / Output Voltage](#) and "Range" / "Shunt" settings do not take effect until [Apply](#) is pressed.

Remote command:

```
CONTrol<Ch>:GPIO<Port>:RANGe
CONTrol<Ch>:GPIO<Port>:SHUNT?
```

Meas

Starts the voltage and current measurement.

Note that "Start Meas" does not automatically activate the "Voltage" and "Range" / "Shunt" settings of the current channel. Use [Apply](#) to activate them manually.

The measurement (=sampling) time can only be set via remote command. It is not channel-specific and applies to RFFE and GPIO measurements.

Remote command:

```
CONTrol<Ch>:GPIO:SENSe:TRIGger
```

```
CONTrol<Ch>:GPIO:TIME
```

Voltage, Current

Results of the voltage/current measurements on the related GPIO pins.

Remote command:

```
CONTrol:GPIO<Port>:SENSe:VOLTage?
```

```
CONTrol:GPIO<Port>:SENSe:CURREnt?
```

```
CONTrol:GPIO:SENSe:SUMCurrent?
```

5.12.1.6 Sweep Sequencer

Defines the RFFE commands to be executed and the GPIO voltages to be applied before each sweep (segment).

	RFFE1	GPIO1	Wait
1	SA=1 CMD=11 DATA=02 ...	0 V	1 s
2	SA=1 CMD=11 DATA=01 ...	0 V	1 s
3	SA=1 CMD=11 ...	1 V	0 s



- Make sure that the required RFFE bus interfaces and GPIO ports are enabled by setting the respective "Seq." flags in the "RFFE Config" dialog (see ["Basic RFFE interface settings and command execution"](#) on page 659 and [Basic GPIO configuration](#)).
- The sequencer settings are only valid for the active channel. In a multiple channel measurement, you have to configure each channel separately.
- On a R&S ZN-B15/Z15 **var. 03**, the sweep sequencer overwrites the currently applied voltages and sets the related shunt resistances to the minimum possible value (see ["RFFE interface voltage and current measurements"](#) on page 661 and ["GPIO voltage and current measurements"](#) on page 663).

Proceed as follows:

1. For segmented sweeps, select the related sweep segment (see ["Range"](#) on page 666).

2. Use the "Add" or "Insert" button to add a new step to the command/switch sequence - either at the end of the existing sequence or above the selected step, respectively.
3. Make the appropriate settings in the sweep sequencer table:
 - a) Define the RFFE commands ("RFFE" columns).
 - b) Set the GPIO voltages ("GPIO" columns).
 - c) Specify the delays between subsequent commands/switches and before the sweep or segment start ("Wait" column).
4. Use "Delete" to remove the selected item or "Delete All" to clear or the command/switch sequence.
5. Select "OK" to apply the settings. To discard the changes, select "Cancel" .

Range

For segmented sweeps, a command/switch sequence can be defined for each sweep segment. For unsegmented sweeps, only a single "Range" is available.

Remote command:

Unsegmented sweeps

```
CONTrol<Ch>:SEQuence:COUNT?
```

```
CONTrol<Ch>:SEQuence:CLEar:ALL
```

Segmented sweeps:

```
CONTrol<Ch>:SEGment<Nr>:SEQuence:COUNT?
```

```
CONTrol<Ch>:SEGment<Nr>:SEQuence:CLEar:ALL
```

RFFE columns (sweep sequencer table)

The cells in the "RFFE" columns define the sequence of commands to be sent over the respective RFFE interface. The command definition dialog (opened from the ellipsis buttons) is described in ["Basic RFFE interface settings and command execution"](#) on page 659.

Remote command:

```
CONTrol<Ch>:RFFE<Bus>:SETTings[:STATe]
```

Unsegmented sweeps

```
CONTrol<Ch>:SEQuence<Nr>:RFFE<Bus>:COMMand:DATA
```

Segmented sweeps:

```
CONTrol<Ch>:SEGment<SegNr>:SEQuence<SeqNr>:RFFE<Bus>:COMMand:
DATA
```

GPIO columns (sweep sequencer table)

The cells in the "GPIO" columns define the sequence of voltages to be applied to the respective GPIO ports.

Remote command:

```
CONTrol<Ch>:GPIO<Port>[:STATe]
```

Unsegmented sweeps

```
CONTrol<Ch>:SEQuence<Nr>:GPIO<Port>:VOLTage
```

Segmented sweeps:

```
CONTrol<Ch>:SEGment<SegNr>:SEQuence<SeqNr>:GPIO<Port>:VOLTage
```

Wait (Sweep Sequencer Table)

The cells in the "Wait" column define the delay times between subsequent sequence steps and between the final sequence step and the sweep (segment) start.

Remote command:

Unsegmented sweeps

`CONTrol<Ch>:SEQuence<Nr>:DELay`

Segmented sweeps:

`CONTrol<Ch>:SEGMENT<SegNr>:SEQuence<SeqNr>:DELay`

5.12.2 Port Config tab

Configures the source and receive ports of the R&S ZNA, for measurements on frequency-converting DUTs, defining arbitrary port frequencies and powers. While the arbitrary mode is active, "Arb" and the selected stimulus axis are displayed in the channel line.

**Background information**

Refer to [Chapter 4.7.3, "Frequency conversion measurements"](#), on page 261.

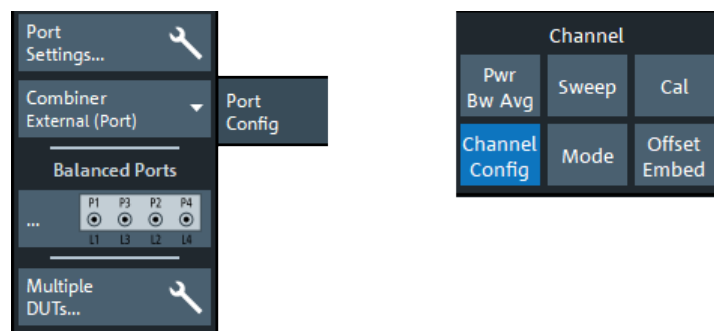
5.12.2.1 Controls on the Port Config tab

If either multiple DUTs are configured (see [Chapter 5.12.2.3, "Define Parallel Measurement dialog"](#), on page 682) or the "Fixture Simulator" is disabled for the related channel (see ["Fixture Simulator"](#) on page 655), the "Balanced Ports..." button is inactive (grayed out).

Port Settings...

Opens a dialog that allows you to configure the source and receiver ports of the R&S ZNA for arbitrary frequencies, source and receiver levels: see [Chapter 5.12.2.2, "Port Settings dialog"](#), on page 668.

Combiner

Tells the analyzer if and how signals from two ports are combined. For descriptions and visualizations of the supported combiner configurations, see ["Combiner Configuration"](#) on page 383.

Balanced Ports...

Opens a dialog that allows you to enable/disable physical ports and to define logical ports (balanced or unbalanced) in the active channel. See [Chapter 5.2.2.5, "Balanced Ports dialog"](#), on page 352.

Note: If either multiple DUTs are configured (see [Chapter 5.12.2.3, "Define Parallel Measurement dialog"](#), on page 682) or the "Fixture Simulator" is disabled for the related channel (see ["Fixture Simulator"](#) on page 655), the "Balanced Ports..." button is inactive (grayed out).

Multiple DUTs...

Opens a dialog that allows you to set up the analyzer for parallel measurements on multiple DUTs. See [Chapter 5.12.2.3, "Define Parallel Measurement dialog"](#), on page 682.

5.12.2.2 Port Settings dialog

The "Port Settings" dialog is an example of a [Multi-channel setup dialog](#). For the selected channel, it configures the source and receiver ports of the R&S ZNA for arbitrary frequencies, source and receiver levels.

Furthermore, it gives convenient access to the stimulus settings, and allows you to define and configure alternative input and output paths related to R&S ZNAxx-B16 and R&S ZNA-B26.

Access: Channel – [Channel Config] > "Port Config" > "Port Settings..."

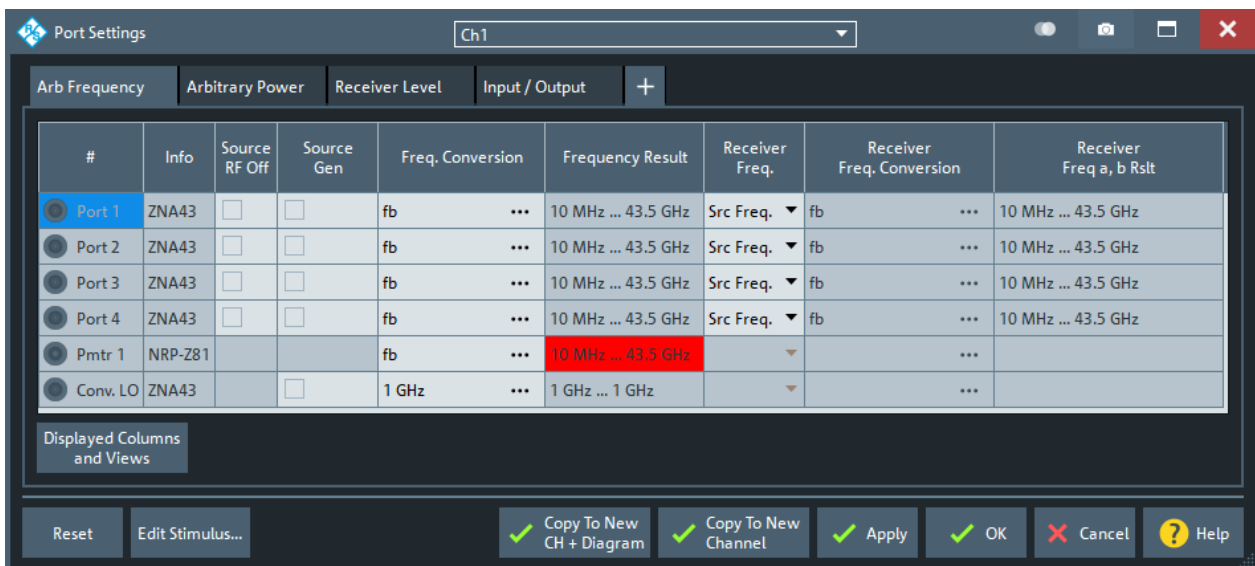



Related information

Refer to the following sections:

- [Chapter 4.7.3, "Frequency conversion measurements"](#), on page 261
- [Chapter 5.19.4.2, "External Power Meters dialog"](#), on page 891
- [Chapter 5.19.5.2, "External Generators dialog"](#), on page 897
- [Chapter 4.7.7, "Millimeter-wave converter support"](#), on page 281



If the channel is set up for a particular measurement in the measurement setup dialog (e.g. the [Scalar Mixer Meas setup dialog](#)), then a change in the "Port Settings" dialog does not change the settings in the setup dialog. The firmware adapts this logic to keep the settings in the setup dialog consistent.

Arb Frequency tab

Defines port-specific frequencies (arbitrary mode) and other port-specific source settings.



Arbitrary mode requires software option R&S ZNA-K4, see [Chapter 4.7.3, "Frequency conversion measurements"](#), on page 261.

If any of the port frequencies are changed from their preset values, the frequency conversion mode is activated on pressing "Apply" or "OK" in the dialog. An "Arb" label appears in the channel line. "Reset" plus "Apply" or "OK" deactivates the arbitrary mode.



Channel base frequency

After a [Reset](#), all port frequencies are set to the channel base frequency f_b . For frequency sweeps, f_b corresponds to the unmodified sweep range. For power, time, and CW mode sweeps, it is equal to the CW frequency. f_b is defined by the "Stimulus" parameters (see [Chapter 5.8, "Stimulus softtool"](#), on page 522).

Arb Frequency

#	Info	Source RF Off	Source Gen	Freq. Conversion	Frequency Result	Receiver Freq.	Receiver Freq. Conversion	Receiver Freq a, b Rslt
Port 1	ZNA43	<input type="checkbox"/>	<input type="checkbox"/>	fb ...	10 MHz ... 43.5 GHz	Src Freq. ▼	fb ...	10 MHz ... 43.5 GHz
Port 2	ZNA43	<input type="checkbox"/>	<input type="checkbox"/>	fb ...	10 MHz ... 43.5 GHz	Src Freq. ▼	fb ...	10 MHz ... 43.5 GHz
Port 3	ZNA43	<input type="checkbox"/>	<input type="checkbox"/>	fb ...	10 MHz ... 43.5 GHz	Src Freq. ▼	fb ...	10 MHz ... 43.5 GHz
Port 4	ZNA43	<input type="checkbox"/>	<input type="checkbox"/>	fb ...	10 MHz ... 43.5 GHz	Src Freq. ▼	fb ...	10 MHz ... 43.5 GHz
Pmtr 1	NRP-Z81			fb ...	10 MHz ... 43.5 GHz	▼	...	
Conv. LO	ZNA43		<input type="checkbox"/>	1 GHz ...	1 GHz ... 1 GHz	▼	...	

Displayed Columns and Views

Figure 5-31: Arb Frequency tab, default columns

Active frequency converter ports are displayed with their RF IN and LO IN components.

#	Info	Source RF Off	Source Gen	Freq. Conversion	Frequency Result	Receiver Freq.	Receiver Freq. Conversion	Receiver Freq a, b Rslt
Conv 1	ZVA-Z110	<input type="checkbox"/>	<input type="checkbox"/>	fb ...	75 GHz ... 110 GHz	Src Freq. ▼	fb ...	75 GHz ... 110 GHz
RF IN	Port 1	<input type="checkbox"/>	<input type="checkbox"/>	$1/6 \cdot f$...	12.5 GHz ... 18.333333 GHz	Src Freq. ▼	fb ...	75 GHz ... 110 GHz
LO IN	Conv. LO	<input type="checkbox"/>	<input checked="" type="checkbox"/>	$1/8 \cdot f - 1/8 \cdot 279 \text{ MHz}$	9.340125 GHz ... 13.715125 GHz	Src Freq. ▼	fb ...	75 GHz ... 110 GHz

Non-editable table cells

In addition to the test ports ("Port" or "Conv"), the source ports include all configured External generators ("Source Gen"), and the LO Out port ("Conv. LO"), if not assigned to a converter.

In addition to the test ports ("Port"), the source ports include all configured external generators ("Source Gen").

The receive ports include all configured external power meters ("Pmtr" ...).

Each port is displayed with its port number, device type ("Info"), and its frequency results according to the current channel base frequency and frequency conversion settings.

Values that cannot be modified are displayed with a gray background; frequency results that cannot be measured are displayed with a red background.

Source RF Off

Turns the RF signal at a source port (analyzer test port or generator port) on or off.

While the RF power is switched off, the port can still be used as a receive port.

Remote command:

`SOURce<Ch>:POWer<PhyPt>:STATe`

`SOURce<Ch>:POWer<PhyPt>:GENERator<Gen>:STATe`

Source Gen

Defines the behavior of the RF signal source at the related port.

- If unchecked (default), it is only switched on for the partial measurements that require the port as a drive port.
- If checked, it is switched on for all partial measurements (permanent signal source).

"Source Gen" has no effect, if [Source RF Off](#) is checked.

Permanent signal sources can eliminate the power settling times of the DUT but can introduce measurement inaccuracies, e.g. due to crosstalk between ports. Therefore, during system error corrections permanent signal sources must be deactivated.

Note:

- Permanent sources can provide the required power, frequency and phase at every point. However, channel- and sweep-related changes can cause disturbances on the generated signal. The **independent generator mode** introduced with FW V2.60 lets you configure internal sources as permanent CW signals that are independent of all channels. See [Chapter 5.19.8.3, "Independent Generator Settings dialog"](#), on page 920.
- Among the analyzer ports driven by the same internal source, only one can operate as generator port.
(See the explanations in [Chapter 4.7.23, "Internal 2nd source and 2nd LO generator for 2-port R&S ZNA"](#), on page 303, and [Chapter 4.7.20, "Internal 3rd and 4th source for 4-port R&S ZNA"](#), on page 302.)

An **external generator** always represents a permanent signal source that is switched on for all partial measurements. "Source Gen" determines whether the generator is available as a signal source in the test setup. The analyzer provides two alternative, independent ways of selecting a generator as a signal source:

- Check "Source Gen" in the "Port Settings" dialog, especially if the generator is not assigned to a particular measurement result or drive port.
- Select the generator as a source for a particular measurement result or for a power calibration, see e.g. [Chapter 5.2.3.2, "More Wave Quantities dialog"](#), on page 359.

Note: If [external switch matrices](#) are used, then, depending on the matrix RF connections, the available matrix paths, and the configured measurements, some test ports cannot be used as permanent ports. The firmware displays an error message if it detects a configuration problem.

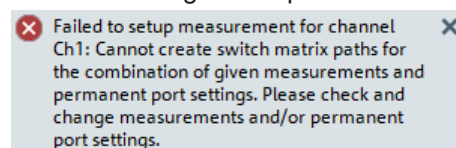

Remote command:

```
SOURce<Ch>:POWer<PhyPt>:PERManent[:STATe]
```

```
SOURce<Ch>:RLO:PERMenable
```

```
SOURce<Ch>:POWer<PhyPt>:GENerator<Gen>:PERManent[:STATe]
```

Freq. Conversion

Opens a dialog to define a port-specific stimulus frequency range (for frequency sweeps) or CW frequency (for power, time and CW mode sweeps); see "[Modify Frequency Conversion dialog](#)" on page 673. In the default configuration, the channel base frequency f_b is used.

This cell is only enabled, if the analyzer is equipped with option R&S ZNA-K4. For frequency converter ports (with option R&S ZNA-K8), the formulas for the RF IN and "LO IN" components are derived from the converter settings and hence are read-only.

The result is displayed in the "Frequency Result" column. A red "Freq. Conversion" cell indicates that certain hardware limits are exceeded.

Remote command:

```
SOURce<Ch>:FREQuency<PhyPt>:CONVersion:ARBitrary:IFREquency
SOURce<Ch>:RLO:FREQuency
```

Receiver Freq.

This cell is only enabled, if the analyzer is equipped with option R&S ZNA-K4. It defines the frequencies to which the receivers are set while this port is the source port.

"Src. Freq." (default)	Both receivers use the source formula (see " Freq. Conversion " on page 672).
"a,b"	Both receivers use the receiver formula (see " Freq. Conversion " on page 672).
"only b"	The a-wave receiver uses the source formula, the b-wave receiver the uses the receiver formula.

Remote command:

```
[SENSe<Ch>:]FREQuency<Pt>:CONVersion:AWReceiver[:STATe]
```

Receiver Freq. Conversion

This cell is only enabled, if [Receiver Freq.](#) is not set to "Src Freq.".

It opens a dialog to define a port-specific receiver frequency range (for frequency sweeps) or CW frequency (for power, time and CW mode sweeps); see "[Modify Frequency Conversion dialog](#)" on page 673. In the default configuration, the source frequency range is used.

For frequency converter ports (with option R&S ZNA-K8), the formulas for the RF IN and "LO IN" components are derived from the converter settings and hence are read-only.

This cell is only enabled, if the analyzer is equipped with option R&S ZNA-K4.

The result is displayed in the "Frequency Result" column. A red "Freq. Conversion" field indicates that certain hardware limits are exceeded.

Remote command:

```
[SENSe<Ch>:]FREQuency<Pt>:CONVersion:ARBitrary
```

Receiver Freq a, b Rslt

Displays the resulting receiver frequencies.

If [Receiver Freq.](#) is set to "Src Freq.", "Receiver Freq a, b Rslt" is identical to "Source Frequency Result.". Otherwise it is calculated according to the [Receiver Freq. Conversion](#) formula and either applies to the reference receiver and the measurement receiver ("a,b"), or to the measurement receiver only ("only b").

Modify Frequency Conversion dialog

The "Modify Frequency Conversion" dialog defines a port-specific frequency formula (for frequency sweeps) or CW frequency (for power, time and CW Mode sweeps).

Different formulas can be specified for source and receiver frequencies.

Access: [Port Settings dialog](#) > "Arb Frequency" tab > "Freq. Conversion" cells



Dependencies

For balanced ports, the constituent physical ports must use the same [Frequency Conversion Formula](#). The analyzer firmware enforces the alignment of formulas.

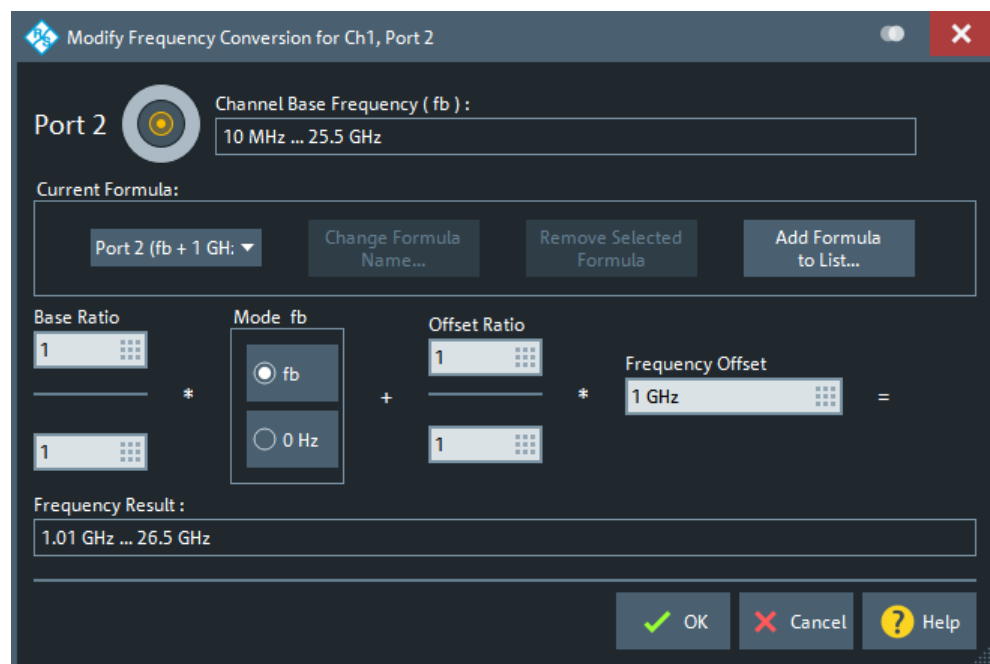

Current Formula

Apart from the current [Frequency Conversion Formula](#), the analyzer firmware maintains a list of named, user-defined formulas.

- "Add Formula to List..." adds the current frequency conversion formula to this list.

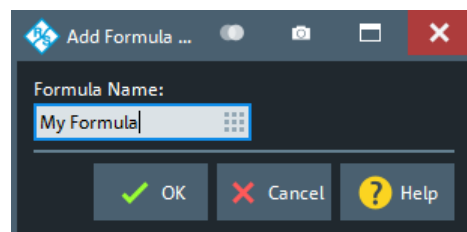

- "Remove Selected Formula" removes the selected user-defined formula from this list.
- "Change Formula Name..." allows you to change the name of the currently selected user-defined formula.

Note:

- User-defined formulas are persisted in the recall set. A preset deletes all user-defined formulas.
- User-defined formulas are updated automatically: if a user defined formula is selected and the "Frequency Conversion Formula" on page 674 is modified, then the formula itself is modified. As a consequence, all "Freq. Conversion" definitions using this formula are modified as well.
- If a user-defined frequency conversion formula is removed from the list, all "Freq. Conversion" definitions using this formula are replaced by the "unlinked" formula.

Frequency Conversion Formula

The conversion formula has been modeled according to the needs of a typical frequency-converting measurement where mixer products, intermodulation products, or harmonics occur.

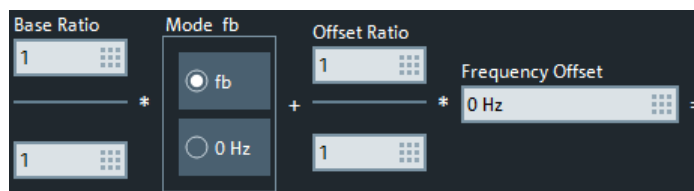

- For mixer measurements, select a "Base Ratio" of 1, a "Frequency Offset" equal to the LO frequency, and an "Offset Ratio" of ± 1 . If the RF signal is at the channel base frequency, the port frequency is at the frequency of the upper (lower) sideband.
- To measure n-th order intermodulation products, select integer "Base Ratio" and "Offset Ratio" with $|\text{"Base Ratio"}| + |\text{"Offset Ratio"}| = n$.
- To measure the n-th harmonic of the channel base frequency, select a "Frequency Offset" of 0 and an integer "Base Ratio" = n.

Remote command:

```
SOURce<Ch>:FREQuency<PhyPt>:CONVersion:ARBitrary:IFRequency
SOURce<Ch>:FREQuency<PhyPt>:CONVersion:ARBitrary:EFRequency<Gen>
[SENSe<Ch>:]FREQuency<Pt>:CONVersion:ARBitrary
[SENSe<Ch>:]FREQuency:CONVersion:ARBitrary:PMETer<Pmtr>
```

Arbitrary Power tab

Configures the source ports of the R&S ZNA for port-specific powers.

**Channel base power**

After a [Reset](#), all source port powers are set to the channel base power P_b . For power sweeps, P_b corresponds to the unmodified sweep range. For frequency, time, and CW mode sweeps, it is equal to the fixed "Power". f_b is defined by the "Stimulus" parameters (see [Chapter 5.8, "Stimulus softtool"](#), on page 522).

Arbitrary Power

#	Info	Channel Base Power	Port Power Offset	Cal Power Offset	M. Source Att.	El. Source Att.	ALC	ALC Params	Avail. Power Range	Power Result	Slope
Port 1	ZNA43	Pb(-10 dBm)	0 dB	0 dB	0 dB	Auto	<input checked="" type="checkbox"/>	±5 dB, s 0 dB ...	-80 dBm ... 20 dBm	-10 dBm	0 dB/GHz
Port 2	ZNA43	Pb(-10 dBm)	0 dB	0 dB	0 dB	Auto	<input checked="" type="checkbox"/>	±5 dB, s 0 dB ...	-80 dBm ... 20 dBm	-10 dBm	0 dB/GHz
Port 3	ZNA43	Pb(-10 dBm)	0 dB	0 dB	0 dB	Auto	<input checked="" type="checkbox"/>	±5 dB, s 0 dB ...	-80 dBm ... 20 dBm	-10 dBm	0 dB/GHz
Port 4	ZNA43	Pb(-10 dBm)	0 dB	0 dB	0 dB	Auto	<input checked="" type="checkbox"/>	±5 dB, s 0 dB ...	-80 dBm ... 20 dBm	-10 dBm	0 dB/GHz
Conv. LO	ZNA43	0 dBm	0 dB	0 dB				...		0 dBm	0 dB/GHz

Displayed Columns and Views

Active frequency converter ports are displayed with their RF IN and LO IN components.

#	Info	Channel Base Power	Port Power Offset	Cal Power Offset	M. Source Att.	El. Source Att.	ALC	ALC Params	Avail. Power Range	Power Result	Slope
Conv 1	ZVA-Z110	Pb(0 dBm)	0 dB	0 dB				...		0 dBm	0 dB/GHz
RF IN	Port 1	0 dBm	8 dB	-1 dB	0 dB	Auto		...	-80 dBm ... 20 dBm	7 dBm	0 dB/GHz
LO IN	Conv. LO	0 dBm	8 dB	-1 dB	0 dB	Auto		...	-80 dBm ... 20 dBm	7 dBm	0 dB/GHz

Non-editable table columns

In addition to the test ports ("Port"), the source ports include all configured external generators ("Source Gen"). Each port is displayed with its port number and device type ("Info").

For each port, the available power range and resulting port power are calculated from the configured power conversion and source attenuation settings.

Channel Base Power

Allows you to select between the channel base power P_b and a fixed value of 0 dBm.

If frequency converters are configured, the "Channel Base Power" at the RF IN port can also show "varies", which either indicates that [leveling data](#) are used or that a source flatness calibration at the converter port is active. In the former case, the combo-box is disabled. In the latter case, you can alternatively select P_b or 0 dBm, which deactivates the source flatness cal, or select "varies" to reactivate it.

Remote command:

```
SOURce<Ch>:POWer<PhyPt>[:LEVel] [:IMMediate]:OFFSet
SOURce<Ch>:RLO:PABSolut
```

Port Power Offset

Defines a port-specific offset to the [Channel Base Power](#). The actual output power at the port is equal to the "Channel Base Power" plus the "Port Power Offset".

If P_b is selected as "Channel Base Power", then for a power sweep the actual port power varies across the sweep. Otherwise the port power is constant.

Remote command:

```
SOURce<Ch>:POWer<PhyPt>[:LEVel] [:IMMediate]:OFFSet
SOURce<Ch>:RLO:POFFset
```

```
SOURce<Ch>:POWer<PhyPt>:GENerator<Gen>:OFFSet
SOURce<Ch>:POWer<PhyPt>:CONVerter:OFFSet
```

Cal Power Offset

See ["Cal Power Offset"](#) on page 593.

M. Source Att.

See ["Source Step Att."](#) on page 526.

If an [external switch matrix](#) is used, the attenuation settings of the matrix test ports that can be connected to the same VNA port are coupled:

- "M. Source Att." can only be applied, if all these ports are equipped with source step attenuators.
- The firmware enforces identical attenuation settings for those ports.

For matrix connectivity, see [Chapter 4.7.41.3, "RF connections and matrix connectivity"](#), on page 325.

EI. Source Att.

The R&S ZNA comes with an electronic step attenuator in the source path of each port. You can either select one of the possible attenuation factors (0 dB, 20 dB, 40 dB) or select "Auto" to let the firmware decide (default).

If an [external switch matrix](#) is used, the attenuation settings of the matrix test ports that can be connected to the same VNA port are coupled. The firmware enforces identical attenuation settings for those ports.

For matrix connectivity, see [Chapter 4.7.41.3, "RF connections and matrix connectivity"](#), on page 325.

Remote command:

```
SOURce<Ch>:POWer<Pt>:EATTenuation:MODE
SOURce<Ch>:POWer<Pt>:EATTenuation
```

ALC

Enables/disables automatic level control (ALC) for the current channel.

Same functionality as "ALC ON" on the [Power tab](#) or in the [ALC Config dialog](#).

Remote command:

```
SOURce<Ch>:POWer:ALC:CState
```

ALC Params

Displays the current ALC parameters. Click on the table cell to open the [ALC Config dialog](#) that allows you to (enable and) configure automatic level control (ALC) for the current channel.

Slope

Defines a linear factor to modify the port-specific source power as a function of the stimulus frequency. The resulting output power at port frequency f is calculated as $\langle \text{Power Result} \rangle + \langle \text{Slope} \rangle * f$.

Remote command:

```
SOURce<Ch>:POWer<PhyPt>[:LEVel] [:IMMediate]:SLOPe
[SENSe:]CONVerter<Port>:RFSLOpe
```

Receiver Level tab

Provides access to the receiver step attenuator settings.



Receiver step attenuators are optional hardware (see [Chapter 4.7.31, "Receiver step attenuators"](#), on page 309).

Receiver Level			
#	Info	Attenuation	Wb/Nb IF Gain
Port 1 Meas(b1)	ZNA43	10 dB	0 dB
Port 2 Meas(b2)	ZNA43	10 dB	0 dB
Port 3 Meas(b3)	ZNA43	10 dB	0 dB
Port 4 Meas(b4)	ZNA43	10 dB	0 dB

Attenuation

Sets the attenuation at the respective measurement receiver (b-wave). See ["Receiver Step Att."](#) on page 527.

Remote command:

```
[SENSe<Ch>:]POWER:ATTenuation
```

Wb/Nb IF Gain

Controls the gain of the wideband and narrowband signal paths.

Same functionality as "IF Gain Mode" on the [Mode tab](#).

Remote command:

```
[SENSe<Ch>:]POWER:GAINcontrol:GLOBal
```

Input/Output tab

This tab gives access the settings for the optional [Direct generator/receiver access](#) and [Chapter 4.7.30, "Direct IF access"](#), on page 308.

Input / Output							
#	Info	Receiver Input	Rear Out	Auto determine IF Out	Rear Input Path	Rear IF Frequency	Frequency Result
Port 1	ZNA43	Port	<input type="checkbox"/>			...	
Port 2	ZNA43	Port	<input type="checkbox"/>			...	
Port 3	ZNA43	Port	<input type="checkbox"/>			...	
Port 4	ZNA43	Port	<input type="checkbox"/>			...	

If a port is configured as converter port, all its "Input / Output" settings are derived from the settings in the [Converter Configuration dialog](#). Hence the corresponding table row is read-only.

#	Info	Receiver Input	Rear Out	Auto determine IF Out	Rear Input Path	Rear IF Frequency	IF Freq. (Converter)	Frequency Result
Conv 1	ZVA-Z110	Rear IN			BP_279M	...	279 MHz	



Background information

Refer to [Chapter 4.7.27, "Direct generator/receiver access"](#), on page 306 and [Chapter 4.7.30, "Direct IF access"](#), on page 308.

Receiver Input

Determines how the MEAS and REF signals are routed to the respective receivers.

Depending on the selected path, the hardware and factory correction values are set. If "Port" is used, also the factory calibration is applied. This setting ensures reasonably corrected data with the different cabling options.

"Port"	Via the standard port and with standard jumpering of the Direct generator/receiver access connectors.
"Direct Access"	Via the direct generator/receiver access connectors (see Chapter 4.7.27, "Direct generator/receiver access" , on page 306).
"Reverse Coupler"	Via the standard port but with reversed coupler configuration (see "Reverse Coupler Configuration" on page 307).
"Source Monitor"	Via the direct source monitor access connector (see Chapter 4.7.34, "Direct source monitor access" , on page 310). Can only be selected for analyzer ports 1 and 3, and only if the optional source monitor access is available for this port.
"Rear IN"	Via the direct IF access connectors (see Chapter 4.7.30, "Direct IF access" , on page 308).

For "Direct Access", "Reverse Coupler", and "Source Monitor" access, the LED above the direct generator/receiver access connectors is switched on

For analyzer ports that are used as converter ports, the "Receiver Input" is configured in the [Converter Configuration dialog](#).

Remote command:

```
[SENSe<Ch>:] PATH<Pt>:DIRectaccess
SOURce<Ch>:PATH<Pt>:DIRectaccess
[SENSe<Ch>:] PATH<Pt>:MEASurement:DIRectaccess?
[SENSe<Ch>:] PATH<Pt>:REFerence:DIRectaccess?
[SENSe<Ch>:] PATH<Pt>:MEASurement:IFSWitch?
```

Rear Out

If checked, the [Direct IF access](#) connectors on the rear panel are used as (additional) output.

Remote command:

```
[SENSe<Ch>:] PATH<Pt>:IFSWitch
[SENSe<Ch>:] PATH<Pt>:MEASurement:IFSWitch?
[SENSe<Ch>:] PATH<Pt>:REFerence:IFSWitch?
```

Auto Determine IF Out

This checkbox is only enabled, if [Rear Out](#) is used.

If unchecked (default), you can define the [Rear IF Frequency](#) manually. However, this frequency is also used internally and is possibly not optimal for the Direct IF Access Input / Output ports. If you activate "Auto Determine IF Out", the analyzer firmware selects suitable rear IF frequencies.

Remote command:

```
[SENSe<Ch>:] PATH<Pt>:IFOutauto
[SENSe<Ch>:] PATH<Pt>:MEASurement:IFOutauto?
[SENSe<Ch>:] PATH<Pt>:REFerence:IFOutauto?
```

Rear Input Path

This selection is only enabled if "Rear IN" is used as [Receiver Input](#). Internally three different paths are available for the IF signal.

- "Direct" – frequency range 5kHz to 1 GHz
- "LP_60M" – low pass, frequency range 5 kHz to 60 MHz
- "BP_279M" – band pass, frequency range 260 MHz to 290 MHz

The limitation of the Frequency to the smaller frequency ranges increases the system performance. Standard case could be a fixed frequency input, as it is for the mm-converter IF frequency.

Remote command:

```
[SENSe<Ch>:] PATH<Pt>:IFINpath
[SENSe<Ch>:] PATH<Pt>:MEASurement:IFINpath?
[SENSe<Ch>:] PATH<Pt>:REFerence:IFINpath?
```

Rear IF Frequency

Sets the frequency at the related [Direct IF access](#) ports as a linear transformation of the channel base frequency f_b .

This setting is available in one of the following cases:

- "Rear IN" is used as [Receiver Input](#)
- [Rear Out](#) is used and [Auto Determine IF Out](#) is disabled.

Remote command:

```
[SENSe<Ch>:] PATH<Pt>:IFRequency
[SENSe<Ch>:] PATH<Pt>:MEASurement:IFRequency?
[SENSe<Ch>:] PATH<Pt>:REFerence:IFRequency?
```

Frequency Result

Shows the frequency resulting from the from [Rear IF Frequency](#) configuration.

Common controls

+/x

Use the "+" button next to the rightmost tab title, to add a custom tab. In the [Displayed Columns dialog](#) that opens, give the new tab a name ("Tab Title") and select the port parameters to display in the tab's configuration table.

Custom tabs can be deleted using the "x" icon in the tab title.

Displayed Columns

Opens the [Displayed Columns dialog](#) that allows you to configure the columns to be displayed in the current tab.

Reset

Resets the "Freq. Conversion" and "Power Conversion" settings of all ports. After "Reset", an "Apply" or "OK" terminates the arbitrary mode.

Remote command:

```
[SENSe<Ch>:]FREQuency:CONVersion FUNDamental
```

Edit Stimulus

For non-segmented sweeps, the "Edit Stimulus..." button opens the [Stimulus dialog](#) that allows you to access the stimulus settings without having to leave the "Port Settings" dialog.

Apply / OK / Cancel

Modified "Port Settings" take effect on "Apply" or "OK". Use "Cancel" to discard possible changes.

If R&S ZNA-K4 is available, then, depending on the current port configuration, "Apply" and "OK" also deactivate the (arbitrary) frequency conversion mode.

- If individual port frequencies are selected, the arbitrary mode is activated.
- If individual port powers but no individual frequencies are selected, the current mode is maintained.
- If all port frequencies are equal to the channel base frequency, and all port powers are equal to the channel base power (e.g. after [Reset](#), the arbitrary mode is deactivated).

Remote command:

```
[SENSe<Ch>:]FREQuency:CONVersion ARBbitrary | FUNDamental
```

Displayed Columns dialog

To reduce complexity and to focus on particular settings, you can limit the columns to be displayed in the configuration tables. This possibility is particularly suitable for custom tabs, which allow you to display an arbitrary subset of the available port settings.

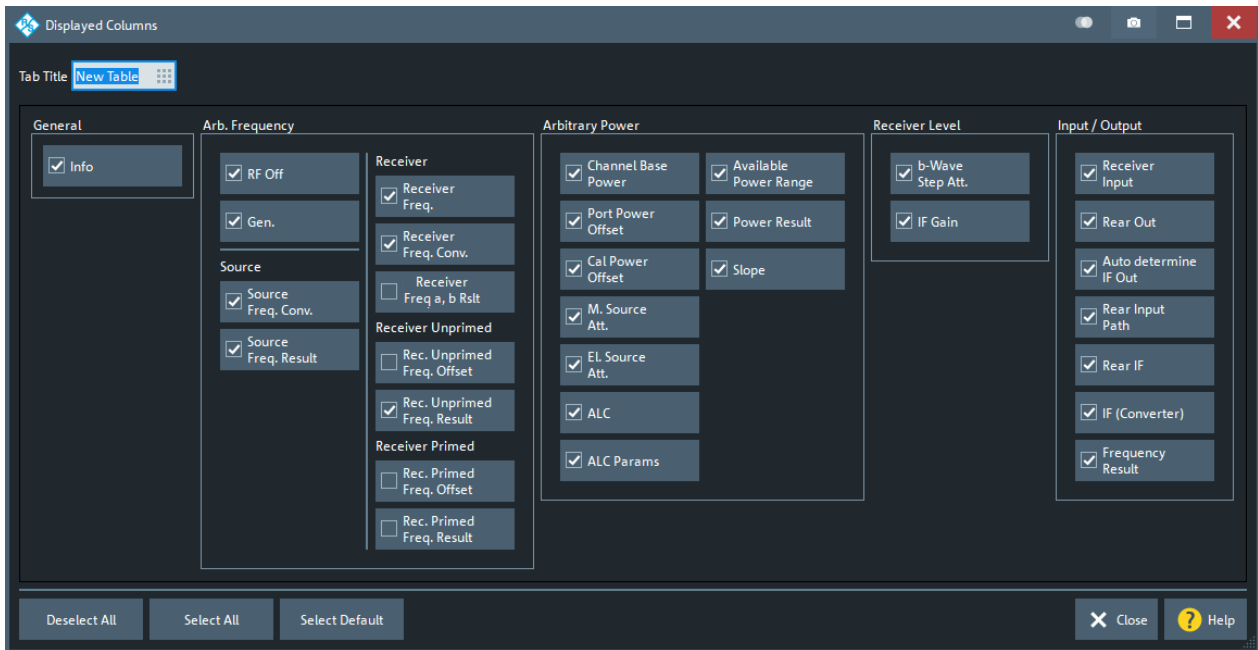

Figure 5-32: Displayed Columns dialog (custom tab)

For the predefined tabs, only the "General" and the tab's related parameter group ("Arbitrary Frequency", "Arbitrary Power", "Receiver Level", or "Input / Output") are available for selection.

Stimulus dialog

The "Stimulus" dialog gives access to the parameters of a non-segmented sweep.

Access: [Port Settings dialog](#) > "Edit Stimulus..."

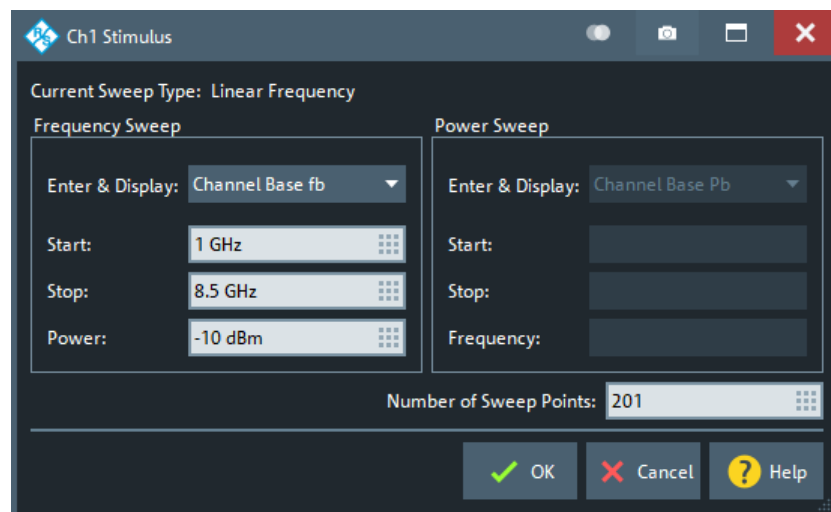

Figure 5-33: Stimulus Dialog: Linear Frequency Sweep

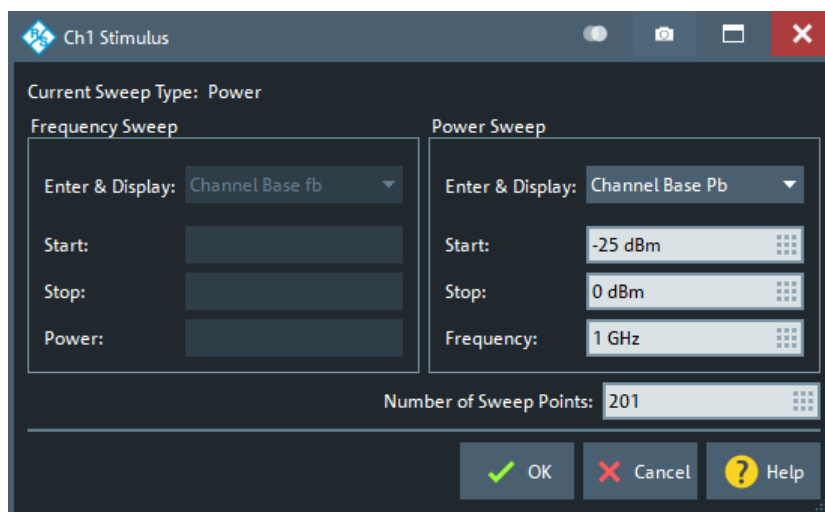

Figure 5-34: Stimulus Dialog: Power Sweep

Except for the "Enter & Display" properties, all these parameters can also be set in the [Sweep Softtool](#). Depending on the channel's [Sweep Type](#), a different set of parameters can be modified.

Table 5-6: Parameters for frequency sweeps

	Lin/Log Freq Sweep	CW Mode Sweep	Time Sweep
Enter & Display	x	x	x
Start	x	–	–
Stop	x	–	–
Power	x	x	x
Number of Sweep Points	x	x	x

Enter & Display

The "Enter & Display" combo boxes in the "Frequency Sweep" and "Power Sweep" sections of the "Stimulus" dialog control how frequency and power values are entered and displayed in this dialog.

You can either take the channel perspective (f_b , P_b), or the perspective of a particular source or receiver. The two can be used interchangeably to define the sweep, if the user-defined linear transformation relating them is not constant.

Note: For frequency sweeps, source/receiver-specific linear frequency transformation are enabled with option R&S ZNA-K4 (see [Chapter 4.7.3, "Frequency conversion measurements"](#), on page 261).

5.12.2.3 Define Parallel Measurement dialog

With a 4-port R&S ZNA or a 2-port R&S ZNA with [2nd internal source](#), you can measure multiple DUTs (or multiple paths of a single DUT) in parallel. The "Define Parallel Measurement" dialog allows you to configure these DUTs and to declare the connec-

tions between physical VNA ports and DUT ports. Furthermore it provides convenient access to port-related settings.



New in firmware version 2.30

On a R&S ZNA with [four internal sources](#), four 1-port DUTs can be measured in parallel.



Related information

See [Chapter 4.1.4.2, "Parallel measurements on multiple DUTs"](#), on page 112.

The "Parallel Measurement" is automatically configured when "Enabled" is selected, as shown in [Figure 5-35](#).

A R&S ZNA with two internal sources allows parallel measurements with "Frequency Offset", which can be configured in the corresponding tab on the right.

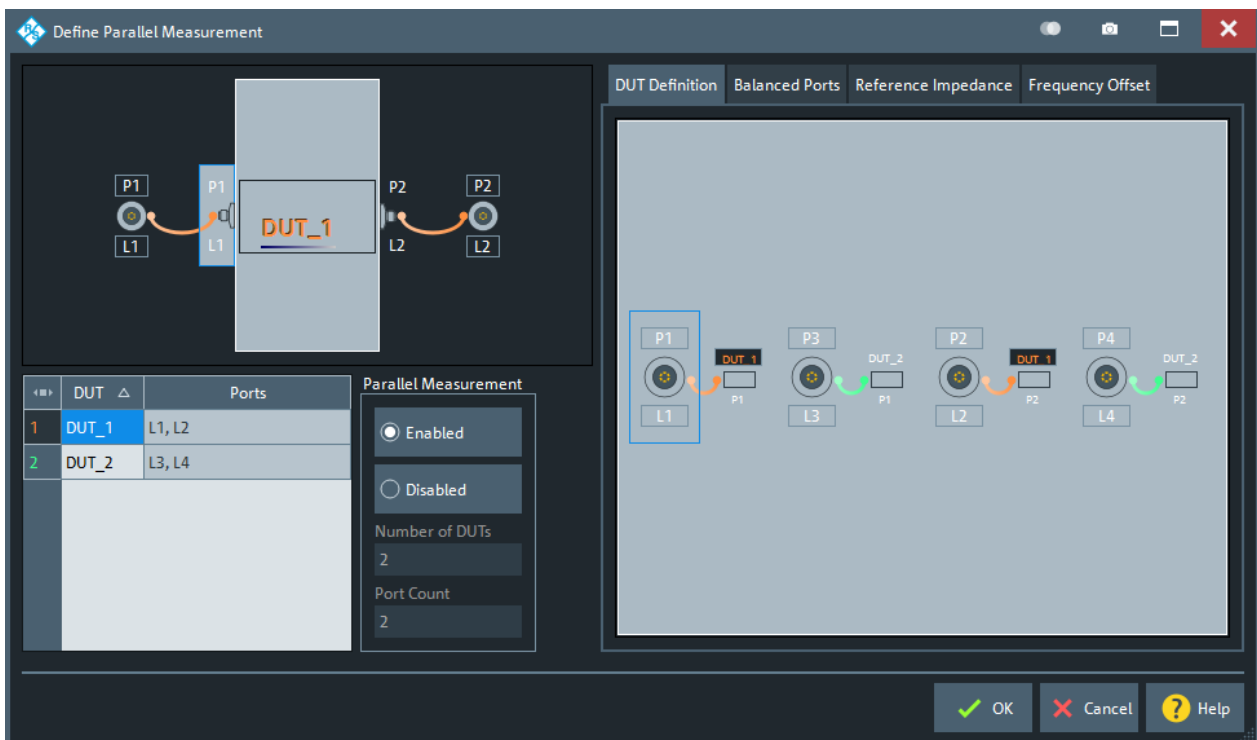

Figure 5-35: Define Parallel Measurement



- Modified settings are not applied unless the "Define Parallel Measurement" dialog is closed with the "OK" button.
- On "OK", any pre-existing logical port configuration is overwritten.
- Each configured DUT can have its own ground loop embedding and deembedding network

DUT Definition tab

Modify an existing DUT

The DUT table allows you to rename an existing DUT.

1. Locate the related row in the DUT table.
2. In the "DUT" column, specify the DUT's name.

Controls and Functions

The GUI functions are self-explanatory; their use is sufficiently explained in the above procedures.

The remote control implementation of the "Multiple DUTs" feature introduces an additional "port group" layer. A DUT's port group consists of the logical VNA ports that are connected to this DUT.

Remote command:

`SOURce<Ch>:GROup:COUNT?`

`SOURce<Ch>:GROup<Grp>:NAME`

Balanced Ports tab

The "Balanced Ports" tab of the "Define Parallel Measurement" dialog allows you to define the balanced ports of the configured DUTs.

In order to modify the balanced port configuration, proceed as follows:

1. Select the related row in the DUT table.
The DUT perspective (upper left part of the dialog) now displays the selected DUT.
2. Activate the "Balanced Ports" tab.
3. To create a balanced port:
 - a) In the DUT perspective, toggle select two DUT ports.
 - b) In the "Balanced Ports" tab, select "Balanced" to create the balanced port from the selected DUT ports.
4. To dissolve one or more balanced ports:
 - a) In the DUT perspective, for each balanced port you want to dissolve, toggle-select one of its constituent DUT ports.
 - b) In the "Balanced Ports" tab, select "Single" to dissolve all related balanced ports.

Reference Impedance tab

The "Reference Impedance" tab of the "Define Parallel Measurement" dialog allows you to set the reference impedance for balanced and unbalanced DUT ports.

To change the reference impedance for a particular DUT port, proceed as follows:

1. Select the related row in the DUT table (lower left part of the dialog).

- The DUT perspective (upper left part of the dialog) now displays the selected DUT.
2. Activate the "Reference Impedance" tab.
 3. In the DUT perspective, toggle select (one of) the related DUT ports.
 4. Use the controls in the Reference Impedance tab to specify the impedance settings. The user interface is identical to the one described in ["Reference Impedance tab"](#) on page 355.

Frequency Offset tab

The "Frequency Offset" tab allows you to activate [Parallel measurements on multiple DUTs](#) and to define a "Minimum Offset" between the stimuli.

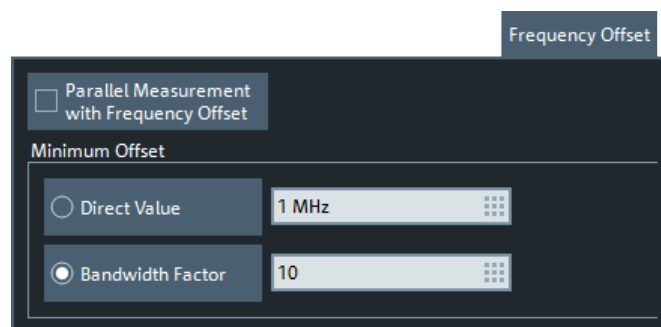

To get access to the "Frequency Offset" configuration, set "Parallel Measurement" to "Enabled") and activate the "Frequency Offset" tab.



It is essential to perform the calibration with the same "Frequency Offset" settings as for the actual measurement; otherwise the calibration is deactivated ("Cal Off"). If there is a mismatch, the [Calibration Manager dialog](#) provides additional information.

201 Points in Linear Grid, 10 kHz meas BW
 Frequency Shifted Parallel Measurement **not active**. (Correction Deactivated; Active Setup Differs in Highlighted Settings)
 Frequency Sweep Mode 'Stepped' used

Parallel Measurement with Frequency Offset

Enables/disables a frequency offset in parallel measurements.

For segmented sweeps, the parallel measurements are performed segment per segment. If the [Minimum Offset](#) is specified as a "Bandwidth Factor" and the segments use different measurement bandwidths, then the resulting frequency offsets are also different.

Remote command:

```
SOURce<Ch>:GROup<Grp>:SIMultaneous:FOFFset:STATe
```

Minimum Offset

The "Minimum Offset" can be specified either as an absolute value ("Direct Value") or as a multiple of the measurement bandwidth ("Bandwidth Factor").

Remote command:

```
SOURce<Ch>:GROup<Grp>:SIMultaneous:FOFFset:MOFFset:MODE
SOURce<Ch>:GROup<Grp>:SIMultaneous:FOFFset:MOFFset:DVALue
SOURce<Ch>:GROup<Grp>:SIMultaneous:FOFFset:MOFFset:BWFactor
```

State indication warning

When attempting to activate the "Parallel Measurement with Frequency Offset" (i.e. on closing the "Define Parallel Measurement" dialog with the "OK" button), the VNA Firmware checks whether the requested settings are technically feasible. If not, the firmware disables parallel measurement (i.e. the measurements are performed one after the other) and generates a warning message indicating the current configuration problem.

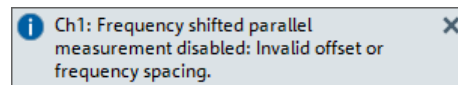

In particular, activation is rejected if:

- the start frequency is < 31 MHz
- the measurement bandwidth is > 100 kHz
- the resulting frequency offset (i.e. the minimum frequency offset, rounded to a multiple of the current frequency step size) would be too high
- the port groups are configured with different frequency conversion settings

The generated error code can be retrieved via remote control command

```
SOURce<Ch>:GROup:SIMultaneous:FOFFset:CONDition?. The configuration problems listed above are indicated as error codes -8 "invalid offset or frequency spacing" and -6 "no simultaneous mode possible".
```

Remote command:

```
SOURce<Ch>:GROup<Grp>:SIMultaneous:FOFFset:CONDition
```

5.12.3 Pwr Cal Settings tab

Replicates the "Pwr Cal Settings" tab of the "Cal" softtool (see [Chapter 5.11.3, "Pwr Cal Settings tab"](#), on page 626).

5.13 Mode softtool

The mode softtool allows you to prepare the channel for different "non-standard" measurement modes.

Access: Channel – [Mode]

5.13.1 Mode tab

Optimizes the measurement process.

5.13.1.1 Controls on the Mode tab



Driving Mode

Determines the order of partial measurements and sweeps.

- In "Auto" mode, the analyzer optimizes the display update: Fast sweeps are performed in "Alternated" mode, slower sweeps in "Chopped" mode.
- In "Alternated" mode, a partial measurement is performed at all sweep points (partial sweep) before the hardware settings are changed. The next partial measurement is carried out in an additional sweep. This mode is usually faster than "Chopped" mode.
- In "Chopped" mode, the analyzer completes the necessary sequence of partial measurements at each sweep point and obtains the result (measurement point) before proceeding to the next sweep point. A trace is obtained from the beginning of the sweep.

The "Driving Mode" setting is also used during a system error correction. For channels which require a single partial measurement only, the driving mode settings are equivalent. See also [Chapter 4.1.4.1, "Partial measurements and driving mode"](#), on page 111.

Remote command:

```
[SENSe<Ch>:]COUPlE
```

Image Suppr.

The "Image Suppr." settings define whether the analyzer measures with a local oscillator frequency LO below or above the RF input frequency. This feature can be used to

eliminate known spurious components in the input signal that can distort the measurement, especially in the low frequency range.

- In "Auto" mode, the analyzer auto-selects the LO frequency, depending on the receiver (RF) frequency and the test port. This mode systematically avoids known spurious signals if no frequency conversion occurs in the test setup. For [Intermodulation measurements](#), the selected LO frequency is trace-specific. Depending on the measured quantity, either "LO < RF" or "LO > RF" is selected.
- "LO < RF" means that the LO frequency is always below the measured RF frequency. This mode is appropriate for avoiding single, known spurious signals.
- "LO > RF" means that the LO frequency is always above the measured RF frequency. This mode is appropriate for avoiding single, known spurious signals.

Tip: In the presence of several spurious signals, setting the "Image Suppr." parameter globally can be insufficient. To improve the result, perform a segmented frequency sweep and assign independent LO frequencies to the individual sweep segments.

Application example

Consider the following test setup with a strongly reflecting DUT (e.g. a bandpass in its stop band) that is measured in transmission. The incident wave a_1 is generated at a frequency RF. The reflected wave b_1 falls into the receiver mixer of the analyzer port 1; a small fraction of the mixer product $RF + 2*IF$ can be reflected back towards the DUT. If this spurious wave a'_1 passes the DUT, then it is received as b'_2 at port 2, together with the wanted signal b_2 .

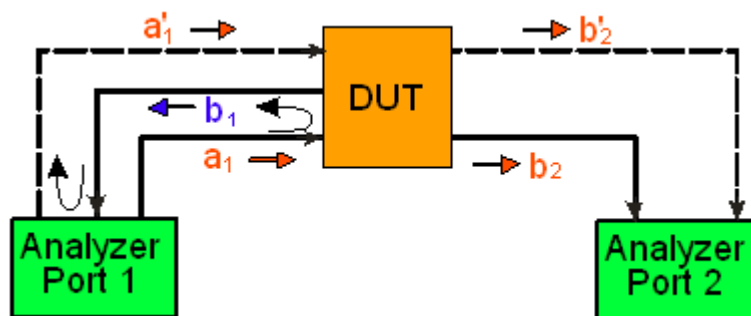

LO > RF implies that LO = RF + IF. The mixer at port 2 converts both the wanted signal b_2 and the spurious signal b'_2 which is at the frequency $RF' = IF + LO$, to the same IF frequency. The response of an ideal, infinitely steep bandpass filter with a pass band between B^- and B^+ looks as follows:

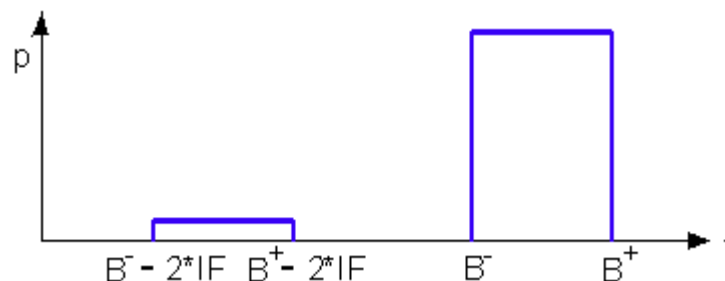

For a wide bandpass, the spurious response flattens the filter edges.

The spurious signal can be eliminated by dividing the sweep range into two segments with different LO settings:

- In the low-frequency segment ranging up to the center frequency of the bandpass filter, the frequency of the local oscillator is set to $LO < RF$. This setting ensures that the spurious signal b'_2 is not measured at port 2.
- In the high-frequency segment, starting at the center frequency of the bandpass filter, the frequency of the local oscillator is set to $LO > RF$. If the center frequency is larger than $B^+ - 2*IF$, then there is no distortion from b'_2 .

Remote command:

```
[SENSe<Ch>:] FREQuency: SBANd
```

IF Gain Mode

Controls the gain of the wideband and narrowband signal path.

The "IF Gain Mode" can only be configured if [IF Filter \(analog\)](#) is set to "Wideband" or "Narrowband" or if [Direct IF access](#) is used as [Receiver Input](#) ("Rear IN").

"Manual" mode allows you to select the preferred "IF Gain Mode" per sweep segment, drive port and receiver (see ["Drive-port specific settings"](#) on page 691).

Remote command:

```
[SENSe<Ch>:] POWer: GAINcontrol: GLOBal
```

Manual Config...

The "Manual Config..." button opens the [Wideband IF Gain Manual Configuration dialog](#) that allows to configure the GC for the individual sweep segments, drive ports and receivers. This button is enabled in "Manual" [IF Gain Mode](#) only.

Segmented IF Gain

"Segmented IF Gain" enables segment-specific gain control settings. It is available for "Segmented" sweep type only.

Remote command:

```
[SENSe<Ch>:] SEGMENT<Seg>: POWer: GAINcontrol: CONTrol
```

Phase Mode

De/Activates coherence mode in combination with low phase noise mode.

With "Coherence Off", measurement times are shorter than with "Coherence ON". If coherence is required, the setup dialog switches it on automatically.

Note: With FW V1.80, the default "Phase Mode" was changed from "Coherence On" to "Coherence Off".

Remote command:

```
[SENSe<Ch>:] PHASe: MODE
```

LO Usage

This control is only available, if the analyzer is equipped with a second LO. It specifies whether only the first (default) or both LOs are used.

By default it is set to "Use only 1 LO". For frequency-converting DUTs, it is automatically set to "Use both LOs".

Remote command:

[SENSe<Ch>:] SLAMode

Use Primed Waves

If a (two-tone) [Embedded LO mixer group delay measurements](#) is active, in addition to a and b the analyzer can provide "primed" wave quantities a', b'. The unprimed wave quantities correspond to the lower tone, the primed wave quantities correspond to the upper tone.

Remote command:

[SENSe<Ch>:] FREQuency:OFFSet:PWAVes:STATe

Track LO

If a frequency-converting measurement is active, the analyzer can track the difference between the expected and the actual LO frequency.

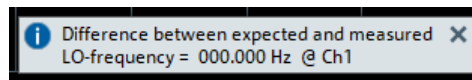

Note: The "Track LO" functionality is now implemented within the original channel. Before V1.80 of the analyzer firmware, each time "Track LO" was switched on, a new (independent) channel was created. In particular, it was up to the user to ensure the correct position in the channel sequence and the consistency of the values with the "parent" channel.

Remote command:

SOURce<Ch>: LOTRack[:STATe]

SOURce<Ch>: LOTRack:DFRequency?

5.13.1.2 Wideband IF Gain Manual Configuration dialog

The "Wideband IF Gain Manual Configuration" dialog allows you to configure the wideband / narrowband IF gain settings for individual sweep segments, drive ports and receivers. This button is enabled in "Manual" [IF Gain Mode](#) only.

Access: Channel – [Mode] > "Mode" > "IF Gain Mode" – "Manual Config..."

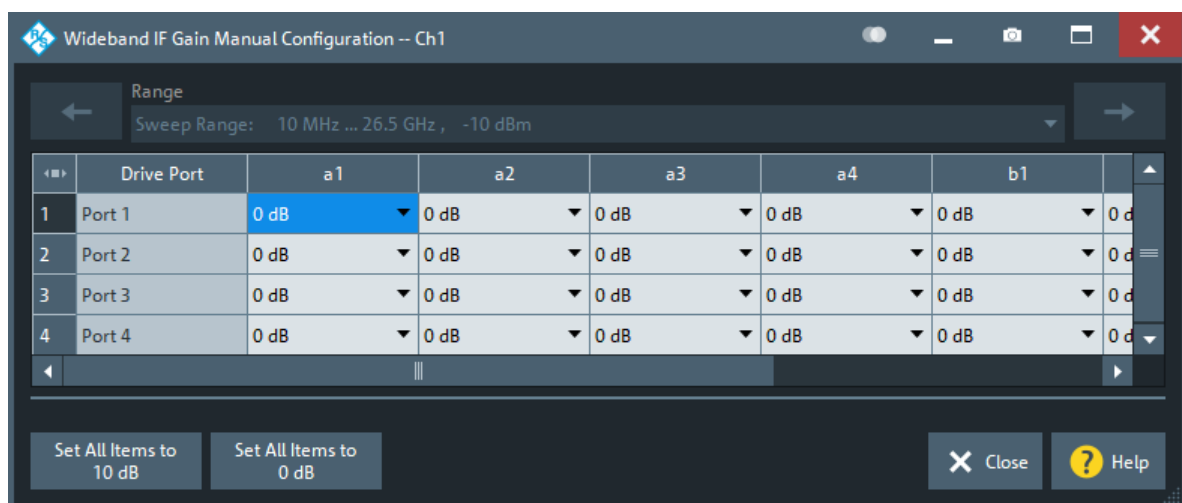

Range

If [Segmented IF Gain](#) is enabled, each sweep segment can be configured separately.

Remote command:

```
[SENSe<Ch>:] SEGment<Seg>:POWer:GAINcontrol
```

```
[SENSe<Ch>:] SEGment<Seg>:POWer:GAINcontrol:ALL
```

Drive-port specific settings

"Drive Port", "a<i>", "b<j>": Selects the wideband / narrowband IF gain mode for the respective drive port, a and b wave and receivers.

Remote command:

```
[SENSe<Ch>:] POWer:GAINcontrol
```

Set All Items to ...

Convenience functions to apply the same manual wideband / narrowband IF gain mode to all a and b wave receivers.

If [Segmented IF Gain](#) is enabled, the setting only applies to the selected segment.

Remote command:

```
[SENSe<Ch>:] POWer:GAINcontrol:ALL
```

5.13.2 Pulse Mod tab

Gives access to the pulse generation, pulse modulation, and pulse profile measurement functionality of the R&S ZNA.

As outlined in the table below, the related functionality is enabled by several hardware and software options.

Table 5-7: Related Options

Option	Functionality			
	Pulse Generator	Pulse Modulator Control	Pulse Modulator	Pulse Profile Measurement
Trigger board (R&S ZNA-B91)	all ports	via Trig Out and PuMo In/Out	–	–
Internal pulse modulators (R&S ZNAxx-B41 B42 B43 B44)	all ports	–	Option R&S ZNAxx-B4y enables the internal pulse modulator of port y	–
Pulsed measurements (R&S ZNA-K7)	Advanced pulse generation (individual pulse widths/delays per port, pulse trains)	–	–	✓

The "Pulse Profile" measurement mode is enabled by selecting the corresponding sweep type (see [Chapter 5.10.3, "Sweep Type tab"](#), on page 546).

5.13.2.1 Controls on the Pulse Mod tab

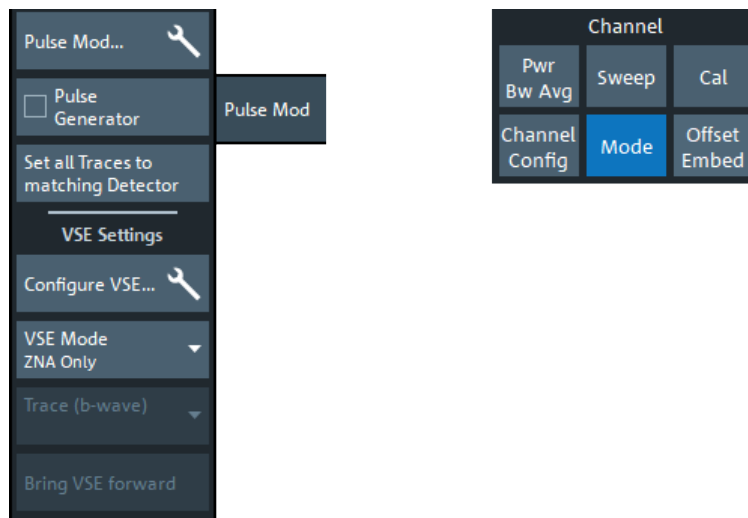

"Pulse Mod..." opens the [Pulse Modulation dialog](#).

Pulse Generator

Enables or disables pulse generation.

Remote command:

```
[SENSe<Ch>:] PULSe [: STATe]
```

Set all Traces to Matching Detector

Tells the firmware to select a suitable detector for all traces in the current channel. For background information, see [Chapter 4.3.5.3, "Detector settings"](#), on page 160.

VSE Settings

The controls in the "VSE Settings" part of the "Pulse Mod" tab allow you to set up, configure and run [Chapter 4.7.6.1, "Live pulse analysis with R&S VSE"](#), on page 280.

Configure VSE ← VSE Settings

Opens the [VSE Connection Configuration dialog](#) that allows you to establish a connection to a local or remote R&S VSE instance.

VSE Mode ← VSE Settings

Determines where the acquired measurement data are processed.

"ZNA Only" (default) The selected [b-wave trace](#) is calculated in the R&S ZNA; no data are pushed to the configured R&S VSE instance.

"VSE Only" The R&S ZNA does not calculate the selected trace. Instead, it prepares I/Q data for the measured b-wave and pushes them to the R&S VSE for further analysis.

"ZNA and VSE"

Trace data are processed in the R&S ZNA and I/Q data are pushed to the R&S VSE.

Note: In the "ZNA and VSE" mode, the R&S ZNA acquires the measurement data for the trace calculation and the I/Q data to be pushed to the R&S VSE in **separate, subsequent sweeps**. Make sure that your DUT can handle the (potentially) doubled pulse sequence without being damaged or changing its characteristics.

Remote command:

`CONTrol:VSE:MODE`

Trace (b-wave) ← VSE Settings

Selects the b-wave trace to be pushed to the configured R&S VSE instance, if the selected [VSE Mode](#) is different from "ZNA Only".

Remote command:

`CONTrol:VSE:TRACe`

5.13.2.2 Pulse Modulation dialog

Sets up the analyzer for the modulation, generation and measurement of pulsed signals.

The screenshot shows the Pulse Modulation dialog box with the following settings:

- Master Pulse Generator:** Pulse Gen (unchecked), Master Pulse Clock Source (Internal), Sweep Type (Lin Freq), Pulse Period (100 μs), Duty Cycle (10%).
- Measurement Settings:** Acq Delay (320 ns), ALC Acq Del (312 ns), Acq Time (760 ns), Bandwidth (1.5 MHz), Auto Set (checked).
- Timing Diagram:** Shows a pulse train with a period of 100 ns and a pulse width of 1.1 μs.
- Pulse Settings:** Coupled (checked), Output Settings (Port 1...4 checked).
- Trigger Out Settings (Rear Panel Connector):**

#	Pulse Delay	Pulse Width	Trig. Out
Trg A	0 s	1 μs	Enable (unchecked), Invert (unchecked)
Trg B	0 s	1 μs	Enable (unchecked), Invert (unchecked)
Trg C	0 s	1 μs	Enable (unchecked), Invert (unchecked)
Trg D	0 s	1 μs	Enable (unchecked), Invert (unchecked)

Schematics

The "Schematics" button in the "Pulse Modulation" dialog opens a separate window that visualizes the pulse generation and modulation logic.

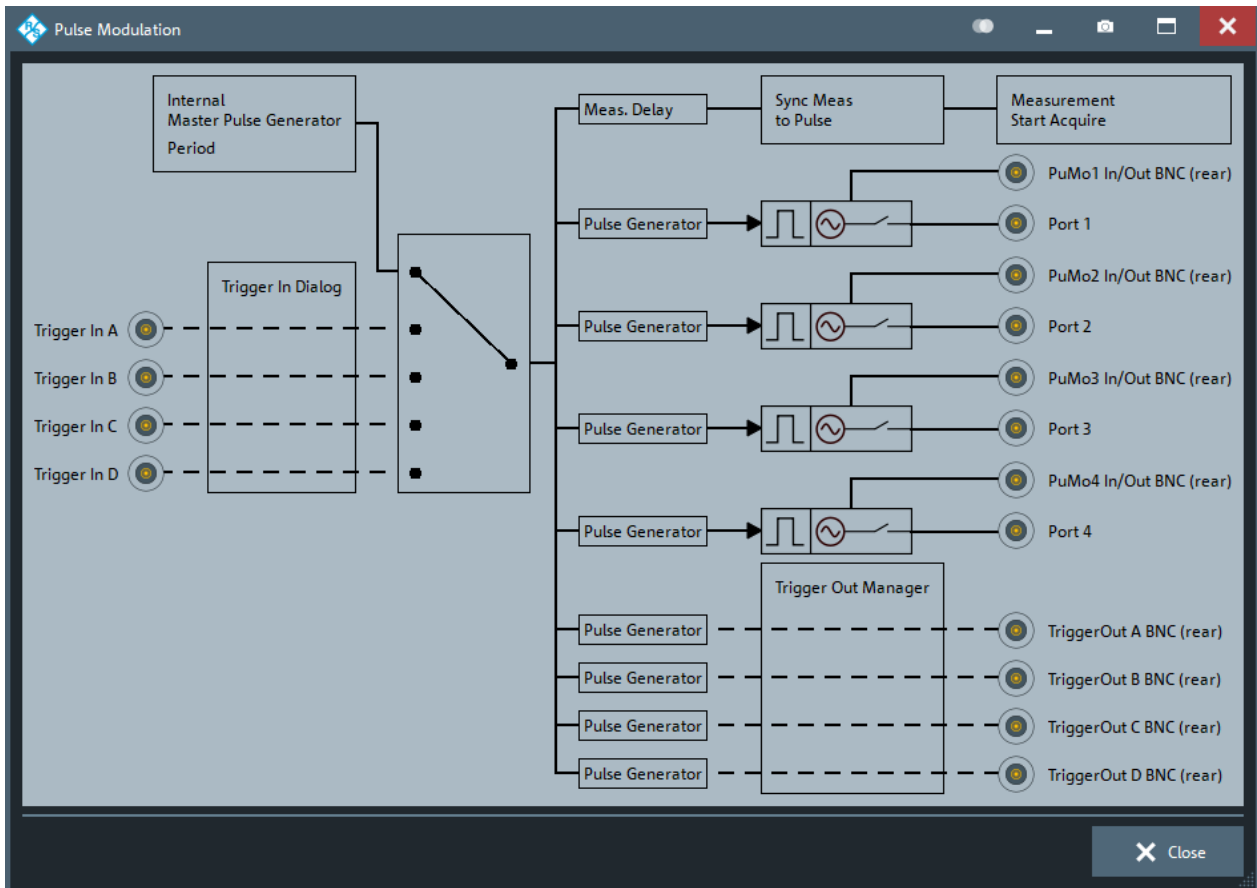

From left to right:

- The master pulse of the internal pulse generators can either be provided internally ("Pulse Period") or externally, via one of the Trigger In connectors.
- The internal pulse modulators can be controlled either via internal pulse generators or externally, via the PuMo In/Out connectors. The latter requires the optional trigger board R&S ZNA-B91.
- If the optional trigger board R&S ZNA-B91 is available, the internal pulse generator signals can also be provided to external pulse modulators.
 - Via the PuMo In/Out connectors
 - Via the Trigger Out connectors

Timing diagram

This diagram visualizes the time and delay settings of the internal pulse modulators, the pulse generator signals provided via the Trigger Out, the ALC, and the data acquisition.

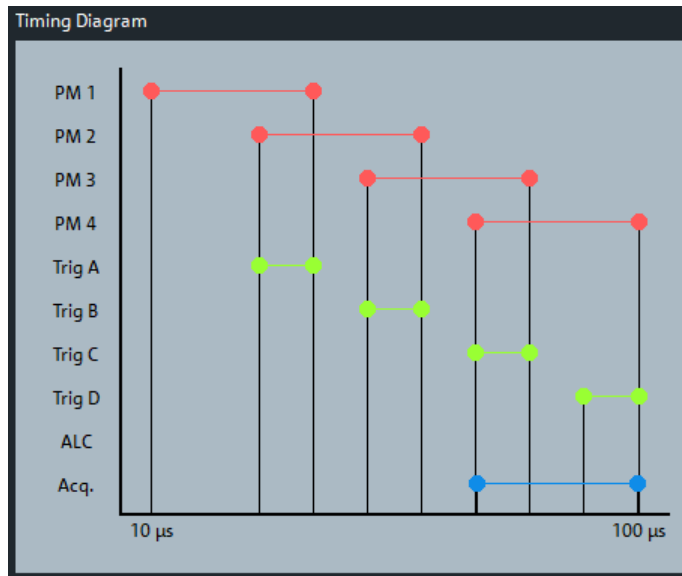

For unsuitable combinations of pulse and measurement settings, the firmware displays a warning above the diagram, indicating the detection type and a possible desensitization loss of sensitivity of the measurement.

Master pulse settings

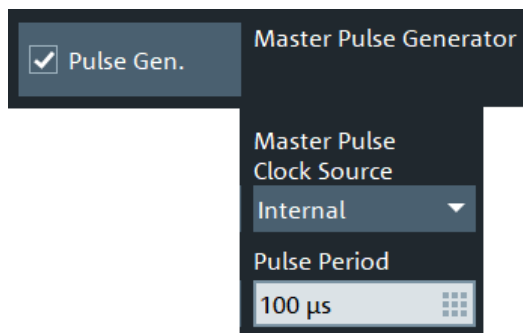

Pulse Gen.

Enables or disables pulse generation.

Remote command:

```
[SENSe<Ch>:] PULSe:GENERator<Id> [:STATe]
```

Master Pulse Clock Source

Defines whether the Master Pulse is provided internally or externally (via any of the available Trigger In interfaces).

Remote command:

```
[SENSe<Ch>:] PULSe:GENERator:SOURce
```

Pulse Period

Defines the (common) pulse period of the internal pulse generators ([Master Pulse Clock Source](#) set to "Internal").

Remote command:

```
[SENSe<Ch>:] PULSe:PERiod
```

Basic pulse generator settings

If option R&S ZNA-K7 is not available, the port-related pulse generators can only operate at a fixed duty cycle.

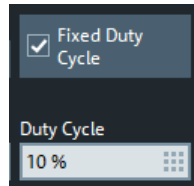

Fixed Duty Cycle/Duty Cycle

If "Fixed Duty Cycle" is enabled, the analyzer automatically adjusts the pulse width of the port-related pulse generators to keep the "Duty Cycle" at the specified percentage. The same pulse width and the minimum possible pulse delay are used for all sources.

These settings are only enabled, if [Master Pulse Clock Source](#) is set to "Internal".

Remote command:

```
[SENSe<Ch>:] PULSe:FXDCycle[:STATE]
```

```
[SENSe<Ch>:] PULSe:DUTYcycle
```

Advanced pulse generator settings

Advanced settings for the port-related pulse generators are only available, if the R&S ZNA is equipped with option R&S ZNA-K7.

They are only active if [Master Pulse Clock Source](#) is set to "Internal" and [Fixed Duty Cycle](#) is not selected.

Pulse Settings			
<input type="checkbox"/> Coupled			
#	Pulse Delay	Pulse Width	Pulse Train
PM1	10 μ s	30 μ s	off ...
PM2	30 μ s	30 μ s	off ...
PM3	50 μ s	30 μ s	off ...
PM4	70 μ s	30 μ s	off ...
Trigger Out Settings (Rear Panel Connector)			
#	Pulse Delay	Pulse Width	
Trg A	20 μ s	20 μ s	
Trg B	40 μ s	20 μ s	
Trg C	60 μ s	20 μ s	
Trg D	80 μ s	20 μ s	

Coupled Settings

Couples the settings of the port pulse generators, i.e. enforces identical settings for all ports.

Remote command:

```
[SENSe<Ch>:] PULSe:COUPlEd[:STATe]
```

Pulse Delay/Pulse Width

Defines the delay and width of the internally generated pulses.

Remote command:

```
[SENSe<Ch>:] PULSe:PORT<Pt>:DELay
[SENSe<Ch>:] PULSe:PORT<Pt>:WIDTh
[SENSe<Ch>:] PULSe:GENerator<Id>:DELay
[SENSe<Ch>:] PULSe:GENerator<Id>:WIDTh
TRIGger:CHANnel<Ch>:AUXiliary<n>:DELay
TRIGger:CHANnel<Ch>:AUXiliary<n>:DURation
```

Pulse Train

Pulse trains can only be configured for the port-related pulse generators. The "Pulse Train" button opens the "Define Pulse Train dialog" on page 697 that allows you to configure the pulse train.

Define Pulse Train dialog

Allows you to configure the pulse train for the related port.

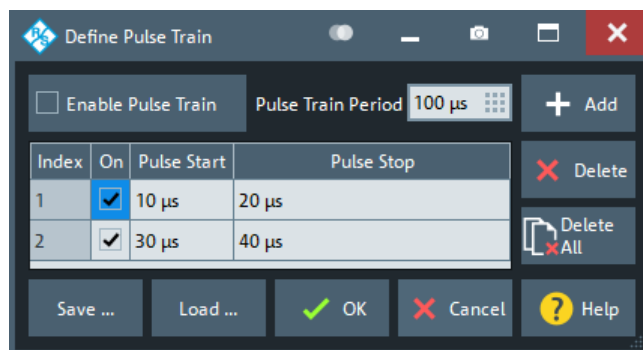

Enable Pulse Train

Enables the configured pulse train.

Remote command:

```
[SENSe<Ch>:] PULSe:GENerator<Id>:TRAIIn[:STATe]
```

Pulse Train Period

See "Pulse Period" on page 695.

Remote command:

```
[SENSe<Ch>:] PULSe:GENerator:TRAIIn:PERiod
```

Segment List

Defines the segments of the pulse train. Use "Add" and "Delete" to add/delete segments. Use "Delete All" to delete all segments.

Remote command:

```
[SENSe<Ch>:] PULSe:GENerator<Id>:TRAIIn:SEGMENT<Seg>:COUNT
[SENSe<Ch>:] PULSe:GENerator<Id>:TRAIIn:SEGMENT<Seg>:STATE
[SENSe<Ch>:] PULSe:GENerator<Id>:TRAIIn:SEGMENT<Seg>:START
[SENSe<Ch>:] PULSe:GENerator<Id>:TRAIIn:SEGMENT<Seg>:STOP
```

Pulse modulator control

Allows you to control the internal pulse modulators (with options R&S ZNAXx-B4y) and external pulse modulators via PuMo In/Out and Trigger Out (with option R&S ZNA-B91).

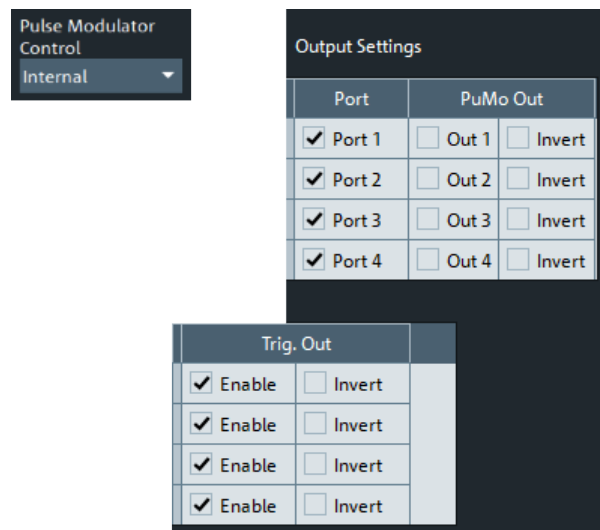

Pulse Modulator Control

If the R&S ZNA is equipped with the [Trigger board](#), the [Internal pulse modulators](#) can be controlled externally, via the PuMo In connectors.

Remote command:

```
[SENSe<Ch>:] PULSe:INTernal[:STATe]
```

Port

Activates or deactivates the respective internal pulse modulator.

The internal pulse modulator for port y is provided by option R&S ZNAXx-B4y. If this option is not installed, the corresponding checkbox is disabled.

Remote command:

```
[SENSe<Ch>:] PULSe:PORT<Pt>[:STATe]
```

PuMo Out

These settings control the generation of an outgoing pulse generator signal at the corresponding PuMo In/Out, with either positive or negative polarity.

Remote command:

```
[SENSe<Ch>:] PULSe:PORT<Pt>:EXTernal:OUTPut[:STATe]
[SENSe<Ch>:] PULSe:PORT<Pt>:EXTernal:OUTPut:INVerted[:STATe]
```

PuMo In

If external [Pulse Modulator Control](#) is enabled, this setting allows you to select between positive or negative polarity of the "PuMo In" signal.

Remote command:

```
[SENSe<Ch>:] PULSe:PORT<Pt>:EXTeRnal:INPut:INVeRted[:STATe]
```

Trig. Out

Allows you to enable/disable pulse modulator control via the respective "Trig. Out".

Note that a Trigger Out that has been previously configured to indicate sweeps, segments or measurement points for this channel, cannot be used for pulse generation. The corresponding table row is disabled in this case.

To change the trigger configuration, use the "Trigger Out Manager..." button to open the [Trigger Out Manager dialog](#).

Remote command:

```
TRIGger:CHANnel<Ch>:AUXiliary<n>:INTerval PGeNerator preceded by
TRIGger:CHANnel<Ch>:AUXiliary<n>:POSition BEFore); TRIGger:
CHANnel<Ch>:AUXiliary<n>:INTerval NONE
TRIGger:CHANnel<Ch>:AUXiliary<n>:STYPe POSitive | NEGative
```

Measurement settings

Sets up the "Pulse Profile" measurement for this channel (see [Chapter 5.10.3, "Sweep Type tab"](#), on page 546).

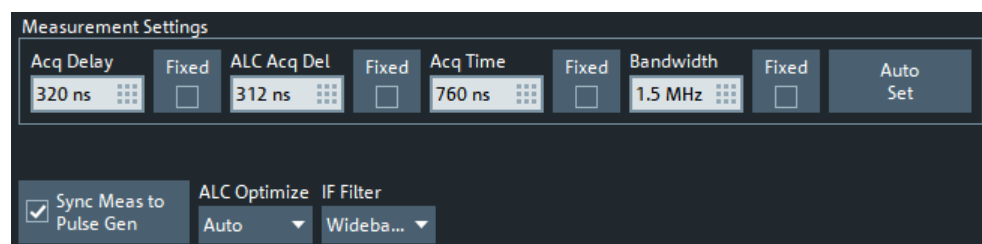
**Acq Delay/Fixed**

Defines the acquisition delay relative to the master pulse. Can only be set in [synchronized](#) measurement mode. "Fixed" means that [Autoset](#) does not change the configured value.

Remote command:

```
[SENSe<Ch>:] PULSe:MEASdelay
```

ALC Acq Delay/Fixed

Defines the acquisition delay of the ALC measurement relative to the master pulse. Can only be set in [synchronized](#) measurement mode and if [ALC optimization](#) is not enforced. "Fixed" means that [Autoset](#) does not change the configured value.

Remote command:

```
[SENSe<Ch>:] PULSe:ALC:MEASdelay
```

Acq Time/Fixed

Defines the duration of the data acquisition. "Fixed" means that [Autoset](#) does not change the configured value.

Remote command:

```
[SENSe<Ch>:] PULSe:ATIME
```

Bandwidth/Fixed

Defines the resolution bandwidth.

Remote command:

```
[SENSe<Ch>:] BWIDth[:RESolution]
```

Autoset

Adjusts [Acq Delay](#), [ALC Acq Delay](#), and [Acq Time](#) according to the configured pulses, unless their value is fixed.

ALC Optimize

Enables/configures [ALC optimization](#).

"Auto" (default) The firmware decides whether speed optimization is performed.

"On" Optimization active

"Off" Optimization inactive

Remote command:

```
SOURce<Ch>: POWer<Pt>: ALC: OPTimize
```

IF Filter

See ["IF Filter \(analog\)"](#) on page 537

Sync Meas to Pulse Gen.

Allows you to switch between synchronous and asynchronous measurement.

Remote command:

```
[SENSe<Ch>:] PULSe: SYNCron[:STATe]
```

5.13.2.3 VSE Connection Configuration dialog

The controls on the "VSE Connection Configuration" dialog allow you to set up and establish a connection to a local or remote R&S VSE instance.

For background information, see [Chapter 4.7.6.1, "Live pulse analysis with R&S VSE"](#), on page 280.

Access: [Pulse Mod tab](#) > "Configure VSE"

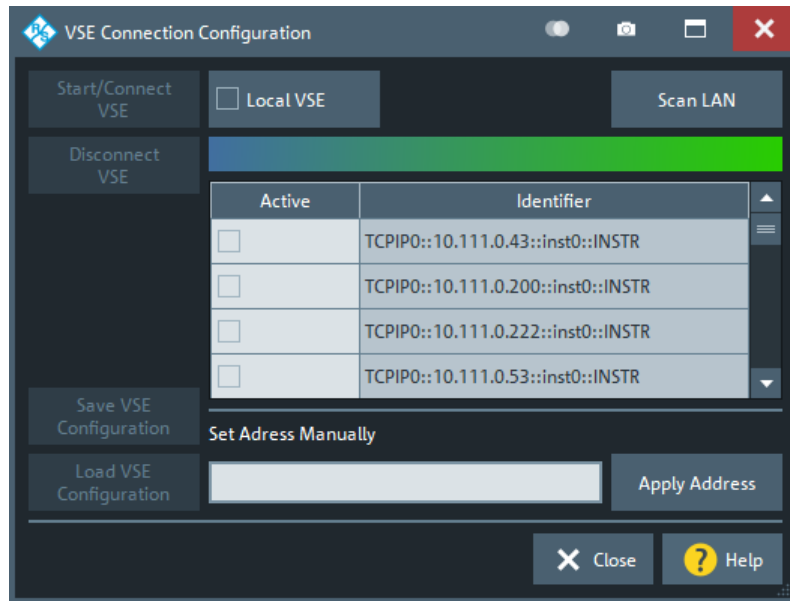

Start/Connect VSE / Disconnect VSE

Select your target R&S VSE using [Local VSE](#) or the [VISA address list](#). Then use the "Start/Connect VSE" button to connect to it and to start its pulse measurements application (R&S VSE-K6). A local R&S VSE is started automatically.

Once the connection is established, you can use "Disconnect VSE" to terminate it.

Remote command:

```
CONTrol:VSE:CONNect
CONTrol:VSE:DISConnect
```

Local VSE

Tells the R&S ZNA that you want to connect to a local R&S VSE. Use [Start/Connect VSE / Disconnect VSE](#) to establish the connection.

Remote command:

```
CONTrol:VSE:LOCal
```

Scan LAN

Scans the LAN for VISA resources (VISA auto-discovery).

VISA address list

A list of known VISA addresses, populated using [Scan LAN](#) and extended [manually](#).

If you do not want to connect to a [Local VSE](#), mark the address of your remote target R&S VSE as "Active" and select [Start/Connect VSE / Disconnect VSE](#).

Remote command:

```
CONTrol:VSE:ADDRess
```

Set Address Manually/Apply Address

Allows you to specify the VISA address of a remote target R&S VSE manually.

"Apply Address" adds the specified address to the [VISA address list](#). Manually added addresses are stored in the active R&S ZNA setup.

Remote command:

`CONTrol:VSE:ADDRESS`

Save VSE Configuration

If a connection to a R&S VSE instance is established, you can download its current configuration and save it to a file on the R&S ZNA.

Remote command:

`CONTrol:VSE:CONFIg:SAVE`

Load VSE Configuration

If a connection to a R&S VSE instance is established, you can load its configuration from a file on the R&S ZNA (previously created using [Save VSE Configuration](#)).

Remote command:

`CONTrol:VSE:CONFIg:LOAD`

5.13.3 Source Coherence tab

The "Source Coherence" tab allows you to configure source signals with defined phase.



Source coherent signals require the [Phase coherent source control](#) option R&S ZNA-K6. If this option is not equipped, the "Source Coherence" tab is not available.

5.13.3.1 Controls on the Source Coherence tab

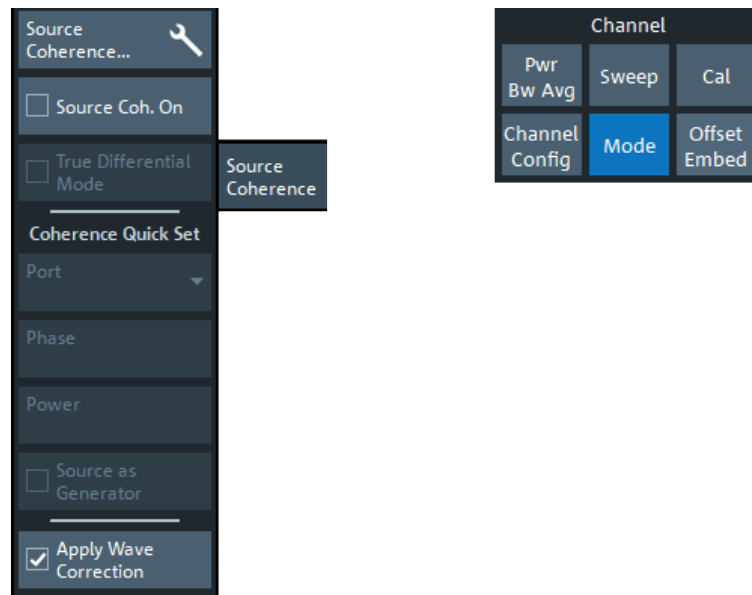

Source Coherence...

Opens the [Source Coherence dialog](#).

If [source coherence](#)) and an [imbalance sweep](#) is active, this button is disabled. In this case, the relevant settings can be found in the [Coherence Quick Set](#) section.

Source Coh. On

Activates or deactivates the source coherence mode.

If [True Differential Mode](#) is active, this button is disabled.

If checked, the main tool bar shows the "Src. Coh." button, with the same functionality as the [Source Coherence...](#) button in the softtool tab.

Remote command:

```
SOURce<Ch>:CMODE[:STATe]
```

True Differential Mode

See "[True Differential Mode](#)" on page 353.

If [Source Coherence](#) is active, this button is disabled.

Coherence Quick Set

This section is only enabled, if [Source Coherence](#) and an [imbalance sweep](#) is active.

It allows you to specify a reduced set of coherence parameters compared to the advanced coherence settings of the [Source Coherence dialog](#).

Apply Wave Correction

Same function as "[Wave Correction](#)" on page 359.

Remote command:

```
SOURce<Ch>:CMODE:WCORection[:STATe]
```

5.13.3.2 Source Coherence dialog

The "Source Coherence" dialog allows you to enable and configure [Phase coherent source control](#) and [True differential mode](#).

Access:

- Channel – [Mode] > "Source coherence" tab > "Source Coherence ..."
- [Balanced Ports dialog](#) > "Source Coherence ..."

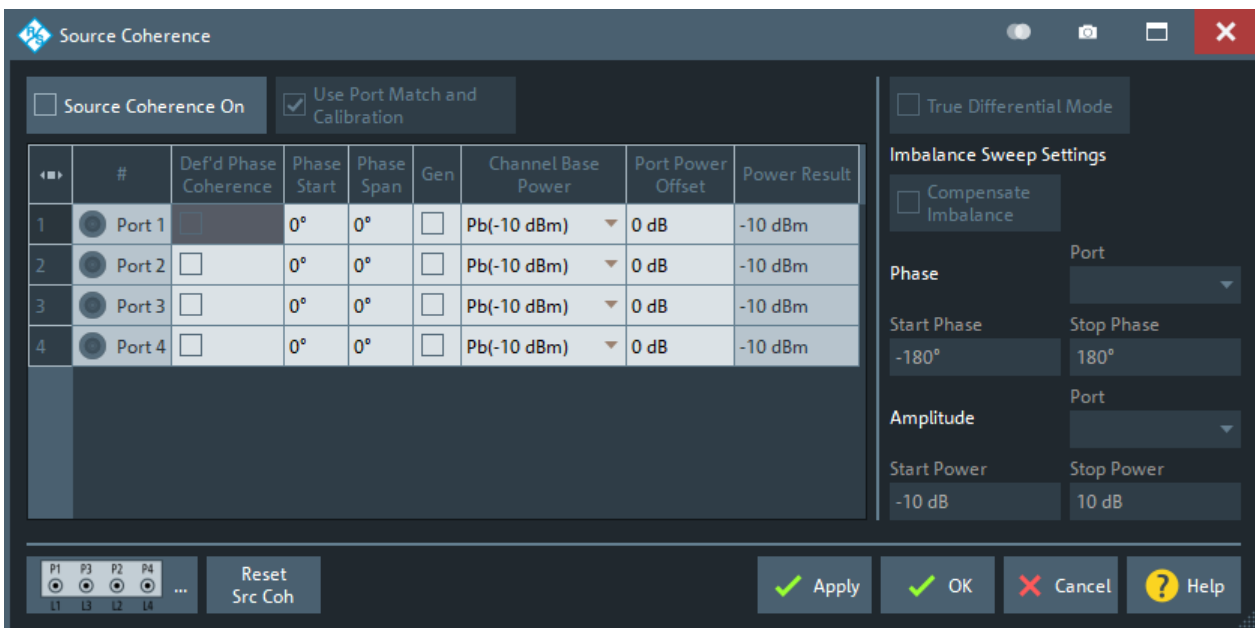

Source Coherence On

Same as [Source Coh. On](#) on the "Source Coherence" softtool tab.

Use Port Match and Calibration

Allows you to select between a raw (unchecked), or an optimized phase control, applying port match corrections and calibration (checked, default).

If checked, the phase values are relative to a common zero. Otherwise the phase relation between the different ports is undetermined.

Remote command:

```
SOURce<Ch>:CMODE:OPTimized[:STATE]
```

Port-specific parameters (table)

The controls in the table allow you to activate and define port-specific phase settings in source coherence mode.

The table is enabled, if and only if [Source Coherence On](#) is checked.

All phase values are defined at the calibrated reference plane of the respective port.

Def'd Phase Coherence ← Port-specific parameters (table)

Defines the individual analyzer sources as coherent or non-coherent.

Remote command:

```
SOURce<Ch>:CMODE:PORT<Pt>[:STATE]
```

Phase Start ← Port-specific parameters (table)

Phase of the port, or first phase sweep point if [Phase Span](#) is not zero.

Remote command:

```
SOURce<Ch>:CMODE:PORT<Pt>:PHASE
```

Phase Span ← Port-specific parameters (table)

Total phase difference between first and last phase sweep point (with constant phase steps).

Remote command:

```
SOURce<Ch>:CMODE:PORT<Pt>:PHASe:SPAN
```

Gen / Channel Base Power / Port Power Offset / Power Result ← Port-specific parameters (table)

Same functionality as in the [Port Settings dialog](#). See:

- ["Source Gen"](#) on page 671
System error corrections must be performed with alternating source signals ("Gen" unchecked).
- ["Channel Base Power"](#) on page 630
- ["Port Power Offset"](#) on page 631

True Differential Mode

See ["True Differential Mode"](#) on page 353.

This button and the [Imbalance Sweep Settings](#) below it are only visible if option R&S ZNA-K6 ([True differential mode](#)) is available, and is only enabled if [Source Coherence On](#) is unchecked.

Remote command:

```
SOURce<Ch>:TDIF[:STATe]
```

Imbalance Sweep Settings ← True Differential Mode

These settings are only available if [True Differential Mode](#) is checked. They configure the imbalance sweep types in true differential mode (see [Chapter 4.7.5.2, "Amplitude imbalance and phase imbalance sweep"](#), on page 278). Use the [Sweep Type tab](#) to activate one of them.

Compensate Imbalance ← Imbalance Sweep Settings ← True Differential Mode

Defines whether the imbalance of the DUT's balanced input line conductors shall be compensated before starting an imbalance sweep (see ["Imbalance Compensation of a-Waves"](#) on page 278

Remote command:

```
CALCulate<Ch>:TDIF:IMBalance:COMPensation[:STATe]
```

Phase > Port / Start Phase / Stop Phase ← Imbalance Sweep Settings ← True Differential Mode

Configures the phase imbalance sweep type in true differential mode:

- "Port" selects the balanced logical port to be swept
- "Start Phase" and "Stop Phase" define the phase difference at the start/stop of each sweep

Remote command:

```
SOURce<Ch>:TDIF:IMBalance:PHASe:LPORT
```

```
SOURce<Ch>:TDIF:IMBalance:PHASe:START
```

```
SOURce<Ch>:TDIF:IMBalance:PHASe:STOP
```

Amplitude > Port / Start Power / Stop Power ← Imbalance Sweep Settings ← True Differential Mode

Configures the amplitude imbalance sweep type in true differential mode:

- "Port" selects the balanced logical port to be swept
- "Start Power" and "Stop Power" define the amplitude difference at the start/stop of each sweep

Remote command:

```
SOURce<Ch>:TDIF:IMBalance:AMPLitude:LPORT
SOURce<Ch>:TDIF:IMBalance:AMPLitude:START
SOURce<Ch>:TDIF:IMBalance:AMPLitude:STOP
```

Topology (graphical button)

Visualizes the logical port configuration. If the [Balanced Ports dialog](#) is not already in the background, you can open it from here.

5.14 Offset Embed softtool

The "Offset Embed" softtool allows you to define a length offset and loss for each test port. The offset compensates for the known length and loss of (non-dispersive and perfectly matched) transmission lines between the calibrated reference plane and the DUT. It also contains advanced functions for deembedding/embedding the DUT from/into more general physical/virtual (matching) networks placed between the calibrated reference plane and the DUT.

Access: Channel – [Offset Embed]



Background information

Refer to [Chapter 4.6, "Offset parameters and de-/embedding"](#), on page 228

5.14.1 Offset Embed dock widget

On activating a tab in the "Offset Embed" softtool, a dock widget is displayed beneath the trace area, whose content pane is synchronized with the selected softtool tab.

Access: Channel – [Offset Embed]

5.14.1.1 Overview panel

Shows an overview of the overall calculation flow and provides quick access to the "Offset Embed" functions.

Access: Channel – [Offset Embed] > "Overview"

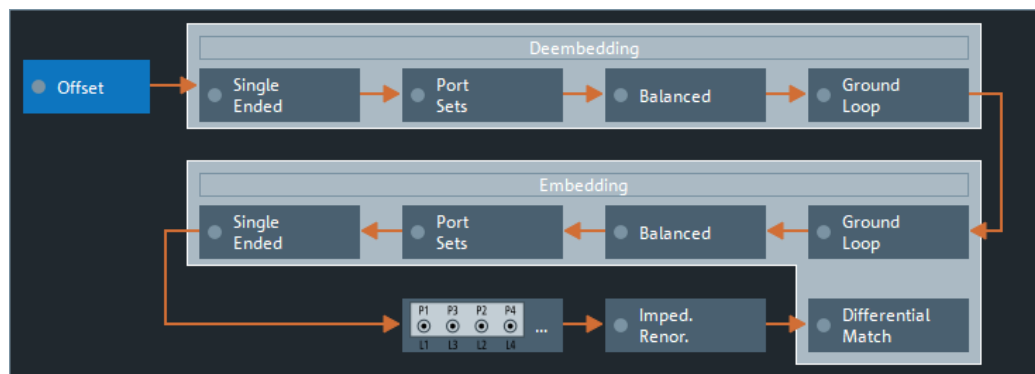

Figure 5-36: Offset Embed dock widget: Overview (Calculation Flow)

Use one of the buttons to configure the corresponding function. A green LED on a button indicates that the corresponding deembedding/embedding function is active.



If the "Fixture Simulator" is disabled for the related channel (see "Fixture Simulator" on page 655), all functions except the "Offset" function are in inactive (grayed out in the "Overview").

5.14.1.2 Offset panel

Allows you to activate or deactivate offset/loss correction for selected physical ports and to set related parameters.

Access: Overview panel > "Offset"

Offset									
Offset	Active	Delay	Loss at DC	Loss at 1st Freq	1st Freq for Loss	Use 2nd Freq	Loss at 2nd Freq	2nd Freq for Loss	
P1 L1	<input checked="" type="checkbox"/>	0 s	0 dB	0 dB	1 GHz	<input type="checkbox"/>	0 dB	500 MHz	Reset Offsets All Offsets On All Offsets Off Displayed Columns...
P2 L2	<input checked="" type="checkbox"/>	0 s	0 dB	0 dB	1 GHz	<input type="checkbox"/>	0 dB	500 MHz	

Figure 5-37: Offset Embed dock widget: Offset panel

The "Offset" panel can also be activated by selecting the [Offset tab](#) or [One Way Loss tab](#). Refer to its description for additional functions and remote commands.

Active

The checkbox in the "Active" column activates/deactivates the configured length and loss parameters for the respective [Port](#) (i.e. adds/removes them to/from the calculation flow) without changing the parameter values.

Remote command:

```
[SENSE<Ch>:]CORRection:OFFSet<PhyPt>:COMPensation[:STATE]
```

Loss at DC / Loss at 1st Freq / 1st Freq for Loss / Use 2nd Freq / Loss at 2nd Freq / 2nd Freq for Loss

Defines the one-way loss parameters of the transmission line at the selected port.

In the limit case, where the length of the transmission line is considered to be "almost zero", the loss is considered constant:

$$Loss(f) = Loss_{DC}$$

Otherwise, if the loss at DC and one additional frequency f_1 is known, the loss at frequency f is approximated by:

$$Loss(f) = Loss_{DC} + (Loss(f_1) - Loss_{DC}) \cdot \sqrt{\frac{f}{f_1}}$$

If, in addition, the loss at a second frequency f_2 is known and "Use 2nd Freq" is enabled, then the loss is approximated by:

$$Loss(f) = Loss_{DC} + (Loss(f_1) - Loss_{DC}) \cdot \left(\frac{f}{f_1}\right)^b, \text{ where } b = \frac{\log_{10}\left(\left|\frac{Loss(f_1)}{Loss(f_2)}\right|\right)}{\log_{10}\left(\frac{f_1}{f_2}\right)}$$

See also [Chapter 4.6.1.2, "Definition of loss parameters"](#), on page 229.

Note: The entered parameters define the loss for a signal traveling in **one direction** through the transmission line. To account for the propagation in both directions, the magnitude shift of a reflection parameter due to a given loss is twice the magnitude shift of a transmission parameter. See also [Chapter 4.6.1.6, "Application and effect of offset parameters"](#), on page 233.

Remote command:

```
[SENSe<Ch>:]CORRection:LOSS<PhyPt>:OFFSet
[SENSe<Ch>:]CORRection:LOSS<PhyPt>
[SENSe<Ch>:]CORRection:LOSS<PhyPt>:FREQuency
[SENSe<Ch>:]CORRection:LOSS<PhyPt>:SECond:STATe
[SENSe<Ch>:]CORRection:LOSS<PhyPt>:SECond
[SENSe<Ch>:]CORRection:LOSS<PhyPt>:SECond:FREQuency
```

Reset Offsets

The "Reset Offsets" button resets the length and loss parameters for all ports to their default values.

Remote command:

```
[SENSe<Ch>:]CORRection:OFFSet<PhyPt>[:STATe]
```

All Offsets On / All Offsets Off

Activates/deactivates the length and loss compensation for all ports.

Use the checkboxes in the [Active](#) column to activate/deactivate the length and loss compensation for selected ports.

Remote command:

```
[SENSe<Ch>:]CORRection:OFFSet<PhyPt>:COMPensation[:STATe]
```

Displayed Columns

Opens a dialog that lets you select between different ways to specify the offset, similar to [Delay / Electrical Length / Mech. Length](#) on the [Offset](#) tab.

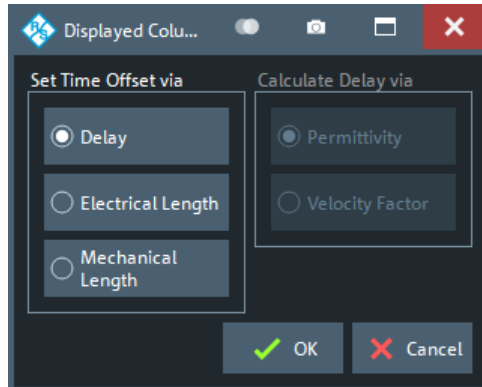

5.14.1.3 Single Ended panel

Allows you to activate or deactivate single ended deembedding/embedding for selected physical ports. For the "2-Port Data" network type, it is also possible to change the underlying s_{2p} Touchstone file from the dock widget.

Access: [Overview panel](#) > "Single Ended"

Single Ended			
Deembedding	Active	File Name 1	Swap Gates
P1 L1	<input type="checkbox"/>	...	<input type="checkbox"/>
P2 L2	<input type="checkbox"/>	...	<input type="checkbox"/>
P3 L3	<input type="checkbox"/>	...	<input type="checkbox"/>
P4 L4	<input type="checkbox"/>	...	<input type="checkbox"/>

The "Single Ended" panel can also be activated by selecting the [Single Ended tab](#) soft-tool tab. Refer to its description for background information, parameters and additional remote commands.

Active

The checkbox in the "Active" column activates or deactivates the selected "Single Ended" de-/embedding [Single Ended tab](#) (i.e. adds or removes it to/from the calculation flow) without changing its parameters.

Remote command:

```
CALCulate<Ch>:TRANSform:VNETworks:SENDED:DEEMbedding<PhyPt>[:STATE]
```

```
CALCulate<Ch>:TRANSform:VNETworks:SENDED:EMBedding<PhyPt>[:STATE]
```

File Name 1 / Swap Gates

The ellipsis button in the "File Name 1" column is enabled as long as the "2-Port Data" network is selected (see [Single Ended tab](#)). This network is defined by its S-parameters stored in a two-port Touchstone file (*.s2p). No additional parameters are required.

When loading the touchstone file, the analyzer by default assumes odd ports left (VNA side), even ports right (DUT side). However, it is also possible to **"Swap Gates"**, instructing the analyzer to reinterpret the loaded S-parameters (e.g. $S_{12} \rightarrow S_{21}$).

Note: The loaded S-parameters are stored in the active recall set. Recall sets contain the full embedding and deembedding data so that they can be transferred to other instruments.

Remote command:

`MMEMory:LOAD:VNETworks<Ch>:SENDEd:DEEMbedding<PhyPt>`

`MMEMory:LOAD:VNETworks<Ch>:SENDEd:EMBedding<PhyPt>`

5.14.1.4 Port Sets panel

The "Port Sets" panel allows you to configure the "Port Sets" to whom a deembedding or embedding network can be assigned ("Add", "Delete"). The touchstone files defining these networks can also be selected from here ("...").

Access: [Overview panel](#) > "Port Sets"

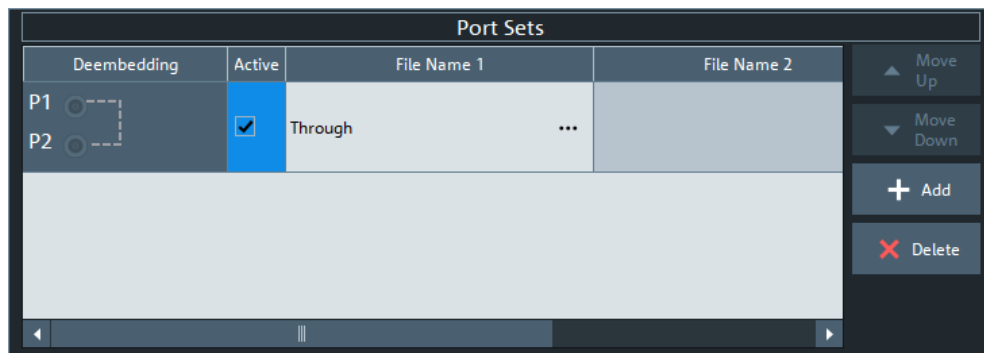

The "Port Sets" panel can also be activated by selecting the [Port Sets tab](#). Refer to its description for background information, parameters and additional remote commands.

Move Up / Move Down

Allows you to modify the sequence in which the active port set deembeddings/embeddings are applied.

Add / Delete

Allows you to define the "Port Sets" to whom a deembedding or embedding network can be assigned.

The "Add" button opens the "Define Port Set" dialog that allows you to define an additional port set, comprising two or more physical ports.

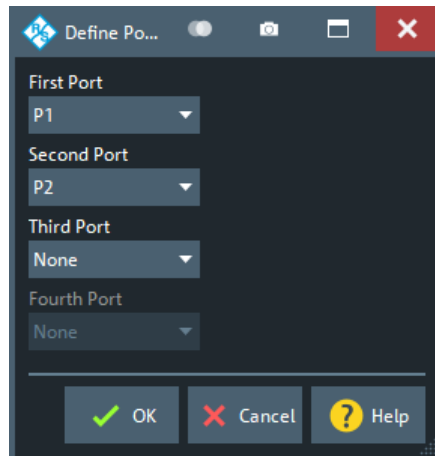

Use the controls on the right-hand side of the dialog to define the port set and the order of the ports within the port set.

Note however that the speed of the de-/embedding calculation depends on the port order. The best performance is achieved if the ports are ordered according to their numbers (i.e. in natural order). This is particularly significant for large port sets.

Remote command:

```
CALCulate<Ch>:TRANSform:VNETworks:PPAir:DEEMbedding<ListId>:
DEFine
```

```
CALCulate<Ch>:TRANSform:VNETworks:PSET:DEEMbedding<ListId>:
DEFine
```

```
CALCulate<Ch>:TRANSform:VNETworks:PPAir:DEEMbedding:DElete
```

```
CALCulate<Ch>:TRANSform:VNETworks:PPAir:EMBedding<ListId>:DEFine
```

```
CALCulate<Ch>:TRANSform:VNETworks:PSET:EMBedding<ListId>:DEFine
```

```
CALCulate<Ch>:TRANSform:VNETworks:PPAir:EMBedding<ListId>:DElete
```

Active

The checkboxes in the "Active" column activate or deactivate the configured de-/embedding for the related port set (i.e. adds or removes it to/from the calculation flow) without changing its parameters.

Remote command:

```
CALCulate<Ch>:TRANSform:VNETworks:PPAir:DEEMbedding<ListId>[:
STATe]
```

```
CALCulate<Ch>:TRANSform:VNETworks:PPAir:EMBedding<ListId>[:
STATe]
```

File Name <i>/Inc. Seq. <i>/Swap Gates <i>

The "File Name 1" (and "File Name 2") buttons are enabled as long as the selected deembedding/embedding [Port Sets tab](#) is defined using one or two Touchstone file(s).

When loading a touchstone file, the analyzer by default assumes odd ports left (VNA side), even ports right (DUT side). However, it is also possible to instruct the analyzer to assume an "Increasing Port Sequence", i.e. that the low port numbers are on the VNA side. Furthermore it is possible to "Swap Gates", i.e. to instruct the analyzer to swap the VNA and DUT side.

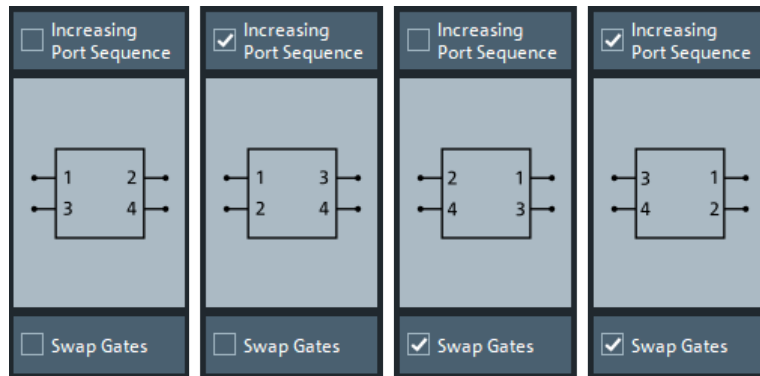

Note: The loaded file is stored in the active recall set. Persisted recall sets contain the full (de-)embedding data so that they can be transferred to other instruments.

Remote command:

`MMEMory:LOAD:VNETworks<Ch>:PPAir:DEEMbedding<ListId>`

`MMEMory:LOAD:VNETworks<Ch>:PPAir:EMBedding<ListId>`

5.14.1.5 Balanced panel

This panel allows you to activate or deactivate deembedding/embedding of balanced ports.

Access: [Overview panel](#) > "Balanced"

If the selected [Balanced tab](#) is defined using one or more touchstone files, these files can be selected from the dock widget ("...").

For network types that are defined using one or more touchstone files, the required files can also be selected from here ("...").

If necessary, use the button on the right-hand side to open the [Balanced Ports dialog](#) and change the balanced port configuration.

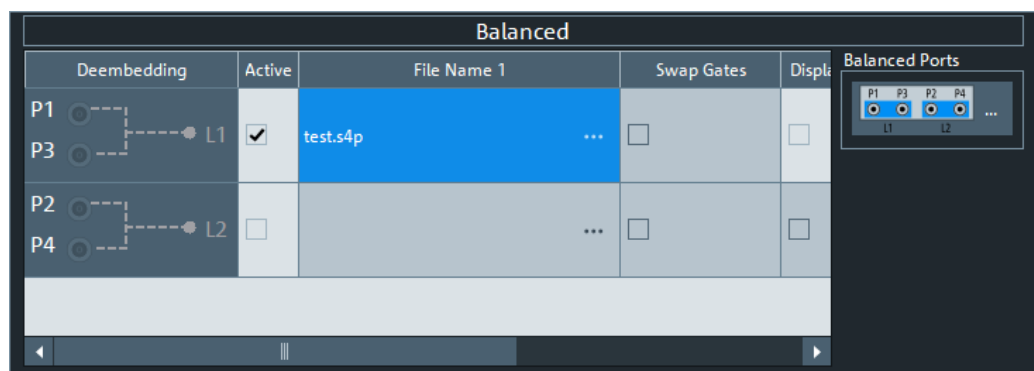

This panel can also be activated by selecting the [Balanced tab](#). Refer to its description for background information, parameters and additional remote commands.

Active

The checkboxes in the "Active" column activate or deactivate the configured de-/embedding for the related balanced port (i.e. adds or removes it to/from the calculation flow) without changing its parameters.

Remote command:

```
CALCulate<Ch>:TRANSform:VNETworks:BALanced:DEEMbedding<LogPt>[:STATE]
```

```
CALCulate<Ch>:TRANSform:VNETworks:BALanced:EMBedding<LogPt>[:STATE]
```

File Name <i>/Inc. Seq. <i>/Swap Gates <i>

The ellipsis button in the "File Name <i>" column is enabled as long as the selected **Balanced tab** comprises a two-port or four-port data network (*.s2p or *.s4p file).

When loading a touchstone file, the analyzer by default assumes odd ports left (VNA side), even ports right (DUT side). However, it is also possible to instruct the analyzer to assume an "Increasing Port Sequence", i.e. that the low port numbers are on the VNA side. Furthermore it is possible to "Swap Gates", i.e. to instruct the analyzer to swap the VNA and DUT side.

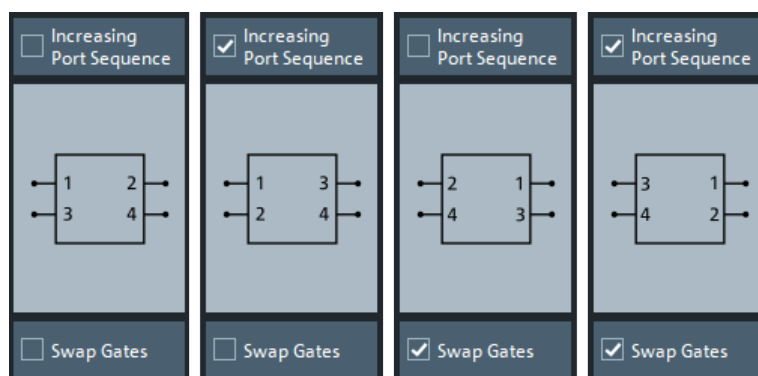

Note: The loaded S-parameters are stored in the active recall set. Persisted recall sets contain the full embedding and deembedding data so that they can be transferred to other instruments.

Remote command:

```
MMEMemory:LOAD:VNETworks<Ch>:BALanced:DEEMbedding<LogPt>
```

```
MMEMemory:LOAD:VNETworks<Ch>:BALanced:EMBedding<LogPt>
```

Balanced Ports

Provides access to the **Balanced Ports dialog** that allows you to modify the balanced port configuration.

5.14.1.6 Ground Loop panel

Allows you to activate or deactivate ground loop deembedding/embedding ("Active").

Access: **Overview panel** > "Ground Loop"

For the "1-Port Data" network type, the required touchstone file can also be selected from here ("...").

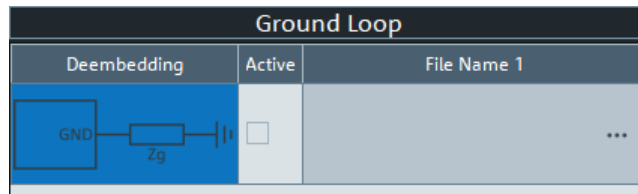

This panel can also be activated by selecting the [Ground Loop tab](#) softtool tab. Refer to its description for background information, parameters and additional remote commands.

If [multiple port groups \(DUTs\)](#) are configured and [Ground Loop per Port Group](#) is enabled, the panel displays the available port groups. Select the port group whose ground loop network shall be configured.



Active

The checkboxes in the "Active" column activate or deactivate the configured ground loop deembedding/embedding (i.e. adds or removes it to/from the calculation flow) without changing its parameters.

Remote command:

```
CALCulate<Ch>:TRANSform:VNETworks:GLOop:DEEMbedding<group>[:STATE]
```

```
CALCulate<Ch>:TRANSform:VNETworks:GLOop:EMBedding<group>[:STATE]
```

File Name 1

The ellipsis button in the "File Name 1" column is enabled if a 1-port data [Network network](#) (*.s1p file) is selected.

Note: The loaded S-parameter trace is stored in the active recall set. Persisted recall sets contain the full embedding and deembedding data so that they can be transferred to other instruments.

Remote command:

```
MMEMory:LOAD:VNETworks<Ch>:GLOop:DEEMbedding<group>
```

```
MMEMory:LOAD:VNETworks<Ch>:GLOop:EMBedding<group>
```

5.14.1.7 Impedance Renormalization panel

This panel provides alternative access to the reference impedance settings (see ["Reference Impedance tab"](#) on page 355).

Access: [Overview panel](#) > "Impedance Renor."

Impedance	Active	Common/Single Real(Z0)	Common/Single Imag(Z0)	Differential Real(Z0)	Differential Imag(Z0)
P1 L1	<input checked="" type="checkbox"/>	50 Ω	0 Ω		
P2 L2	<input checked="" type="checkbox"/>	50 Ω	0 Ω		
P3 L3	<input checked="" type="checkbox"/>	50 Ω	0 Ω		
P4 L4	<input checked="" type="checkbox"/>	50 Ω	0 Ω		

Renormalization

Power Waves

Travelling Waves

i Selected option is only relevant if Im(Z0) of at least one test port is ≠ 0 Ω!

Active

The "Active" flags are inversely related to the [Use Default](#) flags of the logical port configuration (see [Balanced Ports dialog](#)).

"Active"	"Use Default"
<input checked="" type="checkbox"/>	<input type="checkbox"/>
<input type="checkbox"/>	<input checked="" type="checkbox"/>

5.14.1.8 Differential Match panel

This panel allows you to activate or deactivate differential match embedding.

Access: [Overview panel](#) > "Differential Match"

For the "2-Port Data" network type, the required touchstone file can also be selected from here ("...").

If necessary, use the button on the right hand side to open the [Balanced Ports dialog](#) and change the balanced port configuration.

Embedding	Active	File Name 1	Swap Gates	Display
P1 L1	<input checked="" type="checkbox"/>	Through	...	
P2 L2	<input type="checkbox"/>		...	

P1 P3 **P2 P4** ...

This panel can also be activated by selecting the [Differential Match](#) softtool tab. Refer to its description of this softtool tab for background information, parameters and additional remote commands.

Active

The checkboxes in the "Active" column activate or deactivate the configured differential match embedding (i.e. adds or removes it to/from the calculation flow) without changing its parameters.

Remote command:

```
CALCulate<Ch>:TRANSform:VNETworks:DIFFerential:
EMBedding<LogPt>[:STATe]
```

File Name 1

The ellipsis button in the "File Name 1" column is enabled if a 2-port data [Network](#) is selected.

When loading the touchstone file (*.s2p), the analyzer by default assumes odd ports left (VNA side), even ports right (DUT side). However, it is also possible to **"Swap Gates"**, instructing the analyzer to reinterpret the loaded S-parameters (e.g. S_{12} --> S_{21}).

Note: The loaded S-parameter traces are stored in the active recall set. Persisted recall sets contain the full embedding and deembedding data so that they can be transferred to other instruments.

Remote command:

```
MMEMory:LOAD:VNETworks<Ch>:DIFFerential:EMBedding<LogPt>
```

5.14.2 Offset tab

Defines length offset parameters for each port.

Use the complementary dock widget to activate or deactivate length/loss compensation for selected ports (see [Chapter 5.14.1.2, "Offset panel"](#), on page 707).



The marker function [Zero Delay at Marker](#) function overwrites the offset parameters.

**Background information**

Refer to the following sections.

- [Chapter 4.6, "Offset parameters and de-/embedding"](#), on page 228
- [Chapter 4.6.1.1, "Definition of offset parameters"](#), on page 228
- [Chapter 4.6.1.3, "Auto Length"](#), on page 229
- [Chapter 4.6.1.6, "Application and effect of offset parameters"](#), on page 233
- [Chapter 4.6.1.7, "Offset parameters for balanced ports"](#), on page 234
- [Chapter 4.6.1.5, "Fixture Compensation"](#), on page 232

5.14.2.1 Controls on the Offset tab

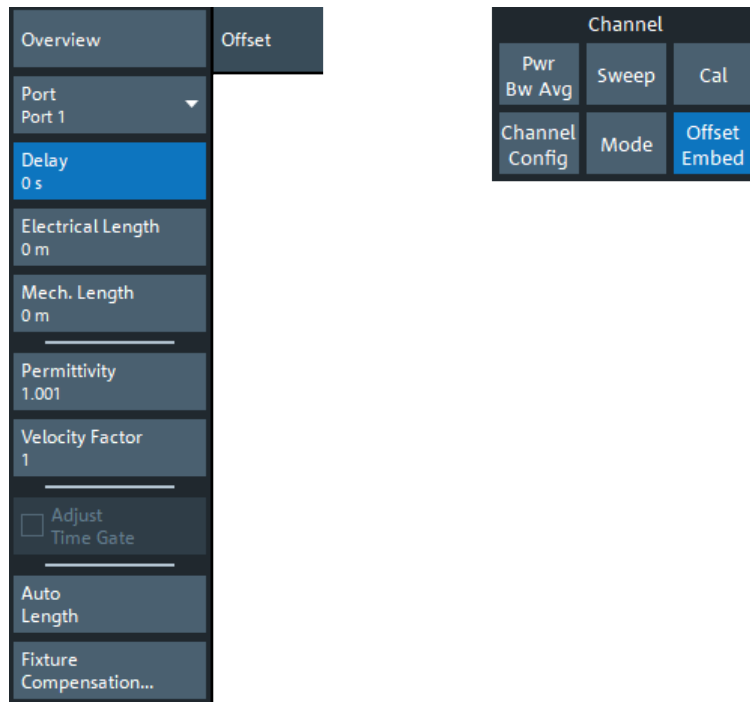

Overview

This button is available on all "Offset Embed" softtool tabs. It opens the [Overview panel](#) in the [Offset Embed dock widget](#).

Port

Physical test port of the analyzer. You can define independent offset parameters for all ports.

Remote command:

The <PhyPt> numeric suffix in the [SENSe<Ch>:]CORRection:... commands identifies the physical port.

Delay / Electrical Length / Mech. Length

Defines the length offset at the selected port as a delay, an electrical length, or a mechanical length. The three quantities are related by:

$$Delay = \frac{L_{mech} \cdot \sqrt{\epsilon_r}}{c}; \quad Electrical\ Length = L_{mech} \cdot \sqrt{\epsilon_r}$$

and overwrite each other. See also [Chapter 4.6.1.1, "Definition of offset parameters"](#), on page 228.

Note: The entered parameters must correspond the actual (one-way) length of the transmission line. To account for the propagation in both directions, the phase shift of a reflection parameter due to a given length offset is twice the phase shift of a transmission parameter. For a numeric example, see [Chapter 4.6.1.6, "Application and effect of offset parameters"](#), on page 233.

Remote command:

```
[SENSe<Ch>:]CORRection:EDELay<PhyPt>[:TIME]
[SENSe<Ch>:]CORRection:EDELay<PhyPt>:ELENgth
[SENSe<Ch>:]CORRection:EDELay<PhyPt>:DISTance
```

Permittivity / Velocity Factor

Defines the permittivity (ϵ_r) and velocity factor of the dielectric in the transmission line between the reference plane and the DUT. The velocity factor is $1/\sqrt{\epsilon_r}$ and is a measure for the velocity of light in a dielectric with permittivity ϵ_r relative to the velocity of light in the vacuum (velocity factor < 1). Permittivity and velocity factor are coupled parameters.

See also [Chapter 4.6.1.1, "Definition of offset parameters"](#), on page 228.

Remote command:

```
[SENSe<Ch>:]CORRection:EDELay<PhyPt>:DIElectric
```

Adjust Time Gate

Activates the operating mode where the time gate is moved in the opposite direction when the "Delay" setting (or any other length offset parameter) is changed. The button is available if a time gate is active (see ["Time Gate"](#) on page 453). In time domain, a positive delay shifts the time gate to the left, a negative delay shifts it to the right.

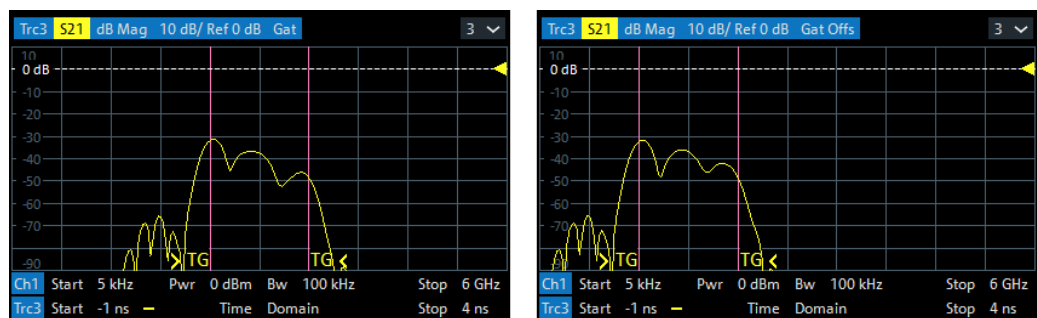

left = no delay
right = delay 1 ns

The position of the time gate is always relative to the end of the offset transmission line. As a consequence, "Adjust Time Gate" allows measurements at variable offset but fixed time gate position.

Example: The impedance of an antenna with possible faults is measured using a time gate and a variable length offset. If "Adjust Time Gate" is off, the time gate is at a constant distance from the offset-corrected reference plane (end of the offset transmission line). Its absolute position is varied along with the length offset.

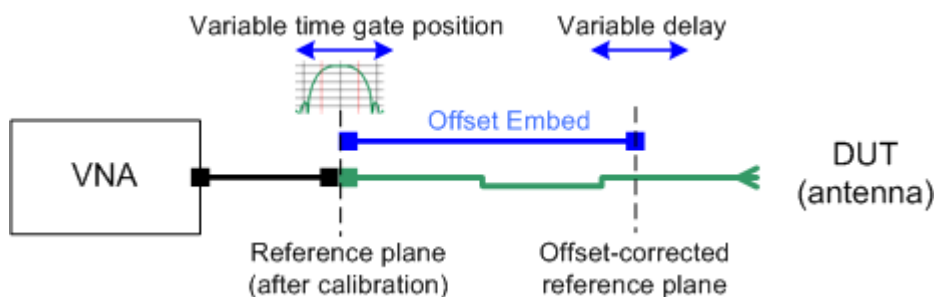

If "Adjust Time Gate" is on, the time gate is moved to left (right) when the offset-corrected reference plane is moved to the right (left). Its absolute position remains fixed. With this setting, it is possible, e.g., to keep the time gate at the position of the antenna connector while the antenna is measured at different length offsets.

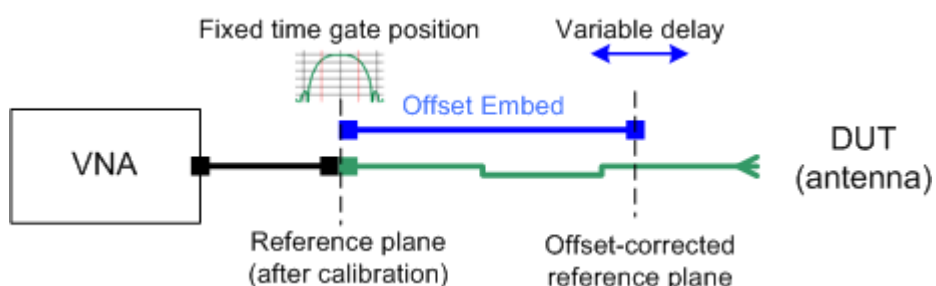

Remote command:

```
CALCulate:FILTer[:GATE]:TIME:AOFFset
```

Auto Length

Calculates the electrical length offset for the receive port of the active trace. See [Chapter 4.6.1.3, "Auto Length"](#), on page 229.

If "Delay" is the selected trace format, the entire trace is shifted in vertical direction and centered on zero. In phase format, the "Auto Length" corrected trace shows the deviation from linear phase.

Note that in order to calculate the electrical length offset of port i , you have to select a trace that uses port i as one of its receive ports. It is **not** relevant for the "Auto Length" function which [Port](#) is selected.

If the measured quantity is a ratio, or if it is derived from a ratio, its receiving port is given as the index of the wave quantity in the numerator. If the active trace shows an S-parameter S_{ij} , then "Auto Length" adds a length offset at port i . If the receive port is balanced, then the same offset is applied to both its physical ports.

Remote command:

```
[SENSe<Ch>:]CORRection:EDELay:AUTO
```

Fixture Compensation...

The "Fixture Compensation..." button opens the [Fixture Compensation dialog](#).

5.14.2.2 Fixture Compensation dialog

This dialog allows you to correct the measurement result for the effects of a test fixture.

Access:

- Channel – [Offset Embed] > "Offset" > "Fixture Compensation..."
- Channel – [Offset Embed] > "One Way Loss" > "Fixture Compensation..."

**Background Information**

Refer to [Chapter 4.6.1.5, "Fixture Compensation"](#), on page 232.

Ports

Selects the ports for whom fixture compensation data shall be acquired.

Auto Length / Auto Length and Loss

"Auto Length" or "Auto Length and Loss" implies that a global electrical length offset and loss is determined in analogy to the general offset compensation (see [Chapter 4.6.1.3, "Auto Length"](#), on page 229 and [Chapter 4.6.1.4, "Auto Length and Loss"](#), on page 231).

Remote command:

```
[SENSe:]CORRection:COLLect:FIXTure:LMPParameter:LOSS[:STATe]
```

Direct Compensation

With "Direct Compensation", a frequency-dependent transmission factor is calculated; see ["Auto Length and Loss vs. Direct Compensation"](#) on page 232.

Remote command:

```
[SENSe:]CORRection:COLLect:FIXTure:LMPParameter[:STATe]
[SENSe<Ch>:]CORRection:OFFSet<PhyPt>:DFComp[:STATe]?
```

Prompt for Each Port

Determines how the R&S ZNA performs the sweeps for a given termination type (Open and/or Short; see ["Measurement Type"](#) on page 720).

- If unchecked, it performs the sweeps for Open/Short without interruption, implicitly assuming that **all** ports are terminated accordingly
- If checked, it interrupts the data acquisition process after each port, which allows you to modify the test setup (e.g. terminate the next measured port).

Measurement Type

The "Open", "Short", and "Open and Short" buttons bring up the ["Measure Fixture wizard"](#) dialog that guides you through the actual fixture measurement. See ["Open/Short vs. Open and Short compensation"](#) on page 233.

Measure Fixture wizard

The "Measure Fixture" dialog guides you through the previously configured fixture compensation measurements.

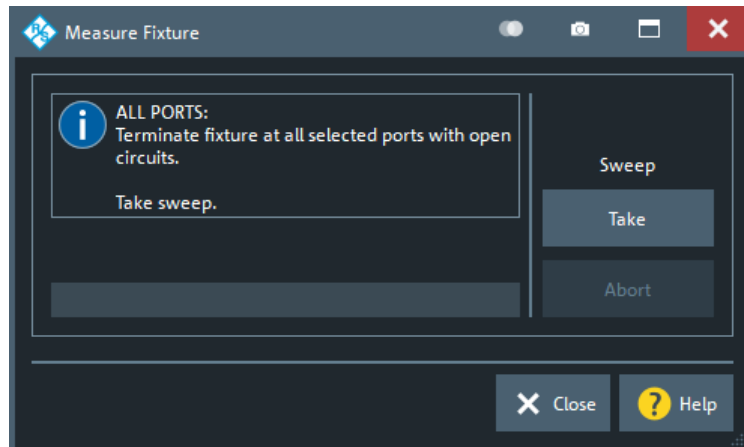
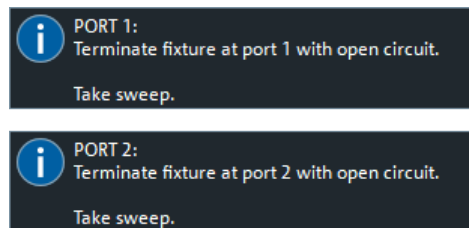

Figure 5-38: Measure Fixture dialog: Auto Length (and Loss)

To acquire the necessary data, proceed as indicated in the information area.

With Prompt for Each Port disabled, "Take" acquires data for all selected ports in one go. Otherwise sweeps are taken port by port.



For "Direct Compensation", it is also possible to save the acquired data to file. In future measurements, you can load these files instead of repeating the data acquisition.

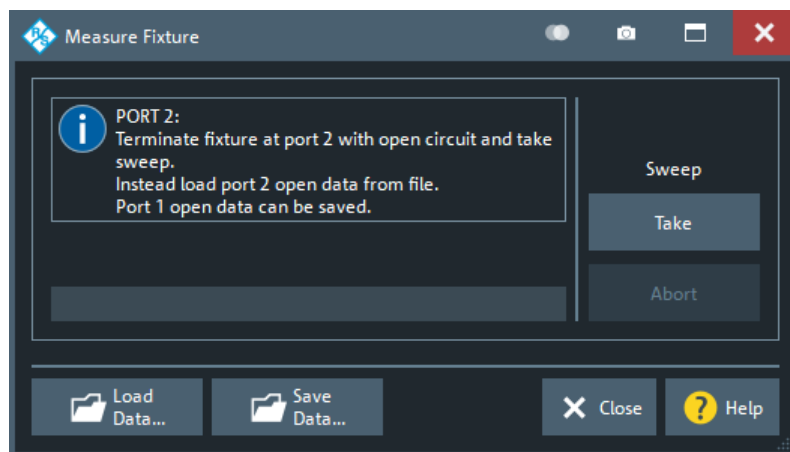

Figure 5-39: Measure Fixture dialog: Direct Compensation (and Prompt for Each Port)

"Direct Compensation" data files are standard trace files, containing reflection parameter traces for the related port and standard:

Table 5-8: Direct Compensation data

Prompt for Each Port	File Type	Description
disabled	csv	One csv trace file per standard, containing reflection traces for all selected ports; see Chapter 4.4.2.2, "ASCII (*.csv) files" , on page 184
enabled	s1p	One 1-port Touchstone file per standard and port (see Chapter 4.4.2.1, "Touchstone files" , on page 177)

Tip: Remote control provides additional flexibility. You can:

- Measure the same ports repeatedly without changing the standards and attribute the results to different channels.
- Calculate the compensation data for different ports, using mixed Open and Short standards.

Refer to the program example for `[SENSe<Ch>:]CORRection:COLLect:FIXTure[:ACQuire]`.

Remote command:

```
[SENSe<Ch>:]CORRection:COLLect:FIXTure:START
[SENSe<Ch>:]CORRection:COLLect:FIXTure[:ACQuire]
[SENSe<Ch>:]CORRection:COLLect:FIXTure:SAVE
[SENSe<Ch>:]CORRection:COLLect:FIXTure:EXPort
[SENSe<Ch>:]CORRection:COLLect:FIXTure:IMPort
```

5.14.3 One Way Loss tab

Defines loss parameters for each physical port.

Use the complementary dock widget to activate or deactivate length/loss compensation for selected ports (see [Chapter 5.14.1.2, "Offset panel"](#), on page 707).



Background information

Refer to the following sections.

- [Chapter 4.6, "Offset parameters and de-/embedding"](#), on page 228
- [Chapter 4.6.1.2, "Definition of loss parameters"](#), on page 229
- [Chapter 4.6.1.4, "Auto Length and Loss"](#), on page 231
- [Chapter 4.6.1.5, "Fixture Compensation"](#), on page 232



Overview

See ["Overview"](#) on page 717.

Port

Physical test port of the analyzer. You can define independent loss parameters for all ports.

Remote command:

The `<PhyPt>` numeric suffix in the `[SENSe<Ch>:]CORRection:...` commands identifies the physical port.

Loss at DC / Loss at 1st Freq / 1st Freq for Loss

See ["Loss at DC / Loss at 1st Freq / 1st Freq for Loss / Use 2nd Freq / Loss at 2nd Freq / 2nd Freq for Loss"](#) on page 708.

Auto Length and Loss

Determines the length offset and one-way loss parameters for the receive port of the active trace. See [Chapter 4.6.1.4, "Auto Length and Loss"](#), on page 231.

Note:

- If "Auto Length and Loss" is used with a line connected to a test port, the end of the line should be left open.
- To calculate the electrical length offset and loss of port i , you have to select a trace that uses port i as one of its receive ports. It is **not** relevant for the "Auto Length and Loss" function which [Port](#) is selected.

If the measured quantity is a ratio, or if it is derived from a ratio, its receiving port is given as the index of the wave quantity in the numerator. If the active trace shows an S-parameter S_{ij} , then "Auto Length" adds a length offset at port i . If the receive port is balanced, then the same offset and length is applied to both its physical ports.

Remote command:

`[SENSe<Ch>:]CORRection:LOSS:AUTO`

Fixture Compensation...

The "Fixture Compensation..." button opens the [Fixture Compensation dialog](#).

Evaluation Range...

The "Evaluation Range..." button opens the [Evaluation Range dialog](#) that allows you to restrict the frequency range of auto length (and loss) calculations.

5.14.4 Single Ended tab

Allows you to specify 2-port deembedding/embedding networks for each physical port.

Such a network is either defined:

- via its S-parameters stored in a two-port Touchstone file (*.s2p) or
- by selecting a predefined lumped element model and specifying the available parameters (resistances/conductances, capacitances, inductances)

See [Chapter 4.6.2.3, "Circuit models for 2-port networks"](#), on page 235.

Use the complementary dock widget to activate or deactivate deembedding/embedding for selected ports (see [Chapter 5.14.1.3, "Single Ended panel"](#), on page 709).

**Background information**

Refer to the section [Chapter 4.6.2.10, "Combining Several de-/embedding networks"](#), on page 244.

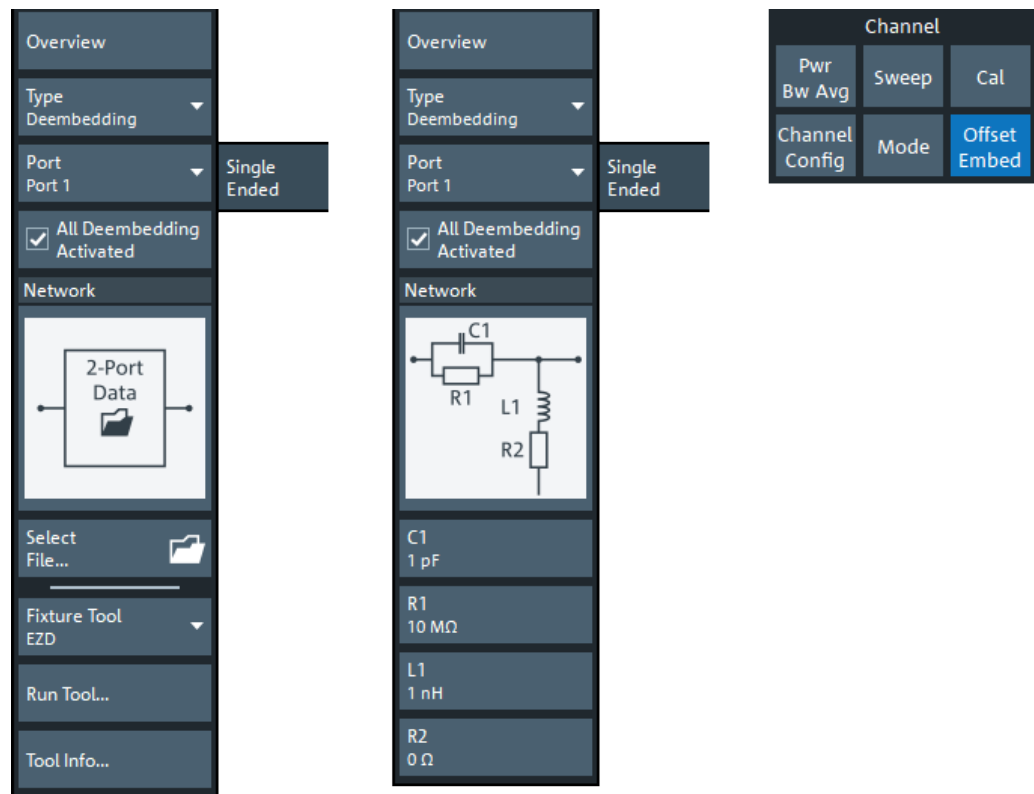

Figure 5-40: Offset Embed > Single Ended softtool

left = 2 port data file selected for deembedding

right = lumped element model selected for de-/embedding



If the "Fixture Simulator" is disabled for the related channel (see "Fixture Simulator" on page 655), this tab is inactive, i.e. all controls except the "Overview" button are grayed out.

Overview

See "Overview" on page 717.

Type

Switches between "Deembedding" and "Embedding" network definition.

Port

Physical port. The transformation networks are defined such that the analyzer is connected to the left of the circuit while the DUT is connected to the right side. You can define independent transformation networks for all ports.

Remote command:

The <PhyPt> numeric suffix in the embedding/deembedding commands identifies the physical port; see e.g. `CALCulate<Ch>:TRANSform:VNETworks:SENDED:DEEMbedding<PhyPt>[:STATe]` or `CALCulate<Ch>:TRANSform:VNETworks:SENDED:EMBedding<PhyPt>[:STATe]`.

All Deembedding Activated

Deactivates or activates all deembeddings (single-ended, balanced, port set, ground loop) for the active channel, if any.

This control is only visible if **Type** = "Deembedding".

Remote command:

n.a.

Network

The graphical list contains all available 2-port networks:

- The  symbol selects "no network" and disables single-ended de-/embedding.
- The "2-Port Data" network is defined by means of an s2p file (see [Select File...](#)). For deembedding, the s2p file can also be generated by a third-party fixture modeling tool (see ["Fixture Tool"](#) on page 727).
- The remaining networks are defined by lumped elements. Their parameters are displayed below the graphical list.

Tip: Drag and drop the network symbols in horizontal or vertical direction to switch to the next symbol. The lumped elements are numbered from top to bottom.

Remote command:

```
CALCulate<Ch>:TRANSform:VNETworks:SENDED:DEEMbedding<PhyPt>[:STATE]
```

```
CALCulate<Ch>:TRANSform:VNETworks:SENDED:DEEMbedding<PhyPt>:TNDefinition
```

```
CALCulate<Ch>:TRANSform:VNETworks:SENDED:DEEMbedding<PhyPt>:PARAMeters:C<Cmp>
```

```
CALCulate<Ch>:TRANSform:VNETworks:SENDED:DEEMbedding<PhyPt>:PARAMeters:G<Cmp>
```

```
CALCulate<Ch>:TRANSform:VNETworks:SENDED:DEEMbedding<PhyPt>:PARAMeters:L<Cmp>
```

```
CALCulate<Ch>:TRANSform:VNETworks:SENDED:DEEMbedding<PhyPt>:PARAMeters:R<Cmp>
```

```
CALCulate<Ch>:TRANSform:VNETworks:SENDED:EMBedding<PhyPt>[:STATE]
```

```
CALCulate<Ch>:TRANSform:VNETworks:SENDED:EMBedding<PhyPt>:TNDefinition
```

```
CALCulate<Ch>:TRANSform:VNETworks:SENDED:EMBedding<PhyPt>:PARAMeters:C<Cmp>
```

```
CALCulate<Ch>:TRANSform:VNETworks:SENDED:EMBedding<PhyPt>:PARAMeters:G<Cmp>
```

```
CALCulate<Ch>:TRANSform:VNETworks:SENDED:EMBedding<PhyPt>:PARAMeters:L<Cmp>
```

```
CALCulate<Ch>:TRANSform:VNETworks:SENDED:EMBedding<PhyPt>:PARAMeters:R<Cmp>
```

Select File...

"Select File..." is enabled as long as the "2-Port Data" network is selected. This network is defined by its S-parameters stored in a two-port Touchstone file (*.s2p). No additional parameters are required.

In case the port number conventions of the loaded two-port Touchstone file differ from network analyzer conventions (port 1 on the left, i.e. on the analyzer side; port 2 on the right, i.e. on the DUT side), it is possible to "Swap Gates". The analyzer will interchange the port numbers (e.g. S_{12} --> S_{21}) when loading the file.

Note: The loaded file is stored in the active recall set. Recall sets contain the full (de-)embedding data so that they can be transferred to other instruments.

Remote command:

```
MMEMory:LOAD:VNETworks<Ch>:SENDED:DEEMbedding<PhyPt>
```

```
MMEMory:LOAD:VNETworks<Ch>:SENDED:EMBedding<PhyPt>
```

Fixture Tool

The "Fixture Tool" section is only available for deembedding 2-port data networks.

Its controls allow you to select and run a third-party fixture modeling tool (see [Chapter 4.6.2.9, "Fixture modeling and deembedding"](#), on page 242) and to use its results for single-ended deembedding.

If the selected fixture modeling tool is not installed on the instrument, the "Run Tool" button is disabled/grayed out. Otherwise it opens the [Fixture modeling dialog](#) that guides you through the fixture modeling.

Use the "Info" button to get additional information about the selected tool.

Remote command:

```
CALCulate:FMODeL:DEASsistant:TOOL
```

5.14.5 Fixture modeling dialog

Allows you to model a test fixture using the selected fixture modeling tool and to deembed selected ports using the generated touchstone files.



Supported fixture modeling tools

The following fixture modeling tools are supported:

- [Chapter 4.7.15, "Eazy de-embedding based on IEEE 370"](#), on page 298
- [Chapter 4.7.16, "In-situ de-embedding"](#), on page 299
- [Chapter 4.7.17, "Smart fixture de-embedding"](#), on page 300

Access: Channel – [Offset Embed] > "Single Ended" / "Balanced" > "Run Tool"

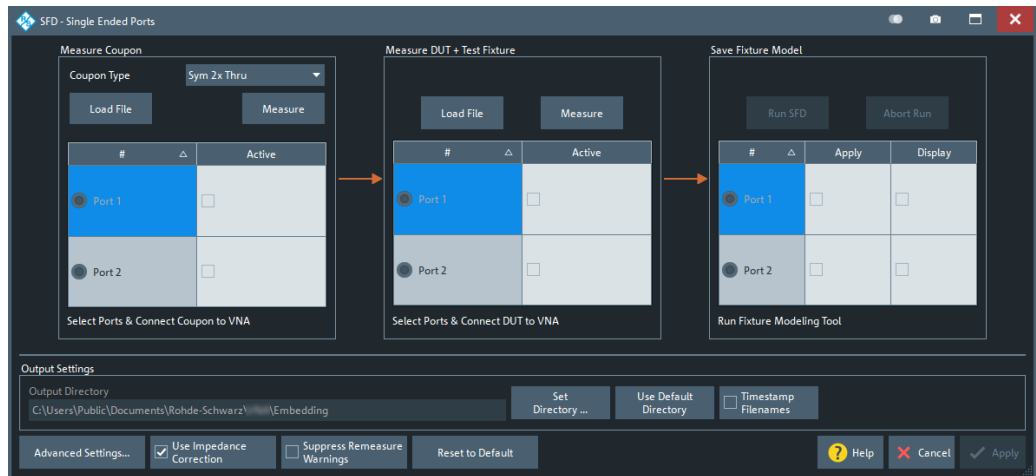

Figure 5-41: Fixture modeling dialog: SFD - Single Ended Ports

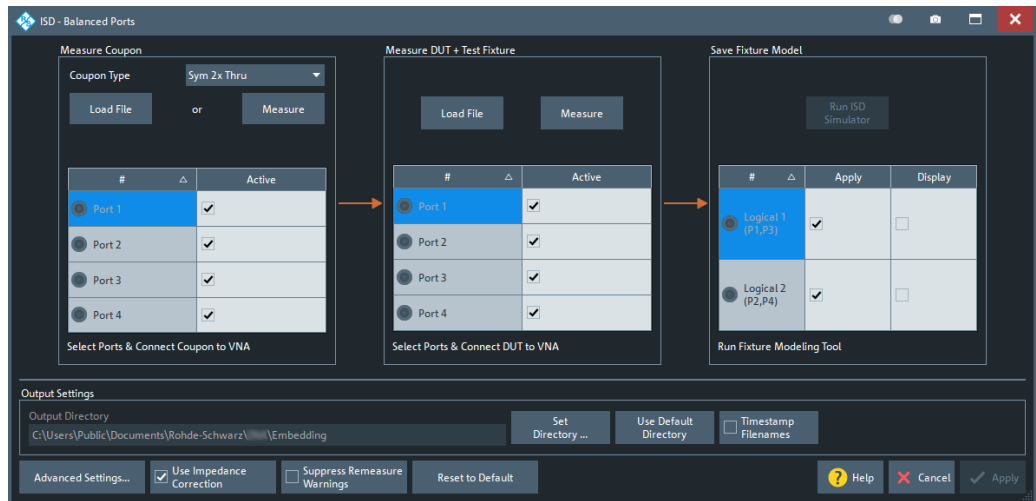

Figure 5-42: Fixture modeling dialog: ISD - Balanced Ports

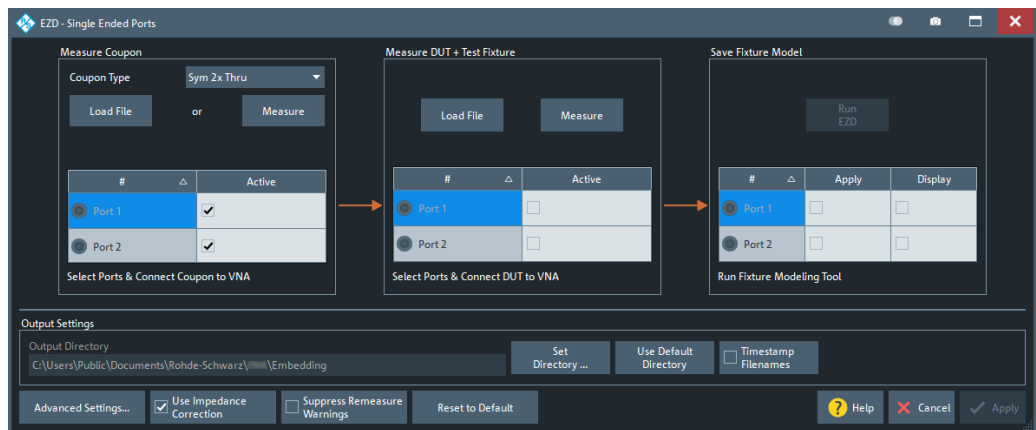

Figure 5-43: Fixture modeling dialog: EZD - Single Ended Ports

The fixture modeling proceeds in the following steps:

1. Measure one or more test coupons for the related fixture; see [Chapter 5.14.5.2, "Measure Coupon"](#), on page 730
The tools differ in the available coupon types.
2. Measure the DUT with the fixture; see [Chapter 5.14.5.3, "Measure DUT + Test Fixture"](#), on page 732
3. Run the selected tool to calculate the Touchstone files modeling the test fixture; see [Chapter 5.14.5.4, "Save Fixture Model"](#), on page 734.

The calculated sNp file(s) can then be used to deembed the DUT at selected port(s).



All files generated by actions in this dialog are stored in the directory C:\Users\Public\Documents\Rohde-Schwarz\ZNA\Embedding.



The current implementation assumes symmetrical lead-ins and lead-outs.

5.14.5.1 Common controls on the dialog

The following controls are located at the bottom of each dialog (ISD/SFD/EZD, single-ended/balanced):

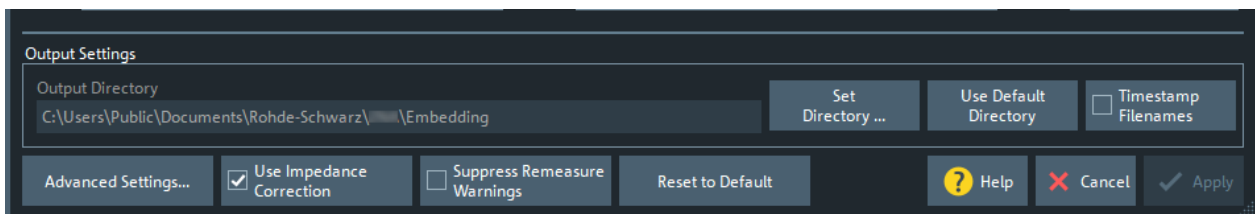

Output Settings

Allows you to specify the directory where the fixture modeling tools store their data.

Default is C:\Users\Public\Documents\Rohde-Schwarz\ZNA\Embedding.

If "Timestamp Filenames" is checked, the names of subsequently generated "Test Coupon" and "DUT + Test Fixture" files are prefixed with the current date and time.

Remote command:

```
CALCulate:FMODEl:DIRectory
CALCulate:FMODEl:DIRectory:DEFault
CALCulate:FMODEl:DIRectory:DEFault:CLEar
CALCulate:FMODEl:REName
```

Advanced Settings ...

Opens the "Advanced Settings" dialog of the selected tool. See:

- [Chapter 5.14.5.6, "ISD Advanced Settings"](#), on page 736
- [Chapter 5.14.5.7, "SFD Advanced Settings"](#), on page 740

- [Chapter 5.14.5.8, "EZD Advanced Settings"](#), on page 741

Use Impedance Correction

Enables/disables the impedance correction functionality of the respective tool.

This is a global setting.

Remote command:

```
CALCulate:FModel:EZD:IMPedance
CALCulate:FModel:ISD:IMPedance
CALCulate:FModel:SFD:IMPedance
(CALCulate:FModel:SFD:AUTO)
```

Suppress Remeasure Warnings

If checked, the [Measure Coupon](#) and [Measure DUT + Test Fixture](#) do not raise warnings, if the measurement is repeated with different ports.

This is a global setting.

Remote command:

n.a.

Reset to Default

Restores the default settings of the selected fixture modeling tool. This comprises:

- The states and settings in the [Measure Coupon](#), [Measure DUT + Test Fixture](#) and [Save Fixture Model](#) sections (common for all tools)
- The global settings of the selected tool (tool specific)

Remote command:

```
CALCulate:FModel:ISD:PRESet
CALCulate:FModel:SFD:PRESet
CALCulate:FModel:EZD:PRESet
```

Apply

This button is only active, if the selected deembedding tool has been successfully run (see [Chapter 5.14.5.4, "Save Fixture Model"](#), on page 734).

Applies the calculated deembedding files `<...>_left_DUT.sNp` and `<...>_right_DUT.sNp` to the ports marked "Active" in the [Save Fixture Model](#) section.

Remote command:

```
MMEMory:LOAD:VNETworks<Ch>:SENDEd:DEEMbedding<PhyPt>
MMEMory:LOAD:VNETworks<Ch>:BALanced:DEEMbedding<LogPt>
```

Cancel

Closes the dialog without applying any deembedding files.

5.14.5.2 Measure Coupon

The "Measure Coupon" section allows you to measure one or more test coupons for the related fixture.

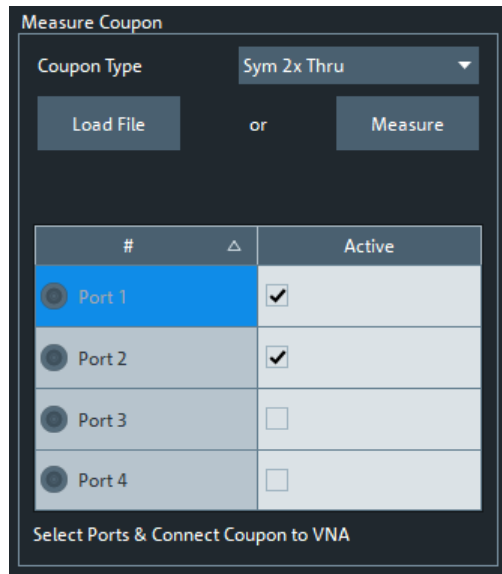

Coupon Type

Selects the coupon type to be measured. The following coupon types are supported:

	ISD	SFD	EZD
"Sym 2x Thru"	✓	✓	✓
"1x Open"	✓	✓	–
"1x Short"	✓	✓	–
"1x Open, 1x Short"	✓	–	–

Remote command:

`CALCulate:FModel:ISD:COUPon:TYPE`

`CALCulate:FModel:SFD:COUPon:TYPE`

Measure / Measure Open / Measure Short

Starts the coupon measurement at the **Active** ports.

The display area shows all the S parameter measurements being made. The resulting Touchstone file is written to C:\Users\Public\Documents\Rohde-Schwarz\ZNA\Embedding.

For **Coupon Type** "1x Open, 1x Short" (ISD only) the measurement proceeds in two steps: one for the "1x Open" and one for the "1x Short" coupon. The label of the "Measure" button changes accordingly.

Remote command:

`CALCulate:FModel:ISD:COUPon:MEASure`

`CALCulate:FModel:ISD:COUPon:MEASure:OPEN`

`CALCulate:FModel:ISD:COUPon:MEASure:SHORT`

`CALCulate:FModel:SFD:COUPon:MEASure`

`CALCulate:FModel:EZD:COUPon:MEASure`

Load File / 1x Open Preset / 1x Short Preset

Allows you to load the coupon properties from a Touchstone file (*.s*p”).

Remote command:

```
CALCulate:FModel:ISD:COUPon:MEASure:FiLename
CALCulate:FModel:ISD:COUPon:MEASure:FiLename:CLear
CALCulate:FModel:ISD:COUPon:MEASure:OPEN:FiLename
CALCulate:FModel:ISD:COUPon:MEASure:SHORt:FiLename
CALCulate:FModel:SFD:COUPon:MEASure:FiLename
CALCulate:FModel:SFD:COUPon:MEASure:FiLename:CLear
CALCulate:FModel:EZD:COUPon:MEASure:FiLename
CALCulate:FModel:EZD:DUT:MEASure:FiLename:CLear
```

Active

Before starting to [measure](#) the test coupon, use these checkboxes to indicate the physical ports to which it is connected.

Table 5-9: Allowed numbers of active ports

	"Sym 2x Thru"	"1x Open, 1x Short"	other
Single-ended	2	1 or 2	1
Balanced	2 or 4	2 or 4	2

Remote command:

```
CALCulate:FModel:ISD<Ph_pt>:COUPon[:STATe]
CALCulate:FModel:SFD<Ph_pt>:COUPon[:STATe]
CALCulate:FModel:EZD<Ph_pt>:COUPon[:STATe]
```

5.14.5.3 Measure DUT + Test Fixture

The "Measure DUT + Test Fixture" section allows you to measure the whole structure, i.e. the DUT with the test fixture.



For EZD this section is only available if [impedance correction](#) is enabled in the "Advanced Settings".

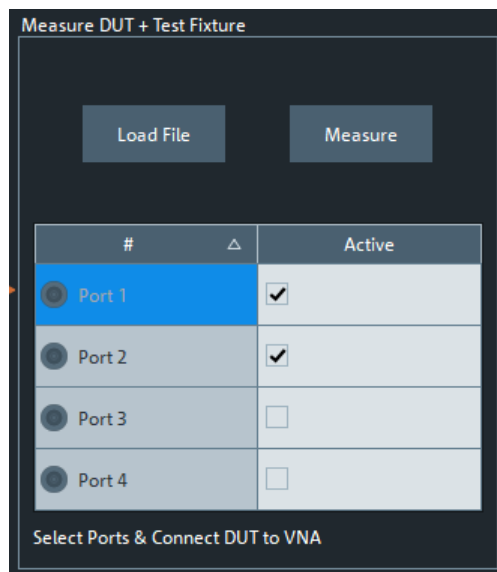

Load File

Load DUT + test fixture data from file

Remote command:

```
CALCulate:FModel:EZD:DUT:MEASure:FiLename
CALCulate:FModel:EZD:DUT:MEASure:FiLename:CLear
CALCulate:FModel:ISD:DUT:MEASure:FiLename
CALCulate:FModel:ISD:DUT:MEASure:FiLename:CLear
CALCulate:FModel:SFD:DUT:MEASure:FiLename
CALCulate:FModel:SFD:DUT:MEASure:FiLename:CLear
```

Measure

Starts the measurement of DUT + test fixture at the **Active** ports.

The display area shows all the S parameter measurements being made. The resulting Touchstone file is written to C:\Users\Public\Documents\Rohde-Schwarz\ZNA\Embedding.

Remote command:

```
CALCulate:FModel:EZD:DUT:MEASure
CALCulate:FModel:ISD:DUT:MEASure
CALCulate:FModel:SFD:DUT:MEASure
```

Active

Before starting to **Measure**, use these checkboxes to indicate the physical ports to which DUT + test fixture are connected. For single-ended deembedding, 2 ports must be active, for balanced deembedding 4 ports.

Remote command:

```
CALCulate:FModel:EZD<Ph_pt>:DUT[:STATe]
CALCulate:FModel:ISD<Ph_pt>:DUT[:STATe]
CALCulate:FModel:SFD<Ph_pt>:DUT[:STATe]
```

5.14.5.4 Save Fixture Model

This section allows you to run the selected deembedding tool to generate the Touchstone files for fixture deembedding (and the Touchstone file of the de-embedded DUT).

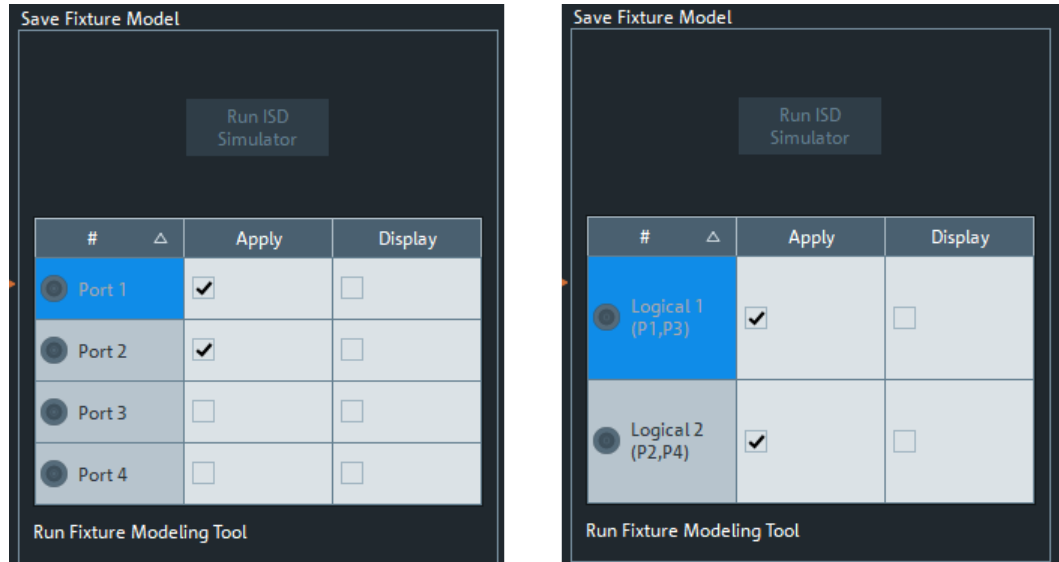

Figure 5-44: Save Fixture Model section

left = single-ended
right = balanced

Run <Fixture Modeling Tool>

Runs the selected fixture deembedding tool.

This button is only active, if both:

- the test coupon measurement finished successfully or the test coupon data were successfully loaded from file (see [Chapter 5.14.5.2, "Measure Coupon"](#), on page 730)
- the measurement of DUT + test fixture finished successfully (see [Chapter 5.14.5.3, "Measure DUT + Test Fixture"](#), on page 732)

The resulting Touchstone files (S parameters of the lead-ins, the lead-outs, and the de-embedded DUT) are written to C:\Users\Public\Documents\Rohde-Schwarz\ZNA\Embedding. If result files with the same names already exist, you can decide whether you want to rename or overwrite them.

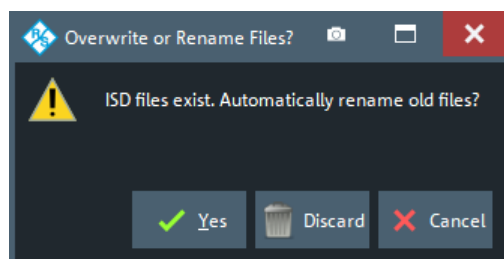

If running the deembedding tool causes errors, the [<Deembedding Tool> Errors dialog](#) provides additional information.

Note: For ISD first a batch task file `Embeddingconfig_znb.abt` is created and then the tool is run in batch mode (see the ISD User Guide).

Remote command:

```
CALCulate:FMODEl:ISD:RUN:RUN
```

```
CALCulate:FMODEl:SFD:RUN:RUN
```

```
CALCulate:FMODEl:EZD:RUN:RUN
```

Apply

Use these checkboxes to indicate the ports (physical for single-ended deembedding, logical for balanced deembedding) to which the deembedding files (generated by [Run <Fixture Modeling Tool>](#)) shall be assigned when the dialog is closed using [Apply](#).

Note: For a "left" deembedding file the original port order is used, for a "right" deembedding files the swap gates (ports) function is used.

Remote command:

```
CALCulate:FMODEl:EZD<Pt>:RUN[:STATe]
```

```
CALCulate:FMODEl:ISD<Pt>:RUN[:STATe]
```

```
CALCulate:FMODEl:SFD<Ph_pt>:RUN[:STATe]
```

Display

Select "Display" to display some or all the S parameter traces of the generated touchstone file that are applied for deembedding. A dialog then allows you to select the S parameter traces to be imported to new memory traces:

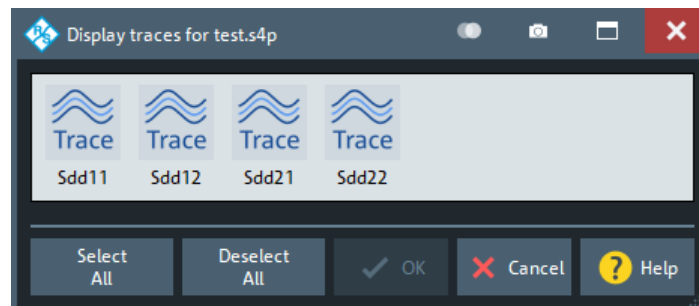

5.14.5.5 <Deembedding Tool> Errors dialog

If running the related deembedding tool causes errors, a dialog provides additional information:

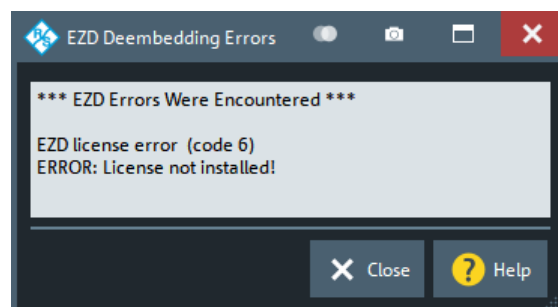

Figure 5-45: EZD error messages

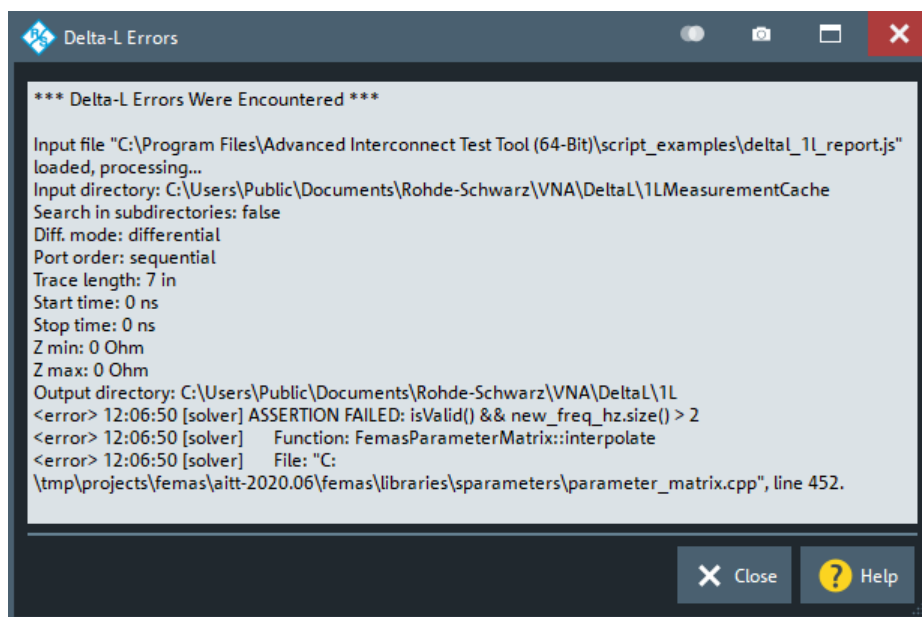
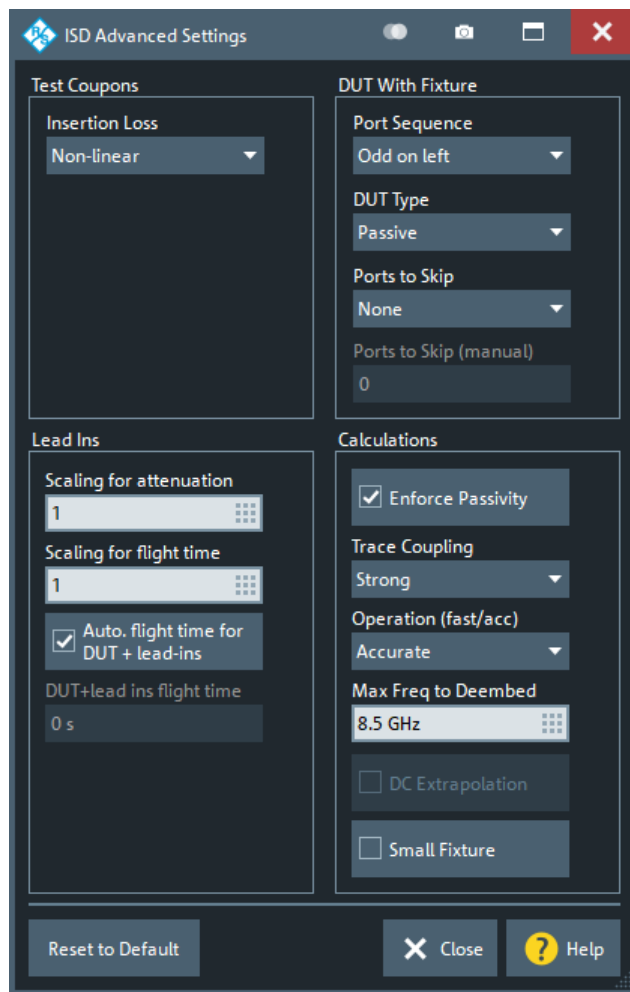

Figure 5-46: Delta-L error messages

5.14.5.6 ISD Advanced Settings

Advanced settings of the ISD tool. For details, see the ISD User Guide.

For the analyzer firmware, these settings are global.



Test Coupons > Insertion Loss

Tells the ISD tool about the linearity of the 2xThru test coupon:

- "Linear": Linear insertion loss
- "Non-Linear" (default): Non-linear insertion loss
- "Resonant": The 2x Thru test coupon is split and used directly for deembedding
This option can be more accurate if the fixture and the 2x Thru have the same impedance at every location.

Remote command:

`CALCulate:FMODEl:ISD:ATTenuation:BEHavior`

Lead Ins

Defines how the ISD tool interprets the lead-in data.

Scaling for attenuation ← Lead Ins

Scales the test coupon's attenuation.

Default is 1.

Remote command:

`CALCulate:FMODEl:ISD:SCALE:ATTenuation`

Scaling for flight time ← Lead Ins

Overrides the lead-in's flight time (i.e. its delay) in case the through-trace test coupon is a bit too short or too long.

Default is 1.

Remote command:

```
CALCulate:FModel:ISD:SCALE:FTIME
```

Auto. flight time for DUT + lead-Ins ← Lead Ins

If checked (default) the flight time for DUT + lead-ins is calculated automatically. Otherwise it can be specified manually (see "DUT + lead-ins flight time" on page 738).

Remote command:

```
CALCulate:FModel:ISD:FTIME:OVERride
```

DUT + lead-ins flight time ← Lead Ins

Allows you to set the flight time for DUT + lead-ins manually, if [Auto. flight time for DUT + lead-Ins](#) is deactivated,

Set the value manually, if the "DUT + Test Fixture" does not have a Through response and the total flight time exceeds 10ns.

Remote command:

```
CALCulate:FModel:ISD:FTIME:DUT
```

DUT With Fixture

Defines how the ISD tool interprets the "DUT + Test Fixture" data.

Port Sequence ← DUT With Fixture

Tells the ISD tool about the arrangement of "DUT + Fixture" ports:

- "1 to N on left": Ports 1 to N are on the left and ports N+1 to 2*N are on the right.
- "Odd on left" (default): 1, 3, 5, etc. are on the left and ports 2, 4, 6, etc. are on the right.
- "All on left": All ports are on the left

Note: Ports on the left/right are assumed to be coupled (if [Trace Coupling](#) is not set to "None". A port on the left side is not considered to be coupled to a port on the right side.

Remote command:

```
CALCulate:FModel:ISD:PORT:ORDER
```

DUT Type ← DUT With Fixture

Select "Passive"/"Active" if the DUT is passive/active.

Default is "Passive".

Remote command:

```
CALCulate:FModel:ISD:DUT:TYPE
```

Ports to Skip ← DUT With Fixture

Tells the ISD tool which ports (in the measured "DUT + Test Fixture" file) to skip when the tool is run.

- "None" (default): do not skip any ports
- "Ports on left": Skip the ports on the left (according to the selected [Port Sequence](#))

- "Ports on right": Skip the ports on the right (according to the selected port sequence)
- "Manually set ports": use [Ports to Skip \(manual\)](#) to define the ports to be skipped

Remote command:

```
CALCulate:FModel:ISD:PORT:SKIP:NONE
```

```
CALCulate:FModel:ISD:PORT:SKIP:LEFT
```

```
CALCulate:FModel:ISD:PORT:SKIP:RIGHT
```

Ports to Skip (manual) ← DUT With Fixture

If [Ports to Skip](#) is set to "Manually set ports", this text field allows you to define the ports to be skipped. Enter the port numbers, separated by blanks (e.g. '1 3 4').

Remote command:

```
CALCulate:FModel:ISD:PORT:SKIP
```

Calculations

Some additional parameters that define how the ISD tool calculates its output.

Enforce Passivity ← Calculations

If checked (default), the ISD tool enforces passivity and reciprocity for the test coupons and the test fixture.

Remote command:

```
CALCulate:FModel:ISD:PASSivity
```

Trace Coupling ← Calculations

Tells the ISD tool about coupling among lead-in traces

- "None": No coupling.
The ISD tool optimizes odd- and single-ended insertion losses.
- "Weak": Coupling is extracted even if there are 2 ports enabled on the test coupon
- "Strong" (default): If the test coupon is a 4-port file, and there are two ports to be extracted, the ISD tool optimizes odd- and even-mode insertion losses.
The ISD tool automatically reverts to "Weak" if these conditions are not met.

Remote command:

```
CALCulate:FModel:ISD:TRACe:COUPLing
```

Operation (fast/acc) ← Calculations

Influences the speed of execution and accuracy of the ISD tool.

- "Accurate" (default): Normal execution mode
- "Fast": reduces the execution time to ~50%
Often this mode can be enabled with only little loss of accuracy.

Remote command:

```
CALCulate:FModel:ISD:OPERation
```

Max Freq to Deembed ← Calculations

When the test coupon's return loss is not less than the insertion loss, the maximum frequency to deembed together with the proper [Insertion Loss](#) setting gives the best accuracy.

By default, the maximum frequency is set to the maximum frequency the VNA can use.

Remote command:

`CALCulate:FModel:ISD:SCALE:FREQUENCY`

DC Extrapolation ← Calculations

This setting is only active, if a recent version of the ISD tool (from 2019-12 or later) is used.

If unchecked (default), the touchstone data of the generated deembedding file reach down to the start frequency of the instrument sweep. If checked, the ISD tool adds (extrapolated) S-parameter data for $f = 0$.

Remote command:

`CALCulate:FModel:ISD:DCEXtrapolat`

Small Fixture ← Calculations

Enables/disables the ISD tool's small fixture mode.

Remote command:

`CALCulate:FModel:ISD:SMALLfixture`

Reset to Default

Resets the settings of the "ISD Advanced Settings" to their defaults.

Remote command:

`CALCulate:FModel:ISD:PRESet`

5.14.5.7 SFD Advanced Settings

Advanced settings of the SFD tool. For the analyzer firmware, these settings are global.

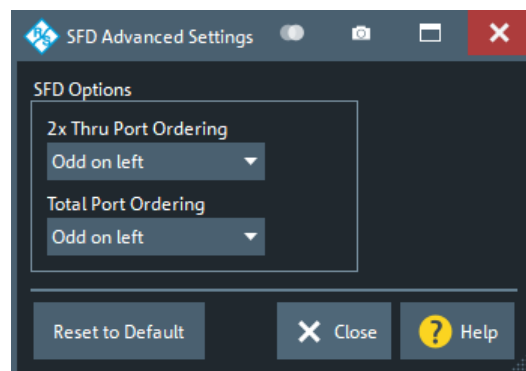

2x Thru Port Ordering

Tells the SFD tool about the port ordering of the 2x Thru test coupon

- "Ports 1&3 on Left" (default): Odd ports are on the left and even ports are on the right
- "Ports 1&2 on Left" ports 1 to N are on the left and ports N+1 to 2·N are on the right

Remote command:

`CALCulate:FModel:SFD:DIFFcfg`

Total Port Ordering

Tells the SFD tool about the port ordering of the test fixture

- "Ports 1&3 on Left" (default): Odd ports are on the left and even ports are on the right
- "Ports 1&2 on Left" ports 1 to N are on the left and ports N+1 to 2·N are on the right

Remote command:

`CALCulate:FMODEl:SFD:TOTaldiffcfg`

Reset to Default

Resets the settings of the "SFD Advanced Settings" to their defaults.

Remote command:

`CALCulate:FMODEl:SFD:PRESet`

5.14.5.8 EZD Advanced Settings

Advanced settings of the EZD tool. For the analyzer firmware, these settings are global.

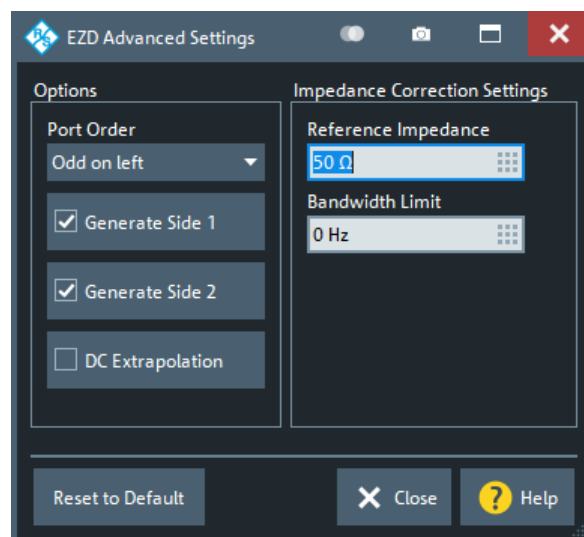
**Port Order**

Tells the EZD tool about the port ordering of the test coupon

- "Odd on left" (default): Odd ports are on the left and even ports are on the right
- "1 to N on left" ports 1 to N are on the left and ports N+1 to 2·N are on the right

Remote command:

`CALCulate:FMODEl:EZD:PORT:ORDER`

Generate Side 1/Generate Side2

If checked (default), the tool generates the deembedding file for side 1 / side 2.

Remote command:

`CALCulate:FMODEl:EZD:GENerate:SIDE<1|2>`

DC Extrapolation

If unchecked (default), the touchstone data of the generated deembedding file reach down to the start frequency of the instrument sweep. If checked, the EZD tool adds (extrapolated) S-parameter data for $f = 0$.

Remote command:

```
CALCulate:FMODEl:EZD:DCEXtrapolat
```

Impedance Correction Settings

Provides additional settings for the impedance correction of the EZD tool, if enabled in the main dialog (see [Use Impedance Correction](#)).

Remote command:

```
CALCulate:FMODEl:EZD:IMPedance:REFerence
```

```
CALCulate:FMODEl:EZD:IMPedance:BWIDlimit
```

Reset to Default

Resets the settings of the "EZD Advanced Settings" to their defaults.

Remote command:

```
CALCulate:FMODEl:EZD:PRESet
```

5.14.6 Port Sets tab

Selects transformation networks for deembedding/embedding arbitrary port sets, defines their parameters, assigns them to a port set and enables embedding.

Use the complementary dock widget to create the required port sets and to activate or deactivate dembedding/embedding for selected port sets (see [Chapter 5.14.1.4, "Port Sets panel"](#), on page 710).

**Background information**

Refer to [Chapter 4.6.2.5, "Port pair de-/embedding"](#), on page 238 and [Chapter 4.6.2.6, "Port set de-/embedding"](#), on page 239.

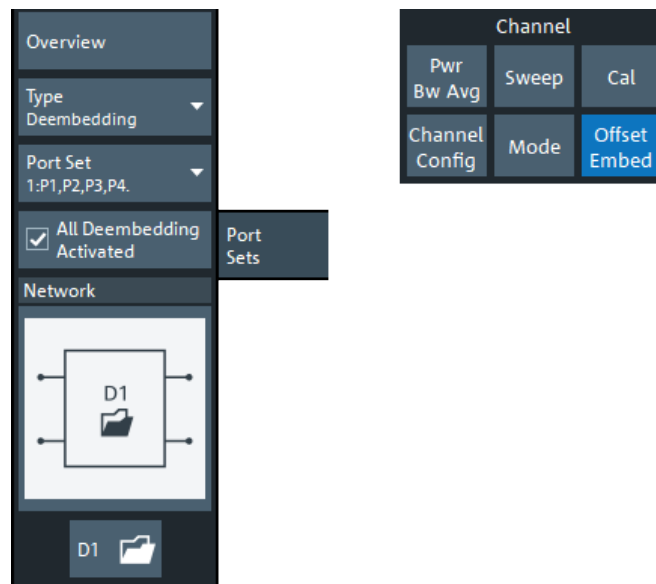

If the "Fixture Simulator" is disabled for the related channel (see ["Fixture Simulator"](#) on page 655), this tab is inactive, i.e. all controls except the "Overview" button are grayed out.

Overview

See ["Overview"](#) on page 717.

Type

Switches between "Deembedding" and "Embedding" network definition.

Port Set

Port sets, defined in the complementary [Port Sets panel](#) dock widget panel. The transformation networks are defined such that the physical analyzer test ports are connected to the left of the circuit; the DUT ports are on the right side. You can define independent transformation networks for all port sets.

The port set number, i.e. the number at the beginning of each "Port Set" item, corresponds to the position of the port set in the [Port Sets panel](#).

Remote command:

The port set number corresponds to the <ListId> numeric suffix in the port set de-/embedding commands; see e.g. `CALCulate<Ch>:TRANSform:VNETworks:PPAir:DEEMbedding<ListId>[:STATE]`.

All Deembedding Activated

Deactivates or activates all deembeddings (single-ended, balanced, port set, ground loop) for the active channel, if any.

This control is only visible if **Type** = "Deembedding".

Network

Depending on the size m of the selected port set, the graphical list contains all available $2m$ -port deembedding/embedding networks.

Note: For port *pairs* ($m=2$) the deembedding/embedding network can be defined either via lumped element models (in combination with s_{2p} Touchstone files) or via a s_{4p} Touchstone file (see [Chapter 4.6.2.5, "Port pair de-/embedding"](#), on page 238). For $m \geq 3$, there are no predefined lumped element models available; the deembedding/embedding network has to be defined via an $s_{<2m>p}$ Touchstone file.

The  symbol selects "no network" and disables de-/embedding for the selected port set. The "D1" and "D2" networks are defined by imported S-parameter data; see [D1](#), [D2](#).

For 4-port networks that are (partly) defined by lumped elements, the lumped element parameters are displayed below the graphical network list. See [Chapter 4.6.2.4, "Circuit models for 4-port networks"](#), on page 237.

Tip:

- Drag and drop the network symbols in horizontal or vertical direction to switch to the next symbol. The lumped elements and S-parameter networks ("D1", "D2") are numbered from top to bottom.
- Use the [Conductance in Embedding Networks](#) switch to change from resistances in "Capacitor in parallel with resistor" circuit blocks to conductances and vice versa.

Remote command:

```
CALCulate<Ch>:TRANSform:VNETworks:PPAir:DEEMbedding<ListId>:
TNDefinition
CALCulate<Ch>:TRANSform:VNETworks:PPAir:DEEMbedding<ListId>:
PARAmeters:C<1|2|3>
CALCulate<Ch>:TRANSform:VNETworks:PPAir:DEEMbedding<ListId>:
PARAmeters:L<1|2|3>
CALCulate<Ch>:TRANSform:VNETworks:PPAir:DEEMbedding<ListId>:
PARAmeters:R<1|2|3>
CALCulate<Ch>:TRANSform:VNETworks:PPAir:DEEMbedding<ListId>:
PARAmeters:G<1|2|3>
CALCulate<Ch>:TRANSform:VNETworks:PPAir:EMBedding<ListId>:
TNDefinition
CALCulate<Ch>:TRANSform:VNETworks:PPAir:EMBedding<ListId>:
PARAmeters:C<1|2|3>
CALCulate<Ch>:TRANSform:VNETworks:PPAir:EMBedding<ListId>:
PARAmeters:L<1|2|3>
CALCulate<Ch>:TRANSform:VNETworks:PPAir:EMBedding<ListId>:
PARAmeters:R<1|2|3>
CALCulate<Ch>:TRANSform:VNETworks:PPAir:EMBedding<ListId>:
PARAmeters:G<1|2|3>
```

D1, D2

The "D1" (and "D2") buttons are enabled as long as the selected deembedding/embedding network is defined using Touchstone files.

When loading a touchstone file, the analyzer by default assumes odd ports left (VNA side), even ports right (DUT side). However, it is also possible to instruct the analyzer to assume an "Increasing Port Sequence", i.e. that the low port numbers are on the VNA side. Furthermore it is possible to "Swap Gates", i.e. to instruct the analyzer to swap the VNA and DUT side.

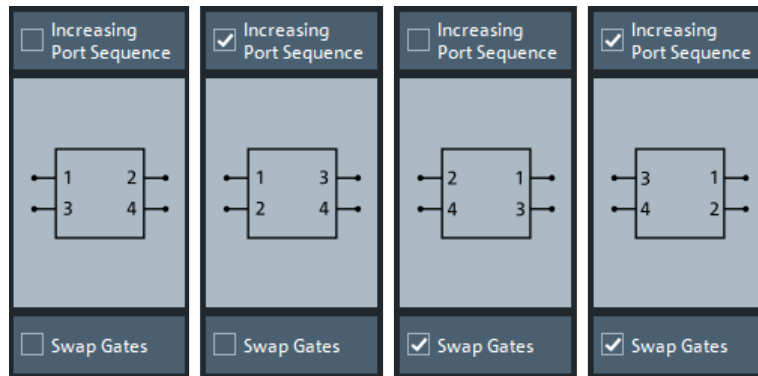

Note: The loaded file is stored in the active recall set. Persisted recall sets contain the full de-/embedding data so that they can be transferred to other instruments.

Remote command:

```
MMEMory:LOAD:VNETworks<Ch>:PPAir:DEEMbedding<ListId>
```

```
MMEMory:LOAD:VNETworks<Ch>:PPAir:EMBedding<ListId>
```

5.14.7 Balanced tab

Selects 4-port transformation networks for balanced port deembedding/embedding, defines their parameters, assigns them to a balanced port and enables embedding.

Use the complementary dock widget to create [Balanced panel](#) and to activate or deactivate deembedding/embedding for selected balanced ports (see [Chapter 5.14.1.5, "Balanced panel"](#), on page 712).



Background information

Refer to the section [Chapter 4.6.2.10, "Combining Several de-/embedding networks"](#), on page 244.

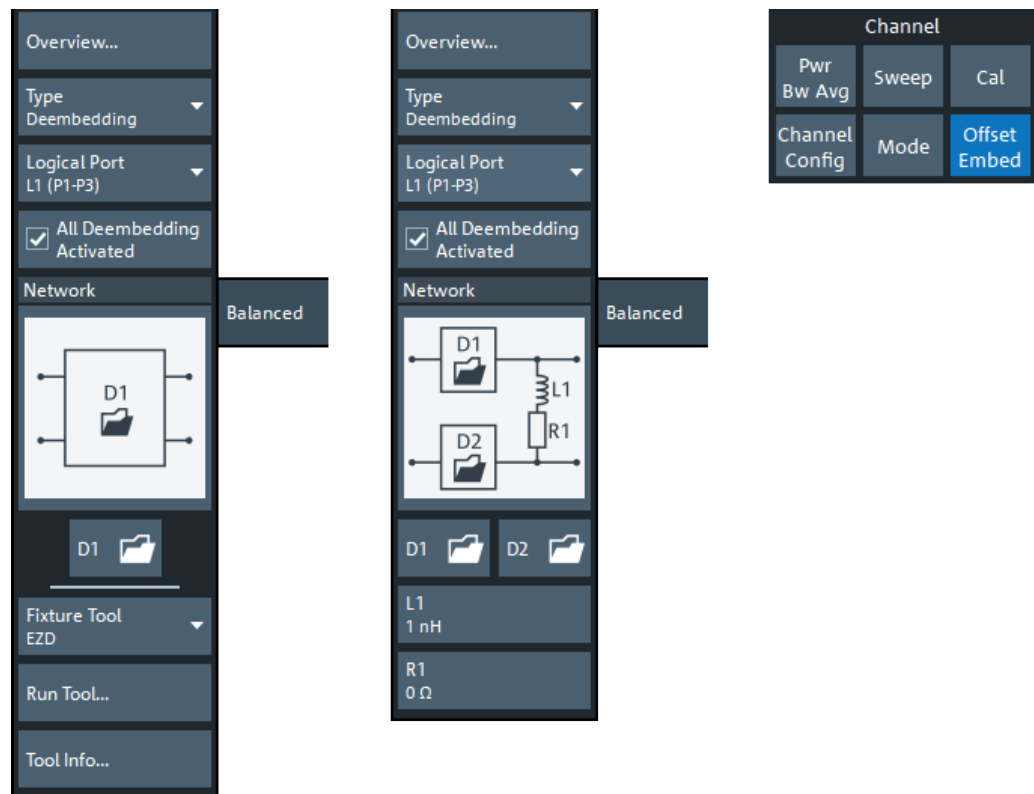

Figure 5-47: Offset Embed > Balanced softtool

left = 4 port data file selected for de-/embedding
 right = other network selected for de-/embedding



If the "Fixture Simulator" is disabled for the related channel (see "Fixture Simulator" on page 655), this tab is inactive, i.e. all controls except the "Overview" button are grayed out.

Overview

See "Overview" on page 717.

Type

Switches between "Deembedding" and "Embedding" network definition.

Logical Port

Logical analyzer port, as defined in the "Balanced Ports" configuration. The transformation networks are defined such that the physical analyzer test ports are connected to the left of the circuit; the DUT ports are on the right side.

You can define independent transformation networks for all balanced ports.

Remote command:

The <LogPt> numeric suffix in the embedding/deembedding commands identifies the logical port; see e.g. `CALCulate<Ch>:TRANSform:VNETworks:BALanced:EMBedding<LogPt>[:STATE]`.

All Deembedding Activated

Deactivates or activates all deembeddings (single-ended, balanced, port set, ground loop) for the active channel, if any.

This control is only visible if **Type** = "Deembedding".

Remote command:

n.a.

Network

The graphical list contains all available 4-port networks (see [Chapter 4.6.2.4, "Circuit models for 4-port networks"](#), on page 237).

The  symbol selects "no network" and disables deembedding/embedding for the selected balanced port.

The 4-port data network (symbol "D1" only) is defined by means of an s4p file (see [D1, D2](#)). For deembedding, the s4p file can also be generated by a third-party fixture modeling tool (see ["Fixture Tool"](#) on page 727).

Other 2-port data-subnetworks (symbols "D1" and "D2") are defined by means of s2p files (see [Network](#)).

The parameters of lumped elements are displayed below the graphical list.

Tip:

- Drag and drop the network symbols in horizontal or vertical direction to switch to the next symbol. The lumped elements and S-parameter networks ("D1", "D2") are numbered from top to bottom.
- Use the [Conductance in Embedding Networks](#) switch to change from resistances in "Capacitor in parallel with resistor" circuit blocks to conductances and vice versa.

Remote command:

```
CALCulate<Ch>:TRANSform:VNETworks:BALanced:DEEMbedding<LogPt>:
TNDefinition
CALCulate<Ch>:TRANSform:VNETworks:BALanced:DEEMbedding<LogPt>:
PARAmeters:C<Cmp>
CALCulate<Ch>:TRANSform:VNETworks:BALanced:DEEMbedding<LogPt>:
PARAmeters:L<Cmp>
CALCulate<Ch>:TRANSform:VNETworks:BALanced:DEEMbedding<LogPt>:
PARAmeters:R<Cmp>
CALCulate<Ch>:TRANSform:VNETworks:BALanced:DEEMbedding<LogPt>:
PARAmeters:G<Cmp>
CALCulate<Ch>:TRANSform:VNETworks:BALanced:EMBedding<LogPt>:
TNDefinition
CALCulate<Ch>:TRANSform:VNETworks:BALanced:EMBedding<LogPt>:
PARAmeters:C<Cmp>
CALCulate<Ch>:TRANSform:VNETworks:BALanced:EMBedding<LogPt>:
PARAmeters:L<Cmp>
CALCulate<Ch>:TRANSform:VNETworks:BALanced:EMBedding<LogPt>:
PARAmeters:R<Cmp>
CALCulate<Ch>:TRANSform:VNETworks:BALanced:EMBedding<LogPt>:
PARAmeters:G<Cmp>
```

D1, D2

The "D1" and "D2" buttons are enabled as long as the selected [Network](#) comprises subnetworks that are defined via two-port or four-port Touchstone files (*.s2p, *.s4p).

When loading a touchstone file, the analyzer by default assumes odd ports left (VNA side), even ports right (DUT side). However, it is also possible to instruct the analyzer to assume an "Increasing Port Sequence", i.e. that the low port numbers are on the VNA side. Furthermore it is possible to "Swap Gates", i.e. to instruct the analyzer to swap the VNA and DUT side.

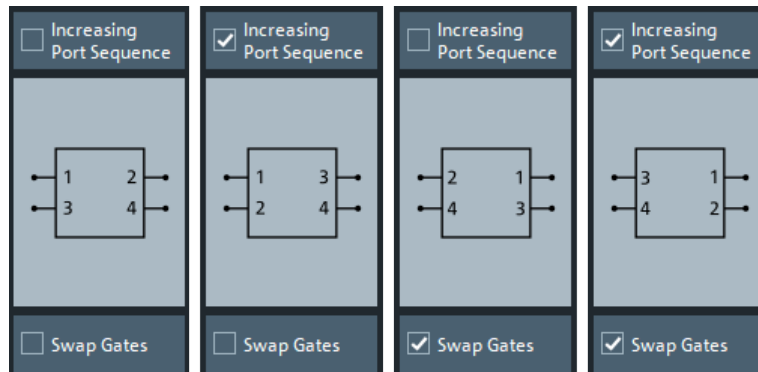

Note: The loaded file is stored in the active recall set. Persisted recall sets contain the full (de-)embedding data so that they can be transferred to other instruments.

Remote command:

`MMEMory:LOAD:VNETworks<Ch>:BALanced:DEEMbedding<LogPt>`

`MMEMory:LOAD:VNETworks<Ch>:BALanced:EMBedding<LogPt>`

Fixture Tool

The "Fixture Tool" section is only available for deembedding 4-port data networks.

Its controls allow you to select and run a third-party fixture modeling tool (see [Chapter 4.6.2.9, "Fixture modeling and deembedding"](#), on page 242) and to use its results for single-ended deembedding.

If the selected fixture modeling tool is not installed on the instrument, the "Run Tool" button is disabled/grayed out. Otherwise it opens the [Fixture modeling dialog](#) that guides you through the fixture modeling.

Use the "Info" button to get additional information about the selected tool.

Note: Define at least two [Balanced panel](#) before running the modeling tool.

5.14.8 Ground Loop tab

Allows you to specify a 1-port ground loop deembedding/embedding network.

Such a network is either defined

- via its S-parameter stored in a one-port Touchstone file (*.s1p) or
- by selecting a predefined lumped element model (Shunt L or Shunt C) and specifying the available parameters (resistance/inductance or resistance/capacitance)

Use the complementary dock widget to activate or deactivate ground loop deembedding and embedding (see [Chapter 5.14.1.6, "Ground Loop panel"](#), on page 713).

If [multiple port groups \(DUTs\)](#) are configured and [Ground Loop per Port Group](#) is enabled, use the dock widget to select the port group whose ground loop network shall be configured.



Background information

Refer to [Chapter 4.6.2.7, "Ground loop de-/embedding"](#), on page 241.

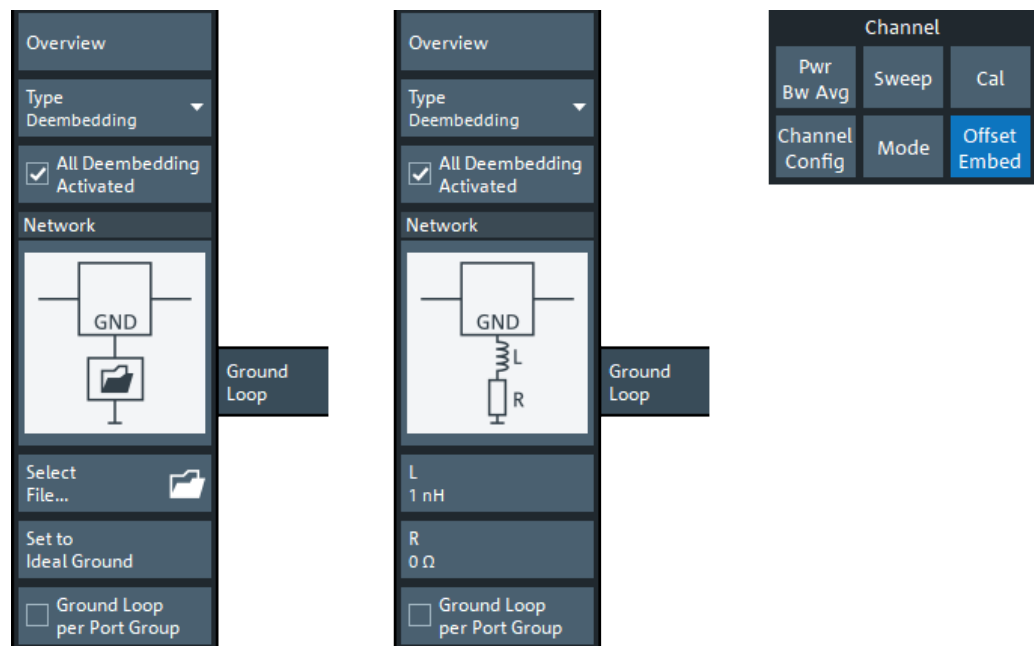

If the "Fixture Simulator" is disabled for the related channel (see ["Fixture Simulator"](#) on page 655), this tab is inactive, i.e. all controls except the "Overview" button are grayed out.

Overview

See ["Overview"](#) on page 717.

Type

Switches between "Deembedding" and "Embedding" network definition.

All Deembedding Activated

Deactivates or activates all deembeddings (single-ended, balanced, port set, ground loop) for the active channel, if any.

This control is only visible if [Type](#) = "Deembedding".

Network

The graphical list contains all available 1-port networks:

The  symbol selects "no network" and disables ground loop de-/embedding.

The "1-Port Data" network is defined by imported S-parameter data; see [Select File...](#)

The remaining networks (Shunt L and Shunt C) are defined by lumped elements whose parameters are displayed below the graphical list.

Tip:

- Drag and drop the network symbols in horizontal or vertical direction to switch to the next symbol.
- Use the [Conductance in Embedding Networks](#) switch to change from resistances in "Capacitor in parallel with resistor" model to conductances and vice versa.

Remote command:

```
CALCulate<Ch>:TRANSform:VNETworks:GLOop:DEEMbedding<group>:
TNDefinition
CALCulate<Ch>:TRANSform:VNETworks:GLOop:DEEMbedding<group>:
PARAMeters:C
CALCulate<Ch>:TRANSform:VNETworks:GLOop:DEEMbedding<group>:
PARAMeters:L
CALCulate<Ch>:TRANSform:VNETworks:GLOop:DEEMbedding<group>:
PARAMeters:R
CALCulate<Ch>:TRANSform:VNETworks:GLOop:DEEMbedding<group>:
PARAMeters:G
CALCulate<Ch>:TRANSform:VNETworks:GLOop:EMBedding<group>:
TNDefinition
CALCulate<Ch>:TRANSform:VNETworks:GLOop:EMBedding<group>:
PARAMeters:C
CALCulate<Ch>:TRANSform:VNETworks:GLOop:EMBedding<group>:
PARAMeters:L
CALCulate<Ch>:TRANSform:VNETworks:GLOop:EMBedding<group>:
PARAMeters:R
CALCulate<Ch>:TRANSform:VNETworks:GLOop:EMBedding<group>:
PARAMeters:G
```

Select File...

"Select File..." is enabled as long as the "1-Port Data" network is selected. This network is defined by its S-parameters stored in a one-port Touchstone file (*.s1p). No additional parameters are required.

Note: The loaded file is stored in the active recall set. Persisted recall sets contain the full (de-)embedding data so that they can be transferred to other instruments.

Remote command:

```
MMEMory:LOAD:VNETworks<Ch>:GLOop:DEEMbedding<group>
MMEMory:LOAD:VNETworks<Ch>:GLOop:EMBedding<group>
```

Set to Ideal Ground

This function is enabled as long as the 1-Port Data network is active. An imported S-parameter set is replaced by the S-parameters of an ideal through connection, which eliminates the transformation network.

Ground Loop per Port Group

If selected, each port group (= DUT) can have its own ground loop deembedding and embedding networks. Otherwise the same de-/embedding network is used for all active ports.

The checkbox is only visible if the instrument supports [multiple DUTs](#), which is the case for 4-port R&S ZNA.

Remote command:

`CALCulate<Ch>:TRANSform:VNETworks:GLOop:GROup`

5.14.9 Differential Match tab

Allows you to specify a 2-port embedding network for the differential mode of a balanced port.

Such a network is either defined

- via its S-parameter stored in a two-port Touchstone file (*.s2p) or
- by specifying the parameters of a "Shunt L, Shunt C" lumped element model

Use the complementary dock widget to access the balanced port configuration and to activate or deactivate "Differential Match" embedding for selected balanced ports (see [Chapter 5.14.1.8, "Differential Match panel"](#), on page 715).



Background information

Refer to [Chapter 4.6.2.8, "Differential match embedding"](#), on page 241.

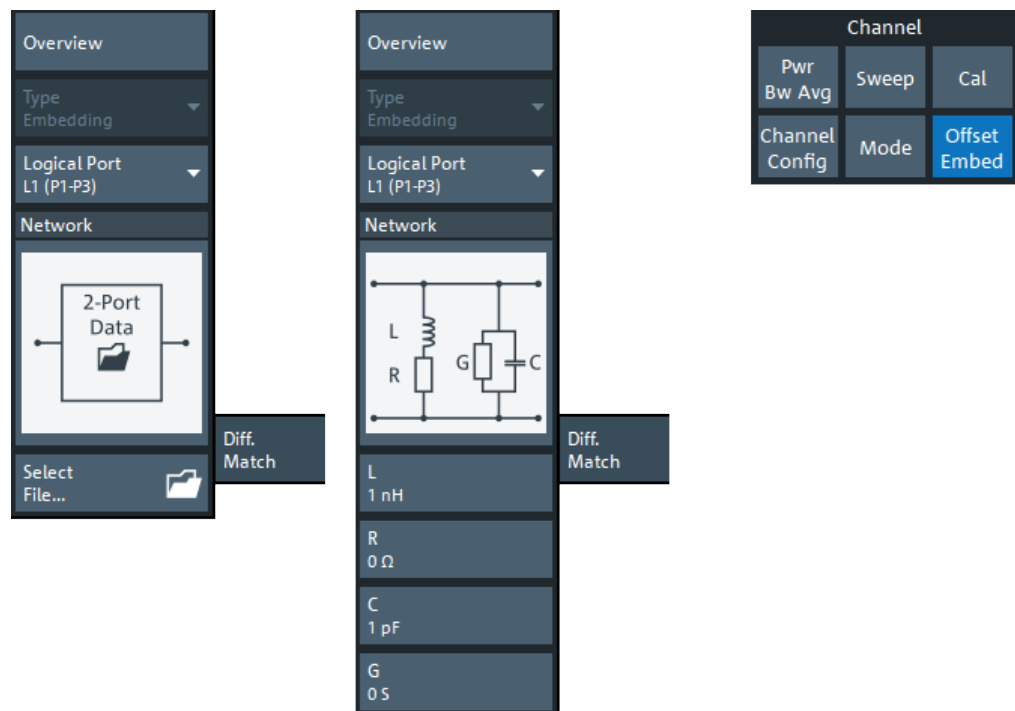



If the "Fixture Simulator" is disabled for the related channel (see ["Fixture Simulator"](#) on page 655), this tab is inactive, i.e. all controls except the "Overview" button are grayed out.

Overview

See ["Overview"](#) on page 717.

Type

Currently only Differential Match"Embedding" is supported.

Logical Port

Logical analyzer port, as defined in the "Balanced Ports" configuration. The transformation networks are defined such that the physical analyzer test ports are connected to the left of the circuit; the DUT ports are on the right side. You can define independent embedding networks for all balanced ports.

Remote command:

The <LogPt> numeric suffix in the embedding/deembedding commands identifies the logical port; see e.g. `CALCulate<Ch>:TRANSform:VNETworks:DIFFerential:EMBedding<LogPt>[:STATe]`.

Network

The graphical list contains the available 2-port networks for Differential Match embedding:

- The  symbol selects "no network" and disables differential match embedding for the selected balanced port.
- The "2-Port Data" network is defined by means of imported S-parameter data; see [Select File...](#)
- The "Shunt L, Shunt C" network is defined by lumped elements whose parameters are displayed below the graphical list.

Tip: Drag and drop the network symbols in horizontal or vertical direction to switch to the next symbol.

Remote command:

```
CALCulate<Ch>:TRANSform:VNETworks:DIFFerential:EMBedding<LogPt>:
TNDefinition
```

```
CALCulate<Ch>:TRANSform:VNETworks:DIFFerential:EMBedding<LogPt>:
PARAMeters:L<Cmp>
```

```
CALCulate<Ch>:TRANSform:VNETworks:DIFFerential:EMBedding<LogPt>:
PARAMeters:R<Cmp>
```

```
CALCulate<Ch>:TRANSform:VNETworks:DIFFerential:EMBedding<LogPt>:
PARAMeters:C<Cmp>
```

```
CALCulate<Ch>:TRANSform:VNETworks:DIFFerential:EMBedding<LogPt>:
PARAMeters:G<Cmp>
```

Select File...

"Select File..." is enabled as long as the "2-Port Data" network is selected. This network is defined by its S-parameters stored in a two-port Touchstone file (* .s2p). No additional parameters are required.

Note: The loaded file is stored in the active recall set. Persisted recall sets contain the full (de-)embedding data so that they can be transferred to other instruments.

Remote command:

`MMEMory:LOAD:VNETworks<Ch>:DIFFerential:EMBedding<LogPt>`

5.14.10 Config tab

The "Config" tab provides means to configure the overall "Offset Embed" calculation.



Offset > Calculate after De-/Embed.

Changes the position of the "Offset" calculation in the "Offset Embed" calculation chain.

If unchecked (default), the offset is calculated before de-/embedding. If checked, it is calculated after de-/embedding.

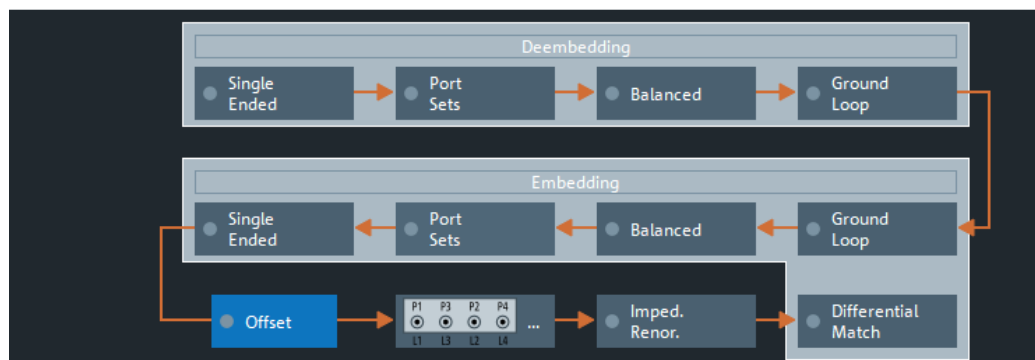
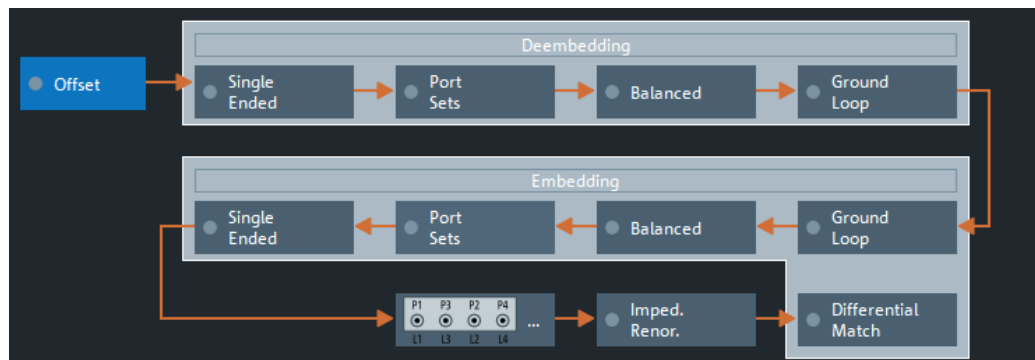

Top = Default offset calculation
 Bottom = Offset calculation after de-/embedding (GUI mockup)

Remote command:

```
[SENSe:]CORRection:EDELay:VNETwork
```

Offset > Wave De-/Embed.

If checked, the firmware uses the new, wave-based de-/embedding calculation (default). Otherwise, the legacy S parameter-based calculation is used. See [Chapter 4.1.7, "Data flow"](#), on page 120.

Remote command:

```
CALCulate<Ch>:TRANsform:VNETworks:WAVes
```

5.14.11 Deembed Assistant tab

The "Deembed Assistant" softtool tab and the related [Deembedding Assistant dock widget panel](#) simplify common fixture deembedding scenarios.



The deembedding assistant functionality requires at least one of the fixture deembedding software options:

- R&S ZNA-K220 (see [Chapter 4.7.16, "In-situ de-embedding"](#), on page 299)
- R&S ZNA-K230 (see [Chapter 4.7.17, "Smart fixture de-embedding"](#), on page 300)
- R&S ZNA-K210 (see [Chapter 4.7.15, "Eazy de-embedding based on IEEE 370"](#), on page 298)

If none of these options are available, the "Deembed Assistant" tab is hidden.



Background information

Refer to [Chapter 4.6.2.9, "Fixture modeling and deembedding"](#), on page 242.

5.14.11.1 Controls on the Deembed Assistant tab

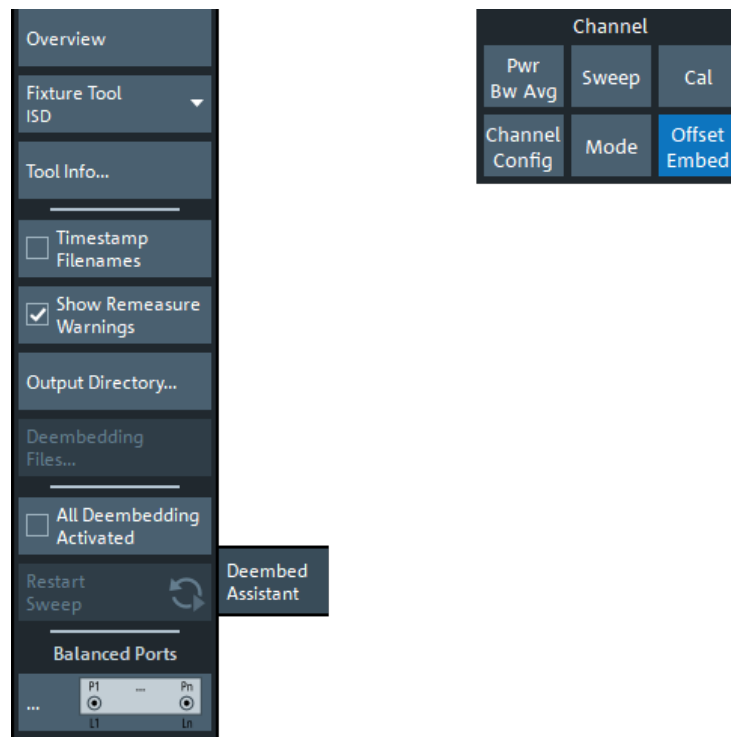

Overview

This button is available on all "Offset Embed" softtool tabs. It opens the [Overview panel](#) in the [Offset Embed dock widget](#).

Fixture Tool/Tool Info

The "Fixture Tool" combo-box allows you to select the third-party fixture modeling tool to be used with the deembedding assistant (see [Chapter 4.6.2.9, "Fixture modeling and deembedding"](#), on page 242).

Use the "Tool Info" button to get additional information about the selected tool.

Remote command:

```
CALCulate:FMODEl:DEASsistant:TOOL
```

Timestamp Filenames

If "Timestamp Filenames" is checked, the names of subsequently generated "Test Coupon" and "DUT + Test Fixture" files are prefixed with the current date and time.

Remote command:

```
CALCulate:FMODEl:REName
```

Show Remeasure Warnings

If checked, the "Coupon" and "DUT + Test Fixture" measurements raise warnings, if the measurement is repeated with different ports.

This setting is global.

Remote command:
n.a.

Output Directory...

Opens a dialog that allows you to specify the directory where the fixture modeling tools store their data.

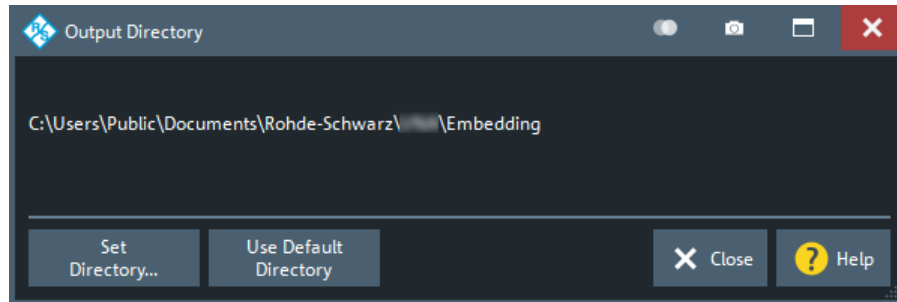

Default is C:\Users\Public\Documents\Rohde-Schwarz\ZNA\Embedding.

Remote command:

`CALCulate:FModel:DIRectory`

`CALCulate:FModel:DIRectory:DEFault`

`CALCulate:FModel:DIRectory:DEFault:CLEar`

Deembedding Files...

This button is only enabled, if the coupon data provided to the deembedding tool was at least partly loaded from file. See "[Page 2: Measure / Load and Apply](#)" on page 761.

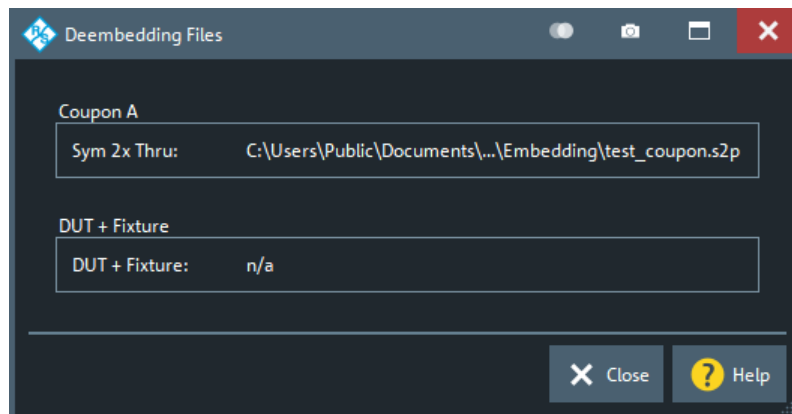

A section "Coupon B" is only available, if you uncheck "[Use Same Coupon Left and Right](#)" on page 760 and specify a file instead of measuring "Coupon B".

Remote command:

`CALCulate:FModel:DEASsistant:COUPon:LEFT:FILE`

`CALCulate:FModel:DEASsistant:COUPon:RIGHT:FILE`

All Deembedding Activated

Deactivates or activates all deembeddings (single-ended, balanced, port set, ground loop) for the active channel, if any.

Remote command:
n.a.

Balanced Ports

Opens the [Balanced Ports dialog](#).

5.14.11.2 Deembedding Assistant dock widget panel

The two pages of the "Offset Embed" dock widget's "Deembedding Assistant" panel allow you to model your DUT and its test fixture, to collect the input data for the selected [fixture tool](#), to run the tool, and to apply the calculated deembedding.

Access: Channel – [Offset Embed] > "Deembed Assistant" tab

(click the tab to reopen)

Page 1: Topology

The first page of the "Deembedding Assistant" defines the deembedding topology. It allows you to describe your device under test (DUT) in terms of inputs, outputs, and the test coupons required to model the DUT's fixture.

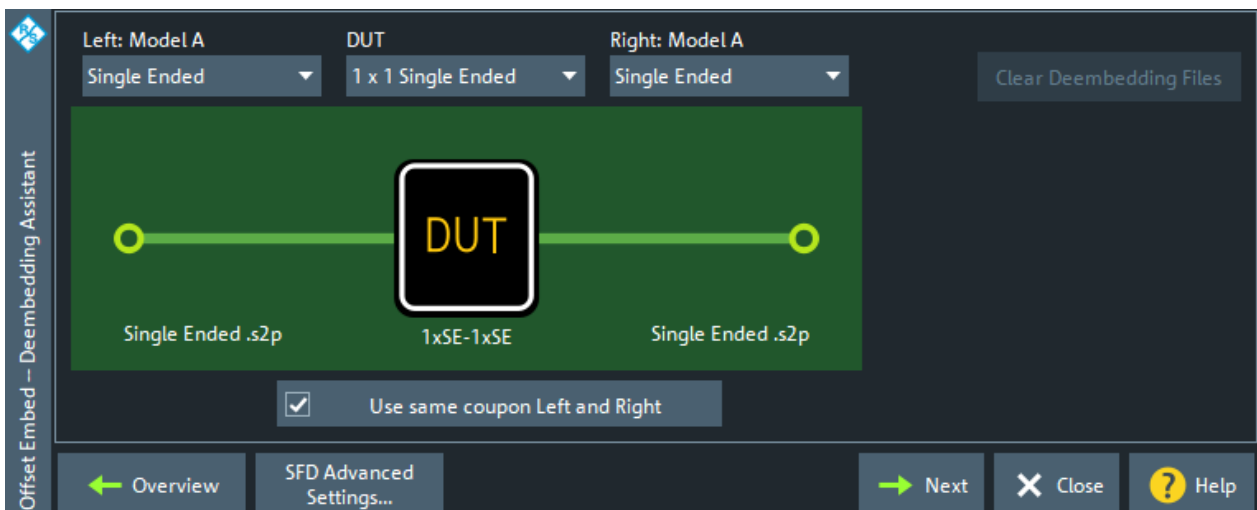

Depending on the selected [fixture tool](#), it narrows down the selectable [DUT](#) types and [test coupon models](#).

DUT

The first step in setting up a new deembedding with the "Deembedding Assistant" is to select the type of DUT. Depending on the number of available test/DUT ports and the selected [fixture tool](#), choose one of the following DUT types:

Table 5-10: DUT types

DUT type	Description	ISD only
"1 x 1 Single Ended"	1 single-ended input, 1 single-ended output	<input type="checkbox"/>
"1 x Single Ended"	1 single-ended input, no output	<input type="checkbox"/>

DUT type	Description	ISD only
"1 x 1 Balanced"	1 balanced input, 1 balanced output	<input type="checkbox"/>
"1 x Balanced"	1 balanced input, no output	<input type="checkbox"/>
"1 x Balanced, 1 x Single Ended"	1 balanced input, 1 single-ended output	<input checked="" type="checkbox"/>
"2 x 1 Single Ended"	2 single-ended inputs, 1 single-ended output	<input checked="" type="checkbox"/>
"2 x 2 Single Ended"	2 single-ended inputs, 2 single-ended outputs	<input checked="" type="checkbox"/>
"n x Single Ended"	n single-ended inputs, no outputs	<input checked="" type="checkbox"/>
"n x m Single Ended"	n single-ended inputs, m single-ended outputs	<input checked="" type="checkbox"/>
"n x Balanced"	n balanced inputs, no outputs	<input checked="" type="checkbox"/>
"n x m Balanced"	n balanced inputs, m balanced outputs Currently not supported	<input checked="" type="checkbox"/>

The dock widget presents a graphical representation of the selected "DUT" and [coupon models](#), e.g. for a "1 x 1 Balanced" DUT with "Balanced" left and right models:

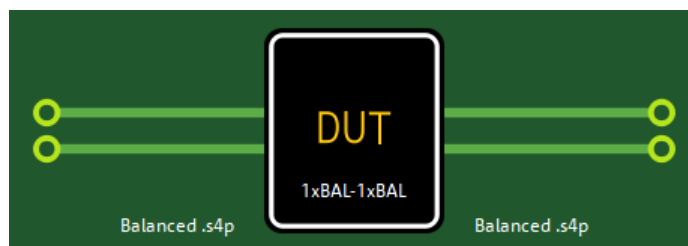

Remote command:

```
CALCulate:FModel:DEAssistant:DUT:TYPE
```

```
CALCulate:FModel:DEAssistant:PRESet
```

Left: Model A / Right: Model A|B

Allows you to select a coupon type, i.e. to define how the coupling at the left side (lead-in) and right side (lead-out) of the DUT is modeled.

If you select the same model for the left and right side and check ["Use Same Coupon Left and Right"](#) on page 760, then also the right side is labeled with "Model A" and in the measurement phase only the data of a single coupon ("Coupon A") must be measured or loaded from file.

- "Single Ended" This coupon model is appropriate for one or more single-ended inputs (outputs), where:
- All inputs (outputs) use the same coupon model and
 - There is no interaction between inputs (outputs) if more than one is present on the DUT

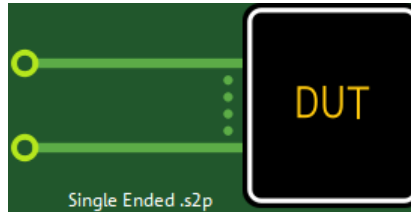

Figure 5-48: n single-ended input ports (uncoupled)

- "Balanced" This coupon type is appropriate for one or more balanced inputs (outputs), if:
- All inputs (outputs) use the same coupon model and
 - There is no interaction between inputs (outputs) if more than one is present on the DUT

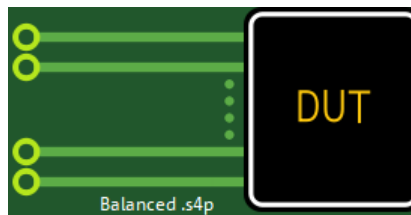

Figure 5-49: n balanced input ports

- "Uncoupled" This coupon type selection is available only for balanced ports on the DUT. It is used for deembedding a balanced port when it is desired to treat the single-ended legs of the port as uncoupled entities.

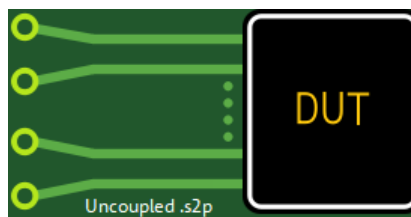

Figure 5-50: n uncoupled balanced input ports

"Coupled" This coupon type is available for DUTs with two or more single-ended or balanced inputs (outputs). It is suitable for a multiport DUT with coupled inputs (outputs) that have to be deembedded as a single unit.

Coupled coupons are drawn with a brace to highlight the difference between coupled and uncoupled ports.

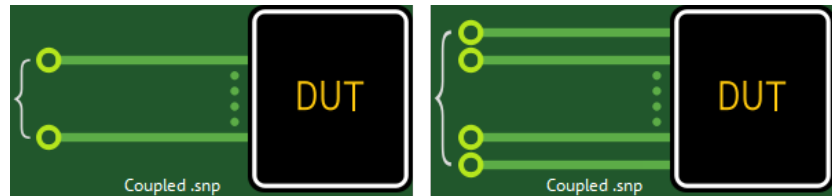

Figure 5-51: $n > 1$ coupled input ports (single-ended | balanced)

Remote command:

```
CALCulate:FMODEl:DEASsistant<Ph_pt>:FIXTure:LEFt:TYPE
CALCulate:FMODEl:DEASsistant:FIXTure:RIGHT:TYPE
CALCulate:FMODEl:DEASsistant:PRESet
```

Use Same Coupon Left and Right

This control is only active, if you selected a two-sided DUT and the same coupon model for the left and right side.

If checked, then in the measurement phase only the data of a single coupon ("Coupon A") must be measured or loaded from file.

Remote command:

```
CALCulate:FMODEl:DEASsistant:SAMCoupon
CALCulate:FMODEl:DEASsistant:PRESet
```

Remove Active Deembedding

Use this button to remove the fixture deembedding and to deactivate all other deembedding in the active channel (see "All Deembedding Activated" on page 726).

Note that the "Deembedding Assistant" works slightly different than the legacy Fixture modeling dialog. In the "Deembedding Assistant", once applied, the deembedding remains active until cleared or (partly) overwritten. The "Fixture Modeling" dialog resets all deembedding files of a specific type (single-ended, balanced, port set), every time you press the "Apply" button.

Overview

This button takes you to the Overview panel of the "Offset Embed" dock widget, which allows you to interact with the individual components of the deembedding calculation chain.

To reopen the "Deembedding Assistant" panel, you have to click/tap on the "Deembed Assistant" tab caption once again.

<Tool> Advanced Settings

Opens the "Advanced Settings" dialog of the selected fixture tool:

- Chapter 5.14.5.6, "ISD Advanced Settings", on page 736
- Chapter 5.14.5.7, "SFD Advanced Settings", on page 740

- [Chapter 5.14.5.8, "EZD Advanced Settings"](#), on page 741

Page 2: Measure / Load and Apply

The second page of the "Deembedding Assistant" dock widget allows you to:

- Measure one or more test coupons, or load their S-parameter data from file
- Measure DUT + test fixture
- Send the measured/loaded data to the selected [fixture tool](#) and apply the calculated deembedding

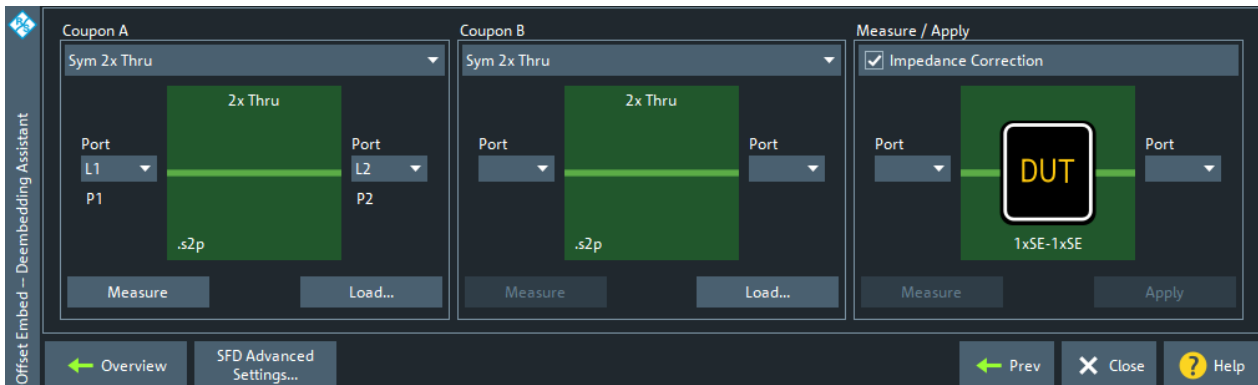

If you select [Use Same Coupon Left and Right](#) on the topology page, then only one set of test coupons can be measured (or loaded from file). The results are used for both sides of the DUT.

With two coupons, "Coupon A" is used to deembed the left-hand side of the DUT and "Coupon B" is used to deembed the right-hand side.

Coupon A / Coupon B section

In the "Coupon A" and "Coupon B" section, you can select one or more test coupons and, for each of them, either measure its S-parameters at selected logical ports or load them from a Touchstone file.

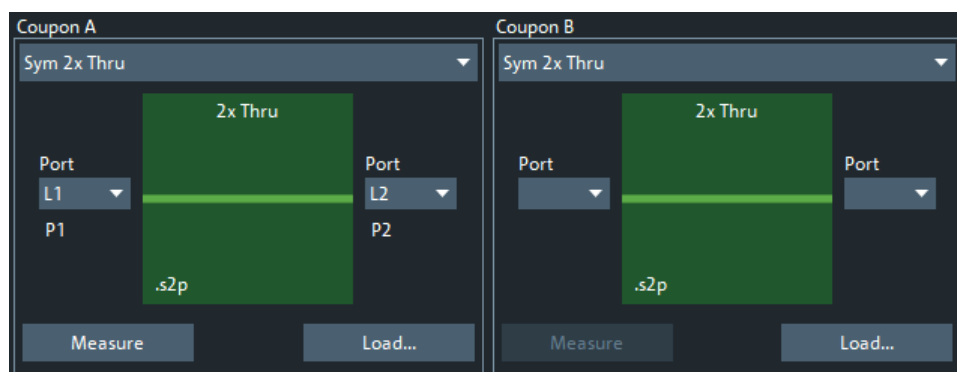

Depending on the selected [DUT](#), a different set of test coupon types is supported.

Test coupon	"Sym 2x Thru"	"1x Open"	"1x Short"	"1x Open, 1x Short"
ISD	<input checked="" type="checkbox"/>	<input checked="" type="checkbox"/>	<input checked="" type="checkbox"/>	<input checked="" type="checkbox"/>
SFD	<input checked="" type="checkbox"/>	<input checked="" type="checkbox"/>	<input checked="" type="checkbox"/>	<input type="checkbox"/>
EZD	<input checked="" type="checkbox"/>	<input type="checkbox"/>	<input type="checkbox"/>	<input type="checkbox"/>

Depending on the selected test coupon type, the number of logical ports and the graphical representation changes:

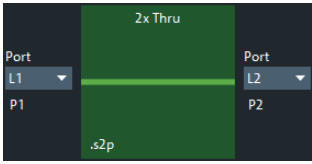
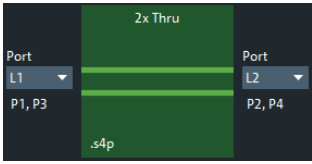
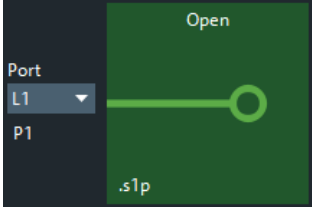
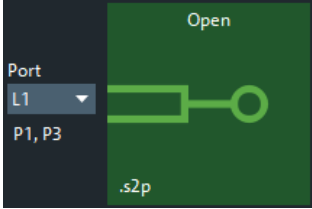
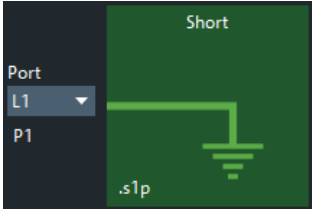
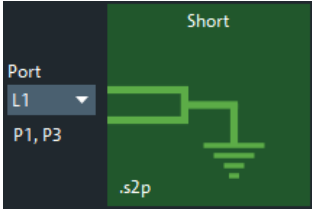
Test coupon type	Single-ended	Balanced
"Sym 2x Thru"		
"1x Open"		
"1x Short"		

Use the [Balanced Ports dialog](#) to create the single ended and balanced ports that are required for the measurements.

There are several rules to be considered with the coupon measurement interface.

- The port selection drop-down allows you to select from any available port of the correct type on the instrument.
 - For single-ended coupons, any physical port can be selected, even if that port is part of a logical balanced port or port set.
 - For balanced coupons, you can only select a precisely defined logical port.
- The ports used for the measurement must be unique. That is, you cannot select P1 for both sides of a "Sym 2x Thru" coupon. However, you can select the same port for both measurements in a "1x Open, 1x Short" coupon, which requires a connection change before the second measurement.
- The "Load" button allows you to load a Touchstone file instead of measuring the coupon. The graphic displays the Touchstone file's required "cardinality".

Remote command:

```
CALCulate:FMODEl:DEASsistant:COUPon:LEFT:TYPE
```

```
CALCulate:FMODEl:DEASsistant:COUPon:RIGHT:TYPE
```

```

CALCulate:FModel:DEAssistant:COUPon:LEFT:PORT
CALCulate:FModel:DEAssistant:COUPon:RIGHT:PORT
CALCulate:FModel:DEAssistant:COUPon:LEFT:MEASure
CALCulate:FModel:DEAssistant:COUPon:RIGHT:MEASure
CALCulate:FModel:DEAssistant:COUPon:LEFT:FILE
CALCulate:FModel:DEAssistant:COUPon:RIGHT:FILE
CALCulate:FModel:DEAssistant:COUPon:LEFT:CLEar
CALCulate:FModel:DEAssistant:COUPon:RIGHT:CLEar

```

Measure / Apply section

After you have measured the coupons (or loaded their data from file), you can proceed with the DUT. Choose:

- A single-ended or balanced port for the 1x DUT sides

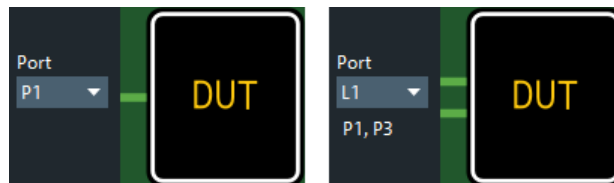

- Two single-ended ports for the 2x single-ended DUT sides



- A range of single-ended or balanced ports for the nx DUT sides

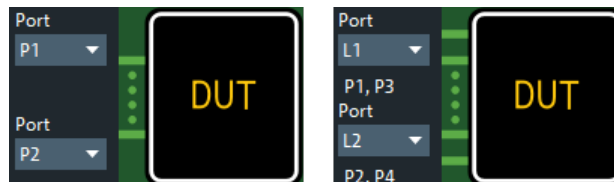

If you want to apply impedance correction, select "Impedance Correction" and "Measure" the DUT.

Once the coupons (and the DUT) are measured, the "Apply" button becomes active. Use it to run the tool and, if successful, perform the deembedding on the selected ports.

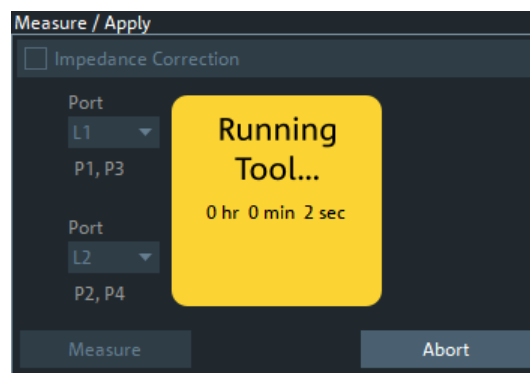

The deembedding of single-ended and decoupled ports is assigned as [Single Ended](#), the deembedding of balanced ports as [Balanced](#), and the deembedding of coupled as [Port Sets](#) deembedding.

Remote command:

```
CALCulate:FMODEl:DEASsistant:IMPCorrect
CALCulate:FMODEl:DEASsistant:DUT:PORT
CALCulate:FMODEl:DEASsistant:DUT:MEASure
CALCulate:FMODEl:DEASsistant:RUN
```

5.14.12 Delta-L tab

The controls on the "Delta-L" tab allow you to set up and perform a Delta-L PCB characterization.



The "Delta-L" tab is only visible if option R&S ZNA-K231 is installed on the instrument. See [Chapter 4.7.18, "Delta-L 4.0 PCB characterization"](#), on page 300.



- The "Delta-L Settings..." button opens the [Delta-L Settings dialog](#), which allows you to configure a Delta-L measurement.
- The "Delta-L Measurement" button runs the configured measurement.
- The "Balanced Ports..." button opens a dialog that allows you to enable/disable physical ports and to define logical ports (balanced or unbalanced) in the active channel. See [Chapter 5.2.2.5, "Balanced Ports dialog"](#), on page 352.



If either multiple DUTs are configured (see [Chapter 5.12.2.3, "Define Parallel Measurement dialog"](#), on page 682) or the "Fixture Simulator" is disabled for the related channel (see ["Fixture Simulator"](#) on page 655), the "Balanced Ports..." button is inactive (grayed out).

5.14.12.1 Delta-L Settings dialog

From the "Delta-L Settings" dialog, you can set up the Delta-L measurement channel and how the external tool is run.

Access: Channel – [Offset Embed] > "Delta-L" > "Delta-L Settings..."

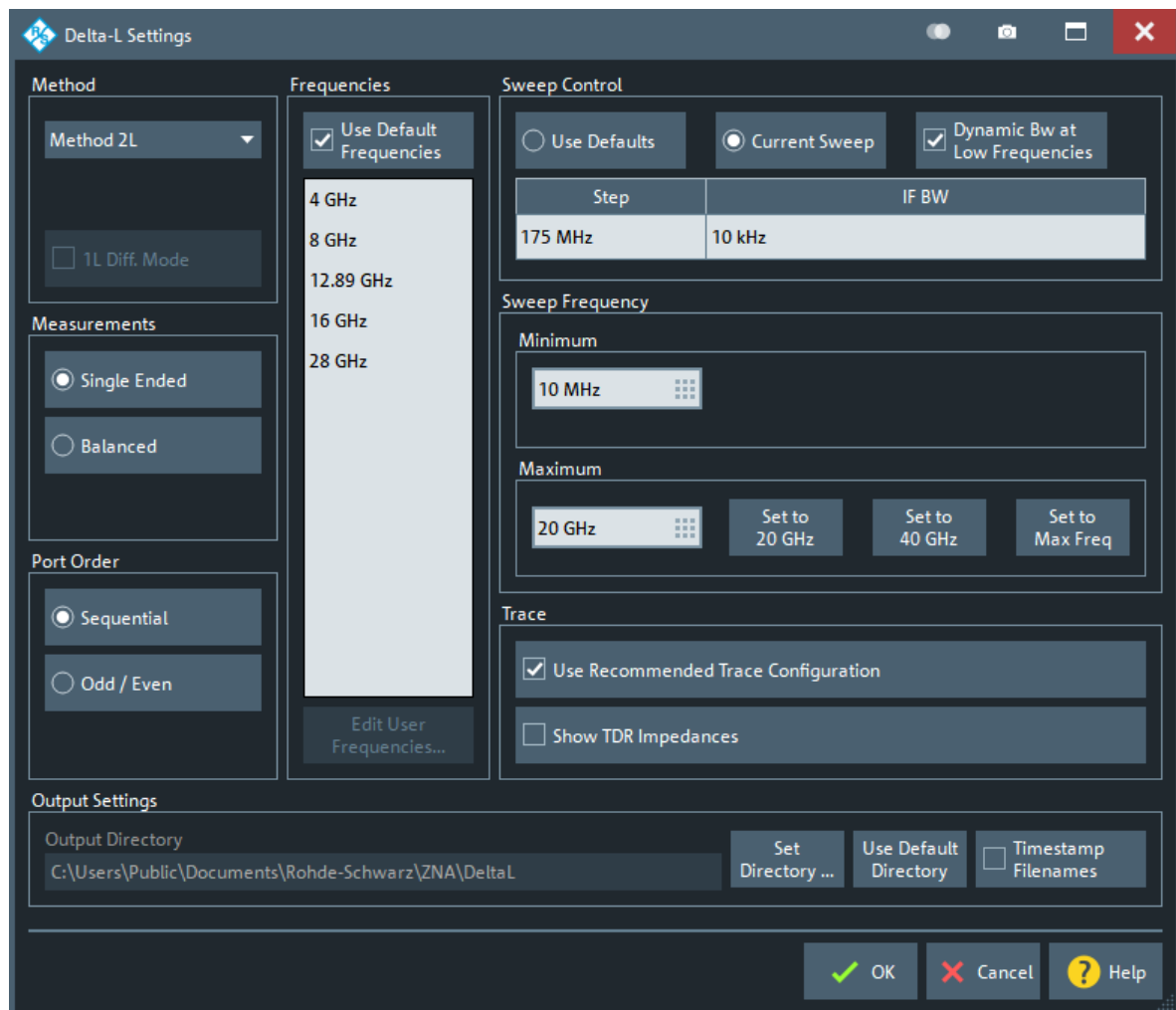

Method

Selects the Delta-L+ characterization method to be used. Default is "Method 2L". For background information, see [Delta-L 4.0 PCB characterization](#).

"Method 1L" handles single-ended and balanced measurement results differently; activate "1L Diff. Mode" for balanced measurements. For "Method 2L" and "Method 3L" measurements can also be single-ended or balanced, but the tool does not distinguish between them.

Remote command:

`CALCulate:FModel:DELT:METHOD`

`CALCulate:FModel:DELT:M1L:DIFFmode`

Measurements

Defines whether single-ended or balanced ports are measured for Delta-L characterizations.

Remote command:

`CALCulate:FModel:DELT:MEASurement`

Port Order

Declares how the DUT is connected to the measurement system. Choosing the wrong port ordering for your setup, can result in erroneous results.

"Sequential" Ports 1, 2 and 3, 4 form input/output pairs

"Odd / Even" Ports 1, 3 and 2, 4 form input/output pairs

Remote command:

```
CALCulate:FMODEl:DELT:PORDer
```

Frequencies

Delta-L computes the uncertainty in the loss-per-inch calculation at specified frequencies.

The "Frequencies" table is pre-populated with the frequencies recommended by Intel. If you want to enter your own values, uncheck "Use Default Frequencies" and select "Edit User Frequencies..." to bring up the "User Frequencies" dialog.

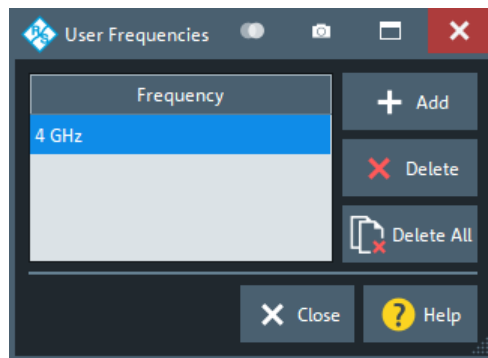

Remote command:

```
CALCulate:FMODEl:DELT:FREQuencies:USEDefault
CALCulate:FMODEl:DELT:FREQuencies:CURREnt?
CALCulate:FMODEl:DELT:FREQuencies:CURREnt:COUNT?
CALCulate:FMODEl:DELT:FREQuencies:DEFault?
CALCulate:FMODEl:DELT:FREQuencies:DEFault:COUNT?
CALCulate:FMODEl:DELT:FREQuencies:USER?
CALCulate:FMODEl:DELT:FREQuencies:USER:COUNT?
CALCulate:FMODEl:DELT:FREQuencies:USER:ADD
CALCulate:FMODEl:DELT:FREQuencies:USER:DELeTe
CALCulate:FMODEl:DELT:FREQuencies:USER:DELeTe:ALL
```

Sweep Control

The Delta-L measurement channel can either "Use Defaults" (10 MHz step size and 1 kHz IF bandwidth), or the "Current Sweep" settings (see "Freq Step Size" on page 540, and "Bandwidth" on page 536).

For "Dynamic Bw at Low Frequencies", see [Dynamic Bw at Low Frequencies](#).

Remote command:

```
CALCulate:FMODEl:DELT:SWEep:CONTRol
CALCulate:FMODEl:DELT:SWEep:CONTRol:BWIDth[:RESolution]:
DREDuction
```

```
CALCulate:FModel:DELT:SWEep:CONTRol:STEP?  
CALCulate:FModel:DELT:SWEep:CONTRol:IFBW?
```

Sweep Frequency

Defines the sweep range of the Delta-L channel. The entered "Minimum" and "Maximum" values are set as [start and stop frequency](#) when the Delta-L settings are applied using "OK". Furthermore, the VNA collects data for the LPI computation at the "Minimum" and "Maximum" frequencies (in addition to the other specified ["Frequencies"](#) on page 766).

The default "Minimum" is the standard Delta-L start frequency of 10 MHz. The default "Maximum" is 20 GHz. Buttons are available to set "Maximum" to the standard Delta-L stop frequencies of 20 GHz and 40 GHz (if within the instrument's frequency range), and to the instrument's maximum frequency.

If you set the "Minimum" or "Maximum" to a non-standard value, a popup indicates that the Delta-L measurement possibly does not provide accurate results.

Remote command:

```
CALCulate:FModel:DELT:SWEep:FREQuency:MINimum  
CALCulate:FModel:DELT:SWEep:FREQuency:MAXimum
```

Trace

On **OK**, the VNA deletes the existing traces and sets up the traces whose measurement is required for the selected Delta-L [Method](#).

If **"Use Recommended Trace Configuration"** is checked, then each of the new traces is displayed in a separate diagram. Otherwise, the VNA places all traces in a single diagram.

If the [Time domain analysis](#) option R&S ZNA-K2 is installed, **"Show TDR Impedances"** adds the TDR-based converted impedance traces to the recommended trace configuration.

Remote command:

```
CALCulate:FModel:DELT:TCONfig  
CALCulate:FModel:DELT:TDR
```

Output Settings

Allows you to specify the directory where the Delta-L tool stores its data.

Default is C:\Users\Public\Documents\Rohde-Schwarz\ZNA\DeltaL.

If "Timestamp Filenames" is checked, the names of subsequently generated "Test Coupon" files are prefixed with the current date and time.

Remote command:

```
CALCulate:FModel:DELT:DIRectory  
CALCulate:FModel:DELT:DIRectory:DEFault  
CALCulate:FModel:DIRectory:DEFault  
CALCulate:FModel:REName
```

OK

"OK" applies the Delta-L settings and starts the [Delta-L measurement](#).

5.14.12.2 Delta-L measurement

When the Delta-L measurement starts, the analyzer firmware prepares the Delta-L measurement channel, populates the diagram area with the required measurement traces, and opens the [Delta-L Measurement dock widget](#).

Delta-L Measurement dock widget

The "Delta-L Measurement" dock widget is where coupon measurements are performed and/or corresponding touchstone files are selected.



The [Measurements](#) setting in the "Delta-L Settings" dialog determines whether single-ended or balanced can be measured. "No ports available!" in the dock widget and "No Trace" in the diagram area indicates that no ports of the selected type are configured.

Access:

- Channel – [Offset Embed] > "Delta-L" > "Delta-L Measurement"
- [Delta-L Settings dialog](#) > "OK"

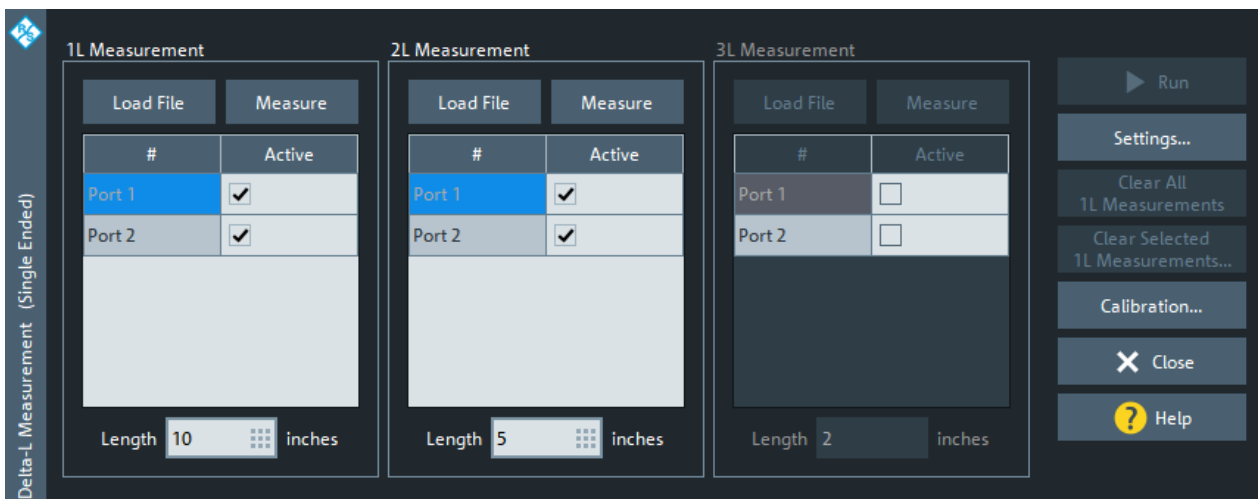

1L Measurement/2L Measurement/3L Measurement

The settings in the "1L Measurement"/"2L Measurement"/"3L Measurement" sections configure and control the measurement of the 1st/2nd/3rd line.

The "1L Measurement" is always enabled. Depending on the selected ["Method"](#) on page 765, the "2L Measurement" and "3L Measurement" can be disabled.

Load File ← 1L Measurement/2L Measurement/3L Measurement

Loads coupon measurement results from a s2p or s4p Touchstone file.

Remote command:

`CALCulate:FModel:DELT:M1L:FILENAME`

`CALCulate:FModel:DELT:M2L:FILENAME`

`CALCulate:FModel:DELT:M3L:FILENAME`

Measure ← 1L Measurement/2L Measurement/3L Measurement

Measures the full set of S-parameters at the selected [ports](#) (full 2- or 4-port).

Remote command:

```
CALCulate:FModel:DELT:M1L:MEASure
```

```
CALCulate:FModel:DELT:M2L:MEASure
```

```
CALCulate:FModel:DELT:M3L:MEASure
```

Ports table ← 1L Measurement/2L Measurement/3L Measurement

Use the checkboxes in the "Active" column to include the respective port into the [measurement](#).

If [Method 1L](#) is used, four ports have to be selected in the "1L Measurement" section.

Remote command:

```
CALCulate:FModel:DELT<Ph_pt>:M1L[:STATe]
```

```
CALCulate:FModel:DELT<Ph_pt>:M2L[:STATe]
```

```
CALCulate:FModel:DELT<Ph_pt>:M3L[:STATe]
```

Length ← 1L Measurement/2L Measurement/3L Measurement

Specifies the length of the related line.

Remote command:

```
CALCulate:FModel:DELT:M1L:LENGth
```

```
CALCulate:FModel:DELT:M2L:LENGth
```

```
CALCulate:FModel:DELT:M3L:LENGth
```

Run

Runs the AITT-DL tool with the collected measurement data and the configured [Delta-L settings](#).

The firmware enables this action when sufficient data for the required [lines](#) are available (either loaded or measured).

If the AITT-DL tool experiences errors, the analyzer firmware displays additional information (see [<Deembedding Tool> Errors dialog](#)).

Remote command:

```
CALCulate:FModel:DELT:RUN
```

Clear All 1L Measurements/Clear Selected 1L Measurements

If [Method 1L](#) is selected in the "Delta-L Settings" dialog, the VNA firmware builds up a cache of coupon measurements (Touchstone files) in the

DeltaL\1LMeasurementCache subfolder of the user data folder

C:\Users\Public\Documents\Rohde-Schwarz\ZNA.

"Clear All 1L Measurements" deletes this cache, "Clear Selected 1L Measurements" displays a "Delete files" dialog that allows you to select the cache files to be deleted.

Remote command:

```
CALCulate:FModel:DELT:M1L:CACHe:CLEAr:ALL
```

```
CALCulate:FModel:DELT:M1L:CACHe:CLEAr:SElected
```

Delta-L diagram

Upon successfully running the external AITT-DL tool, the VNA displays the "Delta-L" diagram.

2L and 3L

For "Method 2L" and "Method 3L", the "Delta-L" diagram includes two traces for every combination of lines/lengths (12 for "Method 2L"; 12, 13, and 23 for "Method 2L")

- Raw traces "DeltaL12", ...
- Smoothed traces "DeltaL12S", ...
Smoothing is performed by the Delta-L algorithm.



Figure 5-52: Method 2L results

Markers are added to the smoothed traces at the [analysis frequencies](#). The marker name indicates to which analysis pair it belongs and the computed Delta-L uncertainty.

Method 1L

For "Method 1L", the Delta-L diagram displays the following traces:

- An insertion loss trace "L<i>" for each touchstone file L<i>.s<2|4>p (loaded or measured) in the measurement cache
- An additional trace "StdDev" representing the standard deviation of the 1L analysis at the [analysis frequencies](#)



Markers "DeltaL1..." are added to the "StdDev" trace at the [analysis frequencies](#). The marker names indicate the computed Delta-L uncertainties.

5.15 File Print softtool

The "File Print" softtool allows you to work with recall sets and trace data.

Access: System – [File Print]

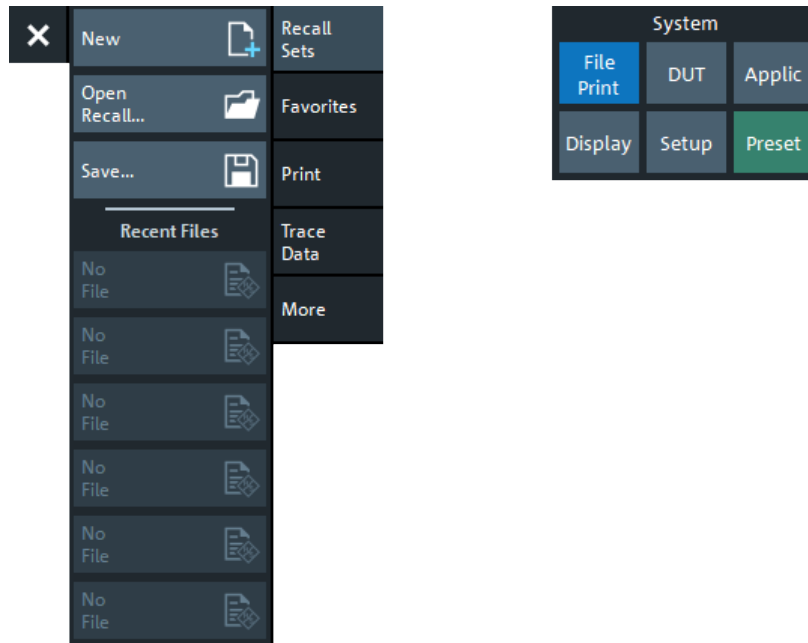

5.15.1 Recall sets tab

A recall set comprises a set of diagrams together with the underlying system, channel, trace and display settings. It can be stored to a VNA recall set file (*.znxml | *.znx).

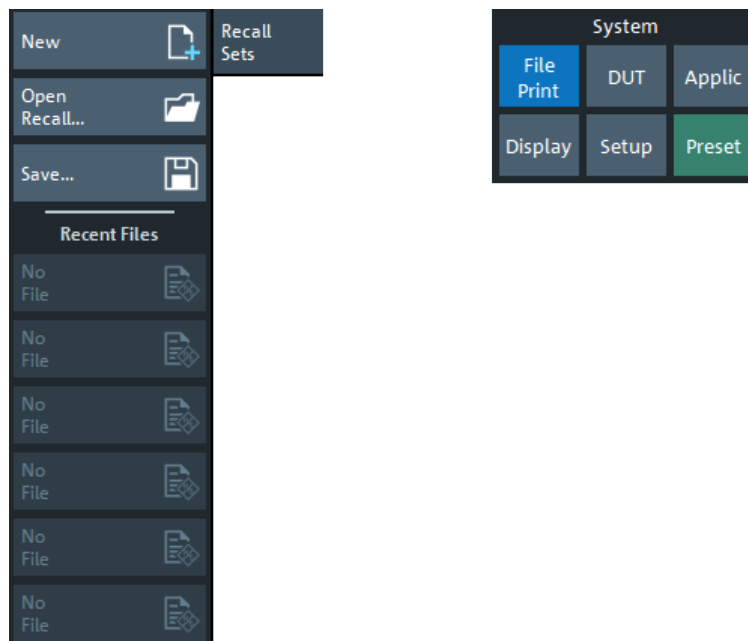

For background information, see [Chapter 4.1.2, "Recall sets"](#), on page 108.

5.15.1.1 Basic Recall Set functions

To create a recall set based on the current analyzer configuration, select [Save](#). To open an existing recall set, select [Open Recall...](#). To create an additional setup, select [New](#).



The R&S ZNA supports two recall set file formats:

- `zxml` (default)
XML based file format, introduced with the R&S ZNA
- `zbx`
Binary file format, originating from the R&S ZNB

New

Adds a new setup. The default names for new setups are "Set1", "Set2" etc. Recall sets are accessible via tabs in the diagram area:



Tip: To open an existing recall set, use "Open Recall...". To rename a setup, use "Save...".

Remote command:

`MEMory:DEFine`

Open Recall...

Loads a recall set from a file (`*.zxml` | `*.zbx`).

Opens the [Open Dialog](#) with suitable file filters.

If the current setup includes [External switch matrices](#) and the recall set to be loaded does not contain a switch matrix configuration, recalling the setup is aborted. You are requested to delete the configured RF connections (see [Chapter 5.19.7.4, "Switch Matrix RF Connections dialog"](#), on page 914) and to remove the switch matrix from the RF paths.

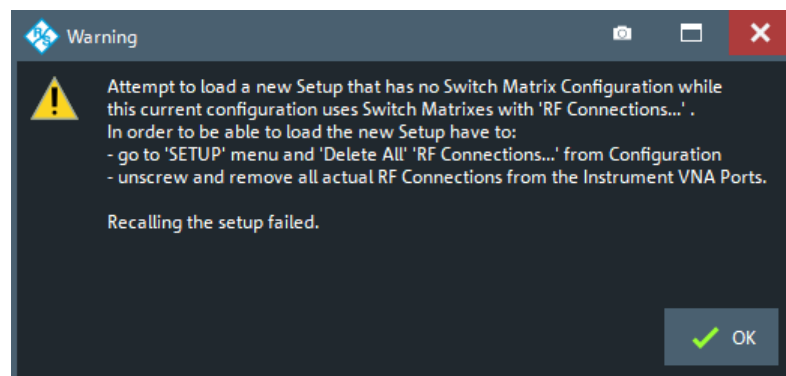

If the recall set to be loaded contains a switch matrix configuration and no differences to the current switch matrix configuration are detected, the recall set is loaded without further inquiry. Otherwise you are asked if you want to adapt the configuration:

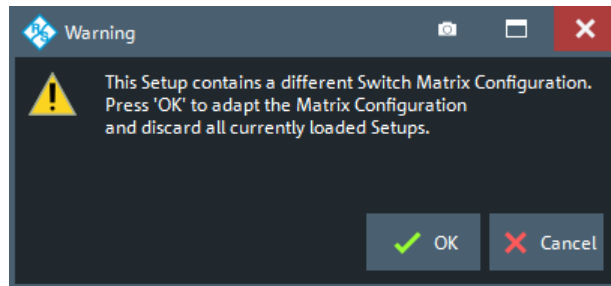

Select "Cancel" to abort the recall process or "OK" to open the [Restore Switch Matrix Configuration dialog](#) that guides you through the required configuration changes.

Note: In case the recall set could only be loaded after adjusting some incompatible settings, the info message **"The setup data changed while loading"** is displayed. Incompatibilities can arise, for example, if you attempt to load a recall set of a different R&S ZNA model or with different optioning. Not all incompatibilities can be adjusted.

Remote command:

`MMEMemory:LOAD:STATE`

Save

Saves the active recall set to a file (*.znxml | *.znx).

Displays the [Save Dialog](#) that allows you to specify a file name and location for the recall set file.

Remote command:

`MMEMemory:STORE:STATE`

Recent Files

The buttons are labeled with the last recall sets which were stored in the current or in previous sessions. They open the corresponding recall set.

5.15.1.2 Restore Switch Matrix Configuration dialog

When opening an existing recall set file, it can be necessary to adapt the current system configuration to the switch matrix configuration of the recall set. The "Restore Switch Matrix Configuration" dialog guides you through this process.

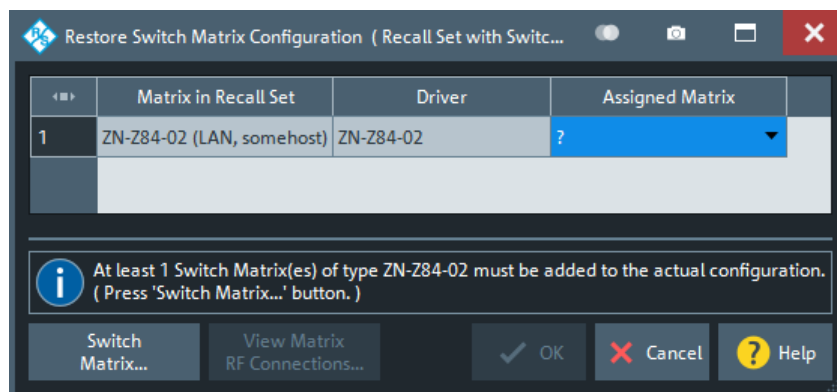

In the dialog, proceed as follows:

1. **Reassign Matrices:** For each "Matrix in Recall Set", select a switch matrix of the same (driver) type as "Assigned Matrix".

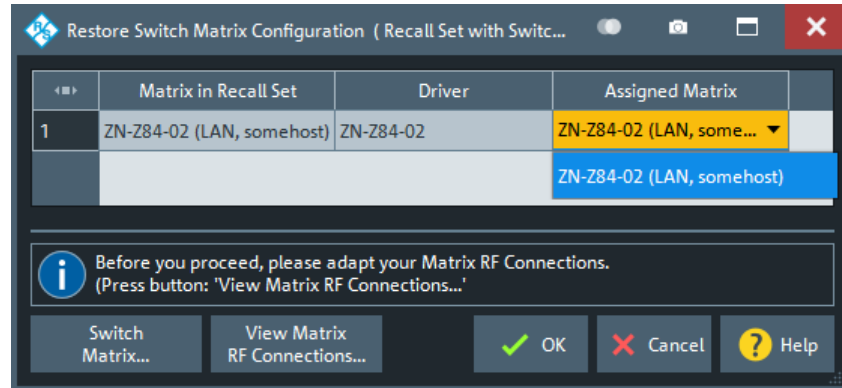

If no switch matrix of the same type exists, select "Switch Matrix" to open the [External Matrices dialog](#) that allows you to register/configure additional switch matrices.

2. **Restore RF connections:** The recall set's switch matrix configuration comprises the physical RF connections of the related switch matrices. For each "Matrix in Recall Set", select the corresponding row and select "View Matrix RF Connections..." to view the respective matrix RF connections. Make sure to connect the "Assigned Matrix" accordingly.



Background information

Refer to [Chapter 4.7.41, "External switch matrices"](#), on page 323.

View Matrix RF Connections...

This dialog presents the RF connections of a selected switch matrix as specified in the recall set you are about to load.

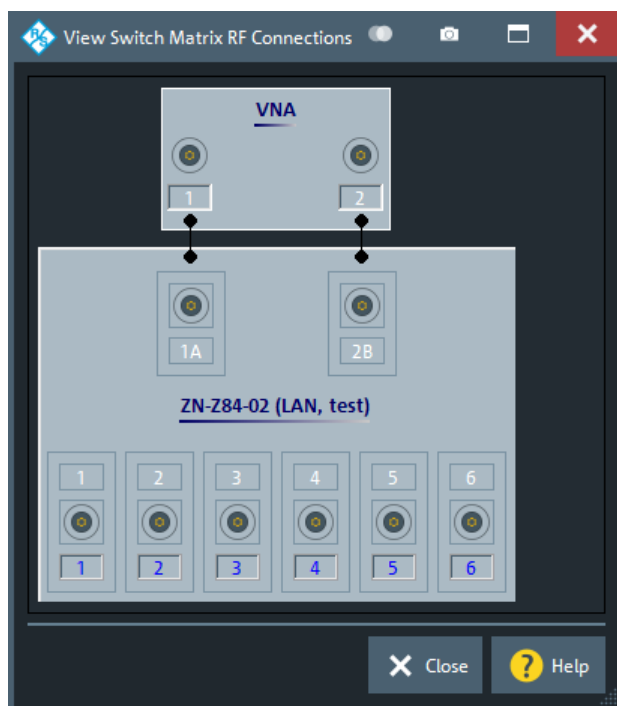

It is a read-only version of the [Switch Matrix RF Connections dialog](#) you can later use to modify the actual configuration.

5.15.2 Favorites tab

The "Favorites" tab allows you to manage a list of favorite recall sets.

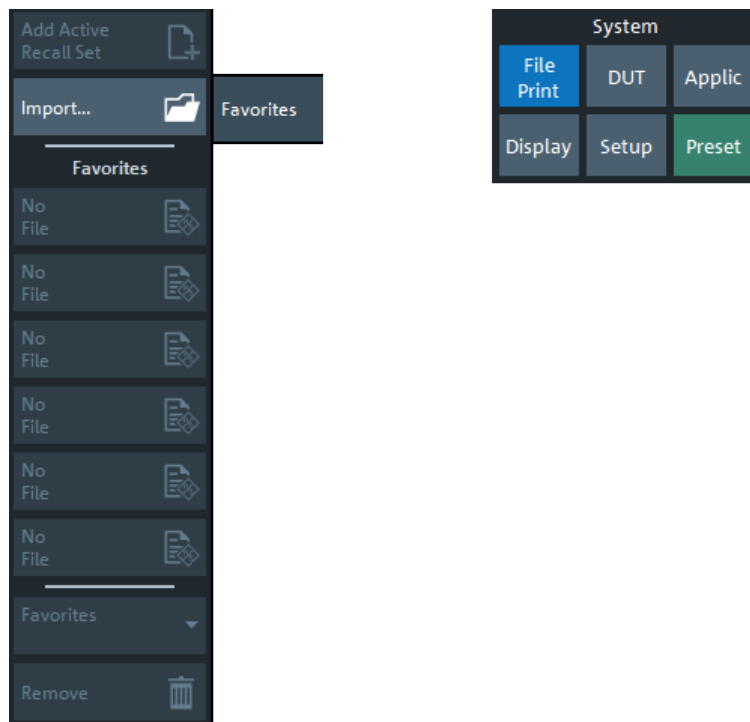

A favorite is actually a path to the related recall set, i.e.:

- If the recall set is modified, then the modified recall set is loaded the next time the favorite is selected
- If the recall set is moved or deleted, the corresponding favorite is broken

The firmware can manage up to 6 favorites. New favorites are always created at the topmost spare position in the favorites list. If the list is complete (i.e. if there are no more spare positions), new favorites can only be added after existing ones were removed.

Add Active Recall Set

Adds the active recall set to the list of favorites.

This button is only active if the current setup was loaded from or saved to a recall set.

Import

Opens a file browser that allows you to add an arbitrary recall set to the favorites list.

Remote command:

`MMEMory:FAVorite<FavId>`

Favorites section

Select one of the active buttons to open the corresponding recall set.

Favorites combo-box / Remove

Use the "Favorites" combo-box to select the favorite to be removed from the list, then select "Remove".

5.15.3 Print tab

The buttons on the "Print" tab allow you to send the diagrams of the active setup to an external printer, to a file or to the clipboard. Content and layout can be defined in the [Printer Setup dialog](#).

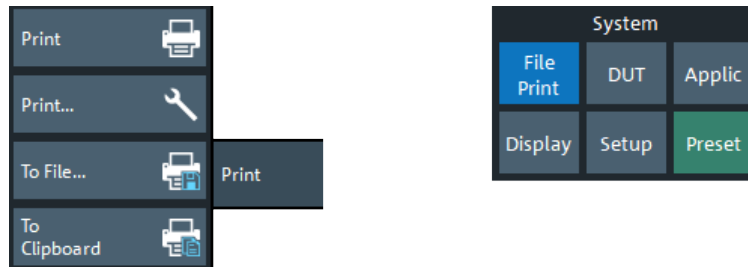

Print

Prints the diagrams using the current content, printer and page settings (see [Chapter 5.15.4, "Printer Setup dialog"](#), on page 779).

Remote command:

The `HCOPY...` commands provide the printer settings; see [HCOPY commands](#).
`HCOPY[:IMMEDIATE]` initiates printing.

Print...

Opens a dialog that allows to define the content, printer and page settings (see [Chapter 5.15.4, "Printer Setup dialog"](#), on page 779).

To File...

Opens the "Save Image" dialog that allows you to select a graphics file type (`*.bmp`, `*.jpg` | `*.jpeg`, `*.pdf`, `*.png`, `*.svg`) and to save diagram content to a file of this type (see also ["Save Dialog"](#) on page 138).

Note that the diagram content to be saved can be configured in the [Content tab](#) > "Print Charts" group of the "Printer Setup" dialog. E.g., if you select "All diagrams on their own page" there, then only the content of the active diagram is saved to file. If you select "No diagram at all", then "To File..." is disabled.

Remote command:

`HCOPY:DESTINATION`

To Clipboard

Copies diagram content to the clipboard, from where you can paste it into another application.

Note that the diagram content to be copied can be configured in the [Content tab](#) > "Print Charts" group of the "Printer Setup" dialog. E.g., if you select "All diagrams on their own page" there, then only the content of the active diagram is copied to clipboard. If you select "No diagram at all", then "To Clipboard" is disabled.

5.15.4 Printer Setup dialog

The "Printer Setup" dialog specifies how the diagram content of, and/or other information on the active recall set is printed. Printer options are specified in three tabs. The lower part of the dialog shows a preview of the print.

Access: System – [File Print] > "Print" > "Print..."

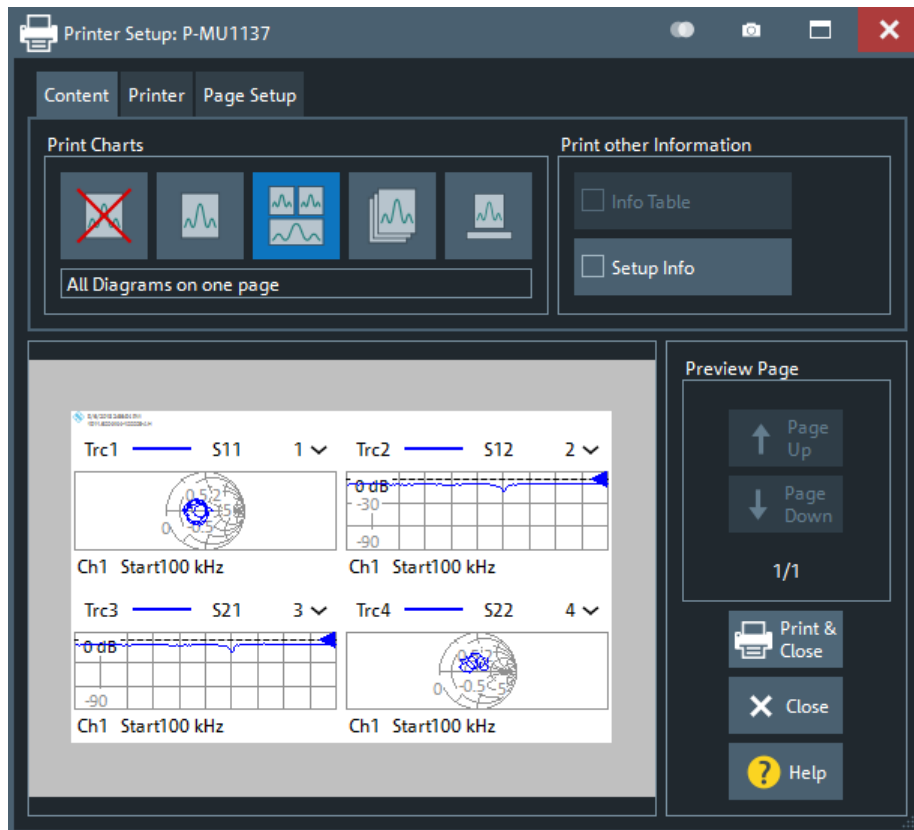

The `HCOPY...` commands provide the printer settings; see [Chapter 7.3.7, "HCOPY commands"](#), on page 1259.

5.15.4.1 Content tab

The "Content" tab allows you to select the diagram content to be printed.

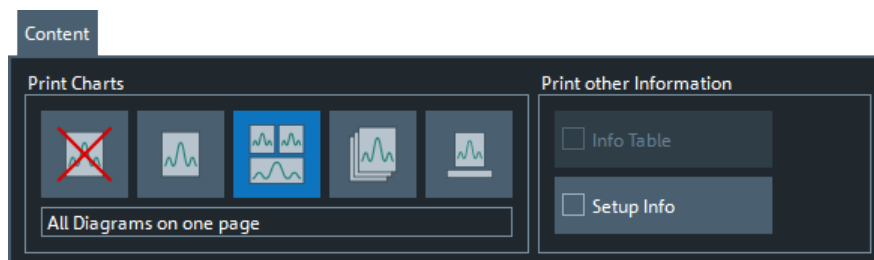

The selected item in the "Print Charts" group specifies how the diagram area of the active recall set is printed. Currently the following options are offered: "No Diagram at

all", "Active Diagram only", "All diagrams on one page", "All diagrams on their own page" and "Hard copy of diagram area". The latter is a screenshot of the diagram area, which preserves colors and layout.

Note that the "Print Charts" setting also affects the [To File...](#) and [To Clipboard](#) actions of the [Print tab](#).

If selected in the "Print other information" group, the content of the "Info Table" (see ["Info Table: Show / Position"](#) on page 846) and/or "Setup Info" (see ["Setup tab"](#) on page 875) is printed on additional pages.

5.15.4.2 Printer tab

The "Printer" settings select one of the installed printers and specify printer options.

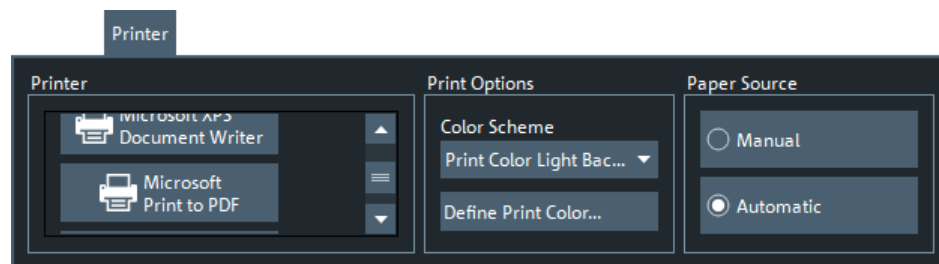

Printers can be installed using the Windows® "Devices and Printers" functionality; see also [Chapter 3.1.11.4, "Connecting a printer"](#), on page 33.

Print Options

Allows you to select and/or define the color scheme for printing.

The "Define Print Color..." button opens the [Define User Color Scheme dialog](#) which allows you to create or modify your own print color scheme.

The R&S ZNA now uses different "User Defined" color schemes for display and printing.

Remote command:

[HCOpy:PAGE:COLor](#)

5.15.4.3 Page Setup tab

The "Page Setup" settings are visualized in the preview page in the lower part of the dialog.

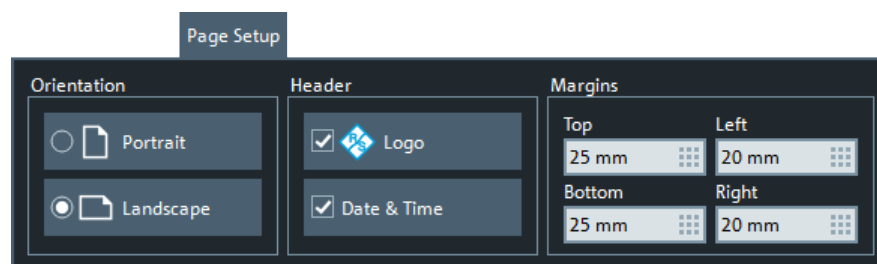

Tip: The printer settings are not affected by a preset of the R&S ZNA. Use the "Remote" tab in the [System Config dialog](#) to restore default settings.

5.15.5 Trace Data tab

See [Chapter 5.5.11, "Trace Data tab"](#), on page 467.

5.15.6 More tab

The buttons on the "More" tab allow you to load simulation data or close the VNA application.



Loading simulation data and adding simulation noise is only available for the PC firmware simulation (see [Chapter 4.7.45, "R&S ZNXSIM"](#), on page 335).



Load Simulation Data...

Imports simulation data into the current setup.

The analyzer opens the "Load Simulation Data" dialog that lets you select a trace file (*.snp, *.csv, *.dat). As an option, you can load the simulation data into the "Active Channel Only", allowing you to analyze different simulation data in different channels of a setup.

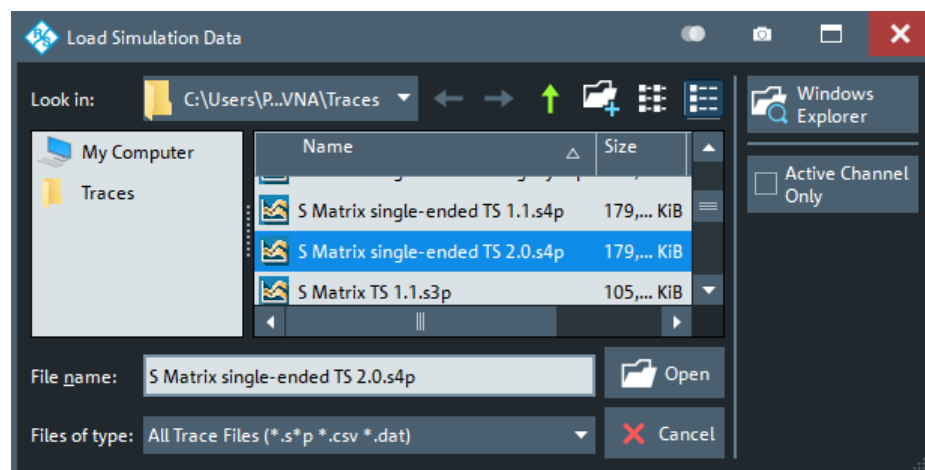

Tip: Using the standard [trace file export](#) functionality, the loaded data can be converted to different formats.

Simulation Noise

Allows you to add random noise to the loaded simulation data to let the traces appear more "realistic" (see [Chapter 4.7.45.2, "Simulation noise"](#), on page 337). By default, "Simulation Noise" is inactive.

Make sure to deactivate "Simulation Noise" before exporting traces to file. Otherwise your exported results comprise an "artificial" random component.

Exit

Persists the current state of all opened setups and ends the analyzer session. These states are automatically recalled when the analyzer application is restarted.

Tip: This button is equivalent to the Windows® "Close window" command and to the close icon  in the title bar of the main firmware application window.

5.16 DUT softtool

The "DUT" softtool comprises a single "DUT Meas" tab, which provides functions for configuring and managing DUTs and for DUT-centric measurement setup.



Access: System – [DUT]

5.16.1 DUT Centric Wizard

The "DUT Centric Wizard" guides you through the measurement setup for certain fundamental DUT types.

Access: System – [DUT] > "DUT Centric Wizard"

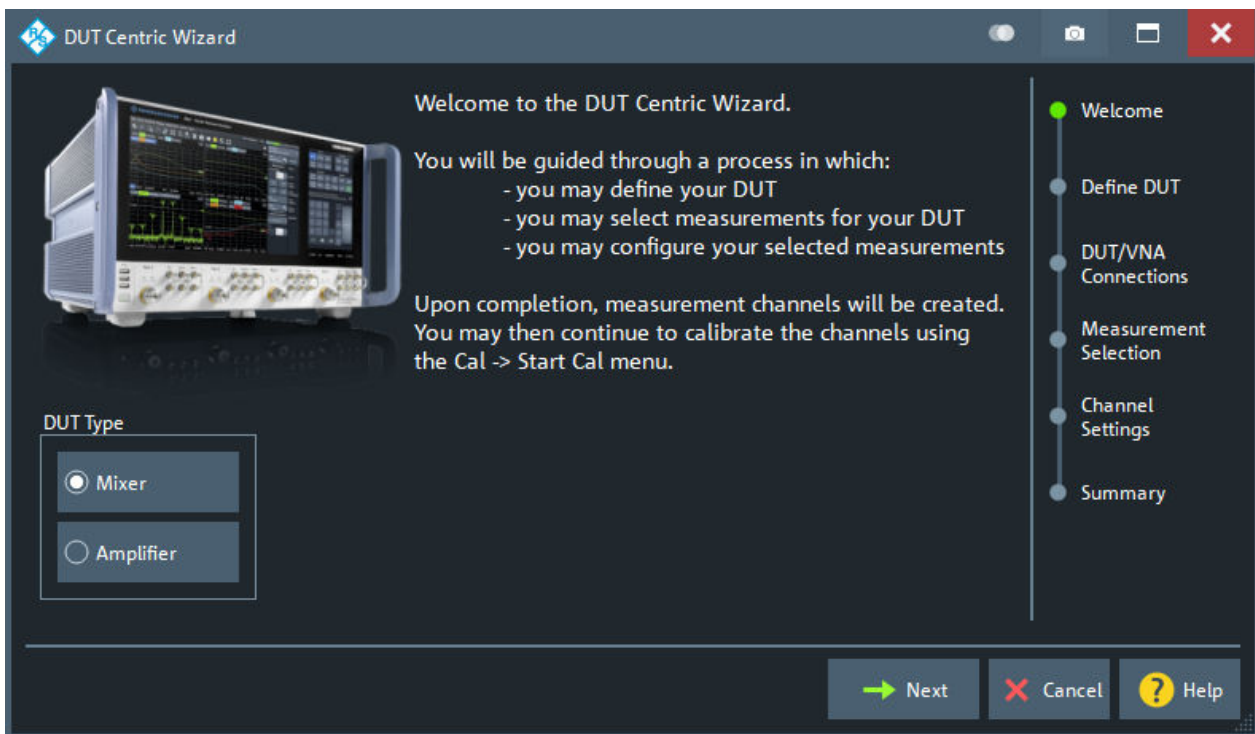

The "DUT Centric Wizard" lets you proceed with the following steps:

1. Select the "DUT Type".
Currently, this can be either "Mixer" or "Amplifier", where "Mixer" measurements require option R&S ZNA-K4 (see [Chapter 4.7.3, "Frequency conversion measurements"](#), on page 261). Other DUT types may be added in future releases of the analyzer firmware.
Currently the wizard only offers support for "Amplifier" measurements. Other DUT types may be added in future releases of the analyzer firmware.
2. Specify the (basic) properties of your DUT.
3. Specify how the DUT is connected to the VNA.
4. Select the measurements to be performed.
At this point, the wizard knows how many additional channels are required, and how they should be set up per default.
5. Adjust the default channel settings to your needs.
6. Review the channels to be created and the parameters to be measured. Decide about calibration.

When you finish the "DUT Centric Wizard", the analyzer firmware creates and configures the required channels for you. If you have decided to proceed with calibration, the wizard selects the suitable calibration types and guides you through the channel calibrations (see [Chapter 5.11.1.7, "Guided Calibration wizard"](#), on page 607).

5.16.1.1 Guided mixer setup

Define DUT

The "Define DUT" page of the "DUT Centric Wizard" allows you to set up the basic properties of a mixer.

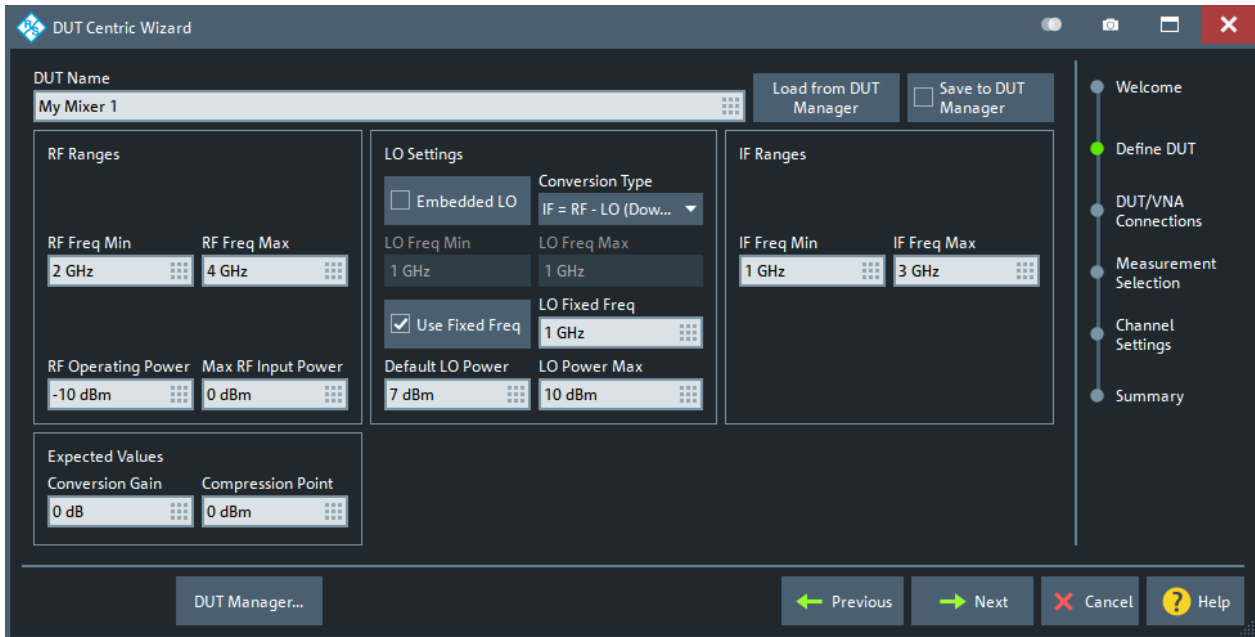

Similar to the [Mixer Configuration dialog](#) of the [DUT Manager](#).

Load from DUT Manager

Use "Load from DUT Manager" to load a previously configured mixer from the DUT manager.

This will open a dialog that allows you to select the DUT to be loaded:

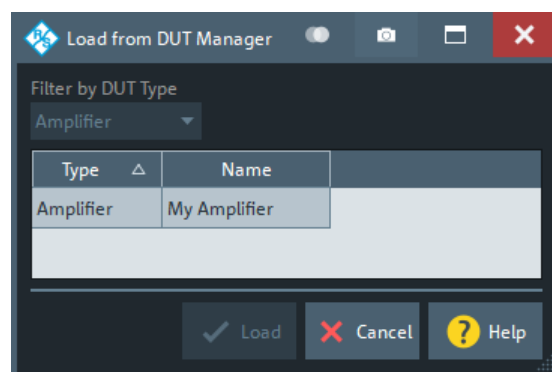

Save to DUT Manager

Use "Save to DUT Manager" to persist new/modified mixer settings to the DUT manager when you proceed to the next step of the "DUT Centric Wizard". If a DUT with the same name exists, you are asked whether you want to overwrite the existing DUT configuration, or to create a DUT with a different name.

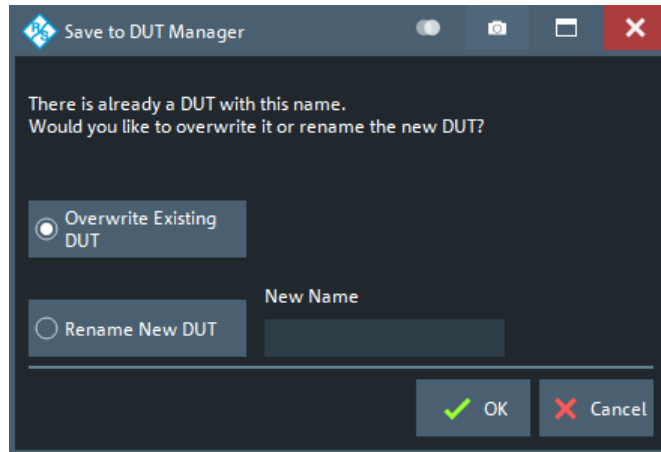

DUT/VNA connections

The "DUT/VNA Connections" page of the "DUT Centric Wizard" allows you to configure the RF connections between VNA and DUT.

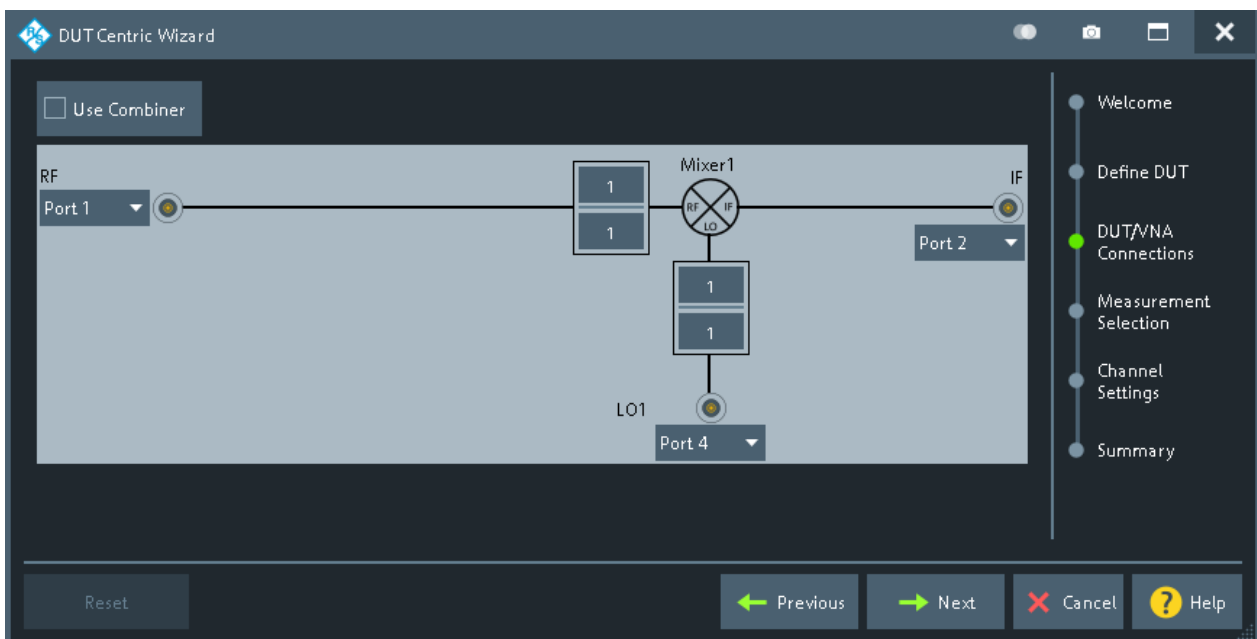

Figure 5-53: Mixer/VNA connections

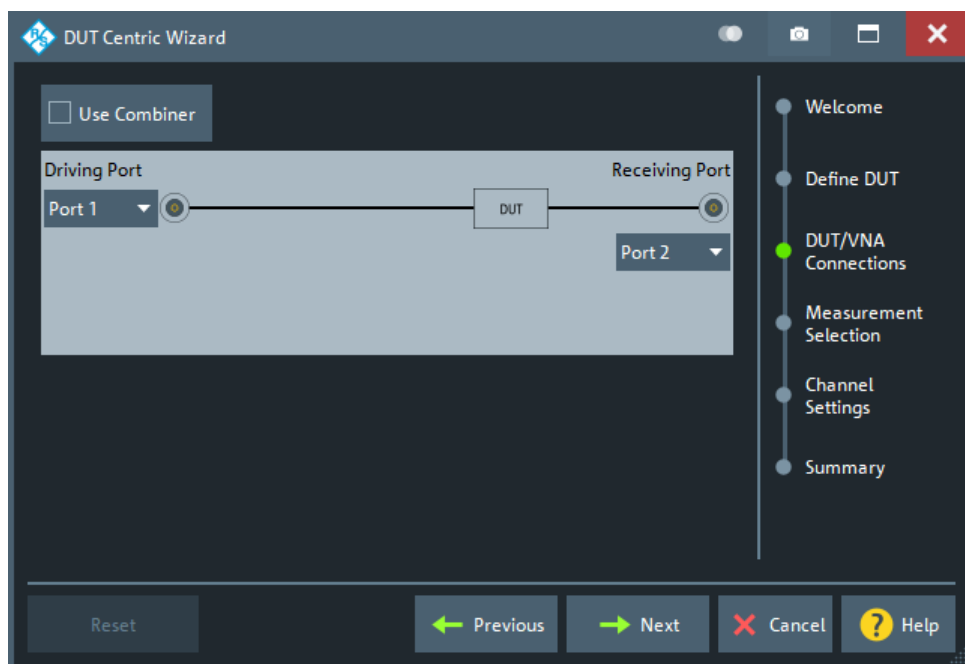
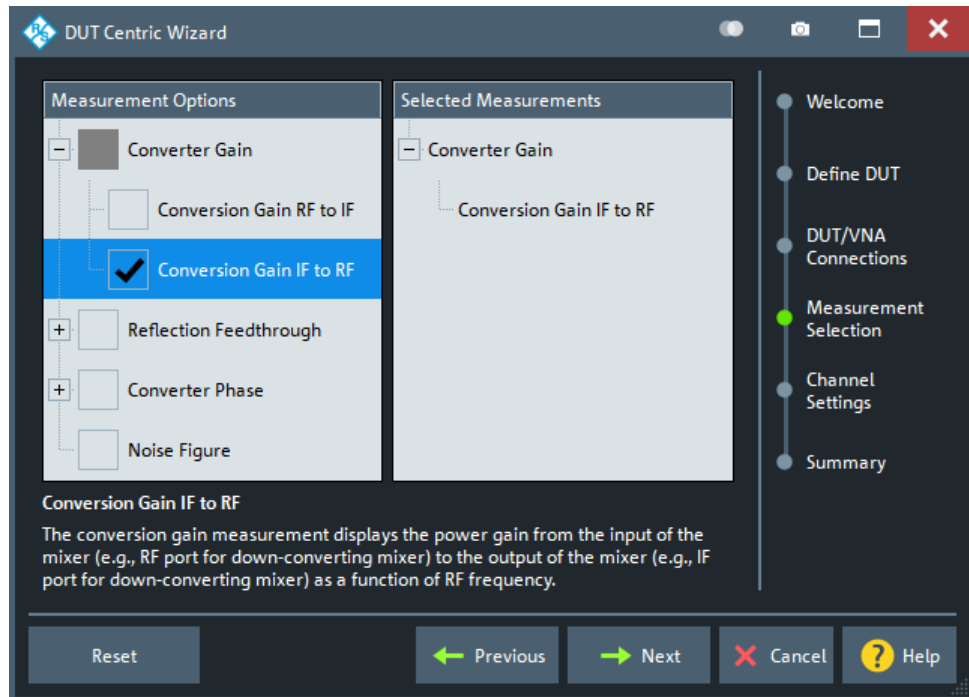

Figure 5-54: Amplifier/VNA connections

Which connections are actually possible, depends on the number of analyzer ports (on the analyzer and connected [switch matrices](#)) and the number of independent sources ([on the VNA](#) and connected [external generators](#)).

Measurement Selection

The "Measurement Selection" page of the "DUT Centric Wizard" allows you to select the mixer properties to be measured.



Channel Settings

The "Channel Settings" page allows you to change the measurement channel configuration proposed by the "DUT Centric Wizard" based on the properties of the DUT, the RF topology and the selected measurements.

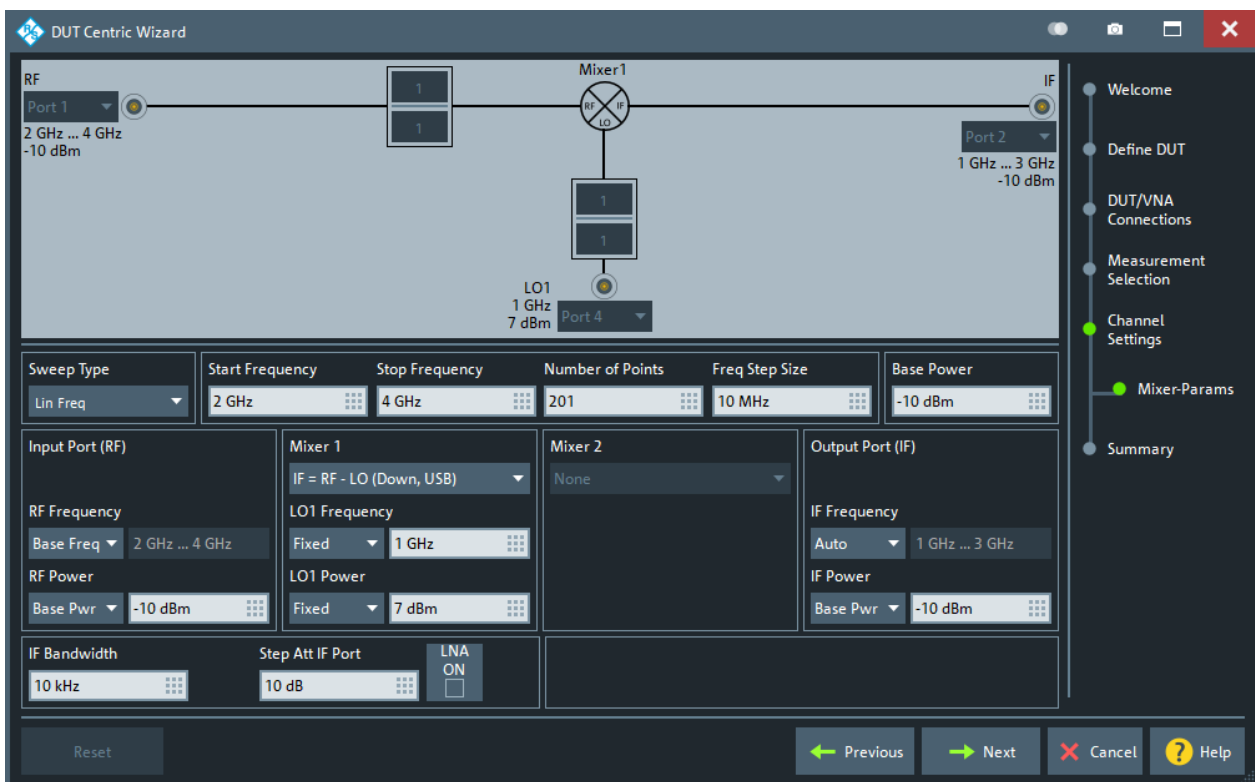

Depending on the "Measurement Selection" on page 786 either one, two, or three channels must be set up:

- one channel for S-parameter measurements
- one channel for intermodulation measurements
- one channel for group delay measurements

Summary

The "Summary" page of the "DUT Centric Wizard"

- summarizes the channels to be created and the parameters to be measured
- allows you where to define these channels (new setup, append to current setup, replace current setup)
- allows you to decide whether to proceed with a (suitable) calibration



Calibrate Newly Created Channels

If you finish the "DUT Centric Wizard" with "Calibrate Newly Created Channels" selected, then, after creating the required (setup and) channels, the FW will proceed with suitable calibrations.

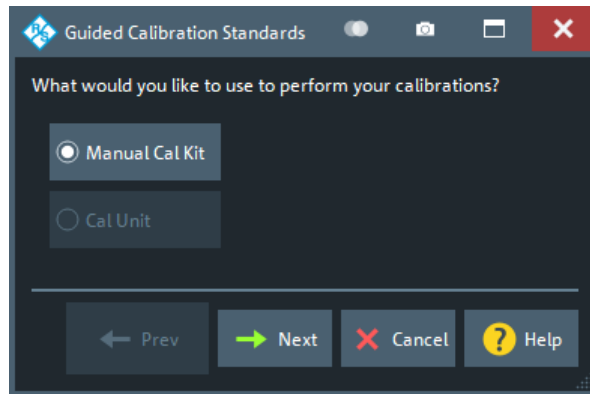

5.16.1.2 Guided amplifier setup

Define DUT

The "Define DUT" step allows you to specify basic properties of an amplifier or load them from the DUT Manager.

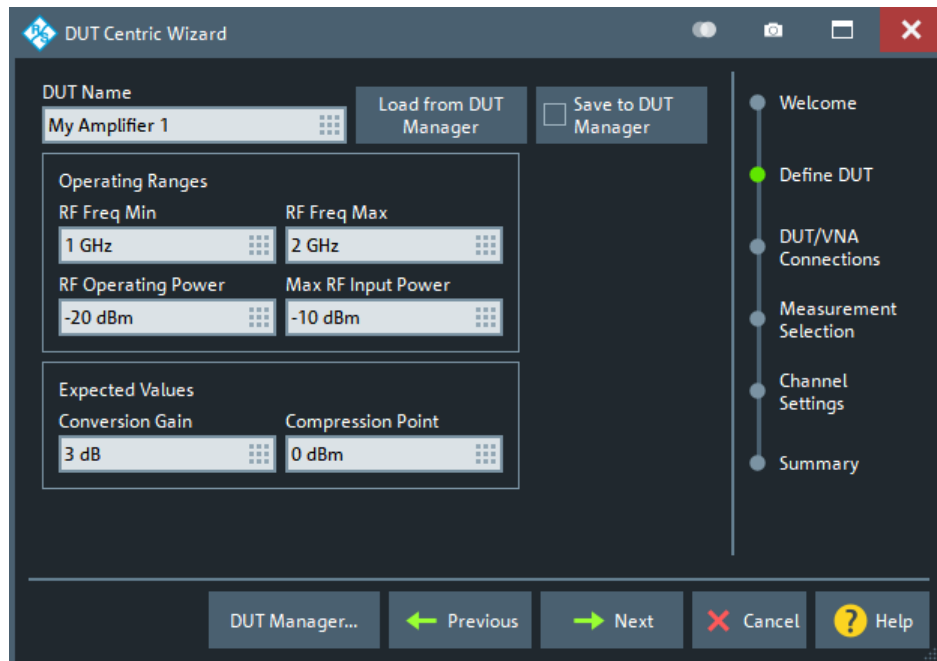

Similar to the [Amplifier Configuration dialog](#) of the [DUT Manager](#).

Load from DUT Manager

Use "Load from DUT Manager" to load a previously configured mixer from the DUT manager.

This will open a dialog that allows you to select the DUT to be loaded:

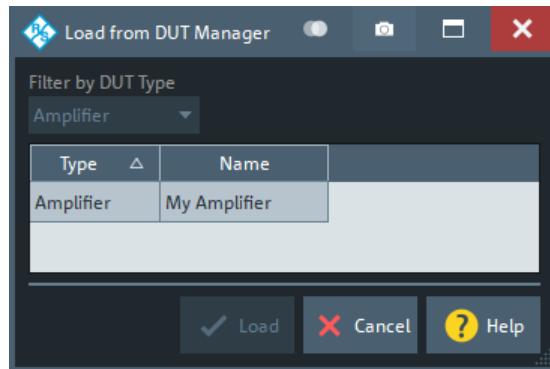

Save to DUT Manager

Use "Save to DUT Manager" to persist new/modified mixer settings to the DUT manager when you proceed to the next step of the "DUT Centric Wizard". If a DUT with the same name exists, you are asked whether you want to overwrite the existing DUT configuration, or to create a DUT with a different name.

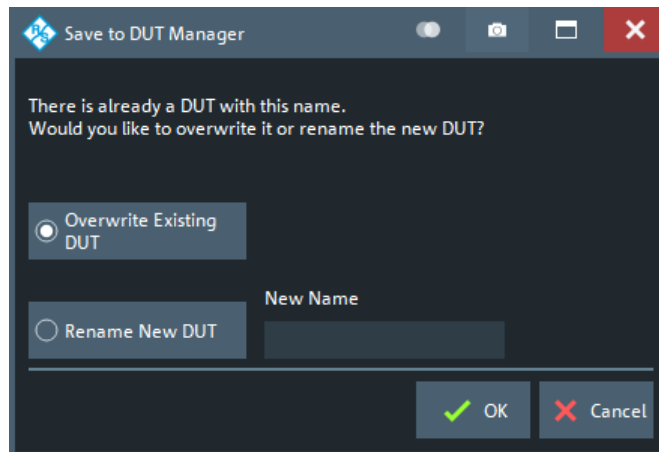

DUT/VNA connections

The "DUT/VNA Connections" page of the "DUT Centric Wizard" allows you to configure the RF connections between VNA and DUT.

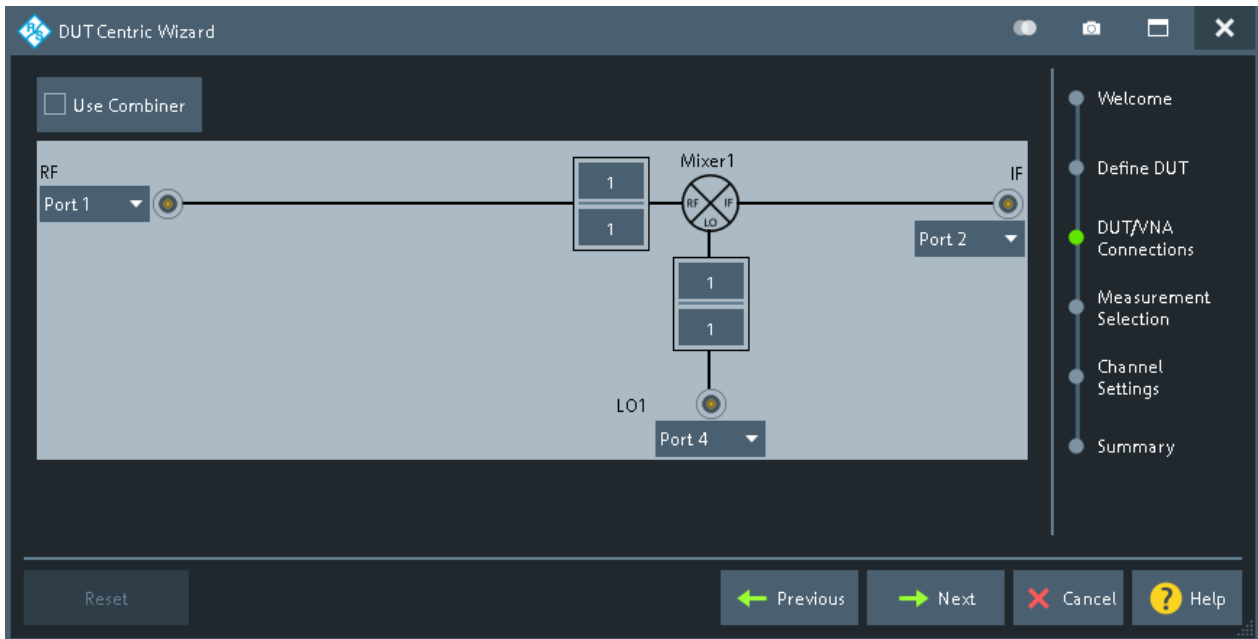

Figure 5-55: Mixer/VNA connections

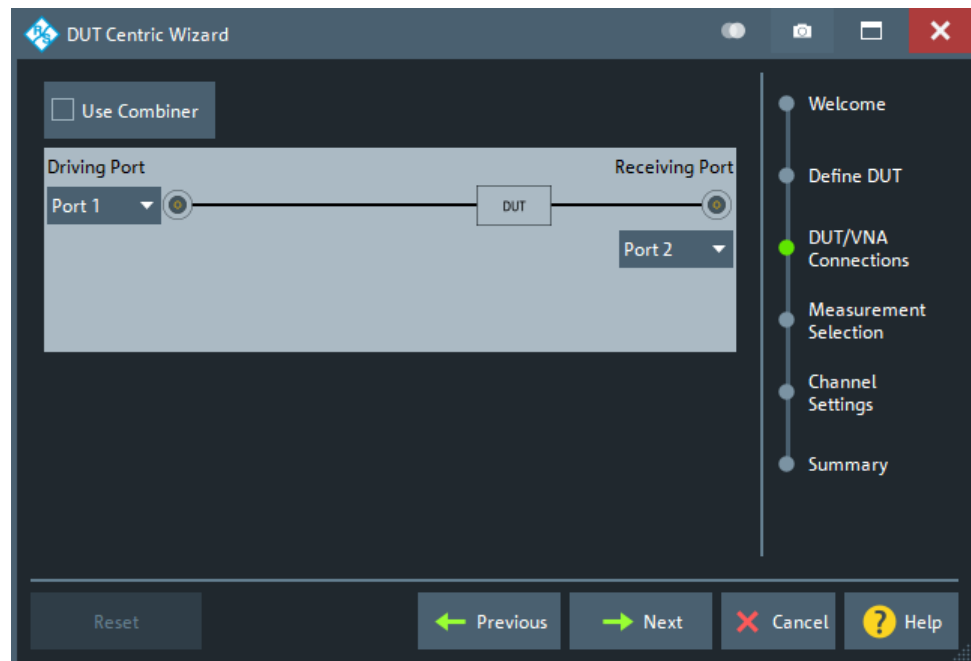
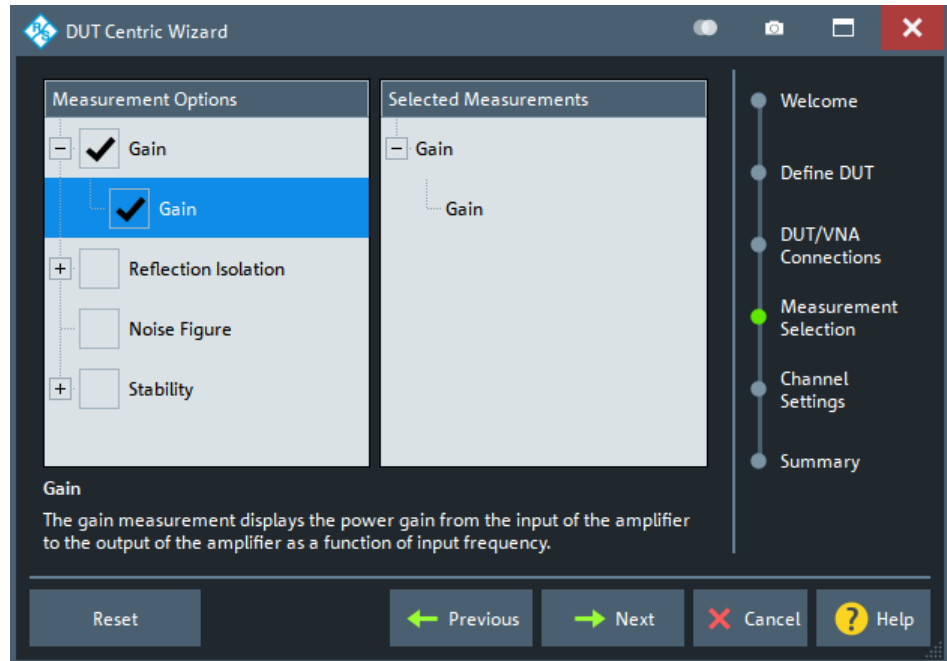

Figure 5-56: Amplifier/VNA connections

Which connections are actually possible, depends on the number of analyzer ports (on the analyzer and connected [switch matrices](#)) and the number of independent sources (on the VNA and connected [external generators](#)).

Measurement Selection

The "Measurement Selection" page of the "DUT Centric Wizard" allows you to select the amplifier properties to be measured.



Channel Settings

The "Channel Settings" page allows you to change the measurement channel configuration proposed by the "DUT Centric Wizard" based on the properties of the DUT, the RF topology and the selected measurements.

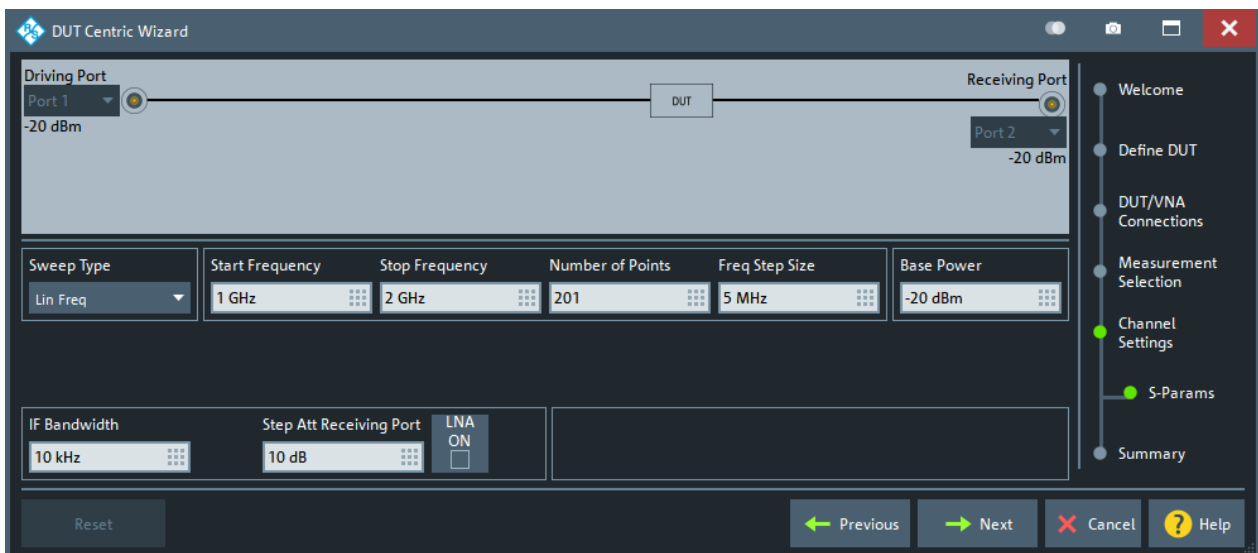

Depending on the "Measurement Selection" on page 786, either one or two channels must be set up:

- one channel for S-parameter measurements

- one channel for intermodulation measurements

Summary

The "Summary" page of the "DUT Centric Wizard"

- summarizes which channels will be created and which parameters they will measure
- allows you where to define these channels (new setup, append to current setup, replace current setup)
- allows you to decide whether to proceed with a (suitable) calibration

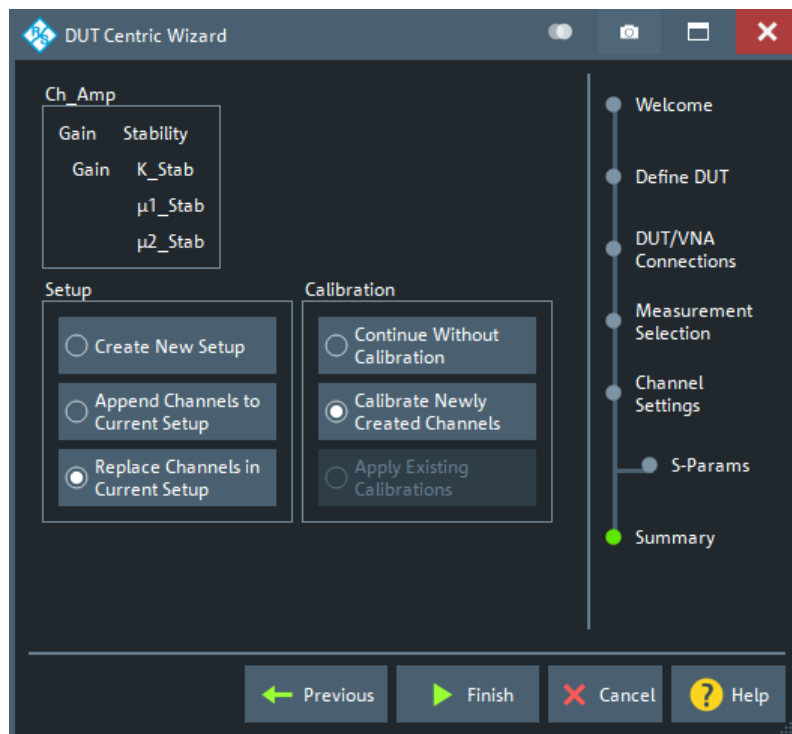

Calibrate Newly Created Channels

If you finish the "DUT Centric Wizard" with "Calibrate Newly Created Channels" selected, then, after creating the required (setup and) channels, the FW will proceed with suitable calibrations.

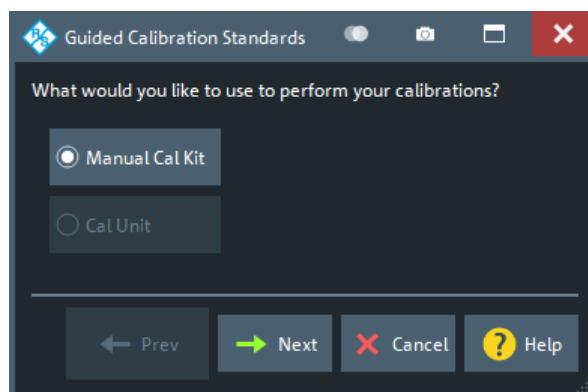

5.16.2 DUT Manager dialog

The DUT manager allows you to create, configure, and manage DUTs.

Access:

- System – [DUT] > "DUT Meas" > "DUT Manager..."
- [DUT Centric Wizard](#) > "Define DUT" > "DUT Manager..."

5.16.2.1 Controls on the DUT Manager dialog

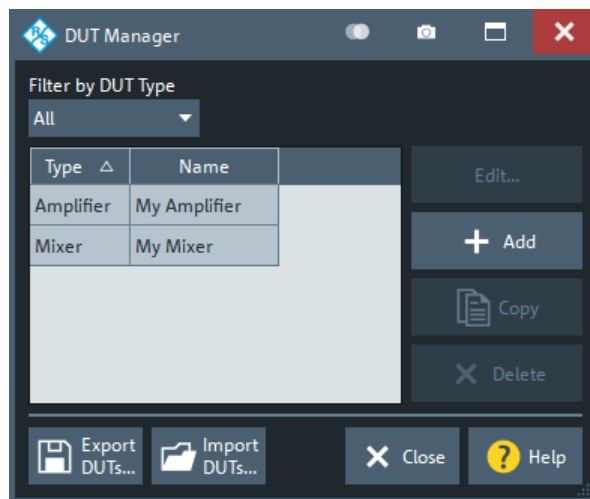

Filter by DUT Type

Use this filter to focus on DUTs of a particular type.

With a particular DUT type selected, the table area only shows DUTs of this type and the "Add" button creates DUTs of this type without further inquiry.

If the "DUT Manager" is opened from the "DUT Centric Wizard", the filter is set to the DUT type that is being configured.

Edit...

This button is only active, if exactly one row is selected in the table area. It allows you to edit the selected DUT.

Depending on the type of the selected DUT, "Edit..." opens the [Amplifier Configuration dialog](#) or [Mixer Configuration dialog](#).

The DUT type "Mixer" is only available if the instrument is equipped with software option R&S ZNA-K4. See [Chapter 4.7.3, "Frequency conversion measurements"](#), on page 261.

Add

Allows you to create a user-defined DUT.

If [Filter by DUT Type](#) is set to a particular DUT type, a DUT of this type is created immediately.

Otherwise an "Add DUT" dialog is shown, which allows you to select the desired DUT type.

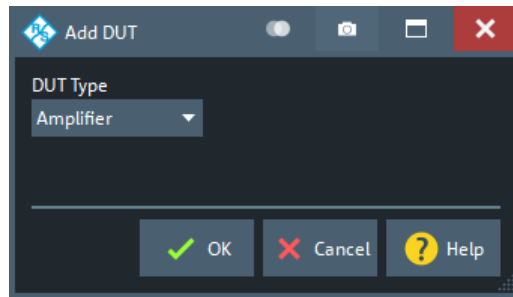

Copy

This button is only active, if exactly one row is selected in the table area. It allows you to copy the selected DUT.

Delete

This button is only active, if at least one row is selected in the table area. It allows you to delete the selected DUTs.

Export DUTs.../Import DUTs...

"Export DUTs..." allows you to save the currently configured DUTs to a file.

"Import DUTs..." allows you to import a set of user-defined DUTs, either in addition to the existing DUTs or replacing them ("Delete Existing DUTs").

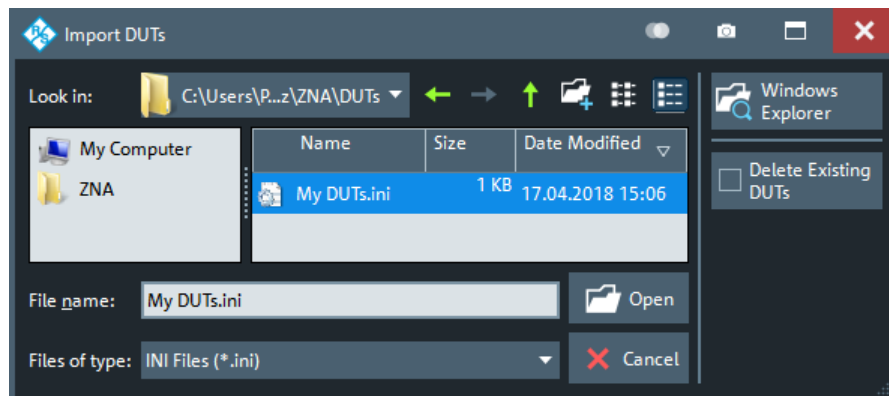

A standard *.ini file format is used for DUT files.

5.16.2.2 Amplifier Configuration dialog

The "Amplifier Configuration" dialog allows you to set up the fundamental properties of an amplifier.

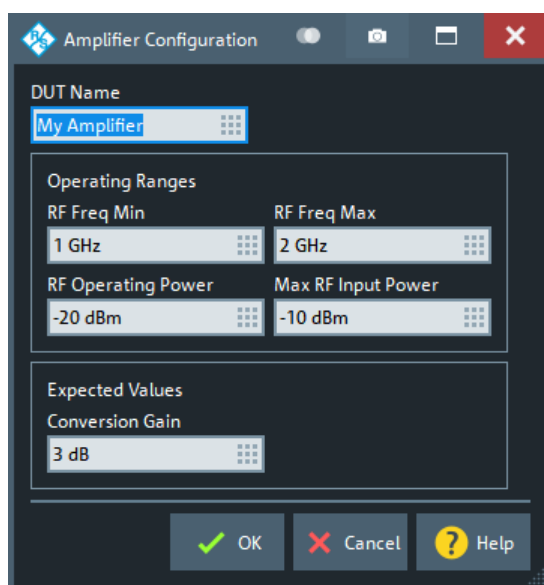

Access: [DUT Manager dialog](#) > "Edit..." with a DUT of type "Amplifier" selected

5.16.2.3 Mixer Configuration dialog

The "Mixer Configuration" dialog allows you to set up the fundamental properties of a mixer.

Access: [DUT Manager dialog](#) > "Edit..." with a DUT of type "Mixer" selected



The DUT type "Mixer" is only available if the instrument is equipped with software option R&S ZNA-K4. See [Chapter 4.7.3, "Frequency conversion measurements"](#), on page 261.

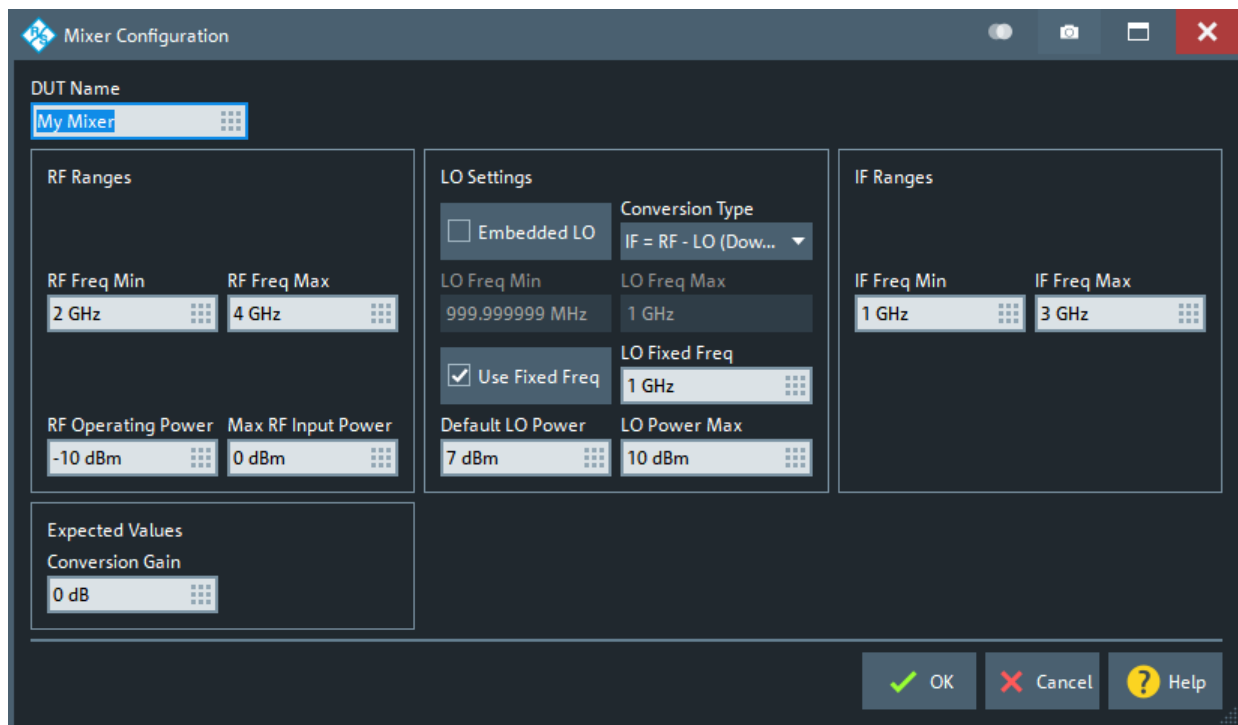

Most of the mixer properties are straight-forward

Embedded LO

Select "Embedded LO" if in the related mixer measurement the LO cannot be provided by the VNA or a connected external generator. Setting this flag makes the LO drive power range read-only.

Note that [Embedded LO mixer group delay measurements](#) requires option R&S ZNA-K9.

Use Fixed Freq

Uncheck "Use Fixed Freq" if you want the LO signal to vary in frequency, which will enable "LO Freq Min" and "LO Freq Max". Otherwise only "LO Fixed Freq" is enabled.

5.17 Applic softtool

The "Applic" softtool gives access to applications and tools that extend the functionality of the analyzer firmware.

Access: System – [Applic]

Use the combo-box at the top of the softtool to load one of the available applications and to display the softtool tabs related to this application.

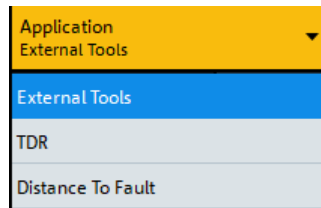

The "External Tools" application is always available, other applications are provided by certain software options.

5.17.1 External Tools application

The "External Tools" application gives access to pre-installed and user-defined external tools.

Access: System – [Applic] > "External Tools"

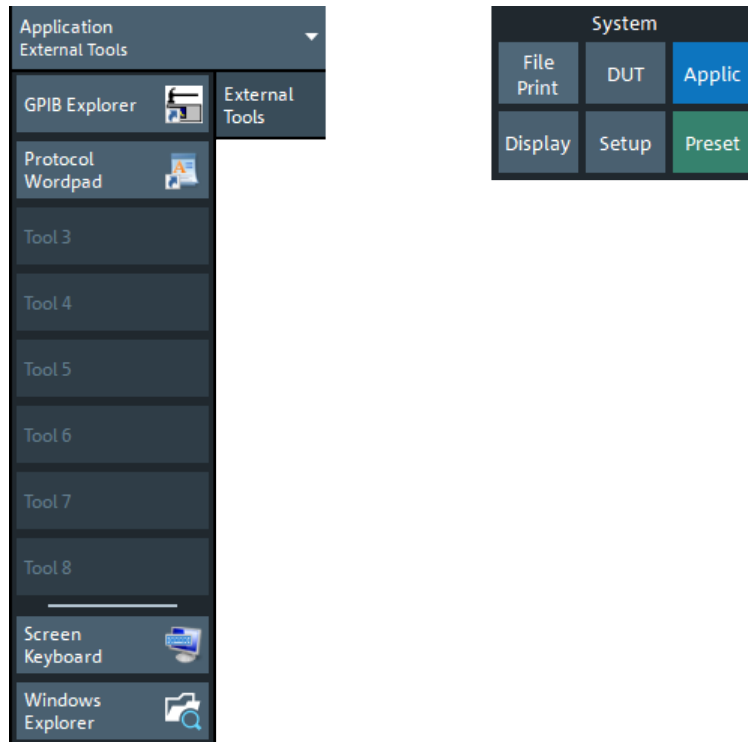

GPIB Explorer

Opens a tool that allows you to connect to the analyzer, obtain an overview of all implemented remote control programs, test programs, compile and run test scripts. For a detailed description, refer to [Chapter 6.1.3, "GPIB Explorer"](#), on page 933.

Protocol Wordpad

Convenience function for opening the WordPad word processor, e.g. for creating ad hoc measurement protocols, reports etc.

Tool 3 ... Tool 8

Allows you to add your own external tools. Any new shortcut in the

C:\Users\Public\Documents\Rohde-Schwarz\ZNA\External Tools directory replaces one of the buttons.

Title and Bar Task Bar On

Displays or hides the title bar and the task bar across the bottom of the screen. Typically you can use the task bar to change between the VNA application and other external tools. See also [Chapter 3.3.2.1, "Title bar"](#), on page 49.

Screen Keyboard

Opens the Windows "On-Screen Keyboard". This tool allows you to enter characters, in particular letters, if an input field cannot call up the analyzer's own on-screen keyboard, and if no external keyboard is connected.

See also [Chapter 3.3.6.4, "Using the Windows® on-screen keyboard"](#), on page 65.

Windows Explorer

Opens the Windows Explorer and shows you the contents of the

C:\Users\Public\Documents\Rohde-Schwarz\ZNA\External Tools application shortcut directory.

5.17.2 TDR application

The "TDR" (Time Domain Reflectometry) application is provided by the Extended Time Domain Analysis option R&S ZNA-K20. It is only visible if this option is installed.

Access: System – [Applic] > "TDR"

**Background information**

See [Chapter 4.7.2.8, "Extended time domain analysis"](#), on page 256.



5.17.2.1 TDR Setup tab

The "TDR Setup" tab allows you to set up the measurement for the time domain transformation, which is then used to analyze the time domain behavior of the DUT (eye diagram, rise time, skew, ...).

Access: System – [Applic] > "TDR" > "TDR Setup"

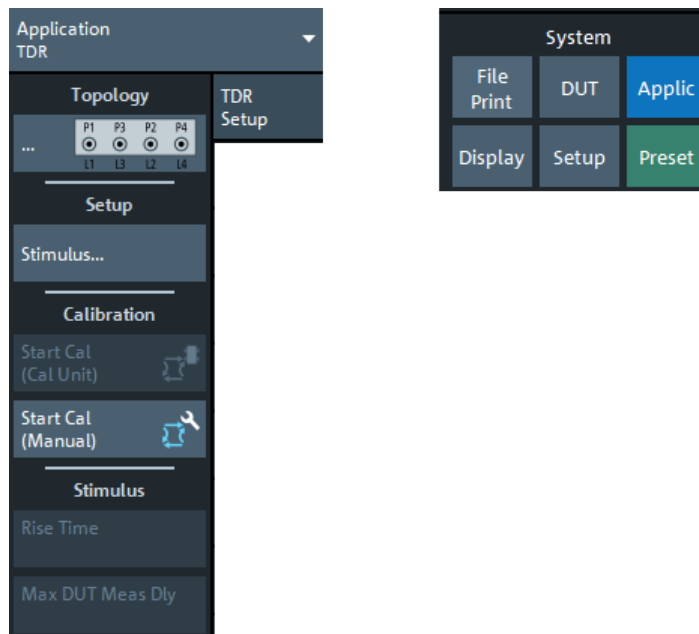

The "TDR Setup" contains the following sections/controls:

- "Topology"

Opens the "Balanced Ports" dialog that allows to configure the logical DUT ports (see [Chapter 5.2.2.5, "Balanced Ports dialog"](#), on page 352)

- "Stimulus..."
Opens the [TDR Stimulus Settings dialog](#) that allows to configure the frequency sweep whose results are then used for the time domain transformation
- "Calibration"
The "Calibration" section provides easy access to (basic) manual and automatic calibration functions (see [Chapter 5.11.1, "Start Cal tab"](#), on page 570)
- "Stimulus"
The "Stimulus" section provides quick access to settings that are also available in the [TDR Stimulus Settings dialog](#). These settings are only available in [Automatic Harmonic Grid](#) mode, which is activated automatically when opening the "TDR Stimulus Settings" dialog.

5.17.2.2 TDR Wizard

With the "TDR Wizard", you can quickly set up and calibrate a TDR measurement. It comprises the following steps:

- [Step 1: Port Topology](#)
- [Step 2: Stimulus Settings](#)

Access: System – [Applic] > "TDR" > "TDR Setup" > "TDR Wizard..."

Step 1: Port Topology

The "Port Topology" step allows you to select between predefined (balanced) port configurations.

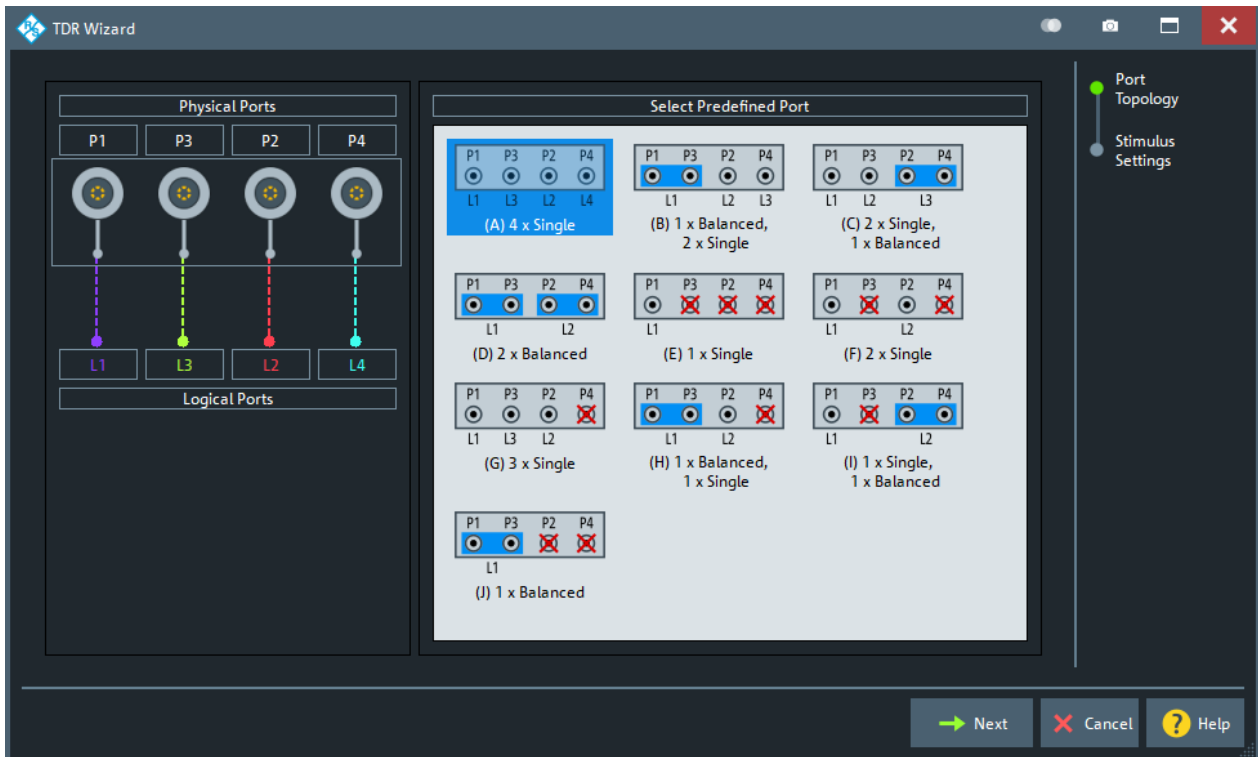
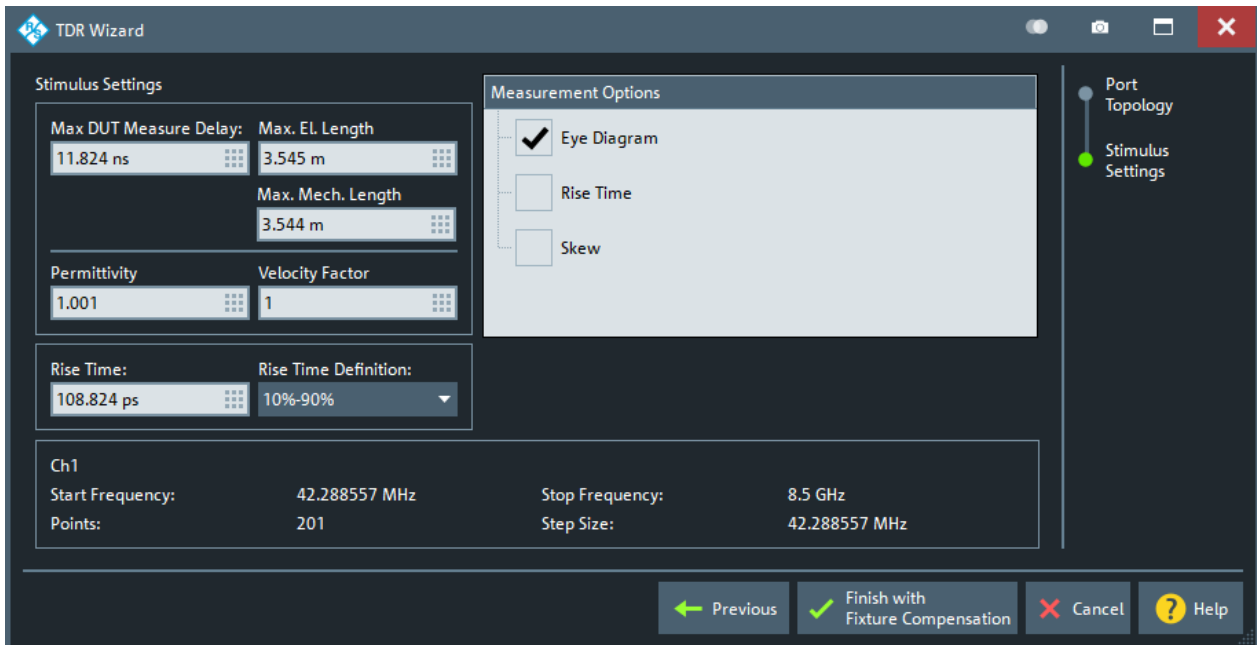

Figure 5-57: Port Topology step

The port configurations are the same as the ones offered on the "Predefined Config" tab of the [Balanced Ports dialog](#).

Step 2: Stimulus Settings

The "Stimulus Settings" step gives access to the basic settings of the [TDR Stimulus Settings dialog](#) and allows you to select the time domain measurements to be performed.



Once you have selected a measurement, you can finish the wizard and proceed to the [Fixture Compensation dialog](#) using the "Finish with Fixture Compensation" button.

5.17.2.3 TDR Stimulus Settings dialog

This dialog allows you to configure the frequency sweep whose results are then used for the time domain transformation and subsequent TDR simulation.

Access: System – [Applic] > "TDR" > "TDR Setup" > "Stimulus..."

After the settings are made, the resulting sweep parameters are shown in the lower part of the dialog, as can be seen in the screenshot below.



Opening the dialog automatically activates the [Automatic Harmonic Grid](#) function.

Controls in the TDR Stimulus Settings dialog

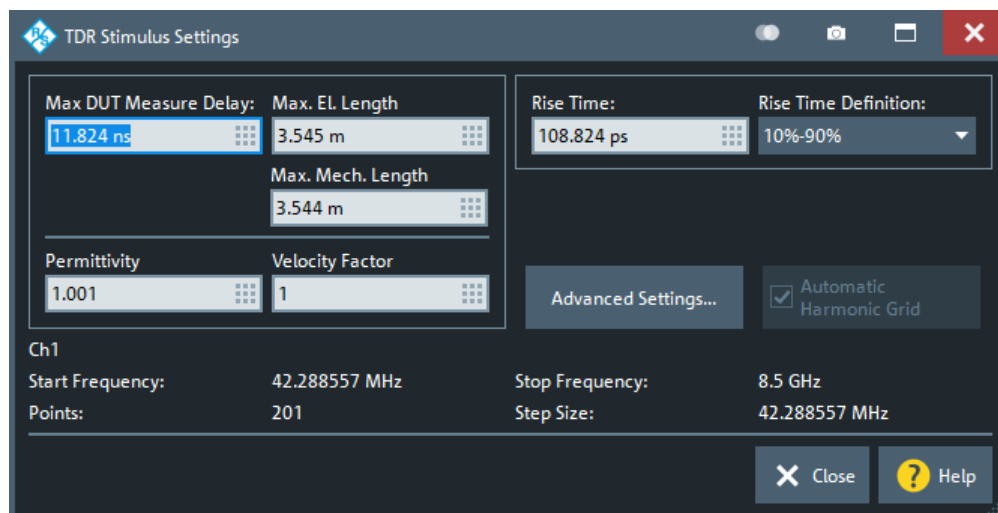

Figure 5-58: TDR Stimulus Settings dialog

The "TDR Stimulus Settings" dialog offers basic settings. Instead of specifying the sweep parameters directly, they are derived from time domain properties of the DUT. After the settings are made, the resulting sweep parameters are shown in the dialog.

Advanced settings can be accessed via "Advanced Settings..." (see "TDR Stimulus - Advanced Settings dialog" on page 805).

Max. DUT Measure Delay / Max. El. Length / Max. Mech. Length

Defines the "length" of the DUT, which can either be specified as delay, electrical length, or mechanical length.

Given the DUT's [permittivity](#) ϵ_r , these alternative "length" parameters are related by:

$$Delay = \frac{L_{mech} \cdot \sqrt{\epsilon_r}}{c}; \quad Electrical\ Length = L_{mech} \cdot \sqrt{\epsilon_r}$$

i.e. setting one of them determines the other two.

Note: The length of the DUT determines the appropriate start frequency and step size of the frequency sweep. It is important that the user enters a value that is at least as high as the actual one. A higher value is acceptable as long as the resulting start frequency is not below the analyzer's minimum frequency, which would be rejected by the analyzer firmware.

Remote command:

```
[SENSe<Ch>:]HARMonic:DLENgth:DATA
[SENSe<Ch>:]HARMonic:ELENgth:DATA
[SENSe<Ch>:]HARMonic:MLENgth:DATA
```

Permittivity / Velocity Factor

Specifies the (relative) permittivity ϵ_r of the DUT or, alternatively, its velocity factor $1/\sqrt{\epsilon_r}$.

The velocity factor is a measure for the velocity of an electromagnetic wave in a dielectric with permittivity ϵ_r , relative to its velocity in a vacuum (velocity factor < 1).

Permittivity and velocity factor are coupled parameters, i.e. setting one of them determines the other. A higher permittivity implies a smaller mechanical length, but leaves delay and electrical length unchanged (see [Max. DUT Measure Delay / Max. El. Length / Max. Mech. Length](#)).

Remote command:

```
[SENSe<Ch>:]HARMonic:PERMittivity:DATA
[SENSe<Ch>:]HARMonic:VELocity:DATA
```

Rise Time Definition

Selects between rise time definitions 10%-90% (default) and 20%-80%.

Remote command:

```
[SENSe<Ch>:]HARMonic:RTIME:THReshold
```

Rise Time

The minimum rise time (according to the selected [Rise Time Definition](#)) the user wishes to measure on the DUT.

The minimum rise time, in turn, determines the stop frequency of the frequency sweep: the smaller the "Rise Time", the larger the stop frequency – limited by the analyzer's maximum frequency.

Remote command:

```
[SENSe<Ch>:]HARMonic:RTIME:DATA
```

TDR Stimulus - Advanced Settings dialog

The "TDR Stimulus - Advanced Settings " compiles advanced settings of the time domain transformation that is available with the standard time domain option R&S ZNA-K2.

Access: [TDR Stimulus Settings dialog](#) > "Advanced Settings..."

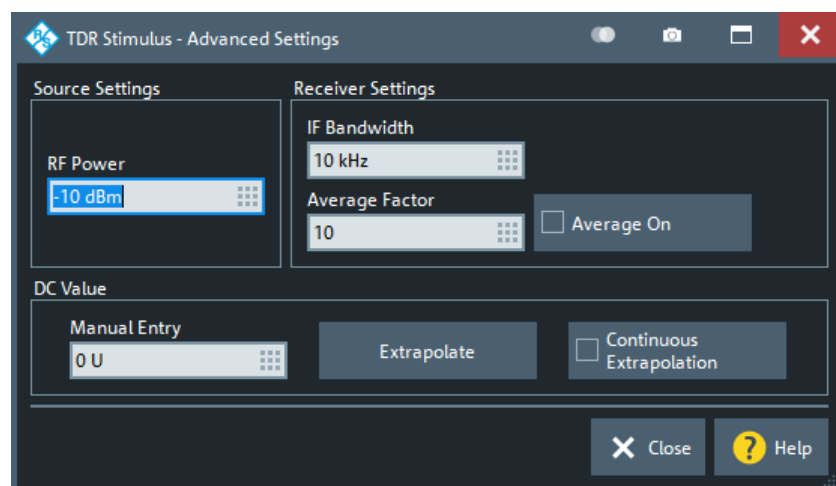

Figure 5-59: TDR Stimulus – Advanced Settings dialog



For additional settings, see [Chapter 5.5.5, "Time Domain tab"](#), on page 447.

Source/Receiver Settings

The "RF Power" is the output power of the R&S ZNA, "IF Bandwidth" and "Average Factor" determine the operation of the related R&S ZNA receiver. For a description and related remote control commands, see [Chapter 5.9, "Pwr Bw Avg softtool"](#), on page 535.

DC Value

Defines how to calculate the DC gain of the DUT (since the R&S ZNA cannot measure down to 0 Hz). These parameters are the same settings as for the standard time domain option R&S ZNA-K2. For a description and related remote control commands, see ["DC Value"](#) on page 452.

5.17.2.4 Eye Diag tab

The "Eye Diag" tab is for enabling and configuring the eye diagram and its measurements.

Access: System – [Applic] > "TDR" > "Eye Diag"

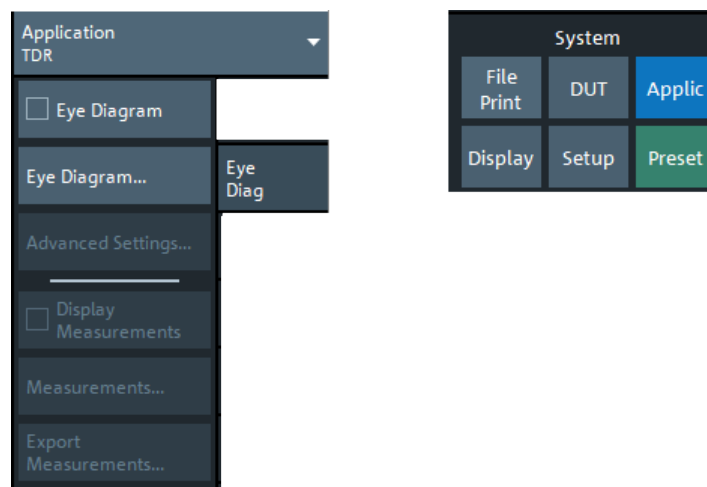

Eye Diagram

The "Eye Diagram" checkbox enables the eye diagram with the current settings (default or defined in [Eye Diagram dialog](#)) or disables it.

Remote command:

`CALCulate<Chn>:EYE:STATe`

Eye Diagram ...

Opens the [Eye Diagram dialog](#) that allows to create an eye diagram and to perform basic settings on the simulated digital signal generator.

Advanced Settings...

If the active trace is an eye diagram, the "Advanced Settings..." button opens the [Advanced Settings dialog](#) that allows in-depth configuration of the simulated digital signal generator and receiver.

Display Measurements

If the active trace is an eye diagram, the "Display Measurements" button in the [Eye Diag tab](#) softtool tab toggles the display of the eye diagram results.

The available results depend on the selected [Modulation](#):

- For NRZ modulated generator signals, the result display comprises two separate info fields for "Basic" and "Time" results (see ["Measurements..."](#) on page 807). By default they are stacked below each other, however, they can be moved independently like any other info field.

Trc1	
Eye Minimum	-3.106 V
Eye Maximum	3.106 V
Eye Base	-2.810 V
Eye Top	2.810 V
Eye Mean	0.000 V
Eye Amplitude	5.621 V

Trc1	
Bit Period	10.000 ns
Rise Time	125.000 ps
Fall Time	125.000 ps
Jitter Pk-Pk	50.125 ps
Jitter RMS	0.000 s
Duty Cycle Dist	25.063 ps
Duty Cycle Pct	0.251 %
Crossing Percent	50.000 %
Opening Factor	1.000
SNR	-----

Figure 5-60: Eye Diagram Results (NRZ Modulation)

- For PAM modulation types, only a reduced set of "Basic" results is available.

Eye Minimum	-2.861 V
Eye Maximum	2.925 V
Eye Base	-2.711 V
Eye Top	2.711 V
Eye Mean	0.000 V
Eye Amplitude	5.422 V

Figure 5-61: Eye Diagram Results (PAM Modulations)

For a description of the result values, see ["Eye Diagram Results"](#) on page 257.

Remote command:

```
CALCulate<Chn>:EYE:MEASurement:STATe
```

```
CALCulate<Chn>:EYE:MEASurement:DATA?
```

Measurements...

If the active trace is an eye diagram, the "Measurements..." button brings up a dialog which allows to select and configure the eye measurements to be displayed (if [Display Measurements](#) is enabled).

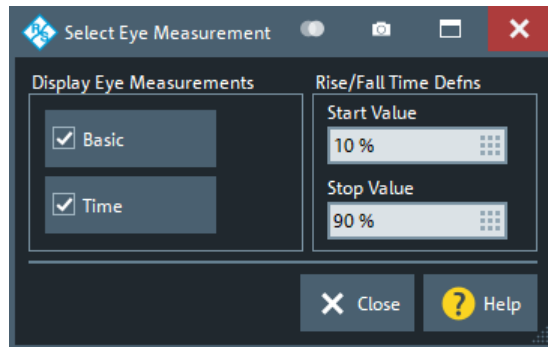

The following measurement results can be selectively enabled/disabled:

- "Basic" – Eye Minimum, Eye Maximum, Eye Base, Eye Top, Eye Mean, Eye Amplitude, Eye Height, Eye Width
For PAM signals (see ["Modulation"](#) on page 811) Eye Height and Eye Width are not available.
- "Time" – Bit Period, Rise Time, Fall Time, Jitter Pk-Pk, Jitter RMS, Duty Cycle Dist, Duty Cycle Pct, Crossing Percent, Opening Factor, SNR
For PAM signals these results are not available.

For a description of the result values, see ["Eye Diagram Results"](#) on page 257.

Furthermore it is possible to change the Rise (and Fall) Time definition for the eye measurement from the standard 10–90% (90–10%) step to any other "Start Value"/"Stop Value" pair.

Remote command:

`CALCulate<Chn>:EYE:MEASurement:TTIME:THReshold`

Export Measurements...

If the active trace is an eye diagram, the "Export Measurements" button opens the "Export Eye Measurements – ASCII Files" dialog that allows to save the [Eye Diagram Results](#) to an ASCII file.

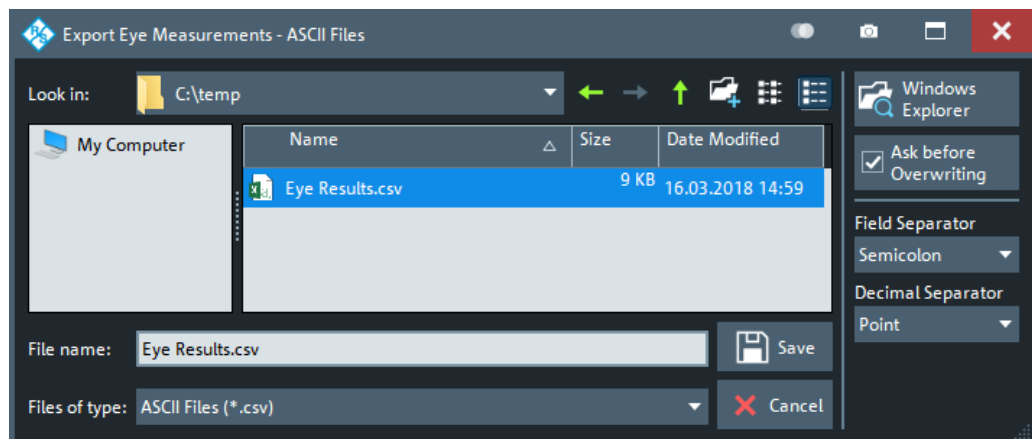

The "Export Eye Measurements – ASCII Files" dialog is a standard "Save File" dialog with the additional options of selecting a "Field Separator" (semicolon, comma, tab or space) and a "Decimal Separator" (comma or point).

Note that the decimal separator and field separator must be different.

Remote command:

`MMEMoRY:STORe:EYE:MEASurements`

5.17.2.5 Eye Diagram dialog

Allows basic configuration of the eye diagram simulation.

Access: System – [Applic] > "TDR" > "Eye Diag" > "Eye Diagram..."

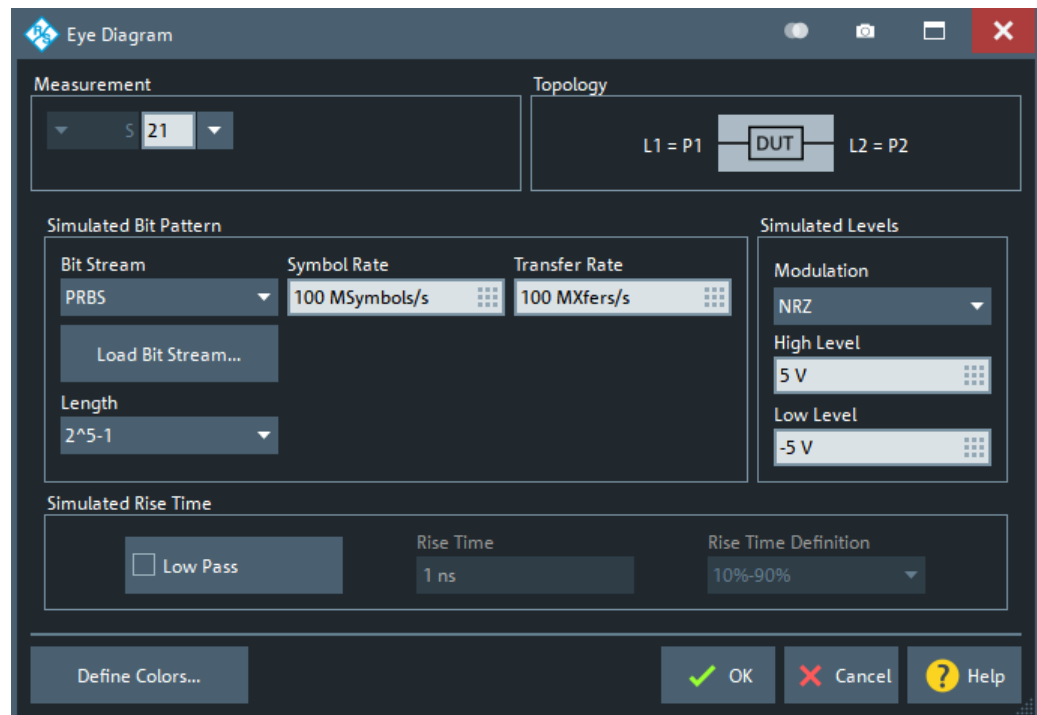

For advanced configuration of the eye diagram simulation, see [Chapter 5.17.2.6, "Advanced Settings dialog"](#), on page 812

Measurement / Topology

"Measurement" allows you to select an S-Parameter, i.e. the transmission (or reflection) whose time domain properties you want to analyze. The "Topology" to the right is updated accordingly.

Remote command:

`CALCulate<Ch>:PARAmeter:MEASure`

Bit Stream

Describes the bit stream generated by the "virtual" generator.

"Bit Stream" can either be a pseudo-random binary sequence (PRBS) of the selected [Length](#) or a user-defined bit stream.

The PRBSs are generated using a linear feedback shift register with generator polynomials allowing the maximal run length of the sequence.

Remote command:

`CALCulate<Chn>:EYE:INPut:BPATtern:TYPE`

Length

Length of the bit stream.

For a user defined **Bit Stream** the length can be specified in terms of bits, Kibits (2^{10} bits), Mibits (2^{20} bits), Gibits (2^{30} bits).

Remote command:

`CALCulate<Chn>:EYE:INPut:LENGth:PRBS`

`CALCulate<Chn>:EYE:INPut:LENGth:BITS`

Load Bit Stream

A user-defined bit stream can be loaded from file and is repeated until the configured **Length** is reached. If no pattern is loaded from file, the default pattern "10" is repeated instead.

The "Bit Stream Load" dialog allows you to select a suitable "bit stream file".

Access: "Load Bit Stream" button in [Eye Diagram dialog](#)

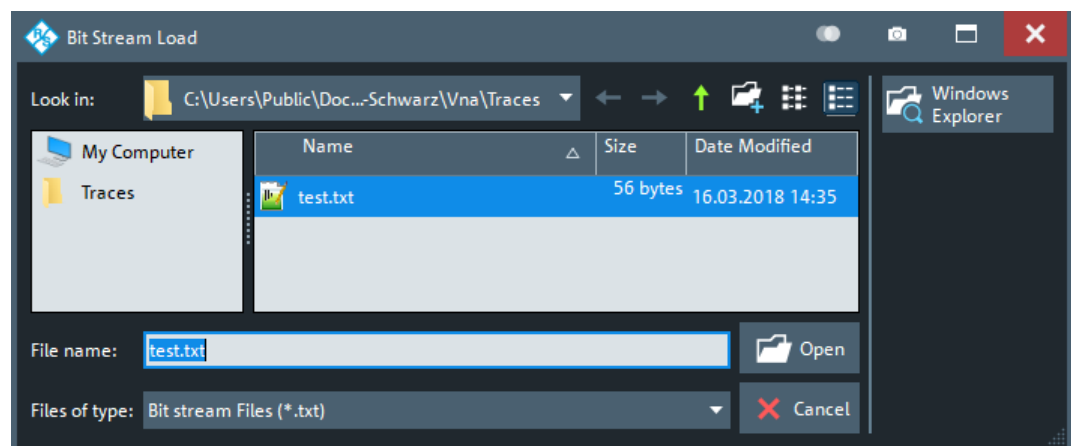

Such a bit stream file must be a 7-bit ASCII compatible text file; the Byte Order Mark (BOM) that is common with UTF encodings is not allowed. Only the ASCII codes 0x30 ("0") and 0x31 ("1") are interpreted, all other codes including whitespace and line endings are ignored.

Remote command:

`MMEMory:LOAD:EYE:BPATtern`

Symbol Rate/Transfer Rate

The **"Symbol Rate"** (= baud rate) defines the number of symbol changes per unit time, or, equivalently, the symbol period (= $1 / \text{"Symbol Rate"}$).

To convert symbol rate to data rate, multiply the symbol rate with the number of bits per symbol (2 bits per symbol for NRZ, ..., 4 bits per symbol for PAM-16).

The **"Transfer Rate"** is the number of transfers per second ("Xfers/s"). It can be calculated from the "Symbol Rate" and vice versa:

- For NRZ, transfers and symbols are identical
- For PAM- n , the number of transfers is n x the number of symbols

Remote command:

```
CALCulate<Chn>:EYE:INPut:DRATe  
CALCulate<Chn>:EYE:INPut:XRATe
```

Modulation

Defines the modulation of the generated bit stream (NRZ, PAM-4, PAM-8 or PAM-16).

Note that for a modulation type other than NRZ, eye masks and eye mask tests are not available (the buttons on the [Eye Mask Test tab](#) are grayed out).

Remote command:

```
CALCulate<Chn>:EYE:INPut:MODulation
```

High Level / Low Level

Defines the highest/lowest (nominal) voltage level of the multilevel signal that is used to generate the related eye diagram.

The [Modulation](#) type can only be changed in the advanced "Generator Settings" dialog (see "[Generator](#)" on page 813).

Remote command:

```
CALCulate<Chn>:EYE:INPut:OLEVel  
CALCulate<Chn>:EYE:INPut:ZLEVel
```

Low Pass

Defines the signal shape of the simulated digital signal: toggles between ideal rectangular shape ("Low Pass" = disabled, default) and a more realistic shape ("Low Pass" = enabled).

If enabled a single pole low pass filter is inserted into the simulated signal path, which is defined using its rise time (see "[Rise Time / Rise Time Definition](#)" on page 811).

Remote command:

```
CALCulate<Chn>:EYE:STIMulus:LOWPass
```

Rise Time / Rise Time Definition

The [Low Pass](#) is defined by its "Rise Time" from 10% to 90% or from 20% to 80% of the signal amplitude.

Note that the measured rise time after the DUT is also affected by the rise time of the DUT. Hence the measured rise time can be higher than the specified rise time.

Remote command:

```
CALCulate<Chn>:EYE:INPut:RTIME:DATA  
CALCulate<Chn>:EYE:INPut:RTIME:THReshold
```

Define Colors

Opens a dialog that allows to change the color gradient of the eye diagram (as a heat map).

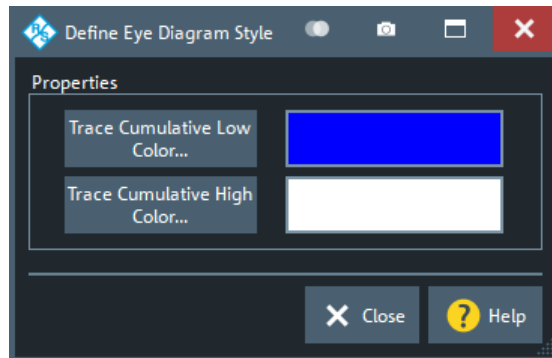

"Trace Cumulative Low Color" is the color that is used for the occurrence value 1, "Trace Cumulative High Color" is the color that is used for the most frequent occurrences. No occurrence (value 0) is always displayed fully transparent with the background being visible.

OK / Cancel

"OK" enables/modifies the eye diagram, "Cancel" leaves the [Eye Diagram dialog](#) without applying possible changes.

Remote command:

`CALCulate<Chn>:EYE:STATe`

5.17.2.6 Advanced Settings dialog

The "Advanced Settings" dialog gives full access to the calculation chain of the eye diagram simulation.

Access: System – [Applic] > "TDR" > "Eye Diag" > "Advanced Settings..."



This dialog is available with [Extended time domain analysis](#) option R&S ZNA-K20 only.

Controls in the dialog

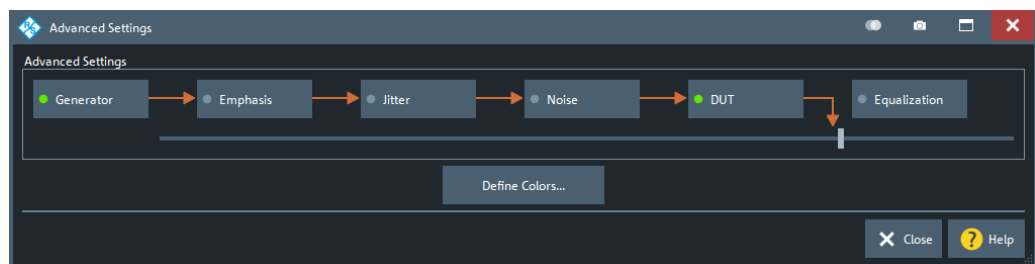

- [Generator](#), [Emphasis](#), [Jitter](#) and [Noise](#) allow you to specify the simulated input signal of the DUT
- [DUT](#) allows you to switch between different transmission (and reflection) paths of the DUT and to configure its DC properties.
- [Equalization](#) allows you to perform signal equalization at the "virtual receiver".

A green LED indicates that the respective building block is active. However the calculation chain can also be shortened using the [\[Slider\]](#) control below the building blocks.

[Slider]

Allows you to shorten the simulation/calculation chain without deactivating the building blocks at the tail end.

Remote command:

`CALCulate<Chn>:EYE:VIEW`

Define Colors...

See ["Define Colors"](#) on page 811

Generator

The "Generator Settings" dialog gives full access to the "virtual" signal generator of the related eye diagram simulation. Most of the settings are also available in the [Eye Diagram dialog](#).

Access: "Generator" button in the [Advanced Settings dialog](#)

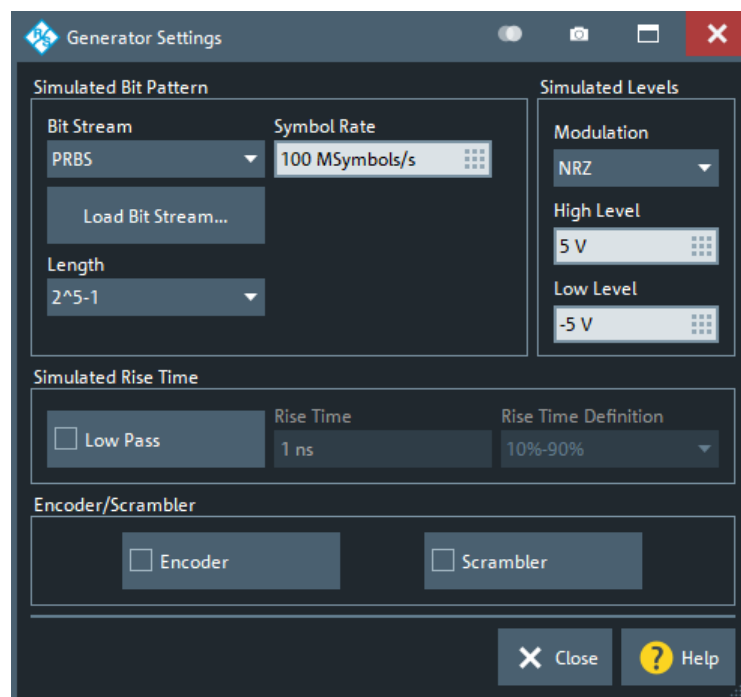

This dialog is available with [Extended time domain analysis](#) option R&S ZNA-K20 only.

Simulated Bit Pattern / Simulated Rise Time

See [Chapter 5.17.2.5, "Eye Diagram dialog"](#), on page 809

Modulation

See ["Modulation"](#) on page 811

High Level / Low Level

See ["High Level / Low Level"](#) on page 811.

Encoder

Enables or disables [8b/10b encoding](#) of the original bit stream.

Remote command:

```
CALCulate<Chn>:EYE:STIMulus:ENCoder
```

Scrambler

Enables/disables scrambling of the ([encoded](#)) bit stream.

The scrambler is a linear feedback shift register (LFSR) implementing the polynomial $G(X) = X^{16} + X^5 + X^4 + X^3 + 1$.

Remote command:

```
CALCulate<Chn>:EYE:STIMulus:SCRambler
```

Emphasis

The "Emphasis" dialog allows you to introduce a pre-emphasis filter to the digital signal simulated for the eye diagram measurement. "Emphasis" and [Equalization](#) can be used to compensate for the signal integrity degradations caused by the DUT.

Access: "Emphasis" button in the [Advanced Settings dialog](#)

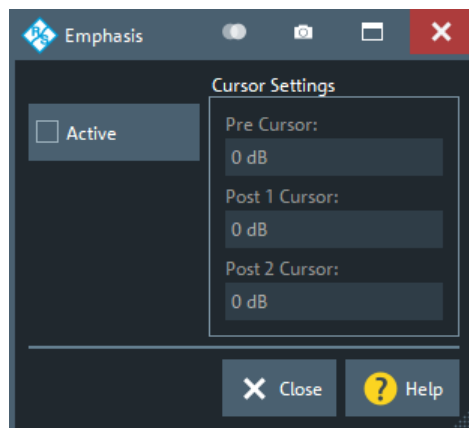

This dialog is available with [Extended time domain analysis](#) option R&S ZNA-K20 only.

In transmission systems known losses of the channel are typically compensated already in the transmitter. The most common setting is to boost high frequencies compared to low frequencies since the channels show typically larger losses for high frequencies.

This type of equalization is done using finite impulse response (FIR) filters using between 2 and 4 taps. The filter's sampling time is identical to bit period.

The coefficients of the FIR filter are not provided directly but in terms of pre- and post-cursor values. The cursor value is defined as voltage ratio of two adjoining bits. Since up to four taps can be used, the bit pattern for defining all cursor values must use four

consecutive bit values. Here a repeating bit pattern 0 1 1 1 1 0 is used. By definition the voltage levels for encoding the bits are symmetrical using +V for the ones and -V for the zeros.

In the graphic below the blue and the red trace indicate the signals used for differential encoding on a symmetric line. Va indicates the level directly after a transition, Vd indicates the level before a transition, Vb and Vc are optionally used to specify further levels after the transition.

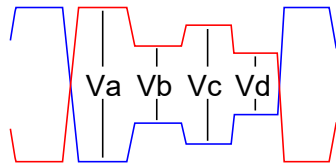

... 0 1 1 1 1 0 ...

In dB the pre- and post cursors are defined as:

- Pre Cursor = $20 \log_{10}(Vd / Vc)$
- Post 1 Cursor = $20 \log_{10}(Vb / Va)$
- Post 2 Cursor = $20 \log_{10}(Vc / Vb)$

Simple applications of the emphasis only define the Post 1 Cursor. Use a negative value (in dB) for increasing the amplitude of the first bit after a transition. Below an example for Post 1 Cursor = -3dB:

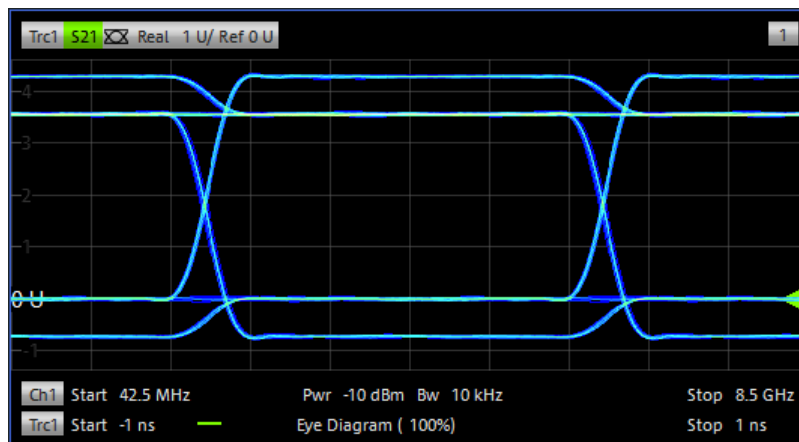

The FIR filter coefficients are found by solving the equations:

$$c_{-1} + c_0 - c_1 - c_2 = Va$$

$$c_{-1} + c_0 + c_1 - c_2 = Vb$$

$$c_{-1} + c_0 + c_1 + c_2 = Vc$$

$$-c_{-1} + c_0 + c_1 + c_2 = Vd$$

subject to the normalization condition $|c_{-1}| + |c_0| + |c_1| + |c_2| = 1$.

Active

Enables/disables pre-emphasis.

Remote command:

```
CALCulate<Chn>:EYE:EMPHasis:STATE
```

Cursor Settings

Sets the weights of the filter taps in the pre-emphasis FIR filter.

Remote command:

```
CALCulate<Chn>:EYE:EMPHasis:CURSor:PRE
```

```
CALCulate<Chn>:EYE:EMPHasis:CURSor:POST<1|2>
```

Jitter

The "Define Eye Jitter" dialog allows you to add jitter to the digital signal simulated for the eye diagram measurement.

Access: "Jitter" button in the [Advanced Settings dialog](#)

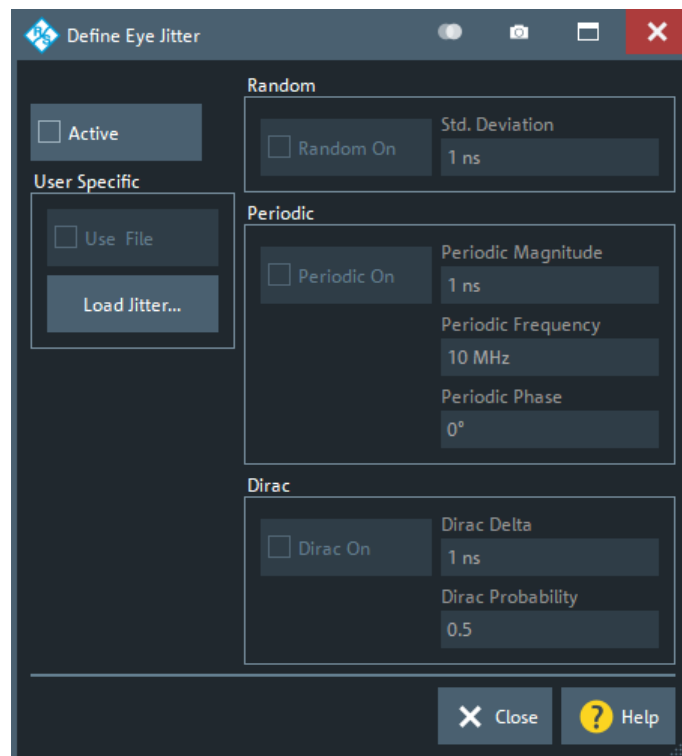

This dialog is available with [Extended time domain analysis](#) option R&S ZNA-K20 only.

Four types of jitter can be configured and selectively enabled: random, periodic, Dirac and user defined. If enabled, the jitter is added at the start of each symbol period, and its magnitude depends on the parameters specified in the dialog.

Active

This button must be first checked to activate any of the jitter sources. At this point, each of the individual jitter sources can be activated.

Remote command:

```
CALCulate<Chn>:EYE:JITTer:STATe
```

Random

Random jitter is determined from a normal (Gaussian) random distribution whose mean is zero, and whose "Std. Deviation" in seconds is specified by the user.

Remote command:

```
CALCulate<Chn>:EYE:JITTer:TYPE:RANDom
```

```
CALCulate<Chn>:EYE:JITTer:RANDom:STDDeviation
```

Periodic

This type of jitter is determined by a sine wave whose amplitude ("Periodic Magnitude"), frequency ("Periodic Frequency") and phase ("Periodic Phase") is specified by the user.

Remote command:

```
CALCulate<Chn>:EYE:JITTer:TYPE:PERiodic
```

```
CALCulate<Chn>:EYE:JITTer:PERiodic:MAGNitude
```

```
CALCulate<Chn>:EYE:JITTer:PERiodic:FREQuency
```

```
CALCulate<Chn>:EYE:JITTer:PERiodic:PHASe
```

Dirac

This type of jitter is specified by the amplitude in seconds ("Dirac Delta", positive or negative), and the probability of the jitter occurring at each symbol period ("Dirac Probability").

Remote command:

```
CALCulate<Chn>:EYE:JITTer:TYPE:DIRac
```

```
CALCulate<Chn>:EYE:JITTer:DIRac:DELTA
```

```
CALCulate<Chn>:EYE:JITTer:DIRac:PROBability
```

User Specific

The "Load Jitter" button allows the user to open a "Jitter File (*.txt)" with each entry in the file equal to the jitter to be added at each symbol period.

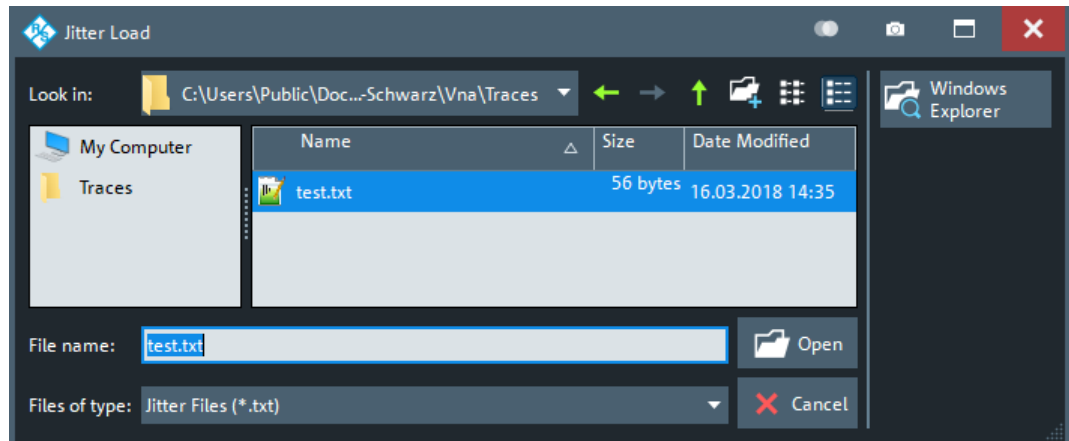

Such a Jitter File must be a 7-bit ASCII compatible text file; the Byte Order Mark (BOM) that is common with UTF encodings is not allowed. The file must consist of floating point values (in parsable format), separated by any whitespace and/or line endings.

Each value describes the jitter for a symbol transition (even when the current and the previous symbols are the same). The jitter value is implicitly given in the unit [s] and denotes the delta between the time of the ideally expected transition (given by the data rate) and the actual one. Positive values describe a transition that is occurring after the ideally expected transition. The values are limited to the range $-1.0e-3$ to $+1.0e-3$. Any values outside this range are limited to this range.

After the values in the file have been exhausted, the jitter values are taken starting from the beginning of the file.

Remote command:

`CALCulate<Chn>:EYE:JITTer:TYPE:USER`

`MMEMoRY:LOAD:EYE:JITTer`

Noise

The "Define Noise" dialog allows you to add Gaussian noise to the digital signal simulated for the eye diagram.

Access: "Noise" button in the [Advanced Settings dialog](#)

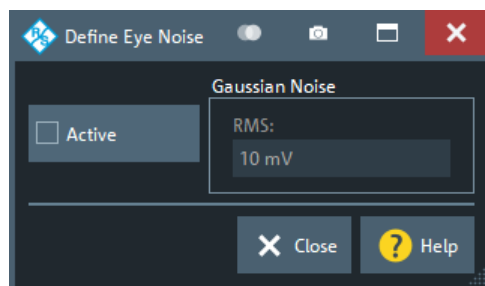

This dialog is available with [Extended time domain analysis](#) option R&S ZNA-K20 only.

Active

Enables/disables noise insertion.

Remote command:

`CALCulate<Chn>:EYE:NOISE:STATE`

RMS

Defines the root mean square noise level.

Remote command:

`CALCulate<Chn>:EYE:NOISE:RMS`

DUT

The "Define DUT" dialog allows you to switch between different transmission (and reflection) paths of the DUT and to configure its DC properties. In addition, it allows you to switch between the real DUT (with measured frequency response) and an ideal one (with flat frequency response), which can be useful when configuring the other eye diagram blocks (see [Chapter 5.17.2.6, "Advanced Settings dialog"](#), on page 812).

Access: "DUT" button in the [Advanced Settings dialog](#)

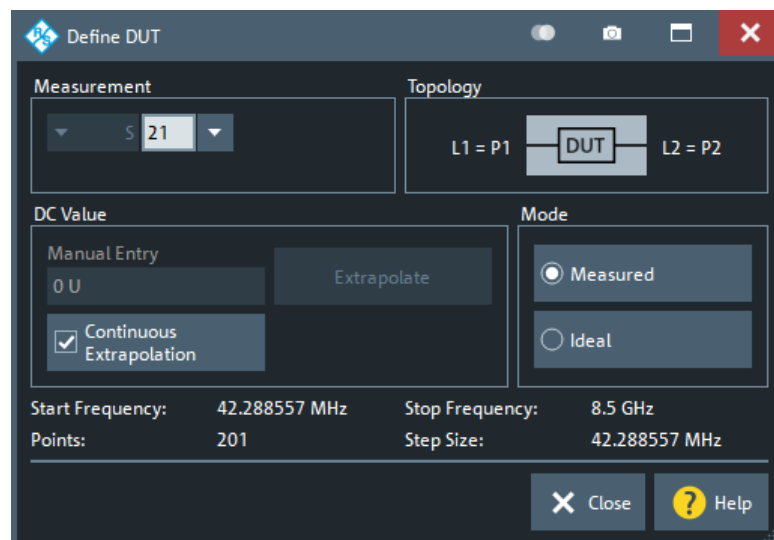

This dialog is available with [Extended time domain analysis](#) option R&S ZNA-K20 only.

Measurement / Topology

see ["Measurement / Topology"](#) on page 809

DC Value

See ["DC Value"](#) on page 452

Mode

Allows you to switch temporarily between the real DUT (with measured frequency response) and an ideal one (with flat frequency response).

Remote command:

`CALCulate<Chn>:EYE:DUT:MODE`

Equalization

The "Define Equalization" dialog allows you to activate and define a continuous time linear equalization at the receive side for the simulated eye diagram measurement.

Access: "Equalize" button in the [Advanced Settings dialog](#)

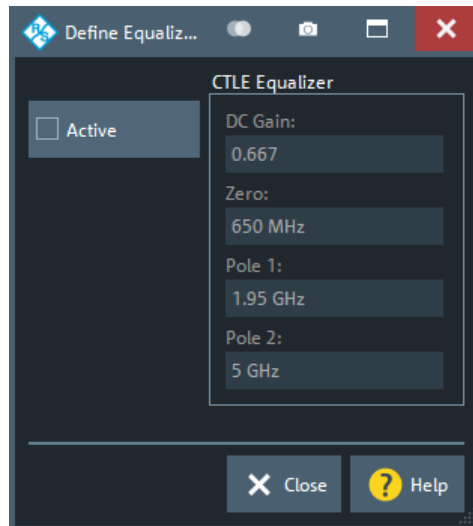

This dialog is available with [Extended time domain analysis](#) option R&S ZNA-K20 only.

Similar to the usage of emphasis the equalization targets to improve the signal quality at the receiver end of the transmission system. The building block "Equalize" simulates a continuous-time linear equalizer (CTLE) which is typically realized as an analog circuit in receivers.

Standards like USB 3.0 or PCIe specify the equalizer's frequency response using a gain factor plus poles and zeros in the frequency domain.

Active

Enables/disables equalization.

Remote command:

`CALCulate<Chn>:EYE:EQualization:STATe`

CTLE Equalizer

Specifies the parameters of the equalizer – a two-pole filter with single zero. With angular frequencies $\omega = 2\pi f$, the transfer function is given by:

$$H(s) = \frac{\text{"DC Gain"} \omega_{\text{Pole 1}} \omega_{\text{Pole 2}}}{\omega_{\text{Zero}}} \frac{s + \omega_{\text{Zero}}}{(s + \omega_{\text{Pole 1}})(s + \omega_{\text{Pole 2}})}$$

The default values are taken from the USB 3.0 standard for the 'Long Channel' model.

Remote command:

```
CALCulate<Chn>:EYE:EQualization:CTLE:DC
```

```
CALCulate<Chn>:EYE:EQualization:CTLE:ZERO
```

```
CALCulate<Chn>:EYE:EQualization:CTLE:POLE<1|2>
```

5.17.2.7 Eye Mask Test tab

If the active trace is represented as an eye diagram, the "Eye Mask Test" tab allows you to set up an eye mask for it, to enable testing against this mask and to export the test results.

Access: System – [Applic] > "TDR" > "Eye Mask Test"

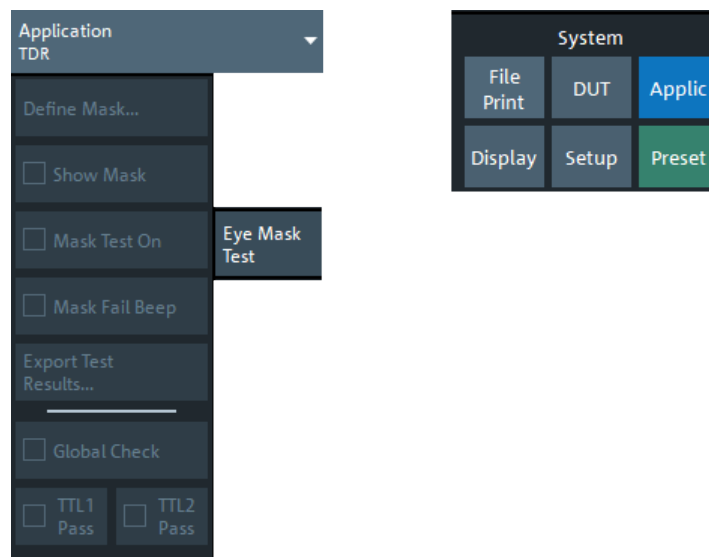

For a [Modulation](#) type other than NRZ, display of eye mask and eye mask test is not available, i.e. the buttons in the "Eye Mask Test" tab are grayed out.

Define Mask

Opens the [Define Mask Configuration dialog](#)

Show Mask

This checkbox determines whether the mask is shown in the eye diagram display.

Remote command:

```
CALCulate<Chn>:EYE:MASK:SHOW
```

Mask Test On

This checkbox tells the firmware to run the mask test after every recalculation of the eye diagram. If the mask test is enabled an info field with the test results is displayed:

Fail Condition Type	Samples
Violation Tolerance	1
Total Number of Samples	10948
Mask 1 (Top) Not Active	
Samples Hits	-----
Fail Rate	-----
Test Result	-----
Mask 2 (Bottom) Not Active	
Samples Hits	-----
Fail Rate	-----
Test Result	-----
Mask 3 (Octagon) Active	
Samples Hits	3152
Fail Rate	28.791 %
Test Result	Fail

An [acoustic signal](#) and a [TTL signal](#) indicating pass or fail can be generated in addition.

Remote command:

```
CALCulate<Chn>:EYE:MASK:STATe
CALCulate<Chn>:EYE:MASK:DATA?
CALCulate<Chn>:EYE:MASK:FAIL?
```

Mask Fail Beep

This checkbox determines whether the R&S ZNA should make an audible beep on mask failures.

Note: The R&S ZNA does not have a built-in audio device and loudspeaker. To hear sounds, connect a USB audio device to the instrument or operate it via remote desktop.

Remote command:

```
CALCulate<Chn>:EYE:MASK:FAIL:BEEP
```

Export Test Results

Opens a dialog that allows the user to save the mask test results to an ASCII file.

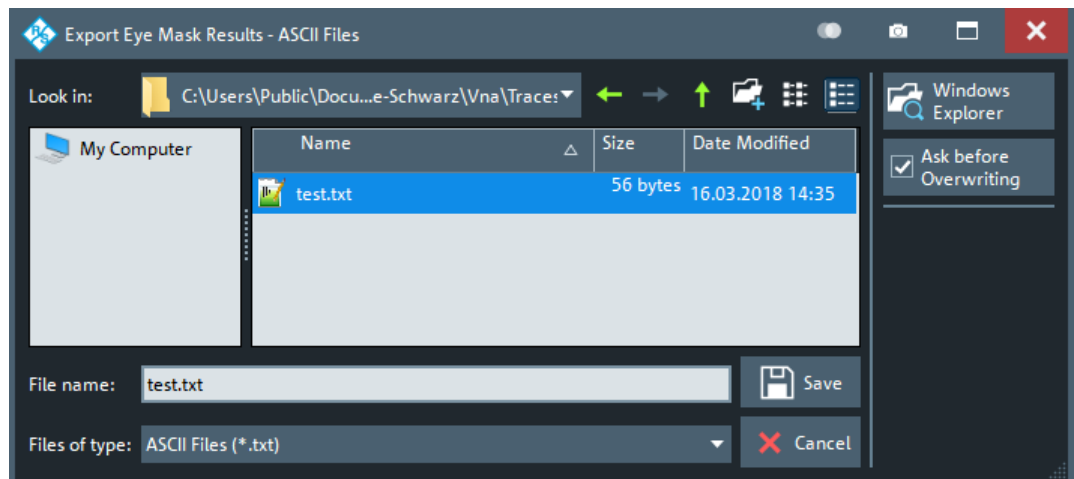

Remote command:

```
MMEMoRY:STORe:EYE:MASK:RESUltS
```

Global Check, TTL1 Pass, TTL2 Pass

see [Chapter 5.6.1, "Limit Test tab"](#), on page 478

5.17.2.8 Define Mask Configuration dialog

Allows you to set up the mask the simulated eye diagram shall be tested against.

Access: System – [Applic] > "TDR" > "Eye Mask Test" > "Define Mask..."

There are three mask areas that can be set up for the eye diagram test: center polygon, top rectangle, and bottom rectangle. Testing against these mask areas can be selectively enabled.

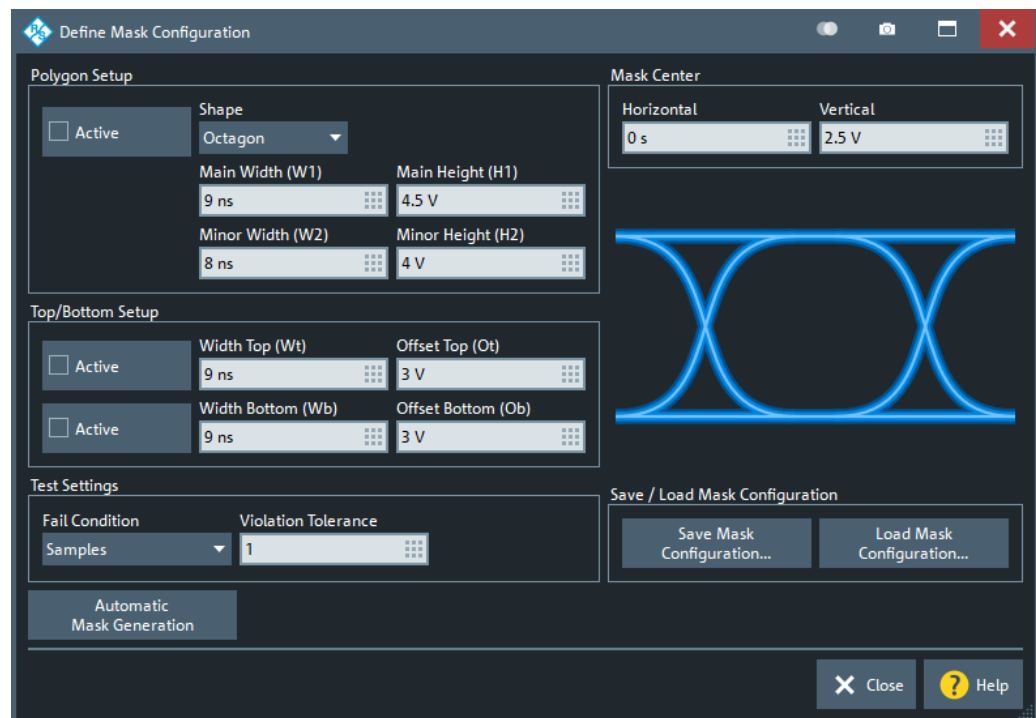
**Polygon Setup**

Allows you to define the center polygon and to activate it in the mask test. The center polygon can either be an octagon, a hexagon, or a rectangle ("Shape" combo-box). The sizes of the polygon can be set using the main/minor widths and heights as shown in the corresponding visualization.

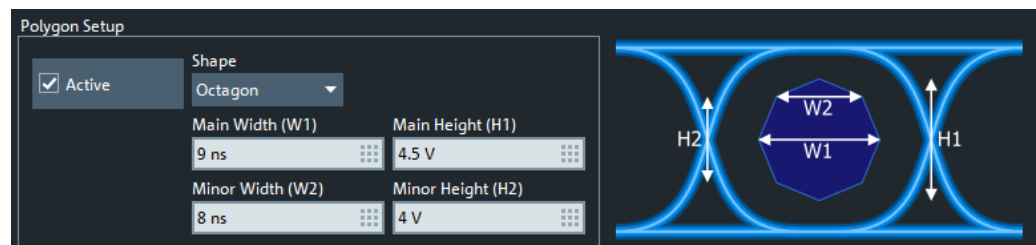

Figure 5-62: Center polygon setup: octagon

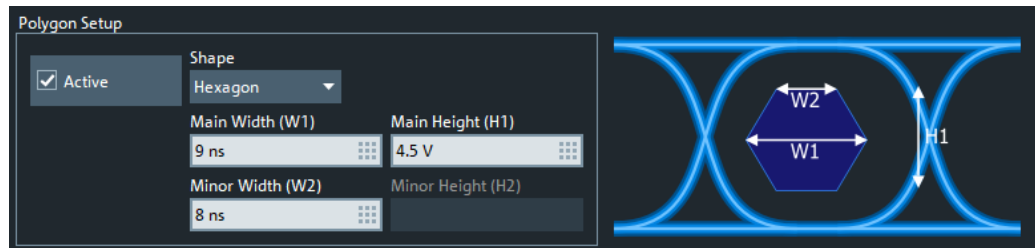

Figure 5-63: Center polygon setup: hexagon

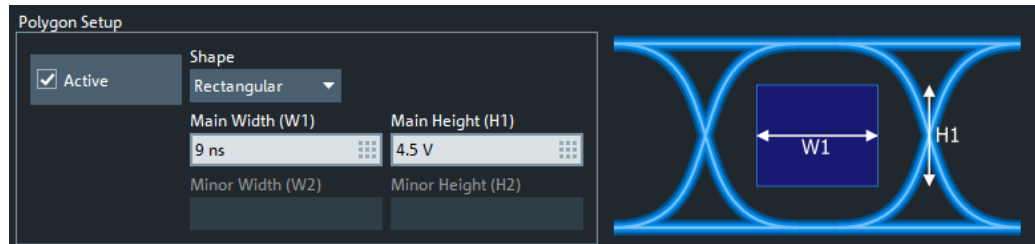

Figure 5-64: Center polygon setup: rectangle

The polygon is centered at the [Mask Center](#).

Remote command:

```
CALCulate<Chn>:EYE:MASK:SHAPE:POLYGON:STATE
CALCulate<Chn>:EYE:MASK:SHAPE:POLYGON:TYPE
CALCulate<Chn>:EYE:MASK:SHAPE:POLYGON:HORIZONTAL
CALCulate<Chn>:EYE:MASK:SHAPE:POLYGON:VERTICAL
```

Top/Bottom Setup

Defines and activates the top and bottom rectangles.

Both rectangles are horizontally centered at the [Mask Center](#) and also their vertical offsets are specified relative to this point.

Remote command:

```
CALCulate<Chn>:EYE:MASK:SHAPE:TOP:STATE
CALCulate<Chn>:EYE:MASK:SHAPE:TOP:HORIZONTAL
CALCulate<Chn>:EYE:MASK:SHAPE:TOP:VERTICAL
CALCulate<Chn>:EYE:MASK:SHAPE:BOTTOM:STATE
CALCulate<Chn>:EYE:MASK:SHAPE:BOTTOM:HORIZONTAL
CALCulate<Chn>:EYE:MASK:SHAPE:BOTTOM:VERTICAL
```

Mask Center

Defines the center point of the eye mask:

- The center polygon is centered at this point
- The top and bottom rectangles are horizontally centered at the mask center and also their vertical offsets are specified relative to this point.

Remote command:

```
CALCulate<Chn>:EYE:MASK:CENTER:HORIZONTAL
CALCulate<Chn>:EYE:MASK:CENTER:VERTICAL
```

Test Settings

Allows you to set the absolute or relative number of mask violations that will result in a mask fail condition.

Remote command:

```
CALCulate<Chn>:EYE:MASK:FAIL:CONDition
CALCulate<Chn>:EYE:MASK:VIOLation:TOLerance
CALCulate<Chn>:EYE:MASK:VIOLation:RATE
```

Save / Load Mask Configuration

Opens a dialog that allows to save/load the mask test configuration to/from a 7bit ASCII file (*.mask). An example is shown below:

```
[Mask Top]
Active = true
Width Top = 9e-009
Offset Top = 6

[Mask Bottom]
Active = true
Width Bottom = 9e-009
Offset Bottom = 6

[Mask Polygon]
Active = true
Shape = Octagon
Main Width = 9e-009
Minor Width = 8e-009
Main Height = 9
Minor Height = 8

[MASK CENTER]
Horizontal = 0
Vertical = 0

[TEST SETTING]
Fail Condition = Samples (Percent)
Violation Tolerance = 1
Violation Percent = 10
```

Remote command:

```
MMEMemory:LOAD:EYE:MASK
MMEMemory:STORe:EYE:MASK
```

Automatic Mask Generation

The "Automatic Mask Generation" function attempts to size the polygon, top, and bottom masks in a reasonable manner based on the current eye measurement settings.

Remote command:

```
CALCulate<Chn>:EYE:MASK AUTO
```

5.17.2.9 Rise Time tab

The "Rise Time" tab allows you to enable and configure the [Rise Time Measurement](#).

Access: System – [Applic] > "TDR" > "Rise Time"

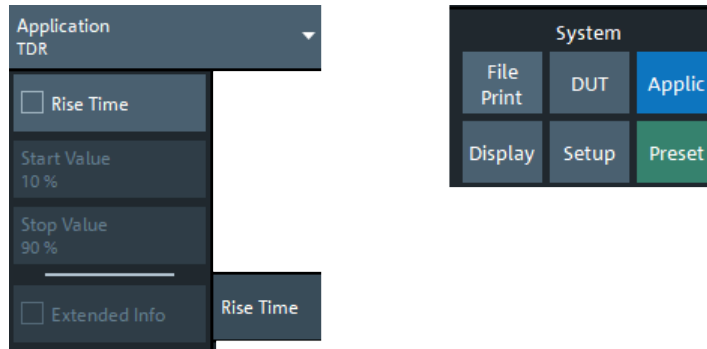

Access: [Applic] key or "Application > Rise Time" menu

Rise Time

Enables/disables the rise time measurement.

The rise time measurement can only be performed if the active trace is [Real, Time Domain](#) is enabled, and the transformation [Type](#) "Low Pass Step" is used. The latter, in turn, requires the stimulus grid to be harmonic.

If the rise time measurement cannot be enabled, a message is displayed:

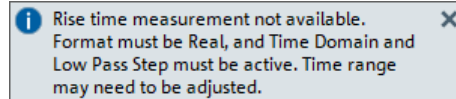

Instead of performing the required configuration changes manually, you may also use the "Auto Setup" button of the info field to let the firmware do this for you.

Remote command:

`CALCulate<Chn>:TTIME:STATe`

Start Value / Stop Value

Defines the lower/upper percentage for the rise time measurement.

Remote command:

`CALCulate<Chn>:TTIME:THReshold`

Extended Info

Defines whether the info field for the rise time measurement should only provide basic information (default) or extended information:

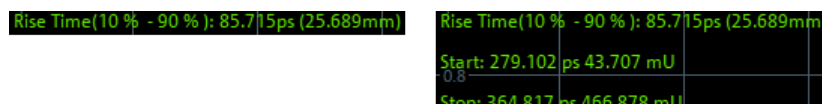

Figure 5-65: Rise time info, basic vs. extended

Remote command:

CALCulate<Chn>:TTIME:DATA?

5.17.2.10 Skew tab

The "Skew" tab allows you to enable and configure the [Skew Measurement](#).

Access: System – [Applic] > "TDR" > "Skew"

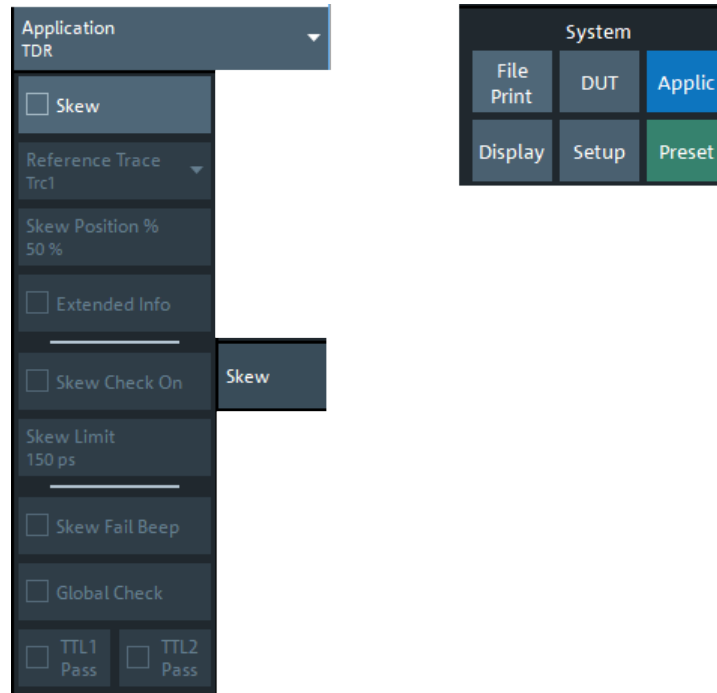

Skew

Enables/disables the skew measurement between the active trace and the [Reference Trace](#)

The skew measurement can only be performed if the following conditions are met for both the active trace and the reference trace:

- the trace format is [Real](#)
- [Time Domain](#) is enabled
- the "Low Pass Step" time domain transformation [Type](#) is used (which requires the stimulus grid to be harmonic)

If these conditions are not met, a message is displayed:

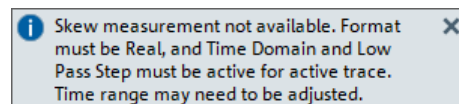

Instead of performing the required configuration changes manually, you may also use the "Auto Setup" button of the corresponding info field to let the firmware do this for you.

Remote command:

`CALCulate<Chn>:DTIME:STATe`

Reference Trace

Selects the reference trace for the skew measurement.

Note that the reference trace must be in the same channel as the active trace.

See [Skew](#) for additional conditions on both the active and the reference trace.

Remote command:

`CALCulate<Chn>:DTIME:TARGet`

Skew Position

Defines the percentage of the step size that defines the position of the reference points on the current and the reference trace. The "Skew" value is the delta between the X coordinates of these reference points.

Remote command:

`CALCulate<Chn>:DTIME:POSition`

Extended Info

Defines whether the info field for the skew measurement shall only provide basic information (default) or extended information:

<code>Skew (Trc1 to Trc1): 0.000s (0.000m)</code>	<code>Skew (Trc1 to Trc1): 0.000s (0.000m)</code>
	<code>Trc1 326.129 ps 246.921 mU</code>
	<code>0.8</code>
	<code>Trc1 326.129 ps 246.921 mU</code>

Figure 5-66: Skew info, basic vs. extended

The displayed skew values are positive, if, at the defined [Skew Position](#), the active trace is to the right of the [Reference Trace](#).

Remote command:

`CALCulate<Chn>:DTIME:DATA?`

Skew Check On

Enables the skew check with the specified [Skew Limit](#).

Remote command:

`CALCulate<Chn>:DTIME:LIMit:STATe`

Skew Limit

Defines the limit value for the skew check. The unit depends on the current format of the X axis (see "[Time / Distance](#)" on page 535).

An [acoustic signal](#) and a [TTL signal](#) indicating pass or fail can be generated in addition.

Remote command:

`CALCulate<Chn>:DTIME:LIMit:LIMit`

Skew Fail Beep

This checkbox determines whether the R&S ZNA should make an audible beep on skew limit violations.

Note: The R&S ZNA does not have a built-in audio device and loudspeaker. To hear sounds, connect a USB audio device to the instrument or operate it via remote desktop.

Remote command:

`CALCulate<Chn>:DTIME:LIMit:FAIL:BEEP`

Global Check, TTL1 Pass, TTL2 Pass

see [Chapter 5.6.1, "Limit Test tab"](#), on page 478

5.17.2.11 Time Gate tab

Replicates the "Time Gate" tab of the "Traces" softtool (see [Chapter 5.5.6, "Time Gate tab"](#), on page 452).

Access: System – [Applic] > "TDR" > "Time Gate"



Since for the eye diagram, the time axis always equals two times the symbol time, the display of the time gate range lines ("Show Range Lines") does not make sense, and is therefore not available.

5.17.2.12 Y Axis tab

The "Y Axis" tab allows you to define the y axis scaling of the active diagram. The scaling logic is the same as for all other diagram types, see [Chapter 5.4, "Scale softtool"](#), on page 425.

Access: System – [Applic] > "TDR" > "Y Axis"

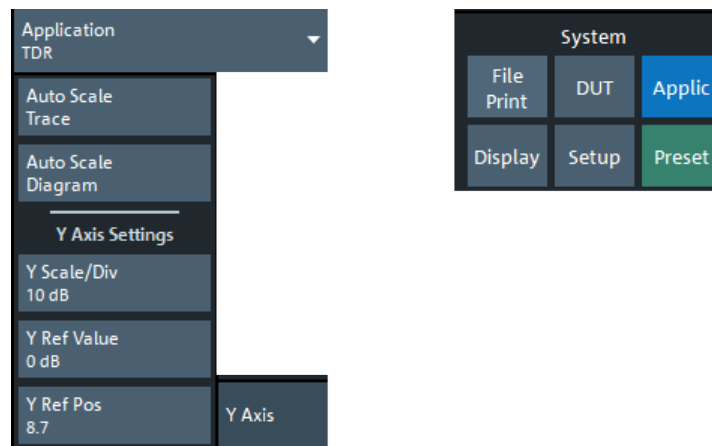

This tab is only visible if the [Extended time domain analysis](#) option R&S ZNA-K20 is available.

5.17.2.13 X Axis tab

The "X Axis" tab allows you to define the x axis scaling of the active diagram. The scaling logic is the same as for all other diagram types, see [Chapter 5.4, "Scale softtool"](#), on page 425.

Access: System – [Applic] > "TDR" > "X Axis"

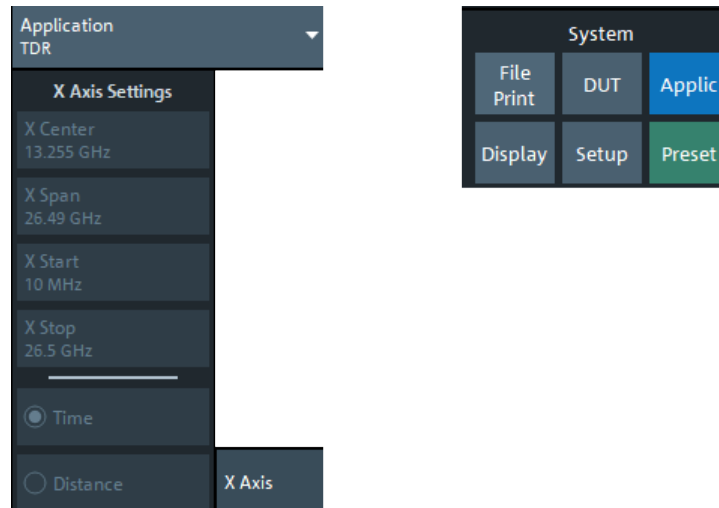

- This tab is only visible if the [Extended time domain analysis](#) option R&S ZNA-K20 is available.
- If the active trace is represented as an eye diagram, the "X Axis Settings" are grayed out, as shown above. If the active trace is represented as a rise time or skew diagram, the "X Axis Settings" allow you to adjust the center/span or start/stop, no matter if the X axis represents "Time" or "Distance" (see "[Time / Distance](#)" on page 535).

5.17.3 Distance to Fault application

With option K2, the R&S ZNA can locate faults and discontinuities on cables and transmission lines. The measured S_{ij} -parameter trace is mathematically converted to the time domain, and represented in the distance domain. The x-axis of the DtF trace (derived from S_{ij}) shows the distance from the calibrated reference plane; faults appear as peaks above a certain level.

If option R&S ZNA-K2 is not installed on the R&S ZNA, the "Distance to Fault" application is not available.



To achieve the best distance resolution, set the sweep span as large as possible and use the [Auto Number of Points](#) to adjust the number of sweep points.



Background information

Refer to [Chapter 4.7.2.7, "Distance-to-fault measurements"](#), on page 255.

5.17.3.1 Controls on the Distance to Fault tab

The controls on the "Distance to Fault" tab allow you to enable and configure a standard Distance to Fault (DtF) measurement.

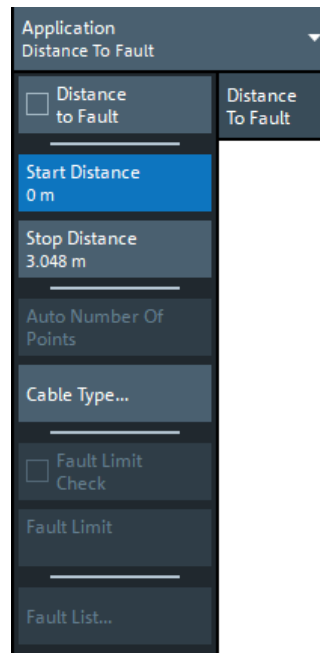

A standard DtF measurement is prepared in the order from top to bottom:

1. Enable DtF measurement, see ["Distance to Fault"](#) on page 831
2. Configure the distance window, see ["Start Distance / Stop Distance"](#) on page 832
3. Adjust the number of sweep points (and, if necessary, the frequency span), see [Auto Number of Points](#)
4. Select (or define and select) a suitable cable type, see ["Cable Type..."](#) on page 833
5. Perform a full one-port calibration at physical port 2.

You should now be able to locate the faults (peaks) by examining the trace.

You can also let the firmware generate a list of faults by enabling [Fault Limit Check](#) and defining a suitable [Fault Limit](#). Use [Fault List...](#) to display (and export) the detected faults.

Distance to Fault

Activates/deactivates Distance to Fault representation for the active trace.

Note that "Distance to Fault" can only be enabled, if the active channel is configured to perform a [linear frequency sweep](#).

If the active trace is a reflection trace S_{ij} , the analyzer firmware assumes that the DUT is connected to port $p=i$. Otherwise it assumes that the DUT is connected to port $p=2$.

When activating "Distance to Fault", the analyzer firmware

- sets S_{pp} as measured quantity of the active trace
- enables additional controls on the "Distance to Fault" tab
- appends the selected cable type to the trace label (see "Cable Type..." on page 833)
- displays an additional "Distance Domain" trace info line below the channel line

Ch1	Start	5 kHz	Pwr	-10 dBm	Bw	10 kHz	Stop	3 GHz
Trc1	Start	0 m	—	Distance	Domain		Stop	3.048 m

Note that all info lines (channel info, trace info, "Distance Domain" trace info) allow quick access to related parameters via specific context menus:

"Distance to Fault" can also be enabled/disabled via the context menu of the trace label.

Remote command:

```
CALCulate<Chn>:TRANSform:DTFault:STATe
```

Start Distance / Stop Distance

Define the distance window for the Distance to Fault measurement. "Start Distance" and "Stop Distance" correspond to the left and right edge of the diagram area and are displayed in the "Distance Domain" trace info line.

Note:

- If the "Stop Distance" is so high that for the selected [cable type](#) the signal reflected at "far away discontinuities" would be too small, a warning tooltip is displayed:

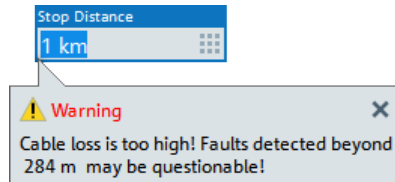

- If the "Stop Distance" exceeds the unambiguous range (for the given frequency span and number of sweep points), a warning is displayed in the instrument status bar:

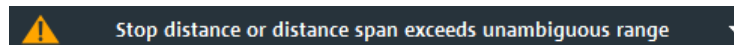

Use the [Auto Number of Points](#) function to adjust the number of sweep points so that the impulse response becomes unambiguous in the configured distance window.

Remote command:

```
CALCulate<Chn>:TRANSform:DTFault:START
```

```
CALCulate<Chn>:TRANSform:DTFault:STOP
```

```
CALCulate<Chn>:TRANSform:DTFault:CENTER
```

```
CALCulate<Chn>:TRANSform:DTFault:SPAN
```

Auto Number of Points

Selects the minimum number of sweep points that are required to provide an unambiguous display of fault locations for the active Distance to Fault trace.

If "Auto Number of Points" actually modifies the [Number of Points](#), a tooltip is displayed:

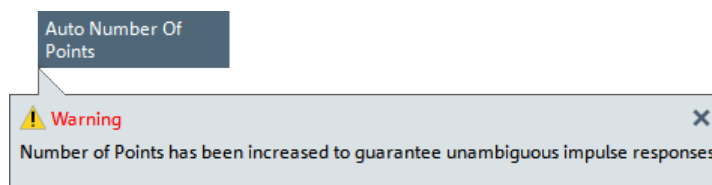

The required number of points depends on:

- the frequency span $\Delta f = f_{stop} - f_{start}$ (see ["Start Frequency / Stop Frequency / Center Frequency / Span Frequency"](#) on page 523),
- the stop distance d_{stop} (see ["Start Distance / Stop Distance"](#) on page 832), and
- the velocity factor v of the transmission line (see ["Cable Type..."](#) on page 833).

With c_0 denoting the speed of light in a vacuum, the analyzer sets the number of sweep points N to

$$N = \max \{ \lceil 2.6 \cdot d_{stop} \cdot \Delta f / (v \cdot c_0) \rceil, 201 \}$$

If the required number of sweep points would be higher than 100001 (the maximum number of sweep points of the R&S ZNA), the analyzer sets N to 100001 and displays the following message box:

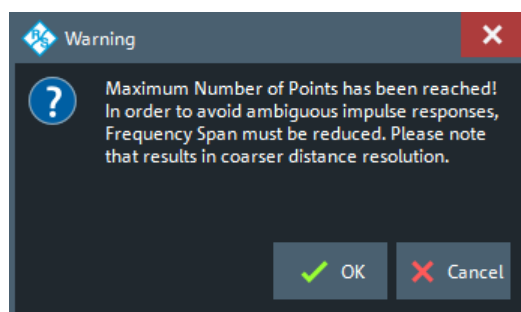

"OK" reduces the frequency span Δf to

$\Delta f = v \cdot c_0 \cdot 100001 / (2.6 \cdot d_{stop})$, which makes 100001 sweep points sufficient for unambiguous display (see the formula above). However, this reduction of the frequency span comes at the cost of coarser distance resolution.

"Cancel" (default) leaves the frequency unchanged.

Remote command:

`CALCulate<Chn>:TRANSform:DTFault:POINTs`

Cable Type...

Opens a dialog that allows to select a preconfigured cable type to be used for the calculation of the Distance to Fault traces on the active channel. A cable type is defined by its relative permittivity (or its velocity factor), and a frequency-dependent attenuation table.

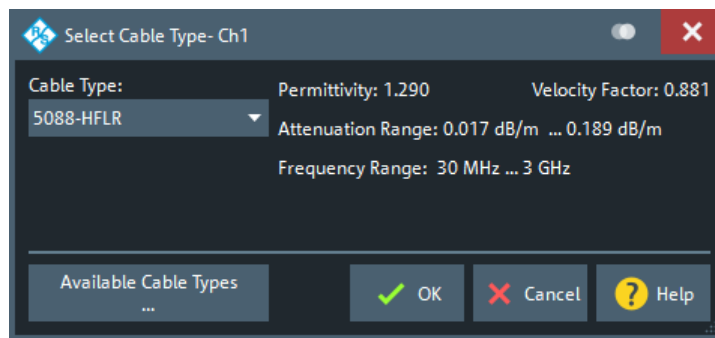

Select "Available Cable Types..." to access the list of predefined and user-defined cable types (see [Chapter 5.17.3.2, "Available Cable Types... dialog"](#), on page 835).

Remote command:

```
CALCulate<Chn>:TRANSform:DTFault:SElect
```

Fault Limit Check

Enables/disables checking the current "Distance to Fault" trace for spikes above the given [Fault Limit](#) (red line).

The fault limit is defined relative to the 0 dB-line in the test diagram, i.e. the peak response value for total reflection after proper calibration.

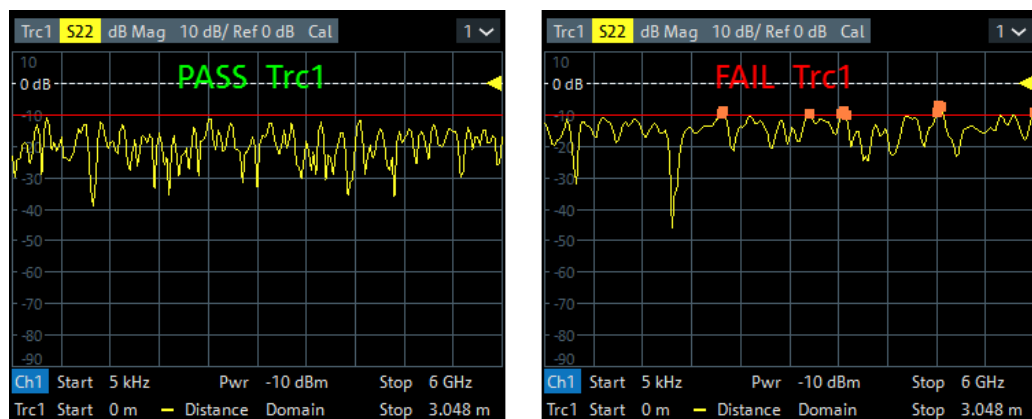

Note that the fault limit is handled like any other limit line. When "Fault Limit Check" is enabled, the current "Fault Limit" forms a new upper line segment replacing other previously defined limit lines (see [Chapter 5.6.1.2, "Define Limit Lines dialog"](#), on page 482).

Remote command:

```
CALCulate<Chn>:TRANSform:DTFault:PEAK:STATE
```

Fault Limit

Determines the level above which peaks in the active "Distance to Fault" trace are considered as faults.

The fault limit is defined relative to the 0 dB-line in the test diagram, i.e. the peak response value for total reflection after proper calibration.

Note:

- When the "Fault Limit" is modified, the new "Fault Limit" replaces other limit lines (see [Chapter 5.6.1.2, "Define Limit Lines dialog"](#), on page 482)
- This field is only enabled, if [Fault Limit Check](#) is active.

Remote command:

`CALCulate<Chn>:TRANSform:DTFault:PEAK:THReshold`

Fault List...

This button is only enabled, if [Fault Limit Check](#) is active.

It opens the [Fault List dock widget](#).

5.17.3.2 Available Cable Types... dialog

The "Available Cable Types..." dialog allows you to display predefined and user-defined cable types and to add/modify/delete user-defined cable types.

Among the predefined cable types, there is an ideal air line (with a relative permittivity of 1, a corresponding velocity factor of 1, and zero attenuation) and a wide range of standard cable types.

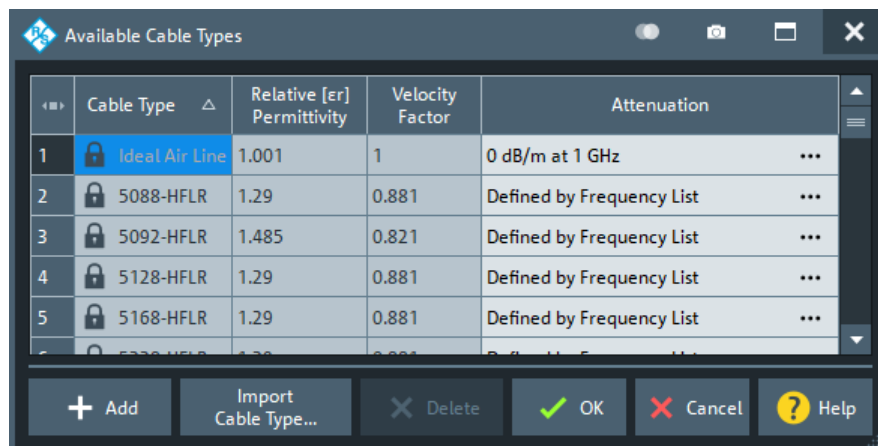

Cable types are defined by their relative permittivity ϵ_r or, equivalently, by their velocity factor $1/\sqrt{\epsilon_r}$, and a frequency-dependent attenuation table (see ["Frequency-Dependent Attenuation Table"](#) on page 835)

The velocity factor is a measure for the velocity of an electromagnetic wave in a dielectric with permittivity ϵ_r , relative to its velocity in a vacuum (velocity factor < 1). It is needed to convert the propagation times into distances.

Frequency-Dependent Attenuation Table

The "Attenuation of <Cable Type>" dialog defines the frequency dependence of the cable attenuation. The measured cables are assumed to be homogeneous so that the attenuation per length unit is constant. This means that the attenuation can be expressed in units of dB/m. Due to the skin effect and various other factors, the attenuation is frequency-dependent.



For predefined cables, the table is read-only.

Access: [Available Cable Types... dialog](#) > "Attenuation" column > ...

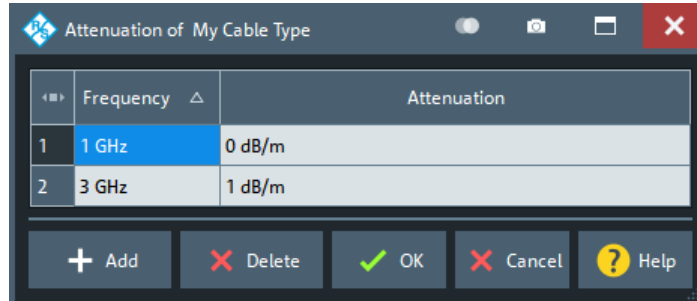

Given the specified attenuation values the R&S ZNA calculates the attenuation factor at the center of the channel's sweep range and corrects the impulse response trace using this attenuation factor $Attenuation(f_{center})$.

The frequency dependence can be defined in two alternative ways:

- Single reference frequency**
 If the cable attenuation is specified at a single frequency f_1 , the R&S ZNA calculates $Attenuation(f_{center})$ using

$$Attenuation(f_1) / Attenuation(f_{center}) = \sqrt{f_1 / f_{center}}$$
 which accounts for the impact of the skin effect.
- Frequency list**
 If the cable attenuation is specified at several frequency points, the R&S ZNA calculates the $Attenuation(f_{center})$ by linear interpolation. If f_{center} is below (above) the specified frequency range, then $Attenuation(f_{center})$ is linearly extrapolated from the two lowest (highest) frequency points.



It is recommended to specify the cable attenuation as accurately as possible. The correction due to the attenuation factor is proportional to the measured distance between the fault and the reference plane: The larger the distance, the larger the correction.

Add / Delete

Creates/deletes a user-defined cable type.

Remote command:

```
CALCulate<Chn>:TRANSform:DTFault:DEFine
CALCulate<Chn>:TRANSform:DTFault:DELeTe
MMEORY:LOAD:CABLE
MMEORY:STORe:CABLE
```

Import Cable Type

Opens the "Import Cable Type" variant of the [Open File](#) dialog that lets you select a cable type file (*.rsc) for import.

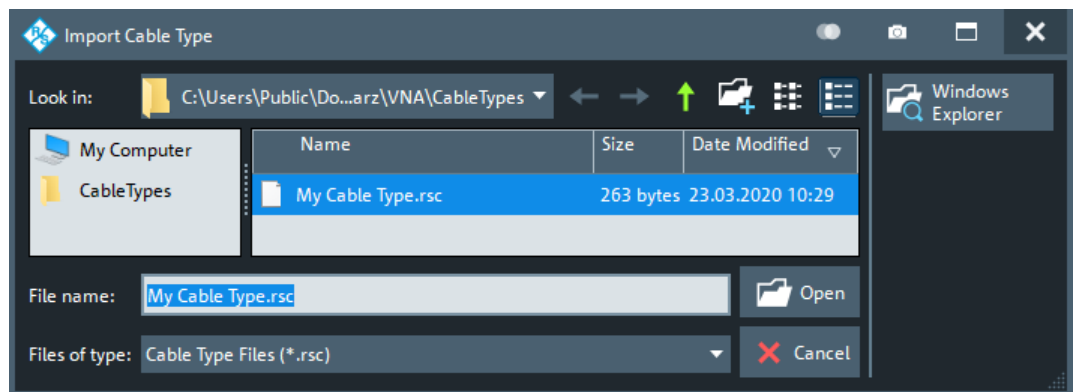

Remote command:

`MMEMoRY:LOAD:CABLe`

5.17.3.3 Fault List dock widget

The "Fault List" dock widget allows you to explore and save all peaks that violate the active [Fault Limit](#).

Access: [Trace] > "Distance to Fault" > "Fault List..."

Fault	Trace	Distance	Peak Response
1	Trc1	15.24 mm	-14.23 dB
2	Trc1	106.68 mm	-17.63 dB
1	Trc2	15.24 mm	-15.05 dB
2	Trc2	106.68 mm	-18.46 dB

Figure 5-67: Fault List Dock Widget

Fault Table

The displays a list of all peaks that violate the active [Fault Limit](#). Unless tracking is disabled (see "[Tracking Enabled](#)" on page 838), the table is updated with every sweep.

Remote command:

`CALCulate<Chn>:TRANSform:DTFault:PEAK:COUNT?`

`CALCulate<Chn>:TRANSform:DTFault:PEAK:DATA<FaultNo>`

Contents

Allows you to filter the [Fault Table](#):

- "All Channels" (default)
The table displays the faults of all Distance to Fault traces in the current recall set.
- "Active Channel"
The table displays the faults of all Distance to Fault traces in the active channel (if any).
- "Active Trace"

The table displays the faults of the active trace (in case it is a Distance to Fault trace).

Export to File... ← Contents

Opens a dialog that allows to export the (filtered) content of the fault list to an ASCII file with configurable "Field Separator" and "Decimal Separator".

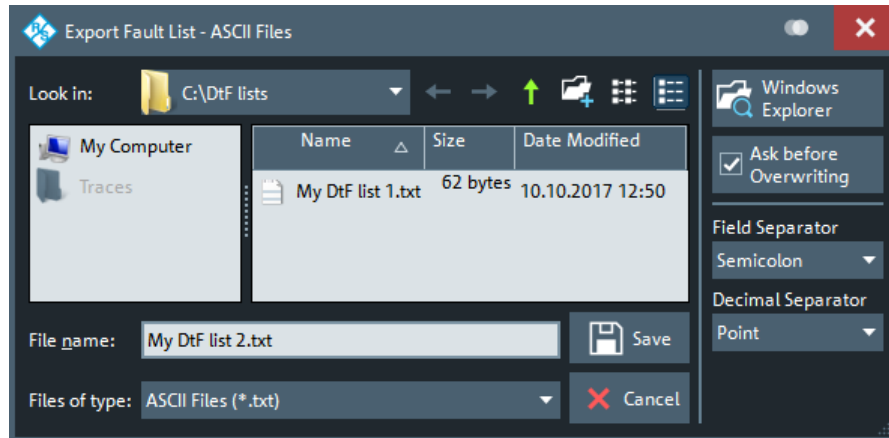

This CSV type file contains one line (terminated by CR+LF) per fault. With ";" as "Field Separator" and "." as "Decimal Separator", the fault list of [Figure 5-67](#) is exported to

```
1; Trc1; 457.2 mm; -8.56 dB
2; Trc1; 1.539 m; -9.24 dB
```

For an explanation of the possible filters, see ["Contents"](#) on page 837).

Tracking Enabled

If checked (default), the ["Fault Table"](#) on page 837 is cleared at every sweep start and populated in real time. Uncheck "Tracking Enabled" to freeze the table contents.

5.18 Display softtool

The "Display" softtool provides all display settings and the functions for activating, modifying and arranging different diagrams.

Access: System – [Display]



Related information

Refer to the following sections:

- [Chapter 4.1.3, "Traces, channels and diagrams"](#), on page 108
- [Chapter 4.2.1, "Display elements of a diagram"](#), on page 124
- [Chapter 3.3.5, "Handling diagrams, traces, and markers"](#), on page 58

5.18.1 Diagram tab

Selects a diagram as the active diagram, defines a title, deletes or adds diagrams and arranges them on the screen. Many of the functions are unavailable if the active recall set contains only one diagram.



Related settings

Use the icons in the toolbar to add diagrams and traces. Use the "Zoom Active Trc" icon to zoom into a rectangular portion inside a diagram. See also [Chapter 3.3.5, "Handling diagrams, traces, and markers"](#), on page 58 and [Chapter 3.3.7.1, "Using the graphical zoom"](#), on page 66.

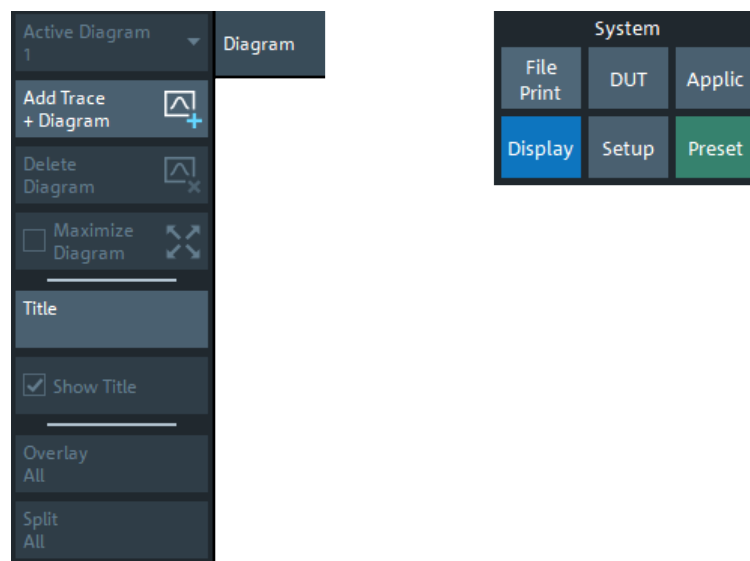

Active Diagram

Selects the active diagram.

Each recall set screen can display several diagrams simultaneously, each with a variable number of traces. One of these diagrams and traces is active at each time. The diagram number (or name) in the upper right corner of the active diagram is highlighted. At the same time, the active trace is highlighted in the trace list on top of the active diagram (Trc3 in the figure below):

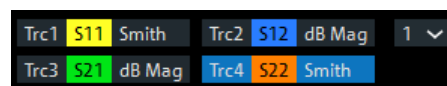

The analyzer provides several tools for activating diagrams:

- tap on a point in the diagram to activate the diagram including the last active trace in the diagram.
- tap on a trace list to activate the trace including the corresponding diagram.
- Some of the functions of the [Traces tab](#) activate a particular trace including the corresponding diagram.

Remote command:

```
DISPlay[:WINDow<Wnd>]:TRACe<WndTr>:CATalog?
```

Add Trace + Diagram

Creates a diagram and a trace which is displayed in the new diagram. The trace is created with the channel settings of the previous active trace but with default trace settings. The new diagram area is numbered <n>, where <n> is the largest of all existing diagram area numbers plus one.

Tip: Dragging the "Trc+" toolbar icon to a new diagram area is similar to "Add Trace + Diagram".

Remote command:

```
DISPlay[:WINDow<Wnd>] [:STATe] ON
```

Delete Diagram

Deletes the current diagram area including all traces displayed in the diagram area. The remaining diagrams are renumbered; each recall set always contains diagrams with contiguous numbers. "Delete Diag Area" is disabled if the recall set contains only one diagram area: In manual control, each recall set must contain at least one diagram area with one channel and one trace.

Tip: To restore a diagram area that was unintentionally deleted, use the undo functionality.

Remote command:

```
DISPlay[:WINDow<Wnd>] [:STATe] OFF
```

Maximize Diagram

Maximizes the active diagram or restores the previous diagram arrangement.

For other split types, use the functions in the [Split tab](#).

Remote command:

```
DISPlay[:WINDow<Wnd>]:MAXimize
```

Title

Defines a title for the [Active Diagram](#).

The visibility of the title area can be toggled using [Show Title](#).

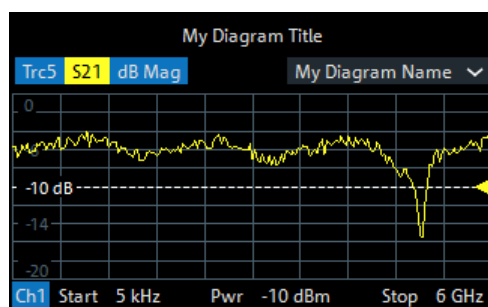

Remote command:

```
DISPlay[:WINDow<Wnd>]:TITLE:DATA
```

Via remote control, it is also possible to define a diagram **name**, and to retrieve the lists of diagrams together with their names:

```
DISPlay[:WINDow<Wnd>]:NAME
```

```
DISPlay[:WINDow<Wnd>]:CATalog?
```

Show Title

Displays or hides the title area of the active diagram.

This property can only be set if **Title** is non-empty. If "Title" is empty, the title area is always hidden

Remote command:

```
DISPlay[:WINDow<Wnd>]:TITLE[:STATE]
```

Overlay All

Places all traces in a single diagram area which is maximized to occupy the whole screen. This function is available irrespective of the trace format and the channel settings; it is even possible to overlay Cartesian and complex diagrams.

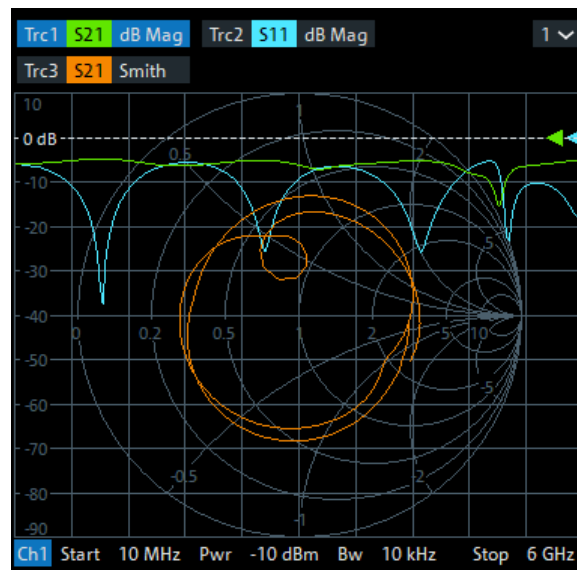

The active trace and active channel is highlighted. The scaling of the axes corresponds to the active trace.

Tip: To hide all traces except one, activate the context menu of the respective trace name segment in the trace list and select "Hide all other Traces".

Remote command:

```
DISPlay:LAYout:OVERlay
```

Split All

Creates a separate diagram for each trace in the active recall set and automatically arranges those diagrams in the diagram area. Existing diagrams are deleted during this process.

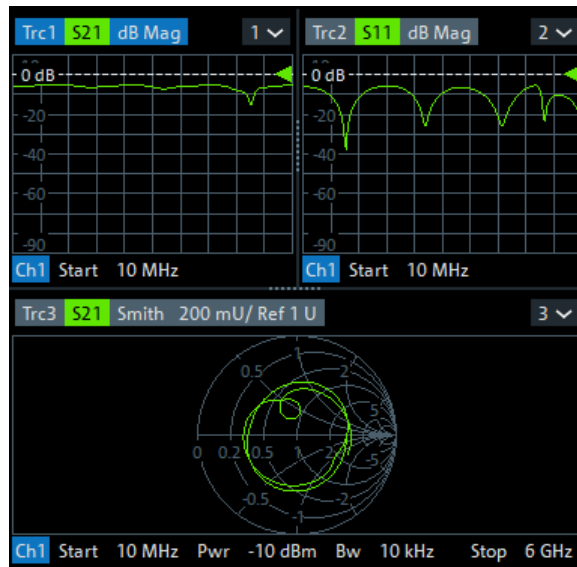

Tip: To vary the size and position of the diagram areas, drag and drop the separating frames or use the functions in the "Split" tab.

Remote command:

`DISPlay:LAYout:SPLit`

5.18.2 Split tab

Arranges multiple diagrams on the screen.

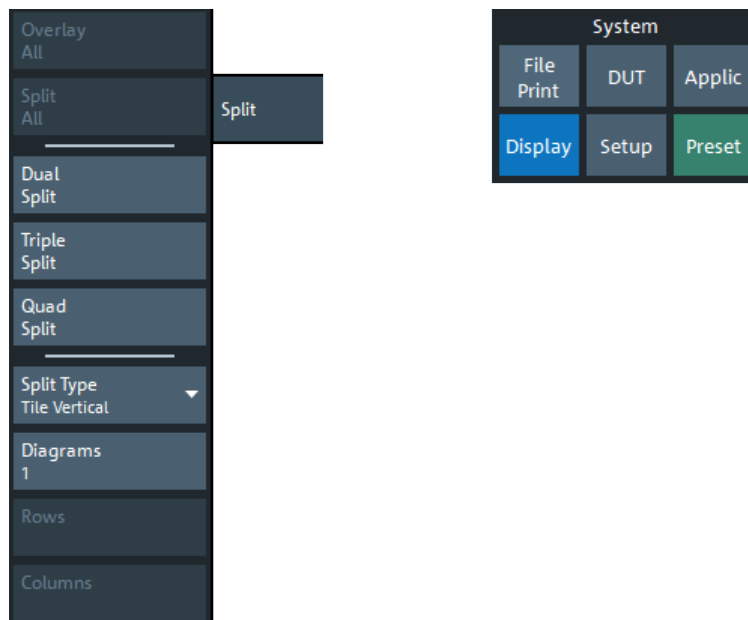

Some of the "Split" settings are also available in the [Diagram tab](#). Refer to the following sections:

- ["Overlay All"](#) on page 841

- ["Split All"](#) on page 841

Dual Split / Triple Split / Quad Split

Splits the diagram area into two (three / four) diagrams and distributes the traces among the diagrams. Traces with different format and channel settings (e.g. Cartesian and complex diagrams) are separated, if possible. Example of four traces in "Quad Split" display:

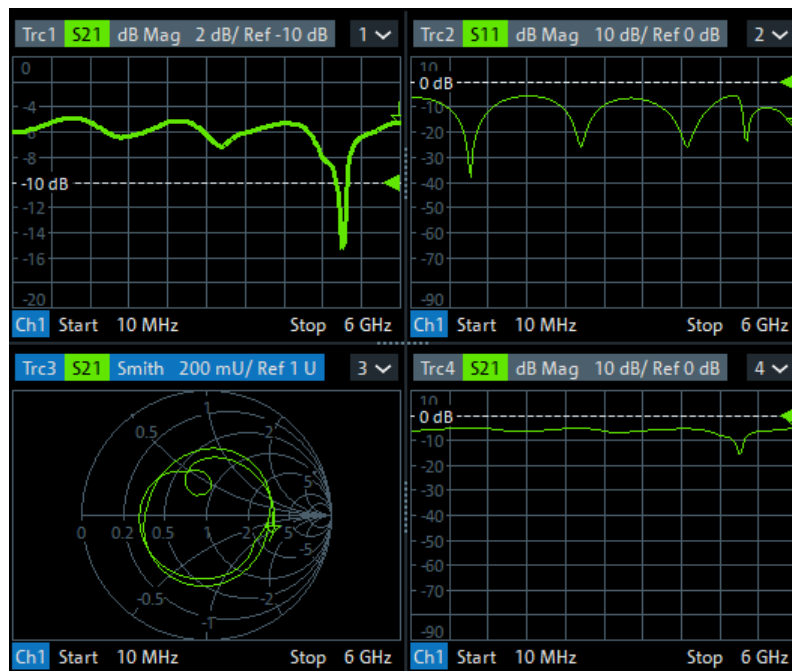

If less than two (three / four) traces are available, the new diagrams are created with a default trace. Dual (triple / quad) split corresponds to "Split Type: Tile Horizontal" with 2 (3 / 4) diagrams.

Tip: To vary the size and position of the diagrams, drag and drop the separating frames or use the functions in the "Diagram" tab.

Remote command:

No command; display configuration only.

Split Type

The R&S ZNA provides the following split types:

- "Lineup": The diagrams are arranged side by side; each diagram occupies the entire screen height.
- "Stack": The diagrams are arranged one below the other; each diagram occupies the entire screen width.
- "Tile Horizontal": The diagrams are arranged in rows. With 2 (3 / 4) diagrams, the result is equivalent to Dual Split (Triple Split / Quad Split); see ["Dual Split / Triple Split / Quad Split"](#) on page 843.
- "Tile Vertical": The diagrams are arranged in columns.
- "Rows + Cols": The diagrams are arranged as a rectangular matrix. The number of rows and columns is as defined in the corresponding input fields.

If the selected number of "Diagrams" exceeds the number of traces, some of the new diagrams are created with a default trace.

Tip: To vary the size and position of the diagrams, drag and drop the separating frames or use the functions in the "Diagram" tab.

Remote command:

```
DISPlay:LAYout
```

Diagrams / Rows / Columns

Selects the number of "Diagrams" (or "Rows" and "Columns") to which the traces in the active recall set are split. The split is performed according to the selected [Split Type](#).

If the entered number of "Diagrams" exceeds the number of previously existing traces, some of the new diagrams are created with default traces.

For a "Split Type" other than "Rows + Cols", only the total number of "Diagrams" can be specified.

Remote command:

```
DISPlay:LAYout:GRID
```

Additional Functionality: SCPI Commands

The analyzer provides remote control commands for efficient diagram handling. The commands listed below extend the functionality of the "Display > Diagram" and "Display > Split" softtool panels. For programming examples, refer to [Chapter 8.2.2.6, "Creating diagrams"](#), on page 1739.

Remote command:

```
DISPlay:LAYout:APPLY
```

```
DISPlay:LAYout:DEFine
```

```
DISPlay:LAYout:EXECute
```

```
DISPlay:LAYout:JOIN
```

5.18.3 Config tab

Displays or hides controls and information elements of the screen and controls the appearance of the individual diagrams.

Hiding the controls and information elements leaves more space for the diagrams. All elements can be shown or hidden simultaneously.



Related information

Refer to [Chapter 4.2.1, "Display elements of a diagram"](#), on page 124.

5.18.3.1 Controls on the Config tab

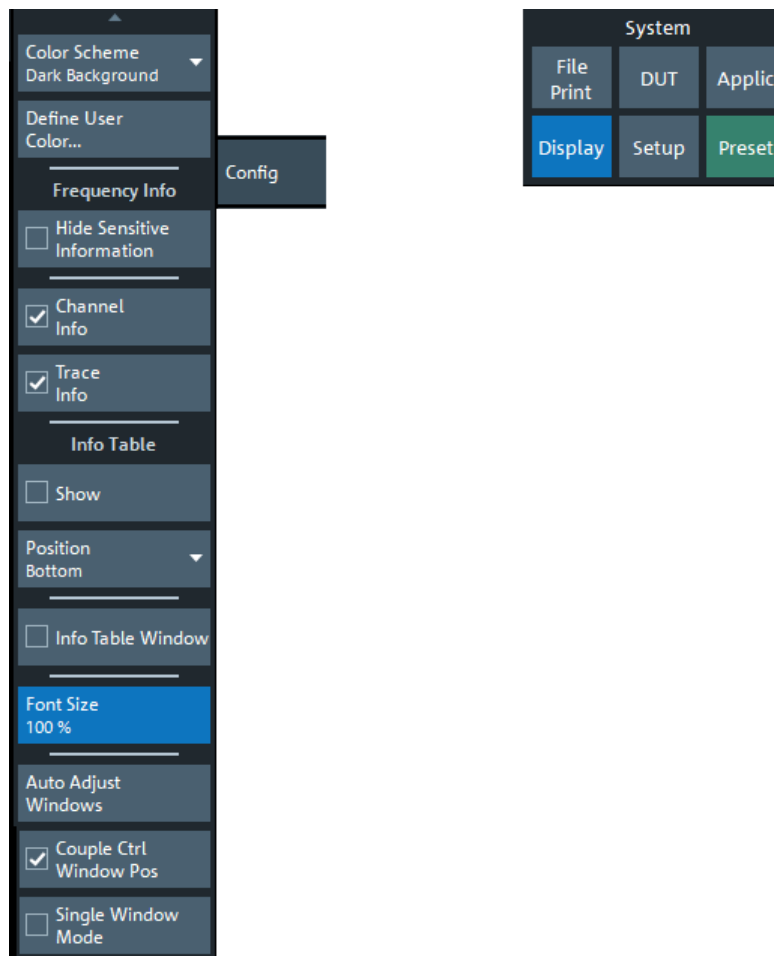

Color Scheme

Controls the colors in the diagram areas. Color schemes are global settings and apply to all active recall sets.

The following predefined color schemes are optimized for the analyzer screen and for color hardcopies, respectively:

- "Dark Background" sets a black background color. The traces and information elements in the diagram areas are displayed in different colors. This setting is usually suitable for observing results on the analyzer screen.
- "Light Background" sets a light background color. The traces and information elements in the diagram areas are displayed in different colors. This setting is suitable for generating color hardcopies of the screen.

The following predefined color schemes can be appropriate for generating black and white hardcopies of the screen:

- "Black and White Line Styles" sets a white background color. All traces and information elements in the diagram areas are black, however, the traces are drawn in different line styles.
- "Black and White Solid" sets a white background color. All traces and information elements in the diagram areas are black. All traces are drawn with solid lines.

"User Define..." opens a dialog to modify the predefined schemes, changing the colors and styles of the individual display elements.

See [Chapter 5.18.3.2, "Define User Color Scheme dialog"](#), on page 847.

Remote command:

```
SYSTem:DISPlay:COLor
```

Hide Sensitive Information

Unmasks or masks all stimulus value occurrences in the VNA GUI for the current recall set.

When you check "Hide Sensitive Information" for a particular recall set (to mask the stimulus values), you are asked to set a password. If this password is non-empty, it is requested the next time someone tries to uncheck "Hide Sensitive Information" (to unmask all stimulus values) for this recall set.

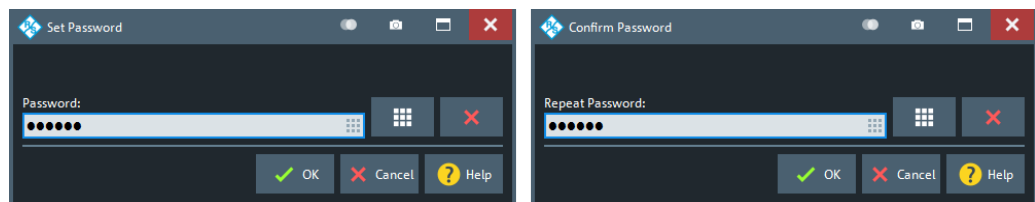

Both checked state and password are stored in (and loaded from) the active recall set.

Remote command:

```
DISPlay:ANNotation:FREQuency[:STATE]
```

Channel Info

Shows or hides the channel lists in the lower part of the diagrams.

Ch1	Start	5 kHz	—	Pwr	-10 dBm	Bw	10 kHz	Stop	6 GHz
Ch2	Freq	1 GHz	—	Pwr	-10 dBm	Bw	10 kHz	Stop	201
Ch3	Freq	1 GHz	—	Pwr	-10 dBm	Bw	10 kHz	Stop	1 s
Ch4	Start	5 kHz	—	Pwr	-10 dBm	Bw	10 kHz	Stop	6 GHz
Trc4	Start	-1 ns	—	Time	Domain			Stop	4 ns

Remote command:

```
DISPlay:ANNotation:CHANnel[:STATE]
```

Trace Info

Shows or hides the trace lists in the upper part of the diagrams.

Trc1	S11	Smith	Trc2	S12	dB Mag	1	▼
Trc3	S21	dB Mag	Trc4	S22	Smith		

Remote command:

```
DISPlay:ANNotation:TRACe[:STATE]
```

Info Table: Show / Position

Shows or hides the info table and defines its position.

The info table is a possible container for info fields and can be placed to the bottom, to the left, or to the right of the screen. See also [Chapter 5.7.8, "Info Field tab"](#), on page 520.

M1	Trc1	5.130001 GHz	-15.6388 dB	Bandstop Trc1	Ref to Max	Track
• M2	Trc1	4.718891 GHz	-7.3323 dB	Bandwidth	535.657892 MHz	
M3	Trc1	5.254549 GHz	-7.3323 dB	Center	4.979523 GHz	
M4	Trc1	4.979523 GHz	-9.5924 dB	Lower Edge	4.718891 GHz	
				Upper Edge	5.254549 GHz	
				Quality Factor (3dB)	9.296 U	
				Loss	15.6388 dB	

Remote command:
No command; display configuration only.

Info Window

Shows/hides the [Info Window](#)

Remote command:
`DISPlay: IWINdow[:STATe]`

Font Size

Scales the fonts in the diagrams. The scaling affects the trace and channel lists, and the info fields.

Remote command:
`DISPlay: RFSize`

Auto Adjust Windows

Resets the position and size of the application window and the control window.

Couple Ctrl Window Pos

If checked (default), the relative position of the application window and the control window is locked: if you drag one of them, then both windows move together.

Single Window Mode

If enabled (default), the control window is visible. Otherwise it is hidden and the "Hard Key" panel is displayed.

5.18.3.2 Define User Color Scheme dialog

The "Define User Color Scheme" dialog allows you to configure user-defined diagram color schemes for display and print. User-defined color schemes can be saved to a file for later re-use.

Access:

- System – [Display] > "Config" > "Define User Color..."
- [Printer Setup dialog](#) > "Print" tab > "Define Print Color..."



Related settings

Refer to ["Color Scheme"](#) on page 845.

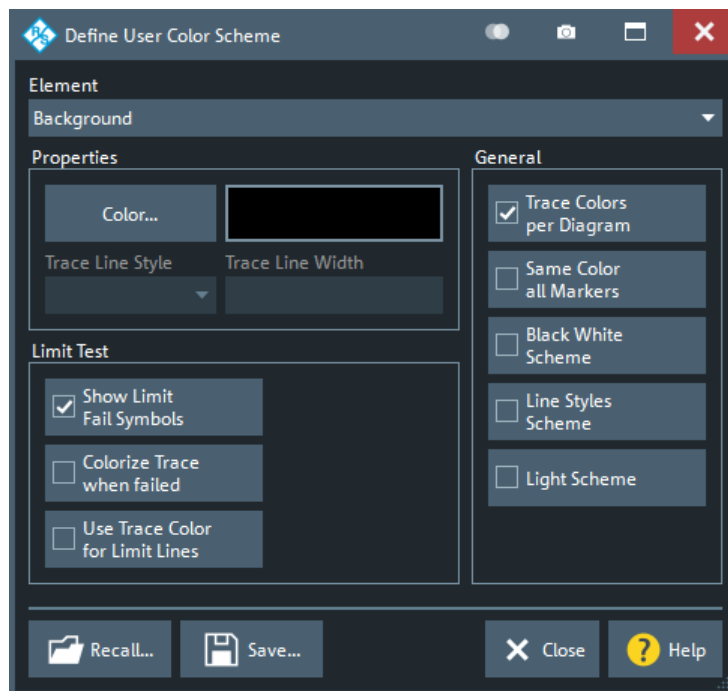

Element

Selects the diagram element to be modified. The list contains the background and all traces (more precisely trace properties), text elements and lines in the diagrams.

The maximum number of trace properties can be configured in the "User Interface" tab of the "System Config" dialog (see ["Number of Trace Colors"](#) on page 862).

Remote command:

The `<DispEl>` suffix in the `DISPlay:CMAP<DispEl>...` commands identifies the screen element. See [DISPlay:CMAP<DispEl>:RGB](#).

Properties

Configures the selected screen element.

- "Color" opens a standard color dialog where you can assign a color to the selected element.
- "Trace Line Style" and "Trace Line Width" are enabled if the selected element is a trace.

Remote command:

Display color scheme only!

[DISPlay:CMAP<DispEl>:RGB](#)

[DISPlay:CMAP:TRACe:RGB](#)

Limit Test > Show Limit Fail Symbols

Displays or hides the colored squares on the trace indicating failed measurement points. Hide the squares if they cover too much of the trace. Instead of using the limit fail symbols, you can colorize the trace to highlight failed trace sections.

Remote command:

Display color scheme only!

[DISPlay:CMAP:LIMit:FSYMBOL\[:STATE\]](#)

Limit Test > Colorize Trace when Failed

Assigns a different trace color to failed trace segments.

The different color reaches from the last passed measurement point before the start of the failed segment to the last failed measurement point in the segment. Consequently, the colorized trace segment can begin before the begin of the failed range and can end before its end.

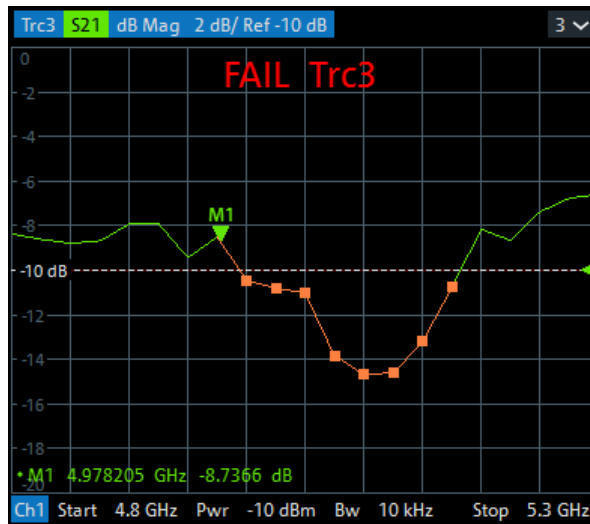

Remote command:

Display color scheme only!

`DISPlay:CMAP:LIMit:FCOLorize[:STATe]`

Limit Test > Use Trc Color for Limit Lines

Assigns the trace color to all limit line segments associated with the trace. All other limit line color definitions are ignored.

Remote command:

Display color scheme only!

`DISPlay:CMAP:LIMit[:STATe]`

General > Trace Colors per Diagram

Controls the color of traces that are created in a diagram or moved to another diagram.

- If "Trace Colors per Diagram" is enabled (factory preset), all diagrams use the same trace colors. The first trace in each diagram gets trace color 1, the second trace color 2 etc. (cyclically).
In particular, if a trace is removed from a diagram, then all traces in this diagram that were created after the removed one, will change their color. And if this trace is moved to another diagram, its color typically changes as well.
- If "Trace Colors per Diagram" is disabled, then the traces are colored with trace colors 1 to 8 (cyclically) in the order they are created. No matter to which diagram they are assigned.
All traces keep their original trace color (number).

Remote command:

Display color scheme only!

`DISPlay:CMAP:TRACe:COLor[:STATe]`

General > Same Color all Markers

Selects a common marker color, which is independent of the trace colors.

Remote command:

Display color scheme only!

`DISPlay:CMAP:MARKer[:STATe]`

General > Black White Scheme / Line Styles Scheme / Light Scheme

Modifies the user color scheme, in particular the trace and channel lines, in a predefined way. As an alternative, select predefined color schemes; see ["Color Scheme"](#) on page 845.

Remote command:

`DISPlay:CMAP<DispEl>:RGB`

Recall... / Save...

Opens standard dialogs to recall a previously saved color scheme or save the current scheme to a file. Color scheme files are non-editable files with the extension `*.ColorScheme`; the default directory is

`C:\Users\Public\Documents\Rohde-Schwarz\ZNA\ColorSchemes.`

Remote command:

Display color scheme:

`MMEMory:STORe:CMAP`

`MMEMory:LOAD:CMAP`

Print color scheme:

`MMEMory:STORe:CMAP:HCOPY`

`MMEMory:LOAD:CMAP:HCOPY`

5.18.3.3 Info Window

The "Info Window" displays a configurable set of marker properties and [Bandfilter search](#) results. It automatically resizes the displayed text to fit the window height and width.

Access: System – [Display] > "Config" > "Info Window" checkbox

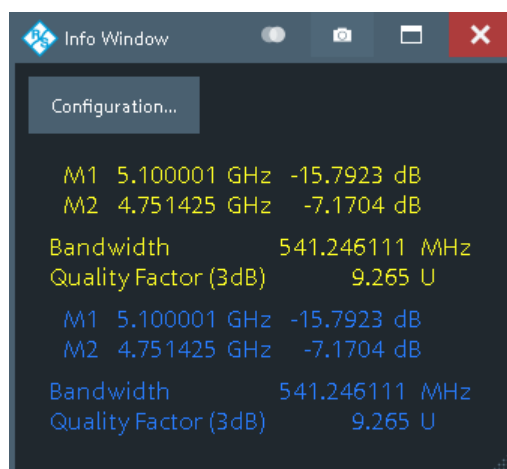

Use the "Configuration..." button to open the [Info Window Configuration dialog](#) and select the information items to be displayed.

To disambiguate the displayed marker info fields, you can assign descriptive names to the markers (see ["Marker Name"](#) on page 501).



If a trace is hidden, then its marker and bandfilter search info is also hidden in the "Info Window".

Info Window Configuration dialog

The "Info Window Configuration" dialog allows you to select the markers and [Display elements of a diagram](#) results to be displayed in the [Info Window](#).

Access: [Info Window](#) > "Configuration..."

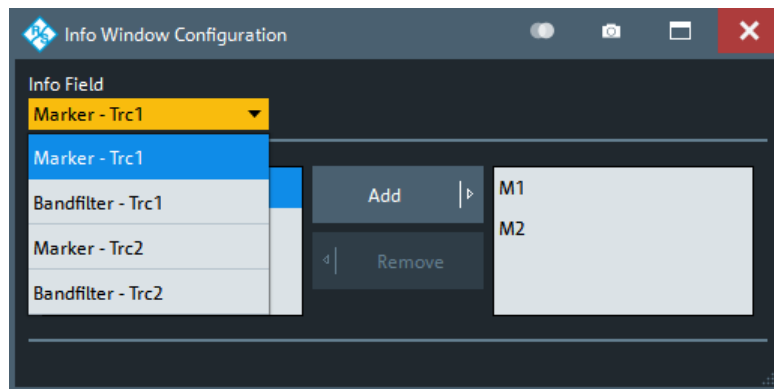

Use the "Info Field" combo box to select a marker or bandfilter search info field whose contents you want to display in parts or in total. It contains all info fields of the current recall set that are currently not displayed in the info table (see ["Info Table: Show / Position"](#) on page 846).

Content Selection

The lower part of the "Info Window Configuration" dialog allows you to pick the contents of the selected info field you want to display in the [Info Window](#).

For marker info fields, use the "Add" and "Remove" buttons to show/hide the selected marker in the "Info Window".

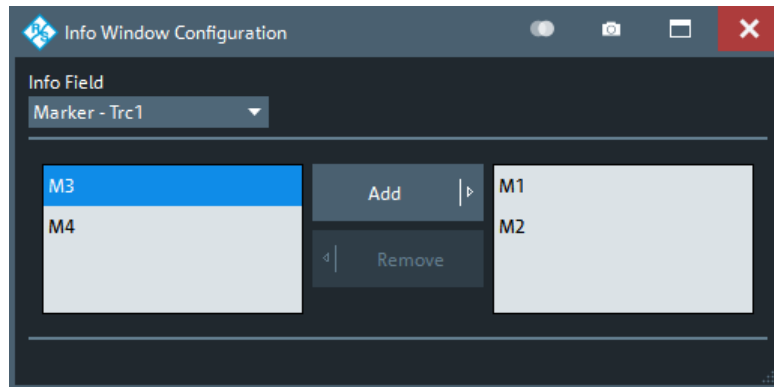

Figure 5-68: Content selection: marker info fields

For **Bandfilter search** info fields simply pick the results to be displayed.

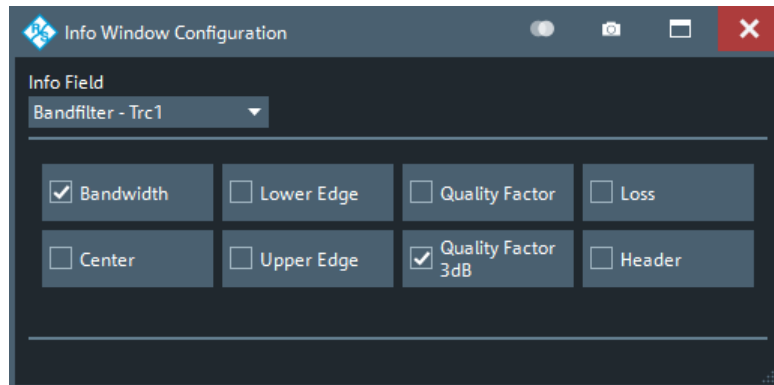

Figure 5-69: Content selection: bandfilter search info fields

Remote command:

```
DISplay:IWINDOW:MARKer<Mk>[:STATE]
```

```
DISplay:IWINDOW:BFILter[:STATE]
```

5.18.4 View Bar tab

Displays or hides information panels and bars of the graphical user interface. Hiding the information elements leaves more space for the diagrams. All elements can be shown or hidden simultaneously.

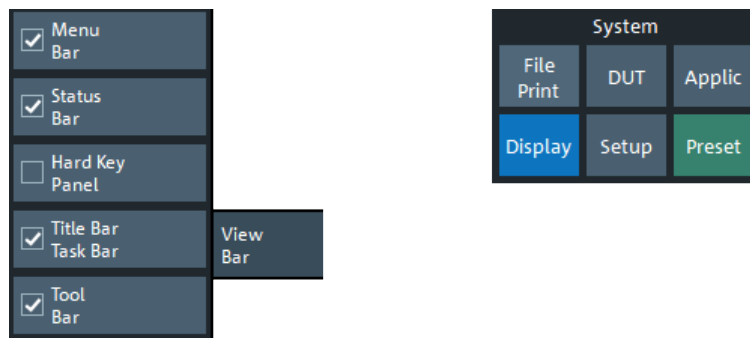

Menu Bar

Toggles the visibility of the "Menu Bar".

For background information, see [Chapter 3.3.2.4, "Menu bar"](#), on page 51.

Remote command:

```
SYSTem:DISPlay:BAR:MENU[:STATE]
```

Status Bar

Toggles the visibility of the "Status Bar".

For background information, see [Chapter 3.3.2.7, "Status bar"](#), on page 54.

Remote command:

```
SYSTem:DISPlay:BAR:STATus[:STATE]
```

Hard Key Panel

Toggles the visibility of the "Hard Key Panel".

For background information, see [Chapter 3.3.2.6, "Hardkey panel"](#), on page 53.

The "Hard Key Panel" can also be closed via the "X" button in its top right corner.

Remote command:

```
SYSTem:DISPlay:BAR:HKEY[:STATE]
```

Title Bar Task Bar

Toggles the visibility of the title bar of the VNA application window and the Windows® task bar.

If unchecked (default) the VNA application is displayed in full screen mode with invisible title bar and Windows® task bar. If checked it is displayed as a regular window.

For background information, see [Chapter 3.3.2.1, "Title bar"](#), on page 49.

Remote command:

```
SYSTem:DISPlay:BAR:TITLe[:STATE]
```

Tool Bar

Toggles the visibility of the "Tool Bar".

For background information, see [Chapter 3.3.2.2, "Toolbar"](#), on page 49.

Remote command:

```
SYSTem:DISPlay:BAR:TOOLs[:STATE]
```

Additional Function: Minimize/Maximize the Softtool Panel

The softtool panel can be minimized/maximized via the cross/hamburger icon at its top left corner.

Remote command:

`SYSTem:DISPlay:BAR:STOols[:STATe]`

5.18.5 Touchscreen tab

Allows you to lock the touchscreen functionality of the R&S ZNA to prevent inadvertent entries.

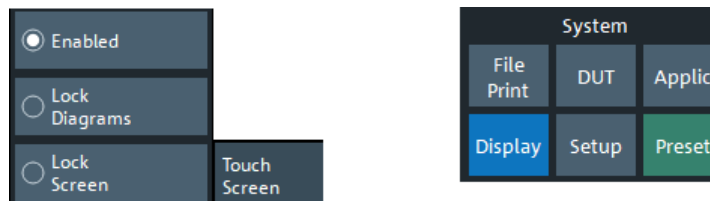

Enabled / Lock Diagrams / Lock Screen

- "Enabled" – touchscreen control of the R&S ZNA fully enabled. All control elements are active.
- Lock diagrams – drag and drop functions in the diagrams are disabled, all other control elements (e.g. the softtool panels) are still active.
- Lock screen – all control elements are locked. Pressing any front panel key on the analyzer (or sending `SYSTem:TSLock OFF`) re-enables touchscreen control.

Remote command:

`SYSTem:TSLock`

5.19 Setup softtool

The "Setup" softtool allows you to define various system-related settings, to manage global resources, to get system information and to execute service functions.

Access: System – [Setup]



Persistent vs. session settings

The settings in the "Setup" softtool and the configuration dialogs are global settings and not affected by a "Preset" or shutdown of the analyzer.

5.19.1 Setup tab

Gives access to system-wide properties, settings, resources and service functions.

5.19.1.1 Controls on the Setup tab

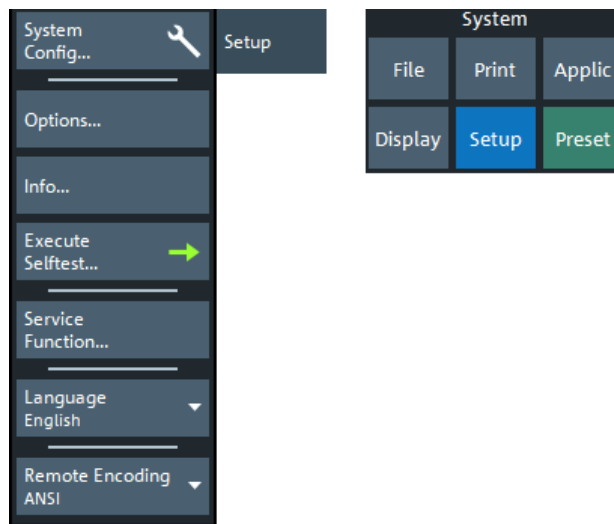

The following buttons in the "Setup" tab open related dialogs:

- **"System Config...":** [System Config dialog](#)
- **"Options...":** "Info" dialog > [Options tab](#)
- **"Info...":** "Info" dialog > [Setup tab](#)
- **"Operators Check...":** [Operators Check wizard](#)
- **"Execute Selftest...":** "Info" dialog > [Selftest tab](#)
(Runs the selftest first)
- **"Service Function...":** [Service Function dialog](#)

Language

Selects the language of the graphical user interface. A message box indicates that the vector network analyzer application needs to be restarted to activate a different language.

English is the preinstalled language. A setup file for additional languages ("Vector Network Analyzer Translation Setup") is available for download from the [Rohde & Schwarz Internet site](#).

Remote command:
n/a

Remote Encoding

Selects the character encoding used at the remote interface. The selected encoding applies to directory and file names, calibration kit names, calibration unit characterizations and display titles.

Currently the following encodings are supported: ANSI (default), UTF-8, Shift JIS.

Remote command:
`SYSTEM:COMMunicate:CODEC`

5.19.1.2 System Config dialog

The "System Config" dialog allows you to define global settings that are not affected by an instrument reset. See [Chapter 4.1.1, "Global \(persistent\) settings"](#), on page 107.

Access: System – [Setup] > "Setup" > "System Config..."

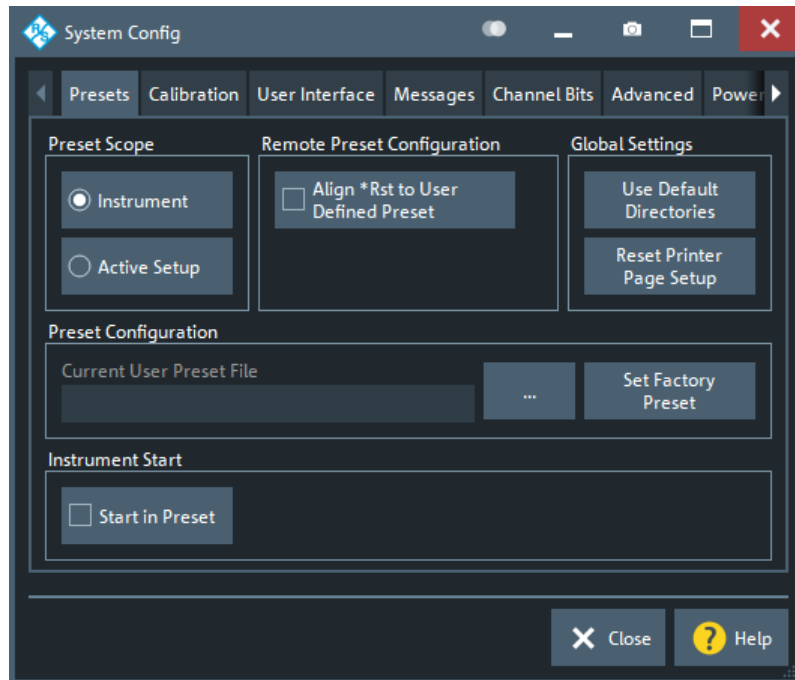

• Presets tab	856
• Calibration tab	858
• User Interface tab	860
• Messages tab	863
• Channel Bits tab	864
• Advanced tab	865
• Power tab	867
• Recovery tab	870
• HUMS tab	871

Presets tab

Specifies the behavior of the R&S ZNA upon a preset.

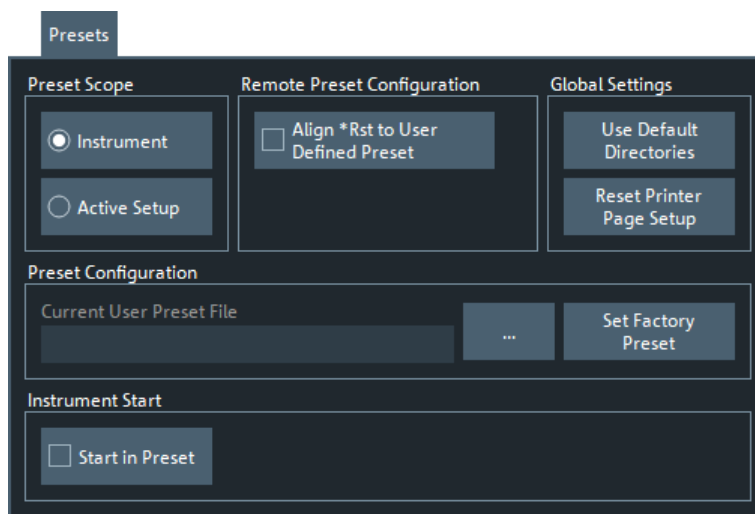

Preset Scope

Defines whether a preset affects all open recall sets ("Instrument") or the active recall set only.

The "Preset Scope" applies to the GUI and to the `SYSTEM:PRESet[:DUMMy]` command. The `*RST` command always resets all open recall sets.

Remote command:

`SYSTEM:PRESet:SCOPE`

Remote Preset Configuration

"Align *RST to User Defined Preset" defines the behavior of the `*RST` and `SYSTEM:PRESet` commands. If checked, and if a valid setup file is selected in the [Preset Configuration](#) section, then they perform a user-defined preset. Otherwise, they perform a factory preset.

Note that the [preset modes](#) "RF Off" and "Normal, GUI, Ext Setup" are not available via remote commands.

Remote command:

`SYSTEM:PRESet:REMOte[:STATe]`

Global Settings

The two buttons reset all directory settings (e.g. the directories for storing trace data, limit lines, calibration data...) and all settings in the "Printer Setup" dialog to default values. See [Chapter 5.15.4, "Printer Setup dialog"](#), on page 779.

Remote command:

n/a

Preset Configuration

Specifies whether the preset action performs a factory preset or restores a user preset file. A user preset file is an arbitrary recall set file (`*.znxml` | `*.znx`), that can be created from the active setup using `System – [File Print] > "Save..."`. If the current user preset file is not found (e.g. because it was deleted or moved), `System – [Preset]` initiates a factory preset.

The preset configuration applies to:

- the System – [Preset] hardkey (if "Immediate Preset" on page 929 is selected)
- the [Preset](#) button
- the remote commands *RST and SYSTem:PRESet (if "Align *RST to User Defined Preset" is selected in the [Remote Preset Configuration](#) section).

Furthermore, the user preset file is used as a template, whenever [New](#) recall set files are created from the GUI.

Remote command:

```
SYSTem:PRESet:USER:NAME
SYSTem:PRESet:USER[:STATe]
```

Start in Preset

If this option is active, the R&S ZNA FW always starts with the configured [Preset Configuration](#). Otherwise it starts with the previous state, i.e. the settings that were persisted during the previous shutdown.

Remote command:

```
SYSTem:PRESet:START
```

Calibration tab

Provides general system error correction (calibration) settings.

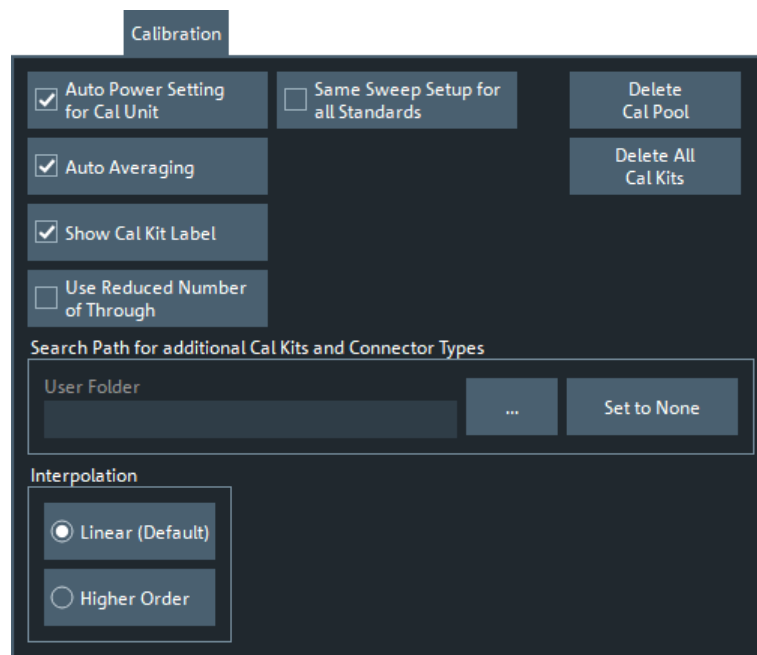

Auto Power Setting for Cal Unit

Sets the source power at all test ports to -10 dBm while an automatic calibration is active. Applying this source power to the ports of the calibration unit ensures best accuracy of the automatic calibration. The source powers are reset to their original values after the calibration is completed. The automatic power reduction can be deactivated in case that the test setup introduces a large attenuation.

Remote command:

```
SYSTem:COMMunicate:RDEvice:AKAL:PREduction[:STATe]
```

Auto Averaging

Activates automatic averaging, which means that the VNA performs multiple calibration sweeps and applies averaging to reduce trace noise. In contrast to regular averaging (see [Chapter 5.9.3, "Average tab"](#), on page 538), the number of calibration sweeps is calculated automatically.

Remote command:

```
[SENSe:]CORRection:COLLect:AVERage
```

Show Cal Kit Label

Enables/disables the "Calibration Info" dialog during manual calibration (see ["Start Cal Sweep"](#) on page 576).

Independent of the state of the "Show Cal Kit Label" flag, cal kit labels are displayed in several other manual calibration dialogs.

Use Reduced Number of Through

Enables or disables the [Reduced Through](#) logic for every port assignment of an automatic calibration.

Note that for this to work, the port assignments must have a star topology, with a "Common Port" set using `[SENSe<Ch>:]CORRection:COLLect:AUTO:CPOrt` on page 1368.

Remote command:

```
[SENSe:]CORRection:COLLect:AUTO:MCONnect
```

Same Sweep Setup for All Standards

Selects one of two alternative calibration methods:

- If unchecked, then for each measured standard the analyzer individually prepares the calibration sweep and reduces the number of drive ports to the required minimum. This method can be faster if the calibration sweeps take longer than the preparation phase (e.g. due to small bandwidths or many sweep points), or if many ports are calibrated.
- If checked, then each standard involved in an n-port calibration (or in n one-port calibrations) is measured with n drive ports. The calibration sweep setup is the same for all standards; no individual preparation phases are required. This method can be faster if the calibration sweeps are fast compared to the preparation phases. Due to the similarity of the measurement phases and timing with the later measurement of the device under test, this calibration method is potentially more accurate than the previous method. If the sweeps are relatively slow, or if many ports are calibrated, it causes longer calibration times.

Note that noise figure calibrations require individual setups, and hence this setting is ignored.

Remote command:

```
[SENSe:]CORRection:COLLect:CSETup
```

Delete Cal Pool / Delete All Cal Kits

Deletes all calibration data and all cal kit data. See [Chapter 5.11.4.3, "Calibration Manager dialog"](#), on page 638.

Remote command:

n/a

Search Path for additional Cal Kits and Connector Types

Contains the name and path of a special directory for cal kit files (*.calkit). All cal kit files in the special directory are loaded automatically as predefined kits (i.e. read-only kits which cannot be modified) every time the VNA application is started. It is possible to select the default cal kit directory

C:\Users\Public\Documents\Rohde-Schwarz\ZNA\Calibration\Kits or any other directory. "None" means that no additional cal kit files are loaded on start-up.

Use the special directory to make sure that you do not have to import kits manually, even after terminating the VNA application improperly. In this case, previously imported cal kit files are not stored in the recall set file.

Remote command:

`MMEemory:LOAD:CKIT:UDIRectory`

Interpolation

Selects the algorithm for the interpolation of user system error corrections.

Interpolation is used if the sweep points during the measurement differ from the sweep points during calibration (state label "Cal int"). Compared to the default linear interpolation, the "Higher Order" (cubic spline) interpolation can slightly slow down the measurement but can provide better results, at least if the measured trace shows no significant noise or discontinuities. For the factory system error correction, the analyzer always uses linear interpolation.

Generally, it is recommended to avoid interpolation whenever possible.

Remote command:

`[SENSe:]CORRection:IMETHod`

User Interface tab

Provides general user interface configurations.

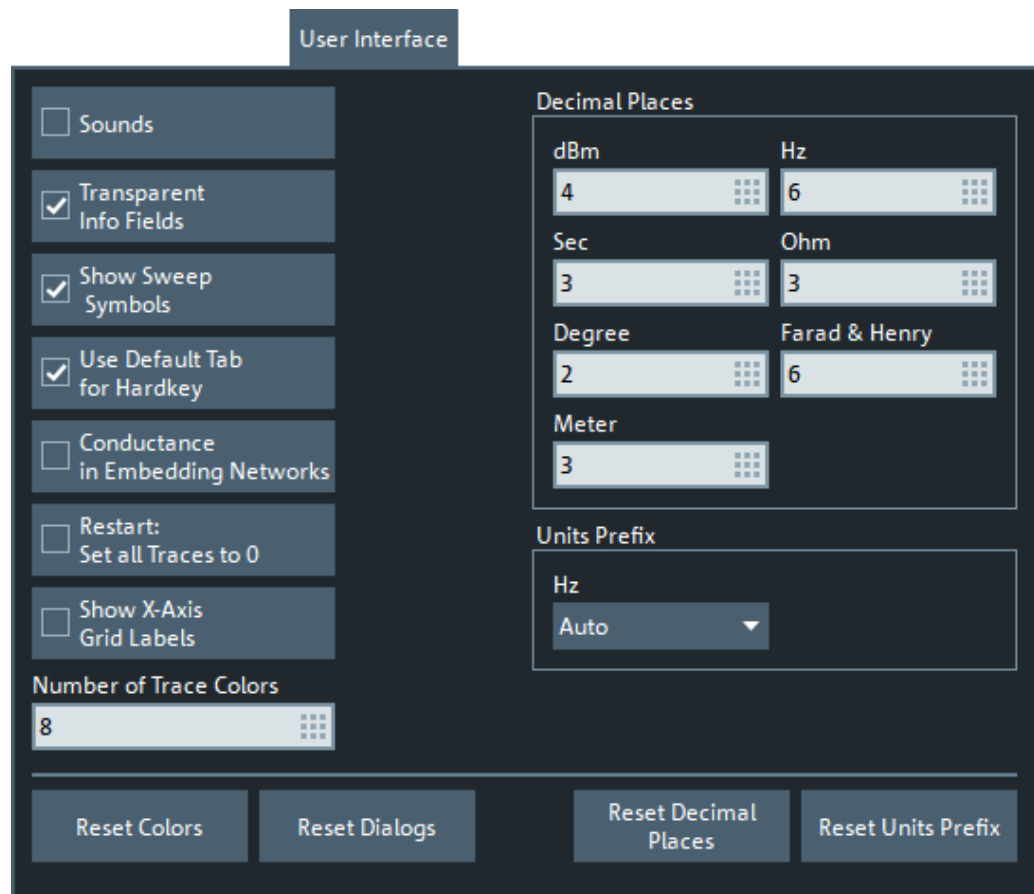

Sounds

Switches the sounds generated by the analyzer GUI on or off. Sounds are generated for certain GUI events, when the analyzer generates a notice, status or warning message (alarm sounds) or during calibration.

Limit fail beeps for [limit tests](#), [ripple tests](#), and [circle tests](#) is not affected by this setting. If enabled, those beeps are generated even if "Sounds" is unchecked.

Note: The R&S ZNA does not have a built-in audio device and loudspeaker. To hear sounds, connect a USB audio device to the instrument or operate it via remote desktop.

Remote command:

```
SYSTem: SOUNd: ALARm [ : STATe]
```

```
SYSTem: SOUNd: STATus [ : STATe]
```

Transparent Info Fields

This checkbox enables or disables transparent info fields for markers and trace statistics.

Transparent info fields do not hide an underlying trace.

Remote command:

n.a.

Show Sweep Symbols

This checkbox turns sweep symbols on or off.

Sweep symbols are arrows pointing downward onto the trace. They are displayed if the sweep time exceeds an upper limit, e.g. if the number of points is high or the measurement bandwidth is low.

Remote command:
n.a.

Use Default Tab for Hardkey

If the checkbox is selected (system default), the [Function Keys](#) activate the first enabled tab of their associated softtool. Otherwise the last used tab is activated.

For background information, see [Chapter 5.1, "Function keys and softtools"](#), on page 339.

Remote command:
n/a

Conductance in Embedding Networks

Changes the presentation of "capacitance $C_{i>}$ in parallel with resistance $R_{i>}$ " circuit blocks in lumped de/embedding networks (see [Chapter 4.6.2.3, "Circuit models for 2-port networks"](#), on page 235 and [Chapter 4.6.2.4, "Circuit models for 4-port networks"](#), on page 237).

If active, the resistance $R_{i>}$ is displayed and specified as conductance $G_{i>}$ ($=1/R_{i>}$).

Remote command:
`SYSTem:DISPlay:CONDuctancesn/a`

Restart: Set all Traces to 0

Defines the behavior of the "Restart Sweep" function (see ["Restart Sweep"](#) on page 566).

If unchecked (factory default) the previous measurement data are preserved. If checked, they are deleted.

Remote command:
`SYSTem:TRESet [:STATe]`

Show X-Axis Grid Labels

If enabled, the firmware displays X-axis grid labels in cartesian diagrams with linear scale.

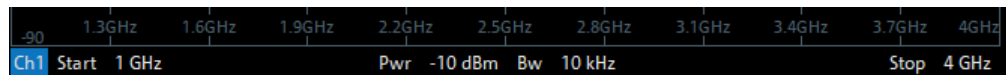

Remote command:
`SYSTem:DISPlay:XLABELs`

Number of Trace Colors

Defines the maximum number of trace colors (trace properties for the [user defined color scheme](#)).

Remote command:

`SYSTem:DISPlay:TRACes:CCOunt`

Decimal Places

Defines the number of fractional digits for quantities with different physical units. The settings affect entries and results, e.g. the values in the marker lists.

Note: If your instrument is equipped with option R&S ZNA-K19, 1 mHz Frequency Resolution, set "Decimal Places" of unit "Hz" to 12 to utilize the high frequency resolution.

Remote command:

n/a

Units Prefix

Sets the unit prefix for frequencies (Base unit: Hz) to kilo (k), mega (M), giga (G) or tera (T) or lets the R&S ZNA select the appropriate prefix ("Auto" = default setting).

Remote command:

n/a

Reset Colors / Reset Dialogs / Reset Decimal Places / Reset Units Prefix

Resets the color settings ("System" > "Display" < "Config"), the dialog properties, the "Decimal Places" and the "Units Prefix" settings. These settings are global and not affected by an instrument preset.

Remote command:

n/a

Messages tab

Defines which instrument events are indicated by an information popup.

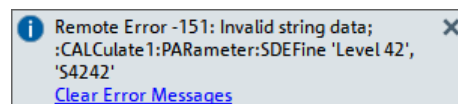

Display of information popups can be globally disabled or limited to certain event types.

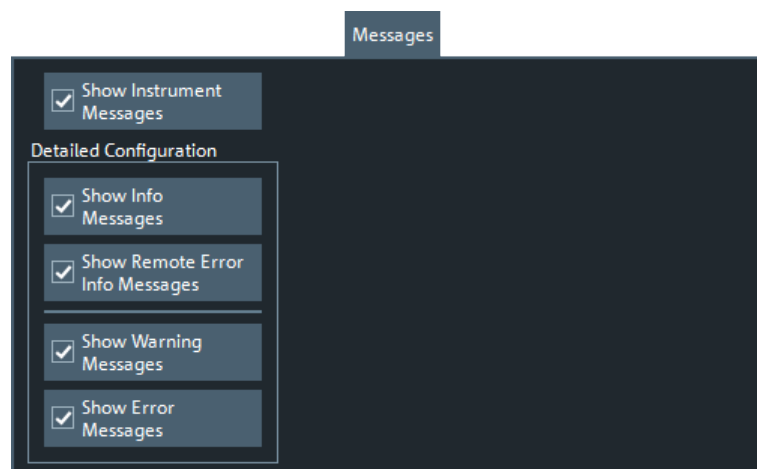

Show Instrument Messages

Defines whether information popups are displayed at all.

Remote command:

```
SYSTem:ERRor:DISPlay:STATe
```

Show Info Messages / Show Warning Messages / Show Error Messages

Selectively disables/enables display of information popups for the related event type.

If information popups are globally switched off ([Show Instrument Messages](#) unchecked), these buttons are disabled. However, their checked state is memorized.

Remote command:

```
SYSTem:ERRor:DISPlay:INFO
```

```
SYSTem:ERRor:DISPlay:WARNings
```

```
SYSTem:ERRor:DISPlay:ERRor
```

Show Remote Error Info Messages

Defines whether information popups are displayed whenever a remote control command error occurs.

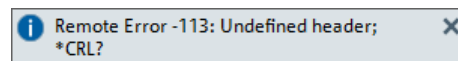

The displayed information can be useful for program development and optimization; it does not necessarily indicate that a remote control script is faulty or non-executable.

Note

- If either "Show Instrument Messages" or "Show Info Messages" is unchecked, this button is disabled. However, its checked state is memorized.
- For SCPI error -113, Undefined header, no tooltip is displayed.

Remote command:

```
SYSTem:ERRor:DISPlay[:REMote]
```

Channel Bits tab

Sets a channel-dependent 8-bit decimal value (0, ..., 255) to control eight independent output signals at the User Port connector (lines 8 to 11 and 16 to 19).

Setting the channel bits does not change the analyzer state.

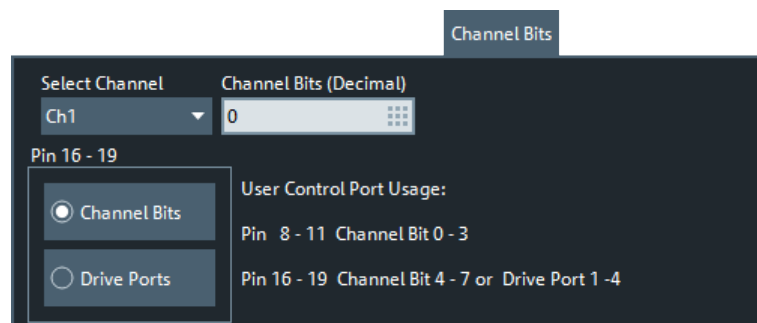

Channel Bits (Decimal)

Entry of the 8-bit decimal value (0 ... 255) for the selected channel. The channel bits control eight output signals at the User Port connector. The signals are 3.3 V TTL signals which can be used to differentiate between up to 256 independent analyzer states. For an application example, refer to the description of the remote-control command.

The decimal values have the following effect:

- 0 means that no output signals are enabled at any of the pins 8, 9, 10, 11 and 16, 17, 18, 19.
- 1 enables the output signal at pin 8. The signal is switched on while a measurement sweep is running in the selected channel. All other signals are inactive.
- 2 enables the output signal at pin 9.
- 3 enables the output signals at pins 8 and 9.
- ...
- 255 enables the output signals at all pins. See also "[Pin 16 - 19](#)" on page 865.

Remote command:

`OUTPut<Ch>:UPORT[:VALue]`

Pin 16 - 19

Selects the control mechanism for the signals at pins 16 to 19 of the User Port connector.

- **"Channel Bits"**: Signals are controlled by channel bits 4 to 7. No drive port indication at the User Port connector.
- **"Drive Ports"**: Signals indicate the active drive ports. The number of active channel bits is reduced to 4 (pins 8 to 11).

Remote command:

`OUTPut:UPORT:ECBits`

Advanced tab

Collects several advanced settings.

Advanced

Mathematical Options

Geometric Calculation of Bandfilter Center

Dump Configuration

Error Dump Type
Minimal

Touchstone Export Options

Use TAB (instead of blanks) Trim leading whitespace

Positive number prefix
Space Skip separator lines

TTL Pass Default Values

TTL1 Pass On

TTL2 Pass On

Geometric Calculation of Bandfilter Center

Defines how bandfilter searches calculate the center frequency of the passband or stopband (see ["Bandfilter search"](#) on page 133).

If "Geometric Calculation of Bandfilter Center" is checked, the *geometric mean* of the lower band edge and upper band edge frequencies is used, otherwise their *arithmetic mean*.

Remote command:

`CALCulate:MARKer:FUNction:BWIDth:GMCenter`

Error Dump Type

Determines the level of detail ("Minimal", "Normal", "Large", "Full") and hence the size of the dump files that are created if a firmware exception occurs. "None" disables dump file creation.

The latest 5 exception dumps can be retrieved using the "Save Report" function of the "Info" dialog (see ["Create R&S Support Information"](#) on page 875).

For further information, see [Chapter 9, "Error messages and troubleshooting"](#), on page 1766.

Remote command:

`DIAGnostic:DUMP:SIZE`

Touchstone Export Options

Configures whitespace insertion during legacy [Version 1.1 \(ZNx\)](#) Touchstone file export.

The default export format is explained in [Chapter 4.4.2.1, "Touchstone files"](#), on page 177:

- logical columns are vertically aligned using spaces

- positive and negative numbers are vertically aligned by prefixing positive numbers with blanks
- the frequencies are horizontally separated from the corresponding S matrices using leading spaces
- the content parts (header, S matrices for different frequencies) are separated by blank lines

Use TAB (instead of blanks) ← Touchstone Export Options

If checked, columns are separated by tabs rather than spaces.

Remote command:

```
MMEMoRY:STORe:TRACe:OPTion:TABS
```

Trim Leading Whitespace ← Touchstone Export Options

If checked, whitespace at the beginning of each line is removed.

Remote command:

```
MMEMoRY:STORe:TRACe:OPTion:TRIM
```

Positive Number Prefix ← Touchstone Export Options

Positive numbers can either be prefixed by blanks, by plus signs or not at all.

Remote command:

```
MMEMoRY:STORe:TRACe:OPTion:PLUS
```

Skip Separator Lines ← Touchstone Export Options

If checked, the content parts are no longer separated by blank lines.

Remote command:

```
MMEMoRY:STORe:TRACe:OPTion:SSEParator
```

TTL Pass Default Values

Defines the default values of [TTL1 Pass](#) / [TTL2 Pass](#) for new traces.

Remote command:

```
SYSTem:TTLout<Pt>:STATus[:STATe]
```

Power tab

The settings in this tab define global power settings of the VNA.

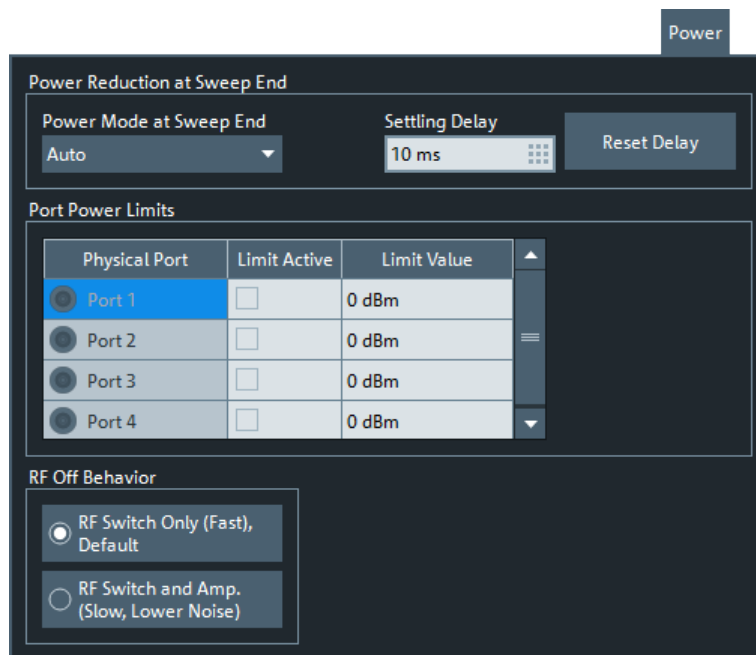

Power Reduction at Sweep End

The power reduction settings apply to all sweep modes but are particularly useful in single sweep mode.

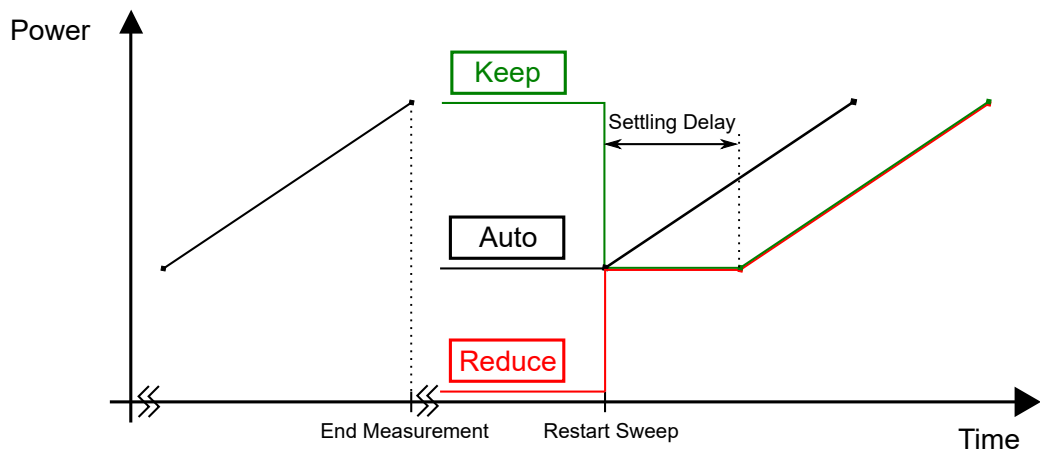

Figure 5-70: Power control at sweep end in Single Sweep mode (power sweep)

Note: By default, at sweep end the output power of the first measurement point is restored ("Auto" mode). After a small settling time (~10 ms), the sweep can be restarted.

Selecting a different behavior can result in a significantly longer total measurement time, in particular if a long "Settling Delay" is used. Do not forget to revert the [Power Mode at Sweep End](#) to "Auto" mode if it is not necessary to "Reduce" or "Keep" the power at the sweep end. A preset is not sufficient for this purpose.

Power Mode at Sweep End ← Power Reduction at Sweep End

The analyzer offers three power modes at sweep end:

- "Auto" results in the shortest measurement time (default setting). If enabled, at sweep end the output power of the first measurement point is restored. The configured [Settling Delay](#) is not applied.
- "Reduce" is intended for measurements on sensitive DUTs (primarily: power sweeps). If enabled, at sweep end the output power of the driving port is reduced as if the channel base power was set to its minimum possible value. The configured settling delay is applied.
- "Keep" is intended for power sweeps. If enabled, at sweep end the output power of the last measurement point is kept. The configured settling delay is applied.

See [Figure 5-70](#) for an illustration.

Note:

- Compared to "Auto" mode, "Reduce" and "Keep" can result in significantly longer measurement times - in particular if an extended settling delay is used.
- The output power is not altered if there is only a single channel with a single driving port, performing a "Time" or "CW Mode" sweep.
- In triggered mode, the analyzer always uses the settings of the first measurement point while waiting for the trigger signal.

Remote command:

```
SOURce:POWer:SWEepend:MODE
```

Settling Delay / Reset Delay ← Power Reduction at Sweep End

If [Power Mode at Sweep End](#) is set to "Reduce" or "Keep", the "Settling Delay" defines the time between [Restart Sweep](#) request and sweep start. See [Figure 5-70](#) for an illustration.

Use the "Reset Delay" button to adjust the "Settling Delay" to its default value.

Remote command:

```
SOURce:POWer:SWEepend:SDELay
```

External Generators > Minimum Settling Delay

Defines the minimum settling delay for external generators. The delay is enforced:

- whenever settings are applied to a driving generator port, i.e. as a minimum delay between the setting and the actual measurement
- irrespective of the sweep type, and whether the generator actually sweeps

Factory default is 180 µs.

Remote command:

```
SOURce:POWer:GENerator:SDELay
```

Port Power Limits

Allows you to enable and define port-specific power limits.

Remote command:

```
SOURce<Ch>:POWer<PhyPt>[:LEVel] [:IMMediate]:LLIMit[:STATe]
SOURce<Ch>:POWer<PhyPt>[:LEVel] [:IMMediate]:LLIMit:VALue
SOURce<Ch>:POWer<PhyPt>:GENerator<Gen>:LLIMit[:STATe]
SOURce<Ch>:POWer<PhyPt>:GENerator<Gen>:LLIMit:VALue
```

RF Off Behavior

Allows you to define how the R&S ZNA turns the RF power off.

"RF Switch Only (Fast), Default" Only the RF switch is used.

"RF Switch and Amp. (Slow, Lower Noise)" In addition to the switches, all amplifiers are turned off. Results in lower broadband noise.

Remote command:

`OUTPut [:STATe] :TYPE`

Global AGC (R&S ZNB only!)

Allows you to select between two [AGC](#) algorithms:

"Memory AGC" (factory default) Optimized gain control pre-measurement: only if required and for as few sweep points as possible.

"Point AGC" Legacy AGC algorithm: gain control pre-measurement at every sweep point. Typically significantly slower than "Memory AGC".

Remote command:

`SYSTem:AGC:GLOBal:METHod`

Recovery tab

Provides a single function "Boot into Recovery Screen" that allows you reboot the instrument and launch the "R&S Recovery Environment". From there you can restore the original system image (including operating system and firmware).

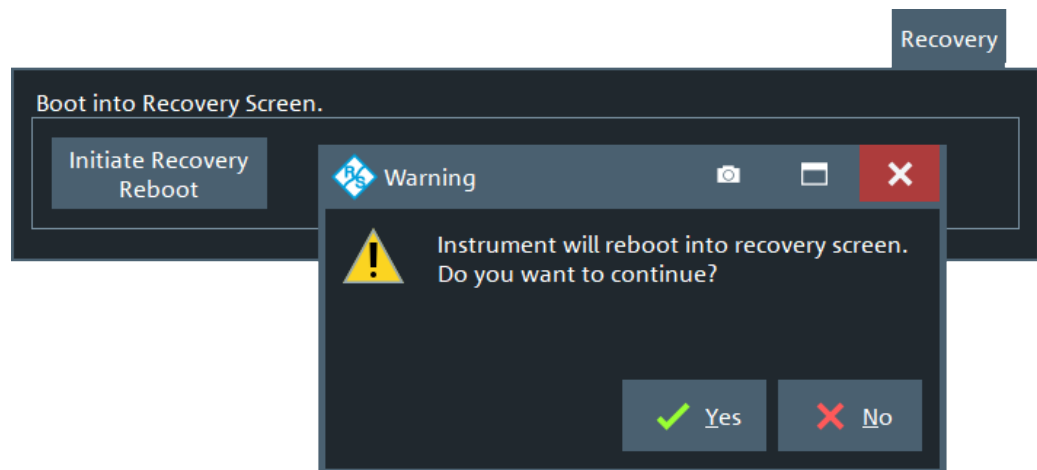

See [Chapter 12.2, "System recovery"](#), on page 1779.

HUMS tab

The "HUMS" tab allows you to enable and configure R&S HUMS (see [Chapter 4.7.19, "Health and usage monitoring service \(HUMS\)"](#), on page 301). It is only available if software option R&S ZNA-K980 is installed.

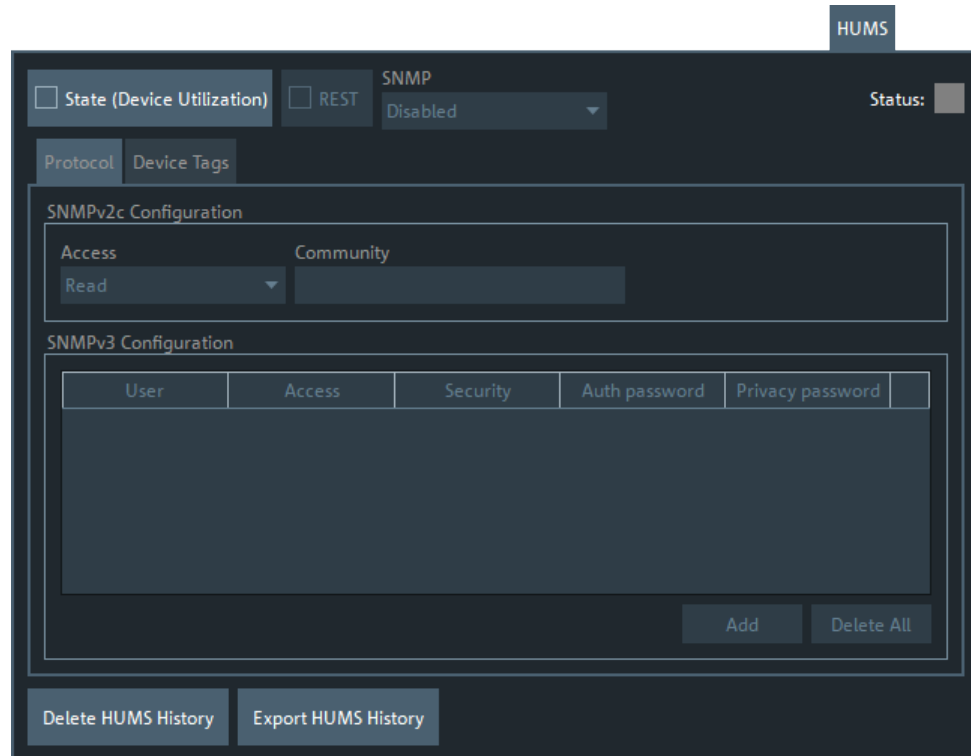

Common controls

State (Device Utilization)/Status

Enables/disables the HUMS service.

The "Status" LED indicates the current state of the HUMS service:

- grey: inactive
- green: up and running

If HUMS has been used before, turning on restores the previous [protocol settings](#).

Remote command:

```
DIAGnostic:HUMS:STATe
```

REST ← State (Device Utilization)/Status

Enables/disables the [REST](#) interface to the HUMS service.

Remote command:

```
SYSTem:COMMunicate:REST:ENABLE
```

SNMP ← State (Device Utilization)/Status

Enables/disables the [SNMP](#) interface to the HUMS service and allows you to select the supported SNMP protocol versions.

Depending on the enabled versions, different parts of the [Protocol subtab](#) are enabled.

Note: If you activate v2c, version v1 is also active.

Remote command:

```
SYSTem:COMMunicate:SNMP:VERSion
```

Delete HUMS History

Allows you to delete the previously collected health and monitoring information from the instrument.

Remote command:

```
DIAGnostic:HUMS:DELeTe:ALL
```

Export HUMS History

Allows you to export the previously collected health and monitoring information to a zip-ped JSON file.

Remote command:

```
DIAGnostic:HUMS:DELeTe:ALL
```

Protocol subtab

Gives access to SNMP configuration options for protocol version 2c and 3.

SNMPv2c Configuration

Allows you to grant read or read-write access via SNMPv2c, and to specify the related community string.

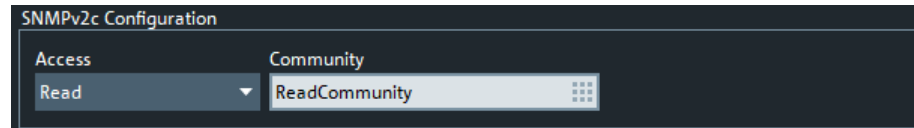

An SNMP community represents a collection of devices and agents grouped to monitor them. Authorized managers and the managed devices belong to an SNMP community. You can specify different communities for read-write and read-only access.

Remote command:

```
SYSTem:COMMunicate:SNMP:COMMunity:RO
```

```
SYSTem:COMMunicate:SNMP:COMMunity:RW
```

SNMPv3 Configuration

Allows you to enable and configure the SNMPv3-specific authentication and privacy features (passwords for access security and data encryption).

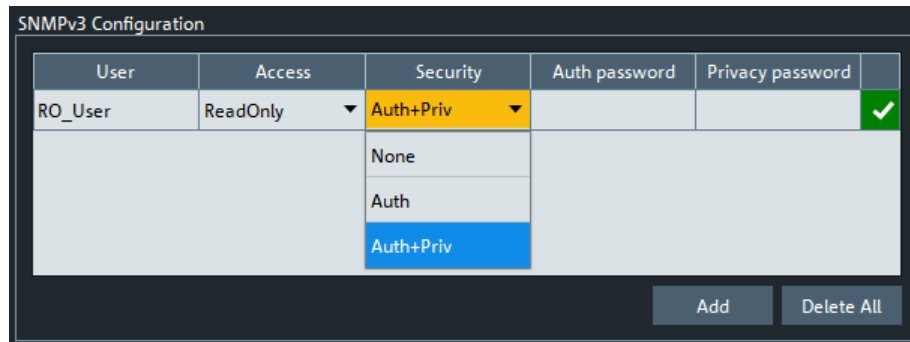

- To add a new user, select the "Add" button, enter the data and create the user by selecting the "✓" icon.
- To delete a single user, select the trash icon in the corresponding row.
- To delete all users, select the "Delete All" button.

Remote command:

```

SYSTEM:COMMunicate:SNMP:USM:USER:ALL?
SYSTEM:COMMunicate:SNMP:USM:USER
SYSTEM:COMMunicate:SNMP:USM:USER:DElete
SYSTEM:COMMunicate:SNMP:USM:USER:DElete:ALL

```

Device Tags subtab

Allows you to manage key-value pairs for HUMS device tagging.

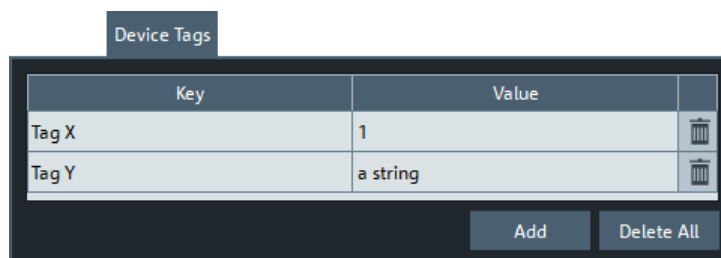

A device tag is a label to assign to your instrument. You can create any device tag for your instrument and define it by a specific key and value.

Add / Delete (Trash) / Delete All

- To add a new device tag, select the "Add" button and enter the "Key" and "Value strings".
The "Key" must be unique.
- To delete a single device tag, select the trash icon in the corresponding row.
- To delete all device tags, select the "Delete All" button.

Remote command:

```

DIAGnostic:HUMS:TAgS:ALL?
DIAGnostic:HUMS:TAgS[:VALue]
DIAGnostic:HUMS:TAgS:DElete
DIAGnostic:HUMS:TAgS:DElete:ALL

```

5.19.1.3 Info dialog

The "Info" dialog displays information about the instrument and its operation. All functions are primarily intended for error diagnostic and service purposes; see [Chapter 9.3, "Collecting information for technical support"](#), on page 1768. Many "Info" tabs also display softkeys for printing the contents or saving them to a file.

Access: System – [Setup] > "Setup" > "Info..."

Common controls in the Info dialog

The "Save...", "Print...", and " Save Report" buttons at the bottom of the "Info" dialog allow you to save the contents of the open tab to a file or to create a hardcopy.

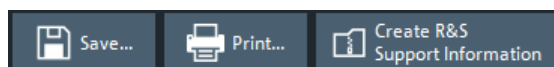

Save...

Allows you to save the contents of the open tab to an HTML file.

Remote command:

```
DIAGnostic:DEVICE:STATE  
SYSTem:DFPPrint?
```

Print...

Allows you to print the contents of the open tab. Opens a "Print Preview" dialog for printer and paper setup.

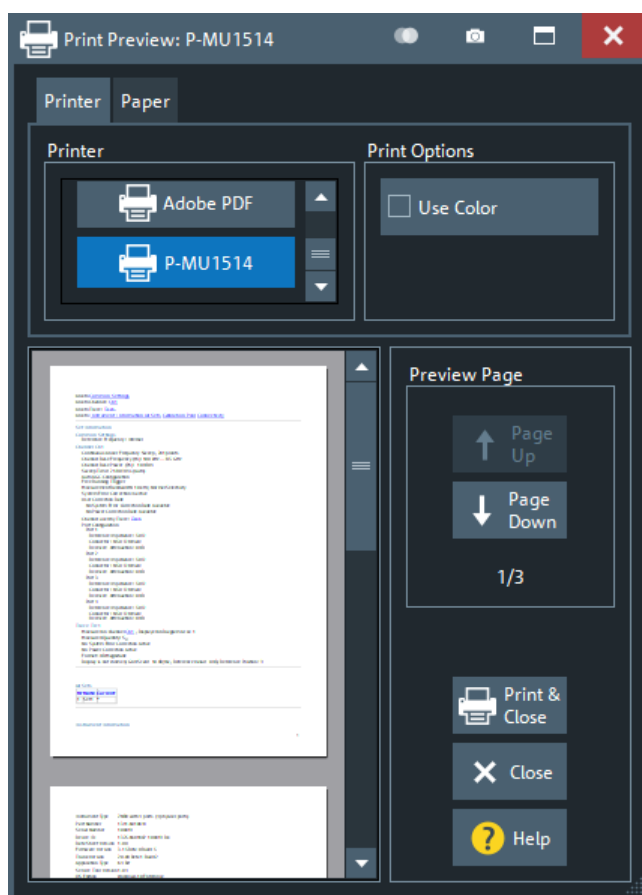

Create R&S Support Information

Saves the current selftest results to a zipped report file you can send to R&S Support for fault diagnosis; see [Chapter 9.3, "Collecting information for technical support"](#), on page 1768.

Remote command:

```
DIAGnostic:DEvIce:STATe
SYSTem:DFPRint?
```

Setup tab

Displays the channel and trace settings of the active recall set and the main characteristics of the instrument, including its IP address.

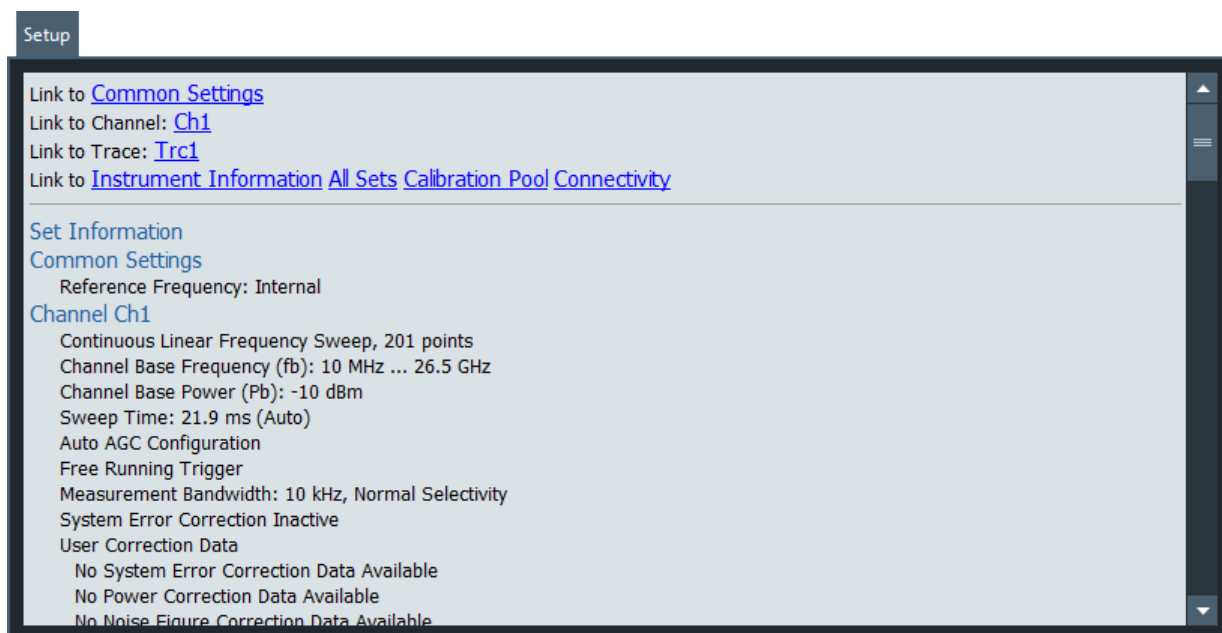

Options tab

Shows the installed software and hardware options. You can also enable additional software options using the option key supplied with the option. Proceed according to the instructions in the dialog.

For an overview of options, refer to [Chapter 4.7, "Optional extensions and accessories"](#), on page 246.

Options

New Option Key You can enter the option key here or insert a memory stick with the option key XML file. Then press Install. The application restarts with the option key installed.

Software Option Info

Option	Description	Key Type	Activation	Expires	Option Key
ZNA-K1	Spectrum Analyzer Mode	Simulation	---	---	---
ZNA-K2	Time Domain Analysis	Simulation	---	---	---
ZNA-K4	Frequency Conversion Meas	Simulation	---	---	---
ZNA-K5	Mixer phase measurements	Simulation	---	---	---
ZNA-K6	Phase coherent src ctrl	Simulation	---	---	---
ZNA-K7	Pulsed measurements	Simulation	---	---	---
ZNA-K8	Enhanced Frq-Converter Meas	Simulation	---	---	---
ZNA-K9	Embedded LO mixer GD meas	Simulation	---	---	---
ZNA-K17	Inceased IF BW 50 MHz	Simulation	---	---	---
ZNA-K19	1 mHz Resolution	Simulation	---	---	---
ZNA-K20	Extended Time Domain Analysis	Simulation	---	---	---
ZNA-K30	Noise Figure Measurements	Simulation	---	---	---
ZNA-K41	Non-linear measurements	Simulation	---	---	---
ZNA-K42	PIM localization meas	Simulation	---	---	---
ZNA-K61	True differential mode	Simulation	---	---	---
ZNA-K91	Embedded LO mixer GD meas	Simulation	---	---	---

Hardware Option Info

Option	Description	Part Number	Note
ZNA26-B4	Precision F-ref. (OCXO)	1332.4530.02	---
ZNA26-B31	Rec. Step Attenuator P1	1332.4700.31	---
ZNA26-B31	Rec. Step Attenuator P1	1332.4620.31	---

Software Option Info

Software options are listed with their name and description, the option key and key type, and the activation and expiration date (if applicable).

Remote command:

`DIAGnostic:PRODUct:OPTion:INFO?`

Hardware tab

Gives an overview of the analyzer's hardware configuration and basic hardware-related instrument settings.

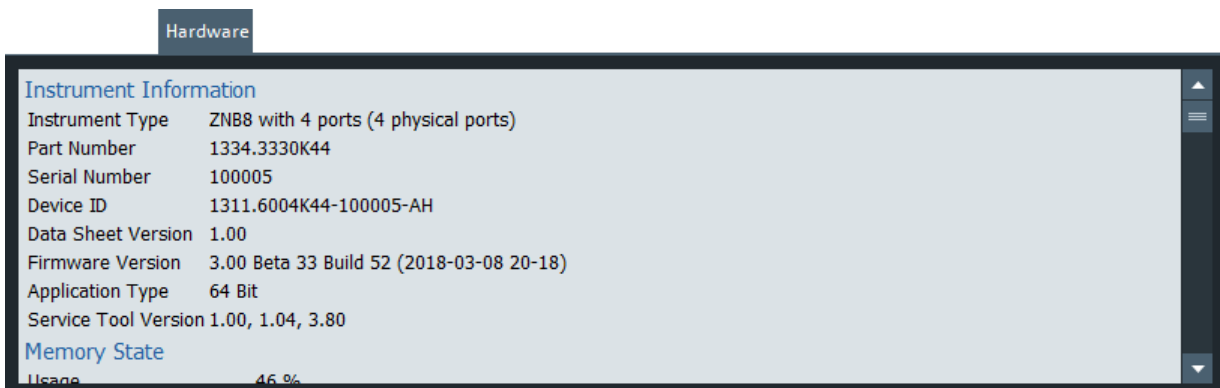

Configured External Switch Matrices

The "Hardware" tab also provides information about connected switch matrices. In particular, for mechanical matrices the current relay switch counts are reported (if supported by the matrix).

Remote command:

```
SYSTEM:COMMunicate:RDEVICE:SMATrix<Matr>:RELays:SWITCh:COUNT?
```

Selftest tab

Allows you to run an automatic selftest on the analyzer, and to display its results. Check "Show Details" to see the detailed test results.

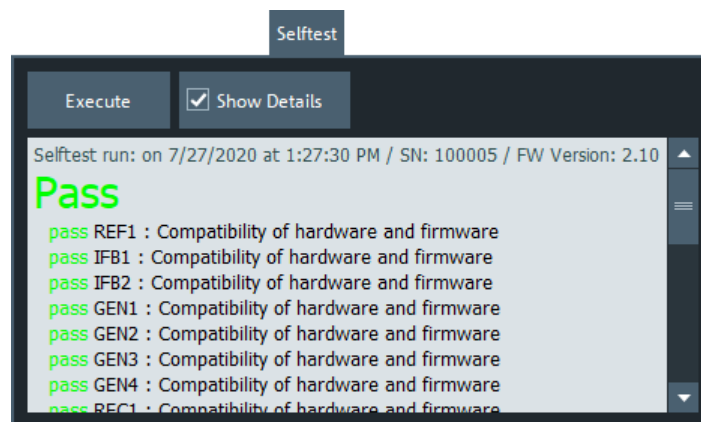

Error Log tab

Contains a chronological record of errors that occurred in the current and in previous sessions (see [Chapter 9.1, "Errors during firmware operation"](#), on page 1766).

The "Error" tab comes with an additional button for clearing the log ("Delete Error Log").

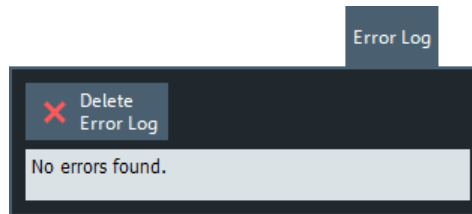

Cal Validation tab

Displays the result of the last cal validation. See "[Cal Validation ...](#)" on page 573.

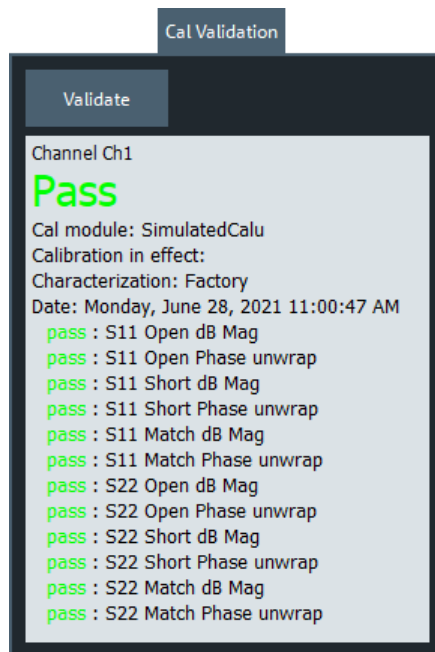

Lost Trigger tab

Displays the [lost trigger events](#) that occurred in the current and in previous VNA sessions ("lost trigger event log").

For each sweep with at least one lost trigger event, a log entry is created. The time-stamp of an entry indicates the end time of the related sweep.

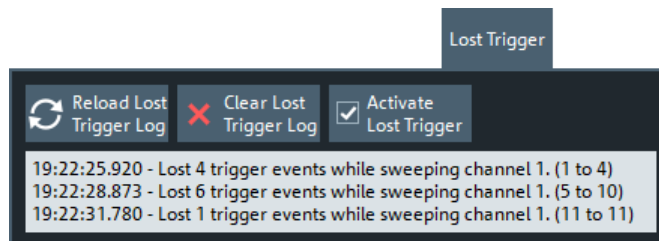

Reload Lost Trigger Log

While the "Lost Trigger" tab is open, the display is not refreshed automatically. Use "Reload Lost Trigger Log" to reload the lost trigger log file.

Remote command:

`TRIGger[:SEquence]:LTRigger:COUNT?`

Clear Lost Trigger Log

Does what it says. Also resets the lost trigger counter.

Remote command:

`TRIGger[:SEquence]:LTRigger:RESet`

`TRIGger[:SEquence]:LTRigger:COUNT?`

Activate Lost Trigger

Activates/deactivates tracking of lost trigger events.

Remote command:

`TRIGger[:SEquence]:LTRigger[:STATe]`

Service tab

Allows you to read or specify service-related information. This information can be read via [R&S HUMS](#), however, it does not require the corresponding option R&S ZNA-K980.

Next Calibration Due

The date (and time) the instrument needs calibration to be done.

Remote command:

`DIAGnostic:SERVice:CALibration:DUE:DATE`

Recommended Calibration Interval

Queries the recommended calibration interval, set by Rohde&Schwarz service.

Remote command:

`DIAGnostic:SERVice:CALibration:INTERval?`

Last Service

The last date (and time) the instrument was serviced.

Typically set by Rohde&Schwarz service.

Remote command:

`DIAGnostic:SERVice:DATE`

Last Calibration

The last date (and time) the instrument was calibrated.

Typically set by Rohde&Schwarz service.

Remote command:

`DIAGnostic:SERVice:CALibration:DATE`

5.19.1.4 Operators Check wizard

Welcome page

The "Operators Check" wizard allows you to perform selftests and other helpful checks from one central place in the analyzer GUI. The start page of the wizard is the selection page for the checks, its final page is the summary of all selected and executed checks.

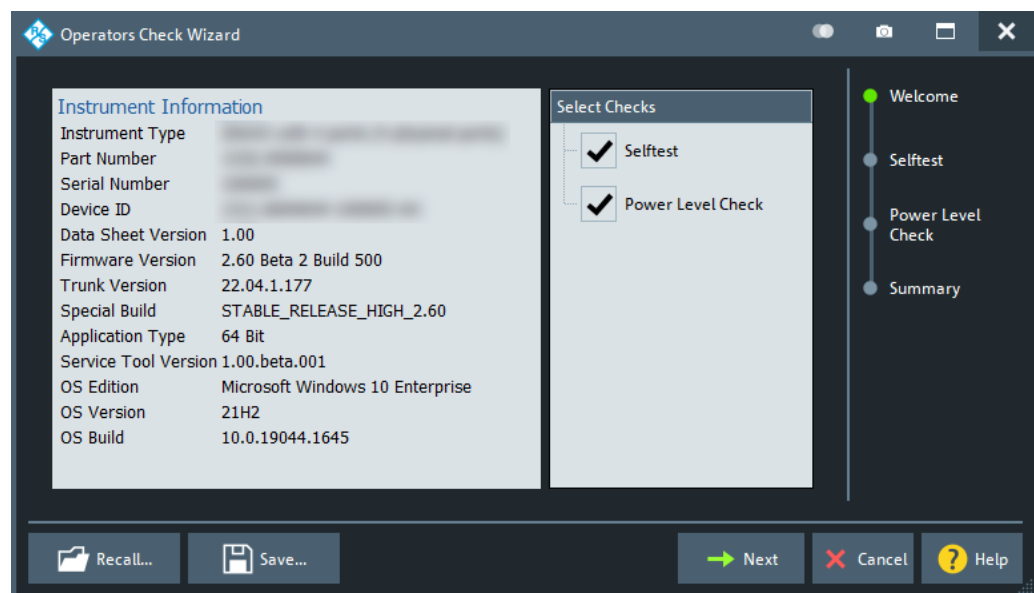

Recall

Allows you to load an operators check definition from an existing "OperatorsCheck XML" (*.opch) file. Such a file can be created with the [Save](#) function of the "Operators Check" wizard.

Save

Saves the current "Operators Check" definition to a "OperatorsCheck XML" (*.opch) file.

Note that if the "Operators Check" definition uses custom settings, then the opch file possibly references external files. E.g., for [power checks](#) with custom limit lines, the generated "OperatorsCheck XML" file <filename>.opch references external limit line files <filename>_opch<i>.line. To be able to recall the operator check definition, keep all these files in one directory and do not rename the external files.

Selftest page

In case you selected "Selftest" on the [Welcome page](#), the next step in the "Operators Check" wizard is the standard [selftest functionality](#) of the R&S ZNA firmware.

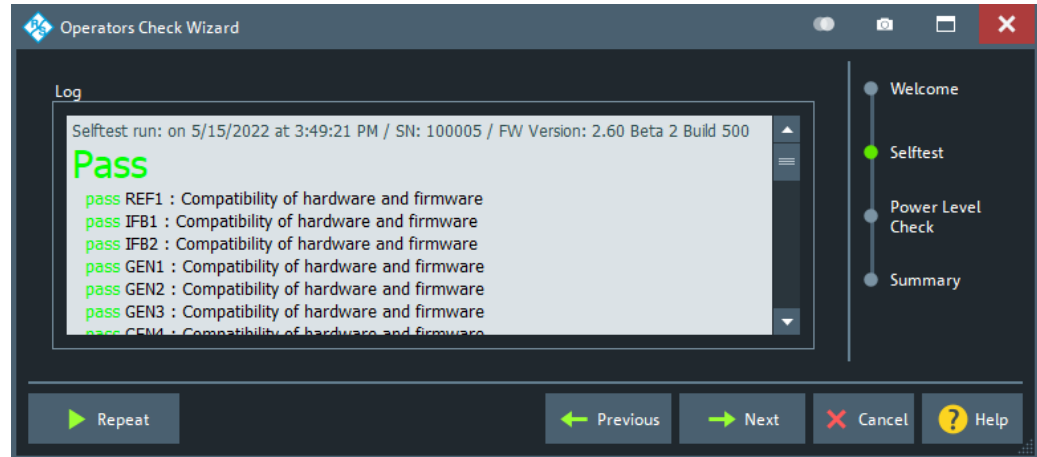

Execute/Repeat

Executes the selftest for the first time in this "Operators Check" wizard session, or repeats it.

Remote command:

`SYSTEM:OPCheck:SELFtest?`

Power Check page

In case you selected "Power Check" on the [Welcome page](#), you can configure and run port power checks from this page.

During the port power check, the firmware performs a 201-point-linear frequency sweep over the whole frequency range of the analyzer.

By default, the source power is set to -10 dBm and the firmware checks whether the measured a- and b-waves are at most 3 dBm above or below this value.

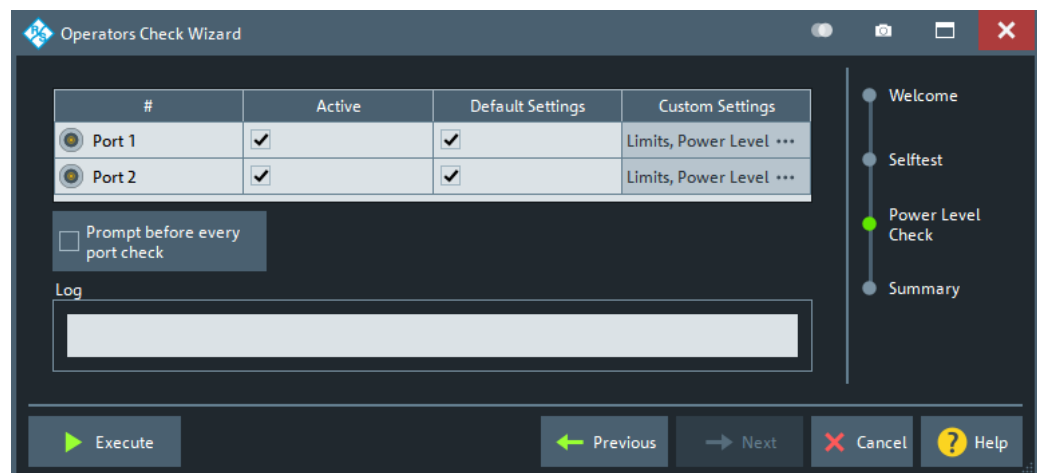

The upper part of the page allows you to define the checks, which can then be run with the "Execute" button. The results are displayed in the "Log" area.

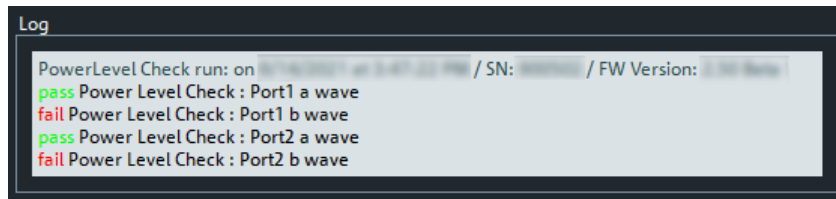
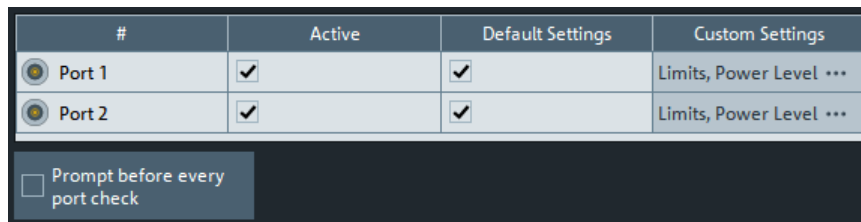

Figure 5-71: Log area

Power check definition

For each physical VNA port, you can decide whether to perform a power check ("Active"), whether to use default or custom settings ("Default Settings"), and whether you want to ask the firmware to "Prompt before every port check".



Active

Defines whether a power test shall be executed for the related port.

Default Settings

Defines whether default or [custom power and limit line settings](#) shall be used for the power test of the related port.

The checkbox is only enabled, if this port is set to [Active](#). If you uncheck it, a tap/click on the respective [Custom Settings](#) cell allows you to customize the port power test.

Custom Settings

If [Default Settings](#) is unchecked, a click/tap on the respective "Custom Settings" field opens the "Define Limit Lines and Power Level" dialog. This dialog allows you to set the source power for the test of the respective port, and to define port-specific [limit lines](#) for the test.

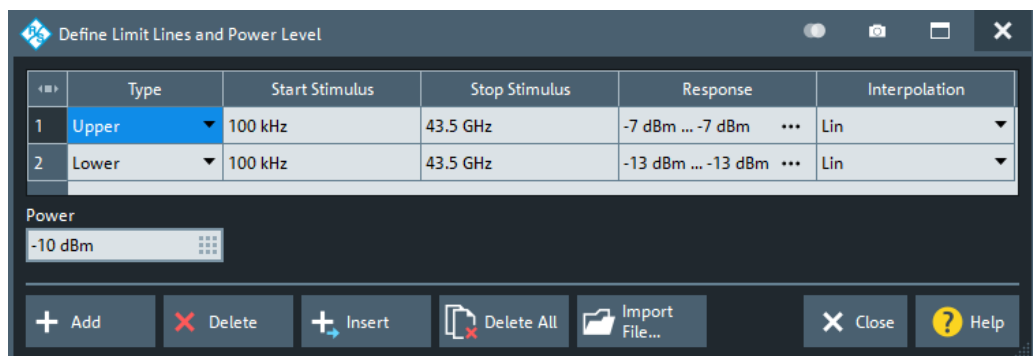

The available GUI elements for the limit line definition are the same as in the general-purpose limit line setup dialog. For their description, see [Chapter 5.6.1.2, "Define Limit Lines dialog"](#), on page 482.

Prompt before every port check

This option comes in handy if you want to connect a particular device such as a reflection standard to the related port before you [execute or repeat](#) the test.

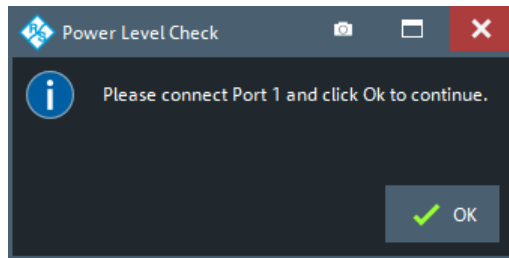

Execute/Repeat

Executes or repeats the "Active" port power tests with their current [limit line and power level settings](#). The firmware displays the relevant a- and b-wave traces, limit lines and PASS/FAIL results and in the diagram area:

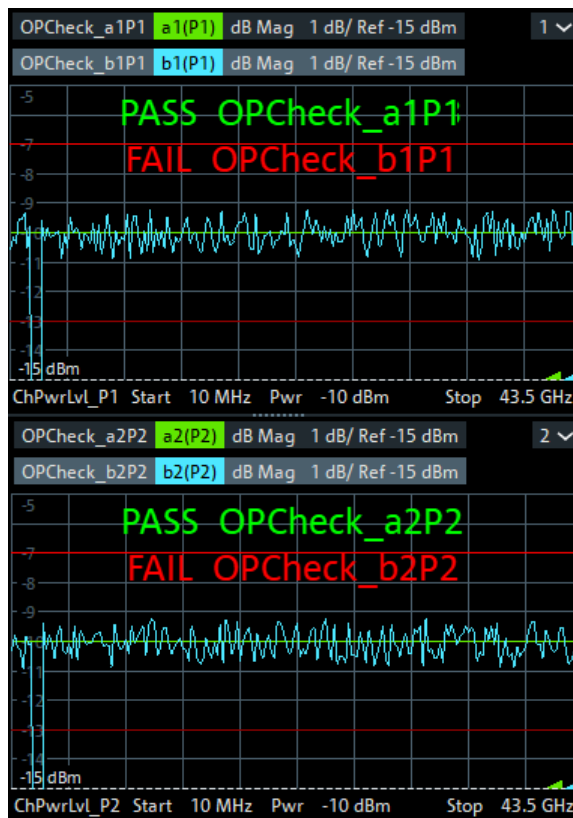

The PASS/FAIL results are also written to the [Log area](#).

Remote command:

```
SYSTem:OPCheck:PLEVel:PORT<Port>?
```

Summary page

Summarizes the check results and allows you to [print](#) them.

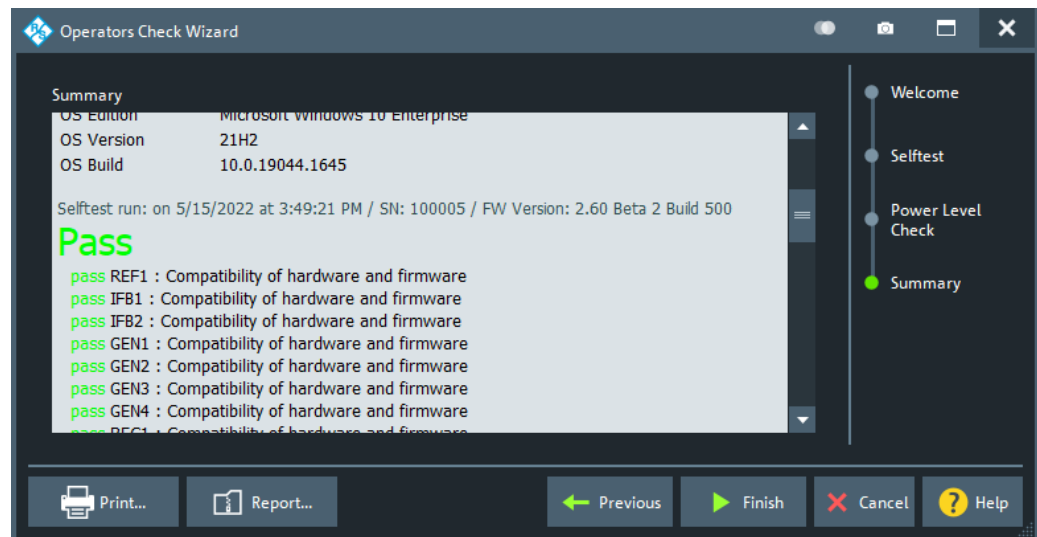

Print

Allows you to print the "Summary" of the executed tests, similar to the [Print...](#) functionality of the system "Info" dialog.

Report

Same functionality as [Create R&S Support Information](#) in the system "Info" dialog.

5.19.1.5 Service Function dialog

The "Service Function" dialog gives access to the service functions of the instrument.

Access: [Setup] > "Setup" > "Service Function..."

Most of the service functions require a service level > 0 that is protected by a password. Those service functions should be used by a Rohde & Schwarz service representative only. Refer to the service manual for more information.

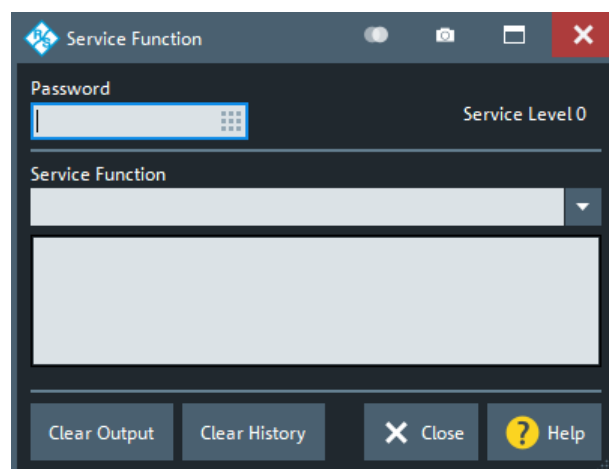

Password

Enter a password here to activate the required service level.

Remote command:

`SYSTem:PASSword[:CENable]`

Service Function

Identifier of the service function in "dotted textual" (example: sw.common.memory_usage) or "dotted decimal" (example: 0.1.18.0) representation.

Remote command:

`DIAGnostic:SERvice:SFUNction`

5.19.2 Freq. Ref. tab

Selects a reference signal for synchronization between the R&S ZNA and external devices. A common reference frequency is advisable to ensure frequency accuracy and frequency stability in the test setup.

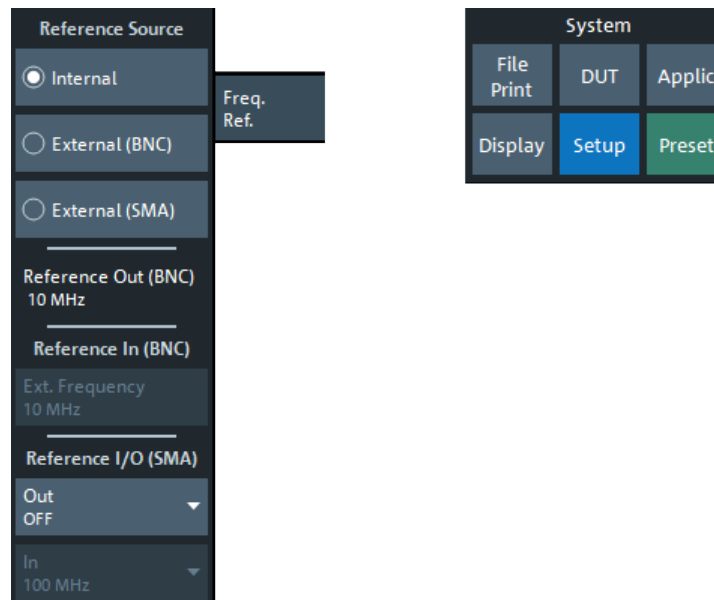
**Reference Source**

Selects the internal or an external reference clock signal for synchronization.

"Internal"

The analyzer synchronizes to its internal reference oscillator.

The synchronized internal 10 MHz reference clock is also made available at the rear panel Reference Out BNC connector. In addition, a synchronized 100 MHz reference signal can be provided at the Reference In/Out SMA connector (see ["Reference I/O \(SMA\) > Out"](#) on page 887). Use these signals to synchronize other devices.

"External (BNC)"	The analyzer synchronizes to an external reference clock via its rear panel Reference In BNC connector. The external reference signal has to meet the specifications of the data sheet; its frequency must be specified in the Ext Frequency field. The synchronized internal 10 MHz reference clock is also made available at the Reference Out BNC connector. In addition, a synchronized 100 MHz reference signal can be provided at the Reference In/Out SMA connector (see " Reference I/O (SMA) > Out " on page 887). Use these signals to synchronize other devices.
"External (SMA)"	The analyzer synchronizes to an external 100 MHz or 1 GHz reference clock via its rear panel Reference In/Out SMA connector. No reference signal is provided to the Reference Out BNC connector.

Remote command:

```
[SENSe<Ch>:]ROSCillator[:SOURce]
```

Reference Out (BNC)

The outgoing reference signal the analyzer provides at its rear panel Reference Out BNC connector depends on the selected [reference clock source](#):

Reference Clock Source	"Reference Out (BNC)"
"Internal"	10 MHz
"External (BNC)"	10 MHz
"External (SMA)"	Off

Ext Frequency

Specifies the frequency of the external reference clock signal at Reference In.

Remote command:

```
[SENSe:]ROSCillator:EXTernal:FREQUENCY
```

Reference I/O (SMA) > Out

Defines whether a 100 MHz reference clock signal is output to the Reference In/Out SMA connector.

Ineffective and disabled if this connector is used as [reference clock source](#).

Remote command:

```
[SENSe:]ROSCillator:SMA:OUTPut
```

Reference I/O (SMA) > In

Specifies the frequency of the incoming reference clock signal at the Reference In/Out SMA connector (100 MHz or 1 GHz).

Effective and enabled if and only if the Reference In/Out SMA connector is used as [reference clock source](#).

Remote command:

```
[SENSe:]ROSCillator:SMA:INPut
```

5.19.3 Remote Settings tab

Configures the remote control interfaces of the R&S ZNA.

5.19.3.1 Controls on the Remote Settings tab

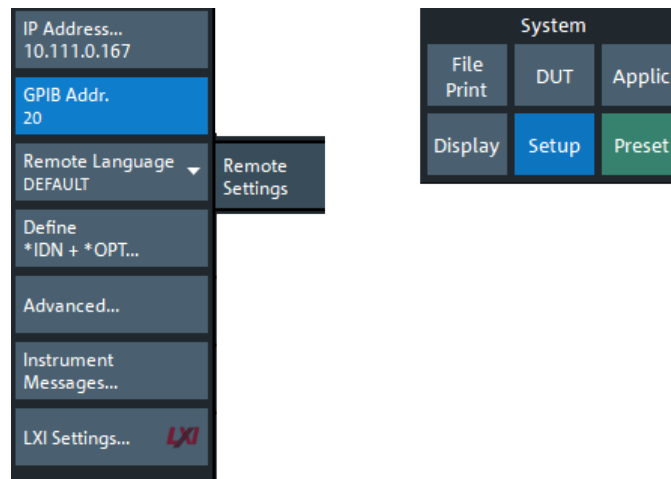

IP Address

Displays the current IP4 address of the R&S ZNA. By default, the analyzer is configured to use dynamic TCP/IP configuration (DHCP) and obtain all IP address information automatically. See [Chapter 12.1.2.1, "Assigning an IP address"](#), on page 1775.

The button opens the Windows "Network Connections" system config dialog that allows you to configure the IP4 (and IP6) settings of your instrument.

GPIB Address

Defines the analyzer's GPIB address. The address must be in the range between 0 and 30.

Remote command:

```
SYSTem:COMMunicate:GPIB[:SELF]:ADDRESS
```

```
SYSTem:COMMunicate:GPIB[:SELF]:DClear:SUPPpress
```

Remote Language

Selects the syntax of the R&S ZNA's instrument control commands.

- The DEFAULT language corresponds to the commands reported in this documentation; see [Chapter 7.3, "SCPI command reference"](#), on page 971. The byte order for binary data is set to little endian (see [FORMat:BOReDer SWAPped](#)).
- The ZVABT language ensures compatibility with network analyzers of the R&S ZVA/B/T family. E.g., compared to the DEFAULT language, the command set does not include `INITiate:CONTinuous:ALL` and `INITiate[:IMMediate]:ALL`, and the function of `INITiate:CONTinuous` and `INITiate[:IMMediate][:DUMMy]` is modified. Refer to the remote control documentation in [Chapter 7.3.8, "INITiate commands"](#), on page 1265. The byte order for binary data is set to little endian.

- The ZVR language ensures compatibility with network analyzers of the R&S ZVR family. See also [Chapter 7.5, "R&S ZVR/ZVABT compatible commands"](#), on page 1695. The byte order for binary data is set to little endian.
- The other languages define command sets for network analyzers from other instruments or manufacturers. The byte order for binary data is set to big endian (see [FORMat:BOReDer NORMal](#)).

Note: Remote languages other than DEFAULT are intended for remote control only. A mixed approach, with parts of the instrument configuration defined via the GUI can cause unexpected results.

Remote command:

`SYSTem:LANGuage`

Define *IDN + *OPT...

Opens the "Remote *IDN + *OPT..." dialog, which allows you to define the ID string (*IDN?) and the option string (*OPT?) of the analyzer.

- If the DEFAULT language is activated, the factory ID and option strings are used. The factory ID contains information on the instrument and firmware. Its format can be changed using [SYSTem:FORMat:IDENtify](#). The option string is a comma-separated list of all installed software and hardware options.
- The default strings are automatically adjusted to the selected [Remote Language](#).
 - If the PNA language is activated, Keysight-compatible ID and option strings are set. The bit order for transferred binary data is normal.
 - If one of the "HP xxxx" languages is activated, "HP xxxx"-compatible ID and option strings are set. Binary data is transferred in a device-specific bit order, however, the bit order can be changed using "HP xxxx"-specific commands.

The ID and option strings can be set manually, or reset to the factory defaults.

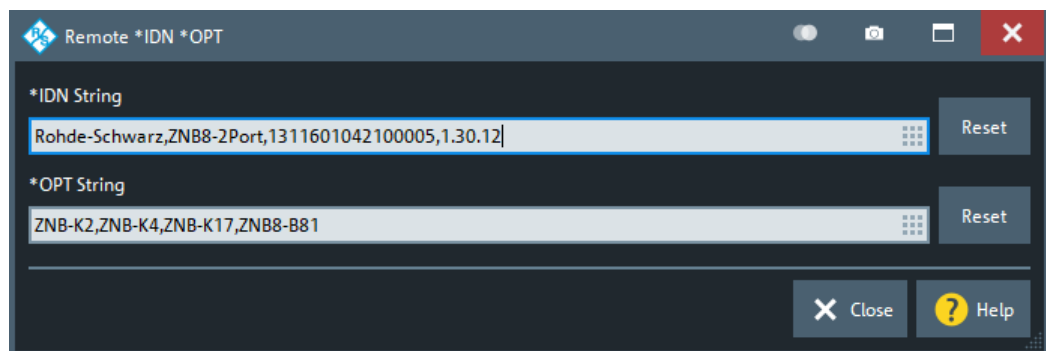

Remote command:

`SYSTem:IDENtify`

`SYSTem:IDENtify:FACTory`

`SYSTem:FORMat:IDENtify`

`SYSTem:OPTions[:STRing]`

`SYSTem:OPTions:FACTory`

`FORMat:BOReDer`

Advanced ...

Opens a dialog that allows to set the following parameters:

- "Wait for Data after Sweep" determines the execution behavior of `INITiate[:IMMEDIATE]` commands (see [Chapter 7.3.8, "INITiate commands"](#), on page 1265).
If enabled, an automatic `*WAI` is added (see [Chapter 7.2, "Common commands"](#), on page 970).
By default this is disabled.
- "Auto-Align Logical Ports" determines the logical port creation logic.
If enabled (default), logical ports are aligned and must be set from low to high port (which was the only possibility prior to firmware V1.91). If set to disabled, new ports can be created freely, like in manual operation.
- "No Device Clear" suppresses Device Clear (DCL, SDC) GPIB interface messages.

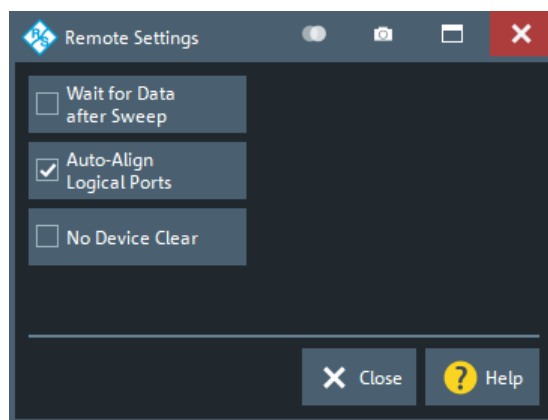

Remote command:

```
SYSTem:COMMunicate:GPIB[:SELF]:INIT:WAIT
SYSTem:COMMunicate:GPIB[:SELF]:LPORT:ALIGN
SYSTem:COMMunicate:GPIB[:SELF]:DClear:SUPPress
```

Instrument Messages...

Opens the System Configuration dialog with the [Messages tab](#) selected. From there you can configure the display of instrument messages as information popups, in particular the display of remote control command errors.

5.19.4 Power Meter tab

Allows you to set up and configure power meters and to enable error logging for the current session.

**Remote control via GPIB**

The built-in GPIB interface can be used to control external devices. An additional [USB-to-IEC/IEEE adapter](#) is only required in case you want to control the R&S ZNA via GPIB at the same time..

5.19.4.1 Controls on the Power Meter tab



The buttons in the "Power Meter" tab open the following dialogs:

- "Power Meters...", see [Chapter 5.19.4.2, "External Power Meters dialog"](#), on page 891
- "Power Meter Config...", see [Chapter 5.19.4.3, "External Power Meter Config dialog"](#), on page 895
This button is active only if at least one external power meter is online (physically connected, switched on, ready to be used).

Log Errors

Enables the transfer of error messages for external devices (e.g. connection errors) to the error log. The error log appears in the "Info" dialog; see [Chapter 5.19.1.3, "Info dialog"](#), on page 874.

Remote command:

n/a

5.19.4.2 External Power Meters dialog

The "External Power Meters" dialog configures external power meters so that they can be used for measurements and power calibrations.

Access: System – [Setup] > "Power Meter" > "Power Meters..."



Background information

Refer to section [Chapter 4.7.39, "External power meters"](#), on page 316.

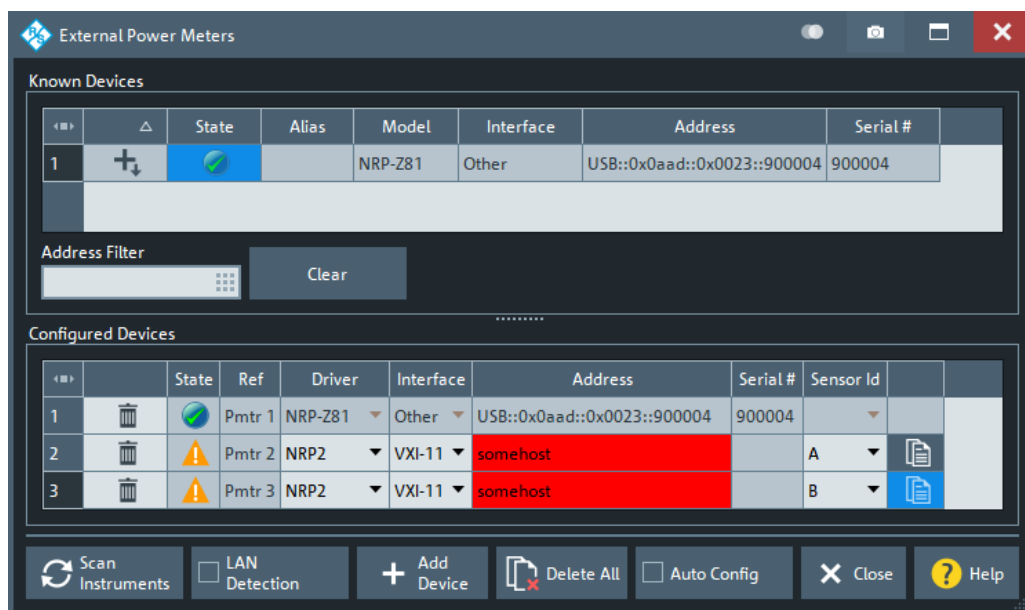

The configuration of a new external power meter involves the following steps:

1. Connect the power meter to your R&S ZNA using a LAN (VXI-11), GPIB, or USB interface.
2. If the power meter is connected via LAN, enable [LAN Detection](#)
3. Select [Scan Instruments](#) and wait until the power meter appears in the table of "Known Devices".
4. Select [+](#) to add the power meter to the list of [Configured Devices](#).

If the R&S ZNA fails to detect a connected power meter:

- ▶ Select [Add Device](#) to define the interface type and address.

The R&S ZNA can auto-detect the instrument type (driver) and the serial number of the connected power meter.



To control external devices via GPIB, the pre-installed RS Visa library (`visa32.dll`) must be replaced by the **NI Visa** library.

Known Devices

Table with all power sensors/meters the analyzer detects to be on line (i.e. connected and switched on). "Scan Instruments" refreshes the table.

Select [+](#) to add a power sensor/meter to the table of [Configured Devices](#).

Note: Even though an R&S NRP2 power meter can appear in the table of "Known Devices", adding it to the list of "Configured Devices" directly results in an invalid configuration. Use [Add Device](#) to configure it manually instead.

Remote command:

n/a

Configured Devices

Table with all power meters in use with their properties.



Except for the auto-detected [Known Devices](#), to appear in the table of "Configured Devices" a power sensor/meter must have been configured manually using [Add Device](#). The properties of manually configured power meters ([Add Device](#)) can be changed in the table cells.

The "**Sensor Id**" column is used for power meters that can control several power sensors, such as the R&S NRP2. By selecting the suitable "Sensor Id", you can address the related power sensor.

The R&S NRP2, for example, has four power sensor connectors, Sensor A to Sensor D. By selecting "A", "B", "C", or "D" you can address the power sensor that is attached to this connector.

Use the  icon beneath the "Sensor Id" cell to take control over another power sensor attached to the same power meter.

The following symbols (grayed out for *used* devices) indicate the status of the respective device:

-  – The device is online (connected, switched on, ready to be used).
-  – There is a problem with the device.
This state can be caused by different problems:
 - General communication error
In this case, check whether the device is properly connected to the configured interface.
 - Self test error
In this case enable error logging for external devices (see "[Log Errors](#)" on page 891), and search the [Error Log tab](#) for self test error codes of the device.
-  – The device driver does not match exactly the device type. Probably the device cannot be controlled properly. Measurements results are questionable.

Remote command:

```
SYSTEM:COMMunicate:RDEVICE:PMETER<Pmtr>:DEFine
SYSTEM:COMMunicate:RDEVICE:PMETER:DELete
SYSTEM:COMMunicate:RDEVICE:PMETER:CATalog?
SYSTEM:COMMunicate:RDEVICE:PMETER:COUNT?
```

Scan Instruments

Performs an autodetection of "Known Devices" on the supported interfaces.

Note: Unintentional switchover to remote control

When using the NI-VISA library, ensure that the network analyzer itself is not listed as a network device in the Measurement & Automation Explorer. Otherwise, "Scan Instruments" initiates an identification query (*IDN?), causing the analyzer to close the "External Power Meters" dialog (without executing "Scan Instruments") and to activate the remote screen.

Remote command:

n/a

LAN Detection

Activate "LAN Detection" to include the LAN interface in the autodetection sequence (see [Scan Instruments](#)).

Note: "LAN detection" only works for external devices on the IP subnet with the R&S ZNA.

As a prerequisite, the R&S ZNA must accept incoming connections on UDP port 2473. If necessary, add a corresponding inbound rule to your firewall settings.

Remote command:

n/a

Add Device

Adds a new instrument to the list of "Configured Devices".

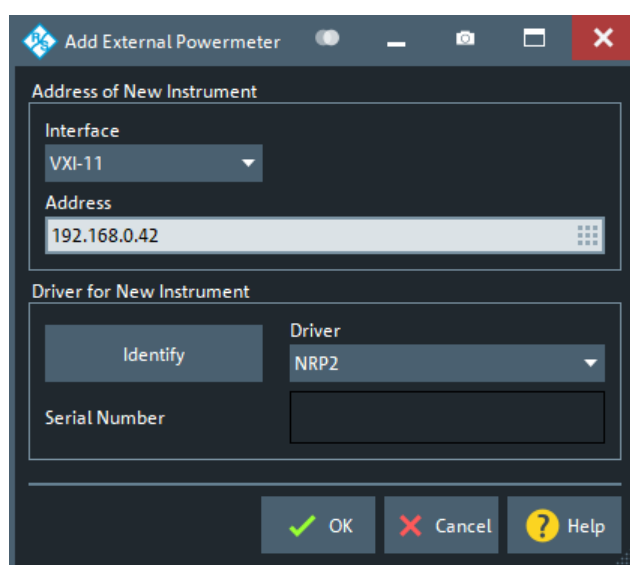

In the "Add External Power Meter" dialog, you can specify the instrument and connection properties:

- "Interface" selects an interface/protocol type for the connection. In addition to the GPIB, VXI-11, SOCKET and "Raw Serial" interface types, the analyzer accepts any "Other" interface supported by the installed VISA library.
 - GPIB, VXI-11 and SOCKET is applicable for devices connected to the GPIB Bus or LAN connectors on the rear panel of the analyzer, respectively.
 - "Raw Serial" is used for [VDI Erickson power meters PM5 and PM4](#), whose control units are connected to the R&S ZNA via USB. The PM5 control unit is equipped with a USB interface, for the PM4 an additional USB-to-RS232 adapter is required.
 - "Other" is used in particular for USB connections, e.g. for auto-detected R&S NRP-Zxx sensors.
- "Address" contains the address for the current interface type. GPIB addresses must be unique for all devices connected to the GPIB bus (range: 0 to 30), GPIB and IP addresses must agree with the entries in the VISA library. The remaining interface types require composite address formats; see [Table 5-11](#). For VDI Erickson PM4 power meters, the (virtual) COM port of the related USB-to-RS232 adapter must be specified (see ["Control connection"](#) on page 319). PM4

power meters can be auto-configured; for manual configuration use the serial number ("V" number) of the power meter's measurement head.

If an instrument is connected to the R&S ZNA, the entries in the [Driver for New Instrument] panel can be auto-detected for the specified interface type and address.

- "Identify" sends an identification query ("IDN?") to the specified device address to identify the type and serial number of the connected power meter and select an appropriate driver file. Power meter driver files (*.pwm) are stored in the Resources\ExtDev subdirectory of the analyzer's program directory.

Table 5-11: Interface types for external power meters and address formats

Physical interface (connector)	Interface (protocol)	Address	Remarks
LAN	VXI-11	<IpAddress> for example 10.11.12.13	Full VISA resource string: TCPIP[board]::<Address>[::INSTR]
	SOCKET	<IpAddress>::<PortNo> for example 10.11.12.13::50000	LAN connection with pure TCP/IP protocol; refer to your VISA user documentation.
GPIB	GPIB0 ... GPIB9	<Address> for example 20	Full VISA resource string: GPIB[board]::<Address>[::INSTR]
USB	Raw Serial	PM5: serial number ("V" number) PM4: (virtual) COM port number	For VDI Erickson PMx power meters
LAN or USB	Other	Interface-specific, e.g. for SOCKET: TCPIP0::<IpAddress>::<PortNo>::SOCKET	Use complete VISA resource string.

Remote command:

```
SYSTem:COMMunicate:RDEvice:PMETer<Pmtr>:DEFine
```

Auto Config

Causes the analyzer to clear the lists of "Known Devices" and "Configured Devices" and to configure all R&S NRPxxS/SN power sensors, detected at any of the USB ports, automatically. No manual configuration is required.

Remote command:

```
SYSTem:COMMunicate:RDEvice:PMETer:CONFigure:AUTO[:STATe]
```

5.19.4.3 External Power Meter Config dialog

Allows to modify configuration of certain external power meters, i.e. settings that are persistently stored on the power meter (and NOT on the R&S ZNA). This requires the respective device to be online, i.e. connected, switched on and ready to be used.

Access: System – [Setup] > "External Devices" > "Power Meter Config..."

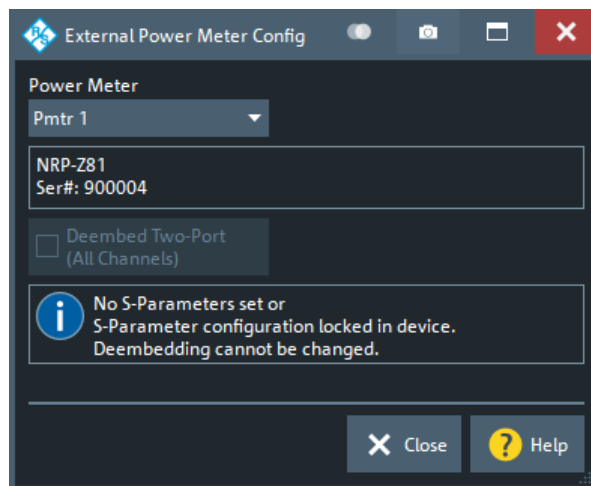

Deembed Two-Port (All Channels)

Reads and modifies the state of the built-in S-parameter correction that is available on certain R&S®NRP-Z power sensors. See Application Note 1GP70 "Using S-Parameters with R&S®NRP-Z Power Sensors" for background information. This Application Note is available on the Rohde & Schwarz internet at <http://www.rohde-schwarz.com/appnotes/1GP70>.

Remote command:

```
SYSTem:COMMunicate:RDEvice:PMETer<Pmtr>:SPCorrection[:STATe]
```

5.19.5 Generator tab

Allows you to set up and configure external generators and to enable error logging for the current session.



Remote control via GPIB

The built-in GPIB interface can be used to control external devices. An additional [USB-to-IEC/IEEE adapter](#) is only required in case you want to control the R&S ZNA via GPIB at the same time..

5.19.5.1 Controls on the Generator tab

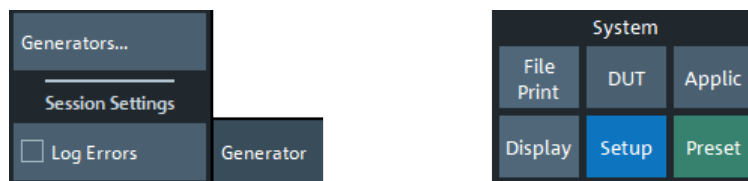

"Generators..." opens the "External Generators" Dialog; see [Chapter 5.19.5.2, "External Generators dialog"](#), on page 897.

Log Errors

Enables the transfer of error messages for external devices (e.g. connection errors) to the error log. The error log appears in the "Info" dialog; see [Chapter 5.19.1.3, "Info dialog"](#), on page 874.

Remote command:
n/a

5.19.5.2 External Generators dialog

The "External Generators" dialog configures external generators so that they can be used for measurements and power calibrations.

Access: System – [Setup] > "Generator" > "Generators..."

**Background information**

Refer to section [Chapter 4.7.40, "External generators"](#), on page 321.

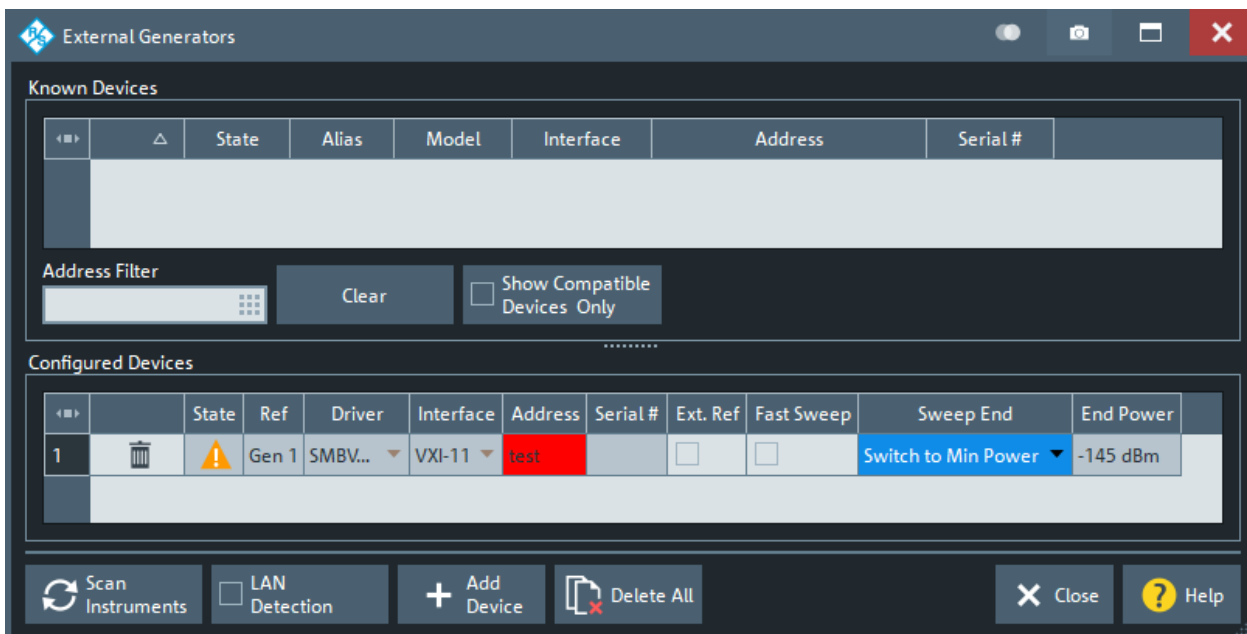

The configuration of a new external generator involves the following steps:

1. Connect the generator to your R&S ZNA using a LAN (VXI-11), GPIB, or USB interface.
2. If the generator is connected via LAN, enable "LAN detection"
3. Click "Scan Instruments" and wait until the generator appears in the table of "Known Devices".
4. Click  to copy the generator into the list of configured devices.

If the R&S ZNA fails to detect a connected generator,

- ▶ Click "Add Device" to define the interface type and address.

The R&S ZNA can auto-detect the instrument type (driver) and the serial number of the connected generator.



To control external devices via GPIB, the pre-installed RS Visa library (`visa32.dll`) must be replaced by the **NI Visa** library.

Known Devices

Table with all generators that the analyzer detects to be on line (i.e. connected and switched on). "Scan Instruments" refreshes the table;  copies a detected instrument to the table of "Configured Devices".

Remote command:

n/a

Show Compatible Devices

If checked, only supported generators are displayed in the list of [Known Devices](#).

Remote command:

n.a.



Configured Devices

Table with all generators in use with their properties. The properties of manually configured generators ("Add Device", opens the "Add External Generator" dialog) may be changed in the dialog.

The following generator properties are not defined in the "Add External Generator" dialog but configurable here:

- "Ext. Ref." switches the generator to either external (box checked) or internal frequency reference. The setting does not affect the frequency reference settings of the analyzer System – [Setup] > "Freq. Ref.". Make sure to establish consistent settings in your test setup (one instrument is the master, the others use external reference frequency). See ["Reference frequency"](#) on page 322.
- "Fast Sweep" enables or disables the fast sweep mode for external generators that support a frequency and level list mode (triggered mode). See ["Fast sweep mode and conditions"](#) on page 323.
- "Sweep End" defines the output power of the external generator after the end of a sweep or sweep sequence (single sweep mode; Channel – [Sweep] > "Sweep Control" > "Single"). The minimum power value ("Switch to Min. Power") depends on the generator type. "Set to Selected Power" means that the generator is commanded to transmit at the selected "End Power".

The following symbols (grayed out for *used* devices) indicate the status of the respective device:

-  – The device is online (connected, switched on, ready to be used).
-  – There is a problem with the device.

This state can be caused by different problems:

- General communication error

In this case, check whether the device is properly connected to the configured interface.

- Self test error
In this case enable error logging for external devices (see ["Log Errors"](#) on page 891), and search the [Error Log tab](#) for self test error codes of the device.
-  – The device driver does not match exactly the device type. Probably the device cannot be controlled properly. Measurements results are questionable.

Remote command:

```
SYSTem:COMMunicate:RDEvice:GENerator<Gen>:DEFine  
SYSTem:COMMunicate:RDEvice:GENerator:DElete  
SYSTem:COMMunicate:RDEvice:GENerator<Gen>:CATalog?  
SYSTem:COMMunicate:RDEvice:GENerator<Gen>:DEFine  
SYSTem:COMMunicate:RDEvice:GENerator<Gen>:SEPMode  
SYSTem:COMMunicate:RDEvice:GENerator<Gen>:SEPower
```

Scan Instruments

Performs an autodetection of "Known Devices" on the supported interfaces.

Note: Unintentional switchover to remote control

When using the NI-VISA library, ensure that the network analyzer itself is not listed as a network device in the Measurement & Automation Explorer. Otherwise, "Scan Instruments" will send an identification query (*IDN?), causing the analyzer to close the "External Generators" dialog (without executing "Scan Instruments") and to activate the remote screen.

Remote command:

n/a

LAN Detection

Activate "LAN Detection" to include the LAN interface in the autodetection sequence (see [Scan Instruments](#)).

Note: "LAN detection" will only work for external devices sharing the same IP subnet with the R&S ZNA.

As a prerequisite, the R&S ZNA must accept incoming connections on UDP port 2473. If necessary, add a corresponding inbound rule to your firewall settings.

Remote command:

n/a

Add Device

Adds a new instrument to the list of "Configured Devices". In the "Add External Generator" dialog opened, you can specify the properties of the new instrument and the connection.

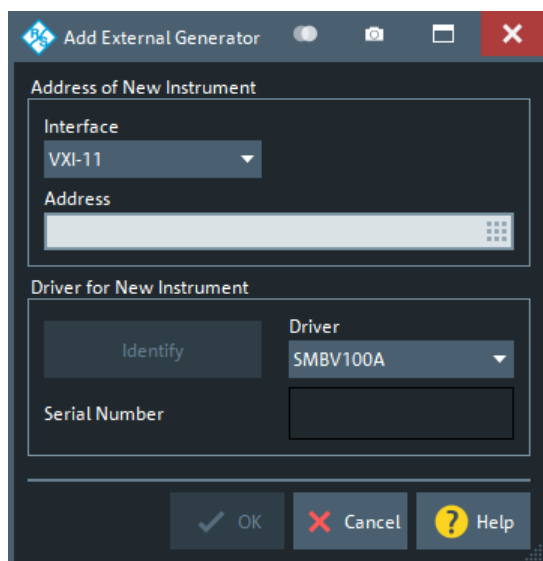

- "Interface" selects an interface/protocol type for the connection. In addition to the GPIB, VXI-11, SOCKET, and USB-VISA interface types (for devices connected to the GPIB Bus, LAN or USB connectors of the analyzer; see [Table 5-12](#)), the analyzer supports any "Other" interface supported by the installed VISA library.
- "Address" contains the address for the current interface type. GPIB addresses must be unique for all devices connected to the GPIB bus (range: 0 to 30), GPIB and IP addresses must agree with the entries in the VISA library. The remaining interface types require composite address formats; see [Table 5-12](#). If an instrument is connected to the R&S ZNA, the entries in the [Driver for New Instrument] panel can be auto-detected for the specified interface type and address.
- "Identify" sends an identification query ("IDN?") to the specified device address in order to identify the type and serial number of the connected generator and select an appropriate driver file. Generator driver files (*.gen) are stored in the Resources\ExtDev subdirectory of the analyzer's program directory.

Table 5-12: Interface types for external generators and address formats

Physical interface (connector)	Interface (protocol)	Address	Remarks
LAN	VXI-11	<IpAddress> e.g. 127.0.0.0	Full VISA resource string: TCPIP[board]::<Address>[::INSTR]
	SOCKET	<IpAddress>::<PortNo> e.g.127.0.0.0::50000	LAN connection with pure TCP/IP protocol; refer to your VISA user documentation.
GPIB	GPIB0 ... GPIB9	<Address> e.g. 20	Full VISA resource string: GPIB[board]::<Address>[::INSTR]

Physical interface (connector)	Interface (protocol)	Address	Remarks
USB	USB-VISA	<ManID>::<ProdID>::<SerialNo> e.g. 0x0AAD::0x0047::100098	2733 (0x0AAD) is the manufacturer ID of Rohde & Schwarz. 71 (0x0047) is an example for a R&S product ID (R&S SMF100A). The serial number is device-specific.
LAN or USB	Other	Interface-specific, e.g. for SOCKET: TCPIP0::<IpAddress>::<PortNo>::SOCKET For USB-VISA: USB0::<ManID>::<ProdID>::<SerialNo>::INSTR	Use complete VISA resource string.

Remote command:

```
SYSTem:COMMunicate:RDEvice:GENerator<Gen>:DEFine
```

5.19.6 Frequency Converter tab

Allows you to set up the R&S ZNA for measurements using external frequency converters.

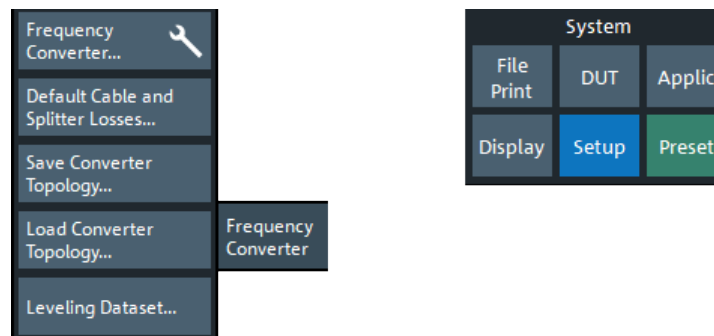

The buttons on the "Frequency Converter" tab open the following dialogs

- "Frequency Converter..." opens a dialog that allows you to define the "Converter Topology", i.e. which converters are used and how they are connected to the R&S ZNA. See [Chapter 5.19.6.1, "Converter Configuration dialog"](#), on page 902.
- "Default Cable and Splitter Losses ..." opens a dialog that lets you specify the losses between the IF and LO ports of the VNA and the converter. See [Chapter 5.19.6.3, "Default Cable and Splitter Losses dialog"](#), on page 906.
- "Save Converter Topology..." / "Load Converter Topology..." open standard file save/open dialogs that allow you to save the current converter topology to a file or to load a previously defined converter topology from a file (*.zcxml).
- "Leveling Dataset" opens a dialog that allows you to provide leveling information to the configuration. See [Chapter 5.19.6.4, "Leveling Datasets dialog"](#), on page 907.

5.19.6.1 Converter Configuration dialog

In the "Converter Configuration" dialog, you can define the converter topology, i.e. which converter types are used, and how they are connected to the R&S ZNA (and possibly external generators).

Converter <i> represents the converter that is connected to VNA port <i>.

Access: System – [Setup] > "Frequency Converter" > "Frequency Converter..."



Converter Type

Selects the type of the converter that is connected to the related VNA port.

- "None" No converter connected to this port
- ZCxxx<Serial #> If a converter R&S ZCxxx is connected via USB, it is auto-detected by the analyzer firmware and can be selected from the list. Make sure that each of them (identified by its serial number) is assigned to the correct analyzer port.
- "ZNA67EXT-TS" External test set of a VNA system R&S ZNA67EXT. See [Chapter 3.5, "Getting started with R&S ZNA67EXT"](#), on page 79.
- other One of the preconfigured or user-defined converter types; see [Chapter 5.19.6.2, "Converter Types dialog"](#), on page 904.

Remote command:

[SENSe:] FREquency:CONVersion:DEvice<Port>:NAME

IF Frequency

Defines the intermediate frequency at the related port. Defaults to the **IF** of the selected **Converter Type**.

If you specify an IF below 28 MHz, then during spectrum measurements the firmware automatically adjusts the IF to 31.25 MHz.

Remote command:

```
[SENSe:]CONVerter<Port>:IFrequency
```

IF Input

Selects the IF input connectors to be used.

"Dir. Access" requires [Chapter 4.7.27, "Direct generator/receiver access"](#), on page 306

"Rear IF" requires [Chapter 4.7.30, "Direct IF access"](#), on page 308

Remote command:

```
[SENSe:]CONVerter<Port>:IFPort
```

Active

Activates/deactivates the converter configuration for the related port.

Remote command:

```
[SENSe:]CONVerter<Port>:STATE
```

Source

Displays the related source port on the VNA (read-only).

Remote command:

```
[SENSe:]CONVerter<Port>:RFPort?
```

Local

Defines the source for the LO In port of the converter.

In general, if two or more converters are used in a measurement, it is recommended to distribute a single LO signal to all converters using a splitter. Select "Splitter 1" or "Splitter 2" in this case and use the intended LO source as source of "[Splitter <i>](#)" on page 904 instead.

"None" No LO source assigned. Results in an invalid converter configuration that cannot be activated.

"Port <i>" Use a VNA port that is not used as converter port as the LO source.

"Gen <i>" Use an external generator as LO source.

"Splitter <i>" Distribute the LO source via a splitter. "Splitter 2" is only useful, if 2 independent 2-port converter measurements shall be performed.

"LO Out" Use the optional [LO Out](#) at the rear panel as LO source.

If compatible with the overall converter setup, the source providing the LO IN signal to a frequency converter is automatically configured as permanent (see "[Source Gen](#)" on page 671).

Remote command:

```
[SENSe:]CONVerter<Port>:LOPort
```

Splitter <i>

The source of the LO signal distributed via splitter <i>.

If two or more converters are used in a measurement, it is recommended to distribute a single LO signal to all involved converters using a splitter. The corresponding configuration is to select the suitable LO source here and set **Local** to "Splitter <i>".

"Splitter 2" is only useful, if 2 independent 2-port converter measurements shall be performed.

If compatible with the overall converter setup, the source is automatically configured as permanent (see "Source Gen" on page 671).

Remote command:

```
[SENSe:]CONVerter:SPLitter<Port>:LOPort
```

5.19.6.2 Converter Types dialog

The "Converter Types" dialog displays the configured converter types. Browse through the tabs to explore their properties.

Access: [Converter Configuration dialog](#) > "Converter Types..."

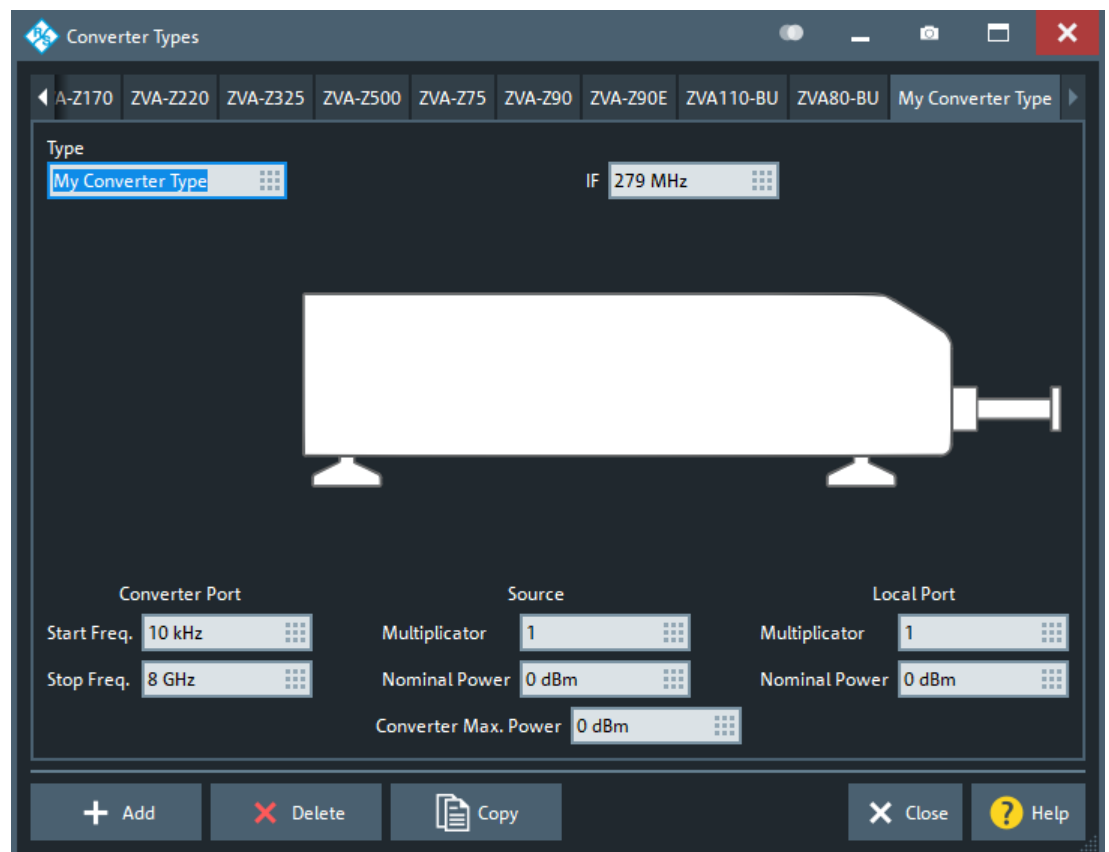

Initially a set of preconfigured converter types is available, mainly comprising the legacy converter models R&S ZVA-Zxxx(E). To define your own converter types, proceed as follows:

1. Use "Add" to create a converter type with default properties or use "Copy" to duplicate the properties of the converter type whose tab is currently selected.
2. Enter a (unique) name for the new converter type.
3. Modify the converter properties to suit the converter type you want to introduce to the R&S ZNA.



Preconfigured converter types are read-only.

Defined Converter Types (Tabs)

The tabs in the "Converter Types" represent the converter types that are currently defined (pre-defined and user-defined).

Remote command:

```
[SENSe:]CONVerter:DEFinition:CATalog?  
[SENSe:]CONVerter:DEFinition:COUNT?
```

Type

The name of the converter type.

Remote command:

```
[SENSe:]CONVerter:DEFinition:CATalog?  
[SENSe:]CONVerter:DEFinition:DEFine
```

IF

Defines the fixed IF frequency of the converter type.

Remote command:

```
[SENSe:]CONVerter:DEFinition:IFrequency
```

Converter Port: Start Freq./Stop Freq.

Defines the start and stop frequency of the (converter port of the) converter type.

Remote command:

```
[SENSe:]CONVerter:DEFinition:FREQUENCY
```

Source: Multiplier

Defines the source multiplier, i.e. the factor by which the incoming RF frequency is multiplied by the converter.

Remote command:

```
[SENSe:]CONVerter:DEFinition:SMUL
```

Source: Nominal Power

Defines the preferred input power at the RF In port of the converter.

Remote command:

```
[SENSe:]CONVerter:DEFinition:SPOWer
```

Source: Converter Max. Power

Defines the maximum tolerable input power at the RF In port of the converter.

Remote command:

```
[SENSe:]CONVerter:DEFinition:MPOWer
```

Local Port: Multiplier

Defines the source multiplier, i.e. the factor by which the incoming LO frequency is multiplied by the converter.

Remote command:

```
[SENSe:]CONVerter:DEFinition:LMUL
```

Local Port: Nominal Power

Defines the preferred input power at the LO In port of the converter.

Remote command:

```
[SENSe:]CONVerter:DEFinition:LPOWer
```

Add/Copy

Use "Add" to create a converter type with default properties or use "Copy" to duplicate the properties of the converter type whose tab is currently selected.

Remote command:

```
[SENSe:]CONVerter:DEFinition:DEFine
```

Delete

Deletes the converter type whose tab is currently selected.

Only user-defined converter types can be deleted.

Remote command:

```
[SENSe:]CONVerter:DEFinition:DELeTe
```

5.19.6.3 Default Cable and Splitter Losses dialog

After the converter ports have been set up in the [Converter Configuration dialog](#), you can configure the converter port-specific cable and splitter losses and slope factors.

Access: System – [Setup] > "Frequency Converter" > "Default Cable and Splitter Losses..."

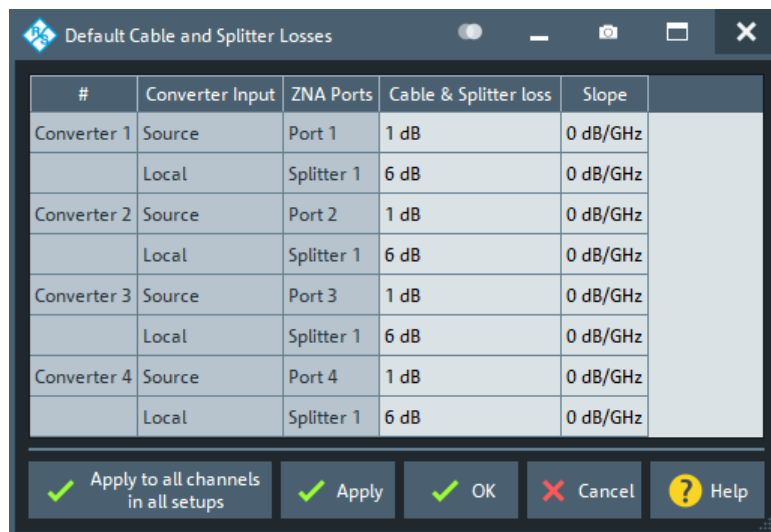

Cable & Splitter Loss

Defines the loss of

- the cables for source ports
- the cables and the splitter (if used) for LO ports

With [Apply to all channels in all setups](#) (or after a [Preset]), these values are written to the [Port Power Offset](#) of the respective ports.

Remote command:

```
[SENSe:] CONVerter<Port>:RFLoss
[SENSe:] CONVerter<Port>:CSLoss
```

Slope

Defines the slope factor of cabling (and splitter).

With [Apply to all channels in all setups](#) (or after a [Preset]), these values are written to the [Slope](#) of the respective ports.

Remote command:

```
[SENSe:] CONVerter<Port>:CSSLope
```

Apply to all channels in all setups

Use "Apply to all channels in all setups" to write the [Cable & Splitter Loss](#) and [Slope](#) values to the [Port Power Offset](#) and [Slope](#) channel settings of the respective ports.

Remote command:

```
SOURce<Ch>:POWer<PhyPt>[:LEVel][:IMMediate]:OFFSet
SOURce<Ch>:POWer<PhyPt>:GENerator<Gen>:OFFSet
SOURce<Ch>:POWer<PhyPt>[:LEVel][:IMMediate]:SLOPe
```

5.19.6.4 Leveling Datasets dialog

After you went through the [Leveling procedure](#), you can configure the usage of the available leveling datasets, persist and recall them.

Access::

- System – [Setup] > "Frequency Converter" > "Leveling Dataset..."
- Channel – [Cal] > "Use Cal" > "Active Power Cals..."

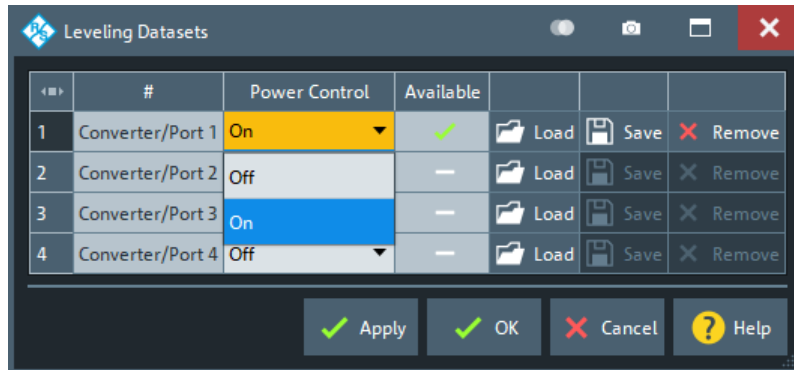
**Background Information**

See [Chapter 4.7.7.1, "Leveling"](#), on page 283.

Power Control

Select whether you want activate converter power control, if a leveling dataset is [available](#).

Remote command:

```
SOURce<Ch>:POWER<PhyPt>:CORRection:SLEVeling:STATe
```

Available

Shows the availability of a leveling data set.

Remote command:

```
SOURce:POWER<PhyPt>:CORRection:SLEVeling:STATe?
```

Load/Save

Use "Save" to persist the leveling dataset of the respective port to a *.lev file (R&S ZNA-proprietary, binary file format). Use "Load" to recall a leveling dataset from a *.lev file.

Remote command:

```
MMEMemory:LOAD:CORRection:SLEVeling<PhyPt>
MMEMemory:STORe:CORRection:SLEVeling<PhyPt>
```

Remove

Deletes the (global) leveling data set of the respective port.

Remote command:

```
SOURce:POWER<PhyPt>:CORRection:SLEVeling:DELeTe
```

5.19.7 Switch Matrix tab

Allows you to set up switch matrices.



5.19.7.1 Controls on the Switch Matrix tab

The buttons on the "Switch Matrix" tab open the following dialogs:

- "Switch Matrix...", see [Chapter 5.19.7.2, "External Matrices dialog"](#), on page 909
- "RF Connections...", see [Chapter 5.19.7.4, "Switch Matrix RF Connections dialog"](#), on page 914

"RF Connections" is enabled if at least one switch matrix is configured.

Optimization

Allows you to select between different switch matrix routing optimizations:

- "Speed" – switch as little as possible
- "Precision" – always use the best possible route in terms of quality ("priority")

See [Chapter 4.7.41.4, "Multiple paths: precision vs. speed"](#), on page 327 for background information.

The selection is only enabled, if at least one of the connected switch matrices has multiple routes with non-identical priorities.

5.19.7.2 External Matrices dialog

The "External Matrices" dialog allows you to discover and register external switch matrices.

Access: System – [Setup] > "External Ports" > "Switch Matrix..."



Background information

Refer to section [Chapter 4.7.41, "External switch matrices"](#), on page 323.

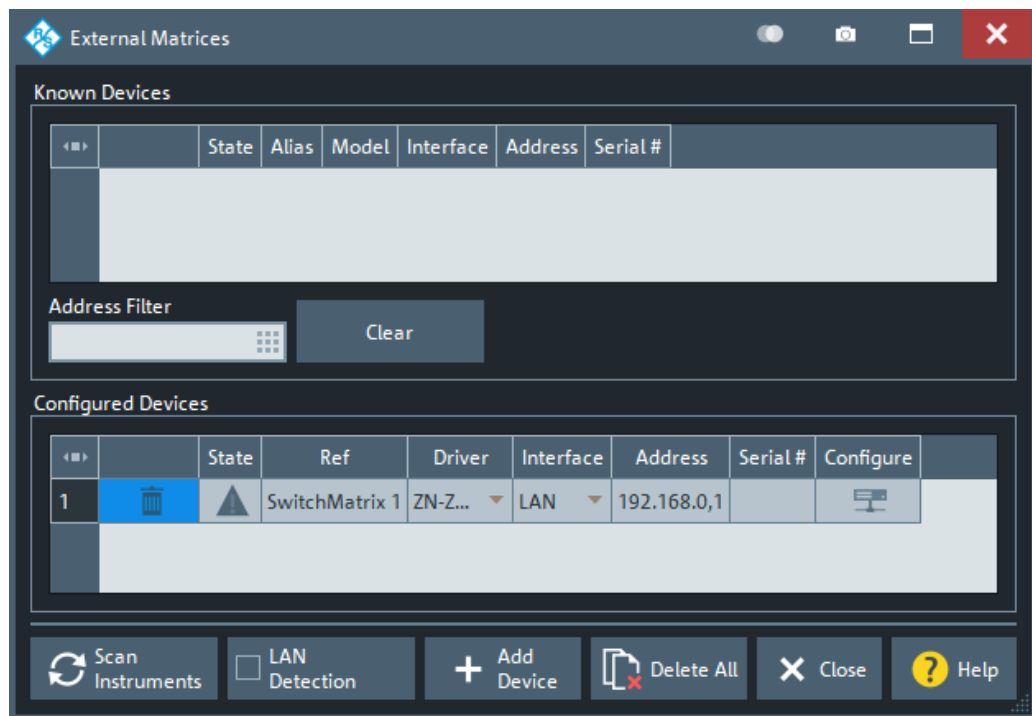

The registration of a new external switch matrix typically involves the following steps:

1. Connect the switch matrix to your R&S ZNA via USB or LAN.
2. If you have connected switch matrix and VNA to the LAN:
 - a) Enable "LAN Detection".
 - b) Select "Scan Instruments".
3. Wait until the switch matrix appears in the table of "Known Devices".
4. Select  to copy it to the list of configured devices.

If "LAN Detection" fails for some reason (see below for details), the external switch matrix can also be registered manually:

1. Select "Add Device" to open the "Add External Switchmatrix" dialog (see figure below).
2. In the "Add External Switchmatrix" dialog:
 - a) Specify the IP address or hostname of the switch matrix.
 - b) Select "Identify" to auto-detect the matrix type ("Driver") of the remote switch matrix.
If the firmware cannot identify the device (e.g. because it is temporarily unavailable), select the appropriate "Driver" manually.



Registering a switch matrix is only the first step. To make the external ports available to the vector network analyzer, the RF connections have to be configured, as described in [Chapter 5.19.7.4, "Switch Matrix RF Connections dialog"](#), on page 914.

Known Devices

Table with the discovered switch matrices.

"Scan Instruments" refreshes the table;  copies a discovered switch matrix to the table of "Configured Devices".

Remote command:

n/a

Configured Devices

Table displaying the registered switch matrices.



A distinction is made between those switch matrices that are used in RF connections (see [Chapter 5.19.7.4, "Switch Matrix RF Connections dialog"](#), on page 914) and those that are not.

- *Used* matrices are represented by inactive rows (grayed out).
- *Unused* matrices are represented by active table rows (colored).

For unused switch matrices that were manually registered via "Add Device", some properties can be changed by editing the corresponding table cells.

A matrix can always be unregistered using the  button of the respective row. This automatically deletes the related RF connections and renumbers the remaining test ports.

The following symbols (grayed out for *used* devices) indicate the status of the respective device:

-  – The device is online (connected, switched on, ready to be used).
-  – There is a problem with the device.
This state can be caused by different problems:
 - General communication error
In this case, check whether the device is properly connected to the configured interface.
 - Self test error
In this case enable error logging for external devices (see ["Log Errors"](#) on page 891), and search the [Error Log tab](#) for self test error codes of the device.
-  – The device driver does not match exactly the device type. Probably the device cannot be controlled properly. Measurements results are questionable.

For matrices with LAN interface, the  button in the last column of the "Configured Devices" table opens the "Device LAN configuration" dialog which allows to read and modify their "IP Configuration" (see [Chapter 5.19.7.3, "Device LAN Configuration dialog"](#), on page 913).

The related switch matrix must be **online** and connected via USB (and not via LAN interface). Otherwise the button is disabled.

Remote command:

```
SYSTem:COMMunicate:RDEvice:SMATrix:COUNT?
```

```
SYSTem:COMMunicate:RDEvice:SMATrix<Matr>:SERial?
```

Scan Instruments

Performs an autodetection of "Known Devices" on the supported interfaces.

Note: Unintentional switchover to remote control

When using the NI-VISA library, ensure that the network analyzer itself is not listed as a network device in the Measurement & Automation Explorer. Otherwise, "Scan Instruments" sends an identification query (*IDN?), causing the analyzer to close the "External Switch Matrix" dialog (without executing "Scan Instruments") and to activate the remote screen.

Remote command:

```
SYSTem:COMMunicate:RDEvice:SMATrix:SCAN?
```

LAN Detection

Activate "LAN Detection" to include the LAN interface in the autodetection sequence (see [Scan Instruments](#)).

Note: "LAN detection" only works for external devices sharing the same IP subnet with the R&S ZNA.

As a prerequisite, the R&S ZNA must accept incoming connections on UDP port 2473. If necessary, add a corresponding inbound rule to your firewall settings.

Remote command:

n/a

Add Device

Opens the "Add External Switchmatrix" dialog that allows manual registration of an external switch matrix.

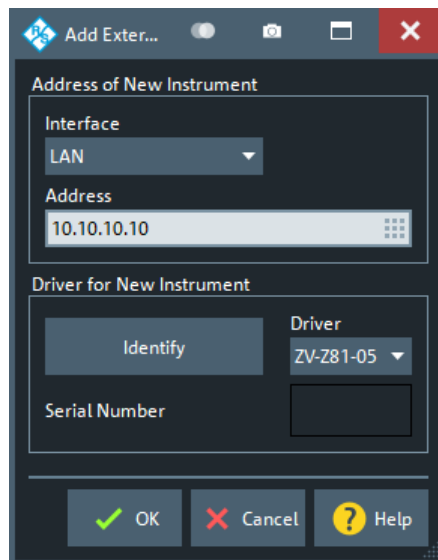

In the "Address of New Instrument" part, you can specify the required connection properties:

- "Interface" selects the connection type; currently only "LAN" is available.
- "Address" specifies the IP address or hostname of the external switch matrix.

If a connection can be established, the entries in the [Driver for New Instrument] panel can be auto-detected: "Identify" sends an identification query ("IDN?") to the specified device address to get the type and serial number of the connected switch matrix and to select the appropriate driver file.

Otherwise, manually select the "Driver". Matrix driver files (*.matrix) are stored in the Resources\ExtDev subdirectory of the analyzer's program directory.

Remote command:

```
SYSTem:COMMunicate:RDEvice:SMATrix<Matr>:DEFine
SYSTem:COMMunicate:RDEvice:SMATrix<Matr>:SERial?
```

Delete All

Unregisters all switch matrices, automatically deleting all switch matrix RF connections.

Remote command:

```
SYSTem:COMMunicate:RDEvice:SMATrix:DELeTe
```

5.19.7.3 Device LAN Configuration dialog

The "Device LAN Configuration" dialog allows you to read and to modify the "IP Configuration" of an external device that is equipped with a LAN interface.

Access: [External Matrices dialog](#) > "Configure"



Because the IP configuration is written to the device, the device must be **online** for the settings to be applied.



Uncheck "Manual Configuration" if you want the device to discover its host configuration via DHCP. In this case only the device's "Hostname" can be specified.

In "Manual Configuration" mode also the unit's "IP Address", "Subnet Mask" and "Standard Gateway" can be set. If the unit is located in the same subnet as the analyzer,

simply use "Copy from local network" to copy the "Subnet Mask" and "Standard Gateway" from the analyzer's IP settings.

5.19.7.4 Switch Matrix RF Connections dialog

The "Switch Matrix RF Connections" dialog allows you to define the RF connections between the VNA and the switch matrices, and the test port numbering.

Access: System – [Setup] > "External Ports" > "RF Connections..."



Background information

Refer to section [Chapter 4.7.41, "External switch matrices"](#), on page 323.

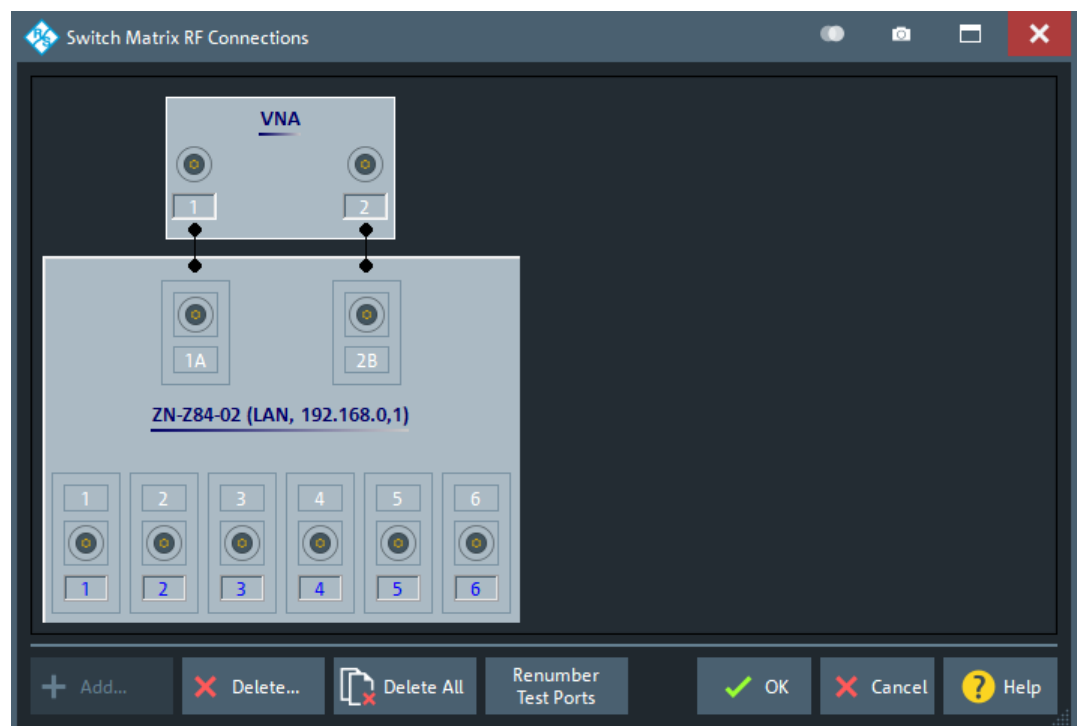

Defining switch matrix RF connections typically involves the following steps.

1. [Add](#) one or more external switch matrices to the RF connection configuration. These matrices must have been registered before; see [Chapter 5.19.7.2, "External Matrices dialog"](#), on page 909 for details.
2. For each matrix VNA port (the "north" ports in the graphical representation), specify the connected VNA port or define it as "Unused" if no such connection exists. For every matrix, there must be at least one RF connection to the VNA.
3. Select [Renumber Test Ports](#) to load the default test port assignment.

Unusable matrix test ports are marked with an "x". If the result does not suit your needs, consider the switchable paths of your matrix and adjust the matrix VNA port connections (see [Chapter 4.7.41.3, "RF connections and matrix connectivity"](#), on page 325). Then select "Renumber Test Ports" again.



You can tweak the resulting test port assignment by renumbering the test ports and/or setting some of the matrix test ports to "Unused" (see ["Edit Test Port Connection"](#) on page 917). Configuration errors are displayed in balloon popups appearing at the lower left corner of the dialog.



A redefinition of the physical VNA ports (see [Chapter 5.19.8.2, "Define Physical Ports dialog"](#), on page 919) causes a factory reset and deletes all switch matrix RF connections. So the RF configuration for switch matrices has to be done *after* the port redefinition.

Add

Opens the "Add Switch Matrix" dialog:

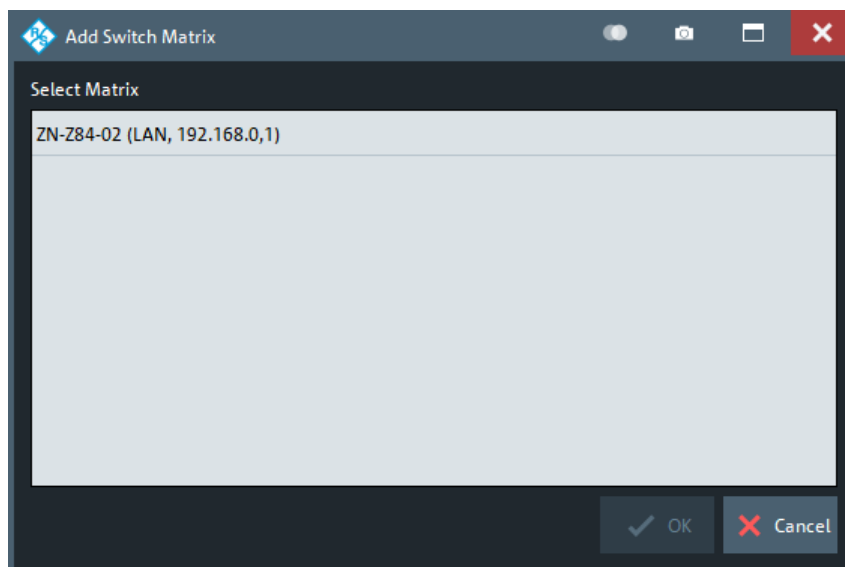

Select the required matrices and tap "OK" to add them to the RF connection configuration or tap "Cancel" to quit the dialog without adding a switch matrix to the RF connection configuration

Note:

- This dialog is shown automatically, in case no matrix has been added to the RF connection configuration yet.
- If the RF configuration already contains all registered switch matrices, the "Add" button is disabled.

Remote command:

n.a.

Delete

Opens the "Delete Switch Matrix" dialog:

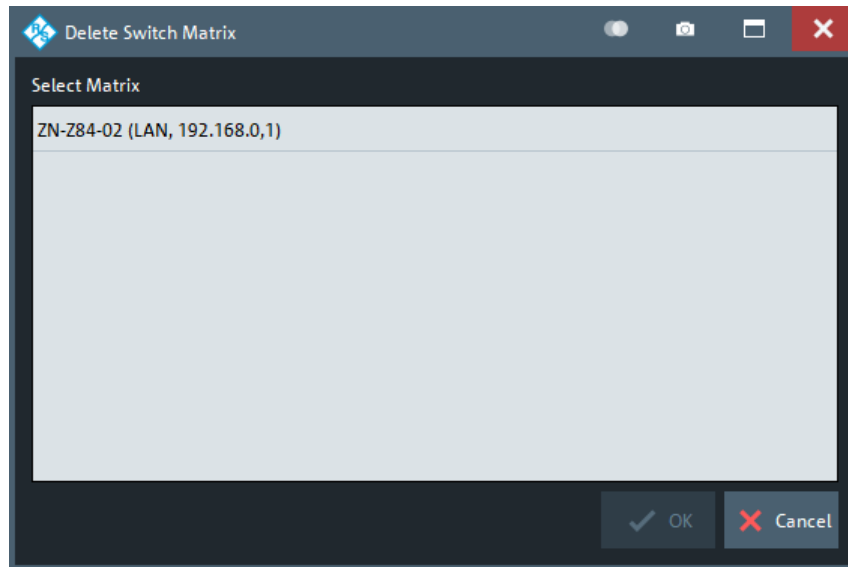

Select some matrices and tap "OK" to remove them from the RF connection configuration or tap "Cancel" to quit the dialog without removing a switch matrix from the RF connection configuration.

Delete All

Opens a confirmation dialog

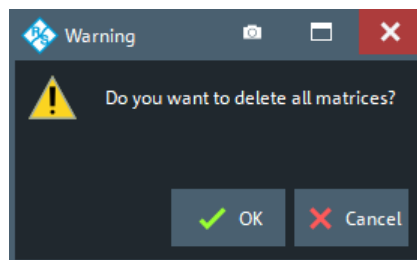

Either select "OK" to remove all switch matrices from the RF connection configuration, or "Cancel" to quit the dialog without removing a switch matrix.

Remote command:

`SYSTEM:COMMunicate:RDEvice:SMATrix:DElete`

Renumber Test Ports

Use this function at any time to generate the default test port assignment for the given matrix VNA port connections.

The following RF ports are used as test ports (and numbered from 1 to N):

- All matrix test ports that can be switched to at least one of the connected matrix VNA ports
- All VNA ports that are not connected to a switch matrix

Note that "Renumber Test Ports" does not preserve manually assigned test port numbers or "Unused" flags. See "[Edit Test Port Connection](#)" on page 917.

Remote command:

n.a.

Edit Matrix VNA Port Connections

To edit a matrix VNA port connection, tap on the corresponding port symbol.

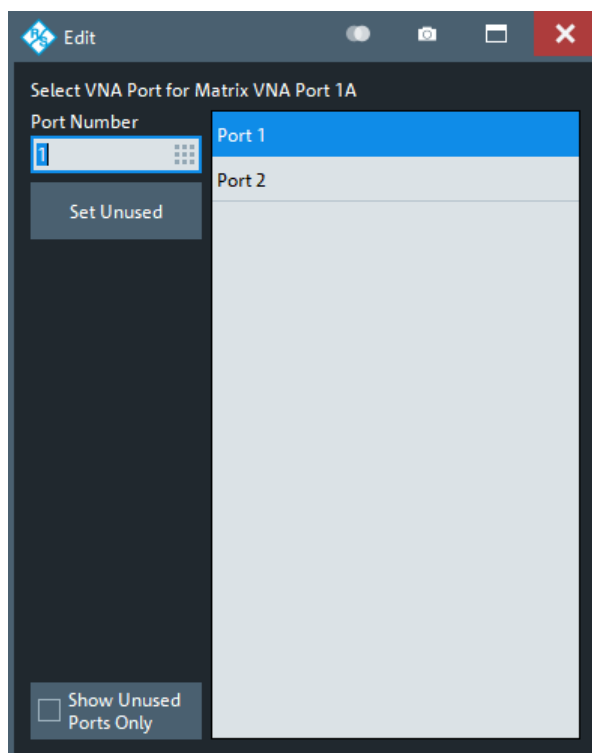

In the "Edit" dialog, define the appropriate VNA port or "Set Unused" to delete the matrix VNA port connection.

Remote command:

```
SYSTEM:COMMunicate:RDEvice:SMATrix<Matr>:CONFigure:MVNA  
SYSTEM:COMMunicate:RDEvice:SMATrix<Matr>:CONFigure:MLVNA
```

Edit Test Port Connection

To edit a test port connection, tap on the corresponding port symbol.

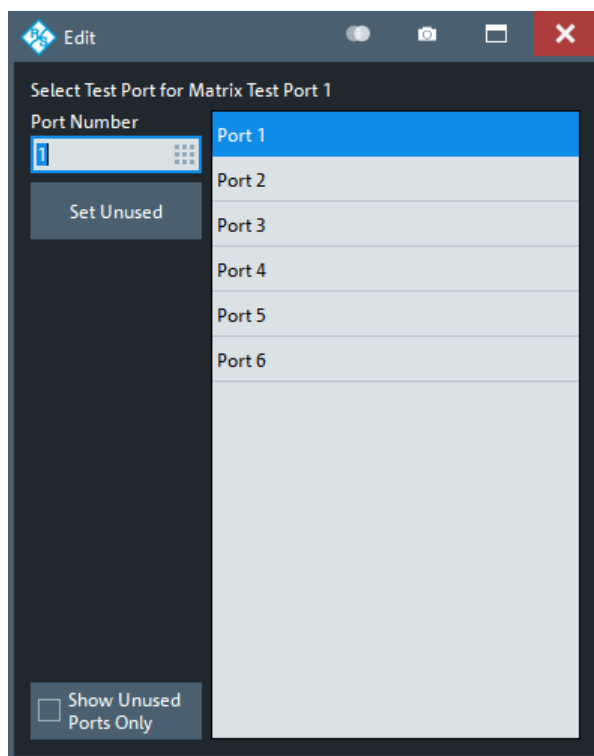

In the "Edit" dialog, define the appropriate test port or select "Set Unused" to delete the test port assignment. Configuration errors are displayed in balloon popups appearing at the lower left corner of the "Switch Matrix RF Connections" dialog.

Remote command:

```
SYSTEM:COMMunicate:RDEvice:SMATrix<Matr>:CONFigure:MTEST  
SYSTEM:COMMunicate:RDEvice:SMATrix<Matr>:CONFigure:MLTest  
SYSTEM:COMMunicate:RDEvice:SMATrix:CONFigure:TVNA
```

5.19.8 Port Setup tab

Collects functions for the (re) definition of internal and external physical ports and their signal paths.

5.19.8.1 Controls on the Port Setup tab

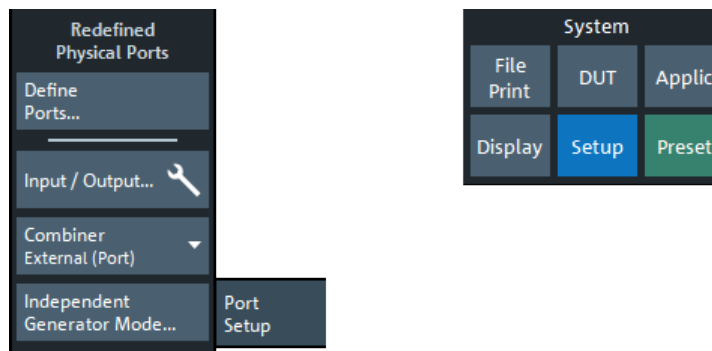

Define Ports...

Opens a dialog that allows you to redefine the physical VNA ports. See [Chapter 5.19.8.2, "Define Physical Ports dialog"](#), on page 919.

Input / Output

Opens the [Input/Output tab](#) of the [Port Settings dialog](#).

Combiner

Tells the analyzer if and how signals from two ports are combined. For descriptions and visualizations of the supported combiner configurations, see ["Combiner Configuration"](#) on page 383.

Independent Generator Mode

Opens a dialog that lets you activate and configure some VNA ports as independent CW sources. See [Chapter 5.19.8.3, "Independent Generator Settings dialog"](#), on page 920.

5.19.8.2 Define Physical Ports dialog

Allows you to redefine the physical VNA ports (see [Chapter 4.3.1.2, "Redefined S-parameters"](#), on page 151).

Access: System – [Setup] > "Port Setup" > "Define Ports..."



- Redefined physical ports are global, persistent settings, i.e. they are valid for all recall sets. A [Preset] does not reset the physical port configuration.
- Redefining physical ports causes a factory reset.
The factory reset deletes all switch matrix RF connections.

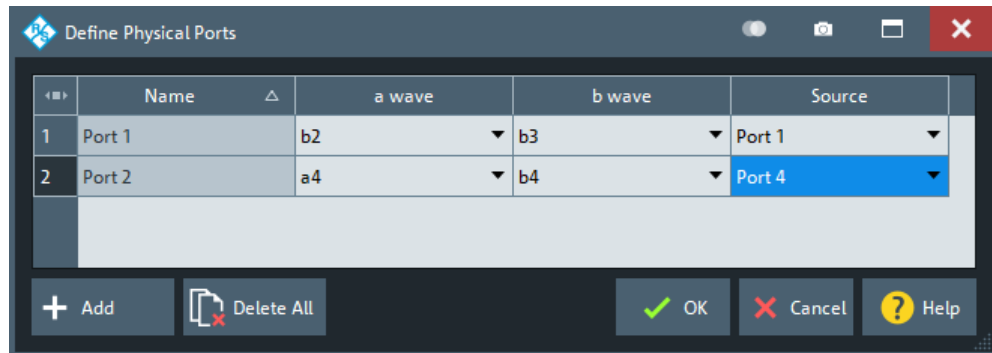

a wave, b wave, Source

Define a physical port by assigning its reference receiver, measurement receiver and generator, respectively.

The receivers and generators can be freely assigned, but without reusing the same (original) physical port in different (redefined) ports.

Remote command:

```
[SENSe:]UDSPARAMS<Pt>:PARAm
```

```
[SENSe:]UDSPARAMS:ACTive
```

5.19.8.3 Independent Generator Settings dialog

Allows you to set up one or more of the internal sources as permanent CW signals.

In contrast to the [generator mode](#), where the internal source is still synchronized with the related channel, in internal mode, the R&S ZNA creates a CW signal that is independent of all channels.

Access: System – [Setup] > "Port Setup" tab > "Independent Generator Mode..."

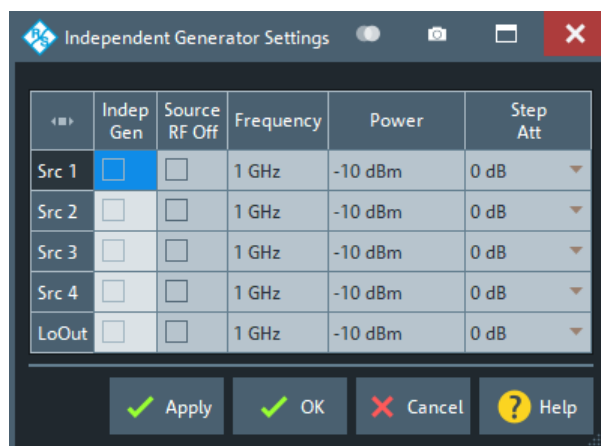



- Among the analyzer ports driven by the same internal source, only one (per setup) can operate as generator port. If one of them is used as independent generator port (in the current setup), then none of them can be used as regular driving port (in the current setup).
- If [external switch matrices](#) are used, then only VNA ports that are **not** connected to a matrix can be used as independent generators.

Independent Gen

Use the checkboxes in the "Independent Gen" column, to select the VNA ports you want to configure as independent CW sources.

Remote command:

```
SOURce: INDependent<Pt>[:STATe]
SOURce: INDependent:CLO[:STATe]
```

Source RF Off

If "Independent Gen" is checked, you can use "Source RF Off" checkbox to switch the corresponding independent CW source on or off.

Remote command:

```
SOURce: INDependent<Pt>:OFF
SOURce: INDependent:CLO:OFF
```

Frequency / Power

If "Independent Gen" is checked, these parameters define the generated CW sweep.

Remote command:

```
SOURce: INDependent<Pt>:FREQuency
SOURce: INDependent:CLO:FREQuency
SOURce: INDependent<Pt>:POWer
SOURce: INDependent:CLO:POWer
```

Step Att

If "Independent Gen" is checked for "VNA RF Src <Pt>" and VNA port <Pt> is equipped with a [source step attenuator](#) R&S ZNAXx-B2<Pt>, this command sets the source attenuation to be applied.

Remote command:

```
SOURce: INDependent<Pt>:ATTenuator
```

5.19.9 Generic Device tab

The "Generic Devices" tab allows you to define and configure VISA-capable external devices that are not natively supported by the analyzer firmware.



Background information

Refer to [Chapter 4.7.42, "Generic devices"](#), on page 331.

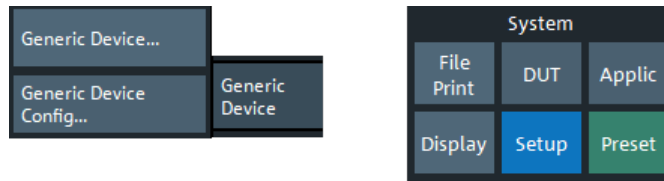

1. Use "Generic Device..." to open the [External Generic Devices dialog](#), which allows you to set up the VISA connection to the device and make it a part of the system configuration.
2. Use "Generic Device Config..." to open the [External Generic Device Config dialog](#), which allows you to define the channel-specific command sequences that are sent to the configured devices.

5.19.9.1 External Generic Devices dialog

The "External Generic Devices" dialog allows you to set up the communication to an external VISA-capable device that is not natively supported by the analyzer firmware.

Access: System – [Setup] > "Generic Device" > "Generic Device..."



Background information

Refer to [Chapter 4.7.42, "Generic devices"](#), on page 331.

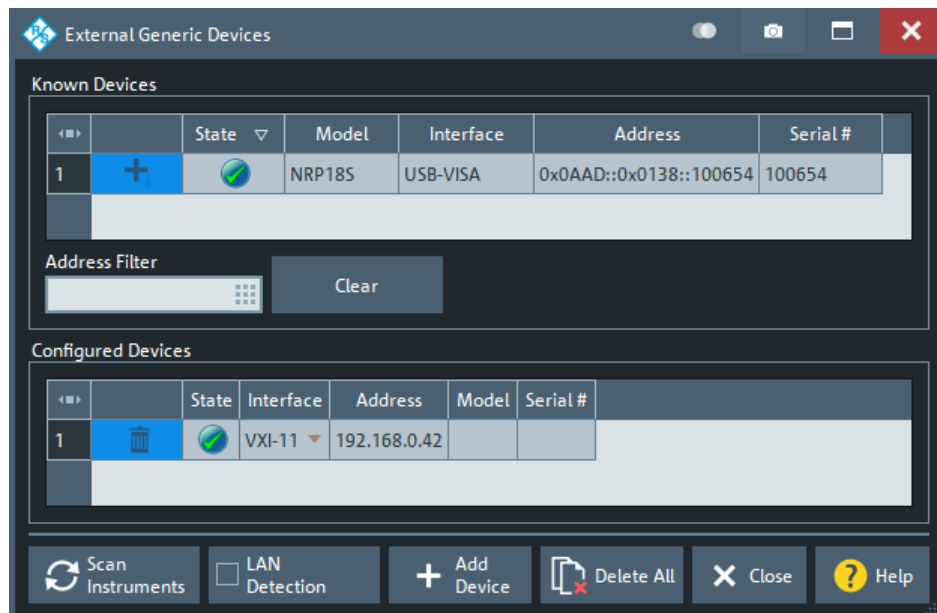

The configuration of a new generic device involves the following steps:

1. Connect the device to your R&S ZNA using a LAN (VXI-11), GPIB, or USB interface.
2. If the device is connected via LAN, enable "LAN detection"

3. Select "Scan Instruments" and wait until the device appears in the table of "Known Devices".
4. Select "+" to copy the device to the list of configured devices.

If the R&S ZNA fails to detect a connected external device, click [Add Device](#) to define the interface type and address manually.



To control external devices via GPIB, the pre-installed RS Visa library (`visa32.dll`) must be replaced by the **NI Visa** library.

Known Devices/Address Filter/Clear

Table with all VISA-capable devices that the analyzer detects to be online (i.e. connected and switched on). [Scan Instruments](#) refreshes the table. The R&S ZNA can auto-detect the serial number of the connected devices.

"Address Filter" allows you to filter the known devices to the specified address fragment, "Clear" removes the filter.

For devices that are not autoconfigured by the analyzer firmware, "+" copies the device to the table of [Configured Devices](#).

Remote command:
n/a

Configured Devices

Table with all generators in use with their properties. The properties of manually configured devices (using [Add Device](#)) can be changed in the dialog.

The following symbols indicate the status of the respective device:

- ● – The device is online (connected, switched on, ready to be used)
- ▲ – Communication error
In this case, check whether the device is properly connected to the configured interface.

Remote command:

```
SYSTem:COMMunicate:RDEvice:GDEvice<Gdev>:DEFine
SYSTem:COMMunicate:RDEvice:GDEvice<Gdev>:DElete
SYSTem:COMMunicate:RDEvice:GDEvice:DElete:ALL
SYSTem:COMMunicate:RDEvice:GDEvice:CATalog?
```

Scan Instruments

Performs an autodetection of "Known Devices" on the supported interfaces.

Note: Unintentional switchover to remote control

When using the NI-VISA library, ensure that the network analyzer itself is not listed as a network device in the Measurement & Automation Explorer. Otherwise, "Scan Instruments" sends an identification query (*IDN?), causing the analyzer to close the "External Generators" dialog (without executing "Scan Instruments") and to activate the remote screen.

Remote command:
n/a

LAN Detection

Activate "LAN Detection" to include the LAN interface in the autodetection sequence (see [Scan Instruments](#)).

Note: "LAN detection" only works for external devices sharing the IP subnet with the R&S ZNA.

As a prerequisite, the R&S ZNA must accept incoming connections on UDP port 2473. If necessary, add a corresponding inbound rule to your firewall settings.

Remote command:

n/a

Add Device

Opens the "Add Generic Device" dialog that allows you to configure the connection to a generic device that was not auto-detected. The configured device is added to the list of "Configured Devices".

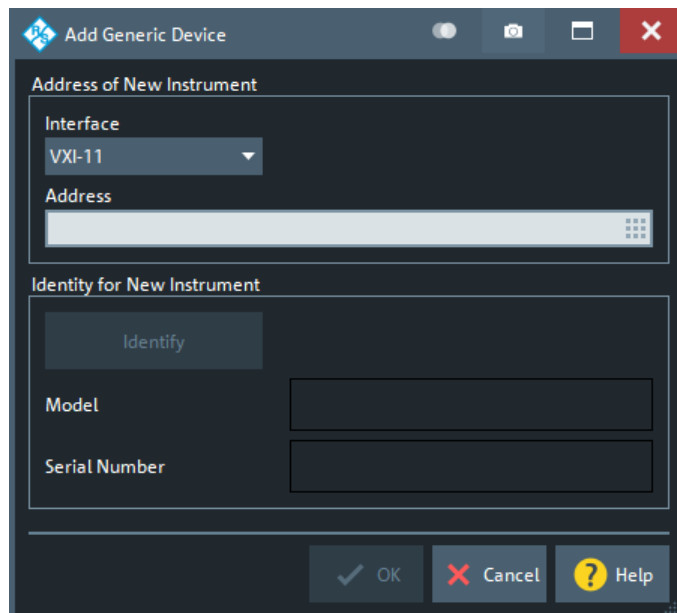

The connection is defined with the following settings:

- "Interface" selects an interface/protocol type for the connection. In addition to the VXI-11, SOCKET, and GPIB interfaces, the analyzer supports any "Other" interface supported by the installed VISA library. USB-VISA devices are auto-detected and hence this interface type does not show up here.
- "Address" contains the address for the current interface type. GPIB addresses must be unique for all devices connected to the GPIB bus (range: 0 to 30), GPIB and IP addresses must agree with the entries in the VISA library. The remaining interface types require composite address formats; see [Table 5-13](#).
- "Identify" sends an identification query ("IDN?") to the specified device address to identify the model and serial number of the connected device.

Table 5-13: Interface types for external device and address formats

Physical interface (connector)	Interface (protocol)	Address	Remarks
LAN	VXI-11	<IpAddress> e.g. 127.0.0.0	Full VISA resource string: TCPIP[board]::<Address>[::INSTR]
	SOCKET	<IpAddress>::<PortNo> e.g. 127.0.0.0::50000	LAN connection with pure TCP/IP protocol; refer to your VISA user documentation.
GPIB	GPIB0 ... GPIB9	<Address> e.g. 20	Full VISA resource string: GPIB[board]::<Address>[::INSTR]
USB	USB-VISA	<ManID>::<ProdID>::<SerialNo> e.g. 0x0AAD::0x0047::100098	2733 (0x0AAD) is the manufacturer ID of Rohde & Schwarz. The serial number is device-specific.
LAN or USB	Other	Interface-specific, e.g. for SOCKET: TCPIP0::<IpAddress>::<PortNo>::SOCKET For USB-VISA: USB0::<ManID>::<ProdID>::<SerialNo>::INSTR	Use complete VISA resource string.

Remote command:

```
SYSTem:COMMunicate:RDEvice:GDEvice<Gdev>:DEFine
```

5.19.9.2 External Generic Device Config dialog

The "External Generic Device Config" is a [Multi-channel setup dialog](#). It allows you to select channel-specific commands (or rather command sequences) to be sent to the configured generic devices during channel initialization.

Access: System – [Setup] > "Generic Device" > "Generic Device Config..."



- If the previously measured channel uses the same command to control a generic device, the command is not sent again.
- After sending the command to the device, the analyzer waits for the "Settling Time" requested in the loaded command file.
- The execution order among the configured devices is undefined.



Background information

Refer to [Chapter 4.7.42, "Generic devices"](#), on page 331.

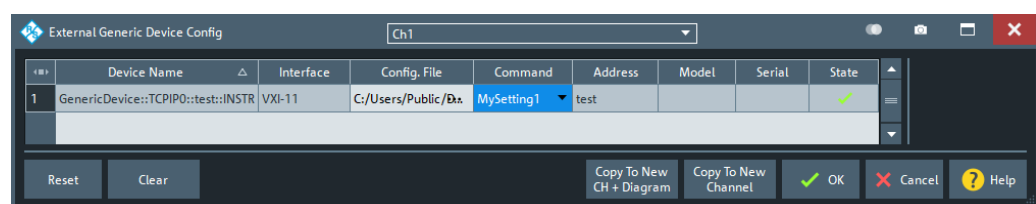

The "Device Name", "Interface", "Address", "Model", "Serial" and "State" columns allow you to identify the connected device and to determine its operational state.

Config. File/Command

To configure a device for the channel selected in the title bar of the dialog, first pick a configuration file for this device (column "Config. File") and then select one of the commands defined in this configuration file (column "Command").

Note:

- The recall set only stores the paths of the command files, but not their contents. When loading the recall set, the referenced command files must be available at the same locations.
- In case loading a command file fails, the [Error Log](#) provides more information.

Remote command:

```
[SENSe<Ch>:]GDEvice:SElect
```

Reset

"Reset" unconfigures the command assignment for the selected device.

Remote command:

```
[SENSe<Ch>:]GDEvice:DElete <Address>
```

Clear

"Clear" unconfigures the command assignment for all devices.

Remote command:

```
[SENSe<Ch>:]GDEvice:DElete
```

5.19.10 Inline Cal System tab

The "Inline Cal System" tab gives access to inline calibration systems connected to the R&S ZNA via USB.



Background Information

See [Chapter 4.5.5.4, "Inline calibration"](#), on page 211



5.19.10.1 Inline Calibration Systems dialog

USB-connected Inline Calibration Controllers (ICCs) are autodetected by the analyzer firmware.

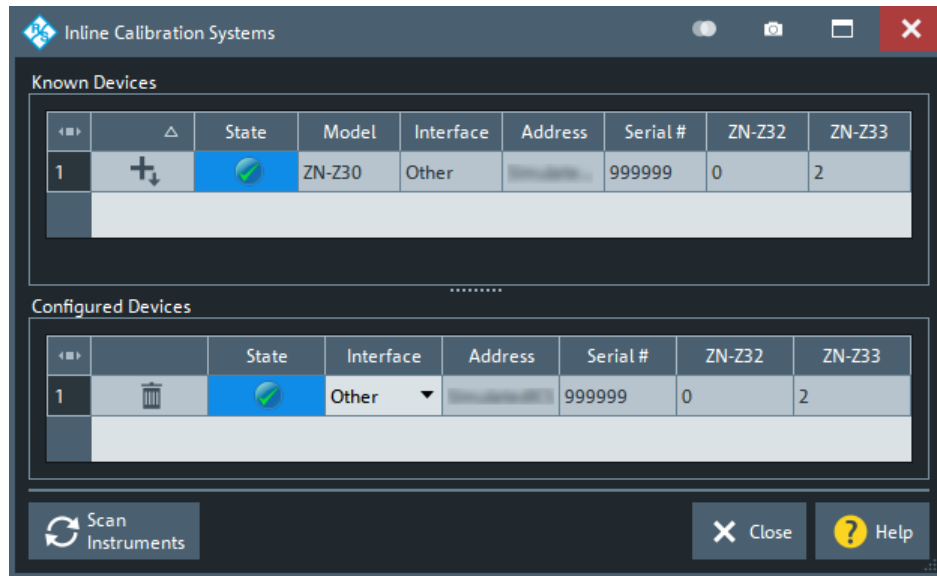

- The ICC does not support hot plugging of ICUs, so connect the ICUs to the ICC before connecting the ICC to the R&S ZNA.
- For background information, see [Chapter 4.5.5.4, "Inline calibration"](#), on page 211.

Configured Devices

Each ICC R&S ZN-Z30 is listed with its connected Inline Calibration Units (ICUs) R&S ZN-Z32 and R&S ZN-Z33.

Remote command:

`SYSTEM:COMMUNICATE:RDEVICE:AKAL:ADDRESS:SUBMODULE:ALL?`

5.20 Help softtool

The "Help" softtool presents the functions of the menu bar's "Help" menu, except calling context sensitive help.

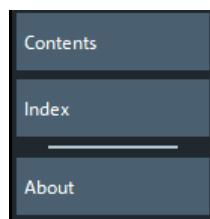

Access: "Help" – "Contents..." | "Index..." | "About..." from the menu bar.

Contents...

Opens the help browser and activates its "Contents" tab.

The "Contents" tab displays the table of contents of the analyzer's online help.

Index...

Opens the help browser and activates its "Index" tab.

The "Index" tab displays the index keywords of the analyzer's online help.

About...

Opens the "About Vna" dialog.

The "About Vna" provides basic information about the analyzer model and the current firmware. It also gives access to related license agreements.

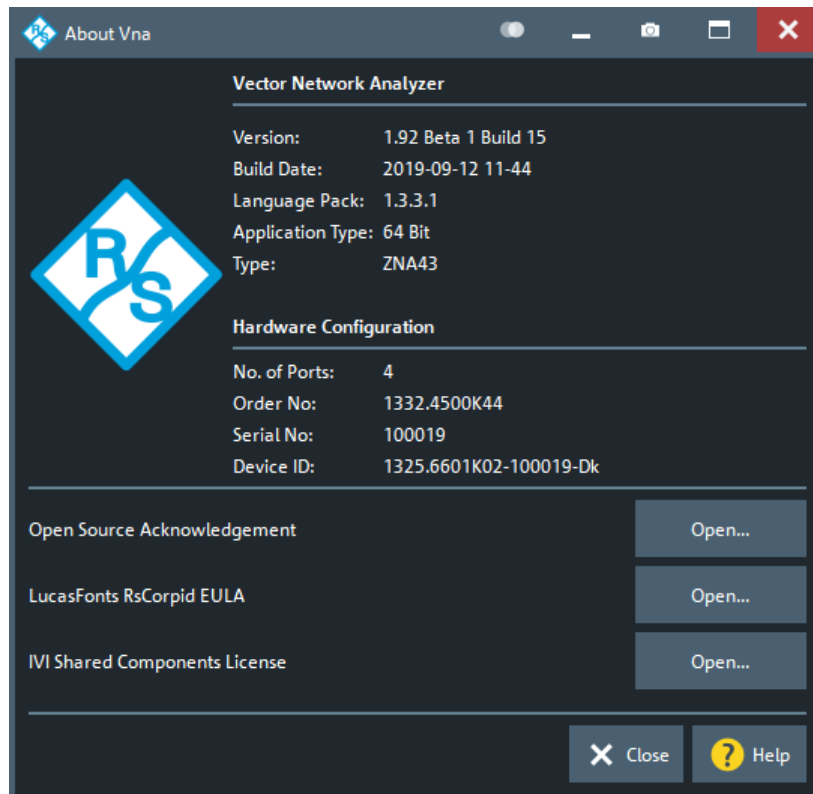

Open the [Info dialog](#) for full information about the instrument.

5.21 Preset softtool

Access:

- System – [Preset]
- Menu bar: "Channel" > "Preset" > "Select Preset" > (various menu items)

5.21.1 Select Preset tab

The controls on the "Select Preset" tab allow you to customize the function of the System – [Preset] hardkey, or to disable its immediate preset functionality in favor of the [Preset](#) button on the softtool.

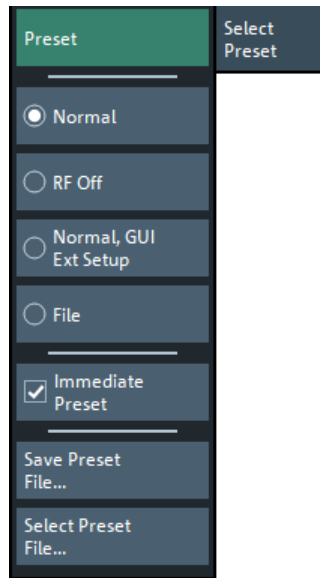

More preset options are available via the [Presets tab](#) of the "System Config" dialog.

Preset

Executes the configured preset action. See "[Normal / RF Off / Normal, GUI, Ext Setup / <File Name>](#)" on page 929.

Normal / RF Off / Normal, GUI, Ext Setup / <File Name>

These radio buttons allow you to select between different preset modes, i.e. the determine the functionality of the [Preset](#) button and the System – [Preset] hardkey (if [Immediate Preset](#) is enabled).

"Normal"	Factory preset.
"RF Off"	Factory preset + RF Off All Channels
"Normal, GUI, Ext Setup"	Factory preset + GUI reset actions (all of Reset Colors / Reset Dialogs / Reset Decimal Places / Reset Units Prefix) + reset RF connection configuration between VNA and external devices. Currently, the latter only resets the frequency converter configuration .
"<File Name>"	User preset file. If another preset action is active, the button is labeled "File". Click the button to select a recall set file to be used as user preset file and activate it (same as Select Preset File...). The button then displays the file name.

The [Preset Scope](#) can be configured in the "Presets" tab of the "System Config" dialog.

Remote command:

```
SYSTem:PRESet:MODE
```

Immediate Preset

Deactivate this checkbox to disable the preset functionality of the System – [Preset] hardkey and let it open the "Select Preset" softtool tab only. The selected preset action must be triggered using the [Preset](#) button then.

Remote command:

n.a.

Save Preset File...

Lets you save the current setup to a recall set file and to [select it as user preset file](#) in one go. Opens a standard "Save File" dialog.

Remote command:

```
MMEMory:STORe:STATe 1,<RecallSetFile>  
SYSTem:PRESet:USER:NAME <RecallSetFile>
```

Select Preset File...

Lets you select a recall set file to be used as user preset file.

The same function is available via the "Presets" tab of the "System Config" dialog (see ["Preset Configuration"](#) on page 857).

Remote command:

```
SYSTem:PRESet:USER:NAME
```

6 Remote control

This chapter provides instructions on how to set up the analyzer for remote control, a general introduction to remote control of programmable instruments, and the description of the analyzer's remote control concept. For reference information about all remote control commands implemented by the instrument, complemented by comprehensive program examples, refer to [Chapter 7, "Command reference"](#), on page 968.



For additional information on remote control of network analyzers, see the following documents available from the Rohde & Schwarz website:

- [Remote control via SCPI](#)
- [1EF62: Hints and Tricks for Remote Control of Spectrum and Network Analyzers](#)
- [1MA171: How to use Rohde & Schwarz Instruments in MATLAB](#)
- [1MA208: Fast Remote Instrument Control with HiSLIP](#)

6.1 Introduction to remote control

The instrument offers different interfaces for remote control:

- **LAN**
Analyzers connected to a LAN can be remote-controlled via the RSIB, VXI-11, or HiSLIP protocols. The LAN connector is on the rear panel of the instrument (see [Chapter 3.2.2, "Rear panel"](#), on page 41). A VISA installation on the remote control PC is required.
- **USB**
The R&S ZNA can also be remote-controlled via USB. The USB Device connector is on the rear panel of the instrument. A VISA installation on the remote control PC is required.
- **GPIB**
The R&S ZNA offers a GPIB bus interface according to standard IEC 625.1/IEEE 488.1. The GPIB bus connector is on the rear panel of the instrument. The R&S ZNA can be remote-controlled via GPIB.
- The network analyzer can itself act as a master and control external devices via LAN, USB, or GPIB. A VISA installation on the analyzer is a prerequisite for this type of remote control. The RS VISA library is installed with the VNA firmware.
 - To control external devices via USB, the "IVI Visa Shared Components" must be installed in addition. You can easily install it from the "Start" menu of your analyzer.
 - To control external devices via GPIB, the built-in GPIB interface can be used. An additional [USB-to-IEC/IEEE adapter](#) is only required in case that you want to control the R&S ZNA via GPIB at the same time.



VISA library

VISA is a standardized software interface library providing input and output functions to communicate with instruments. The I/O channel (LAN, USB, GPIB, ...) is selected at initialization time by its channel-specific resource string (also termed address string), or by an appropriately defined VISA alias (short name).

For more information about VISA, refer to the installed library's user documentation.



HiSLIP protocol

The HiSLIP (High Speed LAN Instrument Protocol) is a protocol for TCP-based instruments specified by the IVI foundation. Compared to its predecessor VXI-11, it provides speed and other improvements. HiSLIP is encapsulated in VISA; the resource string reads `TCPIP::::hislip0`.

The RS Visa library supports HiSLIP. If the connection fails, access the Windows control panel of the controlled instrument and open port 4880 for incoming connections.

6.1.1 Remote control via USB

The instrument can be remote-controlled via USB. The VISA resource string for controlling a device via USB has to be specified in the format

```
USB[board]::::<Device ID>::::INSTR.
```

The `<Manufacturer ID>` of Rohde & Schwarz is `0x0AAD`, the `<Device ID>` is model-specific:

- **2-port R&S ZNA26:** `0x0198`
- **4-port R&S ZNA26:** `0x0199`
- **2-port R&S ZNA43** with 2.92 mm connectors: `0x019A`
- **4-port R&S ZNA43** with 2.92 mm connectors: `0x019B`
- **2-port R&S ZNA43** with 2.4 mm connectors: `0x023F`
- **4-port R&S ZNA43** with 2.4 mm connectors: `0x0240`
- **2-port R&S ZNA50:** `0x0251`
- **4-port R&S ZNA50:** `0x0252`
- **2-port R&S ZNA67:** `0x0253`
- **4-port R&S ZNA67:** `0x0254`

Hence a possible resource string for the 4-port R&S ZNA26 is `USB1::0x0AAD::0x0199::100067::INSTR.`

6.1.2 Starting a remote control session

A remote control program must open a connection to the analyzer (using VISA functionality), before it can send commands to the analyzer and receive device responses (e.g. measurement data). The programming details depend on the library version used

and on the programming language. For this reason, the examples in chapters "Command Reference" and "Programming Examples" are reduced to the mere SCPI syntax.

Example controller programs can be obtained from the Rohde & Schwarz support centers. However, it can be preferable to integrate the controller program into post-processing tools (e.g. Microsoft Excel) to list, draw, or manipulate the measured values retrieved from the analyzer.

The following tools can make remote control more comfortable and faster:

- Various software tools provide an easy-to-use graphical user interface for remote control. An example is the "GPIB Explorer" (also termed "IECWIN32") which is pre-installed on the analyzer. See [Chapter 6.1.3, "GPIB Explorer"](#), on page 933.
- Instrument drivers provide an improved interface between the test software and the test instruments. They perform the actual control of the instrument using higher-level functions for operations such as configuring, reading from, writing to, and triggering the instrument. Hence, drivers can reduce development time, eliminating the need to learn the specific command set for each instrument. In general, program development is further simplified by a graphical program environment. Rohde & Schwarz offers various R&S ZNA driver types (LabView, LabWindows/CVI, IVI, VXIplug&play...) for different programming languages. The drivers are available free of charge on the product pages in the R&S internet, along with installation information.

6.1.3 GPIB Explorer

The GPIB Explorer is a software tool that allows you to connect to the analyzer, and to obtain an overview of all implemented remote control commands. You can use it to compile and run test scripts. The program can be opened from the Windows® start menu: "Programs – R&S ZNA Vector Network Analyzer – GPIB Explorer" or via System – [Applic] "External Tools " > "GPIB Explorer". You can also start the executable file `iecw32.exe` in the program directory of the network analyzer (e.g.

`C:\Program Files\Rohde-Schwarz\Vector Network Analyzer\ZNA\Bin`).

After the GPIB Explorer is started, the interface and protocol for the connection to the instrument can be selected in a dialog:

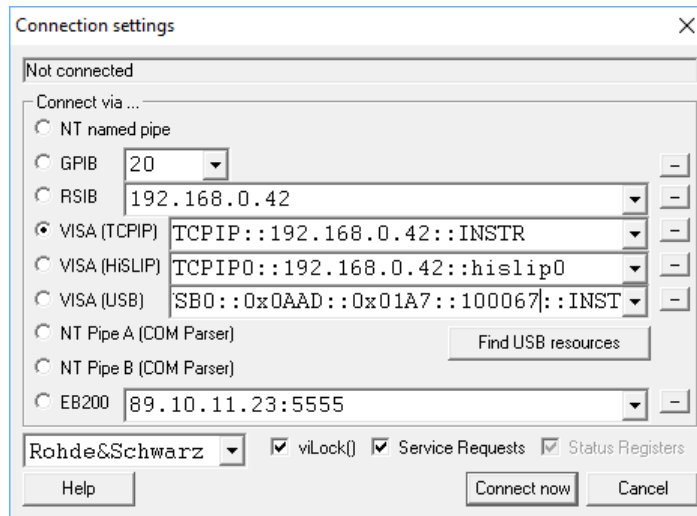

The following options are provided:

- **NT named pipe** (currently not supported)
- **GPIB address** (for connection to controllers equipped with a National Instruments GPIB interface using the GPIB bus connector)
- **RSIB, VISA (TCPIP)** and **VISA (HSLIP)** (for LAN connection, requires an appropriate IP or local host address); see [Chapter 12.1.2.1, "Assigning an IP address"](#), on page 1775.
- **VISA (USB)**
Depending on the instrument model and variant, specify the resource string as `USB1::0x0AAD::<Device ID>::<Serial>::INSTR` (see [Chapter 6.1.1, "Remote control via USB"](#), on page 932).
- **NT pipe A/B (COM Parser)** (only for a GPIB Explorer installed on the analyzer, recommended for "remote" test on the instrument)
- **EB200** (currently not supported)



Select "SETUP > Setup > Info..." to look up the IP address information of your analyzer. If you run the GPIB explorer on the analyzer, the local host address (loopback address) is 127.0.0.1.

After the connection is established, the GPIB explorer displays a tree view of all commands included in the current firmware version of the network analyzer. The programs can be selected for execution by a single mouse click.

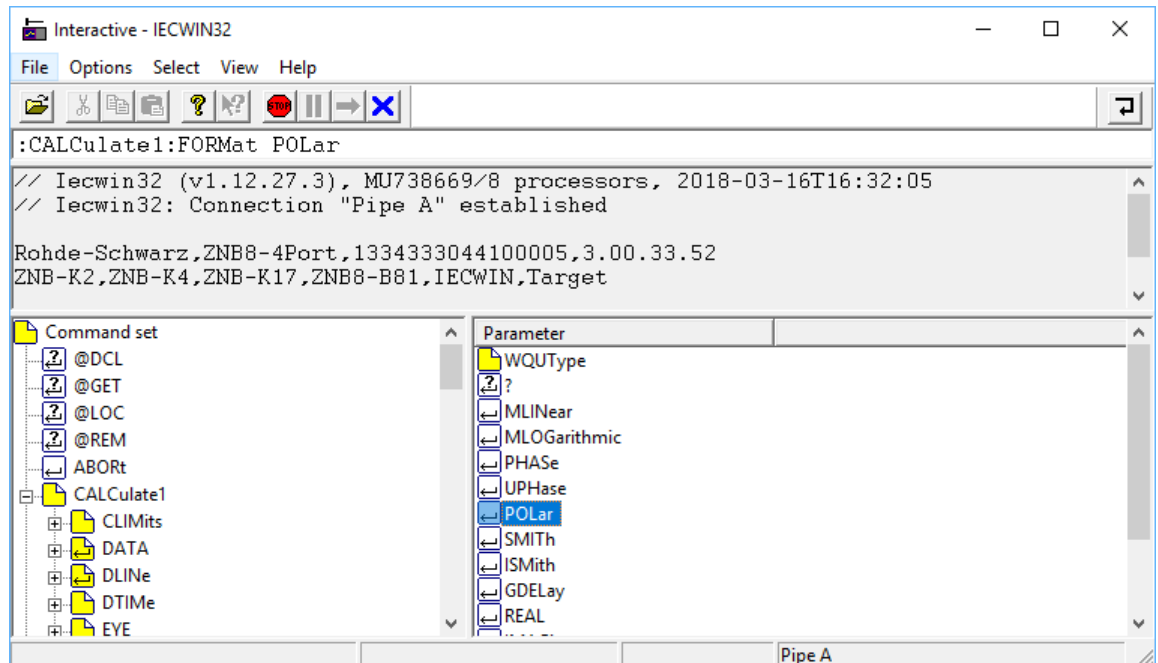

If remote logging is enabled (`SYSTEM:LOGGING:REMOte[:STATE] ON`) the analyzer stores all received commands to the file

'C:\Users\Public\Documents\Rohde-Schwarz\ZNA\RemoteLog'.

6.1.4 Switchover to remote control

On power-up, the instrument is always in the manual operating state and can be operated via the front panel controls. The instrument is switched to remote control when it receives a command from the controller. If the instrument is controlled via RSIB or VXI-11 protocol, the alternative commands `@REM` and `@LOC` can be used to switch from manual to remote control and back.

While remote control is active, operation via the front panel is disabled except the "Remote" softtool. The instrument settings are optimized for maximum measurement speed; the display is switched off:

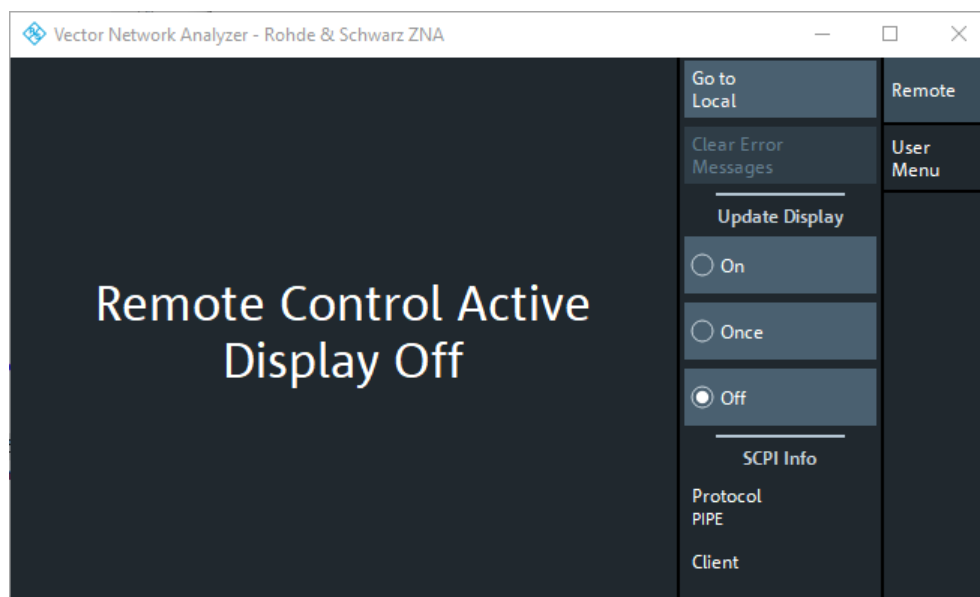

If the "Remote" softtool is not visible, tap/click on the main window to restore it.

The softkeys in the remote screen are used to modify or quit the remote state:

- "Go to Local" switches the instrument to local state.
- "Display" switches the display on or off.
- If a remote error message is displayed at the bottom of the remote screen, you can use "Clear Error Messages" to delete it.

The remaining controls are for future extensions.

Display on and off states

Switching on the display means that the analyzer shows the measurement screen with the current recall sets, diagram areas and traces without leaving the remote state. In this operating mode, it is possible to observe the screen while a remote control script is executed and the control elements on the front panel are still disabled.

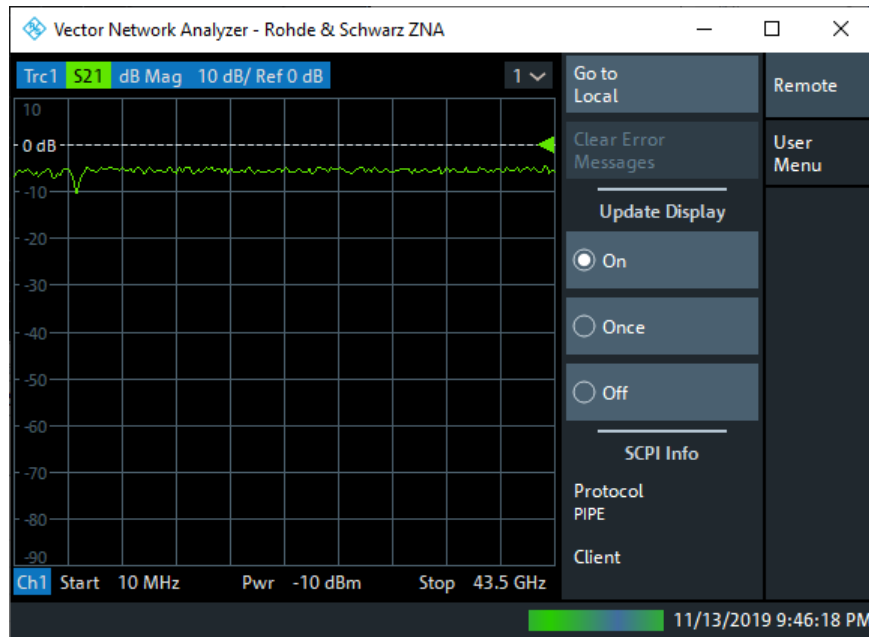

Switching on the display is ideal for program test purposes but tends to slow down the measurement. Therefore, it is recommended to switch off the display in real measurement applications where a tested program script is to be executed repeatedly.



The analyzer provides a third display option where the measurement screen is only updated when triggered by the remote control command `SYSTem:DISPlay:UPDate ONCE`.

The instrument remains in the remote state until it is reset to the manual state via the GUI or via remote control (see [Chapter 6.1.4.2, "Returning to manual operation"](#), on page 938). You can also lock the remote (touch) screen using `SYSTem:TSLock SCReen`.

A tooltip across the bottom of the remote screen indicates a remote command error. You can switch off this tooltip using `SYSTem:ERRor:DISPlay:REMote OFF`.

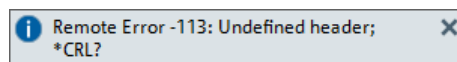

SCPI commands:

```
@REM
```

```
SYSTem:DISPlay:UPDate
```

```
SYSTem:TSLock
```

```
SYSTem:ERRor:DISPlay[:REMote]
```

6.1.4.1 Setting the device address

The GPIB address (primary address) of the instrument is factory-set to 20. It can be changed manually in the System – [Setup] > "Remote Settings" tab or via remote control. For remote control, addresses 0 through 30 are permissible. The GPIB address is maintained after a reset of the instrument settings.

SCPI commands:

```
SYSTem:COMMunicate:GPIB[:SELF]:ADDRes
```

6.1.4.2 Returning to manual operation

Return to manual operation can be initiated via the front panel or via remote control.

- Manually: tap the Local softkey in the remote screen.
- Via GPIB bus: CALL IBLOC(device%)
- Via RSIB or VXI-11 protocol: @LOC and @REM can be used to switch from remote to manual control and back.



Local lockout

Before returning to manual control, command processing must be completed. If not, the analyzer switches back to remote control immediately.

Returning to manual control by tapping the "Go to Local" softkey can be disabled, e.g., by the Local Lockout Message (via GPIB: LLO; see [Chapter 12.3.3.2, "Interface messages"](#), on page 1783). The lockout prevents unintentional switch-over, i.e. return to manual control is possible via remote control only.

Returning to manual control via the front panel keys can be enabled again, e.g. by deactivating the REN control line of the GPIB bus.

6.1.5 Combining manual and remote control

Using a remote control script is the quickest and easiest way of performing complicated tasks which need to be repeated many times. However, it is often preferable to control a previously configured measurement manually to observe the result on the screen.

The analyzer provides various tools for combining manual and remote control:

- **User Keys**

The remote control commands `SYSTem:USER:KEY...` place up to 8 softkeys with arbitrary functionality on the remote screen. The softkeys appear in the "User Menu" tab of the "Remote" softtool. When a softkey is selected, the ESR bit no. 6 (User Request) is set, and the response for `SYSTem:USER:KEY?` is changed. This behavior can serve as a control mechanism in remote control scripts.

SCPI commands:

```
SYSTem:USER:KEY
```

6.2 Messages

The messages transferred on the data lines of the GPIB bus or via the RSIB / VXI-11 protocol can be either interface messages or device messages. For a description of interface messages refer to the relevant sections:

- [Chapter 12.3.3, "GPIB interface"](#), on page 1782
- [Chapter 12.3.2, "LAN interface"](#), on page 1781

6.2.1 Device messages (commands and device responses)

Depending on the selected "Codec" (see `SYSTem:COMMunicate:CODec` on page 1606), device messages are either transferred in ANSI, UTF-8 or Shift JIS format. A distinction is made according to the direction in which device messages are transferred:

- Commands are messages the controller sends to the instrument. They operate the device functions and request information.
- Device responses are messages the instrument sends to the controller after a query. They can contain measurement results, instrument settings and information on the instrument status.

Commands are subdivided according to two criteria:

1. According to the effect they have on the instrument:
 - Setting commands cause instrument settings such as a reset of the instrument or setting the output level to some value.
 - Queries cause data to be provided for output on the GPIB bus, e.g. for identification of the device or polling the active input.
2. According to their definition in standard IEEE 488.2:
 - Common commands have a function and syntax that is precisely defined in standard IEEE 488.2. Typical tasks are the management of the standardized status registers, reset and selftest.
 - Instrument-control commands are functions that depend on the features of the instrument such as frequency settings. Most of these commands has also been standardized by the SCPI consortium.

The device messages have a characteristic structure and syntax. In the SCPI reference chapter, all commands are listed and explained in detail.

6.2.2 SCPI command structure and syntax

SCPI commands consist of a so-called header and, usually, one or more parameters. The header and the parameters are separated by a white space (ASCII code 0 to 9, 11 to 32 decimal, e.g. blank). The headers may consist of several mnemonics. Queries are formed by directly appending a question mark to the header.

Common commands and device-specific commands differ in their syntax.

SCPI compatibility

The analyzers are compatible to the final SCPI version 1999.0. Not all the commands supported by the instrument are taken from the SCPI standard (Standard Commands for Programmable Instruments), however, their syntax follows SCPI rules. The SCPI standard is based on standard IEEE 488.2 and aims at the standardization of instrument-control commands, error handling and the status registers.

The requirements that the SCPI standard places on command syntax, error handling and configuration of the status registers are explained in detail in the following sections.



Reset values

In contrast to instruments with manual control, which are designed for maximum operating convenience, the priority of remote control is the predictability of the device status. This means that when incompatible settings are attempted, the command is ignored and the device status remains unchanged, i.e. other settings are not automatically adapted. Therefore, GPIB bus control programs should always define an initial device status (e.g. with the command *RST) and then implement the required settings.

6.2.2.1 Common commands

Common (=device-independent) commands consist of a header preceded by an asterisk "*" and possibly one or more parameters.

Examples:	
*RST	RESET, resets the instrument.
*ESE 253	EVENT STATUS ENABLE, sets the bits of the event status enable registers.
*ESR?	EVENT STATUS QUERY, queries the contents of the event status register.

6.2.2.2 Instrument-control commands

Instrument-control commands are based on a hierarchical structure and can be represented in a command tree. The command headers are built with one or several mnemonics (keywords). The first level (root level) mnemonic identifies a complete command system.

<p>Example:</p> <p>SENSE This mnemonic identifies the command system SENSE.</p> <p>For commands of lower levels, the complete path has to be specified, starting on the left with the highest level, the individual mnemonics being separated by a colon ":".</p>
<p>Example:</p> <p>SENSE:FREQuency:START 1GHZ</p> <p>This command is located on the third level of the SENSE system. It defines the start frequency of the sweep.</p>

The following rules simplify and abbreviate the command syntax:

- **Multiple mnemonics**

Some mnemonics occur on several levels within one command system. Their effect depends on the structure of the command, i. e. on the position in the command header they are inserted in.

Example:

```
SOURce:FREQuency:CW 1GHZ
```

This command contains the mnemonic `SOURce` in the first command level. It defines the frequency for sweep types operating at fixed frequency.

```
TRIGger:SOURce EXTernal
```

This command contains the mnemonic `SOURce` in the second command level. It defines the trigger source “external trigger”.

- **Optional mnemonics**

Some command systems permit certain mnemonics to be optionally inserted into the header or omitted. These mnemonics are marked by square brackets in this manual. The full command length must be recognized by the instrument for reasons of compatibility with the SCPI standard. Some commands are considerably shortened by omitting optional mnemonics.

Example:

```
TRIGger[:SEQuence]:SOURce EXTernal
```

This command defines the trigger source “external trigger”. The following command has the same effect:

```
TRIGger:SOURce EXTernal
```

Note:

The short form is marked by uppercase letters, the long form corresponds to the complete word. Uppercase and lowercase notation only serves to distinguish the two forms in the manual, the instrument itself is case-insensitive.

- **Parameters**

Parameters must be separated from the header by a white space. If several parameters are specified in a command, they are separated by a comma “,”. For a description of the parameter types, refer to section Parameters.

Example:

```
SOURce:GROup 1,1
```

This command defines a group of measured ports.

- **Numeric suffix**

If a device features several functions or features of the same kind, e.g. several channels or test ports, the desired function can be selected by a suffix added to the command. Entries without suffix are interpreted like entries with the suffix 1.

Example:

```
SOURce:GROup2 1,1
```

This command defines a second group (group no 2) of measured ports.

6.2.2.3 Structure of a command line

A command line may consist of one or several commands. It is terminated by a <New Line>, a <New Line> with EOI or an EOI together with the last data byte. Tools like the GPIB Explorer automatically produce an EOI together with the last data byte.

Several commands in a command line must be separated by a semicolon ";". If the next command belongs to a different command system, the semicolon is followed by a colon.

Example: TRIGger:SOURce EXTernal;:SENSe:FREQuency:START 1GHZ

This command line contains two commands. The first command belongs to the TRIGger system and defines the trigger source (external trigger). The second command belongs to the SENSe system and defines the start frequency of the sweep.

If the successive commands belong to the same system, having one or several levels in common, the command line can be abbreviated. To this end, the second command after the semicolon starts with the level that lies below the common levels. The colon following the semicolon must be omitted in this case.

Example: TRIG:SOUR EXT;:TRIG:TIM 0.1

This command line is represented in its full length and contains two commands separated from each other by the semicolon. Both commands are part of the TRIGger command system, i.e. they have one level in common.

When abbreviating the command line, the second command begins with the level below TRIG. The colon after the semicolon is omitted. The abbreviated form of the command line reads as follows:

TRIG:SOUR EXT; TIM 0.1

However, a new command line always begins with the complete path.

Example:	TRIG:SOUR EXT TRIG:THR LOW
-----------------	-------------------------------

6.2.2.4 Responses to queries

A query is defined for each setting command unless explicitly specified otherwise. It is formed by adding a question mark to the associated setting command. According to SCPI, the responses to queries are partly subject to stricter rules than in standard IEEE 488.2.

1. The requested parameter is transmitted without header.
Example: TRIGger:SOURce? **Response:** IMM
2. Maximum values, minimum values and all further quantities which are requested via a special text parameter are returned as numerical values.
Example: SENSe:FREQuency:STOP? MAX **Response:** 8000000000
3. Numerical values are output without their unit. The default unit for each command is reported in the SCPI command description.
Example: SENSe:FREQuency:STOP? MAX **Response:** 8000000000 for 8 GHz
4. Boolean values are returned as 0 (for OFF) and 1 (for ON).
Example: SWEep:TIME:AUTO? **Response:** 1
5. Text (character data) is returned in short form (see also next section).

Example: TRIGger: SOURce? Response: IMM

6.2.3 SCPI parameters

Many commands are supplemented by a parameter or a list of parameters. The parameters must be separated from the header by a "white space". Permissible parameters are numerical values, Boolean parameters, text, character strings and block data. The type of parameter required for the respective command and the permissible range of values are specified in the command description.

6.2.3.1 Numeric values

Numeric values can be entered in any form, i.e. with sign, decimal point and exponent. Values exceeding the resolution of the instrument are rounded up or down. The mantissa may comprise up to 255 characters, the values must be in the value range –9.9E37 to 9.9E37. The exponent is introduced by an E or e. Entry of the exponent alone is not allowed. In the case of physical quantities, the unit can be entered. Permissible unit prefixes are G (giga), MA (mega), MOHM and MHZ are also permissible), K (kilo), M (milli), U (micro) and N (nano). If the unit is missing, the default unit is used.

Example:

SOUR:RFG:FREQ 1.5GHz is equivalent to:

SOUR:RFG:FREQ 1.5E9

Special numeric values

The texts MINimum, MAXimum, DEFault, UP and DOWN are interpreted as special numeric values. A query returns the associated numerical value.

Example:

Setting command: SENSE:FREQuency:START MINimum

The query SENSE:FREQuency:START? returns 300000 (the exact value depends on the analyzer model).

The following special values can be used:

- MIN/MAX MINimum and MAXimum denote the minimum and maximum value of a range of numeric values.
- DEF DEFault denotes the preset value. This value is set by the *RST command.
- **UP/DOWN** UP, DOWN increases or reduces the numeric value by one step. The step width is reported in the detailed command description.
- INF/NINF Negative INFIinity (NINF) represent the numerical values –9.9E37 or +9.9E37, respectively. INF and NINF are only sent as device responses.
- NAN Not a Number (NAN) represents the value 9.91E37. NAN is only sent as device response. This value is not defined. Possible causes are division by zero, subtraction or addition of infinite and the representation of missing values.



Unless it is explicitly stated in the command description, you can use the special numeric parameters for all commands of the analyzer.

6.2.3.2 Boolean parameters

Boolean parameters represent two states. The **ON** state (logically true) is represented by **ON** or a numerical value different from 0. The **OFF** state (logically false) is represented by **OFF** or the numerical value 0. A query responds with 0 or 1.

Example: Setting command: `SWEp:TIME:AUTO ON`

Query: `SWEp:TIME:AUTO?` returns 1

6.2.3.3 Text parameters

Text parameters observe the syntax rules for mnemonics, i.e. they can be entered using a short or long form. Like any parameter, they have to be separated from the header by a white space. In the case of a query, the short form of the text is provided.

Example: Setting command: `TRIGger:SOURce EXTernal`

Query: `TRIGger:SOURce?` returns EXT

6.2.3.4 Strings

Strings must always be entered within single or double quotation marks (' or ").

Example: `CONFigure:CHANnel:NAME "Channel 4"` or

`CONFigure:CHANnel:NAME 'Channel 4'`

6.2.3.5 Block data format

Block data is a transmission format which is suitable for the transmission of large amounts of data. A command using a block data parameter with definite length has the following structure:

Example: `HEADer:HEADer #45168xxxxxxxx`

The hash symbol # introduces the data block. The next number indicates how many of the following digits describe the length of the data block. In the example the 4 following digits indicate the length to be 5168 bytes. The data bytes follow. During the transmission of these data bytes all End or other control signs are ignored until all bytes are transmitted.

A #0 combination introduces a data block of indefinite length. The use of the indefinite format requires a `NL^END` message to terminate the data block. This format is useful when the length of the transmission is not known or if speed or other considerations prevent segmentation of the data into blocks of definite length.

6.2.3.6 Overview of syntax elements

:	The colon separates the mnemonics of a command. In a command line, the separating semicolon marks the uppermost command level.
;	The semicolon separates two commands of a command line. It does not alter the path.
,	The comma separates several parameters of a command.
?	The question mark forms a query.
*	The asterisk marks a common command.
' , "	Quotation marks introduce a string and terminate it.
#	The hash sign # introduces binary, octal, hexadecimal and block data. Binary: #B10110 Octal: #O7612 Hexadecimal: #HF3A7 Block: #21312
	A "white space" (ASCII-Code 0 to 9, 11 to 32 decimal, e.g. blank) separates header and parameter.

6.3 Basic remote control concepts

The GUI and the remote control command set both aim at maximum operating convenience. In manual control this generally means that the control elements are easy to find and intuitive to handle, and that the effect of each operation is easy to verify on the screen. Convenient remote control operation depends on a simple and systematic program syntax and on a predictable instrument state; the display of results is secondary.

These differences suggest the peculiarities in the analyzer's remote control concept discussed in the following sections.

6.3.1 Traces, channels, and diagram areas

Like in manual control, traces can be assigned to a channel and displayed in diagram areas (see section Traces, Channels and Diagram Areas in Chapter 3). There are two main differences between manual and remote control:

- A trace can be created without being displayed on the screen.
- A channel must not necessarily contain a trace. Channel and trace configurations are independent of each other.

The following frequently used commands create and delete traces, channels, and diagram areas:

Create new trace and new channel (if channel <Ch> does not exist yet)	CALCulate<Ch>:PARAmeter:SDEFine '<Trace Name>', '< Meas Parameter>
Delete trace	CALCulate<Ch>:PARAmeter:DELEte '<Trace Name>'
Create or delete channel	CONFigure:CHANnel<Ch>[:STATe] ON OFF
Create or delete diagram area	DISPlay:WINDow<Wnd>:STATe ON OFF
Display trace in diagram area	DISPlay:WINDow<Wnd>:TRACe<WndTr>:FEED

The assignment between traces, channels, and diagram areas is defined via numeric suffixes as illustrated in the following example:

Example:

```
CALC4:PAR:SDEF 'Ch4Tr1', 'S11'
```

Create channel 4 (channel suffix 4) and a trace named "Ch4Tr1" to measure the input reflection coefficient S11. The trace is created but not displayed.

```
DISP:WIND2:STAT ON
```

Create diagram area no. 2 (window suffix 2).

```
DISP:WIND2:TRAC9:FEED 'CH4TR1'
```

Display the generated trace (identified by its name "Ch4Tr1") in diagram area no. 2 (window suffix 2), assigning the trace number 9 (trace suffix 9) to it.

6.3.2 Active traces in remote control

In manual control there is always exactly one active trace, irrespective of the number of channels and traces defined. The "active channel" contains the active trace; see [Chapter 4.1.3.1, "Trace settings"](#), on page 109.

In remote control, each channel contains an active trace (unless the channel contains no trace at all). This principle actually simplifies the remote control command syntax, because it allows the active trace in a particular channel to be referenced by means of the channel suffix. No additional trace identifier is needed; there is no need either to distinguish channel and trace settings using mnemonics or suffixes.

The active traces are handled as follows:

- After a preset (*RST), the analyzer displays a single diagram area with the default trace no. 1 named Trc1. The trace is active in manual and in remote control.
- In manual control, a new, added trace automatically becomes the active trace. To select another trace as the active trace, tap inside the trace list.
- In remote control, a new trace added via CALCulate<Ch>:PARAmeter:SDEFine '<trace_name>', '<parameter>' also becomes the active trace. To select another trace as the active trace, use (CALCulate<Ch>:PARAmeter:SELEct '<trace_name>').
- The active traces for manual and remote control may be different.

Example:

```
*RST
```

Reset the analyzer, creating channel no. 1 with the default trace "Trc1". The trace is displayed in diagram area no. 1.

```
CALC1:PAR:SDEF 'Trc2', 'S11'; DISP:WIND:TRAC2:FEED 'Trc2'
```

Create a new trace named "Trc2", assigned to channel no. 1 (the suffix 1 after CALC, may be omitted), and display the trace. The new trace automatically becomes the active trace for manual and for remote control. To check this, tap "Trace – Marker – Marker 1" to create a marker. The marker is assigned to "Trc2". Delete all markers ("Trace – Marker – All Markers Off").

```
CALC1:MARK ON
```

Example:

To verify that "Trc2" is also active for remote control, use the channel suffix 1 after CALC (may be omitted) to reference the active trace in channel 1 and create a marker "Mkr 1". The marker is assigned to "Trc2".

Example:

```
CALC:PAR:SEL 'Trc1'; CALC1:MARK ON
```

Select the old default trace "Trc1" as the active trace for remote control. Create a new marker to verify that "Trc1" is now the active trace in channel 1.



In the SCPI command description, the numeric suffix <Ch> is used for channel settings (it denotes the configured channel), whereas <Chn> is used for trace settings (it refers to the active trace in the channel).

6.3.3 Initiating measurements, speed considerations

After a reset the network analyzer measures in continuous mode. The displayed trace shows the result of the last sweep and is continuously updated. This provides a permanent visual control over the measurement and the effect of any analyzer settings.

In remote control, it is advisable to follow a different approach in order use the analyzer's resources to full capacity and gain measurement speed. The following principles can help to optimize a remote control program (see also programming example in [Chapter 8.1.1, "Typical stages of a remote control program"](#), on page 1722):

- Switch off the measurement while configuring your instrument.
- Use a minimum number of suitably positioned sweep points.
- Start a single sweep, observing proper command synchronization, and retrieve your results.

The following command sequence performs a single sweep in a single channel.

Example:

```
*RST; :INITiate:CONTinuous:ALL OFF
```

Activate single sweep mode for all channels (including the channels created later).

```
INITiate1:IMMediate; *WAI
```

Start a single sweep in channel no. 1, wait until the sweep is terminated before proceeding to the next command (see [Chapter 6.4, "Command processing"](#), on page 949).

**Sweeps in several channels**

It is also possible to subdivide the channels within a recall set into active and inactive channels. The analyzer will then measure in the subset of active channels only; see program example for `CONFigure:CHANnel<Ch>:MEASure[:STATe]`.

6.3.4 Addressing traces and channels

The analyzer provides a variety of schemes for addressing traces and channels and for querying trace and channel names. The following tables give an overview.

Table 6-1: Addressing channels

Method	Commands / Example
Channel number <Ch> as a numeric suffix	CONFigure:CHANnel<Ch>[:STATe] ON
Query all channel names	CONFigure:CHANnel:CATalog? (returns the names of all channels)
Assign or query channel name of a channel numbered <Ch>	CONFigure:CHANnel<Ch>:NAME 'ABCD' CONFigure:CHANnel<Ch>:NAME? (returns 'ABCD')
Query channel number assigned to a channel named 'ABCD'	CONFigure:CHANnel<Ch>:NAME:ID? 'ABCD' (returns the actual channel number, the channel suffix is ignored)

Table 6-2: Addressing traces

Method	Commands / Example
Channel number <Chn> used as a reference for the active trace in the channel	CALCulate<Chn>:MARKer<Mk>[:STATe] ON
Trace name (string variable) used as a reference for the trace	CALCulate<Ch>:PARAMeter:DElete '<Trace Name>'
Trace number <Trc> as a numeric suffix (exception!)	CONFigure:TRACe<Trc>:NAME?
Trace number <WndTr> within a particular diagram area <Wnd>	DISPlay:WINDow<Wnd>:TRACe<WndTr>:FEED
Query all trace names	CONFigure:TRACe:CATalog? (returns the names of all traces)

Method	Commands / Example
Assign or query trace name of a trace numbered <Trc>	CONFigure:TRACe<Trc>:NAME 'ABCD' CONFigure:TRACe<Trc>:NAME? (returns 'ABCD')
Query trace number assigned to a trace named 'ABCD'	CONFigure:TRACe<Trc>:NAME:ID? 'ABCD' (returns the actual trace number; the trace suffix is ignored)

Table 6-3: Mixed commands

Method	Commands / Example
Query channel name for a trace referenced by its trace name	CONFigure:TRACe<Trc>:CHANnel:NAME? 'ABCD' (returns the channel name for trace 'ABCD'; the trace suffix is ignored)
Query channel number for a trace referenced by its trace name	CONFigure:TRACe<Trc>:CHANnel:NAME:ID? 'ABCD' (returns the actual channel number for trace 'ABCD'; the trace suffix is ignored)

6.4 Command processing

The block diagram below shows how commands are serviced in the instrument.

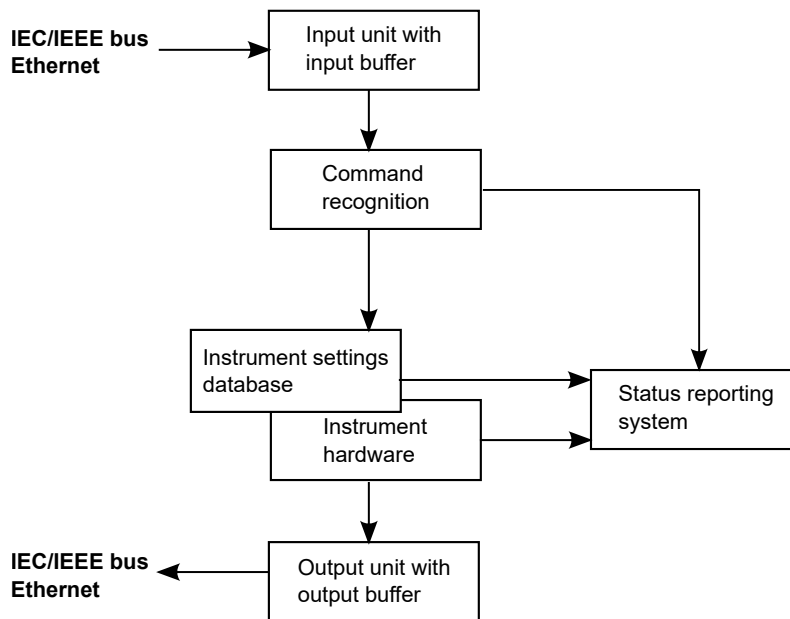

The individual components work independently and simultaneously. They communicate with each other with so-called messages.

6.4.1 Input unit

The input unit receives commands character by character from the controller and collects them in the input buffer. The input unit sends a message to the command recog-

tion when the input buffer is full or when it receives a delimiter, <PROGRAM MESSAGE TERMINATOR>, as defined in IEEE 488.2, or the interface message DCL.

If the input buffer is full, the message data traffic is stopped and the data received up to then is processed. Subsequently the traffic is continued. If, however, the buffer is not yet full when receiving the delimiter, the input unit can already receive the next command during command recognition and execution. The receipt of a DCL clears the input buffer and immediately initiates a message to the command recognition.

6.4.2 Command recognition

The command recognition stage analyzes the data received from the input unit. It proceeds in the order in which it receives the data. Only a DCL is serviced with priority, e.g. a GET (Group Execute Trigger) is only executed after the commands received before. Each recognized command is immediately transferred to the data set but not executed immediately.

The command recognition detects syntax errors in the commands and transfers them to the status reporting system. The rest of a command line after a syntax error is still executed, if possible. After the syntax check, the range of the numerical parameters is checked, if necessary.

If the command recognition detects a delimiter or a DCL, it also requests the data set to perform the necessary instrument hardware settings. Subsequently it is immediately prepared to process further commands. This means that new commands can already be serviced while the hardware is still being set (overlapping execution).

6.4.3 Data base and instrument hardware

The expression instrument hardware denotes the part of the instrument fulfilling the actual instrument function – signal generation, measurement etc. The controller is not included. The data base manages all the parameters and associated settings required for the instrument hardware.

Setting commands lead to an alteration in the data set. The data set management enters the new values (e.g. frequency) into the data set, however, it only passes them on to the hardware when requested by the command recognition. This can only occur at the end of a command line, therefore the order of the setting commands in the command line is not relevant.

The commands are only checked for their compatibility among each other and with the instrument hardware immediately before they are transmitted to the instrument hardware. If the instrument detects that execution is not possible, an execution error is signaled to the status reporting system. All alterations of the data set are canceled, the instrument hardware is not reset. Due to the delayed checking and hardware setting, however, impermissible instrument states can be set for a short period of time within one command line without this leading to an error message (example: simultaneous activation of a frequency and a power sweep). At the end of the command line, however, a permissible instrument state must have been reached again.

Before passing on the data to the hardware, the settling bit in the `STATUS:OPERation` register is set (see [Chapter 6.5.3.4, "STATUS:OPERation"](#), on page 960). The hardware executes the settings and resets the bit again as soon as the new state has settled. This fact can be used to synchronize command servicing.

Queries induce the data set management to send the desired data to the output unit.

6.4.4 Status reporting system

The status reporting system collects information on the instrument state and makes it available to the output unit on request. The exact structure and function are described in [Chapter 6.5, "Status reporting system"](#), on page 953.

6.4.5 Output unit

The output unit collects the information requested by the controller, which it receives from the data set management. It processes it according to the SCPI rules and makes it available in the output buffer. If the information requested is longer, it is made available in portions without this being recognized by the controller.

If the instrument is addressed as a talker without the output buffer containing data or awaiting data from the data set management, the output unit sends the error message `Query UNTERMINATED` to the status reporting system. No data is sent on the GPIB bus or via the Ethernet, the controller waits until it has reached its time limit. This behavior is specified by SCPI.

6.4.6 Command sequence and command synchronization

IEEE 488.2 defines a distinction between overlapped and sequential commands:

- A sequential command is one which finishes executing before the next command starts executing. Commands that are processed quickly are usually implemented as sequential commands.
- An overlapping command is one which does not automatically finish executing before the next command starts executing. Usually, overlapping commands take longer to process and allow the program to do other tasks while being executed. If overlapping commands do have to be executed in a defined order, e.g. to avoid wrong measurement results, they must be serviced sequentially. This is called synchronization between the controller and the analyzer.

According to [Chapter 6.4.3, "Data base and instrument hardware"](#), on page 950, setting commands within one command line, even though they may be implemented as sequential commands, are not necessarily serviced in the order in which they have been received. To make sure that commands are actually carried out in a certain order, each command must be sent in a separate command line.

Example: Commands and queries in one message

The response to a query combined in a program message with commands that affect the queried value is not predictable. Sending

```
:FREQ:STAR 1GHZ;SPAN 100
:FREQ:STAR?
```

always returns 1000000000 (1 GHz). When:

```
:FREQ:STAR 1GHz;STAR?;SPAN 1000000
```

is sent, however, the result is not specified by SCPI. The result could be the value of `START` before the command was sent since the instrument might defer executing the individual commands until a program message terminator is received. The result could also be 1 GHz if the instrument executes commands as they are received.

As a rule, send commands and queries in different program messages.

Example: Overlapping command with *OPC

The analyzer implements `INITiate[:IMMEDIATE]...` commands as overlapped commands. Assuming, e.g., that `INITiate[:IMMEDIATE][:DUMMY]` takes longer to execute than `*OPC`, sending the command sequence:

```
INIT; *OPC.
```

results in initiating a sweep and, after some time, setting the OPC bit in the ESR.

Sending the commands:

```
INIT; *OPC; *CLS
```

still initiates a sweep. Since the operation is still pending when the analyzer executes `*CLS`, forcing it into the Operation Complete Command Idle State (OCIS), `*OPC` is effectively skipped. The OPC bit is not set until the analyzer executes another `*OPC` command.



The analyzer provides only two overlapped commands,

`INITiate<Ch>[:IMMEDIATE][:DUMMY]` and `INITiate<Ch>[:IMMEDIATE]:ALL`. What is said below is not relevant for the other (sequential) SCPI commands.

**Preventing overlapping execution**

To prevent an overlapping execution of commands, one of the commands `*OPC`, `*OPC?` or `*WAI` can be used. For a programming example, refer to [Chapter 8.1.1.3, "Start of the measurement and command synchronization"](#), on page 1723.

Command	Action after the hardware has settled	Programming the controller
*WAI	Stops further command processing until all commands sent before *WAI have been executed Note: The GPIB bus handshake is not stopped	Send *WAI directly after the command which should be terminated before the next command is executed.
*OPC?	Stops command processing until 1 is returned, i.e. until the "Operation Complete" bit has been set in the ESR. This bit indicates that the previous commands have been completed.	Send *OPC? directly after the command which should be terminated before the next command is executed.
*OPC	Sets the operation complete bit in the ESR after all previous commands have been executed.	<ul style="list-style-type: none"> – Set bit 0 in the ESE – Set bit 5 in the SRE – Wait for service request (SRQ)

Example: Non-blocking synchronization on overlapping command termination

*CLS resets the ESR.

INITiate1:IMMEDIATE; OPC* starts a single sweep in channel 1 and sets the OPC bit (bit 0) of the ESR when the sweep has finished. It does not stop further command processing.

With *ESR? you can check for the value of the status bit to see if the sweep has finished..

6.5 Status reporting system

The status reporting system stores all information on the present operating state of the instrument, and on errors which have occurred. This information is stored in the status registers and in the error queue. Both can be queried using the `STATUS...` commands.

Hierarchy of status registers

As shown in section [Overview of status registers](#), the status information is of hierarchical structure.

- STB, SRE:
The Status Byte (STB) register and its associated mask register Service Request Enable (SRE) make up the highest level of the status reporting system. The STB provides a rough overview of the instrument status, collecting the information of the lower-level registers.
- The STB receives its information from:
The Event Status Register (ESR) with the associated mask register standard Event Status Enable (ESE).
The `STATUS:OPERation` and `STATUS:QUESTIONable` registers which are defined by SCPI and contain detailed information on the instrument.
- IST, PPE:
The Individual Status (IST) flag, like the SRQ, combines the entire instrument status in a single bit. The PPE is associated to the IST flag. It fulfills an analogous function for the IST flag as the SRE does for the service request.

- **Output buffer:**
contains the messages the instrument returns to the controller. It is not part of the status reporting system but determines the value of the MAV bit in the STB.

All status registers have the same internal structure, see [Structure of a SCPI status register](#).

For more information on the individual status registers, see [Contents of the status registers](#).



SRE register

The service request enable register SRE can be used as ENABLE part of the STB if the STB is structured according to SCPI. By analogy, the ESE can be used as the ENABLE part of the ESR.

6.5.1 Overview of status registers

The status registers of the R&S ZNA are implemented as shown below.

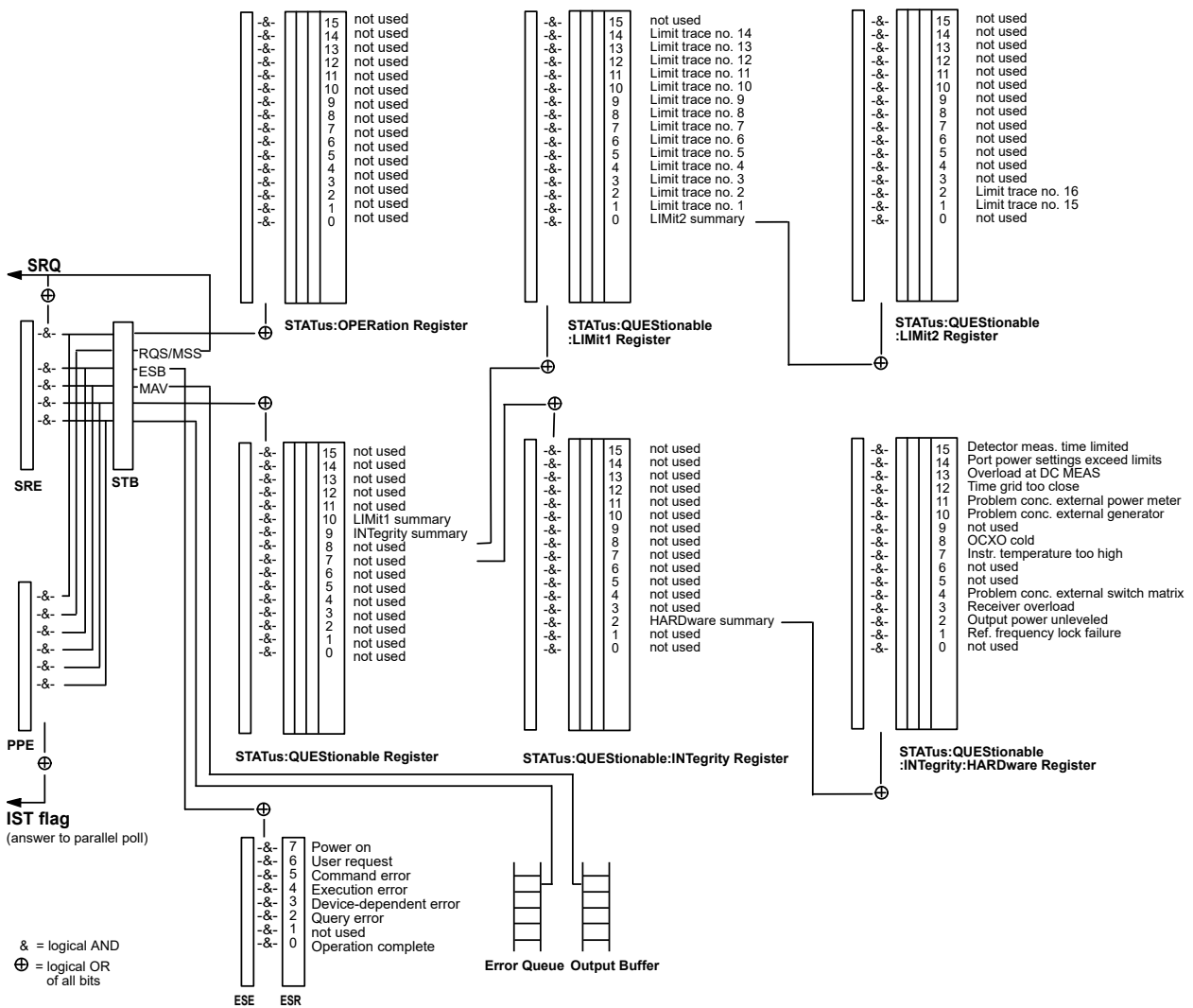

6.5.2 Structure of a SCPI status register

Each standard SCPI register consists of 5 parts which each have a width of 16 bits and have different functions. The individual bits are independent of each other, i.e. each hardware status is assigned a bit number which is valid for all five parts. Bit 15 (the most significant bit) is set to zero for all parts. Thus the contents of the register parts can be processed by the controller as positive integer.

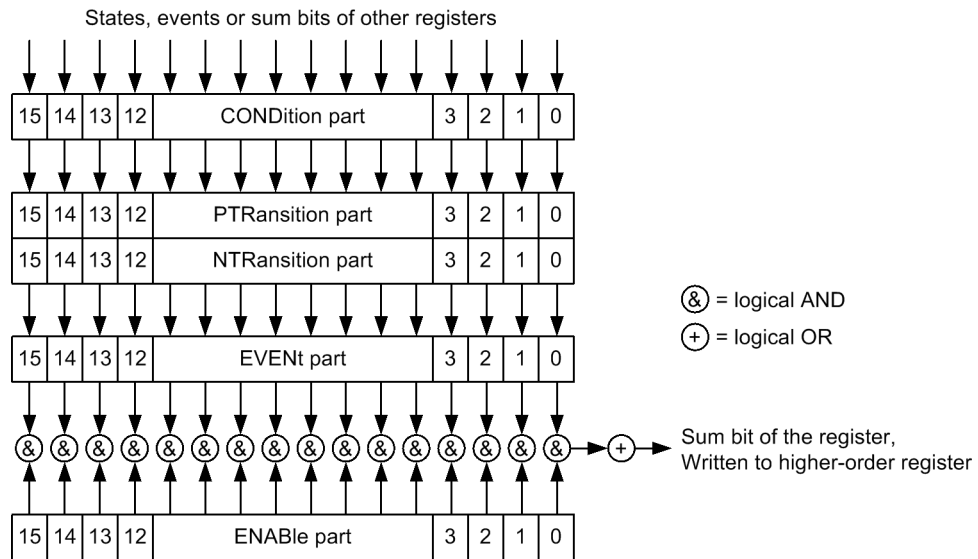

The sum bit is obtained from the EVENT and ENABLE part for each register. The result is then entered into a bit of the CONDition part of the higher-order register.

The instrument automatically generates the sum bit for each register. Thus an event can lead to a [Service request](#) throughout all levels of the hierarchy.

The five parts of a SCPI register have different properties and function as described below.

CONDition

The CONDition part is permanently overwritten by the hardware or the sum bit of the next lower register. Its contents always reflect the current instrument state.

This register part can only be read, but not overwritten or cleared. Reading the CONDition register is nondestructive.

PTRansition

The two transition register parts define which state transition of the condition part (none, 0 to 1, 1 to 0 or both) is stored in the EVENT part.

The Positive TRansition part acts as a transition filter. When a bit of the CONDition part is changed from 0 to 1, the associated PTR bit decides whether the EVENT bit is set to 1:

- PTR bit = 1: the EVENT bit is set
- PTR bit = 0: the EVENT bit is not set

This status register part can be overwritten and read at will. Reading the PTRansition register is nondestructive.

NTRansition

The Negative TRansition part also acts as a transition filter. When a bit of the CONDition part is changed from 1 to 0, the associated NTR bit decides whether the EVENT bit is set to 1.

- NTR bit = 1: the EVENT bit is set.
- NTR bit = 0: the EVENT bit is not set.

This part can be overwritten and read at will. Reading the PTRansition register is non-destructive.

EVENT

The EVENT part indicates whether an event has occurred since the last reading, it is the "memory" of the condition part. It only indicates events passed on by the transition filters. It is permanently updated by the instrument. This part can only be read by the user. Reading the register clears it. This part is often equated with the entire register.

ENABLE

The ENABLE part determines whether the associated EVENT bit contributes to the sum bit (cf. below). Each bit of the EVENT part is ANDed with the associated ENABLE bit (symbol '&'). The results of all logical operations of this part are passed on to the sum bit via an OR function (symbol '+').

- ENAB bit = 0: The associated EVENT bit does not contribute to the sum bit.
- ENAB bit = 1: If the associated EVENT bit is "1", the sum bit is set to "1" as well.

This part can be overwritten and read by the user at will. Its contents are not affected by reading.

The **sum bit** is obtained from the EVENT and ENABLE part for each register. The result is then entered into a bit of the CONDition part of the higher-order register. The instrument automatically generates the sum bit for each register. Thus an event can lead to a service request throughout all levels of the hierarchy.

6.5.3 Contents of the status registers

The individual status registers are used to report different classes of instrument states or errors. The following status registers belong to the general model described in IEEE 488.2:

- The SStatus Byte (STB) gives a rough overview of the instrument status.
- The Individual SStatus (IST) flag combines the entire status information into a single bit that can be queried in a [Parallel poll](#).
- The Event Status Register (ESR) indicates general instrument states.

The status registers below belong to the device-dependent SCPI register model:

- The STATus:OPERation register contains conditions which are part of the instrument's normal operation.
- The STATus:QUEStionable register indicates whether the data currently being acquired is of questionable quality.

- The `STATUS:QUESTIONABLE:LIMIT<1|2>` register indicates the result of the limit check.
- The `STATUS:QUESTIONABLE:INTEGRITY` register monitors hardware failures of the analyzer.

6.5.3.1 STB and SRE

The Status Byte (STB) provides a rough overview of the instrument status by collecting the pieces of information of the lower registers. The STB represents the highest level within the SCPI hierarchy. A special feature is that bit 6 acts as the summary bit of the remaining bits of the status byte.

The STB is linked to the Service Request Enable (SRE) register on a bit-by-bit basis.

- The STB corresponds to the `EVENT` part of a SCPI register, indicating the current instrument state. This register is cleared when it is read.
- The SRE corresponds to the `ENABLE` part of a SCPI register. If a bit is set in the SRE and the associated bit in the STB changes from 0 to 1, a [Service request](#) (SRQ) is generated. Bit 6 of the SRE is ignored, because it corresponds to the summary bit of the STB.

The bits in the STB are defined as follows:

Bit No.	Meaning
2	<p>Error queue not empty</p> <p>If this bit is enabled by the SRE, each entry of the error queue generates a Service request (SRQ). Thus an error can be recognized and further pinned down by polling the error queue. The poll provides an informative error message.</p>
3	<p>QUESTIONABLE status summary bit</p> <p>This bit is set if an <code>EVENT</code> bit is set in the <code>STATUS:QUESTIONABLE</code> register and the associated <code>ENABLE</code> bit is set to 1.</p> <p>The bit indicates a questionable instrument status, which can be further pinned down by polling the <code>QUESTIONABLE</code> register.</p>
4	<p>MAV bit (message available)</p> <p>This bit is set if a message is available and can be read from the output buffer.</p> <p>This bit can be used to transfer data from the instrument to the controller automatically.</p>
5	<p>ESB bit</p> <p>Sum bit of the event status register. It is set if one of the bits in the event status register is set and enabled in the event status enable register.</p> <p>Setting of this bit implies an error or an event which can be further pinned down by polling the event status register.</p>
6	<p>MSS bit (master status summary bit)</p> <p>This bit is set if the instrument triggers a service request, which happens if one of the other bits of this register is set together with its mask bit in the SRE register.</p>
7	<p>OPERATION status register summary bit</p> <p>This bit is set if an <code>EVENT</code> bit is set in the <code>OPERATION</code> status register and the associated <code>ENABLE</code> bit is set to 1.</p> <p>The bit indicates that the instrument is performing an action. The type of action can be determined by polling the <code>STATUS:OPERATION</code> register.</p>

Related common commands

The STB is read out using the command `*STB?` or a [Serial poll](#).

The SRE can be set using command `*SRE` and read using `*SRE?`.

6.5.3.2 IST flag and PPE

In analogy to the [Service request](#) (SRQ), the Individual Status (IST) flag combines the entire status information in a single bit. It can be queried by a [Parallel poll](#).

The Parallel Poll Enable (PPE) register determines which bits of the STB contribute to the IST flag. The bits of the STB are ANDed with the corresponding bits of the PPE, with bit 6 being used as well in contrast to the SRE. The IST flag results from ORing all results.

Related common commands

The IST flag is queried using the common command `*IST?`. The PPE can be set using `*PRE` and read using `*PRE?`.

See also [Common commands](#).

6.5.3.3 ESR and ESE

The Event Status Register (ESR) indicates general instrument states. It is linked to the Event Status Enable (ESE) register on a bit-by-bit basis.

- The ESR corresponds to the CONDition part of a SCPI register indicating the current instrument state (although reading is destructive).
- The ESE corresponds to the ENABLE part of a SCPI register. If a bit is set in the ESE and the associated bit in the ESR changes from 0 to 1, the ESB bit in the Status Byte (STB) is set.

The bits in the ESR are defined as follows:

Bit No.	Meaning
0	<p>Operation complete</p> <p>This bit is set on receipt of the command <code>*OPC</code> after all previous commands have been executed.</p>
2	<p>Query error</p> <p>This bit is set if either the controller wants to read data from the instrument without having sent a query, or if it does not fetch requested data and sends new instructions to the instrument instead. The cause is often a query which is faulty and hence cannot be executed.</p>
3	<p>Device-dependent error</p> <p>This bit is set if a device-dependent error occurs. An error message with a number between -300 and -399 or a positive error number, which describes the error in greater detail, is entered into the error queue. See also Chapter 9, "Error messages and troubleshooting", on page 1766.</p>

Bit No.	Meaning
4	Execution error This bit is set if a received command is syntactically correct, but cannot be performed for other reasons. An error message with a number between -200 and -300, which describes the error in greater detail, is entered into the error queue.
5	Command error This bit is set if a command which is undefined or syntactically incorrect is received. An error message with a number between -100 and -200, which describes the error in greater detail, is entered into the error queue.
6	User request This bit is set when the instrument is switched over to manual control or when a user-defined softkey is used (see SYSTem:USER:KEY).
7	Power On (supply voltage on) This bit is set when the instrument is switched on.

Related common commands

The Event Status Register (ESR) can be queried using `ESR?`. The Event Status Enable (ESE) register can be set using the command `*ESE` and read using `*ESE?`.

See also [Common commands](#).

6.5.3.4 STATus:OPERation

The STATus:OPERation register contains conditions which are part of the instrument's normal operation. The analyzer does not use the STATus:OPERation register.

6.5.3.5 STATus:QUEStionable

The STATus:QUEStionable register indicates whether the acquired data is of questionable quality and monitors hardware failures of the analyzer. It can be queried using the commands `STATus:QUEStionable:CONDition?` or `STATus:QUEStionable:EVENT?`.

Bit No.	Meaning
9	INTEgrity register summary This bit is set if a bit is set in the STATus:QUEStionable:INTEgrity register and the associated ENABLE bit is set to 1.
10	LIMit register summary This bit is set if a bit is set in the STATus:QUEStionable:LIMit1 register and the associated ENABLE bit is set to 1.

STATus:QUEStionable:LIMit<1|2>

The STATus:QUEStionable:LIMit<1|2> registers indicate the result of the limit check. They can be queried using the commands `STATus:QUEStionable:LIMit<1|2>:CONDition?` or

`STATUS:QUESTIONABLE:LIMIT<1|2>[:EVENT]?`

`STATUS:QUESTIONABLE:LIMIT1` is also the summary register of the lower level

`STATUS:QUESTIONABLE:LIMIT2` register.

The bits in the `STATUS:QUESTIONABLE:LIMIT1` register are defined as follows:

Bit No.	Meaning
0	LIMIT2 register summary This bit is set if a bit is set in the <code>STATUS:QUESTIONABLE:LIMIT2</code> register and the associated <code>ENABLE</code> bit is set to 1.
1	Failed limit check for trace no. 1 This bit is set if any point on trace no. 1 fails the limit check.
...	...
14	Failed limit check for trace no. 14 This bit is set if any point on trace no. 14 fails the limit check.

The bits in the `STATUS:QUESTIONABLE:LIMIT2` register are defined as follows:

Bit No.	Meaning
0	Not used
1	Failed limit check for trace no. 15 This bit is set if any point on trace no. 15 fails the limit check.
2	Failed limit check for trace no. 16 This bit is set if any point on trace no. 16 fails the limit check.

Numbering of traces

The traces numbers 1 to 16 are assigned as follows:

- Traces assigned to channels with smaller channel numbers have smaller trace numbers.
- Within a channel, the order of traces reflects their creation time: The oldest trace has the smallest, the newest trace has the largest trace number. This is equivalent to the order of traces in the response string of the `CALCulate<Ch>:PARAMeter:CATalog? query`.
- The number of traces monitored cannot exceed 16. If a setup contains more traces, the newest traces are not monitored.

`STATUS:QUESTIONABLE:INTEGRITY...`

The `STATUS:QUESTIONABLE:INTEGRITY` register monitors hardware failures of the analyzer. It can be queried using the commands

`STATUS:QUESTIONABLE:INTEGRITY:CONDITION?` or

`STATUS:QUESTIONABLE:INTEGRITY[:EVENT]?`

`STATUS:QUESTIONABLE:INTEGRITY` is also the summary register of the lower level

`STATUS:QUESTIONABLE:INTEGRITY:HARDWARE` register.



Refer to the [Chapter 9, "Error messages and troubleshooting"](#), on page 1766 for a detailed description of hardware errors including possible remedies.

The bits in the `STATUS:QUESTIONABLE:INTEGRITY` register are defined as follows.

Bit No.	Meaning
2	<p>HARDware register summary</p> <p>This bit is set if a bit is set in the <code>STATUS:QUESTIONABLE:INTEGRITY:HARDWARE</code> register and the associated <code>ENABLE</code> bit is set to 1.</p>

`STATUS:QUESTIONABLE:INTEGRITY:HARDWARE`

The `STATUS:QUESTIONABLE:INTEGRITY:HARDWARE` register can be queried using the commands `STATUS:QUESTIONABLE:INTEGRITY:HARDWARE:CONDITION?` or `STATUS:QUESTIONABLE:INTEGRITY:HARDWARE[:EVENT]?`

The bits in the `STATUS:QUESTIONABLE:INTEGRITY:HARDWARE` register are defined as follows.

Bit No.	Meaning
0	Not used
1	<p>Reference frequency lock failure</p> <p>If an external reference signal or an internal high precision clock (option B4) is used, the local oscillator is phase locked to a reference signal. This bit is set if this phase locked loop (PLL) fails.</p> <p>For external reference: check frequency and level of the supplied reference signal.</p>
2	<p>Output power unlevelled</p> <p>This bit is set if the level control at one of the ports is unsettled or unstable, possibly due to an external disturbing signal.</p> <p>Change generator level at the port; check external components.</p>
3	<p>Receiver overload protection tripped</p> <p>This bit is set if the analyzer detects an excessive input level at one of the ports. If this condition persists, all internal and external generators are switched off.</p> <p>Reduce RF input level at the port. Check amplifiers in the external test setup, then switch on the internal source using <code>OUTPUT ON</code>.</p>
4	<p>Problem concerning external switch matrix</p> <p>This bit is set if an external matrix has been configured but cannot be controlled or provides error messages.</p> <p>Check whether the matrix is properly connected and switched on. Check for proper wiring of the interfaces, in particular on input and output. If the LAN or USB interface is configured, disconnect the <code>Direct CTRL</code> plug. Exclude address conflicts when using several external switch matrices or other external devices.</p>
6	<p>Internal communication error</p> <p>This bit is set if an internal error caused the analyzer to perform an automatic hardware reset. The current measurement results are possibly invalid.</p> <p>The bit is automatically cleared at the beginning of the next sweep, no action is required.</p>

Bit No.	Meaning
7	<p>Instrument temperature is too high</p> <p>This bit is set if the analyzer detects that the instrument temperature is too high. Reduce ambient temperature, keep ventilation holes of the casing unobstructed.</p>
8	<p>OCXO cold</p> <p>This bit is set if the oven for the internal high precision clock (option B4) is not at its operating temperature. Wait until the oven has been heated up.</p>
9	<p>Unstable level control</p> <p>This bit is set if the analyzer detects an excessive source level at one of the ports. The signal is turned off and the sweep halted. Check signal path for the received wave, especially check external components. Then restart the sweep (<code>INITiate<Ch>[:IMMEDIATE]</code>).</p>
10	<p>Problem concerning external generator</p> <p>This bit is set if an external generator has been configured but cannot be controlled or provides error messages. Check whether the generator is properly connected and switched on. Check the GPIB address; exclude address conflicts when using several external generators or other equipment.</p>
11	<p>Problem concerning external power meter</p> <p>This bit is set if an external power meter has been configured but cannot be controlled or provides error messages. Check whether the power meter is properly connected and switched on. Check the GPIB address; exclude address conflicts when using several external power meters or other equipment.</p>
12	<p>Time grid too close</p> <p>This bit is set if the sweep points for a time sweep are too close, so that the analyzer cannot process the measurement data until the next sweep point starts. Increase stop time, reduce no. of points, increase IF bandwidth. If possible reduce number of partial measurements, e.g. by restricting the number of ports measured.</p>
14	<p>Power settings exceed hardware limits</p> <p>This bit is set if the source power at one of the test ports is too high or too low. Reduce or increase the source power.</p>
15	<p>Detector MEAS time has been internally limited</p> <p>This bit is set if the selected measurement time for a detector (observation time) is too long. If desired, reduce the measurement time or select a smaller IF bandwidth.</p>

6.5.4 Application of the status reporting system

The purpose of the status reporting system is to monitor the status of one or several devices in a measuring system. To do this and react appropriately, the controller must receive and evaluate the information of all devices. The following standard methods described in the following sections are used:

- Service request (SRQ) initiated by the measuring device

- Serial poll of all devices in the bus system, initiated by the controller to find out who sent an SRQ and why
- Parallel poll of all devices
- Query of a specific instrument status by commands
- Query of the error queue

6.5.4.1 Service request

The R&S ZNA can send a service request (SRQ) to the controller. Usually this service request causes an interrupt, to which the control program can react appropriately.

Initiating an SRQ

As shown in section [Overview of status registers](#), an SRQ is initiated if one or several of bits 2, 3, 4, 5 or 7 of the status byte are set and enabled in the SRE. Each of these bits summarizes the information of a further register, the error queue or the output buffer.

The ENABLE parts of the status registers can be set such that arbitrary bits in an arbitrary status register initiate an SRQ. To use the possibilities of the service request effectively, all bits in the enable registers SRE and ESE must be set to "1".

Example: Use *OPC to generate an SRQ

1. Set bit 0 in the ESE (Operation Complete).
2. Set bit 5 in the SRE (ESB).
3. Insert *OPC in the command sequence (e.g. at the end of a sweep).

When all commands preceding *OPC have been completed, the instrument generates an SRQ.

Example: Generate an SRQ when a limit is exceeded

1. Set bit 3 in the SRE (summary bit of the `STATUS:QUESTIONABLE` register, set after `STATUS:PRESet`)
2. Set bit 10 in the `STATUS:QUESTIONABLE:ENABLE` register (summary bit of the `STATUS:QUESTIONABLE:LIMIT1` register)
3. Set bit 1 in the `STATUS:QUESTIONABLE:LIMIT1:ENABLE` register

The R&S ZNA generates an SRQ when the event associated with bit 1 of the `STATUS:QUESTIONABLE:LIMIT1:ENABLE` register occurs, i.e. when any point on the first trace fails the limit check.

Example: Find out which event caused an SRQ

The procedure to find out which event caused an SRQ is analogous the procedure to generate an SRQ:

1. `STB?` (query the contents of the status byte in decimal form)
If bit 3 (QUESTionable summary bit) is set, then:
2. `STAT:QUES:EVENT?` (query STATus:QUESTionable register)
If bit 10 (QUESTionable:LIMit1 summary bit) is set, then:
3. Query `STAT:QUES:LIMit1:EVENT?` (query STATus:QUESTionable:LIMit1 register)
If bit 1 is set, then the first trace failed the limit check.



The SRQ is the only possibility for the instrument to become active on its own. Each controller program should set the instrument such that a service request is initiated in the case of malfunction. The program should react appropriately to the service request.

6.5.4.2 Serial poll

In a serial poll, the controller queries the SStatus Bytes of the devices in the bus system one after another. The query is made via interface messages, so it is faster than a poll using `*STB?`.

The serial poll method is defined in IEEE 488.1 and used to be the only standard possibility for different instruments to poll the status byte. The method also works for instruments which do not adhere to SCPI or IEEE 488.2.

The serial poll is used to obtain a fast overview of the state of several instruments connected to the controller.

6.5.4.3 Parallel poll

In a parallel poll, up to eight instruments are simultaneously requested by the controller with a single command to transmit 1 bit of information each on the data lines, i.e., to set the data line allocated to each instrument to a logical "0" or "1".

In addition to the SRE register, which determines the conditions under which an SRQ is generated, there is a Parallel Poll Enable (PPE) register. This register is ANDed with the STB bit by bit, considering bit 6 as well. The results are ORed, the result is possibly inverted and then sent as a response to the parallel poll of the controller. The result can also be queried without parallel poll with the command `*IST?`.

The parallel poll method is used to find out quickly which one of the instruments connected to the controller has sent a service request. To this effect, SRE and PPE must be set to the same value.

6.5.4.4 Query of an instrument status

Each part of any status register can be read using queries. There are two types of commands:

- The common commands `*ESR?`, `*IDN?`, `*IST?`, `*STB?` query the higher-level registers.
- The commands of the STATUS system query the SCPI registers (e.g. `STATus:OPERation...`)

All queries return a decimal number which represents the bit pattern of the status register. This number is evaluated by the controller program.

Queries are usually used after an SRQ to obtain more detailed information on its cause.

Decimal representation of a bit pattern

The STB and ESR registers contain 8 bits, the SCPI registers 16 bits. The contents of a status register is keyed and transferred as a single decimal number. To make this possible, each bit is assigned a weighted value. The decimal number is calculated as the sum of the weighted values of all bits in the register that are set to 1.

Bits	0	1	2	3	4	5	6	7	...
Weight	1	2	4	8	16	32	64	128	...

Example: The decimal value $40 = 32 + 8$ indicates that bits no. 3 and 5 in the status register (e.g. the QUESTIONable status summary bit and the ESB bit in the STB) are set.

6.5.4.5 Error queue

Each error state in the instrument leads to an entry in the error queue, whose current number of entries can be queried using `SYSTem:ERRor:COUNT?`. The entries of the error queue are detailed plain text error messages that can be queried via remote control using `SYSTem:ERRor[:NEXT]?` or `SYSTem:ERRor:ALL?`. Each call of `SYSTem:ERRor[:NEXT]?` provides one entry from the error queue. If no error messages are stored there any more, the instrument responds with 0, "No error".

The error queue should be queried after every SRQ in the controller program as the entries describe the cause of an error more precisely than the status registers. Especially in the test phase of a controller program the error queue should be queried regularly since faulty commands from the controller to the instrument are recorded there as well.

6.5.5 Reset values of the status reporting system

The table below indicates the effects of various commands upon the status reporting system of the R&S ZNA.

DCL, SDC (Device Clear, Selected Device Clear)

Event	Switching on supply voltage Power-On-Status-Clear		DCL, SDC (Device Clear, Selected Device Clear)	*RST or SYS-Tem:PRE-Set:ALL	STA-Tus:PRE-Set	*CLS
	0	1				
Effect	0	1				
Clear STB, ESR		yes				yes
Clear SRE, ESE		yes				
Clear PPE		yes				
Clear EVENT parts of the registers		yes				yes
Clear ENABLE parts of all OPERATION and QUESTIONABLE registers, Fill ENABLE parts of all other registers with "1".		yes			yes	
Fill PTRansition parts with "1" Clear NTRansition parts		yes			yes	
Clear error queue	yes	yes				yes
Clear output buffer	yes	yes	yes	1)	1)	1)
Clear command processing and input buffer	yes	yes	yes			

1) Every command being the first in a command line, i.e. immediately following a <PROGRAM MESSAGE TERMINATOR> clears the output buffer.

7 Command reference

This chapter describes all common commands and SCPI commands implemented by the analyzer.



Validity of the command set

The commands reported in this chapter are valid for vector network analyzers with any number of ports. However, some of the program examples assume that more than 2 ports are available. In most cases, a simple adjustment of the port suffixes or parameters ensures compatibility with 2-port analyzers.

Compatibility with R&S ZVB and older instruments

The SCPI command set for the R&S ZNA vector network analyzer has been designed for compatibility with network analyzers R&S ZVA and R&S ZVB. A special subset of commands has been implemented for compatibility with older analyzers of the R&S ZVR family. These commands are listed in [Chapter 7.5, "R&S ZVR/ZVABT compatible commands"](#), on page 1695.

If you want to make full use of the R&S ZNA features but do not need R&S ZVR compatibility, you should use the commands listed in [Chapter 7.3, "SCPI command reference"](#), on page 971.

7.1 Special terms and notation

This section explains the meaning of special syntax elements used in the SCPI command reference sections.

The following information is provided in the reference sections:

- Complete command syntax and parameter list
- Description of the command and its relationship with other commands
- List and description of the parameters with their numerical ranges, default values and default units
- Supported command types (setting command, query). If nothing is mentioned, the command can be used to write **and** read data (setting command and query).
- Program example

The SCPI conformance information is stated at the beginning of each section. Unless otherwise stated, the commands are device-specific.

The commands are generally arranged in alphabetical order. Commands with similar function (e.g. a pair of `...START` and `...STOP` commands) may be described in a common section, which in some instances disrupts the strict alphabetical order.

7.1.1 Upper- vs. lower-case

Upper-/lower-case characters characterize the long and short form of the mnemonics in a command. The short form consists of all uppercase characters, the long form of all uppercase plus all lowercase characters. It is recommended to use either the short form or the long form; mixed forms are not always recognized. The R&S ZNA itself does not distinguish uppercase and lowercase characters.

7.1.2 Special characters

The following special characters are frequently used in the command description:

- **|** A vertical stroke characterizes alternative parameter settings. Only one of the parameters separated by | must be selected.
- **[]** Mnemonics in square brackets can be omitted when composing the command header. The complete command must be recognized by the instrument for reasons of compatibility with the SCPI standard. Parameters in square brackets are optional as well. They may be used in some application contexts, omitted in others.
- **{ }** Braces or curly brackets enclose one or more parameters that may be included zero or more times.

7.1.3 Parameters

Many commands are supplemented by a parameter or a list of parameters. Parameters either provide alternative options (setting a or setting b or setting c ..., see special character "|"), or they form a list separated by commas (setting x, y).

- **<Parameter1>, <Parameter2>...**: In the command tables and lists, parameters are generally described by a name (Parameter1, Parameter2...) written in angle brackets (<>). In an application program, <Parameter1>, <Parameter2>... must be replaced by one of the possible settings reported in the detailed parameter description.

Example: `CONTRol:AUXiliary:C[:DATA] <DecValue>`

with <DecValue> = 0 to 255

--> possible command syntax: `CONTRol:AUXiliary:C:DATA 1`

- **NAN (Not A Number)** (as a returned value) is generally used to represent missing data, e.g. if a portion of a trace has not been acquired yet. It is also returned after invalid mathematical operations such as division by zero. As defined in the SCPI standard, NAN is represented as 9.91 E 37.
- **INV (INValid)** is returned e.g. if a limit check is performed without defining the appropriate tolerance values.

7.1.4 Numeric suffixes

Symbols in angular brackets (<Ch>, <Chn>, <Mk>...) are numeric suffixes. Numeric suffixes are replaced by integer numbers to distinguish various items of the same type.

The analyzer provides numeric suffixes for channels, traces, ports, markers etc. If unspecified, a numeric suffix is replaced by 1.

The number of ports depends on the analyzer model. No restrictions apply to number of markers, channel, trace, and diagram suffixes.

In remote control, one active trace can be selected for each channel; see [Chapter 6.3.2, "Active traces in remote control"](#), on page 946. This concept simplifies the remote control command syntax, because it allows the active trace in a particular channel to be referenced by means of the channel suffix.

To keep the syntax transparent,

- <Ch> is used for channel settings (<Ch> refers to the configured channel)
- <Chn> is used for trace settings (<Chn> refers to the channel whose active trace is configured)

7.2 Common commands

Common commands are described in the IEEE 488.2 (IEC 625-2) standard. These commands have the same effect and are employed in the same way on different devices. The headers of these commands consist of "*" followed by three letters. Many common commands are related to the status reporting system; see [Chapter 6.5, "Status reporting system"](#), on page 953.

Table 7-1: List of common commands

Command	Parameters / Remarks	Short Description
*CLS Clear Status	– / no query	Sets the status byte (STB), the standard event register (ESR) and the EVENT part of the QUESTIONable and the OPERATION register to zero. The command does not alter the mask and transition parts of the registers. It clears the output buffer and the tooltip error messages for remote control.
*ESE Event Status Enable	0...255	Sets the event status enable register to the value indicated. The query *ESE? returns the contents of the event status enable register in decimal form.
*ESR? Event Status Read	– / query only	Returns the contents of the event status register in decimal form (0 to 255) and sets the register to zero.
*IDN? Identification Query	– / query only	Queries the instrument identification string of the R&S ZNA, including the manufacturer, the instrument type, its serial number, and the software revision.. The identification string is editable; see " Define *IDN + *OPT... " on page 889.
*IST? Individual Status query	– / query only	Returns the contents of the IST flag in decimal form (0 1). The IST-flag is the status bit which is sent during a parallel poll.
*OPC Operation Complete	–	Sets bit 0 in the event status register when all preceding commands have been executed. This bit can be used to initiate a service request. The query form writes a "1" to the output buffer when all preceding commands have been executed. This logic is used for command synchronization.

Command	Parameters / Remarks	Short Description
*OPT? OPTion identification query	– query only	Queries the options included in the instrument and returns a list of the options installed. The response consists of arbitrary ASCII response data according to IEEE 488.2. The options are returned at fixed positions in a comma-separated string. A zero is returned for options that are not installed. The OPT information is editable; see "Define *IDN + *OPT..." on page 889.
*PCB Pass Control Back	0...30 / no query	Indicates the controller address to which GPIB bus control is returned after termination of the triggered action.
*PRE Parallel poll Register Enable	0...255	Sets parallel poll enable register to the value indicated. Query *PRE? returns the contents of the parallel poll enable register in decimal form.
*PSC Power on Status Clear	0 1	Determines whether the contents of the ENABLE registers is maintained or reset when the instrument is switched on. *PSC = 0 causes the contents of the status registers to be maintained. Thus a service request can be triggered on switching on in the case of a corresponding configuration of status registers ESE and SRE. *PSC = 1 resets the registers. Query *PSC? reads out the contents of the power-on-status-clear flag. The response can be 0 or 1.
*RST Reset	– / no query	Sets the instrument to a defined default status. The command is equivalent to <code>SYSTem:PRESet [:DUMMy]</code> . The *RST value of each command is reported in the reference description. See also <code>SYSTem:PRESet:SCOPE</code> .
*SRE Service Request Enable	0...255	Sets the service request enable register to the value indicated. Bit 6 (MSS mask bit) remains 0. This command determines under which conditions a service request is triggered. The query *SRE? returns the contents of the service request enable register in decimal form. Bit 6 is always 0.
*STB? Status Byte query	– / query only	Reads the contents of the status byte in decimal form.
*TRG Trigger	– / no query	Triggers all actions waiting for a trigger event. *TRG generates a manual trigger signal. This common command complements the <code>TRIGger...</code> commands of the analyzer.
*TST? Self test	– / query only	Performs a self test and returns its boolean result (0 = passed, 1 = failed)
*WAI Wait to continue	– / no query	Prevents servicing of the subsequent commands until all preceding commands have been executed and all signals have settled.

7.3 SCPI command reference

The following sections provide detailed reference information on the instrument control commands implemented by the R&S ZNA network analyzer.

- [CALCulate commands](#)..... 972
- [CONFigure commands](#)..... 1202
- [CONTRol commands](#)..... 1210
- [DIAGnostic commands](#)..... 1230
- [DISPlay commands](#)..... 1232
- [FORMat commands](#)..... 1258
- [HCOPY commands](#)..... 1259

• INITiate commands.....	1265
• INSTRument commands.....	1268
• MEMory commands.....	1269
• MMEMory commands.....	1271
• OUTPut commands.....	1313
• PROGram commands.....	1319
• [SENSE:] commands.....	1322
• SOURce commands.....	1521
• STATus commands.....	1601
• SYSTem commands.....	1604
• TRACe commands.....	1650
• TRIGger commands.....	1653
• New commands for R&S ZNA.....	1662

7.3.1 CALCulate commands

The `CALCulate...` commands perform post-acquisition data processing. Functions in the `SENSE` subsystem are related to data acquisition, while the `CALCulate` subsystem operates on the data acquired by a `SENSE` function.

• <code>CALCulate:CALValidate</code>	972
• <code>CALCulate:DATA</code>	975
• <code>CALCulate:DTIME</code>	985
• <code>CALCulate:EYE</code>	988
• <code>CALCulate:FILTer[:GATE]</code>	1012
• <code>CALCulate:FMODEl</code>	1017
• <code>CALCulate:LDEVIation</code>	1052
• <code>CALCulate:LIMit</code>	1055
• <code>CALCulate:MARKer</code>	1073
• <code>CALCulate:MATH</code>	1096
• <code>CALCulate:PARAmeter</code>	1101
• <code>CALCulate:RIPPlE</code>	1111
• <code>CALCulate:STATistics</code>	1119
• <code>CALCulate:TRANSform</code>	1130
• <code>CALCulate:TTIME</code>	1194
• <code>CALCulate...</code> (other).....	1196

7.3.1.1 `CALCulate:CALValidate...`

Commands related to [Calibration validation](#).

<code>CALCulate:CALValidate:AVERAge[:STATe]</code>	973
<code>CALCulate:CALValidate:CHARacteriza</code>	973
<code>CALCulate:CALValidate:FORMat</code>	973
<code>CALCulate:CALValidate:RESPonse:IMAGinary:LOWer</code>	973
<code>CALCulate:CALValidate:RESPonse:IMAGinary:UPPer</code>	973
<code>CALCulate:CALValidate:RESPonse:MAGNitude:LOWer</code>	973
<code>CALCulate:CALValidate:RESPonse:MAGNitude:UPPer</code>	973
<code>CALCulate:CALValidate:RESPonse:PHASe:LOWer</code>	974

CALCulate:CALValidate:RESPonse:PHASe:UPPer	974
CALCulate:CALValidate:RESPonse:PRESet	974
CALCulate:CALValidate:RESPonse:REAL:LOWer	974
CALCulate:CALValidate:RESPonse:REAL:UPPer	974
CALCulate:CALValidate:RUN	974
CALCulate:CALValidate:RUN:RESult?	974
CALCulate:CALValidate:STANdard	975

CALCulate:CALValidate:AVERAge[:STATe] <Boolean>

Parameters:

<Boolean>

Manual operation: See "[Preferences](#)" on page 612

CALCulate:CALValidate:CHARacteriza <String>

Selects the CalU characterization to be used for the cal validation.

Use [CALCulate:CALValidate:STANdard](#) to select the CalU standard to be used for the validation.

Parameters:

<String> *RST: 'Factory'

Manual operation: See "[Characterization](#)" on page 611

CALCulate:CALValidate:FORMat <Format>

Parameters:

<Format> MLINear | REAL

Manual operation: See "[Preferences](#)" on page 612

CALCulate:CALValidate:RESPonse:IMAGinary:LOWer <Port>, <Value>

CALCulate:CALValidate:RESPonse:IMAGinary:UPPer <Port>, <Value>**Parameters:**

<Port>

<Value>

Manual operation: See "[Validation Limits](#)" on page 611

CALCulate:CALValidate:RESPonse:MAGNitude:LOWer <Port>, <Value>

CALCulate:CALValidate:RESPonse:MAGNitude:UPPer <Port>, <Value>

Defines the maximum magnitude deviations from the reference characterization S-parameters that are allowed during cal validation.

Use [CALCulate:CALValidate:CHARacteriza](#) to select the reference characterization.

Parameters:

<Port> Physical analyzer port no.
 <Value> *RST: -0.2 (LOWer) | +0.2 (UPPer)
 Default unit: dB

Manual operation: See "[Validation Limits](#)" on page 611

CALCulate:CALValidate:RESPonse:PHASe:LOWer <Port>, <Value>

CALCulate:CALValidate:RESPonse:PHASe:UPPer <Port>, <Value>

Defines the maximum phase deviations from the reference characterization S-parameters that are allowed during cal validation.

Use [CALCulate:CALValidate:CHARacteriza](#) to select the reference characterization.

Parameters:

<Port>
 <Value> *RST: -2 (LOWer) | +2 (UPPer)
 Default unit: degrees

Manual operation: See "[Validation Limits](#)" on page 611

CALCulate:CALValidate:RESPonse:PRESet

Usage: Event

Manual operation: See "[Validation Limits](#)" on page 611

CALCulate:CALValidate:RESPonse:REAL:LOWer <Port>, <Value>

CALCulate:CALValidate:RESPonse:REAL:UPPer <Port>, <Value>

Parameters:

<Port>
 <Value>

Manual operation: See "[Validation Limits](#)" on page 611

CALCulate:CALValidate:RUN

Runs the cal validation with its configured settings.

Usage: Event

Manual operation: See "[Validate](#)" on page 610

CALCulate:CALValidate:RUN:RESult?

Displays the result (PASS/FAIL) of the preceding cal validation ([CALCulate:CALValidate:RUN](#)).

Usage: Query only
Manual operation: See "Validate" on page 610

CALCulate:CALVAlidate:STANdard <Standard>

Selects the CalU standard to be used for cal validation.

Parameters:

<Standard> OPEN | SHORt | MATCh

7.3.1.2 CALCulate:DATA...

The CALCulate:DATA... commands provide access to the results of a measurement.



Data format

The trace data is transferred in either ASCII or block data (REAL) format, depending on the FORMat[:DATA] setting. If block data format is used, it is recommended to select EOI as a receive terminator (SYSTem:COMMunicate:GPIB[:SELF]:RTERminator EOI).

CALCulate<Chn>:DATA.....	975
CALCulate:DATA:ALL?.....	978
CALCulate<Ch>:DATA:CALL.....	979
CALCulate<Ch>:DATA:CALL:CATalog?.....	980
CALCulate<Ch>:DATA:CHANnel:ALL?.....	980
CALCulate<Ch>:DATA:CHANnel:DALL?.....	980
CALCulate:DATA:DALL?.....	981
CALCulate<Ch>:DATA:MDATa:INTerpolate.....	981
CALCulate<Chn>:DATA:NSWeep:COUNT?.....	981
CALCulate<Chn>:DATA:NSWeep:FIRSt?.....	982
CALCulate<Chn>:DATA:NSWeep[:LAST]?.....	983
CALCulate<Ch>:DATA:SGRoup?.....	983
CALCulate<Chn>:DATA:STIMulus?.....	984
CALCulate:DATA:TRACe.....	984

CALCulate<Chn>:DATA <Format>, <Data>...

CALCulate<Chn>:DATA? <Format>

The query reads the response values of the selected channel's active trace or reads error terms of the selected channel.

The "set command" either imports formatted or unformatted trace data to the selected channel's active trace (see Chapter 4.1.7, "Data flow", on page 120) or writes error terms of the selected channel.

Note

- The data format is parameter-dependent; see tables below. The unit is the default unit of the measured parameter; see `CALCulate<Ch>:PARAmeter:SDEFine`.
- Unformatted trace data (SDATa) can only be imported to memory traces
- Formatted trace data (FDATa) can only be imported to "live" traces if the related channel is in single sweep mode (`INITiate<Ch>:CONTInuous OFF`).
Before the import, the target trace must be prepared according to the settings used during export. Any request for new data from the hardware ("Restart Sweep" in single sweep mode or switching to continuous sweep mode) discards imported data and switches back the display to measured data.

Suffix:

<Chn> Channel number used to identify the active trace

Parameters:

<Data> Trace data either in ASCII or block data format, depending on the current `FORMat[:DATA]` setting.

Parameters for setting and query:

<Format> FDATa | SDATa | MDATa | TSData | NCData | UCData | SCORr1 | SCORr2 | SCORr3 | SCORr4 | SCORr5 | SCORr6 | SCORr7 | SCORr8 | SCORr9 | SCORr10 | SCORr11 | SCORr12 | SCORr13 | SCORr14 | SCORr15 | SCORr16 | SCORr17 | SCORr18 | SCORr19 | SCORr20 | SCORr21 | SCORr22 | SCORr23 | SCORr24 | SCORr25 | SCORr26 | SCORr27

See list of parameters below.

Example:

```
*RST; SWE:POIN 20
```

Create a trace with 20 sweep points, making the created trace the active trace of channel 1 (omitted optional mnemonic `SENSe1`).

```
CALC:DATA? FDAT
```

Query the 20 response values of the created trace. In the `FDATa` setting, 20 comma-separated ASCII values are returned.

```
CALC:DATA:STIM?
```

Query the 20 stimulus values of the created trace. 20 comma-separated ASCII values are returned.

```
CALC2:PAR:SDEF 'Trc2', 'S11'
```

Create a second trace in a new channel no. 2. The second trace does not become the active trace and is not displayed.

```
CALC:DATA:TRAC? 'Trc2', FDAT
```

Query the response values of the second (non-active) trace. 20 comma-separated ASCII values are returned.

```
CALC:DATA:ALL? FDAT
```

Query the response values of all traces. 40 comma-separated ASCII values are returned.

Example:**Writing memory traces**

```
*RST; SWE:POIN 3
```

Create a data trace 'Trc1' with 3 sweep points, making the created trace the active trace of channel 1 (omitted optional mnemonic SENSE1).

```
TRAC:COPY 'MemTrc1','Trc1'; :CALC:PAR:SEL
'MemTrc1'
```

Copy the data trace to a memory trace and select the memory trace as an active trace.

```
CALC:DATA SDAT, 1,2, 3,4, 5,6
```

Write numbers (1,2), (3,4), (5,6) to the memory trace.

```
CALC:DATA? SDAT
```

Query the memory trace. The response is 1,2,3,4,5,6.

```
FORM REAL, 32
```

Change the data format to 4-byte block data.

```
CALC:DATA SDAT, #224123456789012345678901234
```

Write 24 bytes (= 4 * 2 * 3 bytes) of data to the memory trace.

The following parameters are related to trace data (see also diagram in [Chapter 4.1.7, "Data flow"](#), on page 120):

Table 7-2: Data format identifiers used in the CALCulate:DATA... commands

FDATa	Formatted trace data, according to the selected trace format (CALCulate<Chn>:FORMat). One value per trace point for Cartesian diagrams, two values for polar diagrams. [Data access point 6]
SDATa	Unformatted trace data: real and imaginary part of each measurement point. Two values per trace point irrespective of the selected trace format. The trace mathematics is not taken into account. [Data access point 4]
MDATa	Unformatted trace data (see SDATa) after evaluation of trace mathematics. [Data access point 5]
TSDat	Raw measured values in pulse profile mode, only available for wave quantities and if pulse profile mode is active. The values correspond to the real output values of the A/D converter; acquired at a fixed sampling rate. The number of values in the returned array is not correlated with the number of sweep points.
NCDat	Factory calibrated trace data: the values are obtained right after applying the factory calibration but before applying a user-defined calibration (if any). [Data access point 1]
UCDat	Uncalibrated trace data. [Data access point 0] Note: <ul style="list-style-type: none"> the respective trace must represent a wave quantity or ratio driving and receiving port must not be on a switch matrix Otherwise an error occurs.

The following parameters denote the error terms generated during a calibration.

Table 7-3: Error terms in the CALCulate:DATA... commands

Error Term	Description	Receive Ports (S-parameter)
SCORr1, ..., SCORr12	2-port error terms; see [SENSe<Ch>:]CORRection:DATA.	1 and 2 (S11, S12, S21, S22)
SCORr13	Directivity	3 (S33)
SCORr14	Source match	3 (S33)
SCORr15	Reflection tracking	3 (S33)
SCORr16	Isolation	3 (S31)
SCORr17	Load match	3 (S31)
SCORr18	Transmission tracking	3 (S13)
SCORr19	Isolation	1 (S13)
SCORr20	Load match	1 (S13)
SCORr21	Transmission tracking	1 (S13)
SCORr22	Isolation	3 (S32)
SCORr23	Load match	3 (S32)
SCORr24	Transmission tracking	3 (S32)
SCORr25	Isolation	2 (S23)
SCORr26	Load match	2 (S23)
SCORr27	Transmission tracking	2 (S23)

Note: The error terms are channel-specific; they apply to the active calibration of channel no. <Chn> or to the factory calibration (if no channel calibration is active). For the factory calibration, the query form is allowed only (no change of factory calibration data).

Tip: Use the generalized command [SENSe<Ch>:]CORRection:CDATa to read or write error terms for arbitrary analyzer ports. For additional programming examples refer to [Chapter 8.2.5.3, "Saving and recalling error terms"](#), on page 1750.

CALCulate:DATA:ALL? <Format>[, <RecallSet>]

Reads the current response values of all traces of the referenced recall set.

Query parameters:

<Format> FDATa | SDATa | MDATa
 Output format for the S-parameter data, see
[CALCulate<Chn>:DATA.](#)

<RecallSet> Recall set name; if omitted the active recall set is used

Return values:

<Data> Response values either in ASCII or block data format, depending on the current FORMat [:DATA] setting.

Example: See `CALCulate<Ch>:DATA`

Usage: Query only

CALCulate<Ch>:DATA:CALL <Format>, <Data>...

The query reads the current response values of all S-parameter data traces at channel <Ch>'s data access point <DACPoint>.

If a full n-port system error correction is active in the related channel, the command reads the full nxn S-matrix of the calibrated ports (there is no need to create or display the S-parameter traces). Use `CALCulate<Ch>:DATA:CALL:CATalog?` to query the available traces.

The "set direction" allows you to import measurement data at the "Fixture Simulation Input" data access point (see [Chapter 4.1.7, "Data flow"](#), on page 120).

Note

- Importing data is only supported in single sweep mode (`INITiate<Ch>:CONTinuous OFF`)
- Before importing data, the channel must be configured with the same settings that were used during export (user calibration, balanced port configuration, stimulus axis etc.).
Furthermore the switch matrix configuration must match.
- After importing data, "downstream" parameters in the data flow can be changed and their effect is shown directly
- Any request for new data from the hardware (Restart Sweep in single sweep mode or switching to continuous sweep mode) discards imported data and switches back the display to measured data

Suffix:

<Ch> Channel number

Parameters:

<Format> SDATa | FSIData

SDATa

Output as unformatted trace data; see `CALCulate<Ch>:DATA`. Query only.

FSIData

Output or input at "Fixture Simulation Input" data access point.

<Data>

Trace data either in ASCII or block data format, depending on the current `FORMat [:DATA]` setting.

The column order must match the one used during export.

Example: Suppose that a TOSM calibration for ports 1 and 2 is active in channel no. 1.
`CALCulate:DATA:CALL:CATalog?`
 Query the traces available for `CALCulate<Ch>:DATA:CALL?`.
 The response is 'S11, S12, S21, S22'.
`CALCulate:DATA:CALL? SDATa`
 Return the complex response values of all traces. The traces in the catalog list are read one after another: The response array contains n (number of points) pairs of real and imaginary values for S₁₁, followed by n pairs of values for S₁₂, S₂₁, and S₂₂.

CALCulate<Ch>:DATA:CALL:CATalog?

Returns all traces which are available for `CALCulate<Ch>:DATA:CALL` in channel no. <Ch>. The response is a string parameter with all S-parameter traces in the current channel or in the active system error correction; see example.

Suffix:
 <Ch> Channel number

Example: See `CALCulate<Ch>:DATA:CALL`

Usage: Query only

CALCulate<Ch>:DATA:CHANnel:ALL? <Format>

Reads the current response values of all traces of the selected channel.

Suffix:
 <Ch> Channel number

Query parameters:
 <Format> FDATa | SDATa | MDATa
 Output format for the S-parameter data, see `CALCulate<Chn>:DATA`.

Return values:
 <Data> Trace data either in ASCII or block data format, depending on the current `FORMat[:DATA]` setting.

Usage: Query only

CALCulate<Ch>:DATA:CHANnel:DALL? <Format>

Reads the current response values of all data traces of the selected channel. Use `CALCulate<Ch>:DATA:CHANnel:ALL?` to query data traces and memory traces.

Suffix:
 <Ch> Channel number

Query parameters:

<Format> FDATA | SDATA | MDATA
 Output format for the S-parameter data, see [CALCulate<Chn>:DATA](#).

Return values:

<Data> Trace data either in ASCII or block data format, depending on the current [FORMat \[:DATA\]](#) setting.

Usage: Query only

CALCulate:DATA:DALL? <Format>

Reads the current response values of all data traces of the current recall set. Use [CALCulate:DATA:ALL?](#) to query data traces and memory traces.

Query parameters:

<Format> FDATA | SDATA | MDATA
 Output format for the S-parameter data, see [CALCulate<Chn>:DATA](#).

Return values:

<Data> Response values either in ASCII or block data format, depending on the current [FORMat \[:DATA\]](#) setting.

Example: Analogous to [CALCulate:DATA:DALL?](#); see [CALCulate<Chn>:DATA](#).

Usage: Query only

CALCulate<Ch>:DATA:MDATA:INTerpolate

Uses linear inter-/extrapolation to "regrid" all memory traces of the related channel to the channel's current stimulus values.

Suffix:

<Ch> Channel number

Usage: Event

CALCulate<Chn>:DATA:NSweep:COUNT?

Reads the number of completed sweeps in single sweep mode ([INITiate<Ch>:CONTinuous OFF](#)). The trace can be any of the traces acquired during the single sweep cycle.

Tip:

This command can only be used for [\[SENSe<Ch>:\]SWEep:COUNT](#) > 1.

Suffix:

<Chn> Channel number used to identify the active trace

Example: See `CALCulate<Chn>:DATA:NSweep:FIRSt?`

Usage: Query only

CALCulate<Chn>:DATA:NSweep:FIRSt? <Format>, <FwCount>[, <FwCountEnd>]

Reads the response values of a trace or a consecutive group of traces acquired in single sweep mode (`INITiate<Ch>:CONTinuous OFF`).

Tip:

This command can only be used for `[SENSe<Ch>:]SWEep:COUNT > 1`.

Suffix:

<Chn> Channel number used to identify the active trace

Query parameters:

<Format> SDATa

Read unformatted sweep data (fixed parameter): Returns the real and imaginary part of each measurement point (2 values per trace point irrespective of the selected trace format).

<FwCount> Number of first sweep to be read. 1 denotes the first sweep acquired, 2 denotes the second and so forth. The sweep count in single sweep mode is defined via `[SENSe<Ch>:]SWEep:COUNT`.

Range: 1 to sweep count

<FwCountEnd> Number of last sweep to be read. If this parameter is omitted, it is implicitly set to <FwCount> (a single sweep is read).

Range: <FwCount> to sweep count

Return values:

<Data> Response values either in ASCII or block data format, depending on the current `FORMat[:DATA]` setting.

Example:

```
SWE:COUN 10
```

Define the number of sweeps (10) to be measured in single sweep mode.

```
INIT:CONT OFF; :INIT;
```

Activate single sweep mode and start a single sweep sequence in channel no. 1. No synchronization is necessary.

```
if (CALC:DATA:NSW:COUN? > 4)
```

```
CALC:DATA:NSW:FIRS? SDAT, 5
```

Wait until 5 sweeps have been measured, then query the results of the 5th sweep.

See also [Chapter 8.2.4.3, "Retrieving the results of previous sweeps"](#), on page 1745.

Usage: Query only

CALCulate<Chn>:DATA:NSweep[:LAST]? <Format>, <RvCount>

Reads the response values of a trace acquired in single sweep mode (`INITiate<Ch>:CONTinuous OFF`). The trace can be any of the traces acquired during the single sweep cycle.

Tip:

- This command can only be used for `[SENSe<Ch>:]SWEep:COUNT > 1`.
- Ensure that the single sweep is terminated before using this command, otherwise the results of the trace count will be unpredictable (see example below). Alternatively, use the `CALCulate<Chn>:DATA:NSweep:FIRSt?` command.

Suffix:

<Chn> Channel number used to identify the active trace

Query parameters:

<Format> SDATa

Read unformatted sweep data (fixed parameter): Returns the real and imaginary part of each measurement point (2 values per trace point, irrespective of the selected trace format).

<RvCount> Number of sweep to be read. 1 denotes the last sweep acquired, 2 denotes the second-last and so forth.

Range: 1 to sweep count defined via `[SENSe<Ch>:]SWEep:COUNT`

Example:

```
SWE:COUN 10
```

Define the number of sweeps (10) to be measured in single sweep mode.

```
INIT:CONT OFF; :INIT; *OPC?
```

Activate single sweep mode and start a single sweep sequence in channel no. 1. Wait until the single sweep sequence is complete.

```
CALC:DATA:NSW? SDAT, 3
```

Query the results of the 8th sweep.

See also [Chapter 8.2.4.3, "Retrieving the results of previous sweeps"](#), on page 1745.

Usage:

Query only

CALCulate<Ch>:DATA:SGRoup? <Format>

Reads the current response values of all S-parameters associated to a group of logical ports (S-parameter group). The S-parameter group must be created before using `CALCulate<Ch>:PARAMeter:DEFine:SGRoup`.

Suffix:

<Ch> Channel number of the previously defined S-parameter group.

Query parameters:

<Format> FDATA | SDATA | MDATA
Output format for the S-parameter data, see [CALCulate<Chn>:DATA](#) on page 975.

Example: See [CALCulate<Ch>:PARAMeter:DEFine:SGROUP](#)

Usage: Query only

CALCulate<Chn>:DATA:STIMulus?

Reads the stimulus values of the active data or memory trace.

Suffix:

<Chn> Channel number used to identify the active trace

Example: See [CALCulate<Chn>:DATA](#)

Usage: Query only

CALCulate:DATA:TRACe <TraceName>, <Format>, <Data>...

The query gets the trace data of an arbitrary (not necessarily the active) trace, referenced by its trace name <TraceName>.

The "set direction" allows to import formatted or unformatted trace data to an existing trace.

Note

- Unformatted trace data (SDATA) can only be imported to memory traces
- Formatted trace data (FDATA) can only be imported to "live" traces if the related channel is in single sweep mode ([INITiate<Ch>:CONTInuous OFF](#)). Before the import, the target trace must be prepared according to the settings used during export. Any request for new data from the hardware ("Restart Sweep" in single sweep mode or switching to continuous sweep mode) discards imported data and switches back the display to measured data.

Parameters:

<TraceName> String parameter containing the trace name

<Format> FDATA | SDATA | MDATA | NCDATA | UCData
Data format; see [Table 7-2](#).

<Data> Trace data for FDATA | SDATA import either in ASCII or block data format, depending on the current [FORMat \[:DATA\]](#) setting. The column order must match the one used during export.

Example: See [CALCulate<Chn>:DATA](#).

7.3.1.3 CALCulate:DTIME...

Defines the properties and retrieves the results of the skew measurement provided with the [Extended time domain analysis](#) option R&S ZNA-K20.

CALCulate<Chn>:DTIME:DATA?	985
CALCulate<Chn>:DTIME:LIMit:FAIL?	985
CALCulate<Chn>:DTIME:LIMit:FAIL:BEEP	986
CALCulate<Chn>:DTIME:LIMit:LIMit	986
CALCulate<Chn>:DTIME:LIMit:STATe	986
CALCulate<Chn>:DTIME:POSition	987
CALCulate<Chn>:DTIME:STATe	987
CALCulate<Chn>:DTIME:TARGet	987

CALCulate<Chn>:DTIME:DATA? [<Data>]

Queries the results of the skew measurement

Suffix:

<Chn> Channel number used to identify the active trace

Query parameters:

<Data> ALL

If omitted, a single numeric value is returned. If ALL is specified, the result consists of 6 numeric values. Furthermore, the interpretation of the result values depends on the active trace's stimulus axis ([CALCulate<Chn>:TRANSform:TIME:XAXis](#)). See the table below.

Note that the skew value is positive, if, at the defined position ([CALCulate<Chn>:DTIME:POSition](#)), the active trace is to the right of the reference trace.

Usage: Query only

Options: R&S ZNA-K20

Manual operation: See "[Extended Info](#)" on page 828

	<Data> omitted	<Data> = ALL
Stimulus axis: time	<skew time>	<skew time>, <skew distance>, <X value of ref. point on current trace>, <Y value of ref. point on current trace>, <X value of ref. point on reference trace>, <Y value of ref. point on reference trace>
Stimulus axis: distance	<skew distance>	<skew distance>, <skew time>, <X value of ref. point on current trace>, <Y value of ref. point on current trace>, <X value of ref. point on reference trace>, <Y value of ref. point on reference trace>

CALCulate<Chn>:DTIME:LIMit:FAIL? <Boolean>

Indicates whether the skew has passed or failed.

Suffix:
 <Chn> Channel number used to identify the active trace

Return values:
 <Boolean> 0 – skew check has passed
 1 – skew check has failed

Usage: Query only

Options: R&S ZNA-K20

CALCulate<Chn>:DTIME:LIMit:FAIL:BEEP <Boolean>

Defines whether the R&S ZNA makes an audible beep on skew limit violations.

Suffix:
 <Chn> Channel number used to identify the active trace

Parameters:
 <Boolean> *RST: OFF

Options: R&S ZNA-K20

Manual operation: See "[Skew Fail Beep](#)" on page 828

CALCulate<Chn>:DTIME:LIMit:LIMit <arg0>

Defines the limit value for the skew check.

Suffix:
 <Chn> Channel number used to identify the active trace

Parameters:
 <arg0> Limit value in seconds or meters, depending on the format of the current trace's stimulus axis (see [CALCulate<Chn>:TRANSform:TIME:XAXis](#)).

Options: R&S ZNA-K20

Manual operation: See "[Skew Limit](#)" on page 828

CALCulate<Chn>:DTIME:LIMit:STATe <Boolean>

Activates/deactivates the skew limit check.

Use [CALCulate<Chn>:DTIME:LIMit:LIMit](#) to set the applicable limit.

Suffix:
 <Chn> Channel number used to identify the active trace

Parameters:
 <Boolean> *RST: OFF

Options: R&S ZNA-K20

Manual operation: See "[Skew Check On](#)" on page 828

CALCulate<Chn>:DTIME:POSITION <SkewPos>

Defines the position of the skew measurement.

Suffix:

<Chn> Channel number used to identify the active trace

Parameters:

<SkewPos> Skew position as integer percentage of the step size

Options: R&S ZNA-K20

Manual operation: See "[Skew Position](#)" on page 828

CALCulate<Chn>:DTIME:STATE <Boolean>

Enables/disables the [Skew Measurement](#).

Note: The skew measurement can only be performed if the following conditions are met for both the active trace and the reference trace:

- the trace format is real (`CALCulate<Chn>:FORMat REAL`)
- Time Domain is enabled (`CALCulate<Chn>:TRANSform:TIME:STATE ON`)
- the Low Pass Step time domain transform is used `CALCulate<Chn>:TRANSform:TIME[:TYPE] LPASs` and `CALCulate<Chn>:TRANSform:TIME:STIMulus STEP`)

The latter, in turn, requires the stimulus grid to be harmonic. This can be achieved, for example, using `[SENSe<Ch>:]HARMonic:AUTO ON`.

Suffix:

<Chn> Channel number used to identify the active trace

Parameters:

<Boolean> *RST: OFF

Options: R&S ZNA-K20

Manual operation: See "[Skew](#)" on page 827

CALCulate<Chn>:DTIME:TARGET <SkewRefTrace>

Selects the reference trace for the skew measurement.

See `CALCulate<Chn>:DTIME:STATE` for conditions on both the active and the reference trace.

Suffix:

<Chn> Channel number used to identify the active trace

Parameters:

<SkewRefTrace> Reference trace, identified by its name (within channel <Chn>).

Options: R&S ZNA-K20

Manual operation: See "[Reference Trace](#)" on page 828

7.3.1.4 CALCulate:EYE...

Defines the properties and retrieves the results of the eye diagram measurement provided with the [Extended time domain analysis](#) option R&S ZNA-K20.

CALCulate<Chn>:EYE:DUT:MODE.....	989
CALCulate<Chn>:EYE:EMPHasis:CURSor:POST<1 2>.....	989
CALCulate<Chn>:EYE:EMPHasis:CURSor:PRE.....	990
CALCulate<Chn>:EYE:EMPHasis:STATe.....	990
CALCulate<Chn>:EYE:EQUalization:CTLE:DC.....	990
CALCulate<Chn>:EYE:EQUalization:CTLE:POLE<1 2>.....	991
CALCulate<Chn>:EYE:EQUalization:CTLE:ZERO.....	991
CALCulate<Chn>:EYE:EQUalization:STATe.....	992
CALCulate<Chn>:EYE:INPut:BPATtern:TYPE.....	992
CALCulate<Chn>:EYE:INPut:DRATe.....	992
CALCulate<Chn>:EYE:INPut:LENGth:BITS.....	993
CALCulate<Chn>:EYE:INPut:LENGth:PRBS.....	993
CALCulate<Chn>:EYE:INPut:MODulation.....	994
CALCulate<Chn>:EYE:INPut:XRATe.....	994
CALCulate<Chn>:EYE:INPut:OLEVel.....	994
CALCulate<Chn>:EYE:INPut:ZLEVel.....	994
CALCulate<Chn>:EYE:INPut:RTIME:DATA.....	995
CALCulate<Chn>:EYE:INPut:RTIME:THReshold.....	995
CALCulate<Chn>:EYE:JITTer:DIRac:DELTA.....	995
CALCulate<Chn>:EYE:JITTer:DIRac:PROBability.....	996
CALCulate<Chn>:EYE:JITTer:PERiodic:FREQUency.....	996
CALCulate<Chn>:EYE:JITTer:PERiodic:MAGNitude.....	997
CALCulate<Chn>:EYE:JITTer:PERiodic:PHASe.....	997
CALCulate<Chn>:EYE:JITTer:RANDom:STDDeviation.....	997
CALCulate<Chn>:EYE:JITTer:STATe.....	998
CALCulate<Chn>:EYE:JITTer:TYPE:DIRac.....	998
CALCulate<Chn>:EYE:JITTer:TYPE:PERiodic.....	999
CALCulate<Chn>:EYE:JITTer:TYPE:RANDom.....	999
CALCulate<Chn>:EYE:JITTer:TYPE:USER.....	1000
CALCulate<Chn>:EYE:MASK:AUTO.....	1000
CALCulate<Chn>:EYE:MASK:CENTer:HORizontal.....	1000
CALCulate<Chn>:EYE:MASK:CENTer:VERTical.....	1001
CALCulate<Chn>:EYE:MASK:DATA?.....	1001
CALCulate<Chn>:EYE:MASK:FAIL?.....	1002
CALCulate<Chn>:EYE:MASK:FAIL:BEEP.....	1003
CALCulate<Chn>:EYE:MASK:FAIL:CONDition.....	1003
CALCulate<Chn>:EYE:MASK:SHAPe:BOTTom:HORizontal.....	1004
CALCulate<Chn>:EYE:MASK:SHAPe:TOP:HORizontal.....	1004
CALCulate<Chn>:EYE:MASK:SHAPe:BOTTom:STATe.....	1004
CALCulate<Chn>:EYE:MASK:SHAPe:POLYgon:STATe.....	1004
CALCulate<Chn>:EYE:MASK:SHAPe:TOP:STATe.....	1004
CALCulate<Chn>:EYE:MASK:SHAPe:BOTTom:VERTical.....	1004
CALCulate<Chn>:EYE:MASK:SHAPe:TOP:VERTical.....	1004
CALCulate<Chn>:EYE:MASK:SHAPe:POLYgon:HORizontal.....	1005
CALCulate<Chn>:EYE:MASK:SHAPe:POLYgon:TYPE.....	1005

<code>CALCulate<Chn>:EYE:MASK:SHAPE:POLYGON:VERTICAL</code>	1006
<code>CALCulate<Chn>:EYE:MASK:SHOW</code>	1006
<code>CALCulate<Chn>:EYE:MASK:STATE</code>	1006
<code>CALCulate<Chn>:EYE:MASK:VIOLATION:RATE</code>	1007
<code>CALCulate<Chn>:EYE:MASK:VIOLATION:TOLERANCE</code>	1007
<code>CALCulate<Chn>:EYE:MEASUREMENT:DATA?</code>	1007
<code>CALCulate<Chn>:EYE:MEASUREMENT:STATE</code>	1009
<code>CALCulate<Chn>:EYE:MEASUREMENT:TTIME:THRESHOLD</code>	1009
<code>CALCulate<Chn>:EYE:NOISE:RMS</code>	1009
<code>CALCulate<Chn>:EYE:NOISE:STATE</code>	1010
<code>CALCulate<Chn>:EYE:STATE</code>	1010
<code>CALCulate<Chn>:EYE:STIMULUS:ENCODER</code>	1010
<code>CALCulate<Chn>:EYE:STIMULUS:LOWPASS</code>	1011
<code>CALCulate<Chn>:EYE:STIMULUS:SCRAMBLER</code>	1011
<code>CALCulate<Chn>:EYE:VIEW</code>	1011

`CALCulate<Chn>:EYE:DUT:MODE <DUTMode>`

Allows to (temporarily) switch between the measured DUT and an ideal one (with flat frequency response) in the related eye diagram.

This command will raise an execution error if the active trace in the selected channel is not an eye diagram.

Suffix:

<Chn> Channel number used to identify the active trace

Parameters:

<DUTMode> IDEal | MEASured

Options:

R&S ZNA-K20

Manual operation: See "[Mode](#)" on page 819

`CALCulate<Chn>:EYE:EMPHASIS:Cursors:POST<1|2> <Weight>`

Sets the weights of the post-cursor taps for the pre-emphasis FIR filter in the calculation chain of the related eye diagram.

This command will raise an execution error if the active trace in the selected channel is not an eye diagram.

Emphasis in the generator simulation for eye diagram measurements is enabled using `CALCulate<Chn>:EYE:EMPHASIS:STATE`.

Suffix:

<Chn> Channel number used to identify the active trace

<1|2> 1 for the "Post 1" filter tap, 2 for the "Post 2" filter tap.

Parameters:

<Weight> Weight relative to the "Cursor" tap

*RST: 0 dB

Default unit: dB

Options: R&S ZNA-K20

Manual operation: See "[Cursor Settings](#)" on page 816

CALCulate<Chn>:EYE:EMPHasis:CURSor:PRE <Weight>

Sets the weight of the pre-cursor tap for the pre-emphasis FIR filter in the calculation chain of the related eye diagram.

This command will raise an execution error if the active trace in the selected channel is not an eye diagram.

Emphasis in the generator simulation for eye diagram measurements is enabled using [CALCulate<Chn>:EYE:EMPHasis:STATe](#).

Suffix:

<Chn> Channel number used to identify the active trace

Parameters:

<Weight> Weight relative to the "Cursor" tap
 *RST: 0 dB
 Default unit: dB

Options: R&S ZNA-K20

Manual operation: See "[Cursor Settings](#)" on page 816

CALCulate<Chn>:EYE:EMPHasis:STATe <Boolean>

Activates/deactivates pre-emphasis in the calculation chain of the related eye diagram.

This command will raise an execution error if the active trace in the selected channel is not an eye diagram.

Suffix:

<Chn> Channel number used to identify the active trace

Parameters:

<Boolean> *RST: OFF

Options: R&S ZNA-K20

Manual operation: See "[Active](#)" on page 816

CALCulate<Chn>:EYE:EQUalization:CTLE:DC <DC Gain>

Specifies the DC gain of the CTLE (a two-pole filter with single zero) at the receiver simulation of the related eye diagram.

This command will raise an execution error if the active trace in the selected channel is not an eye diagram.

The equalizer can be enabled/disabled using [CALCulate<Chn>:EYE:EQUalization:STATe](#).

Suffix:
 <Chn> Channel number used to identify the active trace

Parameters:
 <DC Gain> *RST: 0 dB
 Default unit: dB

Options: R&S ZNA-K20

Manual operation: See "[CTLE Equalizer](#)" on page 820

CALCulate<Chn>:EYE:EQUalization:CTLE:POLE<1|2> <CTLE Poles>

Specifies the poles of the CTLE (a two-pole filter with single zero) used at the receiver simulation of the related eye diagram.

This command will raise an execution error if the active trace in the selected channel is not an eye diagram.

The equalizer can be enabled/disabled using [CALCulate<Chn>:EYE:EQUalization:STATE](#).

Suffix:
 <Chn> Channel number used to identify the active trace
 <1|2>

Parameters:
 <CTLE Poles> Default unit: Hz

Options: R&S ZNA-K20

Manual operation: See "[CTLE Equalizer](#)" on page 820

CALCulate<Chn>:EYE:EQUalization:CTLE:ZERO <CTLE Zero>

Specifies the zero of the equalizer (a two-pole filter with single zero) used at the receiver simulation of the related eye diagram.

This command will raise an execution error if the active trace in the selected channel is not an eye diagram.

The equalizer can be enabled/disabled using [CALCulate<Chn>:EYE:EQUalization:STATE](#).

Suffix:
 <Chn> Channel number used to identify the active trace

Parameters:
 <CTLE Zero> Default unit: Hz

Options: R&S ZNA-K20

Manual operation: See "[CTLE Equalizer](#)" on page 820

CALCulate<Chn>:EYE:EQUalization:STATe <Boolean>

Enables/disables the CTLE at the receiver simulation of the related eye diagram.

This command will raise an execution error if the active trace in the selected channel is not an eye diagram.

The parameters of the equalizer (a two-pole filter with single zero) can be specified using [CALCulate<Chn>:EYE:EQUalization:CTLE:DC](#), [CALCulate<Chn>:EYE:EQUalization:CTLE:ZERO](#) and [CALCulate<Chn>:EYE:EQUalization:CTLE:POLE<1|2>](#).

Suffix:

<Chn> Channel number used to identify the active trace

Parameters:

<Boolean> *RST: OFF

Options: R&S ZNA-K20

Manual operation: See "[Active](#)" on page 820

CALCulate<Chn>:EYE:INPut:BPATtern:TYPE <BitPattern>

Defines the type of bit stream to be simulated for the related eye diagram.

This command will raise an execution error if the active trace in the selected channel is not an eye diagram.

Suffix:

<Chn> Channel number used to identify the active trace

Parameters:

<BitPattern> PRBS | USER

PRBS

Pseudo-random binary sequence of selectable length (see [CALCulate<Chn>:EYE:INPut:LENGth:PRBS](#))

USER

User defined bit pattern, can be loaded from a 7-bit ASCII file (see [MMEMory:LOAD:EYE:BPATtern](#)) and is repeated until the configured bit length is reached (see [CALCulate<Chn>:EYE:INPut:LENGth:BITS](#)). If not loaded from file, the default pattern "10" is repeated.

Options: R&S ZNA-K20

Manual operation: See "[Bit Stream](#)" on page 809

CALCulate<Chn>:EYE:INPut:DRATe <Rate>

Defines the data rate of the bit stream generator for the related eye diagram.

This command will raise an execution error if the active trace in the selected channel is not an eye diagram.

Suffix:	
<Chn>	Channel number used to identify the active trace
Parameters:	
<Rate>	Data rate with units BPS, KBPS (=10 ³ BPS), MBPS (=10 ⁶ BPS), GBPS (=10 ⁹ BPS) Default unit: BPS
Options:	R&S ZNA-K20
Manual operation:	See " Symbol Rate/Transfer Rate " on page 810

CALCulate<Chn>:EYE:INPut:LENGth:BITS <BitLength>

Defines the length of a user-defined bit stream to be simulated for the related eye diagram. The user-defined bit pattern (the default "10" or loaded from file, see [MMEMory:LOAD:EYE:BPATtern](#)) is repeated until the specified length is reached.

This command will raise an execution error if the active trace in the selected channel is not an eye diagram.

Before executing this command, the pattern type must be set to USER (see [CALCulate<Chn>:EYE:INPut:BPATtern:TYPE](#)).

Suffix:	
<Chn>	Channel number used to identify the active trace
Parameters:	
<BitLength>	Stream length, specified with units BITS, KIBITS (2 ¹⁰ BITS), MIBITS (2 ²⁰ BITS), or GIBITS (2 ³⁰ BITS) Default unit: BITS
Options:	R&S ZNA-K20
Manual operation:	See " Length " on page 810

CALCulate<Chn>:EYE:INPut:LENGth:PRBS <PrbsLength>

Defines the length of the pseudo-random binary sequence to be simulated for the related eye diagram.

This command will raise an execution error if the active trace in the selected channel is not an eye diagram.

Before executing this command the pattern type must be set to PRBS (see [CALCulate<Chn>:EYE:INPut:BPATtern:TYPE](#)).

Suffix:	
<Chn>	Channel number used to identify the active trace
Parameters:	
<PrbsLength>	L5 L7 L9 L10 L11 L13 L15 L_i represents an actual sequence length of $2^i - 1$.
Options:	R&S ZNA-K20

Manual operation: See ["Length"](#) on page 810

CALCulate<Chn>:EYE:INPut:MODulation <PAMType>

Defines or queries the modulation type of the signal to be simulated for the related eye diagram.

This command will raise an execution error if the active trace in the selected channel is not an eye diagram.

Suffix:

<Chn> Channel number used to identify the active trace

Parameters:

<PAMType> NRZ | PM4 | PM8 | PM16
 NRZ, PAM-4, PAM-8 or PAM-16
 *RST: NRZ

Manual operation: See ["Modulation"](#) on page 811

CALCulate<Chn>:EYE:INPut:XRATe <Rate>

Defines the transfer rate of the bit stream generator for the related eye diagram.

Suffix:

<Chn> Channel number used to identify the active trace

Parameters:

<Rate> Transfer rate with units XPS (= transfers per second), KXPS (=10³ XPS), MXPS (=10⁶ XPS), GXPS (=10⁹ XPS)
 Default unit: XPS

Options: R&S ZNA-K20

Manual operation: See ["Symbol Rate/Transfer Rate"](#) on page 810

CALCulate<Chn>:EYE:INPut:OLEVel <OneLevel>

CALCulate<Chn>:EYE:INPut:ZLEVel <VoltageLevel>

Defines the highest/lowest (nominal) voltage level of the simulated digital signal generating the related eye diagram.

This command will raise an execution error if the active trace in the selected channel is not an eye diagram.

Suffix:

<Chn> Channel number used to identify the active trace

Parameters:

<VoltageLevel> Default unit: V

Options: R&S ZNA-K20

Manual operation: See ["High Level / Low Level"](#) on page 811

CALCulate<Chn>:EYE:INPut:RTIME:DATA <RiseTime>

Sets/gets the rise time of the low pass in the binary signal generator simulation of the related eye diagram.

This command will raise an execution error if the active trace in the selected channel is not an eye diagram.

The low pass is enabled using `CALCulate<Chn>:EYE:STIMulus:LOWPass`. The rise time definition can be modified using `CALCulate<Chn>:EYE:INPut:RTIME:THReshold`.

Suffix:

<Chn> Channel number used to identify the active trace

Parameters:

<RiseTime> Default unit: s

Options:

R&S ZNA-K20

Manual operation: See "[Rise Time / Rise Time Definition](#)" on page 811

CALCulate<Chn>:EYE:INPut:RTIME:THReshold <RiseThreshold>

Selects the appropriate rise time definition for the low pass in the binary signal generator simulation of the related eye diagram.

The rise time itself can be configured using `CALCulate<Chn>:EYE:INPut:RTIME:DATA`.

This command will raise an execution error if the active trace in the selected channel is not an eye diagram.

Suffix:

<Chn> Channel number used to identify the active trace

Parameters:

<RiseThreshold> T1_9 | T2_8

T1_9: 10% to 90% (of the voltage amplitude between 1-level and 0-level)

This is the default threshold for eye diagrams.

T2_8: 20% to 80%

Options:

R&S ZNA-K20

Manual operation: See "[Rise Time / Rise Time Definition](#)" on page 811

CALCulate<Chn>:EYE:JITTer:DIRac:DELTA <DiracDelta>

Defines the magnitude of the Dirac jitter in the generator simulation of the related eye diagram.

This command will raise an execution error if the active trace in the selected channel is not an eye diagram.

Dirac jitter insertion can be enabled using `CALCulate<Chn>:EYE:JITTer:TYPE:PERiodic`.

Suffix:

<Chn> Channel number used to identify the active trace

Parameters:

<DiracDelta> *RST: 1 ns
Default unit: s

Options: R&S ZNA-K20

Manual operation: See "Dirac" on page 817

CALCulate<Chn>:EYE:JITTer:DIRac:PROBability <DiracProbability>

Defines the probability of the Dirac jitter in the generator simulation of the related eye diagram.

This command will raise an execution error if the active trace in the selected channel is not an eye diagram.

Dirac jitter insertion can be enabled using `CALCulate<Chn>:EYE:JITTer:TYPE:PERiodic`.

Suffix:

<Chn> Channel number used to identify the active trace

Parameters:

<DiracProbability> Probability of the jitter occurring at each symbol period
*RST: 0.5

Options: R&S ZNA-K20

Manual operation: See "Dirac" on page 817

CALCulate<Chn>:EYE:JITTer:PERiodic:FREQuency <PeriodicFrequency>

Defines the frequency of the periodic jitter in the generator simulation of the related eye diagram.

This command will raise an execution error if the active trace in the selected channel is not an eye diagram.

Periodic jitter insertion can be enabled using `CALCulate<Chn>:EYE:JITTer:TYPE:PERiodic`.

Suffix:

<Chn> Channel number used to identify the active trace

Parameters:

<PeriodicFrequency> *RST: 10 MHz
Default unit: Hz

Options: R&S ZNA-K20

Manual operation: See "[Periodic](#)" on page 817

CALCulate<Chn>:EYE:JITTer:PERiodic:MAGNitude <PeriodicMagnitude>

Defines the magnitude of the periodic jitter in the generator simulation of the related eye diagram.

This command will raise an execution error if the active trace in the selected channel is not an eye diagram.

Periodic jitter insertion can be enabled using [CALCulate<Chn>:EYE:JITTer:TYPE:PERiodic](#).

Suffix:

<Chn> Channel number used to identify the active trace

Parameters:

<PeriodicMagnitude> *RST: 1 ns
Default unit: s

Options: R&S ZNA-K20

Manual operation: See "[Periodic](#)" on page 817

CALCulate<Chn>:EYE:JITTer:PERiodic:PHASe <PeriodicPhase>

Defines the phase of the periodic jitter in the generator simulation of the related eye diagram.

This command will raise an execution error if the active trace in the selected channel is not an eye diagram.

Periodic jitter insertion can be enabled using [CALCulate<Chn>:EYE:JITTer:TYPE:PERiodic](#).

Suffix:

<Chn> Channel number used to identify the active trace

Parameters:

<PeriodicPhase> *RST: 0 deg
Default unit: deg

Options: R&S ZNA-K20

Manual operation: See "[Periodic](#)" on page 817

CALCulate<Chn>:EYE:JITTer:RANDom:STDDeviation <StdDeviation>

Defines the standard deviation of the random jitter in the generator simulation of the related eye diagram.

This command will raise an execution error if the active trace in the selected channel is not an eye diagram.

Random jitter insertion can be enabled using `CALCulate<Chn>:EYE:JITTer:TYPE:RANDom`.

Suffix:

<Chn> Channel number used to identify the active trace

Parameters:

<StdDeviation> Default unit: s

Options:

R&S ZNA-K20

Manual operation: See "[Random](#)" on page 817

CALCulate<Chn>:EYE:JITTer:STATe <Boolean>

Activates the jitter functionality in the generator simulation of the related eye diagram.

This command will raise an execution error if the active trace in the selected channel is not an eye diagram.

The individual jitter sources can be selectively enabled using

- `CALCulate<Chn>:EYE:JITTer:TYPE:DIRac`
- `CALCulate<Chn>:EYE:JITTer:TYPE:PERiodic`
- `CALCulate<Chn>:EYE:JITTer:TYPE:RANDom`
- `CALCulate<Chn>:EYE:JITTer:TYPE:USER`

This command will raise an execution error if the active trace in the selected channel is not an eye diagram.

Suffix:

<Chn> Channel number used to identify the active trace

Parameters:

<Boolean> *RST: OFF

Options:

R&S ZNA-K20

Manual operation: See "[Active](#)" on page 817

CALCulate<Chn>:EYE:JITTer:TYPE:DIRac <Boolean>

Enables/disables Dirac jitter insertion in the generator simulation of the related eye diagram.

This command will raise an execution error if the active trace in the selected channel is not an eye diagram.

Amplitude and probability of the jitter can be specified using `CALCulate<Chn>:EYE:JITTer:DIRac:DELTA` and `CALCulate<Chn>:EYE:JITTer:DIRac:PROBability`, respectively.

Note that jitter will not be applied unless the jitter functionality is activated using `CALCulate<Chn>:EYE:JITTer:STATe`.

Suffix:
 <Chn> Channel number used to identify the active trace

Parameters:
 <Boolean> *RST: OFF

Options: R&S ZNA-K20

Manual operation: See "[Dirac](#)" on page 817

CALCulate<Chn>:EYE:JITTer:TYPE:PERiodic <Boolean>

Enables/disables periodic jitter insertion in the generator simulation of the related eye diagram.

This command will raise an execution error if the active trace in the selected channel is not an eye diagram.

Amplitude, frequency and phase of the jitter can be specified using [CALCulate<Chn>:EYE:JITTer:PERiodic:MAGNitude](#), [CALCulate<Chn>:EYE:JITTer:PERiodic:FREQuency](#) and [CALCulate<Chn>:EYE:JITTer:PERiodic:PHASe](#), respectively.

Note that jitter will not be applied unless the jitter functionality is activated using [CALCulate<Chn>:EYE:JITTer:STATe](#).

Suffix:
 <Chn> Channel number used to identify the active trace

Parameters:
 <Boolean> *RST: OFF

Options: R&S ZNA-K20

Manual operation: See "[Periodic](#)" on page 817

CALCulate<Chn>:EYE:JITTer:TYPE:RANDom <Boolean>

Enables/disables random jitter insertion in the generator simulation of the related eye diagram.

This command will raise an execution error if the active trace in the selected channel is not an eye diagram.

The standard deviation can be set using [CALCulate<Chn>:EYE:JITTer:RANDom:STDDeviation](#).

Note that jitter will not be applied unless the jitter functionality is activated using [CALCulate<Chn>:EYE:JITTer:STATe](#).

Suffix:
 <Chn> Channel number used to identify the active trace

Parameters:
 <Boolean> *RST: OFF

Options: R&S ZNA-K20

Manual operation: See ["Random"](#) on page 817

CALCulate<Chn>:EYE:JITTer:TYPE:USER <Boolean>

Enables/disables user-defined jitter insertion in the generator simulation of the related eye diagram.

This command will raise an execution error if the active trace in the selected channel is not an eye diagram.

Prior to enabling user-defined jitter, the jitter values must have been loaded from file using [MMEMory:LOAD:EYE:JITTer](#).

Note that jitter will not be applied unless the jitter functionality is activated using [CALCulate<Chn>:EYE:JITTer:STATe](#).

Suffix:

<Chn> Channel number used to identify the active trace

Parameters:

<Boolean> *RST: OFF

Options: R&S ZNA-K20

Manual operation: See ["User Specific"](#) on page 817

CALCulate<Chn>:EYE:MASK AUTO

Automatically creates an eye mask, based on the current eye measurement settings.

Suffix:

<Chn> Channel number used to identify the active trace

Usage: Setting only

Manual operation: See ["Automatic Mask Generation"](#) on page 825

CALCulate<Chn>:EYE:MASK:CENTer:HORizontal <HorizontalOffset>

Defines the horizontal center of the eye mask in the related eye diagram.

This command will raise an execution error if the active trace in the selected channel is not an eye diagram.

Suffix:

<Chn> Channel number used to identify the active trace

Parameters:

<HorizontalOffset> Horizontal offset relative to the middle of the eye diagram
Default unit: s

Options: R&S ZNA-K20

Manual operation: See ["Mask Center"](#) on page 824

CALCulate<Chn>:EYE:MASK:CENTer:VERTical <VerticalOffset>

Defines the vertical center of the eye mask in the related eye diagram.

This command will raise an execution error if the active trace in the selected channel is not an eye diagram.

Suffix:

<Chn> Channel number used to identify the active trace

Parameters:

<VerticalOffset> Vertical offset relative to the 0 V level, i.e. the Voltage level of the center.

Default unit: V

Options: R&S ZNA-K20

Manual operation: See "[Mask Center](#)" on page 824

CALCulate<Chn>:EYE:MASK:DATA?

Returns the detailed results of the mask test in the related eye diagram (i.e. the contents of the corresponding result info field).

This command will raise an execution error if the active trace in the selected channel is not an eye diagram, or if [CALCulate<Chn>:EYE:MASK:STATE](#) is OFF.

Use [MMEMory:STORe:EYE:MASK:RESults](#) to save these results to an ASCII file.

Suffix:

<Chn> Channel number used to identify the active trace

Example: `CALCulate1:EYE:MASK:DATA?`
returns something like
'Eye Mask

Fail Condition Type Samples
Violation Tolerance 1
Total Number of Samples 10342

Mask 1 (Top) Active

Samples Hits 366
Fail Rate 3.539 %
Test Result Fail

Mask 2 (Bottom) Not Active

Samples Hits -----
Fail Rate -----
Test Result -----

Mask 3 (Octagon) Not Active

Samples Hits -----
Fail Rate -----
Test Result -----
'

Usage: Query only

Options: R&S ZNA-K20

Manual operation: See "[Mask Test On](#)" on page 821

CALCulate<Chn>:EYE:MASK:FAIL?

Returns 'Pass' or 'Fail' to indicate the result of the limit check in the related eye diagram.

This command will raise an execution error if the active trace in the selected channel is not an eye diagram, if the eye test is not enabled (`CALCulate<Chn>:EYE:MASK:STATe ON`), or if the mask is empty (see `CALCulate<Chn>:EYE:MASK:SHAPE:BOTTom | TOP | POLYgon:STATe`).

Tip

- Use `CALCulate:CLIMits:FAIL?` to perform a composite (global) limit check
- The result is automatically recalculated whenever a relevant setting is changed, i.e. a subsequent query will return the updated mask test result

Suffix:

<Chn> Channel number used to identify the active trace

Return values:

<TestResults>

Usage: Query only**Options:** R&S ZNA-K20**Manual operation:** See "[Mask Test On](#)" on page 821**CALCulate<Chn>:EYE:MASK:FAIL:BEEP <Boolean>**

Defines whether the R&S ZNA should make an audible beep on mask failures in the related eye diagram.

This command will raise an execution error if the active trace in the selected channel is not an eye diagram.

Suffix:

<Chn> Channel number used to identify the active trace

Parameters:

<Boolean> *RST: OFF

Options: R&S ZNA-K20**Manual operation:** See "[Mask Fail Beep](#)" on page 822**CALCulate<Chn>:EYE:MASK:FAIL:CONDition <FailCondition>**

Defines whether the fail condition for the eye mask test of the related eye diagram is specified in absolute or relative terms.

This command will raise an execution error if the active trace in the selected channel is not an eye diagram.

Suffix:

<Chn> Channel number used to identify the active trace

Parameters:

<FailCondition> SAMPlEs | RATE

SAMPlEs: The eye mask test will fail if a configurable number of samples violate the mask (see [CALCulate<Chn>:EYE:MASK:VIOLation:TOLerance](#)).

RATE: The eye mask test will fail if the share of the samples violating the mask is higher than a configurable percentage (see [CALCulate<Chn>:EYE:MASK:VIOLation:RATE](#)).

*RST: SAMPlEs

Options: R&S ZNA-K20**Manual operation:** See "[Test Settings](#)" on page 825

CALCulate<Chn>:EYE:MASK:SHAPE:BOTTom:HORizontal <Width>

CALCulate<Chn>:EYE:MASK:SHAPE:TOP:HORizontal <Width>

Defines the width of the bottom/top rectangle in the eye mask of the related eye diagram.

This command will raise an execution error if the active trace in the selected channel is not an eye diagram.

Use [CALCulate<Chn>:EYE:MASK:SHAPE:BOTTom:STATE](#) or [CALCulate<Chn>:EYE:MASK:SHAPE:TOP:STATE](#) to activate or deactivate the area in the eye mask.

The eye mask test is enabled/disabled using [CALCulate<Chn>:EYE:MASK:STATE](#).

Suffix:

<Chn> Channel number used to identify the active trace

Parameters:

<Width> Default unit: s

Options: R&S ZNA-K20

Manual operation: See "[Top/Bottom Setup](#)" on page 824

CALCulate<Chn>:EYE:MASK:SHAPE:BOTTom:STATE <Boolean>

CALCulate<Chn>:EYE:MASK:SHAPE:POLYgon:STATE <Boolean>

CALCulate<Chn>:EYE:MASK:SHAPE:TOP:STATE <Boolean>

Activates/deactivates the respective area in the eye mask of the related eye diagram.

This command will raise an execution error if the active trace in the selected channel is not an eye diagram.

The eye mask test is enabled/disabled using [CALCulate<Chn>:EYE:MASK:STATE](#).

Suffix:

<Chn> Channel number used to identify the active trace

Parameters:

<Boolean> *RST: OFF

Options: R&S ZNA-K20

Manual operation: See "[Top/Bottom Setup](#)" on page 824

CALCulate<Chn>:EYE:MASK:SHAPE:BOTTom:VERTical <Offset>

CALCulate<Chn>:EYE:MASK:SHAPE:TOP:VERTical <Offset>

Defines the offset of the bottom/top rectangle in the mask of the related eye diagram.

The offset is specified relative to the vertical center of the eye mask (see [CALCulate<Chn>:EYE:MASK:CENTer:VERTical](#) on page 1001).

This command will raise an execution error if the active trace in the selected channel is not an eye diagram.

Use `CALCulate<Chn>:EYE:MASK:SHAPE:BOTTom:STATe` or `CALCulate<Chn>:EYE:MASK:SHAPE:TOP:STATe` to activate or deactivate the area in the eye mask. The eye mask test is enabled/disabled using `CALCulate<Chn>:EYE:MASK:STATe`.

Suffix:

<Chn> Channel number used to identify the active trace

Parameters:

<Offset> Default unit: V

Options:

R&S ZNA-K20

Manual operation: See "[Top/Bottom Setup](#)" on page 824

CALCulate<Chn>:EYE:MASK:SHAPE:POLYgon:HORizontal <Main>[, <Minor>]

Defines the main [and minor] width of the center polygon in the mask of the related eye diagram. The [geometric interpretation](#) depends on the selected polygon type (see `CALCulate<Chn>:EYE:MASK:SHAPE:POLYgon:TYPE` on page 1005):

This command will raise an execution error if the active trace in the selected channel is not an eye diagram.

Use `CALCulate<Chn>:EYE:MASK:SHAPE:POLYgon:STATe` to activate or deactivate the center polygon in the eye mask. The eye mask test is enabled/disabled using `CALCulate<Chn>:EYE:MASK:STATe`.

Suffix:

<Chn> Channel number used to identify the active trace

Parameters:

<Main> Default unit: s

<Minor> Default unit: s

Options:

R&S ZNA-K20

Manual operation: See "[Polygon Setup](#)" on page 823

CALCulate<Chn>:EYE:MASK:SHAPE:POLYgon:TYPE <PolygonType>

Defines the shape of the center polygon (octagon, hexagon or rectangle) in the eye mask of the related eye diagram.

This command will raise an execution error if the active trace in the selected channel is not an eye diagram.

Use `CALCulate<Chn>:EYE:MASK:SHAPE:POLYgon:STATe` to activate or deactivate the area in the eye mask. The eye mask test is enabled/disabled using `CALCulate<Chn>:EYE:MASK:STATe`.

Suffix:

<Chn> Channel number used to identify the active trace

Parameters:

<PolygonType> OCTogon | HEXAgon | RECTangle

Options: R&S ZNA-K20

Manual operation: See "[Polygon Setup](#)" on page 823

CALCulate<Chn>:EYE:MASK:SHAPE:POLYgon:VERTical <Main>[, <Minor>]

Defines the main [and minor] height of the center polygon in the mask of the related eye diagram. The [geometric interpretation](#) depends on the selected polygon type (see [CALCulate<Chn>:EYE:MASK:SHAPE:POLYgon:TYPE](#) on page 1005):

This command will raise an execution error if the active trace in the selected channel is not an eye diagram.

Use [CALCulate<Chn>:EYE:MASK:SHAPE:POLYgon:STATE](#) to activate or deactivate the center polygon in the eye mask. The eye mask test is enabled/disabled using [CALCulate<Chn>:EYE:MASK:STATE](#).

Suffix:

<Chn> Channel number used to identify the active trace

Parameters:

<Main> Default unit: V

<Minor> Default unit: V

Options: R&S ZNA-K20

Manual operation: See "[Polygon Setup](#)" on page 823

CALCulate<Chn>:EYE:MASK:SHOW <Boolean>

Defines the visibility of the configured eye mask in the related eye diagram.

This command will raise an execution error if the active trace in the selected channel is not an eye diagram.

Suffix:

<Chn> Channel number used to identify the active trace

Parameters:

<Boolean> *RST: OFF

Options: R&S ZNA-K20

Manual operation: See "[Show Mask](#)" on page 821

CALCulate<Chn>:EYE:MASK:STATE <Boolean>

Defines whether the eye mask test shall be run after every recalculation of the related eye diagram.

This command will raise an execution error if the active trace in the selected channel is not an eye diagram.

Suffix:

<Chn> Channel number used to identify the active trace

Parameters:

<Boolean> *RST: OFF

Options:

R&S ZNA-K20

Manual operation: See "[Mask Test On](#)" on page 821

CALCulate<Chn>:EYE:MASK:VIOLation:RATE <ViolationRate>

Defines the violation rate (i.e. the share of bad samples) for the mask test in the related eye diagram.

This command will raise an execution error if the active trace in the selected channel is not an eye diagram.

This rate will only be used if [CALCulate<Chn>:EYE:MASK:FAIL:CONDition](#) is set to RATE.

Suffix:

<Chn> Channel number used to identify the active trace

Parameters:

<ViolationRate> Default unit: percent

Options:

R&S ZNA-K20

Manual operation: See "[Test Settings](#)" on page 825

CALCulate<Chn>:EYE:MASK:VIOLation:TOLerance <ViolationTolerance>

Defines the violation tolerance (i.e. the number of bad samples) for the mask test in the related eye diagram.

This command will raise an execution error if the active trace in the selected channel is not an eye diagram.

This tolerance will only be used if [CALCulate<Chn>:EYE:MASK:FAIL:CONDition](#) is set to SAMPLES.

Suffix:

<Chn> Channel number used to identify the active trace

Parameters:

<ViolationTolerance>

Options:

R&S ZNA-K20

Manual operation: See "[Test Settings](#)" on page 825

CALCulate<Chn>:EYE:MEASurement:DATA?

Returns the measurement results of the related eye diagram (see "[Eye Diagram Results](#)" on page 257).

The return value is of type string and returns the eye measurement results in csv format with decimal separator "." and field separator "," (see also [MMEMory:STORe:EYE:MEASurements](#)).

Note that the full set of measurement results is only available for NRZ modulated generator signals (see [CALCulate<Chn>:EYE:INPut:MODulation](#) on page 994).

This command will raise an execution error if the active trace in the selected channel is not an eye diagram.

Suffix:

<Chn> Channel number used to identify the active trace

Example:

For NRZ modulated generator signals

`CALCulate:EYE:MEASurement:DATA?` returns something like

```
'Eye Measurements
Eye Minimum,-102.344 mV,
Eye Maximum,2.699 V,
Eye Base,277.189 µV,
Eye Top,2.597 V,
Eye Mean,1.298 V,
Eye Amplitude,2.596 V,
Eye Height,2.596 V,
Eye Width,10.000 ns,
Bit Period,10.000 ns,
Rise Time,115.000 ps,
Fall Time,115.000 ps,
Jitter Pk-Pk,50.125 ps,
Jitter RMS,0.000 s,
Duty Cycle Dist,0.000 s,
Duty Cycle Pct,0.000 %,
Crossing Percent,50.000 %,
Opening Factor,1.000 ,
SNR,0.000 '
```

For PAM modulated generator signals a reduced set of measurement results is returned:

```
'Eye Measurements
Eye Minimum,-2.909 V,
Eye Maximum,2.997 V,
Eye Base,-2.734 V,
Eye Top,2.734 V,
Eye Mean,0.000 V,
Eye Amplitude,5.468 V'
```

Usage: Query only

Options: R&S ZNA-K20

Manual operation: See "[Display Measurements](#)" on page 807

CALCulate<Chn>:EYE:MEASurement:STATe <Boolean>

Defines the visibility of the result info field in the related eye diagram.

This command will raise an execution error if the active trace in the selected channel is not an eye diagram.

Suffix:

<Chn> Channel number used to identify the active trace

Parameters:

<Boolean>

Options:

R&S ZNA-K20

Manual operation: See "[Display Measurements](#)" on page 807

CALCulate<Chn>:EYE:MEASurement:TTIME:THReshold <ThresholdEnum|
LowerThreshold>[, <UpperThreshold>]

Defines the lower and upper threshold that are used to calculate the transition times (rise/fall time) in an eye measurement.

The thresholds can either be specified by enum constants for the standard 10–90% or 20–80% rise times, or numerically.

Suffix:

<Chn> Channel number used to identify the active trace

Parameters:

<ThresholdEnum|LowerThreshold> T1_10: 10–90% rise time
T2_8: 20–80% rise time
<integer>: Lower rise time threshold as integer percentage
*RST: T1_9:

<UpperThreshold> Upper rise time threshold as integer percentage

Options:

R&S ZNA-K20

Manual operation: See "[Measurements...](#)" on page 807

CALCulate<Chn>:EYE:NOISe:RMS <NoiseRMS>

Defines the root mean square (RMS) noise level in the generator simulation of the related eye diagram.

This command will raise an execution error if the active trace in the selected channel is not an eye diagram.

Gaussian noise insertion can be enabled using [CALCulate<Chn>:EYE:NOISe:STATe](#).

Suffix:

<Chn> Channel number used to identify the active trace

Parameters:

<NoiseRMS> Default unit: V

Manual operation: See "[RMS](#)" on page 819

CALCulate<Chn>:EYE:NOISe:STATe <Boolean>

Enables/disables Gaussian noise in the generator simulation of the related eye diagram.

This command will raise an execution error if the active trace in the selected channel is not an eye diagram.

The noise RMS level can be set using [CALCulate<Chn>:EYE:NOISe:RMS](#).

Suffix:

<Chn> Channel number used to identify the active trace

Parameters:

<Boolean> *RST: OFF

Options: R&S ZNA-K20

Manual operation: See "[Active](#)" on page 819

CALCulate<Chn>:EYE:STATe <Boolean>

Defines whether the active trace in the selected channel shall be represented as an eye diagram.

Suffix:

<Chn> Channel number used to identify the active trace

Parameters:

<Boolean>

Example:

```
*RST
// switch trace to to S31 and switch on the eye diagram
:CALCulate1:PARAMeter:MEASure 'Trc1', 'S31'
CALCulate1:EYE:STATe ON
```

Options: R&S ZNA-K20

Manual operation: See "[Eye Diagram](#)" on page 806

CALCulate<Chn>:EYE:STIMulus:ENCoder <Boolean>

Enables or disables [8b/10b encoding](#) in the bit stream simulation of the related eye diagram.

This command will raise an execution error if the active trace in the selected channel is not an eye diagram.

Suffix:

<Chn> Channel number used to identify the active trace

Parameters:

<Boolean> *RST: OFF

Options: R&S ZNA-K20

Manual operation: See "[Encoder](#)" on page 814

CALCulate<Chn>:EYE:STIMulus:LOWPass <Boolean>

Enables/disables a single pole low pass filter in the binary signal generator simulation of the related eye diagram measurement.

The low-pass is defined using its rise time (see [CALCulate<Chn>:EYE:INPut:RTIME:DATA](#) on page 995) and rise time definition (see [CALCulate<Chn>:EYE:INPut:RTIME:THReshold](#) on page 995).

This command will raise an execution error if the active trace in the selected channel is not an eye diagram.

Suffix:

<Chn> Channel number used to identify the active trace

Parameters:

<Boolean> *RST: OFF

Options: R&S ZNA-K20

Manual operation: See "[Low Pass](#)" on page 811

CALCulate<Chn>:EYE:STIMulus:SCRambler <Boolean>

Enables/disables the scrambler in the bit stream simulation of the related eye diagram.

This command will raise an execution error if the active trace in the selected channel is not an eye diagram.

Suffix:

<Chn> Channel number used to identify the active trace

Parameters:

<Boolean> *RST: OFF

Options: R&S ZNA-K20

Manual operation: See "[Scrambler](#)" on page 814

CALCulate<Chn>:EYE:VIEW <EyeView>

Allows to shorten the calculation chain of the related eye diagram without deactivating the building blocks at the tail end.

This command will raise an execution error if the active trace in the selected channel is not an eye diagram.

Suffix:

<Chn> Channel number used to identify the active trace

Parameters:

<EyeView>

STIMulus | EMPHasis | JITTER | NOISe | DUT | EQUalization

The rightmost building block that shall be part of the calculation chain STIMulus > EMPHasis > JITTER > NOISe > DUT > EQUal-ization.

Note that the selected block must be active, for example

CALCulate1:EYE:VIEW JITTER requires

CALCulate<Chn>:EYE:JITTER:STATE to be ON.

Conversely, if CALCulate1:EYE:VIEW is set to JITTER and

subsequently CALCulate1:EYE:JITTER:STATE is turned

OFF, the calculation chain is further shortened to the next active building block.

Options:

R&S ZNA-K20

Manual operation: See "[Slider]" on page 813

7.3.1.5 CALCulate:FILTer[:GATE]...

The CALCulate:FILTer[:GATE]... commands define the properties of the time gate which is used to optimize the time domain response.

CALCulate:FILTer[:GATE]:TIME:AOFFset.....	1012
CALCulate<Chn>:FILTer[:GATE]:TIME:CENTER.....	1013
CALCulate<Chn>:FILTer[:GATE]:TIME:DCHebyshev.....	1013
CALCulate<Chn>:FILTer[:GATE]:TIME:LINK.....	1014
CALCulate<Chn>:FILTer[:GATE]:TIME:SHAPE.....	1014
CALCulate<Chn>:FILTer[:GATE]:TIME:SHOW.....	1015
CALCulate<Chn>:FILTer[:GATE]:TIME:SPAN.....	1015
CALCulate<Chn>:FILTer[:GATE]:TIME:START.....	1015
CALCulate<Chn>:FILTer[:GATE]:TIME:STOP.....	1015
CALCulate<Chn>:FILTer[:GATE]:TIME:STATE.....	1016
CALCulate<Chn>:FILTer[:GATE]:TIME[:TYPE].....	1016
CALCulate<Chn>:FILTer[:GATE]:TIME:WINDow.....	1017

CALCulate:FILTer[:GATE]:TIME:AOFFset <Boolean>

Activates the operating mode where the time gate is moved in the opposite direction when the "Delay" setting is changed.

Parameters:

<Boolean>

ON | OFF - enable or disable "Adjust Time Gate".

*RST: OFF

Example:

```
*RST; :CALCulate1:TRANSform:TIME:STATE ON
CALCulate1:FILTer:GATE:TIME:STATE ON; SHOW ON
Activate time domain representation and a time gate in channel
no. 1. Display the time gate
CALCulate1:FILTer:GATE:TIME:START 2ns; STOP 3
ns
Restrict the time gate to the time interval between 2 ns and 3 ns.
CALCulate:FILTer:GATE:TIME:AOFFset ON
Activate an offset of the time gate according to a new delay set-
ting.
SENSE1:CORRection:EDELay1:TIME 1ns
Specify a 1 ns delay at port 1.
CALCulate1:FILTer:GATE:TIME:START?; STOP?
Query the time gate position. The response is 1E-009;2E-009.
```

Manual operation: See ["Adjust Time Gate"](#) on page 718

CALCulate<Chn>:FILTer[:GATE]:TIME:CENTer <CenterTime>

Defines the center time of the time gate.

Suffix:

<Chn> Channel number used to identify the active trace

Parameters:

<CenterTime> Center time of the time gate
 Range: -99.8999999 s to +99.8999999 s
 Increment: 0.1 ns
 *RST: 1.5E-009 s
 Default unit: s

Example:

```
*RST; :CALC:TRAN:TIME:STAT ON; :CALC:FILT:TIME:
STAT ON
Reset the instrument and enable the time domain representation
and the time gate.
CALC:FILT:TIME:CENT 0; SPAN 5ns
Set the center time to 0 ns and the time span to 5 ns.
```

Manual operation: See ["Axis Pair"](#) on page 454

CALCulate<Chn>:FILTer[:GATE]:TIME:DCHebyshev <SidebandSupp>

Sets the sideband suppression for the Dolph-Chebyshev time gate. The command is only available if a Dolph-Chebyshev time gate is active ([CALCulate<Chn>:FILTer\[:GATE\]:TIME:WINDow DCHebyshev](#)).

Suffix:

<Chn> Channel number used to identify the active trace

Parameters:

<SidebandSupp> Sideband suppression
 Range: 10 dB to 120 dB
 Increment: 10 dB
 *RST: 32 dB
 Default unit: dB

Example:

```
*RST; :CALC:FILT:TIME:WIND DCH
Reset the instrument and select a Dolph-Chebyshev time gate
for filtering the data in the frequency domain.
CALC:FILT:TIME:DCH 25
Set the sideband suppression to 25 dB.
```

Manual operation: See ["Side Lobe Level"](#) on page 454

CALCulate<Chn>:FILTer[:GATE]:TIME:LINK <TraceName>**Suffix:**

<Chn>

Parameters:

<TraceName>

Manual operation: See ["Time Gate Linking/Single Time Gate Linking"](#) on page 455

CALCulate<Chn>:FILTer[:GATE]:TIME:SHAPE <TimeGate>

Selects the time gate to be applied to the time domain transform.

Tip:

Use the generalized command `CALCulate<Chn>:FILTer[:GATE]:TIME:WINDOW` if you wish to select a Dolph-Chebyshev time gate.

Suffix:

<Chn> Channel number used to identify the active trace

Parameters:

<TimeGate> MAXimum | WIDE | NORMal | MINimum
 MINimum - Steepest edges (rectangle)
 WIDE - Normal gate (Hann)
 NORM - Steep edges (Hamming)
 Maximum - Maximum flatness (Bohman)
 *RST: WIDE

Example:

```
*RST; :CALC:FILT:TIME:SHAP?
Reset the instrument and query the type of time gate used. The
response is WIDE.
```

Manual operation: See ["Shape"](#) on page 454

CALCulate<Chn>:FILTer[:GATE]:TIME:SHOW <Boolean>

Enables or disables permanent display of the gate limits.

Suffix:

<Chn> Channel number used to identify the active trace

Parameters:

<Boolean> ON - time gate permanently displayed
 OFF - time gate hidden
 *RST: OFF

Example: See [CALCulate<Chn>:FILTer\[:GATE\]:TIME:CENTer](#)

Manual operation: See "[Show Range Lines](#)" on page 454

**CALCulate<Chn>:FILTer[:GATE]:TIME:SPAN **

Defines the span of the time gate.

Suffix:

<Chn> Channel number used to identify the active trace

Parameters:

 Span of the time gate.
 Range: 2E-012 s to 200 s
 Increment: 0.1 ns
 *RST: 5E-009 s
 Default unit: s

Example: See [CALCulate<Chn>:FILTer\[:GATE\]:TIME:CENTer](#)

Manual operation: See "[Gate Span](#)" on page 450

CALCulate<Chn>:FILTer[:GATE]:TIME:START <StartTime>**CALCulate<Chn>:FILTer[:GATE]:TIME:STOP <StopTime>**

These commands define the start and stop times of the time gate, respectively.

Suffix:

<Chn> Channel number used to identify the active trace

Parameters:

<StopTime> Start or stop time of the time gate.
 Range: -100 s to +99.999999999998 s (start time) and
 -99.999999999998 s to +100 s (stop time)
 Increment: 0.1 ns
 *RST: -1E-009 s (start time) to +4E-009 s (stop time)
 Default unit: s

Example: ***RST**; :**CALC**:**TRAN**:**TIME**:**STAT** **ON**; :**CALC**:**FILT**:**TIME**:**STAT** **ON**
 Reset the instrument and enable the time domain representation and the time gate.
CALC:**FILT**:**TIME**:**STAR** **0**; **STOP** **10ns**; **SHOW** **ON**
 Set the start time to 0 ns and the stop time to 10 ns and display the time gate permanently.

Manual operation: See "[Axis Pair](#)" on page 454

Note: If the start frequency entered is greater than the current stop frequency, the stop frequency is set to the start frequency plus the minimum frequency span (**CALCulate**<Chn>:**FILT**er[:**GATE**]:**TIME**:**SPAN**).

If the stop frequency entered is smaller than the current start frequency, the start frequency is set to the stop frequency minus the minimum frequency span.

CALCulate<Chn>:**FILT**er[:**GATE**]:**TIME**:**STATE** <Boolean>

Determines whether the time gate for trace no. <Chn> is enabled.

Suffix:

<Chn> Channel number used to identify the active trace

Parameters:

<Boolean> **ON** - time gate enabled
 OFF - time gate disabled
 ***RST**: **OFF**

Example: ***RST**; :**CALC**:**TRAN**:**TIME**:**STAT**?
CALC:**FILT**:**TIME**:**STAT**?
 Reset the instrument, activating a frequency sweep, and query whether the default trace is displayed in the time domain and whether the time gate is enabled. The response to both queries is 0.

Manual operation: See "[Time Gate](#)" on page 453

CALCulate<Chn>:**FILT**er[:**GATE**]:**TIME**[:**TYPE**] <TimeGateFilter>

Selects the time gate filter type, defining what occurs to the data in the specific time region.

Suffix:

<Chn> Channel number used to identify the active trace

Parameters:

<TimeGateFilter> **BPASs** | **NOTCh**

BPASs

Band pass filter: Pass all information in specified time region and reject everything else

NOTCh

Notch filter: Reject all information in specified time region and pass everything else

*RST: BPASs

Example:

```
*RST; :CALC:FILT:TIME:STAT ON
```

Reset the instrument and enable the time gate.

```
CALC:FILT:TIME NOTCh
```

Select a notch filter in order to reject unwanted pulses.

Manual operation: See ["Bandpass / Notch"](#) on page 454

CALCulate<Chn>:FILTer[:GATE]:TIME:WINDow <TimeGate>

Selects the time gate to be applied to the time domain transform.

Suffix:

<Chn> Channel number used to identify the active trace

Parameters:

<TimeGate> RECT | HAMMing | HANNing | BOHMan | DCHebyshev

RECT - steepest edges (rectangle)

HANN - normal gate (Hann)

HAMMing - steep edges (Hamming)

BOHMan - minimum flatness (Bohman)

DCHebyshev - arbitrary gate shape (Dolph-Chebyshev)

*RST: HANN

Example:

See [CALCulate<Chn>:FILTer\[:GATE\]:TIME:DCHebyshev](#)

Manual operation: See ["Shape"](#) on page 454

7.3.1.6 CALCulate:FMODEl...

The `CALCulate:FMODEl...` commands are related to "fixture modeling" tools (see [Chapter 4.6.2.9, "Fixture modeling and deembedding"](#), on page 242).

- [CALCulate:FMODEl:DEASsistant...](#) 1017
- [CALCulate:FMODEl:DELT...](#) 1023
- [CALCulate:FMODEl:EZD...](#) 1033
- [CALCulate:FMODEl:ISD...](#) 1038
- [CALCulate:FMODEl:SFD...](#) 1047
- [CALCulate:FMODEl... \(other\)](#) 1051

CALCulate:FMODEl:DEASsistant...

These commands implement the functionality of the [Deembed Assistant tab](#) and the related [Deembedding Assistant dock widget panel](#).



The deembedding assistant functionality requires at least one of the fixture deembedding software options:

- R&S ZNA-K220 (see [Chapter 4.7.16, "In-situ de-embedding"](#), on page 299)
- R&S ZNA-K230 (see [Chapter 4.7.17, "Smart fixture de-embedding"](#), on page 300)
- R&S ZNA-K210 (see [Chapter 4.7.15, "Easy de-embedding based on IEEE 370"](#), on page 298)

If options are of these available, the `CALCulate:FMODEl:DEASsistant` commands cannot be used.

CALCulate:FMODEl:DEASsistant:COUPon:LEFT:CLEar
CALCulate:FMODEl:DEASsistant:COUPon:RIGHT:CLEar

Clears the test coupon data available for the lead-in/lead-out.

Usage: Event

Options: R&S ZNA-K220 | R&S ZNA-K230 | R&S ZNA-K210

Manual operation: See "[Coupon A / Coupon B section](#)" on page 761

CALCulate:FMODEl:DEASsistant:COUPon:LEFT:FILE <CouponType>, <Path>
CALCulate:FMODEl:DEASsistant:COUPon:RIGHT:FILE <CouponType>, <Path>

Loads the properties of a test coupon for the lead-in/lead-out of the DUT.

Parameters:

<CouponType> SYMMetric2x | OPEN1x | SHORt1x

<Path> Path to the Touchstone file, either absolute or relative to the selected working directory (`CALCulate:FMODEl:DIRectory`).
 For
`CALCulate:FMODEl:DEASsistant:COUPon:`
`<LEFT|RIGHT>:TYPE OPShort1x`, you have to load a file for OPEN1x **and** SHORt1x (or measure it). Otherwise only for the selected coupon type.

Options: R&S ZNA-K220 | R&S ZNA-K230 | R&S ZNA-K210

Manual operation: See "[Deembedding Files...](#)" on page 756

CALCulate:FMODEl:DEASsistant:COUPon:LEFT:MEASure <CouponType>
CALCulate:FMODEl:DEASsistant:COUPon:RIGHT:MEASure <CouponType>

Measures the test coupon.

Before measuring, select the test coupon type using `CALCulate:FMODEl:DEASsistant:COUPon:<LEFT|RIGHT>:TYPE` and the ports using `CALCulate:FMODeL:DEASsistant:COUPon:<LEFT|RIGHT>:PORT`.

Setting parameters:

<CouponType> SYMMetric2x | OPEN1x | SHORt1x
 Test coupon type to be measured
 For
 CALCulate:FMODEl:DEASsistant:COUPon:
 <LEFT|RIGHT>:TYPE OPShort1x, you have to measure
 OPEN1x and SHORt1x (or load it from file). Otherwise measure
 only the selected coupon type.

Usage: Setting only

Options: R&S ZNA-K220 | R&S ZNA-K230 | R&S ZNA-K210

Manual operation: See "[Coupon A / Coupon B section](#)" on page 761

CALCulate:FMODEl:DEASsistant:COUPon:LEFT:PORT <Position>, <PortNum>

CALCulate:FMODEl:DEASsistant:COUPon:RIGHT:PORT <Position>, <PortNum>

Defines the port or ports for measuring the selected test coupon ([CALCulate:FMODEl:DEASsistant:COUPon:RIGHT:TYPE](#))

Parameters:

<Position> UPLeft | UPRight
UPLeft
 Left side of the test coupon
UPRight
 Right side of the test coupon (SYMMetric2x only)

Setting parameters:

<PortNum> Port number (physical port number for single-ended ports, logical port number for balanced ports)

Options: R&S ZNA-K220 | R&S ZNA-K230 | R&S ZNA-K210

Manual operation: See "[Coupon A / Coupon B section](#)" on page 761

CALCulate:FMODEl:DEASsistant:COUPon:LEFT:TYPE <CouponType>

CALCulate:FMODEl:DEASsistant:COUPon:RIGHT:TYPE <CouponType>

For fixture modeling with the deembedding assistant, this command selects a test coupon to be measured for the lead-in/lead-out, or loaded from file.

The valid test coupons depend on the selected deembedding tool ([CALCulate:FMODEl:DEASsistant:TOOL](#)).

	SYMMetric2x	OPEN1x	SHORt1x	OPShort1x
ISD	<input checked="" type="checkbox"/>	<input checked="" type="checkbox"/>	<input checked="" type="checkbox"/>	<input checked="" type="checkbox"/>
SFD	<input checked="" type="checkbox"/>	<input checked="" type="checkbox"/>	<input checked="" type="checkbox"/>	<input type="checkbox"/>
EZD	<input checked="" type="checkbox"/>	<input type="checkbox"/>	<input type="checkbox"/>	<input type="checkbox"/>

- To measure the test coupon, use:

- `CALCulate:FMODEl:DEASsistant:COUPon:<LEFT|RIGHT>:PORT` to select the port(s) at which the test coupon is measured.
- `CALCulate:FMODEl:DEASsistant:COUPon:<LEFT|RIGHT>:MEASure`
- To load the measurement data from file, use `CALCulate:FMODEl:DEASsistant:COUPon:<LEFT|RIGHT>:FILE`.

Parameters:

`<CouponType>` SYMMetric2x | OPEN1x | SHORt1x | OPShort1x
 Test coupon type

SYMMetric2x
 Symmetric 2 x Thru

OPEN1x
 1 x Open

SHORt1x
 1 x Short

Options: R&S ZNA-K220 | R&S ZNA-K230 | R&S ZNA-K210

Manual operation: See "[Coupon A / Coupon B section](#)" on page 761

CALCulate:FMODEl:DEASsistant:DUT:MEASure

Measures DUT + fixture at the ports defined using `CALCulate:FMODEl:DEASsistant:DUT:PORT`.

Usage: Event

Options: R&S ZNA-K220 | R&S ZNA-K230 | R&S ZNA-K210

Manual operation: See "[Measure / Apply section](#)" on page 763

CALCulate:FMODEl:DEASsistant:DUT:PORT <Position>, <PortNum>

Before you can measure DUT + fixture or run the fixture deembedding tool (`CALCulate:FMODEl:DEASsistant:RUN`), you have to define consecutive port ranges for the left/right side of the fixture.

Parameters:

`<Position>` UPLeft | UPRight | LOLeft | LORight
 Defines the port ranges.
 For DUTs with one single-ended or balanced ports on the left/right, specifying an up-port is sufficient for this side.

UPLeft
 Upper end of the port range on the left

UPRight
 Upper end of the port range on the right

LOLeft
 Lower end of the port range on the left

LORight

Lower end of the port range on the right

Options: R&S ZNA-K220 | R&S ZNA-K230 | R&S ZNA-K210**Manual operation:** See "[Measure / Apply section](#)" on page 763**CALCulate:FMODEl:DEASsistant:DUT:TYPE** <ScpiDutType>

Selects the DUT type for the "Deembedding Assistant".

Depending on the number of available test/DUT ports and the selected fixture tool ([CALCulate:FMODEl:DEASsistant:TOOl](#)), choose the appropriate <DutType>.**Parameters:**

<DutType> SEX | SEXSe | BX | BXB | BXSE | SE21 | SE22 | NXSE | NXMSe | NXB | NXMB

SEX

1 x single-ended

SEXSe

1 x 1 single-ended

BX

1 x balanced

BXB

1 x 1 balanced

BXSE

1 x balanced, 1 x single-ended (ISD only)

SE21

2 x 1 single-ended (ISD only)

SE22

2 x 2 single-ended (ISD only)

NXSE

n x single-ended (ISD only)

NXMSe

n x m single-ended (ISD only)

NXB

n x balanced (ISD only)

NXMB

n x m balanced (ISD only; currently not supported)

Options: R&S ZNA-K220 | R&S ZNA-K230 | R&S ZNA-K210**Manual operation:** See "[DUT](#)" on page 757

CALCulate:FMODEl:DEASsistant<Ph_pt>:FIXTure:LEFT:TYPE <FixtureType>
CALCulate:FMODEl:DEASsistant:FIXTure:RIGHT:TYPE <FixtureType>

Allows you to specify models for the left side (lead-in) and right side (lead-out) of the DUT, depending on the selected DUT type ([CALCulate:FMODEl:DEASsistant:DUT:TYPE](#) on page 1021).

Parameters:

<FixtureType> NONE | SE | BALanced | COUPlEd | UNCOUplEd

NONE

Only for non-existing right sides (lead-outs).

SE

Single-ended; for single-ended lead-ins/outs

BALanced

Balanced; for balanced lead-ins/outs

COUPlEd

Coupled ports; for lead-ins/outs with more than two logical ports

UNCOUplEd

Coupled ports; for lead-ins/outs with more than two physical ports

Options: R&S ZNA-K220 | R&S ZNA-K230 | R&S ZNA-K210

Manual operation: See "[Left: Model A / Right: Model A|B](#)" on page 758

CALCulate:FMODEl:DEASsistant:IMPCorrect <Boolean>

Parameters:

<Boolean>

Manual operation: See "[Measure / Apply section](#)" on page 763

CALCulate:FMODEl:DEASsistant:PRESet

Resets the DUT and fixture settings of the deembedding assistant to their respective defaults.

Note that a *RST does not affect these settings.

Usage: Event

Options: R&S ZNA-K220 | R&S ZNA-K230 | R&S ZNA-K210

Manual operation: See "[DUT](#)" on page 757

CALCulate:FMODEl:DEASsistant:RUN

Runs the selected demmbedding ([CALCulate:FMODEl:DEASsistant:TOOL](#)) tool and applies the calculated fixture deembedding to the ports selected using [CALCulate:FMODEl:DEASsistant:DUT:PORT](#).

Usage: Event

Options: R&S ZNA-K220 | R&S ZNA-K230 | R&S ZNA-K210

Manual operation: See ["Measure / Apply section"](#) on page 763

CALCulate:FMODEl:DEASsistant:SAMCOupon <Boolean>

For the deembedding assistant, this command defines whether only the left coupon model is measured or loaded from file.

This simplification is allowed for two-sided DUTs using the same coupon model for the left and right side (`CALCulate:FMODEl:DEASsistant:COUPon:LEFT|RIGHT:TYPE`).

Parameters:

<Boolean> ON (1) | OFF (0), where ON means only the left coupon model is measured (`CALCulate:FMODEl:DEASsistant:COUPon:LEFT:MEASure`) or loaded from file (`CALCulate:FMODEl:DEASsistant:COUPon:LEFT:FILE`).

Options: R&S ZNA-K220 | R&S ZNA-K230 | R&S ZNA-K210

Manual operation: See ["Use Same Coupon Left and Right"](#) on page 760

CALCulate:FMODEl:DEASsistant:TOOL <FixtureTool>

Selects the fixture modeling tool to be used in the deembedding assistant.

Parameters:

<FixtureTool> ISD | SFD | EZD

ISD

AtaiTec's *In Situ De-Embedding* tool

See [Chapter 4.7.16, "In-situ de-embedding"](#), on page 299

SFD

PacketMicro's *Smart Fixture De-embedding* tool

See [Chapter 4.7.17, "Smart fixture de-embedding"](#), on page 300

EZD

Eazy Deembedding based on IEEE 370

See [Chapter 4.7.15, "Eazy de-embedding based on IEEE 370"](#), on page 298

Options: R&S ZNA-K220 | R&S ZNA-K230 | R&S ZNA-K210

Manual operation: See ["Fixture Tool"](#) on page 727

CALCulate:FMODEl:DELT...

Commands for *Delta-L* PCB characterization (see [Chapter 4.7.18, "Delta-L 4.0 PCB characterization"](#), on page 300).

<code>CALCulate:FMODEl:DELT:DIRectory</code>	1024
<code>CALCulate:FMODEl:DELT:DIRectory:DEFault</code>	1025
<code>CALCulate:FMODEl:DELT:FREQuencies:CURRent?</code>	1025

CALCulate:FMODEl:DELT:FREQuencies:CURRent:COUNT?	1025
CALCulate:FMODEl:DELT:FREQuencies:DEFAult?	1025
CALCulate:FMODEl:DELT:FREQuencies:DEFAult:COUNT?	1026
CALCulate:FMODEl:DELT:FREQuencies:USEDDefault	1026
CALCulate:FMODEl:DELT:FREQuencies:USER?	1026
CALCulate:FMODEl:DELT:FREQuencies:USER:ADD	1026
CALCulate:FMODEl:DELT:FREQuencies:USER:DELeTe	1026
CALCulate:FMODEl:DELT:FREQuencies:USER:DELeTe:ALL	1027
CALCulate:FMODEl:DELT:FREQuencies:USER:COUNT?	1027
CALCulate:FMODEl:DELT:M1L:CAChE:CLEAr:ALL	1027
CALCulate:FMODEl:DELT:M1L:CAChE:CLEAr:SELEcted	1028
CALCulate:FMODEl:DELT:M1L:DIFFmode	1028
CALCulate:FMODEl:DELT:M1L:FIleName	1028
CALCulate:FMODEl:DELT:M2L:FIleName	1028
CALCulate:FMODEl:DELT:M3L:FIleName	1028
CALCulate:FMODEl:DELT:M1L:LENGth	1029
CALCulate:FMODEl:DELT:M2L:LENGth	1029
CALCulate:FMODEl:DELT:M3L:LENGth	1029
CALCulate:FMODEl:DELT:M1L:MEASure	1029
CALCulate:FMODEl:DELT:M2L:MEASure	1029
CALCulate:FMODEl:DELT:M3L:MEASure	1029
CALCulate:FMODEl:DELT<Ph_pt>:M1L[:STATe]	1029
CALCulate:FMODEl:DELT<Ph_pt>:M2L[:STATe]	1029
CALCulate:FMODEl:DELT<Ph_pt>:M3L[:STATe]	1029
CALCulate:FMODEl:DELT:MEASurement	1030
CALCulate:FMODEl:DELT:METhod	1030
CALCulate:FMODEl:DELT:PORDer	1030
CALCulate:FMODEl:DELT:RUN	1030
CALCulate:FMODEl:DELT:SWEEp:CONTRol	1031
CALCulate:FMODEl:DELT:SWEEp:CONTRol:BWIDth[:RESolution]:DREDuction	1031
CALCulate:FMODEl:DELT:SWEEp:CONTRol:IFBW?	1031
CALCulate:FMODEl:DELT:SWEEp:CONTRol:STEP?	1032
CALCulate:FMODEl:DELT:SWEEp:FREQuency:MAXimum	1032
CALCulate:FMODEl:DELT:SWEEp:FREQuency:MINimum	1032
CALCulate:FMODEl:DELT:TCONfig	1032
CALCulate:FMODEl:DELT:TDR	1033

CALCulate:FMODEl:DELT:DIRectory <String>

Defines the working directory of the Delta-L tool.

Parameters:

<String> Directory path, either absolute or relative to the current directory (MMEMory:CDIRectory).

Options: R&S ZNA-K231

Manual operation: See "Output Settings" on page 767

CALCulate:FMODEl:DELT:DIRectory:DEFault

Resets the working directory of the Delta-L tool to its default

C:\Users\Public\Documents\Rohde-Schwarz\ZNA\DeltaL.

Usage: Event

Options: R&S ZNA-K231

Manual operation: See "[Output Settings](#)" on page 767

CALCulate:FMODEl:DELT:FREQuencies:CURRent?

Returns the frequencies at which the Delta-L algorithm calculates the loss-per-inch uncertainties.

You can use the algorithms's default or custom frequencies (see [CALCulate:FMODEl:DELT:FREQuencies:USEDefault](#)).

Usage: Query only

Options: R&S ZNA-K231

Manual operation: See "[Frequencies](#)" on page 766

CALCulate:FMODEl:DELT:FREQuencies:CURRent:COUNT?

Returns at how many frequencies the Delta-L algorithm calculates the loss-per-inch uncertainties.

Use [CALCulate:FMODEl:DELT:FREQuencies:CURRent?](#) to query the list of frequencies.

Usage: Query only

Options: R&S ZNA-K231

Manual operation: See "[Frequencies](#)" on page 766

CALCulate:FMODEl:DELT:FREQuencies:DEFault?

Returns the frequencies at which the Delta-L algorithm calculates the loss-per-inch uncertainties per default.

You can either use the algorithms's default or custom frequencies (see [CALCulate:FMODEl:DELT:FREQuencies:USEDefault](#)).

Usage: Query only

Options: R&S ZNA-K231

Manual operation: See "[Frequencies](#)" on page 766

CALCulate:FMODEl:DELT:FREQuencies:DEFault:COUNT?

Returns the number of frequencies at which the Delta-L algorithm calculates the loss-per-inch uncertainties per default.

Use `CALCulate:FMODEl:DELT:FREQuencies:DEFault?` to query the frequencies.

Usage: Query only
Options: R&S ZNA-K231
Manual operation: See "[Frequencies](#)" on page 766

CALCulate:FMODEl:DELT:FREQuencies:USEDefault <Boolean>

Delta-L computes the uncertainty in the loss-per-inch calculation at specified frequencies.

This command specifies whether to use the tool's default frequencies or custom frequencies, which can be defined using `CALCulate:FMODEl:DELT<Ph_pt>:FREQuencies:USER` commands.

Parameters:
 <Boolean> **ON (1)**
 Use default frequencies
 OFF (0)
 Use custom frequencies

Options: R&S ZNA-K231
Manual operation: See "[Frequencies](#)" on page 766

CALCulate:FMODEl:DELT:FREQuencies:USER?

The Delta-L algorithm can calculate the loss-per-inch uncertainties either at default or at custom frequencies (see `CALCulate:FMODEl:DELT:FREQuencies:USEDefault`).

This command returns the custom frequencies, defined using `CALCulate:FMODEl:DELT:FREQuencies:USER:ADD` etc.

Usage: Query only
Options: R&S ZNA-K231
Manual operation: See "[Frequencies](#)" on page 766

CALCulate:FMODEl:DELT:FREQuencies:USER:ADD <UserFrequencies>
CALCulate:FMODEl:DELT:FREQuencies:USER:DELeTe <Frequency>

The Delta-L algorithm can calculate the loss-per-inch uncertainties either at default or at custom frequencies (see `CALCulate:FMODEl:DELT:FREQuencies:USEDefault`).

`CALCulate:FMODEl:DELT<Ph_pt>:FREQuencies:USER:ADD|DELeTe` adds/deletes a frequency to/from the list of custom frequencies.

Setting parameters:

<Frequency> Custom frequency
 Range: The frequency range of the analyzer
 Default unit: Hz

Usage: Setting only

Options: R&S ZNA-K231

Manual operation: See "[Frequencies](#)" on page 766

CALCulate:FMODEl:DELT:FREQuencies:USER:DELeTe:ALL

The Delta-L algorithm can calculate the loss-per-inch uncertainties either at default or at custom frequencies (see [CALCulate:FMODEl:DELT:FREQuencies:USEDefault](#)).

This command clears the list of custom frequencies.

Usage: Event

Options: R&S ZNA-K231

Manual operation: See "[Frequencies](#)" on page 766

CALCulate:FMODEl:DELT:FREQuencies:USER:COUNT?

The Delta-L algorithm can calculate the loss-per-inch uncertainties either at default or at custom frequencies (see [CALCulate:FMODEl:DELT:FREQuencies:USEDefault](#)).

This command returns the number of custom frequencies, defined using [CALCulate:FMODEl:DELT:FREQuencies:USER:ADD](#) etc.

Usage: Query only

Options: R&S ZNA-K231

Manual operation: See "[Frequencies](#)" on page 766

CALCulate:FMODEl:DELT:M1L:CAChE:CLEAr:ALL

If the 1-length method is used ([CALCulate:FMODEl:DELT:METHod M1L](#)), the VNA firmware builds up a cache of coupon measurements (Touchstone files) in the `DeltaL\1LMeasurementCache` subfolder of the user data folder `C:\Users\Public\Documents\Rohde-Schwarz\ZNA`.

This command clears this cache.

Usage: Event

Options: R&S ZNA-K231

Manual operation: See "[Clear All 1L Measurements/Clear Selected 1L Measurements](#)" on page 769

CALCulate:FMODEl:DELT:M1L:CAChE:CLEAr:SELEcted <String>

If the 1-length method is used (`CALCulate:FMODEl:DELT:METHod M1L`), the VNA firmware builds up a cache of coupon measurements (Touchstone files) in the `DeltaL\1LMeasurementCache` subfolder of the user data folder `C:\Users\Public\Documents\Rohde-Schwarz\ZNA`.

This command deletes the selected file from this cache.

Setting parameters:

<String> Path to the Touchstone file, relative to the cache directory.

Usage: Setting only

Options: R&S ZNA-K231

Manual operation: See "[Clear All 1L Measurements/Clear Selected 1L Measurements](#)" on page 769

CALCulate:FMODEl:DELT:M1L:DIFFmode <Boolean>

The one-length method (`CALCulate:FMODEl:DELT:METHod M1L`) handles single-ended and balanced measurement results differently. This command selects between the two modes.

Parameters:

<Boolean>

OFF (0)
Single-ended mode

ON (1)
Differential mode

*RST: OFF (0)

Options: R&S ZNA-K231

Manual operation: See "[Method](#)" on page 765

CALCulate:FMODEl:DELT:M1L:FILEname <String>

CALCulate:FMODEl:DELT:M2L:FILEname <String>

CALCulate:FMODEl:DELT:M3L:FILEname <String>

For a Delta-L+ PCB characterization, this command loads the "1L Measurement" data from a Touchstone file.

Parameters:

<String> Path to the Touchstone file, either absolute or relative to the selected working directory (`CALCulate:FMODEl:DELT:DIRectory`).

Options: R&S ZNA-K231

Manual operation: See ["Load File"](#) on page 768

CALCulate:FMODEl:DELT:M1L:LENGth <Length>

CALCulate:FMODEl:DELT:M2L:LENGth <Length>

CALCulate:FMODEl:DELT:M3L:LENGth <Length>

Specifies the length of the 1st/2nd/3rd line in Delta-L measurements ([CALCulate:FMODEl:DELT<Ph_pt>:M1L|M2L|M3L:MEASure](#)).

Parameters:

<Length> Length in inches

Options: R&S ZNA-K231

Manual operation: See ["Length"](#) on page 769

CALCulate:FMODEl:DELT:M1L:MEASure

CALCulate:FMODEl:DELT:M2L:MEASure

CALCulate:FMODEl:DELT:M3L:MEASure

Measures the full set of S-parameters at the active ports (see [CALCulate:FMODEl:DELT<Ph_pt>:M1L|M2L|M3L\[:STATe\]](#)).

Usage: Event

Options: R&S ZNA-K231

Manual operation: See ["Measure"](#) on page 769

CALCulate:FMODEl:DELT<Ph_pt>:M1L[:STATe] <Boolean>

CALCulate:FMODEl:DELT<Ph_pt>:M2L[:STATe] <Boolean>

CALCulate:FMODEl:DELT<Ph_pt>:M3L[:STATe] <Boolean>

Defines the active ports for the 1st/2nd/3rd line Delta-L measurement ([CALCulate:FMODEl:DELT<Ph_pt>:M1L|M2L|M3L:MEASure](#)).

For each measurement, either two or four ports must be active. If the 1-length method is used ([CALCulate:FMODEl:DELT:METhod M1L](#)), then four ports must be active for the first line.

Suffix:

<Ph_pt> Physical port number

Parameters:

<Boolean> **ON (1)**
Port <Ph_pt> is active in the respective measurement

OFF (0)

Port <Ph_pt> is inactive in the respective measurement

Options: R&S ZNA-K231

Manual operation: See ["Ports table"](#) on page 769

CALCulate:FMODEl:DELT:MEASurement <Measurement>

Defines whether single-ended or balanced ports are measured for Delta-L characterizations.

Parameters:

<Measurement> SINGleended | BALanced

SINGleended

Single-ended ports only

BALanced

Balanced ports only

*RST: SINGleended

Options: R&S ZNA-K231

Manual operation: See "[Measurements](#)" on page 765

CALCulate:FMODEl:DELT:METHod <Method>

Selects the Delta-L+ characterization method to be used.

Parameters:

<Method> M1L | M2L | M3L

One, two, or three line/length analysis

Options: R&S ZNA-K231

Manual operation: See "[Method](#)" on page 765

CALCulate:FMODEl:DELT:PORDer <PortOrder>

Declares how the DUT is connected to the measurement system. Choosing the wrong port ordering for your setup, can result in erroneous results.

Parameters:

<PortOrder> ODDeven | SEQuential

ODDeven

Ports 1, 3 and 2, 4 form input/output pairs

SEQuential

Ports 1, 2 and 3, 4 form input/output pairs

Options: R&S ZNA-K231

Manual operation: See "[Port Order](#)" on page 766

CALCulate:FMODEl:DELT:RUN

Runs the AITT-DL tool with the collected measurement data and the configured Delta-L settings.

Usage: Event

Options: R&S ZNA-K231

Manual operation: See ["Run"](#) on page 769

CALCulate:FMODEl:DELT:SWEep:CONTRol <SweepControl>

Tells the firmware to use either default values for frequency step size and IF bandwidth, or the settings of the active channel for the Delta-L measurement.

The resulting frequency step size and IF bandwidth can be queried using [CALCulate:FMODEl:DELT:SWEep:CONTRol:STEP?](#) on page 1032 and [CALCulate:FMODEl:DELT:SWEep:CONTRol:IFBW?](#) on page 1031, respectively.

Parameters:

<SweepControl> DEFault | CURRent

DEFault

Use the default values of the Delta-L algorithm:
10 MHz frequency step size, 1 kHz IF bandwidth

SweepControl

Use the values of the active channel

Options: R&S ZNA-K231

Manual operation: See ["Sweep Control"](#) on page 766

CALCulate:FMODEl:DELT:SWEep:CONTRol:BWIDth[:RESolution]:DREDuction <Boolean>

Defines whether dynamic bandwidth at low frequencies is used for Delta-L measurements (see [\[SENSe<Ch>:\]BANDwidth\[:RESolution\]:DREDuction](#))

Parameters:

<Boolean> **ON (1)**
Dynamic bandwidth at low frequencies is active (default)
OFF (0)
Dynamic bandwidth at low frequencies is inactive

Options: R&S ZNA-K231

Manual operation: See ["Sweep Control"](#) on page 766

CALCulate:FMODEl:DELT:SWEep:CONTRol:IFBW?

For the Delta-L measurement, the firmware can either use a default IF bandwidth, or the active channel setting (see [CALCulate:FMODEl:DELT:SWEep:CONTRol](#)).

This query returns the resulting IF bandwidth.

Usage: Query only

Options: R&S ZNA-K231

Manual operation: See ["Sweep Control"](#) on page 766

CALCulate:FMODEl:DELT:SWEep:CONTRol:STEP?

For the Delta-L measurement, the firmware can either use a default frequency step size, or the active channel setting (see [CALCulate:FMODEl:DELT:SWEep:CONTRol](#)).

This query returns the resulting frequency step size.

Usage: Query only

Options: R&S ZNA-K231

Manual operation: See "[Sweep Control](#)" on page 766

CALCulate:FMODEl:DELT:SWEep:FREQuency:MAXimum <Frequency>
CALCulate:FMODEl:DELT:SWEep:FREQuency:MINimum <Frequency>

Defines the sweep range of the Delta-L measurement channel. The entered MAXimum and MINimum values are set as [\[SENSe<Ch>:\]FREQuency:STOP](#) and [\[SENSe<Ch>:\]FREQuency:START](#), respectively.

Furthermore, the VNA collects data for the LPI computation at the MAXimum and MINimum frequencies (in addition to [CALCulate:FMODEl:DELT:FREQuencies:CURRent?](#)).

Parameters:

<Frequency> Frequency values
 The default MINimum frequency is the standard Delta-L start frequency of 10 MHz. The default MAXimum frequency is 20 GHz.
 Default unit: Hz

Options: R&S ZNA-K231

Manual operation: See "[Sweep Frequency](#)" on page 767

CALCulate:FMODEl:DELT:TCONfig <Boolean>

Defines how the analyzer firmware sets up the diagram area for the Delta-L measurement.

Parameters:

<Boolean> **ON (1)**
 Use the recommended trace configuration, i.e. display each of the traces in a separate diagram.

OFF (0)
 Display all traces in a single diagram.

Options: R&S ZNA-K231

Manual operation: See "[Trace](#)" on page 767

CALCulate:FMODEl:DELT:TDR <Boolean>

If the [Time domain analysis](#) option R&S ZNA-K2 is installed, this command allows you to add the TDR-based converted impedance traces to the recommended trace configuration.

Parameters:

<Boolean> **OFF (0)**
 TDR-based impedance traces added

ON (1)
 TDR-based impedance traces not added

*RST: OFF

Options: R&S ZNA-K231

Manual operation: See "[Trace](#)" on page 767

CALCulate:FMODEl:EZD...

Commands for *Eazy Deembedding* (see [Chapter 4.7.15, "Eazy de-embedding based on IEEE 370"](#), on page 298).

CALCulate:FMODEl:EZD:COUPon:MEASure.....	1033
CALCulate:FMODEl:EZD:COUPon:MEASure:FiLename.....	1034
CALCulate:FMODEl:EZD:COUPon:MEASure:FiLename:CLear.....	1034
CALCulate:FMODEl:EZD<Ph_pt>:COUPon[:STATe].....	1034
CALCulate:FMODEl:EZD:DCEXtrapolat.....	1034
CALCulate:FMODEl:EZD:DUT:MEASure.....	1035
CALCulate:FMODEl:EZD:DUT:MEASure:FiLename.....	1035
CALCulate:FMODEl:EZD:DUT:MEASure:FiLename:CLear.....	1035
CALCulate:FMODEl:EZD<Ph_pt>:DUT[:STATe].....	1035
CALCulate:FMODEl:EZD:GENerate:SIDE<1 2>.....	1036
CALCulate:FMODEl:EZD:IMPedance.....	1036
CALCulate:FMODEl:EZD:IMPedance:BWIDlimit.....	1036
CALCulate:FMODEl:EZD:IMPedance:REFerence.....	1037
CALCulate:FMODEl:EZD:PORT:ORDer.....	1037
CALCulate:FMODEl:EZD:PRESet.....	1037
CALCulate:FMODEl:EZD:RUN:RUN.....	1037
CALCulate:FMODEl:EZD<Pt>:RUN[:STATe].....	1038

CALCulate:FMODEl:EZD:COUPon:MEASure

For a fixture modeling with the Easy De-embedding (EZD) tool, this command starts the measurement of the symmetrical 2xThru coupon at the active ports (see [CALCulate:FMODEl:EZD<Ph_pt>:COUPon\[:STATe\]](#) on page 1034).

Usage: Event

Options: R&S ZNA-K210

Manual operation: See "[Measure / Measure Open / Measure Short](#)" on page 731

CALCulate:FMODEl:EZD:COUPon:MEASure:FILEname <String>

For a fixture modeling with the EZD tool, this command loads the coupon properties from a Touchstone file.

Parameters:

<String> Path to the Touchstone file, either absolute or relative to the selected working directory ([CALCulate:FMODEl:DIRectory](#)).

Options: R&S ZNA-K210

Manual operation: See "[Load File / 1x Open Preset / 1x Short Preset](#)" on page 732

CALCulate:FMODEl:EZD:COUPon:MEASure:FILEname:CLEar

Invalidates the file path previously set using [CALCulate:FMODEl:EZD:COUPon:MEASure:FILEname](#).

Usage: Event

Options: R&S ZNA-K210

CALCulate:FMODEl:EZD<Ph_pt>:COUPon[:STATe] <Boolean>

For a fixture modeling with the EZD tool, this command allows to specify the ports to which the test coupon is connected.

This has to be defined before measuring the test coupon (using [CALCulate:FMODEl:EZD:COUPon:MEASure](#)).

Suffix:

<Ph_pt> Physical port number

Parameters:

<Boolean> **ON (1)**
if the test coupon is connected to port <Ph_pt>
OFF (0)
otherwise

Options: R&S ZNA-K210

Manual operation: See "[Active](#)" on page 732

CALCulate:FMODEl:EZD:DCEXtrapolat <Boolean>

Defines whether the Touchstone de-embedding file generated by the EZD tool contains data for DC.

Parameters:

<Boolean> **ON (1)**
The EZD tool adds (extrapolated) S-parameter data for $f = 0$.

OFF (0)

The frequencies only reach down to the start frequency of the instrument sweep.

Options: R&S ZNA-K210

Manual operation: See "[DC Extrapolation](#)" on page 742

CALCulate:FMODEl:EZD:DUT:MEASure

For a fixture modeling with the EZD tool, this command allows to measure "DUT + Test Fixture" at the active ports (see [CALCulate:FMODEl:EZD<Ph_pt>:DUT\[:STATe\]](#))

Usage: Event

Options: R&S ZNA-K210

Manual operation: See "[Measure](#)" on page 733

CALCulate:FMODEl:EZD:DUT:MEASure:FILEname <String>

For a fixture modeling with the EZD tool, this command loads the "DUT + Test Fixture" properties from a Touchstone file.

Parameters:

<String> Path to the Touchstone file, either absolute or relative to the selected working directory ([CALCulate:FMODEl:DIRectory](#)).

Options: R&S ZNA-K210

Manual operation: See "[Load File](#)" on page 733

CALCulate:FMODEl:EZD:DUT:MEASure:FILEname:CLEar

Invalidates the file path previously set using [CALCulate:FMODEl:EZD:DUT:MEASure:FILEname](#).

Usage: Event

Options: R&S ZNA-K210

Manual operation: See "[Load File / 1x Open Preset / 1x Short Preset](#)" on page 732

CALCulate:FMODEl:EZD<Ph_pt>:DUT[:STATe] <Boolean>

Defines the physical ports to which DUT + test fixture are connected.

Suffix:

<Ph_pt> Physical port number

Parameters:

<Boolean> **ON (1)**
Port <Ph_pt> connected

OFF (0)

Port <Ph_pt> not connected

Options: R&S ZNA-K210**Manual operation:** See "[Active](#)" on page 733**CALCulate:FMODEl:EZD:GENERate:SIDE<1|2>** <Boolean>

Tells the EZD tool to create fixture deembedding data at side 1, at side 2, or at both sides.

Suffix:

<1|2> Side

Parameters:

<Boolean>

ON (1)

Create fixture deembedding data at the specified side (<1|2>)

OFF (0)

Do not create fixture deembedding data at the specified side (<1|2>)

Options: R&S ZNA-K210**Manual operation:** See "[Generate Side 1/Generate Side2](#)" on page 741**CALCulate:FMODEl:EZD:IMPedance** <Boolean>Switches the impedance correction of the EZD tool ON or OFF. Its reference impedance and bandwidth limit parameters can be set using [CALCulate:FMODEl:EZD:IMPedance:REFerence](#) and [CALCulate:FMODEl:EZD:IMPedance:BWIDlimit](#), respectively.

This is a global setting.

Parameters:

<Boolean> ON (1) or OFF (0)

Options: R&S ZNA-K210**Manual operation:** See "[Use Impedance Correction](#)" on page 730**CALCulate:FMODEl:EZD:IMPedance:BWIDlimit** <Value>Defines the "Bandwidth Limit" parameter of the EZD tool's impedance correction (see [CALCulate:FMODEl:EZD:IMPedance](#)).**Parameters:**

<Value> Default unit: Hz

Options: R&S ZNA-K210**Manual operation:** See "[Impedance Correction Settings](#)" on page 742

CALCulate:FMODEl:EZD:IMPedance:REference <Value>

Defines the reference impedance for the impedance correction of the EZD tool (see [CALCulate:FMODEl:EZD:IMPedance](#)).

Parameters:

<Value> Default unit: Ohm

Options: R&S ZNA-K210

Manual operation: See "[Impedance Correction Settings](#)" on page 742

CALCulate:FMODEl:EZD:PORT:ORDer <PortOrder>

Tells the EZD tool about the port ordering of the test fixture.

Parameters:

<PortOrder> ODD | NON

ODD: odd ports are on the left and even ports are on the right
NON: ports 1 to N are on the left and ports N+1 to 2·N are on the right

Options: R&S ZNA-K210

Manual operation: See "[Port Order](#)" on page 741

CALCulate:FMODEl:EZD:PRESet

Restores the global default settings of the EZD tool.

Usage: Event

Options: R&S ZNA-K210

Manual operation: See "[Reset to Default](#)" on page 730

CALCulate:FMODEl:EZD:RUN:RUN

Runs the EZD tool.

Before executing this command, make sure that:

- The test coupon measurement (using [CALCulate:FMODEl:EZD:COUPon:MEASure](#)) finished successfully, or the test coupon data were successfully loaded from file (using [CALCulate:FMODEl:EZD:COUPon:MEASure:FILEname](#))
- The measurement of DUT + test fixture (using [CALCulate:FMODEl:EZD:COUPon:MEASure](#)) finished successfully.

The resulting Touchstone files are written to C:\Users\Public\Documents\Rohde-Schwarz\ZNA\Embedding. If result files with the same name already exist, they are overwritten.

Usage: Event

Options: R&S ZNA-K210

Manual operation: See "Run <Fixture Modeling Tool>" on page 734

CALCulate:FMODEl:EZD<Pt>:RUN[:STATe] <Boolean>

Tells the analyzer to assign deembedding files to certain ports, after the EZD tool has run.

Suffix:

<Pt> Physical port number for single-ended deembedding, logical port number for balanced deembedding.

Parameters:

<Boolean> **ON (1)**
Assign a deembedding file to port <Pt>
OFF (0)
Otherwise

Options: R&S ZNA-K210

Manual operation: See "Apply" on page 735

CALCulate:FMODEl:ISD...

Commands for AtaiTec's *In Situ De-Embedding* (ISD) tool, see <http://ataitec.com/products/isd/>

CALCulate:FMODEl:ISD:ATTenuation:BEHavior.....	1039
CALCulate:FMODEl:ISD:COUPon:MEASure.....	1039
CALCulate:FMODEl:ISD:COUPon:MEASure:FILEname.....	1039
CALCulate:FMODEl:ISD:COUPon:MEASure:FILEname:CLEar.....	1040
CALCulate:FMODEl:ISD:COUPon:MEASure:OPEN.....	1040
CALCulate:FMODEl:ISD:COUPon:MEASure:OPEN:FILEname.....	1040
CALCulate:FMODEl:ISD:COUPon:MEASure:SHORT.....	1040
CALCulate:FMODEl:ISD:COUPon:MEASure:SHORT:FILEname.....	1040
CALCulate:FMODEl:ISD<Ph_pt>:COUPon[:STATe].....	1041
CALCulate:FMODEl:ISD:COUPon:TYPE.....	1041
CALCulate:FMODEl:ISD:DCEXtrapolat.....	1041
CALCulate:FMODEl:ISD:DUT:MEASure.....	1042
CALCulate:FMODEl:ISD:DUT:MEASure:FILEname.....	1042
CALCulate:FMODEl:ISD:DUT:MEASure:FILEname:CLEar.....	1042
CALCulate:FMODEl:ISD<Ph_pt>:DUT[:STATe].....	1042
CALCulate:FMODEl:ISD:DUT:TYPE.....	1042
CALCulate:FMODEl:ISD:FTIME:DUT.....	1043
CALCulate:FMODEl:ISD:FTIME:OVERride.....	1043
CALCulate:FMODEl:ISD:IMPedance.....	1043
CALCulate:FMODEl:ISD:OPERation.....	1043
CALCulate:FMODEl:ISD:PASSivity.....	1044
CALCulate:FMODEl:ISD:PORT:ORDER.....	1044
CALCulate:FMODEl:ISD:PORT:SKIP.....	1044
CALCulate:FMODEl:ISD:PORT:SKIP:LEFT.....	1045
CALCulate:FMODEl:ISD:PORT:SKIP:NONE.....	1045
CALCulate:FMODEl:ISD:PORT:SKIP:RIGHT.....	1045

CALCulate:FMODEl:ISD:PRESet.....	1045
CALCulate:FMODEl:ISD:RUN:RUN.....	1045
CALCulate:FMODEl:ISD<Pt>:RUN[:STATe].....	1046
CALCulate:FMODEl:ISD:SCALe:ATTenuation.....	1046
CALCulate:FMODEl:ISD:SCALe:FREQUency.....	1046
CALCulate:FMODEl:ISD:SCALe:FTIME.....	1046
CALCulate:FMODEl:ISD:SMALIfixture.....	1046
CALCulate:FMODEl:ISD:TRACe:COUPling.....	1047

CALCulate:FMODEl:ISD:ATTenuation:BEHavior <AttenuationBehavior>

Sets/gets the `linear_2x` batch mode parameter of the ISD tool

Parameters:

<AttenuationBehavior> RESonant | LINear | NONLinear

LINear

Used for linear insertion loss of test coupon (parameter value 1)

NONLinear

Used for non-linear insertion loss of test coupon (parameter value 2)

RESonant

The 2x thru test coupon will be split and used directly for deembedding (parameter value 3).

This option may be more accurate when the fixture and 2x Thru have the same impedance at every location

Manual operation: See ["Test Coupons > Insertion Loss"](#) on page 737

CALCulate:FMODEl:ISD:COUPon:MEASure

For a fixture modeling with the ISD tool and coupon types SYMMetric2x | OPEN1x | SHORt1x (see [CALCulate:FMODEl:ISD:COUPon:TYPE](#)), this command starts the measurement of the coupon at the active ports (see [CALCulate:FMODEl:ISD<Ph_pt>:COUPon\[:STATe\]](#)).

Example: See [Chapter 8.2.9, "Fixture modeling"](#), on page 1762

Usage: Event

Manual operation: See ["Measure / Measure Open / Measure Short"](#) on page 731

CALCulate:FMODEl:ISD:COUPon:MEASure:FILEname <String>

For a fixture modeling with the ISD tool and coupon types SYMMetric2x | OPEN1x | SHORt1x (see [CALCulate:FMODEl:ISD:COUPon:TYPE](#)), this command loads the coupon properties from a Touchstone file.

Parameters:

<String> Path to the Touchstone file, either absolute or relative to the selected working directory ([CALCulate:FMODEl:DIRectory](#)).

Manual operation: See "Load File / 1x Open Preset / 1x Short Preset" on page 732

CALCulate:FMODEl:ISD:COUPon:MEASure:FILEname:CLEar

Invalidates the file path previously set using `CALCulate:FMODEl:ISD:DUT:MEASure:FILEname`, `CALCulate:FMODEl:ISD:COUPon:MEASure:OPEN:FILEname`, or `CALCulate:FMODEl:ISD:COUPon:MEASure:SHORT:FILEname`.

Usage: Event

Manual operation: See "Load File / 1x Open Preset / 1x Short Preset" on page 732

CALCulate:FMODEl:ISD:COUPon:MEASure:OPEN

For a fixture modeling with the ISD tool and coupon type OPShort1x (see `CALCulate:FMODEl:ISD:COUPon:TYPE`), this command starts the measurement of the **Open** coupon at the active ports (see `CALCulate:FMODEl:ISD<Ph_pt>:COUPon[:STATe]`).

Usage: Event

Manual operation: See "Measure / Measure Open / Measure Short" on page 731

CALCulate:FMODEl:ISD:COUPon:MEASure:OPEN:FILEname <String>

For a fixture modeling with the ISD tool and coupon type OPShort1x (see `CALCulate:FMODEl:ISD:COUPon:TYPE`), this command loads the properties of the Open coupon from a Touchstone file.

Parameters:

<String> Path to the Touchstone file, either absolute or relative to the selected working directory (`CALCulate:FMODEl:DIRectory`).

Manual operation: See "Load File / 1x Open Preset / 1x Short Preset" on page 732

CALCulate:FMODEl:ISD:COUPon:MEASure:SHORT

For a fixture modeling with the ISD tool and coupon type OPShort1x (see `CALCulate:FMODEl:ISD:COUPon:TYPE`), this command starts the measurement of the **Short** coupon at the active ports (see `CALCulate:FMODEl:ISD<Ph_pt>:COUPon[:STATe]`).

Usage: Event

Manual operation: See "Measure / Measure Open / Measure Short" on page 731

CALCulate:FMODEl:ISD:COUPon:MEASure:SHORT:FILEname <String>

For a fixture modeling with the ISD tool and coupon type OPShort1x (see `CALCulate:FMODEl:ISD:COUPon:TYPE`), this command loads the properties of the Short coupon from a Touchstone file.

Parameters:

<String> Path to the Touchstone file, either absolute or relative to the selected working directory ([CALCulate:FMODEl:DIRectory](#)).

Manual operation: See "[Load File / 1x Open Preset / 1x Short Preset](#)" on page 732

CALCulate:FMODEl:ISD<Ph_pt>:COUPon[:STATe] <Boolean>

For a fixture modeling with the ISD tool, this command allows to specify the ports to which the test coupon is connected.

This has to be defined before measuring the test coupon (using [CALCulate:FMODEl:ISD:COUPon:MEASure](#) or [CALCulate:FMODEl:ISD:COUPon:MEASure:OPEN](#) and [CALCulate:FMODEl:ISD:COUPon:MEASure:SHORT](#)).

Suffix:

<Ph_pt> Physical port number

Parameters:

<Boolean> 1 (ON, true) if the test coupon is connected to port <Ph_pt>, 0 (OFF, false) otherwise

Example: See [Chapter 8.2.9, "Fixture modeling"](#), on page 1762

Manual operation: See "[Active](#)" on page 732

CALCulate:FMODEl:ISD:COUPon:TYPE <CouponType>

Sets/gets the coupon type to be measured for a fixture modeling with the ISD tool.

Parameters:

<CouponType> SYMMetric2x | OPEN1x | SHORt1x | OPShort1x

Example: See [Chapter 8.2.9, "Fixture modeling"](#), on page 1762

Manual operation: See "[Coupon Type](#)" on page 731

CALCulate:FMODEl:ISD:DCEXtrapolat <Boolean>

Defines whether the de-/embedding file generated by the ISD tool contains (extrapolated) DC data.

Can only be set to ON, if a recent version of the ISD tool (from 2019-12 or later) is used. ON corresponds to `add_dc=1` in the tool's batch mode.

Parameters:

<Boolean>

OFF (0)
No DC data added, i.e. the touchstone data reach down to the start frequency of the instrument sweep.

ON (1)
The ISD tool adds (extrapolated) S-parameter data for $f = 0$.

*RST: OFF (0)

Manual operation: See "[DC Extrapolation](#)" on page 740

CALCulate:FMODEl:ISD:DUT:MEASure

For a fixture modeling with the ISD tool, this command allows to measure DUT + Fixture at the active ports (see [CALCulate:FMODEl:ISD<Ph_pt>:DUT\[:STATe\]](#))

Example: See [Chapter 8.2.9, "Fixture modeling"](#), on page 1762

Usage: Event

Manual operation: See ["Measure"](#) on page 733

CALCulate:FMODEl:ISD:DUT:MEASure:FILEname <String>

For a fixture modeling with the ISD tool, this command loads the "DUT + Test Fixture" properties from a Touchstone file.

Parameters:

<String> Path to the Touchstone file, either absolute or relative to the selected working directory ([CALCulate:FMODEl:DIRectory](#)).

Manual operation: See ["Load File"](#) on page 733

CALCulate:FMODEl:ISD:DUT:MEASure:FILEname:CLEar

Invalidates the file path previously set using [CALCulate:FMODEl:ISD:DUT:MEASure:FILEname](#).

Usage: Event

Manual operation: See ["Load File"](#) on page 733

CALCulate:FMODEl:ISD<Ph_pt>:DUT[:STATe] <Boolean>

For a fixture modeling with the ISD tool, this command allows to specify the ports to which the test fixture is connected.

This has to be defined before measuring DUT + Fixture (using [CALCulate:FMODEl:ISD:DUT:MEASure](#)).

Suffix:

<Ph_pt> Physical port number

Parameters:

<Boolean> 1 (ON, true) if the test fixture is connected to port <Ph_pt>, 0 (OFF, false) otherwise

Example: See [Chapter 8.2.9, "Fixture modeling"](#), on page 1762

Manual operation: See ["Active"](#) on page 733

CALCulate:FMODEl:ISD:DUT:TYPE <DUTType>

Defines whether the DUT is active or passive.

Corresponds to the `active_dut` batch mode parameter of the ISD tool.

Parameters:

<DUTType> PASSive | ACTIVE

Manual operation: See "[DUT Type](#)" on page 738

CALCulate:FMODEl:ISD:FTIME:DUT <FitDutAndLeadIns>

If [CALCulate:FMODEl:ISD:FTIME:OVERride](#) is set to TRUE, this command allows to set the flight time for DUT + Lead-ins manually.

This is equivalent to setting the `leadin_dut_time` batch mode parameter of the ISD tool to a numeric value (not `auto`).

Parameters:

<FitDutAndLeadIns> Default unit: s

Manual operation: See "[DUT + lead-ins flight time](#)" on page 738

CALCulate:FMODEl:ISD:FTIME:OVERride <Boolean>

If set to true, the flight time for DUT + lead-in is specified using [CALCulate:FMODEl:ISD:FTIME:DUT](#). Otherwise, it is calculated automatically.

True is equivalent to setting the `leadin_dut_time` batch mode parameter of the ISD tool to `auto`.

Parameters:

<Boolean>

Manual operation: See "[Auto. flight time for DUT + lead-Ins](#)" on page 738

CALCulate:FMODEl:ISD:IMPedance <Boolean>

Enables/disables the impedance correction of the ISD tool.

This is a global setting.

Parameters:

<Boolean> **ON (1)**
 Impedance correction enabled
 OFF (0)
 Impedance correction disabled

Manual operation: See "[Use Impedance Correction](#)" on page 730

CALCulate:FMODEl:ISD:OPERation <Operation>

Defines the execution mode of the ISD tool.

Parameters:

<Operation> FAST | ACCurate
 ACCurate: normal execution mode
 FAST: reduces the execution time to ~50%
 In many cases the FAST mode can be enabled with only little loss of accuracy.

Manual operation: See "[Operation \(fast/acc\)](#)" on page 739

CALCulate:FMODEl:ISD:PASSivity <Boolean>

Defines whether the ISD tool shall enforce passivity and reciprocity for the test coupons and the test fixture.

Corresponds to the `passive` batch mode parameter of the ISD tool.

Parameters:

<Boolean> ON (0): enforce passivity and reciprocity
 OFF (0): do not enforce passivity and reciprocity

Manual operation: See "[Enforce Passitivity](#)" on page 739

CALCulate:FMODEl:ISD:PORT:ORDER <PortOrder>

Defines how the ISD tool shall interpret the DUT + Fixture data (see [CALCulate:FMODEl:ISD:DUT:MEASure](#)):

- NON: ports 1 to N are on the left and ports N+1 to 2*N are on the right
- ODD: ports 1, 3, 5, etc. are on the left and ports 2, 4, 6, etc. are on the right.
- ALL: use this to tell the ISD tool that all ports are on the left (i.e. assumed to be coupled)

Corresponds to the `port_order` batch mode parameter of the ISD tool.

Parameters:

<PortOrder> ODD | NON | ALL

Manual operation: See "[Port Sequence](#)" on page 738

CALCulate:FMODEl:ISD:PORT:SKIP <String>

Tells the ISD tool which ports (in the measured DUT + Test Fixture file) shall be skipped when the tool is run.

Equivalent to using the `ports_to_skip` batch mode parameter of the ISD tool with a list of (positive) port numbers.

Parameters:

<String> The port numbers, separated by blanks (e.g. '1 3 4').

Manual operation: See "[Ports to Skip \(manual\)](#)" on page 739

CALCulate:FMODEl:ISD:PORT:SKIP:LEFT
CALCulate:FMODEl:ISD:PORT:SKIP:NONE
CALCulate:FMODEl:ISD:PORT:SKIP:RIGHT

Tells the ISD tool which ports (in the measured DUT + Test Fixture file) shall be skipped when the tool is run.

- **...:LEFT**: skip the ports on the left (according to the port order specified using `CALCulate:FMODEl:ISD:PORT:ORDER`)
- **...:NONE**: do not skip any ports
- **...:RIGHT**: skip the ports on the right (according to the port order specified using `CALCulate:FMODEl:ISD<Ph_pt>:PORT:ORDER`)

Equivalent to setting the `ports_to_skip` batch mode parameter of the ISD tool to -1, 0 or -2, respectively.

Use `CALCulate:FMODEl:ISD:PORT:SKIP` to define an arbitrary set of ports to be skipped.

Usage: Event

Manual operation: See "Ports to Skip" on page 738

CALCulate:FMODEl:ISD:PRESet

Restores the global default settings of the ISD tool.

Usage: Event

Manual operation: See "Reset to Default" on page 730

CALCulate:FMODEl:ISD:RUN:RUN

Runs the ISD tool.

Before executing this command, make sure that

- the test coupon measurement (using `CALCulate:FMODEl:ISD:COUPon:MEASure:OPEN` and `CALCulate:FMODEl:ISD:COUPon:MEASure:SHORT` for 1xOpen+1xShort, `CALCulate:FMODEl:ISD:COUPon:MEASure` otherwise) finished successfully, or the test coupon data were successfully loaded from file (using `CALCulate:FMODEl:ISD:COUPon:MEASure:FILENAME`)
- the measurement of DUT + test fixture (using `CALCulate:FMODEl:ISD:DUT:MEASure`) finished successfully

The resulting Touchstone files are written to C:\Users\Public\Documents\Rohde-Schwarz\ZNA\Embedding. If result files with the same name already exist, they will be overwritten.

Example: See Chapter 8.2.9, "Fixture modeling", on page 1762

Usage: Event

Manual operation: See "Run <Fixture Modeling Tool>" on page 734

CALCulate:FMODEl:ISD<Pt>:RUN[:STATe] <Boolean>

For a fixture modeling with the ISD tool, this command allows to specify the ports to which the deembedding files shall be assigned after the tool has run.

Suffix:

<Pt> Physical port number for single-ended deembedding, logical port number for balanced deembedding.

Parameters:

<Boolean> 1 (ON) if a deembedding file shall be assigned to port <Pt>, 0 (OFF) otherwise

Example: See [Chapter 8.2.9, "Fixture modeling"](#), on page 1762

Manual operation: See ["Apply"](#) on page 735

CALCulate:FMODEl:ISD:SCALE:ATTenuation <AttenLeadInScaling>

Scales the test coupon's attenuation (dB).

Sets/gets the `atten_scale 1` batch mode parameter of the ISD tool

Parameters:

<AttenLeadInScaling>

Manual operation: See ["Scaling for attenuation"](#) on page 737

CALCulate:FMODEl:ISD:SCALE:FREQuency <MaxFrequency>

Defines the maximum frequency to deembed.

Corresponds to the `max_frequency` batch mode parameter of the ISD tool.

Parameters:

<MaxFrequency> Default unit: Hz

Manual operation: See ["Max Freq to Deembed"](#) on page 739

CALCulate:FMODEl:ISD:SCALE:FTIME <FitLeadInScalingTime>

Overrides the lead-in's flight time in case the through-trace test coupon is a bit too short or too long.

Sets/gets the `atten_scale 1` batch mode parameter of the ISD tool.

Parameters:

<FitLeadInScalingTime>

Manual operation: See ["Scaling for flight time"](#) on page 738

CALCulate:FMODEl:ISD:SMALIfixture <Boolean>

Enables/disables the ISD tool's small fixture mode.

Parameters:

<Boolean>

Manual operation: See "[Small Fixture](#)" on page 740**CALCulate:FMODEl:ISD:TRACe:COUPling** <TraceCoupling>

Tells the ISD tool about coupling among lead-in traces.

Corresponds to the `coupling` batch mode parameter of the ISD tool.**Parameters:**

<TraceCoupling>

NONE | WEAK | STRong

NONE: no coupling.

WEAK: coupling will be extracted even if there are 2 ports enabled on the test coupon

STRong: if the test coupon is a 4-port file, and there are two ports to be extracted, the ISD tool will optimize odd- and even-mode insertion losses

Manual operation: See "[Trace Coupling](#)" on page 739**CALCulate:FMODEl:SFD...**Commands for PacketMicro's *Smart Fixture De-embedding* (SFD), see <https://www.packetmicro.com/Products/sfd-tool.html>

CALCulate:FMODEl:SFD:AUTO	1047
CALCulate:FMODEl:SFD:COUPon:MEASure	1048
CALCulate:FMODEl:SFD:COUPon:MEASure:FILename	1048
CALCulate:FMODEl:SFD:COUPon:MEASure:FILename:CLEar	1048
CALCulate:FMODEl:SFD<Ph_pt>:COUPon[:STATe]	1048
CALCulate:FMODEl:SFD:COUPon:TYPE	1049
CALCulate:FMODEl:SFD:DIFFcfg	1049
CALCulate:FMODEl:SFD:DUT:MEASure	1049
CALCulate:FMODEl:SFD:DUT:MEASure:FILename	1049
CALCulate:FMODEl:SFD:DUT:MEASure:FILename:CLEar	1050
CALCulate:FMODEl:SFD<Ph_pt>:DUT[:STATe]	1050
CALCulate:FMODEl:SFD:IMPedance	1050
CALCulate:FMODEl:SFD:PRESet	1050
CALCulate:FMODEl:SFD:RUN:RUN	1050
CALCulate:FMODEl:SFD<Ph_pt>:RUN[:STATe]	1051
CALCulate:FMODEl:SFD:TOTaldiffcfg	1051

CALCulate:FMODEl:SFD:AUTO <Boolean>

Enables/disables the impedance correction of the SFD tool.

This is a global setting.

Duplicate of `CALCulate:FMODEl:SFD:IMPedance`, kept for backward compatibility.

Parameters:

<Boolean> **ON (1)**
 Impedance correction enabled

OFF (0)
 Impedance correction disabled

Manual operation: See "[Use Impedance Correction](#)" on page 730

CALCulate:FMODEl:SFD:COUPon:MEASure

For a fixture modeling with the SFD tool, this command starts the measurement of the coupon at the active ports (see `CALCulate:FMODEl:SFD<Ph_pt>:COUPon[:STATe]`).

The coupon type can be selected using `CALCulate:FMODEl:SFD:COUPon:TYPE`.

Usage: Event

Manual operation: See "[Measure / Measure Open / Measure Short](#)" on page 731

CALCulate:FMODEl:SFD:COUPon:MEASure:FILEname <String>

For a fixture modeling with the SFD tool, this command loads the coupon properties from a Touchstone file.

The coupon type can be selected using `CALCulate:FMODEl:SFD:COUPon:TYPE`.

Parameters:

<String> Path to the Touchstone file, either absolute or relative to the selected working directory (`CALCulate:FMODEl:DIRectory`).

Manual operation: See "[Load File / 1x Open Preset / 1x Short Preset](#)" on page 732

CALCulate:FMODEl:SFD:COUPon:MEASure:FILEname:CLEar

Invalidates the file path previously set using `CALCulate:FMODEl:SFD:COUPon:MEASure:FILEname`.

Usage: Event

Manual operation: See "[Load File / 1x Open Preset / 1x Short Preset](#)" on page 732

CALCulate:FMODEl:SFD<Ph_pt>:COUPon[:STATe] <Boolean>

For a fixture modeling with the SFD tool, this command allows to specify the ports to which the test coupon is connected.

This has to be defined before measuring the test coupon (using `CALCulate:FMODEl:SFD:DUT:MEASure`).

Suffix:

<Ph_pt> Physical port number

Parameters:

<Boolean> 1 (ON, true) if the test coupon is connected to port <Ph_pt>, 0 (OFF, false) otherwise

Manual operation: See ["Active"](#) on page 732

CALCulate:FMODEl:SFD:COUPon:TYPE <CouponType>

Sets/gets the coupon type to be measured for a fixture modelling with the SFD tool.

Parameters:

<CouponType> SYMMetric2x | OPEN1x | SHORT1x

Manual operation: See ["Coupon Type"](#) on page 731

CALCulate:FMODEl:SFD:DIFFcfig <SFDPortConfig>

Tells the SFD tool about the port ordering of the 2x Thru test coupon.

Parameters:

<SFDPortConfig> ODD | NON

ODD: odd ports are on the left and even ports are on the right

NON: ports 1 to N are on the left and ports N+1 to 2·N are on the right

Manual operation: See ["2x Thru Port Ordering"](#) on page 740

CALCulate:FMODEl:SFD:DUT:MEASure

For a fixture modeling with the ISD tool, this command allows to measure the DUT + Fixture at the active ports (see [CALCulate:FMODEl:SFD<Ph_pt>:DUT\[:STATe\]](#)).

Usage: Event

Manual operation: See ["Measure"](#) on page 733

CALCulate:FMODEl:SFD:DUT:MEASure:FILEname <String>

For a fixture modeling with the EZD tool, this command loads the "DUT + Test Fixture" properties from a Touchstone file.

Parameters:

<String> Path to the Touchstone file, either absolute or relative to the selected working directory ([CALCulate:FMODEl:DIRectory](#)).

Manual operation: See ["Load File"](#) on page 733

CALCulate:FMODEl:SFD:DUT:MEASure:FILEname:CLEar

Invalidates the file path previously set using `CALCulate:FMODEl:SFD:DUT:MEASure:FILEname`.

Usage: Event

Manual operation: See "[Load File](#)" on page 733

CALCulate:FMODEl:SFD<Ph_pt>:DUT[:STATe] <Boolean>

For a fixture modeling with the SFD tool, this command allows to specify the ports to which the test fixture is connected.

This has to be defined before measuring DUT + Fixture (using `CALCulate:FMODEl:SFD:DUT:MEASure`).

Suffix:

<Ph_pt> Physical port number

Parameters:

<Boolean> 1 (ON, true) if the test fixture is connected to port <Ph_pt>, 0 (OFF, false) otherwise

Manual operation: See "[Active](#)" on page 733

CALCulate:FMODEl:SFD:IMPedance <Boolean>

Enables/disables the impedance correction of the SFD tool.

This is a global setting.

Parameters:

<Boolean> **ON (1)**
Impedance correction enabled
OFF (0)
Impedance correction disabled

Manual operation: See "[Use Impedance Correction](#)" on page 730

CALCulate:FMODEl:SFD:PRESet

Restores the global default settings of the SFD tool.

Usage: Event

Manual operation: See "[Reset to Default](#)" on page 730

CALCulate:FMODEl:SFD:RUN:RUN

Runs the SFD tool.

Before executing this command, make sure that:

- The test coupon measurement (using `CALCulate:FMODEl:SFD:COUPon:MEASure`) finished successfully, or the test coupon data were successfully loaded from file (using `CALCulate:FMODEl:SFD:COUPon:MEASure:FILEname`)
- The measurement of DUT + test fixture (using `CALCulate:FMODEl:SFD:DUT:MEASure`) finished successfully.

The resulting Touchstone files are written to C:\Users\Public\Documents\Rohde-Schwarz\ZNA\Embedding. If result files with the same name already exist, they are overwritten.

Usage: Event

Manual operation: See "[Run <Fixture Modeling Tool>](#)" on page 734

CALCulate:FMODEl:SFD<Ph_pt>:RUN[:STATe] <Boolean>

For a fixture modeling with the SFD tool, this command allows to specify the ports to which the deembedding files shall be assigned after the tool has run.

Suffix:

<Ph_pt> Physical port number for single-ended deembedding, logical port number for balanced deembedding.

Parameters:

<Boolean> 1 (ON) if a deembedding file shall be assigned to port <Pt>, 0 (OFF) otherwise

Manual operation: See "[Apply](#)" on page 735

CALCulate:FMODEl:SFD:TOTAlDIFFcFG <SFDPortConfig>

Tells the SFD tool about the port ordering of the test fixture.

Parameters:

<SFDPortConfig> ODD | NON
 ODD: odd ports are on the left and even ports are on the right
 NON: ports 1 to N are on the left and ports N+1 to 2·N are on the right

Manual operation: See "[Total Port Ordering](#)" on page 741

CALCulate:FMODEl... (other)

CALCulate:FMODEl:DIRectory	1051
CALCulate:FMODEl:DIRectory:DEFault	1052
CALCulate:FMODEl:DIRectory:DEFault:CLEar	1052
CALCulate:FMODEl:REName	1052

CALCulate:FMODEl:DIRectory <String>

Defines the common working directory of the ISD, SFD and EZD fixture modeling tools.

Parameters:

<String> Directory path, either absolute or relative to the current directory (MMEMory:CDIRectory).

Manual operation: See "Output Settings" on page 729

CALCulate:FMODEl:DIRectory:DEFault

Resets the common working directory of the ISD, SFD, and EZD tool to its default C:\Users\Public\Documents\Rohde-Schwarz\ZNA\Embedding.

Suffix:

<Ph_pt> This suffix is ignored.

Usage: Event

Manual operation: See "Output Settings" on page 729

CALCulate:FMODEl:DIRectory:DEFault:CLEar

Deletes all files in the common default working directory of the of the ISD, SFD, and EZD tool (C:\Users\Public\Documents\Rohde-Schwarz\ZNA\Embedding).

Usage: Event

Manual operation: See "Output Settings" on page 729

CALCulate:FMODEl:REName <Boolean>

If set to ON (1), the names of subsequently generated "Test Coupon" and "DUT + Test Fixture" files are prefixed with the current date and time.

Parameters:

<Boolean>

Manual operation: See "Output Settings" on page 729

7.3.1.7 CALCulate:LDEVIation...

CALCulate<Chn>:LDEVIation:AUTO.....	1052
CALCulate<Chn>:LDEVIation:CONStant.....	1053
CALCulate<Chn>:LDEVIation:ELENgth.....	1053
CALCulate<Chn>:LDEVIation:MODE.....	1054
CALCulate<Chn>:LDEVIation:SLOPe.....	1054

CALCulate<Chn>:LDEVIation:AUTO <Activate>

Initiates a (re-)calculation of the linearity deviation correction factors and applies them to the active trace.

Suffix:
 <Chn> Channel number used to identify the active trace. If unspecified the numeric suffix is set to 1.

Setting parameters:
 <Activate> ONCE
 Initiates the calculation

Example: *RST; CALC:FORM PHAS
 Reset the analyzer; assign the phase of the transmission parameter S21 to the default trace.
 CALC:LDEV:AUTO ONCE
 Calculate correction factors and apply them to the default trace.
 CALC:LDEV:SLOP?; ELEN?; CONS?
 Query the values of the correction factors.
 CALC:LDEV:MODE OFF
 Disable the correction.

Usage: Setting only

Manual operation: See "[Auto Linearity Deviation](#)" on page 476

CALCulate<Chn>:LDEVIation:CONStant <Constant>

Defines the constant value for the linearity deviation calculation.

Suffix:
 <Chn> Channel number used to identify the active trace.

Parameters:
 <Constant> Constant value
 Range: The range depends on the trace format. For the default trace: -200 dB to + 200 dB.
 Increment: 10E-2 dB
 *RST: 0 dB

Example: See [CALCulate<Chn>:LDEVIation:AUTO](#) on page 1052

Manual operation: See "[Constant](#)" on page 477

CALCulate<Chn>:LDEVIation:ELENgtH <EILength>

Defines the electrical length for the linearity deviation calculation. This command is available if the active trace format is Phase or Unwrapped Phase, or if a mixer delay is measured.

Suffix:
 <Chn> Channel number used to identify the active trace.

Parameters:

<ElLength> Electrical length
 Range: 0 m to + 1000 m.
 Increment: 10E-4 m
 *RST: 0 m
 Default unit: m

Example: See [CALCulate<Chn>:LDEVIation:AUTO](#) on page 1052

Manual operation: See ["El. Length"](#) on page 477

CALCulate<Chn>:LDEVIation:MODE <Mode>

Applies /discards the correction factors or re-calculates them for each trace (Tracking).

Suffix:

<Chn> Channel number used to identify the active trace.

Parameters:

<Mode> OFF | ON | TRACKing
 Apply the correction using the latest correction factors.
 ON - Apply the correction using the latest correction factors.
 OFF - Discard the correction.
 TRACKing - Repeat calculation for each measured trace and apply the correction.
 *RST: 0 dB/MHz

Example: See [CALCulate<Chn>:LDEVIation:AUTO](#) on page 1052

Manual operation: See ["On"](#) on page 476

CALCulate<Chn>:LDEVIation:SLOPe <Slope>

Defines the slope of the regression line for the linearity deviation calculation.

Suffix:

<Chn> Channel number used to identify the active trace.

Parameters:

<Slope> Slope of the regression line
 Range: The range depends on the trace format. For the default trace: -1015 dB/MHz to +1015 dB/MHz.
 Increment: 10E-4 dB/MHz
 *RST: 0 dB/MHz

Example: See [CALCulate<Chn>:LDEVIation:AUTO](#) on page 1052

Manual operation: See ["Slope"](#) on page 477

7.3.1.8 CALCulate:LIMit...

The `CALCulate:LIMit...` commands define the limit lines and control the limit check.

<code>CALCulate<Chn>:LIMit:CIRClE:CLEar</code>	1055
<code>CALCulate<Chn>:LIMit:CIRClE:DATA</code>	1056
<code>CALCulate<Chn>:LIMit:CIRClE:DISPlay[:STATe]</code>	1056
<code>CALCulate<Chn>:LIMit:CIRClE:FAIL?</code>	1057
<code>CALCulate:LIMit:CIRClE:FAIL:ALL?</code>	1057
<code>CALCulate<Chn>:LIMit:CIRClE:SOUNd[:STATe]</code>	1057
<code>CALCulate<Chn>:LIMit:CIRClE[:STATe]</code>	1057
<code>CALCulate<Chn>:LIMit:CLEar</code>	1058
<code>CALCulate<Chn>:LIMit:CONTRol[:DATA]</code>	1058
<code>CALCulate<Chn>:LIMit:CONTRol:SHIFt</code>	1059
<code>CALCulate<Chn>:LIMit:DATA</code>	1059
<code>CALCulate<Chn>:LIMit:DCIRClE:CLEar</code>	1060
<code>CALCulate<Chn>:LIMit:DCIRClE:DATA</code>	1060
<code>CALCulate<Chn>:LIMit:DCIRClE:DISPlay[:STATe]</code>	1061
<code>CALCulate<Chn>:LIMit:DCIRClE[:STATe]</code>	1061
<code>CALCulate<Chn>:LIMit:DELeTe:ALL</code>	1061
<code>CALCulate<Chn>:LIMit:DISPlay[:STATe]</code>	1062
<code>CALCulate<Chn>:LIMit:FAIL?</code>	1062
<code>CALCulate:LIMit:FAIL:ALL?</code>	1063
<code>CALCulate:LIMit:FAIL:DATA?</code>	1063
<code>CALCulate<Chn>:LIMit:LOWer[:DATA]</code>	1063
<code>CALCulate<Chn>:LIMit:UPPer[:DATA]</code>	1063
<code>CALCulate<Chn>:LIMit:LOWer:FEED</code>	1065
<code>CALCulate<Chn>:LIMit:UPPer:FEED</code>	1065
<code>CALCulate<Chn>:LIMit:LOWer:SHIFt</code>	1066
<code>CALCulate<Chn>:LIMit:UPPer:SHIFt</code>	1066
<code>CALCulate:LIMit:POINts:LOWer?</code>	1066
<code>CALCulate:LIMit:POINts:UPPer?</code>	1066
<code>CALCulate<Chn>:LIMit:SEGMENT<Seg>:AMPLitude:START</code>	1067
<code>CALCulate<Chn>:LIMit:SEGMENT<Seg>:AMPLitude:STOP</code>	1067
<code>CALCulate<Chn>:LIMit:SEGMENT:COUNT?</code>	1068
<code>CALCulate<Chn>:LIMit:SEGMENT<Seg>:FORMula</code>	1068
<code>CALCulate<Chn>:LIMit:SEGMENT<Seg>:FORMula:STATe</code>	1069
<code>CALCulate<Chn>:LIMit:SEGMENT<Seg>:INTerpol</code>	1069
<code>CALCulate<Chn>:LIMit:SEGMENT<Seg>:STIMulus:START</code>	1070
<code>CALCulate<Chn>:LIMit:SEGMENT<Seg>:STIMulus:STOP</code>	1070
<code>CALCulate<Chn>:LIMit:SEGMENT<Seg>:TYPE</code>	1070
<code>CALCulate<Chn>:LIMit:SOUNd[:STATe]</code>	1071
<code>CALCulate<Chn>:LIMit:STATe</code>	1071
<code>CALCulate<Chn>:LIMit:STATe:AREA</code>	1072
<code>CALCulate<Chn>:LIMit:TTLout<Pt>[:STATe]</code>	1072

CALCulate<Chn>:LIMit:CIRClE:CLEar

Resets the circle test for the active trace of channel <Chn>.

Suffix:
 <Chn> Channel number used to identify the active trace

Usage: Event

Manual operation: See "[Clear Test](#)" on page 495

CALCulate<Chn>:LIMit:CIRClE:DATA <CenterX>, <CenterY>, <Radius>

Defines a circle limit lines by its center coordinates and its radius.

Suffix:
 <Chn> Channel number used to identify the active trace

Parameters:

<CenterX> Range: Virtually no restriction for center coordinates.
 *RST: 0
 Default unit: NN

<CenterY> Range: Virtually no restriction for center coordinates.
 *RST: 0
 Default unit: NN

<Radius> Range: Virtually no restriction for radius (use positive values).
 *RST: 1
 Default unit: NN

Example: See [CALCulate<Chn>:LIMit:CIRClE\[:STATe\]](#)

Manual operation: See "[Radius / Center X / Center Y](#)" on page 495

CALCulate<Chn>:LIMit:CIRClE:DISPlay[:STATe] <Boolean>

Displays or hides the circle limit line associated to the active trace.

Suffix:
 <Chn> Channel number used to identify the active trace

Parameters:

<Boolean> ON | OFF - Circle limit line on or off.
 *RST: OFF

Example: *RST; CALCulate:LIMit:CIRClE:DATA 0, 0, 0.5
 Define a circle limit line centered around the origin of the polar diagram, assigning a radius of 0.5 U.
 CALCulate:FORMat POLar
 CALCulate:LIMit:CIRClE:DISPlay ON
 Activate a polar diagram and show the circle limit line in the diagram.

Manual operation: See "[Show Limit Circle](#)" on page 492

CALCulate<Chn>:LIMit:CIRClE:FAIL?

Returns a 0 or 1 to indicate whether or not the circle limit check has failed. 0 represents pass and 1 represents fail

Tip: Use `CALCulate:CLIMits:FAIL?` to perform a composite (global) limit check.

Suffix:

<Chn> Channel number used to identify the active trace

Example:

See `CALCulate<Chn>:LIMit:CIRClE[:STATe]`

Usage:

Query only

Manual operation: See "[Limit Check](#)" on page 493

CALCulate:LIMit:CIRClE:FAIL:ALL? [<RecallSet>]

Returns a 0 or 1 to indicate whether or not the circle limit check has failed for at least one channel in the referenced recall set. 0 represents pass and 1 represents fail

Query parameters:

<RecallSet> Recall set name; if omitted the active recall set is used

Usage:

Query only

Manual operation: See "[Limit Check](#)" on page 493

CALCulate<Chn>:LIMit:CIRClE:SOUNd[:STATe] <Boolean>

Switches the acoustic signal (fail beep) on or off. The fail beep is generated each time the analyzer detects an exceeded circle limit.

Suffix:

<Chn> Channel number used to identify the active trace

Parameters:

<Boolean> ON | OFF - Fail beep on or off.

*RST: OFF

Example:

`CALCulate:LIMit:CIRClE:STATe ON; SOUNd ON`

Switch the limit check on and activate the fail beep.

Manual operation: See "[Limit Fail Beep](#)" on page 495

CALCulate<Chn>:LIMit:CIRClE[:STATe] <Boolean>

Switches the circle limit check on or off.

Suffix:

<Chn> Channel number used to identify the active trace

Parameters:

<Boolean>

Example: `*RST; CALCulate:LIMit:CIRClE:DATA 0, 0, 0.5`
 Define a circle limit line centered around the origin of the polar diagram, assigning a radius of 0.5 U.
`CALCulate:LIMit:CIRClE:STATe ON; FAIL?`
 Switch the limit check on and query the result.

Manual operation: See "[Limit Check](#)" on page 493

CALCulate<Chn>:LIMit:CLEAr

Resets the limit check results for the limit line test.

Suffix:

<Chn> Channel number used to identify the active trace

Usage: Event

Manual operation: See "[Clear Test](#)" on page 481

CALCulate<Chn>:LIMit:CONTRol[:DATA] <StartStim>, <StopStim>[, ...]

Defines the stimulus values of the limit line and/or creates new limit line segments. See also [Chapter 4.4.1.1, "Rules for limit line definition"](#), on page 169.

Rules for creating segments

The following rules apply to an active trace with n existing limit line segments:

- An odd number of values is rejected; an error message -109, "Missing parameter..." is generated.
- An even number of $2 \cdot k$ values updates or generates k limit line segments.
- For $n > k$ the stimulus values of all existing limit line segments no. 1 to k are updated, the existing limit line segments no. k+1, ..., n are deleted.
- For $n < k$ the stimulus values of the limit line segments no. 1 to n are updated, the limit line segments n+1, ..., k are generated with default response values (see [CALCulate<Chn>:LIMit:UPPer\[:DATA\]](#), [CALCulate<Chn>:LIMit:LOWer\[:DATA\]](#)).

Note: The generated segments are upper or lower limit line segments, depending on the [CALCulate<Chn>:LIMit:SEGment<Seg>:TYPE](#) setting.

[CALCulate<Ch>:LIMit:CONTRol\[:DATA\]](#) does not overwrite the type setting.

Tip: To define additional new limit line segments without overwriting the old segments use [CALCulate<Chn>:LIMit:DATA](#).

Suffix:

<Chn> Channel number used to identify the active trace

Parameters:

<StartStim>

<StopStim>	<p>Pairs of stimulus values, each pair confining a limit line segment. See also Chapter 4.4.1.1, "Rules for limit line definition", on page 169.</p> <p>If not specified, the units are adjusted to the sweep type of the active channel (<code>[SENSe<Ch>:]SWEep:TYPE</code>).</p> <p>Range: Virtually no restriction for limit segments.</p> <p>*RST: A segment that is created implicitly, e.g. by means of <code>CALCulate<Ch>:LIMit:UPPer[:DATA]</code> or <code>CALCulate<Ch>:LIMit:LOWer[:DATA,]</code>, covers the maximum sweep range of the analyzer.</p>
Example:	<pre>*RST; :CALC:LIM:CONT 1 GHZ, 2 GHZ</pre> <p>Select a lin. frequency sweep (default) and define an upper limit line segment in the stimulus range between 1 GHz and 2 GHz, using default response values (–40 dB).</p> <pre>CALC:LIM:DISP ON</pre> <p>Show the limit line segment in the active diagram.</p>
Manual operation:	See "Segment List" on page 483

CALCulate<Chn>:LIMit:CONTRol:SHIFt <LimShift>

Shifts an existing limit line in horizontal direction. See also [Chapter 4.4.1.1, "Rules for limit line definition"](#), on page 169.

Suffix:

<Chn> Channel number used to identify the active trace

Setting parameters:

<LimShift> Offset value for the limit line

Range: Virtually no restriction for limit segments

Default unit: NN

Example:

```
*RST; :CALC:LIM:CONT 1 GHZ, 2 GHZ
```

Define a limit line segment in the stimulus range between 1 GHz and 2 GHz, using default response values.

```
CALC:LIM:CONT:SHIF 1; :CALC:LIM:CONT?
```

Shift the segment by 1 Hz. The modified limit line segment ranges from 1000000001 (Hz) to 2000000001 (Hz).

Usage: Setting only

Manual operation: See ["Shift Lines"](#) on page 482

CALCulate<Chn>:LIMit:DATA <Type>, <StartStim>, <StopStim>, <StartResp>, <StopResp>

Defines the limit line type, the stimulus and response values for a limit line with an arbitrary number of limit line segments. See [Chapter 4.4.1.1, "Rules for limit line definition"](#), on page 169.

Note: In contrast to `CALCulate<Chn>:LIMit:CONTRol[:DATA]`, this command does not overwrite existing limit line segments. The defined segments are appended to the segment list as new segments.

Suffix:

<Chn> Channel number used to identify the active trace

Parameters:

<Type> Identifier for the type of the limit line segment:
 0 – limit line segment off, segment defined but no limit check performed.
 1 – upper limit line segment
 2 – lower limit line segment
 Range: 0, 1, 2 (see above)

<StartStim>, <StopStim>, <StartResp>, <StopResp> Stimulus and response values of the first and last points of the limit line segment.
 The unit of the stimulus values is adjusted to the sweep type of the active channel (`[SENSe<Ch>:]SWEep:TYPE`), the unit of the ripple limit is adjusted to the format of the active trace (`CALCulate<Chn>:FORMat`).

Example:

```
*RST; :CALC:LIM:CONT 1 GHz, 1.5 GHz
Define an upper limit line segment in the stimulus range
between 1 GHz and 1.5 GHz, using default response values.
CALC:LIM:DATA 1, 1500000000, 2000000000, 2, 3
Define an upper limit line segment in the stimulus range
between 1.5 GHz and 2 GHz, assigning response values of +2
dB and +3 dB.
CALC:LIM:DISP ON
Show the limit line segment in the active diagram.
```

Manual operation: See "[Segment List](#)" on page 483

CALCulate<Chn>:LIMit:DCIRcle:CLEar

Resets the display circle to its default configuration (unit circle; show border: off; limit to circle: off).

Suffix:

<Chn> Channel number used to identify the active trace

Usage:

Event

Manual operation: See "[Clear Circle](#)" on page 497

CALCulate<Chn>:LIMit:DCIRcle:DATA <CenterX>, <CenterY>, <Radius>

Defines the display circle for the active trace of channel <Chn>.

Suffix:

<Chn> Channel number used to identify the active trace

Parameters:

<CenterX>	X position (real part) of the display circle's center
<CenterY>	Y position (imaginary part) of the display circle's center
<Radius>	Radius of the display circle

Manual operation: See "[Draw Circle / Radius, Center X, Center Y](#)" on page 497

CALCulate<Chn>:LIMit:DCIRcle:DISPlay[:STATe] <Boolean>

Sets/queries the visibility of the display circle for the active trace of channel <Chn>.

The display circle is defined using [CALCulate<Chn>:LIMit:DCIRcle:DATA](#).

Suffix:

<Chn>	Channel number used to identify the active trace
-------	--------------------------------------------------

Parameters:

<Boolean>	If set to ON, the line of the display circle is shown whenever the related trace is displayed in complex format.
-----------	------------------------------------------------------------------------------------------------------------------

Manual operation: See "[Show Border](#)" on page 496

CALCulate<Chn>:LIMit:DCIRcle[:STATe] <Boolean>

Sets/queries the state of the display circle for the active trace of channel <Chn>.

The display circle is defined using [CALCulate<Chn>:LIMit:DCIRcle:DATA](#).

Suffix:

<Chn>	Channel number used to identify the active trace
-------	--------------------------------------------------

Parameters:

<Boolean>	If set to ON, only trace points within the display circle are shown at the GUI whenever the related trace is displayed in complex format.
-----------	-------------------------------------------------------------------------------------------------------------------------------------------

Manual operation: See "[Limit to Circle On/Off](#)" on page 496

CALCulate<Chn>:LIMit:DELeTe:ALL

Deletes all limit line segments.

Suffix:

<Chn>	Channel number used to identify the active trace
-------	--------------------------------------------------

- Example:** `*RST; :CALC:LIM:CONT 1 GHZ, 1.5 GHZ`
 Define an upper limit line segment in the stimulus range between 1 GHz and 1.5 GHz, using default response values.
`CALC:LIM:DATA 1,1500000000, 2000000000,2,3`
 Define an upper limit line segment in the stimulus range between 1.5 GHz and 2 GHz, assigning response values of +2 dB and +3 dB.
`CALC:LIM:DEL:ALL`
 Delete both created limit line segments.
- Usage:** Event
- Manual operation:** See ["Add / Insert / Delete / Delete All"](#) on page 484

CALCulate<Chn>:LIMit:DISPlay[:STATe] <Boolean>

Displays or hides the entire limit line (including all segments) associated to the active trace.

Suffix:
 <Chn> Channel number used to identify the active trace

Parameters:
 <Boolean> ON | OFF - Limit line on or off.
 *RST: OFF

Example: `*RST; :CALC:LIM:CONT 1 GHZ, 2 GHZ`
 Define an upper limit line segment in the stimulus range between 1 GHz and 2 GHz, using default response values.
`CALC:LIM:DISP ON`
 Show the limit line segment in the active diagram.

Manual operation: See ["Show Limit Line"](#) on page 478

CALCulate<Chn>:LIMit:FAIL?

Returns a 0 or 1 to indicate whether or not the limit check has failed. 0 represents pass and 1 represents fail

Tip: Use `CALCulate:CLIMits:FAIL?` to perform a composite (global) limit check.

Since V2.20 of the R&S ZNA FW the result is automatically recalculated whenever a relevant setting is changed, i.e. a subsequent query will return the updated limit violation state.

Suffix:
 <Chn> Channel number used to identify the active trace

Example: *RST; :CALC:LIM:CONT 1 GHZ, 2 GHZ
 Define an upper limit line segment in the stimulus range between 1 GHz and 2 GHz, using default response values.
 CALC:LIM:STAT ON; FAIL?
 Switch the limit check on and query the result.
 CALC:LIM:STAT:AREA LEFT, TOP
 For a subsequent check at the GUI or a hardcopy, move the pass/fail message to the top left position.

Usage: Query only

Manual operation: See "[Limit Check](#)" on page 479

CALCulate:LIMit:FAIL:ALL? [<RecallSet>]

Returns a 0 or 1 to indicate whether or not the limit line check has failed for at least one channel in the referenced recall set. 0 represents pass and 1 represents fail.

Query parameters:

<RecallSet> Recall set name; if omitted the active recall set is used

Usage: Query only

Manual operation: See "[Limit Check](#)" on page 479

CALCulate:LIMit:FAIL:DATA? <TraceName>, <LimitFailType>

Returns those sweep points that have caused a limit violation of the given <LimitFailType> for trace <TraceName>.

Query parameters:

<TraceName> Trace name, uniquely identifying the related trace

<LimitFailType> LIMit | RIPPlE | CIRClE
 Limit (fail) type

Usage: Query only

CALCulate<Chn>:LIMit:LOWer[:DATA] <ResponseValue>, <ResponseValue>...

CALCulate<Chn>:LIMit:UPPer[:DATA] <StartResponse>,
 <StopResponse>[,<StartResponse>, <StopResponse>[,...]]

Sets/gets the response (y-axis) values of the lower/upper limit lines and/or creates new limit line segments. See also [Chapter 4.4.1.1, "Rules for limit line definition"](#), on page 169.

Note that in contrast to commands addressing a single limit line segment <Seg> (such as `CALCulate<Chn>:LIMit:SEGMENT<Seg>:TYPE`), these commands **assume** that

- lower limit line segments are assigned even numbers (<Seg> = 2, 4, 6, ...) and
- upper limit line segments are assigned odd numbers (<Seg> = 1, 3, 5, ...).

`CALCulate<Chn>:LIMit:LOWer/UPPer` sets the type and response values of even/odd limit line segments and gets the response values of even/odd limit line segments - no matter what the current type of these segments actually is!

Both commands will only work, if the total number of limit line segments is even.

Rules for creating and updating segments

Suppose that the active trace is equipped with $2s$ limit line segments (of any type) and k pairs of response values are passed with the command.

- `CALCulate:LIMit:LOWer`
 - deletes "obsolete" limit line segments $2k+1, \dots, 2s$
 - updates even limit line segments $2, 4, \dots, 2s$ with `type=lower` and the given response values
 - creates lower limit line segments $2s+2, 2s+4, \dots, 2k$ with (`type=lower` and) the given response values
 - creates "missing" upper limit line segments $2s+1, 2s+3, \dots, 2k-1$ with (`type=upper` and) default response values
- `CALCulate:LIMit:UPPer`
 - deletes "obsolete" limit line segments $2k+1, \dots, 2s$
 - updates odd limit line segments $1, 3, \dots, 2s-1$ with `type=upper` and the given response values
 - creates upper limit line segments $2s+1, 2s+3, \dots, 2k-1$ with (`type=upper` and) the given response values
 - creates "missing" lower limit line segments $2s+2, 2s+4, \dots, 2k$ with (`type=lower` and) default response values

If $s > 0$, newly created lower/upper limit line segments inherit their start and stop stimuli from the limit line segment with the highest even/odd number. Otherwise their stimulus range is set to the entire sweep range.

See `CALCulate<Chn>:LIMit:CONTRol[:DATA]` on how to change the stimulus values of a limit line segment.

Suffix:

`<Chn>` Channel number used to identify the active trace

Parameters:

`<StartResponse>`, `<StopResponse>`, ... Pair(s) of response values. In the parameter list, item $2s-1$ defines the "Start Response" and item $2s$ defines the "Stop Response" of upper/lower limit line segment $s = 1, 2, \dots$. An odd number of values is rejected with an error message `-109,"Missing parameter..."`.

Range: Virtually no restriction for limit segments.

*RST: Implicitly created segments are created with a default response value of `-40dB`.

Default unit: `dB`

Example: `CALC:LIM:LOW -10, 0, 0, -10`
 Define two limit line segments covering the entire sweep range. Two upper limit line segments with default response values are created in addition.
`CALC:LIM:UPP 0, 10, 10, 0`
 Change the response values of the upper limit line segments .
`CALC:LIM:DISP ON`
 Show the limit line segments in the active diagram.

Manual operation: See "[Segment List](#)" on page 483

CALCulate<Chn>:LIMit:LOWer:FEED <StimulusOffset>, <ResponseOffset>[, <TraceName>]

CALCulate<Chn>:LIMit:UPPer:FEED <StimulusOffset>, <ResponseOffset>[, <TraceName>]

Generates a lower or an upper limit line using the stimulus values of a data or memory trace and specified offset values.

Suffix:

<Chn> Channel number used to identify the active trace. This trace provides the stimulus data for the limit line unless another trace <TraceName> is specified.

Setting parameters:

<StimulusOffset> Stimulus offset value, used to shift all imported limit line segments in horizontal direction.

Default unit: NN

<ResponseOffset> Response offset value, used to shift all imported limit line segments in vertical direction.

Default unit: dB

<TraceName> Name of the selected trace as used e.g. in `CALCulate<Ch>:PARAmeter:SDEFine`. If no trace name is specified the analyzer uses the active trace no. <Chn>.

Example: `CALC:LIM:LOW:FEED 1 GHZ, -10`
 Use the stimulus values of the active trace, shifted by 1 GHz to the right and decreased by -10 dB, to create a lower limit line.
`CALC:LIM:UPP:FEED 1 GHZ, 10`
 Use the stimulus values of the active trace, shifted by 1 GHz to the right and increased by 10 dB, to create an upper limit line.
`CALC:LIM:LOW:SHIF -3; :CALC:LIM:CONT:SHIF 1 GHz`
 Shift the lower limit line by an additional -3 dB in vertical and by 1 GHz in horizontal direction. The upper limit line is also shifted.

Usage: Setting only

Manual operation: See "[Segment List](#)" on page 483

CALCulate<Chn>:LIMit:LOWer:SHIFt <LimShift>

CALCulate<Chn>:LIMit:UPPer:SHIFt <LimShift>

These commands shift all lower and upper limit line segments assigned to the active trace in vertical direction. Both commands shift **all** limit lines; they have the same functionality. See also [Chapter 4.4.1.1, "Rules for limit line definition"](#), on page 169.

Suffix:

<Chn> Channel number used to identify the active trace

Setting parameters:

<LimShift> Response offset value for all limit line segments.
 Range: Virtually no restriction for limit segments
 Default unit: NN

Example: See `CALCulate<Chn>:LIMit:LOWer:FEED`

Usage: Setting only

Manual operation: See ["Shift Lines"](#) on page 482

CALCulate:LIMit:POINts:LOWer? <TraceName>

CALCulate:LIMit:POINts:UPPer? <TraceName>

Reads the effective lower/upper limit points from a limit line test for an arbitrary (not necessarily the active) trace, referenced by its name <TraceName>.

"Effective" means:

- Only points within the sweep range and only active limit checks are considered.
- Disabled limit line segments (`CALCulate<Chn>:LIMit:SEGment<Seg>:TYPE OFF`) are ignored.
- Both linear/logarithmic interpolation and limit line formulae are supported.
- If there are overlapping limit line segments, only the tighter limit is reported.

Query parameters:

<TraceName> String parameter containing the trace name

Return values:

<Data> Limit points, either in ASCII or block data format, depending on the current `FORMat[:DATA]`.
 One limit point = one value (y-axis) per sweep point (x-axis).
 "No limit point" is reported as Not a Number, which is the string "-NAN(IND)" in ASCII and a float testing true for "isnan".
 If there is no effective limit point, an empty response is returned.

Example:

```
*RST
:SENSE1:FREQUENCY1:START 1 GHZ; STOP 5 GHZ
:SENSE1:SWEEP:POINTS 5
```

After a reset, modify the default trace 'Trc1'.

```
:CALCulate1:LIMit1:DATA 1, 1000000000,
2000000000, -40, -30
:CALCulate1:LIMit2:DATA 1, 4000000000,
5000000000, -30, -40
```

Define upper limit lines for frequency ranges [1 GHz, 2 GHz] and [4 GHz, 5 GHz]

```
:CALCulate1:LIMit1:POINTS:UPPER? 'Trc1'
```

Query the limit lines. Returns an empty string, because limit checking is inactive.

```
:CALCulate1:LIMit1:STATE ON
```

Activate limit checking.

```
:CALCulate17:LIMit1:POINTS:UPPER? 'Trc1'
```

Returns -40, -30, -NAN (IND), -30, -40, where -NAN (IND) is related to the center frequency 3 GHz, whose trace value is not limited.

Usage:

Query only

Manual operation:

See "[Limit Check](#)" on page 479

CALCulate<Chn>:LIMit:SEGMENT<Seg>:AMPLitude:START <Response>

CALCulate<Chn>:LIMit:SEGMENT<Seg>:AMPLitude:STOP <Response>

These commands change the start or the stop response values (i.e. the response values assigned to the start or stop stimulus values) of a limit line segment. A segment must be created first to enable the commands (e.g. [CALCulate<Chn>:LIMit:DATA](#)). See also [Chapter 4.4.1.1, "Rules for limit line definition"](#), on page 169.

Tip: To define the response values of several limit line segments with a single command, use [CALCulate<Chn>:LIMit:LOWer\[:DATA\]](#) or [CALCulate<Chn>:LIMit:UPPER\[:DATA\]](#).

Suffix:

<Chn> Channel number used to identify the active trace

<Seg> Segment number

Parameters:

<Response> Response value

Range: Virtually no restriction for limit segments

*RST: The default response values of a segment that is created by defining its stimulus values only (e.g. by means of [CALCulate<Ch>:LIMit:CONTROL\[:DATA\]](#)), are -40 dB.

Default unit: NN

Example: `CALC:LIM:DATA 1,1500000000, 2000000000,2,3`
 Define an upper limit line segment (segment no. 1) in the stimulus range between 1.5 GHz and 2 GHz, assigning response values of +2 dB and +3 dB.
`:CALC:LIM:SEGM:AMPL:STAR 5; STOP 5; :CALC:LIM:SEGM:TYPE LMIN`
 Change the segment to a lower limit line segment with a constant response value of +5 dB.
`CALC:LIM:DATA?`
 Query the type, the stimulus and response values of the created segment with a single command. The response is `2,1500000000,2000000000,5,5`.

Manual operation: See "[Segment List](#)" on page 483

CALCulate<Chn>:LIMit:SEGMent:COUNT?

Returns the number of limit line segments, including enabled and disabled segments.

Suffix:

<Chn> Channel number used to identify the active trace

Example:

`CALC:LIM:DATA 1,1500000000, 2000000000,2,3`
 Define an upper limit line segment (segment no. 1) in the stimulus range between 1.5 GHz and 2 GHz, assigning response values of +2 dB and +3 dB.
`CALC:LIM:SEGM:COUNT?`
 Query the number of segments. The response is 1.

Usage: Query only

Manual operation: See "[Segment List](#)" on page 483

CALCulate<Chn>:LIMit:SEGMent<Seg>:FORMula <Formula>

Defines a custom formula for limit line segment <Seg> of the related trace.

The formula is only used, if `CALCulate<Chn>:LIMit:SEGMent<Seg>:FORMula` is set to ON.

Suffix:

<Chn> Channel number used to identify the active trace

<Seg> Segment number

Parameters:

<Formula> User-defined formula (string).
 Allows for the same mathematical expressions as `CALCulate<Chn>:MATH[:EXPRession]:SDEFine`.

Example:

```
*RST
SENS:FREQ:STAR 1GHz
SENS:FREQ:STOP 3GHz
CALC:LIM:CONT 1GHz, 2GHz, 2GHz, 3GHz
CALC:LIM:SEGM1:FORM '22-(20/25.78)*StimVal/1e9'
CALC:LIM:SEGM1:FORM:STAT ON
CALC:LIM:SEGM2:FORM '15-(6/25.78)*StimVal/1e9'
CALC:LIM:SEGM2:TYPE LMIN
CALC:LIM:DISP ON
CALC:LIM:STAT ON
```

Manual operation: See "[Linear/Formula](#)" on page 486

CALCulate<Chn>:LIMit:SEGment<Seg>:FORMula:STATe <State>

Defines whether a custom formula is used for limit line segment <Seg> of the related trace.

Suffix:

<Chn> Channel number used to identify the active trace

<Seg> Segment number

If you want to use a custom formula for a segment, use [CALCulate<Chn>:LIMit:CONTrol\[:DATA\]](#) to create it.

Parameters:

<State> **OFF (0)**

The line segment is a straight line, connecting the endpoints specified in the segment definition.

ON (1)

The line segment is defined by a custom formula. Use [CALCulate<Chn>:LIMit:SEGment<Seg>:FORMula](#) to specify the formula.

*RST: OFF

Example: See [CALCulate<Chn>:LIMit:SEGment<Seg>:FORMula](#) on page 1068

Manual operation: See "[Linear/Formula](#)" on page 486

CALCulate<Chn>:LIMit:SEGment<Seg>:INTerpol <LimLineInterpolation>

"Interpolation" determines whether the limit line segment is interpolated linearly or logarithmically. The latter may be more suitable for logarithmic sweeps.

Suffix:

<Chn> Channel number used to identify the active trace

<Seg> Segment number

Parameters:

<LimLineInterpolation> LOGarithmic | LINear

Manual operation: See "[Segment List](#)" on page 483

CALCulate<Chn>:LIMit:SEGment<Seg>:STIMulus:STARt <FreqPowTime>
CALCulate<Chn>:LIMit:SEGment<Seg>:STIMulus:STOP <StimVal>

These commands change the start and stop stimulus values (i.e. the smallest and the largest stimulus values) of a limit line segment. A segment must be created first to enable the commands (e.g. `CALCulate<Chn>:LIMit:DATA`). See also [Chapter 4.4.1.1, "Rules for limit line definition"](#), on page 169.

Tip: To define the stimulus values of several limit line segments with a single command, use `CALCulate<Chn>:LIMit:CONTRol[:DATA]`.

Suffix:

<Chn> Channel number used to identify the active trace

<Seg> Segment number

Parameters:

<StimVal> Stimulus value confining the limit line segment.
 If specified, the unit of a stimulus value must in accordance with the sweep type of the active channel (`[SENSe<Ch>:]SWEep:TYPE`). Default units are *Hz* for frequency sweeps, *dBm* for power sweeps, and *s* for time sweeps. For CW mode sweeps, stimulus values are dimensionless.

Default unit: NN

Example:

```
CALC:LIM:DATA 1,1500000000, 2000000000,2,3
```

Define an upper limit line segment (segment no. 1) in the stimulus range between 1.5 GHz and 2 GHz, assigning response values of +2 dB and +3 dB.

```
CALC:LIM:SEGM:STIM:STAR 1GHZ; STOP 2 GHZ; :
```

```
CALC:LIM:SEGM:TYPE LMIN
```

Change the segment to a lower limit line segment with a stimulus range between 1 GHz and 2 GHz.

```
CALC:LIM:DATA?
```

Query the type, the stimulus and response values of the created segment with a single command. The response is 2,1000000000,2000000000,2,3.

Manual operation: See "[Segment List](#)" on page 483

CALCulate<Chn>:LIMit:SEGment<Seg>:TYPE <LimLineType>

Selects the limit line type for a limit line segment. This can be done before or after defining the stimulus and response values of the segment, however, a segment must be created first to enable this command (e.g. `CALC:LIM:DATA`).

Note: The type command overwrites the `CALCulate<Chn>:LIMit:DATA` settings and is overwritten by them. It is not affected by the other commands in the `CALCulate<Chn>:LIMit...` subsystem defining stimulus and response values of limit lines.

Suffix:
 <Chn> Channel number used to identify the active trace
 <Seg> Segment number

Parameters:
 <LimLineType> LMIN | LMAX | OFF
 Limit line type
 Range: LMAX (upper limit line segment), LMIN (lower limit line segment), OFF (limit check switched off, limit line segment not deleted)
 *RST: LMAX

Example: *RST; :CALC:LIM:UPP 0, 0
 Define an upper limit line segment across the entire sweep range, using a constant upper limit of 0 dBm.
 CALC:LIM:SEGM:TYPE LMIN
 Turn the defined limit line segment into a lower limit line segment.

Manual operation: See "[Segment List](#)" on page 483

CALCulate<Chn>:LIMit:SOUNd[:STATe] <Boolean>

Switches the acoustic signal (fail beep) on or off. The fail beep is generated each time the analyzer detects an exceeded limit.

Suffix:
 <Chn> Channel number used to identify the active trace

Parameters:
 <Boolean> ON | OFF - Fail beep on or off.
 *RST: OFF

Example: CALC:LIM:STAT ON; SOUN ON
 Switch the limit check on and activate the fail beep.

Manual operation: See "[Limit Fail Beep](#)" on page 480

CALCulate<Chn>:LIMit:STATe <Boolean>

Switches the limit check (including upper and lower limits) on or off.

Tip: Use CALCulate<Ch>:LIMit:UPPer:STATe or CALCulate<Ch>:LIMit:LOWer:STATe to switch on or off the individual limit checks for upper or lower limit lines.

Suffix:
 <Chn> Channel number used to identify the active trace

Parameters:
 <Boolean> ON | OFF - Limit check on or off.
 *RST: OFF

Example: `*RST; CALC:LIM:CONT 1 GHZ, 2 GHZ`
 Define an upper limit line segment in the stimulus range between 1 GHz and 2 GHz, using default response values.
`CALC:LIM:STAT ON; FAIL?`
 Switch the limit check on and query the result.

Manual operation: See "[Limit Check](#)" on page 479

CALCulate<Chn>:LIMit:STATe:AREA <HorizontalPos>, <VerticalPos>

Moves the limit check pass/fail message for the active trace <Chn> to one of nine pre-defined positions in the active diagram.

Suffix:

<Chn> Channel number used to identify the active trace

Parameters:

<HorizontalPos> LEFT | MID | RIGHT
 Horizontal position

<VerticalPos> TOP | MID | BOTTOm
 Vertical position

Example: See `CALCulate<Chn>:LIMit:FAIL?`

Manual operation: See "[Limit Check](#)" on page 479

CALCulate<Chn>:LIMit:TTLout<Pt>[:STATe] <Boolean>

Switches the TTL pass/fail signals on or off. The signals are applied to the USER PORT as long as the active trace <Chn> is within limits, including the ripple limits.

See [Chapter 12.3.1.1, "User Port"](#), on page 1779.

Suffix:

<Chn> Channel number used to identify the active trace

<Pt> 1 - TTL out pass 1 (pin 13 of User Port connector)
 2 - TTL out pass 2 (pin 14 of User Port connector)

Parameters:

<Boolean> ON | OFF - TTL output signal on or off.
`*RST: OFF`

Example: `*RST; :CALC:LIM:CONT 1 GHZ, 2 GHZ`
 Define an upper limit line segment in the stimulus range between 1 GHz and 2 GHz, using default response values.
`CALC:LIM:STAT ON; TTL2 ON`
 Switch the limit check on and activate the TTL out pass 2 signal.

Manual operation: See "[TTL1 Pass / TTL2 Pass](#)" on page 481

7.3.1.9 CALCulate:MARKer...

The `CALCulate:MARKer...` commands control the marker functions. The commands are device-specific and beyond what is specified in the SCPI subsystem `SOURCE:MARKer...`

Marker addressing

For all these commands, markers are addressed via:

1. Channel number <Chn>
The command operates on the active trace of channel <Chn>.
2. Marker number <Mk>
Selects a particular marker (ignored for reference markers).
The command operates on marker <Mk> of channel <Chn>'s active trace.

<code>CALCulate<Chn>:MARKer<Mk>:AOFF</code>	1074
<code>CALCulate<Chn>:MARKer<Mk>:BWIDth</code>	1075
<code>CALCulate:MARKer:COUPled[:STATe]</code>	1076
<code>CALCulate:MARKer:COUPled:TYPE</code>	1076
<code>CALCulate<Chn>:MARKer:DEFault:FORMat</code>	1077
<code>CALCulate<Chn>:MARKer<Mk>:DELTA[:STATe]</code>	1079
<code>CALCulate<Chn>:MARKer<Mk>:EXCursion</code>	1079
<code>CALCulate<Chn>:MARKer<Mk>:REFerence:EXCursion</code>	1079
<code>CALCulate<Chn>:MARKer<Mk>:EXCursion:STATe</code>	1079
<code>CALCulate<Chn>:MARKer<Mk>:REFerence:EXCursion:STATe</code>	1079
<code>CALCulate<Chn>:MARKer<Mk>:FORMat</code>	1080
<code>CALCulate<Chn>:MARKer<Mk>:REFerence:FORMat</code>	1080
<code>CALCulate:MARKer:FUNCTion:BWIDth:GMCenter</code>	1080
<code>CALCulate<Chn>:MARKer<Mk>:FUNCTion:BWIDth:MODE</code>	1081
<code>CALCulate<Chn>:MARKer<Mk>:FUNCTion:CENTer</code>	1081
<code>CALCulate<Chn>:MARKer<Mk>:REFerence:FUNCTion:CENTer</code>	1081
<code>CALCulate<Chn>:MARKer<Mk>:FUNCTion:DOMain:USER[:RANGE]</code>	1082
<code>CALCulate<Chn>:MARKer<Mk>:REFerence:FUNCTion:DOMain:USER[:RANGE]</code>	1082
<code>CALCulate<Chn>:MARKer<Mk>:FUNCTion:DOMain:USER:SHOW</code>	1082
<code>CALCulate<Chn>:MARKer<Mk>:REFerence:FUNCTion:DOMain:USER:SHOW</code>	1082
<code>CALCulate<Chn>:MARKer<Mk>:FUNCTion:DOMain:USER:START</code>	1083
<code>CALCulate<Chn>:MARKer<Mk>:FUNCTion:DOMain:USER:STOP</code>	1083
<code>CALCulate<Chn>:MARKer<Mk>:REFerence:FUNCTion:DOMain:USER:START</code>	1083
<code>CALCulate<Chn>:MARKer<Mk>:REFerence:FUNCTion:DOMain:USER:STOP</code>	1083
<code>CALCulate<Chn>:MARKer<Mk>:FUNCTion:EXECute</code>	1083
<code>CALCulate<Chn>:MARKer<Mk>:REFerence:FUNCTion:EXECute</code>	1083
<code>CALCulate<Chn>:MARKer<Mk>:FUNCTion:RESult?</code>	1084
<code>CALCulate<Chn>:MARKer<Mk>:REFerence:FUNCTion:RESult?</code>	1084
<code>CALCulate<Chn>:MARKer<Mk>:FUNCTion:SPAN</code>	1085
<code>CALCulate<Chn>:MARKer<Mk>:FUNCTion:SPECTrum</code>	1085
<code>CALCulate<Chn>:MARKer<Mk>:FUNCTion:START</code>	1085
<code>CALCulate<Chn>:MARKer<Mk>:FUNCTion:STOP</code>	1085
<code>CALCulate<Chn>:MARKer<Mk>:REFerence:FUNCTion:START</code>	1085

CALCulate<Chn>:MARKer<Mk>:REFerence:FUNCTion:STOP.....	1085
CALCulate<Chn>:MARKer<Mk>:MODE.....	1086
CALCulate<Chn>:MARKer<Mk>:REFerence:MODE.....	1086
CALCulate<Chn>:MARKer:MPEak:EXCursion.....	1087
CALCulate<Chn>:MARKer:MPEak:EXCursion:STATe.....	1087
CALCulate<Chn>:MARKer:MPEak:THReshold.....	1087
CALCulate<Chn>:MARKer:MPEak:THReshold:STATe.....	1087
CALCulate<Chn>:MARKer<Mk>:NAME.....	1088
CALCulate<Chn>:MARKer<Mk>:REFerence:NAME.....	1088
CALCulate<Chn>:MARKer:SEARch:BFILter:RESUlt[:STATe].....	1088
CALCulate<Chn>:MARKer:SEARch:BFILter:RESUlt[:STATe]:AREA.....	1089
CALCulate<Chn>:MARKer<Mk>:SEARch:FORMat.....	1089
CALCulate<Chn>:MARKer<Mk>:REFerence:SEARch:FORMat.....	1089
CALCulate<Chn>:MARKer<Mk>:SEARch:TRACking.....	1090
CALCulate<Chn>:MARKer<Mk>:REFerence:SEARch:TRACking.....	1090
CALCulate<Chn>:MARKer<Mk>[:STATe].....	1091
CALCulate<Chn>:MARKer<Mk>:REFerence[:STATe].....	1091
CALCulate<Chn>:MARKer[:STATe]:AREA.....	1091
CALCulate<Chn>:MARKer<Mk>:TARGet.....	1092
CALCulate<Chn>:MARKer<Mk>:REFerence:TARGet.....	1092
CALCulate<Chn>:MARKer<Mk>:THReshold.....	1092
CALCulate<Chn>:MARKer<Mk>:REFerence:THReshold.....	1092
CALCulate<Chn>:MARKer<Mk>:THReshold:STATe.....	1093
CALCulate<Chn>:MARKer<Mk>:REFerence:THReshold:STATe.....	1093
CALCulate<Chn>:MARKer<Mk>:TYPE.....	1093
CALCulate<Chn>:MARKer<Mk>:REFerence:TYPE.....	1093
CALCulate<Chn>:MARKer<Mk>:X.....	1094
CALCulate<Chn>:MARKer<Mk>:REFerence:X.....	1094
CALCulate<Chn>:MARKer<Mk>:Y.....	1095
CALCulate<Chn>:MARKer<Mk>:REFerence:Y.....	1095

CALCulate<Chn>:MARKer<Mk>:AOFF

Removes all markers from all traces of the active recall set. The removed markers remember their properties (stimulus value, format, delta mode, number) when they are restored (`CALCulate<Chn>:MARKer<Mk>[:STATe] ON`). The marker properties are definitely lost if the associated trace is deleted.

Suffix:

<Chn> Channel number used to identify the active trace. If unspecified the numeric suffix is set to 1.

<Mk> This numeric suffix is ignored and may be set to any value.

Example:

Suppose that the active recall set contains an active trace no. 1.

```
CALC:MARK1 ON; MARK2 ON
```

Create markers 1 and 2 and assign them to the trace no. 1.

```
CALC:MARK:AOFF
```

Remove both markers.

Usage:

Event

Manual operation: See "All Off" on page 499

CALCulate<Chn>:MARKer<Mk>:BWIDth <Bandwidth>

Sets the bandfilter level for a bandfilter search or returns the results. The command is only available after a bandfilter search has been executed (`CALCulate<Chn>:MARKer<Mk>:FUNCTION:EXECute BFIlter`; see example below).

The response to the query `CALCulate<Chn>:MARKer<Mk>:BWIDth?` contains the following bandfilter search results:

- <Bandwidth> – bandwidth of the bandpass/bandstop region.
- <Center> – stimulus frequency at the center of the bandpass/bandstop region (the stimulus value of marker M4).
- <QualityFactor (3 dB)> – quality factor, i.e. the ratio between the center frequency and the 3-dB bandwidth.
- <Loss> – loss at the center of the bandpass/bandstop region (the response value of marker M4 at the time of the bandfilter search).
- <LowerEdge> – lower band edge.
- <UpperEdge> – upper band edge.

Tip: To obtain the <Quality Factor (BW)> result from the bandfilter info field, calculate the ratio <Center> / <Bandwidth>.

Suffix:

<Chn>	Channel number used to identify the active trace
<Mk>	This numeric suffix is ignored and may be set to any value because the bandfilter search functions always use markers M1 to M4.

Parameters:

<Bandwidth>	Difference between the band edges and the center response value of a bandfilter peak; must be negative for a bandpass search and positive for a bandstop search.
Range:	For bandpass: -100.00 dB to -0.01 dB; for bandstop: +0.01 dB to +100.00 dB
Increment:	0.03 dB
*RST:	-3 dB
Default unit:	dB

Example:

```
CALC:MARK:FUNC:BWID:MODE BST
Select a bandstop filter search.
CALC:MARK:FUNC:EXEC BFIL
Initiate the bandpass filter search for the current trace. Create
markers M1 to M4.
CALC:MARK:SEAR:BFIL:RES ON
Display the marker info field in the diaram area.
CALC:MARK:BWID 6
Select a 6-dB bandwidth for the bandstop.
CALC:MARK:BWID?
Query the results of the bandfilter search. An error message is
generated if the bandfilter search fails so that no valid results are
available.
CALC:MARK:SEAR:BFIL:RES:AREA LEFT, TOP
For a subsequent check at the GUI or a hardcopy, move the info
field to the top left position.
```

Manual operation: See "[Bandwidth](#)" on page 515

CALCulate:MARKer:COUPled[:STATe] <Boolean>

Enables marker coupling to the active trace of the active channel or disables it.

Use `CALCulate:MARKer:COUPled:TYPE` to select the suitable coupling type before setting `CALCulate:MARKer:COUPled:STATe` to ON.

Parameters:

<Boolean> ON | OFF - enables or disables marker coupling.
*RST: OFF

Example:

```
Suppose that the active recall set contains traces Trc1 and Trc2,
assigned to channels no. 1 and 2, respectively.
:CALC2:PAR:SEL 'TRC2'; :CALC2:MARK1 ON; MARK2
ON
Select Trc2 as the active trace of channel 2 and activate mark-
ers 1 and 2 for it. The default position for both markers is the
center of the sweep range.
INSTRument:NSElect 2
Make channel 2 the active channel.
CALCulate:MARKer:COUPled:TYPE ALL
Select coupling type "All" (recall set-wide coupling).
CALC:MARK:COUP ON
Activate marker coupling to Trc2 (the active trace of the active
channel). Automatically creates markers no. 1 and 2 on Trc1
and couples them to the respective markers of Trc2.
```

Manual operation: See "[Coupled Markers](#)" on page 501

CALCulate:MARKer:COUPled:TYPE <Type>

Selects the marker coupling type to be used in the current recall set.

Marker coupling is enabled using `CALCulate:MARKer:COUPled[:STATe] ON`. Changing the coupling type automatically disables marker coupling throughout the recall set.

Parameters:

<Type> ALL | CHANnel | DIAGram
 Marker coupling mode

ALL
 recall set-wide

CHANnel
 channel-wide

DIAGram
 diagram-wide

Example: See `CALCulate:MARKer:COUPled[:STATe]` on page 1076

Manual operation: See "Coupling Type" on page 521

CALCulate<Chn>:MARKer:DEFault:FORMat <OutFormat>

Defines the default marker format of the selected channel's active trace.

New markers will be formatted with the default marker format; previously existing markers will be reformatted if (and only if) their marker format is set to (Trace) `DEFault` (using `CALCulate<Chn>:MARKer<Mk>:FORMat`).

Suffix:

<Chn> Channel number used to identify the active trace

Parameters:

<OutFormat> MLINear | MLOGarithmic | PHASe | POLar | GDELay | REAL | IMAGinary | SWR | LINPhase | LOGPhase | IMPedance | ADMittance | DEFault | COMPLex | MDB | MLPPhase | MDPHase | MIMPedance | PIMPedance | PADmittance | MADmittance | MPIMPedance | MPADmittance | INDX | NOISe

DEFault means the default marker format is dynamically adjusted to the selected trace format (`CALCulate<Chn>:FORMat`). For the other marker formats see the table below and the description in "Marker format" on page 130.

*RST: DEFault

Manual operation: See "Dflt Marker Frmt" on page 425

SCPI	GUI
MLINear	"Lin Mag"
MLOGarithmic MDB (for R&S ZVR compatibility)	"dB Mag"
PHASe	"Phase"

SCPI	GUI
POLar COMPLex (for R&S ZVR compatibility)	"Real Imag"
GDELay	"Delay"
REAL	"Real"
IMAGinary	"Imag"
SWR	"SWR"
LINPhase MLPhase (for R&S ZVR compatibility)	"Lin Mag Phas"e
LOGPhase MDPhase (for R&S ZVR compatibility)	"dB Mag Phase"
IMPedance	"R + j X" for reflection measurement traces "R + j X series" for transmission measurement traces
PIMPedance	"R + j X", for reflection measurement traces "R + j X parallel" for transmission measurement traces
ADMittance	"G + j B" for reflection measurement traces "G + j B series" for transmission measurement traces
PADMittance	"G + j B" for reflection measurement traces "G + j B parallel" for transmission measurement traces
MIMPedance	"Imp Mag" for reflection measurement traces "Imp Mag series" for transmission measurement traces
MPIMPedance	"Imp Mag" for reflection measurement traces "Imp Mag parallel" for transmission measurement traces
MADMittance	"Adm Mag" for reflection measurement traces "Adm Mag series" for transmission measurement traces
MPADMittance	"Adm Mag" for reflection measurement traces "Adm Mag parallel" for transmission measurement traces
INDex	Index
NOISe	Noise

CALCulate<Chn>:MARKer<Mk>:DELTA[:STATe] <Boolean>

Switches the delta mode for marker <Mk> on trace no. <Chn> on or off. The marker must be created before using `CALCulate<Chn>:MARKer<Mk>[:STATe] ON`. If the active trace contains no reference marker, the command also creates a reference marker.

Suffix:

<Chn> Channel number used to identify the active trace

<Mk> Marker number.

Parameters:

<Boolean> ON | OFF - Enables or disables the delta mode.

*RST: OFF

Example:

Suppose that the active recall set contains an active trace no. 1.

```
CALC:MARK ON
```

Create marker no. 1 and set it to the center of the sweep range.

```
CALC:MARK:DELTA ON
```

Create a reference marker at the center of the sweep range and set marker 1 to delta mode.

Manual operation: See "[Delta Mode](#)" on page 500

CALCulate<Chn>:MARKer<Mk>:EXCursion <Value>**CALCulate<Chn>:MARKer<Mk>:REFerence:EXCursion <TargetSearchVal>**

Defines a marker-specific minimum excursion value for peak searches.

Use `CALCulate<Chn>:MARKer<Mk>:EXCursion:STATe` or `CALCulate<Chn>:MARKer<Mk>:REFerence:EXCursion:STATe` to activate it.

Suffix:

<Chn> Channel number used to identify the active trace

<Mk> Marker number (ignored for reference markers)

Parameters:

<Value> Minimum peak excursion

The unit is derived from the active trace format and cannot be modified. Changing the trace format resets the excursion to a format-specific default value.

Manual operation: See "[Excursion Settings](#)" on page 509

CALCulate<Chn>:MARKer<Mk>:EXCursion:STATe <Boolean>**CALCulate<Chn>:MARKer<Mk>:REFerence:EXCursion:STATe <Boolean>**

Activates or deactivates the marker-specific minimum excursion for peak searches.

Use `CALCulate<Chn>:MARKer<Mk>:EXCursion` or `CALCulate<Chn>:MARKer<Mk>:REFerence:EXCursion` to set the minimum peak excursion.

Suffix:

<Chn> Channel number used to identify the active trace

<Mk> Marker number (ignored for reference markers)

Parameters:

<Active> Boolean

Manual operation: See ["Excursion Settings"](#) on page 509

CALCulate<Chn>:MARKer<Mk>:FORMat <OutFormat>

CALCulate<Chn>:MARKer<Mk>:REFerence:FORMat <OutFormat>

Sets/queries the output format for the (complex) value of the related marker.

Suffix:

<Chn> Channel number used to identify the active trace

<Mk> Marker number (ignored for reference markers)

Parameters:

<OutFormat> MLINear | MLOGarithmic | PHASe | POLar | GDELay | REAL |
IMAGinary | SWR | LINPhase | LOGPhase | IMPedance |
ADMittance | DEFault | COMPLex | MDB | MLPPhase |
MDPHase | MIMPedance | PIMPedance | PADmittance |
MADMittance | MPIMPedance | MPADmittance | INDX | NOISe

DEFault means the reference marker is formatted according
the related trace's default marker format (see
[CALCulate<Chn>:MARKer:DEFault:FORMat](#)).

For the other marker formats, see [CALCulate<Chn>:MARKer:
DEFault:FORMat](#) and the description in ["Marker format"](#)
on page 130.

*RST: DEFault

Manual operation: See ["Marker Format"](#) on page 502

CALCulate:MARKer:FUNction:BWIDth:GMCenter <arg0>

Defines how bandfilter searches calculate the center frequency of the passband or
stopband.

Parameters:

<arg0> **ON** – use **geometric** mean of lower and upper band edge
OFF – use **arithmetic** mean

*RST: n/a (*RST does not affect the calculation rule; the
factory setting is ON/geometric mean)

Manual operation: See ["Geometric Calculation of Bandfilter Center"](#) on page 866

CALCulate<Chn>:MARKer<Mk>:FUNCTION:BWIDth:MODE <BandfilterType>

Selects the bandfilter search mode. In contrast to manual control, bandfilter tracking is not automatically activated.

Suffix:

<Chn> Channel number used to identify the active trace

<Mk> This numeric suffix is ignored and may be set to any value because the bandfilter search functions always use markers M1 to M4.

Parameters:

<BandfilterType> BPASs | BStOp | BPRMarker | BSRMarker | BPABsolute | BSABsolute | NONE

Bandfilter search type:

BPASs – Bandpass Search Ref to Max

BStOp – Bandstop Search Ref to Max

BPRMarker – Bandpass Search Ref to Marker

BSRMarker – Bandstop Search Ref to Marker

BPABsolute – Bandpass Absolute Level

BSABsolute – Bandstop Absolute Level

NONE – deactivate bandfilter search, result off

*RST: NONE

Example: See [CALCulate<Chn>:MARKer<Mk>:BWIDth](#)

Manual operation: See "[Bandpass Ref to Max](#)" on page 516

CALCulate<Chn>:MARKer<Mk>:FUNCTION:CENTer**CALCulate<Chn>:MARKer<Mk>:REFerence:FUNCTION:CENTer**

Sets the center of the sweep range to the stimulus value of the related marker (marker <Mk> or the reference marker on the active trace of channel <Chn>).

Suffix:

<Chn> Channel number used to identify the active trace

<Mk> Marker number (ignored for reference markers)

Example:

```
*RST; :CALC:MARK ON
```

Create marker 1 in the center of the current sweep range and assign it to trace no. 1.

```
CALC:MARK:FUNC:CENT
```

Leave the sweep range unchanged.

Usage: Event

Manual operation: See "[Center = Marker / Start = Marker / Stop = Marker / Span = Marker](#)" on page 519

CALCulate<Chn>:MARKer<Mk>:FUNcTion:DOMain:USER[:RANGe]
 <NumSearchRange>

CALCulate<Chn>:MARKer<Mk>:REFerence:FUNcTion:DOMain:USER[:RANGe]

Assigns search range no. <NumSearchRange> to the related marker (marker <Mk> or the reference marker of channel <Chn>'s active trace).

Selects the search range, e.g. to display range limit lines or define the start and stop values.

Suffix:

<Chn> Channel number used to identify the active trace

<Mk> Marker number (ignored for reference markers)

Parameters:

<NumSearchRange> Number of the search range.

Range: 0 to 10 where 0 refers to the fixed full span search range (equal to the sweep range) and 1 to 10 refer to user-definable search ranges; see example.

*RST: 0 (reserved for full span search range)

Example:

CALC1:MARK1:FUNC:DOM:USER 2

Select the search range no. 2, assigned to marker no. 1 and trace no. 1.

CALC:MARK:FUNC:DOM:USER:START 1GHz

Set the start frequency of the search range to 1 GHz.

CALC:MARK:FUNC:DOM:USER:STOP 1.2GHz

Set the stop frequency of the search range to 1.2 GHz.

Manual operation: See ["Search Range"](#) on page 507

CALCulate<Chn>:MARKer<Mk>:FUNcTion:DOMain:USER:SHOW <Boolean>

CALCulate<Chn>:MARKer<Mk>:REFerence:FUNcTion:DOMain:USER:SHOW

Displays or hides range limit lines for the search range selected via

[CALCulate<Chn>:MARKer<Mk>:FUNcTion:DOMain:USER\[:RANGe\]](#) or

[CALCulate<Chn>:MARKer<Mk>:REFerence:FUNcTion:DOMain:USER\[:RANGe\]](#) .

Suffix:

<Chn> Channel number used to identify the active trace

<Mk> Marker number (ignored for reference markers)

Parameters:

<Boolean> ON | OFF - range limit lines on or off.

*RST: OFF

Example:

See [CALCulate<Chn>:STATistics:DOMain:USER](#)

Manual operation: See ["Range Limit Lines On"](#) on page 508

```

CALCulate<Chn>:MARKer<Mk>:FUNction:DOMain:USER:START
    <StarSearchRange>
CALCulate<Chn>:MARKer<Mk>:FUNction:DOMain:USER:STOP
    <StopSearchRange>
CALCulate<Chn>:MARKer<Mk>:REFerence:FUNction:DOMain:USER:START
    <StarSearchRange>
CALCulate<Chn>:MARKer<Mk>:REFerence:FUNction:DOMain:USER:STOP
    <Value>

```

These commands define the start and stop values of the search range selected via `CALCulate<Chn>:MARKer<Mk>:FUNction:DOMain:USER[:RANGe]` or `CALCulate<Chn>:MARKer<Mk>:REFerence:FUNction:DOMain:USER[:RANGe]`.

Suffix:

<Chn> Channel number used to identify the active trace
 <Mk> Marker number (ignored for reference markers)

Parameters:

<Value> Beginning or end of the search range.
 Range: Maximum allowed sweep range, depending on the instrument model and on the sweep type.
 Default unit: NN

Example: See `CALCulate<Chn>:MARKer<Mk>:FUNction:DOMain:USER[:RANGe]`

Manual operation: See "Search Range" on page 507

```

CALCulate<Chn>:MARKer<Mk>:FUNction:EXECute [<SearchMode>]
CALCulate<Chn>:MARKer<Mk>:REFerence:FUNction:EXECute [<SearchMode>]

```

Selects a search mode for the related marker (see "Marker addressing" on page 1073) and executes the search.

Except for bandfilter searches (BFILter), you have to create the related marker using `CALCulate<Chn>:MARKer<Mk>[:STATe] ON` or `CALCulate<Chn>:MARKer<Mk>:REFerence[:STATe] ON` before using this command.

Suffix:

<Chn> Channel number used to identify the active trace
 <Mk> Marker number
 Ignored for reference markers and for bandfilter searches (BFILter), which always use markers M1 to M4.

Setting parameters:

<SearchMode> MAXimum | MINimum | RPEak | LPEak | NPEak | TARGet | LTARget | RTARget | BFILter | MMAXimum | MMINimum | SPRogress
 See list of search modes below.

Example: Suppose that the active recall set contains an active trace no. 1.
`CALC:MARK ON`
 Create marker M1 and assign it to trace no. 1.
`CALC:MARK:FUNC:EXEC MAX; RES?`
 Move the created marker to the absolute maximum of the trace and query the stimulus and response value of the search result.

Usage: Setting only

Manual operation: See "Max / Min" on page 504

The analyzer provides the following search modes:

Mode	Find...
MAXimum	Absolute maximum in the search range (see <code>CALCulate<Chn>:MARKer<Mk>:FUNction:DOMain:USER[:RANGE]</code>)
MINimum	Absolute maximum in the search range
RPEak	Next valid peak to the right of the current marker position
LPEak	Next valid peak to the left
NPEak	Next highest or lowest value among the valid peaks (next peak)
TARGet	Target value (see <code>CALCulate<Chn>:MARKer<Mk>:TARGet</code>)
RTARget	Next target value to the right of the current marker position
LTARget	Next target value to the left
BFILter Regular markers only	Bandfilter search. The results are queried using <code>CALCulate<Chn>:MARKer<Mk>:BWIDTH</code> .
MMAximum or MMINimum	Multiple peak search
SPRogress	Sweep progress

CALCulate<Chn>:MARKer<Mk>:FUNction:RESult?

CALCulate<Chn>:MARKer<Mk>:REFerence:FUNction:RESult?

Returns the result (stimulus and response value) of a search started by means of `CALCulate<Chn>:MARKer<Mk>:FUNction:EXECute` or `CALCulate<Chn>:MARKer<Mk>:REFerence:FUNction:EXECute`. The search must be executed before the command is enabled.

Suffix:

<Chn> Channel number used to identify the active trace

<Mk> Marker number (ignored)

Example: See `CALCulate<Chn>:MARKer<Mk>:FUNction:EXECute`

Usage: Query only

Manual operation: See "Max / Min" on page 504

CALCulate<Chn>:MARKer<Mk>:FUNCtion:SPAN

Sets the span of the sweep range equal to the absolute value of the first coordinate of the active delta marker <Mk> on trace no. <Chn>.

Suffix:

<Chn> Channel number used to identify the active trace

<Mk> Marker number.

Example:

```
*RST; :CALC:MARK ON; MARK:DELTA ON
```

Create marker 1 in the center of the current sweep range and enable the delta mode.

```
CALC:MARK:X 300MHz
```

Increase the stimulus value of the delta marker by 300 MHz.

```
CALC:MARK:FUNC:SPAN
```

Set the sweep range equal to 300 MHz. The sweep range starts at the reference marker position, i.e. in the center of the analyzer's frequency range.

Usage: Event

Manual operation: See "[Center = Marker / Start = Marker / Stop = Marker / Span = Marker](#)" on page 519

CALCulate<Chn>:MARKer<Mk>:FUNCtion:SPECtrum

For marker <Mk> of channel <Chn>'s active trace, this command does the following:

- Create a channel
- Set its center to marker <Mk>'s position
- Set its span to 10 times channel <Chn>'s BW
- Switch to spectrum mode

Suffix:

<Chn> Channel number used to identify the active trace

<Mk> Marker number

Usage: Event

Options: R&S ZNA-K1

Manual operation: See "[Spectrum = Marker](#)" on page 506

CALCulate<Chn>:MARKer<Mk>:FUNCtion:START**CALCulate<Chn>:MARKer<Mk>:FUNCtion:STOP****CALCulate<Chn>:MARKer<Mk>:REFerence:FUNCtion:START****CALCulate<Chn>:MARKer<Mk>:REFerence:FUNCtion:STOP**

These commands set the `START` or `STOP` of the sweep range to the stimulus value of the related marker (see "[Marker addressing](#)" on page 1073).

Suffix:

<Chn> Channel number used to identify the active trace

<Mk>	Marker number (ignored for reference markers)
Example:	<pre>*RST; :CALC:MARK ON</pre> <p>Create marker 1 in the center of the current sweep range and assign it to trace no. 1.</p> <pre>CALC:MARK:FUNC:STAR</pre> <p>Divide the sweep range in half, starting at the current marker position. As an alternative:</p> <pre>CALC:MARK:FUNC:STOP</pre> <p>Divide the sweep range in half, ending at the current marker position.</p>
Usage:	Event
Manual operation:	See " Center = Marker / Start = Marker / Stop = Marker / Span = Marker " on page 519

CALCulate<Chn>:MARKer<Mk>:MODE <Mode>

CALCulate<Chn>:MARKer<Mk>:REFerence:MODE <Mode>

Defines the positioning mode of the related marker (see "[Marker addressing](#)" on page 1073). The marker doesn't have to be created before, the mode can be assigned in advance.

Suffix:

<Chn> Channel number used to identify the active trace

<Mk> Marker number (ignored for reference markers)

Parameters:

<Mode> CONTInuous | DISCcrete

CONTInuous - marker can be positioned on any point of the trace, and its response values are obtained by interpolation.
DISCcrete - marker can be set to discrete sweep points only.

*RST: CONT

Example: Suppose that the active recall set contains an active trace no. 1.

```
CALC:MARK:MODE DISC; :CALC:MARK2:MODE CONT
```

Create marker 1 in discrete mode and marker 2 in continuous mode.

```
CALC:MARK ON; MARK2 ON
```

Display the two markers. Due to the different modes the horizontal positions can be different.

Example: Suppose that the active recall set contains an active trace no. 1.

```
CALC:MARK:REF:MODE DISC
```

```
CALC:MARK2:REF:MODE CONT
```

Create the reference marker in discrete mode and marker 2 in continuous mode.

```
CALC:MARK:REF ON; :CALC:MARK2 ON
```

Display the two markers. Due to the different modes the horizontal positions can be different.

Manual operation: See "[Discrete](#)" on page 502

CALCulate<Chn>:MARKer:MPEak:EXCursion <TargetSearchVal>

Defines a minimum excursion value for multiple peak searches.

Use `CALCulate<Chn>:MARKer:MPEak:EXCursion:STATe` to activate it.

Suffix:

<Chn> Channel number used to identify the active trace

Parameters:

<Value> Minimum peak excursion
The unit is derived from the active trace format and cannot be modified. Changing the trace format resets the excursion to a format-specific default value.

Manual operation: See "[Excursion Settings](#)" on page 512

CALCulate<Chn>:MARKer:MPEak:EXCursion:STATe <Boolean>

Activates or deactivates the minimum excursion for multiple peak searches.

Use `CALCulate<Chn>:MARKer:MPEak:EXCursion` to set the minimum peak excursion.

Suffix:

<Chn> Channel number used to identify the active trace

Parameters:

<Active> Boolean

Manual operation: See "[Excursion Settings](#)" on page 512

CALCulate<Chn>:MARKer:MPEak:THReshold <Value>

Defines a threshold value for multiple peak searches.

Use `CALCulate<Chn>:MARKer:MPEak:THReshold:STATe` to activate it.

Suffix:

<Chn> Channel number used to identify the active trace

Parameters:

<Value> Threshold value
The unit is derived from the active trace format and cannot be modified. Changing the trace format resets the threshold to a format-specific default value.

Manual operation: See "[Threshold Settings](#)" on page 511

CALCulate<Chn>:MARKer:MPEak:THReshold:STATe <Boolean>

Activates or deactivates the threshold for multiple peak searches.

Use `CALCulate<Chn>:MARKer:MPEak:THReshold` to set the threshold value.

Suffix:
 <Chn> Channel number used to identify the active trace

Parameters:
 <Active> Boolean

Manual operation: See "[Threshold Settings](#)" on page 511

CALCulate<Chn>:MARKer<Mk>:NAME <MarkerName>
CALCulate<Chn>:MARKer<Mk>:REFerence:NAME <MarkerName>

Defines a name for the related marker (see "[Marker addressing](#)" on page 1073). The marker doesn't have to be created before, the name can be assigned in advance.

Suffix:
 <Chn> Channel number used to identify the active trace
 <Mk> Marker number (ignored for reference markers)

Parameters:
 <MarkerName> Marker name (string parameter)
 *RST: 'M1' for marker no. 1 etc.

Example: Suppose that the active recall set contains an active trace no. 1.
 CALC:MARK:NAME '&\$% 1'; :CALC:MARK ON
 Create marker 1 named "&\$% 1" and display the marker .
 CALC:MARK:REF ON
 CALC:MARK:REF:NAME 'Reference'
 Display the reference marker and rename it "Reference".

Manual operation: See "[Marker Name](#)" on page 501

CALCulate<Chn>:MARKer:SEARch:BFILter:RESult[:STATe] <Boolean>

Shows or hides the bandfilter search results in the diagram area.

Suffix:
 <Chn> Channel number used to identify the active trace

Parameters:
 <Boolean> ON - show the bandfilter search results. If no bandfilter search has been initiated before ([CALCulate<Chn>:MARKer<Mk>:FUNCTION:EXECute BFILter](#)), nothing is displayed.
 OFF - hide the bandfilter search results.
 *RST: OFF

Example: See [CALCulate<Chn>:MARKer<Mk>:BWIDth](#)

Manual operation: See "[Result Off](#)" on page 517

CALCulate<Chn>:MARKer:SEARch:BFILter:RESult[:STATe]:AREA
 <HorizontalPos>, <VerticalPos>

Moves the bandfilter search info field for the active trace <Chn> to one of nine predefined positions in the active diagram.

Suffix:

<Chn> Channel number used to identify the active trace

Parameters:

<HorizontalPos> LEFT | MID | RIGHT
 Horizontal position

<VerticalPos> TOP | MID | BOTTOm
 Vertical position

Example: See [CALCulate<Chn>:MARKer<Mk>:BWIDth](#)

Manual operation: See "[Bandpass Ref to Max](#)" on page 516

CALCulate<Chn>:MARKer<Mk>:SEARch:FORMat <SearchFormat>
CALCulate<Chn>:MARKer<Mk>:REFerence:SEARch:FORMat <SearchFormat>

Defines the format in which you want to specify the target value [CALCulate<Chn>:MARKer<Mk>:TARGet](#) for the related marker (see "[Marker addressing](#)" on page 1073).

Each marker may have a different target format. The table below gives an overview on how a complex target value $z = x + jy$ is converted.

Target Format	Description	Formula
MLINear	Magnitude of z, unconverted.	$ z = \text{sqrt} (x^2 + y^2)$
MLOGarithmic	Magnitude of z in dB	$\text{Mag}(z) = 20 \log z \text{ dB}$
PHASe	Phase of z	$\varphi (z) = \arctan (y/x)$
UPHase	Unwrapped phase of z comprising the complete number of 360° phase rotations	$\Phi(z) = \varphi (z) + 2k \cdot 360^\circ$
REAL	Real part of z	$\text{Re}(z) = x$
IMAGinary	Imaginary part of z	$\text{Im}(z) = y$
SWR	(Voltage) Standing Wave Ratio	$\text{SWR} = (1 + z) / (1 - z)$
DEFault	Identical to trace format. Note: the Smith and Polar traces use "Lin Mag" as the default format for target value.	-

Suffix:

<Chn> Channel number used to identify the active trace

<Mk> Marker number (ignored for reference markers)

Parameters:

<SearchFormat> MLINear | MLOGarithmic | PHASe | UPHase | REAL | IMAGinary | SWR | DEFault

The format of the target value in the marker target search (`CALCulate<Chn>:MARKer<Mk>:FUNction:EXECute TARGet` or `CALCulate<Chn>:MARKer<Mk>:REFerence:FUNction:EXECute TARGet`). See table above.

*RST: DEFault

Example:

Suppose channel 1's selected trace is POLar and marker 1 isn't yet created

```
:CALCULATE1:MARKER1 ON
```

Create/enable Marker 1

```
:CALCulate1:MARKer1:FUNction:SELEct TARGet
```

Select TARGet search mode for marker 1

```
:CALCulate1:MARKer1:SEARch:FORMat?
```

Query the target format of marker 1. The result is DEF and for polar diagrams the default target format is "Phase".

```
:CALCulate1:MARKer1:FUNction:TARGet?
```

Query for the default target value; for "Phase" this is 0 (degrees)

```
:CALCulate1:MARKer1:SEARch:FORMat MLOGarithmic
```

Change the target search format to dB magnitude

```
:CALCulate1:MARKer1:FUNction:TARGet?
```

Query for the default target value; for dB magnitude this is 0 (dB)

```
:CALCulate1:MARKer1:FUNction:TARGet -3
```

Set the target value to -3 dB

```
:CALCulate1:MARKer1:FUNction:EXECute
```

Execute the target search for marker 1

```
:CALCulate1:MARKer1:FUNction:RESult?
```

Query for the results.

Manual operation: See "[Target Format](#)" on page 513

CALCulate<Chn>:MARKer<Mk>:SEARch:TRACking <Boolean>

CALCulate<Chn>:MARKer<Mk>:REFerence:SEARch:TRACking <Boolean>

These commands enable or disable tracking for the respective marker (see "[Marker addressing](#)" on page 1073).

They are only available, if a search mode is active for the respective marker (see `CALCulate<Chn>:MARKer<Mk>:FUNction:EXECute <SearchMode>` or `CALCulate<Chn>:MARKer<Mk>:REFerence:FUNction:EXECute <SearchMode>`), in which case tracking causes the search logic to be repeated after each sweep.

Tip: If the current search mode is a bandfilter or multiple peak search (regular markers only), this command enables or disables the corresponding tracking.

Suffix:

<Chn> Channel number used to identify the active trace

<Mk> Marker number
Ignored not only for reference markers, but also for bandfilter and multiple peak searches, where tracking recalculates the whole marker set for each sweep.

Parameters:

<Boolean> ON | OFF - enables or disables the marker tracking mode.
*RST: OFF

Example:

Suppose the active recall set contains an active trace no. 1.
CALC:MARK ON; :CALC:MARK:FUNC:EXEC MAXimum
Create marker no. 1 and assign it to trace no. 1. Activate a maximum search for marker no. 1.
CALC:MARK:SEAR:TRAC ON
Enable the tracking mode for the created marker.

Manual operation: See "[Tracking](#)" on page 506

CALCulate<Chn>:MARKer<Mk>[:STATe] <Boolean>

CALCulate<Chn>:MARKer<Mk>:REFerence[:STATe] <Boolean>

Creates or removes the related marker (see "[Marker addressing](#)" on page 1073).

Suffix:

<Chn> Channel number used to identify the active trace

<Mk> Marker number (ignored for reference markers)

Parameters:

<Boolean> ON | OFF – creates or removes the marker.
*RST: OFF

Example:

Suppose that the active recall set contains an active trace no. 1.
CALC:MARK ON; MARK2 ON
Create markers 1 and 2 and assign them to trace no. 1. The default position of both markers is the center of the sweep range.

Manual operation: See "[On](#)" on page 499

CALCulate<Chn>:MARKer[:STATe]:AREA <HorizontalPos>, <VerticalPos>

Moves the marker info field for the active trace <Chn> to one of nine predefined positions in the active diagram.

Suffix:

<Chn> Channel number used to identify the active trace

Parameters:

<HorizontalPos> LEFT | MID | RIGHT
Horizontal position

<VerticalPos> TOP | MID | BOTTom
Vertical position

Example: See `CALCulate<Chn>:MARKer<Mk>:Y`

Manual operation: See "Mkr 1 ... Mkr 10" on page 500

CALCulate<Chn>:MARKer<Mk>:TARGet <TargetSearchVal>
CALCulate<Chn>:MARKer<Mk>:REFerence:TARGet <TargetSearchVal>

Defines the target value for the target search of marker the related marker (see "Marker addressing" on page 1073).

The target search can be activated using `CALCulate<Chn>:MARKer<Mk>:FUNCTION:EXECute TARGet` or `CALCulate<Chn>:MARKer<Mk>:REFerence:FUNCTION:EXECute TARGet`.

Suffix:

<Chn> Channel number used to identify the active trace

<Mk> Marker number (ignored for reference markers)

Parameters:

<TargetSearchVal> Target search value of marker no. <Mk>. The value range and reset value depend on the selected target format (see `CALCulate<Chn>:MARKer<Mk>:SEARCH:FORMat` or `CALCulate<Chn>:MARKer<Mk>:REFerence:SEARCH:FORMat`).

Example:

```
CALC:MARK ON
Create marker no. 1 and display it in the center of the sweep range.
:CALC:MARK:TARG -10; FUNC:EXEC TARG
Define a target search value of -10 dB and start the target search.
CALC:MARK:X?
Query the stimulus value corresponding to the target search result.
```

Manual operation: See "Target Value" on page 512

CALCulate<Chn>:MARKer<Mk>:THReshold <Value>
CALCulate<Chn>:MARKer<Mk>:REFerence:THReshold <TargetSearchVal>

Defines a marker-specific threshold value for (single) peak searches with the related marker (see "Marker addressing" on page 1073) .

Use `CALCulate<Chn>:MARKer<Mk>:THReshold:STATe` or `CALCulate<Chn>:MARKer<Mk>:REFerence:THReshold:STATe` to activate it.

Suffix:

<Chn> Channel number used to identify the active trace

<Mk> Marker number (ignored for reference markers)

Parameters:

<Value> Threshold value
 The unit is derived from the active trace format and cannot be modified. Changing the trace format resets the threshold to a format-specific default value.

Manual operation: See ["Threshold Settings"](#) on page 509

CALCulate<Chn>:MARKer<Mk>:THReshold:STATe <Active>

CALCulate<Chn>:MARKer<Mk>:REFerence:THReshold:STATe <Boolean>

Activates or deactivates the marker-specific threshold for (single) peak searches with the related marker (see ["Marker addressing"](#) on page 1073).

Use [CALCulate<Chn>:MARKer<Mk>:THReshold](#) or [CALCulate<Chn>:MARKer<Mk>:REFerence:THReshold](#) to set the threshold value.

Suffix:

<Chn> Channel number used to identify the active trace

<Mk> Marker number (ignored for reference markers)

Parameters:

<Active> Boolean

Manual operation: See ["Threshold Settings"](#) on page 509

CALCulate<Chn>:MARKer<Mk>:TYPE <Mode>

CALCulate<Chn>:MARKer<Mk>:REFerence:TYPE <Mode>

Sets the marker mode for the related marker (see ["Marker addressing"](#) on page 1073). The marker must be created before using [CALCulate<Chn>:MARKer<Mk>\[:STATe\] ON](#) or [CALCulate<Chn>:MARKer<Mk>:REFerence\[:STATe\] ON](#).

Suffix:

<Chn> Channel number used to identify the active trace

<Mk> Marker number (ignored for reference markers)

Parameters:

<Mode> NORMAL | FIXed | ARBitary

NORMAL: If tracking is enabled ([CALCulate<Chn>:MARKer<Mk>:SEARch:TRACking ON](#) or [CALCulate<Chn>:MARKer<Mk>:REFerence:SEARch:TRACking ON](#)), the marker's stimulus value ([CALCulate<Chn>:MARKer<Mk>:X?](#) or [CALCulate<Chn>:MARKer<Mk>:REFerence:X?](#)) is updated automatically with every sweep, otherwise it is fixed. The marker position ([CALCulate<Chn>:MARKer<Mk>:Y?](#) or [CALCulate<Chn>:MARKer<Mk>:REFerence:Y?](#)) is adjusted to the corresponding response value, i.e. the marker is always positioned on the trace.

The marker's stimulus value can be set using

`CALCulate<Chn>:MARKer<Mk>:X` or

`CALCulate<Chn>:MARKer<Mk>:REFerence:X`; the marker automatically follows the trace.

FIXed: freezes the marker at the position determined by the current stimulus and response value. The response value stored with the marker is not adjusted to subsequent sweeps. Tracking is disabled. Stimulus and response value are stored with the marker; they are not adjusted to subsequent sweeps and trace format changes.

The marker stimulus can be set using

`CALCulate<Chn>:MARKer<Mk>:X` or

`CALCulate<Chn>:MARKer<Mk>:REFerence:X`, but the response value remains fixed.

ARBitrary: freezes the marker at the position determined by the current stimulus and response value. Tracking is disabled. The marker stores the stimulus value and – in addition – its X and Y coordinates in the current marker format (see

[CALCulate<Chn>:MARKer<Mk>:FORMat](#) or

[CALCulate<Chn>:MARKer<Mk>:REFerence:FORMat](#)).

The marker position can be set using

`CALCulate<Chn>:MARKer<Mk>:X` and

`CALCulate<Chn>:MARKer<Mk>:Y` or

`CALCulate<Chn>:MARKer<Mk>:REFerence:X` and

`CALCulate<Chn>:MARKer<Mk>:REFerence:Y`. If, in the current trace format, the X axis represents the stimulus, the marker's stimulus value is adjusted accordingly. Otherwise the marker's stimulus value remains unchanged. Switching between trace formats resets the marker position to the response value at the marker's stimulus value.

*RST: NORMal

Example:

`CALC:MARK ON; :CALC:MARK:TYPE FIX`

Create marker 1 and display it in the center of the sweep range as a fixed marker.

`CALC:MARK:X 1GHz`

Shift the marker horizontally. The response value remains fixed.

Manual operation: See "[Marker Mode](#)" on page 502

CALCulate<Chn>:MARKer<Mk>:X <StimulusValue>[, <Seg>[, <MeasPoint>]]

CALCulate<Chn>:MARKer<Mk>:REFerence:X <StimulusValue>[, <Seg>[, <MeasPoint>]]

Defines the stimulus value of the related marker (see "[Marker addressing](#)" on page 1073).

If the marker's mode is NORMal or FIXed (see [CALCulate<Chn>:MARKer<Mk>:TYPE](#) or [CALCulate<Chn>:MARKer<Mk>:REFerence:TYPE](#)), this command sets or gets the marker's stimulus value.

In ARbitrary mode, this is only true if the X axis represents the stimulus. For all other trace formats (see `CALCulate<Chn>:FORMat`) it sets or gets the X position of the marker, which is decoupled from the marker stimulus in this case.

Suffix:

<Chn> Channel number used to identify the active trace
 <Mk> Marker number (ignored for reference markers)

Parameters:

<StimulusValue> If the marker mode of the related marker is ARbitrary and the trace format is complex (Polar, Smith, inverted Smith), this is the real part $\text{Re}(z_M)$ of the marker value z_M . In any other case, it is the marker's stimulus value.
 If the marker mode is ARbitrary and the trace format is complex, the value range is -1 to +1. Otherwise -9.9E+11 Hz to +9.9E+11 Hz for frequency sweeps, -999 dBm to +999 dBm for power sweeps, 0 s to 127500 s for time sweeps and 1 to 100001 for CW mode.

Setting parameters:

<Seg> For a segmented frequency sweep with overlapping segments, you can assign the marker to a particular segment. If specified, the <Seg> number must be valid and the <StimulusValue> must be inside the segment.
 <Point> For a segmented frequency sweep with overlapping segments or with segments that have multiple sweep points at the same frequency, you can assign the marker to a particular segment <Seg> and sweep point <Point>. If specified, the <Seg> and <Point> numbers must be valid and the <StimulusValue> must be inside the segment.

Example:

Suppose that the active recall set contains an active trace no. 1 and the sweep range for a frequency sweep starts at 1 GHz.

```
CALC:MARK ON
```

Create marker no. 1 and display it in the center of the sweep range.

```
CALC:MARK:X 1GHz
```

Set the marker to the beginning of the sweep range.

Manual operation: See "[Mkr <i>Stimulus / Ref Mkr Stimulus](#)" on page 499

CALCulate<Chn>:MARKer<Mk>:Y <ResponseValue>

CALCulate<Chn>:MARKer<Mk>:REFerence:Y <RefResponseValue>

Sets or gets the (response) value of the related marker (see "[Marker addressing](#)" on page 1073).

The marker must be created before using `CALCulate<Chn>:MARKer<Mk>[:STATe] ON` or `CALCulate<Chn>:MARKer<Mk>:REFerence[:STATe] ON`.

Setting this value is only possible in ARbitrary mode (see [CALCulate<Chn>:MARKer<Mk>:TYPE](#) or [CALCulate<Chn>:MARKer<Mk>:REFerence:TYPE](#)). For NORMal and FIXed mode markers it is read-only.

Suffix:

<Chn> Channel number used to identify the active trace
 <Mk> Marker number (ignored for reference markers)

Parameters:

<ResponseValue> **Setting (ARbitrary mode only):** sets the vertical position of the marker in Y units of the current trace format.
Query: returns the marker position formatted according to the current marker format (see [CALCulate<Chn>:MARKer<Mk>:FORMat](#) or [CALCulate<Chn>:MARKer<Mk>:REFerence:FORMat](#)), i.e. as displayed in the marker info field (1 return value per row in the response column). Indetermined result values are returned as a sequence of dashes (-----). This may occur in ARbitrary mode, if the transformation between trace format and marker format requires a concrete stimulus value.
 Default unit: NN

Example:

Suppose that the active recall set contains an active trace no. 1.
 CALC:MARK ON
 Create marker no. 1 and display it in the center of the sweep range.
 CALC:MARK:Y?
 Query the measurement value at the marker position.
 CALC:MARK:STAT:AREA LEFT, TOP
 For a subsequent check at the GUI or a hardcopy, move the info field to the top left position.

Manual operation: See "[Mkr <i> Arb. Response / Ref Mkr Arb. Response](#)" on page 499

7.3.1.10 CALCulate:MATH...

The `CALCulate:MATH...` commands permit processing of measured data in numerical expression format. The operators are +, -, *, / and use of constants and data arrays are permitted.

CALCulate<Chn>:MATH[:EXPRession]:SDEFine	1097
CALCulate<Chn>:MATH:FORMatted[:EXPRession]:SDEFine	1097
CALCulate<Chn>:MATH:FUNctIon	1098
CALCulate<Chn>:MATH:FORMatted:FUNctIon	1098
CALCulate<Chn>:MATH:MEMorize	1099
CALCulate<Chn>:MATH:STATe	1100
CALCulate<Chn>:MATH:FORMatted:STATe	1100
CALCulate<Chn>:MATH:WUNit[:STATe]	1100

CALCulate<Chn>:MATH[:EXPRession]:SDEFine <Expression>

CALCulate<Chn>:MATH:FORMatted[:EXPRession]:SDEFine <Expression>

Defines a mathematical trace for the active trace, using a string expression.

- The expression in the first command refers to raw, unformatted trace data (complex data). In order to apply it, **CALCulate<Chn>:MATH:FUNCTION** must be set to **NORMAL** and **CALCulate<Chn>:MATH:STATE** must be set to **ON**.
- The expression in the second command refers to formatted trace data. In order to apply it, **CALCulate<Chn>:MATH:FORMatted:FUNCTION** must be set to **NORMAL** and **CALCulate<Chn>:MATH:FORMatted:STATE** must be set to **ON**.

Trace math for unformatted and formatted trace data can be used at the same time.

Suffix:

<Chn> Channel number used to identify the active trace

Parameters:

<Expression> Operands, operators and functions; see table below.

Example:

```
*RST; :CALC:MATH:MEM
```

Copy the current state of the default trace 'Trc1' to a memory trace named 'Mem2[Trc1]'. The memory trace is not displayed.

```
CALC:MATH:SDEF 'Trc1 / Mem2[Trc1]'
```

Define a mathematical trace, dividing the raw complex data trace by the stored memory trace. The mathematical trace is not displayed.

```
CALC:MATH:STAT ON
```

Display the mathematical trace instead of the active data trace.

Manual operation: See "[Expression builder](#)" on page 445

Expressions defined via **CALCulate<Ch>:MATH[:EXPRession]:SDEFine** or **CALCulate<Chn>:MATH:FORMatted[:EXPRession]:SDEFine** may contain the following elements:

Type	Complete List	Description
Operands	<Trace name> activeTrc Mem[activeTrc]	All traces and memory traces of the active recall set Active trace Active memory trace assigned to the active trace
Constants	e, pi 1, -1.2, 8e9 1 + 2j, 2 + 1e-9j	Constants Real values in decimal or exponential format Complex numbers
Operators	- + , - , * , / , ^	Basic arithmetic operations; ^ for exponentiation
Functions	linMag (), dBMag (), Arg (), Re (), Im (), log (), ln (), tan (), atan (), sin (), asin (), cos (), acos (), Min (... , ...), Max (... , ...)	Mathematical functions with one or two arguments

Type	Complete List	Description
Special Functions	StimVal	Current stimulus value (see description of operators for User Defined Math)
Brackets	()	Priority of operations in complex expressions

CALCulate<Chn>:MATH:FUNCTION <Mode>

CALCulate<Chn>:MATH:FORMatted:FUNCTION <Mode>

Defines a simple mathematical trace based on the active trace and its active memory trace. The first command applies to raw, unformatted trace data (complex data), the second to formatted trace data. Both methods can be combined.

To apply the trace math, the corresponding mathematical mode must be switched on using `CALCulate<Chn>:MATH:STATe ON` and/or `CALCulate<Chn>:MATH:FORMatted:STATe ON`.

Note: Use `CALCulate<Chn>:MATH[:EXPRession]:SDEFine` and/or `CALCulate<Chn>:MATH:FORMatted[:EXPRession]:SDEFine` to define general math traces.

Suffix:

<Chn> Channel number used to identify the active trace

Parameters:

<Mode> NORMAL | ADD | SUBTRACT | MULTIPLY | DIVIDE

NORMAL

Math. trace = active data trace

When set to `NORMAL`, the corresponding mathematical mode is turned `OFF`, otherwise it is turned `ON`.

ADD

Math. trace = data + memory

SUBTRACT

Math. trace = data - memory

MULTIPLY

Math. trace = data * memory

DIVIDE

Math. trace = data / memory

*RST: NORMAL

Example: *RST; :CALC:MATH:MEM
 Copy the current state of the default trace 'Trc1' to a memory trace named 'Mem2[Trc1]'. The memory trace is not displayed.
 CALC:MATH:FUNC DIV
 Define a mathematical trace, dividing the raw complex data trace trace by the stored memory trace. The mathematical trace is displayed instead of the active data trace.
 CALC:MATH:STAT?
 The response is 1 (mathematical mode for unformatted trace data switched on, mathematical trace displayed).

Manual operation: See "[Data / <Mem>, Data - <Mem>](#)" on page 443

CALCulate<Chn>:MATH:MEMorize

Copies the current state of the active data trace to a memory trace. If a mathematical trace is active, the data trace associated with the mathematical trace is copied. The memory trace is named Mem<n>[<Data_Trace>] where <n> counts all data and memory traces in the active recall set in chronological order, and <Data_Trace> is the name of the associated (copied) data trace.

The exact function of the command depends on the number of memory traces associated to the active data trace:

- If no memory trace is associated to the active trace, a new memory trace is generated.
- If several memory traces are associated to the active trace, the current measurement data overwrites the last generated or changed memory trace.

Note: To copy a trace to the memory without overwriting an existing memory trace or define a memory trace name, use [TRACe:COPI](#)

<MemTraceName>, <DataTraceName>. To copy an active mathematical trace use [TRACe:COPI:MATH](#) <MemTraceName>, <DataTraceName>

Suffix:

<Chn> Channel number used to identify the active trace

Example: *RST; :CALC:MATH:MEM
 Copy the current state of the default trace 'Trc1' to a memory trace named 'Mem2[Trc1]'. The memory trace is not displayed.
 DISP:WIND:TRAC2:FEED 'Mem2[Trc1]'
 Display the created memory trace in the active diagram area (diagram area no. 1).

Usage: Event

Manual operation: See "[Data to <Destination>](#)" on page 438

CALCulate<Chn>:MATH:STATe <Boolean>

CALCulate<Chn>:MATH:FORMatted:STATe <Boolean>

Activates or deactivates trace math for unformatted and/or formatted trace data, i.e. the trace formulae defined via `CALCulate<Chn>:MATH[:EXPRession]:SDEFine` and/or `CALCulate<Chn>:MATH:FORMatted[:EXPRession]:SDEFine`, respectively.

When trace math is active either for unformatted or formatted data, the resulting mathematical trace is calculated and displayed instead of the active data trace.

Suffix:

<Chn> Channel number used to identify the active trace

Parameters:

<Boolean> ON – apply trace math on the
 OFF – display the active data trace
 *RST: OFF

Example:

*RST; :CALC:MATH:MEM

Copy the current state of the default trace 'Trc1' to a memory trace named 'Mem2[Trc1]'. The memory trace is not displayed.

CALC:MATH:SDEF 'Trc1 / Mem2[Trc1]'

Define a mathematical trace, dividing the complex data trace by the stored complex memory trace. The mathematical trace is not displayed.

CALC:MATH:STAT ON

Display the mathematical trace instead of the active data trace.

Manual operation: See "[Trace Math](#)" on page 443

CALCulate<Chn>:MATH:WUNit[:STATe] <Boolean>

Controls the conversion and formatting of the mathematic expression defined via `CALCulate<Chn>:MATH[:EXPRession]:SDEFine`.

Suffix:

<Chn> Channel number used to identify the active trace

Parameters:

<Boolean> ON –"Result is Wave Quantity" enabled: the analyzer assumes that the result of the mathematical expression represents a voltage.
 OFF –"Result is Wave Quantity" disabled: the analyzer assumes that the result of the mathematical expression is dimensionless.
 *RST: OFF

Example:

```
*RST; SWE:TYPE POW
CALC:PAR:SDEF 'Trc1', 'a1'
Reset the instrument, activate a power sweep, and select a
wave quantity a1 for the trace Trc1.
DISP:WIND:TRAC:FEED 'Trc1'
Display the generated trace in the active window.
CALC:MATH:SDEF 'StimVal'; STAT ON
Define a mathematical trace and display it instead of the active
data trace.
CALC:MATH:WUN ON
Take into account that the stimulus value is a voltage (derived
from the source power) rather than a dimensionless quantity.
The y-axis range of the mathematical trace now exactly corre-
sponds to the power sweep range.
```

Manual operation: See ["Result is Wave Quantity"](#) on page 446

7.3.1.11 CALCulate:PARAmeter...

The CALCulate:PARAmeter... commands assign names and measurement parameters to traces. The commands are device-specific.

CALCulate<Ch>:PARAmeter:CATalog?	1101
CALCulate<Ch>:PARAmeter:CATalog:SENDEd?	1102
CALCulate<Ch>:PARAmeter:DEFine:SGRoup	1102
CALCulate<Ch>:PARAmeter:DELeTe	1103
CALCulate:PARAmeter:DELeTe:ALL	1104
CALCulate<Ch>:PARAmeter:DELeTe:CALL	1104
CALCulate<Ch>:PARAmeter:DELeTe:CMEMory	1104
CALCulate:PARAmeter:DELeTe:MEMory	1105
CALCulate<Ch>:PARAmeter:DELeTe:SGRoup	1105
CALCulate<Ch>:PARAmeter:MEASure	1105
CALCulate<Ch>:PARAmeter:MEASure:SENDEd	1106
CALCulate<Ch>:PARAmeter:SDEFine	1106
CALCulate<Ch>:PARAmeter:SDEFine:SENDEd	1110
CALCulate<Ch>:PARAmeter:SELEct	1111

CALCulate<Ch>:PARAmeter:CATalog?

Returns the trace names and measurement parameters of all traces assigned to a particular channel.

The result is a string containing a comma-separated list of trace names and measurement parameters, e.g. 'CH4TR1, S11, CH4TR2, S12'. The measurement parameters are returned according to the naming convention of CALCulate<Ch>:PARAmeter:SDEFine. The order of traces in the list reflects their creation time: The oldest trace is the first, the newest trace is the last trace in the list.

Suffix:

<Ch> Channel number. If unspecified the numeric suffix is set to 1.

Example: `CALC4:PAR:SDEF 'Ch4Tr1', 'S11'`
 Create channel 4 and a trace named Ch4Tr1 to measure the input reflection coefficient S_{11} .
`CALC4:PAR:CAT?`
 Query the traces assigned to channel 4. If Ch4Tr1 is the only trace assigned to channel 4, the response is 'CH4TR1, S11'.

Usage: Query only

CALCulate<Ch>:PARAmeter:CATalog:SENDED?

Returns the trace names and measurement parameters of all traces assigned to a particular channel.

Similar to `CALCulate<Ch>:PARAmeter:CATalog?`, but in presence of balanced ports this command distinguishes between

- single-ended S-parameters for **logical** ports ($SSS<Lj>$)
- "raw" single-ended S-parameters referring to **physical** ports ($S<Pi><Pj>$)

Suffix:
 <Ch> Channel number. If unspecified the numeric suffix is set to 1.

Usage: Query only

CALCulate<Ch>:PARAmeter:DEFine:SGRoup <LogicalPort1>[, <LogicalPort2>]...

Creates the traces for all S-parameters associated with a group of logical ports (S-parameter group). The traces can be queried using `CALCulate<Ch>:DATA:SGRoup?`.

Traces must be selected to become active traces; see `CALCulate<Ch>:PARAmeter:SElect`.

Note: Each channel can contain a single S-parameter group only. Defining a new S-parameter group deletes the previous one. Use `CALCulate<Ch>:PARAmeter:DElete:SGRoup` on page 1105 to delete the current S-group explicitly.

Suffix:
 <Ch> Channel number. <Ch> may be used to reference a previously defined channel. If <Ch> does not exist, it is generated with default channel settings.

Parameters:
 <LogicalPort1> Logical (balanced or unbalanced) port numbers. The port numbers must be in ascending order, their number is limited by the test ports of the analyzer. With n logical port numbers, the command generates n^2 traces. The traces correspond to the following S-parameters:
 $S_{<log_port1><log_port1>}, S_{<log_port1><log_port2>} \dots S_{<log_port1><log_port<n>>}$
 ...
 $S_{<log_port<n>><log_port1>}, S_{<log_port<n>><log_port2>} \dots S_{<log_port<n>><log_port<n>>}$

e.g. S_{11} , S_{12} , S_{21} , S_{22} for $\langle \text{log_port1} \rangle = 1$, $\langle \text{log_port2} \rangle = 2$. If only one logical port $\langle \text{log_port1} \rangle$ is specified, a single trace with the reflection coefficient $S_{\langle \text{log_port1} \rangle \langle \text{log_port1} \rangle}$ is created.

Trace names

The generated traces are assigned the following trace names:

$\langle \text{Ch_name} \rangle_SG_S\langle \text{log_port1} \rangle\langle \text{log_port1} \rangle$,

$\langle \text{Ch_name} \rangle_SG_S\langle \text{log_port1} \rangle\langle \text{log_port2} \rangle \dots$

$\langle \text{Ch_name} \rangle_SG_S\langle \text{log_port1} \rangle\langle \text{log_port}\langle n \rangle \rangle \dots \langle \text{Ch_name} \rangle_SG_S\langle \text{log_port}\langle n \rangle \rangle\langle \text{log_port1} \rangle$,

$\langle \text{Ch_name} \rangle_SG_S\langle \text{log_port}\langle n \rangle \rangle\langle \text{log_port2} \rangle \dots$

$\langle \text{Ch_name} \rangle_SG_S\langle \text{log_port}\langle n \rangle \rangle\langle \text{log_port}\langle n \rangle \rangle$,

e.g. Ch1_SG_S11 , Ch1_SG_S12 , Ch1_SG_S21 , Ch1_SG_S22

for $\langle \text{Ch_name} \rangle = \text{Ch1}$, $\langle \text{log_port1} \rangle = 1$, $\langle \text{log_port2} \rangle = 2$. The trace names are displayed in the "Channel Manager" and in the "Trace Manager" dialogs where they can be changed manually.

The $\langle \text{Ch_name} \rangle$ is defined via

```
CONFigure:CHANnel<Ch>:NAME '<Ch_name>'
```

Trace names are important for referencing the generated traces; see program example below.

$\langle \text{LogicalPort2} \rangle$

Example:

```
CALC2:PAR:DEF:SGR 1,2
```

Create channel 2 and four traces to measure the two-port S-parameters S_{11} , S_{12} , S_{21} , S_{22} . The traces are not displayed.

```
DISP:WIND:TRAC2:FEED 'Ch2_SG_S11'
```

```
DISP:WIND:TRAC3:FEED 'Ch2_SG_S12'
```

```
DISP:WIND:TRAC4:FEED 'Ch2_SG_S21'
```

```
DISP:WIND:TRAC5:FEED 'Ch2_SG_S22'
```

Display the four traces in the diagram no. 1.

```
INIT2:CONT OFF; :INIT2:IMMediate; *OPC
```

Perform a complete sweep in channel no. 2 to ensure the traces are completely "filled" with data.

```
CALC2:DATA:SGR? SDAT
```

Retrieve all four traces as unformatted data (real and imaginary part at each sweep point). The analyzer first returns the complete S_{11} trace, followed by the S_{12} , S_{21} , and S_{22} traces.

```
CALC2:PAR:DEL:SGR
```

Delete the previously created port group.

Manual operation: See "All S-Params" on page 346

CALCulate<Ch>:PARAMeter:DELeTe <TraceName>

Deletes a trace with a specified trace name and channel.

Suffix:

$\langle \text{Ch} \rangle$ Channel number.

Setting parameters:

<TraceName> Trace name, e.g. 'Trc4'. See "Rules for trace names" in [Chapter 5.5.1.3, "Trace Manager dialog"](#), on page 435.

Example:

```
CALCulate4:PARAMeter:SDEFine 'Ch4Tr1', 'S11'
```

Create channel 4 and a trace named Ch4Tr1 to measure the input reflection coefficient S_{11} .

```
CALCulate4:PAR:CAT?
```

Query the traces assigned to channel 4. Ch4Tr1 is the only trace assigned to channel 4, so the response is 'CH4TR1,S11'.

```
CALCulate4:PARAMeter:SDEFine 'CH4TR2', 'S21';
SDEFine 'CH4TR3', 'S12'; SDEFine 'CH4TR4', 'S22'
```

Create three more traces for the remaining 2-port S-parameters.

```
CALCulate4:PARAMeter:DELeTe 'CH4TR1'
```

Delete the first created trace.

```
CALCulate4:PARAMeter:DELeTe:CALL
```

Delete the remaining three traces in channel 4.

```
CALCulate:PARAMeter:DELeTe:ALL
```

Delete all traces, including the default trace Trc1 in channel 1.

Usage: Setting only

Manual operation: See "[Delete Trace](#)" on page 433

CALCulate:PARAMeter:DELeTe:ALL

Deletes all traces in all channels of the active recall set, including the default trace Trc1 in channel 1. The manual control screen shows "No Trace".

Example: See `CALCulate<Ch>:PARAMeter:DELeTe`

Usage: Event

Manual operation: See "[Delete Trace](#)" on page 433

CALCulate<Ch>:PARAMeter:DELeTe:CALL

Deletes all traces in channel no. <Ch>.

Suffix:

<Ch> Channel number

Example: See `CALCulate<Ch>:PARAMeter:DELeTe`

Usage: Event

Manual operation: See "[Delete Trace](#)" on page 433

CALCulate<Ch>:PARAMeter:DELeTe:CMEMory

Deletes all memory traces in channel <Ch>.

Suffix:
 <Ch> Channel number

Usage: Event

CALCulate:PARAmeter:DELEte:MEMory

Deletes all memory traces in all channels.

Usage: Event

Manual operation: See ["Delete All Mem"](#) on page 441

CALCulate<Ch>:PARAmeter:DELEte:SGRoup

Deletes a group of logical ports (S-parameter group), previously defined via [CALCulate<Ch>:PARAmeter:DEFine:SGRoup](#).

Suffix:
 <Ch> Channel number. <Ch> may be used to reference a previously defined channel. If <Ch> does not exist, it is generated with default channel settings.

Example: See [CALCulate<Ch>:PARAmeter:DEFine:SGRoup](#)

Usage: Event

CALCulate<Ch>:PARAmeter:MEASure <TraceName>, <Result>

Assigns a measurement result to an **existing** trace. The query returns the result assigned to the specified trace (no second parameter; see example).

Note: To create a new trace and at the same time assign the attributes, use [CALCulate<Ch>:PARAmeter:SDEFine](#). To display the trace, create a diagram ([DISPlay\[:WINDow<Wnd>\]\[:STATe\] ON](#)) and assign the trace to this diagram ([DISPlay\[:WINDow<Wnd>\]:TRACe<WndTr>:FEED](#)); see example below.

Traces must be selected to become active traces; see [CALCulate<Ch>:PARAmeter:SELEct](#). [CALCulate<Ch>:PARAmeter:CATalog?](#) returns a list of all defined traces. You can open the "Trace Manager" dialog to obtain an overview of all channels and traces, including the traces that are not displayed.

Suffix:
 <Ch> Channel number of an existing channel containing the referenced trace.

Parameters:
 <TraceName> Trace name, string variable, e.g. 'Trc4'. See "Rules for trace names" in ["Table Area"](#) on page 435. Trace names must be unique across all channels and diagrams.

<Result> Measurement parameter (string variable); see [Table 7-4](#).
 A query of a wave quantity 'xy' returns 'xyD<n><Detector>', where <n> numbers the source (drive) port, and <Detector> denotes the detector setting. A query of a ratio 'x/y' returns 'xD<n>/yD<m><Detector>', where <n> and <m> number the source ports

Example:
 CALC4:PAR:SDEF 'Ch4Tr1', 'S11'
 Create channel 4 and a trace named Ch4Tr1 to measure the input reflection coefficient S₁₁.
 CALC4:PAR:MEAS 'Ch4Tr1', 'a1'
 Change the measurement parameter of the trace and measure the wave quantity a₁.
 CALC4:PAR:MEAS? 'Ch4Tr1'
 Query the measured quantity. The response is 'A1D1SAM'.

Manual operation: See "[S-Parameter \(selector\)](#)" on page 345

CALCulate<Ch>:PARAmeter:MEASure:SENDEd <TraceName>, <Result>

Assigns a measurement result to an **existing** trace. The query returns the result assigned to the specified trace (no second parameter; see example).

Similar to [CALCulate<Ch>:PARAmeter:MEASure](#), but in presence of balanced ports this command distinguishes between

- single-ended S-parameters for **logical** ports (SSS<Lj>)
- "raw" single-ended S-parameters referring to **physical** ports (S<Pi><Pj>)

Suffix:

<Ch> Channel number

Setting parameters:

<TraceName> Trace name

<Result> Measured quantity

Manual operation: See "[S-Parameter \(selector\)](#)" on page 345

CALCulate<Ch>:PARAmeter:SDEFine <TraceName>, <Result>

Creates a trace and assigns a channel number, a name and a measurement parameter to it. The trace becomes the active trace in the channel but is not displayed.

Note: To display the trace defined via [CALCulate<Ch>:PARAmeter:SDEFine](#), create a diagram ([DISPlay\[:WINDow<Wnd>\]\[:STATe\] ON](#)) and assign the trace to this diagram ([DISPlay\[:WINDow<Wnd>\]:TRACe<WndTr>:FEED](#)); see example below. [CALCulate<Ch>:PARAmeter:MEASure](#) changes the measurement result of an existing trace.

To select an existing trace as the active trace, use [CALCulate<Ch>:PARAmeter:SElect](#). You can open the trace manager to obtain an overview of all channels and traces, including the traces that are not displayed.

Tip: This command has no query form. Use `CALCulate<Ch>:PARAmeter:MEASure <TraceName>` to query the measurement result of the trace. `CALCulate<Ch>:PARAmeter:CATalog?` returns a list of all defined traces.

Suffix:

<Ch> Channel number referencing a previously defined channel. If <Ch> does not exist, it is generated with default channel settings.

Setting parameters:

<TraceName> Trace name, string variable, e.g. 'Trc4'. See "Rules for trace names" in "Table Area" on page 435. Trace names must be unique across all channels and diagrams.
If a trace with the selected trace name already exists, the analyzer behaves as follows: If the existing trace is assigned to the same channel as the new trace, it is deleted. The new trace is not automatically assigned to a diagram area; see note above. If the existing trace is assigned to a different channel, no new trace can be created. The analyzer returns an error message.

<Result> Measurement result (string variable), see table below.

Example:

```
CALC4:PAR:SDEF 'Ch4Tr1', 'S11'
```

Create channel 4 and a trace named Ch4Tr1 to measure the input reflection coefficient S_{11} .

```
DISP:WIND2:STAT ON
```

Create diagram area no. 2.

```
DISP:WIND2:TRAC:FEED 'CH4TR1'
```

Display the generated trace in diagram area no. 2.

Usage: Setting only

Manual operation: See "[S-Parameter \(selector\)](#)" on page 345

Table 7-4: String identifiers for measurement results

Note:	
All port numbers in a result identifier refer to logical (=DUT) ports ; to avoid ambiguities they must be represented by the same number of digits (e.g. S21 or S0201). The valid port numbers are determined by the channel's logical port configuration For details about the measurement results, see Chapter 4.3, "Measurement results" , on page 149.	
'S11' 'S12' ... 'S0101' ...	Single-ended S-parameters $S_{<i><j>}$ for logical (DUT) ports <i> and <j>. To avoid ambiguities, <i> and <j> must be specified with the same number of digits.
'SCD11' ...	S-parameters involving balanced ports must be specified in the form $S_{<m_i><m_j><i><j>}$, where <m_i> and <m_j> denote the port modes of the related logical ports <i> and <j>. In general, for the port modes <m_i><m_j> all pairs of D (differential, balanced), C (common, balanced) and S (single-ended, unbalanced) are allowed.
'S11SAM' 'S11AVG' 'S12SAM' ... 'SCD11SAM' 'SCD11AVG' ...	The strings SAM and AVG appended to the S-parameters quantities denote a normal (sample) or average detector. The observation time for average detectors is set via <code>[SENSe<Ch>:]SWEep:DETEctor:TIME</code>

'Y11' ... 'YSS11' ... 'YCC11' ... 'YDD11' 'Z11' ... 'ZSS11' ... 'ZCC11' ... 'ZDD11' ...	Short-circuit Y-parameters and open-circuit Z-parameters with port modes and port numbers like for normal mode S-parameters. Selecting a parameter Y...<n><m> or Z...<n><m> sets the range of logical port numbers to be considered for the Y and Z-parameter measurement to <n>:<m>.
'Y-S11' ... 'Y-SSS11' ... 'Y-SCC11' ... 'Y-SDD11' 'Z-S11' ... 'Z-SSS11' ... 'Z-SCC11' ... 'Z-SDD11' ...	S-parameters converted to matched-circuit admittances and impedances with port modes and port numbers like for normal mode S-parameters. For transmission parameters, this refers to series resistances.
'Y-S12SER' 'Y-S12PAR' ... 'Z-S12SER' 'Z-S12PAR' ...	Converted transmission admittances and impedances, calculated as series Chapter 4, "Concepts and features" , on page 107 or parallel admittances/impedances.
'A1' ... 'A01' ... 'B1' ... 'B01' 'A1SAM' 'A1AVG' 'A1AMP'	Wave quantities A<meas>D1 (for a wave) and B<meas>D1. The strings SAM, AVG, AMP appended to the wave quantities denote a normal (sample, SAM), AVG Real Imag (AVG), or AVG Mag Phase (AMP) detector. The observation time for average detectors is set via [SENSe<Ch>:]SWEep:DETEctor:TIME .
'A1D2' ... 'A01D02' ... 'B1D2' ... 'B01D02' 'A1D1SAM' 'A1D1AVG' 'A1D1RMS' 'A1D1PEAK' ...	Wave quantities A<meas>D<drive> (for a wave) and B<meas>D<drive> (for b wave) for logical ports <meas> and <drive>. The strings SAM (sample = normal), AVG, RMS and PEAK, appended to the wave quantities, denote the detector.
'A1G2' ... 'A01G02' ... 'B1G2' ... 'B01G02' ... 'A1G1SAM' 'A1G1AVG' 'A1G1RMS' 'A1G1PEAK' ...	Wave quantities with an external generator providing the stimulus signal (G<no> for generator no.). The strings SAM (sample = normal), AVG, RMS and PEAK, appended to the wave quantities, denote the detector.
'AP1' ... 'AP01' ... 'BP1' ... 'BP01' ... 'AP1SAM' 'AP1RMS' 'AP1PEAK' 'AP1AVG' ..	Primed wave quantities, with port numbers like for normal mode S-parameters. The strings SAM, RMS, PEAK, AVG appended to the wave quantities denote a normal (sample), RMS, peak, or average detector.
'AP1D2' ... 'AP01D02' ... 'BP1D2' ... 'BP01D02' ... 'AP1D1SAM' 'AP1D1RMS' 'AP1D1PEAK' 'AP1D1AVG' ...	Primed wave quantities, with port numbers and source port numbers (D<no> for drive port). The strings SAM, RMS, PEAK, AVG appended to the wave quantities denote a normal (sample), RMS, peak, or average detector.
'AP1G2' ... 'AP01G02' ... 'BP1G2' ... 'BP01G02' ... 'AP1G1SAM' 'AP1G1RMS' 'AP1G1PEAK' 'AP1G1AVG' ...	Primed wave quantities, with port numbers and external generator providing the stimulus signal (G<no> for generator no.). The strings SAM, RMS, PEAK, AVG appended to the wave quantities denote a normal (sample), RMS, peak, or average detector.
'B2/A1' ... 'B02/A01' 'B2/A1SAM' 'B2/A1AVG' 'B2/A1AMP' ...	Ratio of wave quantities with port numbers like for normal mode S-parameters. The strings SAM, AVG, AMP appended to the wave quantities denote a normal (sample, SAM), AVG Real Imag (AVG), or AVG Mag Phase (AMP) detector.
'B2D1/A1D1' ... 'B02D01/A01D01' 'B2D1/A1D1SAM' 'B2D1/A1D1AVG' 'B2D1/ A1D1AMP' ...	Ratios of wave quantities with drive ports The strings SAM, AVG, AMP appended to the wave quantities denote a normal (sample, SAM), AVG Real Imag (AVG), or AVG Mag Phase (AMP) detector.
'B2G1/A1G1' ... 'B02G01/A01G01' ... 'B2G1/ A1G1SAM' 'B2G1/A1G1AVG' 'B2G1/A1G1AMP' ...	Ratios of wave quantities with port numbers and external generator providing the stimulus signal (G<no> for generator no.). The strings SAM, AVG, AMP appended to the wave quantities denote a normal (sample, SAM), AVG Real Imag (AVG), or AVG Mag Phase (AMP) detector.

'BP2/A1' ... 'BP02/A01' ... 'BP2/A1SAM' 'B2/AP1RMS' 'B2/AP1PEAK' 'B2/AP1AVG' ...	Ratio of primed or/unprimed wave quantities with port numbers like for normal mode S-parameters. The strings SAM, RMS, PEAK, AVG appended to the wave quantities denote a normal (sample), RMS, peak, or average detector.
'BP2D1/A1D1' ... 'BP02D01/A01D01' ... 'BP2D1/A1D1SAM' 'B2D1/AP1D1RMS' 'BP2D1/AP1D1PEAK' 'BP2D1/AP1D1AVG'...	Ratio of primed/unprimed wave quantities with port numbers and source port numbers (D<no> for drive port). The strings SAM, RMS, PEAK, AVG appended to the wave quantities denote a normal (sample), RMS, peak, or average detector.
'BP2G1/A1G1' ... 'BP02G1/A01G1' ... 'B2G1/AP1G1SAM' 'B2G1/AP1G1RMS' 'BP2G1/AP1G1PEAK' 'BP2G1/AP1G1AVG' ...	Ratio of primed/unprimed wave quantities with port numbers and external generator providing the stimulus signal (G<no> for generator no.). The strings SAM, RMS, PEAK, AVG appended to the wave quantities denote a normal (sample), RMS, peak, or average detector.
'IMB21' 'IMB12' 'IMB31' ...	Imbalance parameter $I_{mb}<receive_port><drive_port>$ for logical port numbers <receive_port> and <drive_port>. The logical ports must be different and at least one of them must be balanced.
'CMRR11' 'CMRR21' 'CMRR12' 'CMRR22' ...	Common mode rejection ratio $CMRR<receive_port><drive_port>$ parameter for logical port numbers <receive_port> and <drive_port>, at least one of them balanced.
'IMB1-23' 'IMB23-1' 'IMB1-24' ...	Differential Imbalance parameters between a balanced and two single-ended logical ports
'KFAC21' 'KFAC12' ...	Stability factor K (for unbalanced ports only)
'MUF121' 'MUF112' ...	Stability factor 1 (for unbalanced ports only)
'MUF221' 'MUF212' ...	Stability factor 2 (for unbalanced ports only)
'Pmtr1G1' 'Pmtr2G1' 'Pmtr3D1' ...	Power sensor measurement using a power meter 'Pmtr<no>' and either an external generator 'G<no>' or an analyzer source port 'D<no>'
'PAE21' 'PAE12' ...	Power added efficiency (referring to logical ports)
'IM3UI' 'IM3UO' 'IM3LI' 'IM3LO' 'IM3MI' 'IM3MO' 'IM5UI' ... 'IM9MO'	Intermodulation product $IM<order><side><at\ DUT>$ where <order> = 3 5 7 9, <side> = U L M (for upper or lower or major), <at DUT> = I O (for input or output)
'IM3UIR' 'IM3UOR' 'IM3LIR' 'IM3LOR' 'IM3MIR' 'IM3MOR' 'IM5UIR' ... 'IM9MOR'	Intermodulation product (as explained above) displayed in dB units relative to the measured lower tone level at DUT input or output ("intermodulation suppression")
'IP3UI' 'IP3UO' 'IP3LI' 'IP3LO' 'IP3MI' 'IP3MO' 'IP5UI' ... 'IP9MO'	Intercept point $IP<order><side><at\ DUT>$ where <order> = 3 5 7 9, <side> = U L M (for upper or lower or major), <at DUT> = I O (for input or output)
UT1 UTO LT1 LTO	Upper or lower tone at DUT input or output
NLO	Noise level at DUT output Requires option R&S ZNA-K30.
'NF12' 'NF13' ... 'NF21' 'NF23' ...	Noise figure parameters $NF<out><in>$, where <out> and <in> denote the output and input port numbers of the DUT, and <out>≠<in>. Requires option R&S ZNA-K30.
'ND1' 'ND2' ...	Noise (power spectral) density, measured at receive port 1, 2, ... Requires option R&S ZNA-K30.
'b1/a2' 'b1/a3' ... 'b2/a1' 'b2/a3' ...	Gain of the DUT, as measured in noise figure channels Requires option R&S ZNA-K30.

'NF1R' 'NF2R' ...	Receiver noise figure, as measured in noise figure channels Requires option R&S ZNA-K30.
'SA1' 'SA2' ...	Spectrum trace at the measurement receiver of port 1, 2, ... Requires option R&S ZNA-K1.
'SA1REF' 'SA2REF' ...	Spectrum trace at the reference receiver of port 1, 2, ... Requires option R&S ZNA-K1.
'CmpPtPin' 'CmpPtPout' 'CmpPtS'	Compression point traces for gain compression measurements: power in power out S-param
"H<order>B<recPort>[R THDF THDR]" "H<order>B<recPort>D<drvPort>[R THDF THDR]"	Harmonic measurement with: <ul style="list-style-type: none"> • Order <order> • Receive port <recPort> • Drive port <drvPort> (if omitted, 1 is assumed) • Relative, THD_F, THD_R, or direct (if omitted) See Chapter 5.2.4, "Ratio Harmonics tab" , on page 361.
MixDly MixPhas MixDeriv	Delay, phase and derivative for two-tone group delay measurements (R&S ZNA-K9)
Mix_a_LTone Mix_a_UTone Mix_b_LTone Mix_b_UTone	Main tones (Lower/Upper) at input (a) or output (b) for two-tone group delay measurements (R&S ZNA-K9)
Cu(P<Src Port>)<_lowercase_ext_dll_name>/<Task Type>/<Additional Input>	Traces calculated using external DLL <ext_dll_name>.dll.

*) Selecting a parameter Y...<n><m> or Z...<n><m> sets the range of port numbers to be considered for the Y and Z-parameter measurement to <n>:<m>.

CALCulate<Ch>:PARAmeter:SDEFine:SENDED <TraceName>, <Result>

Creates a trace and assigns a channel number, a name and a measurement parameter to it. The trace becomes the active trace in the channel but is not displayed.

Similar to [CALCulate<Ch>:PARAmeter:SDEFine](#), but in presence of balanced ports this command distinguishes between

- single-ended S-parameters for **logical** ports (SSS<Lj>)
- "raw" single-ended S-parameters referring to **physical** ports (S<Pi><Pj>)

Suffix:

<Ch> Channel number

Setting parameters:

<TraceName> Trace name

<Result> Measured quantity

Usage: Setting only

Manual operation: See ["S-Parameter \(selector\)"](#) on page 345

CALCulate<Ch>:PARAmeter:SElect <TraceName>

Selects an existing trace as the active trace of the channel. All trace commands without explicit reference to the trace name act on the active trace (e.g. [CALCulate<Chn>:FORMat](#)). `CALCulate<Ch>:PARAmeter:SElect` is also necessary if the active trace of a channel has been deleted.

Suffix:

<Ch> Channel number.

Parameters:

<TraceName> Trace name, e.g. 'Trc4'. See "Rules for trace names" in ["Table Area"](#) on page 435.

Example:

```
CALC4:PAR:SDEF 'Ch4Tr1', 'S11'
```

Create channel 4 and a trace named Ch4Tr1 to measure the input reflection coefficient S_{11} . The trace is the active trace in channel 4.

```
CALC4:PAR:SDEF 'Ch4Tr2', 'S22'
```

Create another trace named Ch4Tr2 to measure the output reflection coefficient S_{22} . Again this new trace becomes the active trace in channel 4.

```
CALC4:PAR:SEL 'Ch4Tr1'
```

Select the first trace Ch4Tr1 as the active trace.

```
CALC4:FORM MLIN
```

Calculate the magnitude of S_{11} and display it in a linearly scaled Cartesian diagram.

7.3.1.12 CALCulate:RIPPLE...

The `CALCulate:RIPPLE...` commands define the ripple limits and control the ripple limit check.

<code>CALCulate<Chn>:RIPPLE:CLEar</code>	1112
<code>CALCulate<Chn>:RIPPLE:CONTRol:DOMain</code>	1112
<code>CALCulate<Chn>:RIPPLE:DATA</code>	1112
<code>CALCulate<Chn>:RIPPLE:DELeTe:ALL</code>	1113
<code>CALCulate:RIPPLE:DISPlay:RESult:ALL[:STATe]</code>	1114
<code>CALCulate<Chn>:RIPPLE:DISPlay[:STATe]</code>	1114
<code>CALCulate<Chn>:RIPPLE:FAIL?</code>	1114
<code>CALCulate:RIPPLE:FAIL:ALL?</code>	1115
<code>CALCulate<Chn>:RIPPLE:RDOMain:FORMat</code>	1115
<code>CALCulate<Chn>:RIPPLE:SEGMENT:COUNT?</code>	1116
<code>CALCulate<Chn>:RIPPLE:SEGMENT<Seg>:LIMit</code>	1116
<code>CALCulate<Chn>:RIPPLE:SEGMENT<Seg>:RESult?</code>	1117
<code>CALCulate<Chn>:RIPPLE:SEGMENT<Seg>[:STATe]</code>	1117
<code>CALCulate<Chn>:RIPPLE:SEGMENT<Seg>:STIMulus:START</code>	1118
<code>CALCulate<Chn>:RIPPLE:SEGMENT<Seg>:STIMulus:STOP</code>	1118
<code>CALCulate<Chn>:RIPPLE:SOUND[:STATe]</code>	1118
<code>CALCulate<Chn>:RIPPLE:STATe</code>	1119
<code>CALCulate<Chn>:RIPPLE:STATe:AREA</code>	1119

CALCulate<Chn>:RIPple:CLEar

Resets the limit check results for the ripple test.

Suffix:

<Chn> Channel number used to identify the active trace

Usage: Event

Manual operation: See ["Clear Test"](#) on page 489

CALCulate<Chn>:RIPple:CONTRol:DOMain <SweepType>

Deletes the existing ripple limit ranges and (re-)defines the physical units of the stimulus values of the ripple limit lines. The unit of the ripple limit is defined via [CALCulate<Chn>:RIPple:RDOMain:FORMat](#).

Suffix:

<Chn> Channel number used to identify the active trace

Setting parameters:

<SweepType> FLIN | FLOG | FSEG | FSINgle | TLIN | TLOG | PLIN | PLOG | PSINgle

Keywords for the units of the stimulus values; frequency, power, and time units.

The selected unit must be compatible with the sweep type (see [\[SENSe<Ch>:\]SWEep:TYPE](#) on page 1515): Hz for FLIN, FLOG, FSEG and FSINgle, s for TLIN and TLOG, dBm for PLIN, PLOG and PSINgle. Otherwise the ripple limit lines cannot be displayed and no ripple limit check is possible.

*RST: FLIN

Example:

```
SWE:TYPE POW
```

Select a power sweep.

```
CALC:RIPP:CONT:DOM PLIN
```

Delete all existing ripple limit ranges and select level units for the domain of the active trace.

```
CALC:RIPP:DATA 1, -10, -5, 3
```

Define and enable a ripple limit range in the stimulus range between -10 dBm and -5 dBm, assigning a ripple limit of 3 dB.

Usage: Setting only

Manual operation: See ["Add / Insert / Delete / Delete All / Align All"](#) on page 491

CALCulate<Chn>:RIPple:DATA <RippleLimRange>...

Adds and enables/disables an arbitrary number of ripple limit ranges, assigning the stimulus values and the ripple limits. See [Chapter 4.4.1.2, "Rules for ripple test definition"](#), on page 171.

Note: This command does not overwrite existing ripple limit ranges. The defined ranges are appended to the range list as new ranges. Use the `CALCulate<Chn>:RIPple:SEGment<Seg>...` commands to change existing ripple limits.

Suffix:

<Chn> Channel number used to identify the active trace

Parameters:

<RippleLimRange> Parameter list in the format <Type>, <StartStimulus>, <StopStimulus>, <RippleLimit>[, {<Type>, <StartStimulus>, <StopStimulus>, <RippleLimit>}], where:

<Type> – Boolean identifier for the ripple limit range type. 1 for ripple limit range on (with limit check). 0 for ripple limit range off: The range is defined, but no limit check result displayed. The result is still available via `CALCulate<Chn>:RIPple:SEGment<Seg>:RESult?`.

<StartStimulus>/<StopStimulus>– stimulus values (unitless) confining the ripple limit range

<RippleLimit> – ripple limit (unitless) in the stimulus range between <StartStimulus> and <StopStimulus>

The unit of a stimulus value is adjusted to the sweep type of the active channel (`[SENSE<Ch>:]SWEep:TYPE`), the unit of a ripple limit is adjusted to the format of the active trace (`CALCulate<Chn>:FORMat`).

Range: Virtually no restriction for ripple limit ranges.

*RST: n/a (no ripple limit line defined after a reset)

Example:

```
*RST; CALC:RIPP:DATA 1, 1500000000, 2000000000,
3, 1, 2000000000, 3000000000, 5
```

Define and enable a ripple limit range in the stimulus range between 1.5 GHz and 2 GHz, assigning a ripple limit of +3 dB. Define and enable a second ripple limit range in the stimulus range between 2 GHz and 3 GHz, assigning a ripple limit of +5 dB.

```
CALC:RIPP:DISP ON
```

Show the ripple limits in the active diagram.

Manual operation: See ["Add / Insert / Delete / Delete All / Align All"](#) on page 491

CALCulate<Chn>:RIPple:DELeTe:ALL

Deletes all ripple limit ranges.

Suffix:

<Chn> Channel number used to identify the active trace

Example: `*RST; CALC:RIPP:DATA 1,1500000000, 2000000000, 3, 1, 2000000000, 3000000000, 5`
 Define and enable a ripple limit range in the stimulus range between 1.5 GHz and 2 GHz, assigning a ripple limit of +3 dB. Define and enable a second ripple limit range in the stimulus range between 2 GHz and 3 GHz, assigning a ripple limit of +5 dB.
`CALC:RIPP:DEL:ALL`
 Delete both created ripple limit ranges.

Usage: Event

Manual operation: See ["Add / Insert / Delete / Delete All / Align All"](#) on page 491

CALCulate:RIPple:DISPlay:RESult:ALL[:STATe] <Enable>

Configures the display of ripple check info fields for the active recall set.

Parameters:

<Enable> ON - Info fields are displayed for all traces, for which a limit check is enabled.
 OFF - Only the info field for the active trace is displayed (if the ripple check is enabled for this trace).
`*RST: OFF`

Manual operation: See ["Show Results All Traces"](#) on page 489

CALCulate<Chn>:RIPple:DISPlay[:STATe] <Boolean>

Displays or hides all ripple limit lines (including all ranges) associated to the active trace.

Suffix:

<Chn> Channel number used to identify the active trace

Parameters:

<Boolean> ON | OFF - ripple limit line on or off.
`*RST: OFF`

Example: `*RST; CALC:RIPP:DATA 1,1500000000, 2000000000, 3`
 Define and enable a ripple limit range in the stimulus range between 1.5 GHz and 2 GHz, assigning a ripple limit of +3 dB.
`CALC:RIPP:DISP ON`
 Show the ripple limit range in the active diagram.

Manual operation: See ["Show Ripple Limits"](#) on page 488

CALCulate<Chn>:RIPple:FAIL?

Returns a 0 or 1 to indicate whether or not the global ripple limit check has failed.

Tip: Use `CALCulate<Chn>:RIPple:SEGment<Seg>:RESult?` to query the result for a single ripple limit range.

Suffix:

<Chn> Channel number used to identify the active trace

Example:

```
*RST; CALC:RIPP:DATA 1, 1500000000, 2000000000,
3
```

Define and enable a ripple limit range in the stimulus range between 1.5 GHz and 2 GHz, assigning a ripple limit of +3 dB.

```
CALC:RIPP:STAT ON; FAIL?
```

Switch the limit check on and query the result.

```
CALC:RIPP:STAT:AREA LEFT, TOP
```

For a subsequent check at the GUI or a hardcopy, move the info field to the top left position.

Usage: Query only

Manual operation: See "[Ripple Check](#)" on page 488

CALCulate:RIPple:FAIL:ALL? [<RecallSet>]

Returns a 0 or 1 to indicate whether or not the global ripple limit check has failed for at least one channel in the referenced recall set.

Query parameters:

<RecallSet> Recall set name; if omitted the active recall set is used

Usage: Query only

Manual operation: See "[Ripple Check](#)" on page 488

CALCulate<Chn>:RIPple:RDOMain:FORMat <UnitRef>

Deletes the existing ripple limit ranges and (re-)defines the physical unit of the ripple limit. The units of the stimulus values are defined via `CALCulate<Chn>:RIPple:CONTrol:DOMain`.

Suffix:

<Chn> Channel number used to identify the active trace

Setting parameters:

<UnitRef> COMPlEx | MAGNitude | PHASe | REAL | IMAGinary | SWR | GDELay | L | C

Keyword for the physical unit of the response values; dimensionless numerals, relative power, phase, time, inductance, capacitance units.

*RST: n/a

Default unit: 1 (U, for COMPlEx, REAL, IMAGinary, and SWR); dB (for MAGNitude), deg (for PHASe), s (for GDELay), H (Henry, for L), F (Farad, for C).

Example: `*RST; CALC:RIPP:DATA 1, 1500000000, 2000000000, 3`
 Define and enable a ripple limit range in the stimulus range between 1.5 GHz and 2 GHz, assigning a ripple limit of +3 dB.
`CALC:RIPP:RDOM:FORM COMP`
 Delete the ripple limit range, select complex units for the ripple limit.

Usage: Setting only

CALCulate<Chn>:RIPple:SEGment:COUNT?

Queries the number of ripple limit ranges. The response is an integer number.

Suffix:
 <Chn> Channel number used to identify the active trace

Example: `*RST; CALC:RIPP:DATA 1, 1500000000, 2000000000, 3, 1, 2000000000, 3000000000, 5`
 Define and enable a ripple limit range in the stimulus range between 1.5 GHz and 2 GHz, assigning a ripple limit of +3 dB.
 Define and enable a second ripple limit range in the stimulus range between 2 GHz and 3 GHz, assigning a ripple limit of +5 dB.
`CALC:RIPP:SEGM:COUNT?`
 Query the number of ranges. The response is 2.

Usage: Query only

Manual operation: See "[Range List](#)" on page 490

CALCulate<Chn>:RIPple:SEGment<Seg>:LIMit <Limit>

Defines the ripple limit for ripple limit range no. <Seg>. A range must be created first to enable this command (e.g. `CALCulate<Chn>:RIPple:DATA`). See [Chapter 4.4.1.2, "Rules for ripple test definition"](#), on page 171.

Tip: To define several ripple limit ranges with a single command, use `CALCulate<Chn>:RIPple:DATA`.

Suffix:
 <Chn> Channel number used to identify the active trace
 <Seg> Number of the ripple limit range.

Parameters:
 <Limit> Ripple limit in the range. The unit is adjusted to the format of the active trace (`CALCulate<Chn>:FORMat`).

Range: Virtually no restriction for ripple limit ranges.
 *RST: n/a (no ripple limit line defined after a reset)
 Default unit: See above.

Example: See `CALCulate<Chn>:RIPple:SEGment<Seg>:STIMulus:START`

Manual operation: See "Range List" on page 490

`CALCulate<Chn>:RIPple:SEGment<Seg>:RESult?`

Returns the result of the ripple limit check in the previously defined limit range no. <Seg>. The response consists of two parameters:

- <Boolean> – 0 for "passed", 1 for "failed".
- <Limit> – measured ripple in the limit range. A result is returned even if the limit check in the range no. <Seg> is disabled; see example below.

A reset deletes all ripple limit ranges. Use `CALCulate<Ch>:RIPple:FAIL?` to query the result for global ripple limit check.

Note: In remote control, the ripple limit check result is calculated once at the end of each sweep. If the ripple limits are changed, a new sweep is required to obtain updated ripple limit check results. In single sweep mode (`INITiate<Ch>:CONTinuous OFF`), the new sweep must be started explicitly. This behavior is different from manual control where a changed ripple limit line can directly affect the pass/fail result of the displayed trace.

Suffix:

<Chn> Channel number used to identify the active trace

<Seg> Number of the ripple limit range.

Example: `*RST; CALC:RIPP:DATA 1, 1500000000, 2000000000, 3`

Define and enable a ripple limit range in the stimulus range between 1.5 GHz and 2 GHz, assigning a ripple limit of +3 dB.

`CALC:RIPP:STAT ON; SEGM:RES?`

Enable the limit check and query the result for the created range. Possible response: `0,0.3529814004.`

`CALC:RIPP:DATA 0, 2500000000, 3000000000, 3`

Define a second ripple limit range with disabled limit check (no limit check results are displayed in the diagram area).

`CALC:RIPP:SEGM2:RES?`

Query the result for the second range. Possible response:

`0,1.149071925.`

Usage: Query only

Manual operation: See "Ripple Check" on page 488

`CALCulate<Chn>:RIPple:SEGment<Seg>[:STATe] <Boolean>`

Enables or disables the limit check in the ripple limit range no. <Seg>.

Suffix:

<Chn> Channel number used to identify the active trace

<Seg> Number of the ripple limit range.

Parameters:

<Boolean> ON | OFF - Limit check on or off. A result is available even if the limit check is disabled; see example for `CALCulate<Chn>:RIPple:SEGment<Seg>:RESult?`.

*RST: n/a (no ripple limit line defined after a reset)

Example: See `CALCulate<Chn>:RIPple:SEGment<Seg>:STIMulus:START`

Manual operation: See "Range List" on page 490

CALCulate<Chn>:RIPple:SEGment<Seg>:STIMulus:START <FreqPowTime>
CALCulate<Chn>:RIPple:SEGment<Seg>:STIMulus:STOP <StimValue>

These commands change the start or stop stimulus values (i.e. the smallest or largest stimulus values) of a ripple limit range. A range must be created first to enable these commands (e.g. `CALCulate<Chn>:RIPple:DATA`). See [Chapter 4.4.1.2, "Rules for ripple test definition"](#), on page 171.

Tip: To define several ripple limit ranges with a single command, use `CALCulate<Chn>:RIPple:DATA`.

Suffix:

<Chn> Channel number used to identify the active trace

<Seg> Number of the ripple limit range.

Parameters:

<StimValue> Stimulus values (unitless) confining the ripple limit range. The unit is adjusted to the sweep type of the active channel (`[SENSe<Ch>:]SWEep:TYPE`).

Range: Virtually no restriction for ripple limit ranges.

*RST: n/a (no ripple limit line defined after a reset)

Default unit: NN

Example: `*RST; CALC:RIPP:DATA 1,1500000000, 2000000000,3`
 Define and enable a ripple limit range in the stimulus range between 1.5 GHz and 2 GHz, assigning a ripple limit of +3 dB.
`CALC:RIPP:SEGM:STIM:STAR 1GHZ; STOP 2.5 GHZ; :`
`CALC:RIPP:SEGM:LIM 5`
 Change the range to a stimulus range between 1 GHz and 2.5 GHz and a limit of 5 dB.
`CALC:RIPP:SEGM:STAT OFF`
 Disable the limit check in the modified stimulus range.

Manual operation: See "Range List" on page 490

CALCulate<Chn>:RIPple:SOUNd[:STATe] <Boolean>

Switches the acoustic signal (fail beep) on or off. The fail beep is generated each time the analyzer detects an exceeded ripple limit.

Suffix:
 <Chn> Channel number used to identify the active trace

Parameters:
 <Boolean> ON | OFF - fail beep on or off.
 *RST: OFF

Example: CALC:RIPP:STAT ON; SOUN ON
 Switch the limit check on and activate the fail beep.

Manual operation: See "Ripple Fail Beep" on page 489

CALCulate<Chn>:RIPple:STATe <Boolean>

Switches the ripple limit check for the active trace on or off.

Tip: Use CALCulate<Chn>:RIPple:SEGment<Seg>[:STATe] to switch the limit check for a single ripple limit range on or off.

Suffix:
 <Chn> Channel number used to identify the active trace

Parameters:
 <Boolean> ON | OFF – ripple limit check on or off.
 *RST: OFF

Example: See CALCulate<Chn>:RIPple:FAIL?

Manual operation: See "Ripple Check" on page 488

CALCulate<Chn>:RIPple:STATe:AREA <HorizontalPos>, <VerticalPos>

Moves the ripple test info field for the active trace <Chn> to one of nine predefined positions in the active diagram.

Suffix:
 <Chn> Channel number used to identify the active trace

Parameters:
 <HorizontalPos> LEFT | MID | RIGHT
 Horizontal position
 <VerticalPos> TOP | MID | BOTTom
 Vertical position

Example: See CALCulate<Chn>:RIPple:FAIL?

Manual operation: See "Ripple Check" on page 488

7.3.1.13 CALCulate:STATistics...

The CALCulate:STATistics... commands evaluate and display statistical and phase information of the trace.

CALCulate<Chn>:STATistics:DOMain:USER.....	1120
CALCulate<Chn>:STATistics:DOMain:USER:SHOW.....	1121
CALCulate<Chn>:STATistics:DOMain:USER:START.....	1121
CALCulate<Chn>:STATistics:DOMain:USER:STOP.....	1121
CALCulate<Chn>:STATistics:EPDelay[:STATe].....	1121
CALCulate<Chn>:STATistics:MMPTpeak[:STATe].....	1121
CALCulate<Chn>:STATistics:MSTDdev[:STATe].....	1121
CALCulate<Chn>:STATistics:FORMat.....	1122
CALCulate<Chn>:STATistics:NLINear:COMP:LEVel.....	1122
CALCulate<Chn>:STATistics:NLINear:COMP:PHase.....	1122
CALCulate<Chn>:STATistics:NLINear:COMP:RDOMain:USER.....	1123
CALCulate<Chn>:STATistics:NLINear:COMP:RDOMain:USER:SHOW.....	1123
CALCulate<Chn>:STATistics:NLINear:COMP:RDOMain:USER:START.....	1124
CALCulate<Chn>:STATistics:NLINear:COMP:RDOMain:USER:STOP.....	1124
CALCulate<Chn>:STATistics:NLINear:COMP:REFerence.....	1124
CALCulate<Chn>:STATistics:NLINear:COMP:RESult?.....	1124
CALCulate<Chn>:STATistics:NLINear:COMP:RLEVel.....	1125
CALCulate<Chn>:STATistics:NLINear:COMP:RMARker.....	1125
CALCulate<Chn>:STATistics:NLINear:COMP:RPHase.....	1126
CALCulate<Chn>:STATistics:NLINear:COMP[:STATe].....	1126
CALCulate<Chn>:STATistics:PRATio[:STATe].....	1126
CALCulate<Chn>:STATistics:PRATio:RESult?.....	1127
CALCulate<Chn>:STATistics:RDOMain:USER.....	1127
CALCulate<Chn>:STATistics:RDOMain:USER:SHOW.....	1128
CALCulate<Chn>:STATistics:RDOMain:USER:START.....	1128
CALCulate<Chn>:STATistics:RDOMain:USER:STOP.....	1128
CALCulate<Chn>:STATistics:RESult?.....	1128
CALCulate<Chn>:STATistics:RMS[:STATe].....	1129
CALCulate<Chn>:STATistics:SFLatness[:STATe].....	1129
CALCulate<Chn>:STATistics[:STATe].....	1129
CALCulate<Chn>:STATistics[:STATe]:AREA.....	1130

CALCulate<Chn>:STATistics:DOMain:USER <EvalRange>

Selects one out of 10 evaluation ranges to be configured with the `CALCulate<Chn>:STATistics:DOMain:USER:SHOW`, `CALCulate<Chn>:STATistics:DOMain:USER:START`, and `CALCulate<Chn>:STATistics:DOMain:USER:STOP` commands.

Suffix:

<Chn> Channel number used to identify the active trace

Parameters:

<EvalRange>

Number of the evaluation range.

Range: 1 to 10. In addition, 0 denotes the (non-configurable) "Full Span" evaluation range.

*RST: 0

Example: *RST; :CALC:STAT:DOM:USER?
 Query the default evaluation range. The response is zero, i.e. the evaluation range is equal to the complete sweep range
 CALC:STAT:DOM:USER 1
 CALC:STAT:DOM:USER:START 1GHZ; STOP 2GHZ; SHOW
 ON
 Select evaluation range no. 1 and define the evaluation range between 1 GHz and 2 GHz. Display the range limit lines.

Manual operation: See ["Evaluation Range"](#) on page 462

CALCulate<Chn>:STATistics:DOMain:USER:SHOW <Boolean>

Displays or hides range limit lines for the evaluation range selected via [CALCulate<Chn>:STATistics:DOMain:USER](#).

Suffix:
 <Chn> Channel number used to identify the active trace

Parameters:
 <Boolean> ON | OFF - range limit lines on or off.
 *RST: OFF

Example: See [CALCulate<Chn>:STATistics:DOMain:USER](#)

Manual operation: See ["Range Limit Lines On"](#) on page 462

CALCulate<Chn>:STATistics:DOMain:USER:START <Start> **CALCulate<Chn>:STATistics:DOMain:USER:STOP <Stop>**

These commands define the start and stop values of the evaluation range selected via [CALCulate<Chn>:STATistics:DOMain:USER](#).

Suffix:
 <Chn> Channel number used to identify the active trace

Parameters:
 <Stop> Start or stop value of the evaluation range.
 Default unit: NN

Example: See [CALCulate<Chn>:STATistics:DOMain:USER](#)

Manual operation: See ["Evaluation Range"](#) on page 462

CALCulate<Chn>:STATistics:EPDelay[:STATe] <Boolean> **CALCulate<Chn>:STATistics:MMPTpeak[:STATe] <Boolean>** **CALCulate<Chn>:STATistics:MSTDdev[:STATe] <Boolean>**

These commands display or hide the "Phase/EI Length" results, the "Min/Max/Peak-Peak" results, and the "Mean/Std Dev" results in the diagram area of trace no. <Chn>.

Suffix:
 <Chn> Channel number used to identify the active trace

Parameters:

<Boolean> ON | OFF - statistical info field on or off.
 *RST: OFF

Example: See [CALCulate<Chn>:STATistics\[:STATe\]](#)

Manual operation: See "[Min/Max/Peak-Peak, Mean/Std Dev/RMS](#)" on page 456

CALCulate<Chn>:STATistics:FORMat <Format>

For complex-valued traces (Smith, Polar) this determines how the MEAN, STDDev, MAX, MIN, RMS and PTPeak statistics are calculated, see [CALCulate<Chn>:STATistics:RESult?](#).

Suffix:

<Chn> Channel number used to identify the active trace

Parameters:

<Format> ZVAB | IMPedance | ADMittance

ZVAB

The results are based on unformatted wave quantities (voltages)

IMPedance

The results are based on resistance values

ADMittance

The results are based on conductance vaules

Manual operation: See "[Format](#)" on page 457

CALCulate<Chn>:STATistics:NLINear:COMP:LEVel <dBValue>

Defines the compression value x for the compression point measurement for dB formatted traces.

Use [CALCulate<Chn>:STATistics:NLINear:COMP:RESult?](#) to retrieve the compression results.

Suffix:

<Chn> Channel number used to identify the active trace

Parameters:

dBValue Compression value

Example: See [CALCulate<Chn>:STATistics:NLINear:COMP:RESult?](#)

Manual operation: See "[Compr. Point / Compr. Val.](#)" on page 459

CALCulate<Chn>:STATistics:NLINear:COMP:PHASe <PhaseValue>

Defines the compression value x for the compression point measurement for phase formatted traces.

Use `CALCulate<Chn>:STATistics:NLINear:COMP:RESult?` to retrieve the compression results.

Suffix:

<Chn> Channel number used to identify the active trace

Parameters:

<PhaseValue> Compression value
Default unit: deg

Manual operation: See "[Compr. Point / Compr. Val.](#)" on page 459

CALCulate<Chn>:STATistics:NLINear:COMP:RDOMain:USER <RefRange>

Selects one of the 10 channel-specific user defined ranges as the reference range for compression point calculation.

Only applies if `CALCulate<Chn>:STATistics:NLINear:COMP:REFerence` is set to `RANGE`.

The selected range can then be configured with the `CALCulate<Chn>:STATistics:NLINear:COMP:RDOMain:USER:START`, `CALCulate<Chn>:STATistics:NLINear:COMP:RDOMain:USER:STOP`, and `CALCulate<Chn>:STATistics:NLINear:COMP:RDOMain:USER:SHOW` commands.

Suffix:

<Chn> Channel number used to identify the active trace

Parameters:

<RefRange> Range number
Range: 1 to 10. In addition, 0 denotes the (non-configurable) "Full Span" evaluation range.
*RST: 0

Manual operation: See "[Ref. Range](#)" on page 460

CALCulate<Chn>:STATistics:NLINear:COMP:RDOMain:USER:SHOW <Boolean>

Displays or hides range limit lines for the reference range selected via `CALCulate<Chn>:STATistics:NLINear:COMP:RDOMain:USER`.

Suffix:

<Chn> Channel number used to identify the active trace

Parameters:

<Boolean> ON | OFF – reference range limit lines on or off.
*RST: OFF

Manual operation: See "[Ref. Range](#)" on page 460

CALCulate<Chn>:STATistics:NLINear:COMP:RDOMain:USER:START <Start>
CALCulate<Chn>:STATistics:NLINear:COMP:RDOMain:USER:STOP <Value>

Defines the start/stop value of the range selected via [CALCulate<Chn>:STATistics:NLINear:COMP:RDOMain:USER](#).

Suffix:

<Chn> Channel number used to identify the active trace

Parameters:

<Value> Start/stop value of the related range

Manual operation: See "[Ref. Range](#)" on page 460

CALCulate<Chn>:STATistics:NLINear:COMP:REFerence <ReferenceValue>

Defines how the reference value ("small signal value") for the compression point calculation is calculated.

Suffix:

<Chn> Channel number used to identify the active trace

Parameters:

<ReferenceValue> FPOint | DVALue | MARKer | RANGe

FPOint – uses the value at the first point of the selected evaluation range as the reference value (see [CALCulate<Chn>:STATistics:DOMain:USER](#))

DVALue – allows to specify the reference value manually (see [CALCulate<Chn>:STATistics:NLINear:COMP:RLEVel](#) and [CALCulate<Chn>:STATistics:NLINear:COMP:RPHase](#))

MARKer: uses the value at a selectable marker as the reference value (see [CALCulate<Chn>:STATistics:NLINear:COMP:RMARker](#))

RANGe – uses the average value in a configurable reference range as the reference value (see [CALCulate<Chn>:STATistics:NLINear:COMP:RDOMain:USER](#))

*RST: FPOint

Manual operation: See "[Reference Value](#)" on page 460

CALCulate<Chn>:STATistics:NLINear:COMP:RESult?

Returns the compression point of an S-parameter or ratio measured in a power sweep.

For dB formatted traces, the compression value x is set via [CALCulate<Chn>:STATistics:NLINear:COMP:LEVel](#), for phase formatted traces it is set via [CALCulate<Chn>:STATistics:NLINear:COMP:PHASE](#).

The response contains two numeric values:

- <Cmp In> – stimulus level at the compression point in dBm.

- <Cmp Out>
 - For dB formatted traces, the sum of <Cmp In> plus the magnitude of the measured response value at the compression point in dBm.
 - For phase formatted traces, the response value at the compression point

Suffix:

<Chn> Channel number used to identify the active trace

Example:

```
*RST; SWE:TYPE POW
```

Select a power sweep with default CW frequency and sweep range.

```
CALC:STAT:NLIN:COMP:LEV 2
```

Define a compression value of 2 dB.

```
CALC:STAT:NLIN:COMP:RES?
```

Query the compression point results <Cmp In>, <Cmp Out>. An execution error message (error no. -200) is returned if no compression point is found.

```
CALC:STAT:NLIN:COMP ON
```

Display the compression point result in the diagram area.

Usage:

Query only

Manual operation: See "[Compr. Point / Compr. Val.](#)" on page 459

CALCulate<Chn>:STATistics:NLINear:COMP:RLEVEL <Level>

Manually defines the reference level for compression point calculation on dB formatted traces.

This only applies if [CALCulate<Chn>:STATistics:NLINear:COMP:REFERENCE](#) is set to `DVALUE`. For phase formatted traces, the reference level can be set using [CALCulate<Chn>:STATistics:NLINear:COMP:RPHASE](#).

Suffix:

<Chn> Channel number used to identify the active trace

Parameters:

<Level> Reference level

```
*RST:      1 dB
```

Default unit: dB

Manual operation: See "[Defined Value](#)" on page 461

CALCulate<Chn>:STATistics:NLINear:COMP:RMARKer <Marker>

Allows you to select the marker whose value shall be used as the reference ("small signal value") for the compression point calculation.

Only applies if [CALCulate<Chn>:STATistics:NLINear:COMP:REFERENCE](#) is set to `MARKer`.

Suffix:

<Chn> Channel number used to identify the active trace

Parameters:

<Marker> Marker number
 If marker <Marker> is OFF for the related trace, the set command is silently ignored.

Manual operation: See ["Selected Marker"](#) on page 460

CALCulate<Chn>:STATistics:NLINear:COMP:RPHase <Phase>

Manually defines the reference phase for compression point calculation on phase formatted traces.

Only applies if [CALCulate<Chn>:STATistics:NLINear:COMP:REference](#) is set to DVALue.

For dB formatted traces, the reference level can be set using [CALCulate<Chn>:STATistics:NLINear:COMP:RLEVEL](#).

Suffix:

<Chn> Channel number used to identify the active trace

Parameters:

<Phase> Reference phase
 *RST: 1°
 Default unit: deg

Manual operation: See ["Defined Value"](#) on page 461

CALCulate<Chn>:STATistics:NLINear:COMP[:STATe] <Boolean>

Displays or hides the compression point result in the diagram area channel <Chn>'s active trace..

Suffix:

<Chn> Channel number used to identify the active trace

Parameters:

<Boolean> ON | OFF - statistical info field on or off.
 *RST: OFF

Example: See [CALCulate<Chn>:STATistics:NLINear:COMP:RESult?](#)

Manual operation: See ["Compr. Point / Compr. Val."](#) on page 459

CALCulate<Chn>:STATistics:PRATio[:STATe] <Boolean>

Displays or hides the power ratio statistics in the diagram area of spectrum analysis channel <Chn>'s active trace.

Use [CALCulate<Chn>:STATistics:PRATio:RESult?](#) to query the results.

Suffix:	
<Chn>	Channel number used to identify the active trace
Parameters:	
<Boolean>	ON OFF – info field on or off.
	*RST: OFF
Options:	R&S ZNA-K1
Manual operation:	See " Power Ratio " on page 458

CALCulate<Chn>:STATistics:PRATio:RESult?

Returns the power ratio statistics (three comma-separated numeric values) of a spectrum analysis trace:

- Power density in reference range
(see [CALCulate<Chn>:STATistics:RDOMain:USER](#))
- Power density in evaluation range
(see [CALCulate<Chn>:STATistics:DOMain:USER](#))
- Power ratio (trace value vs. reference range)

Suffix:	
<Chn>	Channel number used to identify the active trace
Usage:	Query only
Options:	R&S ZNA-K1
Manual operation:	See " Power Ratio " on page 458

CALCulate<Chn>:STATistics:RDOMain:USER <EvalRange>

Selects one of the 10 channel-specific user defined ranges as the reference range for spectrum power ratio calculations.

The selected range can then be configured with the [CALCulate<Chn>:STATistics:RDOMain:USER:START](#), [CALCulate<Chn>:STATistics:RDOMain:USER:STOP](#), and [CALCulate<Chn>:STATistics:RDOMain:USER:SHOW](#) commands.

Suffix:	
<Chn>	Channel number used to identify the active trace
Parameters:	
<EvalRange>	
Options:	R&S ZNA-K1
Manual operation:	See " Ref. Range " on page 460

CALCulate<Chn>:STATistics:RDOMain:USER:SHOW <Boolean>

Displays or hides range limit lines for the reference range selected via [CALCulate<Chn>:STATistics:RDOMain:USER](#).

Suffix:

<Chn> Channel number used to identify the active trace

Parameters:

<Boolean> ON | OFF – reference range limit lines on or off.
*RST: OFF

Options: R&S ZNA-K1

Manual operation: See "[Ref. Range](#)" on page 460

CALCulate<Chn>:STATistics:RDOMain:USER:START <Start>**CALCulate<Chn>:STATistics:RDOMain:USER:STOP <Value>**

Defines the start/stop value of the range selected via [CALCulate<Chn>:STATistics:RDOMain:USER](#).

Suffix:

<Chn> Channel number used to identify the active trace

Parameters:

<Stop> Start/stop value of the related range
Default unit: Hz

Options: R&S ZNA-K1

Manual operation: See "[Ref. Range](#)" on page 460

CALCulate<Chn>:STATistics:RESult? <Result>

Returns a single statistical parameter of the trace no. <Chn> or all parameters. It is not necessary to display the info field ([CALCulate<Chn>:STATistics\[:STATe\] ON](#)) before using this command.

Suffix:

<Chn> Channel number used to identify the active trace

Query parameters:

<Result> MEAN | STDDev | MAX | MIN | RMS | PTPeak | PEAK2p | ELENgth | PDELay | GAIN | SLOPe | FLATness | ALL
 MEAN - return arithmetic mean value of all response values of the trace in the entire sweep range (or in the evaluation range defined in manual control).
 STDDev - return standard deviation of all response values.
 MAX - return the maximum of all response values.
 MIN - return the minimum of all response values.
 RMS - return the root mean square of all response values.
 PTPeak - return the peak-to-peak value (MAX - MIN).

ELENgth - return the electrical length.
 PDELaY - return the phase delay.
 GAIN - return the gain, i.e. the larger of two marker values.
 SLOPe - return the slope (difference) between two marker values.
 FLATness - return the flatness of the trace between two marker positions.
 ALL - return all statistical values, observing the order used above.
 The data is returned as a comma-separated list of real numbers. The unit is the default unit of the measured parameter (see [CALCulate<Ch>:PARAmeter:SDEFine](#)) but may also depend on the trace format (see [CALCulate<Chn>:FORMat](#)). For complex traces the statistical results MEAN, STDDev, MAX, MIN, RMS and PTPeak are calculated in the selected format (see [CALCulate<Chn>:STATistics:FORMat](#)).

Example:

```
*RST; :CALC:STAT:RES? MAX
```

Calculate and return the maximum of the default trace showing an S-parameter on a dB Mag scale.

```
:CALC:FORM POL; STAT:RES? MAX
```

Display the trace in a polar diagram and re-calculate the maximum. The result corresponds to the previous result but is converted to a unitless linear value.

Usage:

Query only

Manual operation: See ["Min/Max/Peak-Peak, Mean/Std Dev/RMS"](#) on page 456

CALCulate<Chn>:STATistics:RMS[:STATe] <Boolean>

CALCulate<Chn>:STATistics:SFlatness[:STATe] <Boolean>

These commands display or hide the "RMS" and the "Flatness/Gain/Slope" results in the diagram area of trace no. <Chn>.

Suffix:

<Chn> Channel number used to identify the active trace

Parameters:

<Boolean> ON | OFF - statistical info field on or off.

```
*RST: OFF
```

Example:

See [CALCulate<Chn>:STATistics\[:STATe\]](#)

Manual operation: See ["Flatness/Gain/Slope"](#) on page 458

CALCulate<Chn>:STATistics[:STATe] <Boolean>

Displays or hides all statistical results in the diagram area of trace no. <Chn> except the compression point results.

Tip: You can display or hide the "Min/Max/Peak-Peak", "Mean/Std Dev/RMS", "Phase/EI Length" and "Flatness/Gain/Slope" results separately; see example below.

Suffix:	
<Chn>	Channel number used to identify the active trace
Parameters:	
<Boolean>	ON OFF - Statistical info field on or off.
	*RST: OFF
Example:	<pre>*RST; :CALC:STAT:MMPT ON</pre> <p>Reset the instrument, hiding all statistical results. Display the "Min/Max/Peak-Peak" results.</p> <pre>CALC:STAT:MSTD ON</pre> <p>Display the "Mean/Std Dev" results in addition.</p> <pre>CALC:STAT:RMS ON</pre> <p>Display the "RMS" results in addition.</p> <pre>CALC:STAT:EPD ON</pre> <p>Display the "Phase/EI Length" results in addition.</p> <pre>CALC:STAT:SFL ON</pre> <p>Display the "Flatness/Gain/Slope" results in addition.</p> <pre>CALC:STAT:STAT:AREA LEFT, TOP</pre> <p>For a subsequent check at the GUI or a hardcopy, move the info field to the top left position.</p> <p>...</p> <pre>CALC:STAT OFF</pre> <p>Hide all results.</p>
Manual operation:	See "Min/Max/Peak-Peak, Mean/Std Dev/RMS" on page 456

CALCulate<Chn>:STATistics[:STATe]:AREA <HorizontalPos>, <VerticalPos>

Moves the statistics info field for the active trace <Chn> to one of nine predefined positions in the active diagram.

Suffix:	
<Chn>	Channel number used to identify the active trace
Parameters:	
<HorizontalPos>	LEFT MID RIGHT Horizontal position
<VerticalPos>	TOP MID BOTTom Vertical position
Example:	See CALCulate<Chn>:STATistics[:STATe]
Manual operation:	See "Min/Max/Peak-Peak, Mean/Std Dev/RMS" on page 456

7.3.1.14 CALCulate:TRANSform...

The `CALCulate:TRANSform...` commands convert measured data from one representation to another.

- [CALCulate:TRANSform:DTFault...](#)..... 1131
- [CALCulate:TRANSform:TIME](#)..... 1136
- [CALCulate:TRANSform:VNETworks](#)..... 1144
- [CALCulate:TRANSform... \(other\)](#)..... 1193

CALCulate:TRANSform:DTFault...

The `CALCulate:TRANSform:DTFault...` commands set up and control a distance to fault measurement (with option R&S ZNA-K2).

CALCulate<Chn>:TRANSform:DTFault:CENTer	1131
CALCulate<Chn>:TRANSform:DTFault:SPAN	1131
CALCulate<Chn>:TRANSform:DTFault:DEFine	1131
CALCulate<Chn>:TRANSform:DTFault:DELeTe	1132
CALCulate<Chn>:TRANSform:DTFault:PEAK:COUNT?	1133
CALCulate<Chn>:TRANSform:DTFault:PEAK:DATA<FaultNo>	1133
CALCulate<Chn>:TRANSform:DTFault:PEAK:STATe	1134
CALCulate<Chn>:TRANSform:DTFault:PEAK:THReshold	1134
CALCulate<Chn>:TRANSform:DTFault:POINts	1134
CALCulate<Chn>:TRANSform:DTFault:SELeCt	1135
CALCulate<Chn>:TRANSform:DTFault:STARt	1135
CALCulate<Chn>:TRANSform:DTFault:STOP	1135
CALCulate<Chn>:TRANSform:DTFault:STATe	1136

CALCulate<Chn>:TRANSform:DTFault:CENTer <Center>

**CALCulate<Chn>:TRANSform:DTFault:SPAN **

Defines the distance window of the Distance to Fault measurement using its center and span.

See also [CALCulate<Chn>:TRANSform:DTFault:STARt](#) and [CALCulate<Chn>:TRANSform:DTFault:STOP](#).

Suffix:

<Chn> Channel number used to identify the active trace.

Parameters:

<Center>/ Center/span value.
Default unit: m

Example:

```
:CALCulate1:TRANSform:DTFault:CENTer 2; SPAN 2
```

Defines the DtF distance window of the active trace of channel 1 via its center (2m) and span (2m).

Options:

R&S ZNA-K2

Manual operation: See "[Start Distance / Stop Distance](#)" on page 832

CALCulate<Chn>:TRANSform:DTFault:DEFine <CblName>, <CblPermittivity>, <CblAtt1>, <CblFreq1>{, <CblAtt2>, <CblFreq2>}...

Defines a new user-defined cable type for Distance to Fault (DtF) measurements.

The cable's frequency-dependent attenuation is defined via attenuation/frequency pairs <Cb1Att1>, <Cb1Freq1>, <Cb1Att2>, <Cb1Freq2>, At least one pair has to be specified.

Suffix:

<Chn> Channel number
This suffix is ignored: cable types are defined for all channels.

Setting parameters:

<Cb1Name> Name of the cable type.
Must be unique among all DtF cable types, with case insensitive match.

<Cb1Permittivity> Relative permittivity ϵ_r of the cable type.

<Cb1Att[i]> Attenuation value i in the frequency-dependent attenuation table of the cable type.
Default unit: dB/m

<Cb1Freq[i]> Frequency i in the frequency-dependent attenuation table of the cable type.
Default unit: Hz

Example:

```
CALCulate:TRANSform:DTFault:DEFine 'My cable
type', 1.1, 0.01, 1GHz, 0.015, 2GHz, 0.012,
3GHz
```

Defines a new cable type "My cable type" with relative permittivity $\epsilon_r=1.1$ and the frequency-dependent attenuation given in the table below.

Usage: Setting only

Options: R&S ZNA-K2

Manual operation: See ["Add / Delete"](#) on page 836

Table 7-5: Example: frequency-dependent attenuation table

[i]	Frequency	Attenuation
1	1 GHz	0.01 dB/m
2	2 GHz	0.015 dB/m
3	3 GHz	0.012 dB/m

CALCulate<Chn>:TRANSform:DTFault:DElete <DtfDeleteCable>

Deletes the user-defined cable type with the given name.

Suffix:

<Chn> Channel number
This suffix is ignored: cable types are defined for (and deleted from) all channels.

Setting parameters:

<DtfDeleteCable> Name of a user-defined cable type.

Example: `CALCulate:TRANSform:DTFault:DElete 'My cable type'`
Deletes the user-defined cable type "My cable type".

Usage: Setting only

Options: R&S ZNA-K2

Manual operation: See ["Add / Delete"](#) on page 836

CALCulate<Chn>:TRANSform:DTFault:PEAK:COUNT?

If the active trace of channel <Chn> is a Distance to Fault (DtF) trace and DtF limit checking is enabled, this query returns the number of DtF limit violations of this trace.

Use `CALCulate<Chn>:TRANSform:DTFault:PEAK:STATE` to enable DtF limit checking and `CALCulate<Chn>:TRANSform:DTFault:PEAK:THReshold` to set the fault limit.

Suffix:
<Chn> Channel number used to identify the active trace

Usage: Query only

Options: R&S ZNA-K2

Manual operation: See ["Fault Table"](#) on page 837

CALCulate<Chn>:TRANSform:DTFault:PEAK:DATA<FaultNo>

If the active trace of channel <Chn> is a Distance to Fault (DtF) trace and DtF limit checking is enabled, this query returns the peak data of DtF limit violation <FaultNo>

<FaultNo> must be between 1 and `CALCulate<Chn>:TRANSform:DTFault:PEAK:COUNT?`. The peak data are returned as value pair *distance, response value*. Peaks are numbered according to their distance (fault no. 1 has the smallest distance).

Use `CALCulate<Chn>:TRANSform:DTFault:PEAK:STATE` to enable DtF limit checking and `CALCulate<Chn>:TRANSform:DTFault:PEAK:THReshold` to set the fault limit.

Suffix:
<Chn> Channel number used to identify the active trace
<FaultNo> 1 ... `CALCulate<Chn>:TRANSform:DTFault:PEAK:COUNT?`

Example: Suppose `CALCulate1:TRANSform:DTFault:PEAK:COUNT?` returns 3, then
`CALCulate1:TRANSform:DTFault:PEAK:DATA1; DATA2; DATA3`
returns the coordinates of the DtF limit violation peaks.

Options: R&S ZNA-K2

Manual operation: See ["Fault Table"](#) on page 837

CALCulate<Chn>:TRANSform:DTFault:PEAK:STATE <DtfPeakState>

If the active trace of channel <Chn> is a Distance to Fault (DtF) trace, this command allows to enable/disable DtF limit checking.

Suffix:

<Chn> Channel number used to identify the active trace

Parameters:

<DtfPeakState> OFF|ON (0|1)

Example:

```
*RST; :CALCulate1:TRANSform:DTFault:STATE ON
makes the active trace of channel 1 a DtF trace.
CALCulate1:TRANSform:DTFault:PEAK:STATE ON
enables DtF limit checking.
```

Options:

R&S ZNA-K2

Manual operation: See "[Fault Limit Check](#)" on page 834

CALCulate<Chn>:TRANSform:DTFault:PEAK:THReshold <PeakThreshold>

If the active trace of channel <Chn> is a Distance to Fault (DtF) trace, this command allows to set the fault limit for DtF limit checking.

Use `CALCulate<Chn>:TRANSform:DTFault:PEAK:STATE` to enable DtF limit checking.

Suffix:

<Chn> Channel number used to identify the active trace

Parameters:

<PeakThreshold> Fault limit
 *RST: -20 dB
 Default unit: dB

Example:

```
*RST; :CALCulate1:TRANSform:DTFault:STATE ON
makes the active trace of channel 1 a DtF trace.
CALCulate1:TRANSform:DTFault:PEAK:THReshold -30
sets the DtF limit to -30 dB.
```

Options:

R&S ZNA-K2

Manual operation: See "[Fault Limit](#)" on page 834

CALCulate<Chn>:TRANSform:DTFault:POINTS

If the active trace of channel <Chn> is a Distance to Fault (DtF) trace, this command starts the "Auto Number of Points" calculation (see "[Auto Number of Points](#)" on page 832).

An execution error is raised, if the calculated number of points is higher than the maximum number of sweep points the firmware allows (100001). To avoid this, reduce the frequency span Δf (see [\[SENSe<Ch>:\]SWEep:POINTs](#) on page 1511) and/or the stop frequency d_{stop} (see [CALCulate<Chn>:TRANSform:DTFault:STOP](#)) so that

$$2.6 \cdot d_{\text{stop}} \cdot \Delta f / (v \cdot c_0) \leq 100001 ,$$

where v denotes the velocity factor of the measured cable (see [CALCulate<Chn>:TRANSform:DTFault:SElect](#)).

Suffix:

<Chn> Channel number used to identify the active trace

Example:

```
*RST; :CALCulate1:TRANSform:DTFault:STATE ON
makes the active trace of channel 1 a DtF trace.
SENSe1:SWEep:POINTs?
returns the default number of sweep points (201).
:CALCulate1:TRANSform:DTFault:START 0; STOP 100
widens the DtF distance window to 100m.
CALCulate1:TRANSform:DTFault:POINTs
starts the "Auto Number of Points calculation". Now
SENSe1:SWEep:POINTs?
returns an increased number of sweep points.
```

Usage:

Event

Options:

R&S ZNA-K2

Manual operation: See ["Auto Number of Points"](#) on page 832

CALCulate<Chn>:TRANSform:DTFault:SElect <DtFSelectCable>

Selects one of the available (predefined or user-defined) cable types for Distance to Fault measurements.

Suffix:

<Chn> Channel number used to identify the active trace.

Parameters:

<DtFSelectCable> Name of the cable type.

Example:

```
CALCulate1:TRANSform:DTFault:SElect '5088-HFLR'
Selects cable type "5088-HFLR".
```

Options:

R&S ZNA-K2

Manual operation: See ["Cable Type..."](#) on page 833

CALCulate<Chn>:TRANSform:DTFault:START <Start>**CALCulate<Chn>:TRANSform:DTFault:STOP <Stop>**

Defines the window of the Distance to Fault measurement using its start and stop distance.

See also [CALCulate<Chn>:TRANSform:DTFault:CENTer](#) and [CALCulate<Chn>:TRANSform:DTFault:SPAN](#).

Suffix:

<Chn> Channel number used to identify the active trace

Parameters:

<Start>/<Stop> Start/stop distance.
Default unit: m

Example:

```
:CALCulate1:TRANSform:DTFault:START 1; STOP 3
Defines the DtF distance window of the active trace of channel 1
as [1m, 3m].
```

Options:

R&S ZNA-K2

Manual operation: See "[Start Distance / Stop Distance](#)" on page 832

CALCulate<Chn>:TRANSform:DTFault:STATE <DtfState>

If channel <Chn> is performing an unsegmented frequency sweep, this command allows to transform its active trace into a Distance to Fault (DtF) trace.

Suffix:

<Chn> Channel number used to identify the active trace

Parameters:

<DtfState> OFF|ON – DtF disabled|enabled
*RST: OFF

Example:

```
:CALCulate1:TRANSform:DTFault:STATE ON
turns the DtF representation of the active trace of channel 1 ON.
```

Options:

R&S ZNA-K2

Manual operation: See "[Distance to Fault](#)" on page 831

CALCulate:TRANSform:TIME...

The `CALCulate:TRANSform:TIME...` commands control the transformation into the time domain (see [Chapter 4.7.2, "Time domain analysis"](#), on page 247).

CALCulate<Chn>:TRANSform:TIME:CENTer	1137
CALCulate<Chn>:TRANSform:TIME:DCHebyshev	1137
CALCulate<Chn>:TRANSform:TIME:LPASs	1138
CALCulate<Chn>:TRANSform:TIME:LPASs:DCSPParam	1138
CALCulate<Chn>:TRANSform:TIME:LPASs:DCSPParam:CONTInuous	1139
CALCulate<Chn>:TRANSform:TIME:LPASs:DCSPParam:EXTRapolate	1139
CALCulate<Chn>:TRANSform:TIME:LPFRequency	1140
CALCulate<Chn>:TRANSform:TIME:RESolution:EFACtor	1140
CALCulate<Chn>:TRANSform:TIME:SPAN	1140
CALCulate<Chn>:TRANSform:TIME:START	1141
CALCulate<Chn>:TRANSform:TIME:STATE	1141
CALCulate<Chn>:TRANSform:TIME:STIMulus	1142

CALCulate<Chn>:TRANSform:TIME:STOP.....	1142
CALCulate<Chn>:TRANSform:TIME[:TYPE].....	1142
CALCulate<Chn>:TRANSform:TIME:WINDow.....	1143
CALCulate<Chn>:TRANSform:TIME:XAXis.....	1143

CALCulate<Chn>:TRANSform:TIME:CENTer <CenterTime>

Defines the center time of the diagram in time domain.

Suffix:

<Chn> Channel number used to identify the active trace

Parameters:

<CenterTime> Center time of the diagram in time domain.
 Range: -99.999999999999 s to +99.999999999999 s
 Increment: 0.1 ns
 *RST: 1.5E-009 s
 Default unit: s

Example:

```
*RST; :CALC:TRAN:TIME:STAT ON
Reset the instrument, activating a frequency sweep, and enable
the time domain transformation for the default trace.
CALC:TRAN:TIME:CENT 0; SPAN 5ns
Set the center time to 0 ns and the time span to 5 ns.
```

Manual operation: See "Time Start / Time Stop / Time Center / Time Span" on page 534

Note: If the x-axis is scaled in distance units (CALCulate<Chn>:TRANSform:TIME:XAXis DISTance), then the center value is entered in m; the range and default value changes accordingly.

CALCulate<Chn>:TRANSform:TIME:DCHebyshev <SidebandSupp>

Sets the sideband suppression for the Dolph-Chebyshev window. The command is only available if a Dolph-Chebyshev window is active (CALCulate<Chn>:TRANSform:TIME:WINDow DCHebyshev).

Suffix:

<Chn> Channel number used to identify the active trace

Parameters:

<SidebandSupp> Sideband suppression
 Range: 10 dB to 120 dB
 Increment: 10 dB
 *RST: 32 dB
 Default unit: dB

Example:

```
*RST; :CALC:TRAN:TIME:WIND DCH
Reset the instrument and select a Dolph-Chebyshev window for
filtering the data in the frequency domain.
CALC:TRAN:TIME:DCH 25
Set the sideband suppression to 25 dB.
```

Manual operation: See ["Side Lobe Level"](#) on page 449

CALCulate<Chn>:TRANSform:TIME:LPASs <Algorithm>

Calculates the harmonic grid for low pass time domain transforms according to one of the three alternative algorithms.

Suffix:

<Chn> Channel number used to identify the active trace

Parameters:

<Algorithm> KFSTop | KDFrequency | KSDFrequency
 KFSTop - keep stop frequency and number of points
 KDFrequency - keep frequency gap and number of points
 KSDFrequency - keep stop frequency and approximate frequency gap

Example: See [CALCulate<Chn>:TRANSform:TIME\[:TYPE\]](#)

Manual operation: See ["Set Harmonic Grid and Keep"](#) on page 451

CALCulate<Chn>:TRANSform:TIME:LPASs:DCSParm <DCValue>

Defines the DC value for low pass transforms. The command is enabled only if the sweep points are on a harmonic grid (to be set explicitly or using [CALCulate<Chn>:TRANSform:TIME:LPASs](#)).

Suffix:

<Chn> Channel number used to identify the active trace

Parameters:

<DCValue> DC value of the measured quantity
 Range: Depending on the measured quantity (-1 to +1 for S-parameters)
 *RST: 0

Example: `*RST; :CALC:TRAN:TIME:STAT ON`
 Reset the instrument, activating a frequency sweep with S_{21} as measured quantity, and enable the time domain transformation for the default trace.
`CALC:TRAN:TIME LPAS; TIME:STIM STEP`
 Select a low pass step transformation.
`CALC:TRAN:TIME:LPAS KFST`
 Calculate a harmonic grid, maintaining the stop frequency and the number of points.
`CALC:TRAN:TIME:LPAS:DCSP 0.2`
 Set the DC value.
`CALC:TRAN:TIME:LPAS:DCSP:EXTR; :CALC:TRAN:TIME:LPAS:DCSP?`
 Extrapolate the measured trace, overwrite the defined DC value, and query the new value.
`CALC:TRAN:TIME:LPAS:DCSP:CONT ON`
 Switch over to continuous extrapolation (e.g. because you noticed a discrepancy between the manually entered DC value and the extrapolation and assume the extrapolation to be more trustworthy).
`CALC:TRAN:TIME:RES:EFAC 3`
 Select a resolution enhancement factor of 3 in order to improve the resolution in time domain.

Manual operation: See ["DC Value"](#) on page 452

CALCulate<Chn>:TRANSform:TIME:LPASs:DCSParam:CONTInuous <Boolean>

Determines whether continuous extrapolation for the DC value is enabled.

Suffix:

<Chn> Channel number used to identify the active trace

Parameters:

<Boolean> ON - continuous extrapolation enabled
 OFF - continuous extrapolation disabled
 *RST: OFF

Example: See [CALCulate<Chn>:TRANSform:TIME:LPASs:DCSParam](#)

Manual operation: See ["DC Value"](#) on page 452

CALCulate<Chn>:TRANSform:TIME:LPASs:DCSParam:EXTRapolate

Extrapolates the measured trace towards $f = 0$ and overwrites the current DC value ([CALCulate<Chn>:TRANSform:TIME:LPASs:DCSParam](#)). The command is relevant for low pass time domain transforms.

Suffix:

<Chn> Channel number used to identify the active trace

Example: See [CALCulate<Chn>:TRANSform:TIME:LPASs:DCSParam](#)

Usage: Event
Manual operation: See ["DC Value"](#) on page 452

CALCulate<Chn>:TRANSform:TIME:LPFRequency

Calculates the harmonic grid for low pass time domain transforms, keeping the stop frequency and the number of points.

Tip: Use `CALCulate<Chn>:TRANSform:TIME:LPASs` if you wish to use one of the other algorithms for calculating the grid.

Suffix:
 <Chn> Channel number used to identify the active trace

Example: See `CALCulate<Chn>:TRANSform:TIME[:TYPE]`

Usage: Event

Manual operation: See ["DC Value"](#) on page 452

CALCulate<Chn>:TRANSform:TIME:RESolution:EFACtor <REfactor>

Defines the resolution enhancement factor for the time domain transform.

Suffix:
 <Chn> Channel number used to identify the active trace

Parameters:
 <REfactor> Resolution enhancement factor.
 Range: 1 to 10.
 Increment: 0.1
 *RST: 1 (no resolution enhancement)

Example: See `CALCulate<Chn>:TRANSform:TIME:LPASs:DCSParam`

Manual operation: See ["Resolution Enh."](#) on page 450

**CALCulate<Chn>:TRANSform:TIME:SPAN **

Defines the time span of the diagram in time domain.

Suffix:
 <Chn> Channel number used to identify the active trace

Parameters:
 Time span of the diagram in time domain.
 Range: 2E-012 s to 200 s.
 Increment: 0.1 ns
 *RST: 5E-009 s
 Default unit: s

Example: See `CALCulate<Chn>:TRANSform:TIME:CENTer`

Manual operation: See "Time Start / Time Stop / Time Center / Time Span" on page 534

Note: If the x-axis is scaled in distance units (`CALCulate<Chn>:TRANSform:TIME:XAXis DISTance`), then the span is entered in m; the range and default value changes accordingly.

`CALCulate<Chn>:TRANSform:TIME:START <StartTime>`

Defines the start time of the diagram in time domain.

Suffix:

<Chn> Channel number used to identify the active trace

Parameters:

<StartTime> Start time of the diagram.
 Range: -100 s to +99.999999999998 s.
 Increment: 0.1 ns
 *RST: -1E-009 s
 Default unit: s

Example:

```
*RST; :CALC:TRAN:TIME:STAT ON
Reset the instrument, activating a frequency sweep, and enable
the time domain transformation for the default trace.
CALC:TRAN:TIME:STAR 0; STOP 10 ns
Set the start time to 0 ns and the stop time to 10 ns.
```

Manual operation: See "Time Start / Time Stop / Time Center / Time Span" on page 534

Note: If the x-axis is scaled in distance units (`CALCulate<Chn>:TRANSform:TIME:XAXis DISTance`), then the start value is entered in m; the range and default value changes accordingly.

`CALCulate<Chn>:TRANSform:TIME:STATe <Boolean>`

Determines whether the time domain transformation for trace no. <Chn> is enabled.

Suffix:

<Chn> Channel number used to identify the active trace

Parameters:

<Boolean> ON - time domain representation active.
 OFF - frequency domain representation active.
 *RST: OFF

Example:

```
*RST; :CALC:TRAN:TIME:STAT?
Reset the instrument, activating a frequency sweep, and query
whether the default trace is displayed in the time domain. The
response is 0.
```

Manual operation: See "Time Domain" on page 448

CALCulate<Chn>:TRANSform:TIME:STIMulus <Type>

Selects the type of stimulus to be simulated in the low pass transformation process.

Suffix:

<Chn> Channel number used to identify the active trace

Parameters:

<Type> IMPulse | STEP

IMPulse - impulse response, in bandpass or lowpass mode.

STEP - step response, only in lowpass mode (a bandpass mode setting `CALCulate<Chn>:TRANSform:TIME[:TYPE] BPASs` is automatically changed to lowpass).

*RST: IMP

Example: See `CALCulate<Chn>:TRANSform:TIME[:TYPE]`

Manual operation: See "Type" on page 449

CALCulate<Chn>:TRANSform:TIME:STOP <StopTime>

Defines the stop time of the diagram in time domain.

Suffix:

<Chn> Channel number used to identify the active trace

Parameters:

<StopTime> Stop time of the diagram.

Range: -99.999999999998 s to +100 s.

Increment: 0.1 ns

*RST: +4E-009 s

Default unit: s

Example: See `CALCulate<Chn>:TRANSform:TIME:START`

Manual operation: See "Time Start / Time Stop / Time Center / Time Span" on page 534

Note: If the x-axis is scaled in distance units (`CALCulate<Chn>:TRANSform:TIME:XAXis DISTance`), then the stop value is entered in m; the range and default value changes accordingly.

CALCulate<Chn>:TRANSform:TIME[:TYPE] <TransformType>

Selects the time domain transformation type.

Suffix:

<Chn> Channel number used to identify the active trace

Parameters:

<TransformType> BPASs | LPASs
 BPASs - band pass impulse (only impulse response; a step response `CALCulate<Chn>:TRANSform:TIME:STIMulus STEP` is automatically changed to impulse response)
 LPASs - low pass (impulse or step response, depending on `CALCulate<Chn>:TRANSform:TIME:STIMulus` setting)
 *RST: BPASs

Example:

```
*RST; :CALC:TRAN:TIME:STAT ON
```

Reset the instrument, activating a frequency sweep, and enable the time domain transformation for the default trace.

```
CALC:TRAN:TIME LPAS; TIME:STIM STEP
```

Select a low pass step transformation.

```
CALC:TRAN:TIME:LPAS KFST
```

Calculate a harmonic grid, keeping the stop frequency and the number of points.

Manual operation: See "[Type](#)" on page 449

CALCulate<Chn>:TRANSform:TIME:WINDow <WindowType>

Selects the window type for filtering the data in the frequency domain prior to the time domain transformation.

Suffix:

<Chn> Channel number used to identify the active trace

Parameters:

<WindowType> RECT | HAMMing | HANNing | BOHMan | DCHebyshev
 RECT - no profiling (rectangle)
 HANN - normal profile (Hann)
 HAMMing - low first sidelobe (Hamming)
 BOHMan - steep falloff (Bohman)
 DCHebyshev - arbitrary sidelobes (Dolph-Chebyshev)
 *RST: HANN

Example: See `CALCulate<Chn>:TRANSform:TIME:DCHebyshev`

Manual operation: See "[Impulse Response](#)" on page 449

CALCulate<Chn>:TRANSform:TIME:XAXis <Unit>

Switches over between the x-axis scaling in time units or distance units.

Suffix:

<Chn> Channel number used to identify the active trace

Parameters:

<Unit> TIME | DISTance
 TIME - x-axis scaled in time units.
 DISTance - x-axis scaled in distance units (Distance = Time * c_0
 * Velocity Factor).

Example:

```
*RST; :CALC:TRAN:TIME:STAT ON
```

Reset the instrument, activating a frequency sweep, and enable the time domain transformation for the default trace.

```
CALC:TRAN:TIME:XAX DIST
```

Convert the x-axis scaling to distance units.

Manual operation: See "[Time / Distance](#)" on page 535

CALCulate:TRANSform:VNETworks...

The CALCulate:TRANSform:VNETworks... commands define and activate the circuit models for the different de-/embedding types. See [Chapter 4.6.2, "Embedding and deembedding"](#), on page 234 .

The circuit models are addressed by predefined enum constants. Except for the FIM-Port model, that consists of a single snp file, the models and constants are different for the different de-/embedding types.

Table 7-6: Circuit models for single ended port embedding/deembedding

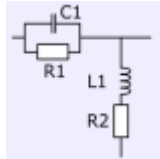
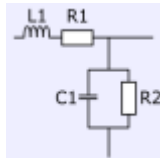
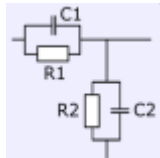
Parameter	Circuit model	Pictogram
FIMPort	File import, generic 2-port (no circuit model)	
CSL	Serial C, shunt L	
LSC	Serial L, shunt C	
CSC	Serial C, shunt C	

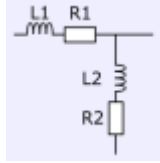
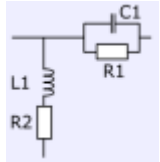
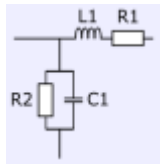
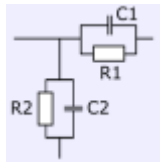
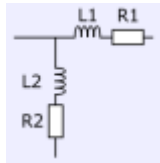
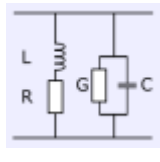
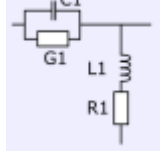
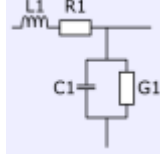
Parameter	Circuit model	Pictogram
LSL	Serial L, shunt L	
SLC	Shunt L, serial C	
SCL	Shunt C, serial L	
SCC	Shunt C, serial C	
SLL	Shunt L, serial L	
SHLC	Shunt L, shunt C	
GSL	Serial C, shunt L	
LSG	Serial L, shunt C	



Parameter	Circuit model	Pictogram
GSG	Serial C, shunt C	
SGL	Shunt C, serial L	
SLG	Shunt L, serial C	
SGG	Shunt C, serial C	

Table 7-7: Circuit models for balanced port (and port pair) de-/embedding

Parameter	Circuit model	Pictogram
FIMPort	File import, generic 4-port (.s4p, no circuit model)	
STSL	Serial Touchstone (.s2p) data, shunt L	
STSC	Serial Touchstone (.s2p) data, shunt C	

Parameter	Circuit model	Pictogram
SLST	Shunt L, serial Touchstone (.s2p) data	
SCST	Shunt C, serial Touchstone (.s2p) data	
CSSL	Serial Cs, shunt L	
LSSC	Serial Ls, shunt C	
CSSC	Serial Cs, shunt C	
LSSL	Serial Ls, shunt L	
SLCS	Shunt L, serial Cs	
SCLS	Shunt C, serial Ls	

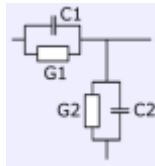
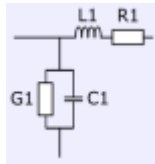
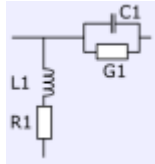
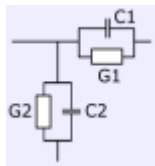
Parameter	Circuit model	Pictogram
SCCS	Shunt C, serial Cs	
SLLS	Shunt L, serial Ls	
STSG	Serial Touchstone (.s2p) data, shunt C	
SGST	Shunt C, serial Touchstone (.s2p) data	
GSSL	Serial Cs, shunt L	
LSSG	Serial Ls, shunt C	
GSSG	Serial Cs, shunt C	
SLGS	Shunt L, serial Cs	

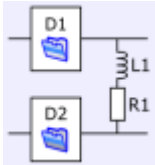
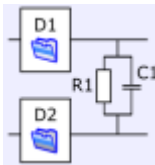
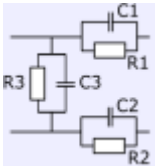
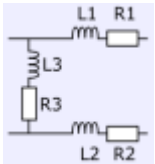
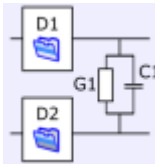
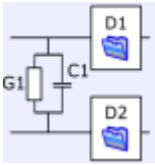
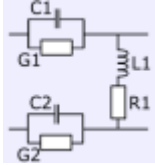
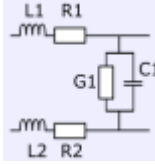
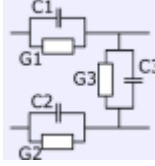
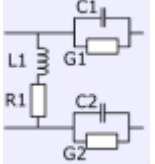
Parameter	Circuit model	Pictogram
SGLS	Shunt C, serial Ls	
SGGS	Shunt C, serial Cs	

Table 7-8: Circuit models for port set de-/embedding

Parameter	Circuit model	Pictogram
FIMPort	File import, no circuit model	
STSL, ..., SGGS	The models for port pairs (i.e. port sets with two ports) are the same as the ones for balanced ports See Table 7-7 .	

Table 7-9: Circuit models for ground loop de-/embedding

Parameter	Circuit model	Pictogram
FIMPort	File import, no circuit model	
SL	Shunt L	

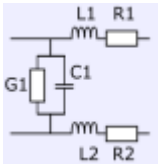
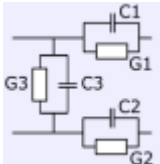

Parameter	Circuit model	Pictogram
SC	Shunt C	
SG	Shunt C	

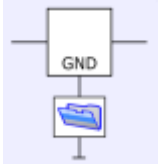
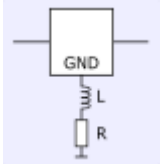
Table 7-10: Circuit models for differential match embedding

Parameter	Circuit model	Pictogram
FIMPort	File import, generic 2-port (no circuit model)	
SHLC	Shunt L, shunt C	

CALCulate<Ch>:TRANSform:VNETworks:BALanced:DEEMbedding<LogPt>:
 PARAmeters:C<Cmp>..... 1152

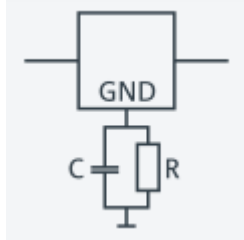
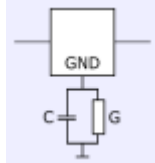
CALCulate<Ch>:TRANSform:VNETworks:BALanced:DEEMbedding<LogPt>:
 PARAmeters:DATA<Port>..... 1153

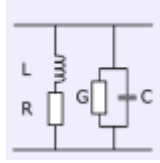
CALCulate<Ch>:TRANSform:VNETworks:BALanced:DEEMbedding<LogPt>:
 PARAmeters:G<Cmp>..... 1154

CALCulate<Ch>:TRANSform:VNETworks:BALanced:DEEMbedding<LogPt>:
 PARAmeters:L<Cmp>..... 1155

CALCulate<Ch>:TRANSform:VNETworks:BALanced:DEEMbedding<LogPt>:
 PARAmeters:R<Cmp>..... 1155

CALCulate<Ch>:TRANSform:VNETworks:BALanced:DEEMbedding<LogPt>[:STATE]..... 1156

CALCulate<Ch>:TRANSform:VNETworks:BALanced:DEEMbedding<LogPt>:TNDefinition... 1157

CALCulate<Ch>:TRANSform:VNETworks:BALanced:EMBedding<LogPt>:PARAmeters:
 C<Cmp>..... 1157

CALCulate<Ch>:TRANSform:VNETworks:BALanced:EMBedding<LogPt>:PARAmeters:
 DATA<Port>..... 1158

CALCulate<Ch>:TRANSform:VNETworks:BALanced:EMBedding<LogPt>:PARAmeters:
 G<Cmp>..... 1159

CALCulate<Ch>:TRANSform:VNETworks:BALanced:EMBedding<LogPt>:PARAmeters: L<Cmp>.....	1159
CALCulate<Ch>:TRANSform:VNETworks:BALanced:EMBedding<LogPt>:PARAmeters: R<Cmp>.....	1160
CALCulate<Ch>:TRANSform:VNETworks:BALanced:EMBedding<LogPt>[:STATe].....	1161
CALCulate<Ch>:TRANSform:VNETworks:BALanced:EMBedding<LogPt>:TNDefinition.....	1162
CALCulate<Ch>:TRANSform:VNETworks:DIFFerential:EMBedding<LogPt>: PARAmeters:C<Cmp>.....	1162
CALCulate<Ch>:TRANSform:VNETworks:DIFFerential:EMBedding<LogPt>: PARAmeters:DATA.....	1162
CALCulate<Ch>:TRANSform:VNETworks:DIFFerential:EMBedding<LogPt>: PARAmeters:G<Cmp>.....	1163
CALCulate<Ch>:TRANSform:VNETworks:DIFFerential:EMBedding<LogPt>: PARAmeters:L<Cmp>.....	1164
CALCulate<Ch>:TRANSform:VNETworks:DIFFerential:EMBedding<LogPt>: PARAmeters:R<Cmp>.....	1164
CALCulate<Ch>:TRANSform:VNETworks:DIFFerential:EMBedding<LogPt>[:STATe].....	1165
CALCulate<Ch>:TRANSform:VNETworks:DIFFerential:EMBedding<LogPt>:TNDefinition....	1165
CALCulate<Ch>:TRANSform:VNETworks:FSIMulator[:STATe].....	1165
CALCulate<Ch>:TRANSform:VNETworks:GLOop:DEEMbedding<group>:PARAmeters:C....	1166
CALCulate<Ch>:TRANSform:VNETworks:GLOop:DEEMbedding<group>:PARAmeters:G....	1166
CALCulate<Ch>:TRANSform:VNETworks:GLOop:DEEMbedding<group>:PARAmeters:L....	1167
CALCulate<Ch>:TRANSform:VNETworks:GLOop:DEEMbedding<group>:PARAmeters:R....	1168
CALCulate<Ch>:TRANSform:VNETworks:GLOop:DEEMbedding<group>[:STATe].....	1168
CALCulate<Ch>:TRANSform:VNETworks:GLOop:DEEMbedding<group>:TNDefinition.....	1169
CALCulate<Ch>:TRANSform:VNETworks:GLOop:EMBedding<group>:PARAmeters:C.....	1169
CALCulate<Ch>:TRANSform:VNETworks:GLOop:EMBedding<group>:PARAmeters:G.....	1170
CALCulate<Ch>:TRANSform:VNETworks:GLOop:EMBedding<group>:PARAmeters:L.....	1171
CALCulate<Ch>:TRANSform:VNETworks:GLOop:EMBedding<group>:PARAmeters:R.....	1171
CALCulate<Ch>:TRANSform:VNETworks:GLOop:EMBedding<group>[:STATe].....	1172
CALCulate<Ch>:TRANSform:VNETworks:GLOop:EMBedding<group>:TNDefinition.....	1173
CALCulate<Ch>:TRANSform:VNETworks:GLOop:GROup.....	1173
CALCulate<Ch>:TRANSform:VNETworks:PPAir:DEEMbedding<ListId>:DEFine.....	1174
CALCulate<Ch>:TRANSform:VNETworks:PPAir:DEEMbedding:DELeTe.....	1174
CALCulate<Ch>:TRANSform:VNETworks:PPAir:DEEMbedding<ListId>:PARAmeters: C<1 2 3>.....	1174
CALCulate<Ch>:TRANSform:VNETworks:PPAir:DEEMbedding<ListId>:PARAmeters: G<1 2 3>.....	1175
CALCulate<Ch>:TRANSform:VNETworks:PPAir:DEEMbedding<ListId>:PARAmeters: L<1 2 3>.....	1176
CALCulate<Ch>:TRANSform:VNETworks:PPAir:DEEMbedding<ListId>:PARAmeters: R<1 2 3>.....	1177
CALCulate<Ch>:TRANSform:VNETworks:PPAir:DEEMbedding<ListId>[:STATe].....	1177
CALCulate<Ch>:TRANSform:VNETworks:PPAir:DEEMbedding<ListId>:TNDefinition.....	1178
CALCulate<Ch>:TRANSform:VNETworks:PPAir:EMBedding<ListId>:DEFine.....	1178
CALCulate<Ch>:TRANSform:VNETworks:PPAir:EMBedding<ListId>:DELeTe.....	1179
CALCulate<Ch>:TRANSform:VNETworks:PPAir:EMBedding<ListId>:PARAmeters:C<1 2 3>.....	1179
CALCulate<Ch>:TRANSform:VNETworks:PPAir:EMBedding<ListId>:PARAmeters:L<1 2 3>.....	1180
CALCulate<Ch>:TRANSform:VNETworks:PPAir:EMBedding<ListId>:PARAmeters:R<1 2 3>.....	1181
CALCulate<Ch>:TRANSform:VNETworks:PPAir:EMBedding<ListId>:PARAmeters:G<1 2 3>.....	1181

CALCulate<Ch>:TRANSform:VNETworks:PPAir:EMBedding<ListId>[:STATe].....	1182
CALCulate<Ch>:TRANSform:VNETworks:PPAir:EMBedding<ListId>:TNDefinition.....	1183
CALCulate<Ch>:TRANSform:VNETworks:PSET:DEEMbedding<ListId>:DEFine.....	1183
CALCulate<Ch>:TRANSform:VNETworks:PSET:EMBedding<ListId>:DEFine.....	1183
CALCulate<Ch>:TRANSform:VNETworks:SENDEd:DEEMbedding<PhyPt>: PARAmeters:C<Cmp>.....	1184
CALCulate<Ch>:TRANSform:VNETworks:SENDEd:DEEMbedding<PhyPt>: PARAmeters:DATA.....	1184
CALCulate<Ch>:TRANSform:VNETworks:SENDEd:DEEMbedding<PhyPt>: PARAmeters:G<Cmp>.....	1185
CALCulate<Ch>:TRANSform:VNETworks:SENDEd:DEEMbedding<PhyPt>: PARAmeters:L<Cmp>.....	1186
CALCulate<Ch>:TRANSform:VNETworks:SENDEd:DEEMbedding<PhyPt>: PARAmeters:R<Cmp>.....	1187
CALCulate<Ch>:TRANSform:VNETworks:SENDEd:DEEMbedding<PhyPt>[:STATe].....	1187
CALCulate<Ch>:TRANSform:VNETworks:SENDEd:DEEMbedding<PhyPt>:TNDefinition.....	1188
CALCulate<Ch>:TRANSform:VNETworks:SENDEd:EMBedding<PhyPt>:PARAmeters: C<Cmp>.....	1188
CALCulate<Ch>:TRANSform:VNETworks:SENDEd:EMBedding<PhyPt>:PARAmeters: DATA.....	1189
CALCulate<Ch>:TRANSform:VNETworks:SENDEd:EMBedding<PhyPt>:PARAmeters: G<Cmp>.....	1190
CALCulate<Ch>:TRANSform:VNETworks:SENDEd:EMBedding<PhyPt>:PARAmeters: L<Cmp>.....	1190
CALCulate<Ch>:TRANSform:VNETworks:SENDEd:EMBedding<PhyPt>:PARAmeters: R<Cmp>.....	1191
CALCulate<Ch>:TRANSform:VNETworks:SENDEd:EMBedding<PhyPt>[:STATe].....	1192
CALCulate<Ch>:TRANSform:VNETworks:SENDEd:EMBedding<PhyPt>:TNDefinition.....	1192
CALCulate<Ch>:TRANSform:VNETworks:WAVes.....	1193

CALCulate<Ch>:TRANSform:VNETworks:BALanced:DEEMbedding<LogPt>:

PARAmeters: C<Cmp> <CircuitModel>, <Capacitance>

CALCulate<Ch>:TRANSform:VNETworks:BALanced:DEEMbedding<LogPt>:

PARAmeters: C<Cmp>? <CircuitModel>

Specifies the capacitance value C<Cmp> in the different circuit models for balanced port deembedding.

In the query form, the <Capacitance> parameter must be omitted. The command returns the capacitance value for the specified circuit model.

Suffix:

<Ch>	Channel number
<LogPt>	Logical port number (balanced port)
<Cmp>	Number of capacitance in circuit model. The total number of capacitances depends on the selected circuit model.

Parameters:

<Capacitance> Capacitance C<Cmp> for the specified circuit model.
 Range: -1mF to 1 mF.
 Increment: 1 fF (1E-15 F)
 *RST: 1 pF (1E-12 F)
 Default unit: F

Parameters for setting and query:

<CircuitModel> STSC | SCST | CSSL | LSSC | CSSC | SLCS | SCLS | SCCS |
 STSG | SGST | GSSL | LSSG | GSSG | SLGS | SGLS | SGGS
 Possible circuit models (character data); see [Table 7-7](#).

Example:

```
*RST; :SOUR:LPOR1 1,2; :CALC:TRAN:VNET:BAL:
DEEM:PAR:C2? CSSL
Create a balanced port and query the default capacitance C2 for
the Serial Cs, shunt L circuit model. The response is 1E-012 (1
pF).
CALC:TRAN:VNET:BAL:DEEM:PAR:C2 CSSL, 2.2E-12
Increase the capacitance to 2.2 pF.
```

Manual operation: See "[Network](#)" on page 747

**CALCulate<Ch>:TRANSform:VNETworks:BALanced:DEEMbedding<LogPt>:
 PARAmeters:DATA<Port> <Interchange>, <arg1>**

Defines a deembedding network for a balanced port based on the given S-Parameter traces.

Circuit models STSL | STSC | SLST | SCST require S-Parameter traces of two 2-port networks, to be assigned to the different ports PMAin and PSECondary; the FIMPort model requires S-Parameter traces of a single 4-port network but no additional port assignment.

Use

- [CALCulate<Ch>:TRANSform:VNETworks:BALanced:DEEMbedding<LogPt>:TNDefinition](#) to select the adequate circuit model **before** executing this command.
- [MMEMoRY:LOAD:VNETworks<Ch>:BALanced:DEEMbedding<LogPt>](#) to load circuit data from a Touchstone file located at the R&S ZNA's file system.

Suffix:

<Ch> Channel number
 <LogPt> Logical port number
 <Port> Port assignment for two 2-port networks:
 1 - Port 1
 2 - Port 2
 This suffix is ignored for 4-port networks.

Setting parameters:

<Interchange> FPORTs | IPORts | SGATes | SINCreasing

FPORts (or omitted)

Standard port sequence (odd port numbers towards VNA, even port numbers towards DUT)

IPORts

- Two-port networks: inverted port sequence (network port 2 towards VNA, network port 1 towards DUT)
- Four-port networks: increasing port sequence (low port numbers towards VNA, high port numbers towards DUT)

SGATes

Swapped gates (even port numbers towards VNA, odd port numbers towards DUT)

SINcreasing

Swapped increasing port sequence (high port numbers towards VNA, low port numbers towards DUT)

<arg1>	<block_data> Content of a Touchstone file (*.s2p or *.s4p) in IEEE488.2 Block data format .
Usage:	Setting only

CALCulate<Ch>:TRANSform:VNETworks:BALanced:DEEMbedding<LogPt>:

PARAmeters:G<Cmp> <CircuitModel>, <Conductance>

CALCulate<Ch>:TRANSform:VNETworks:BALanced:DEEMbedding<LogPt>:

PARAmeters:G<Cmp>? <CircuitModel>

Specifies the conductance value G<Cmp> in the different circuit models for balanced port deembedding.

In the query form, the <Conductance> parameter must be omitted. The command returns the capacitance value for the specified circuit model.

Suffix:

<Ch>	Channel number
<LogPt>	Logical port number (balanced port)
<Cmp>	Number of conductance in circuit model. The total number of conductances depends on the selected circuit model.

Parameters:

<Conductance>	Conductance G<Cmp> for the specified circuit model. Range: -1kS to 1 kS. Increment: 1 nS (1E-9 S) *RST: 0 S Default unit: Siemens (SI unit symbol: S)
----------------------------	-------------------------------------------------------------------------------------------------------------------------------------------------------------------

Parameters for setting and query:

<CircuitModel>	STSG SGST GSSL LSSG GSSG SLGS SGLS SGGS Possible circuit models (character data); see Table 7-7 .
-----------------------------	------------------------------------------------------------------------------------------------------------------------------------

Manual operation: See "[Network](#)" on page 747

**CALCulate<Ch>:TRANSform:VNETworks:BALanced:DEEMbedding<LogPt>:
PARAmeters:L<Cmp> <CircuitModel>, <Inductance>**
**CALCulate<Ch>:TRANSform:VNETworks:BALanced:DEEMbedding<LogPt>:
PARAmeters:L<Cmp>? <CircuitModel>**

Specifies the inductance value L<Cmp> in the different circuit models for balanced port deembedding.

In the query form, the <Inductance> parameter must be omitted. The command returns the inductance value for the specified circuit model.

Suffix:

<Ch>	Channel number
<LogPt>	Logical port number (balanced port)
<Cmp>	Number of inductance in circuit model. The total number of inductances depends on the selected circuit model.

Parameters:

<Inductance>	Inductance L<Cmp> for the specified circuit model. Range: -1H to 1 H. Increment: 1 pH (1E-12 H) *RST: 1 nH (1E-9 H) Default unit: H
--------------	-------------------------------------------------------------------------------------------------------------------------------------------------

Parameters for setting and query:

<CircuitModel>	STSL SLST CSSL LSSC LSSL SLCS SCLS SLLS GSSL LSSG SLGS SGLS Possible circuit models (character data); see Table 7-7 .
----------------	-------------------------------------------------------------------------------------------------------------------------------------------------------------------

Example:

```
*RST; :SOUR:LPOR1 1,2; :CALC:TRAN:VNET:BAL:
DEEM:PAR:L1? CSSL
Create a balanced port and query the default inductance L1 for
the Serial Cs, shunt L circuit model. The response is 1E-009 (1
nH).
CALC:TRAN:VNET:BAL:DEEM:PAR:L1 CSSL, 2.2E-9
Increase the inductance to 2.2 nH.
```

Manual operation: See "[Network](#)" on page 747

**CALCulate<Ch>:TRANSform:VNETworks:BALanced:DEEMbedding<LogPt>:
PARAmeters:R<Cmp> <CircuitModel>, <Resistance>**
**CALCulate<Ch>:TRANSform:VNETworks:BALanced:DEEMbedding<LogPt>:
PARAmeters:R<Cmp>? <CircuitModel>**

Specifies the resistance value R<Cmp> in the different circuit models for balanced port deembedding.

In the query form, the <Resistance> parameter must be omitted. The command returns the resistance value for the specified circuit model.

Suffix:

<Ch>	Channel number
------	----------------

<LogPt> Logical port number (balanced port)

<Cmp> Number of resistance in circuit model. The total number of resistances depends on the selected circuit model.

Parameters:

<Resistance> Resistance R<Cmp> for the specified circuit model.

Range: -10 MΩ to 10 MΩ.

Increment: 1 mΩ (1E-3 Ω)

*RST: 0 Ω for all resistances connected in series with an inductance. 10 MΩ for all resistances connected in parallel with a capacitance

Default unit: Ω

Parameters for setting and query:

<CircuitModel> STSL | STSC | SLST | SCST | CSSL | LSSC | CSSC | LSSL | SLCS | SCLS | SCCS | SLLS | GSSL | LSSG | SLGS | SGLS

Possible circuit models (character data); see [Table 7-7](#).

Example:

```
*RST; :SOUR:LPOR1 1,2; :CALC:TRAN:VNET:BAL:
DEEM:PAR:R1? CSSL; R2? CSSL; R3? CSSL
Create a balanced port and query the default resistances for the
Serial Cs, shunt L circuit model. The response is
10000000000;10000000000; 0.
CALC:TRAN:VNET:BAL:DEEM:PAR:R3 CSSL, 2.2E+3
Increase the resistance R3 to 2.2 kΩ.
```

Manual operation: See "[Network](#)" on page 747

**CALCulate<Ch>:TRANSform:VNETworks:BALanced:DEEMbedding<LogPt>[:
STATE] <Boolean>**

Enables or disables the deembedding function for balanced ports. It is allowed to change the circuit model and its parameters while deembedding is enabled.

Suffix:

<Ch> Channel number

<LogPt> Logical port number (balanced port)

Parameters:

<Boolean> ON - deembedding active
OFF - deembedding inactive

*RST: OFF

Example:

```
*RST; SOUR:LPOR1 1,2; LPOR2 3,4
Define a balanced port configuration.
CALC:TRAN:VNET:BAL:DEEM:TND CSSL
Select the Serial Cs, shunt L circuit model for deembedding.
CALC:TRAN:VNET:BAL:DEEM:PAR:R3 CSSL, 2.2E+3; :
CALC:TRAN:VNET:BAL:DEEM ON
Increase the resistance R3 for the Serial Cs, shunt L circuit
model to 2.2 kΩ and enable deembedding.
```

Manual operation: See ["Active"](#) on page 713

**CALCulate<Ch>:TRANSform:VNETworks:BALanced:DEEMbedding<LogPt>:
TNDefinition <CircuitModel>**

Selects the circuit model for balanced port deembedding.

Suffix:

<Ch> Channel number
<LogPt> Logical port number (balanced port)

Parameters:

<CircuitModel> FIMPort | STSL | STSC | SLST | SCST | CSSL | LSSC | CSSC |
LSSL | SLCS | SCLS | SCCS | SLLS | STSG | SGST | GSSL |
LSSG | GSSG | SLGS | SGLS | SGGS

Possible circuit models (character data); see [Table 7-7](#).

*RST: CSSL

Example: See [CALCulate<Ch>:TRANSform:VNETworks:BALanced:
DEEMbedding<LogPt>\[:STATE\]](#)

Manual operation: See ["Network"](#) on page 747

**CALCulate<Ch>:TRANSform:VNETworks:BALanced:EMBedding<LogPt>:
PARAMeters:C<Cmp> <CircuitModel>, <Capacitance>
CALCulate<Ch>:TRANSform:VNETworks:BALanced:EMBedding<LogPt>:
PARAmeters:C<Cmp>? <CircuitModel>**

Specifies the capacitance value C<Cmp> in the different circuit models for balanced port embedding.

In the query form, the <Capacitance> parameter must be omitted. The command returns the capacitance value for the specified circuit model.

Suffix:

<Ch> Channel number
<LogPt> Logical port number (balanced port)
<Cmp> Number of capacitance in circuit model. The total number of capacitances depends on the selected circuit model.

Parameters:

<Capacitance> Capacitance C<Cmp> for the specified circuit model.
Range: -1mF to 1 mF.
Increment: 1 fF (1E-15 F)
*RST: 1 pF (1E-12 F)
Default unit: F

Parameters for setting and query:

<CircuitModel> STSC | SCST | CSSL | LSSC | CSSC | SLCS | SCLS | SCCS | STSG | SGST | GSSL | LSSG | GSSG | SLGS | SGLS | SGGS
Possible circuit models (character data); see [Table 7-7](#).

Example:

```
*RST; :SOUR:LPOR1 1,2; :CALC:TRAN:VNET:BAL:EMB:
PAR:C2? CSSL
Create a balanced port and query the default capacitance C2 for
the Serial Cs, shunt L circuit model. The response is 1E-012 (1
pF).
CALC:TRAN:VNET:BAL:EMB:PAR:C2 CSSL, 2.2E-12
Increase the capacitance to 2.2 pF.
```

Manual operation: See "[Network](#)" on page 747

**CALCulate<Ch>:TRANSform:VNETworks:BALanced:EMBedding<LogPt>:
PARAmeters:DATA<Port> <Interchange>, <arg1>**

Defines an embedding network for a balanced port based on the given S-Parameter traces.

Circuit models `STSL` | `STSC` | `SLST` | `SCST` require S-Parameter traces of two 2-port networks, to be assigned to the different ports; the `FIMPort` model requires S-Parameter traces of a single 4-port network but no additional port assignment.

Use

- `CALCulate<Ch>:TRANSform:VNETworks:BALanced:EMBedding<LogPt>:TNDefinition` to select the adequate circuit model **before** executing this command.
- `MMEMemory:LOAD:VNETworks<Ch>:BALanced:EMBedding<LogPt>` to load circuit data from a Touchstone file located at the R&S ZNA's file system.

Suffix:

<Ch> Channel number
<LogPt> Logical port number
<Port> Port assignment for two 2-port networks:
1 - Port 1
2 - Port 2
This suffix is ignored for 4-port networks.

Setting parameters:

<Interchange> FPORts | IPORts | SGATes | SINcreasing
FPORts (or omitted)
Standard port sequence (odd port numbers towards VNA, even port numbers towards DUT)
IPORts
– Two-port networks: inverted port sequence (network port 2 towards VNA, network port 1 towards DUT)
– Four-port networks: increasing port sequence (low port numbers towards VNA, high port numbers towards DUT)

SGATes

Swapped gates (even port numbers towards VNA, odd port numbers towards DUT)

SINcreasing

Swapped increasing port sequence (high port numbers towards VNA, low port numbers towards DUT)

<arg1>	<block_data> Content of a Touchstone file (*.s2p or *.s4p) in IEEE488.2 Block data format .
Usage:	Setting only

**CALCulate<Ch>:TRANSform:VNETworks:BALanced:EMBedding<LogPt>:
PARAmeters:G<Cmp>** <CircuitModel>, <Conductance>

**CALCulate<Ch>:TRANSform:VNETworks:BALanced:EMBedding<LogPt>:
PARAmeters:G<Cmp>?** <CircuitModel>

Specifies the conductance value G<Cmp> in the different circuit models for balanced port embedding.

In the query form, the <Conductance> parameter must be omitted. The command returns the capacitance value for the specified circuit model.

Suffix:

<Ch>	Channel number
<LogPt>	Logical port number (balanced port)
<Cmp>	Number of conductance in circuit model. The total number of conductances depends on the selected circuit model.

Parameters:

<Conductance>	Conductance G<Cmp> for the specified circuit model. Range: -1kS to 1 kS. Increment: 1 pS (1E-12 S) *RST: 0 S Default unit: Siemens (SI unit symbol: S)
---------------	--------------------------------------------------------------------------------------------------------------------------------------------------------------------

Parameters for setting and query:

<CircuitModel>	STSG SGST GSSL LSSG GSSG SLGS SGLS SGGS Possible circuit models (character data); see Table 7-7 .
----------------	------------------------------------------------------------------------------------------------------------------------------------

Manual operation: See "[Network](#)" on page 747

**CALCulate<Ch>:TRANSform:VNETworks:BALanced:EMBedding<LogPt>:
PARAmeters:L<Cmp>** <CircuitModel>, <Inductance>

**CALCulate<Ch>:TRANSform:VNETworks:BALanced:EMBedding<LogPt>:
PARAmeters:L<Cmp>?** <CircuitModel>

Specifies the inductance values L1, L2, L3 in the different circuit models for balanced port embedding.

In the query form, the <Inductance> parameter must be omitted. The command returns the inductance value for the specified circuit model.

Suffix:

<Ch>	Channel number
<LogPt>	Logical port number (balanced port)
<Cmp>	Number of inductance in circuit model. The total number of inductances depends on the selected circuit model.

Parameters:

<Inductance>	Inductance L<Cmp> for the specified circuit model. Range: -1H to 1 H. Increment: 1 pH (1E-12 H) *RST: 1 nH (1E-9 H) Default unit: H
--------------	-------------------------------------------------------------------------------------------------------------------------------------------------

Parameters for setting and query:

<CircuitModel>	STSL SLST CSSL LSSC LSSL SLCS SCLS SLLS GSSL LSSG SLGS SGLS Possible circuit models (character data); see Table 7-7 .
----------------	----------------------------------------------------------------------------------------------------------------------------------------------------------------

Example:

```
*RST; :SOUR:LPOR1 1,2; :CALC:TRAN:VNET:EMB:
PAR:L1? CSSL
```

Create a balanced port and query the default inductance L1 for the Serial Cs, shunt L circuit model. The response is 1E-009 (1 nH).

```
CALC:TRAN:VNET:EMB:PAR:L1 CSSL, 2.2E-9
```

Increase the inductance to 2.2 nH.

Manual operation: See "[Network](#)" on page 747

**CALCulate<Ch>:TRANSform:VNETworks:BALanced:EMBedding<LogPt>:
PARAmeters:R<Cmp> <CircuitModel>, <Resistance>**
**CALCulate<Ch>:TRANSform:VNETworks:BALanced:EMBedding<LogPt>:
PARAmeters:R<Cmp>? <CircuitModel>**

Specifies the resistance values R1, R2, R3 in the different circuit models for balanced port embedding.

In the query form, the <Resistance> parameter must be omitted. The command returns the resistance value for the specified circuit model.

Suffix:

<Ch>	Channel number
<LogPt>	Logical port number (balanced port)
<Cmp>	Number of resistance in circuit model. The total number of resistances depends on the selected circuit model.

Parameters:

<Resistance> Resistance R<Cmp> for the specified circuit model.
 Range: -10 MΩ to 10 MΩ.
 Increment: 1 mΩ (1E-3 Ω)
 *RST: 0 Ω for all resistances connected in series with an inductance. 10 MΩ for all resistances connected in parallel with a capacitance
 Default unit: Ω

Parameters for setting and query:

<CircuitModel> STSL | STSC | SLST | SCST | CSSL | LSSC | CSSC | LSSL | SLCS | SCLS | SCCS | SLLS | GSSL | LSSG | SLGS | SGLS
 Possible circuit models (character data); see [Table 7-7](#).

Example:

```
*RST; :SOUR:LPOR1 1,2; :CALC:TRAN:VNET:BAL:EMB:
PAR:R1? CSSL; R2? CSSL; R3? CSSL
Create a balanced port and query the default resistances for the
Serial Cs, shunt L circuit model. The response is
10000000000;10000000000;0.
CALC:TRAN:VNET:BAL:EMB:PAR:R3 CSSL, 2.2E+3
Increase the resistance R3 to 2.2 kΩ.
```

Manual operation: See "[Network](#)" on page 747

CALCulate<Ch>:TRANSform:VNETworks:BALanced:EMBedding<LogPt>[:STATe]
 <Boolean>

Enables or disables the embedding function for balanced ports. It is allowed to change the circuit model and its parameters while embedding is enabled.

Suffix:

<Ch> Channel number
 <LogPt> Logical port number (balanced port)

Parameters:

<Boolean> ON | OFF - embedding active or inactive
 *RST: OFF

Example:

```
*RST; SOUR:LPOR1 1,2; LPOR2 3,4
Define a balanced port configuration.
CALC:TRAN:VNET:BAL:EMB:TND CSSL
Select the Serial Cs, shunt L circuit model for embedding.
CALC:TRAN:VNET:BAL:EMB:PAR:R3 CSSL, 2.2E+3; :
CALC:TRAN:VNET:BAL:EMB ON
Increase the resistance R3 for the Serial Cs, shunt L circuit
model to 2.2 kΩ and enable embedding.
```

Manual operation: See "[Active](#)" on page 713

**CALCulate<Ch>:TRANSform:VNETworks:BALanced:EMBedding<LogPt>:
TNDefinition <CircuitModel>**

Selects the circuit model for balanced port embedding.

Suffix:

<Ch> Channel number
<LogPt> Logical port number (balanced port)

Parameters:

<CircuitModel> FIMPort | STSL | STSC | SLST | SCST | CSSL | LSSC | CSSC |
LSSL | SLCS | SCLS | SCCS | SLLS | STSG | SGST | GSSL |
LSSG | GSSG | SLGS | SGLS | SGGS

Possible circuit models (character data); see [Table 7-7](#).

*RST: CSSL

Example: See [CALCulate<Ch>:TRANSform:VNETworks:BALanced:
EMBedding<LogPt>\[:STATe\]](#)

Manual operation: See "[Network](#)" on page 747

**CALCulate<Ch>:TRANSform:VNETworks:DIFFerential:EMBedding<LogPt>:
PARAmeters:C<Cmp> <CircuitModel>[, <Capacitance>]**

Specifies the capacitance value C in the "Shunt L, Shunt C" lumped element model for differential match embedding.

In the query form, the <Capacitance> parameter must be omitted.

Suffix:

<Ch> Channel number
<LogPt> Logical port number (balanced port)
<Cmp> Must be omitted or set to 1.

Parameters:

<CircuitModel> SHLC
Currently only the "Shunt L, Shunt C" lumped element model is supported

<Capacitance> Range: -1mF to 1 mF.
Increment: 1 fF (1E-15 F)
*RST: 1 pF (1E-12 F)
Default unit: F

Manual operation: See "[Network](#)" on page 752

**CALCulate<Ch>:TRANSform:VNETworks:DIFFerential:EMBedding<LogPt>:
PARAmeters:DATA <Interchange>, <SParamTrcs>**

Defines a [Differential match embedding](#) network for a balanced port based on the given S-Parameter traces.

Use `MMEMory:LOAD:VNETworks<Ch>:DIFFerential:EMBedding<LogPt>` to load circuit data from a Touchstone file located at the R&S ZNA's file system instead.

Suffix:

<Ch> Channel number
 <LogPt> Logical port number of a balanced port

Setting parameters:

<Interchange> FPORts | IPORts | SGATes
FPORts (or omitted)
 Standard port sequence (network port 1 towards VNA, network port 2 towards DUT)
IPORts | SGATes
 Inverted port sequence (network port 2 towards VNA, network port 1 towards DUT)

<SParmTrcs> <block_data>
 Content of a two-port Touchstone file (*.s2p) in IEEE488.2 [Block data format](#).

Usage: Setting only

**CALCulate<Ch>:TRANSform:VNETworks:DIFFerential:EMBedding<LogPt>:
 PARAmeters:G<Cmp> <CircuitModel>[, <Conductance>]**

Specifies the conductance value G in the "Shunt L, Shunt C" lumped element model for differential match embedding.

In the query form, the <Conductance> parameter must be omitted.

Suffix:

<Ch> Channel number
 <LogPt> Logical port number (balanced port)
 <Cmp> Must be omitted or set to 1.

Parameters:

<CircuitModel> SHLC
 Currently only the "Shunt L, Shunt C" lumped element model is supported

<Conductance> Range: -10 MS to 10 MS.
 Increment: 1 μS (1E-6 F)
 *RST: 0 S
 Default unit: S(iemens)

Manual operation: See "[Network](#)" on page 752

**CALCulate<Ch>:TRANSform:VNETworks:DIFFerential:EMBedding<LogPt>:
PARAmeters:L<Cmp> <CircuitModel>[, <Inductance>]**

Specifies the inductance value L in the "Shunt L, Shunt C" lumped element model for differential match embedding.

In the query form, the <Inductance> parameter must be omitted.

Suffix:

<Ch>	Channel number
<LogPt>	Logical port number (balanced port)
<Cmp>	Must be omitted or set to 1

Parameters:

<CircuitModel>	SHLC Currently only the "Shunt L, Shunt C" lumped element model is supported
<Inductance>	Range: -1 H to 1 H Increment: 1 pH (1E-12 H) *RST: 1 nH (1E-9 H) Default unit: H

Manual operation: See "[Network](#)" on page 752

**CALCulate<Ch>:TRANSform:VNETworks:DIFFerential:EMBedding<LogPt>:
PARAmeters:R<Cmp> <CircuitModel>[, <Resistance>]**

Specifies the resistance value R in the "Shunt L, Shunt C" lumped element model for differential match embedding.

In the query form, the <Resistance> parameter must be omitted.

Suffix:

<Ch>	Channel number
<LogPt>	Logical port number (balanced port)
<Cmp>	Must be omitted or set to 1.

Parameters:

<CircuitModel>	SHLC Currently only the "Shunt L, Shunt C" lumped element model is supported
<Resistance>	Range: -10 MΩ to 10 MΩ. Increment: 1 mΩ (1E-3 Ω) *RST: 0 Ω Default unit: Ohm

Manual operation: See "[Network](#)" on page 752

**CALCulate<Ch>:TRANSform:VNETworks:DIFFerential:EMBedding<LogPt>[:
STATE] <Boolean>**

Enables or disables differential match embedding for balanced port <LogPt>.

Suffix:

<Ch> Channel number
 <LogPt> Logical port number (balanced port)

Parameters:

<Boolean> ON | OFF - embedding active or inactive
 *RST: OFF

Manual operation: See "[Active](#)" on page 716

**CALCulate<Ch>:TRANSform:VNETworks:DIFFerential:EMBedding<LogPt>:
TNDefinition <CircuitModel>**

Selects the circuit model for differential match embedding.

Suffix:

<Ch> Channel number
 <LogPt> Logical port number (balanced port)

Parameters:

<CircuitModel> FIMPort | SHLC
 Possible circuit models (character data), see [Circuit models for differential match embedding](#)

Manual operation: See "[Network](#)" on page 752

CALCulate<Ch>:TRANSform:VNETworks:FSIMulator[:STATE] <Enable>

De/activates the "Fixture Simulator" switch that allows to disable and (re-)enable the configured deembedding, embedding, balanced ports, and port impedance settings for the selected channel.

Suffix:

<Ch> Channel number

Parameters:

<Enable>

Manual operation: See "[Fixture Simulator](#)" on page 655

**CALCulate<Ch>:TRANSform:VNETworks:GLOop:DEEMbedding<group>:
PARAMeters:C** <CircuitModel>, <Capacitance>
**CALCulate<Ch>:TRANSform:VNETworks:GLOop:DEEMbedding<group>:
PARAMeters:C?** <CircuitModel>

Specifies the capacitance value C in the different circuit models for ground loop embedding.

Suffix:

<Ch> Channel number

<group> Port group (DUT) number.
If multiple port groups are configured (see [SOURCE<Ch>:GROup<Grp>:PPORts](#)) and [CALCulate<Ch>:TRANSform:VNETworks:GLOop:GROup](#) is ON, then each port group can have its own de-/embedding models.

Parameters:

<Capacitance> Capacitance C for ground loop deembedding.
Range: -1mF to 1 mF.
Increment: 1 fF (1E-15 F)
*RST: 1 pF (1E-12 F)
Default unit: F

Parameters for setting and query:

<CircuitModel> SC | SG
Possible circuit models (character data); see [Table 7-9](#).

Example:

```
*RST; :CALC:TRAN:VNET:GLO:DEEM:PAR:C? SC
Query the default capacitance for ground loop deembedding.
The response is 1E-012 (1 pF).
CALC:TRAN:VNET:GLO:DEEM:PAR:C SC, 2.2E-12
Increase the capacitance to 2.2 pF.
```

Manual operation: See "[Network](#)" on page 749

**CALCulate<Ch>:TRANSform:VNETworks:GLOop:DEEMbedding<group>:
PARAMeters:G** <CircuitModel>, <Conductance>
**CALCulate<Ch>:TRANSform:VNETworks:GLOop:DEEMbedding<group>:
PARAMeters:G?** <CircuitModel>

Specifies the conductance value G in the different circuit models for ground loop embedding.

Suffix:

<Ch> Channel number.

<group> Port group (DUT) number.
If multiple port groups are configured (see [SOURCE<Ch>:GROup<Grp>:PPORts](#)) and [CALCulate<Ch>:TRANSform:VNETworks:GLOop:GROup](#) is ON, then each port group can have its own de-/embedding models.

Parameters:

<Conductance> Conductance G for the specified circuit model.
 Range: -1kS to 1 kS.
 Increment: 1 nS (1E-9 S)
 *RST: 0 S
 Default unit: Siemens (SI unit symbol: S)

Parameters for setting and query:

<CircuitModel> SG
 Possible circuit models (character data); see [Table 7-9](#).

Manual operation: See "[Network](#)" on page 749

CALCulate<Ch>:TRANSform:VNETworks:GLOop:DEEMbedding<group>:

PARAmeters:L <CircuitModel>, <Inductance>

CALCulate<Ch>:TRANSform:VNETworks:GLOop:DEEMbedding<group>:

PARAmeters:L? <CircuitModel>

Specifies the inductance value in the different circuit models for ground loop deembedding.

Suffix:

<Ch> Channel number.
 <group> Port group (DUT) number.
 If multiple port groups are configured (see [SOURCE<Ch>:GROup<Grp>:PPORts](#)) and [CALCulate<Ch>:TRANSform:VNETworks:GLOop:GROup](#) is ON, then each port group can have its own de-/embedding models.

Parameters:

<Inductance> Inductance L for ground loop deembedding.
 Range: -1 H to 1 H.
 Increment: 1 pH (1E-12 H)
 *RST: 1 nH (1E-9 H)
 Default unit: H

Parameters for setting and query:

<CircuitModel> SL
 Possible circuit models (character data); see [Table 7-9](#).

Example:

```
*RST; :CALC:TRAN:VNET:GLO:DEEM:PAR:L? SL
Query the default inductance for ground loop deembedding. The
response is 1E-009 (1 nH).
CALC:TRAN:VNET:GLO:DEEM:PAR:L SL, 2.2E-9
Increase the inductance to 2.2 nH.
```

Manual operation: See "[Network](#)" on page 749

**CALCulate<Ch>:TRANSform:VNETworks:GLOop:DEEMbedding<group>:
PARAmeters:R <CircuitModel>, <Resistance>**
**CALCulate<Ch>:TRANSform:VNETworks:GLOop:DEEMbedding<group>:
PARAmeters:R? <CircuitModel>**

Specifies the resistance value R in the different circuit models for ground loop deembedding.

Suffix:

<Ch> Channel number.
 <group> Port group (DUT) number.
 If multiple port groups are configured (see [SOURCE<Ch>:GROup<Grp>:PPORts](#)) and [CALCulate<Ch>:TRANSform:VNETworks:GLOop:GROup](#) is ON, then each port group can have its own de-/embedding models.

Parameters:

<Resistance> Resistance R for the specified circuit model.
 Range: -10 MΩ to 10 MΩ
 Increment: 1 mΩ
 *RST: 0 Ω if the resistance is connected in series with an inductance. 10 MΩ if the resistance is connected in parallel with a capacitance)
 Default unit: Ω

Parameters for setting and query:

<CircuitModel> SL | SC
 Possible circuit models (character data); see [Table 7-9](#).

Example:

```
*RST; :CALC:TRAN:VNET:GLO:DEEM:PAR:R? SC; R? SL
Query the default resistances for ground loop deembedding. The
response is 10000000; 0.
CALC:TRAN:VNET:GLO:DEEM:PAR:R SC, 2.2E+3
Increase the resistance for the Shunt C model to 2.2 kΩ.
```

Manual operation: See "[Network](#)" on page 749

**CALCulate<Ch>:TRANSform:VNETworks:GLOop:DEEMbedding<group>[:STATE]
<Boolean>**

Enables or disables the deembedding function for ground loops. It is allowed to change the circuit model and its parameters while deembedding is enabled.

Suffix:

<Ch> Channel number.
 <group> Port group (DUT) number.
 If multiple port groups are configured (see [SOURCE<Ch>:GROup<Grp>:PPORts](#)) and [CALCulate<Ch>:TRANSform:VNETworks:GLOop:GROup](#) is ON, then each port group can have its own de-/embedding models.

Parameters:

<Boolean> ON - Deembedding active
 OFF - Deembedding inactive
 *RST: OFF

Example:

```
CALC:TRAN:VNET:GLO:DEEM:TND SL
Select the Shunt L circuit model for deembedding.
CALC:TRAN:VNET:GLO:DEEM:PAR:R SL, 2.2E+3; :
CALC:TRAN:VNET:GLO:DEEM ON
Increase the resistance for the Shunt L circuit model to 2.2 kΩ
and enable deembedding.
```

Manual operation: See ["Active"](#) on page 714

**CALCulate<Ch>:TRANSform:VNETworks:GLOop:DEEMbedding<group>:
 TNDefinition <CircuitModel>**

Selects the circuit model for ground loop deembedding.

Suffix:

<Ch> Channel number.
 <group> Port group (DUT) number.
 If multiple port groups are configured (see [SOURCE<Ch>:
 GROup<Grp>:PPORTs](#)) and [CALCulate<Ch>:TRANSform:
 VNETworks:GLOop:GROup](#) is ON, then each port group can
 have its own de-/embedding models.

Parameters:

<CircuitModel> FIMPort | SL | SC | SG
 Possible circuit models (character data); see [Circuit models for
 ground loop de-/embedding](#).

Example:

See [CALCulate<Ch>:TRANSform:VNETworks:GLOop:
 DEEMbedding<group>\[:STATE\]](#) on page 1168

Manual operation: See ["Network"](#) on page 749

**CALCulate<Ch>:TRANSform:VNETworks:GLOop:EMBedding<group>:
 PARAmeters:C <CircuitModel>, <Capacitance>
 CALCulate<Ch>:TRANSform:VNETworks:GLOop:EMBedding<group>:
 PARAmeters:C? <CircuitModel>**

Specifies the capacitance value C in the different circuit models for ground loop
 embedding.

Suffix:

<Ch> Channel number.

<group> Port group (DUT) number.
If multiple port groups are configured (see [SOURCE<Ch>:GROUp<Grp>:PPORts](#)) and [CALCulate<Ch>:TRANSform:VNETworks:GLOOp:GROUp](#) is ON, then each port group can have its own de-/embedding models.

Parameters:

<Capacitance> Capacitance C for ground loop embedding.
Range: -1mF to 1 mF.
Increment: 1 fF (1E-15 F)
*RST: 1 pF (1E-12 F)
Default unit: F

Parameters for setting and query:

<CircuitModel> SC | SG
Possible circuit models (character data); see [Table 7-9](#).

Example:

```
*RST; :CALC:TRAN:VNET:GLO:EMB:PAR:C? SC
Query the default capacitance for ground loop embedding. The
response is 1E-012 (1 pF).
CALC:TRAN:VNET:GLO:EMB:PAR:C SC, 2.2E-12
Increase the capacitance to 2.2 pF.
```

Manual operation: See "[Network](#)" on page 749

CALCulate<Ch>:TRANSform:VNETworks:GLOOp:EMBedding<group>:

PARAMeters:G <CircuitModel>, <Conductance>

CALCulate<Ch>:TRANSform:VNETworks:GLOOp:EMBedding<group>:

PARAMeters:G? <CircuitModel>

Specifies the conductance value G in the different circuit models for ground loop embedding.

Suffix:

<Ch> Channel number.

<group> Port group (DUT) number.
If multiple port groups are configured (see [SOURCE<Ch>:GROUp<Grp>:PPORts](#)) and [CALCulate<Ch>:TRANSform:VNETworks:GLOOp:GROUp](#) is ON, then each port group can have its own de-/embedding models.

Parameters:

<Conductance> Conductance G for the specified circuit model.
Range: -1kS to 1 kS.
Increment: 1 pS (1E-12 S)
*RST: 0 S
Default unit: Siemens (SI unit symbol: S)

Parameters for setting and query:

<CircuitModel> SG
Possible circuit models (character data); see [Table 7-9](#).

Manual operation: See ["Network"](#) on page 749

**CALCulate<Ch>:TRANSform:VNETworks:GLOop:EMBedding<group>:
PARAmeters:L** <CircuitModel>, <Inductance>
**CALCulate<Ch>:TRANSform:VNETworks:GLOop:EMBedding<group>:
PARAmeters:L?** <CircuitModel>

Specifies the inductance value in the different circuit models for ground loop embedding.

Suffix:

<Ch> Channel number.

<group> Port group (DUT) number.
If multiple port groups are configured (see [SOURCE<Ch>:GROup<Grp>:PPORts](#)) and [CALCulate<Ch>:TRANSform:VNETworks:GLOop:GROup](#) is ON, then each port group can have its own de-/embedding models.

Parameters:

<Inductance> Inductance L for ground loop embedding.
Range: -1H to 1 H.
Increment: 1 pH (1E-12 H)
*RST: 1 nH (1E-9 H)
Default unit: H

Parameters for setting and query:

<CircuitModel> SL
Possible circuit models (character data); see [Table 7-9](#).

Example:

```
*RST; :CALC:TRAN:VNET:GLO:EMB:PAR:L? SL
Query the default inductance for ground loop embedding. The
response is 1E-009 (1 nH).
CALC:TRAN:VNET:GLO:EMB:PAR:L SL, 2.2E-9
Increase the inductance to 2.2 nH.
```

Manual operation: See ["Network"](#) on page 749

**CALCulate<Ch>:TRANSform:VNETworks:GLOop:EMBedding<group>:
PARAmeters:R** <CircuitModel>, <Resistance>
**CALCulate<Ch>:TRANSform:VNETworks:GLOop:EMBedding<group>:
PARAmeters:R?** <CircuitModel>

Specifies the resistance value R in the different circuit models for ground loop embedding.

Suffix:

<Ch> Channel number.

<group> Port group (DUT) number.
If multiple port groups are configured (see [SOURCE<Ch>:GROUp<Grp>:PPORts](#)) and [CALCulate<Ch>:TRANsform:VNETworks:GLOOp:GROUp](#) is ON, then each port group can have its own de-/embedding models.

Parameters:

<Resistance> Resistance R for the specified circuit model.
Range: -10 MΩ to 10 MΩ
Increment: 1 mΩ
*RST: 0 Ω if the resistance is connected in series with an inductance. 10 MΩ if the resistance is connected in parallel with a capacitance)
Default unit: Ω

Parameters for setting and query:

<CircuitModel> SL | SC
Possible circuit models (character data); see [Table 7-9](#).

Example: *RST; :CALC:TRAN:VNET:GLO:EMB:PAR:R? SC; R? SL
Query the default resistances for ground loop embedding. The response is 10000000; 0.
CALC:TRAN:VNET:GLO:EMB:PAR:R SC, 2.2E+3
Increase the resistance for the Shunt C model to 2.2 kΩ.

Manual operation: See "[Network](#)" on page 749

CALCulate<Ch>:TRANsform:VNETworks:GLOOp:EMBedding<group>[:STATe]
<Boolean>

Enables or disables the embedding function for ground loops. It is allowed to change the circuit model and its parameters while embedding is enabled.

Suffix:

<Ch> Channel number.

<group> Port group (DUT) number.
If multiple port groups are configured (see [SOURCE<Ch>:GROUp<Grp>:PPORts](#)) and [CALCulate<Ch>:TRANsform:VNETworks:GLOOp:GROUp](#) is ON, then each port group can have its own de-/embedding models.

Parameters:

<Boolean> ON - Embedding active
OFF - Embedding inactive
*RST: OFF

Example: `CALC:TRAN:VNET:GLO:EMB:TND SL`
 Select the Shunt L circuit model for embedding.
`CALC:TRAN:VNET:GLO:EMB:PAR:R SL, 2.2E+3; :CALC:`
`TRAN:VNET:GLO:EMB ON`
 Increase the resistance for the Shunt L circuit model to 2.2 kΩ
 and enable embedding.

Manual operation: See ["Active"](#) on page 714

CALCulate<Ch>:TRANSform:VNETworks:GLOop:EMBedding<group>: TNDefinition <CircuitModel>

Selects the circuit model for ground loop embedding.

Suffix:

<Ch> Channel number.

<group> Port group (DUT) number.
 If multiple port groups are configured (see [SOURCE<Ch>:
 GROup<Grp>:PPORTs](#)) and [CALCulate<Ch>:TRANSform:
 VNETworks:GLOop:GROup](#) is ON, then each port group can
 have its own de-/embedding models.

Parameters:

<CircuitModel> FIMPort | SL | SC | SG
 Possible circuit models (character data); see [Circuit models for
 ground loop de-/embedding](#).
 *RST: FIMPort

Example: See [CALCulate<Ch>:TRANSform:VNETworks:GLOop:
 EMBedding<group>\[:STATE\]](#) on page 1172

Manual operation: See ["Network"](#) on page 749

CALCulate<Ch>:TRANSform:VNETworks:GLOop:GROup <Boolean>

If set to ON (1), each port group (defined using [SOURCE<Ch>:GROup<Grp>:PPORTs](#))
 has its own ground loop embedding and deembedding network. Otherwise the same
 embedding network and deembedding network is used for all active ports.

See the

[CALCulate<Ch>:TRANSform:VNETworks:GLOop:DEEMbedding<group>:...](#)
 and [CALCulate<Ch>:TRANSform:VNETworks:GLOop:EMBedding<group>:...](#)
 commands.

Suffix:

<Ch> Channel number

Parameters:

<Boolean> Range: ON (1) | OFF (0)
 *RST: OFF (0)

Manual operation: See ["Ground Loop per Port Group"](#) on page 751

CALCulate<Ch>:TRANSform:VNETworks:PPAir:DEEMbedding<ListId>:DEFine
 <PP_First>,<PP_Second>,<PP_First>,...

Creates one or more port pairs for port set deembedding. The command can be used repeatedly to extend or (partially) overwrite the list of port sets for deembedding.

See [CALCulate<Ch>:TRANSform:VNETworks:PSET:DEEMbedding<ListId>:DEFine](#) on page 1183 for general port set definition.

Suffix:

<Ch> Channel number

<ListId> Index of the defined port set within the channel's overall list of port sets for deembedding.
 Port sets for deembedding must be numbered consecutively, i.e. port set <ListId> can only be created if port set <ListId>-1 already exists. If several port pairs are specified, <ListId> is the number of the first port pair to be created.

Parameters:

<PP_First>, <PP_Second>, <PP_First>, ...
 Sequence of port pairs, each one consisting of two different ports.
 The port pairs don't have to be disjoint.

Example: See [CALCulate<Ch>:TRANSform:VNETworks:PPAir:DEEMbedding<ListId>\[:STATE\]](#)

Usage: Setting only

Manual operation: See ["Add / Delete"](#) on page 710

CALCulate<Ch>:TRANSform:VNETworks:PPAir:DEEMbedding:DELeTe

Deletes all port sets (including port pairs) previously defined for deembedding.

Suffix:

<Ch> Channel number

Example: See [CALCulate<Ch>:TRANSform:VNETworks:PPAir:DEEMbedding<ListId>\[:STATE\]](#)

Usage: Event

Manual operation: See ["Add / Delete"](#) on page 710

CALCulate<Ch>:TRANSform:VNETworks:PPAir:DEEMbedding<ListId>:

PARAMeters:C<1|2|3> <CircuitModel>, <Capacitance>

CALCulate<Ch>:TRANSform:VNETworks:PPAir:DEEMbedding<ListId>:

PARAMeters:C<1|2|3>? <CircuitModel>

Specifies the capacitance value C<i> in the different lumped circuit models for port pair deembedding.

In the query form, the <Capacitance> parameter must be omitted. The command returns the capacitance value for the specified circuit model.

Suffix:

<Ch>	Channel number
<ListId>	Index of the affected port pair (see CALCulate<Ch>:TRANSform:VNETworks:PPAir:DEEMbedding<ListId>:DEFine)
<1 2 3>	Index i of the capacitance C<i> in the related lumped circuit model. If unspecified the numeric suffix is set to 1.

Parameters:

<Capacitance>	Capacitance Ci
	Range: -1 mF to 1 mF
	Increment: 1 fF (1E-15 F)
	*RST: 1 pF (1E-12 F)
	Default unit: F

Parameters for setting and query:

<CircuitModel>	STSC SCST CSSL LSSC CSSC SLCS SCLS SCCS STSG SGST GSSL LSSG GSSG SLGS SGLS SGGS
	Circuit model whose capacitance C<i> shall be set, see Table 7-7

Example:

See [CALCulate<Ch>:TRANSform:VNETworks:PPAir:DEEMbedding<ListId>\[:STATE\]](#)

Manual operation: See "[Network](#)" on page 743

**CALCulate<Ch>:TRANSform:VNETworks:PPAir:DEEMbedding<ListId>:
PARAmeters:G<1|2|3> <CircuitModel>, <Conductance>**
**CALCulate<Ch>:TRANSform:VNETworks:PPAir:DEEMbedding<ListId>:
PARAmeters:G<1|2|3>? <CircuitModel>**

Specifies the conductance value G<i> in the different lumped circuit models for port pair deembedding.

In the query form, the <Conductance> parameter must be omitted. The command returns the conductance value for the specified circuit model.

Suffix:

<Ch>	Channel number
<ListId>	Index of the affected port pair (see CALCulate<Ch>:TRANSform:VNETworks:PPAir:DEEMbedding<ListId>:DEFine)
<1 2 3>	Index i of the conductance G<i> in the related lumped circuit model. If unspecified the numeric suffix is set to 1.

Parameters:

<Conductance> Conductance G<i> for the specified circuit model.
 Range: -1kS to 1 kS.
 Increment: 1 nS (1E-9 S)
 *RST: 0 S
 Default unit: Siemens (SI unit symbol: S)

Parameters for setting and query:

<CircuitModel> STSG | SGST | GSSL | LSSG | GSSG | SLGS | SGLS | SGGS
 Circuit model whose conductance G<i> shall be set, see [Table 7-7](#)

Manual operation: See "[Network](#)" on page 743

CALCulate<Ch>:TRANSform:VNETworks:PPAir:DEEMbedding<ListId>:

PARAmeters:L<1|2|3> <CircuitModel>, <Inductance>

CALCulate<Ch>:TRANSform:VNETworks:PPAir:DEEMbedding<ListId>:

PARAmeters:L<1|2|3>? <CircuitModel>

Specifies the inductance value L<i> in the different lumped circuit models for port pair deembedding.

In the query form, the <Inductance> parameter must be omitted. The command returns the inductance value for the specified circuit model.

Suffix:

<Ch> Channel number
 <ListId> Index of the affected port pair (see [CALCulate<Ch>:TRANSform:VNETworks:PPAir:DEEMbedding<ListId>:DEFine](#))
 <1|2|3> Index i of the inductance L<i> in the related lumped circuit model. If unspecified the numeric suffix is set to 1.

Parameters:

<Inductance> Inductance L<i>
 Range: -1 H to 1 H.
 Increment: 1 pH (1E-12 H)
 *RST: 1 nH (1E-9 H)
 Default unit: H

Parameters for setting and query:

<CircuitModel> STSL | SLST | CSSL | LSSC | LSSL | SLCS | SCLS | SLLS | GSSL | LSSG | SLGS | SGLS
 Circuit model whose inductance L<i> shall be set, see [Table 7-7](#)

Example: See [CALCulate<Ch>:TRANSform:VNETworks:PPAir:DEEMbedding<ListId>\[:STATE\]](#)

Manual operation: See "[Network](#)" on page 743

**CALCulate<Ch>:TRANSform:VNETworks:PPAir:DEEMbedding<ListId>:
PARAmeters:R<1|2|3> <CircuitModel>[, <Resistance>]**

Specifies the resistance value R<i> in the different lumped circuit models for port pair deembedding.

In the query form, the <Resistance> parameter must be omitted. The command returns the resistance value for the specified circuit model.

Suffix:

<Ch>	Channel number
<ListId>	Index of the affected port pair (see CALCulate<Ch>:TRANSform:VNETworks:PPAir:DEEMbedding<ListId>:DEFine)
<1 2 3>	Index i of the resistance R<i> in the related lumped circuit model. If unspecified the numeric suffix is set to 1.

Parameters:

<CircuitModel>	STSL STSC SLST SCST CSSL LSSC CSSC LSSL SLCS SCLS SCCS SLLS GSSL LSSG SLGS SGLS Circuit model whose resistance R<i> shall be set, see Table 7-7
<Resistance>	Resistance R<i> for the specified circuit model. Range: -10 MΩ to 10 MΩ Increment: 1 mΩ *RST: 0 Ω if the resistance is connected in series with an inductance. 10 MΩ if the resistance is connected in parallel with a capacitance) Default unit: Ohm

Example: See [CALCulate<Ch>:TRANSform:VNETworks:PPAir:DEEMbedding<ListId>\[:STATE\]](#)

Manual operation: See "[Network](#)" on page 743

**CALCulate<Ch>:TRANSform:VNETworks:PPAir:DEEMbedding<ListId>[:STATE]
<arg0>**

Enables or disables the deembedding function for port set (or port pair) <ListId>. It is allowed to change the deembedding network while embedding is enabled.

Suffix:

<Ch>	Channel number
<ListId>	Index of the affected port set

Parameters:

<arg0>	OFF (0): Deembedding inactive ON (1): Deembedding active *RST: OFF (0)
--------	--------------------------------------------------------------------------------------------

Example: *RST; CALC:TRAN:VNET:PPA:DEEM:DEF 1,2,3,4
 Define a port pair configuration with port pairs (1,2) and (3,4).
 CALC:TRAN:VNET:PPA:DEEM1:TND CSSL
 Select the Serial Cs, shunt L circuit model for the first port pair.
 CALC:TRAN:VNET:PPA:DEEM1:PAR:
 R3 CSSL, 2.2E+3; CALC:TRAN:VNET:PPA:DEEM1 ON
 Increase the resistance R3 for the Serial Cs, shunt L circuit
 model to 2.2 kΩ and enable deembedding.
 CALC:TRAN:VNET:PPA:DEEM:DEL
 Delete the port pair configuration.

Manual operation: See "Active" on page 711

CALCulate<Ch>:TRANSform:VNETworks:PPAir:DEEMbedding<ListId>: TNDefinition <arg0>

Selects the circuit model for port pair deembedding.

Suffix:

<Ch> Channel number
 <ListId> Index of the affected port pair (see [CALCulate<Ch>:
 TRANSform:VNETworks:PPAir:DEEMbedding<ListId>:
 DEFine](#))

Parameters:

<arg0> FIMPort | STSL | STSC | SLST | SCST | CSSL | LSSC | CSSC |
 LSSL | SLCS | SCLS | SCCS | SLLS | STSG | SGST | GSSL |
 LSSG | GSSG | SLGS | SGLS | SGGS
 Circuit model to be used for the addressed port pair, see
[Table 7-7](#)

Example: See [CALCulate<Ch>:TRANSform:VNETworks:PPAir:
 DEEMbedding<ListId>\[:STATE\]](#)

Manual operation: See "Network" on page 743

CALCulate<Ch>:TRANSform:VNETworks:PPAir:EMBedding<ListId>:DEFine <PP_First>,<PP_Second>,<PP_First>,...

Creates one or more port pairs for port set embedding. The command can be used repeatedly to extend or (partially) overwrite the list of port sets for embedding.

See [CALCulate<Ch>:TRANSform:VNETworks:PSET:EMBedding<ListId>:
 DEFine](#) for general port set definition.

Suffix:

<Ch> Channel number

<ListId> Index of the defined port set within the channel's overall list of port sets for embedding.
Port sets for embedding must be numbered consecutively, i.e. port set <ListId> can only be created if port set <ListId>-1 already exists. If several port pairs are specified, <ListId> is the number of the first port pair to be created.

Parameters:

<PP_First>, Sequence of port pairs, each one consisting of two different ports.
<PP_Second>,
<PP_First>, ... The port pairs don't have to be disjoint.

Example:

See [CALCulate<Ch>:TRANSform:VNETworks:PPAir:EMBedding<ListId>\[:STATE\]](#)

Usage:

Setting only

Manual operation: See ["Add / Delete"](#) on page 710

CALCulate<Ch>:TRANSform:VNETworks:PPAir:EMBedding<ListId>:DELEte

Deletes all port sets (including port pairs) previously defined for embedding.

Suffix:

<Ch> Channel number

<ListId> This suffix is ignored

Example:

See [CALCulate<Ch>:TRANSform:VNETworks:PPAir:EMBedding<ListId>\[:STATE\]](#)

Usage:

Event

Manual operation: See ["Add / Delete"](#) on page 710

CALCulate<Ch>:TRANSform:VNETworks:PPAir:EMBedding<ListId>:PARAmeters: C<1|2|3> <CircuitModel>, <Capacitance>**CALCulate<Ch>:TRANSform:VNETworks:PPAir:EMBedding<ListId>:PARAmeters: C<1|2|3>? <CircuitModel>**

Specifies the capacitance value C<i> in the different lumped circuit models for port pair embedding.

In the query form, the <Capacitance> parameter must be omitted. The command returns the capacitance value for the specified circuit model.

Suffix:

<Ch> Channel number

<ListId> Index of the affected port pair (see [CALCulate<Ch>:TRANSform:VNETworks:PPAir:DEEMbedding<ListId>:DEFine](#))

<1|2|3> Index i of the capacitance C<i> in the related lumped circuit model. If unspecified the numeric suffix is set to 1.

Parameters:

<Capacitance> Capacitance Ci
 Range: -1 mF to 1 mF
 Increment: 1 fF (1E-15 F)
 *RST: 1 pF (1E-12 F)
 Default unit: F

Parameters for setting and query:

<CircuitModel> STSC | SCST | CSSL | LSSC | CSSC | SLCS | SCLS | SCCS |
 STSG | SGST | GSSL | LSSG | GSSG | SLGS | SGLS | SGGS
 Circuit model whose capacitance C<i> shall be set, see
[Table 7-7](#)

Example: See `CALCulate<Ch>:TRANSform:VNETworks:PPAir:
 EMBedding<ListId>[:STATE]`

Manual operation: See "[Network](#)" on page 743

**CALCulate<Ch>:TRANSform:VNETworks:PPAir:EMBEdding<ListId>:PARAMeters:
 L<1|2|3> <arg0>, <Inductance>**

**CALCulate<Ch>:TRANSform:VNETworks:PPAir:EMBEdding<ListId>:PARAMeters:
 L<1|2|3>? <arg0>**

Specifies the inductance value L<i> in the different lumped circuit models for port pair embedding.

In the query form, the <Inductance> parameter must be omitted. The command returns the inductance value for the specified circuit model.

Suffix:

<Ch> Channel number
 <ListId> Index of the affected port pair (see `CALCulate<Ch>:
 TRANSform:VNETworks:PPAir:DEEMBEdding<ListId>:
 DEFine`)
 <1|2|3> Index i of the inductance L<i> in the related lumped circuit
 model. If unspecified the numeric suffix is set to 1.

Parameters:

<Inductance> Inductance L<i>
 Range: -1 H to 1 H.
 Increment: 1 pH (1E-12 H)
 *RST: 1 nH (1E-9 H)
 Default unit: H

Parameters for setting and query:

<arg0> STSL | SLST | CSSL | LSSC | LSSL | SLCS | SCLS | SLLS |
 GSSL | LSSG | SLGS | SGLS
 Circuit model whose inductance L<i> shall be set, see [Table 7-7](#)

Example: See `CALCulate<Ch>:TRANSform:VNETworks:PPAir:
 EMBedding<ListId>[:STATE]`

Manual operation: See ["Network"](#) on page 743

**CALCulate<Ch>:TRANSform:VNETworks:PPAir:EMBedding<ListId>:PARAmeters:
R<1|2|3> <arg0>, <Resistance>**

**CALCulate<Ch>:TRANSform:VNETworks:PPAir:EMBedding<ListId>:PARAmeters:
R<1|2|3>? <arg0>**

Specifies the resistance value R<i> in the different lumped circuit models for port pair embedding.

In the query form, the <Resistance> parameter must be omitted. The command returns the resistance value for the specified circuit model.

Suffix:

<Ch>	Channel number
<ListId>	Index of the affected port pair (see CALCulate<Ch>:TRANSform:VNETworks:PPAir:DEEMbedding<ListId>:DEFine)
<1 2 3>	Index i of the resistance R<i> in the related lumped circuit model. If unspecified the numeric suffix is set to 1.

Parameters:

<Resistance>	Resistance R<i> for the specified circuit model. Range: -10 MΩ to 10 MΩ Increment: 1 mΩ *RST: 0 Ω if the resistance is connected in series with an inductance. 10 MΩ if the resistance is connected in parallel with a capacitance) Default unit: Ohm
--------------	-------------------------------------------------------------------------------------------------------------------------------------------------------------------------------------------------------------------------------------------------------------------

Parameters for setting and query:

<arg0>	STSL STSC SLST SCST CSSL LSSC CSSC LSSL SLCS SCLS SCCS SLLS GSSL LSSG SLGS SGLS Circuit model whose resistance R<i> shall be set, see Table 7-7
--------	--------------------------------------------------------------------------------------------------------------------------------------------------------------------------------------------------

Example: See [CALCulate<Ch>:TRANSform:VNETworks:PPAir:EMBedding<ListId>\[:STATe\]](#)

Manual operation: See ["Network"](#) on page 743

**CALCulate<Ch>:TRANSform:VNETworks:PPAir:EMBedding<ListId>:PARAmeters:
G<1|2|3> <arg0>, <Conductance>**

**CALCulate<Ch>:TRANSform:VNETworks:PPAir:EMBedding<ListId>:PARAmeters:
G<1|2|3>? <arg0>**

Specifies the conductance value G<i> in the different lumped circuit models for port pair embedding.

In the query form, the <Conductance> parameter must be omitted. The command returns the conductance value for the specified circuit model.

Suffix:	
<Ch>	Channel number
<ListId>	Index of the affected port pair (see CALCulate<Ch>:TRANSform:VNETworks:PPAir:DEEMbedding<ListId>:DEFine)
<1 2 3>	Index i of the conductance G<i> in the related lumped circuit model. If unspecified the numeric suffix is set to 1.
Parameters:	
<Conductance>	Conductance G<i> for the specified circuit model. Range: -1kS to 1 kS. Increment: 1 pS (1E-12 S) *RST: 0 S Default unit: Siemens (SI unit symbol: S)
Parameters for setting and query:	
<arg0>	STSG SGST GSSL LSSG GSSG SLGS SGLS SGGS Circuit model whose conductance G<i> shall be set, see Table 7-7
Manual operation:	See " Network " on page 743

CALCulate<Ch>:TRANSform:VNETworks:PPAir:EMBedding<ListId>[:STATe] <Boolean>

Enables or disables the embedding function for **port set** <ListId>. It is allowed to change the embedding network while embedding is enabled.

Suffix:	
<Ch>	Channel number
<ListId>	Index of the affected port set (see CALCulate<Ch>:TRANSform:VNETworks:PPAir:EMBedding<ListId>:DEFine)

Parameters:	
<Boolean>	OFF (0): Embedding inactive ON (1): Embedding active *RST: OFF (0)

Example:

```
*RST; CALC:TRAN:VNET:PPA:EMB:DEF 1,2,3,4
Define a port pair configuration with port pairs (1,2) and (3,4).
CALC:TRAN:VNET:PPA:EMB1:TND CSSL
Select the Serial Cs, shunt L circuit model for the first port pair.
CALC:TRAN:VNET:PPA:EMB1:PAR:
R3 CSSL, 2.2E+3; CALC:TRAN:VNET:PPA:EMB1 ON
Increase the resistance R3 for the Serial Cs, shunt L circuit
model to 2.2 kΩ and enable deembedding.
CALC:TRAN:VNET:PPA:EMB:DEL
Delete the port pair configuration.
```

Manual operation: See ["Active"](#) on page 711

CALCulate<Ch>:TRANSform:VNETworks:PPAir:EMBedding<ListId>:TNDefinition
<CircuitModel>

Selects the circuit model for port pair embedding.

Suffix:

<Ch> Channel number

<ListId> Index of the affected port pair (see [CALCulate<Ch>:TRANSform:VNETworks:PPAir:EMBedding<ListId>:DEFine](#))

Parameters:

<CircuitModel> FIMPort | STSL | STSC | SLST | SCST | CSSL | LSSC | CSSC | LSSL | SLCS | SCLS | SCCS | SLLS | STSG | SGST | GSSL | LSSG | GSSG | SLGS | SGLS | SGGS

Circuit model to be used for the addressed port pair, see [Table 7-7](#)

Example: See [CALCulate<Ch>:TRANSform:VNETworks:PPAir:EMBedding<ListId>\[:STATE\]](#)

Manual operation: See ["Network"](#) on page 743

CALCulate<Ch>:TRANSform:VNETworks:PSET:DEEMbedding<ListId>:DEFine
<Port1>, <Port2>[, <Port3>[, <Port4>]]

CALCulate<Ch>:TRANSform:VNETworks:PSET:EMBedding<ListId>:DEFine
<Port1>, <Port2>, ...

Defines port set <ListId> for port set deembedding/embedding.

Note that **port pairs** (i.e. 2-element port sets) can also be created using [CALCulate<Ch>:TRANSform:VNETworks:PPAir:DEEMbedding<ListId>:DEFine](#) / [CALCulate<Ch>:TRANSform:VNETworks:PPAir:EMBedding<ListId>:DEFine](#).

Use [CALCulate<Ch>:TRANSform:VNETworks:PPAir:DEEMbedding:DELeTe](#) / [CALCulate<Ch>:TRANSform:VNETworks:PPAir:EMBedding<ListId>:DELeTe](#) on page 1179 to delete all port sets (including port pairs).

Suffix:

<Ch> Channel number

<ListId> Index of the defined port set within the channel's overall list of port sets for deembedding/embedding.

Parameters:

<Port1>, <Port2>, ... A port set consist of two or more (different) ports.
A port can be an element of multiple port sets.

Manual operation: See ["Add / Delete"](#) on page 710

**CALCulate<Ch>:TRANSform:VNETworks:SENDED:DEEMbedding<PhyPt>:
PARAMeters:C<Cmp>** <CircuitModel>, <Capacitance>
**CALCulate<Ch>:TRANSform:VNETworks:SENDED:DEEMbedding<PhyPt>:
PARAMeters:C<Cmp>?** <CircuitModel>

Specifies the capacitance value C<Cmp> in the different circuit models for single ended port embedding.

In the query form, the <Capacitance> parameter must be omitted. The command returns the capacitance value for the specified circuit model.

Suffix:

<Ch>	Channel number
<PhyPt>	Physical port number
<Cmp>	Number of capacitance in circuit model. The total number of capacitances depends on the selected circuit model.

Parameters:

<Capacitance>	Capacitance C<Cmp> for the specified circuit model. Range: -1mF to 1 mF. Increment: 1 fF (1E-15 F) *RST: 1 pF (1E-12 F) Default unit: F
---------------	-----------------------------------------------------------------------------------------------------------------------------------------------------

Parameters for setting and query:

<CircuitModel>	CSL LSC CSC SLC SCL SCC SHLC GSL LSG GSG SLG SGL SGG Possible circuit models (character data); see Table 7-6 .
----------------	-----------------------------------------------------------------------------------------------------------------------------------------------------------

Example:

```
*RST; :CALC:TRAN:VNET:SEND:DEEM:PAR:C2? CSC
Query the default capacitance C2 for the Serial C, shunt C circuit model. The response is 1E-012 (1 pF).
CALC:TRAN:VNET:SEND:DEEM:PAR:C2 CSC, 2.2E-12
Increase the capacitance to 2.2 pF.
```

Manual operation: See "[Network](#)" on page 726

**CALCulate<Ch>:TRANSform:VNETworks:SENDED:DEEMbedding<PhyPt>:
PARAMeters:DATA** <Interchange>, <arg1>

Defines an embedding network for a single-ended port based on the given S-Parameter traces.

Use

- [CALCulate<Ch>:TRANSform:VNETworks:SENDED:DEEMbedding<PhyPt>:TNDefinition](#) to select the adequate circuit model **before** executing this command.
- [MMEMemory:LOAD:VNETworks<Ch>:SENDED:DEEMbedding<PhyPt>](#) to load circuit data from a Touchstone file located at the R&S ZNA's file system.

Suffix:

<Ch>	Channel number
<PhyPt>	Physical port number

Setting parameters:

<Interchange>	FPORts IPORts SGATes FPORts (or omitted) Standard port sequence (network port 1 towards VNA, network port 2 towards DUT) IPORts SGATes Inverted port sequence (network port 2 towards VNA, network port 1 towards DUT)
---------------	--------------------------------------------------------------------------------------------------------------------------------------------------------------------------------------------------------------------------------------------------------

<arg1>	<block_data> Content of a Touchstone file (*.s2p) in IEEE488.2 Block data format .
--------	-------------------------------------------------------------------------------------------------------

Usage:	Setting only
---------------	--------------

**CALCulate<Ch>:TRANSform:VNETworks:SENDEd:DEEMbedding<PhyPt>:
PARAmeters:G<Cmp>** <CircuitModel>, <Conductance>

**CALCulate<Ch>:TRANSform:VNETworks:SENDEd:DEEMbedding<PhyPt>:
PARAmeters:G<Cmp>?** <CircuitModel>

Specifies the conductance value G in the "shunt L, shunt C" circuit model for single ended port deembedding.

In the query form, the <Conductance> parameter must be omitted.

Suffix:

<Ch>	Channel number
<PhyPt>	Physical port number
<Cmp>	Number of the conductance component in the circuit model. The total number of conductances depends on the selected circuit model.

Parameters:

<Conductance>	Conductance G<Cmp> for the specified circuit model. Range: -1kS to 1 kS. Increment: 1 nS (1E-9 S) *RST: 0 S Default unit: Siemens (SI unit symbol: S)
---------------	-------------------------------------------------------------------------------------------------------------------------------------------------------------------

Parameters for setting and query:

<CircuitModel>	SHLC Circuit model whose conductance G<Cmp> shall be set, see Table 7-6 .
----------------	----------------------------------------------------------------------------------------------

Example: ***RST**; :**CALC**:**TRAN**:**VNET**:**SEND**:**DEEM**:**PAR**:**L**? **SHLC**; **R**?
SHLC; **C**? **SHLC**; **G**? **SHLC**
 Query the default component values for the "shunt L, shunt C"
 circuit model.
CALC:**TRAN**:**VNET**:**SEND**:**DEEM**:**PAR**:**G** **SHLC**, 1
 Increase the conductance G to 1 Siemens.

Manual operation: See "[Network](#)" on page 726

CALCulate<Ch>:TRANSform:VNETworks:SENDEd:DEEMbedding<PhyPt>:

PARAMeters:L<Cmp> <CircuitModel>, <Inductance>

CALCulate<Ch>:TRANSform:VNETworks:SENDEd:DEEMbedding<PhyPt>:

PARAMeters:L<Cmp>? <CircuitModel>

Specifies the inductance value L<Cmp> in the different circuit models for single ended port deembedding.

In the query form, the <Inductance> parameter must be omitted. The command returns the inductance value for the specified circuit model.

Suffix:

<Ch> Channel number

<PhyPt> Physical port number

<Cmp> Number of inductance in circuit model. The total number of inductances depends on the selected circuit model.

Parameters:

<Inductance> Inductance L<Cmp> for the specified circuit model.

Range: -1H to 1 H.

Increment: 1 pH (1E-12 H)

*RST: 1 nH (1E-9 H)

Default unit: H

Parameters for setting and query:

<CircuitModel> **CSL** | **LSC** | **LSL** | **SLC** | **SCL** | **SLL** | **SHLC** | **GSL** | **LSG** | **SLG** | **SGL**

Possible circuit models (character data); see [Table 7-6](#).

Example: ***RST**; :**CALC**:**TRAN**:**VNET**:**SEND**:**DEEM**:**PAR**:**L1**? **SLL**
 Query the default inductance L1 for the Shunt L, serial L circuit model. The response is 1E-009 (1 nH).

CALC:**TRAN**:**VNET**:**SEND**:**DEEM**:**PAR**:**L1** **SLL**, 2.2E-9

Increase the inductance to 2.2 nH.

Manual operation: See "[Network](#)" on page 726

**CALCulate<Ch>:TRANSform:VNETworks:SENDEd:DEEMbedding<PhyPt>:
PARAmeters:R<Cmp>** <CircuitModel>, <Resistance>
**CALCulate<Ch>:TRANSform:VNETworks:SENDEd:DEEMbedding<PhyPt>:
PARAmeters:R<Cmp>?** <CircuitModel>

Specifies the resistance value R<Cmp> in the different circuit models for single ended port deembedding.

In the query form, the <Resistance> parameter must be omitted. The command returns the resistance value for the specified circuit model.

Suffix:

<Ch> Channel number
 <PhyPt> Physical port number
 <Cmp> Number of resistance in circuit model. The total number of resistances depends on the selected circuit model.

Parameters:

<Resistance> Resistance R<Cmp> for the specified circuit model.
 Range: -10 MΩ to 10 MΩ.
 Increment: 1 mΩ (1E-3 Ω)
 *RST: 0 Ω for all resistances connected in series with an inductance. 10 MΩ for all resistances connected in parallel with a capacitance
 Default unit: Ohm

Parameters for setting and query:

<CircuitModel> CSL | LSC | CSC | LSL | SLC | SCL | SCC | SLL | SHLC | GSL | LSG | SLG | SGL
 Possible circuit models (character data); see [Table 7-6](#).

Example:

```
*RST; :CALC:TRAN:VNET:SEND:DEEM:PAR:R1? CSL;
R2? CSL
Query the default resistances for the Serial C, shunt L circuit
model. The response is 10000000; 0.
CALC:TRAN:VNET:SEND:DEEM:PAR:R2 CSL, 2.2E+3
Increase the resistance R2 to 2.2 kΩ.
```

Manual operation: See "[Network](#)" on page 726

**CALCulate<Ch>:TRANSform:VNETworks:SENDEd:DEEMbedding<PhyPt>[:
STATE]** <Boolean>

Enables or disables the deembedding function for single ended ports. It is allowed to change the circuit model and its parameters while deembedding is enabled.

Suffix:

<Ch> Channel number
 <PhyPt> Physical port number

Parameters:

<Boolean> ON - deembedding active
 OFF - deembedding inactive
 *RST: OFF

Example:

```
CALC:TRAN:VNET:SEND:DEEM:TND CSL
Select the Serial C, shunt L circuit model for deembedding.
CALC:TRAN:VNET:SEND:DEEM:PAR:R2 CSL, 2.2E+3; :
CALC:TRAN:VNET:SEND:DEEM ON
Increase the resistance R2 for the Serial C, shunt L circuit model
to 2.2 kΩ and enable deembedding.
```

Manual operation: See ["Active"](#) on page 709

**CALCulate<Ch>:TRANSform:VNETworks:SENDEd:DEEMbedding<PhyPt>:
 TNDefinition <CircuitModel>**

Selects the circuit model for single ended port deembedding.

Suffix:

<Ch> Channel number
 <PhyPt> Physical port number

Parameters:

<CircuitModel> FIMPort | CSL | LSC | CSC | LSL | SLC | SCL | SCC | SLL |
 SHLC | GSL | LSG | GSG | SLG | SGL | SGG
 Possible circuit models (character data); see [Table 7-6](#)
 *RST: CSL

Example:

See [CALCulate<Ch>:TRANSform:VNETworks:SENDEd:DEEMbedding<PhyPt>\[:STATE\]](#)

Manual operation: See ["Network"](#) on page 726

**CALCulate<Ch>:TRANSform:VNETworks:SENDEd:EMBedding<PhyPt>:
 PARAmeters:C<Cmp> <CircuitModel>, <Capacitance>**

**CALCulate<Ch>:TRANSform:VNETworks:SENDEd:EMBedding<PhyPt>:
 PARAmeters:C<Cmp>? <CircuitModel>**

Specifies the capacitance value C<Cmp> in the different circuit models for single ended port embedding.

In the query form, the <Capacitance> parameter must be omitted. The command returns the capacitance value for the specified circuit model.

Suffix:

<Ch> Channel number
 <PhyPt> Physical port number
 <Cmp> Number of capacitance in circuit model. The total number of capacitances depends on the selected circuit model.

Parameters:

<Capacitance> Capacitance C<Cmp> for the specified circuit model.
 Range: -1mF to 1 mF.
 Increment: 1 fF (1E-15 F)
 *RST: 1 pF (1E-12 F)
 Default unit: F

Parameters for setting and query:

<CircuitModel> CSL | LSC | CSC | SLC | SCL | SCC | SHLC | GSL | LSG |
 GSG | SLG | SGL | SGG
 Possible circuit models (character data); see [Table 7-6](#).

Example:

```
*RST; :CALC:TRAN:VNET:SEND:EMB:PAR:C2? CSC
Query the default capacitance C2 for the Serial C, shunt C cir-
cuit model. The response is 1E-012 (1 pF).
CALC:TRAN:VNET:SEND:EMB:PAR:C2 CSC, 2.2E-12
Increase the capacitance to 2.2 pF.
```

Manual operation: See "[Network](#)" on page 726

CALCulate<Ch>:TRANSform:VNETworks:SENDED:EMBedding<PhyPt>:

PARAMeters:DATA <Interchange>, <arg1>

Defines a dembedding network for a single-ended port based on the given S-Parameter traces.

Use

- [CALCulate<Ch>:TRANSform:VNETworks:SENDED:EMBedding<PhyPt>:TNDefinition](#) to select the adequate circuit model **before** executing this command.
- [MMEMemory:LOAD:VNETworks<Ch>:SENDED:EMBedding<PhyPt>](#) to load circuit data from a Touchstone file located at the R&S ZNA's file system.

Suffix:

<Ch> Channel number
 <PhyPt> Physical port number

Setting parameters:

<Interchange> FPORts | IPORts | SGATes
FPORts (or omitted)
 Standard port sequence (network port 1 towards VNA, network port 2 towards DUT)
IPORts | SGATes
 Inverted port sequence (network port 2 towards VNA, network port 1 towards DUT)

<arg1> <block_data>
 Content of a Touchstone file (*.s2p or *.s4p) in IEEE488.2 [Block data format](#).

Usage: Setting only

**CALCulate<Ch>:TRANSform:VNETworks:SENDED:EMBedding<PhyPt>:
PARAMeters:G<Cmp>** <CircuitModel>, <Conductance>
**CALCulate<Ch>:TRANSform:VNETworks:SENDED:EMBedding<PhyPt>:
PARAMeters:G<Cmp>?** <CircuitModel>

Specifies the conductance value G<Cmp> in the different circuit models for single ended port embedding.

In the query form, the <Conductance> parameter must be omitted. The command returns the conductance value for the specified circuit model.

Suffix:

<Ch>	Channel number
<PhyPt>	Physical port number
<Cmp>	Number of the conductance component in the circuit model. The total number of conductances depends on the selected circuit model.

Parameters:

<Conductance>	Conductance G<Cmp> for the specified circuit model. Range: -1kS to 1 kS. Increment: 1 pS (1E-12 S) *RST: 0 S Default unit: Siemens (SI unit symbol: S)
---------------	--------------------------------------------------------------------------------------------------------------------------------------------------------------------

Parameters for setting and query:

<CircuitModel>	GSL LSG GSG SLG SGL SGG SHLC Circuit model whose conductance G<Cmp> shall be set, see Table 7-6 .
----------------	----------------------------------------------------------------------------------------------------------------------------------

Example:

```
*RST; :CALC:TRAN:VNET:SEND:EMB:PAR:L? SHLC; R?
SHLC; C? SHLC; G? SHLC
Query the default component values for the "shunt L, shunt C"
circuit model.
CALC:TRAN:VNET:SEND:EMB:PAR:G SHLC, 1
Increase the conductance G to 1 Siemens.
```

Manual operation: See "[Network](#)" on page 726

**CALCulate<Ch>:TRANSform:VNETworks:SENDED:EMBedding<PhyPt>:
PARAMeters:L<Cmp>** <CircuitModel>, <Inductance>
**CALCulate<Ch>:TRANSform:VNETworks:SENDED:EMBedding<PhyPt>:
PARAMeters:L<Cmp>?** <CircuitModel>

Specifies the inductance value L<Cmp> in the different circuit models for single ended port embedding.

In the query form, the <Inductance> parameter must be omitted. The command returns the inductance value for the specified circuit model.

Suffix:

<Ch>	Channel number
------	----------------

<PhyPt>	Physical port number
<Cmp>	Number of inductance in circuit model. The total number of inductances depends on the selected circuit model.

Parameters:

<Inductance>	Inductance L<Cmp> for the specified circuit model. Range: -1H to 1 H. Increment: 1 pH (1E-12 H) *RST: 1 nH (1E-9 H) Default unit: H
--------------	-------------------------------------------------------------------------------------------------------------------------------------------------

Parameters for setting and query:

<CircuitModel>	CSL LSC LSL SLC SCL SLL SHLC GSL LSG SLG SGL Possible circuit models (character data); see Table 7-6 .
----------------	-----------------------------------------------------------------------------------------------------------------------------------------------

Example:

```
*RST; :CALC:TRAN:VNET:SEND:EMB:PAR:L1? SLL
Query the default inductance L1 for the Shunt L, serial L circuit
model. The response is 1E-009 (1 nH).
CALC:TRAN:VNET:SEND:EMB:PAR:L1 SLL, 2.2E-9
Increase the inductance to 2.2 nH.
```

Manual operation: See "[Network](#)" on page 726

**CALCulate<Ch>:TRANSform:VNETworks:SENDEd:EMBedding<PhyPt>:
PARAmeters:R<Cmp> <CircuitModel>, <Resistance>
CALCulate<Ch>:TRANSform:VNETworks:SENDEd:EMBedding<PhyPt>:
PARAmeters:R<Cmp>? <CircuitModel>**

Specifies the resistance value R<Cmp> in the different circuit models for single ended port embedding.

In the query form, the <Resistance> parameter must be omitted. The command returns the resistance value for the specified circuit model.

Suffix:

<Ch>	Channel number
<PhyPt>	Physical port number
<Cmp>	Number of resistance in circuit model. The total number of resistances depends on the selected circuit model.

Parameters:

<Resistance>	Resistance R<Cmp> for the specified circuit model. Range: -10 MΩ to 10 MΩ. Increment: 1 mΩ (1E-3 Ω) *RST: 0 Ω for all resistances connected in series with an inductance. 10 MΩ for all resistances connected in parallel with a capacitance Default unit: Ohm
--------------	----------------------------------------------------------------------------------------------------------------------------------------------------------------------------------------------------------------------------------------------------------------------------

Parameters for setting and query:

<CircuitModel> CSL | LSC | CSC | LSL | SLC | SCL | SCC | SLL | SHLC | GSL | LSG | SLG | SGL

Possible circuit models (character data); see [Table 7-6](#).

Example:

```
*RST; :CALC:TRAN:VNET:SEND:EMB:PAR:R1? CSL; R2?
CSL
```

Query the default resistances for the Serial C, shunt L circuit model. The response is 10000000; 0.

```
CALC:TRAN:VNET:SEND:EMB:PAR:R2 CSL, 2.2E+3
```

Increase the resistance R2 to 2.2 kΩ.

Manual operation: See ["Network"](#) on page 726

CALCulate<Ch>:TRANSform:VNETworks:SENDEd:EMBedding<PhyPt>[:STATe]
<Boolean>

Enables or disables the embedding function for single ended ports. It is allowed to change the circuit model and its parameters while embedding is enabled.

Suffix:

<Ch> Channel number

<PhyPt> Physical port number

Parameters:

<Boolean> ON - embedding active
OFF - embedding inactive

```
*RST: OFF
```

Example:

```
CALC:TRAN:VNET:SEND:EMB:TND CSL
```

Select the Serial C, shunt L circuit model for embedding.

```
CALC:TRAN:VNET:SEND:EMB:PAR:R2 CSL, 2.2E+3; :
```

```
CALC:TRAN:VNET:SEND:EMB ON
```

Increase the resistance R2 for the Serial C, shunt L circuit model to 2.2 kΩ and enable embedding.

Manual operation: See ["Active"](#) on page 709

CALCulate<Ch>:TRANSform:VNETworks:SENDEd:EMBedding<PhyPt>:
TNDefinition <CircuitModel>

Selects the circuit model for single ended port embedding.

Suffix:

<Ch> Channel number

<PhyPt> Physical port number

Parameters:

<CircuitModel> FIMPort | CSL | LSC | CSC | LSL | SLC | SCL | SCC | SLL | SHLC | GSL | LSG | GSG | SLG | SGL | SGG

Possible circuit models (character data); see [Table 7-6](#)

*RST: CSL

Example:

See `CALCulate<Ch>:TRANSform:VNETworks:SENDED:EMBedding<PhyPt>[:STATe]`

Manual operation: See "[Network](#)" on page 726

CALCulate<Ch>:TRANSform:VNETworks:WAVes <Boolean>

Defines whether the wave-based, or the classical S parameter-based de-/embedding calculation is used in channel <Ch>.

Suffix:

<Ch> Channel number

Parameters:

<Boolean> **ON (1)**
Wave-based calculation (default)

OFF (0)
S parameter-based calculation

Manual operation: See "[Offset > Wave De-/Embed.](#)" on page 754

CALCulate:TRANSform... (other)**CALCulate<Chn>:TRANSform:COMPLex <Result>**

Converts S-parameters into converted (matched-circuit) Y-parameters or Z-parameters and vice versa, assuming that port no. i is terminated with Z_{0i} so that the three parameter sets are equivalent and the following formulas apply:

$$Z_{ii} = Z_{0i} \frac{1 + S_{ii}}{1 - S_{ii}}$$

$$Z_{ij} = 2 \frac{\sqrt{Z_{0i} Z_{0j}}}{S_{ij}} - (Z_{0i} + Z_{0j}) \quad \text{for } i \neq j$$

$$Y_{ii} = 1/Z_{ij} = \frac{1}{Z_{0i}} \cdot \frac{1 - S_{ii}}{1 + S_{ii}}$$

$$Y_{ij} = 1/Z_{ij} = \frac{S_{ij}}{2\sqrt{Z_{0i} Z_{0j}} - S_{ij}(Z_{0i} + Z_{0j})} \quad \text{for } i \neq j$$

Suffix:

<Chn> Channel number used to identify the active trace

Parameters:

<Result> S | Y | Z
S-parameters, Y-parameters, Z-parameters

Example:

```
*RST; CALC:PAR:MEAS 'Trc1', 'Y-S22'
```

Select the converted admittance Y <-- S22 as measurement parameter of the default trace.

```
CALC:TRAN:COMP S
```

Convert the converted Y-parameter into an S-parameter.

CALCulate<Chn>:TRANSform:IMPedance:RNORmal <Model>

Selects the theory for the renormalization of port impedances. The selection has an impact on the conversion formulas for wave quantities and S-parameters.

Suffix:

<Chn> Channel number used to identify the active trace

Parameters:

<Model> TWAVes | PWAVes
TWAVes - travelling waves
PWAVes - power waves
*RST: TWAVes

Example: See [\[SENSe<Ch>:\]PORT<PhyPt>:ZREference](#)

Manual operation: See "[Renormalization According to Theory of](#)" on page 357

7.3.1.15 CALCulate:TTIME:...

Defines the properties and retrieves the results of the rise time measurement provided with the [Extended time domain analysis](#) option R&S ZNA-K20.

CALCulate<Chn>:TTIME:DATA?	1194
CALCulate<Chn>:TTIME:STATE	1195
CALCulate<Chn>:TTIME:THReshold	1195

CALCulate<Chn>:TTIME:DATA? [<Data>]

Queries the results of the rise time measurement

Suffix:

<Chn> Channel number used to identify the active trace

Query parameters:

<Data> ALL
If omitted, a single numeric value is returned. If ALL is specified, the result consists of 6 numeric values. Furthermore, the interpretation of the result values depends on the current trace's stimulus axis ([CALCulate<Chn>:TRANSform:TIME:XAXis](#)). See the table below.

Usage: Query only

Options: R&S ZNA-K20

Manual operation: See "[Extended Info](#)" on page 826

	<Data> omitted	<Data> = ALL
Stimulus axis: time	<rise time>	<rise time>, <rise distance>, <start threshold crossing time>, <start threshold crossing voltage>, <stop threshold crossing time>, <stop threshold crossing voltage>
Stimulus axis: distance	<rise distance>	<rise distance>, <rise time>, <start threshold crossing distance>, <start threshold crossing voltage>, <stop threshold crossing distance>, <stop threshold crossing voltage>

CALCulate<Chn>:TTIME:STATe <Boolean>

Enables/disables the [Rise Time Measurement](#).

Note: The rise time measurement can only be enabled if the active trace is real (CALCulate<Chn>:FORMat REAL), Time Domain is enabled (CALCulate<Chn>:TRANSform:TIME:STATe ON), and the Low Pass Step time domain transform is used (CALCulate<Chn>:TRANSform:TIME[:TYPE] LPASs and CALCulate<Chn>:TRANSform:TIME:STIMulus STEP). The latter, in turn, requires the stimulus grid to be harmonic. This can be achieved, for example, using [SENSe<Ch>:]HARMonic:AUTO ON.

Suffix:
<Chn> Channel number used to identify the active trace

Parameters:
<Boolean> ON – Rise time measurement enabled
OFF – Rise time measurement disabled
*RST: OFF

Options: R&S ZNA-K20

Manual operation: See "[Rise Time](#)" on page 826

CALCulate<Chn>:TTIME:THReshold <ThresholdEnum|LowerThreshold>[, <UpperThreshold>]

Defines the lower/upper threshold for the rise time measurement.

The thresholds can either be specified by enum constants for the standard 10–90% or 20–80% rise times, or as integer percentages.

Suffix:
<Chn> Channel number used to identify the active trace

Parameters:

<ThresholdEnum|LowerThreshold>: 0–100% rise time
 T2_8: 20–80% rise time
 <integer>: Lower rise time threshold as integer percentage
 *RST: T1_9:
 <UpperThreshold> Upper rise time threshold as integer percentage

Options: R&S ZNA-K20

Manual operation: See "[Start Value / Stop Value](#)" on page 826

7.3.1.16 CALCulate... (other)

CALCulate:CLIMits:FAIL?	1196
CALCulate<Chn>:DLINe	1197
CALCulate<Chn>:DLINe:STATe	1197
CALCulate<Chn>:FORMat	1197
CALCulate<Chn>:FORMat:WQUType	1199
CALCulate<Chn>:GDAPerture:SCOUnt	1199
CALCulate<Chn>:IAverage:MODE	1199
CALCulate<Chn>:IAverage[:STATe]	1200
CALCulate<Chn>:PHOLd	1200
CALCulate<Chn>:SMOothing:APERture	1201
CALCulate<Chn>:SMOothing[:STATe]	1201
CALCulate<Ch>:TDIF:IMBalance:COMPensation[:STATe]	1201
CALCulate:TDVSwr[:STATe]	1202

CALCulate:CLIMits:FAIL?

Returns a 0 or 1 to indicate whether or not a global, composite limit check on several traces has failed.

Since V2.20 of the R&S ZNA FW the result is automatically recalculated whenever a relevant setting is changed, i.e. a subsequent query will return the updated limit violation state.

Example:

```
*RST; CALC:LIM:CONT 1 GHZ, 2 GHZ
```

Define an upper limit line segment in the stimulus range between 1 GHz and 2 GHz, using default response values.

```
CALC:LIM:STAT ON; FAIL?
```

Switch the limit check on and query the result.

```
CALC:CLIM:FAIL?
```

Query the result for the composite limit check. As only one trace is tested, the response should be equal to the previous response.

Usage: Query only

Manual operation: See "[Global Check](#)" on page 481

CALCulate<Chn>:DLINe <Position>

Defines the position (response value) of the horizontal line.

Suffix:

<Chn> Channel number used to identify the active trace

Parameters:

<Position> See list of parameters below.

Default unit: NN

Example:

```
*RST; :CALC:DLIN 10
```

Define the position of the horizontal line in the default dB Mag diagram at +10 dB.

```
CALC:DLIN:STAT ON
```

Display the defined horizontal line.

Manual operation: See ["Response Value"](#) on page 498

CALCulate<Chn>:DLINe:STATe <Boolean>

Switches the horizontal line on or off.

Suffix:

<Chn> Channel number used to identify the active trace

Parameters:

<Boolean> ON | OFF - horizontal line on or off

```
*RST: OFF
```

Example:

See [CALCulate<Chn>:DLINe](#)

Manual operation: See ["Show Horiz. Line"](#) on page 498

CALCulate<Chn>:FORMat <Type>

Defines how the measured result at any sweep point is post-processed and presented in the graphical display.

Note: The analyzer allows arbitrary combinations of display formats and measured quantities; see [Chapter 5.3, "Format softtool"](#), on page 419 and `CALCulate<Ch>:PARAmeter...` commands. Nevertheless, it is advisable to check which display formats are generally appropriate for an analysis of a particular measured quantity; see [Chapter 4.2.3.3, "Measured quantities and trace formats"](#), on page 148.

Suffix:

<Chn> Channel number used to identify the active trace

Parameters:

<Type>

MLINear | MLOGarithmic | PHASe | UPHase | POLar | SMITH | ISMith | GDElay | REAL | IMAGinary | SWR | COMPLex | MAGNitude | LOGarithmic

See list of parameters below.

*RST: MLOGarithmic

Example:

CALC4:PAR:SDEF 'Ch4Tr1', 'S11'

Create channel 4 and a trace named Ch4Tr1 to measure the input reflection coefficient S₁₁. The trace becomes the active trace in channel 4.

CALC4:FORM MLIN; :DISP:WIND:TRAC2:FEED 'CH4TR1'

Calculate the magnitude of S₁₁ and display it in a linearly scaled Cartesian diagram, assigning the trace number 2.**Manual operation:** See "dB Mag" on page 420

Assume that the result at a sweep point is given by the complex quantity $z = x + jy$. Then the magnitude of z is calculated as

$$|z| = \sqrt{x^2 + y^2}$$

and in phase notation we have

$$z = |z| e^{j \text{Phase}(z)}, \text{ where } \text{Phase}(z) = \arctan(y/x).$$

The meaning of the parameters is as follows (see also table in [CALCulate<Chn>: MARKer<Mk>: FORMat](#) description):

MLINear	Displays $ z $ in a Cartesian diagram
MLOGarithmic MAGNitude (for compatibility with R&S ZVR analyzers)	Calculates $ z $ in dB (= 20 log $ z $) and displays it in a Cartesian diagram
PHASe	Calculates Phase(z) in the range between -180° and +180° and displays it in a Cartesian diagram
UPHase	Calculates Phase(z) (unwrapped) and displays it in a Cartesian diagram
POLar COMPLex (for compatibility with R&S ZVR analyzers)	Displays z in a polar diagram
SMITH	Displays z in a Smith diagram
ISMith	Displays z in an inverted Smith diagram
GDElay	For frequency sweeps only Calculates the group delay at the related sweep point and displays it in a Cartesian diagram
REAL	Calculates $\text{Re}(z) = x$ and displays it in a Cartesian diagram
IMAGinary	Calculates $\text{Im}(z) = y$ and displays it in a Cartesian diagram

SWR	Calculates the standing wave ratio $(1 + z) / (1 - z)$ and displays it in a Cartesian diagram
LOGarithmic	Displays z in a Cartesian diagram with logarithmic scale

CALCulate<Chn>:FORMat:WQUType <Unit>

Selects the physical unit of the displayed trace.

Suffix:

<Chn> Channel number used to identify the active trace

Parameters:

<Unit> POWER | VOLTage
 Power or voltage units
 *RST: POWER

Example:

```
CALC4:PAR:SDEF 'Ch4Tr1', 'b1'
Create channel 4 and a trace named Ch4Tr1 to measure the
wave quantity  $b_1$ . The trace becomes the active trace in channel
4.
CALC4:FORM:WQUT VOLT
Select voltage units for the created trace (identified by the suffix
4).
```

Manual operation: See "[Display unit](#)" on page 361

CALCulate<Chn>:GDAPerture:SCOut <Steps>

Defines an aperture for the calculation of the group delay as an integer number of frequency sweep steps.

Suffix:

<Chn> Channel number used to identify the active trace

Parameters:

<Steps> Number of steps
 Range: 1 to 10000
 *RST: 10

Example:

```
*RST; :CALC:FORM GDEL
Select group delay calculation for the active trace.
CALC:GDAP:SCO 15
Select an aperture of 15 steps.
```

Manual operation: See "[Aperture Points](#)" on page 424

CALCulate<Chn>:IAverage:MODE <Mode>

Selects the quantities to be averaged if infinite averaging is enabled
 (CALCulate<Chn>:IAverage[:STATE] ON).

Suffix:
 <Chn> Channel number used to identify the active trace

Parameters:
 <Mode> MAGPhase | REIMag
 Selects the averaging mode.

MAGPhase
 Averaging of magnitude and phase (default) of the complex trace value

REIMag
 Averaging of real and imaginary part of the complex trace value

Manual operation: See "[Mode](#)" on page 466

CALCulate<Chn>:IAverage[:STATE] <Boolean>

Turns infinite averaging on or off.

The averaging mode can be selected using `CALCulate<Chn>:IAverage:MODE`.

Suffix:
 <Chn> Channel number used to identify the active trace

Parameters:
 <Boolean> ON | OFF | 1 | 0
 *RST: 0

Manual operation: See "[Reset History](#)" on page 399

CALCulate<Chn>:PHOLd <HoldFunc>

Enables, disables, or restarts the max hold and the min hold functions.

Suffix:
 <Chn> Channel number used to identify the active trace

Parameters:
 <HoldFunc> MIN | MAX | OFF
 MIN - Enable the min hold function.
 MAX - enable the max hold function.
 OFF - disable the max hold or min hold function.
 *RST: OFF

Example:
 *RST; :CALC:PHOL MAX
 Reset the instrument and enable the max hold function.
 CALC:PHOL OFF; PHOL MAX
 Restart max hold.

Manual operation: See "[Reset History](#)" on page 399

CALCulate<Chn>:SMOothing:APERture <SmoothAperture>

Defines how many measurement points are averaged to smooth the trace.

Suffix:

<Chn> Channel number used to identify the active trace

Parameters:

<SmoothAperture> Smoothing aperture. A smoothing aperture of n % means that the smoothing interval for each sweep point i with stimulus value x_i is equal to $[x_i - \text{span} \cdot n/200, x_i + \text{span} \cdot n/200]$, and that the result of i is replaced by the arithmetic mean value of all measurement points in this interval.

Range: 0.05% to 100%.

*RST: 1

Default unit: %

Example:

```
*RST; :CALC:SMO ON
```

Activate smoothing for the default trace.

```
CALC:SMO:APER 0.5
```

Reduce the smoothing aperture to 0.5 %.

Manual operation: See ["Aperture"](#) on page 464

CALCulate<Chn>:SMOothing[:STATe] <Boolean>

Enables or disables smoothing for trace no. <Chn>.

Suffix:

<Chn> Channel number used to identify the active trace

Parameters:

<Boolean> ON | OFF - smoothing on or off.

*RST: OFF

Example:

See [CALCulate<Chn>:SMOothing:APERture](#)

Manual operation: See ["Smoothing"](#) on page 463

CALCulate<Ch>:TDIF:IMBalance:COMPensation[:STATe] <Boolean>

Selects the calculation method for S-parameters, ratios and derived quantities during an amplitude imbalance or phase imbalance sweep.

Suffix:

<Ch> Channel number

Parameters:

<Boolean>

ON

Compensate imbalance of a waves (see ["Imbalance Compensation of a-Waves"](#) on page 278)

OFF

Use the actual a-waves, depending on the imbalance parameters

*RST: OFF

Example: See `SOURCE<Ch>:TDIF:IMBalance:AMPLitude:LPORT` on page 1594

Options: R&S ZNA-K61

Manual operation: See "[Compensate Imbalance](#)" on page 705

CALCulate:TDVSwr[:STATe] <Boolean>

Enables/disables time domain site VSWR measurements.

Parameters:

<Boolean> ON | OFF – TD-VSWR on or off.

*RST: OFF

Manual operation: See "[TD-VSWR](#)" on page 450

7.3.2 CONFigure commands

The `CONFigure...` commands create and delete channels or traces, assign channel and trace names, and define the channel sweep order. The commands are device-specific.

<code>CONFigure:CHANnel:CATalog?</code>	1203
<code>CONFigure:CHANnel:MEASure:ACTive[:STATe]</code>	1203
<code>CONFigure:CHANnel:MEASure:ALL[:STATe]</code>	1203
<code>CONFigure:CHANnel:MEASure:OPTimized</code>	1203
<code>CONFigure:CHANnel<Ch>:MEASure[:STATe]</code>	1204
<code>CONFigure:CHANnel<Ch>:NAME</code>	1205
<code>CONFigure:CHANnel<Ch>:NAME:ID?</code>	1205
<code>CONFigure:CHANnel<Ch>[:STATe]</code>	1206
<code>CONFigure:CHANnel<Ch>:TRACe:CATalog?</code>	1206
<code>CONFigure:CHANnel<Ch>:TRACe:REName</code>	1206
<code>CONFigure:TRACe:CATalog?</code>	1207
<code>CONFigure:TRACe<Trc>:CHANnel:NAME?</code>	1208
<code>CONFigure:TRACe<Trc>:CHANnel:NAME:ID?</code>	1208
<code>CONFigure:TRACe<Trc>:NAME</code>	1208
<code>CONFigure:TRACe<Trc>:NAME:ID?</code>	1209
<code>CONFigure:TRACe<Trc>:REName</code>	1209
<code>CONFigure:TRACe:WINDow?</code>	1209
<code>CONFigure:TRACe:WINDow:TRACe?</code>	1210

CONFigure:CHANnel:CATalog?

Returns the numbers and names of all channels in the current recall set. The response is a string containing a comma-separated list of channel numbers and names; see example below. If all channels have been deleted the response is an empty string ("").

Example: *RST; :CONF:CHAN2:STAT ON; NAME 'New Channel'
 Create channel 2 and assign the channel name "New Channel".
 CONF:CHAN:CAT?
 Query all channels and their names. As a default channel no. 1
 is created on *RST, the response is
 '1,Ch1,2,New_Channel'.
 CONF:CHAN:NAME:ID? 'New Channel'
 Query the channel number for the channel named "New Chan-
 nel". The response is 2.

Usage: Query only

Manual operation: See ["Channel table"](#) on page 656

CONFigure:CHANnel:MEASure:ACTive[:STATe] <Boolean>

If set to ON (1), only the active channel is measured. All other channels are switched off temporarily, i.e. until `CONFigure:CHANnel:MEASure:ACTive` is set to OFF.

Parameters:
 <Boolean> ON (1) | OFF (0)

Manual operation: See ["Only Active Channel On"](#) on page 655

CONFigure:CHANnel:MEASure:ALL[:STATe] <Boolean>

Enables or disables the sweep in all channels of the active recall set. This command can be used in combination with `CONFigure:CHANnel<Ch>:MEASure[:STATe]` to optimize the measurement speed.

Parameters:
 <Boolean> ON | OFF
 *RST: ON

Example: See `CONFigure:CHANnel<Ch>:MEASure[:STATe]`

Manual operation: See ["Continuous / Single"](#) on page 565

CONFigure:CHANnel:MEASure:OPTimized <Order>[, <Ch1>, <Ch2>, ...]

This setting tells the firmware to optimize the channel switching times for a particular channel sweep order.

Note that the optimization can only be applied, if **all** channels in the current setup are in single sweep mode (`INITiate<Ch>:CONTinuous OFF`), and if there is no ongoing sweep sequence. Any change in the current setup or a wrong sweep sequence lets the analyzer fall back to unoptimized channel switching.

Setting parameters:

<code><Order></code>	AUTO MANual
	AUTO Optimize the switching times for the channel order that is automatically used with <code>INIT:ALL</code> (increasing order of channel numbers).
	MANual Optimize the switching times for the channel order manually specified using channel numbers <code><Ch1></code> , <code><Ch2></code> , ...
<code><Ch1></code> , <code><Ch2></code> , ...	Can only and must be specified for MANual optimized channel ordering. Defines the order in which the channels are measured. To get the optimization to work, you have to sweep the channels manually, and in the specified order: <code>INIT<Ch1></code> , <code>INIT<Ch2></code> , ...

Example:

```
*RST;
*RST creates channel 1, trace 1, and diagram 1.
:INITiate1:CONTinuous OFF
enable single sweep mode
CALC2:PAR:SDEF 'Ch2Tr1', 'S11'
CALC3:PAR:SDEF 'Ch3Tr1', 'S11'
CALC4:PAR:SDEF 'Ch4Tr1', 'S11'

create additional channels 2, 3 and 4 with one trace each
DISP:WIND1:TRAC2:FEED 'CH2TR1'
DISP:WIND1:TRAC3:FEED 'CH3TR1'
DISP:WIND1:TRAC4:FEED 'CH4TR1'

assign these traces to diagram 1
:CONF:CHAN:MEAS:OPT AUTO; :INITiate1:IMMediate:
ALL
optimize the switching times for the AUTOMatic channel order
1,2,3,4, and restart the sweep in all channels
:CONF:CHAN:MEAS:OPT MAN, 2,3,1,4; :INIT2; :
INIT3; :INIT1; :INIT4
optimize the switching times for channel order 2,3,1,4 and
restart the sweeps in the same order
```

Usage: Setting only

CONFigure:CHANnel<Ch>:MEASure[:STATe] <Boolean>

Enables or disables the sweep in channel no. `<Ch>`. This command can be used to restrict the measurement in a subset of channels in order to optimize the measurement speed.

Suffix:
<Ch> Number of an existing channel.

Parameters:
<Boolean> ON | OFF
*RST: ON (all existing channels)

Example:
*RST; :CONFigure:CHANnel2 ON; CHANnel3 ON
Create channels 2 and 3, in addition to the default channel no. 1. The analyzer performs sweeps in all three channels.
CONFigure:CHANnel:MEASure:ALL OFF
Disable the measurement in all channels
CONFigure:CHANnel2:MEASure ON
(Re-)enable the measurement in channel no. 2. The analyzer measures in channel 2; the channels no. 1 and 3 are not measured.

Manual operation: See "[Continuous / Single](#)" on page 565

CONFigure:CHANnel<Ch>:NAME <ChannelName>

Assigns a name to channel number <Ch>. The channel must be created before ([CONFigure:CHANnel<Ch>\[:STATE\] ON](#)). Moreover it is not possible to assign the same name to two different channels. [CONFigure:CHANnel:CATalog?](#) returns a list of all defined channels with their names.

Suffix:
<Ch> Number of an existing channel.

Parameters:
<ChannelName> Channel name, e.g. 'Channel 4'.
*RST: 'Ch1'

Example: See [CONFigure:CHANnel:CATalog?](#)

Manual operation: See "[Channel table](#)" on page 656

CONFigure:CHANnel<Ch>:NAME:ID? <ChannelName>

Queries the channel number (numeric suffix) of a channel with known channel name. A channel name must be assigned before ([CONFigure:CHANnel<Ch>:NAME <ChannelName>](#)). [CONFigure:CHANnel:CATalog?](#) returns a list of all defined channels with their names.

Suffix:
<Ch> Channel number. This suffix is not relevant and may be omitted (the command returns the actual channel number).

Query parameters:
<ChannelName> Channel name, e.g. 'Channel 4'.

Example: See [CONFigure:CHANnel:CATalog?](#)

Usage: Query only
Manual operation: See "Table Area" on page 435

CONFigure:CHANnel<Ch>[:STATe] <Boolean>

Creates channel no. <Ch> and selects it as the active channel, or deletes it.
 CONFigure:CHANnel<Ch>:NAME defines the channel name.

A channel created using CONFigure:CHANnel<Ch>[:STATe] ON can be configured but has no trace assigned so that no measurement can be initiated. Use CALCulate<Ch>:PARAMeter:SDEFine <TraceName>, <Result> to create a channel and a trace. In remote control, it is possible to remove all channels. This is in contrast to manual control where at least one channel with one diagram area and one trace must be available.

Suffix:

<Ch> Number of the channel to be created or deleted.

Parameters:

<Boolean>

ON - create channel no. <Ch>. If the channel no. <Ch> exists already, it is not modified but selected as the active channel.
 OFF - delete channel no. <Ch>.

*RST: ON for channel no. 1 (created on *RST), OFF for all other channels.

Example: See CONFigure:CHANnel:CATalog?

Manual operation: See "New Channel" on page 654

CONFigure:CHANnel<Ch>:TRACe:CATalog?

Returns the numbers and names of all traces in channel no. <Ch>. The response is a string containing a comma-separated list of trace numbers and names; see example. If all traces have been deleted the response is an empty string ("").

Tip: Use CONFigure:TRACe:CATalog? to query the traces in all channels of the active recall set.

Suffix:

<Ch> Channel number

Example: See CONFigure:TRACe:CATalog?

Usage: Query only

Manual operation: See "Table Area" on page 435

CONFigure:CHANnel<Ch>:TRACe:REName <TraceName>

Assigns a (new) name to the active trace in channel <Ch>.

Suffix:

<Ch> Channel number

Setting parameters:

<TraceName> Trace name, e.g. 'Trace 4'.

Example:

```
*RST; :CONF:CHAN:TRAC:REN 'Testtrace_1'
Reset the analyzer to create a default trace in channel 1 and set
this trace as the active trace. Rename the trace 'Testtrace_1'.
CALC:PAR:SDEF 'Testtrace_2', 'S11'
Create a new trace which will become the active trace in chan-
nel no. 1.
CONF:TRAC:REN 'Testtrace_1', 'Testtrace_3'
Rename the first trace (which is currently not active) 'Test-
trace_3'.
```

Usage: Setting only

Manual operation: See ["Table Area"](#) on page 435

CONFigure:TRACe:CATalog?

Returns the numbers and names of all traces in the current recall set. The response is a string containing a comma-separated list of trace numbers and names, see example below. If all traces have been deleted the response is an empty string ("").

Tip: Use [CONFigure:CHANnel<Ch>:TRACe:CATalog?](#) to query the traces in a particular channel; see example.

Example:

```
*RST; :CALC2:PAR:SDEF 'Ch2Trc2', 'S11'
Create channel 2 and a new trace named Ch2Trc2.
CONF:TRAC:CAT?
Query all traces and their names. As a default trace no. 1 is cre-
ated upon *RST, the response is '1,Trc1,2,Ch2Trc2'.
CONF:CHAN1:TRAC:CAT?
Query the channels in channel no. 1. The response is
'1,Trc1'.
CONF:TRAC:NAME:ID? 'Ch2Trc2'
Query the trace number for the trace named "Ch2Trc2". The
response is 2.
CONF:TRAC2:NAME?
Query the trace name for trace no. 2. The response is
'Ch2Trc2'.
CONF:TRAC:CHAN:NAME? 'Ch2Trc2'
Query the channel name for trace Ch2Trc2. The response is
'Ch2'.
CONF:TRAC:CHAN:NAME:ID? 'Ch2Trc2'
Query the channel number for trace Ch2Trc2. The response is
2.
```

Usage: Query only

Manual operation: See ["Table Area"](#) on page 435

CONFigure:TRACe<Trc>:CHANnel:NAME? <TraceName>

Queries the channel name for an existing trace named '<TraceName>'.

Suffix:

<Trc> Trace number. This suffix is ignored; the trace is referenced by its name.

Query parameters:

<TraceName> Trace name, e.g. 'Ch2Trc2'.

Example: See [CONFigure:TRACe:CATalog?](#)

Usage: Query only

Manual operation: See "[New Channel](#)" on page 654

CONFigure:TRACe<Trc>:CHANnel:NAME:ID? <TraceName>

Queries the channel number (numeric suffix) for an existing trace named '<TraceName>'.

Suffix:

<Trc> Trace number. This suffix is ignored; the trace is referenced by its name.

Query parameters:

<TraceName> Trace name, e.g. 'Ch2Trc2'.

Example: See [CONFigure:TRACe:CATalog?](#)

Usage: Query only

Manual operation: See "[New Channel](#)" on page 654

CONFigure:TRACe<Trc>:NAME <TraceName>

Assigns a name to an existing trace number <Trc>. Note that it is not possible to assign the same name to two different traces. [CONFigure:TRACe:CATalog?](#) returns a list of all traces in the active recall set with their names.

Suffix:

<Trc> Number of an existing trace.

Parameters:

<TraceName> Trace name, e.g. 'Ch2Trc2'.

*RST: 'Trc1'

Example: See [CONFigure:TRACe:CATalog?](#)

CONFigure:TRACe<Trc>:NAME:ID? <TraceName>

Queries the trace number (numeric suffix) of a trace with known trace name.

[CONFigure:TRACe:CATalog?](#) returns a list of all traces in the active recall set with their names.

Suffix:

<Trc> Trace number. This suffix is not relevant and may be omitted (the command returns the actual trace number).

Query parameters:

<TraceName> Trace name, e.g. 'Ch2Trc2'.

Example: See [CONFigure:TRACe:CATalog?](#)

Usage: Query only

CONFigure:TRACe<Trc>:REName <OldTraceName>, <NewTraceName>

Assigns a new name to a trace. The trace does not have to be the active trace.

Suffix:

<Trc> Trace number. This suffix is ignored; the trace is identified via its <TraceName>

Setting parameters:

<OldTraceName> String parameter with old trace name, e.g. 'Trc1'

<NewTraceName> String parameter with new trace name, e.g. 'S11 Trace'
*RST: n/a

Example: See [CONFigure:CHANnel<Ch>:TRACe:REName](#)

Usage: Setting only

Manual operation: See ["Table Area"](#) on page 435

CONFigure:TRACe:WINDow? <TraceName>

Returns the trace number within a diagram which is assigned to the trace <TraceName> is assigned to. A zero is returned when the trace is not assigned/ displayed.

The trace number is equal to the <WndTr> suffix in [DISPlay\[:WINDow<Wnd>\]:TRACe<WndTr>:FEED](#) and similiar commands; see example.

Query parameters:

<TraceName> Trace name (string), e.g. 'Trc1'

Example: See [CONFigure:TRACe:WINDow:TRACe?](#)

Usage: Query only

CONFigure:TRACe:WINDow:TRACe? <TraceName>

Returns the number of the diagram which the trace <TraceName> is assigned to. A zero is returned when the trace is not assigned/displayed.

The diagram number is equal to the <Wnd> suffix in `DISPlay[:WINDow<Wnd>]:TRACe<WndTr>:FEED` and similar commands; see example.

Query parameters:

<TraceName> Trace name (string), e.g. 'Trc1'

Example:

```
*RST; :CALC:PAR:SDEF 'Trc2', 'S11'
```

Create a trace named Trc2.

```
CONF:TRAC:WIND:TRAC? 'Trc2'
```

Query the diagram number for Trc2. The new trace is not displayed, so the response is 0.

```
DISP:WIND2:STAT ON
```

Create a diagram no. 2.

```
DISP:WIND2:TRAC3:FEED 'Trc2'
```

Display the trace in the new diagram no. 2, assigning the trace number 3.

```
CONF:TRAC:WIND? 'Trc2'
```

Query the diagram number for Trc2. The response is 2.

```
CONF:TRAC:WIND:TRAC? 'Trc2'
```

Query the trace number for Trc2. The response is 3.

Usage: Query only

Manual operation: See "Table Area" on page 435

7.3.3 CONTrol commands

The `Control...` commands allow you to configure the following interfaces:

- User Port
- External Handler I/O (Universal Interface, option R&S ZNBT-Z14)
- [RFFE GPIO interface](#) (option R&S ZNA-B15)
- R&S VSE (see [Chapter 4.7.6.1, "Live pulse analysis with R&S VSE"](#), on page 280)

<code>CONTrol:AUXiliary:C[:DATA]</code>	1212
<code>CONTrol<Ch>:GPIO<Port>:RANGe</code>	1213
<code>CONTrol:GPIO<Port>:SENSe:CURRent?</code>	1214
<code>CONTrol:GPIO:SENSe:SUMCurrent?</code>	1214
<code>CONTrol<Ch>:GPIO:SENSe:TRIGger</code>	1214
<code>CONTrol:GPIO<Port>:SENSe:VOLTage?</code>	1215
<code>CONTrol<Ch>:GPIO<Port>:SHUNT?</code>	1215
<code>CONTrol<Ch>:GPIO<Port>[:STATe]</code>	1216
<code>CONTrol<Ch>:GPIO:TIME</code>	1217
<code>CONTrol<Ch>:GPIO<Port>:VOLTage[:DEFault]</code>	1217
<code>CONTrol<Ch>:GPIO:VOLTage:OUTPut</code>	1217
<code>CONTrol<Ch>:RFFE<Bus>:COMMand:DATA</code>	1218

CONTRol<Ch>:RFFE<Bus>:COMMand:SEND.....	1218
CONTRol<Ch>:RFFE<Bus>:COMMand:SEND?.....	1218
CONTRol<Ch>:RFFE<Bus>:SETTings:FREQuency.....	1219
CONTRol<Ch>:RFFE<Bus>:SETTings[:STATe].....	1219
CONTRol<Ch>:RFFE<Bus>:SETTings:VOLTagE:HIGH.....	1219
CONTRol<Ch>:RFFE<Bus>:SETTings:VOLTagE:IO.....	1219
CONTRol<Ch>:RFFE<Bus>:SETTings:VOLTagE:LOW.....	1219
CONTRol<Ch>:RFFE<Bus>:TEST:CLOCK.....	1220
CONTRol<Ch>:RFFE<Bus>:TEST:DATA.....	1220
CONTRol<Ch>:RFFE<Bus>:TEST:VIO.....	1220
CONTRol:RFFE<Bus>:TEST:CLOCK:CURRent?.....	1220
CONTRol:RFFE<Bus>:TEST:DATA:CURRent?.....	1220
CONTRol:RFFE<Bus>:TEST:VIO:CURRent?.....	1220
CONTRol<Ch>:RFFE<Bus>:TEST:CLOCK:RANGe.....	1221
CONTRol<Ch>:RFFE<Bus>:TEST:DATA:RANGe.....	1221
CONTRol<Ch>:RFFE<Bus>:TEST:VIO:RANGe.....	1221
CONTRol<Ch>:RFFE<Bus>:TEST:CLOCK:SHUNt?.....	1221
CONTRol<Ch>:RFFE<Bus>:TEST:DATA:SHUNt?.....	1221
CONTRol<Ch>:RFFE<Bus>:TEST:VIO:SHUNt?.....	1221
CONTRol:RFFE<Bus>:TEST:CLOCK:VOLTagE?.....	1222
CONTRol:RFFE<Bus>:TEST:DATA:VOLTagE?.....	1222
CONTRol:RFFE<Bus>:TEST:VIO:VOLTagE?.....	1222
CONTRol<Ch>:RFFE:TEST:OUTPut.....	1222
CONTRol<Ch>:RFFE:TEST:SENSe:TRIGger.....	1223
CONTRol<Ch>:RFFE:TEST:TIME.....	1223
CONTRol<Ch>:SEGMENT<SegNr>:SEQuence<SeqNr>:DELay.....	1223
CONTRol<Ch>:SEGMENT<SegNr>:SEQuence<SeqNr>:GPIO<Port>:VOLTagE.....	1224
CONTRol<Ch>:SEGMENT<SegNr>:SEQuence<SeqNr>:RFFE<Bus>:COMMand:DATA.....	1224
CONTRol<Ch>:SEGMENT<Nr>:SEQuence:CLEAr:ALL.....	1225
CONTRol<Ch>:SEGMENT<Nr>:SEQuence:COUNT?.....	1225
CONTRol<Ch>:SEQuence:CLEAr:ALL.....	1226
CONTRol<Ch>:SEQuence:COUNT?.....	1226
CONTRol<Ch>:SEQuence<Nr>:DELay.....	1226
CONTRol<Ch>:SEQuence<Nr>:GPIO<Port>:VOLTagE.....	1227
CONTRol<Ch>:SEQuence<Nr>:RFFE<Bus>:COMMand:DATA.....	1227
CONTRol:VSE:ADDReSS.....	1228
CONTRol:VSE:CONFIg:LOAD.....	1228
CONTRol:VSE:CONFIg:SAVE.....	1228
CONTRol:VSE:CONNEct.....	1228
CONTRol:VSE:DISCONNEct.....	1229
CONTRol:VSE:LOCAl.....	1229
CONTRol:VSE:MODE.....	1229
CONTRol:VSE:TRACe.....	1229

CONTRol:AUXiliary:C[:DATA] <DecValue>

Sets or queries a channel-dependent eight-bit decimal value to control eight independent output signals at the User Port connector (lines 8, 9, 10, 11 and lines 16, 17, 18, 19). The output signals are 3.3 V TTL signals which can be used to differentiate between up to 255 independent analyzer states. `CONTRol:AUXiliary:C[:DATA]` itself does not change the analyzer state.

Channel bit definition and activation

The channel bits have the following properties:

- After a `*RST` of the analyzer all channel bits (including the value for the active, sweeping channel no. 1) are set to zero; no signal is applied to pins 8 to 11 and 16 to 19 of the User Port connector.
- The value defined with `CONTRol:AUXiliary:C[:DATA]` is assigned to the **active** channel (`INSTrument:NSElect <Ch>`).
- The signals at the User Port connector reflect the channel bits of the **measuring** channel, i.e. the channel for which the analyzer performs a sweep. This channel is not necessarily identical with the active channel.
- The signals are switched on as soon as a measurement (sweep) in a channel with non-zero channel bits is started. They are changed whenever a channel with different channel bits becomes the measuring channel.
- The signals at the User Port connector are maintained after the analyzer enters the hold state. This happens if all channels use single sweep mode and if all sweep sequences have been terminated.
- Pins 16 to 19 may be reserved for monitoring the drive ports 1 to 4 of the analyzer (`OUTPut:UPORt:ECBits OFF`). This leaves up to 16 different monitored channel states.

Tip: A simple application consists of selecting the channel numbers as parameters for `CONTRol:AUXiliary:C[:DATA]` and monitor the activity of up to 255 different channels at the User Port connector; see example below. You can also use the User Port output signals as channel-dependent trigger signals for external devices. Use `OUTPut<Ch>:UPORt[:VALue]` to transfer the eight bit value for an arbitrary channel `<Ch>` in binary representation.

Parameters:

<code><DecValue></code>	Decimal value. The values correspond to the following states of the User Port connector: 0 - no signal at any of the no signal at any of the eight pins 8, 9, 10, 11, 16, 17, 18, 19 1 - output signal at pin 8 2 - output signal at pin 9 3 - output signal at pins 8 and 9 ... 255 - output signal at pins 8, 9, 10, 11, 16, 17, 18, 19
Range:	0 to 255
*RST:	0 (no signal)

Example: `*RST; :CONT:AUX:C 1`
 Assign the channel bit value 1 to the active channel no. 1. The analyzer performs a measurement in channel no. 1, therefore the output signal at pin 8 is switched on.

`CONF:CHAN2:STAT ON; :CONT:AUX:C 2`
 Create channel no. 2, causing it to become the active channel, and assign the channel bit value 2. The analyzer performs no measurement in channel no. 2, therefore the output signal is not changed.

`CALC2:PAR:SDEF 'Ch2Tr1', 'S11'`
 Create a trace named 'Ch2Tr1' and assign it to channel 2. While the analyzer measures in channel 2, the output signal changes from pin 8 to pin 9.

Manual operation: See "[Optional Columns](#)" on page 557

CONTrol<Ch>:GPIO<Port>:RANGe <Current Range>

Defines an upper bound of the current to be measured on the respective GPIO pin. The analyzer firmware automatically selects a suitable shunt resistance, which can be queried using `CONTrol<Ch>:GPIO<Port>:SHUNT?`.

Suffix:

<Ch> Channel number
 <Port> GPIO port number 1, ..., 10

Parameters:

<Current Range> **Ports 1 to 8:** { $2 \cdot 10^n \mu\text{A} \mid n=1, \dots, 5$ }
Ports 9 and 10: {0 mA, 100 mA}
Note: The high resistance configuration of pins 9 and 10 requires FPGA version 6.1.0 or higher. For older versions of the R&S ZN-B15/Z15 Var. 03, pins 9 and 10 have the same current range as pins 1 to 8.
 Default unit: A

Example:

```
:CONTrol:GPIO1:RANGe 2uA
:CONTrol:GPIO2:RANGe 20uA
:CONTrol:GPIO3:RANGe 200uA
:CONTrol:GPIO4:RANGe 2mA
:CONTrol:GPIO5:RANGe 20mA
:CONTrol:GPIO9:RANGe 0
:CONTrol:GPIO9:RANGe 100mA
```

Options: R&S ZN-B15/Z15 Var. 03

Manual operation: See "[Range / Shunt](#)" on page 664

CONTRol:GPIO<Port>:SENSE:CURRent? [<ALL>]

Returns the results of the current measurement on the related GPIO pin or ALL GPIO pins.

Suffix:

<Port> 1, ..., 10
GPIO port number
If ALL currents are queried, this suffix is ignored.

Query parameters:

<ALL> ALL
Use ALL to measure the currents at all GPIO pins.

Return values:

<Results> Measured currents, either a single value or a comma-separated list.
Default unit: A

Usage: Query only

Options: R&S ZN-B15/Z15 Var. 03

Manual operation: See "[Voltage, Current](#)" on page 665

CONTRol:GPIO:SENSE:SUMCurrent? <GpioPorts>

Returns the sum of the currents measured at the specified GPIO ports

Query parameters:

<GpioPorts> Comma-separated list of GPIO port numbers
The list must contain minimum two and maximum 10 numbers between 1 and 10 in arbitrary order.

Example: CONTRol:GPIO:SENSE:SUMCurrent? 1,2,3,4,5
returns the sum of the currents measured in GPIO ports 1 to 5

Usage: Query only

Options: R&S ZN-B15/Z15 Var. 03

Manual operation: See "[Voltage, Current](#)" on page 665

CONTRol<Ch>:GPIO:SENSE:TRIGger

Starts the voltage/current measurements on all GPIO pins.

The measurement time can be defined using [CONTRol<Ch>:GPIO:TIME](#).

Suffix:

<Ch> Channel number
This suffix is ignored and can be omitted.

Usage: Event

Options: R&S ZN-B15/Z15 Var. 03

Manual operation: See "[Meas](#)" on page 664

CONTrol:GPIO<Port>:SENSe:VOLTage? [<ALL>]

Returns the results of the voltage measurement on the related GPIO pin or ALL GPIO pins.

Suffix:

<Port> GPIO port number.
If ALL voltages are queried, this suffix is ignored and can be omitted.

Query parameters:

<ALL> ALL
Use ALL to measure the voltages at all GPIO pins.

Return values:

<Results> Measured voltages, either a single value or a comma-separated list.
Default unit: V

Usage: Query only

Options: R&S ZN-B15/Z15 Var. 03

Manual operation: See "[Voltage, Current](#)" on page 665

CONTrol<Ch>:GPIO<Port>:SHUNT?

Returns the shunt resistance (in Ω) selected by the analyzer firmware for the configured current range (see [CONTrol<Ch>:GPIO<Port>:RANGe](#)).

The dependency between current range and shunt resistance is displayed in the tables below.

Note: The high resistance configuration of pins 9 and 10 requires FPGA version 6.1.0 or higher. For older versions of the R&S ZN-B15/Z15 Var. 03, pins 9 and 10 have the same current range as pins 1 to 8.

Suffix:

<Ch> Channel number
<Port> GPIO port 1, ..., 10

Example: :CONTRo11:GPIO1:RANGe 20mA
 :CONTRo11:GPIO1:SHUNt?
Returns 10 [Ω]
 :CONTRo11:GPIO1:RANGe 2mA
 :CONTRo1:GPIO1:TEST:CLOCK:SHUNt?
Returns 100 [Ω]
 :CONTRo11:GPIO1:RANGe 200uA
 :CONTRo1:GPIO1:SHUNt?
Returns 1000 [Ω]
 :CONTRo11:GPIO9:RANGe 0
 :CONTRo1:GPIO9:SHUNt?
Returns 100000000 [Ω]
 :CONTRo11:GPIO9:RANGe 100mA
 :CONTRo1:GPIO9:SHUNt?
Returns 1 [Ω]

Usage: Query only

Options: R&S ZN-B15/Z15 Var. 03

Manual operation: See "[Range / Shunt](#)" on page 664

Table 7-11: Pins 1 to 8

	Range				
	2 μA	20 μA	200 μA	2 mA	20 mA
Shunt	100 kΩ	10 kΩ	1 kΩ	100 Ω	10 Ω

Table 7-12: Pins 9 and 10

	Range	
	0 mA	100 mA
Shunt	100 MΩ	1 Ω

CONTRo1<Ch>:GPIO<Port>[:STATe] <EnableInSequence>

Enables/disables GPIO port <port> in the Sweep Sequencer for channel <Ch> (see [CONTRo1<Ch>:SEQuence<Nr>:GPIO<Port>:VOLTage](#) and [CONTRo1<Ch>:SEGMENT<SegNr>:SEQuence<SeqNr>:GPIO<Port>:VOLTage](#)).

Suffix:

<Ch> Channel number
 <Port> GPIO port number

Parameters:

<EnableInSequence> Enabled state

Manual operation: See "[Seq.](#)" on page 663

CONTRol<Ch>:GPIO:TIME <MeasTime>

Sets the measurement time for the voltage/current measurements on the RFFE and GPIO pins.

Same functionality as [CONTRol<Ch>:RFFE:TEST:TIME](#).

Suffix:

<Ch> Channel number
This suffix is ignored and can be omitted: the measurement time is valid for all channels.

Parameters:

<MeasTime> Measurement (= sampling = averaging) time
Range: 95 µs to 100 ms
*RST: 100 ms
Default unit: s

Options: R&S ZN-B15/Z15 Var. 03

Manual operation: See "[Meas](#)" on page 664

CONTRol<Ch>:GPIO<Port>:VOLTage[:DEFault] <Voltage>

Sets the output voltage of the respective GPIO port.

This voltage is applied using [CONTRol<Ch>:GPIO:VOLTage:OUTPut](#).

Suffix:

<Ch> Channel number
<Port> GPIO port number

Parameters:

<Voltage> Range: -7 to +15 V
Increment: 5 mV
Default unit: V

Manual operation: See "[Voltage / Output Voltage](#)" on page 663

CONTRol<Ch>:GPIO:VOLTage:OUTPut

Applies the current output voltage and current range (shunt) settings to the RFFE/ GPIO pins.

Same function as [CONTRol<Ch>:RFFE:TEST:OUTPut](#) on page 1222.

Suffix:

<Ch> Channel number

Usage: Event

Manual operation: See "[Apply](#)" on page 663

CONTRol<Ch>:RFFE<Bus>:COMMand:DATA <Command>

Defines an RFFE command for channel <Ch> and RFFE bus interface <Bus>, which can be executed using [CONTRol<Ch>:RFFE<Bus>:COMMand:SEND](#) (write-only) or [CONTRol<Ch>:RFFE<Bus>:COMMand:SEND? <BytesToRead>](#) (with read-back).

For details and background information see the "MIPI Alliance Specification for RF Front-End Control Interface".

Suffix:

<Ch>	Channel number
<Bus>	RFFE bus interface number

Parameters:

<Command>	3, 5, ..., 35, or 37 hexadecimal digits (0-F), defining the command to be executed: <ul style="list-style-type: none"> - digit 1 is the slave address, - digits 2 and 3 specify the command number and - the remaining digits represent the data part with up to 17 bytes (0, 2, ..., 32, or 34 hex digits).
-----------	------------------------------------------------------------------------------------------------------------------------------------------------------------------------------------------------------------------------------------------------------------------------------------------------------------------------------------------------------

Manual operation: See "[RFFE Command](#)" on page 660

CONTRol<Ch>:RFFE<Bus>:COMMand:SEND**CONTRol<Ch>:RFFE<Bus>:COMMand:SEND? <BytesToRead>**

Sends the RFFE command for channel <Ch> and RFFE bus interface <Bus>.

In its "set" form, it is a pure write command. In its query form, the command attempts to read <BytesToRead> bytes back: the result is returned in the form <ParityBit>,<ReadError>,'<result>', where

- <ReadError>==1 indicates a parity mismatch
- <result> consists of 2·<BytesToRead> hexadecimal digits.

The command has to be defined previously using [CONTRol<Ch>:RFFE<Bus>:COMMand:DATA](#). On a R&S ZN-B15/Z15 **var. 03**, before the command is executed the related shunt resistance is set to its minimum possible value.

For details and background information see the "MIPI Alliance Specification for RF Front-End Control Interface".

Suffix:

<Ch>	Chanel number
<Bus>	RFFE bus interface

Query parameters:

<BytesToRead>	The number of bytes to be read back from the RFFE interface.
*RST:	0 to 16

Manual operation: See "[SEND](#)" on page 661

CONTRol<Ch>:RFFE<Bus>:SETTings:FREQUency <ClockFrequency>

Sets/gets the clock frequency for channel <Ch> and RFFE bus <Bus>.

Suffix:

<Ch>	Channel number
<Bus>	1 or 2 RFFE bus number

Parameters:

<ClockFrequency>	Clock rate. Possible values are 52/1664 MHz, 52/1663 MHz, ..., 52/2 MHz. Range: 31.25 kHz to 26 MHz Default unit: Hz
------------------	-------------------------------------------------------------------------------------------------------------------------------

Manual operation: See "[CLK, VIO, VLow, VHigh](#)" on page 660

CONTRol<Ch>:RFFE<Bus>:SETTings[:STATE] <EnableInSequence>

Enables/disables RFFE bus interface <Bus> in the Sweep Sequencer for channel <Ch> (see [CONTRol<Ch>:SEQUence<Nr>:RFFE<Bus>:COMMANd:DATA](#) and [CONTRol<Ch>:SEGMENT<SegNr>:SEQUence<SeqNr>:RFFE<Bus>:COMMANd:DATA](#)).

Suffix:

<Ch>	Channel number
<Bus>	RFFE bus interface number

Parameters:

<EnableInSequence>	Enabled state
--------------------	---------------

Manual operation: See "[Seq.](#)" on page 659

CONTRol<Ch>:RFFE<Bus>:SETTings:VOLTage:HIGH <VoltageHigh>**CONTRol<Ch>:RFFE<Bus>:SETTings:VOLTage:IO <IOVoltage>****CONTRol<Ch>:RFFE<Bus>:SETTings:VOLTage:LOW <Voltage>**

Sets/gets the IO, Low and High voltages for channel <Ch> and RFFE bus interface <Bus>, respectively.

Note that these voltages are only applied while an RFFE command is executed using [CONTRol<Ch>:RFFE<Bus>:COMMANd:SEND](#) or [CONTRol<Ch>:RFFE<Bus>:COMMANd:SEND?](#).

Suffix:

<Ch>	Channel number
<Bus>	RFFE bus number

Parameters:

<Voltage>	Range: 0 to 2.5 V Increment: 0.001 V Default unit: V
-----------	------------------------------------------------------------

Manual operation: See "[CLK, VIO, VLow, VHigh](#)" on page 660

CONTROL<Ch>:RFFE<Bus>:TEST:CLOCK <Test Clock Voltage>
CONTROL<Ch>:RFFE<Bus>:TEST:DATA <Test Data Voltage>
CONTROL<Ch>:RFFE<Bus>:TEST:VIO <OutputVoltage>

These commands define the output voltages for the voltage/current measurements on the RFFE pins.

Note: The voltages for DATA and CLOCK are always identical; their values cannot be set independently.

The output voltages are applied using [CONTROL<Ch>:RFFE:TEST:OUTPUT](#), the voltage/current measurements are started using [CONTROL<Ch>:RFFE:TEST:SENSE:TRIGGER](#).

Suffix:

<Ch> Channel number
 <Bus> RFFE bus interface 1 or 2

Parameters:

<OutputVoltage> Range: 0 V to 2.5 V
 Increment: 1 mV
 *RST: 0 V
 Default unit: V

Example:

```
:CONTROL:RFFE1:TEST:DATA 1V
:CONTROL:RFFE1:TEST:CLOCK?
DATA and CLOCK are set simultaneously, so this should return
1V
:CONTROL:RFFE1:TEST:VIO 1V
:CONTROL:RFFE2:TEST:CLOCK 2V
:CONTROL:RFFE2:TEST:DATA?
DATA and CLOCK are set simultaneously, so this should return
2V
:CONTROL:RFFE2:TEST:VIO 2V
```

Options: R&S ZN-B15/Z15 Var. 03

Manual operation: See "[Output Voltage](#)" on page 661

CONTROL:RFFE<Bus>:TEST:CLOCK:CURRENT?
CONTROL:RFFE<Bus>:TEST:DATA:CURRENT?
CONTROL:RFFE<Bus>:TEST:VIO:CURRENT?

Returns the results of the current measurement on the related RFFE pin.

Suffix:

<Bus> RFFE bus interface 1 or 2

Return values:

<Measured> Measured current

Usage: Query only

Options: R&S ZN-B15 Var. 03

Manual operation: See "[Voltage, Current](#)" on page 662

CONTrol<Ch>:RFFE<Bus>:TEST:CLOCK:RANGe <Clock Current Range>

CONTrol<Ch>:RFFE<Bus>:TEST:DATA:RANGe <Data Current Range>

CONTrol<Ch>:RFFE<Bus>:TEST:VIO:RANGe <CurrentRange>

Defines the (upper bound of the) current range for the voltage/current measurement on the respective RFFE pin. The analyzer firmware automatically selects a suitable shunt resistance, which can be queried using [CONTrol<Ch>:RFFE<Bus>:TEST:CLOCK | DATA | VIO:SHUNt](#).

Suffix:

<Ch> Channel number

<Bus> RFFE bus interface 1 or 2

Parameters:

<CurrentRange> Range: $2 \times 10^n \mu\text{A}$ with $n=1, \dots, 5$
Default unit: A

Example: See [CONTrol<Ch>:RFFE<Bus>:TEST:CLOCK | DATA | VIO:SHUNt](#)

Options: R&S ZN-B15/Z15 Var. 03

Manual operation: See "[Range / Shunt](#)" on page 661

CONTrol<Ch>:RFFE<Bus>:TEST:CLOCK:SHUNt?

CONTrol<Ch>:RFFE<Bus>:TEST:DATA:SHUNt?

CONTrol<Ch>:RFFE<Bus>:TEST:VIO:SHUNt?

Returns the shunt resistance (in Ω) selected by the analyzer firmware for the configured current range (see [CONTrol<Ch>:RFFE<Bus>:TEST:CLOCK | DATA | VIO:RANGe](#)).

The dependency between current range and shunt resistance is displayed in the table below.

Suffix:

<Ch> Channel number

<Bus> RFFE bus interface 1 or 2

Example:

```
:CONTRo11:RFFE1:TEST:DATA:RANGe 20.0mA
:CONTRo11:RFFE1:TEST:CLOCK:RANGe 2mA
:CONTRo11:RFFE1:TEST:VIO:RANGe 0.2mA
:CONTRo11:RFFE1:TEST:DATA:SHUNt?
Returns 10 [Ω]
:CONTRo11:RFFE1:TEST:VIO:RANGe 2mA
:CONTRo11:RFFE1:TEST:CLOCK:SHUNt?
Returns 100 [Ω]
:CONTRo11:RFFE1:TEST:VIO:RANGe 0.2mA
:CONTRo11:RFFE1:TEST:VIO:SHUNt?
Returns 1000 [Ω]
```

Usage: Query only

Options: R&S ZN-B15/Z15 Var. 03

Manual operation: See ["Range / Shunt"](#) on page 661

	2 μ A	20 μ A	200 μ A	2 mA	20 mA
Shunt	10 Ω	100 Ω	1 k Ω	10 k Ω	100 k Ω

CONTRo11:RFFE<Bus>:TEST:CLOCK:VOLTage?
CONTRo11:RFFE<Bus>:TEST:DATA:VOLTage?
CONTRo11:RFFE<Bus>:TEST:VIO:VOLTage?

Returns the results of the voltage measurement on the related RFFE pin.

Suffix:

<Bus> RFFE bus interface 1 or 2

Return values:

<Measured> Measured voltage

Usage: Query only

Options: R&S ZN-B15 Var. 03

Manual operation: See ["Voltage, Current"](#) on page 662

CONTRo11:<Ch>:RFFE:TEST:OUTPut

Applies the current output voltage and current range (shunt) settings to the RFFE/GPIO pins.

Same function as [CONTRo11:<Ch>:GPIO:VOLTage:OUTPut](#).

Suffix:

<Ch> Channel number

Usage: Event

Options: R&S ZN-B15/Z15 Var. 03

Manual operation: See ["Set"](#) on page 662

CONTRol<Ch>:RFFE:TEST:SENSe:TRIGger

Starts the voltage/current measurements on all RFFE pins.

The measurement time can be defined using [CONTRol<Ch>:RFFE:TEST:TIME](#).

Suffix:

<Ch> Channel number
This suffix is ignored and can be omitted.

Usage: Event

Options: R&S ZN-B15/Z15 Var. 03

Manual operation: See "[Start Meas](#)" on page 662

CONTRol<Ch>:RFFE:TEST:TIME <MeasTime>

Sets the measurement time for the voltage/current measurements on the RFFE and GPIO pins.

Same functionality as [CONTRol<Ch>:GPIO:TIME](#).

Suffix:

<Ch> Channel number
This suffix is ignored and can be omitted: the measurement time is valid for all channels.

Parameters:

<MeasTime> Measurement (= sampling = averaging) time
Range: 95 µs to 100 ms
*RST: 100 ms
Default unit: s

Options: R&S ZN-B15/Z15 Var. 03

Manual operation: See "[Start Meas](#)" on page 662

CONTRol<Ch>:SEGMENT<SegNr>:SEQUENCE<SeqNr>:DELAy <Delay>

For segmented sweeps this command allows to introduce delays between subsequent sequence steps and between the final sequence step and the sweep (segment) start.

The command/switch sequences are defined using [CONTRol<Ch>:SEGMENT<SegNr>:SEQUENCE<SeqNr>:RFFE<Bus>:COMMAND:DATA](#) and [CONTRol<Ch>:SEGMENT<SegNr>:SEQUENCE<SeqNr>:GPIO<Port>:VOLTage](#).

Suffix:

<Ch> Channel number
<SegNr> Segment number

<SeqNr> Sequence number, defining the order in which the commands shall be executed.
For every channel, segment and RFFE interface, the sequence numbers must be consecutive, starting at 1; reusing a sequence number overwrites a previously defined command.

Parameters:

<Delay> Delay time
Default unit: s

Manual operation: See "[Wait \(Sweep Sequencer Table\)](#)" on page 667

CONTRol<Ch>:SEGMENT<SegNr>:SEQUENCE<SeqNr>:GPIO<Port>:VOLTage
<Voltage>

For segmented sweeps this command allows to define the GPIO voltage settings to be applied at the start of each segment.

The GPIO ports can be enabled/disabled using [CONTRol<Ch>:GPIO<Port>\[:STATe\]](#). Complementary RFFE commands can be defined using [CONTRol<Ch>:SEGMENT<SegNr>:SEQUENCE<SeqNr>:RFFE<Bus>:COMMAND:DATA](#).

Suffix:

<Ch> Channel number
<SegNr> Segment number
<SeqNr> Sequence number, defining the order in which the commands shall be executed.
For every channel, segment and RFFE interface, the sequence numbers must be consecutive, starting at 1; reusing a sequence number overwrites a previously defined command.

Parameters:

<Voltage> Range: -6 to +12 V
Increment: 0.005 V
Default unit: V

Manual operation: See "[GPIO columns \(sweep sequencer table\)](#)" on page 666

CONTRol<Ch>:SEGMENT<SegNr>:SEQUENCE<SeqNr>:RFFE<Bus>:COMMAND:DATA <Command>

For segmented sweeps this command allows to define the RFFE command(s) to be executed at the start of each segment.

Command execution on an RFFE interface can be enabled/disabled using [CONTRol<Ch>:RFFE<Bus>:SETTings\[:STATe\]](#). Complementary GPIO switches can be defined using [CONTRol<Ch>:SEGMENT<SegNr>:SEQUENCE<SeqNr>:GPIO<Port>:VOLTage](#).

Suffix:

<Ch> Channel number

<SegNr>	Segment number
<SeqNr>	Sequence number, defining the order in which the commands shall be executed. For every channel, segment and RFFE interface, the sequence numbers must be consecutive, starting at 1; reusing a sequence number overwrites a previously defined command.
<Bus>	RFFE bus interface number

Parameters:

<Command>	3 to 37 hexadecimal digits (0-F), defining the command to be executed: digit 1 is the slave address, digits 2 and 3 specify the command number and the remaining digits represent the data part (up to 17 digit pairs).
-----------	----------------------------------------------------------------------------------------------------------------------------------------------------------------------------------------------------------------------------------------

Manual operation: See "[RFFE columns \(sweep sequencer table\)](#)" on page 666

CONTRol<Ch>:SEGMENT<Nr>:SEQUENCE:CLEAR:ALL

For segmented sweeps this command deletes the command/switch sequence for the respective channel and sweep segment (defined using [CONTRol<Ch>:SEGMENT<SegNr>:SEQUENCE<SeqNr>:RFFE<Bus>:COMMAND:DATA](#) and [CONTRol<Ch>:SEGMENT<SegNr>:SEQUENCE<SeqNr>:GPIO<Port>:VOLTage](#)).

Suffix:

<Ch>	Channel number
<Nr>	Segment number

Usage: Event

Manual operation: See "[Range](#)" on page 666

CONTRol<Ch>:SEGMENT<Nr>:SEQUENCE:COUNT?

For segmented sweeps this command queries the length of the command/switch sequence defined for a particular channel and sweep segment.

The command/switch sequences are defined using [CONTRol<Ch>:SEGMENT<SegNr>:SEQUENCE<SeqNr>:RFFE<Bus>:COMMAND:DATA](#) and [CONTRol<Ch>:SEGMENT<SegNr>:SEQUENCE<SeqNr>:GPIO<Port>:VOLTage](#).

Suffix:

<Ch>	Channel number
<Nr>	Segment number

Usage: Query only

Manual operation: See "[Range](#)" on page 666

CONTRol<Ch>:SEQuence:CLEAr:ALL

For unsegmented sweeps this command deletes the command/switch sequence for the respective channel (defined using `CONTRol<Ch>:SEQuence<Nr>:RFFE<Bus>:COMMand:DATA` and `CONTRol<Ch>:SEQuence<Nr>:GPIO<Port>:VOLTage`).

Suffix:

<Ch> Channel number

Usage: Event

Manual operation: See "[Range](#)" on page 666

CONTRol<Ch>:SEQuence:COUnT?

For unsegmented sweeps this command queries the length of the command sequence defined for a particular channel (using `CONTRol<Ch>:SEQuence<Nr>:RFFE<Bus>:COMMand:DATA`).

Suffix:

<Ch> Channel number

Usage: Query only

Manual operation: See "[Range](#)" on page 666

CONTRol<Ch>:SEQuence<Nr>:DELay <Delay>

For unsegmented sweeps this command allows to introduce delays between subsequent sequence steps and between the final sequence step and the sweep (segment) start.

The command/switch sequences are defined using `CONTRol<Ch>:SEQuence<Nr>:RFFE<Bus>:COMMand:DATA` and `CONTRol<Ch>:SEQuence<Nr>:GPIO<Port>:VOLTage`.

Suffix:

<Ch> Channel number

<Nr> Sequence number, defining the order in which the commands shall be executed.

For every channel and RFFE interface, the sequence numbers must be consecutive, starting at 1; reusing a sequence number overwrites a previously defined command.

Parameters:

<Delay> Delay time
Default unit: s

Manual operation: See "[Wait \(Sweep Sequencer Table\)](#)" on page 667

CONTRol<Ch>:SEQuence<Nr>:GPIO<Port>:VOLTagE <Voltage>

For unsegmented sweeps this command allows to define the GPIO voltage settings to be applied at the start of each sweep.

The GPIO ports can be enabled/disabled using [CONTRol<Ch>:GPIO<Port>\[:STATe\]](#). Complementary RFFE commands can be defined using [CONTRol<Ch>:SEQuence<Nr>:RFFE<Bus>:COMManD:DATA](#).

Suffix:

<Ch>	Channel number
<Nr>	Sequence number, defining the order in which the switches/commands shall be executed. For every channel and GPIO port, the sequence numbers must be consecutive, starting at 1; reusing a sequence number overwrites a previous voltage setting. Delays between subsequent settings/command and - finally - the start of the respective sweep segment can be introduced using CONTRol<Ch>:SEQuence<Nr>:DELay .
<Port>	GPIO port number

Parameters:

<Voltage>	Range: -6 to +12 V Increment: 0.005 V Default unit: V
-----------	-------------------------------------------------------------

Manual operation: See "[GPIO columns \(sweep sequencer table\)](#)" on page 666

CONTRol<Ch>:SEQuence<Nr>:RFFE<Bus>:COMManD:DATA <Command>

For unsegmented sweeps this command allows to define the RFFE command(s) to be executed at the start of each sweep.

Command execution on an RFFE interface can be enabled/disabled using [CONTRol<Ch>:RFFE<Bus>:SETTings\[:STATe\]](#). Complementary GPIO switches can be defined using [CONTRol<Ch>:SEQuence<Nr>:GPIO<Port>:VOLTagE](#).

Suffix:

<Ch>	Channel number
<Nr>	Sequence number, defining the order in which the commands shall be executed. For every channel and RFFE interface, the sequence numbers must be consecutive, starting at 1; reusing a sequence number overwrites a previously defined command. Delays between subsequent commands and - finally - the start of the respective sweep can be introduced using CONTRol<Ch>:SEQuence<Nr>:DELay
<Bus>	RFFE bus interface number

Parameters:

<Command> 3 to 37 **hexadecimal digits** (0-F), defining the command to be executed: digit 1 is the slave address, digits 2 and 3 specify the command number and the remaining digits represent the data part (up to 17 digit **pairs**).

Manual operation: See "[RFFE columns \(sweep sequencer table\)](#)" on page 666

CONTRol:VSE:ADDRess <Adress>

Sets/gets the VISA address of a remote R&S VSE instance.

Parameters:

<Adress> VISA resource string

Manual operation: See "[VISA address list](#)" on page 701

CONTRol:VSE:CONFIg:LOAD <FilePathOnVna>

If a connection to a R&S VSE instance is established, you can load its configuration from a file on the R&S ZNA (previously created using [Save VSE Configuration](#)).

Setting parameters:

<FilePathOnVna> A file path on the R&S ZNA, either absolute or relative to the current directory (see [MMEMory:CDIRectory](#))

Usage: Setting only

Manual operation: See "[Load VSE Configuration](#)" on page 702

CONTRol:VSE:CONFIg:SAVE <FilePathOnVna>

If a connection to a R&S VSE instance is established, you can download its current configuration and save it to a file on the R&S ZNA.

Setting parameters:

<FilePathOnVna> A file path on the R&S ZNA, either absolute or relative to the current directory (see [MMEMory:CDIRectory](#))

Usage: Setting only

Manual operation: See "[Save VSE Configuration](#)" on page 702

CONTRol:VSE:CONNEct

If [CONTRol:VSE:LOCAl](#) on page 1229 is set to 1, the setting tries to connect to a local R&S VSE. Otherwise it tries to connect to a remote R&S VSE, whose VISA address was previously specified using [CONTRol:VSE:ADDRess](#).

The query returns the connection state: 1 = connected to a R&S VSE, 0 = not connected .

Manual operation: See "[Start/Connect VSE / Disconnect VSE](#)" on page 701

CONTRol:VSE:DISConnect

Disconnects an active R&S VSE connection (see [CONTRol:VSE:CONNect](#))

Usage: Event

Manual operation: See "[Start/Connect VSE / Disconnect VSE](#)" on page 701

CONTRol:VSE:LOCal <Boolean>

Tells the R&S ZNA whether you want to connect to a local or remote R&S VSE instance.

Use [CONTRol:VSE:CONNect](#) on page 1228 to establish the connection.

Parameters:

<Boolean> **1**
 Local R&S VSE
0
 Remote R&S VSE
*RST: 0

Manual operation: See "[Local VSE](#)" on page 701

CONTRol:VSE:MODE <VseMode>

Determines where the acquired measurement data are processed.

Parameters:

<VseMode> DEVICE | VSE | BOTH
DEVICE
 Only on the R&S ZNA
VSE
 Only on the R&S VSE
BOTH
 On the R&S ZNA and on the R&S VSE

Manual operation: See "[VSE Mode](#)" on page 692

CONTRol:VSE:TRACe <No>

Select the trace to be pushed to R&S VSE, if connected (see [CONTRol:VSE:CONNect](#)) and enabled (see [CONTRol:VSE:MODE](#)).

Parameters:

<No> Trace number

Manual operation: See "[Trace \(b-wave\)](#)" on page 693

7.3.4 DIAGnostic commands

The `DIAGnostic...` commands provide access to service and diagnostic routines used in service, maintenance and repair. In accordance with the SCPI standard, all commands are device-specific.

Service functions are password-protected (`SYSTem:PASSword[:CENable]`) and are intended for Rohde & Schwarz service staff. Refer to the service manual for more information.

<code>DIAGnostic:DEvice:STATe</code>	1230
<code>DIAGnostic:DUMP:SIZE</code>	1230
<code>DIAGnostic:PRODUct:OPTion:INFO?</code>	1231
<code>DIAGnostic:SERVice:RFPower</code>	1231
<code>DIAGnostic:SERVice:SFUNction</code>	1231

`DIAGnostic:DEvice:STATe` <Filename>

Generates a system report and writes it to the specified file. See [Chapter 9.3, "Collecting information for technical support"](#), on page 1768.

Setting parameters:

<Filename> String parameter containing the file name. If no path is specified, the file is stored to the directory `C:\Users\Public\Documents\ZNA\Report`; the extension `*.zip` is appended automatically.

*RST: n/a

Example:

```
DIAG:DEV:STAT 'report_16032011_1120'
```

Generate a report and store it to `C:\Users\Public\Documents\ZNA\Report\report_16032011_1120`. Use the `MMEMory...` commands to rename, move, or delete the file.

Usage: Setting only

Manual operation: See ["Save..."](#) on page 874

`DIAGnostic:DUMP:SIZE` <DumpSize>

Determines the level of detail and hence the size of the dump files created in case of firmware exceptions.

Parameters:

<DumpSize> NONE | MINI | NORMal | LARGe | FULL

Either disables dump file creation (NONE) or determines the level of detail.

Manual operation: See ["Error Dump Type"](#) on page 866

DIAGnostic:PRODUct:OPTion:INFO? <Option>, <Detail>

Queries a property of an installed software option, identified by its name.

Query parameters:

<Option> Option name, e.g. 'ZNA-K2'.

<Detail> DESCRIPTION | TYPE | ACTIVation | EXPIration | KEY
You can query for an option's DESCRIPTION, its KEY and key TYPE, and its ACTIVation and EXPIration date (if applicable).

Example: DIAGnostic:PRODUct:OPTion:INFO? 'ZNA-K2',DESC
On a R&S ZNA this returns 'Time Domain Analysis' (if installed).

Usage: Query only

Manual operation: See "[Software Option Info](#)" on page 877

DIAGnostic:SERVice:RFPower <Boolean>

Turns the internal source power at all ports and the power of all external generators on or off. This command is equivalent to [OUTPut<Ch>\[:STATE\]](#) .

Parameters:

<Boolean> ON | OFF - switch the power on or off.
*RST: ON

Example: DIAG:SERV:RFP OFF
Turn off the RF source power.

DIAGnostic:SERVice:SFUNction <SFIdentifier>

Calls a service function (mainly for internal use).

- Use [SYSTem:PASSword\[:CENable\]](#) to activate the required service level.
- Use the query form to read back the data returned by the service function.

Parameters:

<SFIdentifier> Service function in "dotted textual" (example: 'sw.common.memory_usage') or "dotted decimal" (example: '0.1.18.0') representation.

Example: DIAGnostic:SERVice:SFUNction?
'sw.common.memory_usage'
This is an "Info Level" service function, i.e. it is not password-protected. It returns the current memory usage of the analyzer firmware.

Manual operation: See "[Service Function](#)" on page 886

7.3.5 DISPLAY commands

The `DISPlay...` commands control the selection and presentation of graphical and trace information on the screen.



Trace display

Traces are identified by a string parameter defining the trace name (e.g. `CALCulate<Ch>:PARAMeter:SElect <TraceName>`). In the `DISPlay...` subsystem, traces are assigned to diagrams (`DISPlay[:WINDow<Wnd>]:TRACe<WndTr>:FEED <TraceName>`). While this assignment is valid, the trace is identified by the numeric suffix `<Wnd>`, and the trace name is not needed.

Units for DISPlay... commands

The `DISPlay...` subsystem contains commands to define particular points in the diagram, e.g. to set the scale or a reference value. Some settings require a numeric value and a physical unit, depending on the related parameter type. The following table lists the physical units accepted by the analyzer.

Parameter type	Physical unit
Power	DBM, DB, DBW, W, MW, UW, NW, PW
Voltage	V, MV, UV, NV, PV, DBV, DBMV, DBUV
Phase	DEG, KDEG, MDEG, UDEG, NDEG, PDEG
Group delay	S, MS, US, NS, PS
Impedance	OHM, GOHM, MOHM, KOHM
Admittance	SIE, MSIE, USIE, NSIE
Inductance	H, MH, UH, NH, PH, FH
Capacitance	F, MF, UF, NF, PF, FF
Dimensionless	UNIT, MUNIT, UUNIT, NUNIT, PUNIT, FUNIT

<code>DISPlay:ANNotation:CHANnel[:STATe]</code>	1233
<code>DISPlay:ANNotation:TRACe[:STATe]</code>	1233
<code>DISPlay:ANNotation:FREQuency[:STATe]</code>	1234
<code>DISPlay:CMAP:LIMit:FCOLorize[:STATe]</code>	1234
<code>DISPlay:CMAP:LIMit:FSYMBOL[:STATe]</code>	1234
<code>DISPlay:CMAP:LIMit[:STATe]</code>	1234
<code>DISPlay:CMAP:MARKer[:STATe]</code>	1235
<code>DISPlay:CMAP<DispEl>:RGB</code>	1235
<code>DISPlay:CMAP:TRACe:COLor[:STATe]</code>	1237
<code>DISPlay:CMAP:TRACe:RGB</code>	1237
<code>DISPlay:IWINDow:BFILter[:STATe]</code>	1238
<code>DISPlay:IWINDow:MARKer<Mk>[:STATe]</code>	1238
<code>DISPlay:IWINDow[:STATe]</code>	1239
<code>DISPlay:LAYout</code>	1239
<code>DISPlay:LAYout:APPLy</code>	1239

DISPlay:LAYout:DEFine.....	1240
DISPlay:LAYout:EXECute.....	1240
DISPlay:LAYout:GRID.....	1241
DISPlay:LAYout:JOIN.....	1242
DISPlay:LAYout:OVERlay.....	1242
DISPlay:LAYout:SPLit.....	1242
DISPlay:MENU:KEY:ACTion:CATalog?.....	1242
DISPlay:MENU:KEY:EXECute.....	1243
DISPlay:MENU:KEY:SElect.....	1243
DISPlay:MENU:KEY:TOOL:CATalog?.....	1243
DISPlay:RFSize.....	1243
DISPlay[:WINDow<Wnd>]:CATalog?.....	1244
DISPlay[:WINDow<Wnd>]:MAXimize.....	1244
DISPlay[:WINDow<Wnd>]:NAME.....	1245
DISPlay[:WINDow<Wnd>]:OVERview[:STATe].....	1245
DISPlay[:WINDow<Wnd>][:STATe].....	1246
DISPlay[:WINDow<Wnd>]:TITLe:DATA.....	1246
DISPlay[:WINDow<Wnd>]:TITLe[:STATe].....	1246
DISPlay[:WINDow<Wnd>]:TRACe<WndTr>:CATalog?.....	1247
DISPlay[:WINDow<Wnd>]:TRACe<WndTr>:DELeTe.....	1247
DISPlay[:WINDow<Wnd>]:TRACe<WndTr>:EFEEd.....	1248
DISPlay[:WINDow<Wnd>]:TRACe<WndTr>:FEED.....	1248
DISPlay[:WINDow<Wnd>]:TRACe<WndTr>:LABel:SHOW.....	1249
DISPlay[:WINDow<Wnd>]:TRACe<WndTr>:SHOW.....	1249
DISPlay[:WINDow<Wnd>]:TRACe<WndTr>:X:OFFSet.....	1250
DISPlay[:WINDow<Wnd>]:TRACe<WndTr>:Y:OFFSet.....	1250
DISPlay[:WINDow<Wnd>]:TRACe<WndTr>:Y[:SCALe]:AUTO.....	1251
DISPlay[:WINDow<Wnd>]:TRACe<WndTr>:Y[:SCALe]:BOTTom.....	1252
DISPlay[:WINDow<Wnd>]:TRACe<WndTr>:Y[:SCALe]:TOP.....	1252
DISPlay[:WINDow<Wnd>]:TRACe<WndTr>:Y[:SCALe]:PDIVision.....	1253
DISPlay[:WINDow<Wnd>]:TRACe<WndTr>:Y[:SCALe]:RLEVel.....	1254
DISPlay[:WINDow<Wnd>]:TRACe<WndTr>:Y[:SCALe]:RPOSition.....	1255
DISPlay[:WINDow<Wnd>]:TRACe<WndTr>:ZOOM:BOTTom.....	1256
DISPlay[:WINDow<Wnd>]:TRACe<WndTr>:ZOOM:TOP.....	1256
DISPlay[:WINDow<Wnd>]:TRACe<WndTr>:ZOOM:START.....	1257
DISPlay[:WINDow<Wnd>]:TRACe<WndTr>:ZOOM:STOP.....	1257
DISPlay[:WINDow<Wnd>]:TRACe<WndTr>:ZOOM[:STATe].....	1257

DISPlay:ANNotation:CHANnel[:STATe] <Boolean>

DISPlay:ANNotation:TRACe[:STATe] <Boolean>

Shows or hides the channel/trace list(s) in all diagrams of the current recall set.

Parameters:

<Boolean> ON | OFF - show or hide information element(s).

*RST: ON

Example:

*RST; :DISP:ANN:TRAC OFF; CHAN ON; FREQ OFF

Create diagram area no. 1 (with default trace) and hide the trace list. Keep the channel list but hide the swept frequency range.

Manual operation: See ["Trace Info"](#) on page 846

DISPlay:ANNotation:FREQuency[:STATe] <Boolean>

Unmasks or masks all stimulus values in the VNA GUI for the active recall set.

Parameters:

<Boolean> ON | OFF - unmask or mask stimulus values
 *RST: ON - all stimulus values unmasked

Example:

*RST; :DISP:ANN:FREQ OFF

Create diagram area no. 1 (with default trace) and mask all stimulus values.

Manual operation: See ["Hide Sensitive Information"](#) on page 846

DISPlay:CMAp:LIMit:FCOLORize[:STATe] <Boolean>

Assigns a different trace color to failed trace segments ("Colorize Trace when Failed").

Parameters:

<Boolean> ON | OFF - colorize trace or keep original trace color.
 *RST: n/a (a *RST does not affect the setting). In the factory configuration, OFF is preset.

Example:

See [DISPlay:CMAp:LIMit\[:STATe\]](#)

Manual operation: See ["Limit Test > Colorize Trace when Failed"](#) on page 849

DISPlay:CMAp:LIMit:FSYMBOL[:STATe] <Boolean>

Displays or hides the limit fail symbols (colored squares) on the trace.

Parameters:

<Boolean> ON | OFF - show or hide symbols.
 *RST: n/a (a *RST does not affect the setting). In the factory configuration, ON is preset.

Example:

See [DISPlay:CMAp:LIMit\[:STATe\]](#)

Manual operation: See ["Limit Test > Show Limit Fail Symbols"](#) on page 848

DISPlay:CMAp:LIMit[:STATe] <Boolean>

Displays all limit lines either with individually configured colors or with the color of the associated trace(s). The colors of all display elements are defined via [DISPlay:CMAp<DispEl>:RGB](#).

Parameters:

<Boolean> ON - the limit line colors are defined via
`DISPlay:CMAP<DispEl>:RGB` where <DispEl> = 9 ... 12.
 The limit line colors are independent of the trace colors.
 OFF - all limit lines have the color of the associated trace.
 *RST: n/a (a *RST does not affect the setting). In the factory configuration, OFF is preset.

Example:

```
DISP:CMAP:LIMit OFF
Use the trace colors for all limit lines associated with each trace.
Subsequent limit line color definitions will be ignored until individual
limit settings are enabled again.
DISPlay:CMAP:LIMit:FCOLorize:STATe ON
Assign a different trace color to failed trace sections.
DISPlay:CMAP:LIMit:FSYMBOL:STATe OFF
Remove the limit fail symbols from the trace.
```

Manual operation: See "[Limit Test > Use Trc Color for Limit Lines](#)" on page 849

DISPlay:CMAP:MARKer[:STATe] <Boolean>

Displays all markers with the same color or display each marker with the color of the associated trace. The colors of all display elements are defined via
`DISPlay:CMAP<DispEl>:RGB <Red>, <Green>, <Blue> ...`

Parameters:

<Boolean> ON - all markers have the same color, to be defined via
`DISPlay:CMAP<DispEl>:RGB <Red>, <Green>, <Blue>`.
 The marker color is independent of the trace colors.
 OFF - each marker has the color of the associated trace.

Example:

See `DISPlay:CMAP<DispEl>:RGB`

Manual operation: See "[General > Same Color all Markers](#)" on page 850

DISPlay:CMAP<DispEl>:RGB <Red>, <Green>, <Blue>[, <TraceStyle>[, <TraceWidth>]]

Defines the user color scheme using the Red/Green/Blue color model. For traces also the line style and width can be defined.

Use `DISPlay:CMAP:TRACe:RGB` to define the properties of a particular trace, referenced by its name.

Suffix:

<DispEl> Number of the display element as described in the table below.

Parameters:

<Red> Red content of the defined color.
 Range: 0 (zero intensity, corresponding to a 0 in the 24-bit color model) to 1 (full intensity, corresponding to 255 in the 24-bit color model).

<Green>	Green content of the defined color. Range: 0 (zero intensity, corresponding to a 0 in the 24-bit color model) to 1 (full intensity, corresponding to 255 in the 24-bit color model).
<Blue>	Blue content of the defined color. Range: 0 (zero intensity, corresponding to a 0 in the 24-bit color model) to 1 (full intensity, corresponding to 255 in the 24-bit color model).
<TraceStyle>	SOLid DASHed DOTTed DDOTted DDDotted Optional trace style, only for traces (<DispEl> > 12): One of the string parameters SOLid DASHed DOTTed DDOTted DDDotted.
<TraceWidth>	Optional trace width, only for traces (<DispEl> > 12). Range: 1 to 20

Example:

```
*RST; :DISP:CMAP:MARK ON; :CALC:MARK ON
```

Create diagram area no. 1 (with default trace showing the S-parameter S_{21}) and a marker M1.

```
CALC:PAR:SDEF 'Trc2', 'S11'
```

```
DISP:WIND:TRAC2:FEED 'TRC2'
```

Create a trace named Trc2 and display the trace in diagram area no. 1. Note that the new trace automatically becomes the active trace.

```
CALC:MARK2 ON
```

Assign a marker M2 to the trace. Both markers are displayed with the same color.

```
DISP:CMAP13:RGB 1,0,0; :DISP:CMAP14:RGB 0,1,0
```

Color the first trace red, the second trace green.

```
DISP:CMAP6:RGB?
```

Query the marker color. The marker color depends on the settings made in previous sessions; it is not reset. A possible response is 0, 0, 0 for black markers.

```
DISP:CMAP:MARK OFF
```

Change the marker colors: M1 turns red, M2 turns green.

Manual operation: See "[Element](#)" on page 848

The numeric suffixes <DispEl> denote the following display elements:

<DispEl>	Display Element
1	Background
2	Text
3	Selected Text
4	Grid
5	Reference Line
6	Same Color for all Markers

<DispEl>	Display Element
7	Vertical Range Lines
8	Diagram Title
9	Limit Fail Trace Color
10	Limit Line Type Off
11	Limit Line Type Upper
12	Limit Line Type Lower
13 to 12+N	Trace properties 1 to N, where N is the number of trace colors configured using SYSTem:DISPlay:TRACes:CCOunt

DISPlay:CMAP:TRACe:COLor[:STATe] <Boolean>

Defines the trace color schemes in different diagram areas.

Parameters:

<Boolean>

OFF - independent color scheme in new diagram area. Moved traces change their color.

ON - color scheme in new diagram area continues the previous color scheme. Moved traces keep their color.

Example:

```
*RST; :DISP:CMAP13:RGB 1,0,0
```

Create diagram area no. 1 (with default trace showing the S-parameter S_{21}) and color the trace red.

```
DISP:CMAP:TRAC:COL OFF; :DISP:WIND2:STAT ON
```

Select independent color schemes for new diagram areas. Create a new diagram area no. 2.

```
CALC:PAR:SDEF 'Trc2', 'S11'; :DISP:WIND2:TRAC2:FEED 'TRC2'
```

Create a new trace named Trc2 and display the trace in a new diagram area no. 2. The new trace is red like the first trace.

```
DISP:CMAP:TRAC:COL ON; :DISP:WIND3:STAT ON
```

Continue the same color scheme in new diagram areas. Create a new diagram area no. 3.

```
CALC:PAR:SDEF 'Trc3', 'S22'; :DISP:WIND3:TRAC3:FEED 'Trc3'
```

Create a new trace named Trc3 and display the trace in a new diagram area no. 3. The new trace is not red.

Manual operation: See "[General > Trace Colors per Diagram](#)" on page 849

DISPlay:CMAP:TRACe:RGB <TraceName>, <Red>, <Green>, <Blue>[, <TraceStyle>[, <TraceWidth>]]

Defines the color, style and width of a trace referenced by its name, based on the Red/Green/Blue color model. Use the generalized command [DISPlay:CMAP<DispEl>:RGB](#) to define the color of other display elements.

Parameters:

<TraceName>	Trace name, string parameter
<Red>	Red content of the defined color. Range: 0 (zero intensity, corresponding to a 0 in the 24-bit color model) to 1 (full intensity, corresponding to 255 in the 24-bit color model).
<Green>	Green content of the defined color. Range: 0 (zero intensity, corresponding to a 0 in the 24-bit color model) to 1 (full intensity, corresponding to 255 in the 24-bit color model).
<Blue>	Blue content of the defined color. Range: 0 (zero intensity, corresponding to a 0 in the 24-bit color model) to 1 (full intensity, corresponding to 255 in the 24-bit color model).
<TraceStyle>	SOLid DASHed DOTTed DDOTted DDDotted Optional trace style, only for traces (<DispEl> > 12): One of the string parameters SOLid DASHed DOTTed DDOTted DDDotted.
<TraceWidth>	Optional trace width, only for traces (<DispEl> > 12). Range: 1 to 20

Example:

```
*RST; :DISP:CMAP:TRAC:RGB 'Trc1', 1, 0, 0
Color the default trace 'Trc1' red.
See also DISPLAY:CMAP<DispEl>:RGB
```

Manual operation: See "[Properties](#)" on page 848

DISPlay:IWInDow:BFILter[:STATe] <TraceName>, <BandfilterItem>, <Boolean>

Defines the bandfilter search results to be displayed in the [Info Window](#).

Parameters:

<Boolean>	0 – Result <BandfilterItem> of trace <TraceName> is displayed 1 – Result <BandfilterItem> of trace <TraceName> is hidden
-----------	-----------------------------------------------------------------------------------------------------------------------------

Setting parameters:

<TraceName>	Name of the related trace.
<BandfilterItem>	CENTer BANdwidth UPPer LOWer LOSS QFActor QFA3 HEADer Bandfilter search result (see Display elements of a diagram)

Manual operation: See "[Content Selection](#)" on page 851

DISPlay:IWInDow:MARKer<Mk>[:STATe] <TraceName>, <Boolean>

Defines the markers to be displayed in the [Info Window](#).

Suffix:

<Mk> Marker number.

Parameters:

<Boolean> 0 – Marker <Mk> of trace <TraceName> is displayed
1 – Marker <Mk> of trace <TraceName> is hidden

Setting parameters:

<TraceName> Name of the related trace.

Manual operation: See "[Content Selection](#)" on page 851

DISPlay:IWInDow[:STATe] <Boolean>

Shows/hides the [Info Window](#)

Parameters:

<Boolean> 0 – hide the "Info Window" (default)
1 – show the "Info Window"

Manual operation: See "[Info Window](#)" on page 847

DISPlay:LAYout <LayoutMode>

Arranges the diagrams in the screen, leaving the diagram contents unchanged.

Parameters:

<LayoutMode> LINEup | STACK | HORizontal | VERTical | GRID
 LINEup – the diagrams are arranged side by side.
 STACK – the diagrams are arranged one on top of the other.
 HORizontal – the diagrams are arranged in horizontal rows.
 VERTical – the diagrams are arranged in vertical rows.
 GRID – the diagrams are arranged as a rectangular matrix. The number of rows and columns is as defined with command [DISPlay:LAYout:GRID](#).

Example: See [DISPlay:LAYout:GRID](#)

Manual operation: See "[Split Type](#)" on page 843

DISPlay:LAYout:APPLy <LayoutId>

Selects a previously defined layout for display in the analyzer screen.

Parameters:

<LayoutId> Integer value 1, 2 ...
 Current number, as defined by [DISPlay:LAYout:DEFine](#).

Example: See [Creating diagrams](#)

Manual operation: See "[Additional Functionality: SCPI Commands](#)" on page 844

DISPlay:LAYout:DEFine <LayoutId>, <LayoutFormatMode>, <LayoutData>
DISPlay:LAYout:DEFine? <LayoutId>

Creates a horizontal or vertical display layout and provides it with an identifier (<LayoutId>).

Layouts are defined row by row (horizontal layouts) or column by column (vertical layouts).

- A horizontal layout consists of N rows, each of height h_i ($i = 1$ to N). The heights are defined in units relative to the total height of the screen, i.e. their sum $h_1 + h_2 + \dots + h_N$ must be equal to 1.00.
 Each row contains a selectable number of diagrams with independent widths w_{ij} ($j = 1, 2 \dots M(i)$). The sum of the widths in each row must also match the screen width, hence $w_{i1} + w_{i2} + \dots + w_{iM(i)} = 1.00$ for all rows ($i = 1$ to N).
 The <LayoutData> string for horizontal layouts reads ' $h_1, w_{11}, w_{12} \dots w_{1M(1)}; h_2, w_{21}, w_{22} \dots w_{2M(2)}; \dots; h_N, w_{N1}, w_{N2} \dots w_{NM(N)}$ '.
 A semicolon separates different rows, a comma separates different diagram widths within a row.
- The definition of a vertical layout is analogous, however, the role of rows and columns is interchanged.

The query returns the layout data in an alternative, executable format. The executable format is also used by [DISPlay:LAYout:EXECute](#).

Use [DISPlay:LAYout:JOIN](#) or [DISPlay:LAYout:EXECute](#) to create more complicated (nested) layouts.

Note: The maximum number of diagrams in a layout is 256.

Parameters:

<LayoutFormatMode> HORIZONTAL | VERTICAL

Horizontal or vertical layout; see above.

<LayoutData>

String parameter defining the number of diagrams and their position (easy format); see above.

Parameters for setting and query:

<LayoutId>

Integer value 1, 2 ...

Current number, used by other [DISPlay:LAYout...](#) commands to reference the created layout.

Example:

See [Creating diagrams](#)

Manual operation: See "[Additional Functionality: SCPI Commands](#)" on page 844

DISPlay:LAYout:EXECute <LayoutData>

Creates and displays a horizontal or vertical display layout. The query returns the layout data of the currently displayed layout (the last layout selected via [DISPlay:LAYout:APPLY](#)) in executable format.

The executable format is an extension of the easy format used by `DISPlay:LAYout:DEFine`.

- The `<LayoutData>` string consists of two parts: `<LayoutData> = '(<StartFormat>,<RepeatFormat1>,<RepeatFormat2> ...)`. The `<StartFormat>` descriptor distinguishes between horizontal and vertical layouts and defines the number of rows or columns. A `<RepeatFormat>` descriptor follows for each row or column in the layout. The `<RepeatFormat>` descriptors can be nested in order to describe joined layouts; refer to [Creating diagrams](#) for an easy example.
- For a horizontal layout with N rows, each of height h_i ($i = 1 \dots N$) and filled with $M(i)$ diagrams with independent widths w_{ij} ($j = 1, 2 \dots M(i)$), the data string is composed as follows:
`<StartFormat> = N,1,0.00,0.00`
`<RepeatFormati> = (1,M(i),1.00,hi[wi1,1.00], [wi2,1.00] ... [wiM(i),1.00])`
- For a vertical layout with N columns, each of width w_i ($i = 1 \dots N$) and filled with $M(i)$ diagrams with independent heights h_{ij} ($j = 1, 2 \dots M(i)$), the data string is composed as follows:
`<StartFormat> = 1,N,0.00,0.00`
`<RepeatFormati> = (M(i),1,wi,1.00,[1.00,hi1], [1.00,hi2] ... [1.00,hiM(i)])`

Note: The maximum number of diagrams in a layout is 256.

Parameters:

`<LayoutData>` String parameter defining the number of diagrams and their position (executable format); see above.

Example: See [Creating diagrams](#)

Manual operation: See "[Additional Functionality: SCPI Commands](#)" on page 844

DISPlay:LAYout:GRID <Rows>, <Columns>

Defines the number of rows and columns if `DISPlay:LAYout GRID` is set.

Parameters:

`<Rows>` Range: 1 to 16
 *RST: 1

`<Columns>` Range: 1 to 16
 *RST: 1

Example:

`DISPlay:LAYout GRID`

Select to split type where the diagrams are arranged in rows and columns.

`DISPlay:LAYout:GRID 2,2`

Arrange 4 diagrams in two rows and two columns.

Manual operation: See "[Diagrams / Rows / Columns](#)" on page 844

DISPlay:LAYout:JOIN <MainLayoutId>, <DiagramNumber>, <SubLayoutId>

Creates a nested layout, inserting a sub-layout into one of the diagrams of a main layout. Main layout and sub-layout must be defined previously, preferably using [DISPlay:LAYout:DEFine](#).

Note: The maximum number of joined levels within a layout is 16.

Setting parameters:

<MainLayoutId>	Integer value 1, 2 ... Current number of main layout, as defined by DISPlay:LAYout:DEFine .
<DiagramNumber>	Integer value 1, 2 ... Diagram number in the main layout
<SubLayoutId>	Integer value 1, 2 ... Current number of sub-layout, as defined by DISPlay:LAYout:DEFine . *RST: n/a

Example: See [Creating diagrams](#)

Usage: Setting only

Manual operation: See "[Additional Functionality: SCPI Commands](#)" on page 844

DISPlay:LAYout:OVERlay

Displays all traces of the active recall set in a single diagram, which is maximized to occupy the whole screen.

Usage: Event

Manual operation: See "[Overlay All](#)" on page 841

DISPlay:LAYout:SPLit

Creates a separate diagram for each trace in the active recall set and automatically arranges those diagrams in the diagram area. Existing diagrams are deleted.

Usage: Event

Manual operation: See "[Split All](#)" on page 841

DISPlay:MENU:KEY:ACTion:CATalog?

Displays the identifiers of the available dialog opener actions as a comma-separated list of strings.

Use [DISPlay:MENU:KEY:EXECute](#) to open one of the dialogs.

Usage: Query only

DISPlay:MENU:KEY:EXECute <MenuKey>

Opens the dialog identified by <MenuKey>.

Use [DISPlay:MENU:KEY:ACTion:CATalog?](#) to display the available opener IDs.

Note that no error is generated if a valid <MenuKey> is specified but the dialog cannot be opened for any other reason.

Setting parameters:

<MenuKey> Identifier of a dialog opener

Example: `*RST; DISP:MENU:KEY:EXECute ':Cal:Management:CalConnectorTypes'`
Activates the [Cal Connector Types dialog](#).

Usage: Setting only

Tip: When working with the [GPIB Explorer](#), switch to raw mode ("Options > Raw mode" in the IECWIN32 GUI) before executing this command.

DISPlay:MENU:KEY:SElect <MenuKey>

Activates the softtool tab with identifier <MenuKey>.

Use [DISPlay:MENU:KEY:TOOL:CATalog?](#) to display the available identifiers.

Note that no error is generated if a valid <MenuKey> is specified but the tab cannot be activated for any other reason.

Setting parameters:

<MenuKey> Identifier of a softtool tab

Example: `*RST; DISP:MENU:KEY:SEL ':Meas:SParams'`
Activates the "S-Params" tab of the "Meas" softtool.

Usage: Setting only

Tip: When working with the [GPIB Explorer](#), switch to raw mode ("Options > Raw mode" in the IECWIN32 GUI) before executing this command.

DISPlay:MENU:KEY:TOOL:CATalog?

Displays the identifiers of the available softtool tabs as a comma-separated list of strings.

Use [DISPlay:MENU:KEY:SElect](#) to activate one of the tabs.

Usage: Query only

DISPlay:RFSize <RelFontSize>

Defines the size of the fonts in the diagram on a relative scale.

Parameters:

<RelFontSize> Relative font size
 Range: 80 % to 170 %
 *RST: 100 %
 Default unit: percent

Example:

*RST; :DISP:RFS 80
 Use smaller fonts to gain more space for the traces in the diagram.

Manual operation: See ["Font Size"](#) on page 847

DISPlay[:WINDow<Wnd>]:CATalog?

Returns the numbers and names of all diagrams in the current recall set.

The response is a string containing a comma-separated list of diagram area numbers and names, see example below. If all diagram areas have been deleted, the response is an empty string ("").

Suffix:

<Wnd> Number of a diagram. This suffix is ignored; the command returns a list of all diagrams.

Example:

```
*RST; :DISP:WIND2:STAT ON
Create diagram no. 2.
DISP:WIND2:NAME 'S11 Test Diagram'
Assign a name to the new diagram.
DISP:CAT?
Query all diagrams and their names. As a default diagram no. 1
is created upon *RST, the response is '1,1,2,S11 Test
Diagram'. The first diagram is not named; its default name is
equal to the diagram number.
CALC:PAR:SDEF 'Win2_Tr1', 'S11'
Create a trace named Win2_Tr1 to measure the input reflection
coefficient S11.
DISP:WIND2:TRAC9:FEED 'Win2_Tr1'
Display the generated trace in diagram area no. 2, assigning the
trace number 9 to it.
DISP:WIND2:TRAC:CAT?
Query all traces in diagram area no. 2. The response is
'9,Win2_Tr1'.
```

Usage: Query only

Manual operation: See ["Title"](#) on page 840

DISPlay[:WINDow<Wnd>]:MAXimize <Boolean>

Maximizes all diagram areas in the active recall set or restores the previous display configuration.

Suffix: <Wnd>	Number of the diagram area to become the active diagram area. <code>DISPlay:WINDow<Wnd>:MAXimize</code> acts on all diagrams of the current recall set, however, the diagram no. <Wnd> is displayed on top of the others.
Parameters: <Boolean>	ON OFF - maximize all diagram areas or restore the previous display configuration. *RST: OFF
Example:	*RST; :DISP:WIND2:STAT ON Create diagram areas no. 1 (with default trace) and 2 (with no trace). <code>DISP:WIND2:MAXimize ON</code> Maximize the diagram areas, placing area no. 2 on top.
Manual operation:	See " Maximize Diagram " on page 840

DISPlay[:WINDow<Wnd>]:NAME <Name>

Defines a name for diagram area <Wnd>. The name appears in the list of diagram areas, to be queried by `DISPlay[:WINDow<Wnd>]:CATalog?`.

Suffix: <Wnd>	Number of the diagram area.
Parameters: <Name>	String variable for the name.
Example:	See <code>DISPlay[:WINDow<Wnd>]:CATalog?</code>
Manual operation:	See " Title " on page 840

DISPlay[:WINDow<Wnd>]:OVERview[:STATE] <Boolean>

Enables the zoom function with an additional overview window for the diagram no. <Wnd> or removes the overview window from a diagram.

Suffix: <Wnd>	Number of the zoomed diagram area
Parameters: <Boolean>	ON – activate the zoom window with overview window OFF – remove the overview window *RST: OFF
Example:	See <code>DISPlay[:WINDow<Wnd>]:TRACe<WndTr>:ZOOM[:STATE]</code>

DISPlay[:WINDow<Wnd>][:STATe] <Boolean>

Creates or deletes a diagram area, identified by its area number <Wnd>.

Suffix:

<Wnd> Number of the diagram area to be created or deleted.

Parameters:

<Boolean> ON | OFF - creates or deletes diagram area no. <Wnd>.

*RST: -

Example:

```
CALC4:PAR:SDEF 'Ch4Tr1', 'S11'
```

Create channel 4 and a trace named Ch4Tr1 to measure the input reflection coefficient S₁₁.

```
DISP:WIND2:STAT ON
```

Create diagram area no. 2.

```
DISP:WIND2:TRAC9:FEED 'CH4TR1'
```

Display the generated trace in diagram area no. 2, assigning the trace number 9 to it.

Manual operation: See ["Add Trace + Diagram"](#) on page 433

DISPlay[:WINDow<Wnd>]:TITLe:DATA <Title>

Defines a title for diagram area <Wnd>.

Suffix:

<Wnd> Number of the diagram area.

Parameters:

<Title> String variable for the title. The length of the title is practically unlimited but should be kept short enough to be displayed in the diagrams.

Example:

```
*RST; :DISP:WIND:TITL:DATA 'S21 Test Diagram'
```

Define a title for the default diagram area. The title is displayed below the top of the diagram area.

```
DISP:WIND:TITL OFF; TITL:DATA?
```

Hide the title. The title is no longer displayed but still defined so it can be displayed again.

Manual operation: See ["Title"](#) on page 840

DISPlay[:WINDow<Wnd>]:TITLe[:STATe] <Boolean>

Displays or hides the title for area number <Wnd>, defined by means of

```
DISPlay:WINDow<Wnd>:TITLe:DATA.
```

Suffix:

<Wnd> Number of the diagram area.

Parameters:

<Boolean> ON | OFF - displays or hides the title.
 *RST: ON

Example: See [DISPlay\[:WINDow<Wnd>\]:TITLe:DATA](#)

Manual operation: See ["Show Title"](#) on page 841

DISPlay[:WINDow<Wnd>]:TRACe<WndTr>:CATalog?

Returns the numbers and names of all traces in diagram area no. <Wnd>.

Suffix:

<Wnd> Number of a diagram area.
 <WndTr> Trace number used to distinguish the traces of the same diagram area <Wnd>. This suffix is ignored; the command returns a list of all traces.

Example: See [DISPlay\[:WINDow<Wnd>\]:CATalog?](#)

Usage: Query only

Manual operation: See ["Active Diagram"](#) on page 839

DISPlay[:WINDow<Wnd>]:TRACe<WndTr>:DElete

Releases the assignment between a trace and a diagram area, as defined by means of [DISPlay\[:WINDow<Wnd>\]:TRACe<WndTr>:FEED <TraceName>](#) and expressed by the <WndTr> suffix. The trace itself is not deleted; this must be done via [CALCulate<Ch>:PARAmeter:DElete <TraceName>](#).

Suffix:

<Wnd> Number of an existing diagram area (defined by means of [DISPlay\[:WINDow<Wnd>\]\[:STATE\] ON](#)).
 <WndTr> Trace number used to distinguish the traces of the same diagram area <Wnd>.

Example: `CALC4:PAR:SDEF 'Ch4Tr1', 'S11'`
 Create channel 4 and a trace named Ch4Tr1 to measure the input reflection coefficient S₁₁.
`DISP:WIND2:STAT ON`
 Create diagram area no. 2.
`DISP:WIND2:TRAC9:FEED 'CH4TR1'`
 Display the generated trace in diagram area no. 2, assigning the trace number 9 to it.
`DISP:WIND2:TRAC9:DElete`
 Release the assignment between trace no. 9 and window no. 2. The trace can still be referenced with its trace name Ch4Tr1.

Usage: Event

DISPlay[:WINDow<Wnd>]:TRACe<WndTr>:EFEed <TraceName>

Assigns an existing trace (`CALCulate<Ch>:PARAmeter:SDEFine <TraceName>`) to a diagram area `<Wnd>`, and displays the trace. Use `DISPlay[:WINDow<Wnd>]:TRACe<WndTr>:FEED` to assign the trace to a diagram area using a numeric suffix (e.g. in order to use the `DISPlay[:WINDow<Wnd>]:TRACe<WndTr>:Y:OFFSet` command).

Tip: You can open the "Trace Manager" dialog to obtain an overview of all channels and traces, including the traces that are not displayed.

Suffix:

`<Wnd>` Number of an existing diagram area (defined by means of `DISPlay[:WINDow<Wnd>][:STATE] ON`).

`<WndTr>` Trace number. This suffix is ignored; the trace is referenced by its name.

Setting parameters:

`<TraceName>` String parameter for the trace name, e.g. 'Trc4'.

Example:

```
CALC4:PAR:SDEF 'Ch4Tr1', 'S11'
```

Create channel 4 and a trace named Ch4Tr1 to measure the input reflection coefficient S_{11} .

```
DISP:WIND2:STAT ON
```

Create diagram area no. 2.

```
DISP:WIND2:TRAC:EFE 'CH4TR1'
```

Display the generated trace in diagram area no. 2. No trace number is assigned.

Usage: Setting only

DISPlay[:WINDow<Wnd>]:TRACe<WndTr>:FEED <TraceName>

Assigns an existing trace (`CALCulate<Ch>:PARAmeter:SDEFine`) to a diagram area, using the `<WndTr>` suffix, and displays the trace. Use `DISPlay[:WINDow<Wnd>]:TRACe<WndTr>:EFEed` to assign the trace to a diagram area without using a numeric suffix.

Tip: A trace can be assigned to a diagram only once. If a attempt is made to assign the same trace a second time (e.g. by typing `DISP:WIND2:TRAC8:FEED 'CH4TR1'` after executing the program example below) an error message -114,"Header suffix out of range" is generated. You can open the "Trace Manager" dialog to obtain an overview of all channels and traces, including the traces that are not displayed.

Suffix:

`<Wnd>` Number of an existing diagram area (defined by means of `DISPlay[:WINDow<Wnd>][:STATE] ON`).

`<WndTr>` Trace number used to distinguish the traces of the same diagram area `<Wnd>`.

Parameters:

`<TraceName>` String parameter for the trace name, e.g. 'Trc4'.

Example: `CALC4:PAR:SDEF 'Ch4Tr1', 'S11'`
 Create channel 4 and a trace named Ch4Tr1 to measure the input reflection coefficient S_{11} .
`DISP:WIND2:STAT ON`
 Create diagram area no. 2.
`DISP:WIND2:TRAC9:FEED 'CH4TR1'`
 Display the generated trace in diagram area no. 2, assigning the trace number 9 to it.

Manual operation: See ["Add Trace"](#) on page 432

DISPlay[:WINDow<Wnd>]:TRACe<WndTr>:LABel:SHOW <TraceName>[, <Boolean>]

Displays or hides the label of an existing trace, identified by its <TraceName>.

Suffix:

<Wnd> ignored

<WndTr> ignored

Parameters:

<TraceName> Trace name (string parameter), e.g. 'Trc4'

<Boolean> ON | OFF – display or hide the label of the related trace

Example:

`*RST; :DISP:TRAC:LAB:SHOW? 'Trc1'`

Reset the analyzer, creating the default trace 'Trc1'. The trace label is displayed; the query returns 1.

`DISP:TRAC:LAB:SHOW 'Trc1', OFF`

Hide the label of trace 'Trc1'.

Manual operation: See ["Table Area"](#) on page 435

DISPlay[:WINDow<Wnd>]:TRACe<WndTr>:SHOW <TraceName>[, <Boolean>]

Displays or hides an existing trace, identified by its trace name <Trace_Name>, or a group of traces.

Tip: You can open the trace manager to obtain an overview of all channels and traces, including the traces that are not displayed.

Suffix:

<Wnd> Number of a diagram area. This suffix is ignored; the command affects traces in all diagram areas.

<WndTr> Trace number. This suffix is ignored; the trace is referenced by its name.

Parameters:

<TraceName> DALL – all data traces

MALL – all memory traces

<string> – single trace identified by its trace name (string parameter), e.g. 'Trc4'.

<Boolean> ON | OFF – display or hide traces.

Example:

```
*RST; :DISP:TRAC:SHOW? 'Trc1'
```

Reset the analyzer, creating the default trace 'Trc1'. The trace is displayed; the query returns 1.

```
CALC4:PAR:SDEF 'Ch4Tr1', 'S11'
```

Create channel 4 and a trace named Ch4Tr1 to measure the input reflection coefficient S_{11} .

```
DISP:WIND2:STAT ON; :DISP:WIND2:TRAC:FEED  
'CH4TR1'
```

Create diagram area no. 2 and display the generated trace in the diagram area.

```
DISP:TRAC:SHOW DALL, OFF
```

Hide both traces in both diagrams.

```
DISP:TRAC:SHOW? DALL
```

Query whether all data traces are displayed. The response 0 means that at least one trace is hidden.

Manual operation: See "[Table Area](#)" on page 435

DISPlay[:WINDow<Wnd>]:TRACe<WndTr>:X:OFFSet <StimulusOffset>

Shifts the trace <WndTr> in horizontal direction, leaving the positions of all markers unchanged.

Suffix:

<Wnd>

Number of an existing diagram area (defined by means of [DISPlay\[:WINDow<Wnd>\]\[:STATe\] ON](#)).

<WndTr>

Existing trace number, assigned by means of [DISPlay\[:WINDow<Wnd>\]:TRACe<WndTr>:FEED](#).

Parameters:

<StimulusOffset>

Stimulus offset value.

The range and unit depends on the sweep type.

Default unit: NN

Example:

```
*RST; :DISP:WIND:TRAC:X:OFFS 1MHZ; :DISP:WIND:  
TRAC:Y:OFFS 10
```

Create the default trace and shift it horizontally by 1 MHz, vertically by 10 dB.

Manual operation: See "[Stimulus](#)" on page 465

DISPlay[:WINDow<Wnd>]:TRACe<WndTr>:Y:OFFSet <MagnitudeFactor>[, <PhaseFactor>[, <RealPart>[, <ImaginaryPart>]]]

Modifies all points of the trace <WndTr> by means of an added and/or a multiplied complex constant. The response values M of the trace are transformed according to:

Suffix:

<Wnd> Number of an existing diagram area (defined by means of `DISPlay[:WINDow<Wnd>][:STATE] ON`).

<WndTr> Existing trace number, assigned by means of `DISPlay[:WINDow<Wnd>]:TRACe<WndTr>:FEED`.

Parameters:

<MagnitudeFactor> Multiplied magnitude factor

Range: -300 dB to + 300 dB

*RST: 0 dB

Default unit: dB

<PhaseFactor> Multiplied phase factor, optional for setting command but returned by query

Range: -3.4*1038 deg to +3.4*1038 deg

*RST: 0 deg

Default unit: deg

<RealPart> Real and imaginary part of added complex constant, optional for setting command but returned by query

Range: -3.4*1038 to +3.4*1038

*RST: 0

<ImaginaryPart>

Example:

```
*RST; :DISP:WIND:TRAC:X:OFFS 1MHZ; :DISP:WIND:
TRAC:Y:OFFS 10
```

Create the default trace and shift it horizontally by 1 MHz, vertically by 10 dB.

```
DISP:WIND:TRAC:Y:OFFS?
```

Query all response offset values. The response is 10, 0, 0, 0.

Manual operation: See "[Mag / Phase / Real / Imag](#)" on page 465

```
DISPlay[:WINDow<Wnd>]:TRACe<WndTr>:Y[:SCALE]:AUTO <Activate>[,
<TraceName>]
```

Displays the entire trace in the diagram area, leaving an appropriate display margin.

The trace can be referenced either by its number <WndTr> or by its name

<TraceName>.

Suffix:

<Wnd> Number of an existing diagram area (defined by means of `DISPlay[:WINDow<Wnd>][:STATE] ON`). This suffix is ignored if the optional <TraceName> parameter is used.

<WndTr> Existing trace number, assigned by means of `DISPlay[:WINDow<Wnd>]:TRACe<WndTr>:FEED`. This suffix is ignored if the optional <TraceName> parameter is used.

Setting parameters:

<Activate>	ONCE Activate the autoscale function.
<TraceName>	Optional string parameter for the trace name, e.g. 'Trc4'. If this optional parameter is present, both numeric suffixes are ignored (trace names must be unique across different channels and windows).

Example:

```
*RST; DISP:WIND:TRAC:Y:PDIV?; RLEV?
```

Query the value between two grid lines and the reference value for the default trace. The response is 10;0.

```
DISP:WIND:TRAC:Y:AUTO ONCE; PDIV?; RLEV?
```

or:

```
DISP:WIND:TRAC:Y:AUTO ONCE, 'Trc1'; PDIV?; RLEV?
```

Autoscale the default trace and query the scaling parameters again. In general both values have changed.

Usage: Setting only

Manual operation: See ["Auto Scale Trace"](#) on page 427

```
DISPlay[:WINDow<Wnd>]:TRACe<WndTr>:Y[:SCALE]:BOTTom <LowEdge>[,  
  <TraceName>]
```

```
DISPlay[:WINDow<Wnd>]:TRACe<WndTr>:Y[:SCALE]:TOP <UppEdge>[,  
  <TraceName>]
```

These commands define the lower (bottom) and upper (top) edge of the diagram area <Wnd>.

Suffix:

<Wnd>	Number of an existing diagram area (defined by means of DISPlay[:WINDow<Wnd>][:STATE] ON). This suffix is ignored if the optional <TraceName> parameter is used.
<WndTr>	Existing trace number, assigned by means of DISPlay[:WINDow<Wnd>]:TRACe<WndTr>:FEED . This suffix is ignored if the optional <TraceName> parameter is used.

Parameters:

<UppEdge>	Value and unit for the lower or upper diagram edge. Range and unit depend on the measured quantity, see "Units for DISPlay... commands" on page 1232. Default unit: NN
<TraceName>	Optional string parameter for the trace name, e.g. 'Trc4'. If this optional parameter is present, both numeric suffixes are ignored (trace names must be unique across different channels and windows).

Example:

```
CALC4:PAR:SDEF 'Ch4Tr1', 'S11'
```

Create channel 4 and a trace named Ch4Tr1 to measure the input reflection coefficient S_{11} .

```
DISP:WIND2:STAT ON
```

Create diagram area no. 2.

```
DISP:WIND2:TRAC9:FEED 'CH4TR1'
```

Display the generated trace in diagram area no. 2, assigning the trace number 9 to it.

```
DISP:WIND2:TRAC9:Y:BOTT -40; TOP 10
```

or:

```
DISP:WIND2:TRAC:Y:BOTT -40, 'CH4TR1'; TOP 10, 'CH4TR1'
```

Scale the diagram between -40 dB and +10 dB.

Manual operation: See "[Max / Min](#)" on page 428

DISPlay[:WINDow<Wnd>]:TRACe<WndTr>:Y[:SCALE]:PDIVision <VerticalDiv>[, <TraceName>]

Sets the value between two grid lines (value "per division") for the diagram area <Wnd>. When a new PDIVision value is entered, the current RLEVel is kept the same, while the top and bottom scaling is adjusted for the new PDIVision value.

Suffix:

<Wnd> Number of an existing diagram area (defined by means of [DISPlay\[:WINDow<Wnd>\]\[:STATE\] ON](#)). This suffix is ignored if the optional <TraceName> parameter is used.

<WndTr> Existing trace number, assigned by means of [DISPlay\[:WINDow<Wnd>\]:TRACe<WndTr>:FEED](#). This suffix is ignored if the optional <TraceName> parameter is used.

Parameters:

<VerticalDiv> Value and unit for the vertical diagram divisions. Range and unit depend on the measured quantity, see "[Units for DISPlay... commands](#)" on page 1232.
Default unit: NN

<TraceName> Optional string parameter for the trace name, e.g. 'Trc4'. If this optional parameter is present, both numeric suffixes are ignored (trace names must be unique across different channels and windows).

Example:

```
CALC4:PAR:SDEF 'Ch4Tr1', 'S11'
```

Create channel 4 and a trace named Ch4Tr1 to measure the input reflection coefficient S_{11} .

```
DISP:WIND2:STAT ON
```

Create diagram area no. 2.

```
DISP:WIND2:TRAC9:FEED 'CH4TR1'
```

Display the generated trace in diagram area no. 2, assigning the trace number 9 to it.

```
DISP:WIND2:TRAC9:Y:PDIV 5
```

or:

```
DISP:WIND2:TRAC:Y:PDIV 5, 'CH4TR1'
```

Set the value per division to 5 dB.

Manual operation: See ["Scale/Div"](#) on page 427

```
DISPlay[:WINDow<Wnd>]:TRACe<WndTr>:Y[:SCALE]:RLEVel <RefLevel>[,  
  <TraceName>]
```

Sets the reference level (or reference value) for a particular displayed trace. Setting a new reference level does not affect the value of `PDIVision`. The trace can be referenced either by its number `<WndTr>` or by its name `<TraceName>`.

Suffix:

`<Wnd>`

Number of an existing diagram area (defined by means of `DISPlay[:WINDow<Wnd>][:STATE] ON`). This suffix is ignored if the optional `<TraceName>` parameter is used.

`<WndTr>`

Existing trace number, assigned by means of `DISPlay[:WINDow<Wnd>]:TRACe<WndTr>:FEED`. This suffix is ignored if the optional `<TraceName>` parameter is used.

Parameters:

`<RefLevel>`

Value and unit for the reference level (or reference value, if the trace does not show a level). Range and unit depend on the measured quantity, see ["Units for DISPlay... commands"](#) on page 1232.

Default unit: NN

`<TraceName>`

Optional string parameter for the trace name, e.g. 'Trc4'. If this optional parameter is present, both numeric suffixes are ignored (trace names must be unique across different channels and windows).

Example:

```
CALC4:PAR:SDEF 'Ch4Tr1', 'S11'
```

Create channel 4 and a trace named Ch4Tr1 to measure the input reflection coefficient S_{11} .

```
DISP:WIND2:STAT ON
```

Create diagram area no. 2.

```
DISP:WIND2:TRAC9:FEED 'CH4TR1'
```

Display the generated trace in diagram area no. 2, assigning the trace number 9 to it.

```
DISP:WIND2:TRAC9:Y:RLEV -10
```

or:

```
DISP:WIND2:TRAC:Y:RLEV -10, 'CH4TR1'
```

Change the reference level to -10 dB.

Manual operation: See ["Ref Value"](#) on page 428

```
DISPlay[:WINDow<Wnd>]:TRACe<WndTr>:Y[:SCALe]:RPOSition <RefPosition>[,  
  <TraceName>]
```

Sets the point on the y-axis to be used as the reference position as a percentage of the length of the y-axis. The reference position is the point on the y-axis which should equal the `RLEVEL`.

Suffix:

<Wnd>

Number of an existing diagram area (defined by means of `DISPlay[:WINDow<Wnd>][:STATe] ON`). This suffix is ignored if the optional <TraceName> parameter is used.

<WndTr>

Existing trace number, assigned by means of `DISPlay[:WINDow<Wnd>]:TRACe<WndTr>:FEED`. This suffix is ignored if the optional <TraceName> parameter is used.

Parameters:

<RefPosition>

Value of the reference position in percent. The top of the y-axis is defined to have a reference position of 100%, while the bottom of the y-axis is defined to have a reference position of 0%.

Range: 0% to 100%

*RST: 80%

Default unit: %

<TraceName>

Optional string parameter for the trace name, e.g. 'Trc4'. If this optional parameter is present, both numeric suffixes are ignored (trace names must be unique across different channels and windows).

Example: `CALC4:PAR:SDEF 'Ch4Tr1', 'S11'`
 Create channel 4 and a trace named Ch4Tr1 to measure the input reflection coefficient S_{11} .
`DISP:WIND2:STAT ON`
 Create diagram area no. 2.
`DISP:WIND2:TRAC9:FEED 'CH4TR1'`
 Display the generated trace in diagram area no. 2, assigning the trace number 9 to it.
`DISP:WIND2:TRAC9:Y:RPOS 50`
 or:
`DISP:WIND2:TRAC:Y:RPOS 50, 'CH4TR1'`
 Set the reference position to the center of the diagram area.

Manual operation: See ["Ref Pos"](#) on page 428

DISPlay[:WINDow<Wnd>]:TRACe<WndTr>:ZOOM:BOTTom <LowEdge>[, <TraceName>]
DISPlay[:WINDow<Wnd>]:TRACe<WndTr>:ZOOM:TOP <UppEdge>[, <TraceName>]

These commands specify the lower and upper edge of the zoom window. In contrast to manual control, all or part of the zoom window may be outside the original diagram.

Suffix:

<Wnd>

Number of an existing diagram (defined by means of [DISPlay\[:WINDow<Wnd>\]\[:STATe\] ON](#)). This suffix is ignored if the optional <TraceName> parameter is used.

<WndTr>

Existing trace number, assigned by means of [DISPlay\[:WINDow<Wnd>\]:TRACe<WndTr>:FEED](#). This suffix is ignored if the optional <TraceName> parameter is used.

Parameters:

<UppEdge>

Lower or upper edge of the zoom window. Range and unit depend on the measured quantity, see ["Units for DISPlay... commands"](#) on page 1232.

Default unit: NN

<TraceName>

Optional string parameter for the trace name, e.g. 'Trc4'. If this optional parameter is present, both numeric suffixes are ignored (trace names must be unique across different channels and windows).

Example:

See [DISPlay\[:WINDow<Wnd>\]:TRACe<WndTr>:ZOOM\[:STATe\]](#)

Manual operation: See ["Max / Min / Start / Stop"](#) on page 431

```

DISPlay[:WINDow<Wnd>]:TRACe<WndTr>:ZOOM:START <LeftBorder>[,
    <TraceName>]
DISPlay[:WINDow<Wnd>]:TRACe<WndTr>:ZOOM:STOP <RightBorder>[,
    <TraceName>]

```

These commands specify the start and stop values of the zoom window (left and right border), respectively. In contrast to manual control, all or part of the zoom window may be outside the original diagram. The range of possible values depends on the R&S ZNA's frequency range; see [Chapter 7.3.14.11, "\[SENSe:\]FREQUency..."](#), on page 1421.

Suffix:

<Wnd> Number of an existing diagram (defined by means of [DISPlay\[:WINDow<Wnd>\]\[:STATE\] ON](#)). This suffix is ignored if the optional <TraceName> parameter is used.

<WndTr> Existing trace number, assigned by means of [DISPlay\[:WINDow<Wnd>\]:TRACe<WndTr>:FEED](#). This suffix is ignored if the optional <TraceName> parameter is used.

Parameters:

<RightBorder> Left or right border of the zoom window.
 Range: See description above.
 *RST: Start or stop of the analyzer's sweep range.
 Default unit: NN

<TraceName> Optional string parameter for the trace name, e.g. 'Trc4'. If this optional parameter is present, both numeric suffixes are ignored (trace names must be unique across different channels and windows).

Example: See [DISPlay\[:WINDow<Wnd>\]:TRACe<WndTr>:ZOOM\[:STATE\]](#)

Manual operation: See "[Max / Min / Start / Stop](#)" on page 431

```

DISPlay[:WINDow<Wnd>]:TRACe<WndTr>:ZOOM[:STATE] <Boolean>[,
    <TraceName>]

```

Applies or disables the zoom function based on the current zoom window settings.

Suffix:

<Wnd> Number of an existing diagram (defined by means of [DISPlay\[:WINDow<Wnd>\]\[:STATE\] ON](#)). This suffix is ignored if the optional <TraceName> parameter is used.

<WndTr> Existing trace number, assigned by means of [DISPlay\[:WINDow<Wnd>\]:TRACe<WndTr>:FEED](#). This suffix is ignored if the optional <TraceName> parameter is used.

Parameters:

<Boolean>

Enable or disable the zoom. OFF also restores the original diagram size after a zoom function was applied.

OFF

<TraceName>

Optional string parameter for the trace name, e.g. 'Trc4'. If this optional parameter is present, both numeric suffixes are ignored (trace names must be unique across different channels and windows).

Example:

```
*RST; :DISPlay:WINDow1:TRACe:ZOOM:BOTTom -20;
TOP +10; START 1GHz; STOP 1.5 GHz
```

Define a zoom rectangle in the default diagram no. 1 ranging from -20 dB to +10 dB and from 1 GHz to 1.5 GHz.

```
DISPlay:WINDow1:TRACe:ZOOM ON
```

Zoom into the diagram no. 1 so that the zoom window fills the entire diagram. The actual sweep range and the stimulus values of the sweep points are not affected.

```
DISPlay:WINDow1:OVERview:STATe ON
```

Activate an additional overview window in the upper part of the diagram.

Manual operation: See "[Zoom Select/Stim. Zoom Select](#)" on page 430

7.3.6 FORMat commands

The `FORMAT . . .` commands select a data format for transferring numeric data (including arrays) from and to the analyzer.

<code>FORMat:BORDER</code>	1258
<code>FORMat[;DATA]</code>	1259

FORMat:BORDER <ByteOrder>

Defines how binary data are transferred and interpreted (byte order or endianness).

The firmware adjusts the byte order with the selected remote language (`SYSTEM:LANGuage`).

Parameters:

<ByteOrder>

NORMAL | SWAPped

NORMAL

Most significant byte first (big endian).

Default for remote languages 'ENA' | 'E5071' | 'PNA' | 'HP8510' | 'HP8530' | 'HP8714' | 'HP8720' | 'HP8753'

SWAPped

Least significant byte first (little endian).

Default for remote languages 'SCPI' | 'ZVABT' | 'ZVR'

Example: `FORM:BORD NORM`
Change the byte order to normal mode.

Manual operation: See "[Define *IDN + *OPT...](#)" on page 889

FORMat[:DATA] <TransferFormat>[, <Length>]

Selects the format for numeric data transferred to and from the analyzer.

Note: The format setting is only valid for commands and queries whose description states that the response is formatted as described by `FORMat[:DATA]`. In particular, it affects trace data transferred by means of the commands in the `TRACe:...` system.

Parameters:

`<TransferFormat>` `ASCIi | REAL`
`ASCIi` - numeric data is transferred as ASCII bytes. The numbers are separated by commas as specified in IEEE 488.2.
`REAL` - Data is transferred in a definite length block as IEEE floating point numbers of the specified `<Length>`. See [Chapter 6.2.3.5, "Block data format"](#), on page 944.
Note: If binary data is transferred to the analyzer, the receive terminator should be set to EOI (`SYSTem:COMMunicate: GPIB[:SELF]:RTERminator EOI`) to avoid inadvertent interruption of the data transfer.

`<Length>` The optional `<Length>` parameter is needed for `REAL` format only. It defines the length of the floating point numbers in bits. Valid values are 32 and 64.

`*RST:` `ASCIi`. The default length of `REAL` data is 32 bits (single precision).

Example: `FORM REAL, 32`
Select real data format.
`SYST:COMM:GPIB:RTER EOI`
Set the terminator to EOI.
 (During a calibration) ... `CORR:CDAT?`
`'REFLTRACK',1,0`
 Query a system error correction term. The data is transferred in a definite length block which can be written to a file; the analyzer displays the message "<no> bytes binary data received".

7.3.7 HCOPy commands

The `HCOPy...` commands control the output of screen information to an external device. Part of the functionality of this system is included in the "File" menu.

<code>HCOPy:DESTination</code>	1260
<code>HCOPy:DEVIce:LANGUage</code>	1260
<code>HCOPy[:IMMediate]</code>	1261
<code>HCOPy:ITEM:ALL</code>	1261
<code>HCOPy:ITEM:LOGO[:STATe]</code>	1261

HCOPY:ITEM:MLIST[:STATe].....	1262
HCOPY:ITEM:TIME[:STATe].....	1262
HCOPY:PAGE:COLor.....	1262
HCOPY:PAGE:MARGIn:BOTTom.....	1263
HCOPY:PAGE:MARGIn:LEFT.....	1263
HCOPY:PAGE:MARGIn:RIGHT.....	1263
HCOPY:PAGE:MARGIn:TOP.....	1264
HCOPY:PAGE:ORientation.....	1264
HCOPY:PAGE:WINDow.....	1264

HCOPY:DESTination <PrinterName>

Selects a printer name or file as destination for the screen output.

Parameters:

<PrinterName>	String variable containing the printer name. One of the printers accessible from your PC. The following strings are supported in addition: 'MMEM' - print to file. The file name is defined via <code>MMEMoRY:NAME</code> . The command <code>HCOPY:DEVIce:LANGUage</code> selects the file format. 'DEFPRT' - use default printer, to be selected in the "Devices and Printers" dialog of the Windows control panel. *RST: n/a (*RST does not overwrite the printer destination)
---------------	--------------------------------------------------------------------------------------------------------------------------------------------------------------------------------------------------------------------------------------------------------------------------------------------------------------------------------------------------------------------------------------------------------------------------------------------------------------------------------------------

Example:

```
MMEM:NAME 'C:\Screenshots\PLOT1.BMP'
```

Define a printer file name (without creating the file), assuming that .BMP is the current file format (see `HCOPY:DEVIce:LANGUage`).

```
HCOP:DEST 'MMEM'; :HCOP
```

Select 'Print to file' and create the printer file specified before.

Manual operation: See "To File..." on page 778

HCOPY:DEVIce:LANGUage <Format>

Selects a file format for printer files. Selecting the format is recommended to ensure that the file defined via `MMEMoRY:NAME` can be read or imported by an external application.

Parameters:

<Format>	BMP PNG JPG PDF SVG BMP - Windows bitmap JPG - JPEG bitmap PNG - portable network graphics format PDF - portable document format (Adobe® Systems) SVG - scalable vector graphics format, XML-based *RST: n/a (*RST does not affect the printer configuration)
----------	-----------------------------------------------------------------------------------------------------------------------------------------------------------------------------------------------------------------------------------------------------------------------------------------

Example: `HCOP:DEV:LANG BMP`
 Select Windows bitmap format for printer files.
`MMEM:NAME 'C:\Screenshots\PLOT1.BMP'`
 Define a printer file name and specify an existing directory (without creating the file).
`HCOP:DEST 'MMEM'; :HCOP`
 Select 'Print to file' and create the printer file specified before.

HCOPY[:IMMEDIATE]

Initializes the print according to the current `HCOPY...` configuration.

Example: `HCOP:DEST '<Printer_name>'`
 Select the printer for the output of screen data.
`HCOP`
 Start printing.

Usage: Event

Manual operation: See "[Print](#)" on page 778

HCOPY:ITEM:ALL

Selects the complete screen contents to be printed, including the logo ([HCOPY:ITEM:LOGO\[:STATE\]](#)), time ([HCOPY:ITEM:TIME\[:STATE\]](#)), and the marker list ([HCOPY:ITEM:MLIST\[:STATE\]](#)).

Example: `HCOP:ITEM:ALL`
 Select the complete information to be printed.
`HCOP`
 Start printing.

Usage: Event

HCOPY:ITEM:LOGO[:STATE] <Boolean>

Qualifies whether or not the printed output contains the logo. The default R&S logo (file `Logo.gif`) is stored in the `Resources\Images` subdirectory of the VNA program directory and can be replaced by another logo.

Parameters:

<Boolean> ON | OFF - logo is included or excluded.
 *RST: n/a (*RST does not affect the printer configuration)

Example: `HCOP:ITEM:ALL`
 Select the complete information to be printed.
`HCOP:ITEM:LOGO ON; :HCOP`
 Include the logo in the printed output and start printing.

HCOPY:ITEM:MLIST[:STATe] <Boolean>

Qualifies whether or not the printed output contains the information in the marker info field (marker list).

Parameters:

<Boolean> ON | OFF - marker list is included or excluded.
 *RST: n/a (*RST does not affect the printer configuration)

Example:

```
HCOPY:ITEM:ALL
Select the complete information to be printed.
HCOPY:ITEM:MLIST ON; :HCOPY
Include the marker list in the printed output and start printing.
```

HCOPY:ITEM:TIME[:STATe] <Boolean>

Qualifies whether or not the printed output contains the current date and time.

Parameters:

<Boolean> ON | OFF - date and time is included or excluded.
 *RST: n/a (*RST does not affect the printer configuration)

Example:

```
HCOPY:ITEM:ALL
Select the complete information to be printed.
HCOPY:ITEM:TIME ON; :HCOPY
Include the data and time in the printed output and start printing .
```

HCOPY:PAGE:COLor <ColorScheme>

Select the color scheme to be used for printing.

Use [SYSTEM:DISPlay:COLor](#) to select the color scheme for on-screen display.

Parameters:

<ColorScheme> UDEFined | DBACKground | LBACKground | BWLStyles | BWSolid | PBWLstyles | PCLBackgrnd | ON | OFF
 ON – print with color or grayscale (depending on the printer capabilities).
 OFF – use black-and-white printing using line styles to allow identification of different traces.

UDEFined
 User-defined print color scheme
Note that there are currently no remote commands to configure the user-defined print color scheme. Use [MMEMory:LOAD:CMAP:HCOPY](#) to load and activate the user-defined print color scheme from file.

DBACKground
 Dark background

LBACKground
 Light background

BWLStyles

Black and white with white background and different line styles

BWSolid

Black and white with white background and black solid lines

PBWLstyles

Printer optimized black and white with different line styles

PCLBackgrnd

Printer-optimized color scheme with light background

ON | OFF

For compatibility with previous versions of this command: ON = PCLBackgrnd, OFF = PBWLstyles

*RST: n/a (*RST does not affect the printer configuration)

Example:

```
HCOP:PAGE:COL PCLBackgrnd
```

Select the printer-optimized color scheme with light background.

Manual operation: See "[Print Options](#)" on page 780

HCOPy:PAGE:MARGin:BOTTom <LowMargin>

Defines the distance between the bottom of the page and the bottom of the printed information.

Parameters:

<LowMargin> Lower margin

Range: 0.01 mm to 10000 mm

*RST: n/a (*RST does not affect the printer configuration)

Example:

```
HCOP:PAGE:MARG:BOT 10; TOP 10
```

Set an upper and a lower margin of 1 cm.

HCOPy:PAGE:MARGin:LEFT <LeftMargin>

Defines the distance between the left edge of the page and the left edge of the printed information.

Parameters:

<LeftMargin> Left margin

Range: 0.01 mm to 10000 mm

*RST: n/a (*RST does not affect the printer configuration)

Example:

```
HCOP:PAGE:MARG:LEFT 10; RIGHT 10
```

Set an left and a right margin of 1 cm.

HCOPy:PAGE:MARGin:RIGHT <RightMargin>

Defines the distance between the right edge of the page and the right edge of the printed information.

Parameters:

<RightMargin> Right margin
 Range: 0.01 mm to 10000 mm
 *RST: n/a (*RST does not affect the printer configuration)

Example:

HCOP:PAGE:MARG:LEFT 10; RIGHT 10
 Set an left and a right margin of 1 cm.

HCOPY:PAGE:MARGin:TOP <UppMargin>

Defines the distance between the top of the page and the top of the printed information.

Parameters:

<UppMargin> Upper margin
 Range: 0.01 mm to 10000 mm
 *RST: n/a (*RST does not affect the printer configuration)

Example:

HCOP:PAGE:MARG:BOTT 10; TOP 10
 Set an upper and a lower margin of 1 cm.

HCOPY:PAGE:ORientation <Orientation>

Defines the orientation of the printed page. Switching between LANDscape and PORTrait rotates the hardcopy result by 90 degrees. No other settings are changed.

Parameters:

<Orientation> LANDscape | PORTrait
 LANDscape - long edge of the paper is the top of the page.
 PORTrait - short edge of the paper is the top of the page.
 *RST: n/a (*RST does not affect the printer configuration)

Example:

HCOP:PAGE:ORI LAND; :HCOP
 Select landscape page orientation and start printing.

HCOPY:PAGE:WINDow <PrintDiagram>

Defines how the diagrams shall be printed (using `HCOPY[:IMMEDIATE]`).

Parameters:

<PrintDiagram> ALL | SINGLE | ACTIVE | HARDcopy | NONE
 ALL - all diagrams are printed on one page.
 SINGLE - one diagram per page.
 ACTIVE - print only active diagram.
 HARDcopy - print a screenshot of the diagram area, preserving layout and colors ("real screenshot")
 NONE - print no diagram at all.
 *RST: n/a (*RST does not affect the printer configuration)

Example: `HCOP:PAGE:WIND SING; :HCOP`
Select one diagram per page and start printing.

7.3.8 INITiate commands

The `INITiate...` commands control the initiation of the trigger system and define the scope of the triggered measurement.

<code>INITiate<Ch>:CONTInuous</code>	1265
<code>INITiate:CONTInuous:ALL</code>	1266
<code>INITiate<Ch>:CTIMing</code>	1266
<code>INITiate[:IMMediate]:ALL</code>	1267
<code>INITiate<Ch>[:IMMediate][:DUMMy]</code>	1267
<code>INITiate<Ch>[:IMMediate]:SCOPE</code>	1267

`INITiate<Ch>:CONTInuous <Boolean>`

Qualifies whether the analyzer measures in single sweep or in continuous sweep mode.

Suffix:

`<Ch>` Channel number.
This suffix is ignored in the "ZVR" and "ZVABT" compatibility modes (`SYSTem:LANGUage 'ZVR' | 'ZVABT'`).

Parameters:

`<Boolean>` ON - the analyzer measures continuously, repeating the current sweep.
OFF - the measurement is stopped after the number of sweeps defined via `[SENSe<Ch>:]SWEep:COUNT`. `INITiate<Ch>[:IMMediate][:DUMMy]` initiates a new measurement cycle.

*RST: ON

Example:

```
*RST; :CALC2:PAR:SDEF 'TRC2','S11'
DISPlay:WINDow:TRACe2:FEED 'Trc2'
```

Reset the analyzer to create the default channel no. 1 and default trace. Create a second trace and display the trace. Both traces are measured continuously.

```
INIT1:CONT OFF
```

Activate single sweep mode for the first channel. The measurement in channel no. 1 is stopped after the current sweep. Channel no. 2 is still measured continuously.

```
INIT1
```

Activate a new (single) sweep in channel no. 1. Channel no. 2 is still measured continuously.

```
INIT:CONT:ALL OFF
```

Activate single sweep mode for all channels. The measurement in channel no. 2 is also stopped after the current sweep.

```
INIT:ALL
```

Re-start a single sweep in both channels.

Example: Alternative settings using the R&S ZVAB compatibility mode:
`*RST; :SYSTEM:LANGuage 'ZVABT'`
`*RST; :INIT:CONT OFF`
 Activate single sweep mode for all channels (including channel no. 2 created later).
`INIT:SCOP SING`
 State that a single sweep will be performed in the active channel.
`CALC2:PAR:SDEF 'TRC2','S11'; :INIT2`
 Create channel no. 2 with a new trace and start a single sweep in channel no. 2. Start a single sweep in the second channel.

Manual operation: See ["Continuous / Single"](#) on page 565

INITiate:CONTinuous:ALL <Boolean>

Qualifies whether the analyzer measures in single sweep or in continuous sweep mode.

This command is not supported in the "ZVR" or "ZVABT" compatibility modes.

Parameters:

<Boolean> ON - the analyzer measures continuously in all channel, repeating the current sweep. The query returns ON (1) if at least one channel is measured continuously.
 OFF - the measurement is stopped after the number of sweeps defined via `[SENSE<Ch>:]SWEep:COUNT`. `INITiate<Ch>[:IMMediate][:DUMMy]` initiates a new measurement cycle.

`*RST: ON`

Example: See `INITiate<Ch>:CONTinuous`

Manual operation: See ["All Channels Continuous/All Channels on Hold"](#) on page 567

INITiate<Ch>:CTIMing <Boolean>

Activates/deactivates the controlled timing mode.

Can only be executed if the current setup contains a single channel.

Suffix:

<Ch> Channel number

Parameters:

<Boolean> ON (1) | OFF (0)
`*RST: OFF`

Options: R&S ZNA-K28

Manual operation: See ["Controlled Timing"](#) on page 566

INITiate[:IMMEDIATE]:ALL

Starts a new single sweep sequence in all channels. This command is available in single sweep mode only (`INITiate:CONTinuous:ALL OFF`). The data of the last sweep (or of previous sweeps, see [Retrieving the results of previous sweeps](#)) can be read using `CALCulate<Ch>:DATA:NSweep:FIRSt? SDATa, <count>`.

This command is not supported in the "ZVR" or "ZVABT" compatibility modes.

Note: In contrast to all other commands of the analyzer, the `INITiate<Ch>[:IMMEDIATE]...` commands have been implemented for overlapped execution; see [Chapter 6.4, "Command processing"](#), on page 949.

Example: See `INITiate<Ch>:CONTinuous`

Usage: Event

Manual operation: See ["Restart Sweep"](#) on page 566

INITiate<Ch>[:IMMEDIATE][:DUMMY]

Starts a new single sweep sequence. This command is available in single sweep mode only (`INITiate<Ch>:CONTinuous OFF`). The data of the last sweep (or previous sweeps, see [Chapter 8.2.4.3, "Retrieving the results of previous sweeps"](#), on page 1745) can be read using `CALCulate<Ch>:DATA:NSweep:FIRSt? SDATa, <count>`.

Note: In contrast to all other commands of the analyzer, the `INITiate<Ch>[:IMMEDIATE]...` commands have been implemented for overlapped execution; see [Chapter 6.4, "Command processing"](#), on page 949.

Suffix:

`<Ch>` Channel number. If the channel number does not exist the analyzer returns an error message. If the "ZVR" or "ZVABT" compatibility mode is active and `INITiate<Ch>[:IMMEDIATE]:SCOPE ALL` is selected, this suffix is ignored.

Example: See `INITiate<Ch>:CONTinuous`

Usage: Event

Manual operation: See ["Restart Sweep"](#) on page 566

INITiate<Ch>[:IMMEDIATE]:SCOPE <Scope>

Selects the scope of the single sweep sequence. The setting is applied in single sweep mode only (`INITiate<Ch>:CONTinuous OFF`).

This command is required in compatibility modes only (see [SYSTEM:LANGUAGE](#)).

Suffix:

`<Ch>` Channel number

Parameters:**<Scope>** ALL | SINGle

`INITiate<Ch>[:IMMediate][:DUMMy]` starts a single sweep in all channels or in the referenced channel `<Ch>` only.

Example:See `INITiate<Ch>:CONTinuous`**Manual operation:**

See "Sweep All Channels/Sweeps" on page 569

7.3.9 INSTRument commands

The `INSTRument...` commands select or query particular resources (SCPI: logical instruments) of the analyzer.

<code>INSTRument:NSElect</code>	1268
<code>INSTRument:PORT:COUNT?</code>	1268
<code>INSTRument:SMATrix</code>	1268
<code>INSTRument:TPORt:COUNT?</code>	1269

INSTRument:NSElect <Channel>

Selects a channel as the active channel.

Parameters:**<Channel>**Number of the channel to be activated. The channel must be created before using `CONFigure:CHANnel<Ch>[:STATe] ON`.

Range: 1, 2, ...

*RST: 1

Example:`CONF:CHAN2:STAT ON; :INST:NSEL?`

Create channel no. 2 and select it as the active channel. The query returns 2.

INSTRument:PORT:COUNT?

Returns the number of test ports (Port 1, Port 2 ...) of the analyzer.

Example:`INST:PORT:COUN?`

Return the number of ports of your analyzer.

Usage:

Query only

INSTRument:SMATrix <Boolean>

In "set direction" this command performs a default setup or "clear" of the switch matrix RF connections; in "get direction" it queries whether at least one RF connection to a switch matrix is configured.

Parameters:**<Boolean>**

ON | 1 (setting) – adds all registered switch matrices to the RF configuration, performing a default assignment of VNA ports and test ports.

OFF | 0 (setting) – removes all switch matrices from the RF configuration

1 (query) – at least one RF connection to a switch matrix

0 (query) – no RF connection to a switch matrix

Example:

See `SYSTEM:COMMunicate:RDEvice:SMATrix:CONFigure:START`

INSTRument:TPORt:COUNT?

Returns the total number of test ports.

Because the R&S ZNA doesn't support switch matrices, this is always the same as the number of analyzer ports (see `INSTRument:PORT:COUNT?`).

In absence of switch matrices, i.e. if no RF connection to a switch matrix is configured, this is identical to the number of VNA ports (see `INSTRument:PORT:COUNT?`).

With switch matrices, the return value is the total number of matrix test ports plus the number of VNA ports that are not connected to a switch matrix.

Usage: Query only

7.3.10 MEMory commands

The `MEMory...` commands control the loaded recall sets of the analyzer.

**Storing setups**

The `MEMory...` commands do not affect any stored files. Use the `MMEMory...` commands to store and load data and to manage files stored on a mass storage device.

<code>MEMory:CATalog?</code>	1269
<code>MEMory:CATalog:COUNT?</code>	1270
<code>MEMory:DEFine</code>	1270
<code>MEMory:DELete:ALL</code>	1270
<code>MEMory:DELete[:NAME]</code>	1270
<code>MEMory:SELect</code>	1271

MEMory:CATalog?

Returns the names of all loaded recall sets.

Example: *RST; :MEM:DEF 'SET_2'
 Create a recall set named 'Set_2' and make it the active recall set.
 MEM:CAT?
 Query all recall sets. The response is 'Set1,SET_2'.
 MMEM:STOR:STAT 1, 'C:\Users\Public\Documents\Rohde-Schwarz\ZNA\RecallSets\Set_2.znxml'
 MEM:DEL 'Set_2.znxml'
 Store the active recall set "Set_2" to a file, renaming it "Set_2.znxml". Close the setup.

Usage: Query only

MEMory:CATalog:COUNT?

Returns the number of loaded recall sets.

Usage: Query only

MEMory:DEFine <Name>

Creates a new recall set<Name> using default settings for the traces, channels and diagram areas. The created recall set becomes the active recall set.

Setting parameters:

<Name> String parameter to specify the name of the created recall set.

Example: See [MEMory:CATalog?](#)

Usage: Setting only

Manual operation: See "[New](#)" on page 773

MEMory:DELeTe:ALL

Deletes all loaded recall sets.

Example: MEM:DEL:ALL; :MEM:CAT?
 Delete all recall sets. The query MEM:CAT? returns an empty string. The local screen shows no recall set.

Usage: Event

MEMory:DELeTe[:NAME] <Name>

Closes the specified recall set.

Setting parameters:

<Name> String parameter to specify the name of the recall set to be closed.

Example: See [MEMory:CATalog?](#)

Usage: Setting only

MEMory:SElect <RecallSet>

Selects a recall set as the active recall set or returns the name of the active recall set.

Parameters:

<RecallSet> String parameter to specify the recall set.

Example:

```
*RST; :MEM:DEF 'SET_2'
Create a recall set named "SET_2" and make it the active recall
set.
MEM:SEL 'Set1'
Activate the default recall set"Set1".
MMEM:STOR:STAT 1, 'C:\Users\Public\
Documents\Rohde-Schwarz\ZNA\RecallSets\
Set1.znxml'; :MEM:DEL 'Set1.znxml'
Store the active recall set"Set1" to a file, renaming it
Set1.znxml. Close the recall set.
```

7.3.11 MMEMory commands

The `MMEMory...` commands provide mass storage capabilities for the analyzer.

Internal and external mass storage

The mass storage of the analyzer can be internal or external. The internal mass storage location is either the public folder or the instrument folder of the internal hard disk (`C:\Users\Public` or `C:\Users\Instrument`, see below). The external mass storage device can be a USB memory stick connected to one of the USB ports (mapped to any free drive letter) or a network connection.

File and directory names

The parameters for file names and directory names are strings. Some commands use a fixed "working" directory. For others, the file name parameter must contain the absolute path including the drive name and all subdirectories. If the specified path is not absolute, the file location is interpreted relative to the current directory (queried with `MMEMory:CDIRectory`). The file name itself can contain the period as a separator for extensions.

File and directory names can be chosen according to Windows® conventions. All letters and numbers are allowed, plus the special characters `"_"`, `"^"`, `"$"`, `"~"`, `"!"`, `"#"`, `"%"`, `"&"`, `"-"`, `"{"`, `"}"`, `"("`, `")"`, `"@"` and `"\"`. Reserved file names are `CON`, `AUX`, `COM1`, ..., `COM4`, `LPT1`, ..., `LPT3`, `NUL` and `PRN`. The use of wildcards `?` and `*` is not allowed.

Public folders in Windows® and default file locations

To achieve maximum system security, most of the folders on the internal hard disk are read-only folders. Only the following folders can be changed:

- `C:\Users\Public`

- C:\Users\Instrument

The public and instrument folders can be used to store user data. To simplify this task, the public folder contains predefined subfolders; e.g. the subfolder

C:\Users\Public\Documents\Rohde-Schwarz\ZNA\Calibration\Kits is intended for calibration kit data. The subfolder structure is similar to R&S ZVA/B instruments, however, the R&S ZVA/B default path C:\Rohde&Schwarz\Nwa is replaced by C:\Users\Public\Documents\Rohde-Schwarz\ZNA..

MMEMory:AKAL:FACTory:CONVersion.....	1273
MMEMory:AKAL:USER:CONVersion.....	1274
MMEMory:CATalog?.....	1274
MMEMory:CATalog:ALL?.....	1275
MMEMory:CDIRectory.....	1275
MMEMory:CKIT:INFO?.....	1276
MMEMory:COpy.....	1276
MMEMory:DATA.....	1277
MMEMory:DELeTe.....	1277
MMEMory:DELeTe:CORRection.....	1277
MMEMory:FAVorite<FavId>.....	1278
MMEMory:LOAD:CABLe.....	1278
MMEMory:LOAD:CKIT.....	1279
MMEMory:LOAD:CKIT:SDATa.....	1279
MMEMory:LOAD:CKIT:SDATa:WLABel.....	1280
MMEMory:LOAD:CKIT:UDIRectory.....	1281
MMEMory:LOAD:CMAP.....	1282
MMEMory:LOAD:CMAP:HCOPy.....	1282
MMEMory:LOAD:CORRection.....	1283
MMEMory:LOAD:CORRection:MERGe.....	1283
MMEMory:LOAD:CORRection:RESolve.....	1284
MMEMory:LOAD:CORRection:SLEVeling<PhyPt>.....	1285
MMEMory:LOAD:CORRection:TCoefficient<Ch>.....	1285
MMEMory:LOAD:EYE:BPATtern.....	1286
MMEMory:LOAD:EYE:JITTer.....	1287
MMEMory:LOAD:EYE:MASK.....	1287
MMEMory:LOAD:LIMit.....	1287
MMEMory:LOAD:MDAData.....	1289
MMEMory:LOAD:MDCData.....	1290
MMEMory:LOAD:RIPPLe.....	1290
MMEMory:LOAD:SEGMENT.....	1291
MMEMory:LOAD:STATe.....	1292
MMEMory:LOAD:TRACe.....	1292
MMEMory:LOAD:TRACe:AUTO.....	1293
MMEMory:LOAD:VNETworks<Ch>:BALanced:DEEMbedding<LogPt>.....	1294
MMEMory:LOAD:VNETworks<Ch>:BALanced:EMBedding<LogPt>.....	1294
MMEMory:LOAD:VNETworks<Ch>:DIFFerential:EMBedding<LogPt>.....	1295
MMEMory:LOAD:VNETworks<Ch>:GLOop:DEEMbedding<group>.....	1296
MMEMory:LOAD:VNETworks<Ch>:GLOop:EMBedding<group>.....	1296
MMEMory:LOAD:VNETworks<Ch>:PPAir:DEEMbedding<ListId>.....	1296
MMEMory:LOAD:VNETworks<Ch>:PPAir:EMBedding<ListId>.....	1296
MMEMory:LOAD:VNETworks<Ch>:SENDEd:DEEMbedding<PhyPt>.....	1298

MMEMory:LOAD:VNETworks<Ch>:SENDEd:EMBedding<PhyPt>.....	1298
MMEMory:MDIRectory.....	1299
MMEMory:MOVE.....	1299
MMEMory:MSIS.....	1299
MMEMory:NAME.....	1300
MMEMory:RDIRectory.....	1300
MMEMory:STORe:CABLe.....	1301
MMEMory:STORe:CKIT.....	1301
MMEMory:STORe:CKIT:WLABel.....	1302
MMEMory:STORe:CMAP.....	1302
MMEMory:STORe:CMAP:HCOPy.....	1302
MMEMory:STORe:CORRection.....	1302
MMEMory:STORe:CORRection:SLEVelng<PhyPt>.....	1303
MMEMory:STORe:CORRection:TCOEfficient<Ch>.....	1303
MMEMory:STORe:EYE:MASK.....	1304
MMEMory:STORe:EYE:MASK:RESults.....	1304
MMEMory:STORe:EYE:MEASurements.....	1305
MMEMory:STORe:LIMit.....	1305
MMEMory:STORe:MARKer.....	1306
MMEMory:STORe:MDCData.....	1306
MMEMory:STORe:RIPPlE.....	1306
MMEMory:STORe:SEGMENT.....	1307
MMEMory:STORe:STATe.....	1307
MMEMory:STORe:TRACe.....	1308
MMEMory:STORe:TRACe:CHANnel.....	1309
MMEMory:STORe:TRACe:OPTion:BALanced.....	1310
MMEMory:STORe:TRACe:OPTion:SYMMetric.....	1310
MMEMory:STORe:TRACe:OPTion:COMMeNt.....	1311
MMEMory:STORe:TRACe:OPTion:DECimals:DATA.....	1311
MMEMory:STORe:TRACe:OPTion:DECimals:STIMulus.....	1311
MMEMory:STORe:TRACe:OPTion:FORMat.....	1311
MMEMory:STORe:TRACe:OPTion:PLUS.....	1312
MMEMory:STORe:TRACe:OPTion:SSEParator.....	1312
MMEMory:STORe:TRACe:OPTion:TABS.....	1312
MMEMory:STORe:TRACe:OPTion:TRIM.....	1312
MMEMory:STORe:TRACe:PORTs.....	1312

MMEMory:AKAL:FACTory:CONVersion <Directory>

Converts the factory calibration data of the standards in the active calibration unit (`SYSTEM:COMMunicate:RDEvice:AKAL:ADDRESS`) to Touchstone format and copies it to the specified directory.

Setting parameters:

<Directory> String parameter to specify the directory.

Example:

```
MMEM:AKAL:FACTory:CONVersion 'C:\Users\Public\
Documents\Rohde-Schwarz\ZNA\AKAL\Touchstone'
```

Convert and copy the factory calibration data of the active calibration unit to the specified (writable) directory.

Usage: Setting only

MMEMory:AKAL:USER:CONVersion <Directory>[, <CalKitFile>]

Converts an arbitrary (e.g. user-defined) set of calibration data of the standards in the active calibration unit (**SYSTEM:COMMunicate:RDEvice:AKAL:ADDRESS**) to Touchstone format and copies it to the specified directory.

Setting parameters:

<Directory> String parameter to specify the directory.

<CalKitFile> Name and (possibly) directory of the cal kit file to be used for the automatic calibration (optional string parameter):

- If the parameter is omitted, the analyzer uses the last characterized cal kit file.
- If an empty string (' ') is specified, the factory cal kit file stored in the active calibration unit (**SYSTEM:COMMunicate:RDEvice:AKAL:ADDRESS**) is used. By default this file is also used in manual control.
- A cal kit file name *.calkit without path denotes a specific cal kit file stored in the active calibration unit.
- A cal kit file name *.calkit with path denotes a specific cal kit file stored in an arbitrary directory.

Example:

```
MMEM:AKAL:USER:CONV 'C:\Users\Public\
Documents\Rohde-Schwarz\ZNA\AKAL\Touchstone'
Convert and copy the calibration data of the standards of the last
characterized cal kit to the specified (writable) directory.
MMEM:AKAL:USER:CONV 'C:\Users\Public\
Documents\Rohde-Schwarz\ZNA\AKAL\Touchstone',
'user.calkit'
Convert and copy the calibration data of the standards of the
user-defined cal kit 'user.calkit' to the specified directory.
```

Usage: Setting only

MMEMory:CATalog? [<Directory>]

Returns the contents of the current or of a specified directory. The directory information is returned in the following format:

```
<Used Size>, <FreeDiskSpace>{,<FileEntry>}{,<DirectoryEntry>}
```

The information elements indicate the following:

- <Used Size> – disk space in bytes used by the listed files, excluding subdirectories
- <FreeDiskSpace> – available free disk space in bytes
- <FileEntry> – file name, (blank), file size in bytes
- <DirectoryEntry> – directory name, <Dir>, (blank)

Tip: Use **MMEMory:CATalog:ALL?** to query the contents of the current directory and all subdirectories.

Query parameters:

<Directory> String parameter to specify the directory. If the directory is omitted, the command queries the contents of the current directory, to be queried with `MMEMemory:CDIRectory?`.

Example:

MMEM:CAT?

Possible response: 0, 771604480, calibration, <DIR>, , colorschemes, <DIR>, ,

Usage:

Query only

MMEMemory:CATalog:ALL? [<Directory>]

Returns the contents of the current or of a specified directory and all subdirectories. The information is returned in the following format:

Directory of <Directory>, <Used Size>, <FreeDiskSpace>{<FileEntry>}{<DirectoryEntry>}{<Directory of <Subdirectory>, <Used Size>, <FreeDiskSpace>{<FileEntry>}{<DirectoryEntry>}}

See also `MMEMemory:CATalog?`.

Tip: Use `MMEMemory:CATalog?` to query the contents of the current directory.

Query parameters:

<Directory> String parameter to specify the directory path. If the directory is omitted, the command queries the contents of the current directory, to be queried with `MMEMemory:CDIRectory?`

Example:

MMEM:CAT:ALL?

Possible response:

Directory of C:\Users\Public\Documents\Rohde-Schwarz\ZNA\,0, 2283155456, calibration, <DIR>, , colorschemes, <DIR>, , hardcopy, <DIR>, , limitlines, <DIR>, , ...

Usage:

Query only

MMEMemory:CDIRectory <Directory>

Changes the *current directory* for MMEMemory commands.

Relative paths are interpreted relative to this directory.

Parameters:

<Directory> String parameter to specify the directory. If `Default` is used, the analyzer selects the default directory `C:\Users\Public\Documents\Rohde-Schwarz\ZNA`.

Example: `MMEemory:CDIRectory 'C:\temp'`
 sets the current directory to C:\temp.
`MMEemory:CATalog? 'somedir'`
 lists the content of C:\temp\somedir.
 See also [MMEemory:MSIS](#) and the condensed programming example in section [Path-independent remote control programs](#).

MMEemory:CKIT:INFO? <CalKitFile>[, <Detail>]

Queries connector type, name, label and gender of a cal kit defined in the specified cal kit file

Query parameters:

<CalKitFile> Path to the cal kit file, either absolute or relative to the current directory (see [MMEemory:CDIRectory](#))

<Detail> CONNECTor | LABEL | NAME | GENDER
 If specified, the command only returns the corresponding property

Return values:

<ConnectorType>

<CalKitName>

<KitLabel>

<Gender> 1: has a gender
 0: doesn't have a gender

Usage: Query only

MMEemory:COPY <SourceFile>, <NewFile>

Copies an existing file to a new file.

Setting parameters:

<SourceFile>

<NewFile> String parameters to specify the name of the file to be copied and the name of the new file.
 *RST: n/a

Example: `MMEemory:COPY 'C:\Users\Public\Documents\Rohde-Schwarz\ZNA\RecallSets\SET1.znxml', 'D: ' 'Copy file Set1.znxml in directory C:\Users\Public\Documents\Rohde-Schwarz\ZNA\RecallSets to the external storage medium, mapped to drive D:.'`

Usage: Setting only

MMEMory:DATA <Filename>[, <DataBlock>]

Loads a <DataBlock> into the file <FileName>.

Parameters:

<Filename>	String parameter to specify the name of the file.
<DataBlock>	<block_data> Data in IEEE488.2 block data format. The delimiter EOI must be selected to achieve correct data transfer.

Example:

```
MMEM:DATA? 'C:\Users\Public\TEST01.HCP'
```

Query the block data contained in file TEST01.HCP.

MMEMory:DELeTe <File>[, <Force>]

Removes a file from the specified directory.

Setting parameters:

<File>	Mandatory string parameter containing the path and file name of the removed file. If the path is omitted, the current directory is used (see MMEMory:CDIRectory).
<Force>	FORCe Optional parameter, allows you to delete read-only files, too.

Example:

```
MMEM:DEL 'C:\Users\Public\TEST01.HCP'
```

Remove file TEST01.HCP from the directory C:\Users\Public. The file must not be read-only; otherwise the additional parameter FORCe is required.

Usage:

Setting only

MMEMory:DELeTe:CORRection <CalGroupName>

Deletes a system error correction data set stored in the cal pool (cal group file).

Setting parameters:

<CalGroupName>	String parameter to specify the name of the cal group file to be deleted. Cal group files must have the extension *.cal. The directory path must not be specified; the analyzer always uses the default cal pool directory C:\Users\Public\Documents\Rohde-Schwarz\ZNA\Calibration\Data.
----------------	---------------------------------------------------------------------------------------------------------------------------------------------------------------------------------------------------------------------------------------------------------------------------------------------

Example:

See [MMEMory:LOAD:CORRection](#)

Usage:

Setting only

Manual operation:

See "[Pool / Delete from Pool](#)" on page 640

MMEMory:FAVorite<FavId> <RecallSetFile>

Manages the list of favorite recall sets

Suffix:

<FavId> Position in the favorites list

Setting parameters:

<RecallSetFile> File path, either absolute or relative to the current directory (see [MMEMory:CDIRectory](#)). The empty string represents an empty position in the favorites list.
Note that when a non-empty favorite is set, the target recall set must exist.

Example:

```
:MMEMory:CDIRectory DEFault
:MMEM:FAV1 'RecallSets\My_RecallSet1.znxml'
Sets My_RecallSet1.znxml at position 1 of the favorites list.
MMEM:FAV1?
Returns 'C:\Users\Public\Documents\Rohde-Schwarz\
ZNA\RecallSets\My_RecallSet1.znxml'
MMEM:FAV1 'RecallSets\My_RecallSet2.znxml'
Sets My_RecallSet2.znxml as favorite 1, overwriting the pre-
vious favorite 1
MMEM:FAV1 ''
Clears position 1 of the favorites list
MMEM:FAV1?
Returns ''
```

Manual operation: See ["Import"](#) on page 777

MMEMory:LOAD:CABLe <InputDir>

Loads Distance to Fault (DtF) cable type files (*.rsc) from the specified input directory.

Cable types are loaded "by name", overwriting user-defined cable types of the same name. Predefined cable types of the same name will not be overwritten.

Setting parameters:

<InputDir> Input Directory

Example:

```
MMEMory:STORe:CABLe 'C:\dtf-cables'
Saves all predefined and user-defined Distance to Fault (DtF)
cable types to the directory C:\dtf-cables.
Edit *.rsc files for user defined cable types, copy *.rsc files,
rename and edit them. Afterwards execute
MMEMory:LOAD:CABLe 'C:\dtf-cables'
to update existing and create new user-defined cable types.
```

Usage: Setting only

Options: R&S ZNA-K2

Manual operation: See ["Add / Delete"](#) on page 836

MMEMory:LOAD:CKIT <CalKitFile>

Loads cal kit data from the specified cal kit file.

Setting parameters:

<CalKitFile> String parameter to specify name and directory of the loaded cal kit file. If no path is specified the analyzer searches the current directory, to be queried with [MMEMory:CDIRectory](#)

Example:

```
MMEM:LOAD:CKIT 'C:\Users\Public\Documents
\Rohde-Schwarz\ZNA\Calibration\Kits\New_kit.calkit'
Load the previously created cal kit file New_kit.calkit from
the default cal kit directory.
... :MMEM:STOR:CKIT 'New_kit', 'C:
\Users\Public\Documents
\Rohde-Schwarz\ZNA\Calibration\Kits\New_kit.calkit'
Store the data for the user-defined cal kit Newkit and overwrite
the cal kit file New_kit.calkit.
```

Usage: Setting only

Manual operation: See "[Import Cal Kit...](#)" on page 589

MMEMory:LOAD:CKIT:SDATa <ConnectorType>, <CalKitName>, <StandardType>, <StandardLabel>, <TouchstoneFile>[, <FirstPort>[, <SecondPort>]]

Loads cal kit data for a calibration standard from a specified Touchstone file. A restriction on the port assignment may be defined in addition.

Use the newer command [MMEMory:LOAD:CKIT:SDATa:WLAbel](#) to be able to distinguish cal kits by label.

Setting parameters:

<ConnectorType> String parameter containing the name of the connector type.

<CalKitName> String parameter containing the name of a calibration kit available on the analyzer.

<StandardType> MMTHrough | MFTHrough | FFTHrough | MMLine | MMLine1 | MMLine2 | MMLine3 | MFLine | MFLine1 | MFLine2 | MFLine3 | FFLine | FFLine1 | FFLine2 | FFLine3 | MMATten | MFATten | FFATten | MMSNetwork | MFSNetwork | FFSNetwork | MOPen | FOPen | MSHort | FSHort | MOShort | MOShort1 | MOShort2 | MOShort3 | FOSHort | FOSHort1 | FOSHort2 | FOSHort3 | MREFlect | FREFlect | MMTCh | FMTCh | MSMatch | FSMatch
Standard types; for a description refer to table [Standard types and their parameters](#).

<StandardLabel> String parameter addressing a particular calibration standard by its label. An empty string means that no label is defined.

<TouchstoneFile> String parameter to specify name and directory of the Touchstone file to be loaded. A *.s1p file must be used for one-port standards, a *.s2p file for two-port standards. If no path is specified the analyzer searches the current directory, to be queried with [MMEMoRY:CDIRectory](#)

*RST: -

<FirstPort> First port number (sufficient for one-port standards). If the port numbers are omitted, the cal kit data is valid for all ports.

<SecondPort> Second port number, for two-port standards. If the port numbers are omitted, the cal kit data is valid for all ports.

Example:

```
MMEM:LOAD:CKIT:SDAT 'N 50 Ohm','Default
Kit',MOPEN,'Test data','test.s1p',1
```

Load the file Test.s1p from the current directory in order to define the properties of an Open (m) standard in the cal kit named "Default Kit" for the N 50 Ω connector type. Assign the label "Test data" and specify that the standard data is valid for port no. 1 only.

Usage: Setting only

Manual operation: See "[Read .s1p File... / Read .s2p File...](#)" on page 619

Connector and cal kit naming conventions:

Connector and calibration kit names must be entered as string parameters. The strings contain the connector and cal kit names used in the *Calibration Kits* dialog; a Ω in the name must be replaced by 'Ohm', e.g.:

-'NewKit1' denotes the user-defined calibration kit "NewKit1".

-'N 50 Ohm Ideal Kit' denotes the "N 50 Ω Ideal Kit".

-'ZV-Z21 typical' denotes the cal kit "ZV-Z21 typical".

MMEMoRY:LOAD:CKIT:SDATa:WLABel <ConnectorType>, <CalKitName>, <KitLabel>, <StandardType>, <StandardLabel>, <TouchstoneFile>[, <FirstPort>[, <SecondPort>]]

Loads characterization data from the given Touchstone file; similar to existing command [MMEMoRY:LOAD:CKIT:SDATa](#) but supports cal kit addressing **by label**.

Setting parameters:

<ConnectorType> String parameter containing the name of the connector type.

<CalKitName> String parameter containing the name of a calibration kit available on the analyzer.

<KitLabel> String parameter containing the label of a calibration kit available on the analyzer. An empty string means that no label is defined.

<StandardType>	MMTHrough MFTThrough FFTHrough MMLine MMLine1 MMLine2 MMLine3 MFLine MFLine1 MFLine2 MFLine3 FFLine FFLine1 FFLine2 FFLine3 MMATten MFATten FFATten MMSNetwork MFSNetwork FFSNetwork MOPen FOPen MSHort FSHort MOShort MOShort1 MOShort2 MOShort3 FOShort FOShort1 FOShort2 FOShort3 MREFlect FRElect MMTCh FMTCh MSMATCH FSMATCH Standard types; for a description refer to table Standard types and their parameters .
<StandardLabel>	String parameter addressing a particular calibration standard by its label. An empty string means that no label is defined.
<TouchstoneFile>	String parameter to specify the name and directory of the Touchstone file to be loaded. A *.s1p file must be used for one-port standards, a *.s2p file for two-port standards. If no path is specified the analyzer searches the current directory, to be queried with MMEMory:CDIRectory
<FirstPort>	First port number (sufficient for one-port standards). If the port numbers are omitted, the cal kit data is valid for all ports.
<SecondPort>	Second port number, for two-port standards. If the port numbers are omitted, the cal kit data is valid for all ports.
Example:	<pre>MMEM:LOAD:CKIT:SDAT:WLAB 'N 50 Ohm', 'Default Kit', '0815', MOPEN, 'Test data', 'test.s1p', 1</pre> <p>Load the file Test.s1p from the current directory in order to define the properties of an Open (m) standard in the cal kit "Default Kit" with label "0815" for the N 50 Ω connector type. Assign the label "Test data" and specify that the standard data is valid for port no. 1 only.</p>

Usage: Setting only

Connector and cal kit naming conventions:

Connector and calibration kit names must be entered as string parameters. The strings contain the connector and cal kit names used in the *Calibration Kits* dialog; a Ω in the name must be replaced by 'Ohm', e.g.:

- 'NewKit1' denotes the user-defined calibration kit "NewKit1".

- 'N 50 Ohm Ideal Kit' denotes the "N 50 Ω Ideal Kit".

- 'ZV-Z21 typical' denotes the cal kit "ZV-Z21 typical".

MMEMory:LOAD:CKIT:UDIRectory <Directory>

Specifies the "Search Path for Additional Cal Kits and Connector Types". All cal kit files in the specified directory will be (re-)loaded automatically as predefined kits (i.e. read-only kits which cannot be modified) every time the VNA application is started.

Parameters:

<Directory> String parameter to specify the directory path. The directory can be created separately ([MMEMory:MDIRectory](#)). An empty string means that no cal kit files will be loaded.

Example:

```
MMEM:LOAD:CKIT:UDIR 'C:\Users\Public\Documents
\Rohde-Schwarz\ZNA\Calibration\Kits\Autoload'
```

Specify the directory for additionally available cal kits.

```
MMEM:MDIR 'C:\Users\Public\Documents
\Rohde-Schwarz\ZNA\Calibration\Kits\Autoload'
```

Create the specified "Autoload" directory.

```
MMEM:STOR:CKIT 'New Kit 1', 'C:
\Users\Public\Documents
\Rohde-Schwarz\ZNA\Calibration\Kits\Autoload
\New Kit 1.calkit'
```

Store the data for the existing, user-defined cal kit "New Kit 1" to the "Autoload" directory.

Manual operation: See ["Search Path for additional Cal Kits and Connector Types"](#) on page 860

MMEMory:LOAD:CMAP <ColorSchemeFile>

MMEMory:LOAD:CMAP:HCOPY <ColorSchemeFile>

Loads a color scheme from a the VNA color scheme file and activates it as the user-defined color scheme for display or printing (HCOPY).

Setting parameters:

<ColorSchemeFile> String parameter to specify the name and directory of the color scheme file to be loaded. The default extension (manual control) for color scheme files is *.ColorScheme, although other extensions are allowed.

Example:

```
MMEM:LOAD:CMAP 'C:\Users\Public
\Documents\Rohde-Schwarz\ZNA\ColorSchemes\
Test.ColorScheme'
```

Load the previously created color scheme file

Test.ColorScheme from the default color scheme directory.

```
DISP:CMAP13:RGB 1,0,0; :DISP:CMAP14:RGB 0,1,0
```

Color the first trace red, the second trace green.

```
MMEM:STOR:CMAP 'C:\Users\Public
\Documents\Rohde-Schwarz\ZNA\ColorSchemes\
Test.ColorScheme'
```

Store the data for the user-defined cal kit "Newkit" and overwrite the cal kit file New_kit.calkit.

Usage:

Setting only

Manual operation: See ["Recall... / Save..."](#) on page 850

MMEMory:LOAD:CORRection <Channel>[, <CalGroupFile>]

Applies a system error correction data set stored in the cal pool (cal group file) to channel <Channel>.

Parameters:

<Channel>	Channel number of an existing channel. ALL applies the selected data set to all channels.
<CalGroupFile>	String parameter to specify the name of the cal group file to be loaded. Cal group files must have the extension *.cal. The directory path must not be specified; the analyzer always uses the default cal pool directory C:\Users\Public\Documents\Rohde-Schwarz\ZNA\Calibration\Data.

Example:

```
MMEM:STOR:CORR 1, 'Calgroup1.cal'
```

Copy the current correction data set of channel 1 to a cal group file Calgroup1.cal.

```
CONF:CHAN2:STAT ON; :MMEM:LOAD:CORR 2, 'Calgroup1.cal'
```

Apply the stored correction data (cal group file) to channel 2.

```
MMEM:LOAD:CORR? 2
```

Query the cal group file for channel 2. Response:

```
'Calgroup1.cal'
```

```
MMEM:LOAD:CORR:RES 2, 'Calgroup1.cal'
```

Resolve the pool link between channel 2 and the cal group file.

```
MMEM:LOAD:CORR? 2
```

Query the cal group file for channel 2. Response: ''

```
MMEM:DEL:CORR 'Calgroup1.cal'
```

Delete the created cal group file.

Manual operation: See ["Add / Add All... / Replace / Apply / Apply to All"](#) on page 639

MMEMory:LOAD:CORRection:MERGe <Channel>[, <CalGroupFile>[, <CalGroupFile>]...]

Merges (activates) several cal group files for channel no. <Channel> so that the query [\[SENSe<Ch>:\]CORRection:COLLect:METhod:DEFine?](#) returns a list of all merged calibration types (equivalent to the calibration pool list in the "Calibration Manager" dialog). The merged cal group files can be stored to a common file (see example).

Note that the calibrations to be merged must be based on the same frequency grid (identical frequency sweep points).

Setting parameters:

<Channel>	Channel number of an existing channel
<CalGroupFile>	

<CalGroupFile> String parameters with the names of the merged cal group files. Cal group files must have the extension *.cal. The file extensions must be specified as part of the string parameters. In contrast the directory path must not be specified; the analyzer always uses the default path
C:\Users\Public\Documents\Rohde-Schwarz\ZNA\CALibration\DATA.

Example:

```
SENS1:CORR:COLL:METH:DEF 'Test', FRTRans, 1, 3
Select a bidirectional transmission normalization between ports 1 and 3 as a calibration type for channel 1.
```

```
CORR:COLL:SAVE:SEL:DEF; :MMEM:STOR:CORR 1, 'P1-P3.cal'
```

Create a default calibration data set for the selected calibration type and store the data to a cal group file.

```
SENS1:CORR:COLL:METH:DEF 'Test', FRTRans, 1, 4
Select a bidirectional transmission normalization between ports 1 and 4 as a calibration type for channel 1.
```

```
CORR:COLL:SAVE:SEL:DEF; :MMEM:STOR:CORR 1, 'P1-P4.cal'
```

Create a default calibration data set for the selected calibration type and store the data to a cal group file.

```
CORR:COLL:METH:DEF?
```

Query the active calibrations for channel 1. The response is FRTR0104 (the last data set stored).

```
MMEM:LOAD:CORR:
MERGE 1, 'P1-P3.cal', 'P1-P4.cal'; :CORR:COLL:
METH:DEF?
```

Merge the two calibration types and query the active calibrations again. The response is FRTR0103, FRTR0104.

```
MMEM:STOR:CORR 1, 'Merged.cal'
```

Store both sets of calibration data to a common cal group file.

Usage: Setting only

Manual operation: See ["Add / Add All... / Replace / Apply / Apply to All"](#) on page 639

MMEMory:LOAD:CORRection:RESolve <Channel>[, <CalGroupFile>]

Resolves the pool link between channel <Channel> and a correction data set (cal group file). After resolving the pool link, the analyzer keeps the previous system error correction as a channel calibration ("Channel Cal"). A new calibration will replace the channel calibration but not overwrite the old cal group file (and not affect other channels).

Setting parameters:

<Channel> Channel number of an existing channel. ALL resolves the pool link for all channels.

<CalGroupFile> Optional string parameter to specify the name of the cal group file. Cal group files must have the extension *.cal. The directory must not be specified; the analyzer always uses the default path C:\Users\Public\Documents\Rohde-Schwarz\ZNA\Calibration\Data. If there is no link between <Ch> and the specified file, the command has no effect. If no file is specified, the command resolves any link between <Ch> and an arbitrary cal group file.

Example: See [MMEMory:LOAD:CORRection](#)

Usage: Setting only

Manual operation: See ["Resolve Pool Link / Remove Pool Link"](#) on page 640

MMEMory:LOAD:CORRection:SLEVeling<PhyPt> <File>

Loads a leveling dataset for port <PhyPt> from the specified *.lev file (R&S ZNA-proprietary, binary file format).

*.lev files can be created using [MMEMory:STORe:CORRection:SLEVeling<PhyPt>](#).

Suffix:
 <PhyPt> Physical port number

Setting parameters:
 <File> String parameter containing the path and file name of the *.lev file. If the path is omitted, the current directory is used (see [MMEMory:CDIRectory](#)).

Usage: Setting only

Options: R&S ZNA-K8

Manual operation: See ["Load/Save"](#) on page 908

MMEMory:LOAD:CORRection:TCOefficient<Ch> <TraceFile>[, <Trace>[, <DeEmbedding Position>]]

Loads two-port transmission coefficients from the specified power meter correction file or trace file to channel <Ch>.

Suffix:
 <Ch> Channel number

Parameters:
 <DeEmbedding Position> BOTH | DUT | PM
 Determines the two-port the command refers to:

DUT

The two-port between VNA and DUT (during measurement)

PM

The two-port between VNA and PM (during power calibration)

BOTH

Both positions

(parameter omitted)

If the parameter is omitted, the command refers to the two-port selected using `SOURce<Ch>:POWer<PhyPt>:CORRection:TCOefficient:CALibration`.

Setting parameters:

<TraceFile>

String parameter specifying the name and directory of the loaded trace file. The R&S ZNA supports power meter correction list files (*.pmc1, generated using `MMEMemory:STORe:CORRection:TCOefficient<Ch>`), *csv, and Touchstone (*.s1p, *.s2p, ...) files.

If no path is specified the analyzer searches the current directory, to be queried with `MMEMemory:CDIRectory`

The file extensions *.s<n>p, *csv, and *.pmc1 for Touchstone, ASCII, and power meter correction list files are mandatory.

*RST: n/a

<Trace>

Optional string parameter: For multiport Touchstone files (*.snp, n > 1), the parameter refers to a particular S-parameter trace ('S11', 'S12', ...). For ASCII (*.csv) files, the parameter references a trace name in the file (case sensitive). If the parameter is omitted, the first trace in the specified file is imported.

This parameter is not used for power meter correction list files (*.pmc1).

*RST: n/a

Example:

See `SOURce:POWer:CORRection:TCOefficient[:STATe]` on page 1563

Usage:

Setting only

Manual operation: See "Import File..." on page 634

MMEMemory:LOAD:EYE:BPATtern <TraceName>, <TraceFile>

Loads a user-defined bit pattern for the related eye diagram from a 7-bit ASCII file.

The pattern is repeated until the configured length is reached (see `CALCulate<Chn>:EYE:INPut:LENGth:BITS` on page 993).

Loading a pattern from file implicitly sets the type of bit stream to USER (see `CALCulate<Chn>:EYE:INPut:BPATtern:TYPE`).

Setting parameters:

<TraceName> Name of the related eye diagram

<TraceFile> String parameter containing the path and file name of the bit pattern file. If the path is omitted, the current directory is used (see [MMEMory:CDIRectory](#)).

Usage: Setting only

Options: R&S ZNA-K20

Manual operation: See "[Load Bit Stream](#)" on page 810

MMEMory:LOAD:EYE:JITTer <TraceName>, <TraceFile>

Loads user-defined jitter from a 7-bit ASCII file into the generator simulation of an eye diagram.

The file must consist of floating point values (in parsable format), separated by any whitespace and/or line endings.

Setting parameters:

<TraceName> Name of the related eye diagram

<TraceFile> String parameter containing the path and file name of the jitter file. If the path is omitted, the current directory is used (see [MMEMory:CDIRectory](#)).

Usage: Setting only

Options: R&S ZNA-K20

Manual operation: See "[User Specific](#)" on page 817

MMEMory:LOAD:EYE:MASK <TraceName>, <TraceFile>

Loads a user-defined eye mask from a 7bit ASCII file.

Setting parameters:

<TraceName> Name of the related eye diagram

<TraceFile> String parameter containing the path and file name of the eye mask file. If the path is omitted, the current directory is used (see [MMEMory:CDIRectory](#)).

Usage: Setting only

Options: R&S ZNA-K20

Manual operation: See "[Save / Load Mask Configuration](#)" on page 825

MMEMory:LOAD:LIMit <TraceName>, <LimLineFile>[, <TouchstoneFile>[, <StimulusOffset>[, <ResponseOffset>[, <LimLineType>]]]]

Loads a limit line definition from a specified file and assigns it to a trace with a specified name. Limit lines are created using the `CALCulate<Ch>:LIMit...` commands.

Note: Limit lines can be loaded from Touchstone files (*.s<n>p, where <n> denotes the number of ports). The optional parameters '<TouchstoneFile>', '<StimulusOffset>', '<ResponseOffset>', '<LimLineType>' are only relevant for Touchstone files. For *.limit files, no optional parameters can be set.

Setting parameters:

<TraceName>	Name of an existing trace in the active recall set (string parameter). The imported limit line is assigned to this trace, irrespective of the trace information in the limit line file.
<LimLineFile>	String parameter to specify the name and directory of the limit line file to be loaded. The default extension (manual control) for limit line files is *.limit, although other extensions are allowed. If no path is specified the analyzer searches the current directory, to be queried with <code>MMEMoRY:CDIRectory?</code> . See also note on Touchstone files above.
<TouchstoneFile>	String parameter, selects an S-parameter from a Touchstone file. The parameter must be compatible with the file type (e.g. for one-port Touchstone files *.s1p, only the parameter name 'S11' is allowed). *RST: 'S11' (if all optional parameters are omitted)
<StimulusOffset>	Stimulus offset for limit lines loaded from a Touchstone file. A 1 GHz offset shifts the limit line by 1 GHz in (positive) horizontal direction. Range: Depending on the sweep range of the analyzer. *RST: 0 Default unit: NN
<ResponseOffset>	Response offset for limit lines loaded from a Touchstone file. A 1 dB offset shifts the limit line by 1 dB in (positive) vertical direction. Range: Depending on the measured quantity. *RST: 0 Default unit: NN
<LimLineType>	LMIN LMAX OFF Limit line type : LMAX - upper limit line LMIN - lower limit line OFF - limit line off *RST: LMAX (if all optional parameters are omitted)

Example: Assume that the current recall set contains two traces named Trc1 and Trc2, respectively, and that limit lines have been defined for Trc1.

```
MMEM:STOR:LIM 'TRC1', 'C:
\Users\Public\Documents
\Rohde-Schwarz\ZNA\LIMitLines\Lim_Trcl.limit'
```

Store the limit line definition of Trc1 to a limit line file.

```
MMEM:LOAD:LIM 'TRC2', 'C:
\Users\Public\Documents
\Rohde-Schwarz\ZNA\LIMitLines\Lim_Trcl.limit'
```

Load the previously created limit line file and assign the limit lines to Trc2.

```
MMEM:STOR:TRAC 'TRC1', 'C:
\Users\Public\Documents
\Rohde-Schwarz\ZNA\LIMitLines\Trcl.slp'
```

Store the current trace data of Trc1 to a limit line file in Touchstone format.

```
MMEM:LOAD:LIM 'TRC1', 'C:
\Users\Public\Documents
\Rohde-Schwarz\ZNA\LIMitLines\Trcl.slp', 'S11',
0, 2, LMAX
```

Load the previously created Touchstone limit line file and assign the limit lines to Trc1, applying a response offset of 2 dB.

```
CALC:LIMit:DISPlay ON
```

Show the limit line in the diagram.

Usage: Setting only

Manual operation: See ["Recall... / Save..."](#) on page 484

MMEMory:LOAD:MDAData <Channel Id>, <Filename or CDELAy>

Loads the known delay values of a calibration mixer, to be used as a reference for a mixer delay measurement calibration. Mixer delay measurements are controlled using the `SENSe<Ch>:FREQuency:MDELAy...` commands.

Setting parameters:

<Channel Id>	Channel number
<Filename or CDELAy>	String parameter to specify the name and directory of the loaded file. The default extension (manual control) for files containing known delays is *.csv, although other extensions are allowed. If no path is specified the analyzer searches the current directory, to be queried with <code>MMEMory:CDIRectory?</code> .

Example: See [MMEMory:LOAD:MDCData](#) on page 1290

Usage: Setting only

Manual operation: See ["Variable Cal Delay File"](#) on page 592

MMEMory:LOAD:MDCData <Channel Id>, <Filename>

Loads correction data for a mixer delay measurement calibration from a specified file and assigns it to a channel with a specified number. Mixer delay measurements are controlled using the `SENSe<Ch>:FREQuency:MDElay...` commands.

Use `MMEMory:LOAD:MDAData` to load delay values of a calibration mixer stored in a file.

Setting parameters:

<Channel Id>	Channel number *RST: -
<Filename>	String parameter to specify the name and directory of the calibration file to be loaded. The default extension (manual control) for mixer delay calibration files is *.mcal, although other extensions are allowed. If no path is specified the analyzer searches the current directory, to be queried with <code>MMEMory:CDIRectory?</code> .

Example:

Assume that a mixer delay measurement has been configured and enabled (see examples for the `SENSe<Ch>:FREQuency:MDElay...` commands), and that a calibration mixer is connected to the analyzer.

```
MMEM:LOAD:MDAD 1, 'C:
```

```
\Rohde&Schwarz\NWA\Calibration\MixerDelay\MDelay.csv'
```

Load mixer data for the calibration mixer.

```
SENS1:FREQ:MDElay:CORR OFF
```

Disable the current correction (if a correction is on).

```
SENS1:FREQ:MDEL:ACQ
```

Take a calibration sweep.

```
MMEM:STOR:MDCD 1, 'C:
```

```
\Rohde&Schwarz\NWA\Calibration\MixerDelay\Mixer1.mcal'
```

Store the measured calibration data for the calibration mixer to a file.

For a new mixer delay measurement:

```
MMEM:LOAD:MDCD 1, 'C:
```

```
\Rohde&Schwarz\NWA\Calibration\MixerDelay\Mixer1.mcal'
```

Load the previously generated mixer delay calibration file and apply the calibration data to the current mixer delay measurement.

Usage: Setting only

MMEMory:LOAD:RIPPLE <TraceName>, <RippleLimFile>

Loads a ripple limit definition from a specified file and assigns it to a trace with a specified name. Ripple limits are created using the `CALCulate<Ch>:RIPple...` commands.

Setting parameters:

- <TraceName> Name of an existing trace in the active setup (string parameter). The imported ripple limit line is assigned to this trace, irrespective of the trace information in the ripple limit file.
- *RST: -
- <RippleLimFile> String parameter to specify the name and directory of the ripple limit file to be loaded. The default extension (manual control) for ripple limit files is *.ripple, although other extensions are allowed. If no path is specified the analyzer searches the current directory, to be queried with [MMEMemory:CDIRectory](#)

Example:

Assume that the current setup contains two traces named Trc1 and Trc2, respectively, and that ripple limits have been defined for Trc1.

```
MME:STOR:RIPP 'TRC1', 'C:
\Users\Public\Documents
\Rohde-Schwarz\ZNA\LIMitLines\Lim_Trcl.limit'
```

Store the ripple limit definition of Trc1 to a ripple limit file.

```
MME:LOAD:RIPP 'TRC2', 'C:
\Users\Public\Documents
Rohde-Schwarz\ZNA\LIMitLines\Lim_Trcl.limit'
```

Load the previously created ripple limit file and assign the limits to Trc2.

```
CALC:RIPP:DISPlay ON
```

Show the ripple limit line for the active trace in the diagram.

Usage: Setting only

Manual operation: See "[Recall Ripple Test.../Save Ripple Test...](#)" on page 491

MMEMemory:LOAD:SEGMENT <Channel>, <SweepSegFile>

Replaces the related channel's current sweep segment definition by a sweep segment definition loaded from the specified ASCII file.

Setting parameters:

- <Channel> Channel number
- <SweepSegFile> String parameter to specify the name and directory of the sweep segment file to be loaded. The default extension (manual control) for sweep segment files is *.SegList, although other extensions are allowed. If no path is specified the analyzer searches the current directory, to be queried with [MMEMemory:CDIRectory](#)

- Example:** Assume that the current recall set contains two channels numbered 1 and 2, respectively, and that sweep segments have been defined for channel no. 1.
`MME:STOR:SEGM 1, 'C:\Users\Public\Documents\Rohde-Schwarz\ZNA\SweepSegments\Seg_Ch1.SegList'`
 Store the sweep segment definition of channel 1 to a sweep segment file.
`MME:LOAD:SEGM 2, 'C:\Users\Public\Documents\Rohde-Schwarz\ZNA\SweepSegments\Seg_Ch1.SegList'`
 Load the previously created sweep segment file and use the sweep segments for channel 2.
- Usage:** Setting only
- Manual operation:** See "[Import.../ Export...](#)" on page 555

MME:LOAD:STATe <Compatibility>, <RecallSetFile>

Loads configuration data from a specified recall set file (*.znxml|*.znx) and sets the analyzer to the corresponding instrument state.

Setting parameters:

- <Compatibility> 1 (this value is used for compatibility with the SCPI standard but is ignored).
- <RecallSetFile> String parameter to specify the absolute or relative path of the recall set file to be loaded. Relative paths are evaluated relative to the current directory (see [MME:CDIRectory](#)).

- Example:** `MME:STOR:STAT 1, 'C:\Users\Public\Documents\Rohde-Schwarz\ZNA\RecallSets\Set_0413.znxml'`
 Store the current setup configuration in the file Set_0413.znxml in the default directory for recall set files.
`MME:LOAD:STAT 1, 'C:\Users\Public\Documents\Rohde-Schwarz\ZNA\RecallSets\Set_0413.znxml'`
 Load the settings stored in Set_0413.znxml.

- Usage:** Setting only
- Manual operation:** See "[Open Recall...](#)" on page 773

MME:LOAD:TRACe <DestinationTraceName>, <TraceFile>[, <SParamOrTraceName>]

Loads trace data from a specified trace file and assigns it to a trace with a specified name. Traces are created using the [CALCulate<Ch>:PARAMeter:SDEFine](#) command.

Setting parameters:

<Destination TraceName>	Name of an existing data trace in the active recall set (string parameter). The trace data is loaded into a memory trace associated with the specified data trace. If one or more memory traces are already associated with the specified data trace, the last generated memory trace is overwritten.
<TraceFile>	String parameter to specify the name and directory of the trace file to be loaded. Several file formats for trace files are supported. The file extensions *.s<n>p, *.csv, and *.dat for Touchstone, ASCII, and Matlab files are mandatory. If no path is specified the analyzer searches the current directory, to be queried with MMEMoRY:CDIRectory
<SParam OrTraceName>	Optional string parameter: For imported Touchstone files for more than one port (*.s2p, *.s3p, *.s4p), the parameter denotes the imported S-parameter ('S11', 'S12', ...). For ASCII (*.csv) and Matlab (*.dat) files, the parameter references a trace name in the file (case sensitive). If the parameter is omitted, the first trace in the specified file is imported.

Example:

Assume that the current recall set contains a trace named Trc1.

```
MMEM:STOR:TRAC 'TRC1', 'C:\Users\Public
\Documents\Rohde-Schwarz\ZNA\Traces\Trc1.s1p'
```

Store the current trace data of Trc1 to a trace file.

```
MMEM:LOAD:TRAC 'TRC1', 'C:\Users\Public
\Documents\Rohde-Schwarz\ZNA\Traces\Trc1.s1p'
```

Load the previously created trace file and create a memory trace assigned to Trc1.

```
CALC:PAR:DEF:SGR 1,2
```

Create four traces to measure the two-port S-parameters S_{11} , S_{12} , S_{21} , S_{22} . The traces are not displayed.

```
MMEM:STOR:TRAC 'TRC1', 'C:\Users\Public
\Documents\Rohde-Schwarz\ZNA\Traces\Trc1.s2p'
```

Store the four S-parameter traces to a two-port Touchstone file.

```
MMEM:LOAD:TRAC 'TRC1', 'C:\Users\Public
\Documents\Rohde-Schwarz\ZNA\Traces\Trc1.s2p'
```

Load the previously created Touchstone file and overwrite the previously generated memory trace assigned to Trc1 with the S_{11} trace.

Usage: Setting only

Manual operation: See ["Import Data to New Mem"](#) on page 469

MMEMoRY:LOAD:TRACe:AUTO <TraceFile>

Loads the specified trace file and automatically distributes the imported S-parameter traces S_{ij} to all diagrams in the active channel that are currently displaying S_{ij} .

Setting parameters:

<TraceFile> String parameter to specify the name and directory of the trace file to be loaded. Several file formats for trace files are supported. The file extensions `*.s<n>p`, `*.csv`, and `*.dat` for Touchstone, ASCII, and Matlab files are mandatory. If no path is specified the analyzer searches the current directory, to be queried with `MMEMory:CDIRectory`

Usage: Setting only

Manual operation: See "Auto Distribute" on page 474

MMEMory:LOAD:VNETworks<Ch>:BALanced:DEEMbedding<LogPt>

`<TouchstoneFile>[, <Port>[, <Interchange>]]`

MMEMory:LOAD:VNETworks<Ch>:BALanced:EMBedding<LogPt>

`<TouchstoneFile>[, <Port>[, <Interchange>]]`

Loads the S-parameter data that (partly) specify the de-/embedding network of balanced port `<LogPt>` from local Touchstone files.

Use `CALCulate<Ch>:TRANSform:VNETworks:BALanced:DEEMbedding<LogPt>:TNDefinition` or `CALCulate<Ch>:TRANSform:VNETworks:BALanced:EMBedding<LogPt>:TNDefinition` to select the desired **circuit model** before loading the data files.

- The `FIMPort` model requires a single `*.s4p` file and hence a single set command.
- The circuit models `STSL` | `STSC` | `SLST` | `SCST` require 2 `*.s2p` files, that have to be assigned to the appropriate port using two set commands.

Suffix:

<Ch> Channel number

<LogPt> Logical port number

Parameters:

<TouchstoneFile> String parameter to specify the name and directory of the loaded Touchstone file.

If no path is specified the analyzer searches the current directory, which can be set and queried using `MMEMory:CDIRectory`

<Port> `PMAin` | `PSEConary`

Assigns a 2-port (`*.s2p`) file to the appropriate port. `PMAin` corresponds to D1, `PSEConary` to D2 in the **circuit model pictograms**.

For an `s4p` file, this parameter is ignored. However, it must be specified unless the `<Interchange>` parameter is also omitted.

<Interchange> `FPORts` | `IPORts` | `SGATes` | `SINCreasing`

Defines how to interpret the (implicit) port numbering of the Touchstone file in the context of the de-/embedding network.

FPORts (or omitted)

Standard interpretation: odd port numbers towards VNA, even port numbers towards DUT

IPORts

For *s2p* files IPORts means "inverted port sequence": network port 2 towards VNA, network port 1 towards DUT

For *s4p* files IPORts means "increasing port sequence": low port numbers towards VNA, high port numbers towards DUT

SGATes

Swapped gates: even port numbers towards VNA, odd port numbers towards DUT

SINcreasing

Swapped increasing port sequence: high port numbers towards VNA, low port numbers towards DUT

Example:

```
*RST; SOUR:LPOR1 1,2; LPOR2 3,4
```

Define a balanced port configuration.

```
CALC:TRAN:VNET:BAL:DEEM:TND STSL
```

Select the "Serial .s2p data, shunt L" circuit model.

```
MMEM:LOAD:VNET:BAL:DEEM2 'C:\Users\Public
\Documents\Rohde-Schwarz\ZNA\VNET\Test.s2p',
PMA
```

Load a Touchstone file and assign it to logical port no. 2.

Manual operation: See "[File Name <i>/Inc. Seq. <i>/Swap Gates <i>](#)" on page 713

MMEMory:LOAD:VNETworks<Ch>:DIFFerential:EMBedding<LogPt>
 <TouchstoneFile>[, <Interchange>]

Loads data of a [Differential match embedding](#) network from the specified Touchstone *.s2p file.

Use [CALCulate<Ch>:TRANSform:VNETworks:BALanced:EMBedding<LogPt>:PARAmeters:DATA<Port>](#) to load circuit data from the remote client instead.

The query returns the name of the loaded file.

Suffix:

<Ch> Channel number

<LogPt> Logical port number of a balanced port

Parameters:

<TouchstoneFile> String parameter to specify the name and directory of the loaded *.s2p file.

If no path is specified the analyzer searches the current directory, which can be set and queried using [MMEMory:CDIRectory](#)

<Interchange> FPORts | IPORts | SGATes

FPORts (or omitted)

Standard port sequence (network port 1 towards VNA, network port 2 towards DUT)

IPORts | SGATes

Inverted port sequence (network port 2 towards VNA, network port 1 towards DUT)

Example:

```
MMEM:LOAD:VNET1:DIFF:EMBM1 'C:\Users\Public\
Documents\Rohde-Schwarz\ZNA\Embedding\Test.s2p'
Load a Touchstone file.
```

Manual operation: See ["File Name 1"](#) on page 716

MMEMory:LOAD:VNETworks<Ch>:GLOop:DEEMbedding<group>
 <TouchstoneFile>

MMEMory:LOAD:VNETworks<Ch>:GLOop:EMBedding<group> <TouchstoneFile>

Loads data from a specified one-port (*.s1p) Touchstone file defining a ground loop circuit model for de-/embedding.

Suffix:

<Ch> Channel number

<group> Port group (DUT) number.
 If multiple port groups are configured (see [SOURCE<Ch>:GROup<Grp>:PPORts](#)) and [CALCulate<Ch>:TRANsform:VNETworks:GLOop:GROup](#) is ON, then each port group can have its own ground loop de-/embedding model.

Parameters:

<TouchstoneFile> String parameter to specify the name and directory of the loaded Touchstone file.
 If no path is specified the analyzer searches the current directory, which can be set and queried using [MMEMory:CDIRectory](#)

Example:

```
CALC:TRAN:VNET:SEND:GLO:TND FIMP
Select the 1-Port Data (s1p) circuit model.
MMEM:LOAD:VNET:GLO:EMB 'C:\Users\Public\
Documents\Rohde-Schwarz\ZNA\Embedding\Test.s1p'
Load a Touchstone file.
```

Manual operation: See ["File Name 1"](#) on page 714

MMEMory:LOAD:VNETworks<Ch>:PPAir:DEEMbedding<ListId>
 <TouchstoneFile>[, <Port>[, <Interchange>]]

MMEMory:LOAD:VNETworks<Ch>:PPAir:EMBedding<ListId> <TouchstoneFile>[, <Port>[, <Interchange>]]

Loads the S-parameter data that (partly) specify the deembedding network of port group <ListId> from local Touchstone files.

Use `CALCulate<Ch>:TRANSform:VNETworks:PPAir:DEEMbedding<ListId>:TNDefinition` or `CALCulate<Ch>:TRANSform:VNETworks:PPAir:EMBedding<ListId>:TNDefinition` to select the desired **circuit model** before loading the data files.

- For any n-port set, the `FIMPort` model requires a single `*.s<2n>p` file and hence a single set command.
- For 2-port sets (port pairs), the circuit models `STSL` | `STSC` | `SLST` | `SCST` require 2 `*.s2p` files, that have to be assigned to the appropriate port using two set commands.

Suffix:

<Ch>	Channel number
<ListId>	Index of the port set within the channel's overall list of port sets for deembedding.

Parameters:

<TouchstoneFile>	String parameter specifying the name and directory of the loaded Touchstone file. If no path is specified, the analyzer searches the current directory, which can be set and queried using <code>MMEMemory:CDIRectory</code>
<Port>	<code>PMAin</code> <code>PSECondy</code> For port pairs, <Port> assigns a 2-port (<code>*.s2p</code>) file to the appropriate port. <code>PMAin</code> corresponds to D1, <code>PSECondy</code> to D2 in the circuit model pictograms for balanced ports For an <code>s<2m>p</code> file with $m > 1$, this parameter is ignored. However, it must be specified unless the <Interchange> parameter is also omitted.
<Interchange>	<code>FPORts</code> <code>IPORts</code> <code>SGATes</code> <code>SINCreasing</code> Defines how to interpret the (implicit) port numbering of the Touchstone file in the context of the deembedding network. FPORts (or omitted) Standard interpretation: odd port numbers towards VNA, even port numbers towards DUT IPORts For <code>s2p</code> files <code>IPORts</code> means "inverted port sequence": network port 2 towards VNA, network port 1 towards DUT For <code>s4p</code> files <code>IPORts</code> means "increasing port sequence": low port numbers towards VNA, high port numbers towards DUT SGATes Swapped gates: even port numbers towards VNA, odd port numbers towards DUT SINCreasing Swapped increasing port sequence: high port numbers towards VNA, low port numbers towards DUT

Example: `*RST; :CALC:TRAN:VNET:PPA:DEEM:DEF 1,2,3,4`
 Define a port pair configuration with port pairs (1,2) and (3,4).
`CALC:TRAN:VNET:PPA:DEEM2:TND STSL`
 Select the *Serial Touchstone .s2p data, shunt L* circuit mode for the second port pair.
`MMEM:LOAD:VNET:PPA:DEEM2 'C:\Rohde-Schwarz\ZNA\Traces\Test.s2p', PMA`
 Load a Touchstone file and assign it to the second port pair.

Manual operation: See "[File Name <i>/Inc. Seq. <i>/Swap Gates <i>](#)" on page 711

MMEMory:LOAD:VNETworks<Ch>:SENDEd:DEEMbedding<PhyPt>
 <TouchstoneFile>[, <Interchange>]

MMEMory:LOAD:VNETworks<Ch>:SENDEd:EMBedding<PhyPt>
 <TouchstoneFile>[, <Interchange>]

Loads data from a specified two-port (* .s2p) Touchstone file defining a single ended circuit model for de-/embedding.

Use

- `CALCulate<Ch>:TRANSform:VNETworks:SENDEd:DEEMbedding<PhyPt>:TNDefinition` or `CALCulate<Ch>:TRANSform:VNETworks:SENDEd:EMBedding<PhyPt>:TNDefinition` to select the adequate circuit model **before** executing this command.
- `CALCulate<Ch>:TRANSform:VNETworks:SENDEd:EMBedding<PhyPt>:PARAmeters:DATA` to load circuit data from the remote client.

Suffix:

<Ch> Channel number

<PhyPt> Physical port number

Parameters:

<TouchstoneFile> String parameter to specify the name and directory of the loaded Touchstone file.
 If no path is specified the analyzer searches the current directory, which can be set and queried using `MMEMory:CDIRectory`

<Interchange> FPORts | IPORts | SGATes

FPORts (or omitted)

Standard port sequence (network port 1 towards VNA, network port 2 towards DUT)

IPORts | SGATes

Inverted port sequence (network port 2 towards VNA, network port 1 towards DUT)

Example: `CALC:TRAN:VNET:SEND:EMB:TND FIMP`
 Select the "Serial .s2p" data circuit model.
`MMEM:LOAD:VNET:SEND:EMB2 'C:\Users\Public\Documents\Rohde-Schwarz\ZNA\VNET\Test.s2p'`
 Load a Touchstone file and assign it to the physical port no. 2.

Manual operation: See ["File Name 1 / Swap Gates"](#) on page 710

MMEMory:MDIRectory <NewDirectory>

Creates a new subdirectory for mass memory storage in an existing directory.

Setting parameters:

<NewDirectory> String parameter to specify the new directory. Either the full path or a subdirectory for the current directory (see [MMEMory:CDIRectory](#)).

Example:

```
MMEM:MDIR 'C:\Users\Public\New_Directory'
Create the specified directory. The parent directory
C:\Users\Public must have been created before.
MMEM:MDIR 'C:
\Users\Public\New_Directory\New_Subdirectory'
Create an additional subdirectory.
MMEM:CDIR 'C:\Users\Public\Instrument'; MDIR
'New_Directory'
Create an additional directory
C:\Users\Public\Instrument\New_Directory.
```

Usage: Setting only

MMEMory:MOVE <SourceFile>, <NewFile>

Moves a file to the indicated directory and stores it under the file name specified, if any. If <NewFile> contains no path indication, the command renames the file without moving it.

Setting parameters:

<SourceFile>

<NewFile> String parameters to specify the name and the path of the file to be copied and the name and the path of the new file.

Example:

```
MMEM:MOVE 'C:\Users\Public\Documents
\Rohde-Schwarz\ZNA\RecallSets\SET1.znxml', 'D:'
Move file Set1.znxml in directory C:
\Users\Public\Documents
\Rohde-Schwarz\ZNA\RecallSets to an external storage
medium, mapped to drive D:.
```

Usage: Setting only

MMEMory:MSIS <Drive>

Sets/gets the *current drive* for MMEMory commands (MSIS = mass storage identification string).

Other MMEMory commands interpret paths starting with a "\" relative to this drive.

`MMEemory:MSIS <Drive>` is equivalent to `MMEemory:CDIRectory <Drive>`. In particular, it sets the current directory to the base directory of the specified drive.

Parameters:

<Drive> Drive letter, followed by a colon, e.g. 'D:'

Example:

```
MMEemory:CDIRectory DEFault
selects the default directory
C:\Users\Public\Documents\Rohde-Schwarz\ZNA.
MMEemory:MSIS?
returns C:.
MMEemory:CATalog? 'hardcopy'
lists the contents of
C:\Users\Public\Documents\Rohde-Schwarz\ZNA\
hardcopy.
MMEemory:CATalog? '\hardcopy'
lists the contents of D:\hardcopy.
```

MMEemory:NAME <Filename>

Defines a name for a file which can be used to store the printer output. The file is created when it is selected as a printer destination (`HCOPY:DESTination 'MMEem'`).

Parameters:

<Filename> String parameter to specify the file name. The supported file formats are *.wmf, *.ewmf, *.bmp, *.png; see command `HCOPY:DEvice:LANGUage`. The specified directory must exist, otherwise no file can be generated. If no path is specified the analyzer uses the current directory, to be queried with `MMEemory:CDIRectory?`.

```
*RST: 'Hardcopy'
```

Example:

```
MMEem:NAME 'C:
\Users\Public\Screenshots\PLOT1.BMP'
Define a printer file name, to be stored in the existing directory
C:\Users\Public\Screenshots (without creating the file).
HCOP:DEST 'MMEem'; :HCOP
Select "Print to file" and create the printer file specified before.
```

MMEemory:RDIRectory <Directory>

Allows you to remove an **empty** directory from the mass memory storage system.

Setting parameters:

<Directory> String parameter to specify the directory.

Example:

```
MMEem:RDIR 'C:
\Users\Public\NetworkService\Application Data'
Removes the specified directory, if empty. Otherwise an error
occurs.
```

Usage:

Setting only

MMEMory:STORe:CABLe <OutputDir>

Saves all predefined and user-defined Distance to Fault (DtF) cable types to the specified output directory.

Each DtF cable type is stored in a separate ASCII file < cable name >.rsc. The command silently overwrites files of the same name previously existing in the output directory.

Setting parameters:

<OutputDir> Output Directory, must be created before the command is executed

Example: see [MMEMory:LOAD:CABLe](#) on page 1278

Usage: Setting only

Options: R&S ZNA-K2

Manual operation: See "[Add / Delete](#)" on page 836

MMEMory:STORe:CKIT <CalKitName>, <CalKitFile>

Stores the data of a calibration kit to a specified file. The calibration kit is identified by its name.

Setting parameters:

<CalKitName> Name of a user-defined calibration kit available on the analyzer.
Tip: It is not possible to modify or store predefined or ideal kits.

<CalKitFile> String parameter to specify the name and directory of the cal kit file to be created. The file is a network analyzer-specific cal kit file with the extension *.calkit.
If no path is specified the analyzer searches the current directory, to be queried with [MMEMory:CDIRectory](#)

Example:

```
MMEM:LOAD:CKIT 'C:\Users\Public\Documents
\Rohde-Schwarz\ZNA\Calibration\Kits\New Kit
1.calkit'
```

Load the previously created cal kit file New Kit 1.calkit from the default cal kit directory.

```
... :MMEM:STOR:CKIT 'New Kit 1', 'C:
\Users\Public\Documents
\Rohde-Schwarz\ZNA\Calibration\Kits\New Kit
1.calkit'
```

Store the data for the user-defined cal kit "New Kit 1" and overwrite the cal kit file New Kit 1.calkit.

Usage: Setting only

Manual operation: See "[Import Cal Kit... / Export Cal Kit...](#)" on page 617

MMEMory:STORe:CKIT:WLABel <CalKitName>, <KitLabel>, <CalKitFile>

Stores the data of a calibration kit to a specified file. The calibration kit is identified by its name and label.

Setting parameters:

<CalKitName>	Name of a user-defined calibration kit available on the analyzer. Tip: It is not possible to modify or store predefined or ideal kits.
<KitLabel>	Label of the calibration kit, usually its serial number.
<CalKitFile>	String parameter to specify the name and directory of the cal kit file to be created. The file is a NWA-specific cal kit file with the extension *.calkit. If no path is specified the analyzer searches the current directory, to be queried with MMEMory:CDIRectory

Example: See [\[SENSe:\]CORRection:CKIT:LLABel](#)

Usage: Setting only

MMEMory:STORe:CMAP <ColorSchemeFile>**MMEMory:STORe:CMAP:HCOPY** <ColorSchemeFile>

Stores the user-defined color scheme (display/print) to a VNA color scheme file.

The `HCOPY` variant is for the print color scheme.

Setting parameters:

<ColorSchemeFile>	String parameter to specify the name and directory of the color scheme file to be created. If no path is specified the analyzer uses the current directory, to be queried with MMEMory:CDIRectory? . The default extension (manual control) for color scheme files is *.ColorScheme, although other extensions are allowed.
-------------------	---------------------------------------------------------------------------------------------------------------------------------------------------------------------------------------------------------------------------------------------------------------------------------------------------------------------------------------------

Example: See [MMEMory:LOAD:CMAP](#)

Usage: Setting only

Manual operation: See "[Recall... / Save...](#)" on page 850

MMEMory:STORe:CORRection <Channel>, <CalGroupFile>

Copies the correction data of channel <Channel> to the cal pool, generating a new correction data file (cal group). The file has the extension *.cal and is stored in the `C:\Users\Public\Documents\Rohde-Schwarz\ZNA\Calibration\Data` directory.

Setting parameters:

<Channel>	Channel number
-----------	----------------

<CalGroupFile> String parameter to specify the name of the created cal group file. There is no need to specify the directory path and file extension; the analyzer uses the default cal pool directory `C:\Users\Public\Documents\Rohde-Schwarz\ZNA\Calibration\Data` and a `*.cal` extension.

Example: See [MMEMory:LOAD:CORRection](#)

Usage: Setting only

Manual operation: See "[Add / Add All... / Replace / Apply / Apply to All](#)" on page 639

MMEMory:STORe:CORRection:SLEVeling<PhyPt> <File>

Persists the current leveling dataset of port `<PhyPt>` to the specified `*.lev` file (R&S ZNA-proprietary, binary file format).

The dataset can be recalled using [MMEMory:LOAD:CORRection:SLEVeling<PhyPt>](#).

Suffix:
`<PhyPt>` Physical port number

Setting parameters:
`<File>` String parameter containing the path and file name of the `*.lev` file. If the path is omitted, the current directory is used (see [MMEMory:CDIRectory](#)).

Usage: Setting only

Options: R&S ZNA-K8

Manual operation: See "[Load/Save](#)" on page 908

MMEMory:STORe:CORRection:TCoefficient<Ch> <PmclFile>

Saves two-port transmission coefficients of channel `<Ch>` to a power meter correction list file.

Suffix:
`<Ch>` Channel number

Parameters:
`<DeEmbedding Position>` BOTH | DUT | PM
Determines the two-port the command refers to:

DUT
The two-port between VNA and DUT (during measurement)

PM
The two-port between VNA and PM (during power calibration)

BOTH
Both positions

(parameter omitted)

If the parameter is omitted, the command refers to the two-port selected using `SOURce<Ch>:POWer<PhyPt>:CORRection:TCOefficient:CALibration`.

Setting parameters:

`<PmclFile>` String parameter specifying the name and directory of the created power meter correction list file. The file extension `*.pmcl` is mandatory.
If no path is specified, the analyzer searches the current directory, to be queried with `MMEMory:CDIRectory`

*RST: n/a

Example: See `SOURce:POWer:CORRection:TCOefficient[:STATe]`

Usage: Setting only

Manual operation: See "Recall... / Save..." on page 634

MMEMory:STORe:EYE:MASK <TraceName>, <TraceFile>

Stores a user-defined eye mask to a 7bit ASCII file.

Setting parameters:

`<TraceName>` Name of the related eye diagram

`<TraceFile>` String parameter containing the path and file name of the eye mask file. If the path is omitted, the current directory is used (see `MMEMory:CDIRectory`).

Usage: Setting only

Options: R&S ZNA-K20

Manual operation: See "Save / Load Mask Configuration" on page 825

MMEMory:STORe:EYE:MASK:RESults <TraceName>, <TraceFile>

Saves the detailed results of the mask test in the related eye diagram to an ASCII file (see `CALCulate<Chn>:EYE:MASK:DATA?` on page 1001).

This command will raise an execution error if `CALCulate<Chn>:EYE:MASK:STATe` is OFF.

Setting parameters:

`<TraceName>` The name of the eye diagram whose mask test results shall be exported

`<TraceFile>` Mandatory string parameter containing the path and file name of the file. If the path is omitted, the current directory is used (see `MMEMory:CDIRectory`).

Usage: Setting only

Options: R&S ZNA-K20

Manual operation: See ["Export Test Results"](#) on page 822

MMEMory:STORe:EYE:MEASurements <TraceName>, <TraceFile>[,
<DecSeparator>[, <FieldSeparator>]]

Allows to export eye diagram results to an ASCII file (csv), with the possibility to specify a decimal separator (comma or point) and a field separator (semicolon, comma, tab or space).

See also [CALCulate<Chn>:EYE:MEASurement:DATA?](#) on page 1007.

Note that the decimal separator and field separator must be different: if both are set to comma, actually a semicolon will be used as field separator.

Setting parameters:

<TraceName>	The name of the eye diagram whose results shall be exported
<TraceFile>	Mandatory string parameter containing the path and file name of the file. If the path is omitted, the current directory is used (see MMEMory:CDIRectory).
<DecSeparator>	POINT COMMa Decimal separator *RST: COMMa
<FieldSeparator>	SEMicolon COMMa TABulator SPACe Field separator *RST: SEMicolon

Usage: Setting only

Options: R&S ZNA-K20

Manual operation: See ["Export Measurements..."](#) on page 808

MMEMory:STORe:LIMit <TraceName>, <LimLineFile>

Saves the limit lines associated to a specified trace to a limit line file. Limit lines are created using the [CALCulate<Chn>:LIMit...](#) commands.

Setting parameters:

<TraceName>	Name of an existing trace in the active recall set (string parameter) for which a limit line definition exists.
<LimLineFile>	String parameter to specify the name and directory of the created limit line file. The default extension (manual control) for limit line files is *.limit, although other extensions are allowed. If no path is specified the analyzer searches the current directory, to be queried with MMEMory:CDIRectory

Example: See [MMEMory:LOAD:LIMit](#)

Usage: Setting only

Manual operation: See ["Recall... / Save..."](#) on page 484

MMEMory:STORe:MARKer <AsciiFile>

Saves the values of all markers to an ASCII file.

Setting parameters:

<AsciiFile> String parameter to specify the name and directory of the created ASCII file. The default extension (manual control) for marker files is *.txt, although other extensions are allowed. If no path is specified the analyzer searches the current directory, to be queried with [MMEMory:CDIRectory](#)

Example:

```
*RST
Reset the analyzer, creating the default trace no. 1 in channel
no. 1.
CALC:MARK ON; MARK:X 1GHz
Create marker no. 1 and place it to 1 GHz.
CALC:MARK2 ON; MARK2:X 2GHz
Create a second marker and place it to 2 GHz.
MMEM:STOR:MARK 'Marker.txt'
Store the marker values to an ASCII file. The file contains both
marker values, e.g.:
Trc1 S21
Mkr 1 1.000000 GHz -4.900 dB
Mkr 2 2.000000 GHz -6.807 dB
```

Usage: Setting only

Manual operation: See "[Export Markers](#)" on page 503

MMEMory:STORe:MDCData <Channel Id>, <Filename>

Stores the correction data for a mixer delay calibration to a specified file. Mixer delay measurements are controlled using the `SENSe<Ch>:FREQuency:MDElay...` commands.

Setting parameters:

<Channel Id> Channel number

<Filename> String parameter to specify the name and directory of the created calibration file. The default extension (manual control) for mixer delay calibration files is *.mcal, although other extensions are allowed. If no path is specified the analyzer uses the current directory, to be queried with `MMEMory:CDIRectory?`.

Example: See [MMEMory:LOAD:MDCData](#) on page 1290

Usage: Setting only

MMEMory:STORe:RIPple <TraceName>, <RippleLimFile>

Saves the ripple limits associated with a specified trace to a ripple limit file. Ripple limit definitions are created using the `CALCulate<Chn>:RIPple...` commands.

Setting parameters:

- <TraceName> Name of an existing trace in the active setup (string parameter) for which a ripple limit definition exists.
- <RippleLimFile> String parameter to specify the name and directory of the created ripple limit file. The default extension (manual control) for ripple limit files is `*.ripple`, although other extensions are allowed.
If no path is specified the analyzer searches the current directory, to be queried with [MMEMory:CDIRectory](#)

Example: See [MMEMory:LOAD:LIMit](#)

Usage: Setting only

Manual operation: See "[Recall Ripple Test.../Save Ripple Test...](#)" on page 491

MMEMory:STORe:SEGMENT <Channel>, <SweepSegFile>

Saves the sweep segment definition of the related channel to a an ASCII file. Sweep segments are defined using [\[SENSe:\]SEGMENT...](#) commands.

Setting parameters:

- <Channel> Channel number
- <SweepSegFile> String parameter to specify the name and directory of the created sweep segment file. The default extension (manual control) for sweep segment files is `*.SegList`, although other extensions are allowed.
If no path is specified the analyzer searches the current directory, to be queried with [MMEMory:CDIRectory](#)

Example: See [MMEMory:LOAD:SEGMENT](#)

Usage: Setting only

Manual operation: See "[Import.../ Export...](#)" on page 555

MMEMory:STORe:STATe <Compatibility>, <RecallSetFile>

Stores the configuration data of the current recall set to the specified recall set file.

`MMEMory:STORe:STATe` also renames the current recall set. See example for `MMEMory:LOAD:STATe`.

Setting parameters:

- <Compatibility> 1 (this value is used for compatibility with the SCPI standard but ignored).

<RecallSetFile> String parameter to specify the absolute or relative path of the created recall set file. Relative paths are evaluated relative to the current directory (see [MMEMoRY:CDIRectory](#)). The default extension for recall set files is `znxml`. Unless you specify `znx` as file name extension, recall sets are always stored in `znxml` file format.

Example: See [MMEMoRY:LOAD:STATE](#)

Usage: Setting only

Manual operation: See "Save" on page 774

MMEMoRY:STORe:TRACe <TraceName>, <TraceFile>[, <FormatInd>[, <Format>[, <DecSeparator>[, <FieldSeparator>]]]]

Stores the trace data of a specified data trace to a trace file. Traces are created using the [CALCulate<Ch>:PARAmeter:SDEFine](#) command.

Tip: `*.s<n>p` Touchstone files (`<n> = 1, 2, 3, ...`) are intended for a complete set of `<n>`-port S-parameters. Data export fails if the active channel does not contain the full set of `<n>`² traces or if the involved ports are not numbered consecutively, starting with port 1. If the necessary traces are available, '`<trc_name>`' can be the name of any of the traces. To create Touchstone files while less than `<n>`² single-ended traces are available, use [MMEMoRY:STORe:TRACe:PORTs](#).

Setting parameters:

<TraceName> Name of an existing data trace in the active recall set (string parameter).

<TraceFile> String parameter to specify the name and directory of the created trace file. Several file formats for trace files are supported. The file extensions `*.s<n>p`, `*.csv`, and `*.dat` for Touchstone, ASCII, and Matlab files are mandatory. To generate a multipoint Touchstone file `*.s2p`, `*.s3p...`, the channel must contain traces for the full set of S-parameters; the '`<trc_name>`' is ignored. If no path is specified the analyzer uses the current directory, to be queried with [MMEMoRY:CDIRectory?](#).

<FormatInd> FORMatted | UNFormatted
UNFormatted - unformatted data export specified by the second optional parameter.
FORMatted - formatted data export (for `*.csv` and `*.dat` files only).
If the first optional parameter is omitted, the command stores unformatted data.

<Format> COMPLex | LINPhase | LOGPhase
COMPLex - complex values (real and imaginary part)
LINPhase - linear magnitude and phase.
LOGPhase - dB-magnitude and phase.

If the second optional parameter is omitted, the command stores complex data.

<DecSeparator>	POINT COMMa POINT - decimal separator: point. COMMa - decimal separator: comma. If the third optional parameter is omitted, points are used.
<FieldSeparator>	SEMicolon COMMa TABulator SPACe SEMicolon - field separator: semicolon COMMa - field separator: comma. TABulator - field separator: tabulator. SPACe - field separator: space. If the fourth optional parameter is omitted, semicolons are used.

Example: See [MMEMory:LOAD:TRACe](#)

Usage: Setting only

Manual operation: See "[Save](#)" on page 473

MMEMory:STORE:TRACe:CHANnel <Channel>, <TraceFile>[, <FormatInd>[, <Format>[, <DecSeparator>[, <FieldSeparator>]]]]

Stores the trace data of all data traces in the specified channel to a trace file. Traces are created using the [CALCulate<Ch>:PARAmeter:SDEFine](#) command.

Tip: *.s<n>p Touchstone files (<n> = 1, 2, 3, ...) are intended for a complete set of <n>-port S-parameters. Data export fails if the active channel does not contain the full set of <n>² traces.

Setting parameters:

<Channel>	Channel number in the active recall set. ALL means that a separate file is created for each channel in the active recall set.
<TraceFile>	String parameter to specify the name and directory of the created trace file. Several file formats for trace files are supported. The file extensions *.s<n>p, *.csvc, and *.dat for Touchstone, ASCII, and Matlab files are mandatory. To generate a multiport Touchstone file *.s2p, *.s3p . . . , the channel must contain traces for the full set of S-parameters. If no path is specified the analyzer uses the C:\Users\Public\Documents\Rohde-Schwarz\ZNA\Traces directory.

<FormatInd>	<p>FORMatted UNFormatted</p> <p>UNFormatted - unformatted data export specified by the second optional parameter.</p> <p>FORMatted - formatted data export (for *.csv and *.dat files only).</p> <p>If the first optional parameter is omitted, the command stores unformatted data.</p>
<Format>	<p>COMPLex LINPhase LOGPhase</p> <p>COMPLex - complex values (real and imaginary part)</p> <p>LINPhase - linear magnitude and phase.</p> <p>LOGPhase - dB-magnitude and phase.</p> <p>If the second optional parameter is omitted, the command stores complex data.</p>
<DecSeparator>	<p>POINT COMMa</p> <p>POINT - Decimal separator: point.</p> <p>COMMa - Decimal separator: comma.</p> <p>If the third optional parameter is omitted, points are used.</p>
<FieldSeparator>	<p>SEMIColon COMMa TABulator SPACe</p> <p>SEMIColon - Field separator: semicolon</p> <p>COMMa - field separator: comma.</p> <p>TABulator - field separator: tabulator.</p> <p>SPACe - field separator: space.</p> <p>If the third optional parameter is omitted, semicolons are used.</p>

Example:

```
*RST; :CONF:TRAC:NAME?
```

Reset the instrument, creating a default channel no 1 and a default trace Trc1.

```
CALC:PAR:DEF:SGR 1,2
```

Create four traces to measure the two-port S-parameters S_{11} , S_{12} , S_{21} , S_{22} . The traces are not displayed.

```
MMEM:STOR:TRAC:CHAN 1, 'C:\Users\Public\Documents\Rohde-Schwarz\ZNA\Traces\Chn1.csv'
```

Store all trace data of channel 1 to a trace file.

```
MMEM:STOR:TRAC:CHAN 1, 'C:\Users\Public\Documents\Rohde-Schwarz\ZNA\Traces\Chn1.s2p'
```

Store the four S-parameter traces to a two-port Touchstone file. The Touchstone file will not contain the default trace Trc1.

Usage:

Setting only

Manual operation:

See ["Save"](#) on page 473

MMEMory:STORe:TRACe:OPTion:BALanced <Boolean>

MMEMory:STORe:TRACe:OPTion:SYMMetric <Boolean>

This command enables/disables the export of balanced (and mixed-mode) S-parameters for `MMEMory:STORe:TRACe:PORTs`.

Parameters:

<Boolean>

MMEMory:STORe:TRACe:OPTion:COMMeNt <Comment>

Defines a comment to be added to (the comment section of) exported trace files.

This is a global setting, i.e. the comment string is used for each trace export in every open recall set.

Parameters:

<Comment> Comment string. If empty, no comment will be added.

Manual operation: See "[Comment Added to File](#)" on page 473

MMEMory:STORe:TRACe:OPTion:DECimals:DATA <NumDecimals>**MMEMory:STORe:TRACe:OPTion:DECimals:STIMulus** <NumDecimals>

Defines the number of decimal places for stimulus and data values in all supported trace data files (Touchstone, ASCII, MatLab)

Note that in the current implementation of the Touchstone file export, only the L11 file format supports independent settings for stimulus and data values (see [MMEMory:STORe:TRACe:OPTion:FORMat](#)). For the F11 and F20 formats, the DATA number of digits is used for both stimulus and data values.

Parameters:

<NumDecimals> Range: 1 to 15

Manual operation: See "[Decimal Places](#)" on page 471

MMEMory:STORe:TRACe:OPTion:FORMat <TS_Frmt>

Selects the [file format](#) to be generated during Touchstone export.

Parameters:

<TS_Frmt> F11 | F20 | L11

F11

Trace output according to Touchstone standard 1.1 (new library)

F20

Trace output according to Touchstone standard 2.0 (new library)

L11

Legacy Touchstone 1.1 output

F11 and L11 slightly differ w.r.t. casing, number formatting and comments. F20 adds keywords etc. introduced with Touchstone standard version 2.0.

Manual operation: See "[File Format](#)" on page 471

MMEMory:STORe:TRACe:OPTion:PLUS <arg0>

This command defines how positive numbers are prefixed during Touchstone file export: by a leading space, a plus sign or not at all.

Parameters:

<arg0> SPACe | PLUS | VOID

Manual operation: See "[Positive Number Prefix](#)" on page 867

MMEMory:STORe:TRACe:OPTion:SSEPARATOR <Boolean>

This command defines whitespace insertion during Touchstone file export.

If set to ON, separator lines are skipped, i.e. the content parts are no longer separated by blank lines.

Parameters:

<Boolean>

Manual operation: See "[Skip Separator Lines](#)" on page 867

MMEMory:STORe:TRACe:OPTion:TABS <Boolean>

This command defines whitespace insertion during Touchstone file export.

If set to ON, columns are separated by tabs rather than spaces.

Parameters:

<Boolean>

Manual operation: See "[Use TAB \(instead of blanks\)](#)" on page 867

MMEMory:STORe:TRACe:OPTion:TRIM <Boolean>

This command defines whitespace insertion during Touchstone file export.

If set to ON, whitespace at the beginning of each line is removed.

Parameters:

<Boolean>

Manual operation: See "[Trim Leading Whitespace](#)" on page 867

MMEMory:STORe:TRACe:PORTs <Channel>, <TouchstoneFile>, <Format>[, <ModelImpedance>, <Port>[, <Port>]...]

Generates an `snp` Touchstone file, where `n` is the number of specified ports.

If the specified physical ports comprise at least one balanced port and [MMEMory:STORe:TRACe:OPTion:BALanced](#) is ON, the Touchstone file contains the full set of mixed mode S-parameters. Otherwise it contains the full set of single-ended S-parameters. Both sets have a size of n^2 .

The command fails unless the conditions for Touchstone file export are met; see "[Conditions for Touchstone file export](#)" on page 183. Traces are created using the `CALCulate<Ch>:PARAmeter:SDEFine` command.

Setting parameters:

<Channel>	Channel number in the active recall set.
<TouchstoneFile>	String parameter to specify the name and directory of the created Touchstone file. The file extension <code>*.snp</code> for an n-port Touchstone file is mandatory. If no path is specified the analyzer searches the current directory, to be queried with <code>MMEMoRY:CDIRectory</code>
<Format>	COMPLex LINPhase LOGPhase COMPLex - complex values (real and imaginary part). LINPhase - Linear magnitude and phase. LOGPhase - dB-magnitude and phase.
<ModelImpedance>	CIMPedance PIMPedance CIMPedance (default, if omitted): normalize to a common target impedance of 50 Ω PIMPedance : normalize to the individual port reference impedances See " Renormalization of S-parameters " on page 184.
<Port>, <Port>, ...	Physical port numbers
<Port>	

Example:

Suppose that a full two-port calibration for ports 1 and 2 and channel 1 has been performed, and that a DUT with two balanced ports is connected. The analyzer measures an arbitrary mixed mode S-parameter.

```
MMEM:STOR:TRAC:PORT 1, 'Test_CIMP.s2p',
COMPLex, CIMPedance, 1, 2
```

Calculate all single-ended S-parameters, renormalize them to the common target impedance and store them to a two-port Touchstone file.

```
MMEM:STOR:TRAC:PORT 1, 'Test_PIMP.s2p',
COMPLex, PIMPedance, 1, 2
```

Calculate all single-ended S-parameters, renormalize them to the individual port reference impedances and store them to a two-port Touchstone file.

Usage: Setting only

Manual operation: See "[Save](#)" on page 473

7.3.12 OUTPut commands

The `OUTPut...` commands control the characteristics of the analyzer's output ports.

OUTPut<Ch>[:STATe].....	1314
OUTPut[:STATe]:TYPE.....	1314
OUTPut:ULED:STATe.....	1314
OUTPut:UPORt:ECBits.....	1315
OUTPut<Ch>:UPORt:SEGMENT<Seg>:STATe.....	1315
OUTPut<Ch>:UPORt:SEGMENT<Seg>[:VALue].....	1315
OUTPut<Ch>:UPORt[:VALue].....	1317

OUTPut<Ch>[:STATe] <Boolean>

Turns the internal source power at all ports and the power of all external generators on or off.

Suffix:

<Ch> Channel number. This suffix is ignored; the setting is valid for all channels.

Parameters:

<Boolean> ON | OFF - switch the power on or off.
*RST: ON

Example:

OUTP OFF
Turn off the RF source power.

Manual operation: See ["RF Off All Channels"](#) on page 526

OUTPut[:STATe]:TYPE <OutputTypeMode_Descript>

Allows you to define how the R&S ZNA turns the RF power off.

Parameters:

<OutputTypeMode_Descript> FAST | LBNoise

FAST

Only the RF switch is used (default).

LBNoise

In addition to the switches, all amplifiers are turned off. Results in lower broadband noise.

Manual operation: See ["RF Off Behavior"](#) on page 870

OUTPut:ULED:STATe <ledState>

Configures the "User Defined" LED at the front panel of the R&S ZNA. This is a persistent setting.

Parameters:

<ledState> OFF | GREen | RED | FGReen | FRED

OFF

Switched off

GREen

Green color, permanently on

RED

Red color, permanently on

FGreen

Green color, flashing

FRED

Red color, flashing

OUTPut:UPORt:ECBits <Boolean>

Defines the usage of pins 16 to 19 of the USER PORT connector.

Parameters:

<Boolean> ON – channel bits 4 to 7
 OFF – drive port 1 to 4
 *RST: ON

Example: See [OUTPut<Ch>:UPORt\[:VALue\]](#)**Manual operation:** See "[Pin 16 - 19](#)" on page 865

OUTPut<Ch>:UPORt:SEGMENT<Seg>:STATe <Boolean>Enables or disables segment bits for the sweep segments in channel no. <Ch>; see [OUTPut<Ch>:UPORt:SEGMENT<Seg>\[:VALue\]](#). The command is valid for segmented frequency sweep.**Suffix:**

<Ch> Channel number.
 <Seg> Sweep segment number. This suffix is ignored; the setting is valid for all segments.

Parameters:

<Boolean> ON | OFF - Enables or disables channel bits.
 *RST: OFF

Example: See [OUTPut<Ch>:UPORt:SEGMENT<Seg>\[:VALue\]](#)
on page 1315**Manual operation:** See "[Optional Columns](#)" on page 557

OUTPut<Ch>:UPORt:SEGMENT<Seg>[:VALue] <BinValue>Sets or queries a sweep segment-dependent four-bit binary value to control four independent output signals at the USER PORT connector (lines 16, 17, 18, 19). The output signals are 3.3 V TTL signals which can be used to differentiate between up to 16 independent analyzer states for each channel. The command is valid for segmented frequency sweeps. It is analogous to the channel-dependent command [OUTPut<Ch>:UPORt\[:VALue\]](#).

The bits for the sweep segments must be enabled explicitly using
[OUTPut<Ch>:UPORt:SEGMENT:STATe](#).

Segment bit definition and activation

The segment bits have the following properties:

- After a *RST of the analyzer all segment bits are set to zero; no signal is applied to pins 16 to 19 of the USER PORT connector.
- The value defined with `OUTPut<Ch>:UPORt:SEGMENT<Seg>[:VALue]` is assigned to segment no. `<Seg>` in channel no. `<Ch>`.
- The signals at the USER CONTROL connector reflect the segments bits of the currently measured segment.
- The signals are switched on as soon as a measurement in a segment with non-zero segment bits is started. They are changed whenever a segment with different segment bits is measured.
- The signals at the USER PORT connector are maintained after the analyzer enters the hold state. This happens in single sweep mode after all sweep sequences have been terminated.

Tip:

You can use the active segment number as a parameter for `OUTPut<Ch>:UPORt:SEGMENT<Seg>[:VALue]` and monitor the measurement in up to 16 different segments per channel at the USER PORT connector; see example below. You can also use the USER PORT output signals as segment-dependent trigger signals for external devices. Use `CONTRol:AUXiliary:C[:DATA]` to transfer the four bit value in decimal representation.

Suffix:

<code><Ch></code>	Channel number.
<code><Seg></code>	Sweep segment number

Parameters:

<code><BinValue></code>	Binary value. The transferred values correspond to the following states of the USER CONTROL connector: #B0000 - no signal at any of the four pins 16, 17, 18, 19 #B0001 - output signal at pin 16 #B0010 - output signal at pin 17 #B0011 - output signal at pin 16 and 17 ... #B1111 - output signal at pin 16, 17, 18 and 19 Range: #B0000 to #B1111 (for setting command), 0 to 15 (query) *RST: #B0000 (0)
-------------------------------	----------------------------------------------------------------------------------------------------------------------------------------------------------------------------------------------------------------------------------------------------------------------------------------------------------------------------------------------------------------------------------------------------------------------------------------

Example:

```
*RST; :SEGM:INS 1MHZ, 1.5MHZ, 111, -21DBM,
0.5S, 0, 10KHZ
```

Create a sweep segment no. 1 with a sweep range between 1.0 MHz and 1.5 MHz.

```
SWE:TYPE SEGM
```

Set the segmented frequency sweep active.

```
OUTP:UPOR:SEGM:STAT ON
```

Enable segment bits.

```
OUTP:UPOR:SEGM1 #B0001
```

Assign the segment bit value #B0001 to segment no. 1. The output signal at pin 16 is switched on while the first segment is measured.

```
SEGM2:ADD
```

Create a second sweep segment. The frequency range of the second segment will be between 1.5 MHz and the maximum frequency of the analyzer.

```
OUTP:UPOR:SEGM2 #B0010
```

Assign the segment bit value #B0010 to segment no. 2. While the analyzer measures the second segment, the output signal changes from pin 16 to pin 17.

Manual operation: See ["Optional Columns"](#) on page 557

OUTPut<Ch>:UPORt[:VALue] <BinValue>

Sets or queries a channel-dependent eight-bit binary value to control eight independent output signals at the USER PORT connector (lines 8, 9, 10, 11 and lines 16, 17, 18, 19). The output signals are 3.3 V TTL signals which can be used to differentiate between up to 255 independent analyzer states. `OUTPut<Ch>:UPORt[:VALue]` itself does not change the analyzer state.

Channel bit definition and activation

The channel bits have the following properties:

- After a `*RST` of the analyzer all channel bits (including the value for the active, sweeping channel no. 1) are set to zero; no signal is applied to pins 8 to 11 and 16 to 19 of the USER PORT connector.
- The value defined with `OUTPut<Ch>:UPORt[:VALue]` is assigned to channel no. <Ch>.
- The signals at the USER PORT connector reflect the channel bits of the **measuring** channel, i.e. the channel for which the analyzer performs a sweep. This channel is not necessarily identical with the active channel.
- The signals are switched on as soon as a measurement (sweep) in a channel with non-zero channel bits is started. They are changed whenever a channel with different channel bits becomes the measuring channel.
- The signals at the USER PORT connector are maintained after the analyzer enters the hold state. This happens if all channels use single sweep mode and if all sweep sequences have been terminated.

- Pins 16 to 19 may be reserved for monitoring the drive ports 1 to 4 of the analyzer (OUTPut<Ch>:UPORt:ECBits OFF). This leaves up to 16 different monitored channel states.

Tip: You can use the active channel number as a parameter for `OUTPut<Ch>:UPORt[:VALue]` and monitor the activity of up to 255 different channels at the USER PORT connector; see example below. You can also use the USER PORT output signals as channel-dependent (or drive port-dependent) trigger signals for external devices. Furthermore you can use `CONTRol:AUXiliary:C[:DATA]` to transfer the eight bit value in decimal representation.

Suffix:

<Ch> Channel number

Parameters:

<BinValue> Binary value. The values correspond to the following states of the USER PORT connector:
 #B00000000 - no signal at any of the eight pins 8, 9, 10, 11, 16, 17, 18, 19
 #B00000001 - output signal at pin 8
 #B00000010 - output signal at pin 9
 #B00000011 - output signal at pins 8 and 9
 ...
 #B11111111 - output signal at pins 8, 9, 10, 11, 16, 17, 18, 19
 Range: #B00000000 to #B11111111 (for setting command),
 0 to 255 (query)
 *RST: #B00000000 (0)

Example:

```
*RST; :OUTP1:UPOR #B00000001
```

Assign the channel bit value #B00000001 to the active channel no. 1. The analyzer performs a measurement in channel no. 1, therefore the output signal at pin 8 is switched on.

```
CONF:CHAN2:STAT ON; OUTP2:UPOR #B00000010
```

Create channel no. 2, causing it to become the active channel, and assign the channel bit value #B00000010. The analyzer performs no measurement in channel no. 2, therefore the output signal is not changed.

```
CALC2:PAR:SDEF 'Ch2Tr1', 'S11'
```

Create a trace named 'Ch2Tr1' and assign it to channel 2. While the analyzer measures in channel 2, the output signal changes from pin 8 to pin 9.

```
OUTP:UPOR:ECB OFF
```

Reserve pin 16 to 19 for monitoring the drive ports of the analyzer.

Manual operation: See "[Channel Bits \(Decimal\)](#)" on page 865

7.3.13 PROGram commands

The PROGram... commands control external application programs that can be run on the analyzer.

PROGram[:SElected]:EXECute.....	1319
PROGram[:SElected]:INIMessage.....	1320
PROGram[:SElected]:INIPParameter.....	1320
PROGram[:SElected]:NAME.....	1321
PROGram[:SElected]:RETVAl?.....	1322
PROGram[:SElected]:WAIT.....	1322

PROGram[:SElected]:EXECute <AppName>

Starts an application process or open a file using an application available on the analyzer.

Use the command sequence `PROGram[:SElected]:WAIT? ; PROGram[:SElected]:RETVAl?` to query the return value (see example below).

Note: It is not possible to run several programs simultaneously. If the command `PROGram[:SElected]:EXECute ...` is sent while a previously started program is still executed, the analyzer generates a SCPI error -100, "Command error...".

Tip: Executing batch files; command prompt

When executing batch scripts or other DOS applications, the analyzer does not display any DOS windows; the screen is left for the vector network analyzer (VNA) application. The same applies to the Windows NT command prompt (`cmd.exe`). To access the command prompt, proceed as follows:

- Create a batch file (e.g. `Start_cmd.bat`) containing the command line `start cmd.exe` and store the file to `C:\Winnt\system32`.
- Execute the batch file: `PROG:EXEC 'C:\winnt\system32\Start_cmd.bat'`

The command prompt window is displayed in front of the VNA application. You can also open several command prompt windows simultaneously.

Setting parameters:

<AppName> String variable containing the name and path of an application program to be executed or of a file to be opened. The path can be defined as an absolute path (e.g. 'c:\...') or relative to the current directory (`MMEMory:CDIRectory`).
Blanks in the <AppName> can be used to separate the application name from (optional) parameters.

Example: `PROG:SElected:NAME PROG`
 Select general program execution.
 `PROG:SElected:EXECute 'Exit42.bat'`
 Run batch script `Exit42.bat`.
 `PROG:SElected:WAIT?`
 Lock command execution and manual control of the analyzer
 until the batch job has finished. This is required for
 `PROG:SElected:RETVal?`
 Get the return value. The answer is ... 42.

Usage: Setting only

PROG:SElected]:INIMessage <IniFile>[, <SendValue>]

Writes a message <SendValue> into the preferences (*.ini) file specified by <IniFile>. The message is entered into the [MESSAGE] section using the fixed key `Send`; the value for the fixed key `Receive` is set to an empty string.

The query reads the value associated with the fixed key `Receive` from the [MESSAGE] section of the preferences file specified by <IniFile>. If no value exists for that key, the query returns an empty string.

Both commands can be used to establish a simple file-based two-way communication mechanism to an external application launched by `PROG[:SElected]:EXECute`; see example.

Parameters:

<IniFile> Name and path of the *.ini file. The *.ini extension may be omitted as it is created automatically by the command. The specified path/directory must exist. If the *.ini file does not exist, it is created.

<SendValue> Value for the fixed key `Send`.

Example: `PROG:INIM 'c:\preferences\myapp', 'this is a message'`
 Write the string `this is a message` into the file
 `c:\preferences\myapp.ini`. The contents of the file look
 like:
 `[MESSAGE] Send="this is a message" Receive=`
 Suppose the external program writes the string
 `this is a response` to the `Receive` key (and possibly dele-
 tes the contents of the `Send` key.
 `PROG:INIM? 'c:\preferences\myapp'`
 Query the value of the key `Receive` in the *.ini file. The
 response is `"this is a response"`.

PROG:SElected]:INIPParameter <IniFile>{ , <Key>,<Value> | '<Value>'}

Defines and writes one or several key/value pairs into the preferences file (*.ini) specified by <file_path>. The information is entered into the [PARAMETER] section.

This command can be used to supply information to an external application launched by `:PROGram[:SElected]:EXECute`.

The query must be sent with a single `<Key>` value. It reads the value associated with the key from the `[PARAMETER]` section of the preferences file specified by `<file_path>`. If the key/value pair does not exist, the query returns an empty string.

Parameters:

<code><IniFile></code>	Name and path of the <code>*.ini</code> file. The <code>*.ini</code> extension may be omitted as it is created automatically by the command. The specified path/directory must exist. If the <code>*.ini</code> file does not exist, it is created.
<code><Key></code>	Key for the key/value pair(s).
<code><Value></code>	String or numeric value for the key/value pair(s). If a string parameter is supplied, it has to be enclosed in single or double quotes.

Example:

```
PROG:INIP 'c:\preferences\myapp',
'myparameter', 'myvalue', 'startf', 123.05
```

Write two key/value pairs into the file

`c:\preferences\myapp.ini`. The contents of the file look like:

```
[PARAMETER]
myparameter="myvalue"
startf="123.05"
PROG:INIP? 'c:\preferences\myapp',
'myparameter'
```

Query the value of the key `myparameter` in the `*.ini` file. The response is `"myvalue"`.

PROGram[:SElected]:NAME <Program>

Selects the application to be run on the analyzer. At present, only the general parameter `PROG` is available. This means that `PROGram[:SElected]:EXECute` can start any program.

Tip: Use this command in order to avoid problems should the default value change in future firmware versions.

Parameters:

<code><Program></code>	<code>PROG</code> Any program running under Windows or any file that can be opened with an application program available on the analyzer.
<code>*RST:</code>	<code>PROG</code>

Example:

See `PROGram[:SElected]:EXECute`

PROGram[:SElected]:RETVal?

Queries the return value of an application or process started via `PROGram[:SElected]:EXECute`.

This will only be successful if preceded by a `PROGram[:SElected]:WAIT?` query (see `PROGram[:SElected]:WAIT` on page 1322).

Example: See `PROGram[:SElected]:EXECute`

Usage: Query only

PROGram[:SElected]:WAIT

Locks command execution from the current controller program while a program started via `PROGram[:SElected]:EXECute` is running. The analyzer does not execute any further commands or queries until the program is stopped or paused.

Use `PROGram[:SElected]:WAIT?` before trying to retrieve the return value of the executed program (`PROGram[:SElected]:RETVal?`).

Example: See `PROGram[:SElected]:EXECute`

7.3.14 [SENSe:] commands

The `[SENSe:]...` commands affect the receiver settings of the R&S ZNA.

7.3.14.1 [SENSe:]AVERage...

The `[SENSe:]AVERage...` commands set sweep averaging parameters. The sweep average is a noise-reduction technique which consists of calculating each measurement point as an average of the same measurement point over several consecutive sweeps.



In contrast to the sweep count (for single sweep mode, `[SENSe<Ch>:]SWEep:COUNT`), averaging is always channel-specific. Both features are completely independent from each other.

<code>[SENSe<Ch>:]AVERage[:STATe]</code>	1322
<code>[SENSe<Ch>:]AVERage:CLEar</code>	1323
<code>[SENSe<Ch>:]AVERage:COUNT</code>	1323
<code>[SENSe<Ch>:]AVERage:MODE</code>	1323

[SENSe<Ch>:]AVERage[:STATe] <Boolean>

Enable or disable the sweep average.

Suffix:

<Ch> Channel number

Parameters:

<Boolean> ON | OFF - enables or disables the automatic calculation of the sweep average over the specified number of sweeps ([SENSe<Ch>:]AVERage:COUNT).

*RST: ON

Example: See [SENSe<Ch>:]AVERage:CLEar

Manual operation: See "Factor / On / Reset" on page 538

[SENSe<Ch>:]AVERage:CLEar

Starts a new average cycle, clearing all previous results and thus eliminating their effect on the new cycle.

Suffix:

<Ch> Channel number

Example:

```
SENS1:AVER:COUN 15; :AVER ON
Set the average factor for channel 1 to 15 (the mnemonic SENS1
can be omitted) and enable the sweep average.
AVER:COUN 5; CLE
Reduce the average factor and restart the average.
```

Usage: Event

Manual operation: See "Factor / On / Reset" on page 538

[SENSe<Ch>:]AVERage:COUNT <AverageFactor>

Defines the number of consecutive sweeps to be combined for the sweep average ("Factor").

Suffix:

<Ch> Channel number

Parameters:

<AverageFactor> Sweep average factor

Range: 1 to 1000

*RST: 10

Example: See [SENSe<Ch>:]AVERage:CLEar

Manual operation: See "Factor / On / Reset" on page 538

[SENSe<Ch>:]AVERage:MODE <Mode>**Suffix:**

<Ch>

Parameters:

<Mode> AUTO | FLATten | REDuce | MOVing

AUTO

Automatic selection between REDuce and FLATten mode, depending on the trace format.

FLATten

Cumulative moving averages of the (linear) magnitude and phase values, provides the most effective noise suppression for the "dB Mag", "Phase", "Unwr Phase", and "Lin Mag" formats.

REDuce

Cumulative moving averages of the real and imaginary parts of each measurement result, provides the most effective noise suppression for the "Real" and "Imag" formats and for complex trace formats.

MOVing

Simple moving averages of the real and imaginary parts of each measurement result; similar to REDuce, but with finite history.

Manual operation: See "[Mode](#)" on page 539

7.3.14.2 [SENSe:]BANDwidth...

The [SENSe:]BANDwidth... commands set the bandwidth of the IF filter (measurement bandwidth). The forms BANDwidth and BWIDth are equivalent.

[SENSe<Ch>:]BANDwidth[:RESolution].....	1324
[SENSe<Ch>:]BWIDth[:RESolution].....	1324
[SENSe<Ch>:]BANDwidth[:RESolution]:DREDuction.....	1325
[SENSe<Ch>:]BWIDth[:RESolution]:DREDuction.....	1325
[SENSe<Ch>:]BANDwidth[:RESolution]:SElect.....	1325
[SENSe<Ch>:]BWIDth[:RESolution]:SElect.....	1325

[SENSe<Ch>:]BANDwidth[:RESolution] <ResBandw>

[SENSe<Ch>:]BWIDth[:RESolution] <IF Bandwidth>

Defines the IF bandwidth of the analyzer (measurement bandwidth). Values between 1 Hz and 1.5 MHz can be set. Option R&S ZNA-K17 enables bandwidths up to 30 MHz (see [Chapter 4.7.8, "Increased IF bandwidth 30 MHz"](#), on page 288).

Suffix:

<Ch> Channel number

Parameters:

<IF Bandwidth> Bandwidths can be set in 1 – 1.5 – 2 – 3 – 5 – 7 steps. The analyzer rounds up any entered value between these steps and rounds down values exceeding the maximum bandwidth.

Range: See above

*RST: 10 kHz

Default unit: Hz

Example: BAND 1.1
Set a IF bandwidth of approx. 1.1 Hz for channel 1.
BAND?
The analyzer returns the rounded bandwidth of 1.5 Hz.

Manual operation: See "[Bandwidth](#)" on page 536

[SENSe<Ch>:]BANDwidth[:RESolution]:DREDuction <Boolean>

[SENSe<Ch>:]BWIDth[:RESolution]:DREDuction <Boolean>

Enables/disables dynamic IF bandwidth reduction at low frequencies.

Suffix:

<Ch>

Parameters:

<Boolean> *RST: OFF (0)

[SENSe<Ch>:]BANDwidth[:RESolution]:SElect <Selectivity>

[SENSe<Ch>:]BWIDth[:RESolution]:SElect <Selectivity>

Defines the selectivity of the IF filter for an unsegmented sweep. The value is also used for all segments of a segmented sweep, provided that separate selectivity setting is disabled

([SENSe<Ch>:]SEGment<Seg>:BWIDth[:RESolution]:SElect:CONTRol OFF).

Suffix:

<Ch> Channel number

Parameters:

<Selectivity> NORMal | HIGH | NFIGure

NORMal – IF filter with normal selectivity and short settling time.

HIGH – IF filter with highest selectivity but longest settling time.

NFIGure – IF filter particularly suitable for noise figure measurements (not supported yet).

*RST: NORMal

Example: See [SENSe<Ch>:]SEGment<Seg>:BWIDth[:RESolution]:SElect:CONTRol

Manual operation: See "[IF Filter \(digital\)](#)" on page 537

7.3.14.3 [SENSe:]CDLL...

Adds, removes and configures [custom \(external\) DLLs](#).

These commands allow you to add/remove external DLLs to/from the firmware. It gives access to their configuration, tasks, and traces.

[SENSe:]CDLL:ADD..... 1326

[SENSe:]CDLL:LIST?..... 1326

[SENSe:]CDLL:LIST:TASK?..... 1326

[SENSe<Ch>:]CDLL:PERManent:ADDITIONal.....	1326
[SENSe<Ch>:]CDLL:PERManent[:STATe].....	1327
[SENSe<Ch>:]CDLL:PERManent:TASK.....	1327
[SENSe:]CDLL:REMOve.....	1328
[SENSe<Ch>:]CDLL[:STATe].....	1328
[SENSe<Ch>:]CDLL:TASK:ADDRess.....	1328

[SENSe:]CDLL:ADD <DllPath>

Tells the analyzer firmware to load a custom (external) DLL.

The DLL and its accompanying files must be packed in a zip archive. It will be loaded on every subsequent firmware start, until it is removed using [\[SENSe:\]CDLL:REMOve](#).

Note that adding/removing custom DLLs is only possible if the firmware is run as administrator.

Setting parameters:

<DllPath> Full path to the zip archive including the DLL (at the top-level).

Usage: Setting only

Manual operation: See ["Add / Remove"](#) on page 404

[SENSe:]CDLL:LIST?

Queries the loaded custom (external) DLL files.

The return value is a single string, comprising a comma-separated list of DLL names, without the `dll` extension.

Use [\[SENSe:\]CDLL:ADD/\[SENSe:\]CDLL:REMOve](#) to load/unload a custom DLL..

Usage: Query only

Manual operation: See ["Loaded DLLs table"](#) on page 403

[SENSe:]CDLL:LIST:TASK? <DllName>

Lists the tasks implemented by the custom (external) DLL <DllName>.

Query parameters:

<DllName> Name of a loaded DLL (see [\[SENSe:\]CDLL:LIST?](#))
Lowercase string, without `dll` extension

Usage: Query only

[SENSe<Ch>:]CDLL:PERManent:ADDITIONal <DllName>, <Additional Input> [SENSe<Ch>:]CDLL:PERManent:ADDITIONal? <DllName>

Defines additional input for the task to be run, if custom DLL <DllName> is set to permanent mode in channel <Ch> ([\[SENSe<Ch>:\]CDLL:PERManent\[:STATe\]](#) '`<DllName>`', ON).

Use `[SENSe<Ch>:]CDLL:PERManent:TASK` to select the type of task to be run.

Suffix:

<Ch> Channel number

Parameters:

<Additional Input> String value, with DLL-specific syntax and semantics. See the docs of your DLL for details.

Parameters for setting and query:

<DllName> Name of a loaded DLL (see `[SENSe:]CDLL:LIST?`)
Lowercase string, without `dll` extension

Manual operation: See "Additional Input" on page 403

`[SENSe<Ch>:]CDLL:PERManent[:STATe] <DllName>, <Boolean>`

`[SENSe<Ch>:]CDLL:PERManent[:STATe]? <DllName>`

Defines whether DLL <DllName> shall operate in permanent mode in channel <Ch>.

Use `[SENSe<Ch>:]CDLL:PERManent:TASK` and `[SENSe<Ch>:]CDLL:PERManent:ADDITIONal` to configure the permanent task to be run.

Suffix:

<Ch> Channel number

Parameters:

<Boolean> **ON (1)**
Permanent mode enabled

OFF (0)
Permanent mode disabled

Parameters for setting and query:

<DllName> Name of a loaded DLL (see `[SENSe:]CDLL:LIST?`)
Lowercase string, without `dll` extension

Manual operation: See "Permanent" on page 403

`[SENSe<Ch>:]CDLL:PERManent:TASK <DllName>, <Task>`

`[SENSe<Ch>:]CDLL:PERManent:TASK? <DllName>`

Defines the type of task to be run, if custom DLL <DllName> is set to permanent mode in channel <Ch> (`[SENSe<Ch>:]CDLL:PERManent[:STATe] '<DllName>', ON`).

Use `[SENSe<Ch>:]CDLL:PERManent:ADDITIONal` to further specify the task.

Suffix:

<Ch> Channel number

Parameters:

<Task> Name of the task to be run permanently.

Parameters for setting and query:

<DllName> Name of a loaded DLL (see [\[SENSe:\]CDLL:LIST?](#))
Lowercase string, without `dll` extension

Manual operation: See ["Task Type"](#) on page 403

[SENSe:]CDLL:REMOve <DllName>

Tells the analyzer firmware to remove a custom (external) DLL that was previously added using [\[SENSe:\]CDLL:ADD](#).

Note that adding/removing custom DLLs is only possible if the firmware is run as administrator.

Setting parameters:

<DllName> Name of a loaded DLL (see [\[SENSe:\]CDLL:LIST?](#))
Lowercase string, without `dll` extension

Usage: Setting only

Manual operation: See ["Add / Remove"](#) on page 404

[SENSe<Ch>:]CDLL[:STATe] <DllName>, <Boolean>**[SENSe<Ch>:]CDLL[:STATe]? <DllName>**

Defines the state of (external) DLL `<DllName>.dll` in channel `<Ch>`.

An active DLL can provide traces or operate in permanent mode (see [\[SENSe<Ch>:\]CDLL:PERManent\[:STATe\]](#)).

Suffix:

<Ch> Channel number

Parameters:

<Boolean> **ON (1)**
DLL is active
OFF (0)
DLL is inactive

Parameters for setting and query:

<DllName> Name of a loaded DLL (see [\[SENSe:\]CDLL:LIST?](#))
Lowercase string, without `dll` extension

Manual operation: See ["Active"](#) on page 403

[SENSe<Ch>:]CDLL:TASK:ADDRess <DllName>, <Task>, <Address>**[SENSe<Ch>:]CDLL:TASK:ADDRess? <DllName>, <Task>**

Defines the address of an external device the external DLL `<DllName>` requires to complete task type `<Task>` in channel `<Ch>`.

Suffix:

<Ch> Channel number

Parameters:

<Address> String value with DLL-specific syntax and semantics. See the docs of your DLL for details.

Parameters for setting and query:

<DllName> Name of a loaded DLL (see [SENSe:]CDLL:LIST?)
Lowercase string, without dll extension

<Task> Task type (see [SENSe:]CDLL:LIST:TASK?)

Manual operation: See "Configure Device Address" on page 405

7.3.14.4 [SENSe:]CONVerter

Commands to set up frequency converters.

[SENSe:]CONVerter<Port>:CSLoss.....	1329
[SENSe:]CONVerter<Port>:CSSLope.....	1330
[SENSe:]CONVerter:DEFinition:CATalog?.....	1330
[SENSe:]CONVerter:DEFinition:COUNt?.....	1330
[SENSe:]CONVerter:DEFinition:DEFine.....	1330
[SENSe:]CONVerter:DEFinition:DElete.....	1331
[SENSe:]CONVerter:DEFinition:FREquency.....	1331
[SENSe:]CONVerter:DEFinition:IFREquency.....	1332
[SENSe:]CONVerter:DEFinition:LMUL.....	1332
[SENSe:]CONVerter:DEFinition:LPOWer.....	1332
[SENSe:]CONVerter:DEFinition:LPOWer:OFFSet.....	1332
[SENSe:]CONVerter:DEFinition:MPOWer.....	1333
[SENSe:]CONVerter:DEFinition:SMUL.....	1333
[SENSe:]CONVerter:DEFinition:SPOWer.....	1333
[SENSe:]CONVerter:DEFinition:SPOWer:OFFSet.....	1334
[SENSe:]CONVerter<Port>:IFPort.....	1334
[SENSe:]CONVerter<Port>:IFREquency.....	1334
[SENSe:]CONVerter<Port>:LOLoss.....	1335
[SENSe:]CONVerter<Port>:LOPort.....	1335
[SENSe:]CONVerter<Port>:RFLoss.....	1336
[SENSe:]CONVerter<Port>:RFPort?.....	1336
[SENSe:]CONVerter<Port>:RFSLope.....	1336
[SENSe:]CONVerter:SPLitter<Port>:LOPort.....	1336
[SENSe:]CONVerter:SPLitter<Port>:LOSS.....	1337
[SENSe:]CONVerter<Port>:STATE.....	1337

[SENSe:]CONVerter<Port>:CSLoss <Loss>

Default cable (and splitter) loss for the local port of converter <Port>.

Suffix:

<Port> Port number

Parameters:

<Loss> Default unit: dB

Options:

R&S ZNA-K8

Manual operation: See ["Cable & Splitter Loss"](#) on page 907

[SENSe:]CONVerter<Port>:CSSLope <Factor>

Default slope factor for the local port of converter <Port>.

Suffix:

<Port> Port number

Parameters:

<Factor> Slope factor
 *RST: 0
 Default unit: dB/GHz

Options: R&S ZNA-K8

Manual operation: See ["Slope"](#) on page 907

[SENSe:]CONVerter:DEFinition:CATalog?

Returns a comma-separated list of the currently defined converter types.

The length of the list can be queried using [\[SENSe:\]CONVerter:DEFinition:COUNT?](#).

Return values:

<Type>

Example:

```
SENSe:CONVerter:DEFinition:CATalog?
returns something like
'ZVA-Z110','ZVA-Z110E','ZVA-Z140', ...
```

Usage: Query only

Options: R&S ZNA-K8

Manual operation: See ["Defined Converter Types \(Tabs\)"](#) on page 905

[SENSe:]CONVerter:DEFinition:COUNT?

Returns how many converter types are currently defined (pre-defined or user-defined)

Return values:

<DefCount>

Usage: Query only

Options: R&S ZNA-K8

Manual operation: See ["Defined Converter Types \(Tabs\)"](#) on page 905

[SENSe:]CONVerter:DEFinition:DEFine <Type>

Creates a converter type with default properties.

Setting parameters:

<Type> The name of the new converter type. Must be unique among the existing ones (see [\[SENSe:\]CONVerter:DEFinition:CATalog?](#)).

Example:

```
SENSe:CONVerter:DEFinition:DEFine 'My converter
type'
creates a new converter type named "My converter type".
SENSe:CONVerter:DEFinition:CATalog?
returns something like 'ZVA-Z110', ..., 'My converter
type'
```

Usage: Setting only

Options: R&S ZNA-K8

Manual operation: See ["Type"](#) on page 905

[SENSe:]CONVerter:DEFinition:DELeTe <Type>

Deletes the related converter type.

Only user-defined converter types can be deleted.

Setting parameters:

<Type> Name of the converter type to be deleted.

Usage: Setting only

Options: R&S ZNA-K8

Manual operation: See ["Delete"](#) on page 906

[SENSe:]CONVerter:DEFinition:FREQuency <Type>, <StartFreq>, <StopFreq>**[SENSe:]CONVerter:DEFinition:FREQuency? <Type>**

Sets/queries the start and stop frequency of (the converter port of) the related converter type.

Parameters:

<StartFreq> Default unit: Hz

<StopFreq> Default unit: Hz

Parameters for setting and query:

<Type> Name of the converter type, whose start and stop frequencies are set/queried.

Options: R&S ZNA-K8

Manual operation: See ["Converter Port: Start Freq./Stop Freq."](#) on page 905

[SENSe:]CONVerter:DEFinition:IFRequency <Type>, <IF>
[SENSe:]CONVerter:DEFinition:IFRequency? <Type>

Sets/queries the fixed intermediate frequency of the related converter type.

Parameters:

<IF> Intermediate frequency
 Default unit: Hz

Parameters for setting and query:

<Type> Name of the converter type, whose IF is set/queried.

Options: R&S ZNA-K8

Manual operation: See ["IF"](#) on page 905

[SENSe:]CONVerter:DEFinition:LMUL <Type>, <LocalMultiplier>
[SENSe:]CONVerter:DEFinition:LMUL? <Type>

Sets/queries the LO multiplier of the related converter type.

Parameters:

<LocalMultiplier>

Parameters for setting and query:

<Type> Name of the converter type, whose LO multiplier is set/queried.

Options: R&S ZNA-K8

Manual operation: See ["Local Port: Multiplier"](#) on page 906

[SENSe:]CONVerter:DEFinition:LPOWER <Type>, <LocalNomPower>
[SENSe:]CONVerter:DEFinition:LPOWER? <Type>

Sets/queries the preferred input power at the LO In port of the related converter type.

Parameters:

<LocalNomPower> Default unit: dBm

Parameters for setting and query:

<Type> Name of the converter type, whose preferred LO input power is set/queried.

Options: R&S ZNA-K8

Manual operation: See ["Local Port: Nominal Power"](#) on page 906

[SENSe:]CONVerter:DEFinition:LPOWER:OFFSet <Type>,
 <LocalNomPowerCalOffset>
[SENSe:]CONVerter:DEFinition:LPOWER:OFFSet? <Type>

Sets/queries the cal power offset of the source port that is connected to the LO In port, when converters of the related type are configured.

See [SOURCE<Ch>:POWER<PhyPt>:CORREction:LEVel:OFFSet](#) and [SOURCE<Ch>:POWER<PhyPt>:CORREction:GENerator<Gen>:LEVel:OFFSet](#)

Parameters:

<LocalNomPowerCalOffset> Default unit: dBm

Parameters for setting and query:

<Type> Name of the converter type, whose cal power offset is set/queried.

Options: R&S ZNA-K8

[SENSe:]CONVerter:DEFinition:MPOWER <Type>, <MaxInputPower>

[SENSe:]CONVerter:DEFinition:MPOWER? <Type>

Sets/queries the maximum tolerable input power at the RF In port of the related converter type.

Parameters:

<MaxInputPower> Default unit: dBm

Parameters for setting and query:

<Type> Name of the converter type, whose maximum RF input power is set/queried.

Options: R&S ZNA-K8

Manual operation: See "[Source: Converter Max. Power](#)" on page 906

[SENSe:]CONVerter:DEFinition:SMUL <Type>, <SourceMultiplier>

[SENSe:]CONVerter:DEFinition:SMUL? <Type>

Sets/queries the source multiplier of the related converter type.

Parameters:

<SourceMultiplier>

Parameters for setting and query:

<Type> Name of the converter type, whose source multiplier is set/queried.

Options: R&S ZNA-K8

Manual operation: See "[Source: Multiplier](#)" on page 905

[SENSe:]CONVerter:DEFinition:SPOWER <Type>, <SourceNomPower>

[SENSe:]CONVerter:DEFinition:SPOWER? <Type>

Sets/queries the preferred input power at the RF In port of the related converter type.

Parameters:

<SourceNomPower> Default unit: dBm

Parameters for setting and query:

<Type> Name of the converter type, whose preferred RF input power is set/queried.

Options: R&S ZNA-K8

Manual operation: See "[Source: Nominal Power](#)" on page 905

[SENSe:]CONVerter:DEFinition:SPOWer:OFFSet <Type>,
<SourceNomPowerCalOffset>

[SENSe:]CONVerter:DEFinition:SPOWer:OFFSet? <Type>

Sets/queries the cal power offset of the source port that is connected to the RF In port, when converters of the related type are configured.

See [SOURCE<Ch>:POWER<PhyPt>:CORRection:LEVel:OFFSet](#) and [SOURCE<Ch>:POWER<PhyPt>:CORRection:GENerator<Gen>:LEVel:OFFSet](#)

Parameters:

<SourceNomPowerCalOffset> unit: dBm

Parameters for setting and query:

<Type> Name of the converter type, whose cal power offset is set/queried.

Options: R&S ZNA-K8

[SENSe:]CONVerter<Port>:IFPort <IfInput>

Selects input connectors to be used for the IF meas and IF ref connection between the converter and the analyzer port <Port>.

Suffix:

<Port> Converter number = VNA port number

Parameters:

<IfInput> DRACcess | REAR

DRACcess

Use the (optional) direct access connectors at the front panel of the R&S ZNA.

REAR

Use the (optional) direct IF access connectors IF Reference <i> and IF Meas <i> at the rear panel of the R&S ZNA.

Options: R&S ZNA-K8

Manual operation: See "[IF Input](#)" on page 903

[SENSe:]CONVerter<Port>:IFRequency <IF>

Sets/queries the intermediate frequency for converter <Port>.

Suffix:	
<Port>	Converter number = VNA port number
Parameters:	
<IF>	Intermediate frequency Defaults to the intermediate frequency ([SENSe:]CONVerter:DEFinition:IFRequency on page 1332) of the connected converter type ([SENSe:]FREQuency:CONVersion:DEVIce<Port>:NAME). Default unit: Hz
Options:	R&S ZNA-K8
Manual operation:	See "IF Frequency" on page 903

[SENSe:]CONVerter<Port>:LOLoss <Loss>

Defines the cable loss at port <Port> if used as LO port (without splitter).

Suffix:	
<Port>	Port number
Parameters:	
<Loss>	Loss value Default unit: dB
Options:	R&S ZNA-K8

[SENSe:]CONVerter<Port>:LOPort <Local>, <LocalIndex>

Defines the source for the LO In port of converter <Port>.

Suffix:	
<Port>	Converter number = VNA port number
Parameters:	
<Local>	NONE RLO PORT GENERator SPLitter The port type, further specified by its index <LocalIndex>
	NONE No LO source defined
	RLO The optional LO Out port at the rear panel of the R&S ZNA
	PORT A VNA port
	GENERator An external generator port
	SPLitter A splitter is used to distribute the original LO signal to the LO In ports of the involved converters

<LocalIndex> The port index, if required.
For NONE and RLO the index is ignored.

Options: R&S ZNA-K8

Manual operation: See "[Local](#)" on page 903

[SENSe:]CONVerter<Port>:RFLoss <Loss>

Defines the cable loss at the source port or converter <Port>.

Suffix:

<Port> Converter port number (= physical VNA port number)

Parameters:

<Loss> Loss value
Default unit: dB

Options: R&S ZNA-K8

Manual operation: See "[Cable & Splitter Loss](#)" on page 907

[SENSe:]CONVerter<Port>:RFPort?

Returns the VNA source port that drives converter <Port>.

Always returns <Port>.

Suffix:

<Port> Converter number

Usage: Query only

Options: R&S ZNA-K8

Manual operation: See "[Source](#)" on page 903

[SENSe:]CONVerter<Port>:RFSlope <Slope>

Suffix:

<Port>

Parameters:

<Slope> Default unit: DB/GHZ

Manual operation: See "[Slope](#)" on page 676

[SENSe:]CONVerter:SPLitter<Port>:LOPort <Local>[, <LocalIndex>]

Defines the source of the LO signal distributed via splitter <Port>.

"Splitter 2" is only useful, if 2 independent 2-port converter measurements shall be performed.

Suffix:	
<Port>	Splitter number
Parameters:	
<Local>	NONE RLO PORT GENERator
	The port type, further specified by its index <LocalIndex>
	NONE
	No LO source defined
	RLO
	The optional LO Out port at the rear panel of the R&S ZNA
	PORT
	A VNA port
	GENERator
	An external generator port
<LocalIndex>	The LO source port index, if required. For RLO the index is ignored.
Options:	R&S ZNA-K8
Manual operation:	See " Splitter <i> " on page 904

[SENSe:]CONVerter:SPLitter<Port>:LOSS <Loss>

Defines the (cable and) splitter loss for splitter no. <Port>.

Suffix:	
<Port>	Splitter number
Parameters:	
<Loss>	Loss value
	Default unit: dB
Options:	R&S ZNA-K8

[SENSe:]CONVerter<Port>:STATe <Boolean>

Activates or deactivates converter <Port>.

Suffix:	
<Port>	Converter number = VNA port number
Parameters:	
<Boolean>	
Options:	R&S ZNA-K8
Manual operation:	See " Active " on page 903

7.3.14.5 SENSe<Ch>:CORRection:ADVanced

Remote control commands for advanced calibration features.

[SENSe<Ch>:]CORRection:ADVanced:HARMonic:ORDER?	1338
[SENSe<Ch>:]CORRection:ADVanced:HARMonic:ORDER:ADD	1338
[SENSe<Ch>:]CORRection:ADVanced:HARMonic:ORDER:REMOve	1339
[SENSe<Ch>:]CORRection:ADVanced:POWer<PhyPt>	1339
[SENSe<Ch>:]CORRection:ADVanced:POWer<PhyPt>:STATe	1339
[SENSe<Ch>:]CORRection:ADVanced:SENSe<PhyPt>:ATTenator	1339
[SENSe<Ch>:]CORRection:ADVanced:SENSe<PhyPt>:ATTenator:STATe	1340
[SENSe<Ch>:]CORRection:ADVanced:SENSe<PhyPt>:PREamp	1340
[SENSe<Ch>:]CORRection:ADVanced:SENSe<PhyPt>:PREamp:STATe	1340
[SENSe<Ch>:]CORRection:ADVanced:SOURce<PhyPt>:ATTenuator	1340
[SENSe<Ch>:]CORRection:ADVanced:SOURce<PhyPt>:ATTenuator:STATe	1341

[SENSe<Ch>:]CORRection:ADVanced:HARMonic:ORDER?

Returns the list of harmonic orders at which the source and receiver power calibration shall be performed for harmonics measurements in channel <Ch>.

Use [SENSe<Ch>:]CORRection:ADVanced:HARMonic:ORDER:ADD/
[SENSe<Ch>:]CORRection:ADVanced:HARMonic:ORDER:REMOve to add/remove harmonic orders to/from this list.

Use SOURce<Ch>:POWer<PhyPt>:CORRection:HARMonic[:ACQuire] and
[SENSe<Ch>:]CORRection:POWer<PhyPt>:HARMonic:ACQuire) to calibrate.

Suffix:

<Ch> Channel number

Usage: Query only

Options: R&S ZNA-K4

Manual operation: See "Harmonic Orders to Calibrate" on page 590

[SENSe<Ch>:]CORRection:ADVanced:HARMonic:ORDER:ADD <Order>

Adds a harmonic order to the list of harmonic orders at which source and receiver calibrations shall be performed for harmonics measurements in channel <Ch>.

Use [SENSe<Ch>:]CORRection:ADVanced:HARMonic:ORDER:REMOve to get this list, and [SENSe<Ch>:]CORRection:ADVanced:HARMonic:ORDER:REMOve to remove a harmonic order from this list.

Use SOURce<Ch>:POWer<PhyPt>:CORRection:HARMonic[:ACQuire] and
[SENSe<Ch>:]CORRection:POWer<PhyPt>:HARMonic:ACQuire) to calibrate.

Suffix:

<Ch> Channel number

Setting parameters:

<Order> Order number

Usage: Setting only

Options: R&S ZNA-K4

Manual operation: See ["Harmonic Orders to Calibrate"](#) on page 590

[SENSe<Ch>:]CORRection:ADVanced:HARMonic:ORDer:REMOve

Removes a harmonic order from the list of harmonic orders at which source and receiver calibrations shall be performed for harmonics measurements in channel <Ch>.

Use [SENSe<Ch>:]CORRection:ADVanced:HARMonic:ORDer:REMOve to get this list, and [SENSe<Ch>:]CORRection:ADVanced:HARMonic:ORDer:ADD to add a harmonic order to it.

Use SOURce<Ch>:POWer<PhyPt>:CORRection:HARMonic[:ACQuire] and [SENSe<Ch>:]CORRection:POWer<PhyPt>:HARMonic:ACQuire) to calibrate.

Suffix:

<Ch> Channel number

Usage: Event

Options: R&S ZNA-K4

Manual operation: See ["Harmonic Orders to Calibrate"](#) on page 590

[SENSe<Ch>:]CORRection:ADVanced:POWer<PhyPt> <Power>

Suffix:

<Ch>

<PhyPt>

Parameters:

<Power> Default unit: dBm

Manual operation: See ["Cal Power"](#) on page 593

[SENSe<Ch>:]CORRection:ADVanced:POWer<PhyPt>:STATe <Boolean>

Suffix:

<Ch>

<PhyPt>

Parameters:

<Boolean>

Manual operation: See ["Cal Power"](#) on page 593

[SENSe<Ch>:]CORRection:ADVanced:SENSe<PhyPt>:ATTenator <Attenuation>

Suffix:

<Ch>

<PhyPt>

Parameters:

<Attenuation> Default unit: dB

[SENSe<Ch>:]CORRection:ADVanced:SENSe<PhyPt>:ATTenator:STATe
 <Boolean>

Suffix:

<Ch>

<PhyPt>

Parameters:

<Boolean>

[SENSe<Ch>:]CORRection:ADVanced:SENSe<PhyPt>:PREamp <Attenuation>

Suffix:

<Ch>

<PhyPt>

Parameters:

<Attenuation> Default unit: dB

Manual operation: See "[Preamp Gain](#)" on page 593

[SENSe<Ch>:]CORRection:ADVanced:SENSe<PhyPt>:PREamp:STATe <Boolean>

Suffix:

<Ch>

<PhyPt>

Parameters:

<Boolean>

Manual operation: See "[Preamp Gain](#)" on page 593

[SENSe<Ch>:]CORRection:ADVanced:SOURce<PhyPt>:ATTenuator
 <Attenuation>

Suffix:

<Ch>

<PhyPt>

Parameters:

<Attenuation> Default unit: dB

Manual operation: See "[Source Step Att](#)" on page 593

[SENSe<Ch>:]CORRection:ADVanced:SOURce<PhyPt>:ATTenuator:STATe
<Boolean>

Suffix:

<Ch>

<PhyPt>

Parameters:

<Boolean>

Manual operation: See "Source Step Att" on page 593**7.3.14.6 [SENSe:]CORRection:CKIT...**

The [SENSe:]CORRection:CKIT... commands deal with calibration kits and cal kit data. The calibration kits are distinguished by their names (<CalkitName>), the optional labels (<label>) can be used to carry information about the calibration standard.

In order to handle several identical calibration kits with different serial numbers use the commands of [Chapter 7.3.14.7, "\[SENSe:\]CORRection:CKIT... with Labels"](#), on page 1349.

[SENSe:]CORRection:CKIT:<StandardType>.....	1341
[SENSe:]CORRection:CKIT:CATalog?.....	1345
[SENSe:]CORRection:CKIT:DELete.....	1345
[SENSe:]CORRection:CKIT:DMODE.....	1346
[SENSe:]CORRection:CKIT:LABel.....	1346
[SENSe:]CORRection:CKIT:SELect.....	1347
[SENSe:]CORRection:CKIT:<ConnType>:SELect.....	1347
[SENSe:]CORRection:CKIT:STANdard:CATalog?.....	1348
[SENSe:]CORRection:CKIT:STANdard:DATA?.....	1348

**[SENSe:]CORRection:CKIT:<StandardType> <ConnType>, <CalKitName>,
<StandardLabel>, <MinFreq>, <MaxFreq>[, <DelayParam>, <Loss>, <Z0>[,
<C0>, <C1>, <C2>, <C3>, <L0>, <L1>, <L2>, <L3>[, OPEN | SHORT | MATCH |
<Resistance>[, <Port1>[, <Port2>]]]]]**

**[SENSe:]CORRection:CKIT:<StandardType>? <ConnType>, <CalKitName>[,
<Port1>[, <Port2>]]]**

Defines the parameters of a (possibly non-ideal) 1 port or 2-port calibration standard <StandardType> within a particular cal kit. Depending on the standard type, only a subset of the parameters is used; see [Table 7-13](#)

Note

As the query does not reflect the delay mode specified using [SENSe:]CORRection:CKIT:DMODE, it is deprecated and only available for backward compatibility reasons. Use [SENSe:]CORRection:CKIT:STANdard:DATA?? instead.

Suffix:

<StandardType> <string>
Standard type
For one-port standards, the first character denotes the gender, for transmission standards the first two characters denote the genders on both ends, e.g. MOPen for a male Open standard or FFThrougH for a Through standard with female connectors.
For a complete list of standards, refer to [Table 7-15](#).

Parameters:

<StandardLabel> Additional string label for the standard, typically the standard's serial number

CalStandardProps Parameters <MinFreq>, ..., OPEN | SHORt | MATCh | <Resistance> define the properties of the calibration standard. See [Parameter list](#).
Note: Sliding Match and Attenuation standards have only 2 parameters (<MinFreq>, <MaxFreq>). Through and Line standards only have 5 parameters (<MinFreq>, ..., <Z0>).

<Port1>, <Port2> Optional port restriction.
For a one-port standard, the validity of the characterization can be restricted to a single port. For a two-port standard, it can be restricted to a port pair (specified using ascending port numbers).
Note: with a port restriction, the defined standard becomes sexless. Hence, for each port (pair) there can be only one standard of a given type, i.e. :SENSe:CORRection:CKIT:MOP <ParameterList>, 1 and :SENSe:CORRection:CKIT:FOP <ParameterList>, 1 overwrite each other.

Parameters for setting and query:

<ConnType>, <CalkitName> String parameters uniquely identifying the cal kit to which the standard belongs.
Note: If the specified cal kit does not exist, it is created with the specified calibration standard.

Example:

```
CORR:CKIT:FOP 'N 50 Ohm', 'New Kit 1', '',
0, 4000000000, 0, 0, 50, 99, -2.3, 0.22, 0, 0, 0, 0, 0
```

Define the properties of the Open (f) standard for a N 50 Ω connector type in cal kit "New Kit 1".

```
CORR:CKIT:FOP? 'N 50 Ohm'
```

Query the properties of the Open (f) standard for a N 50 Ω connector type in the active cal kit.

```
CORR:CKIT:FOP? 'N 50 Ohm', 'New Kit 1'
```

Query the properties of the Open (f) standard for a N 50 Ω connector type in cal kit "New Kit 1".

Manual operation: See ["One Port Standards / Two Port Standards"](#) on page 618

Table 7-13: Set command parameters

	One port standards					Two port standards			
	Open	(Offset) Short	Match	Reflect	Sliding match	Symmetric network	Through, Line	Attenuation	
<ConnType>	mandatory								
<CalKitName>	mandatory (and must not be an empty string)								
<StandardLabel>	mandatory (but can be an empty string)								
<MinFreq>, <MaxFreq>	mandatory								
<DelayParam>, <Loss>, <Z0>	mandatory	mandatory	mandatory	mandatory	not used	mandatory		not used	
<C0>, <C1>, <C2>, <C3>	mandatory	mandatory*	mandatory*	mandatory**		mandatory**	not used		
<L0>, <L1>, <L2>, <L3>	mandatory*	mandatory	mandatory*	mandatory**		mandatory**			
OPEN SHORT MATCH <Resistance>	optional***	optional***	optional***	mandatory: OPEN SHORT <Resistance>		mandatory: OPEN SHORT <Resistance>			
<Port1>[, <Port2>]	optional: <Port 1>				optional: <Port 1>,<Port 2>				
<p>* values are ignored during calibration</p> <p>** if OPEN is selected the residual inductance (L0,...,L3) are during calibration; if SHORT is selected the fringing capacitance (C0,...,C3) are during calibration</p> <p>*** must be provided if the definition is restricted to a single port. Values are ignored during calibration</p>									

The parameters in the `[SENSe<Ch>:]CORRection:CKIT:<StandardType>`, `[SENSe<Ch>:]CORRection:CKIT:<StandardType>:WLABels`, and `[SENSe<Ch>:]CORRection:CKIT:<ConnectorType>:<StandardType>` commands have the following meaning:

Table 7-14: Parameter list

Parameter	Meaning	Comment/Unit
'<ConnType>'	Name of the connector type. Use <code>SENSe1:CORRection:CONNECTION:CATalog?</code> to query connector names.	String parameter
'<CalKitName>'	Name of the calibration kit. Use <code>[SENSe:]CORRection:CKIT:CATalog?</code> to query cal kit names.	String parameter

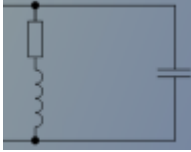
Parameter	Meaning	Comment/Unit
'<CalKitLabel>'	Label (e.g. the serial number) of the calibration kit; for . . . WLABel command only	String parameter
'<StandardLabel>'	Label (e.g. the serial number) of the standard	String parameter
<MinFreq>, <MaxFreq>	Min./max. frequency for which the circuit model is valid	Default unit is Hz
<DelayParam>	Depending on the cal kit's model type (selected using [SENSe:]CORRection:CKIT:DMODE), this parameter is interpreted as: <ul style="list-style-type: none"> • delay [s] for Keysight modeling • el. length [m] for ZVR compatible modeling Cal kits that are not created/modified using [SENSe:]CORRection:CKIT:DMODE use the ZVR compatible modeling.	
<Loss>	Loss (offset parameter) of the standard	Must be specified without unit (implicit unit is dB)
<Z0>	Reference impedance (no unit)	Must be specified without unit (implicit unit is Ω)
<C0>, ..., <C3>	Polynomial coefficients for the fringing capacitance of the standard (load parameter)	Must be specified without unit: implicit unit of <C> is fF / (GHz) ⁱ
<L0>, ..., <L3>	Polynomial coefficients for the residual inductance of the standard (load parameter)	Must be specified without unit: implicit unit of <L> is pH / (GHz) ⁱ
OPEN SHORT MATCH <Resistance>	A load circuit model generally consists of a capacitance (modeled by <C0>, ..., <C3>), connected in parallel to an inductance (modeled by <L0>, ..., <L3>) and a resistance, both connected in series. OPEN SHORT MATCH indicates a simplified modeling as an Open or Short or Match standard. <ul style="list-style-type: none"> • OPEN: the resistance is infinite so that the standard behaves like a capacitor (no inductance) • SHORT: the resistance is zero so that the standard behaves like an inductance (no capacitance) • MATCH: the standard behaves like a match (no inductance, no capacitance, resistance Z0) <Resistance> indicates the general load circuit model.	 Character data numeric value
<Port1>, <Port2>	Optional port restriction: one port number for one-port standards, two port numbers for two-port standards	Integer values

The different standard types are defined by the following parameters. Port restrictions are indicated in brackets:

Table 7-15: Standard types and their parameters

<std_type>	Meaning
MOPen FOPen	Open: male (m) or female (f)
MSHort FSHort	Short: m or f
OShort[<1 2 3>] MOShort[<1 2 3>] FOShort[<1 2 3>]	Offset short: sexless, m or f (three standards each) For user-defined connector types only. Suffix 1 can be omitted.
MMTch FMTCh	Match: m or f

<std_type>	Meaning
MSMatch FSMatch	Sliding match: m or f
MREFlect FRElect	Reflect: m or f
MMTHrough MFTHrough FFTHrough	Through: m-m or m-f or f-f
MMLine[<1 2 3>] MFLine[<1 2 3>] FFLine[<1 2 3>] MMLine[<1 2 3>](P2P3) ...	Line: m-m or m-f or f-f (three standards each) Suffix 1 can be omitted.
MMATten MFATten FFATten	Attenuation: m-m or m-f or f-f
MMSNetwork MFSNetwork FFSNetwork	Symmetric network: m-m or m-f or f-f

[SENSe:]CORRection:CKIT:CATalog? [<ConnectorType>]

Returns a list of all cal kits for a given connector type or for all connector types.

Query parameters:

<ConnectorType> Name of the connector type (optional). Use [\[SENSe<Ch>:\]CORRection:CONNECTION:CATalog?](#) to query connector names.
If omitted, the command returns the list of all cal kits.

Example: See [\[SENSe<Ch>:\]CORRection:CONNECTION:CATalog?](#)

Usage: Query only

Manual operation: See ["Available Cal Kits"](#) on page 616

[SENSe:]CORRection:CKIT:DElete <CalKitName>

Deletes an imported or user-defined cal kit.

Note: It is not possible to modify or store predefined or ideal kits.

Setting parameters:

<CalKitName> String parameter containing an imported or user-defined calibration kit available on the analyzer.

Example: See [\[SENSe:\]CORRection:CKIT:LABel](#)

Usage: Setting only

Manual operation: See ["Add / Copy / Delete / Standards..."](#) on page 617

[SENSe:]CORRection:CKIT:DMODE <ConnectorType>, <CalKitName>, <KitLabel>, <Mode>

Sets/gets the delay mode for the related cal kit (identified by connector type, name and label), i.e allows to toggle between ZVR compatible and Keysight modelling (see "[Offset Parameters](#)" on page 620). Subsequent standard definitions interpret the specified <DelayParam> accordingly.

In "set direction", if a cal kit with the given connector type, name and label is not available on the analyzer, it is created automatically.

Cal kits that are not created/modified using [SENSe:]CORRection:CKIT:DMODE use the ZVR compatible modelling.

Parameters:

- <ConnectorType> Name of the connector type. Use [SENSe<Ch>:]CORRection:CONNection:CATalog? to query connector names.
- <CalKitName> String parameter containing the name of the calibration kit. See "Cal kit naming conventions " under [SENSe:]CORRection:CKIT:<ConnType>:LSElect.
- <KitLabel> String parameter containing the label of the calibration kit, usually the serial number.

Setting parameters:

- <Mode> DELay | ELENgth
 DELay – Keysight modelling
 ELENgth – ZVR compatible modelling

Manual operation: See "[Add / Copy / Delete / Standards...](#)" on page 617

[SENSe:]CORRection:CKIT:LABel <CalKitName>[, <KitLabel>]

Assigns a label to an imported or user-defined calibration kit.

Parameters:

- <CalKitName> String parameter containing an imported or user-defined calibration kit available on the analyzer.
- <KitLabel> String parameter containing the calibration kit label.

Example:

```
CORR:CKIT:FOP 'N 50 Ohm','New Kit 1','',
0,4000000000,0,0,50,99,-2.3,0.22,0,0,0,0,0
Create a new cal kit "New Kit 1" and assign an open (f) standard
for the N 50 Ω connector type with specific properties.
CORR:CKIT:LAB 'New Kit 1', 'Test kit created
today'
Label the previously created kit.
CORR:CKIT:LAB? 'New Kit 1'
Check the label.
CORR:CKIT:DEL 'New Kit 1'
Delete the kit.
```

[SENSe:]CORRection:CKIT:SElect <ConnectorType>[, <CalKitName>]

Selects the calibration kit to be used, specifying its connector type and name (optional).

Tip: The command is suitable for connector types with arbitrary, user-defined names. For standard connector types you can use the command `[SENSe:]CORRection:CKIT:<ConnType>:SElect`.

Parameters:

<ConnectorType> Connector type, e.g. a user-defined connector type (string variable).

<CalKitName> String parameter containing the name of a calibration kit available on the analyzer.

Example:

```
M MEM:LOAD:CKIT 'C:\Users\Public\
Documents\Rohde-Schwarz\ZNA\
Calibration\Kits\New Kit 1.calkit'
Load the previously created cal kit file New Kit 1.calkit
from the default cal kit directory.
CORR:CKIT:SEL 'N 50 Ohm', 'New Kit 1'
Assign the imported kit to the N 50 Ω connector type, assuming
that the cal kit name stored in New Kit 1.calkit reads New
Kit 1.
```

Manual operation: See "[Cal Kit Port <i>](#)" on page 587

[SENSe:]CORRection:CKIT:<ConnType>:SElect <CalKitName>

Selects the calibration kit to be used for a specified connector type <ConnType>. The kit is identified by its name.

Tip: For connector types with arbitrary, user-defined names you can use the command `[SENSe:]CORRection:CKIT:SElect`.

Cal kit naming conventions

Calibration kit names must be entered as string parameters. The string contains the cal kit name used in the calibration dialogs (e.g. "Calibration Presettings"); a "Ω" in the name must be replaced by Ohm, e.g.:

- `NewKit1` denotes the user-defined calibration kit "NewKit1".
- `N 50 Ohm Ideal Kit` denotes the "N 50 Ω Ideal Kit".
- `ZV-Z21 typical` denotes the cal kit "ZV-Z21 typical".

Suffix:

<ConnType> Connector type, one of the following identifiers:
 N50, N75 – N 50 Ω or N 75 Ω connectors
 PC7, PC35, PC292 – PC 7, PC 3.5 or 2.92 mm connectors
 USER<no> – user-defined connectors UserConn1, UserConn2
 SMA – user-defined connector type SMA ...

Parameters:

<CalKitName> String parameter containing the name of a calibration kit available on the analyzer. See "Cal kit naming conventions " above.

*RST: n/a (A *RST does not change the assignment between connector types and calibration kits.)

Example:

```
MMEM:LOAD:CKIT 'C:\Users\Public\
Documents\Rohde-Schwarz\ZNA\
Calibration\Kits\New Kit 1.calkit'
Load the previously created cal kit file New Kit 1.calkit
from the default cal kit directory.
CORR:CKIT:N50:SEL 'New Kit 1'
Assign the imported kit to the N 50 Ω connector type, assuming
that the cal kit name stored in New Kit 1.calkit reads New
Kit 1.
```

Manual operation: See ["Add / Copy / Delete / Standards..."](#) on page 617

[SENSe:]CORRection:CKIT:STANdard:CATalog? <CalKitName>

Returns a list of all standards in a given calibration kit.

Query parameters:

<CalKitName> Name of the cal kit. Use [\[SENSe:\]CORRection:CKIT:CATalog?](#) to query cal kit names.

Example: See [\[SENSe<Ch>:\]CORRection:CONNection:CATalog?](#)

Usage: Query only

[SENSe:]CORRection:CKIT:STANdard:DATA? <ConnectorType>, <CalKitName>, <KitLabel>, <StandardType>, <DelayMode>[, <Port1>[, <Port2>]]

Returns the data of the related calibration standard (identified by <ConnectorType>, <CalKitName>, <KitLabel> and <StandardType>) and - optionally - restricted to the given port(s).

The delay parameter is returned according to the selected <DelayMode>; see [Table 7-14](#).

Query parameters:

<ConnectorType> Name of the connector type. Use [\[SENSe<Ch>:\]CORRection:CONNection:CATalog?](#) to query connector names.

<CalKitName> String parameter containing the name of the calibration kit. See "Cal kit naming conventions " under [\[SENSe:\]CORRection:CKIT:<ConnType>:LSElect](#).

<KitLabel> String parameter containing the label of the calibration kit, usually the serial number.

<StandardType>	MMTHrough MFTThrough FFTHrough MMLine MMLine1 MMLine2 MMLine3 MFLine MFLine1 MFLine2 MFLine3 FFLine FFLine1 FFLine2 FFLine3 MMATten MFATten FFATten MMSNetwork MFSNetwork FFSNetwork MOPen FOPen MSHort FSHort MOShort MOShort1 MOShort2 MOShort3 FOSHort FOSHort1 FOSHort2 FOSHort3 MREFlect FRElect MMTCh FMTCh MSMATCH FSMATCH Standard type; see Table 7-15
<DelayMode>	DELay ELENgth ELENgth (default) – ZVR compatible modelling DELay – Keysight modelling
<Port1>[, <Port2>]	Optional port restriction: one port number for one port standards, two port numbers for two port standards
Usage:	Query only

7.3.14.7 [SENSe:]CORRection:CKIT... with Labels

The following [SENSe:]CORRection:CKIT... commands identify the calibration kit to be used by a combination of its <CalkitName> and <CalkitLabel>. Typically, the serial number of the calibration kit serves as a calibration kit label. Due to their different labels, the analyzer can handle several calibration kits with identical names.

[SENSe:]CORRection:CKIT:LCATalog?.....	1349
[SENSe:]CORRection:CKIT:LDELete.....	1350
[SENSe:]CORRection:CKIT:LLABel.....	1350
[SENSe:]CORRection:CKIT:LSElect.....	1351
[SENSe:]CORRection:CKIT:<ConnType>:LSElect.....	1352
[SENSe:]CORRection:CKIT:STANdard:LCATalog?.....	1353
[SENSe:]CORRection:CKIT:<StandardType>:WLABel.....	1353
[SENSe:]CORRection:CKIT:<OnePortStandardType>:WLABel:SDATa?.....	1353
[SENSe:]CORRection:CKIT:<TwoPortStandard>:WLABel:SDATa?.....	1354

[SENSe:]CORRection:CKIT:LCATalog? [<ConnectorType>]

Returns a list of all cal kits and their labels for a given connector type or for all connector types.

Query parameters:

<ConnectorType>	Name of the connector type. Use [SENSe<Ch>:]CORRection:CONNection:CATalog? to query connector names. If omitted, the command returns the list of all cal kits and labels.
-----------------	------------------------------------------------------------------------------------------------------------------------------------------------------------------------------

Example: See [SENSe<Ch>:]CORRection:CONNection:CATalog?

Usage: Query only

[SENSe:]CORRection:CKIT:LDElete <CalKitName>, <KitLabel>

Deletes an imported or user-defined cal kit which is identified by its cal kit name and label.

Note: It is not possible to modify or store predefined or ideal kits.

Setting parameters:

<CalKitName> String parameter containing an imported or user-defined calibration kit available on the analyzer.

<KitLabel> String parameter containing the label of an imported or user-defined calibration kit available on the analyzer.

Example: See [\[SENSe:\]CORRection:CKIT:LLaBel](#)

Usage: Setting only

[SENSe:]CORRection:CKIT:LLaBel <CalKitName>, <KitLabel>[, <NewKitLabel>]

Assigns a calibration kit label to an imported or user-defined calibration kit or renames an existing calibration kit label.

Parameters:

<CalKitName> String parameter containing an imported or user-defined calibration kit available on the analyzer.

<KitLabel> String parameter containing the current calibration kit label.

<NewKitLabel> String parameter containing the new calibration kit label.

Example:

```

CORR:CKIT:FOP:WLAB 'N 50 Ohm','New Kit 1',
'Test kit created today', '',
0,4000000000,0,0,50,99,-2.3,0.22,0,0,0,0,0
Create a new cal kit "New Kit 1" labelled "Test kit created today"
and assign an open (f) standard for the N 50 Ω connector type
with specific properties.
CORR:CKIT:LLAB 'New Kit 1', 'Test kit created
today', '2012-05-25'
Change the label of the previously created kit.
CORR:CKIT:LLAB? 'New Kit 1', '2012-05-25'
Check the label.
MMEemory:STORE:CKIT:
WLABel 'New Kit 1', '2012-05-25', 'C:
\Users\Public\Documents
\Rohde-Schwarz\ZNA\Calibration\Kits\New Kit 1
(2012-05-25).calkit'
Store the data for the labelled cal kit to the cal kit file
New Kit 1 (2012-05-25).calkit.
CORR:CKIT:LDEL 'New Kit 1', '2012-05-25'
Delete the kit. from the internal memory.
MMEemory:LOAD:CKIT 'C:\Users\Public\Documents
\Rohde-Schwarz\ZNA\Calibration\Kits\New Kit 1
(2012-05-25).calkit'
Re-load the kit.

```

[SENSe:]CORRection:CKIT:LSElect <ConnectorType>, <CalKitName>, <KitLabel>

Selects the calibration kit to be used, specifying its connector type, name, and label.

Tip: The command is suitable for connector types with arbitrary, user-defined names. For standard connector types you can use the command `[SENSe:]CORRection:CKIT:<ConnType>:LSElect`.

Parameters:

<ConnectorType>	Connector type, e.g. a user-defined connector type (string variable).
<CalKitName>	String parameter containing the name of a calibration kit available on the analyzer.
<KitLabel>	String parameter containing the label of a calibration kit available on the analyzer.

Example:

```
MMEM:LOAD:CKIT 'C:\Users\Public\
Documents\Rohde-Schwarz\ZNA\
Calibration\Kits\New Kit 1 (123456).calkit'
```

Load the previously created cal kit file
New Kit 1 (123456).calkit from the default cal kit directory.

```
CORR:CKIT:LSEL 'N 50 Ohm', 'New Kit 1',
'123456'
```

Assign the imported kit to the N 50 Ω connector type, assuming that the cal kit name stored in New Kit 1 (123456).calkit reads New Kit 1 and that its label reads 123456.

[SENSe:]CORRection:CKIT:<ConnType>:LSElect <CalKitName>, <Label>

Selects the calibration kit to be used for a specified connector type <ConnType>. The kit is identified by its name and label.

Tip: For connector types with arbitrary, user-defined names and labels you can use the command [\[SENSe:\]CORRection:CKIT:LSElect](#).

Suffix:

<ConnType> Connector type, one of the following identifiers:
 N50, N75 – N 50 Ω or N 75 Ω connectors
 PC7, PC35, PC292 – PC 7, PC 3.5 or 2.92 mm connectors
 USER<no> – user-defined connectors UserConn1, UserConn2
 SMA – user-defined connector type SMA ...

Parameters:

<CalKitName> String parameter containing the name of a calibration kit available on the analyzer. See "Cal kit naming conventions" under [\[SENSe:\]CORRection:CKIT:<ConnType>:LSElect](#).

*RST: n/a (A *RST does not change the assignment between connector types and calibration kits.)

<CalKitLabel> String parameter containing the label of a calibration kit available on the analyzer, usually the serial number.

*RST: n/a (A *RST does not change the assignment between connector types and calibration kits.)

Example:

```
MMEM:LOAD:CKIT 'C:\Users\Public
\Documents\Rohde-Schwarz
\Vna\Calibration\Kits\New Kit 1
(123456).calkit'
```

Load the previously created cal kit file
New Kit 1 (123456).calkit from the default cal kit directory.

```
CORR:CKIT:N50:LSEL 'New Kit 1', '123456'
```

Assign the imported kit to the N 50 Ω connector type, assuming that the cal kit name stored in New Kit 1 (123456).calkit reads New Kit 1 and that its label reads 123456.

Manual operation: See ["Add / Copy / Delete / Standards..."](#) on page 617

[SENSe:]CORRection:CKIT:STANdard:LCATaLog? <CalKitName>, <KitLabel>

Returns a list of all standards in a given calibration kit.

Query parameters:

<CalKitName> Name of the cal kit. Use [\[SENSe:\]CORRection:CKIT:LCATaLog?](#) to query cal kit names and labels.

<KitLabel> Label of the cal kit.

Example: See [\[SENSe<Ch>:\]CORRection:CONNection:CATaLog?](#)

Usage: Query only

[SENSe:]CORRection:CKIT:<StandardType>:WLAbel <ConnType>, <CalKitName>, <CalKitLabel>, <StandardLabel>, <MinFreq>, <MaxFreq>, <DelayParam>, <Loss>, <Z0>, <C0>, <C1>, <C2>, <C3>, <L0>, <L1>, <L2>, <L3>, OPEN | SHORT | MATCh | <Resistance>[, <Port1>[, <Port2>]]

[SENSe:]CORRection:CKIT:<StandardType>:WLAbel? <ConnType>, <CalKitName>[, <CalKitLabel>[, <Port1>[, <Port2>]]]]

Defines the parameters of a non-ideal 1 port or 2-port calibration standard <StandardType>, where a particular cal kit can be addressed by name **and** label.

Apart from the additional <CalKitLabel> parameter, the syntax and semantics of this command is identical to [Standard types and their parameters](#).

Example:

```
CORR:CKIT:FOP:WLAB 'N 50 Ohm', 'New Kit
1', '123456', '',
0, 4000000000, 0, 0, 50, 99, -2.3, 0.22, 0, 0, 0, 0, 0
Define the properties of the Open (f) standard for a N 50 Ω con-
nector type in the calibration kit "New Kit 1" labelled "123456".
CORR:CKIT:FOP:WLAB? 'N 50 Ohm', 'New Kit 1',
'123456'
Query the properties of the Open (f) standard for a N 50 Ω con-
nector type in the calibration kit.
```

Manual operation: See ["Add / Copy... / Delete / View / Modify..."](#) on page 619

[SENSe:]CORRection:CKIT:<OnePortStandardType>:WLAbel:SDATa?
<ConnectorType>, <CalKitName>[, <CalKitLabel>[, <PhysPort>]]

Reads the S-parameter data for a particular **1-port** cal kit standard previously loaded from Touchstone file using [MMEMory:LOAD:CKIT:SDATa](#) or [MMEMory:LOAD:CKIT:SDATa:WLAbel](#).

The cal kit is identified by its name and label.

Query parameters:

<OnePort StandardType>	MOPen FOPen MSHort FSHort MOShort MOShort1 MOShort2 MOShort3 FOShort FOShort1 FOShort2 FOShort3 MREFlect FRElect MMTCh FMTCh MSMatch FSMatch Standard type. For more information see Table 7-15 .
<ConnectorType>, <CalKitName>, <CalKitLabel>	Together with <StandardType> these parameters fully identify the related standard (see Parameter list).
<PhysPort>	Number of the physical port for which the S-parameter data is valid. Can be omitted if the data are valid for all ports.

Usage: Query only

[SENSe:]CORRection:CKIT:<TwoPortStandard>:WLABEL:SDATA?

<ConnectorType>, <CalKitName>[, <CalKitLabel>[, <SParameter>,
<PhysPort1>, <PhysPort2>]]

Reads the S-parameter data for a particular **2-port** cal kit standard previously loaded from Touchstone file using [MMEMory:LOAD:CKIT:SDATa](#) or [MMEMory:LOAD:CKIT:SDATa:WLABEL](#).

The cal kit is identified by its name and label.

Query parameters:

<TwoPortStandard>	MMTHrough MFTHrough FFTHrough MMLine MMLine1 MMLine2 MMLine3 MFLine MFLine1 MFLine2 MFLine3 FFLine FFLine1 FFLine2 FFLine3 MMATten MFATten FFATten MMSNetwork MFSNetwork FFSNetwork Standard type. For more information see Table 7-15 .
<ConnectorType>, <CalKitName>, <CalKitLabel>	Together with <StandardType> these parameters fully identify the related standard (see Parameter list).
<SParameter>	S11 S12 S21 S22 S-parameter of the 2-port standard.
<PhysPort1>, <PhysPort2>	Numbers of the physical ports for which the S-parameter data is valid. Can be omitted if the data are valid for all port pairs.

Usage: Query only

7.3.14.8 [SENSe:]CORRection:COLLect...

The `[SENSe:]CORRection:COLLect...` commands control the system error correction, the measurement receiver (power) calibration and the noise figure calibration.

[SENSe<Ch>:]CORRection:COLLect[:ACQuire]:SELected.....	1356
[SENSe<Ch>:]CORRection:COLLect:AUTO.....	1358
[SENSe<Ch>:]CORRection:COLLect:AUTO:ASSignment<Asg>:ACQuire.....	1359
[SENSe<Ch>:]CORRection:COLLect:AUTO:ASSignment:ALL:COUNT?.....	1359
[SENSe<Ch>:]CORRection:COLLect:AUTO:ASSignment:COUNT?.....	1360
[SENSe<Ch>:]CORRection:COLLect:AUTO:ASSignment<Asg>:DEFine.....	1360
[SENSe<Ch>:]CORRection:COLLect:AUTO:ASSignment:DEFine:DEFault.....	1362
[SENSe<Ch>:]CORRection:COLLect:AUTO:ASSignment<Asg>:DEFine:TPORt.....	1362
[SENSe<Ch>:]CORRection:COLLect:AUTO:ASSignment:DEFine:TPORt:DEFault.....	1363
[SENSe<Ch>:]CORRection:COLLect:AUTO:ASSignment:DELete:ALL.....	1363
[SENSe:]CORRection:COLLect:AUTO:CKIT.....	1364
[SENSe:]CORRection:COLLect:AUTO:CKIT:PASSword.....	1364
[SENSe:]CORRection:COLLect:AUTO:CKIT:PORTs.....	1365
[SENSe:]CORRection:COLLect:AUTO:CKIT:PORTs:ADD.....	1366
[SENSe<Ch>:]CORRection:COLLect:AUTO:CONFigure.....	1367
[SENSe<Ch>:]CORRection:COLLect:AUTO:CPORT.....	1368
[SENSe:]CORRection:COLLect:AUTO:MCONnect.....	1369
[SENSe<Ch>:]CORRection:COLLect:AUTO:MDELay.....	1369
[SENSe<Ch>:]CORRection:COLLect:AUTO:MIXer.....	1369
[SENSe<Ch>:]CORRection:COLLect:AUTO:PORTs.....	1370
[SENSe:]CORRection:COLLect:AUTO:PORTs:CONNectiOn?.....	1371
[SENSe<Ch>:]CORRection:COLLect:AUTO:PORTs:TYPE.....	1371
[SENSe<Ch>:]CORRection:COLLect:AUTO:POWer.....	1372
[SENSe<Ch>:]CORRection:COLLect:AUTO:REPeat.....	1373
[SENSe<Ch>:]CORRection:COLLect:AUTO:SAVE.....	1373
[SENSe<Ch>:]CORRection:COLLect:AUTO:TEMPcomp.....	1374
[SENSe<Ch>:]CORRection:COLLect:AUTO:TERMinatiOn.....	1374
[SENSe<Ch>:]CORRection:COLLect:AUTO:TYPE.....	1374
[SENSe<Ch>:]CORRection:COLLect:AUTO:UTHRough.....	1375
[SENSe:]CORRection:COLLect:AVERAge.....	1376
[SENSe:]CORRection:COLLect:CHANnels:ALL.....	1376
[SENSe<Ch>:]CORRection:COLLect:CHANnels:CSETup.....	1376
[SENSe:]CORRection:COLLect:CHANnels:MCTypes.....	1377
[SENSe<Ch>:]CORRection:COLLect:CKIT:INSTall.....	1379
[SENSe<Ch>:]CORRection:COLLect:CKIT:LOAD.....	1379
[SENSe<Ch>:]CORRection:COLLect:CKIT:PORT<PhyPt>?.....	1379
[SENSe<Ch>:]CORRection:COLLect:CONNectiOn<PhyPt>.....	1380
[SENSe<Ch>:]CORRection:COLLect:CONNectiOn:GENDerS.....	1381
[SENSe<Ch>:]CORRection:COLLect:CONNectiOn:PORTs.....	1381
[SENSe:]CORRection:COLLect:CSETup.....	1382
[SENSe<Ch>:]CORRection:COLLect:DELete.....	1382
[SENSe<Ch>:]CORRection:COLLect:DETeCtor.....	1383
[SENSe<Ch>:]CORRection:COLLect:DISCard.....	1383
[SENSe<Ch>:]CORRection:COLLect:FIXTure[:ACQuire].....	1383
[SENSe<Ch>:]CORRection:COLLect:FIXTure:EXPort.....	1385
[SENSe<Ch>:]CORRection:COLLect:FIXTure:IMPORt.....	1385
[SENSe:]CORRection:COLLect:FIXTure:LMPParameter[:STATe].....	1386
[SENSe:]CORRection:COLLect:FIXTure:LMPParameter:LOSS[:STATe].....	1386
[SENSe<Ch>:]CORRection:COLLect:FIXTure:SAVE.....	1386
[SENSe<Ch>:]CORRection:COLLect:FIXTure:STARt.....	1386

[SENSe<Ch>:]CORRection:COLLect:LOAD:SElected.....	1387
[SENSe<Ch>:]CORRection:COLLect:MEthod:DEFine.....	1388
[SENSe<Ch>:]CORRection:COLLect:NFIGure[:ACQuire].....	1390
[SENSe<Ch>:]CORRection:COLLect:NFIGure:END.....	1391
[SENSe<Ch>:]CORRection:COLLect:NFIGure:SAVE.....	1391
[SENSe<Ch>:]CORRection:COLLect:NFIGure:START.....	1392
[SENSe:]CORRection:COLLect:PMETer:ID.....	1392
[SENSe<Ch>:]CORRection:COLLect:SAVE:SElected:DEFault.....	1393
[SENSe<Ch>:]CORRection:COLLect:SAVE:SElected[:DUMMy].....	1394
[SENSe<Ch>:]CORRection:COLLect:SCONnection<PhyPt>.....	1394

[SENSe<Ch>:]CORRection:COLLect[:ACQuire]:SElected <Type>, <TestPort>[, <SecondPortOrAdapter>[, <Dispersion>[, <DelayTimePhase>]]]

Starts the acquisition of measurement data for the selected standard and port(s). The standards are reflection or transmission standards and can be connected to arbitrary analyzer ports.

Note:

- The calibration measurement has a variable timeout: $Timeout = (Sweep\ time / Number\ of\ sweep\ points) * 3 + 0.1\ s$
The timeout may be reached e.g. while the measurement waits for the specified trigger event. It is used for all standard measurements including power calibration sweeps.
- For a sliding match, the R&S ZNA can acquire measurement data for up to 20 positions per port. Multiple calls of [SENSe<Ch>:]CORRection:COLLect[:ACQuire]:SElected SLIDe, <TestPort> for the same test port, implicitly increases the position until position 20 has been recorded. Subsequent calls will start over at position 1, overwriting the previously acquired data.

Suffix:

<Ch> Channel number of the calibrated channel

Setting parameters:

<Type> THROUGH | OPEN | SHORT | OSHort | OSHort1 | OSHort2 | OSHort3 | MATCH | NET | ATT | REFL | SLIDe | ISOLation | LINE | LINE1 | LINE2 | LINE3 | UTHRough | POWer | MIXer | TERMination | EATTenuator | MDELay

Standard types: Through, Open, Short, Match, Symmetric Network (NET), Attenuation (ATT), Reflect, Sliding Match (SLIDe), Line1 (LINE1 and LINE are synonymous), Line2 and Line3 (esp. for TRL calibration), Offset Short 1 to 3 (OSHORT), Unknown Through, power meter (for SMARTerCal), Mixer.

ISOLation is not a physical standard: to measure the isolation (supported for transmission normalization and TOSM only!) it is recommended to suitably terminate the related test ports (e.g. with 50 Ω loads).

MIXer represents the calibration mixer measurement that is required for calibrating a mixer phase measurement (with option R&S ZNA-K5).

	<p>TERMination represents a receiver noise measurement in channel <Ch>, with a matched load connected to receiving port <TestPort>. This is part of a noise figure calibration using mechanical calibration standards (with option R&S ZNA-K30).</p> <p>MDELay represents a delay mixer calibration that is required for calibrating a two-tone group delay measurement (with option R&S ZNA-K9).</p>
<TestPort>	<p>Test port number.</p> <p>For a transmission standard, an adapter that is used as a "through", or a mixer, the input and output port numbers must be specified.</p> <p>For reflection standards, only one port number is required.</p> <p>*RST: n/a</p>
<SecondPortOrAdapter>	<p>For a transmission standard, an adapter that is used as a "through", or a mixer, this parameter specifies the second test port.</p> <p>For reflection measurements with an adapter connected between port and standard, set it to ON.</p> <p>Otherwise set it to OFF or simply omit it.</p>
<Dispersion>	<p>Optional status parameter for UTHRough standard:</p> <p>OFF - unknown through standard is non-dispersive.</p> <p>ON - unknown through standard is dispersive.</p> <p>*RST: OFF</p>
<DelayTimePhase>	<p>Optional entry of delay time or phase for UTHRough standard:</p> <p>AUTO - the analyzer determines the delay time or phase during the calibration sweep.</p> <p><delay or phase> - entry of the delay time in ps (for non-dispersive standards) or of the phase at the start frequency of the sweep in deg (for dispersive standards). If an estimate of the start phase is entered, the analyzer uses the calculated value which is closest to the estimate.</p> <p>Automatic determination of the phase</p> <p>The UOSM algorithm provides the transmission factor of the unknown through standard up to an ambiguous sign. This yields the two alternative phase values displayed in the calibration wizard; see Unknown Through Standard.</p>

In remote control, the analyzer performs a plausibility check in order to determine the correct phase. No manual selection is necessary. The check starts at the first sweep point, using the transmission factor with negative phase. The analyzer measures the phase at the subsequent sweep points, assuming that the phase difference between any two consecutive points is less than 90 deg. From these phase values, the analyzer calculates a linear extrapolation and derives an estimate for the DC phase limit. If this DC phase is in the vicinity of ... -180 deg, +180 deg, ... then the transmission factor with negative phase is adopted. If the DC phase is in the vicinity of ... 0 deg, +360 deg, ... then the transmission factor with inverted sign (corresponding to a 180 deg phase shift) is adopted.

*RST: AUTO

Example: See `[SENSe<Ch>:]CORRection:COLLect:SAVE:SELected[:DUMMy]` or [Chapter 8.2.5.4, "Adapter removal"](#), on page 1753

Usage: Setting only

Manual operation: See ["Start Cal Sweep"](#) on page 576

`[SENSe<Ch>:]CORRection:COLLect:AUTO <Characterization>, <TestPort1>[, <TestPort2>[...]]`

Selects and initiates an automatic calibration for the specified test ports using a single, auto-detected port assignment.

Tip:

- If the test setup contains a high attenuation, the analyzer may fail to detect the cal unit ports connected to each of its ports. In this case use the extended command `[SENSe<Ch>:]CORRection:COLLect:AUTO:PORTs`.
- Use `[SENSe<Ch>:]CORRection:COLLect:AUTO:TYPE` if you want to specify a particular calibration type for the automatic calibration.
- If several calibration units are connected, use `SYSTem:COMMunicate:RDEvice:AKAL:ADDRESS` to select a unit for the calibration.
- Use `[SENSe<Ch>:]CORRection:COLLect:AUTO:CONFigure` to prepare an automatic calibration with multiple port assignments.

Suffix:

<Ch> Channel number of the calibrated channel

Setting parameters:

<Characterization> Location of the characterization (cal kit file) to be used for the automatic calibration (string parameter):

- If an empty string (' ') is specified, the factory cal kit file stored in the active calibration unit is used.
- A VNA cal kit file name `*.calkit` without path refers to a specific cal kit file stored in the internal memory of the active calibration unit.

	<ul style="list-style-type: none"> – A VNA cal kit file name without path but prefixed with "SD:" refers to a specific cal kit file stored on the SD card inserted at the active calibration unit. – A VNA cal kit file name *.calkit with path refers to a specific cal kit file stored in an arbitrary directory on the analyzer.
<TestPort1>, <TestPort2>, ...	Test port numbers. For an n-port automatic calibration, n arbitrary (not necessarily consecutive) port numbers must be specified. The analyzer automatically detects the calibration unit ports connected to each analyzer port.
Example:	<pre>CORR:COLL:AUTO '', 1, 2, 4</pre> <p>Perform an automatic 3-port calibration at test ports 1, 2, and 4 using the calibration unit's default calibration kit file and arbitrary test ports of the cal unit.</p>
Usage:	Setting only
Manual operation:	See "Apply" on page 582

[SENSe<Ch>:]CORRection:COLLect:AUTO:ASSignment<Asg>:ACQuire

Starts the automatic calibration sweep for the indicated channel and port assignment.

A complete, valid set of port assignments must be defined before you can initiate a calibration. See [Chapter 4.5.5.6, "Multiple port assignments"](#), on page 216 for background information.

Suffix:

<Ch>	Number of the calibrated channel
<Asg>	Number of the port assignment

Example: See [\[SENSe<Ch>:\]CORRection:COLLect:AUTO:ASSignment<Asg>:DEFine](#)

Usage: Event

Manual operation: See ["Start Cal Sweep / Abort Sweep"](#) on page 581

[SENSe<Ch>:]CORRection:COLLect:AUTO:ASSignment:ALL:COUNT?

Returns the total number of port assignments of *all* calibrations.

See [Chapter 4.5.5.6, "Multiple port assignments"](#), on page 216 for background information.

Note:

Use [\[SENSe<Ch>:\]CORRection:COLLect:AUTO:ASSignment:COUNT?](#) to get the number of port assignments of the "current" calibration.

Suffix:

<Ch>	Channel number
------	----------------

Example: See [Chapter 8.2.5.2, "MultiCal \(with calibration unit\)"](#), on page 1748

Usage: Query only

[SENSe<Ch>:]CORRection:COLLect:AUTO:ASSignment:COUNT?

Returns the number of port assignments of the "current" calibration, i.e. the calibration last created using [\[SENSe<Ch>:\]CORRection:COLLect:AUTO:CONFIgure](#).

This is particularly useful if the default port assignments were established using [\[SENSe<Ch>:\]CORRection:COLLect:AUTO:ASSignment:DEFine:DEFault](#). See [Chapter 4.5.5.6, "Multiple port assignments"](#), on page 216 for background information.

Note:

In MultiCal scenarios, use [\[SENSe<Ch>:\]CORRection:COLLect:AUTO:ASSignment:ALL:COUNT?](#) to get the number of port assignments of all calibrations.

Suffix:

<Ch> Channel number

Example: See [\[SENSe<Ch>:\]CORRection:COLLect:AUTO:ASSignment<Asg>:DEFine](#) on page 1360

Usage: Query only

Manual operation: See ["CalUnit Con"](#) on page 588

[SENSe<Ch>:]CORRection:COLLect:AUTO:ASSignment<Asg>:DEFine <TestPort1>, <CalUnitPort1>[, <TestPort2>]...

Manually defines port assignment no. <Asg> for channel no. <Ch>.

With manual configuration a non-minimal set of port assignments can be created, which may increase measurement accuracy. On the other hand, it is up to the user to ensure that the created set of port assignments is complete and valid for the chosen calibration type (see [\[SENSe<Ch>:\]CORRection:COLLect:AUTO:CONFIgure](#)).

Note that during the corresponding calibration sweep the R&S ZNA expects the physical port connections to be established exactly as defined by the port pairs.

Use

- [\[SENSe<Ch>:\]CORRection:COLLect:AUTO:ASSignment<Asg>:DEFine:TPORt](#) command to take advantage of auto-detection of port connections.
- [\[SENSe<Ch>:\]CORRection:COLLect:AUTO:ASSignment:DEFine:DEFault](#) or [\[SENSe<Ch>:\]CORRection:COLLect:AUTO:ASSignment:DEFine:TPORt:DEFault](#) to create the default assignments instead.

See [Chapter 4.5.5.6, "Multiple port assignments"](#), on page 216 for background information.

Suffix:

<Ch>	Number of the channel
<Asg>	Number of the port assignment

Parameters:

<TestPort1>	First test port number
<CalUnitPort1>	Number of the calibration unit port that is assigned to the first test port
<TestPort2>	Second test port number ...

Example:

Let's perform a full 3-port calibration with a two-port calibration unit, using factory characterization and the port assignments given in the table below.

Prerequisite: the adequate calibration unit was selected before using `SYSTem:COMMunicate:RDEvice:AKAL:ADDResS`
`SENSe1:CORRection:COLLect:AUTO:ASSignment:DELeTe:ALL`

Deletes all available port assignments.

```
SENSe1:CORRection:COLLect:AUTO:CONFigure
'FNPort', ''
```

Sets the automatic calibration to "Full n-port" with factory characterization.

```
SENSe1:CORRection:COLLect:AUTO:ASSignment1:
DEFine 2,1,3,2
```

Creates port assignment 1 explicitly (no auto-detection).

```
SENSe1:CORRection:COLLect:AUTO:ASSignment2:
DEFine:TPORT 3,4
```

Creates port assignment 2 implicitly (auto-detection).

Before starting the calibration sweep for port assignment 1, ensure test port 2 is connected to cal unit port 1 and test port 3 to cal unit port 2

```
SENSe1:CORRection:COLLect:AUTO:ASSignment1:
ACQUire
```

Performs the calibration sweep for port assignment 1

Before starting the calibration sweep for port assignment 2, ensure test ports 3 and 4 are connected to the cal unit (in any order)

```
SENSe1:CORRection:COLLect:AUTO:ASSignment2:
ACQUire
```

Performs the calibration sweep for port assignment 2; auto-detects the existing port-connections at runtime

```
SENSe1:CORRection:COLLect:AUTO:SAVE
```

Checks whether the acquired calibration data are sufficient to calculate the system error correction. If yes, applies them to the selected channel.

See [Chapter 8.2.5.2, "MultiCal \(with calibration unit\)"](#), on page 1748 for a MultiCal example.

Manual operation: See ["CalUnit Con"](#) on page 588

Test Port	Port Assignment 1	Port Assignment 2
2	Cal Unit Port 1	-
3	Cal Unit Port 2	auto-detected
4	-	auto-detected

[SENSe<Ch>:]CORRection:COLLect:AUTO:ASSignment:DEFine:DEFault
 <TestPort1>[, <TestPort2>]...

Creates the default port assignment(s) for the specified test ports.

The number of created assignments can be queried using the [\[SENSe<Ch>:\]CORRection:COLLect:AUTO:ASSignment:COUNt?](#) command.

Note that during the corresponding calibration sweep the R&S ZNA expects the physical port connections to be established exactly as specified by the created port assignments.

Use

- [\[SENSe<Ch>:\]CORRection:COLLect:AUTO:ASSignment:DEFine:TPORT:DEFault](#) on page 1363 to use auto-detection instead of defining "test port --> cal unit port"-connections explicitly
- [\[SENSe<Ch>:\]CORRection:COLLect:AUTO:ASSignment<Asg>:DEFine](#) or [\[SENSe<Ch>:\]CORRection:COLLect:AUTO:ASSignment<Asg>:DEFine:TPORT](#) to define (additional) port assignments manually

See [Chapter 4.5.5.6, "Multiple port assignments"](#), on page 216 for background information.

Suffix:

<Ch> Channel number

Setting parameters:

<TestPort1> Test port number 1

<TestPort2> Test port number 2

Example:

See [\[SENSe<Ch>:\]CORRection:COLLect:AUTO:ASSignment<Asg>:DEFine](#) on page 1360

Usage:

Setting only

Manual operation: See ["CalUnit Con"](#) on page 588

[SENSe<Ch>:]CORRection:COLLect:AUTO:ASSignment<Asg>:DEFine:TPORT
 <TestPort1>[, <TestPort2>]...

Similar logic as [\[SENSe<Ch>:\]CORRection:COLLect:AUTO:ASSignment<Asg>:DEFine](#), but initially defines the port assignment only by its underlying test port set; the connected calibration unit ports are **auto-detected** at the start of the corresponding calibration sweep.

Suffix:

<Ch>	Number of the channel
<Asg>	Number of the port assignment

Parameters:

<TestPort1>	First test port number
<TestPort2>	Second test port number ...

Example:

See [\[SENSe<Ch>:\]CORRection:COLLect:AUTO:ASSignment<Asg>:DEFine](#) on page 1360

Manual operation: See ["CalUnit Con"](#) on page 588

[SENSe<Ch>:]CORRection:COLLect:AUTO:ASSignment:DEFine:TPORt:DEFault
 <TestPort1>[, <TestPort2>]...

Similar logic as [\[SENSe<Ch>:\]CORRection:COLLect:AUTO:ASSignment:DEFine:DEFault](#), but initially defines the default port assignments only by their underlying test port set(s); the connected calibration unit ports are **auto-detected** at the start of the corresponding calibration sweep.

The number of created assignments can be queried using the [\[SENSe<Ch>:\]CORRection:COLLect:AUTO:ASSignment:COUNT?](#) command.

See [Chapter 4.5.5.6, "Multiple port assignments"](#), on page 216 for background information.

Suffix:

<Ch>

Setting parameters:

<TestPort1>
 <TestPort2>

Example:

See [\[SENSe<Ch>:\]CORRection:COLLect:AUTO:ASSignment<Asg>:DEFine](#) on page 1360

Usage:

Setting only

Manual operation: See ["CalUnit Con"](#) on page 588

[SENSe<Ch>:]CORRection:COLLect:AUTO:ASSignment:DELete:ALL

Deletes all port assignments (created using [\[SENSe<Ch>:\]CORRection:COLLect:AUTO:ASSignment<Asg>:DEFine](#)) and calibration definitions (created using [\[SENSe<Ch>:\]CORRection:COLLect:AUTO:CONFigure](#)) of an ongoing automatic calibration in channel <Ch>.

Suffix:

<Ch> Channel number of the calibrated channel

Example:

See [\[SENSe<Ch>:\]CORRection:COLLect:AUTO:ASSignment<Asg>:DEFine](#)

Usage: Event

[SENSe:]CORRection:COLLect:AUTO:CKIT <Characterization>

Generates a characterization (cal kit file) with the specified name containing the cal kit data of the active calibration unit (selected via [SYSTem:COMMunicate:RDEvice:AKAL:ADDRESS](#)). The cal kit file can be saved to a directory on the analyzer, to the calibration unit's internal (flash) memory or to an SD card inserted at the calibration unit (if available).

Note that this command can only be executed if the number of cal unit ports is less or equal to the number of test ports. Furthermore the command assumes the "canonical" assignment of cal unit ports to test ports: cal unit port 1 assigned to test port 1, cal unit port 2 assigned to test port 2 etc. The new command [\[SENSe:\]CORRection:COLLect:AUTO:CKIT:PORTs](#) allows for flexible assignments.

Setting parameters:

<Characterization> Location of the created characterization / cal kit file (string parameter, extension *.calkit):
 If a path is specified, the file is saved to the analyzer's hard disk. The default directory ([MMEMory:CDIRectory](#)) is **not** used.
 If only the file name is specified, the file is saved to the calibration unit's internal (flash) memory. The factory calibration data on the unit is not overwritten.
 If the file name is prefixed by "SD:", the file is saved to the SD card inserted at the calibration unit (if available/accessible).

Example: `CORR:COLL:AUTO:CKIT 'AutoCalChar'`
 Generate a cal kit file `AutoCalChar.calkit` for the active calibration unit and store it in the calibration unit.
`SENSe:CORRection:COLLect:AUTO:CKIT 'SD:test1'`
 Generate a cal kit file `test1.calkit` for the active calibration unit and store it in the calibration unit.

Usage: Setting only

Manual operation: See "[File name / Comment \(Optional\)](#)" on page 626

[SENSe:]CORRection:COLLect:AUTO:CKIT:PASSword <Password>

Enters a password to enable a single password-protected action in the automatic calibration or in the characterization wizard. If password protection has been activated manually in the "Characterize Cal Unit" dialog, the password is required for any single execution of one the following commands, provided that a cal kit (characterization) file different from the active characterization is specified:

`[SENSe]:CORRection:COLLect:AUTO`

`[SENSe]:CORRection:COLLect:AUTO:CKIT`

`[SENSe]:CORRection:COLLect:AUTO:PORTs`

`[SENSe]:CORRection:COLLect:AUTO:PORTs:TYPE`

[SENSe]:CORRection:COLLect:AUTO:TYPE

Tip: You have to send [SENSe:]CORRection:COLLect:AUTO:CKIT:PASSword repeatedly if your command script uses several password-protected commands. You do not need a password to perform automatic calibrations using the active cal unit characterization.

Setting parameters:

<Password> Password (string parameter), as defined in manual control.

Example:

```
SENSe:CORRection:COLLect:AUTO:CKIT:PASSword
'My_password'
```

Enter a password My_password (assuming that password protection has been activated manually).

```
SENSe:CORRection:COLLect:AUTO ' ', 1, 2
```

Perform an automatic 2-port calibration at test ports 1 and 2 using the calibration unit's default calibration kit file and automatic port assignment.

```
SENSe:CORRection:COLLect:AUTO:CKIT:PASSword
'My_password'
```

Re-enter the password.

```
SENSe:CORRection:COLLect:AUTO ' ', 1, 2
```

Repeat the calibration.

Usage: Setting only

Manual operation: See ["Authentication"](#) on page 622

[SENSe:]CORRection:COLLect:AUTO:CKIT:PORTs <Characterization>, <TestPort1>, <CalUnitPort1>[, <TestPort2>...]

Generates a characterization (cal kit file) with the specified name containing the cal kit data of the active calibration unit (SYSTem:COMMunicate:RDEvice:AKAL:ADDResS). The cal kit file can be saved to a directory on the analyzer, to the calibration unit's internal (flash) memory or to an SD card inserted at the calibration unit (if available).

Similar logic as [SENSe:]CORRection:COLLect:AUTO:CKIT, but with flexible port assignment.

Setting parameters:

<Characterization> Location of the created characterization / cal kit file (string parameter, extension *.calkit):

If a path is specified, the file is saved to the analyzer's hard disk.

The default directory (MMEMory:CDIRectory) is **not** used.

If only the file name is specified, the file is saved to the calibration unit's internal (flash) memory. The factory calibration data on the unit is not overwritten.

If the file name is prefixed by "SD:", the file is saved to the SD card inserted at the calibration unit (if available/accessible).

<TestPort1> Number of first test port.

<CalUnitPort1> Number of the calibration unit port to whom the first test port (<TestPort1>) is assigned.

<TestPort2> Number of second test port...

Usage: Setting only

Manual operation: See "[Test Port Assignment](#)" on page 625

[SENSe:]CORRection:COLLect:AUTO:CKIT:PORTs:ADD <Characterization>, <TestPort1>, <CalUnitPort1>[, <TestPort2>]...

Extends or modifies an *existing* characterization of the active calibration unit ([SYSTem:COMMunicate:RDEvice:AKAL:ADDRESS](#)).

This functionality is not available at the GUI.

Setting parameters:

<Characterization> Location of an existing characterization (e.g. created using [\[SENSe:\]CORRection:COLLect:AUTO:CKIT:PORTs](#)).

- A VNA cal kit file name *.calkit without path refers to a specific cal kit file stored in the internal memory of the active calibration unit.
- A VNA cal kit file name without path but prefixed with "SD:" refers to a specific cal kit file stored on the SD card inserted at the active calibration unit.
- A VNA cal kit file name *.calkit with path refers to a specific cal kit file stored in an arbitrary directory on the analyzer.

<TestPort1> Number of first test port.

<CalUnitPort1> Number of the calibration unit port, to whom test port <TestPort1> is assigned.

<TestPort2> Number of the second test port ...

Example:

Prerequisite:

```
SYSTem:COMMunicate:RDEvice:AKAL:ADDRESS
'MyCalU'
```

Sets 'MyCalU' as the active calibration unit.

```
SYSTem:COMMunicate:RDEvice:AKAL:PORTs? 'abc'
```

Queries the ports of characterization 'abc'; returns something like '3,N 50 Ohm,MALE,4,N 50 Ohm,MALE'. In particular, calibration unit ports 1 and 2 are not yet characterized.

```
SENSe:CORRection:COLLect:AUTO:CKIT:PORTs:ADD
'abc',1,2
```

Extend characterization 'abc' with test port 1 assigned to port 2 of the cal unit.

```
SYSTem:COMMunicate:RDEvice:AKAL:PORTs? 'abc'
```

Now returns something like '2,N 50 Ohm,MALE,3,N 50 Ohm,MALE,4,N 50 Ohm,MALE'.

```
SENSe:CORRection:COLLect:AUTO:CKIT:PORTs:ADD
'abc',1,2
```

Repeat characterization of test port 2, e.g. because the connection cable wasn't fastened correctly ...

Usage: Setting only

[SENSe<Ch>:]CORRection:COLLect:AUTO:CONFigure <CalType>, <Characterization>[, <CalName>]

Selects a calibration type and a cal unit characterization (cal kit file) for an automatic calibration.

Suffix:

<Ch> Channel number of the calibrated channel

Parameters:

<CalType> FNPort | TOSM | FOPort | OPTPort | FRTRans | FTRans | RTRans | REFL | RSHort | PFNPort | VUOSm | VPUOSm | CPUOSm | UMDelay | PUMDelay

Calibration Type

FNPort

Full n-port (UOSM) calibration

TOSM

Full n-port calibration with characterized Through.

If the selected cal unit characterization does not contain a Through characterization, the command silently falls back to a FNPort (UOSM) calibration.

FOPort

Full one-port ("Refl OSM") calibration

OPTPort

"One Path Two Ports" calibration

If the selected cal unit characterization does not contain a Through characterization, the command will fail.

FRTRans

Transmission normalization, bidirectional

If the selected cal unit characterization does not contain a Through characterization, the command will fail.

FTRans | RTRans

Transmission normalization, forward | reverse

If the selected cal unit characterization does not contain a Through characterization, the command will fail.

REFL

Reflection normalization, Open

RSHort

Reflection normalization, Short

PFNPort

Full n-port (FNPort) calibration with additional power flatness calibration

VUOSm

FNPort (UOSM) Vector Mixer calibration

VPUOSm

PFNPort (PUOSM) Vector Mixer calibration

CPUOSm

PFNPort (PUOSM) Scalar Vector Mixer calibration

UMDelay

UOSM + Delay Mixer calibration for two-tone group delay measurements

PUMDelay

UMDelay with complementary source flatness calibration

<Characterization> Location of the characterization (cal kit file) to be used for the automatic calibration (string parameter):

- The empty string (' ') refers to the factory calibration of (and stored on) the active calibration unit.
- A VNA cal kit file name *.calkit without path refers to a specific cal kit file stored in the internal memory of the active calibration unit.
- A VNA cal kit file name without path but prefixed with "SD:" refers to a specific cal kit file stored on the SD card inserted at the active calibration unit.
- A VNA cal kit file name *.calkit with path refers to a specific cal kit file stored in an arbitrary directory on the analyzer.

Note that for [inline calibration systems](#) this setting is ignored. The suitable, ICU-specific characterizations must be specified using `SYSTem:COMMunicate:RDEvice:AKAL:CKIT`.

Setting parameters:

<CalName>

Example:

```
SENSe1:CORRection:COLLect:AUTO:CONFIgure
FNPort, ''
```

Sets the automatic calibration to "Full n-port" with factory characterization.

Example:

See [Chapter 8.2.5.6, "Vector mixer calibration using calibration units"](#), on page 1754

Manual operation: See ["Calibration Type"](#) on page 585

[SENSe<Ch>:]CORRection:COLLect:AUTO:CPORT <PortNumber>

Defines the "Common Port" of an automatic calibration.

This port will be part of every port assignment that is defined using `[SENSe<Ch>:]CORRection:COLLect:AUTO:ASSIgnment:DEFine:DEFault`, or `[SENSe<Ch>:]CORRection:COLLect:AUTO:ASSIgnment:DEFine:TPORT:DEFault` on page 1363.

If `[SENSe:]CORRection:COLLect:AUTO:MCONnect` is ON, this port will be used as the center of all Through measurements. If you set up the port assignments manually, make sure that every port assignment contains it.

Suffix:

<Ch> Channel number

Setting parameters:

<PortNumber> Number of the common port

Usage: Setting only

Manual operation: See ["Common Port"](#) on page 585

[SENSe:]CORRection:COLLect:AUTO:MCONnect <MinimumConnect>

Enables or disables the [Reduced Through](#) logic for every port assignment of an automatic calibration.

Note that for this to work, the port assignments must have a star topology, with a "Common Port" set using [\[SENSe<Ch>:\]CORRection:COLLect:AUTO:CPORT](#) on page 1368.

Setting parameters:

<MinimumConnect> ON (1), or OFF (0)

Manual operation: See ["Use Reduced Number of Through"](#) on page 859

[SENSe<Ch>:]CORRection:COLLect:AUTO:MDELay <Port1>, <Port2>

Performs the delay mixer calibration step as part of an automatic calibration

Suffix:

<Ch> Number of the calibrated channel

Setting parameters:

<Port1> RF port

<Port2> IF port

Usage: Setting only

Options: R&S ZNA-K9

[SENSe<Ch>:]CORRection:COLLect:AUTO:MIXer <Port1>, <Port2>

Acquire calibration data for the calibration mixer in an automatic vector mixer calibration

Suffix:

<Ch> Channel number

Setting parameters:

<Port1> VNA port connected to the RF port of the calibration mixer

<Port2> VNA port connected to the IF port of the calibration mixer

Example: See [Chapter 8.2.5.6, "Vector mixer calibration using calibration units"](#), on page 1754

Usage: Setting only

Options: R&S ZNA-K5

[SENSe<Ch>:]CORRection:COLLect:AUTO:PORTs <Characterization>, <TestPort1>, <CalUnitPort1>[, <TestPort2>]...

Selects and initiates an automatic calibration at arbitrary analyzer and calibration unit ports. A progress monitor for the calibration sweeps is displayed.

Tip:

- This command is necessary if the analyzer fails to detect the cal unit ports connected to each of its ports (e.g. because of a high attenuation in the test setup). If auto-detection works you can use the simpler command `[SENSe<Ch>:]CORRection:COLLect:AUTO`.
- If several calibration units are connected, use `SYSTEM:COMMunicate:RDEvice:AKAL:ADDRESS` to select a unit for the calibration.

Suffix:

<Ch> Channel number of the calibrated channel

Setting parameters:

<Characterization> Location of the characterization (cal kit file) to be used for the automatic calibration (string parameter):

- If an empty string (' ') is specified, the factory cal kit file stored in the active calibration unit is used.
- A VNA cal kit file name `*.calkit` without path refers to a specific cal kit file stored in the internal memory of the active calibration unit.
- A VNA cal kit file name without path but prefixed with "SD:" refers to a specific cal kit file stored on the SD card inserted at the active calibration unit.
- A VNA cal kit file name `*.calkit` with path refers to a specific cal kit file stored in an arbitrary directory on the analyzer.

<TestPort1> Test port numbers. For an n-port automatic calibration, n arbitrary (not necessarily consecutive) port numbers must be specified.

<CalUnitPort1> Port numbers of the cal unit. For an n-port automatic calibration, n arbitrary (not necessarily consecutive) port numbers must be specified. It is possible to combine arbitrary (not necessarily matching) pairs of analyzer and cal unit ports.

<TestPort2>

Example:

```
CORR:COLL:AUTO:PORT ' ', 1, 2, 2, 4, 4, 1
```

Perform an automatic 3-port calibration at the analyzer ports 1, 2, and 4 using the calibration unit's default calibration kit file and ports 2, 4, and 1 of the cal unit.

Usage:

Setting only

Manual operation:

See "Apply" on page 582

[SENSe:]CORRection:COLLect:AUTO:PORTs:CONNection?

Returns the assignment between the physical analyzer ports and the ports of the connected automatic calibration unit.

Example: `CORR:COLL:AUTO:PORT '', 1, 2, 2, 4, 4, 1`
 Perform an automatic 3-port calibration at the analyzer ports 1, 2, and 4 using the calibration unit's default calibration kit file and ports 2, 4, and 1 of the cal unit.

`CORR:COLL:AUTO:PORT:CONN?`
 Query the actual port assignment. If the cal unit is properly connected according to the previous command, the response is 1,2,2,4,3,0,4,1. A zero means that the corresponding analyzer port is not connected to any port of the calibration unit.

Usage: Query only

Manual operation: See "[Detect Port Assignment](#)" on page 581

[SENSe<Ch>:]CORRection:COLLect:AUTO:PORTs:TYPE <CalType>[, <Characterization>[, <TestPort1>[, <CalUnitPort1>[, <TestPort2>]...]]]

Selects and initiates an automatic calibration at arbitrary test and calibration unit ports. A progress monitor for the calibration sweeps is displayed.

Tip: This command is necessary if the analyzer fails to detect the cal unit ports connected to each of its ports (e.g. because of a high attenuation in the test setup). If auto-detection works you can use the simpler command `[SENSe<Ch>:]CORRection:COLLect:AUTO:TYPE`.

Suffix:

<Ch> Channel number of the calibrated channel

Setting parameters:

<CalType> FNPort | TOSM | FOPort | OPTPort | FRTRans | FTRans | RTRans | REFL | RSHort | PFNPort | VUOSm | CPUosm | UMDelay | PUMDelay

See `[SENSe<Ch>:]CORRection:COLLect:AUTO:CONFigure` on page 1367.

<Characterization> Location of the characterization (cal kit file) to be used for the automatic calibration (string parameter):

- If an empty string (' ') is specified, the factory cal kit file stored in the active calibration unit is used.
- A VNA cal kit file name `*.calkit` without path refers to a specific cal kit file stored in the internal memory of the active calibration unit.
- A VNA cal kit file name without path but prefixed with "SD:" refers to a specific cal kit file stored on the SD card inserted at the active calibration unit.
- A VNA cal kit file name `*.calkit` with path refers to a specific cal kit file stored in an arbitrary directory on the analyzer.

<TestPort1>	Test port number. For an n-port automatic calibration, n arbitrary (not necessarily consecutive) port numbers must be specified. For a one path two port calibration (OPTPort), the first port no. denotes the source port (fully calibrated port).
<CalUnitPort1>	Port numbers of the cal unit. For an n-port automatic calibration, n arbitrary (not necessarily consecutive) port numbers must be specified. It is possible to combine arbitrary (not necessarily matching) pairs of analyzer and cal unit ports.
<TestPort2>	Second test port number *RST: n/a
Example:	<code>CORR:COLL:AUTO:PORT FNPort, ', 1, 2, 2, 4, 4, 1</code> Perform an automatic full 3-port calibration at test ports 1, 2, and 4 using the calibration unit's default calibration kit file and ports 2, 4, and 1 of the cal unit. See also [SENSe<Ch>:]CORRection:COLLect:AUTO:POWer
Usage:	Setting only
Manual operation:	See "Apply" on page 582

[SENSe<Ch>:]CORRection:COLLect:AUTO:POWer <TestPort>

Initiates a receiver power calibration at physical port <TestPort>. This is the second step of an automatic SMARTerCal.

Note: The power calibration must be performed "after" the system error correction; see example below.

Suffix:

<Ch> Channel number of the calibrated channel

Setting parameters:

<TestPort> Test port number. The port number must match the port number selected via [\[SENSe:\]CORRection:COLLect:PMETer:ID](#); see example.

- Example:** Suppose that a power meter no. 1 is configured and USB-connected to the analyzer.
`SENSe:CORRection:COLLect:PMETer:ID 1, 2`
 Select power meter no. 1, to be connected to Port 2.
 --> Connect the calibration unit between ports 1 and 2 of the analyzer,
`SENSe:CORRection:COLLect:AUTO:PORTs:TYPE`
`PFNPort, '', 1, 1, 2, 2`
 Perform an automatic full 2-port (UOSM) calibration at the analyzer test ports 1 and 2 using the calibration unit's default calibration kit file and default port assignments (ports 1 and 2 of the cal unit).
 --> Remove the cal unit and connect the power meter to Port 2 of the analyzer.
`SENSe:CORRection:COLLect:AUTO:POWer 2`
 Perform an additional receiver power calibration at Port 2. This completes the
- Usage:** Setting only
- Manual operation:** See "[Start Cal Sweep / Abort Sweep](#)" on page 581

[SENSe<Ch>:]CORRection:COLLect:AUTO:REPeat

Use this command to reuse measurement data of the active automatic calibration (if available) for the next automatic calibration. This data reuse allows an automatic calibration to be repeated without repeating all measurements.

Reusing existing calibration data is particularly useful for [inline calibrations](#), whose OSM measurements can be repeated without reconnections, but whose unknown through measurements can not.

Note that this command does not work with "single-command calibrations" performed using `[SENSe<Ch>:]CORRection:COLLect:AUTO:PORTs:TYPE`.

Suffix:

<Ch> Channel number

Example: See [Chapter 8.2.5.5, "Inline calibration"](#), on page 1754

Usage: Event

Manual operation: See "[Repeat Cal](#)" on page 589

[SENSe<Ch>:]CORRection:COLLect:AUTO:SAVE

Calculates the system error correction for automatic calibrations with [Multiple port assignments](#), saves the data and applies the calibration to the active channel.

Requires successful calibration sweeps for all related port assignments (see `[SENSe<Ch>:]CORRection:COLLect:AUTO:ASSignment<Asg>:ACQuire`)

Suffix:

<Ch> Channel number of the calibrated channel

- Example:** See `[SENSe<Ch>:]CORRection:COLLect:AUTO:ASSignment<Asg>:DEFine`
- Usage:** Event
- Manual operation:** See "Apply" on page 582

`[SENSe<Ch>:]CORRection:COLLect:AUTO:TEMPcomp <Boolean>`

Available if the calibration unit selected using `SYSTEM:COMMunicate:RDEVICE:AKAL:ADDRESS` is an [inline calibration system](#) (ICS) only. Applies to all inline calibration units (ICUs) that are connected to the selected ICS and that are used with factory characterization data .

If set to ON (1), the R&S ZNA firmware adjusts the factory characterization data according to the ICU temperatures.

Suffix:
`<Ch>` Channel number

Parameters:
`<Boolean>`

Manual operation: See "Temperature Compensation" on page 589

`[SENSe<Ch>:]CORRection:COLLect:AUTO:TERMination <ReceivingPort>`

Acquires receiver noise data in Channel `<Ch>`, with a matched load connected to `<ReceivingPort>`. This is part of a noise figure calibration using a calibration unit..

Suffix:
`<Ch>` Channel number

Setting parameters:
`<ReceivingPort>` Port number of the receiving port

Example: `SENSe1:CORRection:COLLect:AUTO:TERMination 2`
 Acquire noise data at receive port 2.

Usage: Setting only

Options: R&S ZNA-K30

`[SENSe<Ch>:]CORRection:COLLect:AUTO:TYPE <CalType>[, <Characterization>[, <TestPort1>[, <TestPort2>]...]]`

Selects and initiates an automatic calibration at arbitrary analyzer and cal unit ports. This command also selects the calibration type. A progress monitor for the calibration sweeps is displayed.

Tip: If the test setup contains a high attenuation the analyzer may fail to detect the cal unit ports connected to each of its ports. In this case use the extended command `[SENSe<Ch>:]CORRection:COLLect:AUTO:PORTs:TYPE`.

If several calibration units are connected, use `SYSTEM:COMMunicate:RDEvice:AKAL:ADDRESS` to select a unit for the calibration.

Suffix:

<Ch> Channel number of the calibrated channel

Setting parameters:

<CalType> FNPort | TOSM | FOPort | OPTPort | FRTRans | FTRans | RTRans | REFL | RSHort | PFOPort | POPTport | PFNPort | VUOSm | CPUosm | UMDelay | PUMDelay

See `[SENSe<Ch>:]CORRection:COLLect:AUTO:CONFigure` on page 1367.

<Characterization> Location of the characterization (cal kit file) to be used for the automatic calibration (string parameter):

- The empty string (' ') refers to the factory calibration of (and stored on) the active calibration unit.
- A VNA cal kit file name `*.calkit` without path refers to a specific cal kit file stored in the internal memory of the active calibration unit.
- A VNA cal kit file name without path but prefixed with "SD:" refers to a specific cal kit file stored on the SD card inserted at the active calibration unit.
- A VNA cal kit file name `*.calkit` with path refers to a specific cal kit file stored in an arbitrary directory on the analyzer.

<TestPort1> Test port numbers. For an n-port automatic calibration, n arbitrary (not necessarily consecutive) port numbers must be specified.

<TestPort2> Second test port number of the analyzer

Example:

```
CORR:COLL:AUTO:TYPE FNPort, '', 1, 2, 4
```

Perform an automatic full 3-port calibration at test ports 1, 2, and 4 using the calibration unit's default calibration kit file and arbitrary test ports of the cal unit.

Usage: Setting only

Manual operation: See "Apply" on page 582

`[SENSe<Ch>:]CORRection:COLLect:AUTO:UTHRough <TestPort1>, <TestPort2>`

With this command, you can perform the Unknown Through measurement during an automatic UOSM calibration.

Although it works for all calibration units, it is only useful if the calibration unit selected using `SYSTEM:COMMunicate:RDEvice:AKAL:ADDRESS` is an [inline calibration system](#) (ICS).

Suffix:

<Ch> Channel number

Setting parameters:

<TestPort1>, VNA test port numbers
<TestPort2>

Example: See [Chapter 8.2.5.5, "Inline calibration"](#), on page 1754.

Usage: Setting only

[SENSe:]CORRection:COLLect:AVERage <Average>

Activates automatic averaging, which means that the VNA may perform multiple calibration sweeps and apply averaging to reduce trace noise. In contrast to manual averaging (see [\[SENSe<Ch>:\]AVERage\[:STATe\]](#)) the number of calibration sweeps is calculated automatically.

Parameters:

<Average> AUTO | MANual

Manual operation: See ["Detector"](#) on page 645

[SENSe:]CORRection:COLLect:CHANnels:ALL <Boolean>

Enables calibration of all channels in the active recall set. The command is valid for the following calibration methods:

- Manual system error correction
- Automatic system error correction (cal unit)
- Manual SMARTerCal
- Automatic SMARTerCal (cal unit)

A scalar power calibration is not affected.

Parameters:

<Boolean> ON – calibrate all channels.
OFF – calibrate the active channel only.

Example: See [\[SENSe<Ch>:\]CORRection:COLLect:SAVE:SELeCted\[:DUMMy\]](#)

[SENSe<Ch>:]CORRection:COLLect:CHANnels:CSETup <Boolean>

Same as [\[SENSe:\]CORRection:COLLect:CSETup](#), but applies to channel <Ch> only.

Suffix:

<Ch> Channel number

Parameters:

<Boolean> **OFF (0)**
Individual sweep setups for all standards (faster for some configurations)

ON (1)

Common sweep setup for all standards (no preparation phase for each standard)

Note that noise figure calibrations require individual setups, and hence this setting is ignored.

*RST: OFF

Manual operation: See "[General>Same Sweep Setup for all Standards](#)" on page 591

[SENSe:]CORRection:COLLect:CHANnels:MCTypes <Boolean>

Toggles the **Multiple Calibration TTypes** mode that allows you to calibrate a subset of the available channels using channel-specific ports and calibration types (see [Chapter 4.5.8, "Parallel calibration of multiple channels"](#), on page 227).

Enable the MCTypes mode before defining the calibrations to be performed using `[SENSe<Ch>:]CORRection:COLLect:METHod:DEFine`. Disable the MCTypes mode after the calibrations were saved using `[SENSe<Ch>:]CORRection:COLLect:SAVE:SElected[:DUMMy]`. The latter must be called only *once*, with <Ch> referring to one of the channels to be calibrated (see the example below).

Parameters:

<Boolean>

Example:

Suppose that there are 3 channels in the current recall set and you want to calibrate channels 1 and 2. For channel 1, you want to perform a Reflection Normalization (Short) on ports 1 and 2, for channel 2 an OSM calibration on port 2. This calibration requires measuring standards as shown in the table below. Proceed as follows:

```
:CORRection:COLLect:CHANnels:MCTYPes ON
```

Activate the MCTYPes mode.

```
:SENSe1:CORRection:COLLect:METHod:DEFine
```

```
'Parser Test SFK Ch1', RSHort, 1, 2
```

```
:SENSe2:CORRection:COLLect:METHod:DEFine
```

```
'Parser Test SFK Ch2', FOPort, 2
```

Declare the calibrations to be performed. Then connect the Short standard to port 1

```
:SENSe:CORRection:COLLect:ACQuire:SElected  
SHORT, 1
```

Acquire calibration data for the short on port 1 (needed for calibration in channel 1). Then connect the Open standard to port 2.

```
:SENSe:CORRection:COLLect:ACQuire:SElected  
OPEN, 2
```

Acquire calibration data for the open on port 2 (needed for calibration in channel 2). Then connect the Short standard to port 2.

```
:SENSe:CORRection:COLLect:ACQuire:SElected  
SHORT, 2
```

Acquire calibration data for short on port 2 (needed for calibrations in channel 1 and 2). Then connect the Match standard to port 2.

```
:SENSe:CORRection:COLLect:ACQuire:SElected  
MATCH, 2
```

Acquire calibration data for match on port 2 (needed for calibration in channel 2).

```
:SENSe1:CORRection:COLLect:SAVE:SElected
```

Complete all calibrations. This command is required only once and has to address one of the calibrated channels (channel 1 or 2 in this example).

```
:CORRection:COLLect:CHANnels:MCTYPes OFF
```

Deactivate the MCTYPes mode. Recommended for compatibility with manual operation.

	Port 1	Port 2
Channel 1 Reflection Normalization(Short) for ports 1 and 2	Short	Short
Channel 2 OSM for port 1	-	Open, Short, Match

```
[SENSe<Ch>:]CORRection:COLLect:CKIT:INSTall <CalKitFile>, <Gender>[,
    <Ports>]
```

Allows you to load cal kit data by gender:

- From the given file
- To the given ports or all ports

Use [MMEMory:CKIT:INFO?](#) on page 1276 to get information about cal kit files.

Suffix:

<Ch> Channel number

Setting parameters:

<CalKitFile> Path to the cal kit file, either absolute or relative to the current directory (see [MMEMory:CDIRectory](#))

<Gender> MALE | FEMale | NGENder

<Ports> Either a comma-separated list of port numbers or ALL (optional)

Usage: Setting only

```
[SENSe<Ch>:]CORRection:COLLect:CKIT:LOAD <CalKitName>, <KitLabel>,
    <Gender>[, <Ports>]
```

Allows you to load cal kit data by name, label and gender:

- From the pool
- To the given ports or all ports

Suffix:

<Ch> Channel number

Setting parameters:

<CalKitName> The name of the cal kit to be loaded

<KitLabel> The label of the cal kit to be loaded

<Gender> MALE | FEMale | NGENder
The gender of the cal kit to be loaded

<Port> Either a comma-separated list of port numbers or ALL (optional)

Usage: Setting only

```
[SENSe<Ch>:]CORRection:COLLect:CKIT:PORT<PhyPt>? [<Detail>]
```

Queries the cal kit data assigned to the given port via

- [\[SENSe<Ch>:\]CORRection:COLLect:CKIT:LOAD](#)
or [\[SENSe<Ch>:\]CORRection:COLLect:CKIT:INSTall](#)

Suffix:

<Ch> Channel number

<PhyPt> Port number

[SENSe<Ch>:]CORRection:COLLect:CONNection:GENDeRS <Gender>

Qualifies whether the genders at the test ports (but not their connector types) are equal or independent.

Suffix:

<Ch> Channel number of the calibrated channel

Parameters:

<Gender> ALL | SINGle
 ALL – equal (uniform) genders. If the gender at one port is changed, the connector type at all other ports is changed accordingly.
 SINGle – independent (possibly non-uniform) genders at the ports.
 *RST: SINGle

Example: See [\[SENSe<Ch>:\]CORRection:COLLect:CONNection:PORTs](#)

Manual operation: See ["Same Connector All Ports / Same Gender All Ports"](#) on page 647

[SENSe<Ch>:]CORRection:COLLect:CONNection:PORTs <ConnectorType>

Qualifies whether the connector types at the test ports (but not their gender) are equal or independent. Some calibration types require uniform port connector types.

Suffix:

<Ch> Channel number of the calibrated channel

Parameters:

<ConnectorType> ALL | SINGle
 ALL – equal (uniform) connector types. If the connector type at one port is changed, the connector type at all other ports is changed accordingly.
 SINGle – independent (possibly non-uniform) connector types at the ports.
 *RST: ALL

Example: CORR:COLL:CONN:PORTS SING
 Select independent connector types at the ports.
 CORR:COLL:CONN1 N50MALE; CONN4 N75FEMALE;
 CONN2?
 Select independent connector types at ports 1 and 4. The connector type at port 2 is not changed; the query returns N50FEMALE.

Manual operation: See ["Same Connector All Ports / Same Gender All Ports"](#) on page 647

[SENSe:]CORRection:COLLect:CSETup <Boolean>

Defines how calibration sweeps are prepared and performed.

This setting is valid for manual and automatic calibration.

See [\[SENSe<Ch>:\]CORRection:COLLect:CHANnels:CSETup](#) for a channel-specific variant of this setting.

Parameters:

<Boolean>	OFF (0) Individual sweep setups for all standards (faster for some configurations)
	ON (1) Common sweep setup for all standards (no preparation phase for each standard) Note that noise figure calibrations require individual setups, and hence this setting is ignored.
	*RST: OFF

Manual operation: See ["Same Sweep Setup for All Standards"](#) on page 859

[SENSe<Ch>:]CORRection:COLLect:DELeTe [<CalName>]

Deletes system error correction data generated and stored previously.

Suffix:

<Ch> Channel number of the calibrated channel

Setting parameters:

<CalName>	Name of the calibration (string parameter) defined together with the calibration type ([SENSe<Ch>:]CORRection:COLLect:METhod:DEFine).
	ALL - the analyzer deletes all calibrations.
	If nothing is specified the analyzer deletes the last system error correction stored by means of [SENSe<Ch>:]CORRection:COLLect:SAVE:SELeCted[:DUMMy] .
	*RST: -

Example:

```
CORR:COLL:METH:DEF 'Test',RShort,1
Select a one-port normalization at port 1 with a short standard
as calibration type.
CORR:COLL:SEL SHOR,1
Measure a short standard connected to port 1 and store the
measurement results of this standard.
CORR:COLL:SAVE:SEL
CORR:COLL:DEL ALL
Calculate the system error correction data and apply it to the
active channel, then delete the data.
```

Usage: Setting only

Manual operation: See ["Apply"](#) on page 578

[SENSe<Ch>:]CORRection:COLLect:DETEctor <CalName>[, <CalDetectorType>]

Selects the detector type during manual calibration <CalName>.

Suffix:

<Ch> Channel number

Parameters:

<CalName> Name of a manual calibration previously created e.g. using
[\[SENSe<Ch>:\]CORRection:COLLect:METhod:DEFine](#)

<CalDetectorType> NORMAL | AVERAge

AVERAge

Average detector, recommended for channels measuring traces using detectors other than the NORMAL one

Automatically selected for noise figure calibrations (see [\[SENSe<Ch>:\]CORRection:COLLect:NFIgure:START](#)).

NORMAL

Normal (sample) detector, recommended for all other applications

*RST: NORMAL

Manual operation: See "[Detector](#)" on page 645

[SENSe<Ch>:]CORRection:COLLect:DISCard

Terminates a system error correction, discarding the acquired data.

Suffix:

<Ch> Channel number of the calibrated channel

Example:

```
:SENSe1:CORRection:COLLect:METhod:DEFine 'Test', TOSM, 1, 2
:SENSe1:CORRection:COLLect:ACQuire:SELEcted THROugh, 1, 2
:SENSe1:CORRection:COLLect:ACQuire:SELEcted OPEN, 1
:SENSe1:CORRection:COLLect:ACQuire:SELEcted SHORt, 1
:SENSe1:CORRection:COLLect:ACQuire:SELEcted MATCh, 1
:SENSe1:CORRection:COLLect:ACQuire:SELEcted OPEN, 2
:SENSe1:CORRection:COLLect:ACQuire:SELEcted MATCh, 2
:SENSe1:CORRection:COLLect:DISCard
```

Usage:

Event

**[SENSe<Ch>:]CORRection:COLLect:FIXTure[:ACQuire] <StandardType>,
 <TestPort1>[, <TestPort2>]...**

Starts a fixture compensation sweep in order to acquire measurement data for a test fixture that has its inner conductor terminated with the selected standards.

Suffix:

<Ch> Channel number of the corrected channel

Setting parameters:

<StandardType> OPEN | SHORt

Terminating standard type: open or short.

<TestPort1>

<TestPort2>

Test port numbers. For a fixture compensation, n arbitrary (not necessarily consecutive) port numbers must be specified.

*RST: -

Example:

```
*RST; CORR:COLL:FIXT:LMP:LOSS OFF
```

Configure a fixture compensation measurement (for all channels): The analyzer performs an Auto Length (no loss) calculation.

```
CORR:COLL:FIXT:ACQ OPEN, 2; :CORR:COLL:FIXT:ACQ SHOR, 4
```

Perform a fixture compensation sweep at port 2, terminated with an open standard, and at port 4, terminated with a short.

```
CORR:COLL:FIXT:SAVE
```

Save and apply the compensation data.

```
CORR:COLL:FIXT:STAR
```

Prepare a new fixture compensation measurement, deleting the previous data for channel 1.

```
CORR:COLL:FIXT:LMP OFF
```

Select a Direct Compensation measurement (for all channels and traces).

```
CORR:COLL:FIXT:ACQ SHOR, 1, 3
```

Perform a fixture compensation sweep at ports 1 and 3, terminated with a short standard.

```
CALC2:PAR:SDEF 'Trc2', 'S22'
```

Create channel no. 2 with a trace named Trc2.

```
SENS2:CORR:COLL:FIXT:STAR
```

Prepare a fixture compensation measurement for channel 2. The channel 1 data is not affected.

```
SENS2:CORR:COLL:FIXT:ACQ SHOR, 1, 3
```

Repeat the previous fixture compensation sweep for channel 2.

```
SENS1:CORR:COLL:FIXT:SAVE; :SENS2:CORR:COLL:FIXT:SAVE
```

Save and apply the compensation data for both channels.

```
SENS1:CORR:OFFS3:DFC?; :SENS2:CORR:OFFS3:DFC?
```

Query whether the analyzer uses Direct Compensation results at port 3. The response is 1;1 (true for both channels).

Usage:

Setting only

Manual operation:

See "[Measure Fixture wizard](#)" on page 720

[SENSe<Ch>:]CORRection:COLLect:FIXTure:EXPort <FixtureFile>, <StandardType>, <TestPort1>[, <TestPort2>]...

[SENSe<Ch>:]CORRection:COLLect:FIXTure:IMPort <FixtureFile>, <StandardType>, <TestPort1>[, <TestPort2>]...

Loads/saves "Direct Compensation" data from/to the specified file.

The EXPort command first acquires the required data, just as a [SENSe<Ch>:]CORRection:COLLect:FIXTure[:ACQuire] would do.

"Direct Compensation" data files are standard [Trace files](#), containing reflection parameter traces for the related port(s) and standard.

Table 7-16: Direct Compensation data

#TestPorts	File Type
1	s1p
>=1	csv

For 1-port Touchstone files (*.s1p) only a single test port can be specified - otherwise an error is raised.

Suffix:

<Ch> Channel number

Parameters:

<FixtureFile> Path to the "Direct Compensation" data file, either absolute or relative to the current directory (set/queried using [MMEMory:CDIRectory](#))

Setting parameters:

<StandardType> OPEN | SHORt
Terminating standard type

<TestPort1>[, <TestPort2>, ...] Test port numbers. For a fixture compensation, n different (but not necessarily consecutive) port numbers must be specified.

Example:

```
*RST; SENSE1:CORR:COLL:FIXT:LMP OFF
```

Activate "Direct Compensation".

```
SENSE1:CORR:COLL:FIXT:EXP 'Traces\p12_short.csv', SHOR, 1, 2
```

Acquire "Direct Compensation" data for ports 1 and 2 (whose inner connectors have to be terminated with a Short) and save the acquired data to file.

In a subsequent measurement session you can load and apply these data as follows:

```
*RST;
:SENSE1:CORR:COLL:FIXT:LMP OFF
:SENSE1:CORR:COLL:FIXT:IMP 'Traces\p12short.csv', SHOR, 1, 2
:SENSE1:CORR:COLL:FIXT:SAVE
```

Usage: Setting only

Manual operation: See ["Measure Fixture wizard"](#) on page 720

[SENSe:]CORRection:COLLect:FIXTure:LMPParameter[:STATe] <Boolean>

Selects an Auto Length (and Loss) calculation or a Direct Compensation.

Parameters:

<Boolean> 1 - Auto Length (and Loss), depending on the last
[SENSe<Ch>:]CORRection:COLLect:FIXTure:
LMPParameter:LOSS[:STATe] setting
0 - Direct Compensation
*RST: 1

Example: See [\[SENSe<Ch>:\]CORRection:COLLect:FIXTure\[:ACQuire\]](#)

Manual operation: See ["Direct Compensation"](#) on page 720

[SENSe:]CORRection:COLLect:FIXTure:LMPParameter:LOSS[:STATe] <Boolean>

Selects an Auto Length or an Auto Length and Loss calculation.

Parameters:

<Boolean> 1 - Auto Length and Loss
0 - Auto Length, no loss
*RST: 1

Example: See [\[SENSe<Ch>:\]CORRection:COLLect:FIXTure\[:ACQuire\]](#)

Manual operation: See ["Auto Length / Auto Length and Loss"](#) on page 720

[SENSe<Ch>:]CORRection:COLLect:FIXTure:SAVE

Completes a fixture compensation, storing and applying the acquired data.

Suffix:

<Ch> Channel number of the corrected channel

Example: See [\[SENSe<Ch>:\]CORRection:COLLect:FIXTure\[:ACQuire\]](#)

Usage: Event

Manual operation: See ["Measure Fixture wizard"](#) on page 720

[SENSe<Ch>:]CORRection:COLLect:FIXTure:START

Prepares the analyzer for fixture compensation comprising a single or a series of fixture compensation sweeps

([SENSe<Ch>:]CORRection:COLLect:FIXTure[:ACQuire]). Previous compensation data is deleted.

Suffix:	
<Ch>	Channel number of the corrected channel
Example:	See [SENSe<Ch>:]CORRection:COLLect:FIXTure[:ACQuire]
Usage:	Event
Manual operation:	See "Measure Fixture wizard" on page 720

[SENSe<Ch>:]CORRection:COLLect:LOAD:SElected <CalGroupFile>, <Standard>, <TestPort1>[, <SecondPortOrAdapter>]

Reloads a set of previously acquired calibration data for a particular standard from a file in the cal pool. The loaded data may be combined with new calibration measurement data ([\[SENSe<Ch>:\]CORRection:COLLect\[:ACQuire\]:SElected](#)) in order to simplify and speed up the new calibration procedure. The channel settings for loaded and new calibrations (e.g. the number of sweep points) must be identical.

Note:

- The analyzer performs a consistency check for the loaded data. If the loaded file is incompatible with the channel settings of channel <Ch>, or if it does not contain data for the specified standard and port(s), a command error message (-100, "Command error;...") is generated.
- For a sliding match, the R&S ZNA can acquire and load measurement data for up to 20 positions per port. Multiple calls of [\[SENSe<Ch>:\]CORRection:COLLect:LOAD:SElected](#) <CalGroupFile>, SLIDE, <TestPort> for the same cal group file and test port, implicitly increases the position until position 20 has been recorded. Subsequent calls will start over at position 1, overwriting the previously loaded data.

Suffix:	
<Ch>	Channel number of the calibrated channel
Parameters:	
<CalGroupFile>	String parameter to specify the name of the loaded cal group file.
<Standard>	THROUGH OPEN SHORT OSHort OSHort1 OSHort2 OSHort3 MATCH NET ATT REFL SLIDE ISOLation LINE LINE1 LINE2 LINE3 UTHRough POWer MIXer TERMination EATTenuator MDELay See [SENSe<Ch>:]CORRection:COLLect[:ACQuire]:SElected on page 1356.
<TestPort1>	Test port number. For a transmission standard (through, line, attenuation, symmetric network) or an adapter used as a "through" the input and output port numbers must be specified. For reflection standards, only one port number is required.

Setting parameters:

`<SecondPortOrAdapter>` For a transmission standard or an adapter used as a "through" this parameter specifies the second test port. For reflection measurements with an adapter connected between port and standard, set it to ON. Otherwise set it to OFF or simply omit it.

Example:

Suppose that the cal pool contains a file 'Calgroup3.cal' with a valid through calibration for the active channel no. 1, which you want to include in a new TOSM calibration for ports 1 and 2.

```
MMEM:CDIR DEF; CDIR 'Calibration\Data'
```

Go to the cal group directory.

```
:SENSe1:CORRection:COLLect:MEthod:DEFine 'New Cal', TOSM, 1, 2
```

Define a new TOSM calibration.

```
SENSe1:CORRection:COLLect:LOAD:SElected 'Cal Group 3.cal', THROUGH, 1, 2
```

Load the through data from the cal pool file into the new calibration.

```
SENSe1:CORRection:COLLect:ACquire:SElected OPEN, 1
```

Proceed with the new calibration measurements.

Manual operation: See ["Start Cal Sweep"](#) on page 576

[SENSe<Ch>:]CORRection:COLLect:MEthod:DEFine <CalName>, <CalType>, <TestPort1>[, <TestPort2>[, <TestPort3orAdapterCalKit>[, <TestPorts>]...]]

Defines the calibration to be performed for channel <Ch>.

If multiple channels shall be calibrated in parallel, use

- `[SENSe:]CORRection:COLLect:CHANnels:ALL` ON or
- `[SENSe:]CORRection:COLLect:CHANnels:MCTypes` ON

before executing this command. For background information see [Chapter 4.5.8, "Parallel calibration of multiple channels"](#), on page 227.

Calibration data is acquired using `[SENSe<Ch>:]CORRection:COLLect[:ACquire]:SElected`.

Suffix:

<Ch> Channel number

Parameters:

<CalName> Name of the calibration (string parameter). The name serves as a reference to delete a particular set of system correction data (`[SENSe<Ch>:]CORRection:COLLect:DElete`).

<CalType>	ARTosm ARPTosm PRRCv REFL RSHort FOPort FRTRans FTRans RTRans OPTPort POPTport TOSM TOM TSM TRM TRL TNA UOSM VUOSm PTOSm PTOM PTSM PTRM PTRL PTNA PUOSm VPUosm CPUosm MTOSm MUOSm MOSM MTRL Calibration types; see list below.
<TestPort1>	First calibrated test port number. For an n-port calibration type, n port numbers must be specified. If more than n numbers are defined, the spare numbers (the last ones in the list) are ignored. Entering less than n numbers causes an error message. For a one path two port calibration (OPTPort), the first port no. denotes the node port (fully calibrated port).
<TestPort2>	Second calibrated port number.
<TestPort3 or AdapterCalKit>	Either the third calibrated port number, or - for Adapter Removal calibrations only - the file path (relative to the current directory) where the analyzer shall store the adapter characterization obtained during the calibration. The latter is optional. If a file path is provided the characterization file (in Touchstone s2p format) is generated when the correction terms are finally calculated (<code>[SENSe<Ch>:]CORRection:COLLect:SAVE:SELEcted[:DUMMy]</code>).
<TestPorts>	More ports to be calibrated.

Example:

```
:SENSE1:CORRECTION:COLLECT:METHOD:DEFine
'Test', ARTosm, 1,2, 'Adapter.s2p'
```

Initiate an Adapter Removal calibration for ports 1 and 2 on channel 1 and store the adapter characterization in <MEMORY:CDIR?>\Adapter.s2p.
For another example see `[SENSe<Ch>:]CORRection:COLLect:SAVE:SELEcted[:DUMMy]`.

Manual operation: See "Calibration Type" on page 585

The supported calibration types are listed below.

Parameter	Type (GUI)
ARTosm	Adapter Removal
REFL RSHort	Refl Norm Open Refl Norm Short
FOPort	Full One Port ("Refl OSM")
FTRans RTRans FRTRans	Trans Norm - Forward Trans Norm - Reverse Trans Norm Both "Forward" ("Reverse") means that the port with the smaller (larger) port number serves as a drive port.
OPTPort	One Path Two Ports
TOSM	TOSM
UOSM	UOSM

Parameter	Type (GUI)
VUOSm	UOSM Vector Mixer
TRL TOM TSM TRM TNA	TRL TOM TSM TRM TNA
ARPTosm POPTport PTOSm PUOSm VPUosm PTRL PTOM PTSM PTRM PTNA	One of the previous n-port calibration types, in combination with a receiver power calibration at test port <TestPort1> (SMARTerCal)
PFTRans, PRTRans, PFRTrans	FTRans, RTRans, in combination with a receiver power calibration at the source port(s)
PREFI, PRSHort, PFOPort	REFI, RSHort, FOPort, in combination with a receiver power calibration at all ports
PRRCv	Reference receiver power calibration at all ports
CPUOSm	PUOSM Scalar Vector Mixer
MTOSm MUOSm MOSM MTRL	METAS Calibration of type OSM, UOSM, OSM, or TRL
MDElay	Mixer Delay Delay mixer calibration (stand-alone) for two-tone group delay measurements
UMDelay	UOSM Mixer Delay calibration UOSM combined with delay mixer calibration for two-tone group delay measurements (R&S ZNA-K9)
PUMDelay	UMDelay calibration with complementary source flatness cal for two-tone group delay measurements (R&S ZNA-K9)

[SENSe<Ch>:]CORRection:COLLect:NFIGure[:ACQuire] <arg0>

Starts one of the three noise calibration sweeps that are required for a noise figure calibration of the related channel.

The noise figure calibration is initiated using `[SENSe<Ch>:]CORRection:COLLect:NFIGure:START` and must be terminated by one of the commands `[SENSe<Ch>:]CORRection:COLLect:NFIGure:END` or `[SENSe<Ch>:]CORRection:COLLect:NFIGure:SAVE`.

Note: A noise figure calibration must be terminated with one of the following commands, to be sent immediately after the sequence of `...[:ACQuire]` commands:

- Abort the noise figure calibration, discarding the acquired calibration data.
- Terminate the noise figure calibration, applying the acquired calibration data (the active channel is calibrated) These commands ensure that the analyzer is able to start a new measurement sweep.

Suffix:

<Ch> Number of the channel to be noise figure calibrated.
The other noise figure calibration commands must use the same channel number.

Setting parameters:

<arg0> RECeiver | SOURce | ATTenuator

RECeiver – a receiver noise calibration is performed
 SOURce – a source noise calibration is performed
 ATTenuator – noise calibration of the external attenuator is performed (optional, only if an external attenuator is used; see [\[SENSe<Ch>:\]CORRection:COLLect:NFIGure:START](#)).
 The calibration steps have to be performed in the order SOURce → RECeiver → ATTenuator.

Example: See [Chapter 8.2, "Condensed programming examples"](#), on page 1731.

Usage: Setting only

Options: R&S ZNA-K30

[SENSe<Ch>:]CORRection:COLLect:NFIGure:END

Terminates a noise figure calibration, discarding the acquired calibration data.

A noise figure calibration is initiated using [\[SENSe<Ch>:\]CORRection:COLLect:NFIGure:START](#) and data are acquired using [\[SENSe<Ch>:\]CORRection:COLLect:NFIGure\[:ACquire\]](#). It must be terminated by one of the commands [\[SENSe<Ch>:\]CORRection:COLLect:NFIGure:SAVE](#) or [\[SENSe<Ch>:\]CORRection:COLLect:NFIGure:END](#).

Suffix:
 <Ch> Number of the channel to be noise figure calibrated.
 All commands related to a noise figure calibration must use the same channel number.

Example: See [Chapter 8.2, "Condensed programming examples"](#), on page 1731.

Usage: Event

Options: R&S ZNA-K30

[SENSe<Ch>:]CORRection:COLLect:NFIGure:SAVE

Completes a noise figure calibration, storing and applying the acquired calibration data.

A noise figure calibration is initiated using [\[SENSe<Ch>:\]CORRection:COLLect:NFIGure:START](#) and data are acquired using [\[SENSe<Ch>:\]CORRection:COLLect:NFIGure\[:ACquire\]](#). It must be terminated by one of the commands [\[SENSe<Ch>:\]CORRection:COLLect:NFIGure:SAVE](#) or [\[SENSe<Ch>:\]CORRection:COLLect:NFIGure:END](#).

In case a noise measurement is missing, an error is reported. In this case, simply perform the missing ACQ step, then repeat SAVE.

Suffix:
 <Ch> Number of the channel to be noise figure calibrated.
 All commands related to a noise figure calibration must use the same channel number.

Example:	See Chapter 8.2, "Condensed programming examples" , on page 1731.
Usage:	Event
Options:	R&S ZNA-K30

[SENSe<Ch>:]CORRection:COLLect:NFIGure:STARt <arg0>, <arg1>, <arg2>, <arg3>, <arg4>

Initiates a noise figure calibration for the related channel.

The calibration sweeps are started using `[SENSe<Ch>:]CORRection:COLLect:NFIGure[:ACQuire]`, the noise figure calibration is terminated using `[SENSe<Ch>:]CORRection:COLLect:NFIGure:SAVE` or `[SENSe<Ch>:]CORRection:COLLect:NFIGure:END`.

Suffix:

<Ch> Number of the channel to be noise figure calibrated.
The subsequent noise figure calibration commands must use the same channel number.

Setting parameters:

<arg0> Number of the physical VNA port connected to the DUT output.
<arg1> Number of the physical VNA port connected to the DUT input.
<arg2> ON | OFF - Boolean parameter, indicating whether an external attenuator is used.
<arg3> Attenuation of the source level during the source noise calibration.
<arg4> Attenuation of the source level during the measurement (i.e. after calibration).

Example: See [Chapter 8.2, "Condensed programming examples"](#), on page 1731.

Usage: Setting only
Options: R&S ZNA-K30

[SENSe:]CORRection:COLLect:PMETER:ID <PowerMeter>, <TestPort>

Selects an external power meter for the SMARTerCal and assigns it to an analyzer port.

Note: The command cannot be used unless a power meter is connected via GPIB bus, USB or LAN interface and configured in the "External Power Meters" dialog.

Parameters:

<PowerMeter>	Number of external power meter. The parameters UP, DOWN, MIN, MAX are not available for this command. Range: 1 to number of configured external generators *RST: The power meter selection is not changed by a reset of the analyzer.
<TestPort>	Test port number. During power calibration, the power meter is connected to this port. *RST: 1 to the number of test ports

Example: See `[SENSe<Ch>:]CORRection:COLLect:AUTO:POWer`

Manual operation: See "Power Meter" on page 587

[SENSe<Ch>:]CORRection:COLLect:SAVE:SELected:DEFault

Generates a set of default system error correction data for the selected ports and calibration type. The default data set corresponds to a test setup which does not introduce any systematic errors; none of the measurement results acquired previously (`[SENSe<Ch>:]CORRection:COLLect[:ACQuire]:SELected`) is taken into account.

Tip: The main purpose of the default correction data set is to provide a dummy system error correction which you can replace with your own, external correction data. You may have acquired the external data in a previous session or even on an other instrument. If you want to use the external correction data on the analyzer, simply generate the default data set corresponding to your port configuration and calibration type and overwrite the default data. For details refer to the program example below.

Suffix:

<Ch> Channel number of the calibrated channel.

Example:

```
CORR:COLL:METH:DEF 'Test',RShort,1
```

Select a one-port normalization at port 1 with a short standard as calibration type.

```
CORR:COLL:SAVE:SEL:DEF
```

Calculate a dummy system error correction for the normalization at port 1. The dummy system error correction provides the reflection tracking error term 'REFLTRACK'.

```
CORR:CDAT? 'REFLTRACK',1,0
```

Query the dummy system error correction term. The response is a 1 (written as 1,0 for the real and imaginary part) for each sweep point (no attenuation and no phase shift between the analyzer and the calibration plane).

```
INIT:CONT OFF; :INIT; *WAI
```

Stop the sweep to ensure correct transfer of calibration data.

```
CORR:CDAT 'REFLTRACK',1,0,<ASCII_data>
```

Replace the dummy system error correction term with your own correction data, transferred in ASCII format.

```
INIT:CONT ON
```

Restart the sweep in continuous mode.

Usage: Event

Manual operation: See "Apply" on page 578

[SENSe<Ch>:]CORRection:COLLect:SAVE:SELEcted[:DUMMy]

Calculates the system error correction data from the acquired measurement results ([SENSe<Ch>:]CORRection:COLLect[:ACQuire]:SELEcted), stores it and applies it to the calibrated channel(s). To avoid incompatibilities, older system error correction data is deleted unless it has been transferred into a cal pool (MMEMory:STORe:CORRection <Ch>, '<file_name>').

Suffix:

<Ch> One of the calibrated channels
 If [SENSe:]CORRection:COLLect:CHANnels:ALL is ON this suffix can be omitted

Example:

```
CORRection:COLLect:METhod:DEFine 'Test',RShort,1
```

Select a one-port normalization at port 1 with a short standard as calibration type.

```
CORRection:COLLect:CHANnels:ALL ON
```

Enable calibration in all channels of the active recall set.

```
CORRection:COLLect:SELEcted SHOR,1
```

Measure a short standard connected to port 1 and store the measurement results of this standard.

```
CORRection:COLLect:SAVE:SELEcted
```

Calculate the system error correction data and apply it to all channels of the active recall set.

Usage: Event

Manual operation: See "Apply" on page 578

[SENSe<Ch>:]CORRection:COLLect:SCONnection<PhyPt> <Type>[, <Gender>]

Selects a connector type at a specified port <PhyPt> and its gender. In contrast to [SENSe<Ch>:]CORRection:COLLect:CONNECTION<PhyPt>, this command uses a string variable to identify the connector type.

Suffix:

<Ch> Channel number of the calibrated channel

<PhyPt> Port numbers of the analyzer. If the analyzer is set to use the same connectors at all ports ([SENSe<Ch>:]CORRection:COLLect:CONNECTION:PORTs ALL), then a change of a connector type is valid for all ports. The gender of the connectors can still be different.

Parameters:

<Type>	Connector type (string parameter) of the connectors. See "Cal kit naming conventions" under [SENSe:]CORRection:CKIT:<ConnType>:SElect .
	*RST: 'N 50 Ohm',FEM for all ports.
<Gender>	MALE FEMale Gender of the connectors. The gender designation is not necessary (and ignored) for sexless connector types.

Example:

```
*RST; :CORR:COLL:SCON1 'N 75 Ohm', MALE; SCON4?
Change the connector type at port 1 from 'N 50 Ohm', FEM to 'N 75 Ohm', MALE. The connector type at the other ports is also changed to N 75 Ohm, however, the gender (female) is maintained. CORR:COLL:SCON4? returns 'N 75 Ohm', FEM.
```

Manual operation: See "[Connector / Gender](#)" on page 584

7.3.14.9 [SENSe:]CORRection:METas

Using [\[SENSe:\]CORRection:METas](#) commands you can define additional properties of a [METAS Calibration](#).

To perform a METAS calibration, use the standard commands for manual calibration (see [Chapter 7.3.14.10, "\[SENSe:\]CORRection... \(other\)"](#), on page 1398). For the calibration setup, use [\[SENSe<Ch>:\]CORRection:COLLect:METhod:DEFine](#) with METAS calibration types `MTOsm` | `MUOSm` | `MOSM` | `MTRL`.



- METAS calibration is not fully supported via remote control. The import of cal kits with uncertainties must be performed from the analyzer GUI, and must be done before the first METAS calibration.

[SENSe:]CORRection:METas:CABLe:CATalog?	1395
[SENSe<Ch>:]CORRection:METas:CABLe:MOVement	1396
[SENSe<Ch>:]CORRection:METas:CABLe:REConnection	1396
[SENSe<Ch>:]CORRection:METas:CABLe:TYPE	1396
[SENSe<Ch>:]CORRection:METas[:STATe]	1397
[SENSe<Ch>:]CORRection:METas:UNCertainty	1397

[SENSe:]CORRection:METas:CABLe:CATalog?

Lists the available METAS cable models, identified by their file names (without *.cable extension) in the local METAS VNA Tools II database.

Usage:	Query only
Options:	R&S ZNA-K50
Manual operation:	See " Cable " on page 646

[SENSe<Ch>:]CORRection:METAs:CABLe:MOVement [<Ports>[, <Ports>]...]

While a METAS calibration is active for the related channel (see [\[SENSe<Ch>:\]CORRection:METAs\[:STATe\]](#) on page 1397), this command notifies the METAS VNA Tools II about additional cable movements at the specified ports.

Suffix:

<Ch> Channel number

Setting parameters:

<Ports> **<integer>**
First port number, where cables were moved

ALL

Cable movements at all calibrated ports

NONE

Clears the cable movement history in the METAS project

<Ports> Additional port numbers, where cables were moved

Usage: Setting only

Options: R&S ZNA-K50

Manual operation: See ["Add New Connection/Add Cable Movement"](#) on page 652

[SENSe<Ch>:]CORRection:METAs:CABLe:REConnection [<Ports>[, <Ports>]...]

While a METAS calibration is active for the related channel (see [\[SENSe<Ch>:\]CORRection:METAs\[:STATe\]](#) on page 1397), this command notifies the METAS VNA Tools II about additional connector reconnections at the specified ports.

Suffix:

<Ch> Channel number

Setting parameters:

<Ports> **<integer>**
First port number, where connectors were reconnected

ALL

All ports were reconnected

NONE

Clears the connector reconnection history in the METAS project

<Ports> Additional port numbers, where connectors were reconnected

Usage: Setting only

Options: R&S ZNA-K50

Manual operation: See ["Add New Connection/Add Cable Movement"](#) on page 652

[SENSe<Ch>:]CORRection:METAs:CABLe:TYPE <CableNameFile>[, <Ports>[, <Ports>]...]

Selects the METAS cable type that is used at the respective ports.

Use `[SENSe:]CORRection:METas:CABLe:CATaLog?` to list the available cable types.

Suffix:

<Ch> Channel number
 The related channel must be prepared for a METAS calibration using `[SENSe<Ch>:]CORRection:COLLect:METhod:DEFine<CalName>`, `MTOSm` | `MUOSm` | `MOSM` | `MTRL`,

Setting parameters:

<CableNameFile> Name of a METAS cable model file (without `*.cable` extension) in the database of the local METAS VNA Tools II installation.

<Ports> First port number or `ALL`, if the same cable type is used for all ports.
 The latter is equivalent to omitting all <Ports> parameters.

<Ports> Additional port numbers

Usage: Setting only

Options: R&S ZNA-K50

Manual operation: See "[Cable](#)" on page 646

[SENSe<Ch>:]CORRection:METas[:STATe] <Boolean>

After a successful METAS calibration, this command activates or deactivates the uncertainty calculation for the related channel.

Suffix:

<Ch> Channel number

Parameters:

<Boolean> **ON (1)**
 METAS calibration active
OFF (0)
 METAS calibration inactive

Options: R&S ZNA-K50

Manual operation: See "[METAS Cal Active](#)" on page 642

[SENSe<Ch>:]CORRection:METas:UNCertainty <Level>

Defines the width of the [uncertainty band](#), expressed as multiples of the standard deviation.

Default is 2 (95% confidence interval).

Suffix:

<Ch> Channel number

Parameters:

<Level> Scalar value between 1 and 10
 Increment: 0.1
 *RST: 2

Manual operation: See "[Significance](#)" on page 644

7.3.14.10 [SENSe:]CORRection... (other)

The remaining [SENSe:]CORRection... commands.

[SENSe<Ch>:]CORRection:CDAta.....	1399
[SENSe<Ch>:]CORRection:CDAta:PORT<PhyPt>.....	1399
[SENSe<Ch>:]CORRection:CONNection.....	1401
[SENSe<Ch>:]CORRection:CONNection:CATalog?.....	1402
[SENSe<Ch>:]CORRection:CONNection:DELeTe.....	1403
[SENSe<Ch>:]CORRection:DATA:PARAmeter<Sfk>?.....	1404
[SENSe<Ch>:]CORRection:DATA:PARAmeter<Sfk>:PORT<PhyPt>?.....	1404
[SENSe<Ch>:]CORRection:DATA:PARAmeter:COUNT?.....	1406
[SENSe<Ch>:]CORRection:DATE?.....	1406
[SENSe<Ch>:]CORRection:DELeTe.....	1407
[SENSe<Ch>:]CORRection:EDELay:AUTO.....	1407
[SENSe<Ch>:]CORRection:EDELay<PhyPt>:DIElectric.....	1408
[SENSe<Ch>:]CORRection:EDELay<PhyPt>:DISTance.....	1408
[SENSe<Ch>:]CORRection:EDELay<PhyPt>:ELENgth.....	1408
[SENSe<Ch>:]CORRection:EDELay<PhyPt>[:TIME].....	1409
[SENSe:]CORRection:EDELay:VNETwork.....	1409
[SENSe<Ch>:]CORRection:EWAVe[:STATe].....	1410
[SENSe:]CORRection:IMETHod.....	1410
[SENSe<Ch>:]CORRection:LOSS<PhyPt>.....	1410
[SENSe<Ch>:]CORRection:LOSS<PhyPt>:SECond.....	1410
[SENSe<Ch>:]CORRection:LOSS:AUTO.....	1411
[SENSe<Ch>:]CORRection:LOSS<PhyPt>:FREQuency.....	1411
[SENSe<Ch>:]CORRection:LOSS<PhyPt>:SECond:FREQuency.....	1411
[SENSe<Ch>:]CORRection:LOSS<PhyPt>:OFFSet.....	1411
[SENSe<Ch>:]CORRection:LOSS<PhyPt>:SECond:STATe.....	1412
[SENSe<Ch>:]CORRection:NFIGure[:STATe].....	1412
[SENSe<Ch>:]CORRection:OFFSet<PhyPt>:COMPensation[:STATe].....	1413
[SENSe<Ch>:]CORRection:OFFSet<PhyPt>:DFComp[:STATe]?.....	1413
[SENSe<Ch>:]CORRection:OFFSet<PhyPt>[:STATe].....	1413
[SENSe<Ch>:]CORRection:PCAL.....	1414
[SENSe<Ch>:]CORRection:POWer<PhyPt>:ACQuire.....	1414
[SENSe<Ch>:]CORRection:POWer<PhyPt>:AWAVe[:STATe].....	1416
[SENSe<Ch>:]CORRection:POWer:DATA.....	1416
[SENSe<Ch>:]CORRection:POWer:DATA:PORT<PhyPt>.....	1416
[SENSe<Ch>:]CORRection:POWer<PhyPt>:HARMonic:ACQuire.....	1417
[SENSe<Ch>:]CORRection:POWer<PhyPt>:IMODulation:ACQuire.....	1418
[SENSe<Ch>:]CORRection:POWer:MIXer:IF:ACQuire.....	1418
[SENSe<Ch>:]CORRection:POWer<PhyPt>[:STATe].....	1419
[SENSe<Ch>:]CORRection:SMATrix:CDAta.....	1419

[SENSe<Ch>:]CORRection:SMATrix:CDATa:PORT<PhyPt>.....	1419
[SENSe<Ch>:]CORRection[:STATE].....	1420
[SENSe<Ch>:]CORRection:STIMulus?.....	1420
[SENSe<Ch>:]CORRection:STIMulus:PORT<PhyPt>?.....	1420
[SENSe<Chn>:]CORRection:PState?.....	1421
[SENSe<Chn>:]CORRection:SState?.....	1421

[SENSe<Ch>:]CORRection:CDATa <ErrorTerm>, <SourcePort>, <LoadPort>, <CorrectionData>...

[SENSe<Ch>:]CORRection:CDATa:PORT<PhyPt> <ErrorTerm>, <SourcePort>, <LoadPort>, <CorrectionData>...

Writes or reads system error correction data for a specific channel <Ch>, calibration method ([SENSe<Ch>:]CORRection:COLLect:METhod:DEFine), and port combination <SourcePort>, <LoadPort>. The setting command can be used to transfer user-defined correction data <CorrectionData> to the analyzer; the query returns the current correction data set. ASCII or block data can be transferred, depending on the selected data transfer format (FORMat [:DATA]).

The sweep must be stopped to transfer calibration data; see program example for [SENSe<Ch>:]CORRection:COLLect:SAVE:SElected:DEFault.

Note: This command affects the active calibration of channel no. <Ch> or the factory calibration (if no channel calibration is active). For the factory calibration, the query form is allowed only (no change of factory calibration data).

Tip: The analyzer provides a default calibration corresponding to a test setup which does not introduce any systematic errors; see [SENSe<Ch>:]CORRection:COLLect:SAVE:SElected:DEFault.

For an overview of calibration methods and error terms refer to [Chapter 4.5.1, "Calibration types"](#), on page 187.

G and H matrices

The 7-term calibration types named Txx (e.g. TOM, TRM, TRL, TNA) are based on a network analyzer with two ports i and j, each equipped with a test receiver and a reference receiver. The system errors are described in terms of two "error two-ports" P_G and P_H:

- The error two-port P_G is assigned to port i of the analyzer. Its transmission matrix G describes how the system errors modify the outgoing and incident waves at port i:

$$\begin{bmatrix} \mathbf{b}_i \\ \mathbf{a}_i \end{bmatrix} = \begin{bmatrix} \mathbf{G}_{11} & \mathbf{G}_{12} \\ \mathbf{G}_{21} & \mathbf{G}_{22} \end{bmatrix} * \begin{bmatrix} \mathbf{m}_{i\text{ref}} \\ \mathbf{m}_{i\text{test}} \end{bmatrix}$$

- The error two-port P_H is assigned to port j of the analyzer. Its transmission matrix H describes how the system errors modify the measured incident and outgoing waves at port j:

$$\begin{bmatrix} \mathbf{a}_j \\ \mathbf{b}_j \end{bmatrix} = \begin{bmatrix} \mathbf{H}_{11} & \mathbf{H}_{12} \\ \mathbf{H}_{21} & \mathbf{H}_{22} \end{bmatrix} * \begin{bmatrix} \mathbf{m}_{j\text{test}} \\ \mathbf{m}_{j\text{ref}} \end{bmatrix}$$

In the two equations above, a and b denote the waves at the calibrated reference plane i and j (e.g. the input and output of the 2-port DUT). The m waves are the raw measured waves of test port i and j. The subscripts "ref" and "test" refer to the reference and test receivers, respectively. During the calibration the network analyzer acquires ratios of wave quantities, which leaves one of non-diagonal matrix elements of G or H as a free normalization factor. The network analyzer uses the normalization $H_{21} = 1$.

Suffix:

<Ch> Channel number of the calibrated channel.

<PhyPt> Physical port number, used to select a specific frequency axis in arbitrary mode (with option R&S ZNA-K4).

Parameters:

<ErrorTerm> String parameters describing the different error terms, depending on the current calibration method; see table below. Each term contains one complex value (real and imaginary part) for each sweep point. The parameters must be transferred in full length. The following strings are allowed:

'DIRECTIVITY'

Directivity at source port <SourcePort>

'SRCMATCH'

Source match at source port <SourcePort>

'REFLTRACK'

Reflection tracking at source port <SourcePort>

'LOADMATCH'

Load match at load port <LoadPort>

'TRANSTRACK'

Transmission tracking between source port <SourcePort> and load port <LoadPort>.

'G11' ... 'G22'

G matrix elements at source port <SourcePort>; see explanation above.

'H11' ... 'H22'

H matrix elements at load port <LoadPort>; see explanation above.

'Q11' ... 'Q22', 'PREL'

9-term correction factors, defined at source port <SourcePort>; <LoadPort> is ignored

'PABS'

9-term correction factors, defined for the lowest source port <SourcePort> for each SMARTerCal; <LoadPort> is ignored

'L1', 'L2'

9-term correction factors, defined between the source port <SourcePort> and the load port <LoadPort>

Range: The error terms are dimensionless complex numbers.

*RST: n/a

<SourcePort>	Source port number
<LoadPort>	Load port number. If the error term is not related to the load port, a dummy number can be used; e.g. <code>CORR:CDAT 'REFLTRACK', 1, 0</code>
<CorrectionData>	Correction data set (one complex number per sweep point) to be transferred to the analyzer either in ASCII or block data format, depending on the current <code>FORMat[:DATA]</code> setting. The correction data set is assigned to the specified channel, error term, source and load port. This parameter must not be used for queries.

Example: See `[SENSe<Ch>:]CORRection:COLLect:SAVE:SELected:DEFault`.

The different calibration types of the analyzer provide the following error terms:

Calibration type	Parameters in [SENSe<Ch>:]CORRection: COLLect:METhod:DEFine	Available error terms (depending on port numbers)
One-port normalization (reflection) using an open or a short standard	REFL, RSHort	'REFLTRACK'
Full one port ("Refl OSM")	FOPort	'DIRECTIVITY', 'SRCMATCH', 'REFLTRACK'
Two-port normalization	FRTRans	'TRANSTRACK'
One path two port	OPTPort	'DIRECTIVITY', 'SRCMATCH', 'REFLTRACK', 'TRANSTRACK'
TOSM	TOSM	'DIRECTIVITY', 'SRCMATCH', 'REFLTRACK', 'LOADMATCH', 'TRANSTRACK'
TOM, TSM, TRM, TRL, TNA	TOM TSM TRM TRL TNA	'DIRECTIVITY', 'SRCMATCH', 'REFLTRACK', 'LOADMATCH', 'TRANSTRACK' (for reading and writing) 'G11' ... 'G22' and 'H11', 'H12', 'H22' (for reading only; the 'H21' matrix elements are normalized to 1)

[SENSe<Ch>:]CORRection:CONNection <ConnectorName>[, <Mode>[, <Gender>[, <RelPermittivity>[, <ReflImpedance>]]]]

Configures the user-defined connector types.

Suffix:

<Ch> Channel number

Parameters:

<ConnectorName> Name of the user-defined connectors, string parameter.

<Mode> TEM | WGUide
Transverse electric or waveguide type propagation mode.

<Gender>	GENDER NGENder GENDER – polar connector type (m/f) NGENDER – sexless connector type
<RelPermittivity>	Relative permittivity Range: 0.0000000001 to 1000.
<RefImpedance>	For TEM type connectors: reference impedance in Ω (without unit), For waveguide (WGUide) type connectors: cutoff frequency in Hz (without unit). Range: Ref. impedance: $1\mu\Omega$ to 1000 M Ω . Cutoff frequency: 0 Hz to 1000 GHz. *RST: -

Example:

```

CORR:CONN 'USERCON', TEM, GEND, 1.00000, 50
Define a TEM type connector type named USERCON.
CORR:CONN? 'USERCON'
Query the properties of the configured connector type.
CORR:CONN:DEL 'USERCON'
Delete the configured connector type.

```

Manual operation: See "[Connector / Gender](#)" on page 584

[SENSe<Ch>:]CORRection:CONNection:CATalog?

Returns a list of the connector types of all calibration kits in use.

Suffix:

<Ch> Channel number. This suffix is ignored because connector types are channel-independent.

- Example:** CORRection:CONNection:CATALog?
 Query connector types. Possible response: 'N 50 Ohm,N 75 Ohm,7 mm,3.5 mm,2.92 mm,2.4 mm,1.85 mm,7-16,Type F (75),BNC 50 Ohm,BNC 75 Ohm,SMA,4.3-10,User Conn 1'
 CORRection:CKIT:CATALog? 'N 50 Ohm'
 Query cal kits for N (50 Ω) connector types. Possible response: 'N 50 Ohm Ideal Kit,3653,85054D,ZV-Z121,ZCAN 50 Ohm,ZV-Z21 typical,85032B/E,85032F,85054B,New Kit 1'. We assume that a cal kit New Kit 1 with label 2012-05-25 was created before.
 CORRection:CKIT:LCATALog? 'N 50 Ohm'
 Query cal kits for N (50 Ω) connector types with their labels. Possible response: 'N 50 Ohm Ideal Kit,,3653,,85054D,,ZV-Z121,,ZCAN 50 Ohm,,ZV-Z21 typical,,85032B/E,,85032F,,85054B,,New Kit 1,2012-05-25'. A sequence of two commas means that the preceding cal kit has no label assigned.
 CORRection:CKIT:STANdard:CATALog? '85032B/E'
 Query standards in cal kit named 85032B/E. Possible response: 'MOP,FOP,MSH,FSH,MMMT,FMMT,MFTH'
 CORRection:CKIT:STANdard:LCATALog? 'New Kit 1','2012-05-25'
 Query standards in user cal kit named New Kit 1 labelled 2012-05-25. Possible response: 'MOP,FOP,MSH(P1),FSH,MMMT,FMMT,MSM,FSM,MREF,FREF,MOSHORT2,FOSHORT2,MOSHORT3,FOSHORT3,MMTH,MMTH(P2P3)...' (P1 etc. denote restricted port assignments).
- Usage:** Query only
- Manual operation:** See "[Connector / Gender](#)" on page 584

[SENSe<Ch>:]CORRection:CONNection:DELeTe <ConnectorName>

Deletes a user-defined connector type named <ConnectorName>.

Suffix:

<Ch> Channel number

Setting parameters:

<ConnectorName> Name of the user-defined connectors, string parameter.

Example: See [\[SENSe<Ch>:\]CORRection:CONNection](#)

Usage: Setting only

Manual operation: See "[Connector / Gender](#)" on page 584

```
[SENSe<Ch>:]CORRection:DATA:PARAmeter<Sfk>? [<SfkSettingType>[, <Index>]]
[SENSe<Ch>:]CORRection:DATA:PARAmeter<Sfk>:PORT<PhyPt>?
  [<SfkSettingType>[, <Index>]]
```

Gets the settings of active system error correction no. <Sfk> (or of the factory calibration, if no channel calibration is active).

Suffix:

<Ch> Number of the calibrated channel.

<Sfk> Number of the system error correction.
Less or equal than the total number of active system error corrections for the related channel (see [SENSe<Ch>:]CORRection:DATA:PARAmeter:COUNT? on page 1406)

<PhyPt> Physical port number, used to select a specific frequency axis in arbitrary mode (with option R&S ZNA-K4).

Query parameters:

<SfkSettingType> ACAL | START | STOP | POINTs | SPOWer | STYPE | BANDwidth | PDLY | RATTenuation | TYPE | PORTs | SPORT | THROughs | TSTamp | LTSTamp | TVNA | MVNA | MTEST | CKIT | FSMODE

The requested setting.
If no <SfkSettingType> is specified, the values for START, STOP, POINTs, SPOWer and STYPE are returned

ACAL

1 for automatic calibrations, 0 for manual calibrations

START

Start frequency (or CW frequency, if no frequency sweep is active)

STOP

Stop frequency (or CW frequency, if no frequency sweep is active)

POINTs

Number of points

SPOWer

Source power (or stop power, for power sweeps)

STYPE

Sweep type or grid (LIN, LOG, SEGM)

BANDwidth

Measurement bandwidth

PDLY

Point delay (Meas Delay) for OSM

RATTenuation

Receiver attenuations: comma-separated list containing a value pair <port no.>,<rec. att.> (float,integer) for each of the involved

PORTs

TYPE

Calibration type (see <Type> parameter in [SENSe<Ch>:]CORRection:COLLect[:ACQuire]:SElected on page 1356)

PORTs

The related test port numbers (comma-separated list of integers)

SPORT

For SMARTer calibrations this returns the port to which a power-meter was connected (0 otherwise)

THRoughs

Measured Throughs: comma-separated list of ordered port number pairs <pno1-pno2>

TSTamp

Timestamp (in UTC)

LTSTamp

Timestamp in local time

TVNA

For calibrations involving switch matrices, this indicates the test ports on the VNA itself. Returns a comma-separated list of port pairs *TestPort, VnaPort*

MVNA

For calibrations involving switch matrices, this indicates the mapping between matrix ports and VNA ports for matrix <Index>. Returns a comma-separated list of port pairs *MatrixVnaPort, VnaPort*

MTEST

For calibrations involving switch matrices, this indicates the mapping between matrix (physical) test ports and test ports for matrix <Index>. Returns a comma-separated list of port pairs *MatrixTestPort, TestPort*

CKIT

For each port, the name of the used calibration kit is stored with the calibration.

The query can return one of the following:

– **the cal kit name** (string)

if available and unique

– **'Multiple'**

if cal kit names are available but not unique, i.e. if <PhyPt> was not specified and multiple cal kits were used (multi-port calcs with different connector types, merged calcs)

<Index>

Currently not used

Example: SENSE:CORRection:DATA:PARAmeter?

Unrestricted query. Result looks like this:
 100000,8500000000,201,-10,LIN
 SENSE:CORRection:DATA:PARAmeter? START
 ...
 SENSE:CORRection:DATA:PARAmeter? STYPE
 Query settings one by one.
 SENSE:CORRection:DATA:PARAmeter? RATTenuation
 Query receiver attenuations. Result looks like this:
 1,0.000000,2,0.000000

Usage: Query only

Manual operation: See "[Ch<n> Calibration Properties/Cal Group <n> Properties](#)"
 on page 641

[SENSE<Ch>:]CORRection:DATA:PARAmeter:COUNT?

Gets the number of active system error corrections for channel <Ch>.

The properties of the active system error corrections can be queried using
[\[SENSE<Ch>:\]CORRection:DATA:PARAmeter<Sfk>?](#).

Suffix:
 <Ch> Channel number

Usage: Query only

Manual operation: See "[Ch<n> Calibration Properties/Cal Group <n> Properties](#)"
 on page 641

[SENSE<Ch>:]CORRection:DATE?

Returns the date and time when the active system error correction data for channel <Ch> was acquired (see example).

Suffix:
 <Ch> Channel number of the calibrated channel

Example:	<pre>CORR:COLL:METH REFL1</pre> <p>Select a one-port normalization at port 1 as calibration type.</p> <pre>CORR:COLL OPEN1</pre> <p>Measure an open standard connected to port 1 and store the measurement results of this standard.</p> <pre>CORR:COLL:SAVE</pre> <p>Calculate the system error correction data and apply it to the active channel.</p> <pre>CORR:DATE?</pre> <p>Query the time when the system error correction became active. The analyzer returns the date and time, e.g. '03/20/11,18:30:39'.</p> <pre>CORR:DATA:PAR?</pre> <p>Query the sweep settings for the calibration sweep. The analyzer returns the start and stop frequency, the number of points, source power, and the sweep type, e.g. 300000,8000000000,201,0,LIN.</p> <pre>CORR:SST?</pre> <p>Query the calibration status. The analyzer returns 'CAL OFF' (because the performed one-port calibration is not sufficient for the measured transmission S-parameter S_{21}).</p>
Usage:	Query only
Manual operation:	See " Ch<n> Calibration Properties/Cal Group <n> Properties " on page 641

[SENSe<Ch>:]CORRection:DELeTe

Cleans the channel's existing calibration data and also removes links to the calibration pool.

Suffix:

<Ch> Channel number

Usage: Event

Manual operation: See "[Manage Cals – Remove all Cal Data](#)" on page 637

[SENSe<Ch>:]CORRection:EDELay:AUTO <Activate>

Applies the [Auto Length](#) function to the active trace of channel <Ch>.

Suffix:

<Ch> Channel number

Setting parameters:

<Activate> ONCE
Applies the auto length function.

- Example:** *RST; :CORR:EDEL:AUTO ONCE
Reset the instrument and apply the auto length function to the default trace (Trc1 in channel 1).
- Usage:** Setting only
- Manual operation:** See ["Auto Length"](#) on page 719

[SENSe<Ch>:]CORRection:EDELay<PhyPt>:DIElectric <Permittivity>

Defines the permittivity for the offset correction at test port <PhyPt>.

Suffix:

- <Ch> Channel number of the offset-corrected channel
- <PhyPt> Port number of the analyzer

Parameters:

- <Permittivity> Permittivity
- Range: 1 to +1E+6
- *RST: 1.00062

- Example:** See [\[SENSe<Ch>:\]CORRection:EDELay<PhyPt>:ELENgth](#)
- Manual operation:** See ["Permittivity / Velocity Factor"](#) on page 718

[SENSe<Ch>:]CORRection:EDELay<PhyPt>:DISTance <MechLength>

Defines the offset parameter for test port <PhyPt> as a mechanical length.

Suffix:

- <Ch> Channel number of the offset-corrected channel
- <PhyPt> Port number of the analyzer

Parameters:

- <MechLength> Mechanical length
- Range: -3.402823466E+038 m to +3.4028234664E+038 m.
- *RST: 0 m
- Default unit: m

- Example:** See [\[SENSe<Ch>:\]CORRection:EDELay<PhyPt>:ELENgth](#)
- Manual operation:** See ["Delay / Electrical Length / Mech. Length"](#) on page 717

[SENSe<Ch>:]CORRection:EDELay<PhyPt>:ELENgth <ElecLength>

Defines the offset parameter for test port <PhyPt> as an electrical length.

Suffix:

- <Ch> Channel number of the offset-corrected channel
- <PhyPt> Port number of the analyzer

Parameters:

<ElecLength> Electrical length
 Range: -1E+9 m to +1E+9 m.
 Increment: 1 mm
 *RST: 0 m
 Default unit: m

Example:

```
CORR:EDEL2:ELEN 0.3
```

Define an electrical length of 30 cm for channel 1 and port no. 2.

```
CORR:EDEL2:DIST?; DIEL?
```

Query the values of the mechanical length and the permittivity at port 2. The mechanical length is equal to the electrical length divided by the square root of the permittivity; the latter is set to its default value. The response is 0.29990704322;1.00062.

```
CORR:EDEL2?
```

Query the value of the delay at port 2. The delay is equal to the electrical length divided by the speed of light in the vacuum, so the response is 1.0006922856E-009.

```
CORR:LOSS2 2; LOSS2:FREQ 1.5 GHz; OFFS 3 dB
```

Define the offset loss parameters at port 2.

Manual operation: See "[Delay / Electrical Length / Mech. Length](#)" on page 717

[SENSe<Ch>:]CORRection:EDELay<PhyPt>[:TIME] <Delay>

Defines the offset parameter for test port <PhyPt> as a delay time.

Suffix:

<Ch> Channel number of the offset-corrected channel

<PhyPt> Port number of the analyzer

Parameters:

<Delay> Delay
 Range: -3.40282346638529E+038 s to
 +3.40282346638529E+038 s.
 *RST: 0 s
 Default unit: s

Example: See `[SENSe<Ch>:]CORRection:EDELay<PhyPt>:ELENgth`

Manual operation: See "[Delay / Electrical Length / Mech. Length](#)" on page 717

[SENSe:]CORRection:EDELay:VNETwork <Boolean>

Changes the position of the offset calculation in the "Offset Embed" calculation chain.

Parameters:

<Boolean> **OFF (0)**
 The offset is calculated **before** de-/embedding (default).
ON (1)
 The offset is calculated **after** de-/embedding.

*RST: 0

Manual operation: See "[Offset > Calculate after De-/Embed.](#)" on page 753

[SENSe<Ch>:]CORRection:EWAVE[:STATe] <Boolean>

Activates or deactivates the wave correction logic for wave quantities and ratios.

Suffix:

<Ch> Channel number

Parameters:

<Boolean> *RST: ON (1)

Manual operation: See "[Wave Correction](#)" on page 359

[SENSe:]CORRection:IMETHod <InterpolationMethod>

Selects the algorithm for the interpolation of user system error corrections.

For the factory system error correction data, the analyzer always uses linear interpolation.

Parameters:

<InterpolationMethod>LINear | HORDER

LINear

Linear interpolation

HORDER

Higher order (cubic spline) interpolation

Manual operation: See "[Interpolation](#)" on page 860

[SENSe<Ch>:]CORRection:LOSS<PhyPt> <LossAtFrequency>

[SENSe<Ch>:]CORRection:LOSS<PhyPt>:SECond <LossAtFrequency>

These commands define the [offset loss](#) at the reference frequencies f_1 and f_2 .

The reference frequencies can be set using [\[SENSe<Ch>:\]CORRection:LOSS<PhyPt>:FREQUENCY](#) and [\[SENSe<Ch>:\]CORRection:LOSS<PhyPt>:SECond:FREQUENCY](#).

Suffix:

<Ch> Channel number

<PhyPt> Physical port number

Parameters:

<LossAtFrequency> Loss at reference frequency
 Range: -200 dB to +200 dB
 Increment: 0.001 dB
 *RST: 0 dB
 Default unit: dB

Manual operation: See "Loss at DC / Loss at 1st Freq / 1st Freq for Loss / Use 2nd Freq / Loss at 2nd Freq / 2nd Freq for Loss" on page 708

[SENSe<Ch>:]CORRection:LOSS:AUTO <Activate>

Applies the [Auto Length and Loss](#)) function to the active trace of channel <Ch>.

Suffix:

<Ch> Channel number

Setting parameters:

<Activate> ONCE
Required constant

Example:

*RST; :CORR:LOSS:AUTO ONCE

Reset the instrument and apply the "Auto Length and Loss" function to the default trace (Trc1 in channel 1).

Usage:

Setting only

Manual operation: See "[Auto Length and Loss](#)" on page 723

[SENSe<Ch>:]CORRection:LOSS<PhyPt>:FREQUency <RefFreq>

[SENSe<Ch>:]CORRection:LOSS<PhyPt>:SECond:FREQUency <RefFreq>

These commands define the reference frequencies f_1 and f_2 for the [offset loss](#) approximation.

The corresponding losses can be defined using [\[SENSe<Ch>:\]CORRection:LOSS<PhyPt>:OFFSet](#).

Suffix:

<Ch> Channel number

<PhyPt> Physical port number

Parameters:

<RefFreq> Reference frequency
Range: Frequency range of the analyzer model.
Increment: 1 MHz
*RST: 1000000000 Hz (= 1 GHz)
Default unit: Hz

Manual operation: See "Loss at DC / Loss at 1st Freq / 1st Freq for Loss / Use 2nd Freq / Loss at 2nd Freq / 2nd Freq for Loss" on page 708

[SENSe<Ch>:]CORRection:LOSS<PhyPt>:OFFSet <OffsetLoss>

Defines the frequency-independent part (DC value) of the offset loss.

Suffix:

<Ch> Channel number of the offset-corrected channel

<PhyPt> Port number of the analyzer

Parameters:

<OffsetLoss> Frequency-independent part of the offset loss
 Range: -200 dB to +200 dB
 Increment: 0.001 dB
 *RST: 0 dB
 Default unit: dB

Example:

See [\[SENSe<Ch>:\]CORRection:EDELay<PhyPt>:ELENgth](#)

Manual operation:

See "Loss at DC / Loss at 1st Freq / 1st Freq for Loss / Use 2nd Freq / Loss at 2nd Freq / 2nd Freq for Loss" on page 708

[SENSe<Ch>:]CORRection:LOSS<PhyPt>:SECond:STATe <Boolean>

Defines whether the second reference frequency f_2 is used for the [offset loss](#) approximation.

The second reference frequency and its associated loss value can be defined using [\[SENSe<Ch>:\]CORRection:LOSS<PhyPt>:SECond:FREQuency](#) and [\[SENSe<Ch>:\]CORRection:LOSS<PhyPt>:SECond](#).

Suffix:

<Ch> Channel number
 <PhyPt> Physical port number

Parameters:

<Boolean> **OFF (0)**
 f_2 not used (default)
ON (1)
 f_2 used

Manual operation:

See "Loss at DC / Loss at 1st Freq / 1st Freq for Loss / Use 2nd Freq / Loss at 2nd Freq / 2nd Freq for Loss" on page 708

[SENSe<Ch>:]CORRection:NFIGure[:STATe] <Boolean>

Disables or enables the Noise Figure Calibration for the related channel.

Suffix:

<Ch>

Parameters:

<Boolean> OFF - Disable calibration
 ON - (re-)enable calibration
 *RST: OFF (calibration disabled, no noise figure calibration available after a reset)

Options:

R&S ZNA-K30

[SENSe<Ch>:]CORRection:OFFSet<PhyPt>:COMPensation[:STATe] <Boolean>

Toggles length/loss/fixture compensation for physical port <PhyPt> ON/OFF.

Suffix:

<Ch> Channel number

<PhyPt> Physical port number

Parameters:

<Boolean> ON (1): compensation active
OFF (0): compensation inactive

Manual operation: See "[Active](#)" on page 707

[SENSe<Ch>:]CORRection:OFFSet<PhyPt>:DFComp[:STATe]?

Returns whether a direct fixture compensation has been carried out at port no. <PhyPt>. A direct fixture compensation resets the offset parameters to zero, the analyzer uses calculated transmission factors instead.

Suffix:

<Ch> Channel number of the offset-corrected channel

<PhyPt> Port number of the analyzer.

Return values:

<Boolean> 1 - direct fixture compensation data used
0 - no direct fixture compensation data used

Example:

*RST; CORR:OFFS:DFC?

Reset the instrument and query whether the analyzer uses direct fixture compensation data at port 1. The response is 0.

Usage: Query only

Manual operation: See "[Direct Compensation](#)" on page 720

[SENSe<Ch>:]CORRection:OFFSet<PhyPt>[:STATe] <Boolean>

Resets the offset parameters for all test ports to zero and the reference frequency to 1 GHz or queries whether any of the offset parameters are different from zero.

Suffix:

<Ch> Channel number of the offset-corrected channel

<PhyPt> Port number of the analyzer. This numeric suffix is ignored; the command affects the parameters of all ports.

Parameters:

<Boolean> The parameter function depends on whether the command is used as a setting command or as a query: For setting command:
ON - no effect
OFF - resets all length offsets to zero and the reference frequency to 1 GHz

For query:

1 - at least one length offset parameter is different from its default value

0 - all length offsets are zero / set to default

*RST: OFF

Example:

*RST; :CORR:OFFS?

Reset the instrument and query whether the length offset parameters have been reset as well. The response is 0.

Manual operation: See "[Reset Offsets](#)" on page 708

[SENSe<Ch>:]CORRection:PCAL <ActivatePowerCals>

Activates or deactivates all power calibrations.

Suffix:

<Ch> Calibrated channel number

Setting parameters:

<ActivatePowerCals> NONE | ALL

NONE – deactivate all power calibrations.

ALL – activate all power calibrations.

*RST: n/a

Example:

*RST; CORR:POW:ACQ AWAVE, 1, PORT, 1

Perform a receiver power calibration of the wave a_1 using port 1 as a source port, assuming that the transmitted source power a_1 is correct. No external cabling is needed.

CORR:POW:AWAV?

Check whether the calibration is applied (the response is 1).

CORR:PCAL NONE; POW:AWAV?

Disable all power calibrations and check again whether the calibration is applied (the response is 0).

Usage:

Setting only

Manual operation: See "[Scalar Power Cal – All Power Cals On / All Power Cals Off](#)" on page 636

[SENSe<Ch>:]CORRection:POWER<PhyPt>:ACQuire <Wave>[, <CalPort>[, <SourceType>[, <SourcePort>[, <CalOnlyPortFreq>]]]]

Selects the wave quantity and the source for the receiver power calibration, starts the calibration sweep, and applies the receiver power correction.

Suffix:

<Ch> Calibrated channel number

<PhyPt> This suffix is ignored because the port number is specified in the parameter list.

Setting parameters:

<Wave> AWAVE | BWAVE | B1 | B2 | B3 | B4
 AWAVE – calibration of reference waves a_1, a_2, \dots . In manual control, the reference receiver calibration is included in the source power calibration of each port.
 BWAVE – calibration of received wave b_1, b_2, \dots . The port number <CalPort>, the used <SourceType>, and the <SourcePort> number must be specified in addition.
 Alternative: Parameters B1 and B2.
 B1 | B2 ... – direct wave and cal port setting for received waves $b_1, b_2 \dots$. The parameters B1 and B2 are ZVR-compatible. No additional parameters must be specified. The source for B1 is port 2 and vice versa.

<CalPort> Calibrated port number
 Range: 1 to port number of the analyzer

<SourceType> PORT | GENERATOR
 PORT - internal source at port <CalPort>, to be fed to port <SourcePort> using an external through connection. If <CalPort> = <SourcePort>, an Open or Short standard is required.

<SourcePort> Number of the port for the internal source or generator.

<CalOnlyPortFreq> Relevant for frequency conversion measurements only.
OFF | 0
 The reference receiver at port <CalPort> is calibrated for all frequencies that are relevant for any of the ports.
ON | 1
 Only those frequencies are calibrated that are relevant for this port. This results in shorter calibration times.
 *RST: 0

Example:

```
*RST; CORR:POW:ACQ AWAVE,1,PORT,1
```

Perform a receiver power calibration of the wave a_1 using port 1 as a source port, assuming that the transmitted source power a_1 is correct. No external cabling is needed.

```
CORR:POW:AWAV?
```

Check whether the calibration is applied (the response is 1).

```
CALC:PAR:MEAS 'TRC1', 'A1'
```

Select a_1 as a measured quantity for the default trace.

```
CALC:MARK ON; MARK:Y?; :SOUR:POW?
```

Create marker no. <Mk> in the center of the sweep range and query the measurement value. The calibrated power of the reference wave a_1 is approx. equal to the default source power value.

See also example for [\[SENSe<Ch>:\]CORRection:OFFSet<PhyPt>\[:STATE\]](#).

Usage:

Setting only

Manual operation:

See "[Port Overview](#)" on page 597

[SENSe<Ch>:]CORRection:POWer<PhyPt>:AWAVE[:STATE] <Boolean>

Enables or disables the receiver power calibration for channel <Ch> and for the reference waves a_n . The setting command is disabled unless the reference waves have been power calibrated ([\[SENSe<Ch>:\]CORRection:POWer<PhyPt>:ACQuire](#) on page 1414 *AWAVE*, . . .). The query always returns a result.

This command extends the functionality of manual control, where the reference receiver calibration is included in the source power calibration of each port (and always ON).

Suffix:

<Ch> Calibrated channel number

<PhyPt> Calibrated port number

Parameters:

<Boolean> Enables (ON) or disables (OFF) the receiver power calibration for the reference waves a_n .

```
*RST:            OFF
```

Example:

See [\[SENSe<Ch>:\]CORRection:POWer<PhyPt>:ACQuire](#)

[SENSe<Ch>:]CORRection:POWer:DATA <Wave>, <CorrData>...
[SENSe<Ch>:]CORRection:POWer:DATA:PORT<PhyPt> <Wave>, <CorrData>...

Reads or writes receiver power correction data sets. A power correction data set contains n real values where:

- Each value corresponds to the ratio of the actual power at the receiver input (value provided by the used source) to the uncalibrated power in dB.
- The number n is equal to the number of sweep points.

Increasing (decreasing) the values in the correction data sets increases (decreases) the input power reading. Writing correction data (the setting command) fails if the number of transferred values is not equal to the number of sweep points.

Suffix:

<Ch> Calibrated channel number

<PhyPt> Physical port number, used to select a specific frequency axis in arbitrary mode (with option R&S ZNA-K4).

Parameters:

<Wave> Identifier for the calibrated wave:
'A<n>' or 'AWAV<n>' denote correction data for the reference wave a<n>, where <n> corresponds to the port number.
'B<n>' or 'BWAV<n>' denote correction data for the reference wave b<n>.

<CorrData> Power correction values either in ASCII or block data format, depending on the current `FORMat [:DATA]` setting.

Example:

```
*RST; :SWE:POIN 10
Reset the instrument and reduce the number of sweep points to 10.
CORR:POW:ACQ AWAVE,1,PORT,1
Perform a receiver power calibration of the wave a1 using port 1 as a source port, assuming that the transmitted source power a1 is correct. No external cabling is needed.
CORR:POW:DATA? 'AWAV1'
Query the correction values. The analyzer returns 10 comma-separated real numbers.
CORR:POW:DATA 'AWAV1', 1, 2, 3, 4, 5, -6, -7, -8, -9, -0
Replace the correction values by ten (new) numbers.
```

Manual operation: See "[Start Cal Sweep](#)" on page 602

[SENSe<Ch>:]CORRection:POWer<PhyPt>:HARMonic:ACQuire

Starts the receiver calibration

- at physical port <PhyPt>
- in channel <Ch>
- at harmonic orders `[SENSe<Ch>:]CORRection:ADVanced:HARMonic:ORDeR?`

Then stores and applies the calibration data.

Note: The receiver calibration relies on the source power calibration acquired using `SOURce<Ch>:POWer<PhyPt>:CORRection:HARMonic[:ACQuire]`.

Suffix:

<Ch> Channel number

<PhyPt> Port number.

- Example:** See [SOURCE<Ch>:POWER<PhyPt>:CORREction:HARMonic\[:ACQUIRE\]](#) on page 1571.
- Usage:** Event
- Manual operation:** See "[Harmonic Orders to Calibrate](#)" on page 590

[SENSe<Ch>:]CORREction:POWER<PhyPt>:IMODulation:ACQUIRE [<CalOnlyPortFreq>]

Starts the receiver calibration (3rd power calibration step for intermodulation measurements), stores and applies the calibration data.

Note: The receiver calibration relies on the source power calibration acquired in step nos. 1 and 2.

[SENSe<Ch>:]CORREction:POWER<PhyPt>:IMODulation:ACQUIRE is enabled only after steps 1 and 2 have been carried out ([SOURCE<Ch>:POWER<PhyPt>:CORREction:IMODulation:LTONE\[:ACQUIRE\]](#), [SOURCE<Ch>:POWER<PhyPt>:CORREction:IMODulation:UTONE\[:ACQUIRE\]](#)).

Suffix:

- <Ch> Calibrated channel number
- <PhyPt> Port number. This suffix is ignored; the analyzer calibrates the port that is selected as a receive port for the intermodulation measurement
([SENSe<Ch>:]FREQuency:IMODulation:RECEiver).

Setting parameters:

- <CalOnlyPortFreq> **OFF | 0**
The reference receiver at port <CalPort> is calibrated for all frequencies that are relevant for any of the ports.
- ON | 1**
Only those frequencies are calibrated that are relevant for this port. This results in shorter calibration times.
- *RST: 0

Example: See [SOURCE<Ch>:POWER<PhyPt>:CORREction:IMODulation:LTONE\[:ACQUIRE\]](#)

Usage: Setting only

[SENSe<Ch>:]CORREction:POWER:MIXer:IF:ACQUIRE

Starts the IF receiver calibration (2nd power calibration step for scalar mixer measurements), stores and applies the calibration data.

Note: The receiver calibration relies on the IF source power calibration acquired in step no. 1. [SENSe<Ch>:]CORREction:POWER<PhyPt>:MIXer:IF:ACQUIRE is enabled only after step 1 has been carried out ([SOURCE<Ch>:POWER<PhyPt>:CORREction:MIXer:RF\[:ACQUIRE\]](#)).

Suffix:	
<Ch>	Calibrated channel number
Example:	See SOURCE<Ch>:POWER:CORREction:MIXer:RF[:ACQUIRE] on page 1664.
Usage:	Event

[SENSe<Ch>:]CORREction:POWER<PhyPt>[:STATe] <Boolean>

Enables or disables the receiver power calibration for channel <Ch> and for the received waves b_{PhyPt} . The setting command is disabled unless the received waves have been power calibrated ([\[SENSe<Ch>:\]CORREction:POWER<PhyPt>:ACQUIRE BWAVE, . . .](#)). The query always returns a result.

Suffix:	
<Ch>	Calibrated channel number
<PhyPt>	Calibrated port number
Parameters:	
<Boolean>	Enables (ON) or disables (OFF) the receiver power calibration for the received waves b_{PhyPt} .

*RST: OFF

Example:	<pre>*RST; CORR:POW:ACQ BWAVE,1,PORT,2</pre> <p>Perform a receiver power calibration of the wave b1 using port 2 as a source port, assuming that the source power a_2 is correct. A through connection from port 2 to port 1 is needed.</p> <pre>CORR:POW?</pre> <p>Check whether the calibration is applied (the response is 1).</p> <pre>CALC:PAR:MEAS 'TRC1', 'B1D2'</pre> <p>Select b_1 as a measured quantity for the default trace.</p> <pre>CALC:MARK ON; MARK:Y?; :SOUR:POW?</pre> <p>Create marker no. <Mk> in the center of the sweep range and query the measurement value. The calibrated power of the received wave b_1 is approx. equal to the default source power value.</p> <p>See also example for [SENSe<Ch>:]CORREction:POWER<PhyPt>:ACQUIRE.</p>
-----------------	------------------------------------------------------------------------------------------------------------------------------------------------------------------------------------------------------------------------------------------------------------------------------------------------------------------------------------------------------------------------------------------------------------------------------------------------------------------------------------------------------------------------------------------------------------------------------------------------------------------------------------------------------------------------------------------------------------------------------------------------------------------------------------------------------------------------------------------------

Manual operation: See "[Port Overview](#)" on page 637

[SENSe<Ch>:]CORREction:SMATrix:CDATa <ErrorTerm>, <SourceTestPort>, <LoadTestPort>, <SourceVNAPort>, <LoadVNAPort>, <CorrectionData>...

[SENSe<Ch>:]CORREction:SMATrix:CDATa:PORT<PhyPt> <ErrorTerm>, <SourceTestPort>, <LoadTestPort>, <SourceVNAPort>, <LoadVNAPort>, <CorrectionData>...

Writes or reads system error correction data in the presence of switching matrices.

Same command structure and logic as for `[SENSe<Ch>:]CORRection:CDATA...` commands, except for additional parameters `SourceVNAPort` and `LoadVNAPort` that restrict the returned correction data to the measurement path between by the respective physical VNA ports (if any). See [Chapter 4.7.41.5, "Multiple paths and calibration"](#), on page 329 for details.

Suffix:

<Ch>

<PhyPt>

Parameters:

<ErrorTerm>

<SourceTestPort>

<LoadTestPort>

<SourceVNAPort> Number of the VNA port connected to the source test port (via switch matrix)

<LoadVNAPort> Number of the VNA port connected to the load test port (via switch matrix)

<CorrectionData> Correction data either in ASCII or block data format, depending on the current `FORMat [:DATA]` setting.

[SENSe<Ch>:]CORRection[:STATE] <Boolean>

Enables or disables the system error correction for channel <Ch>.

Suffix:

<Ch>

Calibrated channel number

Parameters:

<Boolean>

Enables (ON) or disables (OFF) the correction.

*RST: ON

Example:

*RST; :CORR?

Reset the instrument and query whether channel 1 is system error corrected. The response is 1.

Manual operation: See "[User Cal Active](#)" on page 635

[SENSe<Ch>:]CORRection:STIMulus?

[SENSe<Ch>:]CORRection:STIMulus:PORT<PhyPt>?

Queries the stimulus values of the active calibration. A calibration must be selected before the command is executed; see example.

Suffix:

<Ch>

Channel number of the calibrated channel

<PhyPt>

Physical port number, used to select a specific frequency axis in arbitrary mode (with option R&S ZNA-K4).

Example: `*RST; :CORR:COLL:METH:DEF 'Test',RShort,1`
 Select a one-port normalization at port 1 with a short standard as calibration type.
`CORR:STIM?`
 Query the stimulus frequencies. The response contains 201 frequency values.
`CORR:COLL:SEL SHOR,1`
 Measure a short standard connected to port 1 and store the measurement results of this standard.
`CORR:COLL:SAVE:SEL`
 Calculate the system error correction data and apply it to the active channel.

Usage: Query only

Manual operation: See ["Apply"](#) on page 578

[SENSe<Chn>:]CORRection:PState?

Gets the power calibration label of the active trace in channel <Chn>.

See [Chapter 4.5.6.3, "Power calibration labels"](#), on page 222 for the possible return values.

Suffix:
 <Chn> Channel number used to identify the active trace

Usage: Query only

Manual operation: See ["Apply"](#) on page 599

[SENSe<Chn>:]CORRection:SState?

Returns the system error correction state label of the active trace in channel <Chn>. The response is a string variable containing the calibration state label in the trace list ('CAL', 'CAI', 'CAL OFF' ..; see [Chapter 4.5.4, "Calibration labels"](#), on page 206).

Suffix:
 <Chn> Channel number used to identify the active trace

Example: See `[SENSe<Ch>:]CORRection:DATE?`

Usage: Query only

Manual operation: See ["Apply"](#) on page 578

7.3.14.11 [SENSe:]FREQuency...

The `[SENSe:] . . .` commands set frequency-related parameters, especially the measurement and display ranges for the different sweep types. The frequency ranges for the different instrument models are listed below; for more details refer to the data sheet.

Table 7-17: Frequency ranges of R&S ZNA analyzers

Frequency settings	Start, Stop	Center	Span
R&S ZNA26	100 kHz to 26.5 GHz	>100 kHz to <26.5 GHz	1 Hz to 26.4999 GHz
R&S ZNA43	100 kHz to 43.5 GHz	>100 kHz to <43.5 GHz	1 Hz to 43.4999 GHz
R&S ZNA50	100 kHz to 50 GHz	>100 kHz to <50 GHz	1 Hz to 49.9999 GHz
R&S ZNA67	100 kHz to 67 GHz	>100 kHz to <67 GHz	1 Hz to 66.9999 GHz
R&S ZNA67EXT	100 kHz to 110 GHz	>100 kHz to <110 GHz	1 Hz to 109.9999 GHz

[SENSe<Ch>]:FREQUENCY:CENTer.....	1423
[SENSe<Ch>]:FREQUENCY:COMPRESSion:POINT.....	1423
[SENSe<Ch>]:FREQUENCY:COMPRESSion:POWER:POINTS.....	1424
[SENSe<Ch>]:FREQUENCY:COMPRESSion:POWER:START.....	1424
[SENSe<Ch>]:FREQUENCY:COMPRESSion:POWER:STOP.....	1424
[SENSe<Ch>]:FREQUENCY:COMPRESSion:SKIP.....	1425
[SENSe<Ch>]:FREQUENCY:COMPRESSion:SKIP:OFFSet.....	1425
[SENSe<Ch>]:FREQUENCY:COMPRESSion:SRCPort.....	1425
[SENSe<Ch>]:FREQUENCY:COMPRESSion:RECeiver.....	1425
[SENSe<Ch>]:FREQUENCY:CONVersion.....	1426
[SENSe<Ch>]:FREQUENCY<Pt>:CONVersion:ARBitrary.....	1426
[SENSe<Ch>]:FREQUENCY:CONVersion:ARBitrary:PMETer<Pmtr>.....	1428
[SENSe<Ch>]:FREQUENCY<Pt>:CONVersion:AWReceiver[:STATe].....	1429
[SENSe]:FREQUENCY:CONVersion:DEVice<Port>:NAME.....	1429
[SENSe<Ch>]:FREQUENCY:CONVersion:GAIN:LMCorrection.....	1430
[SENSe<Ch>]:FREQUENCY:CONVersion:MIXer:FIXed<Stg>.....	1430
[SENSe<Ch>]:FREQUENCY:CONVersion:MIXer:FUNDamental.....	1431
[SENSe<Ch>]:FREQUENCY:CONVersion:MIXer:IFPort.....	1431
[SENSe<Ch>]:FREQUENCY:CONVersion:MIXer:LOMultiplier<Stg>.....	1431
[SENSe<Ch>]:FREQUENCY:CONVersion:MIXer:LOPort<Stg>.....	1432
[SENSe<Ch>]:FREQUENCY:CONVersion:MIXer:MFFixed.....	1432
[SENSe<Ch>]:FREQUENCY:CONVersion:MIXer:PRFImage.....	1434
[SENSe<Ch>]:FREQUENCY:CONVersion:MIXer:RFMultiplier.....	1435
[SENSe<Ch>]:FREQUENCY:CONVersion:MIXer:RFPort.....	1435
[SENSe<Ch>]:FREQUENCY:CONVersion:MIXer:STAGes.....	1435
[SENSe<Ch>]:FREQUENCY:CONVersion:MIXer:TFRrequency<Stg>.....	1436
[SENSe<Ch>]:FREQUENCY[:CW].....	1436
[SENSe<Ch>]:FREQUENCY:FIXed.....	1436
[SENSe<Ch>]:FREQUENCY:IMODulation:CONVersion.....	1437
[SENSe<Ch>]:FREQUENCY:IMODulation:LTONe.....	1437
[SENSe<Ch>]:FREQUENCY:IMODulation:MSPectrum.....	1438
[SENSe<Ch>]:FREQUENCY:IMODulation:ORDer<Im>[:STATe].....	1438
[SENSe<Ch>]:FREQUENCY:IMODulation:RECeiver.....	1439
[SENSe<Ch>]:FREQUENCY:IMODulation:SPEctrum:MORDer.....	1439
[SENSe<Ch>]:FREQUENCY:IMODulation:SPEctrum[:STATe].....	1439
[SENSe<Ch>]:FREQUENCY:IMODulation:TDIStance.....	1440
[SENSe<Ch>]:FREQUENCY:IMODulation:UTONe.....	1441
[SENSe<Ch>]:FREQUENCY:SBANd.....	1441
[SENSe<Ch>]:FREQUENCY:SEGMENT:AXIS.....	1442

[SENSe<Ch>:]FREQUENCY:SPAN.....	1443
[SENSe<Ch>:]FREQUENCY:START.....	1443
[SENSe<Ch>:]FREQUENCY:STOP.....	1443

[SENSe<Ch>:]FREQUENCY:CENTER <CenterFreq>

Defines the center of the measurement and display range for a frequency sweep (sweep range). The default center frequency is the center of the analyzer's maximum frequency range: $(f_{\text{MIN}} + f_{\text{MAX}})/2$. The range depends on the instrument model; see [Table 7-17](#).

Suffix:

<Ch> Channel number

Parameters:

<CenterFreq> Center frequency of the sweep
 Increment: 0.1 kHz
 Default unit: Hz

Example:

```
*RST; :SYST:FREQ? MIN; :SYST:FREQ? MAX
Query the frequency range of the analyzer.
FREQ:CENT 100MHz
Set center frequency to 100 MHz.
FREQ:SPAN 50000
Set frequency span to 50 kHz.
```

Manual operation: See "[Start Frequency / Stop Frequency / Center Frequency / Span Frequency](#)" on page 523

Note: The measurement range defined by means of the center frequency and the current span (`[SENSe<Ch>:]FREQUENCY:SPAN`) must not exceed the allowed frequency range of the analyzer. If necessary, the span is reduced to $\min(\text{<CenterFreq>} - f_{\text{MIN}}, f_{\text{MAX}} - \text{<CenterFreq>})$.

[SENSe<Ch>:]FREQUENCY:COMPRESSION:POINT <CompVal>

Defines the compression value for a gain compression measurement in channel <Ch>.

The gain compression measurement searches for the <CompVal> dB compression points.

Suffix:

<Ch> Channel number

Parameters:

<CompVal> Compression value

Example: The following commands set up and activate a gain compression measurement.

```
*RST; :SENSe:FREQuency:COMPReSSion:POWer:POINts
21
Set the number of power points to 21.
:SENSe:FREQuency:COMPReSSion:POWer:STARt -25;
STOP 10
Set the start and stop power to -25 dB and 10 dB, respectively.
:SENSe:FREQuency:COMPReSSion:POINt 1.5
Set the compression value to 1.5 dB.
:SENSe:FREQuency:COMPReSSion:SRCPort 1;
RECEiver 2
Let test port 1 be the source port and test port 2 the receiver
port.
:CALCulate:PARAmeter:MEASure 'Trc1', 'CmpPtPin'
Show the compression point input as a trace named 'Trc1' in
diagram 1.
:CALCulate:PARAmeter:SDEFine 'Trc2',
'CmpPtPout'
Define trace 'Trc2' as the compression point output
:DISPlay:WINDow1:TRACe2:FEED 'Trc2'
Show trace 'Trc2' as trace no. 2 in diagram 1.
```

Manual operation: See "[Compression Value](#)" on page 393

[SENSe<Ch>:]FREQuency:COMPReSSion:POWer:POINts <Number>

Defines the number of points for all power sweeps of a gain compression measurement in channel <Ch>.

Suffix:

<Ch> Channel number

Parameters:

<Number> Number of power points

Example:

See [\[SENSe<Ch>:\]FREQuency:COMPReSSion:POINt](#) on page 1423.

Manual operation: See "[Power Points](#)" on page 395

[SENSe<Ch>:]FREQuency:COMPReSSion:POWer:STARt <Value>

[SENSe<Ch>:]FREQuency:COMPReSSion:POWer:STOP <Value>

Defines the start and stop power for all power sweeps of a gain compression measurement in channel <Ch>.

Suffix:

<Ch> Channel number

Parameters:

<Value> Start/stop power in dB.

Example: See `[SENSe<Ch>:]FREQuency:COMPReSSion:POINt` on page 1423.

Manual operation: See ["Start Power/Stop Power"](#) on page 394

`[SENSe<Ch>:]FREQuency:COMPReSSion:SKIP <Boolean>`

For two-dimensional gain compression measurements, this command activates or deactivates skipping the linear part, as described in ["Skipping the linear part"](#) on page 392.

Suffix:

<Ch> Channel number

Parameters:

<Boolean> **ON (1)**
Skip irrelevant power sweep points. See `[SENSe<Ch>:]FREQuency:COMPReSSion:SKIP:OFFSet`

OFF (0)
Always sweep from `[SENSe<Ch>:]FREQuency:COMPReSSion:POWer:STARt` to `[SENSe<Ch>:]FREQuency:COMPReSSion:POWer:STOP`.

*RST: OFF

Manual operation: See ["Skip Linear Sweep Section"](#) on page 393

`[SENSe<Ch>:]FREQuency:COMPReSSion:SKIP:OFFSet <Value>`

For two-dimensional gain compression measurements, this command allows you to define the power sweep range to be skipped, if skipping the linear part is active (`[SENSe<Ch>:]FREQuency:COMPReSSion:SKIP ON`).

See ["Skipping the linear part"](#) on page 392.

Suffix:

<Ch> Channel number

Parameters:

<Value> For the next frequency, after measuring at the start power (`[SENSe<Ch>:]FREQuency:COMPReSSion:POWer:STARt`), continue the power sweep <Value> dB to the left of the "Compression Point Power In" determined for the previous frequency.
Default unit: dB

Manual operation: See ["Start Before Cmp"](#) on page 393

`[SENSe<Ch>:]FREQuency:COMPReSSion:SRCPort <TestPort>`

`[SENSe<Ch>:]FREQuency:COMPReSSion:RECeiver <TestPort>`

Defines the driving and receiving port for a gain compression measurement in channel <Ch>.

Suffix:
 <Ch> Channel number

Parameters:
 <TestPort> Port number

Example: See [\[SENSe<Ch>:\]FREQuency:COMPression:POINt](#) on page 1423.

Manual operation: See ["Driving Port/Receiving Port"](#) on page 394

[SENSe<Ch>:]FREQuency:CONVersion <ConversionMode>

Enables a frequency conversion measurement mode for channel <Ch>.

Suffix:
 <Ch> Channel number

Parameters:
 <ConversionMode> FUNDamental | ARBitary | MIXer | IMODulation

FUNDamental

Measurement of the fundamental signal (non frequency-converting mode). This selection cancels all port-specific frequency and power settings (see example).

ARBitary

Frequency conversion mode (arbitrary port frequencies). This mode is automatically activated when a port-specific frequency is defined.

MIXer

Mixer mode, configured using

[\[SENSe<Ch>:\]FREQuency:CONVersion:MIXer...](#) commands.

For vector mixer measurements, set [\[SENSe<Ch>:\]PHASe:MODE](#) to COHerent.

IMODulation

Intermodulation measurement mode, configured using the [\[SENSe<Ch>:\]FREQuency:IMODulation...](#) commands.

*RST: FUNDamental

Example: See [SOURce<Ch>:FREQuency<PhyPt>:CONVersion:ARBitary:IFRequency](#)

Manual operation: See ["OK"](#) on page 412

[SENSe<Ch>:]FREQuency<Pt>:CONVersion:ARBitary <Numerator>, <Denominator>, <Offset>, <SweepType>

Defines the receiver frequency formula at port <Pt> for frequency-converting measurements.

For <SweepType> SWEep, the receiver frequency f_r is calculated according to

$$f_r = \langle \text{Numerator} \rangle / \langle \text{Denominator} \rangle * f_b + \langle \text{Offset} \rangle,$$

where f_b represents channel base frequency.

For $\langle \text{Sweep Type} \rangle$ CW and FIXed, f_r is calculated according to

$$f_r = \langle \text{Offset} \rangle,$$

i.e. f_r is constant.

Make sure the converted frequency or frequency range is within the analyzer's frequency range.

Note: If the resulting frequencies are not (completely) within the allowed range, the analyzer returns an error message. Nevertheless, the frequency formula is applied.

Suffix:

$\langle \text{Ch} \rangle$ Channel number

$\langle \text{Pt} \rangle$ Port number

Note that for "Remote Language" ZVABT, this suffix is ignored and the command defines the receiver frequency for **all** ports (like in R&S ZVA/ZVB).

Parameters:

$\langle \text{Numerator} \rangle$ The specified numerator is rounded to the next higher integer; zero is not allowed.

*RST: 1

$\langle \text{Denominator} \rangle$ The specified denominator must be positive. It is rounded to the next higher integer.

*RST: 1

$\langle \text{Offset} \rangle$ The specified offset value is rounded to (positive or negative) multiples of 1 Hz.

*RST: 0 Hz

Default unit: Hz

$\langle \text{SweepType} \rangle$ CW | FIXed | SWEep

SWEep

A frequency sweep is active, the command defines a frequency range.

CW | FIXed

A power, time or CW Mode sweeps is active, the command defines a fixed frequency.

*RST: SWEep

Example:

```
*RST; FREQ:STAR 1E+9; STOP 1.1E+9
```

Reset the analyzer (activating a frequency sweep) and set the sweep range between 1 GHz and 1.1 GHz.

```
SENS:FREQ:CONV:ARB 2, 1, 1E+9, SWE
```

Convert the receiver frequency to the range between 3 GHz and 3.2 GHz.

Manual operation: See ["Receiver Freq. Conversion"](#) on page 672

[SENSe<Ch>:]FREQuency:CONVersion:ARBitrary:PMETer<Pmtr> <Numerator>, <Denominator>, <Offset>, <SweepType>

Defines the receiver frequency of a power meter used for frequency-converting measurements. The receiver frequency is either a range (for frequency sweeps) or a CW frequency (for power, time and CW Mode sweeps). The receiver frequency is valid for all ports.

<Numerator>, <Denominator> and <Offset> are parameters of the frequency formula. The receiver frequency f_r is calculated according to

$$f_r = \frac{\text{<Numerator>}}{\text{<Denominator>}} * f_b + \text{<Offset>}$$

where f_b represents the channel base frequency (parameter *SWEep*). For parameters *CW* or *FIXed*, $f_b = 0$.

<Numerator>, <Denominator> and <Offset> values are rounded to positive or negative integer numbers; zero is not allowed.

Note:

- The default frequency or frequency range corresponds to the sweep range or CW frequency of the analyzer.
- The <Offset> parameter also includes the "Offset Ratio" in manual control.
- The converted frequency or frequency range must be within the power meter's receiver frequency range. Nevertheless, the frequency formula is applied even if the analyzer returns an error message, because the frequency is outside the allowed range.

Suffix:

<Ch> Channel number
 <Pmtr> Power meter number

Parameters:

<Numerator> *RST: 1
 <Denominator> *RST: 1
 <Offset> *RST: 0
 Default unit: Hz
 <SweepType> CW | FIXed | SWEep
 SWEep - the full formula is applied. For frequency sweeps, the command defines a sweep range.
 CW | FIXed - the reduced formula with $f_b = 0$ is applied; the command defines a fixed frequency.
 *RST: SWEep

Example:

```
*RST;
FREQ:STAR 1E+9;
STOP 1.1E+9
Reset the analyzer (activating a frequency sweep) and set the sweep range between 1 GHz and 1.1 GHz.
SYST:COMM:RDEV:PMET1:DEF 'USB Power Meter',
'NRP-z55', 'usb', '100045'
Configure an R&S NRP power meter as external power meter no. 1, assigning the name USB Power Meter and an serial number 100045.
SENS:FREQ:CONV:ARB:PMET 2, 1, 1E+9, SWE
Convert the receiver frequency to the range between 3 GHz and 3.2 GHz.
```

Manual operation: See "[Frequency Conversion Formula](#)" on page 674

[SENSe<Ch>:]FREQuency<Pt>:CONVersion:AWReceiver[:STATe] <RecFormula>

Defines the frequencies of the "a wave receivers", i.e. the frequencies to which the receivers of port <Pt> are set while this port is the source port.

Suffix:

<Ch> Channel number

<Pt> Port number

Parameters:

<RecFormula> OFF | ON | SRC

OFF

Only the measurement receiver (b wave receiver) uses the receiver formula; the reference receiver uses the source formula.

ON

Both receivers use the receiver formula (see [\[SENSe<Ch>:\]FREQuency<Pt>:CONVersion:ARBitrary](#)).

SRC

Both receivers use the source formula (see [SOURce<Ch>:FREQuency<PhyPt>:CONVersion:ARBitrary:IFRequency](#))

*RST: SRC

Options: R&S ZNA-K4

Manual operation: See "[Receiver Freq.](#)" on page 672

[SENSe:]FREQuency:CONVersion:DEVIce<Port>:NAME <Converter Type>

Sets/queries the type of frequency converter at VNA port <Port>.

Suffix:

<Port> Converter number = VNA port number

Parameters:

<Converter Type> String value, e.g. 'ZVA-Z110'; use [\[SENSe:\]CONVerter:DEFinition:CATalog?](#) to get the list of converter types. An empty string ' ' indicates that no converter is connected.

Options: R&S ZNA-K8

Manual operation: See "[Converter Type](#)" on page 902

[SENSe<Ch>:]FREQuency:CONVersion:GAIN:LMCorrection <Boolean>

Enables or disables load match correction for frequency transmission S-parameters (conversion gain factors in case of frequency-converting measurements).

Suffix:

<Ch> Channel number

Parameters:

<Boolean> *RST: ON

Example: See [SOURce<Ch>:FREQuency<PhyPt>:CONVersion:ARBitrary:IFRequency](#)

Manual operation: See "[Load Match Correction](#)" on page 636

[SENSe<Ch>:]FREQuency:CONVersion:MIXer:FIXed<Stg> <InputOutput>

Selects the mixer input or output signal which is at the fixed frequency defined via [\[SENSe<Ch>:\]FREQuency:CONVersion:MIXer:MFFixed](#).

Suffix:

<Ch> Channel number.

<Stg> Counter for fixed signal (1 if only one mixer stage is used, 1 or 2 for 2 mixer stages).

Parameters:

<InputOutput> RF | LO | LO1 | LO2 | IF
 RF - mixer input signal
 LO | LO1 | LO2 - local oscillator signal 1 or 2 (for 2-stage mixer measurements, see [\[SENSe<Ch>:\]FREQuency:CONVersion:MIXer:STAGes](#))
 IF - mixer output signal (mixing product)
 *RST: LO

Example: See [\[SENSe<Ch>:\]FREQuency:CONVersion:MIXer:MFFixed](#)

[SENSe<Ch>:]FREQuency:CONVersion:MIXer:FUNDamental <InputOutput>

Selects the mixer input or output signal which is at the fundamental frequency (channel frequency, to be defined by means of [SENSe<Ch>:]FREQuency:START, [SENSe<Ch>:]FREQuency:STOP, [SENSe<Ch>:]FREQuency:CW etc.).

Suffix:

<Ch> Channel number.

Parameters:

<InputOutput> RF | LO | LO1 | LO2 | IF
 RF - mixer input signal
 LO | LO1 | LO2 - local oscillator signal 1 or 2 (for 2-stage mixer measurements; see [SENSe<Ch>:]FREQuency:CONVersion:MIXer:STAGes)
 IF - mixer output signal (mixing product)
 *RST: RF

Example: See [SENSe<Ch>:]FREQuency:CONVersion:MIXer:MFFixed

Manual operation: See "RF, IF and Mixer Stages" on page 411

[SENSe<Ch>:]FREQuency:CONVersion:MIXer:IFPort <PortNumber>

Selects an analyzer port as receive port for the IF signal.

Suffix:

<Ch> Channel number

Parameters:

<PortNumber> Range: 1 to number of test ports
 *RST: 2

Example: See [SENSe<Ch>:]FREQuency:CONVersion:MIXer:MFFixed

Manual operation: See "Port selection" on page 410

[SENSe<Ch>:]FREQuency:CONVersion:MIXer:LOMultiplier<Stg> <Numerator>, <Denominator>

Selects the frequency conversion factors for the LO signal.

The conversion factor is a ratio of two positive integers: numerator and denominator.

Suffix:

<Ch> Channel number

<Stg> Mixer stage signals LO 1 or LO 2; see [SENSe<Ch>:]FREQuency:CONVersion:MIXer:STAGes

Parameters:

<Numerator>	Range:	1, 2, 3 ...
	*RST:	1
<Denominator>	Range:	1, 2, 3 ...
	*RST:	1

Example: See [\[SENSe<Ch>:\]FREQuency:CONVersion:MIXer:MFFixed](#)

Manual operation: See "[Multiplication factors](#)" on page 410

[SENSe<Ch>:]FREQuency:CONVersion:MIXer:LOPort<Stg> <SourceType>[, <SourceNumber>]

Selects an analyzer or an external generator port as a signal source for the LO1 or LO2 signal.

Note:

If [External switch matrices](#) are part of the RF connection configuration, operation with more than one internal source is *not* supported. In this case only external generators can be used as local oscillators.

Suffix:

<Ch>	Channel number
<Stg>	Mixer stage (signals LO 1 or LO 2; see [SENSe<Ch>:]FREQuency:CONVersion:MIXer:STAGes).

Parameters:

<SourceType>	PORT GENerator NONE NONE – LO signal is not controlled by the analyzer. PORT – analyzer port GENerator – external generator *RST: NONE
<SourceNumber>	Number of analyzer port or generator.

Example: See [\[SENSe<Ch>:\]FREQuency:CONVersion:MIXer:MFFixed](#)

Manual operation: See "[Port selection](#)" on page 410

[SENSe<Ch>:]FREQuency:CONVersion:MIXer:MFFixed <InputOutput>[, <FixedFrequency>]

Assigns a fixed frequency to the RF, LO 1, LO 2, or to the IF signal. The fixed frequency setting becomes active if the port is selected as a port with fixed frequency ([\[SENSe<Ch>:\]FREQuency:CONVersion:MIXer:FIXed<Stg>](#)).

Suffix:	
<Ch>	Channel number
Parameters:	
<InputOutput>	RF LO LO1 LO2 IF Fixed frequency for the specified port RF – mixer input signal LO LO1 – local oscillator signal no. 1 LO2 – local oscillator signal no. 2, for 2-stage mixer measurements (<code>[SENSe<Ch>:]FREQuency:CONVersion:MIXer:STAGes</code>) IF – mixer output signal
	Range: Depending on the instrument model [Hz]. The increment (parameters UP or DOWN) is 0.1 kHz.
	*RST: Minimum of the analyzer's frequency range
<FixedFrequency>	Default unit: Hz

Example:

The following example assumes a four-port R&S ZNA, and that an external generator Gen 1 is connected to the analyzer and configured.

```
*RST; FREQ:CONV:MIX:STAG 2
```

Select a mixer measurement with two mixer stages.

```
FREQ:CONV:MIX:RFPort 1; IFPort 2
```

Select the analyzer port 1 as a source port for the RF signal, port 2 as a receive port for the IF signal.

```
FREQ:CONV:MIX:LOPort1 PORT, 3; LOPort2 GEN, 1
```

Select port 3 as a source port for the local oscillator LO1, port 3 as a source for LO 2.

```
FREQ:CONV:MIX:RFMultiplier 2, 1; LOMultiplier1  
2, 1 ; LOMultiplier2 2, 1
```

Define frequency conversion factors 2 for the RF signals and the LO signals.

```
FREQ:START 1GHz; STOP 2 GHz
```

Select a sweep range between 1 and 2 GHz.

```
FREQ:CONV:MIX:FIXed1 LO1; FIXed2 LO2
```

Assign fixed frequency settings to the two LO signals.

```
FREQ:CONV:MIX:FUNDamental RF; MFFixed LO1, 10  
MHz; MFFixed LO2, 10 MHz
```

Assign the channel base frequency (sweep range) to the RF signal, fixed frequencies of 10 MHz to both LO signals.

```
FREQ:CONV:MIX:TFRrequency1 DCUP; TFRrequency2  
UCON
```

Select down-conversion (USB) at the first mixer-stage, up-conversion (USB) at the second mixer stage.

```
SOUR:FREQ:CONV:MIX:PMODE RF, FUNDamental; PMODE  
LO1, FIXed; PMODE LO2, FIXed; PMODE IF,  
FUNDamental
```

Assign the channel base power to the RF and IF signals, a fixed power to the LO signals.

```
SOUR:FREQ:CONV:MIX:PMFixed LO1, -20; PMFixed  
LO2, -10
```

Define the fixed powers of the LO signals.

Manual operation: See ["RF, IF and Mixer Stages"](#) on page 411

[SENSe<Ch>:]FREQuency:CONVersion:MIXer:PRFimage <Boolean>

Suffix:

<Ch>

Parameters:

<Boolean>

[SENSe<Ch>:]FREQUENCY:CONVersion:MIXer:RFMultiplier <Numerator>, <Denominator>

Selects the frequency conversion factor for the RF signal. The conversion factor is a ratio of two positive integers (numerator, denominator).

Suffix:

<Ch> Channel number

Parameters:

<Numerator> Range: 1, 2, 3 ...
*RST: 1

<Denominator> Range: 1, 2, 3 ...
*RST: 1

Example: See [\[SENSe<Ch>:\]FREQUENCY:CONVersion:MIXer:MFFixed](#)

Manual operation: See ["Multiplication factors"](#) on page 410

[SENSe<Ch>:]FREQUENCY:CONVersion:MIXer:RFPort <Port>

Selects a test port as source port for the RF signal.

Suffix:

<Ch> Channel number

Parameters:

<Port> Test port number
Range: 1 to number of test ports
*RST: 1

Example: See [\[SENSe<Ch>:\]FREQUENCY:CONVersion:MIXer:MFFixed](#)

Manual operation: See ["Port selection"](#) on page 410

[SENSe<Ch>:]FREQUENCY:CONVersion:MIXer:STAGes <Stages>

Selects the number of mixer stages for scalar mixer measurements.

Suffix:

<Ch> Channel number

Parameters:

<Stages> Number of mixer stages
Range: 1 | 2
*RST: 1

Example: See [\[SENSe<Ch>:\]FREQUENCY:CONVersion:MIXer:MFFixed](#)

Manual operation: See ["RF, IF and Mixer Stages"](#) on page 411

[SENSe<Ch>:]FREQUency:CONVersion:MIXer:TFRrequency<Stg>
 <IFConversionMode>

Selects the frequency conversion mode of the IF signal.

Suffix:

<Ch> Channel number.
 <Stg> Mixer stage (1 or 2; see [SENSe<Ch>:]FREQUency:CONVersion:MIXer:STAGes.

Parameters:

<IFConversionMode> DCUPper | DCLower | UCONversion | BAND1 | BAND2
 DCUPper | BAND2 – IF = RF - LO (down conversion upper sideband, equivalent to BAND2)
 DCLower | BAND1 – IF = LO - RF (down conversion lower sideband, equivalent to BAND1)
 UCONversion – IF = LO + RF (up conversion)
 *RST: DCUPper

Example:

```
*RST;
FREQ:CONV:MIX:LOF 3 GHz
Reset the analyzer and specify a fixed frequency of 1 GHz, to be assigned to the LO signal.
FREQ:STAR 1 GHz;
STOP 2 GHz
Define a sweep range between 3 and 4 GHz, to be assigned to the RF signal.
FREQ:CONV:MIX:TFR DCL
Select down conversion to the lower sideband, corresponding to an IF frequency range between 2 GHz and 1 GHz.
```

Manual operation: See "RF, IF and Mixer Stages" on page 411

[SENSe<Ch>:]FREQUency[:CW] <FixedFreq>

[SENSe<Ch>:]FREQUency:FIXed <FixedFreq>

Defines the fixed (Continuous Wave, CW) frequency for all sweep types operating at fixed frequency ("Power", "Time", "CW Mode"). The two command forms [SENSe<Ch>:]FREQUency[:CW] and [SENSe<Ch>:]FREQUency:FIXed are equivalent.

This command also defines the center frequency of the intermodulation spectrum diagram (with option R&S ZNA-K4). The frequency range depends on the R&S ZNA model; see Chapter 7.3.14.11, "[SENSe:]FREQUency...", on page 1421.

Note: [SENSe<Ch>:]FREQUency[:CW] | :FIXed is equivalent to SOURce<Ch>:FREQUency<PhyPt>[:CW] | :FIXed. Source and receiver frequency are always equal; the four commands overwrite each other.

With option R&S ZNA-K4, Frequency Conversion Measurements, port-specific source and receiver frequencies can be defined; see SOURce<Ch>:FREQUency<PhyPt>:CONVersion:ARbitrary:IFrequency.

Suffix:

<Ch> Channel number

Parameters:

<FixedFreq> Fixed stimulus and analyzer frequency
 *RST: 1 GHz
 Default unit: Hz

Example:

```
FUNC "XTime:POW:A1"
```

Activate a time sweep and select the wave quantity a_1 as measured parameter for channel and trace no. 1.

```
FREQ:CW 100MHz
```

Set the CW frequency to 100 MHz.

Manual operation: See "[CW Frequency](#)" on page 524

[SENSe<Ch>:]FREQuency:IMODulation:CONVersion <OFF>

Disables the intermodulation measurement and switches back to normal mode (no frequency conversion).

Suffix:

<Ch> Channel number

Setting parameters:

<OFF> OFF
 Disable intermodulation measurement
 *RST: n/a

Example: See [\[SENSe<Ch>:\]FREQuency:IMODulation:LTONE](#)

Usage: Setting only

[SENSe<Ch>:]FREQuency:IMODulation:LTONE <SourceType>[, <SourceNumber>]

Selects the source for the lower tone signal that is used for the intermodulation measurement.

Suffix:

<Ch> Channel number

Parameters:

<SourceType> PORT
 Lower tone source; internal source at port <arg1>

<SourceNumber> Number of the port for the internal source
 Range: 1 to port number of the analyzer/number of external generators
 *RST: n/a (for all parameters)

Example:

```
*RST;
FREQ:IMOD:LTON PORT,1
Select port 1 as a source port for the lower tone.
FREQ:IMOD:UTON GEN,1
Select an external generator as a source for the upper tone
(must be configured previously).
SOUR:POWer:CORR:IMOD:PORT 'COMBINER'
Select External Device as a source port for the two tone signal.
FREQ:IMOD:REC 2
Select port 2 as the receiver port for the intermodulation mea-
surement.
FREQ:IMOD:TDIS 2E6
Select a tone distance of 2 MHz.
FREQ:IMOD:ORD3 ON; :ORD5 ON; :ORD7 OFF; :ORD9
OFF
Enable the measurement of the intermodulation products up to
the 5th order.
...
(Perform intermodulation measurement, evaluate results.)
FREQ:IMOD:CONV OFF
Disable intermodulation measurement, switch back to normal
(non frequency-converting) mode.
```

Manual operation: See "[Lower Tone](#)" on page 383

[SENSe<Ch>]:FREQuency:IMODulation:MSpectrum

Creates a new "Spectrum" measurement channel, centered at the position of the active marker. If there is no marker in the active intermodulation trace, the center frequency of the related channel is used.

Suffix:
<Ch> Channel number

Usage: Event

Options: R&S ZNA-K1 and R&S ZNA-K4

Manual operation: See "[CW Mode Spectrum](#)" on page 381

[SENSe<Ch>]:FREQuency:IMODulation:ORDER<Im>[:STATe] <Boolean>

Enables or disables the measurement of the intermodulation products of order <Im order>.

Suffix:
<Ch> Channel number
<Im> Order of IM products

Parameters:
<Boolean> ON | OFF – enables or disables measurement
*RST: ON (for <Im> = 3), OFF (for <Im> > 3)

Example: See [\[SENSe<Ch>:\]FREQuency:IMODulation:LTONE](#)

[SENSe<Ch>:]FREQuency:IMODulation:RECeiver <PortNumber>

Selects the receiving port for the intermodulation measurement.

Suffix:

<Ch> Channel number

Parameters:

<PortNumber> Analyzer port number

Range: 1 to the number of analyzer ports

*RST: 2

Example: See [\[SENSe<Ch>:\]FREQuency:IMODulation:LTONE](#)

Manual operation: See ["Receiving Port"](#) on page 386

[SENSe<Ch>:]FREQuency:IMODulation:SPECTrum:MORDER <IMOrder>

Defines the maximum order of intermodulation products for the intermodulation spectrum measurement.

Suffix:

<Ch> Channel number

Parameters:

<IMOrder> Maximum order of IM products

Range: 3 | 5 | 7 | 9

*RST: 3

Example: See [\[SENSe<Ch>:\]FREQuency:IMODulation:SPECTrum\[:STATe\]](#)

Manual operation: See ["CW Mode Spectrum"](#) on page 381

[SENSe<Ch>:]FREQuency:IMODulation:SPECTrum[:STATe] <Boolean>

Enables or disables the measurement of the intermodulation spectrum. If a new channel is desired, the trace must be created separately; see second example below.

Suffix:

<Ch> Channel number

Parameters:

<Boolean> ON | OFF - enables or disables intermodulation spectrum measurement.

*RST: OFF

Example: Intermodulation spectrum measurement within the active channel.

```
*RST; FREQ:IMOD:LTON PORT,1; UTON GEN, 1
```

Reset the instrument to create the default channel no. 1. Select port 1 as a source port for the lower tone, a (previously configured) external generator no. 1 as a source port for the upper tone.

```
FREQ:STAR 1GHZ; STOP 2GHz
```

Define a suitable sweep range to ensure that the analyzer can measure all intermodulation products.

```
SENS1:FREQ:IMOD:SPEC ON
```

Enable the intermodulation spectrum measurement for channel no. 1.

```
CALC1:PAR:CAT?
```

Query the traces in channel no. 1. The response is 'Trc1,B2D1SAM'.

```
SENS1:FREQ 1.5 GHz; :SENS1:FREQ:IMOD:SPEC:MORD 9
```

Adjust the center frequency and the maximum IM order of the spectrum intermodulation diagram.

Example: Intermodulation spectrum measurement in a new channel.

```
*RST; FREQ:IMOD:LTON PORT,1; UTON GEN, 1
```

Reset the instrument to create the default channel no. 1. Select port 1 as a source port for the lower tone, a (previously configured) external generator no. 1 as a source port for the upper tone.

```
FREQ:STAR 1GHZ; STOP 2GHz
```

Define a suitable sweep range to ensure that the analyzer can measure all intermodulation products.

```
CALC2:PAR:SDEF 'Trc2', 'S21'
```

Create a new channel no. 2 and a trace named 'Trc2'. Select S_{21} as a measured quantity.

```
DISP:WIND:TRAC2:FEED 'Trc2'
```

Display the new trace in diagram no. 1.

```
SENS2:FREQ:IMOD:SPEC ON
```

Enable the intermodulation spectrum measurement for the new channel no. 2.

```
CALC2:PAR:CAT?
```

Query the traces in channel no. 2. The response is 'Trc2,B2D1SAM'.

Manual operation: See "[CW Mode Spectrum](#)" on page 381

[SENSe<Ch>]:FREQuency:IMODulation:TDisTance <ToneDistance>

Defines the tone distance (frequency offset) between the upper and the lower tone.

Suffix:

<Ch> Channel number

Parameters:

<ToneDistance> Upper tone frequency minus lower tone frequency.
 Range: Lower limit: 0 Hz, upper limit depending on the instrument model and the sweep range for the lower tone.
 *RST: 1 MHz
 Default unit: Hz

Example:

See [\[SENSe<Ch>:\]FREQuency:IMODulation:LTONE](#)

Manual operation: See ["Delta Frequency"](#) on page 387

[SENSe<Ch>:]FREQuency:IMODulation:UTONE <SourceType>[, <arg1>]

Selects the source for the upper tone signal that is used for the intermodulation measurement.

Note:

If [External switch matrices](#) are part of the RF connection configuration, operation with more than one internal source is *not* supported. In this case only external generators can be used as local oscillators.

Suffix:

<Ch> Channel number

Parameters:

<SourceType> PORT | GENERator | NONE
 Upper tone source:
 NONE – no source selected (for query only)
 PORT – internal second source at port <arg1>
 GENERator – configured external generator no. <arg1>
 *RST: NONE

<arg1> Analyzer port number or generator number
 Range: 1 to number of ports of the analyzer or number of configured external generators
 *RST: n/a (no analyzer or generator port selected)

Example:

See [\[SENSe<Ch>:\]FREQuency:IMODulation:LTONE](#)

Manual operation: See ["Upper Tone"](#) on page 383

[SENSe<Ch>:]FREQuency:SBANd <Sideband>

Defines whether the analyzer measures with a local oscillator frequency LO below or above the RF input frequency.

Tip: In a segmented frequency sweep, it is possible to set the sideband (SBANd) parameter individually for each segment; see [\[SENSe<Ch>:\]SEGMENT<Seg>:DEFine](#). The [\[SENSe<Ch>:\]FREQuency:SBANd](#) setting is global and not valid for segmented sweeps. The two sideband settings do not overwrite each other.

Suffix:

<Ch> Channel number. This suffix is ignored; the setting applies to all channels in the active recall set.

Parameters:

<Sideband> POSitive | NEGative | AUTO

POSitive

LO > RF; the LO frequency is always above the measured RF frequency.

NEGative

LO < RF; the LO frequency is always below the measured RF frequency.

AUTO

The analyzer auto-selects the LO frequency, depending on the receiver (RF) frequency.

*RST: AUTO

Example:

*RST; :SWE:TYPE?; :FREQ:SBAN?

Query the *RST values for the sweep type and the sideband setting. The response is LIN (linear frequency sweep) and AUTO (automatic setting of the LO frequency).

Manual operation: See "[Image Suppr.](#)" on page 687

[SENSe<Ch>]:]FREQuency:SEGMent:AXIS <Scale>

Selects either frequency based or point based x-axis for segmented sweeps.

Suffix:

<Ch> Channel number

Parameters:

<Scale> POINT | FREQuency

Example:

SENSe:SEGMent:INSert 1MHZ, 1.1MHZ, 101, -21DBM, 0.5S, 0, 10KHZ

SENSe:SEGMent:INSert 2MHZ, 3MHZ, 101, -21DBM, 0.5S, 0, 10KHZ

Create two sweep segments with different frequency spans, each with 101 sweep points.

SENSe:SEGMent:FREQuency:AXIS POINT

Select the point based frequency axis. The first 101 sweep points are distributed over the left half of the diagram, the second 101 points over the right half.

Manual operation: See "[Seg X-Axis](#)" on page 551

**[SENSe<Ch>:]FREQUENCY:SPAN **

Defines the width (span) of the measurement and display range for a frequency sweep (sweep range). The default span equals to the maximum frequency range of the analyzer: $f_{MAX} - f_{MIN}$.

The maximum frequency range depends on the instrument model; see [Table 7-17](#).

Suffix:

<Ch> Channel number

Parameters:

 Frequency span of the sweep
 Increment: 0.1 kHz
 Default unit: Hz

Example: See [\[SENSe<Ch>:\]FREQUENCY:CENTer](#)

Manual operation: See ["Start Frequency / Stop Frequency / Center Frequency / Span Frequency"](#) on page 523

Note: The measurement range defined by means of the span and the current center frequency ([\[SENSe<Ch>:\]FREQUENCY:CENTer](#)), must not exceed the allowed frequency range of the analyzer. If necessary, the center frequency is adjusted to $f_{MIN} + \langle Span \rangle / 2$ or $f_{MAX} - \langle Span \rangle / 2$.

[SENSe<Ch>:]FREQUENCY:START <FreqVal>

[SENSe<Ch>:]FREQUENCY:STOP <FreqVal>

These commands defines the start and stop frequency for a frequency sweep. The values also define the display range in a Cartesian diagram. The default start and stop frequencies equal to the minimum and maximum frequency of the analyzer.

The ranges depend on the instrument model; see [Table 7-17](#).

Suffix:

<Ch> Channel number

Parameters:

<FreqVal> Start and stop frequency of the sweep
 Increment: 0.1 kHz
 Default unit: Hz

Example: *RST; FREQ:STAR 10MHz
 Activate a frequency sweep and set the start frequency to 10 MHz.
 FREQ:STOP 100MHz
 Set the stop frequency to 100 MHz.

Manual operation: See ["Start Frequency / Stop Frequency / Center Frequency / Span Frequency"](#) on page 523

Note: If the start frequency entered is greater than the current stop frequency, the stop frequency is set to the start frequency plus the minimum frequency span ([\[SENSe<Ch>:\]FREQUENCY:SPAN](#)).

If the stop frequency entered is smaller than the current start frequency, the start frequency is set to the stop frequency minus the minimum frequency span.

7.3.14.12 [SENSe:]GDEvice

Configures generic device commands for the related channel.

SENSe:GDEvice:ADDRess?	1444
[SENSe<Ch>:]GDEvice:DELeTe	1444
[SENSe<Ch>:]GDEvice:MSELeCt	1444
[SENSe<Ch>:]GDEvice:SELeCt	1445

SENSe:GDEvice:ADDRess?

Returns the addresses of the configured generic external devices.

Return values:

<Address> Comma-separated list of string values.
 These addresses are used for setting and unsetting the command to be executed via [SENSe<Ch>:]GDEvice:SELeCt and [SENSe<Ch>:]GDEvice:DELeTe, respectively.

Example: See [SENSe<Ch>:]GDEvice:SELeCt on page 1445.

Usage: Query only

[SENSe<Ch>:]GDEvice:DELeTe [<Address>]

Deletes generic device command configurations for channel <Ch>.

Suffix:

<Ch> Channel number

Setting parameters:

<Address> Address string
 If present, only the command configuration of the related device is deleted. Otherwise, the command configurations of all generic external devices are deleted.
 Use SENSe:GDEvice:ADDRess? to get the address strings of the configured generic devices.

Example: See [SENSe<Ch>:]GDEvice:SELeCt on page 1445.

Usage: Setting only

Manual operation: See "Reset" on page 926

[SENSe<Ch>:]GDEvice:MSELeCt <Address>, <CommandFilepath>, <MixerCommandId>

Defines or queries the generic device calibration mixer command configuration of channel <Ch>.

Suffix:	
<Ch>	Channel number
Parameters:	
<Address>	Use <code>SENSe:GDEvice:ADDRess?</code> to get the address strings of the configured generic devices. If omitted as a parameter, the query returns all generic device calibration mixer command configurations of channel <Ch>. As a return value, <Adress> takes the long form described in Table 5-13 , with an additional prefix <code>GenericDevice::</code> (see example).
<CommandFilepath>	Path to the command file, either absolute or relative to the current directory (see MMEMory:CDIRectory).
<MixerCommandId>	A unique "Command Name" (see Chapter 5.19.9, "Generic Device tab" , on page 921) within command file <CommandFilepath>.
Manual operation:	See " Generic Device Setting for Calibration Mixer " on page 591

[SENSe<Ch>:]GDEvice:SElect <Address>, <CommandFilepath>, <CommandId>

Defines or queries the generic device command configuration of channel <Ch>.

Suffix:	
<Ch>	Channel number
Parameters:	
<Address>	Use <code>SENSe:GDEvice:ADDRess?</code> to get the address strings of the configured generic devices. If omitted as a parameter, the query returns all generic device command configurations of channel <Ch>. As a return value, <Adress> takes the long form described in Table 5-13 , with an additional prefix <code>GenericDevice::</code> (see example).
<CommandFilepath>	Path to the command file, either absolute or relative to the current directory (see MMEMory:CDIRectory).
<CommandId>	A unique "Command Name" (see Chapter 5.19.9, "Generic Device tab" , on page 921) within command file <CommandFilepath>.

Example:

```
:SYSTem:COMMunicate:RDEvice:GDEvice1:DEFine
'VXI-11', '192.168.0.1'
:SYSTem:COMMunicate:RDEvice:GDEvice2:DEFine
'VXI-11', '192.168.0.2'
```

Configure two generic external devices.

```
SENSe:GDEvice:ADDRess?
```

Query the configured generic device addresses. The result is

```
'192.168.0.1', '192.168.0.2'.
:SENSe1:GDEvice:SElect '192.168.0.1',
'test.json', 'MySetting1'
:SENSe1:GDEvice:SElect '192.168.0.2',
'test.json', 'MySetting2'
```

Configure the commands to be sent to the devices before channel 1 is measured. The commands 'MySetting1' and 'MySetting2' are defined in a command file `test.json` that is located in the current directory.

```
:SENSe1:GDEvice:DElete '192.168.0.1'
```

For channel 1, no command is sent to generic device 1.

```
:SENSe1:GDEvice:DElete
```

For channel 1, no commands are sent to any generic devices.

Manual operation: See "[Config. File/Command](#)" on page 926

7.3.14.13 [SENSe:]HARMonic...

Implements functions related to harmonic grids for time domain transformation.

[SENSe<Ch>:]HARMonic?	1446
[SENSe<Ch>:]HARMonic:AUTO	1447
[SENSe<Ch>:]HARMonic:DLEnGth:DATA	1447
[SENSe<Ch>:]HARMonic:ELEnGth:DATA	1447
[SENSe<Ch>:]HARMonic:MLEnGth:DATA	1447
[SENSe<Ch>:]HARMonic:PERMittivity:DATA	1448
[SENSe<Ch>:]HARMonic:RTIME:DATA	1448
[SENSe<Ch>:]HARMonic:RTIME:THReshold	1448
[SENSe<Ch>:]HARMonic:VELocity:DATA	1449

[SENSe<Ch>:]HARMonic?

Queries whether the current frequency grid is harmonic.

Suffix:

<Ch> Channel number

Return values:

<arg0>

Usage: Query only

Manual operation: See "[Is the Current Grid Harmonic?](#)" on page 451

[SENSe<Ch>:]HARMonic:AUTO <arg0>

Turns the "Automatic Harmonic Grid" function ON or OFF.

Suffix:

<Ch> Channel number

Parameters:

<arg0> *RST: ON

Options: R&S ZNA-K2

Manual operation: See "[Automatic Harmonic Grid](#)" on page 452

[SENSe<Ch>:]HARMonic:DLENgth:DATA <DUTLength>

Sets/gets the expected maximum time delay through the DUT.

The set command automatically activates the "Automatic Harmonic Grid" function, i.e. it sets [\[SENSe<Ch>:\]HARMonic:AUTO](#) to ON.

Suffix:

<Ch> Channel number

Parameters:

<DUTLength> Default unit: s

Options: R&S ZNA-K20

Manual operation: See "[Max. DUT Measure Delay / Max. El. Length / Max. Mech. Length](#)" on page 804

[SENSe<Ch>:]HARMonic:ELENgth:DATA <DUTELength>

Sets/gets the expected maximum electrical length of the DUT.

The set command automatically activates the "Automatic Harmonic Grid" function, i.e. it sets [\[SENSe<Ch>:\]HARMonic:AUTO](#) to ON.

Suffix:

<Ch> Channel number

Parameters:

<DUTELength> Default unit: m

Options: R&S ZNA-K20

Manual operation: See "[Max. DUT Measure Delay / Max. El. Length / Max. Mech. Length](#)" on page 804

[SENSe<Ch>:]HARMonic:MLENgth:DATA <DUTMLength>

Sets/gets the expected maximum mechanical length of the DUT.

The set command automatically activates the "Automatic Harmonic Grid" function, i.e. it sets [\[SENSe<Ch>:\]HARMonic:AUTO](#) to ON.

Suffix:

<Ch> Channel number

Parameters:

<DUTMLength> Default unit: m

Options:

R&S ZNA-K20

Manual operation: See "[Max. DUT Measure Delay / Max. El. Length / Max. Mech. Length](#)" on page 804

[SENSe<Ch>:]HARMonic:PERMittivity:DATA <DUTPermittivity>

Sets/gets the (relative) permittivity of the DUT.

The set command automatically activates the "Automatic Harmonic Grid" function, i.e. it sets [\[SENSe<Ch>:\]HARMonic:AUTO](#) to ON.

Suffix:

<Ch> Channel number

Parameters:

<DUTPermittivity>

Options:

R&S ZNA-K20

Manual operation: See "[Permittivity / Velocity Factor](#)" on page 804

[SENSe<Ch>:]HARMonic:RTIME:DATA <DUTRiseTime>

Sets/gets the minimum rise time the user wishes to measure on the DUT.

Use [\[SENSe<Ch>:\]HARMonic:RTIME:THReshold](#) to select the underlying rise time definition.

The set command automatically activates the "Automatic Harmonic Grid" function, i.e. it sets [\[SENSe<Ch>:\]HARMonic:AUTO](#) to ON.

Suffix:

<Ch> Channel number

Parameters:

<DUTRiseTime> Default unit: s

Options:

R&S ZNA-K20

Manual operation: See "[Rise Time](#)" on page 805

[SENSe<Ch>:]HARMonic:RTIME:THReshold <DUTRiseThreshold>

Defines how the rise time that is set using [\[SENSe<Ch>:\]HARMonic:RTIME:DATA](#) shall be interpreted. Allows to select between rise time definitions 20%-80% (default) and 10%-90%.

The set command automatically activates the "Automatic Harmonic Grid" function, i.e. it sets [\[SENSe<Ch>:\]HARMonic:AUTO](#) to ON.

Suffix:

<Ch> Channel number

Parameters:

<DUTRiseThreshold> T1_9 | T2_8

Rise time definition:

T1_9: 10%-90%

T2_8: 20%-80%

*RST: T2_8

Options:

R&S ZNA-K20

Manual operation: See ["Rise Time Definition"](#) on page 805

[SENSe<Ch>:]HARMonic:VELOCITY:DATA <DUTVelocity>

Sets/gets the velocity factor of the DUT.

The set command automatically activates the "Automatic Harmonic Grid" function, i.e. it sets [\[SENSe<Ch>:\]HARMonic:AUTO](#) to ON.

Suffix:

<Ch> Channel number

Parameters:

<DUTVelocity>

Options:

R&S ZNA-K20

Manual operation: See ["Permittivity / Velocity Factor"](#) on page 804

7.3.14.14 [SENSe:]LPORt...

The [\[SENSe:\]LPORt...](#) commands define the reference impedances of the balanced ports.

[\[SENSe<Ch>:\]LPORt<LogPt>:ZCOMmon](#)..... 1449

[\[SENSe<Ch>:\]LPORt<LogPt>:ZDIFferent](#)..... 1449

[\[SENSe<Ch>:\]LPORt<LogPt>:ZDEFault\[:STATE\]](#)..... 1450

[SENSe<Ch>:]LPORt<LogPt>:ZCOMmon <RealPart>[, <ImaginaryPart>]

[SENSe<Ch>:]LPORt<LogPt>:ZDIFferent <RealPart>[, <ImaginaryPart>]

These commands specify the complex common mode and differential mode reference impedances for the balanced (logical) port numbered <LogPt>.

Use [\[SENSe<Ch>:\]LPORt<LogPt>:ZDEFault\[:STATE\]](#) to toggle between configured and default reference impedances.

Suffix:

<Ch> Channel number

<LogPt> Logical port number. The logical ports must be defined using `SOURce<Ch>:LPORt<LogPt> <PhysicalPort1>, <PhysicalPort2>`. An n port analyzer supports a maximum of $n/2$ (n even) or $(n - 1)/2$ (n odd) logical ports.

Parameters:

<RealPart> Real part of the port impedance.
 Range: 1 mΩ to 10 MΩ
 *RST: ZCOMmon: 25 Ω; ZDIFferent: 100 Ω (real impedances)
 Default unit: Ohm

<ImaginaryPart> Imaginary part of the port impedance; may be omitted to define a real impedance.
 Range: - 10 MΩ to 10 MΩ
 *RST: 0 Ω (real impedances)
 Default unit: Ohm

Example:

```
*RST; :CALC:PAR:DEL 'TRC1'
```

Reset the analyzer and delete the (default) trace for channel no. 1.

```
SOUR:LPOR1 1,2
```

Combine the physical ports no. 1 and 2 to define the balanced (logical) port no. 1.

```
LPOR1:ZDIF 27, 2
```

Specify a complex differential mode reference impedance of $27\Omega + j * 2\Omega$ for the defined port.

Manual operation: See "[Single Ended Mode / Common Mode / Differential Mode](#)" on page 356

`[SENSe<Ch>]:LPORt<LogPt>:ZDEFault[:STATe] <arg0>`

Allows to toggle between default and renormalized reference impedance(s) for logical port <LogPt>.

Suffix:

<Ch> Channel number

<LogPt> Logical port number

Parameters:

<arg0> ON (1): Use default impedance(s)
 OFF (0): Use the redefined impedances defined via `[SENSe<Ch>]:PORT<PhyPt>:ZREFerence` for single-ended or via `[SENSe<Ch>]:LPORt<LogPt>:ZCOMmon` and `[SENSe<Ch>]:LPORt<LogPt>:ZDIFferent` for balanced logical ports

Manual operation: See "[Use Default](#)" on page 357

7.3.14.15 [SENSE:]NFIGure...

The [SENSE:]NFIGure... commands define properties of a [Noise figure measurement](#).

[SENSe<Ch>:]NFIGure:QSET...

The [SENSe<Ch>:]NFIGure:QSET... commands implement the functions of the [NF quickset dialog](#).

[SENSe<Ch>:]NFIGure:QSET:ATTReceiver.....	1451
[SENSe<Ch>:]NFIGure:QSET:ATTSource.....	1451
[SENSe<Ch>:]NFIGure:QSET:DUT:ENFigure.....	1451
[SENSe<Ch>:]NFIGure:QSET:DUT:GAIN.....	1452
[SENSe<Ch>:]NFIGure:QSET:DUT:POWer.....	1452
[SENSe<Ch>:]NFIGure:QSET:TNOise.....	1452
[SENSe<Ch>:]NFIGure:QSET[:EXEC].....	1452

[SENSe<Ch>:]NFIGure:QSET:ATTReceiver <External Attenuator at the Receiving Port>

Suffix:

<Ch>

Parameters:

<External Attenuator Default unit: dB
at the Receiving Port>

Manual operation: See "[Receiving Port](#)" on page 379

[SENSe<Ch>:]NFIGure:QSET:ATTSource <External Attenuator at the Source Port>

Suffix:

<Ch>

Parameters:

<External Attenuator Default unit: dB
at the Source Port>

Manual operation: See "[Driving Port](#)" on page 378

[SENSe<Ch>:]NFIGure:QSET:DUT:ENFigure <Expected DUT Noise Figure>

Suffix:

<Ch>

Parameters:

<Expected DUT NoiseDefault unit: dB
Figure>

Manual operation: See "[DUT Settings](#)" on page 377

[SENSe<Ch>]:NFIGure:QSET:DUT:GAIN <Expected DUT Gain>

Suffix:

<Ch>

Parameters:

<Expected DUT Gain> Default unit: dB

Manual operation: See ["DUT Settings"](#) on page 377

[SENSe<Ch>]:NFIGure:QSET:DUT:Power <Maximum desired DUT input power>

Suffix:

<Ch>

Parameters:

<Maximum desired DUT input power> Default unit: dBm

Manual operation: See ["DUT Settings"](#) on page 377

[SENSe<Ch>]:NFIGure:QSET:TNOise <Desired maximum Trace Noise>

Suffix:

<Ch>

Parameters:

<Desired maximum Trace Noise> Default unit: dB

Manual operation: See ["Result Settings"](#) on page 377

[SENSe<Ch>]:NFIGure:QSET[:EXEC]

Suffix:

<Ch>

Return values:

<Expected Times>

Manual operation: See ["Apply/OK"](#) on page 379

[SENSE]:NFIGure... (other)

[SENSe<Ch>]:NFIGure:CALibration:GTIME	1453
[SENSe<Ch>]:NFIGure:CALibration:NTIME	1453
[SENSe<Ch>]:NFIGure:DEFine	1453
[SENSe<Ch>]:NFIGure:GTIME	1454
[SENSe<Ch>]:NFIGure:HARMonic[:MAXFrequency]	1454
[SENSe<Ch>]:NFIGure:HARMonic[:MINFrequency]	1454
[SENSe<Ch>]:NFIGure:HARMonic[:MAXimumorder]	1455
[SENSe<Ch>]:NFIGure:HARMonic[:STATE]	1455

[SENSe<Ch>:]NFIGure:IFConst.....	1455
[SENSe<Ch>:]NFIGure:IFConst:STATe.....	1455
[SENSe<Ch>:]NFIGure:NTIME.....	1456
[SENSe<Ch>:]NFIGure:RFICorr.....	1456
[SENSe<Ch>:]NFIGure:TEATtenuator.....	1457
[SENSe<Ch>:]NFIGure:VIRejection[:STATe].....	1457

[SENSe<Ch>:]NFIGure:CALibration:GTIME <DetectorTime>

Defines the detector time of the AVG detector which is used for the gain measurement during a NF calibration in channel <Ch>.

Suffix:

<Ch> Channel number

Parameters:

<DetectorTime> Detector time for the AVG detector
Default unit: s

Example: SENSE1:NFIGure:CALibration:GTIME 10ms

Options: R&S ZNA-K30

Manual operation: See "[Gain Det Meas Time](#)" on page 595

[SENSe<Ch>:]NFIGure:CALibration:NTIME <DetectorTime>

Defines the detector time of the RMS detector which is used for the noise measurement during a NF calibration in channel <Ch>.

Suffix:

<Ch> Channel number

Parameters:

<DetectorTime> Detector time for the RMS detector
Default unit: s

Example: SENSE1:NFIGure:CALibration:NTIME 50ms

Options: R&S ZNA-K30

Manual operation: See "[Noise Det Meas Time](#)" on page 595

[SENSe<Ch>:]NFIGure:DEFine <receiving test port>, <driving test port>[, <further port pairs>...]

[SENSe<Ch>:]NFIGure:DEFine?

The setting initiates a noise figure measurement in channel <Ch> and defines the receive/drive test port pairs to be measured. The query returns the defined receive/drive test port pairs, or an empty string, if no pairs are defined.

Suffix:

<Ch> Channel number

Setting parameters:

<ReceivePort>	Receiving test port number
<DrivePort>	Driving test port number
<further port pairs>	Additional receive/drive port pairs (comma-separated)

Example:

```
SENSE1:NFIGure:DEFine 2,1
```

Initiates a noise figure measurement in channel 1, with drive port 1 and receive port 2.

Options:

R&S ZNA-K30

Manual operation:

See "[Driving Port \(RF\) / Receiving Port \(IF\)](#)" on page 370

[SENSE<Ch>:]NFIGure:GTIME <DetectorTime>

Defines the detector time of the AVG detector which is used for the gain measurement during a NF measurement in channel <Ch>

Suffix:

<Ch> Channel number

Parameters:

<DetectorTime> Detector time for the AVG detector
Default unit: s

Example:

```
SENSE1:NFIGure:GTIME 10ms
```

Options:

R&S ZNA-K30

Manual operation:

See "[Gain Det Meas Time](#)" on page 372

[SENSE<Ch>:]NFIGure:HARMonic[:MAXFrequency] <FrequencyLimit>**[SENSE<Ch>:]NFIGure:HARMonic[:MINFrequency] <FrequencyLimit>**

Sets the lower|upper frequency limit to which the sideband correction is used in a noise figure measurement in channel <Ch>.

Suffix:

<Ch> Channel number

Parameters:

<FrequencyLimit> Frequency limit at which the noise figure sideband correction is used.
Range: 10 MHz | 9 GHz
Default unit: Hz

Options:

R&S ZNA-K30

Manual operation:

See "[Sideband Correction](#)" on page 375

[SENSe<Ch>:JNFIGure:HARMonic[:MAXimumorder] <MaximumOrder>

Sets the sideband order of the sideband correction for a noise figure measurement in channel <Ch>.

Suffix:

<Ch> Channel number

Parameters:

<MaximumOrder> Sets the number of higher order sidebands which are measured and corrected during calibration and measurement.

*RST: 3

Options: R&S ZNA-K30

Manual operation: See "[Sideband Correction](#)" on page 375

[SENSe<Ch>:JNFIGure:HARMonic[:STATe] <State>

Activates or deactivates the sideband correction for a noise figure measurement in channel <Ch>.

Suffix:

<Ch> Channel number

Parameters:

<State> Enables (1) or disables (0) the sideband correction of the noise figure calibration and measurement.

*RST: 1

Options: R&S ZNA-K30

Manual operation: See "[Sideband Correction](#)" on page 375

[SENSe<Ch>:JNFIGure:IFConst <IFFreq>

If manual selection is activated ([\[SENSe<Ch>:JNFIGure:IFConst:STATe ON](#)), this command allows you to select an IF for noise figure measurements in channel <Ch>.

Suffix:

<Ch> Channel number

Parameters:

<IFFreq> Default unit: Hz

Options: R&S ZNA-K30

Manual operation: See "[General > IF Frequency](#)" on page 374

[SENSe<Ch>:JNFIGure:IFConst:STATe <Boolean>

Allows you to switch between automatic and manual IF selection for noise figure measurements in channel <Ch>

Suffix:	
<Ch>	Channel number
Parameters:	
<Boolean>	OFF (0) Automatic selection
	ON (1) Manual selection using <code>[SENSe<Ch>:]NFIGure:IFConst</code>
Options:	R&S ZNA-K30
Manual operation:	See " General > IF Frequency " on page 374

`[SENSe<Ch>:]NFIGure:NTIME <DetectorTime>`

Defines the detector time of the RMS detector which is used for the actual noise measurement during a NF measurement in channel <Ch>

Suffix:	
<Ch>	Channel number
Parameters:	
<DetectorTime>	Detector time for the RMS detector Default unit: s
Example:	<code>SENSe1:NFIGure:NTIME 50ms</code>
Options:	R&S ZNA-K30
Manual operation:	See " Noise Det Meas Time " on page 372

`[SENSe<Ch>:]NFIGure:RFICorr <Boolean>`

Activates or deactivates the image band correction at the DUT, during a frequency converting noise figure measurement in Channel <Ch>.

Suffix:	
<Ch>	Channel number
Parameters:	
<Boolean>	ON (1) image band correction activated
	OFF (0) image band correction deactivated
	*RST: OFF (0)
Example:	<code>SENSe1:NFIGure:RFICorr ON</code>
Options:	R&S ZNA-K30
Manual operation:	See " DUT Correction " on page 375

[SENSe<Ch>]:NFIGure:TEATtenuator <Temperature>

Sets the ambient temperature used for proper determination of the DUT input source noise during a noise figure measurement in channel <Ch>.

Suffix:

<Ch> Channel number

Parameters:

<Temperature> Ambient temperature in Kelvin.

Example:

SENSe1:NFIGure:TEATtenuator 320

Options:

R&S ZNA-K30

Manual operation: See "[General > Ambient Temperature](#)" on page 374

[SENSe<Ch>]:NFIGure:VIRejection[:STATe] <Boolean>

Defines whether virtual image rejection is used in noise figure channel <Ch>.

Note that for segmented sweeps the channel-wide setting is overwritten by segment-specific settings, if [\[SENSe<Ch>\]:SEgment:NFIGure:VIRejection:STATe:CONTRol](#) is set to ON.

Suffix:

<Ch> Channel number

Parameters:

<Boolean> **ON (1)**
Virtual image rejection activated
OFF (0)
Virtual image rejection deactivated

Options:

R&S ZNA-K30

Manual operation: See "[General > Virtual Image Rejection](#)" on page 374

7.3.14.16 [SENSe:]PATH...

Settings for the optional [Direct generator/receiver access](#) and [Chapter 4.7.30, "Direct IF access"](#), on page 308.

[SENSe<Ch>]:PATH<Pt>:DIRectaccess	1458
[SENSe<Ch>]:PATH<Pt>:IFINpath	1458
[SENSe<Ch>]:PATH<Pt>:IFOutauto	1459
[SENSe<Ch>]:PATH<Pt>:IFRequency	1459
[SENSe<Ch>]:PATH<Pt>:IFSWitch	1460
[SENSe<Ch>]:PATH<Pt>:MEASurement:DIRectaccess?	1461
[SENSe<Ch>]:PATH<Pt>:REFerence:DIRectaccess?	1461
[SENSe<Ch>]:PATH<Pt>:MEASurement:IFINpath?	1461
[SENSe<Ch>]:PATH<Pt>:REFerence:IFINpath?	1461
[SENSe<Ch>]:PATH<Pt>:MEASurement:IFOutauto?	1462
[SENSe<Ch>]:PATH<Pt>:REFerence:IFOutauto?	1462

[SENSe<Ch>:]PATH<Pt>:MEASurement:IFRequency?.....	1462
[SENSe<Ch>:]PATH<Pt>:REFerence:IFRequency?.....	1462
[SENSe<Ch>:]PATH<Pt>:MEASurement:IFSWitch?.....	1462
[SENSe<Ch>:]PATH<Pt>:REFerence:IFSWitch?.....	1462

[SENSe<Ch>:]PATH<Pt>:DIRectaccess <path>

Defines the [direct generator/receiver access](#) path.

Same functionality as [SOURCE<Ch>:PATH<Pt>:DIRectaccess](#)

Note that direct generator/receiver access and direct IF input cannot be used at the same time. Direct generator/receiver access is only used if [\[SENSe<Ch>:\]PATH<Pt>:IFSWitch](#) is set to OFF or OUT.

Suffix:

<Ch>	Channel number
<Pt>	Port number

Setting parameters:

<path> NONE | B16 | REV | SRC

NONE

Direct generator/receiver access not used (Out/In pairs jumpered)

B16

Standard use of direct generator/receiver access

REV

Reverse coupler configuration

SRC

Source monitor access

Usage: Setting only

Options: R&S ZNAXx-B16

Manual operation: See "[Receiver Input](#)" on page 678

[SENSe<Ch>:]PATH<Pt>:IFINpath <Direct IF Access InPath>

Selects the input paths of the Direct IF Access Input / Output connectors IF Reference <Pt> and IF Meas <Pt> in channel <Ch>.

This setting only takes effect if [\[SENSe<Ch>:\]PATH<Pt>:IFSWitch](#) is set to IN.

Suffix:

<Ch>	Channel number
<Pt>	Port number

Setting parameters:

<Direct IF Access InPath> DIRect | LP_60m | BP_279m

DIRect

Frequency range 5kHz to 1 GHz

LP_60m

Low pass, frequency range 5 kHz to 60 MHz

BP_279m

Band pass, frequency range 260 MHz to 290 MHz

Usage:	Setting only
Options:	R&S ZNA-B26
Manual operation:	See " Rear Input Path " on page 679

[SENSe<Ch>:]PATH<Pt>:IFOutauto <Boolean>

Defines how the outgoing frequencies at IF Reference <Pt> and IF Meas <Pt> are determined in channel <Ch>.

This setting only takes effect if [\[SENSe<Ch>:\]PATH<Pt>:IFSwitch](#) is set to `OUT`.

Suffix:

<Ch>	Channel number
<Pt>	Port number

Setting parameters:

<Boolean>	OFF The frequencies are set manually. Use [SENSe<Ch>:]PATH<Pt>:IFFrequency to define a suitable frequency conversion formula.
	ON The frequencies are set automatically (by the analyzer firmware). <code>*RST: OFF</code>

Usage:	Setting only
Options:	R&S ZNA-B26
Manual operation:	See " Auto Determine IF Out " on page 678

[SENSe<Ch>:]PATH<Pt>:IFFrequency <Numerator>, <Denominator>, <Offset>, <Sweep type>

Defines the frequency conversion formula for Direct IF Access Input / Output ports IF Reference <Pt> and IF Meas <Pt> in channel <Ch>.

For <Sweep type> `FB`, the IF frequency f_{IF} is calculated according to

$$f_{IF} = \frac{\text{<Numerator>}}{\text{<Denominator>}} * f_b + \text{<Offset>},$$

where f_b represents channel base frequency.

For <Sweep Type> `CW`, f_{IF} is calculated according to

$$f_{IF} = \text{<Offset>},$$

i.e. f_{IF} is constant.

Make sure the converted frequency or frequency range is within the Direct IF Access Input / Output ports' frequency range. If the resulting frequencies are not (completely) within the allowed range, the analyzer returns an error message. Nevertheless, the frequency formula is applied.

Note: This setting only takes effect in one of the following cases:

- `[SENSe<Ch>:]PATH<Pt>:REFerence:IFSWitch?` is set to `IN`.
- `[SENSe<Ch>:]PATH<Pt>:REFerence:IFSWitch?` is set to `OUT` and `[SENSe<Ch>:]PATH<Pt>:IFOutauto` is set to `OFF`.

Suffix:

<Ch> Channel number

<Pt> Port number

Setting parameters:

<Numerator> The specified numerator is rounded to the next higher integer; zero is not allowed.

<Denominator> The specified denominator must be positive. It is rounded to the next higher integer.

<Offset> The specified offset value is rounded to (positive or negative) multiples of 1 Hz.

<Sweep type> FB | CW

FB

The IF frequency at IF Reference <Pt> and IF Meas <Pt> sweeps with the channel base frequency.

CW

Fixed IF frequency at IF Reference <Pt> and IF Meas <Pt>.

*RST: SWEep

Usage: Setting only

Options: R&S ZNA-B26

Manual operation: See "[Rear IF Frequency](#)" on page 679

`[SENSe<Ch>:]PATH<Pt>:IFSWitch` <Selection of IF Switch on Ref and Meas path>

Defines if and how the Direct IF Access Input / Output ports IF Reference <Pt> and IF Meas <Pt> are used in channel <Ch>.

Suffix:

<Ch> Channel number

<Pt> Port number

Setting parameters:

<Selection of IF Switch on Ref and Meas path> OFF | IN | OUT

OFF

The ports are unused.

IN

The ports are for IF input (but not for IF output).

Note that direct generator/receiver access cannot be used in this case.

OUT

The ports are for IF output (but not for IF input).

Usage:	Setting only
Options:	R&S ZNA-B26
Manual operation:	See " Rear Out " on page 678

[SENSe<Ch>:]PATH<Pt>:MEASurement:DIRectaccess?**[SENSe<Ch>:]PATH<Pt>:REFerence:DIRectaccess?**

Queries the [direct generator/receiver access](#) path.

To define the direct generator/receiver access path, use [\[SENSe<Ch>:\]PATH<Pt>:DIRectaccess](#).

Note that direct generator/receiver access and direct IF input cannot be used at the same time. Direct generator/receiver access is only used if [\[SENSe<Ch>:\]PATH<Pt>:IFSWitch](#) is set to OFF or OUT.

Suffix:

<Ch>	Channel number
<Pt>	Port number

Usage:	Query only
Options:	R&S ZNAXx-B16
Manual operation:	See " Receiver Input " on page 678

[SENSe<Ch>:]PATH<Pt>:MEASurement:IFINpath?**[SENSe<Ch>:]PATH<Pt>:REFerence:IFINpath?**

Query for the input paths of Direct IF Access Input / Output connectors IF Reference <Pt> and IF Meas <Pt> in channel <Ch>.

To set the input paths, use [\[SENSe<Ch>:\]PATH<Pt>:IFINpath](#).

Suffix:

<Ch>	Channel number
<Pt>	Port number

Usage:	Query only
Options:	R&S ZNA-B26
Manual operation:	See " Rear Input Path " on page 679

[SENSe<Ch>:]PATH<Pt>:MEASurement:IFOutauto?**[SENSe<Ch>:]PATH<Pt>:REFerence:IFOutauto?**

Queries how the outgoing frequencies at IF Reference <Pt> and IF Meas <Pt> are determined in channel <Ch> if `[SENSe<Ch>:]PATH<Pt>:IFSWitch` is set to `OUT`.

To define how the frequencies are determined, use `[SENSe<Ch>:]PATH<Pt>:IFOutauto`.

Suffix:

<Ch> Channel number

<Pt> Port number

Usage: Query only

Options: R&S ZNA-B26

Manual operation: See "[Auto Determine IF Out](#)" on page 678

[SENSe<Ch>:]PATH<Pt>:MEASurement:IFRequency?**[SENSe<Ch>:]PATH<Pt>:REFerence:IFRequency?**

Queries the frequency conversion formula for Direct IF Access Input / Output ports IF Reference <Pt> and IF Meas <Pt> in channel <Ch>.

To set the formula, use `[SENSe<Ch>:]PATH<Pt>:IFRequency`

Suffix:

<Ch> Channel number

<Pt> Port number

Usage: Query only

Options: R&S ZNA-B26

Manual operation: See "[Rear IF Frequency](#)" on page 679

[SENSe<Ch>:]PATH<Pt>:MEASurement:IFSWitch?**[SENSe<Ch>:]PATH<Pt>:REFerence:IFSWitch?**

Queries if and how the Direct IF Access Input / Output ports IF Reference <Pt> and IF Meas <Pt> are used in channel <Ch>.

To define the port usage, use `[SENSe<Ch>:]PATH<Pt>:IFSWitch`.

Suffix:

<Ch> Channel number

<Pt> Port number

Usage: Query only

Options: R&S ZNA-B26

Manual operation: See "[Rear Out](#)" on page 678

7.3.14.17 [SENSe:]POWer...

The [SENSe:]POWer... commands configure the optional receiver step attenuators (see [Chapter 4.7.31, "Receiver step attenuators"](#), on page 309) and the wideband / narrowband IF gain of the R&S ZNA.

See also [SENSe<Ch>:]SEGMENT<Seg>:POWer:GAINcontrol on page 1490.

[SENSe<Ch>:]POWer:AGCMode<PhyPt>:MEASure.....	1463
[SENSe<Ch>:]POWer:IFGain<PhyPt>:MEASure.....	1463
[SENSe<Ch>:]POWer:ATTenuation.....	1464
[SENSe<Ch>:]POWer:GAINcontrol.....	1464
[SENSe<Ch>:]POWer:GAINcontrol:ALL.....	1465
[SENSe<Ch>:]POWer:GAINcontrol:GLOBal.....	1466

[SENSe<Ch>:]POWer:AGCMode<PhyPt>:MEASure <Mode>

[SENSe<Ch>:]POWer:IFGain<PhyPt>:MEASure <Mode>

These two equivalent commands activate manual gain control and select the IF gain in the measurement channels (b-waves). The IF gain in the reference channel (a-waves) is set automatically if not otherwise defined using [SENSe<Ch>:]POWer:GAINcontrol.

This applies to the wideband signal path only.

Note:

These commands are replaced by [SENSe<Ch>:]POWer:GAINcontrol and [SENSe<Ch>:]POWer:GAINcontrol:GLOBal. They are supported for compatibility with FW versions < 1.5.

Suffix:

<Ch>	Channel number
<PhyPt>	Test port number of the analyzer

Parameters:

<Mode>	LDISortion LNOise
	LDISortion
	0 dB gain, for high input levels
	LNOise
	10 dB gain, for low input levels
*RST:	LDIS

Example:

```
*RST; :SENSe:POWer:IFG2:MEAS LNO; :SENSe:POWer:IFG1:MEAS?
```

Optimize the received waves (measurement channel, b-waves) at port 2 for small input levels and query the wideband / narrowband IF gain settings for the received waves at port 1. The response is LDIS.

[SENSe<Ch>:]POWER:ATTenuation <arg0>[, <arg1>]

Sets an attenuation factor for the received waves. This command is available if at least one of the [Receiver step attenuators](#) is installed.

For redefined physical ports (see [\[SENSe:\]UDSPArms<Pt>:PARAm](#)), the respective measurement receiver (b-wave) is significant. E.g. if physical port 1 is equipped with a step attenuator, then an attenuation factor can be applied to the (redefined) port receiving b1.

Note that in presence of [External switch matrices](#), **all** VNA ports have to be equipped with receiver step attenuator option.

The generated wave is attenuated via `SOURce:POWer<Port_no>:ATTenuation`.

Suffix:

<Ch> Channel number

Parameters:

<arg0> Physical port number
 Instead of port numbers 1, 2, 3 and 4 you can also use the constants `ARECeiver`, `BRECeiver`, `CRECeiver` and `DRECeiver`, respectively.

Default unit: n/a

<arg1> Attenuation factor for the received wave.

Range: 0 dB, 10 dB, 20 dB, 30 dB. The analyzer rounds any entered value below the maximum attenuation to the closest step.

*RST: 0 dB

Default unit: dB

Example:

`POW:ATT AREC, 10`

Set an attenuation factor of 10 dB for the waves received at test port 1 and channel no. 1. The other test ports and channels are not affected.

Manual operation: See "[Receiver Step Att.](#)" on page 527

[SENSe<Ch>:]POWER:GAINcontrol <ReceiverName>, <Mode>

[SENSe<Ch>:]POWER:GAINcontrol? <ReceiverName>

Defines port-specific gain settings for the related channel.

Note:

- This applies to the wideband signal path only.
- These settings will only take effect if [\[SENSe<Ch>:\]POWER:GAINcontrol:GLOBAL](#) is set to `MANual` for channel <Ch>.
- If you also want to distinguish between different sweep segments, use [\[SENSe<Ch>:\]SEGMENT<Seg>:POWER:GAINcontrol](#) instead.

Suffix:

<Ch> Channel number

Parameters:

<Mode> LDISTortion | LNOise

LDISTortion

0 dB gain, for high input levels

LNOise

10 dB gain, for low input levels

*RST: LDISTortion

Parameters for setting and query:

<ReceiverName> String parameter defining the wave(s) followed by the drive port; see examples below and [Table 7-4](#).

Example:

```
*RST; :SENSE:POWer:GAINcontrol:GLOBal MANual
Activate independent GC settings for each drive port.
SENSE:POWer:GAINcontrol 'B2D1', LNO
Set the GC for the received wave b2 (port 2) to "Low Noise". The
setting applies while port 1 is the drive port.
SENSE:POWer:GAINcontrol 'A2B2B3D2', LNO
Set the GC mode for the waves a2, b2, and b3 to "Low Noise".
The setting applies while port 2 is the drive port.
SENSE:POWer:GAINcontrol? 'B1D2'
Query the GC setting for the wave b1 while port 2 is the drive
port. The response is 1, LDIST (default setting).
```

Manual operation: See "[Drive-port specific settings](#)" on page 691

[SENSE<Ch>:]POWER:GAINcontrol:ALL <Mode>

Applies the same manual gain control (GC) <Mode> to all a and b wave receivers.

Note:

- This applies to the wideband signal path only.
- If you also want to distinguish between different sweep segments, use [\[SENSE<Ch>:\]SEGMENT<Seg>:POWER:GAINcontrol:ALL](#) instead.

Suffix:

<Ch> Channel number

Setting parameters:

<Mode> LDISTortion | LNOise

LDISTortion

0 dB gain, for high input levels

LNOise

10 dB gain, for low input levels

*RST: LDISTortion

- Example:** `*RST; :SENSe:POWer:GAINcontrol:GLOBal MANual`
 Enable the manual configuration of independent GC settings for each drive port.
`SENSe:POWer:GAINcontrol:ALL LNO`
 Set the GC mode of all a and b wave receivers to "Low Noise".
- Usage:** Setting only
- Manual operation:** See "[Set All Items to ...](#)" on page 691

[SENSe<Ch>:]POWER:GAINcontrol:GLOBal <GCModesGlobal>

Globally configures the gain control (GC) in all receive paths (measurement receivers, b-waves) for all analyzer ports or enables port-specific gain control configuration.

Suffix:

<Ch> Channel number

Parameters:

<GCModesGlobal> LNOise | LDISTortion | MANual

LDISTortion

0 dB gain, for high input levels

LNOise

10 dB gain, for low input levels

MANual

Enables the manual configuration of independent wideband / narrowband IF gain settings for each segment, drive port and receiver. See [\[SENSe<Ch>:\]POWER:GAINcontrol](#) and [\[SENSe<Ch>:\]SEGMENT<Seg>:POWER:GAINcontrol](#).

*RST: LDIS

Example: See [\[SENSe<Ch>:\]POWER:GAINcontrol](#)

Manual operation: See "[Wb/Nb IF Gain](#)" on page 677

7.3.14.18 **[SENSe:]PULSe...**

Pulsed measurements.

[SENSe<Ch>:]PULSe:ALC:MEASdelay	1467
[SENSe<Ch>:]PULSe:ATIME	1467
[SENSe<Ch>:]PULSe:COUPled[:STATe]	1467
[SENSe<Ch>:]PULSe:DUTYcycle	1468
[SENSe<Ch>:]PULSe:FXDCycle[:STATe]	1468
[SENSe<Ch>:]PULSe:GENerator<Id>:DELay	1469
[SENSe<Ch>:]PULSe:GENerator:PERiod	1469
[SENSe<Ch>:]PULSe:GENerator:SOURce	1469
[SENSe<Ch>:]PULSe:GENerator<Id>[:STATe]	1469
[SENSe<Ch>:]PULSe:GENerator<Id>:TRAI:n:DATA	1470
[SENSe<Ch>:]PULSe:GENerator<Id>:TRAI:n:DELete:ALL	1470
[SENSe<Ch>:]PULSe:GENerator:TRAI:n:PERiod	1470

[SENSe<Ch>:]PULSe:GENerator<Id>:TRAIIn:SEGMENT<Seg>:COUNT.....	1470
[SENSe<Ch>:]PULSe:GENerator<Id>:TRAIIn:SEGMENT<Seg>:START.....	1471
[SENSe<Ch>:]PULSe:GENerator<Id>:TRAIIn:SEGMENT<Seg>:STATE.....	1471
[SENSe<Ch>:]PULSe:GENerator<Id>:TRAIIn:SEGMENT<Seg>:STOP.....	1471
[SENSe<Ch>:]PULSe:GENerator<Id>:TRAIIn[:STATE].....	1472
[SENSe<Ch>:]PULSe:GENerator<Id>:WIDTH.....	1472
[SENSe<Ch>:]PULSe:INTernal[:STATE].....	1472
[SENSe<Ch>:]PULSe:MEASdelay.....	1472
[SENSe<Ch>:]PULSe:PERiod.....	1473
[SENSe<Ch>:]PULSe:PORT<Pt>:DELay.....	1473
[SENSe<Ch>:]PULSe:PORT<Pt>:EXTernal:INPut:INVerted[:STATE].....	1473
[SENSe<Ch>:]PULSe:PORT<Pt>:EXTernal:OUTPut:INVerted[:STATE].....	1474
[SENSe<Ch>:]PULSe:PORT<Pt>:EXTernal:OUTPut[:STATE].....	1474
[SENSe<Ch>:]PULSe:PORT<Pt>[:STATE].....	1474
[SENSe<Ch>:]PULSe:PORT<Pt>:WIDTH.....	1475
[SENSe<Ch>:]PULSe[:STATE].....	1475
[SENSe<Ch>:]PULSe:SYNCron[:STATE].....	1475

[SENSe<Ch>:]PULSe:ALC:MEASdelay <Measurement Delay>

Defines the acquisition delay of the ALC measurement relative to the master pulse. Can only be set in synchronized measurement mode ([SENSe<Ch>:]PULSe:SYNCron[:STATE] ON) and if SOURce<Ch>:POWer<Pt>:ALC:OPTimize is not set to ON.

Suffix:

<Ch> Channel number

Parameters:

<Measurement Delay> Default unit: s

Options:

R&S ZNA-K7

Manual operation: See "ALC Acq Delay/Fixed" on page 699

[SENSe<Ch>:]PULSe:ATIME <Acquisition time>

Defines the duration of the data acquisition for pulse measurements in channel <Ch>.

Suffix:

<Ch> Channel number

Parameters:

<Acquisition time> Data acquisition time
Default unit: s

Manual operation: See "Acq Time/Fixed" on page 700

[SENSe<Ch>:]PULSe:COUPlEd[:STATE] <Boolean>

Enforces identical pulse generator settings for all ports.

Suffix:	
<Ch>	Channel number
Parameters:	
<Boolean>	*RST: OFF (0)
Options:	R&S ZNA<Freq>-B4<Pt> or R&S ZNA-B91
Manual operation:	See " Coupled Settings " on page 696

[SENSe<Ch>:]PULSe:DUTYcycle <Percentage>

Defines the duty cycle of the generated pulses.

This setting only takes effect, if:

- Internal Pulse Control is enabled (`[SENSe<Ch>:]PULSe:INTernal[:STATE] ON`)
- Fixed Duty Cycle is enabled (`[SENSe<Ch>:]PULSe:FXDCycle[:STATE] ON`)

Note that currently the exact value of the duty cycle can not be guaranteed. However, you can be sure that the specified value is not exceeded.

Suffix:	
<Ch>	Channel number
Parameters:	
<Pulse Duty Cycle>	A value between 0 and 100. Default unit: percent
Options:	R&S ZNA<Freq>-B4<Pt> or R&S ZNA-B91
Manual operation:	See " Fixed Duty Cycle/Duty Cycle " on page 696

[SENSe<Ch>:]PULSe:FXDCycle[:STATE] <Boolean>

Defines whether the analyzer firmware shall enforce a fixed duty cycle for all pulse generators.

Suffix:	
<Ch>	Channel number
Parameters:	
<Boolean>	ON (1) Fixed duty cycle for all pulse generators in channel <Ch>. The pulses are defined using <code>[SENSe<Ch>:]PULSe:PERiod</code> and <code>[SENSe<Ch>:]PULSe:DUTYcycle</code> . OFF (0) The generator-specific pulses are defined using <code>[SENSe<Ch>:]PULSe:PORT<Pt>:WIDTH</code> and <code>[SENSe<Ch>:]PULSe:PORT<Pt>:DELay</code> . *RST: OFF
Options:	R&S ZNA<Freq>-B4<Pt> or R&S ZNA-B91

Manual operation: See ["Fixed Duty Cycle/Duty Cycle"](#) on page 696

[SENSe<Ch>:]PULSe:GENerator<Id>:DELay <Delay for the generated pulse>

Suffix:

<Ch>

<Id>

Parameters:

<Delay for the
generated pulse>

Manual operation: See ["Pulse Delay/Pulse Width"](#) on page 697

[SENSe<Ch>:]PULSe:GENerator:PERiod <Period for the generated pulses>

Suffix:

<Ch>

Parameters:

<Period for the
generated pulses>

[SENSe<Ch>:]PULSe:GENerator:SOURce <source for pulse generator>

Suffix:

<Ch>

Parameters:

<source for pulse
generator> EXTA | EXTB | EXTC | EXTD | INT

Manual operation: See ["Master Pulse Clock Source"](#) on page 695

[SENSe<Ch>:]PULSe:GENerator<Id>[:STATe] <Period for the generated pulses>

Suffix:

<Ch>

<Id>

Parameters:

<Period for the
generated pulses>

Manual operation: See ["Pulse Gen."](#) on page 695

[SENSe<Ch>]:JPULSe:GENerator<Id>:TRAI:n:DATA {<Set pulse train element active>, <Set pulse train element start time>, <Set pulse train element stop time>}...

Suffix:

<Ch>

<Id>

Setting parameters:

<Set pulse train element active>

<Set pulse train element start time>

<Set pulse train element stop time>

Usage: Setting only

[SENSe<Ch>]:JPULSe:GENerator<Id>:TRAI:n:DELeTe:ALL

Suffix:

<Ch>

<Id>

Usage: Event

[SENSe<Ch>]:JPULSe:GENerator:TRAI:n:PERiod <Period for the generated pulses>

Suffix:

<Ch>

Parameters:

<Period for the generated pulses>

Manual operation: See "[Pulse Train Period](#)" on page 697

[SENSe<Ch>]:JPULSe:GENerator<Id>:TRAI:n:SEGMeNt<Seg>:COUNt <Number of segments in the pulse train>

Suffix:

<Ch>

<Id>

<Seg>

Parameters:

<Number of segments in the pulse train>

Manual operation: See ["Segment List"](#) on page 697

[SENSe<Ch>:JPULSe:GENerator<Id>:TRAIin:SEGMENT<Seg>:START <Start time of the segment of the pulse train>

Suffix:

<Ch>

<Id>

<Seg>

Parameters:

<Start time of the segment of the pulse train>

Manual operation: See ["Segment List"](#) on page 697

[SENSe<Ch>:JPULSe:GENerator<Id>:TRAIin:SEGMENT<Seg>:STATE <Set pulse train segment active/inactive>

Suffix:

<Ch>

<Id>

<Seg>

Parameters:

<Set pulse train segment active/inactive>

Manual operation: See ["Segment List"](#) on page 697

[SENSe<Ch>:JPULSe:GENerator<Id>:TRAIin:SEGMENT<Seg>:STOP <Stop time of the segment of the pulse train>

Suffix:

<Ch>

<Id>

<Seg>

Parameters:

<Stop time of the segment of the pulse train>

Manual operation: See ["Segment List"](#) on page 697

[SENSE<Ch>]:PULSE:GENERator<Id>:TRAIN[:STATe] <Set pulse train active/
inactive>

Suffix:

<Ch>

<Id>

Parameters:<Set pulse train
active/inactive>**Manual operation:** See ["Enable Pulse Train"](#) on page 697

[SENSE<Ch>]:PULSE:GENERator<Id>:WIDTH <Width for the generated pulse>

Suffix:

<Ch>

<Id>

Parameters:<Width for the
generated pulse> Default unit: s**Manual operation:** See ["Pulse Delay/Pulse Width"](#) on page 697

[SENSE<Ch>]:PULSE:INTERNAL[:STATe] <Boolean>

Switches between internal and external pulse control.

Suffix:

<Ch> Channel number

Parameters:<Boolean> **ON (1)**
Internal pulse control
OFF (0)
External pulse control
*RST: ON**Options:** R&S ZNA-B91**Manual operation:** See ["Pulse Modulator Control"](#) on page 698

[SENSE<Ch>]:PULSE:MEASdelay <Value>

Defines the measurement delay (acquisition delay) relative to the pulse start.

Suffix:

<Ch> Channel number

Parameters:

<Value> Measurement delay [s]

Manual operation: See ["Acq Delay/Fixed"](#) on page 699

[SENSe<Ch>:]PULSe:PERiod <pulse period for pulse modulators and trigger outs>

Defines the (common) pulse period of the internal pulse generators and modulators.

Suffix:

<Ch> Channel number

Parameters:

<pulse period for pulse modulators and trigger outs> Pulse period [s]
Default unit: s

Options: R&S ZNA-K7

Manual operation: See ["Pulse Period"](#) on page 695

[SENSe<Ch>:]PULSe:PORT<Pt>:DELay <pulse delay on pulse modulator>

Defines the port-specific delay of the pulses generated by the respective internal pulse generator.

This setting only takes effect, if:

- Internal Pulse Control is enabled
- Fixed Duty Cycle is disabled ([\[SENSe<Ch>:\]PULSe:FXDCycle\[:STATe\]](#) OFF)

Suffix:

<Ch> Channel number

<Pt> Port number

Parameters:

<pulse delay on pulse modulator> Pulse delay [s]
Default unit: s

Options: R&S ZNA<Freq>-B4<Pt> or R&S ZNA-B91

Manual operation: See ["Pulse Delay/Pulse Width"](#) on page 697

[SENSe<Ch>:]PULSe:PORT<Pt>:EXtErnal:INPut:INVerted[:STATe] <Boolean>

If External Pulse Control is used, this defines the polarity of the incoming generator pulses at PuMo In/Out <Pt>.

Suffix:

<Ch> Channel number

<Pt> Port number

Parameters:

<Boolean> *RST: OFF (0)

Options: R&S ZNA-B91

Manual operation: See "PuMo In" on page 699

[SENSE<Ch>:]PULSE:PORT<Pt>:EXTERNAL:OUTPUT:INVERTED[:STATE] <Boolean>

If pulse generator <Pt> is output to PuMo In/Out <Pt> (see [SENSE<Ch>:] PULSE:PORT<Pt>:EXTERNAL:OUTPUT[:STATE]), this defines the polarity of the outgoing pulses.

Suffix:

<Ch> Channel number

<Pt> Port number

Parameters:

<Boolean> *RST: OFF (0)

Options: R&S ZNA-B91

Manual operation: See "PuMo Out" on page 698

[SENSE<Ch>:]PULSE:PORT<Pt>:EXTERNAL:OUTPUT[:STATE] <Boolean>

If Internal Pulse Control is used, this enables/disables output of pulse generator <Pt> at PuMo In/Out <Pt>.

Suffix:

<Ch> Channel number

<Pt> Port number

Parameters:

<Boolean> *RST: OFF (0)

Options: R&S ZNA-B91

Manual operation: See "PuMo Out" on page 698

[SENSE<Ch>:]PULSE:PORT<Pt>[:STATE] <Boolean>

Activates or deactivates the internal pulse modulator at VNA port <Pt>.

Suffix:

<Ch> Channel number

<Pt> VNA port number

Parameters:

<Boolean>

Options: R&S ZNA<Freq>B4<Pt>

Manual operation: See "Port" on page 698

[SENSe<Ch>:]PULSe:PORT<Pt>:WIDTh <pulse width for pulse modulators and trigger outs>

Defines the port-specific width of the pulses generated by the respective internal pulse generator.

This setting only takes effect, if:

- Internal Pulse Control is enabled (`[SENSe<Ch>:]PULSe:INTernal[:STATe] ON`)
- Fixed Duty Cycle is disabled (`[SENSe<Ch>:]PULSe:FXDCycle[:STATe] OFF`)

Suffix:

<Ch> Channel number
 <Pt> VNA port number

Parameters:

<pulse width for pulse modulators and trigger outs> Default unit: s

Options: R&S ZNA<Freq>-B4<Pt> or R&S ZNA-B91

Manual operation: See "[Pulse Delay/Pulse Width](#)" on page 697

[SENSe<Ch>:]PULSe[:STATe] <Boolean>

Activates or deactivates pulse generation.

Suffix:

<Ch>

Parameters:

<Boolean> **ON (1)**
 Pulse generation activated.
OFF (0)
 Pulse generation deactivated.
 *RST: OFF (0)

Manual operation: See "[Pulse Generator](#)" on page 692

[SENSe<Ch>:]PULSe:SYNCron[:STATe] <Boolean>

Switches between synchronous and asynchronous pulse measurement.

Suffix:

<Ch> Channel number

Parameters:

<Boolean> **ON (1)**
 Synchronous measurement, i.e. the pulse measurement is synchronized to the generated pulses.

OFF (0)

Asynchronous measurement

*RST: ON (1)

Options: R&S ZNA-K7**Manual operation:** See "[Sync Meas to Pulse Gen.](#)" on page 700**7.3.14.19 [SENSe:]ROSCillator...**

The [SENSe:]ROSCillator... commands control the frequency reference signal.

[\[SENSe:\]ROSCillator:EXternal:FREQuency](#)..... 1476[\[SENSe:\]ROSCillator:SMA:INPut](#)..... 1476[\[SENSe:\]ROSCillator:SMA:OUTPut](#)..... 1477[\[SENSe<Ch>:\]ROSCillator\[:SOURce\]](#)..... 1477**[SENSe:]ROSCillator:EXternal:FREQuency <ExtClockFreq>**

Specifies or queries the frequency of the external reference oscillator.

Parameters:

<ExtClockFreq> Frequency of the external reference clock signal.

Range: See the data sheet of your analyzer.

*RST: 10 MHz

Default unit: Hz

Example:

ROSC EXT

Select the external reference clock as clock source.

ROSC:EXT:FREQ 10MHz

Specify the frequency of the external reference clock.

ROSC:EXT:FREQ?

Query the frequency of the external reference oscillator. The response is 10000000 Hz.

Manual operation: See "[Ext Frequency](#)" on page 887**[SENSe:]ROSCillator:SMA:INPut <SupportedFreqs>**Specifies the frequency of the incoming reference clock signal at the Reference In/Out SMA connector (see [\[SENSe<Ch>:\]ROSCillator\[:SOURce\]](#)).**Parameters:**

<SupportedFreqs> F100mhz | F1GHz

100 MHz or 1 GHz

*RST: F100mhz

Manual operation: See "[Reference I/O \(SMA\) > In](#)" on page 887

[SENSe:]ROSCillator:SMA:OUTPut <OffOr100MHz>

Defines whether a reference clock signal shall be output to the Reference In/Out SMA connector.

Ineffective if this connector is used as reference clock source (see [\[SENSe<Ch>:\]ROSCillator\[:SOURce\]](#)).

Parameters:

<OffOr100MHz> OFF | F100mhz
 No output or 100 MHz
 *RST: OFF

Example:

*RST; :ROSC EXT; ROSC:SMA:OUTP F100

Select the Reference In BNC connector as reference clock source and output the 100 MHz reference clock signal at the Reference In/Out SMA connector.

Manual operation: See ["Reference I/O \(SMA\) > Out"](#) on page 887

[SENSe<Ch>:]ROSCillator[:SOURce] <Source>

Selects the source of the reference oscillator signal.

Parameters:

<Source> INTernal | EXTernal | ESMA
 INTernal – internal 10 MHz reference oscillator
 EXTernal – external reference clock via BNC connector
 ESMA – external reference clock via SMA connector
 The frequency of the external reference clock can be defined using [\[SENSe:\]ROSCillator:EXTernal:FREQuency](#)
 *RST: INTernal

Example:

See [\[SENSe:\]ROSCillator:EXTernal:FREQuency](#) on page 1476.

Manual operation: See ["Reference Source"](#) on page 886

7.3.14.20 [SENSe:]SEGMent...

The [\[SENSe:\]SEGMent<Seg>...](#) commands define all channel settings for a segmented frequency sweep. A segmented sweep is activated via [\[SENSe<Ch>:\]SWEep:TYPE SEGMent](#).



The commands in this subsystem do not accept the step parameters UP and DOWN. Numeric values can be entered directly or using the DEFault, MINimum, MAXimum parameters.

[SENSe<Ch>:]SEGMENT<Seg>:ADD.....	1478
[SENSe<Ch>:]SEGMENT<Seg>:BWIDTh[:RESolution].....	1479
[SENSe<Ch>:]SEGMENT<Seg>:BWIDTh[:RESolution]:CONTRol.....	1479
[SENSe<Ch>:]SEGMENT<Seg>:BWIDTh[:RESolution]:SELEct.....	1480
[SENSe<Ch>:]SEGMENT<Seg>:BWIDTh[:RESolution]:SELEct:CONTRol.....	1480
[SENSe<Ch>:]SEGMENT:COUNT?.....	1481
[SENSe<Ch>:]SEGMENT<Seg>:DEFine.....	1482
[SENSe<Ch>:]SEGMENT<Seg>:DEFine:SELEct.....	1483
[SENSe<Ch>:]SEGMENT<Seg>:DELEte:ALL.....	1484
[SENSe<Ch>:]SEGMENT<Seg>:DELEte[:DUMMy].....	1484
[SENSe<Ch>:]SEGMENT<Seg>:FREQUency:CENTer?.....	1484
[SENSe<Ch>:]SEGMENT<Seg>:FREQUency:SPAN?.....	1484
[SENSe<Ch>:]SEGMENT<Seg>:FREQUency:STARt.....	1485
[SENSe<Ch>:]SEGMENT<Seg>:FREQUency:STOP.....	1485
[SENSe<Ch>:]SEGMENT<Seg>:INSert.....	1485
[SENSe<Ch>:]SEGMENT<Seg>:INSert:SELEct.....	1487
[SENSe<Ch>:]SEGMENT<Seg>:NFIGure:VIRejection[:STATe].....	1488
[SENSe<Ch>:]SEGMENT:NFIGure:VIRejection:STATe:CONTRol.....	1488
[SENSe<Ch>:]SEGMENT<Seg>:PORT<PortId>:POWER[:LEVel].....	1489
[SENSe<Ch>:]SEGMENT<Seg>:PORT<PortId>[:STATe].....	1489
[SENSe<Ch>:]SEGMENT<Seg>:POWER:GAINcontrol.....	1490
[SENSe<Ch>:]SEGMENT<Seg>:POWER:GAINcontrol:ALL.....	1491
[SENSe<Ch>:]SEGMENT<Seg>:POWER:GAINcontrol:CONTRol.....	1491
[SENSe<Ch>:]SEGMENT<Seg>:POWER[:LEVel].....	1492
[SENSe<Ch>:]SEGMENT:POWER[:LEVel]:CONTRol.....	1492
[SENSe<Ch>:]SEGMENT<Seg>[:STATe].....	1493
[SENSe<Ch>:]SEGMENT<Seg>:SWEep:DWELL.....	1494
[SENSe<Ch>:]SEGMENT<Seg>:SWEep:DWELL:CONTRol.....	1494
[SENSe<Ch>:]SEGMENT<Seg>:SWEep:POINts.....	1495
[SENSe<Ch>:]SEGMENT<Seg>:SWEep:TIME.....	1495
[SENSe<Ch>:]SEGMENT<Seg>:SWEep:TIME:CONTRol.....	1496
[SENSe<Ch>:]SEGMENT<Seg>:SWEep:TIME:SUM?.....	1497

[SENSe<Ch>:]SEGMENT<Seg>:ADD

Inserts a new sweep segment using default channel settings ("Insert New Segment"). The added segment covers the frequency interval between the maximum frequency of the existing sweep segments and the stop frequency of the entire sweep range.

Tip: Use [SENSe<Ch>:] SEGMENT<Seg>: INSert to create a segment with specific channel settings.

Suffix:

<Ch>	Channel number
<Seg>	Sweep segment number. Segment numbers must be sequential. If n segments exist already, the added segment must have the segment number n+1.

- Example:** SEGM:INS 1MHZ, 1.5MHZ, 111, -21DBM, 0.5S, 0, 10KHZ
 Create a sweep segment with a sweep range between 1.0 MHz and 1.5 MHz.
 SEGM2:ADD
 Create a second sweep segment. The frequency range of the second segment will be between 1.5 MHz and the maximum frequency of the analyzer.
- Usage:** Event
- Manual operation:** See ["Add / Insert / Delete / Delete All"](#) on page 554

[SENSe<Ch>:]SEGMENT<Seg>:BWIDTh[:RESolution] <ResBandwidth>

Defines the IF bandwidth of the analyzer (measurement bandwidth) in sweep segment no. <Seg>. Values between 1 Hz and 1.5 MHz can be set. Option R&S ZNA-K17 enables IF bandwidths up to 10 MHz (see [Chapter 4.7.8, "Increased IF bandwidth 30 MHz"](#), on page 288).

Bandwidths can be set in 1 – 1.5 – 2 – 3 – 5 – 7 steps. The analyzer rounds up any entered value between these steps and rounds down values exceeding the maximum bandwidth.

At the same time, the command activates separate bandwidth setting in all sweep segments ([\[SENSe<Ch>:\]SEGMENT<Seg>:BWIDTh\[:RESolution\]:CONTROL ON](#)).

Suffix:

- <Ch> Channel number
- <Seg> Sweep segment number

Parameters:

- <ResBandwidth> IF bandwidth
- Range: See above
- Increment: 1-1.5-2-3-5-7 steps
- *RST: 10 kHz
- Default unit: Hz

Example: See [\[SENSe<Ch>:\]SEGMENT<Seg>:BWIDTh\[:RESolution\]:CONTROL](#)

Manual operation: See ["Optional Columns"](#) on page 557

[SENSe<Ch>:]SEGMENT<Seg>:BWIDTh[:RESolution]:CONTROL <Boolean>

Selects common or independent "Meas. Bandwidth" settings for the sweep segments.

Suffix:

- <Ch> Channel number
- <Seg> Sweep segment number. This suffix is ignored; the setting controls the whole segmented sweep.

Parameters:

<Boolean>

ON – use independent bandwidth settings, to be defined via `[SENSe<Ch>:]SEGMENT<Seg>:BWIDth[:RESolution]`.
 OFF – reset the bandwidth in all sweep segments to the bandwidth for unsegmented sweeps, defined via `[SENSe<Ch>:]BWIDth[:RESolution]`. ON will not restore the previous values.

The parameter is automatically switched to ON when a bandwidth is entered using `[SENSe<Ch>:]SEGMENT<Seg>:BWIDth[:RESolution]`.

*RST: OFF

Example:

*RST; :SENS:SEGM:ADD

Create a new sweep segment no. 1 in channel no. 1 using default settings and thus 10 kHz measurement bandwidth.

SEGM:BWID 1 MHZ

Increase the IF bandwidth to 1 MHz.

SEGM:BWID:CONT OFF

Couple the bandwidths in all segments and reset the bandwidth in segment no. 1 to the initial value.

Manual operation: See "Optional Columns" on page 557

[SENSe<Ch>:]SEGMENT<Seg>:BWIDth[:RESolution]:SElect <Selectivity>

Defines the "Selectivity" of the IF filter used in sweep segment no. <Seg>. At the same time, the command activates individual selectivity settings for all sweep segments (`[SENSe<Ch>:]SEGMENT<Seg>:BWIDth[:RESolution]:SElect:CONTROL ON`).

Suffix:

<Ch> Channel number

<Seg> Sweep segment number

Parameters:

<Selectivity>

NORMAL | MEDIUM | HIGH

NORMAL - IF filter with normal selectivity and shortest settling time.

MEDIUM - IF filter with steeper edges and longer settling time.

HIGH - IF filter with highest selectivity but longest settling time.

Example:

See `[SENSe<Ch>:]SEGMENT<Seg>:BWIDth[:RESolution]:SElect:CONTROL`

Manual operation: See "Optional Columns" on page 557

[SENSe<Ch>:]SEGMENT<Seg>:BWIDth[:RESolution]:SElect:CONTROL <Boolean>

Selects common or independent "Selectivity" settings for the individual sweep segments.

Suffix:	
<Ch>	Channel number
<Seg>	Sweep segment number. This suffix is ignored; the setting controls the whole segmented sweep.
Parameters:	
<Boolean>	<p>ON - use independent selectivity settings, to be defined via <code>[SENSe<Ch>:]SEGMENT<Seg>:BWIDth[:RESolution]:SElect</code>.</p> <p>OFF - reset the selectivity in all sweep segments to the selectivity for unsegmented sweeps, defined via <code>[SENSe<Ch>:]BWIDth[:RESolution]:SElect</code>. ON will not restore the previous values.</p> <p>The parameter is automatically switched to ON when a selectivity is entered using <code>[SENSe<Ch>:]SEGMENT<Seg>:BWIDth[:RESolution]:SElect</code>.</p> <p>*RST: OFF</p>
Example:	<p>*RST; :SEGM:ADD Create a new sweep segment no. 1 in channel no. 1 using default settings and thus NORMAl selectivity.</p> <p>SEGM:BWID:SEL HIGH Change the selectivity to HIGH.</p> <p>BWID:SEL? Query the (default) selectivity for unsegmented sweeps. The response is NORM.</p> <p>SEGM:BWID:SEL:CONT OFF Couple the selectivities in all segments and reset the selectivity in segment no. 1 to the unsegmented value NORMAl.</p>
Manual operation:	See " Optional Columns " on page 557

[SENSe<Ch>:]SEGMENT:COUNT?

Returns the number of sweep segments in the channel including all segments that are switched off (`[SENSe<Ch>:]SEGMENT<Seg>[:STATe] OFF`).

Suffix:	
<Ch>	Channel number
Example:	<p>SEGM:ADD Create a new sweep segment no. 1 in channel no. 1 using default settings.</p> <p>SEGM OFF Disable the measurement in the created sweep segment.</p> <p>SEGM:COUN? Query the number of segments.</p>
Usage:	Query only
Manual operation:	See " Table Columns " on page 554

[SENSE<Ch>:]SEGMENT<Seg>:DEFine <StartFreq>, <StopFreq>, <Points>, <Power>, <SegmentTime>|<MeasDelay>, <Unused>, <MeasBandwidth>[, <LO>, <Selectivity>, <FreqSweepMode>]

Creates or re-defines a sweep segment no. <Seg> with specific channel settings.

Entry of the first seven numeric parameters is mandatory; no default values are provided. All settings except <LO> can be changed for existing segments using other commands of the [SENSE<Ch>:]SEGMENT<Seg>... subsystem.

Note: Use [SENSE<Ch>:]SEGMENT<Seg>:ADD to create a segment with default channel settings. Use [SENSE<Ch>:]SEGMENT<Seg>:INSERT (no query) to insert a new segment into the current segment list.

Suffix:

<Ch> Channel number

<Seg> Sweep segment number. Segment numbers must be sequential. The specified segment number must be smaller or equal to the number of existing segments plus 1. If segment number <Seg> already exists, it is replaced by the new segment.

Parameters:

<StartFreq> Start frequency of the segment; see [SENSE<Ch>:]SEGMENT<Seg>:FREQUENCY:START.
Default unit: Hz

<StopFreq> Stop frequency of the segment; see [SENSE<Ch>:]SEGMENT<Seg>:FREQUENCY:STOP.
Default unit: Hz

<Points> Number of sweep points in the segment. See [SENSE<Ch>:]SEGMENT<Seg>:SWEep:POINTs.

<Power> Internal source power in the segment. See [SENSE<Ch>:]SEGMENT<Seg>:POWER[:LEVEL].
Default unit: dBm

<SegmentTime> Duration of the sweep in the segment. See [SENSE<Ch>:]SEGMENT<Seg>:SWEep:TIME. In the setting [SENSE<Ch>:]SEGMENT<Seg>:INSERT:SElect DWELL, this parameter is replaced by <MeasDelay>.
Range: Depending on other channel settings. AUTO activates automatic sweep time setting in the segment, which is equivalent to the minimum sweep time possible.
Default unit: s

<MeasDelay> Delay for each partial measurement in the segment. See [SENSE<Ch>:]SEGMENT<Seg>:SWEep:DWELL. In the setting [SENSE<Ch>:]SEGMENT<Seg>:INSERT:SElect SWTime, this parameter is replaced by <SegmentTime>.

<Unused>	Ignored parameter (for compatibility with R&S ZVR analyzers). Should be set to the default value 0.
<MeasBandwidth>	IF bandwidth in the segment. See [SENSe<Ch>:]SEGMENT<Seg>:BWIDTh[:RESolution]. Default unit: Hz
<LO>	POSitive NEGative AUTO Position of the local oscillator frequency LO relative to the RF frequency. In remote control this parameter must be set when a sweep segment is created. See [SENSe<Ch>:]FREQUency:SBANd.

<Mode> AUTO
Ignored.

Example: SEGM:ADD
Create a new sweep segment no. 1 in channel no. 1 using default settings.
SEGM:DEF?
Query the channel settings for the new segment. A possible response is
1000000000,2000000000,51,-300,0.0044625,0,10000,AUTO,NORM,AUTO,STEP.

Manual operation: See "Optional Columns" on page 557

[SENSe<Ch>:]SEGMENT<Seg>:DEFine:SElect <TimeRef>

Defines whether the sweep time of a new segment, i.e. numeric parameter no. 5 of the command [SENSe<Ch>:]SEGMENT<Seg>:DEFine, is entered as a segment sweep time ("Segment Time") or as a measurement delay ("Meas Delay").

Suffix:

<Ch> Channel number
<Seg> Sweep segment number

Parameters:

<TimeRef> SWTime | DWELI
SWTime - use segment sweep time.
DWELI - use measurement delay.

Example: SEGM1:DEF:SEL DWEL
Select the measurement delay to determine the sweep time in a new sweep segment no. 1.
SEGM1:DEF 1MHZ, 1.5MHZ, 111, -21DBM, 0.01S, 0, 10KHZ
Create a sweep segment with a sweep range between 1.0 MHz and 1.5 MHz and a measurement delay of 10 ms.
SEGM1:SWE:TIME?
Query the sweep time in the new segment.

Manual operation: See ["Optional Columns"](#) on page 557

[SENSe<Ch>:]SEGMENT<Seg>:DELEte:ALL

Deletes all sweep segments in the channel. [SENSe<Ch>:]SEGMENT<Seg>:DELEte[:DUMMy] deletes a single segment.

Suffix:

<Ch> Channel number

<Seg> Sweep segment number. This suffix is ignored; the command deletes all segments.

Example:

SEGM:ADD

Create a new sweep segment no. 1 in channel no. 1 using default settings.

SEGM:DEL:ALL

Delete the created segment and all segments in the channel created before.

Usage: Event

Manual operation: See ["Add / Insert / Delete / Delete All"](#) on page 554

[SENSe<Ch>:]SEGMENT<Seg>:DELEte[:DUMMy]

Deletes the specified (single) sweep segment. [SENSe<Ch>:]SEGMENT<Seg>:DELEte:ALL deletes all segments in the channel.

Suffix:

<Ch> Channel number

<Seg> Sweep segment number

Example:

SEGM:ADD

Create a new sweep segment no. 1 in channel no. 1 using default settings.

SEGM:DEL

Delete the created segment.

Manual operation: See ["Add / Insert / Delete / Delete All"](#) on page 554

[SENSe<Ch>:]SEGMENT<Seg>:FREQUency:CENTer?

[SENSe<Ch>:]SEGMENT<Seg>:FREQUency:SPAN?

These commands return the center frequency and the span (width) of sweep segment no. <Seg>.

Suffix:

<Ch> Channel number

<Seg> Sweep segment number

Example: `SEGM:INS 1MHZ, 1.5MHZ, 111, -21DBM, 0.5S, 0, 10KHZ`
 Create a sweep segment with a sweep range between 1.0 MHz and 1.5 MHz.
`SEGM:FREQ:CEN? SPAN?`
 Query the center frequency and span of the created segment.
 The response is `1250000;500000`.

Usage: Query only

Manual operation: See "Table Columns" on page 554

Note: The frequency range of the sweep segment can be changed via `[SENSe<Ch>:]SEGMENT<Seg>:FREQUENCY:START` and `[SENSe<Ch>:]SEGMENT<Seg>:FREQUENCY:STOP`.

`[SENSe<Ch>:]SEGMENT<Seg>:FREQUENCY:START <StartFreq>`

`[SENSe<Ch>:]SEGMENT<Seg>:FREQUENCY:STOP <StopFreq>`

These commands define the start and stop frequency of sweep segment no. <Seg>.

The sweep segments must be within the frequency range of the R&S ZNA; see [Table 7-17](#).

Suffix:

<Ch> Channel number

<Seg> Sweep segment number

Parameters:

<StopFreq> Start or stop frequency of the sweep.

Increment: 0.1 kHz

Default unit: Hz

Example: `SEGM:INS 1MHZ, 1.5MHZ, 111, -21DBM, 0.5S, 0, 10KHZ`
 Create a sweep segment with a sweep range between 1.0 MHz and 1.5 MHz.
`SEGM:FREQ:STAR?; STOP?`
 Query the start and stop frequency of the created segment. The response is `1000000;1500000`.

Manual operation: See "Table Columns" on page 554

Note: If the start frequency entered is greater than the current stop frequency, the stop frequency is set to the start frequency. If the stop frequency entered is smaller than the current start frequency, the start frequency is set to the stop frequency.

`[SENSe<Ch>:]SEGMENT<Seg>:INSERT <StartFreq>, <StopFreq>, <Points>, <Power>, <SegmentTime>|<MeasDelay>, <Unused>, <MeasBandwidth>[, <LO>, <Selectivity>, <Mode>, <FreqSweepMode>]`

Adds a new sweep segment no. <Seg> with specific channel settings.

Entry of the first seven numeric parameters is mandatory; no default values are provided. All settings except <LO> can be changed for existing segments using other commands of the `[SENSE<Ch>:]SEGMENT<Seg>...` subsystem.

Note: Use `[SENSE<Ch>:]SEGMENT<Seg>:ADD` to create a segment with default channel settings. Use `[SENSE<Ch>:]SEGMENT<Seg>:DEFINE` to change or query all settings of an existing segment.

Suffix:

<Ch>	Channel number
<Seg>	Sweep segment number. Segment numbers must be sequential. The specified segment number must be smaller or equal to the number of existing segments plus 1. If one or more sweep segments with segment numbers <Seg> or larger exist in the current channel, then all these existing segment numbers are incremented by 1 and the new segment is inserted as segment no. <Seg>. Note that <Seg> defaults to 1, so <code>[SENSE<Ch>:]SEGMENT:INSERT</code> inserts a new segment 1, shifting the existing segments one position up.

Parameters:

<StartFreq>	Start frequency of the segment. See <code>[SENSE<Ch>:]SEGMENT<Seg>:FREQUENCY:START</code> . Default unit: Hz
<StopFreq>	Stop frequency of the segment; see <code>[SENSE<Ch>:]SEGMENT<Seg>:FREQUENCY:STOP</code> . Default unit: Hz
<Points>	Number of sweep points in the segment. See <code>[SENSE<Ch>:]SEGMENT<Seg>:SWEEP:POINTS</code> .
<Power>	Internal source power in the segment. See <code>[SENSE<Ch>:]SEGMENT<Seg>:POWER[:LEVEL]</code> . Default unit: dBm
<SegmentTime>	Duration of the sweep in the segment. See <code>[SENSE<Ch>:]SEGMENT<Seg>:SWEEP:TIME</code> . In the setting <code>[SENSE<Ch>:]SEGMENT<Seg>:INSERT:SELECT DWELL</code> , this parameter is replaced by <MeasDelay>. Range: Depending on other channel settings. AUTO activates automatic sweep time setting in the segment, which is equivalent to the minimum sweep time possible. Default unit: s
<MeasDelay>	Delay for each partial measurement in the segment. See <code>[SENSE<Ch>:]SEGMENT<Seg>:SWEEP:DWELL</code> . In the setting <code>[SENSE<Ch>:]SEGMENT<Seg>:INSERT:SELECT SWTime</code> , this parameter is replaced by <SegmentTime>.

<Unused>	Ignored parameter (for compatibility with R&S ZVR analyzers). Should be set to the default value 0.
<MeasBandwidth>	IF bandwidth in the segment. See [SENSe<Ch>:]SEGMENT<Seg>:BWIDth[:RESolution] . Default unit: Hz
<LO>	POSitive NEGative AUTO Position of the local oscillator frequency LO relative to the RF frequency. In remote control this parameter must be set when a sweep segment is created. See [SENSe<Ch>:]FREQuency:SBANd .
<Selectivity>	NORMal MEDium HIGH Selectivity of the IF filter. See [SENSe<Ch>:]SEGMENT<Seg>:BWIDth[:RESolution]:SElect .
<Mode>	AUTO Ignored.
Example:	SEGM:INS 1MHZ, 1.5MHZ, 111, -21DBM, 0.5S, 0, 10KHZ Create a sweep segment with a sweep range between 1.0 MHz and 1.5 MHz. SEGM2:ADD Create a second sweep segment. The frequency range of the second segment will be between 1.5 MHz and the maximum frequency of the analyzer.

Manual operation: See ["Add / Insert / Delete / Delete All"](#) on page 554

[SENSe<Ch>:]SEGMENT<Seg>:INSert:SElect <TimeRef>

Defines whether the sweep time of a new segment, i.e. numeric parameter no. 5 of the command [\[SENSe<Ch>:\]SEGMENT<Seg>:INSert](#), is entered as a segment sweep time ("Segment Time") or as a measurement delay ("Meas Delay").

Suffix:

<Ch>	Channel number
<Seg>	Sweep segment number

Parameters:

<TimeRef>	SWTime DWELI SWTime - use segment sweep time. DWELI - use measurement delay.
*RST:	SWTime

Example:

```
SEGM1:INS:SEL DWEL
Select the meas. delay to determine the sweep time in a new
sweep segment no. 1.
SEGM1:INS 1MHZ, 1.5MHZ, 111, -21DBM, 0.01S, 0,
10KHZ
Create a sweep segment with a sweep range between 1.0 MHz
and 1.5 MHz and a meas. delay of 10 ms.
SEGM1:SWE:TIME?
Query the sweep time in the new segment.
```

Manual operation: See ["Optional Columns"](#) on page 557

[SENSe<Ch>:]SEGMent<Seg>:NFIGure:VIRejection[:STATe] <Boolean>

For segmented sweeps in noise figure channel <Ch>, if [\[SENSe<Ch>:\]SEGMent:NFIGure:VIRejection:STATe:CONTRol](#) is set to ON, this command allows you to activate or deactivate virtual image rejection in sweep segment <Seg>.

Suffix:

<Ch> Channel number
 <Seg> Segment number

Parameters:

<Boolean> **ON (1)**
 Virtual image rejection activated
OFF (0)
 Virtual image rejection deactivated

Options: R&S ZNA-K30

Manual operation: See ["Optional Columns"](#) on page 557

[SENSe<Ch>:]SEGMent:NFIGure:VIRejection:STATe:CONTRol <Boolean>

For segmented sweeps in noise figure channels, this command defines whether virtual image rejection can be activated or deactivated per segment or per channel.

Suffix:

<Ch> Channel number

Parameters:

<Boolean> **ON (1)**
 Virtual image rejection can be de-/activated per segment (using [\[SENSe<Ch>:\]SEGMent<Seg>:NFIGure:VIRejection\[:STATe\]](#))
OFF (0)
 Virtual image rejection can be de-/activated per channel (using [\[SENSe<Ch>:\]NFIGure:VIRejection\[:STATe\]](#))

*RST: OFF

Options: R&S ZNA-K30

Manual operation: See "Optional Columns" on page 557

[SENSe<Ch>:]SEGMENT<Seg>:PORT<PortId>:POWER[:LEVel] <IntSourcePortPow>

Defines a port-specific power level for port <PortId> in sweep segment <Seg> of channel <Ch>.

Requires that a port-specific power level has been previously enabled using [\[SENSe<Ch>:\]SEGMENT<Seg>:PORT<PortId>\[:STATE\]](#).

Suffix:

<Ch> Channel number
 <Seg> Sweep segment number
 <PortId> Port number

Parameters:

<IntSourcePortPow> Power level for port <PortId> in sweep segment <Seg> of channel <Ch>
 Default unit: dBm

Manual operation: See "Optional Columns" on page 557

[SENSe<Ch>:]SEGMENT<Seg>:PORT<PortId>[:STATE] <Boolean>

Enables a port-specific power level (base power) for port <PortId> in segment <Seg> of channel <Ch>.

Suffix:

<Ch> Channel number
 <Seg> Sweep segment number
 <PortId> Port number

Parameters:

<Boolean> **OFF (0)**
 No port-specific power level for port <PortId> in segment <Seg> of channel <Ch>.
 If [\[SENSe<Ch>:\]SEGMENT:POWER\[:LEVel\]:CONTROL](#) is set to ON, the segment power level [\[SENSe<Ch>:\]SEGMENT<Seg>:POWER\[:LEVel\]](#) is used. Otherwise the channel base power [SOURCE<Ch>:POWER<PhyPt>\[:LEVel\]\[:IMMEDIATE\]\[:AMPLITUDE\]](#) is used.

ON (1)
 The port-specific power level [\[SENSe<Ch>:\]SEGMENT<Seg>:PORT<PortId>:POWER\[:LEVel\]](#) is used for port <PortId> in segment <Seg> of channel <Ch>.

*RST: OFF

Manual operation: See "Optional Columns" on page 557

[SENSe<Ch>:]SEGMENT<Seg>:POWER:GAINcontrol <ReceiverName>, <Mode>
[SENSe<Ch>:]SEGMENT<Seg>:POWER:GAINcontrol? <ReceiverName>

Defines port- and segment-specific IF gain settings.

These settings apply if and only if segmented gain control (GC) is enabled (see [\[SENSe<Ch>:\]SEGMENT<Seg>:POWER:GAINcontrol:CONTROL](#)).

Note:

- This applies to the wideband signal path only.
- Disable segmented GC and use [\[SENSe<Ch>:\]POWER:GAINcontrol](#) instead, if no distinction between different sweep segments shall be made.

Suffix:

<Ch> Channel number
 <Seg> Sweep segment number

Setting parameters:

<Mode> LDISTortion | LNOise
LDISTortion
 0 dB gain, for high input levels
LNOise
 10 dB gain, for low input levels
 *RST: LDISTortion

Parameters for setting and query:

<ReceiverName> String parameter defining the wave(s) followed by the drive port; see examples below and [Table 7-4](#).

Example:

```
*RST; :SENSe:POWER:GAINcontrol:GLOBal MANual
Activate independent GC settings for each drive port.
SENSe:SEGMENT1:ADD; :SENSe:SWEep:TYPE SEGMENT
Create a new sweep segment no. 1 and activate segmented
sweep type.
SENSe:SEGMENT1:POWER:GAINcontrol:CONTROL ON
Enable segmented GC.
SENSe:SEGMENT1:POWER:GAINcontrol 'B2D1', LNO
Set the ACG for the received wave b2 (port 2) in sweep segment
no. 1 to "Low Noise". The setting applies while port 1 is the drive
port.
SENSe:SEGMENT1:POWER:GAINcontrol 'A2B2B3D2',
LNO
Set the ACG for the waves a2, b2, and b3 in sweep segment no.
1 to "Low Noise". The setting applies while port 2 is the drive
port.
SENSe:SEGMENT1:POWER:GAINcontrol? 'B1D2'
Query the ACG setting for the wave b1 in sweep segment no. 1
while port 2 is the drive port. The response is 1, LDIS (default
setting).
```

Manual operation: See ["Range"](#) on page 691

[SENSe<Ch>:]SEGMent<Seg>:POWer:GAINcontrol:ALL <Mode>

For the selected segment, this command applies the same manual gain control (GC) <Mode> to all a and b wave receivers.

These settings apply if and only if segmented GC is enabled (see [SENSe<Ch>:]SEGMent<Seg>:POWer:GAINcontrol:CONTRol).

Note:

- This applies to the wideband signal path only.
- Disable segmented GC and use [SENSe<Ch>:]POWer:GAINcontrol or [SENSe<Ch>:]POWer:GAINcontrol:ALL instead, if no distinction between different sweep segments shall be made.

Suffix:

<Ch> Channel number
 <Seg> Sweep segment number

Setting parameters:

<Mode> LDISTortion | LNOise
LDISTortion
 0 dB gain, for high input levels
LNOise
 10 dB gain, for low input levels
 *RST: LDISTortion

Example:

```
*RST; :SENSe:POWer:GAINcontrol:GLOBal MANual
Enable the manual configuration of independent GC settings for
each drive port.
:SENSe:SEGMent1:ADD; :SENSe:SWEep:TYPE SEGMent
Create a new sweep segment no. 1 and activate segmented
sweep type.
SENSe:SEGMent1:POWer:GAINcontrol:CONTRol ON
Enable segmented GC.
SENSe:SEGMent1:POWer:GAINcontrol:ALL LNO
For sweep segment no. 1, set the GC mode of all a and b wave
receivers to "Low Noise". Segmented GC is enabled automati-
cally.
```

Usage: Setting only

Firmware/software: V2.75 or higher

Manual operation: See "[Range](#)" on page 691

[SENSe<Ch>:]SEGMent<Seg>:POWer:GAINcontrol:CONTRol <Boolean>

Defines whether common or independent gain control (GC) settings shall be used for the individual sweep segments.

Suffix:

<Ch> Channel number

<Seg> Sweep segment number. This suffix is ignored.

Parameters:

<Boolean> ON – use independent GC settings, to be defined via `[SENSe<Ch>:]SEGMENT<Seg>:POWer:GAINcontrol`.
 OFF – reset the GC mode in all sweep segments to the GC mode for unsegmented sweeps, defined via `[SENSe<Ch>:]POWer:GAINcontrol` or `[SENSe<Ch>:]POWer:GAINcontrol:GLOBal`. ON will not restore the previous values.
 *RST: ON

Example: See `[SENSe<Ch>:]SEGMENT<Seg>:POWer:GAINcontrol`

Manual operation: See "Segmented IF Gain" on page 689

[SENSe<Ch>:]SEGMENT<Seg>:POWer[:LEVel] <IntSourcePow>

Defines the power of the internal signal source in sweep segment no. <Seg>. At the same time, the command activates separate power control in all sweep segments (`[SENSe<Ch>:]SEGMENT:POWer[:LEVel]:CONTrol`).

Suffix:

<Ch> Channel number
 <Seg> Sweep segment number

Parameters:

<IntSourcePow> Internal source power
 Range: -300 dBm to +200 dBm. The usable power range is frequency-dependent; refer to the data sheet.
 *RST: -10 dBm
 Default unit: dBm

Example:

SEGM:ADD
 Create a new sweep segment no. 1 in channel no. 1 using default settings and thus -10 dBm internal source power.
 SEGM:POW -20
 Decrease the power to -20 dBm.

Manual operation: See "Optional Columns" on page 557

[SENSe<Ch>:]SEGMENT:POWer[:LEVel]:CONTrol <Boolean>

Selects common or independent internal source "Power" settings for the sweep segments.

Suffix:

<Ch> Channel number

Parameters:

<Boolean>

ON – use independent power settings, to be defined via

`[SENSe<Ch>:]SEGMENT<Seg>:POWer[:LEVel]`.OFF – reset the power in all sweep segments to the power for unsegmented sweeps, defined via `SOURce<Ch>:``POWer<PhyPt>[:LEVel] [:IMMediate] [:AMPLitude]`. ON will not restore the previous values.The parameter is automatically switched to ON when a segment power is entered using `[SENSe<Ch>:]SEGMENT<Seg>:``POWer[:LEVel]`.***RST:** OFF**Example:**`SEGM:ADD`

Create a new sweep segment no. 1 in channel no. 1 using default settings and thus -10 dBm internal source power.

`SEGM:POW -20`

Decrease the power to -20 dBm.

`SEGM:POW:CONT OFF`

Couple the powers in all segments and reset the power in segment no. 1 to the initial value.

Manual operation: See "[Optional Columns](#)" on page 557**[SENSe<Ch>:]SEGMENT<Seg>[:STATe] <Boolean>**

Activates or deactivates the sweep segment <Seg>. Sweep points belonging to inactive segments only are not measured.

Suffix:

<Ch>

Channel number

<Seg>

Sweep segment number

Parameters:

<Boolean>

ON | OFF - activates or deactivates the measurement in sweep segment <Seg>.

***RST:** ON**Example:**`SEGM:ADD`

Create a new sweep segment no. 1 in channel no. 1 using default settings.

`SEGM OFF`

Disable the measurement in the created sweep segment.

Manual operation: See "[Table Columns](#)" on page 554

[SENSe<Ch>:]SEGMENT<Seg>:SWEep:DWELI <MeasDelay>

Defines the delay time for each partial measurement in sweep segment no. <Seg> ("Meas. Delay"). If coupling of the segments is switched on ([SENSe<Ch>:]SEGMENT<Seg>:SWEep:DWELI:CONTROL ON), the delay is valid for all sweep segments in the current channel.

Suffix:

<Ch> Channel number
 <Seg> Sweep segment number

Parameters:

<MeasDelay> Measurement delay before each partial measurement. Changing the delay leaves the number of points unchanged but has an impact on the duration of the sweep ([SENSe<Ch>:]SEGMENT<Seg>:SWEep:TIME).

Range: 0 s to 2500 s

*RST: 0 s

Default unit: s

Example:

SEGM:ADD

Create a new sweep segment no. 1 in channel no. 1 using default settings.

SEGM:SWE:DWEL 1 MS

Set the meas. delay in segment no. 1 to 1 ms.

SEGM:DEF? Response:

300000,80000000000,51,-300,0.056559,0,10000,POS,NORM

Query the channel parameters for sweep segment 1. The response value for the segment sweep time (olive) implicitly contains the defined meas. delay.

Manual operation: See "Optional Columns" on page 557

[SENSe<Ch>:]SEGMENT<Seg>:SWEep:DWELI:CONTROL <Boolean>

Selects common or independent "Meas. Delay" settings for the sweep segments.

Suffix:

<Ch> Channel number.
 <Seg> Sweep segment number. This suffix is ignored; the command controls the whole segmented sweep.

Parameters:

<Boolean>

ON – use independent delay settings, to be defined via

`[SENSe<Ch>:]SEGMENT<Seg>:SWEep:DWELL.`OFF – reset the delay in all sweep segments to the delay for unsegmented sweeps, defined via `[SENSe<Ch>:]SWEep:``DWELL.`The parameter is automatically switched to ON when a meas. delay time is entered using `[SENSe<Ch>:]SEGMENT<Seg>:``SWEep:DWELL.`***RST:** OFF**Example:**`SEGM:ADD`

Create a new sweep segment no. 1 in channel no. 1 using default settings and thus 0 s meas. delay.

`SEGM:SWE:DWELL 0.1`

Increase the meas. delay to 0.1 s.

`SEGM:SWE:DWELL:CONT OFF`

Couple the meas. delay in all segments and reset the delay in segment no. 1 to the initial value of 0 s.

Manual operation: See "[Optional Columns](#)" on page 557**[SENSe<Ch>:]SEGMENT<Seg>:SWEep:POINTs <SegPoint>**

Defines the total number of measurement points in sweep segment no. <Seg>.

Suffix:

<Ch>

Channel number

<Seg>

Sweep segment number

Parameters:

<SegPoint>

Number of points in the segment

Range: 1 to 100001. 1 is allowed if start and stop frequencies are equal.

***RST:** 51**Example:**`SEGM:ADD`

Create a new sweep segment no. 1 in channel no. 1 using default settings.

`SEGM:SWE:POIN 401`

Increase the number of points to 401.

Manual operation: See "[Table Columns](#)" on page 554**[SENSe<Ch>:]SEGMENT<Seg>:SWEep:TIME <SegSweepTime>**Sets the duration of the sweep in sweep segment no. <Seg> ("Segment Time"). At the same time, the command activates separate sweep time setting in all sweep segments (`[SENSe<Ch>:]SEGMENT<Seg>:SWEep:TIME:CONTROL ON`).

Suffix:

<Ch>	Channel number
<Seg>	Sweep segment number

Parameters:

<SegSweepTime>	Segment time. The minimum segment time depends on the other channel settings, in particular on the number of points (<code>[SENSe<Ch>:]SEGMENT<Seg>:SWEep:POINts</code>), the IF bandwidth (<code>[SENSe<Ch>:]SEGMENT<Seg>:BWIDth[:RESolution]</code>) and the delay for each partial measurement (<code>[SENSe<Ch>:]SEGMENT<Seg>:SWEep:DWELL</code>). The maximum is 1000 s. Changing the duration leaves the number of points unchanged but directly affects the delay.
Range:	Minimum value to 1000 s
*RST:	Minimum value, depending on the channel settings. This default value corresponds to automatic sweep time setting in manual control.
Default unit:	s

Example:

```
SEGM:ADD
Create a new sweep segment no. 1 in channel no. 1.
SEGM:SWE:TIME 0.1
Increase the segment sweep time to 0.1 s.
SEGM:SWE:TIME:SUM?
Query the total duration of the segmented sweep. The response
is 0.1, because there is only one sweep segment.
```

Manual operation: See "[Optional Columns](#)" on page 557

[SENSe<Ch>:]SEGMENT<Seg>:SWEep:TIME:CONTRol <Boolean>

Selects common or independent "Segment Sweep Time" settings for the sweep segments.

Suffix:

<Ch>	Channel number
<Seg>	Sweep segment number. This suffix is ignored; the command controls the whole segmented sweep.

Parameters:

<Boolean>

ON – use independent segment sweep time settings, to be defined via `[SENSe<Ch>:]SEGMENT<Seg>:SWEep:TIME`.
 OFF – reset the segment sweep time in all sweep segments to the segment sweep time for unsegmented sweeps, defined via `[SENSe<Ch>:]SWEep:TIME`. ON will not restore the previous values.

The parameter is automatically switched to ON when a segment sweep time is entered using `[SENSe<Ch>:]SEGMENT<Seg>:SWEep:TIME` or if the channel settings in a sweep segment require a sweep time larger than the unsegmented sweep time.

*RST: OFF

Example:

SEGM:ADD

Create a new sweep segment no. 1 in channel no. 1.

SEGM:SWE:TIME 0.1

Increase the segment sweep time to 0.1 s.

SEGM:SWE:TIME:CONT OFF

Couple the sweep times in all segments and reset the sweep time in segment no. 1 to the initial value.

Manual operation: See "Optional Columns" on page 557**[SENSe<Ch>:]SEGMENT<Seg>:SWEep:TIME:SUM?**

Returns the total duration of the segmented sweep, calculated as the sum of the sweep times of the individual segments (`[SENSe<Ch>:]SEGMENT<Seg>:SWEep:TIME`).

Suffix:

<Ch> Channel number.

<Seg> Sweep segment number. This suffix is ignored; the command returns the sum of all segments.

Example: See `[SENSe<Ch>:]SEGMENT<Seg>:SWEep:TIME`**Usage:** Query only**Manual operation:** See "Optional Columns" on page 557**7.3.14.21 [SENSe:]SPECTrum...**

<code>[SENSe<Ch>:]SPECTrum:DETECTOR</code>	1497
<code>[SENSe<Ch>:]SPECTrum:IREJection</code>	1498
<code>[SENSe<Ch>:]SPECTrum:ZPADing</code>	1498

[SENSe<Ch>:]SPECTrum:DETECTOR <Type>

Defines the detector for the spectrum measurement, i.e. how the measurement result for a particular sweep point is derived from the related sample values.

Suffix:

<Ch>

Parameters:

<Type>

MAXPeak | MINPeak | RMS | AVERage

MAXPeak

Take the largest of all sample values

MINPeak

Take the smallest of all sample values

RMS

Take the root mean square of all sample values

AVERage

Take the arithmetic mean of all sample values

Options:

R&S ZNA-K1

Manual operation: See "[Detector](#)" on page 400**[SENSe<Ch>:]SPEctrum:IREJection <Mode>**

Selects the image rejection strategy: the higher the number of data acquisitions, the better the image rejection.

Suffix:

<Ch>

Channel number

Parameters:

<Mode>

OFF | LOW | NORMal | HIGH

OFF

1 data acquisition (no image rejection)

Recommended if you want to evaluate the noise power ratio
([CALCulate<Chn>:STATistics:PRATio\[:STATE\]](#) ON).**LOW**

2 acquisitions

NORMal

4 acquisitions

HIGH

8 acquisitions

*RST: NORMal

Options:

R&S ZNA-K1

Manual operation: See "[Image Rejection](#)" on page 400**[SENSe<Ch>:]SPEctrum:ZPADing <Boolean>**

Disables/enables zero padding.

Suffix:

<Ch> Channel number

Parameters:

<Boolean>

1 (ON)

Zero padding used (higher level accuracy)

0 (OFF)

Zero padding used (higher level accuracy, in particular for multi-channel measurements)

*RST: 1 (ON)

Options:

R&S ZNA-K1

Manual operation: See ["Increased Level Accuracy"](#) on page 400**7.3.14.22 [SENSe:]SWEep...**

The [SENSe:]SWEep... commands provide general settings to control the sweep. Most of the settings have an impact on the sweep time.

[SENSe<Ch>:]SWEep:AXIS:FREQuency.....	1500
[SENSe<Ch>:]SWEep:AXIS:POWer.....	1501
[SENSe<Ch>:]SWEep:COUNT.....	1501
[SENSe:]SWEep:COUNT:ALL.....	1502
[SENSe<Ch>:]SWEep:CTIMing:CHANnel.....	1502
[SENSe<Ch>:]SWEep:CTIMing:CHANnel:MODE.....	1502
[SENSe<Ch>:]SWEep:CTIMing:COMPression.....	1503
[SENSe<Ch>:]SWEep:CTIMing:COMPression:MODE.....	1503
[SENSe<Ch>:]SWEep:CTIMing:MODE.....	1504
[SENSe<Ch>:]SWEep:CTIMing:OCHannel.....	1504
[SENSe<Ch>:]SWEep:CTIMing:OCHannel:MODE.....	1504
[SENSe<Ch>:]SWEep:CTIMing:PORT:MAX.....	1505
[SENSe<Ch>:]SWEep:CTIMing:PORT:MAX:MODE.....	1505
[SENSe<Ch>:]SWEep:CTIMing:PORT:MIN.....	1505
[SENSe<Ch>:]SWEep:CTIMing:PORT:MIN:MODE.....	1506
[SENSe<Ch>:]SWEep:CTIMing:SEGMENT.....	1506
[SENSe<Ch>:]SWEep:CTIMing:SEGMENT:MODE.....	1507
[SENSe<Ch>:]SWEep:CTIMing:STIME.....	1507
[SENSe<Ch>:]SWEep:CTIMing:STIME:MODE.....	1507
[SENSe<Ch>:]SWEep:CTIMing:STIME:MAX.....	1508
[SENSe<Ch>:]SWEep:CTIMing:STIME:MIN.....	1508
[SENSe<Ch>:]SWEep:CTIMing:VISualize.....	1509
[SENSe<Ch>:]SWEep:DETECTOR:TIME.....	1509
[SENSe<Ch>:]SWEep:DWELI.....	1509
[SENSe<Ch>:]SWEep:DWELI:IPOint.....	1510
[SENSe<Ch>:]SWEep:FPOWer.....	1510
[SENSe<Ch>:]SWEep:GENeration.....	1511
[SENSe<Ch>:]SWEep:POINts.....	1511
[SENSe<Ch>:]SWEep:REVerse.....	1512
[SENSe<Chn>:]SWEep:SRCPort.....	1512
[SENSe<Ch>:]SWEep:STEP.....	1513

[SENSe<Ch>:]SWEep:TIME.....	1514
[SENSe<Ch>:]SWEep:TIME:AUTO.....	1514
[SENSe<Ch>:]SWEep:TIME:MODE.....	1515
[SENSe<Ch>:]SWEep:TYPE.....	1515

[SENSe<Ch>:]SWEep:AXIS:FREQuency <Scale>

Selects either the channel base frequency or one of the port frequencies as the stimulus axis in all diagrams of the active recall set. This command has no effect if no port-specific frequencies are defined.

Suffix:

<Ch> Channel number

Parameters:

<Scale> String parameter, one of the following signals:
 'Channel Base; Source' - base channel frequency
 'Port 1; Source' - source frequency at port 1
 'Port 2; Source' - source frequency at port 2
 ...
 'Gen 1; Source' - external generator frequency 1
 ...
 'Pmtr 1; Receiver' - external power meter frequency 1
 ...
 *RST: 'Channel Base: Source'

Example:

```
*RST; FREQ:STAR 1 GHz; STOP 2 GHz
```

Define a base channel frequency range between 1 GHz and 2 GHz. This frequency is also used as an (initial) frequency range for all test ports and external generators.

```
SOUR:FREQ1:CONV:ARB:IFR 1, 1, 1E+9, SWE
```

Convert the source frequency at test port no. 1 to the range between 2 GHz and 3 GHz.

```
SWE:AXIS:FREQ 'Port 1; Source'
```

Select the source signal at port 1 as the reference signal for frequency definitions.

```
FREQ:STAR 3 GHz; STOP 4 GHz
```

Shift all frequency ranges by +1 GHz.

```
SWE:AXIS:FREQ 'Port 2; Source'
```

Select the source signal at port 2 as the reference signal for frequency definitions.

```
FREQ:STAR?; STOP?
```

Query the frequency range at test port 2. The response is 2000000000;3000000000.

Manual operation: See "[Stimulus Axis – Frequency / Power](#)" on page 524

[SENSe<Ch>:]SWEep:AXIS:POWer <Scale>

Selects either the channel base power or one of the port powers as the stimulus axis in all diagrams of the active recall set. This command has no effect if no port-specific powers are defined.

Suffix:

<Ch> Channel number

Parameters:

<Scale> String parameter, one of the following signals:
 'Channel Base; Source' - base channel power
 'Port *p*; Source' - source power at port *p*
 'Port *p*; Phys' - source power at port *p*, including mechanical source attenuation
 'Gen *g*; Source' - source power at external generator *g*
 *RST: 'Channel Base; Source'

Example:

```
*RST; SOUR:POW 5
```

Define a base channel power of +5 dBm. This power is also used as an (initial) power for all test ports and external generators.

```
SOUR:POW1:OFFS -5, CPAD
```

Change the source power at test port no. 1 to 0 dB without affecting the power at the remaining ports.

```
SWE:AXIS:POW 'Port 1; Source'
```

Select the source signal at port 1 as the reference signal for power definitions.

```
SOUR:POW -5
```

Shift all powers by -5 GHz.

```
SWE:AXIS:POW 'Port 2; Source'
```

Select the source signal at port 2 as the reference signal for power definitions.

```
SOUR:POW?
```

Query the power at test port 2. The response is 0.

Manual operation: See "[Stimulus Axis – Frequency / Power](#)" on page 524

[SENSe<Ch>:]SWEep:COUNT <Sweep>

Defines the channel-specific number of sweeps to be measured and buffered in single sweep mode ([INITiate<Ch>:CONTinuous OFF](#)). Use [\[SENSe:\]SWEep:COUNT:ALL](#) to define the sweep count for all channels.

If controlled timing is active ([INITiate<Ch>:CTIMing ON](#)), then also in continuous sweep mode ([INITiate<Ch>:CONTinuous ON](#)) this setting defines the number of sweeps to be buffered (ring buffer).

Suffix:

<Ch> Channel number

Parameters:

<Sweep> Number of consecutive sweeps to be measured and buffered.
 Range: 1 to 100000
 *RST: 1

Example: See [CALCulate<Chn>:DATA:NSweep:FIRSt?](#)

Manual operation: See "[Sweeps/Memory Size](#)" on page 566

[SENSe:]SWEep:COUNT:ALL <Sweep>

Defines the number of sweeps to be measured in single sweep mode ([INITiate<Ch>:CONTinuous OFF](#)). The setting is applied to all channels. Use [\[SENSe<Ch>:\]SWEep:COUNT](#) to define the sweep count for a single channel.

Setting parameters:

<Sweep> Number of consecutive sweeps to be measured.
 Range: 1 to 100000
 *RST: 1

Example: See [Chapter 8.2.4, "Data handling"](#), on page 1743.

Usage: Setting only

Manual operation: See "[Sweeps/Memory Size](#)" on page 566

[SENSe<Ch>:]SWEep:CTIMing:CHANnel <MinWaitTime>

Sets/gets the minimum wait time for the initialization of channel <Ch>, in case it is the first channel to be swept, or the same as the previously swept channel.

Only takes effect, if both [\[SENSe<Ch>:\]SWEep:CTIMing:CHANnel:MODE](#) and [\[SENSe<Ch>:\]SWEep:CTIMing:MODE](#) are set to ON.

In controlled timing mode, this setting is ignored.

Suffix:

<Ch> Channel number

Parameters:

<arg0> <MinWaitTime>
 Minimum wait time
 Default unit: s

Manual operation: See "[Channel Begin](#)" on page 544

[SENSe<Ch>:]SWEep:CTIMing:CHANnel:MODE <Boolean>

Activates or deactivates manual wait times for the initialization of channel <Ch>, in case it is the first channel to be swept, or the same as the previously swept channel.

The minimum wait time can be set using `[SENSe<Ch>:]SWEep:CTIMing:CHANnel`. It only takes effect, if both `[SENSe<Ch>:]SWEep:CTIMing:CHANnel:MODE` and `[SENSe<Ch>:]SWEep:CTIMing:MODE` on page 1504 are set to ON.

In controlled timing mode, this setting is ignored.

Suffix:

<Ch> Channel number

Parameters:

<Boolean> ON (1) | OFF (0)
*RST: OFF

Manual operation: See "Channel Begin" on page 544

[SENSe<Ch>:]SWEep:CTIMing:COMPression <WaitTime>

Sets/gets the wait time for the first point of each 2D gain compression (power) sub-sweep in channel <Ch> (see `[SENSe<Ch>:]FREQuency:COMPression:POINt`).

Only takes effect, if both `[SENSe<Ch>:]SWEep:CTIMing:COMPression:MODE` and `[SENSe<Ch>:]SWEep:CTIMing:MODE` are set to ON.

Suffix:

<Ch> Channel number

Parameters:

<arg0> <WaitTime>
Wait time (fixed)
Default unit: s

Manual operation: See "First Point of Segments" on page 545

[SENSe<Ch>:]SWEep:CTIMing:COMPression:MODE <Boolean>

Activates or deactivates manual wait times for the first point of each 2D gain compression (power) subsweep in channel <Ch> (see `[SENSe<Ch>:]FREQuency:COMPression:POINt`).

The wait time can be set using `[SENSe<Ch>:]SWEep:CTIMing:COMPression`. It only takes effect, if both `[SENSe<Ch>:]SWEep:CTIMing:COMPression:MODE` and `[SENSe<Ch>:]SWEep:CTIMing:MODE` on page 1504 are set to ON.

Suffix:

<Ch> Channel number

Parameters:

<Boolean> ON (1) | OFF (0)
*RST: OFF

Manual operation: See "First Point of Segments" on page 545

[SENSe<Ch>:]SWEep:CTIMing:MODE <Boolean>

Activates or deactivates manual wait time settings for channel <Ch>.

Note that the manual wait times for the related channel/sweep events must be activated separately using

- [SENSe<Ch>:]SWEep:CTIMing:CHANnel:MODE
- [SENSe<Ch>:]SWEep:CTIMing:OCHannel:MODE
- [SENSe<Ch>:]SWEep:CTIMing:SEGment:MODE
- [SENSe<Ch>:]SWEep:CTIMing:COMPression:MODE
- [SENSe<Ch>:]SWEep:CTIMing:PORT:MAX:MODE
- [SENSe<Ch>:]SWEep:CTIMing:PORT:MIN:MODE
- [SENSe<Ch>:]SWEep:CTIMing:STIME:MODE

Suffix:

<Ch> Channel number

Parameters:

<Boolean> ON (1) | OFF (0)
*RST: OFF

Manual operation: See "[Manual](#)" on page 543

[SENSe<Ch>:]SWEep:CTIMing:OCHannel <MinWaitTime>

Sets/gets the minimum wait time for the initialization of channel <Ch>, in case it is different from the previously swept one.

Only takes effect, if both [SENSe<Ch>:]SWEep:CTIMing:OCHannel:MODE and [SENSe<Ch>:]SWEep:CTIMing:MODE are set to ON.

In controlled timing mode, this setting is ignored.

Suffix:

<Ch> Channel number

Parameters:

<arg0> <MinWaitTime>
Minimum wait time
Default unit: s

Manual operation: See "[Channel Begin](#)" on page 544

[SENSe<Ch>:]SWEep:CTIMing:OCHannel:MODE <Boolean>

Activates or deactivates manual wait times for the initialization of channel <Ch>, in case it is different from the previously swept one.

The minimum wait time can be set using [SENSe<Ch>:]SWEep:CTIMing:OCHannel. It only takes effect, if both [SENSe<Ch>:]SWEep:CTIMing:OCHannel:MODE and [SENSe<Ch>:]SWEep:CTIMing:MODE on page 1504 are set to ON.

In controlled timing mode, this setting is ignored.

Suffix:

<Ch> Channel number

Parameters:

<Boolean> ON (1) | OFF (0)
*RST: OFF

Manual operation: See "[Channel Begin](#)" on page 544

[SENSe<Ch>:]SWEep:CTIMing:PORT:MAX <WaitTime>

Sets/gets the maximum wait time for the first point of channel <Ch>, and the first point after a drive port change in channel <Ch>.

Only takes effect, if both [\[SENSe<Ch>:\]SWEep:CTIMing:PORT:MAX:MODE](#) and [\[SENSe<Ch>:\]SWEep:CTIMing:MODE](#) are set to ON.

Suffix:

<Ch> Channel number

Parameters:

<arg0> <WaitTime>
Maximum wait time
Default unit: s

Manual operation: See "[First Point of Ch / Drive Port Change](#)" on page 545

[SENSe<Ch>:]SWEep:CTIMing:PORT:MAX:MODE <Boolean>

Activates or deactivates manual maximum wait times for the first point of channel <Ch>, and the first point after a drive port change in channel <Ch>.

The maximum wait time can be set using [\[SENSe<Ch>:\]SWEep:CTIMing:PORT:MAX](#). It only takes effect, if both [\[SENSe<Ch>:\]SWEep:CTIMing:PORT:MAX:MODE](#) and [\[SENSe<Ch>:\]SWEep:CTIMing:MODE](#) are set to ON.

Suffix:

<Ch> Channel number

Parameters:

<Boolean> ON (1) | OFF (0)
*RST: OFF

Manual operation: See "[First Point of Ch / Drive Port Change](#)" on page 545

[SENSe<Ch>:]SWEep:CTIMing:PORT:MIN <WaitTime>

Sets/gets the minimum wait time for the first point of channel <Ch>, and the first point after a drive port change in channel <Ch>.

Only takes effect, if both `[SENSe<Ch>:]SWEep:CTIMing:PORT:MIN:MODE` and `[SENSe<Ch>:]SWEep:CTIMing:MODE` are set to ON.

Suffix:

<Ch> Channel number

Parameters:

<arg0> <WaitTime>
Minimum wait time
Default unit: s

Manual operation: See "First Point of Ch / Drive Port Change" on page 545

[SENSe<Ch>:]SWEep:CTIMing:PORT:MIN:MODE <Boolean>

Activates or deactivates manual minimum wait times for the first point of channel <Ch>, and the first point after a drive port change in channel <Ch>.

The minimum wait time can be set using `[SENSe<Ch>:]SWEep:CTIMing:PORT:MIN`. It only takes effect, if both `[SENSe<Ch>:]SWEep:CTIMing:PORT:MIN:MODE` and `[SENSe<Ch>:]SWEep:CTIMing:MODE` are set to ON.

Suffix:

<Ch> Channel number

Parameters:

<Boolean> ON (1) | OFF (0)
*RST: OFF

Manual operation: See "First Point of Ch / Drive Port Change" on page 545

[SENSe<Ch>:]SWEep:CTIMing:SEGMENT <WaitTime>

Sets/gets the wait time for the first point of each segmented frequency sweep in channel <Ch> (`[SENSe<Ch>:]SWEep:TYPE SEGMENT`).

Only takes effect, if both `[SENSe<Ch>:]SWEep:CTIMing:SEGMENT:MODE` and `[SENSe<Ch>:]SWEep:CTIMing:MODE` are set to ON.

Suffix:

<Ch> Channel number

Parameters:

<arg0> <WaitTime>
Wait time (fixed)
Default unit: s

Manual operation: See "First Point of Segments" on page 545

[SENSe<Ch>:]SWEep:CTIMing:SEGMent:MODE <Boolean>

Activates or deactivates manual wait times for the first point of each segmented frequency sweep in channel <Ch> ([SENSe<Ch>:]SWEep:TYPE SEGMent).

The wait time can be set using [SENSe<Ch>:]SWEep:CTIMing:SEGMent. It only takes effect, if both [SENSe<Ch>:]SWEep:CTIMing:SEGMent:MODE and [SENSe<Ch>:]SWEep:CTIMing:MODE on page 1504 are set to ON.

Suffix:

<Ch> Channel number

Parameters:

<Boolean> ON (1) | OFF (0)
*RST: OFF

Manual operation: See "First Point of Segments" on page 545

[SENSe<Ch>:]SWEep:CTIMing:STIME <Value>

Sets/gets a user-defined wait time per measurement point in channel <Ch>.

Only takes effect, if [SENSe<Ch>:]SWEep:CTIMing:STIME:MODE is set to USER and [SENSe<Ch>:]SWEep:CTIMing:MODE is set to ON.

Suffix:

<Ch> Channel number

Parameters:

<Value> Wait time (fixed)
*RST: 1 ms
Default unit: s

Manual operation: See "All Points" on page 545

[SENSe<Ch>:]SWEep:CTIMing:STIME:MODE <Mode>

Enables/disables user-defined wait times per measurement point in channel <Ch>.

Note

- Setting <Mode> to USER or LIMited automatically activates manual wait time control for channel <Ch> ([SENSe<Ch>:]SWEep:CTIMing:MODE ON).
- Deactivating manual wait time control for channel <Ch> ([SENSe<Ch>:]SWEep:CTIMing:MODE OFF) disables all user-defined wait times in this channel, whether active or not.

Suffix:

<Ch> Channel number

Parameters:

<Mode> AUTO | USER | LIMited

AUTO

The wait time is calculated automatically, with the algorithm selected using `[SENSe<Ch>:]SWEep:TIME:MODE`.

USER

A user-defined wait time can be specified using `[SENSe<Ch>:]SWEep:CTIMing:STIME`.

LIMited

Upper and lower limits for the wait time can be specified using `[SENSe<Ch>:]SWEep:CTIMing:PORT:MAX:MODE` and `[SENSe<Ch>:]SWEep:CTIMing:PORT:MIN:MODE`.

Manual operation: See "All Points" on page 545

[SENSe<Ch>:]SWEep:CTIMing:STIME:MAX <Value>

Sets/gets a the maximum wait time per measurement point in channel <Ch>.

Only takes effect, if `[SENSe<Ch>:]SWEep:CTIMing:STIME:MODE` is set to `LIMited` and `[SENSe<Ch>:]SWEep:CTIMing:MODE` is set to `ON`.

The corresponding minimum can be set using `[SENSe<Ch>:]SWEep:CTIMing:STIME:MIN`.

Suffix:

<Ch> Channel number

Parameters:

<Value> Wait time (fixed)
*RST: 1 ms
Default unit: s

Manual operation: See "All Points" on page 545

[SENSe<Ch>:]SWEep:CTIMing:STIME:MIN <Value>

Sets/gets a the minimum wait time per measurement point in channel <Ch>.

Only takes effect, if `[SENSe<Ch>:]SWEep:CTIMing:STIME:MODE` is set to `LIMited` and `[SENSe<Ch>:]SWEep:CTIMing:MODE` is set to `ON`.

The corresponding maximum can be set using `[SENSe<Ch>:]SWEep:CTIMing:STIME:MAX`.

Suffix:

<Ch> Channel number

Parameters:

<Value> Wait time (fixed)
*RST: 1 ms
Default unit: s

Manual operation: See "All Points" on page 545

[SENSe<Ch>:]SWEep:CTIMing:VISualize <Boolean>

Activates or deactivates the sweep timing info box for channel <Ch>.

Suffix:

<Ch> Channel number

Parameters:

<Boolean> ON (1) | OFF (0)
*RST: OFF

Manual operation: See ["Show Sweep Timing"](#) on page 543

[SENSe<Ch>:]SWEep:DETEctor:TIME <DetectorTime>

Defines the observation time per sweep point if a detector other than the "Normal" (SAMple) detector is used. The detector is selected together with the measured quantity ([CALCulate<Ch>:PARAmeter:MEASure](#) or [CALCulate<Ch>:PARAmeter:SDEFine](#)).

Suffix:

<Ch> Channel number

Parameters:

<DetectorTime> Detector time
Range: 0 s to 3456000 s
*RST: 0.01 s
Default unit: s

Example:

```
*RST; :CALC:PAR:MEAS 'TRC1', 'a1D1AVG'
```

Select the wave quantity a₁ for the default trace and activate the AVG detector.

```
SWE:DET:TIME 1
```

Specify an observation time of 1 s at each sweep point.

Manual operation: See ["Detector"](#) on page 350

[SENSe<Ch>:]SWEep:DWELI <MeasDelay>

Defines the "Meas. Delay" before each partial measurement or the first partial measurement (see [\[SENSe<Ch>:\]SWEep:DWELI:IPoint](#)). Setting a delay disables the automatic calculation of the (minimum) sweep time (see [\[SENSe<Ch>:\]SWEep:TIME:AUTO](#)).

Suffix:

<Ch> Channel number

Parameters:

<MeasDelay> Measurement delay before each partial measurement. Changing the delay leaves the number of points unchanged but has an impact on the duration of the sweep (`[SENSe<Ch>:]SWEep:TIME`).

Range: 0 s to 13680 s
 *RST: 0 s
 Default unit: s

Example:

```
*RST
Reset the instrument, activating a frequency sweep with the S-parameter S21 as a measurement result for channel and trace no. 1.
SWEep:TIME?
Query total sweep time.
SWEep:DWEL 1
SWEep:DWEL:IPoint ALL
Set a delay of 1 s for each partial measurement.
SWE:TIME?
Query total sweep time. The time is extended by the delay times the total number of sweep points (one partial measurement per sweep point required).
```

Manual operation: See "[Meas Delay](#)" on page 541

[SENSe<Ch>:]SWEep:DWEL:IPoint <InsertionPoints>

Defines whether the measurement delay (previously defined via `[SENSe<Ch>:]SWEep:DWEL1`) is inserted before all partial measurements or before the first partial measurement only.

Suffix:

<Ch> Channel number

Parameters:

<InsertionPoints> ALL | FIRSt
 Insertion before all or before the first partial measurement
 *RST: ALL

Example: See `[SENSe<Ch>:]SWEep:DWEL1`

Manual operation: See "[All Partial Meas'ments / First Partial Meas'ment](#)" on page 542

[SENSe<Ch>:]SWEep:FPOWer <Mode>

Selects the power sweep mode.

Suffix:

<Ch>

Parameters:

<Mode> OFF | ON | FAST

OFF
Regular power sweep

ON
Fast power sweep

FAST
Pulsed power sweep

Manual operation: See "[Fast Power Sweep](#)" on page 552

[SENSe<Ch>:]SWEep:GENeration <mode>

Sets/gets the sweep mode for linear frequency sweeps.

Suffix:

<Ch> Channel number

Parameters:

<mode> STEPped

The R&S ZNA only supports the stepped mode, i.e, the frequency is changed stepwise and sampling is performed at a tuned frequency for each measurement point.

*RST: STEPped

[SENSe<Ch>:]SWEep:POINts <SweepPoint>

Defines the total number of measurement points per sweep ("Number of Points").

Values between 1 and 100,001 can be set.

Suffix:

<Ch> Channel number 1

Parameters:

<SweepPoint> Number of points per sweep

Range: see above

*RST: 201

Example:

```
*RST
Reset the instrument, activating a frequency sweep with 201
sweep points.
SWE:TIME?
Query total sweep time.
SWE:POIN 2010
Multiply the (default) number of points by 10.
SWE:TIME?
Query total sweep time again. The analyzer estimates a sweep
time that is also multiplied by 10.
```

Manual operation: See "[Number of Points](#)" on page 524

[SENSe<Ch>:]SWEep:REVerse <Boolean>

Reverses the direction of the sweep in channel <Ch>.

Suffix:

<Ch> Channel number

Parameters:

<Boolean> *RST: OFF

Manual operation: See "[Reverse](#)" on page 552

[SENSe<Chn>:]SWEep:SRCPort <Port>

Sets/gets the source port for the stimulus signal. The setting acts on the active trace. The effect of the drive port selection depends on the measurement parameter associated to the active trace:

- If an S-parameter $S_{\langle out \rangle \langle in \rangle}$ is measured, the second port number index <in> (input port of the DUT = drive port of the analyzer) is set equal to the selected drive port: Drive port selection affects the measured quantity.
- If a wave quantity or a ratio is measured, the drive port is independent of the measured quantity:

Suffix:

<Chn> Channel number used to identify the active trace

Parameters:

<Port> Logical port number

*RST: 1

Example: `CALC4:PAR:SDEF "Ch4Tr1", "A1"`
 Create channel 4 and a trace named "Ch4Tr1" to measure the wave quantity a_1 . The trace automatically becomes the active trace.
`SENS4:SWE:SRCP 2`
 Select drive port 2 for the active trace.
`CALC4:PAR:MEAS? "Ch4Tr1"`
 Query the measurement result for "Ch4Tr1". The response is 'A1D2SAM'.

[SENSe<Ch>:]SWEep:STEP <StepSize>

Sets the distance between two consecutive sweep points in a (non-segmented) linear frequency sweep.

Suffix:

<Ch> Channel number

Parameters:

<StepSize> Frequency step size.
 The step size is equal to the current sweep span divided by the number of sweep points minus one (see [\[SENSe<Ch>:\]FREQuency:SPAN?](#) and [\[SENSe<Ch>:\]SWEep:POINts?](#), respectively). See also the description of manual control and the program example below.

Range: Depends on the current sweep span and the maximum number of sweep points: "Span Frequency" / (max. "Number of Points" – 1) ≤ "Freq Step Size" ≤ "Span Frequency"

*RST: Depends on the analyzer model. The default step size is equal to the default sweep span of the analyzer divided by the default number of sweep points minus one.

Default unit: Hz

Example:

`*RST; :SWE:STEP?`

Query the default step size. Currently for all analyzers the default sweep span is the full frequency range and the default number of points is 201. Hence the response is (max. frequency - min. frequency) / 200.

`SWE:STEP UP`

Increase the step size.

`FREQ:STOP?; :SWE:POIN?`

Query the stop frequency of the sweep and the number of points. Increasing the step size has changed both values.

Manual operation: See "[Freq Step Size](#)" on page 540

[SENSe<Ch>:]SWEep:TIME <SweepDuration>

Sets the duration of the sweep ("Sweep Time"). Setting a sweep time disables the automatic calculation of the (minimum) sweep time; see [SENSe<Ch>:]SWEep:TIME:AUTO.

Note: The sweep time is ignored for the sweep types "Time" and "CW Mode" ([SENSe<Ch>:]SWEep:TYPE).

Suffix:

<Ch> Channel number

Parameters:

<SweepDuration> Sweep time. The minimum possible sweep time depends on the other channel settings, in particular on the number of points ([SENSe<Ch>:]SWEep:POINts), the IF bandwidth ([SENSe<Ch>:]BWIDth[:RESolution]) and the measurement delay for each partial measurement ([SENSe<Ch>:]SWEep:DWELl). Changing the duration leaves the number of points unchanged but directly affects the delay.

Range: Between minimum sweep time (for current channel settings) and 100000 s

*RST: Minimum sweep time (for *RST channel settings)

Default unit: s

Example:

SWE:TIME 1

Set a total sweep time of 1 s.

SWE:DWEL?

Query the delay for each partial measurement.

SWE:TIME 2

Increase the total sweep time to 2 s.

SWE:DWEL?

Query the meas. delay for each partial measurement again. The delay is increased by 1 s divided by the total number of partial measurements per sweep.

Manual operation: See "Stop Time" on page 524

[SENSe<Ch>:]SWEep:TIME:AUTO <Boolean>

When enabled, the (minimum) sweep time is calculated internally using the other channel settings and zero delay ([SENSe<Ch>:]SWEep:DWELl).

Note: The automatically calculated sweep duration is ignored for the sweep types "Time" and "CW Mode" ([SENSe<Ch>:]SWEep:TYPE).

Suffix:

<Ch> Channel number

Parameters:

<Boolean> ON | OFF - turn the automatic calculation of the sweep time on or off.
 OFF is also set if the sweep duration or delay is set explicitly using [SENSe<Ch>:]SWEep:TIME or [SENSe<Ch>:]SWEep:DWELL.
 *RST: ON

Example:

```
SWE:TIME 1
Set a total sweep time of 1 s.
SWE:TIME:AUTO?
A query returns the value 1.
```

Manual operation: See "[Sweep Time / Auto](#)" on page 541

[SENSe<Ch>:]SWEep:TIME:MODE <Algorithm>

Defines how the firmware calculates the "hardware settling wait times" in channel <Ch>.

Suffix:

<Ch> Channel number

Parameters:

<Algorithm> AUTO | MONO | CONV | SLOW

AUTO

Let the firmware choose the suitable algorithm, based on the channel's current measurement task

MONO

Manually (and statically) select the algorithm for mono-frequent measurements

CONV

Manually (and statically) select the algorithm for frequency-converting measurements

SLOW

Manually (and statically) select the algorithm for other "slow" measurements (e.g. involving power meters)

*RST: AUTO

Manual operation: See "[Auto | ... | Slow](#)" on page 543

[SENSe<Ch>:]SWEep:TYPE <Format>

Selects the sweep type, i.e. the sweep variable (frequency/power/time) and the position of the sweep points across the sweep range.

Suffix:

<Ch> Channel number.

Parameters:

<Format> LINear | LOGarithmic | POWer | CW | POINT | SEGMENT | PULSe | IAMPLitude | IPHase

LINear

Linear frequency sweep at constant source power

(`SOURce<Ch>:POWer<PhyPt>[:LEVel] [:IMMediate] [:AMPLitude]`). The stimulus frequency

(`[SENSe<Ch>:]FREQuency:...`) is swept in equidistant steps over the frequency range. In a Cartesian diagram, the x-axis is a linear frequency axis.

LOGarithmic

Logarithmic frequency sweep. The frequency is swept in equidistant steps on a logarithmic scale. In a Cartesian diagram, the x-axis is a logarithmic frequency axis.

POWer

Power sweep. The measurement is performed at constant frequency (`SOURce<Ch>:FREQuency<PhyPt>:FIXed`) but with variable generator power that is swept in linear, equidistant steps over a continuous range

(`SOURce<Ch>:POWer<PhyPt>:START, SOURce<Ch>:POWer<PhyPt>:STOP`). In a Cartesian diagram, the x-axis is a dB-linear power axis.

CW

Time sweep. The measurement is performed at constant frequency (`SOURce<Ch>:FREQuency<PhyPt>:FIXed`) and source power (`SOURce<Ch>:POWer<PhyPt>[:LEVel] [:IMMediate] [:AMPLitude]`) and repeated over a specified period of time at constant time intervals.

POINT

CW mode sweep, time sweep triggered according to the current trigger settings.

SEGMENT - segmented frequency sweep. The sweep range is composed of several continuous frequency ranges or single frequency points defined by means of the commands in the `[SENSe<Ch>:]SEGMENT<Seg>... subsystem`.

PULSe

Pulse profile mode, configured via `SENSe:PULSe...`

IAMPLitude | IPHase

Amplitude | Phase imbalance sweep

Only available in source coherence mode (`SOURce<Ch>:CMODE[:STATE] ON`).

The sweep properties can be set using `SOURce:CMODE...` commands.

*RST: LINear

- Example:** *RST
Reset the analyzer, activating a linear frequency sweep.
SWE:TYPE LOG
Change to a logarithmic frequency sweep, resetting the stimulus values of the sweep points.
- Manual operation:** See "[Lin Freq](#)" on page 546

7.3.14.23 [SENSe:]... (other)

[SENSe<Ch>:]COUPle.....	1517
[SENSe<Ch>:]IFPath.....	1517
[SENSe<Ch>:]PAMPlifier<Pt>[:STATe].....	1518
[SENSe<Ch>:]PAMPlifier2:VALue.....	1518
[SENSe<Ch>:]PHASe:MODE.....	1519
[SENSe<Ch>:]PORT<PhyPt>:ZREFerence.....	1519
[SENSe:]JUDSParams:ACTive.....	1520
[SENSe:]JUDSParams<Pt>:PARam.....	1520

[SENSe<Ch>:]COUPle <Mode>

Determines the order of partial measurements and sweeps (see [Chapter 4.1.4.1, "Partial measurements and driving mode"](#), on page 111).

Suffix:

<Ch> Channel number. This suffix is ignored; the sweep mode applies to all channels in the active recall set.

Parameters:

<Mode> ALL | AUTO | NONE
 AUTO – automatic mode: fast sweeps are performed in alternated driving mode, slower sweeps in chopped mode
 ALL – chopped driving mode, complete all partial measurements before proceeding to the next sweep point
 NONE – alternated driving mode on, reverse the order of partial measurements and sweeps
 *RST: NONE

Example:

```
COUP NONE
Activate the alternated driving mode.
TRIG:LINK 'PPO'
Set the triggered measurement sequence equal to one partial measurement. Each trigger event starts one partial measurement for all sweep points.
```

Manual operation: See "[Driving Mode](#)" on page 687

[SENSe<Ch>:]IFPath <If Path>

Selects the analog IF signal path.

Suffix:

<Ch> Channel number

Parameters:

<If Path> WIDeband | NORMal | NARRowband

WIDeband

Wideband path with 50 MHz lowpass filter

NORMal

Standard high precision path

NARRowband

Narrowband path with 10.7 MHz bandpass filter

*RST: NORMal

Manual operation: See "[IF Filter \(analog\)](#)" on page 537

[SENSe<Ch>:]PAMPlifier<Pt>[:STATe] <Boolean>

Enables or disables the internal preamplifier located in the measurement receiver path of port <Pt> = 1 or 2.

Suffix:

<Ch> Channel number

<Pt> {1, 2}

Port number

<Pt>=1 addresses the [Internal low power spur reduction amplifier](#) at port 1 (option R&S ZNAxx-B501, R&S ZNA50-B511, R&S ZNA67-B511)

<Pt>=2 addresses the [Internal low noise preamplifier](#) at port 2 (with option R&S ZNAxx-B301, R&S ZNA50-B312, R&S ZNA67-B312)

Other port numbers are invalid and cause an execution error.

Parameters:

<Boolean> Enables (ON) or disables (OFF) the amplifier.

*RST: OFF

Options:

R&S ZNAxx-B501/B302, or R&S ZNA50-B511/B312, or R&S ZNA67-B511/B302

Manual operation: See "[Preamp. Gain](#)" on page 527

[SENSe<Ch>:]PAMPlifier2:VALue <Gain>

Sets the gain of the [Chapter 4.7.36, "Internal low noise preamplifier"](#), on page 312 located in the measurement receiver path of port 2.

Suffix:

<Ch>

Parameters for setting and query:

<Gain> Gain factor for the internal low noise amplifier in dB
 Range: 20 to 30
 Increment: 5

Options: R&S ZNAXx-B302, or R&S ZNA50-B312, or R&S ZNA67-B312

Manual operation: See "[Preamp. Gain](#)" on page 527

[SENSe<Ch>:]PHASE:MODE <True Phase Mode>

Defines the phase mode of channel <Ch>, i.e. de/activates coherence mode in combination with low phase noise mode.

Suffix:

<Ch> Channel number

Parameters:

<True Phase Mode> NCOHerent | COHerent | LNNCoherent | LNCohere

NCOHerent

Coherence off, low phase noise off

COHerent

Coherence on, low phase noise off

LNNCoherent

Coherence off, low phase noise on

LNCohere

Coherence on, low phase noise on

*RST: NCOHerent

Manual operation: See "[Phase Mode](#)" on page 689

[SENSe<Ch>:]LPORT<PhyPt>:ZREFerence <RealPart>[, <ImaginaryPart>]

Specifies the complex reference impedance for the physical port numbered <PhyPt> (impedance renormalization).

Use `[SENSe<Ch>:]LPORT<LogPt>:ZDEFault[:STATE]` to toggle between configured and default reference impedances.

Suffix:

<Ch> Channel number

<PhyPt> Physical port number

Parameters:

<RealPart> Real part of the port impedance.

Range: 1 mΩ to 10 MΩ

*RST: Default reference impedance of the connector family assigned to the port (real impedance, e.g. 50 Ω).

Default unit: Ohm

<ImaginaryPart>	Imaginary part of the port impedance. This part may be omitted to define a real impedance. Range: - 10 MΩ to 10 MΩ *RST: Default reference impedance of the connector family assigned to the port (real impedance, e.g. 50 Ω). Default unit: Ohm
Example:	<pre>PORT2:ZREF 52, 2</pre> <p>Specify a complex reference impedance of $52 \Omega + j * 2 \Omega$ for the (physical) port no. 2.</p> <pre>CALC:TRAN:IMP:RNOR PWAV</pre> <p>Select renormalization of port impedances according to the power waves theory.</p>
Manual operation:	See " Single Ended Mode / Common Mode / Differential Mode " on page 356

[SENSe:]UDSPArms:ACTive <arg0>

With a "set to OFF", this command disables user-defined physical ports (see [Chapter 4.3.1.2, "Redefined S-parameters"](#), on page 151). In "get direction" it queries whether or not user-defined physical ports are configured.

Note that a "set to ON" doesn't have any effect; user defined ports can only be created using `[SENSe:]UDSPArms<Pt>:PARAm` on page 1520

Parameters:

<arg0> OFF (0) or ON (1)

Example: see `[SENSe:]UDSPArms<Pt>:PARAm`

Manual operation: See "[a wave, b wave, Source](#)" on page 920

[SENSe:]UDSPArms<Pt>:PARAm <PortString>

Creates or redefines a user-defined physical port (see [Chapter 4.3.1.2, "Redefined S-parameters"](#), on page 151). Causes a factory reset.

Note that the factory reset deletes all switch matrix RF connections, so the RF configuration for switch matrices (see `SYSTem:COMMunicate:RDEvice:SMATrix:CONFigure:START`) has to be done *after* the port redefinition.

Suffix:

<Pt> Number of the redefined physical port.

Parameters:

<PortString> String representation '`<Source>:<a wave>:<b wave>`' where
 <Source> = *i* refers to (original) VNA ports
 <Source> = *Gi* refers to external generator ports
 <a wave>, <b wave> is one of the original *ai* or *bi*,
 without reusing the same port in different (redefined) ports,
 Note that an external generator must be configured before it can be used as <Source>.

Example: `SENSe:UDSPArms:ACTive OFF`
 resolves all redefined ports
`SENSe:UDSPArms1:PARAm '1:b2:b3'`
 redefines physical port 1 as source = (original) physical port 1,
 reference receiver = physical port 2, measurement receiver =
 physical port 3
`SENSe:UDSPArms:ACTive?`
 returns 1 (= ON; see [\[SENSe:\]UDSPArms:ACTive](#))

Manual operation: See "[a wave, b wave, Source](#)" on page 920

7.3.15 SOURce commands

The `SOURce...` commands affect the source settings of the R&S ZNA.



Port-specific and general settings

The `SOURce...` subsystem comprises channel-specific and general settings. Channel-specific settings are valid for the channel specified by the numeric suffix `<Ch>` (`SENSe<Ch>:...`). General settings are valid for all channels; the channel suffix is ignored. Refer to the description of the individual commands for more information.

7.3.15.1 SOURce:CMODE...

The `SOURce:CMODE` commands enable and configure [Phase coherent source control](#) (R&S ZNA-K6).

<code>SOURce<Ch>:CMODE:OPTimized[:STATe]</code>	1521
<code>SOURce<Ch>:CMODE:PORT<Pt>:PHASe</code>	1522
<code>SOURce<Ch>:CMODE:PORT<Pt>:PHASe:SPAN</code>	1522
<code>SOURce<Ch>:CMODE:PORT<Pt>[:STATe]</code>	1522
<code>SOURce<Ch>:CMODE[:STATe]</code>	1523
<code>SOURce<Ch>:CMODE:WCORrection[:STATe]</code>	1523

`SOURce<Ch>:CMODE:OPTimized[:STATe]` <Boolean>

Allows to select between optimized and raw phase control in source coherence mode (see `SOURce<Ch>:CMODE[:STATe]` on page 1523).

Suffix:

`<Ch>` Channel number

Parameters:

`<Boolean>` **ON**
 Optimized phase control, applying port match corrections
 and calibration (ON, default)

OFF
 Raw phase control

Options: R&S ZNA-K6

Manual operation: See ["Use Port Match and Calibration"](#) on page 704

SOURce<Ch>:CMODE:PORT<Pt>:PHASe <Value>

Defines the phase (or phase start) for the coherent signal at port no. <PhyPt>.

Use [SOURce<Ch>:CMODE:PORT<Pt>:PHASe:SPAN](#) to set the phase span.

Suffix:

<Ch> Channel number. If unspecified the numeric suffix is set to 1.

<Pt> Physical port number

Parameters:

<Value> Port-specific phase value

Increment: 1-deg

*RST: 0 deg

Example: See [SOURce<Ch>:CMODE:PORT<Pt>\[:STATe\]](#) on page 1522

Options: R&S ZNA-K6

Manual operation: See ["Phase Start"](#) on page 704

SOURce<Ch>:CMODE:PORT<Pt>:PHASe:SPAN <Value>

Sets the phase span for port <Pt> in channel <Ch>, if source coherence is enabled

Use amplitude imbalance sweep [SOURce<Ch>:CMODE:PORT<Pt>:PHASe](#) to set the start phase.

Does not apply if an imbalance sweep is running.

Suffix:

<Ch> Channel number

<Pt> Port number

Parameters:

<Value> Phase span in degrees

Options: R&S ZNA-K6

Manual operation: See ["Phase Span"](#) on page 705

SOURce<Ch>:CMODE:PORT<Pt>[:STATe] <Boolean>

Enables or disables defined phase coherence at physical port <Pt> for channel <Ch>.

The target phase is defined using [SOURce<Ch>:CMODE:PORT<Pt>:PHASe](#).

Suffix:

<Ch> Channel number

<Pt> Physical port number

Parameters:

<Boolean> *RST: OFF

Example:

*RST; SOUR:CMOD:PORT3 ON

Reset the analyzer and define the source signal of port 3 as coherent.

SOUR:CMOD:PORT3:PHAS 90

Assign 90° phase to the voltage of the coherent signal at port 3.

SOUR:CMOD ON

Turn source coherence on.

Options:

R&S ZNA-K6

Manual operation: See "[Def'd Phase Coherence](#)" on page 704

SOURce<Ch>:CMODE[:STATe] <Boolean>

Turns source coherence mode (globally) on or off. Defined coherence for individual analyzer ports is enabled or disabled using [SOURce<Ch>:CMODE:PORT<Pt>\[:STATe\]](#).

Suffix:

<Ch> Channel number

Parameters:

<Boolean> *RST: Off (0)

Options:

R&S ZNA-K6

Manual operation: See "[Source Coh. On](#)" on page 703

SOURce<Ch>:CMODE:WCORrection[:STATe] <Boolean>

Same functionality as [\[SENSe<Ch>:\]CORrection:EWAVE\[:STATe\]](#).

Suffix:

<Ch> Channel number

Parameters:

<Boolean> *RST: On (1)

Options:

R&S ZNA-K6

Manual operation: See "[Apply Wave Correction](#)" on page 703

7.3.15.2 SOURce:FREQuency...

The `SOURce:FREQuency...` commands configure the sources for frequency conversion measurements and control the frequency and power of the internal signal source.

[SOURce<Ch>:FREQuency<PhyPt>:CONVersion:ARBitrary:EFREquency<Gen>](#)..... 1524

[SOURce<Ch>:FREQuency<PhyPt>:CONVersion:ARBitrary:IFREquency](#)..... 1525

[SOURce<Ch>:FREQuency:CONVersion:MIXer:PMFixed](#)..... 1527

[SOURce<Ch>:FREQuency:CONVersion:MIXer:PMODE](#)..... 1527

SOURce<Ch>:FREQuency<PhyPt>[:CW]	1528
SOURce<Ch>:FREQuency<PhyPt>:FIXed	1528

SOURce<Ch>:FREQuency<PhyPt>:CONVersion:ARBitrary:EFREquency<Gen>
 <Boolean>, <Numerator>, <Denominator>, <Offset>, <SweepType>

Defines an external generator frequency for frequency-converting measurements. The external generator frequency is either a range (for frequency sweeps) or a CW frequency (for power, time and CW Mode sweeps).

Suffix:

<Ch>	Channel number
<PhyPt>	Test port number of the analyzer. This suffix is ignored because the generator is referenced via <Gen>.
<Gen>	Generator number

Parameters:

<Boolean>	Switch the generator on or off.
<Numerator>	<p>Parameters of the frequency formula. The source frequency f_s is calculated according to $f_s = \text{<Numerator>/<Denominator> * } f_b + \text{<Offset>}$ where f_b represents the channel base frequency (parameter <code>SWEep</code>). For parameters <code>CW</code> or <code>FIXed</code>, $f_b = 0$.</p> <p>Note: The <Offset> parameter also includes the "Offset Ratio" in manual control.</p> <p>Range: The converted frequency or frequency range must be within the external generator's frequency range. In addition the <Numerator> values are rounded to positive or negative integer numbers.</p> <p>*RST: The default frequency/frequency range corresponds to the sweep range or CW frequency of the analyzer, i.e. <Numerator> = <Denominator> = 1, <Offset> = 0 Hz.</p> <p>Default unit: 1</p>
<Denominator>	<p>See above, <Numerator></p> <p>Range: The converted frequency or frequency range must be within the external generator's frequency range. In addition the <Denominator> values are rounded to positive integer numbers; zero is not allowed.</p> <p>*RST: 1</p> <p>Default unit: 1</p>
<Offset>	<p>See above, <Numerator></p> <p>Range: The converted frequency or frequency range must be within the external generator's frequency range. In addition the <Offset> values are rounded to (positive or negative) multiples of 1 Hz.</p> <p>*RST: 0</p> <p>Default unit: Hz</p>

<SweepType> CW | FIXed | SWEep
 SWEep - the full formula is applied. For frequency sweeps, the command defines a sweep range.
 CW | FIXed - the reduced formula with $f_b = 0$ is applied; the command defines a fixed frequency.
 *RST: SWEep

Example:

```
*RST; FREQ:STAR 1E+9; STOP 1.1E+9
```

Reset the analyzer (activating a frequency sweep) and set the sweep range between 1 GHz and 1.1 GHz.

```
SYST:COMM:RDEV:GEN1:DEF 'Ext. Gen. 1', 'SME02', 'gpib0', '21'
```

Configure an R&S SME02 generator as external generator no. 1, assigning the name "Ext. Gen. 1" and a GPIB address 21.

```
SOUR:FREQ:CONV:ARB:EFR ON, 1, 4, 1E+9, SWE
```

Switch the generator on and convert the generator frequency to the range between 1.25 GHz and 1.275 GHz.

Manual operation: See "[Frequency Conversion Formula](#)" on page 674

SOURce<Ch>:FREQuency<PhyPt>:CONVersion:ARBitrary:IFRequency
 <Numerator>, <Denominator>, <Offset>, <SweepType>

Defines the port-specific frequency for frequency-converting measurements. The port frequency is either a range (for frequency sweeps) or a CW frequency (for power, time and "CW Mode" sweeps).

Note: The frequency formula is applied even if the analyzer returns an error message, because the frequency is outside the allowed range.

Suffix:

<Ch> Channel number

<PhyPt> Test port number of the analyzer

Parameters:

<Numerator>

Parameters of the frequency formula. The port frequency f_p is calculated according to $f_p = \langle \text{Numerator} \rangle / \langle \text{Denominator} \rangle * f_b + \langle \text{Offset} \rangle$ where f_b represents the channel base frequency (parameter `SWEep`). For parameters `CW` or `FIXed`, $f_b = 0$.

Note: The `<Offset>` parameter also includes the "Offset Ratio" in manual control.

Range: The converted frequency or frequency range must be within the analyzer's frequency range, depending on the instrument model. In addition the `<Numerator>` values are rounded to positive or negative integer numbers; zero is not allowed.

***RST:** The default frequency/frequency range corresponds to the sweep range or CW frequency of the analyzer, i.e. `<Numerator> = <Denominator> = 1`, `<Offset> = 0 Hz`.

Default unit: 1

<Denominator>

See above, `<Numerator>`

Range: The converted frequency or frequency range must be within the analyzer's frequency range, depending on the instrument model. In addition the `<Denominator>` values are rounded to positive integer numbers; zero is not allowed.

***RST:** 1

Default unit: 1

<Offset>

See above, `<Numerator>`

Range: The converted frequency or frequency range must be within the analyzer's frequency range, depending on the instrument model. In addition the `<Offset>` values are rounded to (positive or negative) multiples of 1 Hz.

***RST:** 0

Default unit: Hz

<SweepType>

`CW` | `FIXed` | `SWEep`

`SWEep` - the full formula is applied. For frequency sweeps, the command defines a sweep range.

`CW` | `FIXed` - the reduced formula with $f_b = 0$ is applied; the command defines a fixed frequency.

***RST:** `SWEep`

Example: ***RST**; **FREQ:STAR** 1E+9; **STOP** 1.1E+9
 Reset the analyzer (activating a frequency sweep) and set the sweep range between 1 GHz and 1.1 GHz.
SOUR:FREQ2:CONV:ARB:IFR 2, 1, 1E+9, **SWE**
 Convert the source frequency at test port no. 2 to the range between 3 GHz and 3.2 GHz.
SENSe:FREQuency:CONVersion:GAIN:LMCorrection **ON**
 Enable the load match correction for all conversion gains.
SENSe:FREQuency:CONVersion?
 Query the measurement mode. The response is **ARB**, because the port frequency definition also activates the arbitrary mode.
SENSe:FREQuency:CONVersion **FUND**
 De-activate the arbitrary mode, cancel the port frequency definition.

Manual operation: See "[Freq. Conversion](#)" on page 672

SOURce<Ch>:FREQuency:CONVersion:MIXer:PMFixed <arg0>[, <arg1>]

Assigns a fixed power to the RF, LO 1, LO 2, or to the IF signal.

Suffix:

<Ch> Channel number

Parameters:

<arg0> RF | LO | LO1 | LO2 | IF
 RF – mixer input signal
 LO | LO1 – local oscillator signal no. 1
 LO2 – local oscillator signal no. 2, for 2-stage mixer measurements ([\[SENSe<Ch>:\]FREQuency:CONVersion:MIXer:STAGes](#))
 IF – mixer output signal

<arg1> Fixed power
 Range: The exact range depends on the analyzer model or external generator used; refer to the data sheet.
 ***RST**: -25 dBm (for LO)
 Default unit: dBm

Example: See [\[SENSe<Ch>:\]FREQuency:CONVersion:MIXer:MMFixed](#)

Manual operation: See "[RF, IF and Mixer Stages](#)" on page 411

SOURce<Ch>:FREQuency:CONVersion:MIXer:PMODE <arg0>[, <arg1>]

Sets the RF, LO 1, LO 2, or the IF signal ports to fixed power or to the channel base power.

Suffix:	
<Ch>	Channel number
Parameters:	
<arg0>	RF LO LO1 LO2 IF RF – mixer input signal LO LO1 – local oscillator signal no. 1 LO2 – local oscillator signal no. 2, for 2-stage mixer measurements ([SENSe<Ch>:]FREQuency:CONVersion:MIXer:STAGes) IF – mixer output signal
<arg1>	FUNDamental FIXed FIXed – use a fixed power, to be specified via SOURce<Ch>:FREQuency:CONVersion:MIXer:PMFixed FUNDamental – use the channel base power specified via SOURce<Ch>:POWer<Pt>:START, SOURce<Ch>:POWer<Pt>:STOP, SOURce<Ch>:POWer<Pt>[:LEVel] [:IMMediate] [:AMPlitude] *RST: Minimum of the analyzer's frequency range
Example:	See [SENSe<Ch>:]FREQuency:CONVersion:MIXer:MFFixed
Manual operation:	See " RF, IF and Mixer Stages " on page 411

SOURce<Ch>:FREQuency<PhyPt>[:CW] <FixedFreq>

SOURce<Ch>:FREQuency<PhyPt>:FIXed <FixedFreq>

Defines the fixed (Continuous Wave, CW) frequency for all sweep types operating at fixed frequency ("Power", "Time", "CW Mode"). The two command forms

[SOURce<Ch>:FREQuency<PhyPt>:CW](#) and

[SOURce<Ch>:FREQuency<PhyPt>:FIXed](#) are equivalent.

The frequency range depends on the R&S ZNA model; see [Table 7-17](#).

Note: [SOURce<Ch>:FREQuency<PhyPt>\[:CW\] | :FIXed](#) is equivalent to [\[SENSe<Ch>:\]FREQuency\[:CW\] | :FIXed](#). Source and receiver frequency are always equal; the four commands overwrite each other.

With option R&S ZNA-K4, Frequency Conversion Measurements, port-specific source and receiver frequencies can be defined; see [SOURce<Ch>:FREQuency<PhyPt>:CONVersion:ARBitrary:IFRequency](#).

Suffix:	
<Ch>	Channel number
<PhyPt>	Test port number of the analyzer. This suffix is ignored because the selected frequency applies to all source ports in the active channel.

Parameters:

<FixedFreq> Fixed stimulus and analyzer frequency.
 *RST: 1 GHz
 Default unit: Hz

Example:

```
FUNC "XTIME:POW:A1"
Activate a time sweep and select the wave quantity a1 as measured parameter for channel and trace no. 1.
FREQ: CW 100MHz
Set the CW frequency to 100 MHz.
```

Manual operation: See "[CW Frequency](#)" on page 524

7.3.15.3 SOURce:INdependent...

The `SOURce:INdependent...` configure internal RF and LO ports as channel-independent CW sources.

SOURce:INdependent:CLO:FREQUENCY <Frequency>

If the converter [LO Out](#) port is configured as an independent CW source (`SOURce:INdependent:CLO[:STATe] ON`), this command sets the frequency of the CW signal.

Parameters:

<Frequency> Frequency of the CW signal
 *RST: 1 GHz
 Default unit: Hz

Manual operation: See "[Frequency / Power](#)" on page 921

SOURce:INdependent:CLO:OFF <RF off>

If the converter [LO Out](#) port is configured as an independent CW source (`SOURce:INdependent:CLO[:STATe] ON`), this command toggles the CW signal.

Parameters:

<RF off> **ON (1)**
 The independent CW source is switched off.
OFF (0)
 The independent CW source is switched on.
 *RST: OFF (0)

Manual operation: See "[Source RF Off](#)" on page 921

SOURce:INdependent:CLO:POWER <Power>

If the converter [LO Out](#) port is configured as an independent CW source (`SOURce:INdependent:CLO[:STATe] ON`), this command sets the power of the CW signal.

Parameters:

<Power> Power of the CW signal
 *RST: -10 dBm
 Default unit: dBm

Manual operation: See "[Frequency / Power](#)" on page 921

SOURce:INdependent:CLO[:STATe] <Active>

Defines whether the converter [LO Out](#) port operates as independent CW source.

Parameters:

<Active> **ON (1)**
 The converter LO port operates as independent CW source.
OFF (0)
 The converter LO port can be used for other (channel-related) purposes.
 *RST: OFF

Options: R&S ZNA-B8

Manual operation: See "[Independent Gen](#)" on page 921

SOURce:INdependent<Pt>:ATTenuator <Step Attenuator>

If RF port <Pt> is configured as an independent CW source ([SOURce:INdependent<Pt>\[:STATe\]](#) ON) and equipped with a [source step attenuator](#), this command sets the source attenuation to be applied.

Suffix:

<Pt> VNA RF port number

Parameters:

<Step Attenuator> Source step attenuation
 Range: 0 dB to 70 dB
 Increment: 10 dB
 *RST: 0 dB
 Default unit: dB

Options: R&S ZNAxx-B2<Pt>

Manual operation: See "[Step Att](#)" on page 921

SOURce:INdependent<Pt>:FREquency <Frequency>

If RF port <Pt> is configured as an independent CW source ([SOURce:INdependent<Pt>\[:STATe\]](#) ON), this command sets the frequency of the CW signal.

Suffix:

<Pt> VNA RF port number

Parameters:

<Frequency> Frequency of the CW signal
 *RST: 1 GHz
 Default unit: Hz

Manual operation: See "[Frequency / Power](#)" on page 921

SOURce:INDePendent<Pt>:OFF <RF off>

If RF port <Pt> is configured as an independent CW source ([SOURce:INDePendent<Pt>\[:STATe\] ON](#)), this command toggles the CW signal.

Suffix:

<Pt> VNA RF port number

Parameters:

<RF off> **ON (1)**
 The independent CW source is switched off.
 OFF (0)
 The independent CW source is switched on.
 *RST: OFF (0)

Manual operation: See "[Source RF Off](#)" on page 921

SOURce:INDePendent<Pt>:POWer <Power>

If RF port <Pt> is configured as an independent CW source ([SOURce:INDePendent<Pt>\[:STATe\] ON](#)), this command sets the power of the CW signal.

Suffix:

<Pt> VNA RF port number

Parameters:

<Power> Power of the CW signal
 *RST: -10 dBm
 Default unit: dBm

Manual operation: See "[Frequency / Power](#)" on page 921

SOURce:INDePendent<Pt>[:STATe] <Active>

Defines whether port <Pt> operates as independent CW source

Suffix:

<Pt> VNA port number

Parameters:

<Active> **ON (1)**
 Port <Pt> operates as independent CW source.
 OFF (0)
 Port <Pt> can be used as driving port in VNA channels.

*RST: OFF

Manual operation: See ["Independent Gen"](#) on page 921

7.3.15.4 SOURce:RLO...

The SOURce:RLO commands configure the optional [rear LO Out](#) port (R&S ZNA-B8).

SOURce<Ch>:RLO:FREQuency.....	1532
SOURce<Ch>:RLO:PABSolut.....	1533
SOURce<Ch>:RLO:PERMenable.....	1533
SOURce<Ch>:RLO:POFFset.....	1533

SOURce<Ch>:RLO:FREQuency <Numerator>, <Denominator>, <Offset>, <SweepType>

Defines the frequency formula at the (optional) rear [LO Out](#) port for channel <Ch>.

Note: The frequency formula is applied even if the analyzer returns an error message, because the frequency is outside the allowed range.

Suffix:

<Ch> Channel number

Parameters:

<Numerator>, <Denominator>, <Offset>
 Parameters of the port frequency formula
 $f_p = \text{<Numerator>/<Denominator> * } f_b + \text{<Offset> .}$

For <SweepType> FB the variable f_b represents the channel base frequency, for <SweepType> CW it is set to 0 Hz.

Note: The <Offset> parameter also includes the "Offset Ratio" in manual control.

Range: The converted frequency or frequency range must be within the analyzer's frequency range, depending on the instrument model. In addition the <Numerator> values are rounded to positive or negative integer numbers; zero is not allowed.

*RST: The default frequency/frequency range corresponds to the sweep range or CW frequency of the analyzer, i.e. <Numerator> = <Denominator> = 1, <Offset> = 0 Hz.

<SweepType> FB | CW

FB

Sweep with channel base frequency f_b

CW

Fixed frequency

Options: R&S ZNA-B8

Manual operation: See ["Freq. Conversion"](#) on page 672

SOURce<Ch>:RLO:PABSolut <Mode>

Allows you to define the output power mode at the (optional) rear **LO Out** port for channel <Ch>.

Suffix:

<Ch> Channel number

Parameters:

<Mode> **OFF (0)**
Use the channel base power P_b

ON (1)
Use a fixed value of 0 dBm

Options: R&S ZNA-B8

Manual operation: See "[Channel Base Power](#)" on page 630

SOURce<Ch>:RLO:PERMenable <Boolean>

Defines whether the source power at the (optional) rear **LO Out** port is permanently on in channel <Ch> ("generator port") .

Suffix:

<Ch> Channel number

Parameters:

<Boolean> **OFF (0)**
Power is only on for partial measurements that require the port as a drive port.

ON (1)
Power is permanently on

*RST: OFF

Options: R&S ZNA-B8

Manual operation: See "[Source Gen](#)" on page 671

SOURce<Ch>:RLO:POFFset <Value>

Defines the power offset of the the (optional) rear **LO Out** port for channel <Ch>.

If [SOURce<Ch>:RLO:PABSolut](#) on page 1533 is OFF, then the output power is equal to the channel base power f_b plus the power offset. Otherwise the output power is set to the fixed power offset.

Suffix:

<Ch> Channel number

Parameters:

<Value> Offset value in dB

Options: R&S ZNA-B8

Manual operation: See "Port Power Offset" on page 631

7.3.15.5 SOURce:GROup...

The SOURce:GROup . . . commands define the group of (un-)used logical ports.

SOURce<Ch>:GROup<Grp>.....	1534
SOURce<Ch>:GROup<Grp>:CLEar.....	1534
SOURce<Ch>:GROup:COUNT?.....	1535
SOURce<Ch>:GROup<Grp>:NAME.....	1535
SOURce<Ch>:GROup<Grp>:PORTs.....	1535
SOURce<Ch>:GROup<Grp>:PPORTs.....	1536
SOURce<Ch>:GROup<Grp>:SIMultaneous:FOFFset:CONDition.....	1536
SOURce<Ch>:GROup<Grp>:SIMultaneous:FOFFset:MOFFset:BWFactor.....	1538
SOURce<Ch>:GROup<Grp>:SIMultaneous:FOFFset:MOFFset:DVALue.....	1538
SOURce<Ch>:GROup<Grp>:SIMultaneous:FOFFset:MOFFset:MODE.....	1539
SOURce<Ch>:GROup<Grp>:SIMultaneous:FOFFset:STATe.....	1540

SOURce<Ch>:GROup<Grp> <arg0>, <arg1>

In "set direction" this command defines the set of active logical ports (the "master group") as the continuous range from <log_port1> to <log_port2>, i.e. logical ports outside this range are disabled.

In "get direction" it returns the minimum and maximum enabled logical port.

See SOURce<Ch>:LPORt<LogPt> on how to define logical ports.

Suffix:

<Ch> Channel number.

<Grp> Port group number, must be 1 (or omitted).

Parameters:

<arg0>

<arg1> First and last logical port number in the port group. Must be omitted if the command is used as a query.

Example: See SOURce<Ch>:LPORt<LogPt> on page 1598

SOURce<Ch>:GROup<Grp>:CLEar [<arg0>]

Dissolves port group <Grp> or all port groups created using SOURce<Ch>:GROup<Grp> on page 1534 or SOURce<Ch>:GROup<Grp>:PPORTs.

Suffix:

<Ch> Channel number.

<Grp> Port group number.

This suffix is ignored: only <Grp>=1 is supported.

Setting parameters:

<arg0> ALL

If ALL is specified, all port groups are dissolved and a default port group 1, consisting of all available ports, is restored; the <Grp> suffix is ignored.

If ALL is omitted, only the specified port group is dissolved, except the deleted port group was the only one, in which case again default port group 1 is restored. In case an undefined port group number is used, the analyzer generates an error message.

Example: See [SOURCE<Ch>:LPORt<LogPt>](#) on page 1598

Usage: Setting only

SOURCE<Ch>:GROUp:COUNT?

Queries the number of port groups in channel no. <Ch>.

Suffix:

<Ch> Channel number.

Example: See [SOURCE<Ch>:GROUp<Grp>](#) on page 1534

Usage: Query only

Manual operation: See "[Controls and Functions](#)" on page 684

SOURCE<Ch>:GROUp<Grp>:NAME <GroupName>

Sets/gets the name of port group <Grp>.

Suffix:

<Ch> Channel number

<Grp> Port group number

Parameters:

<GroupName> Group name

Manual operation: See "[Controls and Functions](#)" on page 684

SOURCE<Ch>:GROUp<Grp>:PORTs <port0>[, <port1>[, ...]]

Defines the set of active logical ports (the "master group") as an arbitrary selection of logical ports. The ports do not have to be numbered consecutively (as for port groups defined via [SOURCE<Ch>:GROUp<Grp>](#)).

See [SOURCE<Ch>:LPORt<LogPt>](#) on how to define logical ports.

Suffix:

<Ch> Channel number.

<Grp> Port group number, must be 1 (or omitted).

Parameters:

<port0>, <port1>, ... Logical port numbers. Must be omitted if the command is used as a query.

SOURce<Ch>:GROup<Grp>:PPORts <pport1>,<pport2>...

Defines/queries port groups.

In "set direction" this command creates port group <Grp> from physical VNA ports <pport1>, <pport2>, ... In "get direction" it returns the physical VNA ports making up group <Grp>.

Note

- Port groups must be created in ascending order, i.e. first create port group 1, then port group 2 etc.
- By default there is a single port group, which contains all physical VNA ports ("default port group").
- Redefinition of an existing port group is not allowed (exception: "default port group"). Use `SOURce<Ch>:GROup<Grp>:CLEar` to dissolve existing port groups first.
- It is not allowed to assign the same physical VNA port to multiple port groups.
- When a port group is created, the number of ports of the corresponding DUT is set to the port group size and "aligned" port connections are established.

Suffix:

<Ch> Channel number

<Grp> Port group number

Parameters:

<pport1>,<pport2>... Physical VNA port numbers

SOURce<Ch>:GROup<Grp>:SIMultaneous:FOFFset:CONDition

This command is used to query the operation mode of Simultaneous Measurement with Frequency Offset. The list below contains all possible return values of this query.

Please note that this query will return an error if the channel specified by <Ch> does not contain any trace. This is due to the fact that without traces no measurements are performed so that no information about Simultaneous Measurement with Frequency Offset is available.

This query waits until all previous commands are fully executed because these commands may affect the operation mode of Simultaneous Measurement with Frequency Offset.

Suffix:

<Ch> Channel number.
If unspecified, this is set to 1.

<Grp>

Return values:

<errorCode>

0, "switched off"

Simultaneous Measurement with Frequency Offset is switched OFF, meaning `SOURce<Ch>:GROup<Grp>:SIMultaneous:FOFFset:STATe` would return 0

1, "active"

Simultaneous Measurement with Frequency Offset is active, meaning it has been activated via

`SOURce<Ch>:GROup:SIMultaneous:FOFFset:STATe ON` and all preconditions for this mode to be operational are met.

-1, "too few port groups"

There must be at least two port groups defined, otherwise no parallel measurement is possible.

-2, "invalid port groups"

The port groups have to be set up exactly as in the VNA GUI, when "Enabled" is selected in the "Define Parallel Measurement" dialog.

-4, "invalid sweep type"

Simultaneous Measurement with Frequency Offset requires either a linear frequency sweep or a segmented sweep.

-6, "no simultaneous measurement possible"

Simultaneous Measurement with Frequency Offset requires that port groups may actually be measured simultaneously. There are some situations in which this is not possible; in these situations Simultaneous Measurement with Frequency Offset is not available.

-7, "stimulus buffer too small"

The stimulus buffer must contain at least two elements.

-8, "invalid offset or frequency step size"

The frequency offset which is actually used and which is determined both by the minimum frequency offset and the frequency step size may not be too large as in that case the VNA is not able to simultaneously measure at different frequencies anymore. There is no simple formula specifying the maximum frequency offset which can be handled by the VNA. However, in all but very special cases an actual frequency offset of several MHz can be used. Please note, however, that a small minimum frequency offset combined with a large frequency step size may lead to a large actual frequency offset.

-9, "extended stimulus buffer too large"

Internally, the firmware uses additional measurement points which are completely transparent to the user. However, the number of sweep points entered by the user plus the number of additional internal sweep points (called the "extended stimulus buffer") must not exceed the maximum number of sweep points (100001). The number of additional sweep points depends on the relation between minimum frequency offset and frequency step size. The worst case occurs when the minimum frequency offset is equal to or greater than the sweep range, in this case the extended stimulus buffer contains the number of sweep points entered by the user times the number of port groups.

<errorText>

Example: See `SOURce<Ch>:GROup<Grp>:SIMultaneous:FOFFset:STATE`

Manual operation: See ["State indication warning"](#) on page 686

SOURce<Ch>:GROup<Grp>:SIMultaneous:FOFFset:MOFFset:BWFactor <arg0>

This command is related to Parallel Measurement with Frequency Offset. It defines the multiplication factor that is used to calculate the minimum frequency offset from the measurement bandwidth.

Note that this only takes effect if `SOURce<Ch>:GROup<Grp>:SIMultaneous:FOFFset:MOFFset:MODE` is set to `BANDwidth`.

Suffix:

<Ch> Channel number.
If unspecified, this parameter is set to 1.

<Grp>

Parameters:

<arg0> The multiplication factor to calculate the minimum frequency offset.
To get the resulting frequency offset, the minimum frequency offset is rounded to a multiple of the current frequency step size.
Range: 1 to 100
*RST: 10

Example: See `SOURce<Ch>:GROup<Grp>:SIMultaneous:FOFFset:STATE`

Manual operation: See ["Minimum Offset"](#) on page 685

SOURce<Ch>:GROup<Grp>:SIMultaneous:FOFFset:MOFFset:DVALue <StartFreq>

This command is related to Parallel Measurement with Frequency Offset. It specifies the minimum frequency offset directly.

Note that this only takes effect if `SOURce<Ch>:GROup<Grp>:SIMultaneous:FOfFset:MOFFset:MODE` is set to `DIRect`.

Suffix:

<Ch> Channel number.
If unspecified, this parameter is set to 1.

<Grp>

Parameters:

<StartFreq> The minimum frequency offset.
To get the resulting frequency offset, the minimum frequency offset is rounded to a multiple of the current frequency step size.
Range: 0 Hz to 17 MHz
*RST: 1 MHz
Default unit: Hz

Example: See `SOURce<Ch>:GROup<Grp>:SIMultaneous:FOfFset:STATe`

Manual operation: See "[Minimum Offset](#)" on page 685

SOURce<Ch>:GROup<Grp>:SIMultaneous:FOfFset:MOFFset:MODE <arg0>

This command is used to define how the minimum frequency offset between different port groups is determined for Parallel Measurement with Frequency Offset.

The minimum frequency offset specifies the minimum frequency difference between the measurements performed in parallel in any two different port groups. The frequency offset which is actually used may be larger than the minimum offset as the firmware chooses the smallest multiple of the frequency step size between the points in a segment or in a linear frequency sweep, respectively, which is larger than the minimum offset.

Suffix:

<Ch> Channel number.
If unspecified, this parameter is set to 1.

<Grp>

Parameters:

<arg0> `DIRect` | `BANDwidth`

DIRect

The minimum frequency offset to be used is directly specified by the command `SOURce<Ch>:GROup<Grp>:SIMultaneous:FOfFset:MOFFset:DVALue`.

BANDwidth

The minimum frequency offset to be used is calculated by the firmware as a product of the (possibly segment specific) measurement bandwidth and the factor specified by the command `SOURce<Ch>:GROup<Grp>:SIMultaneous:FOFFset:MOFFset:BWFactor`.

In this calculation of the minimum frequency offset neither static nor dynamic bandwidth reduction of the measurement bandwidth is considered, the firmware uses the measurement bandwidth as it has been specified via `[SENSe<Ch>:]BWIDTH[:RESolution]` (for the entire sweep) or via `[SENSe<Ch>:]SEGMENT<Seg>:BWIDTH[:RESolution]` (segment specific).

*RST: BANDwidth

Example: See `SOURce<Ch>:GROup<Grp>:SIMultaneous:FOFFset:STATE`

Manual operation: See "[Minimum Offset](#)" on page 685

SOURce<Ch>:GROup<Grp>:SIMultaneous:FOFFset:STATE <arg0>

This command is used to activate/deactivate a frequency offset for parallel measurements on a 4-port R&S ZNA.

The port groups have to be set up exactly as in the VNA GUI, when "Enabled" is selected in the "Define Parallel Measurement" dialog. The measurement is then performed on port group 1 (ports 1 and 2) and port group 2 (ports 3 and 4) in parallel, applying a configurable frequency offset to port group 2.

Even if the parallel measurement is properly configured and this flag is set to ON, the frequency offset may not be active if not all preconditions are met. For each precondition there is a unique return value for the query `SOURce<Ch>:GROup<Grp>:SIMultaneous:FOFFset:CONDition` which is returned when the according precondition is not met. A complete list of all preconditions can be found in the description of the command's return values. It is possible to first activate the frequency offset and afterwards issue other remote commands to set up all necessary preconditions.

Suffix:

<Ch> Channel number.
If unspecified, this parameter is set to 1.

<Grp>

Parameters:

<arg0> ON | OFF – activates or deactivates frequency shifted parallel measurements

Example:

```

*RST
SENSe:FREQuency:STARt 1GHZ
SENSe:FREQuency:STOP 2GHZ
CALCulate:PARAmeter:MEASure 'Trc1', 'S21'
*WAI
Perform a reset and set up a trace (with the default of 201
sweep points)
:SOUR:GRO1:PPORTs 1,2
:SOUR:GRO2:PPORTs 3,4
:INIT:IMM;*WAI
Create two port groups with ports 1 and 2 in port group 1 and
ports 3 and 4 in port group 2 and start the parallel measurement.
:SOUR:GRO1:NAME 'First DUT'
:SOUR:GRO2:NAME 'Second DUT'
Assign descriptive names to groups
SOUR:GRO:COUN?
Check if two port groups exist.
:SOUR:GRO1:NAME?
:SOUR:GRO2:NAME?
Should return 'First DUT' and 'Second DUT', respectively
:SOUR:GRO1:PPORT1:DPORT 1
:SOUR:GRO1:PPORT2:DPORT 2
:SOUR:GRO2:PPORT3:DPORT 2
:SOUR:GRO2:PPORT4:DPORT 1
:INIT:IMM;*WAI
Assign DUT Ports to VNA Ports
CALCulate1:PARAmeter:SDEFine 'Trc2', 'S34'
DISPlay:WINDow1:TRACe2:FEED 'Trc2'
*WAI
Add and display a second trace for the second DUT (note that
'S34' with VNA poert numbers corresponds to S21 at the second
DUT
SOURce:GROup:SIMultaneous:FOFFset:MOFFSet:
DVALue 6 MHz
SOURce:GROup:SIMultaneous:FOFFset:MOFFset:MODE
DIRect
Set minimum frequency offset for frequency shifted parallel mea-
surement to 5 MHz.
SOURce:GROup:SIMultaneous:FOFFset:CONDition?
Should return %0, "switched off"
SOURce:GROup:SIMultaneous:FOFFset:STATe?
Should return 0
SOURce:GROup:SIMultaneous:FOFFset:STATe ON
Activate frequency shifted parallel measurement.
SOURce:GROup:SIMultaneous:FOFFset:CONDition
Check if frequency shifted parallel measurement is active
(should return 1, "active")
*WAI
Wait until the previous commands are completely executed.

```

SOURce:GROup:SIMultaneous:FOFFset:MOFFSet:
DVALue 0 MHz

Set minimum frequency offset for frequency shifted parallel measurement to 0 MHz.

:SOURce:GROup:SIMultaneous:FOFFset:MOFFset:MODE
BANDwidth

:SOURce:GROup:SIMultaneous:FOFFset:MOFFset:
BWFactor 100

Set the minimum frequency offset for frequency shifted parallel measurement to at least 100 times the measurement bandwidth

Manual operation: See "[Parallel Measurement with Frequency Offset](#)" on page 685

7.3.15.6 SOURce:POWer:ALC...

The following commands set up the automatic level control (ALC).

SOURce<Ch>:POWer:ALC:AUBW.....	1542
SOURce<Ch>:POWer:ALC:BANDwidth.....	1543
SOURce<Ch>:POWer<Pt>:ALC:CLAMP.....	1543
SOURce<Ch>:POWer<Pt>:ALC:COUPlE.....	1544
SOURce<Ch>:POWer:ALC:CSTate.....	1544
SOURce<Ch>:POWer<Pt>:ALC:OPTimize.....	1544
SOURce<Ch>:POWer<Pt>:ALC:PIParameter.....	1545
SOURce<Ch>:POWer:ALC:PIParameter:ASETtling.....	1545
SOURce<Ch>:POWer:ALC:PIParameter:CTIME.....	1546
SOURce<Ch>:POWer<Pt>:ALC:PIParameter:GAIN.....	1546
SOURce<Ch>:POWer<Pt>:ALC:PIParameter:ITIME.....	1546
SOURce<Ch>:POWer<Pt>:ALC:RANGe.....	1547
SOURce<Ch>:POWer<Pt>:ALC:RECeiver.....	1547
SOURce<Ch>:POWer<Pt>:ALC:SOFFset.....	1547
SOURce<Ch>:POWer<Pt>:ALC[:STATe].....	1548
SOURce<Ch>:POWer:ALC:STOLerance.....	1548
SOURce<Ch>:POWer<Pt>:ALC:TPOWer.....	1549
SOURce<Ch>:POWer<Pt>:ALC:TPOWer:DEfault.....	1549
SOURce<Ch>:POWer<Pt>:ALC:VNETwork.....	1549

SOURce<Ch>:POWer:ALC:AUBW <Boolean>

Enables or disables automatic IF bandwidth setting for the ALC path in channel <Ch>.

Set SOURce<Ch>:POWer:ALC:AUBW to OFF and use SOURce<Ch>:POWer:ALC:
BANDwidth to set the bandwidth manually.

Suffix:

<Ch> Channel number

Parameters:

<Boolean>

ON (1)

Enables automatic bandwidth setting for ALC in channel <Ch>.

OFF (0)

Disables automatic bandwidth setting for ALC in channel <Ch>.

Example:

```
*RST: ON
SOURCE1:POWER:ALC:CSTAAte ON
Allow automatic level control for channel 1.
SOURCE1:POWER:ALC ON; SOURCE1:POWER2:ALC ON
Enable automatic level control for all ports in channel 1.
SOURCE1:POWER:ALC:COUPlE ON
Use identical ALC settings for all ports in channel 1.
SOURCE1:POWER:ALC:RANGe 5
Select a 5 dB control range (for all ALC ports).
SOURCE1:POWER1:ALC:SOFFset 0
Select a start value offset of 0.
SOURCE1:POWER:ALC:AUBW ON
Enable automatic bandwidth setting.
SOURCE1:POWER:ALC:STOL 1
Select a 1 dB settling tolerance window.
```

Manual operation: See "[ALC Path IF Bandwidth](#)" on page 531

SOURCE<Ch>:POWER:ALC:BANDwidth <Bandwidth>

Selects the bandwidth in the ALC control loop in channel <Ch>.

Suffix:

<Ch> Channel number

Parameters:

<Bandwidth> Bandwidth [Hz] in the ALC control loop.
 Values above 100 kHz are only available on the wideband signal path ([\[SENSe<Ch>:\]IFPath WIDeband](#)).
 Range: 20, 30, 50, 100, 200, 500, 1E3, 1E4, 1E5, 1E6, 7E6
 *RST: 1E3
 Default unit: Hz

Manual operation: See "[ALC Path IF Bandwidth](#)" on page 531

SOURCE<Ch>:POWER<Pt>:ALC:CLAMP <Boolean>

Suspends the ALC mechanism at physical port <Pt> in channel <Ch> while the analyzer acquires measurement data.

Suffix:

<Ch> Channel number

<Pt> Physical port number

Parameters:

<Boolean> **ON (1)**
 ALC suspended during measurement data acquisition
OFF (0)
 ALC active during measurement data acquisition
 *RST: OFF

Manual operation: See "[Clamp](#)" on page 530

SOURce<Ch>:POWER<Pt>:ALC:COUPlE <Boolean>

Enforces identical ALC settings for the individual ports in channel <Ch>.

Suffix:

<Ch> Channel number

<Pt> Port number. This suffix is ignored; the setting applies to all ports.

Parameters:

<Boolean> **ON (1)**
Enforces identical ALC settings

OFF (0)
Enables port-specific ALC settings

Manual operation: See "[Couple Port Settings](#)" on page 529

SOURce<Ch>:POWER:ALC:CState <Boolean>

Enables or disables Automatic Level Control (ALC) for channel <Ch>.

In addition to the channel level, ALC can also be enabled or disabled at the port level ([SOURce<Ch>:POWER<Pt>:ALC\[:STATE\] ON](#)).

Suffix:

<Ch> Channel number

Parameters:

<Boolean> **ON (1)**
Enable ALC for channel <Ch>

OFF (0)
Disable ALC for channel <Ch>

Manual operation: See "[ALC On](#)" on page 526

SOURce<Ch>:POWER<Pt>:ALC:OPTimize <Alc optimize>

Enables/configures [ALC optimization](#) for port <Pt> in channel <Ch>.

Suffix:

<Ch> Channel number

<Pt> Port number

Parameters:

<Alc optimize> AUTO | ON | OFF

AUTO

The firmware decides whether speed optimization shall be performed

ON
Optimization active

OFF
Optimization inactive

*RST: AUTO

Options: R&S ZNA-K7

Manual operation: See "[ALC Optimize](#)" on page 530

SOURce<Ch>:POWer<Pt>:ALC:PIParameter <Mode>

Enables automatic or manual setting of the ALC PI controller parameters at source port <Pt> in channel <Ch>.

See "[Control loop parameters](#)" on page 117.

Suffix:

<Ch> Channel number

<Pt> Port number

Parameters:

<Mode> AUTO | MANual

AUTO
The control loop parameters are calculated by the analyzer firmware.

MANual
The parameters can be set using [SOURce<Ch>:POWer<Pt>:ALC:PIParameter:GAIN](#) and [SOURce<Ch>:POWer<Pt>:ALC:PIParameter:ITIME](#), respectively.

*RST: AUTO

Manual operation: See "[Control Loop Parameters](#)" on page 531

SOURce<Ch>:POWer:ALC:PIParameter:ASETtling <Boolean>

Enables or disables "Auto Settling" of the ALC control loop.

If enabled, the firmware exits the control loop as soon as the power meets the convergence criteria and doesn't wait until the "Control Time" ([SOURce<Ch>:POWer:ALC:PIParameter:CTIME](#)) has elapsed.

Suffix:

<Ch> Channel number

Parameters:

<Boolean>

Manual operation: See "[Control Loop Parameters](#)" on page 531

SOURce<Ch>:POWER:ALC:PIParameter:CTIME <control time>

Defines the (maximum) settling time of the ALC control loop, per sweep point.

Set `SOURce<Ch>:POWER:ALC:PIParameter:ASETtling` ON to exit the control loop as soon as the convergence criteria are met.

Suffix:

<Ch> Channel number

Parameters:

<control time> Default unit: s

Manual operation: See "[Control Loop Parameters](#)" on page 531

SOURce<Ch>:POWER<Pt>:ALC:PIParameter:GAIN <Value>

Defines the proportional gain of the ALC PI controller at source port <Pt> in channel <Ch>.

This setting only takes effect if `SOURce<Ch>:POWER<Pt>:ALC:PIParameter` is set to `MANual`.

Suffix:

<Ch> Channel number

<Pt> Port number

Parameters:

<Value> Proportional gain factor Kr [dB]

Range: 0 to 100

Increment: 0.001

*RST: 0.4

Manual operation: See "[Control Loop Parameters](#)" on page 531

SOURce<Ch>:POWER<Pt>:ALC:PIParameter:ITIME <Alc control loop coefficients
itime>

Defines the integration time of the ALC PI controller at source port <Pt> in channel <Ch>.

This setting only takes effect if `SOURce<Ch>:POWER<Pt>:ALC:PIParameter` is set to `MANual`.

Suffix:

<Ch> Channel number

<Pt> Port number

Parameters:

<Value> Integration time Ki [s]

Range: 1E-8 to 1E2

*RST: 0.4

Manual operation: See ["Control Loop Parameters"](#) on page 531

SOURce<Ch>:POWER<Pt>:ALC:RANGe <CRange>

Defines the maximum change of the source signal level due to the ALC for physical port <Pt> in channel <Ch>.

Suffix:

<Ch> Channel number
<Pt> Port number

Parameters:

<CRange> Control range [dB]
Range: 0 to 100
Increment: 0.1
*RST: 5

Manual operation: See ["Control Range +/-"](#) on page 528

SOURce<Ch>:POWER<Pt>:ALC:RECeiver <ALCReceiver>

Defines the receiver to be used for ALC at port <Pt> in channel <Ch>.

The target level is taken from the port configuration ([SOURce<Ch>:POWER<Pt>:ALC:TPOWER:DEFault](#) on page 1549 ON) or can be set using [SOURce<Ch>:POWER<Pt>:ALC:TPOWER](#).

Suffix:

<Ch> Channel number
<Pt> Port number

Parameters:

<ALCReceiver> **'A<n>'**
Reference receiver at analyzer port <n>
'B<n>'
Measurement receiver at analyzer port <n>
*RST: 'A<Pt>'

Manual operation: See ["ALC: Meas Port/ALC: Meas Receiver"](#) on page 529

SOURce<Ch>:POWER<Pt>:ALC:SOFFset <StartOffset>

Increases or decreases the signal level before the ALC loop is started for port <Pt> in channel <Ch>.

Suffix:

<Ch> Channel number
<Pt> Physical port number

Parameters:

<StartOffset>

Start offset [dB]

A positive/negative offset Increases/decreases the source signal level before the ALC loop is started.

Note that the offset direction has been reversed in firmware version 2.20, i.e. before FW V2.20 a positive/negative offset decreased/increased the source signal level before the ALC loop is started.

Range: -3 to +3

Increment: 0.1

*RST: 0

Manual operation: See "[Start Value: Offset](#)" on page 529

SOURce<Ch>:POWER<Pt>:ALC[:STATE] <Boolean>

Enables or disables ALC (Automatic Level Control) at source port <Pt> in channel <Ch>.

Enabling ALC for a particular port and channel only takes effect if ALC is enabled for the related channel ([SOURce<Ch>:POWER:ALC:CState ON](#)).

Suffix:

<Ch>

Channel number

<Pt>

Port number

Parameters:

<Boolean>

ON (1)

Enables ALC at source port <Pt> in channel <Ch>.

OFF (0)

Disables ALC at source port <Pt> in channel <Ch>.

*RST: OFF

Manual operation: See "[ALC On \(table area\)](#)" on page 528

SOURce<Ch>:POWER:ALC:STOLerance <Tolerance>

Defines the variation of the ALC-controlled source signal level (Settling Tolerance in ALC Config dialog) in channel <Ch>.

Suffix:

<Ch>

Channel number

Parameters:

<Tolerance>

Settling tolerance [dB]

Range: 0.02 to 1

Increment: 0.01

*RST: 0.1

Manual operation: See "[Settling Tolerance](#)" on page 530

SOURce<Ch>:POWER<Pt>:ALC:TPOWER <Value>

Defines the target power value the ALC for port <Pt> in channel <Ch> stabilizes at the selected measurement receiver ([SOURce<Ch>:POWER<Pt>:ALC:RECEiver](#)).

Only applies if the target power isn't taken from the port configuration ([SOURce<Ch>:POWER<Pt>:ALC:TPOWER:DEFault](#) on page 1549 OFF).

Suffix:

<Ch> Channel number
<Pt> Port number

Parameters:

<Value> Default unit: dBm

Manual operation: See "[ALC: Target Power/Target Power from Port Config](#)" on page 529

SOURce<Ch>:POWER<Pt>:ALC:TPOWER:DEFault <Boolean>

Defines whether the ALC target power is taken from the port configuration or can be set using [SOURce<Ch>:POWER<Pt>:ALC:TPOWER](#).

Suffix:

<Ch> Channel number
<Pt> Port number

Parameters:

<Boolean> *RST: ON (1)

Manual operation: See "[ALC: Target Power/Target Power from Port Config](#)" on page 529

SOURce<Ch>:POWER<Pt>:ALC:VNETWORK <Usage>

Allows you to use the configured offset or single-ended deembedding network for ALC.

Suffix:

<Ch> Channel number
<Pt> Physical port number

Parameters:

<Usage> OFFSet | DEEMbed | OFF

OFFSet

Use the configured offset (--> [SENSe<Ch>:]CORRection:EDELay [<Pt>] commands)

DEEMbed

Use the configured single-ended deembedding (--> CALCulate<Ch>:TRANSform:VNETworks:SENDED:DEEMbedding [<Pt>] commands)

OFF

Do not use the configured offset or the single-ended deembedding network.

*RST: OFF

Manual operation: See "[ALC Deembedding](#)" on page 529

7.3.15.7 SOURce:POWer:CORRection:COLLect...

The `SOURce:POWer:CORRection:COLLect...` commands allow you to set up a scalar source power calibration.

SOURce:POWer:CORRection:COLLect:AVERAge[:COUNT] <NoReadings>

Sets a limit for the number of calibration sweeps in the source power calibration. The command is valid for all channels, ports and external generators.

Equivalent command: `SOURce:POWer:CORRection:NREadings`.

Parameters:

<NoReadings> Number of readings
 Range: 1 to 100
 *RST: 2

Example: See `SOURce<Ch>:POWer:CORRection[:ACQuire]` (for equivalent command `SOURce:POWer:CORRection:NREadings`)

Manual operation: See "[Flatness Cal – Max Iterations](#)" on page 628

SOURce:POWer:CORRection:COLLect:AVERAge:NTOLerance <Tolerance>

Specifies the maximum deviation of the measured power from the target power of the calibration. The command is valid for all channels and calibrated ports.

Parameters:

<Tolerance> Tolerance value
 Range: 0.001 dB to 1000 dB
 *RST: 1 dB
 Default unit: dB

Example: See `SOURce<Ch>:POWer:CORRection[:ACQuire]`

Manual operation: See "[Flatness Cal – Tolerance](#)" on page 628

SOURce:POWer:CORRection:COLLect:CFACTOR <Convergence>

Specifies the convergence factor for a source power calibration.

Parameters:

<Convergence> Convergence factor
 Range: 0 to 2
 Increment: 0.1
 *RST: 1

Example: See `SOURce<Ch>:POWer:CORRection[:ACQuire]`

Manual operation: See "Flatness Cal – Convergence" on page 628

SOURce:POWer:CORRection:COLLect:FLATness <Boolean>

Enables or disables the source power calibration. The command is valid for all channels, ports and external generators.

It is not possible to disable flatness calibration and the reference receiver calibration simultaneously (see `SOURce:POWer:CORRection:COLLect:RRECeiver` on page 1552).

Parameters:

<arg0> <Boolean>
 Disables (OFF|0) or enables (ON|1) the flatness calibration. With disabled flatness calibration, only one calibration sweep is performed in order to calibrate the reference receiver; the previous source calibration data is not overwritten.
 *RST: ON|1

Example:

```
*RST; SOUR:POW:CORR:COLL:VER 0
Disable the verification sweep to speed up the source power calibration procedure.
SOUR:POW:CORR:COLL:FLAT OFF; RREC ON
Disable flatness cal and enable reference receiver calibration.
SOUR:POW:CORR:ACQ PORT, 1
Perform a single source power calibration sweep using port 1 as a source port.
```

SOURce:POWer:CORRection:COLLect:METhod <PowerCalMethod>

Selects the source power calibration method.

Parameters:

<PowerCalMethod> PMONly | RRAfter | RRONly

PMONly

Power meter only, i.e. only the power meter is used during calibration.

To enable a reference receiver and/or source flatness calibration, set `SOURce:POWer:CORRection:COLLect:RRECeiver` and/or `SOURce:POWer:CORRection:COLLect:FLATness` to ON.

RRAfter

First the reference receiver will be calibrated by a single power meter measurement, then the source flatness calibration will be performed using the calibrated reference receiver.

Requires

```
SOURce<Ch>:POWer<PhyPt>:CORRection:COLLect:
FLATness ON.
```

RRONLY

Reference receiver only. The reference receiver will be used to perform a source flatness calibration. Ideally the reference receiver was previously calibrated using a power meter.

Requires

```
SOURce<Ch>:POWer<PhyPt>:CORRection:COLLect:
RRECeiver OFF.
```

```
*RST:      RRAfter
```

Example: See [SOURce<Ch>:POWer:CORRection\[:ACquire\]](#)

Manual operation: See "[Source Leveling/Src. Lev. Method](#)" on page 584

SOURce:POWer:CORRection:COLLect:RRECeiver <Boolean>

Enables or disables calibration of the reference receiver together with the source power calibration.

Note: It is not possible to disable flatness calibration (see [SOURce:POWer:CORRection:COLLect:FLATness](#) on page 1551) and reference receiver calibration simultaneously.

Parameters:

<Boolean> Disables (OFF|1) or enables (ON|1) reference receiver calibration.

```
*RST:      ON|1
```

Example: See [SOURce:POWer:CORRection:COLLect:FLATness](#) on page 1551.

SOURce:POWer:CORRection:COLLect:VNETworks <DeEmbNwType>[, <DeEmbType>]

Defines whether the source flatness cal uses the configured offset de-/embedding to get the power values at the DUT (instead of the calibrated reference plane).

This setting applies to all physical ports and all channels.

Parameters:

<DeEmbNwType> SENDed | GLOop | OFF | ALL | DIFFerential | PSET | RENorm | OFFSet | AOFFset

Selects the offset or de-/embedding type to be used, if configured.

ALL means that all available offset and de-/embedding information is applied. The <DeEmbType> can be omitted in this case.

*RST: OFF

<DeEmbType> EMBedding | DEEMbedding

Selects between embedding and deembedding for the selected <DeEmbNwType>.

Must be specified for network types that can be used for embedding and deembedding

Manual operation: See ["Embedding"](#) on page 629

7.3.15.8 SOURce:POWer:CORRection:SLEVeling...

The following commands define and control the (source) leveling function that is enabled with option R&S ZNA-K8.

See [Chapter 4.7.7.1, "Leveling"](#), on page 283

SOURce:POWer<PhyPt>:CORRection:SLEVeling[:ACQuire].....	1553
SOURce:POWer<PhyPt>:CORRection:SLEVeling:DATA:CLEAr.....	1554
SOURce:POWer:CORRection:SLEVeling:DATA:CLEAr:ALL.....	1554
SOURce:POWer<PhyPt>:CORRection:SLEVeling:STATe?.....	1554
SOURce:POWer<PhyPt>:CORRection:SLEVeling:DELete.....	1555
SOURce:POWer<PhyPt>:CORRection:SLEVeling:FREQuency:POINts.....	1555
SOURce<Ch>:POWer<PhyPt>:CORRection:SLEVeling:FREQuency:STARt.....	1555
SOURce:POWer<PhyPt>:CORRection:SLEVeling:FREQuency:STOP.....	1555
SOURce:POWer<PhyPt>:CORRection:SLEVeling:POWer:ALC.....	1556
SOURce<Ch>:POWer<PhyPt>:CORRection:SLEVeling:POWer:STARt.....	1556
SOURce:POWer<PhyPt>:CORRection:SLEVeling:POWer:STOP.....	1556
SOURce:POWer<PhyPt>:CORRection:SLEVeling:POWer:STEP.....	1557
SOURce<Ch>:POWer<PhyPt>:CORRection:SLEVeling:STATe.....	1557

SOURce:POWer<PhyPt>:CORRection:SLEVeling[:ACQuire]

Starts the leveling data acquisition at port <PhyPt>.

Define the leveling grid using

SOURce<Ch>:POWer<PhyPt>:CORRection:SLEVeling:FREQuency and
SOURce<Ch>:POWer<PhyPt>:CORRection:SLEVeling:POWer commands.

Suffix:

<PhyPt> Physical port number

Example: Suppose we have configured a setup with two converters ZVA-Z110.

```
SOURce:POWer:CORRection:SLEVeling:FREQuency:START 75 GHz
SOURce:POWer:CORRection:SLEVeling:FREQuency:STOP 110 GHz
SOURce:POWer:CORRection:SLEVeling:FREQuency:POINts 101
SOURce:POWer:CORRection:SLEVeling:POWer:START -25
SOURce:POWer:CORRection:SLEVeling:POWer:STOP 0
SOURce:POWer:CORRection:SLEVeling:POWer:STEP 0.5 DB
SOURce:POWer:CORRection:SLEVeling:POWer:ALC ON
SOURce:POWer1:CORRection:SLEVeling:ACQuire
```

Usage: Event

Options: R&S ZNA-K8

Manual operation: See "[Start Cal Sweep](#)" on page 604

SOURce:POWer<PhyPt>:CORRection:SLEVeling:DATA:CLEar

Deletes the [leveling](#) data for physical port <PhyPt>, if available.

Use `SOURce:POWer:CORRection:SLEVeling:DATA:CLEar:ALL` to delete the leveling data for *all* ports.

Suffix:
<PhyPt> Physical port number

Usage: Event

Options: R&S ZNA-K8

SOURce:POWer:CORRection:SLEVeling:DATA:CLEar:ALL

Deletes the [leveling](#) data for *all* physical ports.

Use `SOURce:POWer<PhyPt>:CORRection:SLEVeling:DATA:CLEar` to delete the leveling data for a single port.

Usage: Event

Options: R&S ZNA-K8

SOURce:POWer<PhyPt>:CORRection:SLEVeling:STATe?

Queries whether a [leveling](#) data set is available for physical port <PhyPt>.

Suffix:
<Ch> Channel number
This suffix is ignored. Leveling data are valid for all channels in the active setup.

Return values:
<Boolean>

Usage: Query only

Options: R&S ZNA-K8
Manual operation: See ["Available"](#) on page 908

SOURce:POWer<PhyPt>:CORRection:SLEVeling:DELeTe

Removes the (global) leveling dataset of port <PhyPt>.

Suffix:
 <PhyPt> Physical port number

Usage: Event

Options: R&S ZNA-K8

Manual operation: See ["Remove"](#) on page 908

SOURce:POWer<PhyPt>:CORRection:SLEVeling:FREQuency:POINts <NrOfPts>

Defines the number of frequency sweep points of the [leveling](#) grid for physical port <PhyPt>.

After defining the leveling grid (using `SOURce<Ch>:POWer<PhyPt>:CORRection:SLEVeling:FREQuency` and `SOURce<Ch>:POWer<PhyPt>:CORRection:SLEVeling:POWer` commands), you can start the leveling data acquisition using `SOURce:POWer<PhyPt>:CORRection:SLEVeling[:ACQuire]`.

Suffix:
 <PhyPt> Physical port number

Parameters:
 <NrOfPts> Number of points
 By default the R&S ZNA uses 201 sweep points. The higher the number of "Sweep Points", the more accurate the leveling, but also the longer it takes to create the leveling table). The number of sweep points is limited to 100001.

Example: See `SOURce:POWer<PhyPt>:CORRection:SLEVeling[:ACQuire]`

Options: R&S ZNA-K8

Manual operation: See ["Number of Points"](#) on page 603

SOURce<Ch>:POWer<PhyPt>:CORRection:SLEVeling:FREQuency:STARt <Leveling Tool Start Frequency>

SOURce:POWer<PhyPt>:CORRection:SLEVeling:FREQuency:STOP <FreqValue>

Defines the start and stop frequency of the [leveling](#) grid for physical port <PhyPt>.

By default the vector network analyzer uses the standard frequency range of the selected "Meas Port".

After defining the leveling grid (using `SOURce<Ch>:POWer<PhyPt>:CORRection:SLEVeling:FREQuency` and `SOURce<Ch>:POWer<PhyPt>:CORRection:SLEVeling:POWer` commands), you can start the leveling data acquisition using `SOURce:POWer<PhyPt>:CORRection:SLEVeling[:ACQuire]`.

Suffix:

<PhyPt> Physical port number

Parameters:

<FreqValue> Start/stop value
Default unit: Hz

Example:

See `SOURce:POWer<PhyPt>:CORRection:SLEVeling[:ACQuire]`

Options:

R&S ZNA-K8

Manual operation: See "Start Frequency/Stop Frequency" on page 603

SOURce:POWer<PhyPt>:CORRection:SLEVeling:POWer:ALC <Compatible>

If checked, the power step size of the **leveling** grid for physical port <PhyPt> is fixed to 1 dB. The step size defined using `SOURce:POWer<PhyPt>:CORRection:SLEVeling:POWer:STEP` is ignored.

After defining the leveling grid (using `SOURce<Ch>:POWer<PhyPt>:CORRection:SLEVeling:FREQuency` and `SOURce<Ch>:POWer<PhyPt>:CORRection:SLEVeling:POWer` commands), you can start the leveling data acquisition using `SOURce:POWer<PhyPt>:CORRection:SLEVeling[:ACQuire]`.

Suffix:

<PhyPt> Physical port number

Parameters:

<Compatible>

Example:

See `SOURce:POWer<PhyPt>:CORRection:SLEVeling[:ACQuire]`

Options:

R&S ZNA-K8

Manual operation: See "ALC Step Size" on page 604

SOURce<Ch>:POWer<PhyPt>:CORRection:SLEVeling:POWer:START <Leveling Tool Sart Power>**SOURce:POWer<PhyPt>:CORRection:SLEVeling:POWer:STOP <PowValue>**

Defines the start and stop power of the **leveling** grid for physical port <PhyPt>.

After defining the leveling grid (using `SOURce<Ch>:POWer<PhyPt>:CORRection:SLEVeling:FREQuency` and `SOURce<Ch>:POWer<PhyPt>:CORRection:SLEVeling:POWer` commands), you can start the leveling data acquisition using `SOURce:POWer<PhyPt>:CORRection:SLEVeling[:ACQuire]`.

Suffix:
`<PhyPt>` Physical port number

Parameters:
`<PowValue>` Start/stop power
 Default unit: dB

Example: See `SOURce:POWer<PhyPt>:CORRection:SLEVeling[:ACQuire]`

Options: R&S ZNA-K8

Manual operation: See "Start Power/Stop Power" on page 603

`SOURce:POWer<PhyPt>:CORRection:SLEVeling:POWer:STEP <Size>`

Defines the (source) power step size of the **leveling** grid for physical port `<PhyPt>`.

After defining the leveling grid (using `SOURce<Ch>:POWer<PhyPt>:CORRection:SLEVeling:FREQuency` and `SOURce<Ch>:POWer<PhyPt>:CORRection:SLEVeling:POWer` commands), you can start the leveling data acquisition using `SOURce:POWer<PhyPt>:CORRection:SLEVeling[:ACQuire]`.

Suffix:
`<PhyPt>` Physical port number

Parameters:
`<Size>` Default unit: dB

Example: See `SOURce:POWer<PhyPt>:CORRection:SLEVeling[:ACQuire]`

Options: R&S ZNA-K8

Manual operation: See "Power Step Size" on page 603

`SOURce<Ch>:POWer<PhyPt>:CORRection:SLEVeling:STATe <Active>`

Defines whether converter power control is used, if a **leveling** dataset is available (`SOURce:POWer<PhyPt>:CORRection:SLEVeling:STATe?` on page 1554).

Suffix:
`<PhyPt>` Physical port number

Parameters:
`<Active>`

Options: R&S ZNA-K8

Manual operation: See "Power Control" on page 908

7.3.15.9 SOURce:POWer:CORRection:TCoefficient...

These commands allow you

The "Power Meter Transmission Coefficients" dialog allows you to modify the results of a scalar power calibration to account for additional two-port devices (with known transmission characteristics) in the test setup.

SOURce<Ch>:POWer<PhyPt>:CORRection:TCoefficient:CALibration <Boolean>

Selects the position of the additional two-port in the test setup.

Note that it is now possible to have two-ports at both positions (see [SOURce:POWer:CORRection:TCoefficient\[:STATe\]](#)). This command is kept for compatibility reasons.

Suffix:

<Ch> Calibrated channel number. This parameter is ignored; the transmission coefficient settings are valid for all channels.

<PhyPt> Calibrated port number. This parameter is ignored; the transmission coefficient settings are valid for all sources.

Parameters:

<Boolean> ON – two port at power meter (during calibration)
 OFF – two port at DUT (during measurement)
 *RST: ON (notice that the correction is switched off after a reset)

Example:

```
RST; :SOUR:POW:CORR:TCO:CAL OFF
```

Select the test setup with the additional two-port in front of the DUT.

```
SOUR:POW:CORR:TCO:DEF 1GHz, -5; DEF 2GHz, -10;
DEF2?
```

Define two points in the power loss list; query the second point.

```
SOUR:POW:CORR:TCO:INS2 1.5 GHz, -7.5
```

Insert a third point as point no. 2 in the list.

Example:

```
SOUR:POW:CORR:TCO:COUN?
```

Query the number of points. The response is 3.

```
SOUR:POW:CORR:TCO ON
```

Enable the use of two-port transmission coefficients.

```
SOUR:POW:CORR:TCO:FEED 'Trc1'
```

Replace the previous 3 points by the trace points of the default trace "Trc1".

Example: `MMEM:STOR:CORR:TCO 'C:\Users\Public\Documents\Rohde-Schwarz\ZNA\PowerMeterCorr\Test.pmcl'`
 Store the power loss list to the power meter correction list file `Test.pmcl` in the directory `C:\Users\Public\Documents\Rohde-Schwarz\ZNA\PowerMeterCorr.`
`MMEM:LOAD:CORR:TCO 'C:\Users\Public\Documents\Rohde-Schwarz\ZNA\PowerMeterCorr\Test.pmcl'`
 Reload the stored power meter correction list file.

Example: `SOUR:POW:CORR:TCO:DEL1`
 Delete the first point in the list.
`SOUR:POW:CORR:TCO:DEL:ALL; :SOUR:POW:CORR:TCO?`
 Clear the entire list. Query whether the transmission coefficients are still used. The response is 0.
`MMEM:LOAD:CORR:TCO 'C:\Users\Public\Documents\Rohde-Schwarz\ZNA\Traces\Test.s2p', 'S21'`
 Load a power loss list from a previously created 2-port Touchstone file.

Manual operation: See ["Two Port Config..."](#) on page 633

SOURce:POWer:CORRection:TCOefficient:COUNT? [<DeEmbedding Position>]

Queries the number of entries in the transmission coefficient list.

Parameters:

<DeEmbedding Position> BOTH | DUT | PM
 Determines the two-port the command refers to:

DUT
 The two-port between VNA and DUT (during measurement)

PM
 The two-port between VNA and PM (during power calibration)

BOTH
 Both positions

(parameter omitted)
 If the parameter is omitted, the command refers to the two-port selected using `SOURce<Ch>:POWer<PhyPt>:CORRection:TCOefficient:CALibration.`

Example: See `SOURce:POWer:CORRection:TCOefficient[:STATe]` on page 1563

Usage: Query only

Manual operation: See ["Frequency / Transm. Coefficients: Insert, Delete, Delete All"](#) on page 634

SOURce:POWer:CORRection:TCOefficient:DEFine<ListNo> <Frequency>, <TransCoeff>[, <DeEmbedding Position>]

Adds a new frequency and transmission coefficient to the end of the transmission coefficient list. The query returns the frequency and transmission coefficient no. <ListNo>.

Suffix:

<ListNo> List entry no. (only used for queries)

Parameters:

<Frequency> Stimulus frequency value. If several points with identical frequencies are added, the analyzer automatically ensures a frequency spacing of 1 Hz.
 Range: Stimulus values outside the frequency range of the analyzer are allowed.
 *RST: n/a
 Default unit: Hz

<TransCoeff> Transmission coefficient
 Range: -300 dB to +200 dB
 *RST: n/a
 Default unit: dB

<DeEmbedding Position> BOTH | DUT | PM
 Determines the two-port the command refers to:
DUT
 The two-port between VNA and DUT (during measurement)
PM
 The two-port between VNA and PM (during power calibration)
BOTH
 Both positions
(parameter omitted)
 If the parameter is omitted, the command refers to the two-port selected using [SOURce<Ch>:POWer<PhyPt>:CORRection:TCOefficient:CALibration](#).

Example: See [SOURce:POWer:CORRection:TCOefficient\[:STATE\]](#) on page 1563

Manual operation: See "[Frequency / Transm. Coefficients: Insert, Delete, Delete All](#)" on page 634

SOURce:POWer:CORRection:TCOefficient:DELeTe:ALL [<DeEmbedding Position>]

Clears the transmission coefficient list.

Parameters:

<DeEmbedding Position> BOTH | DUT | PM
 Determines the two-port the command refers to:

DUT

The two-port between VNA and DUT (during measurement)

PM

The two-port between VNA and PM (during power calibration)

BOTH

Both positions

(parameter omitted)

If the parameter is omitted, the command refers to the two-port selected using `SOURce<Ch>:POWer<PhyPt>:CORRection:TCOefficient:CALibration`.

Example: See `SOURce:POWer:CORRection:TCOefficient[:STATe]` on page 1563

Usage: Setting only

Manual operation: See "Frequency / Transm. Coefficients: Insert, Delete, Delete All" on page 634

SOURce:POWer:CORRection:TCOefficient:DELEte<ListNo>[:DUMMy]
 [<DeEmbedding Position>]

Deletes entry <ListNo> from the transmission coefficient list.

Suffix:

<Ch> Calibrated channel number. This suffix is ignored; the transmission coefficient settings are valid for all channels.

<PhyPt> Calibrated port number. This suffix is ignored; the transmission coefficient settings are valid for all sources.

<ListNo> List entry no.

Parameters:

<DeEmbedding Position> BOTH | DUT | PM

Determines the two-port the command refers to:

DUT

The two-port between VNA and DUT (during measurement)

PM

The two-port between VNA and PM (during power calibration)

BOTH

Both positions

(parameter omitted)

If the parameter is omitted, the command refers to the two-port selected using `SOURce<Ch>:POWer<PhyPt>:CORRection:TCOefficient:CALibration`.

Example: See `SOURce:POWer:CORRection:TCOefficient[:STATe]` on page 1563

Manual operation: See "Frequency / Transm. Coefficients: Insert, Delete, Delete All" on page 634

SOURce:POWer:CORRection:TCOefficient:FEED <Trace>[, <DeEmbedding Position>]

Selects a trace which provides the points for the transmission coefficient list.

Parameters:

<DeEmbedding Position> BOTH | DUT | PM
Determines the two-port the command refers to:

DUT
The two-port between VNA and DUT (during measurement)

PM
The two-port between VNA and PM (during power calibration)

BOTH
Both positions

(parameter omitted)
If the parameter is omitted, the command refers to the two-port selected using `SOURce<Ch>:POWer<PhyPt>:CORRection:TCOefficient:CALibration`.

Setting parameters:

<Trace> String parameter for the trace name, e.g. 'Trc1'. The trace must exist in the active recall set.

*RST: n/a

Example: See `SOURce:POWer:CORRection:TCOefficient[:STATe]` on page 1563

Usage: Setting only

Manual operation: See "Get Trace..." on page 634

SOURce:POWer:CORRection:TCOefficient:INSert<ListNo> <Frequency>, <TransCoeff>[, <DeEmbedding Position>]

Inserts a new frequency and transmission coefficient at position no. <ListNo> in the transmission coefficient list. The following points are shifted down in the list.

Suffix:

<ListNo> List entry no.

Parameters:

<Frequency> Stimulus frequency value. If several points with identical frequencies are added, the analyzer automatically ensures a frequency spacing of 1 Hz.

Range: Stimulus values outside the frequency range of the analyzer are allowed.

*RST: n/a

Default unit: Hz

<TransCoeff>	Transmission coefficient Range: -300 dB to +200 dB *RST: n/a Default unit: dB
<DeEmbedding Position>	BOTH DUT PM Determines the two-port the command refers to: DUT The two-port between VNA and DUT (during measurement) PM The two-port between VNA and PM (during power calibration) BOTH Both positions (parameter omitted) If the parameter is omitted, the command refers to the two-port selected using <code>SOURce<Ch>:POWer<PhyPt>:CORRection:TCOefficient:CALibration</code> .
Example:	See <code>SOURce:POWer:CORRection:TCOefficient[:STATe]</code> on page 1563
Manual operation:	See "Frequency / Transm. Coefficients: Insert, Delete, Delete All" on page 634

SOURce:POWer:CORRection:TCOefficient[:STATe] <Boolean>[, <DeEmbedding Position>]

Enables or disables the use of two-port transmission coefficients for power correction.

Parameters:

<Boolean>	Enables (ON) or disables (OFF) the two-port transmission coefficients. *RST: n/a
<DeEmbedding Position>	BOTH DUT PM Determines the two-port the command refers to: DUT The two-port between VNA and DUT (during measurement) PM The two-port between VNA and PM (during power calibration) BOTH Both positions (parameter omitted) If the parameter is omitted, the command refers to the two-port selected using <code>SOURce<Ch>:POWer<PhyPt>:CORRection:TCOefficient:CALibration</code> .

Example:

```
RST; SOUR:POW:CORR:TCO:DEF 1GHz, -5, DUT; DEF
2GHz, -10, DUT; DEF2?
```

Define two points in the power loss list of the two-port in front of the DUT; query the second point.

```
SOUR:POW:CORR:TCO:INS2 1.5 GHz, -7.5, DUT
```

Insert a third point as point no. 2 in the list.

```
SOUR:POW:CORR:TCO:COUN? DUT
```

Query the number of points. The response is 3.

```
SOUR:POW:CORR:TCO ON, DUT
```

Enable the use of two-port transmission coefficients.

```
SOUR:POW:CORR:TCO:FEED 'Trc1', DUT
```

Replace the previous 3 points by the trace points of the default trace "Trc1".

```
MMEM:STOR:CORR:TCO 'C:
\Users\Public\Documents\Rohde-Schwarz\ZNA
\PowerMeterCorr\Test.pmcl', DUT
```

Store the power loss list to the power meter correction list file Test.pmcl in the directory

```
C:\Users\Public\Documents\Rohde-Schwarz\ZNA
\PowerMeterCorr.
```

```
MMEM:LOAD:CORR:TCO 'C:\Users\Public\Documents
\Rohde-Schwarz\ZNA\PowerMeterCorr\Test.pmcl',
DUT
```

Re-load the stored power meter correction list file.

```
SOUR:POW:CORR:TCO:DEL1, DUT
```

Delete the first point in the list.

```
SOUR:POW:CORR:TCO:DEL:ALL, DUT; :SOUR:POW:CORR:
TCO? DUT
```

Clear the entire list. Query whether the transmission coefficients are still taken into account. The response is 0.

```
MMEM:LOAD:CORR:TCO 'C:\Users\Public\Documents
\Rohde-Schwarz\ZNA\Traces\Test.s2p', 'S21', DUT
```

Load a power loss list from a previously created 2-port Touchstone file.

Manual operation: See ["Two Port Config..."](#) on page 633

7.3.15.10 SOURce:POWer:CORRection... (other)

The SOURce:POWer:CORRection... commands control a scalar source power calibration.

SOURce<Ch>:POWer:CORRection[:ACQuire].....	1565
SOURce<Ch>:POWer<PhyPt>:CORRection[:ACQuire]:VERification:RESult?.....	1566
SOURce<Ch>:POWer:CORRection:DATA.....	1567
SOURce<Ch>:POWer:CORRection:DATA:PORT<PhyPt>.....	1567
SOURce<Ch>:POWer:CORRection:DATA:PARAmeter<Wv>?.....	1568
SOURce<Ch>:POWer<PhyPt>:CORRection:DATA:PARAmeter<Wv>:COUNT?.....	1569
SOURce:POWer:CORRection:DEFault.....	1570
SOURce:POWer:CORRection:FAST.....	1570

SOURce<Ch>:POWER:CORRection:GENerator<Gen>[:STATe].....	1571
SOURce<Ch>:POWER<PhyPt>:CORRection:HARMonic[:ACQUIRE].....	1571
SOURce<Ch>:POWER<PhyPt>:CORRection:IMODulation:LTONE[:ACQUIRE].....	1572
SOURce<Ch>:POWER:CORRection:IMODulation:METHod.....	1573
SOURce<Ch>:POWER:CORRection:IMODulation:PORT.....	1574
SOURce<Ch>:POWER<PhyPt>:CORRection:IMODulation:UTONE[:ACQUIRE].....	1574
SOURce:POWER:CORRection:NREadings.....	1574
SOURce<Ch>:POWER:CORRection:OSources[:STATe].....	1575
SOURce:POWER:CORRection:PMETER:ID.....	1575
SOURce:POWER:CORRection:PPOWER.....	1575
SOURce:POWER:CORRection:PPOWER:PATTenuation.....	1576
SOURce:POWER:CORRection:PSElect.....	1576
SOURce<Ch>:POWER<PhyPt>:CORRection:STATe.....	1577
SOURce<Ch>:POWER<PhyPt>:CORRection:UPORt:STATe.....	1577

SOURce<Ch>:POWER:CORRection[:ACQUIRE] <SourceType>[, <SourcePort>[, <CalOnlyPortFreq>]]

Selects the source for the source power calibration, starts and applies the source power calibration.

Note: The command cannot be used unless a power meter is connected via GPIB bus, USB or LAN interface and configured in the "External Power Meters" dialog.

Suffix:

<Ch> Calibrated channel number

Setting parameters:

<SourceType> PORT | GENerator | A1 | A2 | A3 | A4 | ESRC1 | ESRC2 | CLO | UPORt

PORT – analyzer port is the source of the calibrated wave.

GENerator – external generator is the source.

The port and generator numbers are specified by means of the <SourcePort> parameter.

A1 | A2 | A3 | A4 – direct analyzer port selection. The parameters A1 and A2 are ZVR-compatible. No additional port number parameter needs to be specified.

ESRC1 | ESRC2 – direct external generator selection. The parameters are ZVR-compatible. No additional parameters need to be specified.

CLO – the optional (converter) LO Out port.

UPORt – can only be used on a 2-port R&S ZNAxx with [second internal source](#) and [internal combiner](#). If the internal combiner is used ([SOURce<Ch>:COMBiner INTernal](#)),

[SOURce<Ch>:POWER:CORRection UPORt, 2](#) performs a source flatness calibration of the combiner upper port 2. The calibration can be enabled using [SOURce<Ch>:POWER2:CORRection:UPORt:STATe ON](#).

<SourcePort>	Analyzer port or generator port number, if PORT or GENERator is the first parameter.
<CalOnlyPortFreq>	Relevant for frequency conversion measurements only. OFF 0 The reference receiver at port <CalPort> is calibrated for all frequencies that are relevant for any of the ports. ON 1 Only those frequencies are calibrated that are relevant for this port. This results in shorter calibration times. *RST: 0
Example:	<pre>SOUR:POW:CORR:OSO:STAT OFF</pre> <p>To improve the accuracy, switch off all other sources during the calibration sweep.</p> <pre>SOUR:POWer:CORR:COLL:METH RRAF</pre> <p>Enable fast power correction.</p> <pre>SOUR:POW:CORR:NRE 2; COLL:AVER:NTOL 0.5</pre> <p>Increase the number of readings and reduce the power tolerance to improve the accuracy.</p> <pre>SOURce:POW:CORR:COLL:CFAC 0.9</pre> <p>Reduce the correction factor to 0.9.</p> <pre>SOURce:POW:CORR:PSElect PPOW; PPOWer -5</pre> <p>Define reference receiver cal power which is independent of the port power; set its value to -5 dBm.</p> <pre>SOUR:POW:CORR:ACQ PORT,1</pre> <p>Perform a source power calibration using port 1 as a source port.</p> <pre>SOUR:POW:CORR:STAT?</pre> <p>Check whether the calibration is applied (the response is 1).</p>
Example:	<p>Change the test setup, connect a previously configured external generator no. 1 to the reference plane.</p> <pre>SOUR:POW:CORR:ACQ GEN,1</pre> <p>Perform a source power calibration using the external generator no. 1 as a source.</p> <pre>SOUR:POW:CORR:GEN?</pre> <p>Check whether the calibration is applied (the response is 1).</p>
Usage:	Setting only
Manual operation:	See " Port Overview " on page 597

SOURce<Ch>:POWer<PhyPt>:CORRection[:ACQuire]:VERification:RESult?

Returns (and deletes) the result of the last verification sweep. The response contains three values:

- <Channel> – calibrated channel, e.g. Ch 1 for channel no. 1.
- <Boolean> – 1 for "calibration passed" (the maximumr offset is below the tolerance), 0 for "calibration failed".

- **<MaxOffset>** – maximum power offset between the measured power at the reference plane and the "Cal Power" during the verification sweep in dB.

If no verification sweep is available, or if the result has been queried already, the response is 0.

Suffix:

<Ch> Calibrated channel number. This suffix is ignored; the result is based on the last verification sweep acquired.

<PhyPt> Calibrated port number. This suffix is ignored; the result is based on the last verification sweep acquired.

Example:

```
*RST; :SOURce:POWer:CORRection:NREadings 2
SOURce:POWer:CORRection:COLLect:AVERage:
NTOLerance 0.5
```

Increase the number of readings and reduce the power tolerance to improve the accuracy.

```
SOURce:POWer:CORRection:ACQuire PORT,1
```

Perform a source power calibration using port 1 as a source port.

```
SOURce:POWer:CORRection:ACQuire:VERification:
RESult?
```

Query the result of the verification sweep. Possible response:

```
Ch1 1,9.9E+002
```

Usage: Query only

Manual operation: See "[Calibration Sweep Diagram](#)" on page 596

SOURce<Ch>:POWer:CORRection:DATA <Source>, <CorrData>...

SOURce<Ch>:POWer:CORRection:DATA:PORT<PhyPt> <Source>, <CorrData>...

Reads or writes scalar source power correction data sets. A power correction data set contains n real values where:

- Each value corresponds to the ratio of the actual power at the reference plane (value provided by the used source) to the uncalibrated power in dB.
- The number n is equal to the number of sweep points.

Increasing (decreasing) the values in the correction data sets increases (decreases) the power at the reference plane. Writing correction data (the setting command) fails if the number of transferred values is not equal to the number of sweep points.

Suffix:

<Ch> Calibrated channel number

<PhyPt> Physical port number, used to select a specific frequency axis in arbitrary mode (with option R&S ZNA-K4).

Parameters:

<Source>	Identifier for the source of the calibrated wave: 'A<n>' or 'PORT<n>' denote correction data for the analyzer port no. <n>. 'ESRC<n>' or 'GEN<n>' denote correction data for the external generator no. <n>.
<CorrData>	Power correction values either in ASCII or block data format, depending on the current FORMat [:DATA] setting. All numbers are interpreted as dB-values.

Example:

```
*RST; :SWE:POIN 10
Reset the instrument and reduce the number of sweep points to 10.
SOUR:POW:CORR:ACQ PORT,1
Perform a source power calibration using port 1 as a source port.
SOUR:POW:CORR:DATA? 'A1'
Query the correction values. The analyzer returns 10 comma-separated real numbers.
SOUR:POW:CORR:DATA 'A1', 1, 2, 3, 4, 5, -6, -7, -8, -9, -0
Replace the correction values by ten (new) numbers.
```

Manual operation: See "[Apply](#)" on page 599

SOURce<Ch>:POWER:CORRection:DATA:PARAmeter<Wv>? <SettingType>

Gets settings of the available power calibrations.

Suffix:

<Ch>	Number of the calibrated channel.
<Wv>	Number of the power calibration. Use SOURce<Ch>:POWER<PhyPt>:CORRection:DATA:PARAmeter<Wv>:COUNT? on page 1569 to query the number of available power calibrations.

Query parameters:

SettingType	WAVE START STOP POINTs STYPe ATTenuation CPOWer CFRequency TSTamp LTSTamp FSMoDe
WAVE	Calibrated port and calibration type (Gen=Source Power, Rec=Measurement Receiver)
START	Start Frequency or Power Stop Frequency or Power
POINTs	Nr. of sweep points
STYPe	Sweep type or grid (LIN, LOG, SEGM)

ATTenuation

Source or receiver attenuation

CPOWER

Cal Power for frequency sweeps

CFRequency

Cal Frequency for power sweeps

TSTamp

Timestamp in UTC

LTSTamp

Timestamp in local time

TVNA

For calibrations involving switch matrices, this indicates the test ports on the VNA itself. Returns a comma-separated list of port pairs `TestPort,VnaPort`

MVNA

For calibrations involving switch matrices, this indicates the mapping between matrix ports and VNA ports for matrix `<Index>`. Returns a comma-separated list of port pairs `MatrixVnaPort,VnaPort`

MTEST

For calibrations involving switch matrices, this indicates the mapping between matrix (physical) test ports and test ports for matrix `<Index>`. Returns a comma-separated list of port pairs `MatrixTestPort,TestPort`

`<Index>`

If one or more external switch matrices were used during calibration, this refers to the index of a particular switch matrix (see [SYSTEM:COMMunicate:RDEvice:SMATrix<Matr>:DEFine](#) on page 1627)

Usage:

Query only

Manual operation:See "[Port Overview](#)" on page 597**SOURce<Ch>:POWER<PhyPt>:CORRection:DATA:PARAmeter<Wv>:COUNT?**

Gets the number of available power calibrations (both source power and measurement receiver).

Use `SOURce<Ch>:POWER:CORRection:DATA:PARAmeter<Wv>?` to retrieve the related settings.

Suffix:

`<Ch>` Number of the calibrated channel.
`<PhyPt>` This suffix is ignored.
`<Wv>` This suffix is ignored.

Usage:

Query only

Manual operation:See "[Port Overview](#)" on page 597

SOURce:POWer:CORRection:DEFault <Boolean>

Enables the analyzer to create a set of default source power calibration data. The analyzer uses the reference channel power to acquire the default calibration data. No external power meter is required.

Tip:

The main purpose of the default calibration data set is to provide a dummy power calibration which you can replace with your own, external power calibration data. You may have acquired the external data in a previous session or even on an other instrument. If you want to use the external power calibration data on the analyzer, generate the default data set first and overwrite it with the external data. For details refer to the program example below.

Parameters:

<Boolean>

Enables (ON|1) or disables (OFF|0) the dummy source power calibration for port number <PhyPt>. OFF means that a real source power calibration is performed, for which an external power meter must be connected to the analyzer.

```
*RST:      OFF|0
```

Example:

```
*RST; :SWE:POIN 10
```

Reset the instrument and reduce the number of sweep points to 10.

```
SOUR:POW:CORR:COLL:DEF ON
```

Enable a dummy source power calibration.

```
SOUR:POW:CORR:ACQ PORT,1
```

Perform a dummy source power calibration using port 1 as a source port.

```
SOUR:POW:CORR:DATA? 'A1'
```

Query the correction values. The analyzer returns 10 comma-separated real numbers.

```
MMEM:STOR:CORR 1, 'Calgroup_Ch1.cal'
```

Store the default source power calibration data to the calibration pool in the default directory C:\Rohde&Schwarz\NWA\Calibration\Data.

<Replace the generated file Calgroup_Ch1.cal with your external power calibration data.>

```
MMEM:LOAD:CORR 1, 'Calgroup_Ch1.cal'
```

Load the external data and apply them to channel 1 and port 1.

```
DISP:MENU:KEY:EXEC 'Cal Manager'
```

Open the Calibration Manager dialog to check the result of the previous actions.

SOURce:POWer:CORRection:FAST <Boolean>

Enables or disables a fast source power calibration, where the external power meter is used for the first calibration sweep only.

It is recommended to use the more general command [SOURce:POWer:CORRection:COLLect:METhod](#).

Parameters:

<Boolean> Enables (ON|1) or disables (OFF|0) fast source power calibration.

*RST: OFF|0

SOURce<Ch>:POWER:CORRection:GENerator<Gen>[:STATe] <Boolean>

Enables or disables the source power calibration for channel <Ch> and for an external generator number <Gen>. The command is disabled unless a source power calibration for the external generator has been performed ([SOURce<Ch>:POWER:CORRection\[:ACQuire\]](#)). To enable or disable a source power calibration for an analyzer port use [SOURce<Ch>:POWER<PhyPt>:CORRection:STATe](#).

Suffix:

<Ch> Calibrated channel number

<Gen> Generator number

Parameters:

<Boolean> Enables (ON) or disables (OFF) the source power calibration for port number <PhyPt>.

*RST: OFF

Example: See [SOURce<Ch>:POWER:CORRection\[:ACQuire\]](#)

Manual operation: See "[Port Overview](#)" on page 637

SOURce<Ch>:POWER<PhyPt>:CORRection:HARMonic[:ACQuire]

Starts the source calibration

- at physical port <PhyPt>
- in channel <Ch>
- at harmonic orders [\[SENSe<Ch>:\]CORRection:ADVanced:HARMonic:ORDER?](#)

Then stores and applies the calibration data.

Use [SOURce:POWER:CORRection:PMETer:ID](#) to select the suitable power meter.

Suffix:

<Ch> Calibrated channel number

<PhyPt> Port number

Example:	<pre>*RST; FREQ:STAR 0.5E+9; STOP 1E+9</pre> <p>Reset the analyzer (activating a frequency sweep) and set the sweep range between 1 GHz and 1.1 GHz.</p> <pre>CALCulate:PARAmeter:MEASure '<TraceName>', 'h3b2 (p1) '</pre> <p>Configure a 3rd harmonic measurement with source port 1 and receive port 2.</p> <pre>SOUR:POW:CORR:PMET:ID 1</pre> <p>Select power meter no. 1 (previously configured in the External Power Meters dialog and properly connected) for the RF source calibration.</p> <pre>SOUR:POW1:CORR:HARM</pre> <p>Start source power calibration at source port 1.</p> <pre>CORR:POW:HARM:ACQ</pre> <p>Start receiver power calibration at receive port 2.</p>
Usage:	Event
Options:	R&S ZNA-K4
Manual operation:	See " Harmonic Orders to Calibrate " on page 590

SOURce<Ch>:POWER<PhyPt>:CORRection:IMODulation:LTONE[:ACQUIRE]

Starts the source calibration for the lower tone (1st power calibration step for intermodulation measurements), stores and applies the calibration data. The external power meter used is selected via SOURce<Ch>:POWER<PhyPt>:CORRection:PMETer:ID.

Suffix:

<Ch>	Calibrated channel number
<PhyPt>	Port number This suffix is ignored; the analyzer calibrates the port that is selected as a source port for the intermodulation measurement ([SENSe<Ch>:]FREQuency:IMODulation:LTONE).

Example:

```
*RST; FREQ:IMOD:LTON PORT,1; UTON GEN, 1
```

Reset the instrument to create the default channel no. 1. Select port 1 as a source port for the lower tone, the (previously configured) external generator no. 1 as a source port for the upper tone.

```
FREQ:IMOD:REC 2
```

Select port 2 as a receiver port.

```
FREQ:STAR 1GHZ; STOP 2GHz
```

Define a suitable sweep range to ensure that the analyzer can measure all intermodulation products.

```
SOUR:POW:CORR:PMET:ID 1
```

Select power meter no. 1 (previously configured in the "External Power Meters" dialog and properly connected) for the RF source calibration.

```
SOUR:POW:CORR:IMOD:LTON
```

Start source power calibration for the lower tone at the previously selected source port 1.

```
SOUR:POW:CORR:IMOD:UTON
```

Start source power calibration for the upper tone at the previously selected source port 3.

```
CORR:POW:IMOD:ACQ
```

Start receiver power calibration at the previously selected receive port 2.

```
CALC:PAR:SDEF 'IM_Meas', 'IP3UI'
```

Create a new channel no. 2 and a trace named 'IM_Meas'.

Select the upper 3rd-order intercept point at the DUT input as a measured quantity.

Usage:

Event

SOURce<Ch>:POWER:CORRection:IMODulation:METHOD <FastOrNot>

Enables or disables the fast interpolation method for intermodulation calibration.

Suffix:

<Ch> Channel number

Parameters:

<FastOrNot> **ON (1)**
Fast method enabled
OFF (0)
Fast method disabled
*RST: ON (1)

Options:

R&S ZNA-K4

Manual operation:

See "[IMD Cal Method>Fast Cal Interp. Meas](#)" on page 591

SOURce<Ch>:POWER:CORRection:IMODulation:PORT <SourceForRecCal>

Selects the source port for the receiver power calibration of an intermodulation measurement. An external generator must be configured before the generator port is available (`SYSTem:COMMunicate:RDEvice:GENerator<Gen>:DEFine`).

Suffix:

<Ch> Channel number

Parameters:

<SourceForRecCal> String parameter to identify the source port:
 'COMBINER' – combiner output
 'PORT <n>' – analyzer port n (separate port no. by blank, e.g. 'PORT 4')
 'GEN <n>' – external generator port n (separate port no. by blank, e.g. 'GEN 1')
 *RST: 'COMBINER'

Example:

```
*RST; :SOURce:POWER:CORRection:IMODulation:PORT
'PORT 4'
Select the analyzer port no. 4 as a source port for the receiver
power calibration.
```

SOURce<Ch>:POWER<PhyPt>:CORRection:IMODulation:UTONe[:ACQuire] [<CalOnlyPortFreq>]

Starts the source calibration for the upper tone (2nd power calibration step for intermodulation measurements), stores and applies the calibration data. The external power meter used is selected via `SOURce<Ch>:POWER<PhyPt>:CORRection:PMETer:ID`.

Suffix:

<Ch> Calibrated channel number

Setting parameters:

<CalOnlyPortFreq> **OFF | 0**
 The reference receiver at port <CalPort> is calibrated for all frequencies that are relevant for any of the ports.
ON | 1
 Only those frequencies are calibrated that are relevant for this port. This results in shorter calibration times.
 *RST: 0

Example:

```
See SOURce<Ch>:POWER<PhyPt>:CORRection:
IMODulation:LTONE[:ACQuire]
```

Usage:

Setting only

SOURce:POWER:CORRection:NREadings <NoCalSweeps>

Sets a limit for the number of calibration sweeps in a source power flatness cal. The command is valid for all channels, ports and external generators.

Equivalent command: `SOURce:POWer:CORRection:COLLect:AVERAge[:COUNT]`.

Parameters:

<NoCalSweeps> Number of readings
 Range: 1 to 100
 *RST: 2

Example: See `SOURce<Ch>:POWer:CORRection[:ACQuire]`

Manual operation: See "Flatness Cal – Max Iterations" on page 628

SOURce<Ch>:POWer:CORRection:OSources[:STATe] <Boolean>

Switches off all other sources during the calibration sweep for channel <Ch>.

Suffix:

<Ch> Calibrated channel number

Parameters:

<Boolean> ON - other sources not necessarily switched off.
 OFF - other sources switched off during the calibration sweep.
 *RST: ON

Example: See `SOURce<Ch>:POWer:CORRection[:ACQuire]`

Manual operation: See "Switch Off Other Sources" on page 628

SOURce:POWer:CORRection:PMETer:ID <PowerMeter>

Selects an external power meter for the scalar source power calibration (flatness calibration).

Note: The command cannot be used unless a power meter is connected via GPIB bus, USB or LAN interface and configured in the "External Power Meters" dialog.

Parameters:

<PowerMeter> Number of external power meter. The parameters UP, DOWN, MIN, MAX are not available for this command.
 Range: 1 to number of configured external power meters
 *RST: The power meter selection is not changed by a reset of the analyzer.

Example: See `SOURce<Ch>:POWer<PhyPt>:CORRection:COLLect[:ACQuire]` on page 1719

Manual operation: See "Power Meter" on page 629

SOURce:POWer:CORRection:PPOWer <RecCalPower>

Defines the source power the R&S ZNA uses to perform the first calibration sweep of the source power calibration ("Reference Receiver Cal Power"). This predefined power value is ignored if the R&S ZNA is set to use the calculated port power result (`SOURce:POWer:CORRection:PSElect CPOW`).

Parameters:

<RecCalPower> Reference receiver cal power
 Range: Depending on source power range of the analyzer and the power range of the external power meter.
 *RST: 0 dBm
 Default unit: dBm

Example: See `SOURce<Ch>:POWer:CORRection[:ACQuire]`.

Manual operation: See "Reference Receiver Cal Power" on page 631

SOURce:POWer:CORRection:PPOWer:PATTenuation <SrcAtt>

Defines the [source step attenuation](#) the R&S ZNA uses during the first calibration sweep of the source power calibration ("Reference Receiver Cal Power"). This attenuation value is ignored if the R&S ZNA is set to use the calculated port power result (`SOURce:POWer:CORRection:PSElect CPOW`).

Parameters:

<SrcAtt> Attenuation value
 Range: 0 to 70 dB
 Increment: 10 dB
 *RST: 0 dB
 Default unit: dB

Manual operation: See "Reference Receiver Cal Power" on page 631

SOURce:POWer:CORRection:PSElect <CalPower>

Defines how to define the source power the R&S ZNA uses to perform the first calibration sweep of the source power calibration ("Reference Receiver Cal Power").

Parameters:

<CalPower> CPOWer | PPOWer
CPOWer
 Calculated port power result
PPOWer
 Predefined port power value, see `SOURce:POWer:CORRection:PPOWer`
 *RST: CPOWer

Example: See `SOURce<Ch>:POWer:CORRection[:ACQuire]`.

Manual operation: See "Reference Receiver Cal Power" on page 631

SOURce<Ch>:POWER<PhyPt>:CORRection:STATe <Boolean>

Enables or disables the source power calibration for channel <Ch> and for port number <PhyPt>. The setting command is disabled unless a source power calibration for the analyzer port has been performed ([SOURce<Ch>:POWER:CORRection\[:ACQuire\]](#)). The query always returns a result.

To enable or disable a source power calibration for an external generator use [SOURce<Ch>:POWER:CORRection:GENerator<Gen>\[:STATe\]](#).

Suffix:

<Ch> Calibrated channel number
 <PhyPt> Calibrated port number

Parameters:

<Boolean> Enables (ON) or disables (OFF) the source power calibration for port number <PhyPt>.
 *RST: OFF

Example: See [SOURce<Ch>:POWER:CORRection\[:ACQuire\]](#).

Manual operation: See "[Port Overview](#)" on page 637

SOURce<Ch>:POWER<PhyPt>:CORRection:UPORT:STATe <Boolean>

This command can only be used on a 2-port R&S ZNAxx with [Chapter 4.7.23, "Internal 2nd source and 2nd LO generator for 2-port R&S ZNA"](#), on page 303 and [internal combiner](#).

If the internal combiner is used ([SOURce<Ch>:COMBiner INTernal](#)), [SOURce<Ch>:POWER2:CORRection:UPORT:STATe ON|OFF](#) enables or disables the source flatness cal of the upper-tone port 2, previously performed using [SOURce<Ch>:POWER:CORRection\[:ACQuire\] UPORT, 2](#).

Suffix:

<Ch> Channel number
 <PhyPt> Physical port number. Must be 2.

Parameters:

<Boolean> ON (1) or OFF (0)

Manual operation: See "[Port Overview](#)" on page 597

7.3.15.11 SOURce:POWER:CPRe meas commands

These commands enable and configure the calibration premeasurement feature (see [Chapter 4.1.6, "Power correction from pre-measurement"](#), on page 119).

SOURce<Ch>:POWER<Pt>:CPRe meas:CFACTor <Value>

Specifies the convergence factor for a cal premeas at port <Pt> in channel <Ch>.

Suffix:

<Ch> Channel number

<Pt> Port number

Parameters:

<Value> Positive decimal number
Increment: 0.001

Manual operation: See "[Max Iterations/Tolerance/Convergence \(table area\)](#)" on page 532

SOURce<Ch>:POWER:CPRe meas:CSTate <Boolean>

Activates/deactivates cal premeas for channel <Ch>.

In addition, cal premeas can be activated/deactivated at the port level ([SOURce<Ch>:POWER<Pt>:CPRe meas\[:STATe\]](#) on page 1580).

Suffix:

<Ch> Channel number

Parameters:

<Boolean> ON (1) | OFF (0)
*RST: OFF (0)

Manual operation: See "[Cal Premeas On](#)" on page 532

SOURce<Ch>:POWER<Pt>:CPRe meas:DETECTOR <Detector>

Selects the detector to be used during the calibration pre-measurement.

This setting is channel- and port-specific.

Suffix:

<Ch> Channel number

<Pt> Port number

Parameters:

<Detector> SAMPLE | AVERAge | RMS | PEAK

Manual operation: See "[Detector \(table area\)](#)" on page 533

SOURce<Ch>:POWER:CPRe meas:MODE <Precal mode>

Defines how the firmware performs calibration pre-measurements in channel <Ch>:

Suffix:

<Ch>

Parameters:

<Precal mode> ONCE | PSweep

ONCE

The correction is applied once, at the initial start of the measurement.

PSweep

The correction is applied per sweep. from one sweep to the next.

Manual operation: See "[Premeas Mode](#)" on page 533

SOURce<Ch>:POWER<Pt>:CPRemeas:NREadings <Max>

Defines the maximum number of cal precal sweeps to be performed in "once mode" (`SOURce<Ch>:POWER:CPRemeas:MODE ONCE`).

This setting is channel- and port-specific.

Suffix:

<Ch> Channel number

<Pt> Port number

Parameters:

<Max> Maximum number of pre cal sweeps

Manual operation: See "[Max Iterations/Tolerance/Convergence \(table area\)](#)" on page 532

SOURce<Ch>:POWER<Pt>:CPRemeas:NTOLerance <Tolerance>

Defines the maximum tolerated deviation between measured and target power during cal premeas.

This setting is channel- and port-specific.

Suffix:

<Ch> Channel number

<Pt> Port number

Parameters:

<Tolerance> Maximum tolerated deviation in dB

Manual operation: See "[Max Iterations/Tolerance/Convergence \(table area\)](#)" on page 532

SOURce<Ch>:POWER<Pt>:CPRemeas:RECeiver <CPRReceiver>

Defines the received signal to be used for cal premeas.

This setting is channel- and port-specific.

Suffix:

<Ch> Channel number

<Pt> Port number

Parameters:

<CPRReceiver> 'A1' | 'B1' | 'A2' | ... (string parameter)

Manual operation: See "[Meas Port/Meas Receiver \(table area\)](#)" on page 532

SOURce<Ch>:POWER<Pt>:CPRemeas[:STATe] <Boolean>

Enables cal premeas for port <Pt> in channel <Ch>.

Only takes effect, if cal premeas is enabled for channel <Ch> ([SOURce<Ch>:POWER:CPRemeas:CSTate ON](#)).

Suffix:

<Ch> Channel number

<Pt> Port number

Parameters:

<Boolean> ON (1) | OFF (0)

*RST: OFF (0)

Manual operation: See "[Cal Premeas On \(table area\)](#)" on page 532

7.3.15.12 SOURce:POWER... (other)

The [SOURce:POWER...](#) commands define the power of the internal signal source.

SOURce<Ch>:POWER<PhyPt>:ATTenuation	1581
SOURce<Ch>:POWER<PhyPt>:CONVerter:OFFSet	1581
SOURce<Ch>:POWER<PhyPt>:CORRection:GENerator<Gen>:LEVel:OFFSet	1582
SOURce<Ch>:POWER<PhyPt>:CORRection:LEVel:OFFSet	1583
SOURce<Ch>:POWER<Pt>:EATTenuation	1583
SOURce<Ch>:POWER<Pt>:EATTenuation:MODE	1584
SOURce<Ch>:POWER<PhyPt>:GENerator<Gen>:OFFSet	1584
SOURce<Ch>:POWER<PhyPt>:GENerator<Gen>:PERManent[:STATe]	1585
SOURce:POWER:GENerator:SDELay	1586
SOURce<Ch>:POWER<PhyPt>:GENerator<Gen>:STATe	1586
SOURce<Ch>:POWER<PhyPt>:GENerator<Gen>:LLIMit[:STATe]	1586
SOURce<Ch>:POWER<PhyPt>:GENerator<Gen>:LLIMit:VALue	1587
SOURce<Ch>:POWER<PhyPt>[:LEVel][:IMMEDIATE][:AMPLitude]	1587
SOURce<Ch>:POWER<PhyPt>[:LEVel][:IMMEDIATE]:LLIMit[:STATe]	1588
SOURce<Ch>:POWER<PhyPt>[:LEVel][:IMMEDIATE]:LLIMit:VALue	1588
SOURce<Ch>:POWER<PhyPt>[:LEVel][:IMMEDIATE]:OFFSet	1589
SOURce<Ch>:POWER<PhyPt>[:LEVel][:IMMEDIATE]:SLOPe	1590
SOURce<Ch>:POWER<PhyPt>:PERManent[:STATe]	1590
SOURce:POWER:REDuce:SDELay	1591
SOURce<Ch>:POWER<PhyPt>:REDuce[:STATe]	1591
SOURce<Ch>:POWER<PhyPt>:STATe	1592
SOURce<Ch>:POWER<PhyPt>:START	1592
SOURce<Ch>:POWER<PhyPt>:STOP	1592
SOURce:POWER:SWEEpend:MODE	1593
SOURce:POWER:SWEEpend:SDELay	1593

SOURce<Ch>:POWER<PhyPt>:ATTenuation <arg0>

Selects a fixed mechanical attenuation for the generated wave at test port no. <PhyPt>.

This command is only available if the R&S ZNA is equipped with mechanical source step attenuators (see [Chapter 4.7.29, "Source step attenuators"](#), on page 308).

Suffix:

<Ch> Channel number
 <PhyPt> Test port number of the analyzer.

Parameters:

<arg0> Attenuation factor for the generated wave.
 Range: Mechanical attenuation can be set from 0 to 70 dB, in steps of 10 dB.
 Increment: 10 dB
 *RST: 0 dB
 Default unit: dB

Example:

```
SOUR:POW -6
Set the internal source power for channel 1 to -6 dBm.
SOUR:POW2:ATT 10
Set the mechanical step attenuator for the wave transmitted at port 2 to 10 dB. The internal source power and the waves at the other test ports are not affected.
```

Options:

Manual operation: See ["Source Step Att."](#) on page 526

SOURce<Ch>:POWER<PhyPt>:CONverter:OFFSet <Value>, <Type>

Defines the power of a millimeter-wave converter, or its power offset relative to the channel power ([SOURce<Ch>:POWER<PhyPt>\[:LEVEL\]\[:IMMEDIATE\]\[:AMPLITUDE\]](#)).

Suffix:

<Ch> Channel number
 <PhyPt> Converter port number

Parameters:

<Value> Port-specific power or power offset, depending on the offset <Type>.
 Range: -300 dB to +300 dB (adjust to the converter's actual source power range and the test setup)
 *RST: 0 dB
 Default unit: dB
 <Type> ONLY | CPADd
 Offset type

ONLY

Only the port-specific power <Value> is used; the channel power is ignored.

(I.e. <Value> dB is added as an offset to 0 dBm)

CPADd

The port-specific power <Value> is added as an offset to the channel power.

*RST: CPADd

Options: R&S ZNA-K8

Manual operation: See "[Port Power Offset](#)" on page 631

SOURce<Ch>:POWER<PhyPt>:CORREction:GENerator<Gen>:LEVel:OFFSet
<Offset>

Specifies a gain (positive values) or an attenuation (negative values) in the signal path between the external generator and the calibrated reference plane. The value has no impact on the generator power.

Suffix:

<Ch> Calibrated channel number

<PhyPt> Calibrated port number. This suffix is ignored; the generator is selected via <Gen>.

<Gen> Generator number

Parameters:

<Offset> Gain or attenuation value

Range: -300 dB to +300 dB (adjust to the test setup)

Increment: 0.01 dB (other values are rounded)

*RST: 0 dB

Default unit: dB

Example:

Assume that a DUT requires a constant input power of +35 dBm at its port 2, and that the measurement path contains an amplifier with a 30 dB gain.

```
SYST:COMM:RDEV:GEN1:DEF 'Ext. Gen. 1', 'SME02', 'gpib0', '21'
```

Configure an R&S SME02 generator as external generator no. 1, assigning the name Ext. Gen. 1 and a GPIB address 21.

```
SOUR:POW:GEN1:OFFS 5, ONLY
```

Set the source power of generator no. 1 to +5 dBm.

```
SOUR:POW:CORR:GEN1:LEV:OFFS 30
```

Specify the gain of the amplifier in the signal path between the external generator and the input port of the DUT.

```
SOUR:POW:CORR:ACQ GEN,1
```

Perform a source power calibration using the external generator no. 1 as a source port and the target power of +35 dBm.

Manual operation: See "[Cal Power Offset](#)" on page 593

SOURce<Ch>:POWER<PhyPt>:CORREction:LEVel:OFFSet <Offset>

Specifies a gain (positive values) or an attenuation (negative values) in the signal path between the source port and the calibrated reference plane. The value has no impact on the source power.

Suffix:

<Ch> Calibrated channel number
 <PhyPt> Calibrated port number

Parameters:

<Offset> Gain or attenuation value
 Range: -300 dB to +300 dB (adjust to the test setup)
 Increment: 0.01 dB (other values are rounded)
 *RST: 0 dB
 Default unit: dB

Example:

Assume that a DUT requires a constant input power of +35 dBm at port 2, and that the measurement path contains an amplifier with a 30 dB gain.

```
*RST; SOUR:POW 0
```

Reset the instrument and set the internal source power (base channel power) for the default channel 1 to 0 dBm.

```
SOUR:POW2:OFFS 5, ONLY
```

Replace the source power at port 2 by +5 dBm. The powers at the remaining ports are not affected.

```
SOUR:POW2:CORR:LEV:OFFS 30
```

Specify the gain of the amplifier in the signal path between the analyzer port 2 and the input port of the DUT.

```
SOUR:POW:CORR:ACQ PORT, 2
```

Perform a source power calibration using port 2 as a source port and the target power of +35 dBm.

Manual operation: See "[Cal Power Offset](#)" on page 593

SOURce<Ch>:POWER<Pt>:EATTenuation <Manual EISourceAtt>

Defines the electronic source attenuation at port <Pt> in channel <Ch>. This setting will only take effect if `SOURce<Ch>:POWER<Pt>:EATTenuation:MODE` is set to `MANual`.

Suffix:

<Ch> Channel number
 <Pt> Port number

Parameters:

<Manual
 EISourceAtt> Supported attenuation values are 0 dB, 20 dB, and 40 dB.
 Default unit: dB

Manual operation: See "[El. Source Att.](#)" on page 676

SOURce<Ch>:POWER<Pt>:EATTenuation:MODE <ElSourceAttMode>

Defines how the electronic source attenuation of port <Pt> is selected in channel <Ch>.

Suffix:

<Ch> Channel number
 <Pt> Port number

Parameters:

<ElSourceAttMode> AUTO | MANual

AUTO

The firmware selects the suitable electronic attenuation value.

MANual

You can select the electronic attenuation value using

[SOURce<Ch>:POWER<Pt>:EATTenuation](#).

Manual operation: See "El. Source Att." on page 676

SOURce<Ch>:POWER<PhyPt>:GENerator<Gen>:OFFSet <Offset>, <Mode>

Defines the power of an external generator or its power offset relative to the channel power ([SOURce<Ch>:POWER<PhyPt>\[:LEVel\] \[:IMMediate\] \[:AMPLitude\]](#)).

Suffix:

<Ch> Channel number
 <PhyPt> Test port number of the analyzer. This suffix is ignored; the generator is selected via <Gen>.
 <Gen> Generator number

Parameters:

<Offset> Port-specific power offset
 Range: -300 dB to +300 dB (adjust to the generator's actual source power range and the test setup)
 Increment: 0.01 dB (other values are rounded)
 *RST: 0 dB
 Default unit: dB

<Mode> ONLY | CPADd
 ONLY - only the port-specific power is used; the channel power is ignored.
 CPADd - the port-specific power is added as an offset to the channel power.
 *RST: CPADd

Example: `*RST; SOUR:POW -6`
 Reset the instrument, activating a frequency sweep and set the internal source power (channel power) for the default channel 1 to -6 dBm.
`SYST:COMM:RDEV:GEN1:DEF 'Ext. Gen. 1', 'SME02', 'gpib0', '21';`
`SYST:COMM:RDEV:GEN2:DEF 'Ext. Gen. 2', 'SME02', 'gpib0', '22'`
 Configure an R&S SME02 generator as external generator no. 1, assigning the name "Ext. Gen. 1" and a GPIB address 21.
 Configure a second R&S SME02 generator, assigning the name "Ext. Gen. 2" and a GPIB address 22.
`SOUR:POW:GEN1:OFFS 6, ONLY; :SOUR:POW:GEN2:OFFS 6, CPAD`
 Set the source power of generator no. 1 to +6 dBm, the source power of generator no. 2 to 0 dBm.

Manual operation: See ["Port Power Offset"](#) on page 631

SOURce<Ch>:POWER<PhyPt>:GENerator<Gen>:PERMANent[:STATe] <Boolean>

Defines whether the external generator is available as an external signal source in the test setup. External generators are always on for all partial measurements.

Suffix:

<Ch> Channel number
 <PhyPt> Test port number of the analyzer. This suffix is ignored; the generator is selected via <Gen>.
 <Gen> Generator number

Parameters:

<Boolean> ON - generator no. <PhyPt> is available.
 OFF - generator is available only if a measurement result with a generator drive port is selected
 *RST: OFF

Example: `SYST:COMM:RDEV:GEN1:DEF 'Ext. Gen. 1', 'SME02', 'gpib0', '21'`
 Configure an R&S SME02 generator as external generator no. 1, assigning the name Ext. Gen. 1 and a GPIB address 21.
`SOUR:POW:GEN:PERM ON`
 Activate the generator as an external signal source.

Manual operation: See ["Source Gen"](#) on page 671

SOURce:POWer:GENerator:SDELay <SettlingDelay>

If external generators are used in the measurement, this defines the minimum settling delay before the external generators are considered to be ready, i.e. the time between setting the generator to the requested frequency and power and continuing with the measurement.

This is a global setting.

Parameters:

<SettlingDelay> Settling delay per sweep point.
Factory default is 10 μ s (= 10⁻⁵s).
Default unit: s

Manual operation: See ["External Generators > Minimum Settling Delay"](#) on page 869

SOURce<Ch>:POWer<PhyPt>:GENerator<Gen>:STATe <Boolean>

Turns an external generator numbered <Gen> on or off.

Suffix:

<Ch> Channel number
<PhyPt> Test port number of the analyzer. This suffix is ignored; the generator is selected via <Gen>.
<Gen> Generator number

Parameters:

<Boolean> ON | OFF - generator is on or off
*RST: ON

Example:

```
SYST:COMM:RDEV:GEN1:DEF 'Ext. Gen. 1', 'SME02',  
'gpib0', '21'
```

Configure an R&S SME02 generator as external generator no. 1, assigning the name "Ext. Gen. 1" and a GPIB address 21.

```
SOUR:POW:GEN:STAT OFF
```

Turn the external generator off. In the "Port Configuration" dialog, "RF Off" is checked for generator no. 1.

Manual operation: See ["Source RF Off"](#) on page 670

SOURce<Ch>:POWer<PhyPt>:GENerator<Gen>:LLIMit[:STATe] <arg0>

Enables or disables the limit for the source power of an external generator no. <Gen>. The limit is defined using

```
SOURce<Ch>:POWer<PhyPt>:GENerator<Gen>:LLIMit:VALue.
```

Suffix:

<Ch> Channel number. This suffix is ignored; the setting applies to all channels.

<PhyPt> Test port number of the analyzer. This suffix is ignored; the generator is selected via <Gen>.

<Gen> Generator number

Parameters:

<arg0> ON | OFF: Enable or disable the power limit.

*RST: The power limit settings are not changed after a *RST. The factory setting is OFF.

Example: See `SOURce<Ch>:POWER<PhyPt>[:LEVel][:IMMediate]:LLIMit:VALue` on page 1588

Manual operation: See "Port Power Limits" on page 869

SOURce<Ch>:POWER<PhyPt>:GENERator<Gen>:LLIMit:VALue <arg0>

Defines a limit for the source power of an external generator no. <Gen>. The limit must be enabled explicitly using

`SOURce<Ch>:POWER<PhyPt>:GENERator<Gen>:LLIMit[:STATE]`.

Suffix:

<Ch> Channel number. This suffix is ignored; the limit applies to all channels.

<PhyPt> Test port number of the analyzer. This suffix is ignored; the generator is selected via <Gen>.

<Gen> Generator number

Parameters:

<arg0> Limit for the generator power.

Range: Depending on the generator model.

Increment: 0.1-dB

*RST: The power limit is not changed after a *RST. The factory setting is 0 dBm.

Default unit: dBm

Example: See `SOURce<Ch>:POWER<PhyPt>[:LEVel][:IMMediate]:LLIMit:VALue` on page 1588

Manual operation: See "Port Power Limits" on page 869

SOURce<Ch>:POWER<PhyPt>[:LEVel][:IMMediate][:AMPLitude] <IntSourcePow>

Defines the power of the internal signal source (channel base power). The setting is valid for all sweep types, except power sweep.

Tip: Use `SOURce<Ch>:POWER<PhyPt>:START` and `SOURce<Ch>:POWER<PhyPt>:STOP` to define the sweep range for a power sweep.

Suffix:

<Ch> Channel number

<PhyPt> Test port number of the analyzer. This suffix is ignored because the selected channel base power applies to all source ports used in the active channel.
It is possible though to define a port-specific slope factor for the source power (`SOURce<Ch>:POWer<PhyPt>[:LEVel][:IMMediate]:SLOPe`) and a port-specific power offset (`SOURce<Ch>:POWer<PhyPt>[:LEVel][:IMMediate]:OFFSet`).

Parameters:

<IntSourcePow> Internal source power
Range: The usable power range is frequency-dependent; refer to the data sheet.
*RST: -10 dBm
Default unit: dBm

Example:

```
FUNC "XFR:POW:RAT B1, A2"
Activate a frequency sweep and select the ratio B1/A2 as measured parameter for channel and trace no. 1.
SOUR:POW -6
Set the internal source power for channel 1 to -6 dBm.
```

Manual operation: See "Power" on page 526

SOURce<Ch>:POWer<PhyPt>[:LEVel][:IMMediate]:LLIMit[:STATE] <arg0>

Enables or disables the limit for the source power at port no. <PhyPt>. The limit is defined using
`SOURce<Ch>:POWer<PhyPt>[:LEVel][:IMMediate]:LLIMit:VALue`.

Suffix:

<Ch> Channel number. This suffix is ignored; the setting applies to all channels.

<PhyPt> Test port number of the analyzer.

Parameters:

<arg0> ON | OFF: Enable or disable the power limit.
*RST: The power limit settings are not changed after a *RST. The factory setting is OFF.

Example: See `SOURce<Ch>:POWer<PhyPt>[:LEVel][:IMMediate]:LLIMit:VALue` on page 1588

Manual operation: See "Port Power Limits" on page 869

SOURce<Ch>:POWer<PhyPt>[:LEVel][:IMMediate]:LLIMit:VALue <arg0>

Defines a limit for the source power at port no. <PhyPt>. The limit must be enabled explicitly; see example.

Suffix:

<Ch> Channel number. This suffix is ignored; the limit applies to all channels.

<PhyPt> Test port number of the analyzer.

Parameters:

<arg0> Limit for the internal source power at port no. <PhyPt>.
 Range: -40 dBm to +10 dBm. The exact range depends on the analyzer model; refer to the data sheet.
 Increment: 0.1-dB
 *RST: The power limit is not changed after a *RST. The factory setting is 0 dBm.
 Default unit: dBm

Example:

```
SOUR:POW2:LLIM:VAL -10; STAT ON
```

Limit the analyzer source power at port 2 to -10 dBm and enable the source power limit.

```
SOUR:POW2:LLIM:DGR ON
```

Optimize the automatic level control (ALC) for additional connectors (option R&S ZVA-B16).

```
SYST:COMM:RDEV:GEN1:DEF 'Ext. Gen. 1', 'SME02', 'gpib0', '21'
```

Configure an R&S SME02 generator as external generator no. 1, assigning the name Ext. Gen. 1 and a GPIB address 21.

```
SOUR:POW3:GEN:LLIM:VAL -10; STAT ON
```

Limit the power of the external generator port 3 to -10 dBm and enable the source power limit.

Manual operation: See ["Port Power Limits"](#) on page 869

SOURce<Ch>:POWER<PhyPt>[:LEVel][:IMMEDIATE]:OFFSet <Offset>, <OffsetType>

Defines a port-specific source power or a power offset relative to the channel power (`SOURce<Ch>:POWER<PhyPt>[:LEVel][:IMMEDIATE][:AMPLitude]`). An additional "Cal Power Offset" can be defined via `SOURce<Ch>:POWER<PhyPt>:CORRection:LEVel:OFFSet`.

Suffix:

<Ch> Channel number

<PhyPt> Test port number of the analyzer

Parameters:

<Offset> Port-specific power offset
 Range: -300 dB to +300 dB (adjust to the analyzer's actual source power range and the test setup)
 Increment: 0.01 dB (other values are rounded)
 *RST: 0 dB
 Default unit: dB

<OffsetType>	ONLY CPADd ONLY - only the port-specific power is used; the channel power is ignored. CPADd - the port-specific power is added as an offset to the channel power. *RST: CPADd
Example:	*RST; SOUR:POW -6 Reset the instrument, activating a frequency sweep and set the internal source power (channel power) for the default channel 1 to -6 dBm. SOUR:POW1:OFFS 6, ONLY; SOUR:POW2:OFFS 6, CPAD Replace the source power at port 1 by +6 dBm, the source power at port 2 by 0 dBm. The powers at the remaining ports (if available) are not affected.
Manual operation:	See " Port Overview " on page 630

SOURce<Ch>:POWER<PhyPt>[:LEVel][:IMMediate]:SLOPe <Slope>

Defines a linear factor to modify the internal source power at port <PhyPt> as a function of the stimulus frequency.

Suffix:

<Ch>	Channel number
<PhyPt>	Test port number of the analyzer

Parameters:

<Slope>	Port-specific slope factor Range: -40 dB/GHz to +40 dB/GHz. The resulting power range over the entire frequency sweep must be within the power range of the analyzer; refer to the data sheet. Increment: 0.1-dB/GHz *RST: 0 dB/GHz Default unit: DB/GHZ
---------	----------------------------------------------------------------------------------------------------------------------------------------------------------------------------------------------------------------------------------------------------------------------

Example: See `SOURce<Ch>:POWER<PhyPt>[:LEVel][:IMMediate][:AMPLitude]`

Manual operation: See "[Slope](#)" on page 676

SOURce<Ch>:POWER<PhyPt>:PERMANent[:STATe] <Boolean>

Defines whether the source power is permanently on ("generator port").

Note:

If [External switch matrices](#) are part of the RF connection configuration, operation with more than one internal source is *not* supported. In this case only external generators can be used as permanent signal sources.

Suffix:	
<Ch>	Channel number
<PhyPt>	Test port number of the analyzer
Parameters:	
<Boolean>	ON - power at port <PhyPt> is permanently on. OFF - power is only on for the partial measurements that require the port as a drive port. *RST: OFF
Example:	SOUR:POW2:STAT ON Switch the RF power at port no. 2 on. SOUR:POW2:PERM ON Activate a permanent signal source.
Manual operation:	See " Source Gen " on page 671

SOURce:POWer:REDuce:SDELay <SettlingDelay>

Deprecated; superseded by [SOURce:POWer:SWEpend:SDELay](#)

If power reduction at sweep end is enabled ([SOURce<Ch>:POWer<PhyPt>:REDuce\[:STATe\] ON](#)) this defines the settling delay at subsequent sweep starts, i.e. the time between power-up and sweep start when a new sweep is requested.

This is a global setting.

Parameters:	
<SettlingDelay>	Settling delay Default unit: s
Example:	See SOURce:POWer:SWEpend:MODE on page 1593

SOURce<Ch>:POWer<PhyPt>:REDuce[:STATe] <ReduceAtSweepEnd>

Deprecated; superseded by [SOURce:POWer:SWEpend:MODE](#)

Enables/disables power reduction at sweep end.

This is a global setting.

Suffix:	
<Ch>	Channel number. This suffix is ignored; the setting is valid for all channels.
<PhyPt>	Physical port number. This suffix is ignored; the setting is valid for all ports.
Parameters:	
<ReduceAtSweepEnd>	OFF (default): at sweep end the output power of the sweep start is restored ON : at sweep end the output power of the driving port is reduced as if the channel base power was set to its minimum possible value

Example: See `SOURce:POWer:SWEpend:MODE`.
`REDuce:STATe OFF` is equivalent to `SWEpend:MODE AUTO`
`REDuce:STATe ON` is equivalent to `SWEpend:MODE REDuce`

SOURce<Ch>:POWer<PhyPt>:STATe <Boolean>

Turns the RF source power at a specified test port on or off.

Suffix:

<Ch> Channel number
 <PhyPt> Test port number of the analyzer

Parameters:

<Boolean> ON | OFF - turns the internal source power at the specified test port no. <PhyPt> on or off.

*RST: ON

Example: *RST; SOUR:POW -6
 Set the internal source power for channel 1 and all test ports to -6 dBm.
 SOUR:POW2:STAT?
 Query whether the source power at test port 2 is on. The analyzer returns a 1.

Manual operation: See "[Source RF Off](#)" on page 670

SOURce<Ch>:POWer<PhyPt>:STARt <StartPower>

SOURce<Ch>:POWer<PhyPt>:STOP <StopPower>

These commands define the start and stop powers for a power sweep. The values also define the left and right edges of a Cartesian diagram. A power sweep must be active (`[SENSE<Ch>:]SWEep:TYPE POWer`) to use these commands.

Suffix:

<Ch> Channel number
 <PhyPt> Test port number of the analyzer. This suffix is ignored because the selected power sweep range applies to all source ports used in the active channel.

Parameters:

<StopPower> Start or stop power of the sweep.
 Range: -150 dBm to +100 dBm. The usable power range is frequency-dependent; refer to the data sheet.

Increment: 0.01 dB

*RST: -25 dBm start power, 0 dBm stop power

Default unit: dBm

Example: SWE:TYPE POW
 Activate a power sweep.
 SOUR:POW:STAR -6; STOP 10
 Select a power sweep range between -6 dBm and +10 dBm.

Manual operation: See ["Start Power / Stop Power"](#) on page 523

Note: If the start power entered is greater than the current stop power (`SOURce<Ch>:POWer<PhyPt>:STOP`), the stop power is set to the start power plus the minimum power span (increment) of 0.01 dB.

If the stop power entered is smaller than the current start power (`SOURce<Ch>:POWer<PhyPt>:START`), the start power is set to the stop power minus the minimum power span of 0.01 dB.

SOURce:POWer:SWEepend:MODE <SweepEndModes>

Selects the power mode at sweep end.

This is a global setting.

Parameters:

<SweepEndModes> AUTO | REDuce | KEEP

AUTO: at sweep end restore the power at sweep start
 REDuce: at sweep end reduce the output power as if the channel base power was set to its minimum possible value
 KEEP: at sweep end keep the power at its current level

Example:

```
SOURce:POWer:SWEepend:MODE REDuce
```

Reduce power at sweep end.

```
SOURce:POWer:SWEepend:SDELay 0.01
```

Use a settling delay of 10 ms

```
SOURce:POWer:SWEepend:MODE AUTO
```

At sweep end, restore the power at sweep start

Manual operation: See ["Power Mode at Sweep End"](#) on page 869

SOURce:POWer:SWEepend:SDELay <SettlingDelay>

If sweep end mode REDuce or KEEP is active (see [SOURce:POWer:SWEepend:MODE](#)) this defines the settling delay at subsequent sweep starts, i.e. the time between power reset and sweep start when a new sweep is requested.

This is a global setting.

Parameters:

<SettlingDelay> Settling delay

Default unit: s

Manual operation: See ["Settling Delay / Reset Delay"](#) on page 869

7.3.15.13 SOURce:TDIFferential...

The `SOURce<Ch>:TDIFferential` allow you to configure the [True differential mode](#).

[SOURce<Ch>:TDIF\[:STATe\]](#)..... 1594

[SOURce<Ch>:TDIF:IMBalance:AMPLitude:LPORT](#)..... 1594

[SOURce<Ch>:TDIF:IMBalance:AMPLitude:START](#)..... 1595

SOURce<Ch>:TDIF:IMBalance:AMPLitude:STOP	1595
SOURce<Ch>:TDIF:IMBalance:PHASe:LPORT	1596
SOURce<Ch>:TDIF:IMBalance:PHASe:START	1596
SOURce<Ch>:TDIF:IMBalance:PHASe:STOP	1596

SOURce<Ch>:TDIF[:STATE] <TruDi state>

Switches the [True differential mode](#) on or off. This command is available only if a suitable balanced port configuration is active.

Suffix:

<Ch> Channel number.

Parameters:

<TruDi state> True differential mode ON or OFF

*RST: OFF

Example:

```
*RST; SOUR:LPORT 1,3
```

Reset the analyzer and combine the physical ports 1 and 3 to the logical port 1. Defining a balanced port configuration deletes the default trace.

```
SOUR:TDIF ON
```

Switch true differential mode on.

```
CALC:PAR:SDEF 'Trc1', 'BD1D2S'
```

Create a new trace to measure the differential received wave quantity bd1, using the single-ended analyzer port no. 2 as a source port.

Options: R&S ZNA-K61

Manual operation: See "[True Differential Mode](#)" on page 353

SOURce<Ch>:TDIF:IMBalance:AMPLitude:LPORT <lport no>

Selects balanced logical port <lport no> as the sweep port of an [amplitude imbalance sweep](#) [Amplitude imbalance and phase imbalance sweep](#) in true differential mode.

Use [\[SENSe<Ch>:\]SWEep:TYPE IAMplitude](#) to activate the amplitude imbalance sweep and [SOURce<Ch>:TDIF:IMBalance:AMPLitude:STOP START | STOP](#) to define its sweep range..

Suffix:

<Ch> Channel number.

Parameters:

<lport no> Logical port number of the balanced port. The balanced port must be defined using [SOURce<Ch>:LPORT<LogPt>](#) before it can be selected.

Range: Depending on the number of balanced ports defined.

- Example:** `*RST; SOUR:LPOR1 1,3`
 Reset the analyzer and combine the physical ports 1 and 3 to the logical port 1.
`SWE:TYPE IAMP; :SOUR:TDIF?`
 Select an amplitude imbalance sweep. This sweep type automatically activates the true differential mode (the query returns 1).
`CALC:TDIF:IMB:COMP ON`
 Use imbalance-compensated wave quantities to calculate S-parameters, ratios and derived quantities.
`SOUR:TDIF:IMB:AMPL:LPOR 1; STAR -20; STOP 0`
 Configure the amplitude imbalance sweep, selecting the logical port no. 1 and a swept power range between -20 dBm and 0 dBm at the physical port no. 3 (i.e. at the physical port with the highest port number that belongs to the selected logical port).
`CALC:PAR:SDEF 'Trc1', 'SDS12'`
 Create a new trace named 'Trc1' to measure the mixed mode S-parameter Sds12.
`DISP:TRAC:FEED 'Trc1'`
 Display the result
- Options:** R&S ZNA-K61
- Manual operation:** See "[Amplitude > Port / Start Power / Stop Power](#)" on page 706

SOURce<Ch>:TDIF:IMBalance:AMPLitude:START <arg0>
SOURce<Ch>:TDIF:IMBalance:AMPLitude:STOP <value>

Defines the start/stop power difference of an amplitude imbalance sweep. Applies to [source coherence mode](#) (`SOURce<Ch>:CMODE[:STATE] ON`) and [true differential mode](#) (`SOURce<Ch>:TDIF[:STATE] ON`).

In true differential mode, the settings only apply to the port selected using `SOURce<Ch>:TDIF:IMBalance:AMPLitude:LPORt`.

Use `[SENSe<Ch>:]SWEp:TYPE IAMPLitude` to activate amplitude imbalance sweep.

Suffix:
 <Ch> Channel number.

Parameters:
 <value> Start/stop power difference of an amplitude imbalance sweep

Example: See `SOURce<Ch>:TDIF:IMBalance:AMPLitude:LPORt` on page 1594

Options: R&S ZNA-K6

Manual operation: See "[Imb Start Phase, Imb Stop Phase / Imb Start Power, Imb Stop Power](#)" on page 524

SOURce<Ch>:TDIF:IMBalance:PHASe:LPORt <lport no>

Selects balanced logical port <lport no> as the sweep port of a [phase imbalance sweep](#) [Amplitude imbalance and phase imbalance sweep](#) in true differential mode.

Use [\[SENSe<Ch>:\]SWEp:TYPE IPHase](#) to activate the phase imbalance sweep and [SOURce<Ch>:TDIF:IMBalance:PHASe:STOP START | STOP](#) to define its sweep range.

Suffix:

<Ch> Channel number.

Parameters:

<lport no> Logical port number of the balanced port. The balanced port must be defined using [SOURce<Ch>:LPORt<LogPt>](#) before it can be selected.

Range: Depending on the number of balanced ports defined.

Example:

```
*RST; SOUR:LPOR1 1,3
```

Reset the analyzer and combine the physical ports 1 and 3 to the logical port 1.

```
SWE:TYPE IPH; :SOUR:TDIF?
```

Select a phase imbalance sweep. This sweep type automatically activates the true differential mode (the query returns 1).

```
SOUR:TDIF:IMB:PHAS:LPOR 1; STAR -20; STOP 0
```

Configure the phase imbalance sweep, selecting the logical port no. 1 and a swept phase range between -20 deg and 0 deg at the physical port no. 3 (i.e. at the physical port with the highest port number that belongs to the selected logical port).

```
CALC:PAR:SDEF 'Trc1', 'SDS12'
```

Create a new trace named 'Trc1' to measure the mixed mode S-parameter Sds12.

```
DISP:TRAC:FEED 'Trc1'
```

Display the result

Options: R&S ZNA-K61

Manual operation: See "[Phase > Port / Start Phase / Stop Phase](#)" on page 705

SOURce<Ch>:TDIF:IMBalance:PHASe:STARt <arg0>

SOURce<Ch>:TDIF:IMBalance:PHASe:STOP <arg0>

Defines the start/stop phase difference of a phase imbalance sweep. Applies to [source coherence mode](#) ([SOURce<Ch>:CMODE\[:STATe\] ON](#)) and [true differential mode](#) ([SOURce<Ch>:TDIF\[:STATe\] ON](#)).

In true differential mode, the settings only apply to the sweep port selected using [SOURce<Ch>:TDIF:IMBalance:AMPLitude:LPORt](#).

Use [\[SENSe<Ch>:\]SWEp:TYPE IPHase](#) to enable the phase imbalance sweep.

Suffix:	
<Ch>	Channel number.
Parameters:	
<arg0>	Start/stop phase difference of a phase imbalance sweep.
Example:	See SOURce<Ch>:TDIF:IMBalance:PHASe:LPORT on page 1596
Options:	R&S ZNA-K6
Manual operation:	See " Imb Start Phase, Imb Stop Phase / Imb Start Power, Imb Stop Power " on page 524

7.3.15.14 SOURce... (other)

SOURce<Ch>:COMBiner <Path>

Specifies how the lower and upper tone are combined for intermodulation and two-tone group delay measurements.

Suffix:
<Ch> Channel number

Parameters:
<Path> INTernal | EXTernal | B16external | COUPler

INTernal

The signals are combined using the [Internal combiner](#).

EXTernal

The test port signals are combined externally. The two-tone signal is available at the output of the combiner.

B16external

The source out signal (direct access) of the lower tone port and the signal of the upper tone test port are combined externally. The combined signal is fed to the source in (direct access) of the lower tone port and is available at the lower tone test port.

COUPler

With this configuration the signals of the lower tone and upper tone sources are combined using the directional coupler of the upper tone port. The combined signal is available at the lower tone test port.

Options:
R&S ZNA-K4 for intermodulation, R&S ZNA-K9 for two-tone group delay measurements
R&S ZNAXx-B16 for B16external and COUPler signal paths

Manual operation: See "[Combiner Type](#)" on page 384

SOURce<Ch>:LOTRack[:STATe] <Boolean>

Enables tracking of the (unknown) LO signal for two-tone group delay measurements (with wmbded LO).

Suffix:	
<Ch>	Channel number
Parameters:	
<Boolean>	ON OFF 0 1
Options:	R&S ZNA-K9
Manual operation:	See " Track LO " on page 690

SOURce<Ch>:LOTRack:DFRequency?

If LO tracking is active in channel <Ch> (`SOURce<Ch>:LOTRack[:STATe] ON`), this query gets the frequency difference between expected and measured LO frequency

Suffix:	
<Ch>	Channel number
Return values:	
<freq_diff>	Frequency difference
Usage:	Query only
Options:	R&S ZNA-K9
Manual operation:	See " Track LO " on page 690

SOURce<Ch>:LPORt<LogPt> <PhysicalPort>[, <PhysicalPort>]

Assigns the logical port number <LogPt> either to the single-ended physical port <PhysicalPort1> or to a pair of physical ports <PhysicalPort1>,<PhysicalPort2>, at the same time defining them as balanced port.

Important:

- All required logical ports (balanced and single ended) must be created explicitly.
- A balanced port configuration generally introduces a new set of mixed mode measured quantities. Therefore the traces must be redefined when a balanced port is created. To avoid any inconsistencies the analyzer deletes all traces when `SOURce<Ch>:LPORt<LogPt>` is used.
- It is essential to complete the logical port assignment before defining other port properties such as common or differential mode impedances: whenever a logical port is created using `SOURce<Ch>:LPORt<LogPt>`, the parameters of all existing logical ports are reset.

Suffix:	
<Ch>	Channel number.
<LogPt>	Identifying number of the newly created balanced or single-ended logical port. Must be between 1 and the number of physical ports (see INSTrument:TPORt:COUNt?). If unspecified the numeric suffix is set to 1.

Parameters:

<PhysicalPort> Number of first/only physical port
 Range: 1 to number of physical ports

<PhysicalPort> Number of second physical port (optional), forming a balanced port with the first physical port.
 The port numbers must be different. Moreover, a physical port cannot be assigned to several logical ports.
 Range: 1 to number of physical ports

Example:

```
*RST; :SOUR:LPOR1 1,2; :LPOR2 4; :LPOR3 3
```

Combine the physical ports 1 and 2 to the logical port 1 (balanced) and assign physical ports 4 and 3 to logical ports 2 and 3, respectively

```
SOUR:LPOR1?
```

Query the physical ports assigned to logical port no. 1. The response is 1, 2.

```
SOUR:GRO 1,2
```

Define logical ports no. 1 and 2 as used (group 1), port 3 as unused

```
SOUR:GRO?
```

Query the port group no. 1. The response is 1,2.

```
SOUR:GRO:CLE ALL; :SOUR:GRO?
```

Dissolve all port groups and repeat the query. The response is 1,n where n denotes the number of available test ports.

```
SOUR:LPOR:CLE ALL
```

```
SOUR:LPOR1?
```

Dissolve all logical ports and repeat the query. The response is 1: the logical port no. 1 is identical to the physical port no. 1.

Example:

```
SOUR:GRO:PORT 1,3
```

Define logical ports no. 1 and 3 as used (group 1), logical ports 2 and 4 as unused

```
SOUR:GRO?
```

Query the port group no. 1. The response is 1,3.

```
SOUR:GRO:CLE; :SOUR:GRO?
```

Dissolve port group 1 and repeat the query. The response is again 1,n (all logical ports used).

Manual operation: See "[Select Predefined Port](#)" on page 353

SOURce<Ch>:LPORt<LogPt>:CLEar [<Scope>]

Dissolves balanced port <LogPt> or all logical ports.

Suffix:

<Ch> Channel number

<LogPt> Logical port number used to number balanced ports. Range according to the current port configuration (`SOURce<Ch>:LPORT<LogPt>`). If an undefined balanced port number is used, the analyzer generates an error message. Exception: Parameter ALL, see below.

Setting parameters:

<Scope> ALL
If ALL is specified, all logical ports are dissolved; the <log_port> suffix is ignored. If ALL is omitted, only the specified balanced port is dissolved.

Example: See `SOURce<Ch>:LPORT<LogPt>`

Usage: Setting only

Manual operation: See "[Select Predefined Port](#)" on page 353

SOURce<Ch>:NFIGure:CALibration:TPOWER <SourcePowNfigCalExtAtt>

Suffix:

<Ch>

Parameters:

<SourcePowNfigCalExtAtt> Default unit: dBm

Options: R&S ZNA-K30

Manual operation: See "[Src Power Thru Meas](#)" on page 595

SOURce<Ch>:NFIGure:CALibration:TPOWER:STATE <Boolean>

Suffix:

<Ch>

Parameters:

<Boolean>

Options: R&S ZNA-K30

Manual operation: See "[Src Power Thru Meas](#)" on page 595

SOURce<Ch>:PATH<Pt>:DIRectaccess <Path>

Same functionality as `[SENSe<Ch>:]PATH<Pt>:DIRectaccess`.

Suffix:

<Ch> Channel number

<Pt> Port number

Parameters:

<Path> NONE | B16 | REV | SRC

Direct access signal path

Manual operation: See "Receiver Input" on page 678

7.3.16 STATus commands

The `STATus:...` commands control the status reporting system. Status registers are not reset by `*RST`; use `*CLS` for this purpose.

<code>STATus:PRESet</code>	1601
<code>STATus:QUEStionable:CONDition?</code>	1602
<code>STATus:QUEStionable:INTegrity:CONDition?</code>	1602
<code>STATus:QUEStionable:INTegrity:HARDware:CONDition?</code>	1602
<code>STATus:QUEStionable:LIMit<Lev>:CONDition?</code>	1602
<code>STATus:QUEStionable:ENABle</code>	1602
<code>STATus:QUEStionable:INTegrity:ENABle</code>	1602
<code>STATus:QUEStionable:INTegrity:HARDware:ENABle</code>	1602
<code>STATus:QUEStionable:LIMit<Lev>:ENABle</code>	1602
<code>STATus:QUEStionable[:EVENT]?</code>	1602
<code>STATus:QUEStionable:INTegrity[:EVENT]?</code>	1602
<code>STATus:QUEStionable:INTegrity:HARDware[:EVENT]?</code>	1602
<code>STATus:QUEStionable:LIMit<Lev>[:EVENT]?</code>	1602
<code>STATus:QUEStionable:NTRansition</code>	1603
<code>STATus:QUEStionable:INTegrity:NTRansition</code>	1603
<code>STATus:QUEStionable:INTegrity:HARDware:NTRansition</code>	1603
<code>STATus:QUEStionable:LIMit<Lev>:NTRansition</code>	1603
<code>STATus:QUEStionable:PTRansition</code>	1603
<code>STATus:QUEStionable:INTegrity:PTRansition</code>	1603
<code>STATus:QUEStionable:INTegrity:HARDware:PTRansition</code>	1603
<code>STATus:QUEStionable:LIMit<Lev>:PTRansition</code>	1603
<code>STATus:QUEue[:NEXT]?</code>	1604

STATus:PRESet

Configures the status reporting system such that device-dependent events are reported at a higher level.

The command affects only the transition filter registers, the `ENABle` registers, and queue enabling:

- The `ENABle` parts of the `STATus:OPERation` and `STATus:QUEStionable...` registers are set to all 1's.
- The `PTRansition` parts are set all 1's, the `NTRansition` parts are set to all 0's, so that only positive transitions in the `CONDition` part are recognized.

The status reporting system is also affected by other commands, see [Chapter 6.5.5, "Reset values of the status reporting system"](#), on page 966.

Example: `STAT:PRESet`
Preset the status registers.

Usage: Event

STATus:QUESTionable:CONDition?
STATus:QUESTionable:INTegrity:CONDition?
STATus:QUESTionable:INTegrity:HARDware:CONDition?
STATus:QUESTionable:LIMit<Lev>:CONDition?

Returns the contents of the `CONDition` part of the `QUESTionable...` registers. Reading the `CONDition` registers is nondestructive.

Suffix:

<Lev> Selects one of the two `QUESTionable:LIMit` registers; see "[STATus:QUESTionable:LIMit<1|2>](#)" on page 960.

Example:

`STAT:QUES:LIMit:COND?`
 Query the `CONDition` part of the `QUESTionable:LIMit1` register to retrieve the current status of the limit check.

Usage:

Query only

STATus:QUESTionable:ENABLE <BitPattern>
STATus:QUESTionable:INTegrity:ENABLE <BitPattern>
STATus:QUESTionable:INTegrity:HARDware:ENABLE <BitPattern>
STATus:QUESTionable:LIMit<Lev>:ENABLE <BitPattern>

Sets the enable mask which allows true conditions in the `EVENT` part of the `QUESTionable...` registers to be reported in the summary bit. If a bit is 1 in the enable register and its associated event bit transitions to true, a positive transition will occur in the summary bit (e.g. bit 10 of the `QUESTionable` register for the `LIMit1` register, bit 0 of the `LIMit1` register for the `LIMit2` register).

See also [Chapter 6.5.1, "Overview of status registers"](#), on page 954 and [Chapter 6.5.5, "Reset values of the status reporting system"](#), on page 966.

Suffix:

<Lev> Selects one of the two `QUESTionable:LIMit` registers; see "[STATus:QUESTionable:LIMit<1|2>](#)" on page 960.

Parameters:

<BitPattern> Range: 0 to 65535 (decimal representation)
 *RST: n/a

Example:

`STAT:QUES:LIM2:ENAB 6`
 Set bits no. 1 and 2 of the `QUESTionable:LIMit2:ENABLE` register

STATus:QUESTionable[:EVENT]?
STATus:QUESTionable:INTegrity[:EVENT]?
STATus:QUESTionable:INTegrity:HARDware[:EVENT]?
STATus:QUESTionable:LIMit<Lev>[:EVENT]?

These commands return the contents of the `EVENT` parts of the `QUESTionable`, `QUESTionable:INTegrity`, `QUESTionable:INTegrity:HARDware`, and `QUESTionable:LIMit<Lev>` status registers. Reading an `EVENT` register clears it.

Suffix:	
<Lev>	Selects one of the two <code>QUESTionable:LIMit</code> registers; see " STATus:QUESTionable:LIMit<1 2> " on page 960.
Example:	<pre>STAT:QUES:LIM1?</pre> <p>Query the <code>EVENT</code> part of the <code>QUESTionable:LIMit1</code> register to check whether an event has occurred since the last reading.</p>
Usage:	Query only

STATus:QUESTionable:NTRansition <BitPattern>
STATus:QUESTionable:INTEgrity:NTRansition <BitPattern>
STATus:QUESTionable:INTEgrity:HARDware:NTRansition <BitPattern>
STATus:QUESTionable:LIMit<Lev>:NTRansition <BitPattern>

Sets the negative transition filters of the `QUESTionable...` status registers. If a bit is set, a 1 to 0 transition in the corresponding bit of the associated condition register causes a 1 to be written in the associated bit of the corresponding event register.

Suffix:

<Lev> Selects one of the two `QUESTionable:LIMit` registers; see "[STATus:QUESTionable:LIMit<1|2>](#)" on page 960.

Parameters:

<BitPattern> Range: 0 to 65535 (decimal representation)
 *RST: n/a

Example:

```
STAT:QUES:LIM2:NTR 6
```

Set bits no. 1 and 2 of the `QUESTionable:LIMit2:NTRansition` register

STATus:QUESTionable:PTRansition <BitPattern>
STATus:QUESTionable:INTEgrity:PTRansition <BitPattern>
STATus:QUESTionable:INTEgrity:HARDware:PTRansition <BitPattern>
STATus:QUESTionable:LIMit<Lev>:PTRansition <BitPattern>

Configures the positive transition filters of the `QUESTionable...` status registers. If a bit is set, a 0 to 1 transition in the corresponding bit of the associated condition register causes a 1 to be written in the associated bit of the corresponding event register.

See also [Chapter 6.5.5, "Reset values of the status reporting system"](#), on page 966.

Suffix:

<Lev> Selects one of the two `QUESTionable:LIMit` registers; see "[STATus:QUESTionable:LIMit<1|2>](#)" on page 960.

Parameters:

<BitPattern> Range: 0 to 65535 (decimal representation)
 *RST: n/a

Example:

```
STAT:QUES:LIM2:PTR 6
```

Set bits no. 1 and 2 of the `QUESTionable:LIMit2:PTRansition` register

STATus:QUEue[:NEXT]?

Queries and at the same time deletes the oldest entry in the error queue. Operation is identical to that of `SYSTem:ERRor[:NEXT]?`.

The entry consists of an error number and a short description of the error. Positive error numbers are instrument-dependent. Negative error numbers are reserved by the SCPI standard; see section [Chapter 9, "Error messages and troubleshooting"](#), on page 1766.

Example: `STAT:QUE?`
 Query the oldest entry in the error queue. 0, "No error" is returned if the error queue is empty.

Usage: Query only

7.3.17 SYSTem commands

The `SYSTem...` commands provide functions that are not related to instrument performance, such as functions for general housekeeping and functions related to global configurations.

7.3.17.1 SYSTem:COMMunicate...

The `SYSTem:COMMunicate...` commands provide remote control settings and configure remote (external) devices controlled by the R&S ZNA.

<code>SYSTem:COMMunicate:AKAL:CONNectioN</code>	1605
<code>SYSTem:COMMunicate:AKAL:MMEMory[:STATe]</code>	1606
<code>SYSTem:COMMunicate:CODec</code>	1606
<code>SYSTem:COMMunicate:GPIB[:SELF]:ADDRess</code>	1606
<code>SYSTem:COMMunicate:GPIB[:SELF]:DClear:SUPPress</code>	1607
<code>SYSTem:COMMunicate:GPIB[:SELF]:INIT:WAIT</code>	1607
<code>SYSTem:COMMunicate:GPIB[:SELF]:LPORt:ALIGN</code>	1607
<code>SYSTem:COMMunicate:GPIB[:SELF]:RTERminator</code>	1608
<code>SYSTem:COMMunicate:NET:HOSTName</code>	1608
<code>SYSTem:COMMunicate:RDEvice:AKAL:ADDRess</code>	1608
<code>SYSTem:COMMunicate:RDEvice:AKAL:ADDRess:ALL?</code>	1609
<code>SYSTem:COMMunicate:RDEvice:AKAL:ADDRess:SUBModule:ALL?</code>	1609
<code>SYSTem:COMMunicate:RDEvice:AKAL:CKIT</code>	1609
<code>SYSTem:COMMunicate:RDEvice:AKAL:CKIT:CATalog?</code>	1610
<code>SYSTem:COMMunicate:RDEvice:AKAL:CKIT:STANdard:CATalog?</code>	1611
<code>SYSTem:COMMunicate:RDEvice:AKAL:DATE?</code>	1612
<code>SYSTem:COMMunicate:RDEvice:AKAL:FRANge?</code>	1612
<code>SYSTem:COMMunicate:RDEvice:AKAL:PORtS?</code>	1613
<code>SYSTem:COMMunicate:RDEvice:AKAL:PREdUction[:STATe]</code>	1613
<code>SYSTem:COMMunicate:RDEvice:AKAL:SDATa?</code>	1613
<code>SYSTem:COMMunicate:RDEvice:AKAL:WARMup[:STATe]?</code>	1614
<code>SYSTem:COMMunicate:RDEvice:GDEvice:CATalog?</code>	1614
<code>SYSTem:COMMunicate:RDEvice:GDEvice<Gdev>:DEFine</code>	1615

SYSTem:COMMunicate:RDEvice:GDEvice:DELeTe:ALL.....	1615
SYSTem:COMMunicate:RDEvice:GDEvice<Gdev>:DELeTe.....	1616
SYSTem:COMMunicate:RDEvice:GENerator<Gen>:CATalog?.....	1616
SYSTem:COMMunicate:RDEvice:GENerator:COUNT?.....	1617
SYSTem:COMMunicate:RDEvice:GENerator<Gen>:DEFine.....	1617
SYSTem:COMMunicate:RDEvice:GENerator:DELeTe.....	1618
SYSTem:COMMunicate:RDEvice:GENerator<Gen>:SEPMode.....	1618
SYSTem:COMMunicate:RDEvice:GENerator<Gen>:SEPower.....	1619
SYSTem:COMMunicate:RDEvice:PMETer<Pmtr>:AZERo.....	1619
SYSTem:COMMunicate:RDEvice:PMETer:CATalog?.....	1619
SYSTem:COMMunicate:RDEvice:PMETer:CONFigure:AUTO[:STATe].....	1620
SYSTem:COMMunicate:RDEvice:PMETer:COUNT?.....	1620
SYSTem:COMMunicate:RDEvice:PMETer<Pmtr>:DEFine.....	1620
SYSTem:COMMunicate:RDEvice:PMETer:DELeTe.....	1621
SYSTem:COMMunicate:RDEvice:PMETer<Pmtr>:SPCorrection[:STATe].....	1622
SYSTem:COMMunicate:RDEvice:SMATrix<Matr>:CATalog?.....	1622
SYSTem:COMMunicate:RDEvice:SMATrix:CONFigure:ABORt.....	1622
SYSTem:COMMunicate:RDEvice:SMATrix:CONFigure:END.....	1623
SYSTem:COMMunicate:RDEvice:SMATrix:CONFigure:STARt.....	1623
SYSTem:COMMunicate:RDEvice:SMATrix:CONFigure:TVNA.....	1625
SYSTem:COMMunicate:RDEvice:SMATrix<Matr>:CONFigure:MLVNa.....	1625
SYSTem:COMMunicate:RDEvice:SMATrix<Matr>:CONFigure:MLTest.....	1626
SYSTem:COMMunicate:RDEvice:SMATrix<Matr>:CONFigure:MTESt.....	1626
SYSTem:COMMunicate:RDEvice:SMATrix<Matr>:CONFigure:MVNA.....	1627
SYSTem:COMMunicate:RDEvice:SMATrix:COUNT?.....	1627
SYSTem:COMMunicate:RDEvice:SMATrix<Matr>:DEFine.....	1627
SYSTem:COMMunicate:RDEvice:SMATrix:DELeTe.....	1628
SYSTem:COMMunicate:RDEvice:SMATrix<Matr>:RELays:SWITCh:COUNT?.....	1629
SYSTem:COMMunicate:RDEvice:SMATrix:SCAN?.....	1629
SYSTem:COMMunicate:RDEvice:SMATrix<Matr>:SERial?.....	1629

SYSTem:COMMunicate:AKAL:CONNECTION <CalStandard>, <Port>[,
<SecondPort>[, <CalkitIndex>]]

Connects the selected calibration standard to one or two ports of the active calibration unit (see [SYSTem:COMMunicate:RDEvice:AKAL:ADDRESS](#)).

Setting parameters:

<CalStandard>	THROugh OPEN SHORt MATCh Connected one or two-port standard
<Port>	Port number of the calibration unit, for one and two-port standards.
<SecondPort>	Second port number of the calibration unit. For two-port standards (THROugh) this parameter must be provided, for one-port standards (OPEN SHORt MATCh) it must be omitted.

<CalkitIndex> For calibration units that are equipped with more than one calibration kit, this parameter indicates the 1-based index of the calibration kit to be used (mandatory!).
For other calibration units, this parameter is optional, but if it is provided, it must be set to 1.

Example: `SYST:COMM:AKAL:CONN THR, 1, 2`
Connect a through standard between ports 1 and 2 of the calibration unit.

Usage: Setting only

SYSTem:COMMunicate:AKAL:MMEMory[:STATe] <Boolean>

Shows or hides the memory of the active calibration unit (see [SYSTem:COMMunicate:RDEvice:AKAL:ADDRess](#)).

Setting parameters:

<Boolean> ON - memory is shown in a separate drive.
OFF - memory is not shown.
***RST:** OFF

Example: `SYST:COMM:AKAL:MMEM ON`
Show the memory of the active calibration unit.

Usage: Setting only

SYSTem:COMMunicate:CODec <Codec>

Selects the character encoding used at the remote interface. The selected encoding applies to directory and file names, CalKit names, CalUnit characterizations and display titles.

Parameters:

<Codec> ASCII | UTF8 | SJIS
ASCII: 8-bit ANSI (default)
UTF8: UTF-8
SJIS: Shift JIS

Manual operation: See "[Remote Encoding](#)" on page 855

SYSTem:COMMunicate:GPIB[:SELF]:ADDRess <GBIBAddress>

Sets the GPIB address of the analyzer.

Parameters:

<GBIBAddress> GPIB address (integer number)
Range: 0 to 30

Example: `SYST:COMM:GPIB:ADDR 10`
 Set the GPIB address to 10.
`*RST; :SYST:COMM:GPIB:ADDR?`
 After a reset, the address is maintained (the response is 10).

Manual operation: See "[GPIB Address](#)" on page 888

SYSTem:COMMunicate:GPIB[:SELf]:DCLear:SUppress <Boolean>

Suppresses/unsuppresses of Device Clear GPIB interface messages (DCL, SDC).

Parameters:

<Boolean>

Manual operation: See "[GPIB Address](#)" on page 888

SYSTem:COMMunicate:GPIB[:SELf]:INIT:WAIT <Boolean>

Determines/queries the execution behavior of `INITiate[:IMMediate]` commands (see [Chapter 7.3.8, "INITiate commands"](#), on page 1265).

If set to ON, an automatic `*WAI` is added (see [Chapter 7.2, "Common commands"](#), on page 970), i.e. the commands execute synchronously.

Parameters:

<Boolean> `*RST: OFF`

Manual operation: See "[Advanced ...](#)" on page 890

SYSTem:COMMunicate:GPIB[:SELf]:LPORt:ALIGn <Boolean>

Configures/queries the logical port creation.

If set to ON, logical ports are aligned and must be set from low to high port, which was the only possibility prior to firmware V1.90. If set to OFF, new ports can be created freely, like in manual operation. See the example below.

Parameters:

<Boolean> `*RST: ON`

Example: Starting with a 4-port analyzer's default logical port assignment
`L1<-->P1, L2<-->P2, L3<-->P3, L4<-->P4,`
 the remote command
`SOUR:LPOR1 1,2`
 by default (`ALIGn=ON`) generates aligned logical ports
`L1<-->P1&P2, L2<-->P3, L3<-->P4.`
 With `ALIGn=OFF`, the result is
`L1<-->P1&P2, L3<-->P3, L4<-->P4`
 and L2 does not exist.

Manual operation: See "[Advanced ...](#)" on page 890

SYSTem:COMMunicate:GPIB[:SELF]:RTERminator <Terminator>

Sets the receive terminator of the analyzer. The receive terminator indicates the end of a command or a data block.

The receive terminator setting is relevant if block data is transferred to the analyzer (**FORMat [:DATA] REAL**). In the default setting **LFEoi**, the analyzer recognizes an LF character sequence with or without the EOI control bus message as a receive terminator. An accidental LF in a data block can be recognized as a terminator and cause an interruption of the data transfer.

The EOI setting is especially important if commands are transferred in block data format, because it ensures that the parser for command decoding is activated by the terminator only after the command has been completely transferred. Readout of binary data does not require a change of the receive terminator.

Parameters:

<Terminator>

LFEoi | EOI

LFEoi

A line feed character sequence with or without EOI is recognized as receive terminator

EOI

Only EOI is recognized as receive terminator

Example:

```
SYST:COMM:GPIB:RTER EOI
```

Set the terminator to EOI.

SYSTem:COMMunicate:NET:HOSTname <HostName>

Sets or gets the host name of the instrument.

Parameters:

<HostName>

Host name

*RST: A preset of the instrument doesn't change the host name.

SYSTem:COMMunicate:RDEvice:AKAL:ADDRess <Address>

Selects one of the USB-connected calibration units for calibration (see commands **SENSe<Ch>:CORRection:COLLect:AUTO...**). This command is not necessary if only one cal unit is connected.

Parameters:

<Address>

Name (USB address) of a connected calibration unit (string variable). The names of all connected cal units can be queried using **SYSTem:COMMunicate:RDEvice:AKAL:ADDRess:ALL?**.

Example: `SYST:COMM:RDEV:AKAL:ADDR:ALL?`
 Query the names of all connected calibration units.
`SYST:COMM:RDEV:AKAL:ADDR 'ZV-Z52::1234'`
 Select the cal unit named 'ZV-Z52::1234' for calibration.
`CORR:COLL:AUTO ', 1, 2, 4`
 Perform an automatic 3-port TOSM calibration at test ports 1, 2, and 4 using the calibration unit's default calibration kit file and arbitrary test ports of the cal unit.

Manual operation: See "[Calibration Unit](#)" on page 622

SYSTem:COMMunicate:RDEvice:AKAL:ADDRess:ALL?

Queries the names (USB addresses) of all connected calibration units.

Example: See `SYSTem:COMMunicate:RDEvice:AKAL:ADDRess`

Usage: Query only

Manual operation: See "[Calibration Unit](#)" on page 622

SYSTem:COMMunicate:RDEvice:AKAL:ADDRess:SUBModule:ALL?

If the calibration unit selected using `SYSTem:COMMunicate:RDEvice:AKAL:ADDRess` is an [inline calibration system](#) (ICS), this query returns the addresses of the connected ICUs. Otherwise it returns the empty string.

Example: `:SYSTem:COMMunicate:RDEvice:AKAL:ADDRess 'ZN-Z30-02::100010'`
 Selects an ICS via its Inline Calibration Controller (ICC) R&S ZN-Z30 (serial number 100010).
`SYSTem:COMMunicate:RDEvice:AKAL:ADDRess:SUBModule:ALL?`
 Returns something like:
`' [1] ZN-Z33-02::101325, [2] ZN-Z33-02::101325, [3] ZN-Z33-02::101339'`
 i.e. there are three ICUs of type R&S ZN-Z32 variant 02 connected to the ICC. For correct port assignment during calibration, the ICU with serial number 101325 is considered port 1, 101325 port 2, and 101339 port 3 of the ICS.

Usage: Query only

Manual operation: See "[Configured Devices](#)" on page 927

SYSTem:COMMunicate:RDEvice:AKAL:CKIT <Characterization>

If the calibration unit selected using `SYSTem:COMMunicate:RDEvice:AKAL:ADDRess` is an [inline calibration unit](#) (ICU), this command sets/queries the characterization to be used for calibrations with this ICU.

Parameters:**<Characterization>** Name of a characterization of the related ICU**Example:**

```
// Select the ICS
SYSTem:COMMunicate:RDEvice:AKAL:ADDRESS 'ZN-Z30-02::100010'
// Query for the connected ICUs
SYSTem:COMMunicate:RDEvice:AKAL:ADDRESS:SUBModule:ALL?
// '[1]ZN-Z33-02::101325, [2]ZN-Z33-02::101336, [3]ZN-Z33-02::101339'
// Activate ICU[1]
SYSTem:COMMunicate:RDEvice:AKAL:ADDRESS 'ZN-Z33-02::101336'
// Query the available characterizations
:SYSTem:COMMunicate:RDEvice:AKAL:CKIT:CATalog?
// 'Factory,afterAwhile'
// Select the non-factory characterization
:SYSTem:COMMunicate:RDEvice:AKAL:CKIT 'afterAwhile'
// Query the active characterization
:SYSTem:COMMunicate:RDEvice:AKAL:CKIT?
// 'ZN-Z33-02::101336=afterAwhile'
```

Manual operation: See "[Characterization](#)" on page 587**SYSTem:COMMunicate:RDEvice:AKAL:CKIT:CATalog?**

Queries all characterizations (cal kit files) which are stored on the connected calibration unit, either on the calibration unit's internal (flash) memory or on an SD card inserted at the calibration unit (prefix: "SD"). A possible response is 'Factory,ZN-Z51_custom,Throughs,SD:test'. The factory characterization is always available; an empty string denotes that no calibration unit is connected.

If several cal units are USB-connected to the analyzer, the command queries the cal unit selected via [SYSTem:COMMunicate:RDEvice:AKAL:ADDRESS](#).

Example:

```
SYST:COMM:RDEV:AKAL:ADDR:ALL?
```

Query the names of all connected calibration units.

```
SYST:COMM:RDEV:AKAL:ADDR 'ZN-Z51::1234'
```

Select the cal unit named 'ZN-Z51::1234'.

```
SYSTem:COMMunicate:RDEvice:AKAL:CKIT:CATalog?
```

Query all characterizations stored on the connected calibration unit.

```
SYSTem:COMMunicate:RDEvice:AKAL:SDATa?
```

```
'My_calkit', OPEN, S11, 1
```

Query the characterization data for the characterization named 'My_calkit' and an open standard (one-port, port restriction). A characterization with the queried properties must be available on the cal unit.

```
SYSTem:COMMunicate:RDEvice:AKAL:WARMup?
```

Query the warmup status of the calibration unit.

```
SYSTem:COMMunicate:RDEvice:AKAL:DATE? 'Factory'
```

Query the creation date of the factory calibration.

```
SYSTem:COMMunicate:RDEvice:AKAL:FRANge?
```

```
'Factory'
```

Query the frequency range of the factory calibration.

```
SYSTem:COMMunicate:RDEvice:AKAL:PORTs?
```

```
'Factory'
```

Query the port assignment of the factory calibration.

```
SYSTem:COMMunicate:RDEvice:AKAL:CKIT:STANdard:CATalog? 'Factory'
```

Query the standards of the factory calibration. Possible response:

```
'MOP (P1) , MSH (P1) , MMT (P1) , MOP (P2) , MSH (P2) ,
```

```
MMT (P2) ' – denotes an Open (m), Short (m) and Match (m)
```

standard at each of the ports 1 and 2.

Usage:

Query only

Manual operation: See "[Characterization](#)" on page 587

SYSTem:COMMunicate:RDEvice:AKAL:CKIT:STANdard:CATalog? <CalKitName>

Queries all calibration standards of a characterization (calkit file) that is stored on a connected calibration unit, either on the calibration unit's internal (flash) memory or on an SD card inserted at the calibration unit (if available). The query [SYSTem:COMMunicate:RDEvice:AKAL:CKIT:CATalog?](#) returns the names of the cal kit files. The factory characterization is always available.

Query parameters:

<CalKitName>

Name of the calkit file, string parameter.

'Factory' denotes the factory characterization, the prefix

"SD:" indicates that the characterization is stored on an SD card inserted at the calibration unit.

Example:

See [SYSTem:COMMunicate:RDEvice:AKAL:CKIT:CATalog?](#)

Usage: Query only

Manual operation: See "[Characterization](#)" on page 587

SYSTem:COMMunicate:RDEvice:AKAL:DATE? <CalKitName>

Queries the creation date and time of the cal unit characterization (calkit file) <CalKitName>. A possible response is 'Friday, May 26, 2011, 10:13:40'. An empty string is returned if no calibration unit is connected.

If several cal units are USB-connected to the analyzer, the command queries the cal unit selected via [SYSTem:COMMunicate:RDEvice:AKAL:ADDRess](#).

Query parameters:

CalKitName String parameter containing the name of a cal unit characterization (calkit file).
'Factory' denotes the factory characterization; an empty string ' ' refers to the last referenced characterization; the prefix "SD:" indicates that the characterization is stored on an SD card inserted at the calibration unit.

Example: See [SYSTem:COMMunicate:RDEvice:AKAL:CKIT:CATalog?](#)

Usage: Query only

Manual operation: See "[Characterization](#)" on page 587

SYSTem:COMMunicate:RDEvice:AKAL:FRANge? <CalKitName>

Queries the frequency range of the cal unit characterization (calkit file) <CalKitName>. The response consists of the start and stop frequencies in Hz, separated by a comma. 0,0 is returned if no calibration unit is connected.

If several cal units are USB-connected to the analyzer, the command queries the cal unit selected via [SYSTem:COMMunicate:RDEvice:AKAL:ADDRess](#).

Query parameters:

<CalKitName> String parameter containing the name of a cal unit characterization (calkit file).
'Factory' denotes the factory characterization; an empty string ' ' denotes the last referenced characterization; the prefix "SD:" indicates that the characterization is stored on an SD card inserted at the calibration unit.

Example: See [SYSTem:COMMunicate:RDEvice:AKAL:CKIT:CATalog?](#)

Usage: Query only

Manual operation: See "[Characterization](#)" on page 587

SYSTem:COMMunicate:RDEvice:AKAL:PORTs? <CalKitName>

Queries the number of ports of a cal unit characterization (calkit file) <CalKitName>, the assigned connector types, and their gender. A possible response for a two-port calibration is '1,N 50 Ohm,MALE,2,N 50 Ohm,MALE'. An empty string is returned if no calibration unit is connected.

If several cal units are USB-connected to the analyzer, the command queries the cal unit selected via [SYSTem:COMMunicate:RDEvice:AKAL:ADDRESS](#).

Query parameters:

<CalKitName> String parameter containing the name of a cal unit characterization (calkit file).
'Factory' denotes the factory characterization; an empty string ' ' denotes the last referenced characterization; the prefix "SD:" indicates that the characterization is stored on an SD card inserted at the calibration unit.

Example: See [SYSTem:COMMunicate:RDEvice:AKAL:CKIT:CATalog?](#)

Usage: Query only

Manual operation: See "[Characterization](#)" on page 587

SYSTem:COMMunicate:RDEvice:AKAL:PREduction[:STATe] <Boolean>

Enables or disables automatic power reduction at all test ports while an automatic calibration is active.

Parameters:

<Boolean> Power reduction enabled or disabled.
*RST: ON

Example: [SYSTem:COMMunicate:RDEvice:AKAL:PREduction OFF](#)
Disable automatic power reduction.

Manual operation: See "[Auto Power Setting for Cal Unit](#)" on page 858

SYSTem:COMMunicate:RDEvice:AKAL:SDATa? <CalKitName>, <Type>, <SParameter>[, <FirstPort>, <SecondPort>]

Reads the calibration data for a particular standard from a cal unit characterization (calkit file). If more than one calibration unit is connected, the related one must be selected using [SYSTem:COMMunicate:RDEvice:AKAL:ADDRESS](#).

Query parameters:

<CalKitName> String parameter containing the name of a cal unit characterization (calkit file).
'Factory' denotes the factory characterization; an empty string ' ' denotes the last referenced characterization; the prefix "SD:" indicates that the characterization is stored on an SD card inserted at the calibration unit.

<Type>	<p>THRough OPEN SHORt MATCh MMThrougH MFThrougH FFThrougH MOPen FOPen MSHort FSHort MMTCh FMTCh</p> <p>Standard types; for a description refer to table Standard types and their parameters. The standard types of a particular characterization can be queried via <code>SYSTem:COMMunicate:RDEvice:AKAL:CKIT:STANdard:CATalog?</code>.</p> <p>The factory characterization usually does not contain data for a through standard; therefore a query of the type <code>SYSTem:COMMunicate:RDEvice:AKAL:SDATa?'Factory', THR, S11, 1, 2</code> results in an error message.</p>
<SParameter>	<p>S11 S12 S21 S22</p> <p>S-parameter of the standard, use <code>S11</code> for one-port standards, one of the four for 2-port standards.</p>
<FirstPort>	<p>First port number (sufficient for one-port standards). Port numbers can be omitted if the cal kit data is valid for all ports; see <code>MMEMory:LOAD:CKIT:SDATa</code>.</p>
<SecondPort>	<p>Second port number, for two-port standards. Port numbers can be omitted if the cal kit data is valid for all ports.</p>
Example:	<p>See <code>SYSTem:COMMunicate:RDEvice:AKAL:CKIT:CATalog?</code></p>
Usage:	<p>Query only</p>
Manual operation:	<p>See "Characterization" on page 587</p>

SYSTem:COMMunicate:RDEvice:AKAL:WARMup[:STATe]?

Queries the warmup state of the connected calibration unit R&S ZV_Z5x. If several cal units are USB-connected to the analyzer, the command queries the cal unit selected via `SYSTem:COMMunicate:RDEvice:AKAL:ADDRes`.

Possible responses are 1 (true, if the calibration unit has been connected for a sufficient time to reach its operating temperature) or 0 (false). 0 is also returned if no calibration unit is connected.

Example: See `SYSTem:COMMunicate:RDEvice:AKAL:CKIT:CATalog?`

Usage: Query only

Manual operation: See "[Characterization](#)" on page 587

SYSTem:COMMunicate:RDEvice:GDEvice:CATalog?

Queries the numbers of all configured generic external devices. The response is a string containing a comma-separated list of device numbers.

- Example:** See `SYSTem:COMMunicate:RDEvice:GDEvice<Gdev>:DEFine` on page 1615.
- Usage:** Query only
- Manual operation:** See "[Configured Devices](#)" on page 923

SYSTem:COMMunicate:RDEvice:GDEvice<Gdev>:DEFine <InterfaceType>, <Address>

Registers a generic device at the analyzer or queries its connection properties.

Suffix:

<Gdev> Number of the configured device.
If a number is re-used, the previous device configuration is overwritten. Use `SYSTem:COMMunicate:RDEvice:GDEvice:CATalog?` to query the generic device numbers that are already in use.

Parameters:

<InterfaceType> Interface type (string parameter): 'VXI-11', 'socket', 'GPIB0', ..., 'GPIB9', 'usb-visa', or 'other'.

<Address> Interface address (string parameter), depending on the interface type. See [Table 5-13](#).

Example:

```
:SYST:COMM:RDEV:GDEV1:DEF 'VXI-11',
'192.168.0.1'
:SYST:COMM:RDEV:GDEV2:DEF 'VXI-11',
'192.168.0.2'
:SYST:COMM:RDEV:GDEV3:DEF 'VXI-11',
'192.168.0.3'
```

Register generic devices at IP addresses 192.168.0.1, 192.168.0.2 and 192.168.0.3, respectively. Use the VXI-11 protocol to communicate.

```
:SYST:COMM:RDEV:GEN1:CAT?
```

Query the generator numbers. The response is '1, 2, 3'.

```
:SYST:COMM:RDEV:GDEV2:DEL
```

Unregister generic device no. 2.

```
:SYST:COMM:RDEV:GDEV:CAT?
```

The response is '1, 3'.

```
:SYST:COMM:RDEV:GDEV:DEL:ALL
```

Unregister all generic devices. The response is ''.

Manual operation: See "[Configured Devices](#)" on page 923

SYSTem:COMMunicate:RDEvice:GDEvice:DELeTe:ALL

Deletes (unregisters) all configured generic external devices.

Use `SYSTem:COMMunicate:RDEvice:GDEvice<Gdev>:DELeTe` to unregister a single device.

Note that unregistering a device does not automatically delete its command configuration (defined using `[SENSe<Ch>:]GDEvice:SElect`).

Example: See `SYSTem:COMMunicate:RDEvice:GDEvice<Gdev>:DEFine` on page 1615.

Usage: Event

Manual operation: See "Configured Devices" on page 923

`SYSTem:COMMunicate:RDEvice:GDEvice<Gdev>:DELete`

Deletes (unregisters) generic external device no. <Gdev>.

Use `SYSTem:COMMunicate:RDEvice:GDEvice:DELete:ALL` to unregister all devices.

Note that unregistering a device does not automatically delete its command configuration (defined using `[SENSe<Ch>:]GDEvice:SElect`).

Suffix:
<Gdev> Generic device number.

Example: See `SYSTem:COMMunicate:RDEvice:GDEvice<Gdev>:DEFine` on page 1615.

Usage: Event

Manual operation: See "Configured Devices" on page 923

`SYSTem:COMMunicate:RDEvice:GENerator<Gen>:CATalog?`

Queries the numbers of all configured external generators. The response is a string containing a comma-separated list of generator numbers.

Suffix:
<Gen> Number of the configured generator. This suffix is ignored; the command affects all generators.

Example:

```
SYST:COMM:RDEV:GEN1:DEF 'Ext. Gen. 1', 'SME02',
'gpib0', '21'
SYST:COMM:RDEV:GEN2:DEF 'Ext. Gen. 2', 'SME02',
'gpib0', '22'
```

Configure two R&S SME02 generators as external generators no. 1 and 2, assigning different names and GPIB addresses.

```
SYST:COMM:RDEV:GEN1:CAT?
```

Query the generator numbers. The response is '1, 2'.

```
SYST:COMM:RDEV:GEN1:COUN?
```

Query the number of configured generators. The response is 2.

Usage: Query only

Manual operation: See "Configured Devices" on page 898

SYSTem:COMMunicate:RDEvice:GENerator:COUNT?

Queries the number of configured external generators. The response is an integer number of generators.

Example: See `SYSTem:COMMunicate:RDEvice:GENerator<Gen>:CATalog?`

Usage: Query only

SYSTem:COMMunicate:RDEvice:GENerator<Gen>:DEFine <GenName>, <Driver>, <Interface>, <Address>[, <FastSweep>[, <ExtReference>]]

Configures an external generator and adds it to the list of available generators.

Suffix:

<Gen> Number of the configured generator. Generators must be numbered in ascending order, starting with 1. If a number is re-used, the previous generator configuration is overwritten. Generators can be assigned several times so that the number of configured generators is practically unlimited.

Parameters:

<GenName> Name of the external generator (string parameter). An empty string means that no particular name is assigned to the generator.

<Driver> Generator type (string parameter). The generator type is identical with the name of the generator driver file (*.gen) stored in the resources\extdev subdirectory of the analyzer's program directory. Type the driver file name as shown in the "Add External Generator" dialog, i.e. without the file extension ".gen" (example: use 'sme02', if the corresponding driver file name is sme02.gen).

Alternative: The '<driver>' string may also contain the generator driver file name with its complete path, e.g. 'C:\Program Files\Rohde-Schwarz\Vector Network Analyzer\ZNA\resources\extdev\sme02.gen'.

<Interface> Interface type (string parameter): 'GPIB0', 'VXI-11', 'socket', 'usb-visa', 'other' ...

<Address> Interface address (string parameter), depending on the interface type. See [Chapter 5.19.5.2, "External Generators dialog"](#), on page 897.

<FastSweep> ON | OFF
Optional Boolean parameter, enables or disables the fast sweep mode.

<ExtReference> ON | OFF
Optional Boolean parameter, sets the analyzer to internal (OFF) or external (ON) reference frequency.

Example: `SYST:COMM:RDEV:GEN1:DEF 'Ext. Gen. 1', 'SME02', 'gpi0', '21'`
 Configure an R&S SME02 generator as external generator no. 1, assigning the name "Ext. Gen. 1" and a GPIB address 21.
`SYST:COMM:RDEV:GEN1:DEF?`
 Query the generator configuration. The response 'Ext. Gen. 1', 'SME02', 'GPIB0', '21', OFF, OFF indicates that the fast sweep mode is disabled and that the analyzer is set to internal reference frequency.
`SYST:COMM:RDEV:GEN1:DEL`
 Clear the generator configuration table.
`SYST:COMM:RDEV:GEN1:DEF?`
 Query the generator configuration. The analyzer returns an error message because the generator no. 1 is no longer configured.

Manual operation: See ["Configured Devices"](#) on page 898

SYSTem:COMMunicate:RDEvice:GENerator:DELete

Clears the configuration table for external generators.

Example: See [SYSTem:COMMunicate:RDEvice:GENerator<Gen>:DEFine](#)

Usage: Event

Manual operation: See ["Configured Devices"](#) on page 898

SYSTem:COMMunicate:RDEvice:GENerator<Gen>:SEPMode <Type>

Defines the external generator power control after the sweep end.

Suffix:
 <Gen> Generator number

Parameters:
 <Type> OFF | LOW | KEEP | USER
 OFF – power is switched off
 LOW – switch to min. power
 KEEP – keep power at the value selected via [SOURCE<Ch>:POWER<PhyPt>:GENerator<Gen>:OFFSet](#)
 USER – set to end power selected via [SYSTem:COMMunicate:RDEvice:GENerator<Gen>:SEPower](#)

Example: See [SYSTem:COMMunicate:RDEvice:GENerator<Gen>:SEPower](#)

Manual operation: See ["Configured Devices"](#) on page 898

SYSTem:COMMunicate:RDEvice:GENerator<Gen>:SEPower <Power>

Defines the external generator power value after the end of a sweep. The setting is relevant if the generator is switched to a user-selected power; see example.

Suffix:

<Gen> Generator number

Parameters:

<Power> End power
 Range: -145 dBm to +30 dBm
 *RST: 0 dBm
 Default unit: dBm

Example:

```
SYSTem:COMMunicate:RDEvice:GENerator:SEPMoDe
USER
```

Switch the generator to a user-selected power value after the sweep is terminated.

```
SYSTem:COMMunicate:RDEvice:GENerator:SEPower
-10
```

Define a end power of -10 dBm.

Manual operation: See "[Configured Devices](#)" on page 898

SYSTem:COMMunicate:RDEvice:PMETer<Pmtr>:AZERo

Starts auto zeroing of the external power meter.

Suffix:

<Pmtr> Number of the configured power meter. Power meters must be numbered in ascending order, starting with 1. If a number is re-used, the previous power meter configuration is overwritten. Power meters can be assigned several times so that the number of configured power meters is practically unlimited.

Usage: Event

Manual operation: See "[Auto Zero](#)" on page 396

SYSTem:COMMunicate:RDEvice:PMETer:CATalog?

Queries the numbers of all configured external power meters. The response is a string containing a comma-separated list of power meter numbers.

Example:

```

SYST:COMM:RDEV:PMET1:DEF 'USB Power Meter 1',
'NRP-Z55', 'usb', '100045'
SYST:COMM:RDEV:PMET2:DEF 'USB Power Meter 2',
'NRP-Z55', 'usb', '100046'

```

Configure two R&S NRP power meters as external power meter no. 1 and 2, assigning names and serial numbers.

```

SYST:COMM:RDEV:PMET:CAT?

```

Query the power meter numbers. The response is '1, 2'.

```

SYST:COMM:RDEV:PMET:COUN?

```

Query the number of configured power meters. The response is 2.

Usage: Query only

Manual operation: See ["Configured Devices"](#) on page 893

SYSTem:COMMunicate:RDEvice:PMETer:CONFigure:AUTO[:STATe] <Boolean>

Enables or disables auto-configuration of R&S NRPxxS/SN power sensors. If the function is enabled, the analyzer automatically configures all power sensors detected at any of the USB ports as Pmtr 1, Pmtr 2, ...

Parameters:

<Boolean> ON | OFF – enable or disable auto-configuration.

Example: See [SYSTem:COMMunicate:RDEvice:PMETer<Pmtr>:DEFine](#)

Manual operation: See ["Auto Config"](#) on page 895

SYSTem:COMMunicate:RDEvice:PMETer:COUNT?

Queries the number of configured external power meters. The result is an integer number of power meters.

Example: See [SYSTem:COMMunicate:RDEvice:PMETer:CATalog?](#)

Usage: Query only

Manual operation: See ["Configured Devices"](#) on page 893

SYSTem:COMMunicate:RDEvice:PMETer<Pmtr>:DEFine <PmtrName>, <Driver>, <Interface>, <Address>[, <SensorId>]

Configures an external power meter and adds it to the list of available power meters.

Suffix:

<Pmtr> Number of the configured power meter. Power meters must be numbered in ascending order, starting with 1. If a number is reused, the previous power meter configuration is overwritten. Power meters can be assigned several times so that the number of configured power meters is practically unlimited.

Parameters:

<PmtrName>	Name of the external power meter (string parameter). An empty string means that no particular name is assigned to the power meter.
<Driver>	Power meter type (string parameter). The power meter type is identical with the name of the power meter driver file (* .pwm) stored in the <code>resources\extdev</code> subdirectory of the analyzer's program directory. Type the driver file name as shown in the "Add External Powermeter" dialog, i.e. without the file extension ".pwm" (example: use 'NRVD', if the corresponding driver file name is <code>NRVD.pwm</code>). Alternative: The '<Driver>' string can also contain the power meter driver file name with its complete path, e.g. <code>'C:\Program Files\Rohde-Schwarz\Vector Network Analyzer\ZNA\resources\extdev\nrvd.pwm'</code> .
<Interface>	Interface type (string parameter): 'VXI-11', 'socket', 'GPIB0', ..., 'GPIB9', Raw Serial (for VDI Erickson power meters PMx), 'other'
<Address>	Interface address (string parameter), depending on the interface type. See Table 5-11
<SensorId>	This optional string parameter is used for power meters that can control several power sensors, such as the R&S NRP2. By specifying the suitable <SensorId> you can address the related power sensor. The R&S NRP2, for example, has four power sensor connectors, Sensor A to Sensor D. By specifying 'A', 'B', 'C' or 'D', you can take control over the power sensor that is attached to this connector.

Example:

```
SYST:COMM:RDEV:PMET:CONF:AUTO OFF
```

Disables "Auto Config NRP-Zxx" (if it was enabled previously).

```
SYST:COMM:RDEV:PMET1:DEF 'USB Power Meter',  
'NRP-Z55', 'usb', '100045'
```

Configure an R&S NRP power meter as external power meter no. 1, assigning the name "USB Power Meter" and a serial number 100045.

```
SYST:COMM:RDEV:PMET:DEL
```

Clear the power meter configuration table.

```
SYST:COMM:RDEV:PMET:DEF?
```

Query the power meter configuration. The analyzer returns an error message because the power meter no. 1 is no longer configured.

Manual operation: See "[Configured Devices](#)" on page 893

SYSTem:COMMunicate:RDEvice:PMETer:DELeTe

Clears the configuration table for external power meters.

- Example:** See `SYSTem:COMMunicate:RDEvice:PMETer<Pmtr>:DEFine`
- Usage:** Event
- Manual operation:** See "[Configured Devices](#)" on page 893

SYSTem:COMMunicate:RDEvice:PMETer<Pmtr>:SPCorrection[:STATe]
<Boolean>

Gets/sets the state of the built-in S-parameter correction that is available on certain R&S®NRP-Z power sensors.

Note that this state is persistently stored on the power sensor (and NOT on the R&S ZNA).

See Application Note 1GP70 "Using S-Parameters with R&S®NRP-Z Power Sensors" for background information. This Application Note is available on the Rohde & Schwarz internet at <http://www.rohde-schwarz.com/appnotes/1GP70>.

Suffix:
<Pmtr> Number of the configured power meter.

Parameters:
<Boolean> ON | OFF

Manual operation: See "[Deembed Two-Port \(All Channels\)](#)" on page 896

SYSTem:COMMunicate:RDEvice:SMATrix<Matr>:CATalog?

Queries the numbers of the switch matrices currently part of the RF configuration (see [INSTrument:SMATrix](#) on page 1268). The response is a string containing a comma-separated list of switch matrix numbers.

Suffix:
<Matr> This suffix is ignored and can be omitted.

Example: Suppose switch matrices 1 and 2 are currently connected to the R&S ZNA.

`SYST:COMM:RDEV:SMAT1:CAT?`

Query the numbers of the connected switch matrices. The response is '1, 2'.

`SYST:COMM:RDEV:SMAT1:COUN?`

Query the number of connected switch matrices. The response is 2.

Usage: Query only

SYSTem:COMMunicate:RDEvice:SMATrix:CONFigure:ABORT

Aborts a manual RF connection configuration.

Note: a manual RF connection configuration must be performed within a transaction, enclosed by the commands `SYSTem:COMMunicate:RDEvice:SMATrix:CONFigure:START` and `SYSTem:COMMunicate:RDEvice:SMATrix:CONFigure:END`. The modified configuration will not be applied until the end of this transaction.

The new configuration is discarded, i.e. the previous configuration remains active ("rollback"). The transaction will be terminated.

Usage: Event

SYSTem:COMMunicate:RDEvice:SMATrix:CONFigure:END

Ends a manual RF connection configuration: if the configuration is valid, it will be activated ("commit"). Otherwise an error is returned and the new configuration is discarded, i.e. the previous configuration remains active ("rollback").

In any case the transaction will be terminated.

Note: a manual RF connection configuration must be performed within a transaction, enclosed by the commands `SYSTem:COMMunicate:RDEvice:SMATrix:CONFigure:START` and `SYSTem:COMMunicate:RDEvice:SMATrix:CONFigure:END`. The modified configuration will not be applied until the end of this transaction.

The configuration is valid if

- every VNA port is either connected to a matrix port or directly assigned to a DUT test port
- every matrix that is part of the configuration is connected to the VNA by at least one RF connection
- every VNA port that is not connected to a matrix is assigned to a test port
- the test ports are numbered consecutively, starting with 1

Example: See `SYSTem:COMMunicate:RDEvice:SMATrix:CONFigure:START`

Usage: Event

SYSTem:COMMunicate:RDEvice:SMATrix:CONFigure:START

Starts a manual RF connection configuration.

Note: a manual RF connection configuration must be performed within a transaction, enclosed by the commands `SYSTem:COMMunicate:RDEvice:SMATrix:CONFigure:START` and `SYSTem:COMMunicate:RDEvice:SMATrix:CONFigure:END`. The modified configuration will not be applied until the end of this transaction.

An RF connection configuration comprises the RF connections between the VNA, a set of switch matrices and the DUT test ports.

At transaction start the R&S ZNA creates an in-memory copy of the active configuration and strips off all RF connections from this copy. Subsequent RF connection actions such as `SYSTem:COMMunicate:RDEvice:SMATrix<Matr>:CONFigure: MVNA` and `SYSTem:COMMunicate:RDEvice:SMATrix<Matr>:CONFigure:MTESt` operate on the copy.

However, the copy contains the very same switch matrices as the original, so the adequate set of matrices has to be selected beforehand (using manual control or the remote command `INSTRument:SMATrix`).

If a previous transaction is active, it will be silently rolled back.

Note that a redefinition of the physical VNA ports (see `[SENSe:]UDSParams<Pt>:PARAm`) causes a factory reset and deletes all switch matrix RF connections. So the RF configuration for switch matrices has to be done *after* the port redefinition.

Example:

```
:INSTRument:SMATrix OFF
```

Remove all switch matrices from the RF configuration.

```
:SYSTem:COMMunicate:RDEvice:SMATrix:DELeTe
```

Unconfigure all switch matrices, i.e. remove them from the list of configured devices.

```
:SYSTem:COMMunicate:RDEvice:SMATrix1:DEFine ',
'ZV-Z82-30', 'LAN', '192.168.0.42'
```

Register a single switch matrix of type ZV-Z82-30 (with two 2x5 submatrices).

```
:INSTRument:SMATrix ON
```

Add the matrix to the RF configuration, performing a default assignment of VNA ports and test ports.

```
:SYSTem:COMMunicate:RDEvice:SMATrix:CONFigure:
START
```

Start a manual RF connection configuration.

```
:SYSTem:COMMunicate:RDEvice:SMATrix1:CONFigure:
MVNA 1,1,3,2,2,3,4,4
```

Define non-default matrix-VNA port connections: matrix port 1 to VNA port 2, matrix port 3 to VNA port 2, matrix port 2 to VNA port 3 and matrix port 4 to VNA port 4 (default is 1, 3, 2, 4, 3, 1, 4, 2).

```
:SYSTem:COMMunicate:RDEvice:SMATrix1:CONFigure:
MTESt 1,1,2,2,9,3,10,4
```

Configure 4 matrix test ports only: matrix test port 1 is test port 1, matrix test port 2 is test port 2, matrix test port 9 is test port 3 and matrix test port 10 is test port 4.

```
:SYSTem:COMMunicate:RDEvice:SMATrix:CONFigure:
END
```

Apply the manual RF connection configuration.

Usage:

Event

```
SYSTem:COMMunicate:RDEvice:SMATrix:CONFigure:TVNA <TestPort1>,
    <VNAPort1>[, <TestPort2>, <VNAPort2>[...]]
```

Sets/gets the test port connections of the VNA in a switch matrix RF connection setup, i.e. the direct assignments of test ports to physical VNA ports.

Note: a manual RF connection configuration must be performed within a transaction, enclosed by the commands `SYSTem:COMMunicate:RDEvice:SMATrix:CONFigure:START` and `SYSTem:COMMunicate:RDEvice:SMATrix:CONFigure:END`. The modified configuration will not be applied until the end of this transaction.

Setting parameters:

<TestPort1>... Number of the test port.
 Test ports must be numbered subsequently starting at 1.

<VNAPort1>... Number of the VNA port

Example: `SYSTem:COMMunicate:RDEvice:SMATrix:CONFigure:`
 `TVNA 6,2,7,4`
 Test Ports 6 and 7 are assigned to VNA ports 2 and 4.

Manual operation: See "[Edit Test Port Connection](#)" on page 917

```
SYSTem:COMMunicate:RDEvice:SMATrix<Matr>:CONFigure:MLVNA {<Matrix VNA
    Port Label>, <VNA Port Number>}
```

Sets/gets the RF connections between switch matrix and VNA. Similar to `SYSTem:COMMunicate:RDEvice:SMATrix<Matr>:CONFigure:MVNA`, but uses the front panel labels of the matrix VNA ports instead.

By default, these labels are only available for some matrix types.

Note: a manual RF connection configuration must be performed within a transaction, enclosed by the commands `SYSTem:COMMunicate:RDEvice:SMATrix:CONFigure:START` and `SYSTem:COMMunicate:RDEvice:SMATrix:CONFigure:END`. The modified configuration will not be applied until the end of this transaction.

Suffix:

<Matr> Index of the switch matrix (see `SYSTem:COMMunicate:RDEvice:SMATrix<Matr>:DEFine` on page 1627)

Setting parameters:

<Matrix VNA Port Label> These labels are specified in the corresponding matrix driver file (see `SYSTem:COMMunicate:RDEvice:SMATrix<Matr>:DEFine` on page 1627).

<VNA Port Number> Range: 1 ... # of RF ports of the VNA

Example: A switch matrix ZV-Z84-02 is used.
 `SYSTem:COMMunicate:RDEvice:SMATrix1:CONFigure:`
 `MLVNA '1A',1,'2B',2`
 VNA ports 1 and 2 are connected to matrix VNA ports '1A' and '2B', respectively

Manual operation: See "Edit Matrix VNA Port Connections" on page 917

SYSTem:COMMunicate:RDEvice:SMATrix<Matr>:CONFigure:MLTest {<Matrix Test Port Label>, <TPNumber>}

Sets/gets the matrix test port connections. Similar to `SYSTem:COMMunicate:RDEvice:SMATrix<Matr>:CONFigure:MTESt`, but uses the front panel labels of the matrix test ports instead.

By default, these labels are only available for some matrix types.

Note: a manual RF connection configuration must be performed within a transaction, enclosed by the commands `SYSTem:COMMunicate:RDEvice:SMATrix:CONFigure:START` and `SYSTem:COMMunicate:RDEvice:SMATrix:CONFigure:END`. The modified configuration will not be applied until the end of this transaction.

Suffix:

<Matr> Index of the switch matrix (see `SYSTem:COMMunicate:RDEvice:SMATrix<Matr>:DEFine` on page 1627)

Setting parameters:

<Matrix Test Port Label> If available, these labels are specified in the corresponding matrix driver file (see `SYSTem:COMMunicate:RDEvice:SMATrix<Matr>:DEFine` on page 1627).

<Test Port Number> Test ports must be numbered subsequently, starting at 1.

Example:

A switch matrix ZV-Z82-16 is used.

```
SYSTem:COMMunicate:RDEvice:SMATrix1:CONFigure:
MLTESt 'A1',1,'B1',2
```

The first test ports of submatrices A and B are assigned to test ports 1 and 2, respectively.

Manual operation: See "Edit Test Port Connection" on page 917

SYSTem:COMMunicate:RDEvice:SMATrix<Matr>:CONFigure:MTESt {<MatrixTestPort>, <TestPort>}

Sets/gets the matrix test port connections as a comma-separated list of port numbers

Note: a manual RF connection configuration must be performed within a transaction, enclosed by the commands `SYSTem:COMMunicate:RDEvice:SMATrix:CONFigure:START` and `SYSTem:COMMunicate:RDEvice:SMATrix:CONFigure:END`. The modified configuration will not be applied until the end of this transaction.

Suffix:

<Matr> Index of the switch matrix (see `SYSTem:COMMunicate:RDEvice:SMATrix<Matr>:DEFine` on page 1627)

Setting parameters:

{<MatrixTestPort> Number of the switch matrix test port

<TestPort> Number of the test port.
Test ports must be numbered subsequently starting at 1.

Example: See `SYSTem:COMMunicate:RDEvice:SMATrix:CONFigure:START`

Manual operation: See "Edit Test Port Connection" on page 917

SYSTem:COMMunicate:RDEvice:SMATrix<Matr>:CONFigure:MVNA
{<MatrixVNAPort>, <VNAPort>}

Sets/gets the RF connections between switch matrix and VNA as a comma-separated list of port numbers.

Note: a manual RF connection configuration must be performed within a transaction, enclosed by the commands `SYSTem:COMMunicate:RDEvice:SMATrix:CONFigure:START` and `SYSTem:COMMunicate:RDEvice:SMATrix:CONFigure:END`. The modified configuration will not be applied until the end of this transaction.

Suffix:
<Matr> Configuration index of the switch matrix (see `SYSTem:COMMunicate:RDEvice:SMATrix<Matr>:DEFine` on page 1627)

Setting parameters:
{<MatrixVNAPort> Number of the switch matrix VNA port
Range: 1 ... # of VNA ports of the switch matrix
<VNAPort>} Number of the VNA port
Range: 1 ... # of RF ports of the VNA

Example: See `SYSTem:COMMunicate:RDEvice:SMATrix:CONFigure:START`

Manual operation: See "Edit Matrix VNA Port Connections" on page 917

SYSTem:COMMunicate:RDEvice:SMATrix:COUNT?

Gets the number of configured switch matrices (see `SYSTem:COMMunicate:RDEvice:SMATrix<Matr>:DEFine` on page 1627)

Usage: Query only

Manual operation: See "Configured Devices" on page 911

SYSTem:COMMunicate:RDEvice:SMATrix<Matr>:DEFine <Unused>, <Driver>, <Interface>, <Address>

This command allows

- to configure (i.e. register) a new switching matrix
- to modify the (management) connection settings of an already configured switching matrix
- to get the (management) connection settings of a configured switching matrix

Suffix:	
<Matr>	Index of the switch matrix. Switch matrices are numbered in ascending order, starting with 1. If a number is re-used, the current configuration is overwritten.
Parameters:	
<Unused>	Currently this parameter is ignored and always returns an empty string ' '.
<Driver>	Matrix driver name indicating the matrix type (string parameter). Standard drivers: The supported drivers are displayed in the "Driver" dropdown-list of the "Add External Switchmatrix" dialog. Each list entry corresponds to a matrix driver file (*.matrix) located in the Resources\ExtDev subdirectory of the analyzer's program directory. Specify the <Driver> as the driver's file name without the *.matrix extension, e.g. as "ZV-Z81-05". Non-standard driver location: You may also specify the full absolute path to an appropriate driver file, e.g. "C:\Program Files\Rohde-Schwarz\Vector Network Analyzer\ZNA\Resources\ExtDev\ZV-Z81-05.matrix".
<Interface>	Interface type (string parameter) 'USB' USB interface 'LAN' LAN interface
<Address>	Interface-specific address (string parameter).
Example:	:SYST:COMM:RDEV:SMATrix1:DEF ' ', 'ZN-Z84-42', 'USB', '101142' Register switch matrix no.1: type R&S ZN-Z84 (2x24) with serial number 101142 at USB interface. :SYST:COMM:RDEV:SMATrix2:DEF ' ', 'ZV-Z81-05', 'LAN', '10.10.10.10' Register switch matrix no.2: type R&S ZV-Z81 (model .05) at IP address 10.10.10.10.
Manual operation:	See "Add Device" on page 912

SYSTem:COMMunicate:RDEvice:SMATrix:DELeTe

Unregisters all switch matrices, i.e. removes them from the list of configured devices.

Example: See [SYSTem:COMMunicate:RDEvice:SMATrix:CONFigure:START](#)

Usage: Event

Manual operation: See ["Delete All"](#) on page 913

SYSTem:COMMunicate:RDEvice:SMATrix<Matr>:RELays:SWITCh:COUNT?

For mechanical matrices, this command allows to query the list of switch counts for all relays (if supported by the matrix).

Suffix:

<Matr> Index of the switch matrix (see [SYSTem:COMMunicate:RDEvice:SMATrix<Matr>:DEFine](#) on page 1627)

Usage:

Query only

Manual operation: See "[Configured External Switch Matrices](#)" on page 878

SYSTem:COMMunicate:RDEvice:SMATrix:SCAN?

Scans for external switch matrices connected via USB.

Returns a comma-separated list

<Driver_1>,<Interface_1>,<Address_1>,...,<Driver_N>,
<Interface_N>,<Address_N>, one triple
<Driver_n>,<Interface_n>,<Address_n> for each detected switch matrix
<Matr>=1,...,N.

Use [SYSTem:COMMunicate:RDEvice:SMATrix<Matr>:DEFine](#) to configure them.

Usage:

Query only

Manual operation: See "[Scan Instruments](#)" on page 911

SYSTem:COMMunicate:RDEvice:SMATrix<Matr>:SERial?

Returns the serial number of the related switch matrix.

Suffix:

<Matr> Index of the switch matrix (see [SYSTem:COMMunicate:RDEvice:SMATrix<Matr>:DEFine](#) on page 1627)
If the switch matrix is not part of the RF configuration, the query returns an "Invalid suffix" error.

Usage:

Query only

Manual operation: See "[Configured Devices](#)" on page 911

7.3.17.2 SYSTem:... (other)

The following `SYSTem...` commands provide general instrument configurations.

SYSTem:AGC:GLOBal:METHod	1631
SYSTem:CORRection:JOINcal	1631
SYSTem:CORRection:WIZard[:IMMediate]	1632
SYSTem:DATE	1632
SYSTem:DFPPrint?	1632
SYSTem:DISPlay:BAR:HKEY[:STATe]	1632

SYSTem:DISPlay:BAR:MENU[:STATe].....	1632
SYSTem:DISPlay:BAR:STATus[:STATe].....	1632
SYSTem:DISPlay:BAR:STOols[:STATe].....	1632
SYSTem:DISPlay:BAR:TITLe[:STATe].....	1633
SYSTem:DISPlay:BAR:TOOLs[:STATe].....	1633
SYSTem:DISPlay:COLor.....	1633
SYSTem:DISPlay:CONDuctances.....	1633
SYSTem:DISPlay:TRACes:CCOunt.....	1634
SYSTem:DISPlay:UPDate.....	1634
SYSTem:DISPlay:XLABels.....	1634
SYSTem:ERRor:ALL?.....	1634
SYSTem:ERRor:COUnT?.....	1635
SYSTem:ERRor:DISPlay:ERRor.....	1635
SYSTem:ERRor:DISPlay:INFO.....	1635
SYSTem:ERRor:DISPlay:WARNings.....	1635
SYSTem:ERRor:DISPlay[:REMOte].....	1635
SYSTem:ERRor:DISPlay:STATe.....	1636
SYSTem:ERRor[:NEXT]?.....	1636
SYSTem:FIRMWare:UPDate.....	1636
SYSTem:FORMat:IDENtify.....	1637
SYSTem:FPReset.....	1637
SYSTem:FREQuency?.....	1638
SYSTem:HELp:HEADers?.....	1638
SYSTem:HELp:SYNTax?.....	1638
SYSTem:HELp:SYNTax:ALL?.....	1639
SYSTem:IDENtify:FACTory.....	1639
SYSTem:IDENtify[:STRing].....	1639
SYSTem:KLOCK.....	1639
SYSTem:LANGUage.....	1639
SYSTem:LOGGing:REMOte[:STATe].....	1640
SYSTem:OPChEck:PLEVel:PORT<Port>?.....	1640
SYSTem:OPChEck:SELFtest?.....	1641
SYSTem:OPTions:FACTory.....	1641
SYSTem:OPTions[:STRing].....	1641
SYSTem:PASSword[:CENable].....	1642
SYSTem:PRESet[:DUMMy].....	1642
SYSTem:PRESet:MODE.....	1642
SYSTem:PRESet:REMOte[:STATe].....	1643
SYSTem:PRESet:SCOPE.....	1643
SYSTem:PRESet:START.....	1644
SYSTem:PRESet:USER:CAL.....	1644
SYSTem:PRESet:USER:NAME.....	1644
SYSTem:PRESet:USER[:STATe].....	1645
SYSTem:SETTings:UPDate.....	1645
SYSTem:SMATrix:OPTimization.....	1646
SYSTem:SHUTdown.....	1646
SYSTem:SOUNd:ALARm[:STATe].....	1647
SYSTem:SOUNd:STATus[:STATe].....	1647
SYSTem:TIME.....	1647
SYSTem:TRESet[:STATe].....	1647

SYSTem:TSLock.....	1647
SYSTem:TTLout<Pt>:STATus[:STATe].....	1648
SYSTem:USER:DISPlay:TITLe.....	1648
SYSTem:USER:KEY.....	1649
SYSTem:VERSion?.....	1649

SYSTem:AGC:GLOBal:METHod <Global AGC Method>

Allows you to select between two AGC algorithms.

Setting parameters:

<Global AGC Method> POINT | MEMory
POINT
 Point AGC
MEMory
 Memory AGC

Manual operation: See "[Global AGC \(R&S ZNB only!\)](#)" on page 870

SYSTem:CORRection:JOINcal <FirstCal>, <LocationFirstCal>, <SecondCal>, <LocationSecondCal>[, <OutputCal>[, <LocationOutputCal>]]

Command for joining calibrations.

- The query returns whether if the two calibrations <FirstCal> (from <LocationFirstCal>) and <SecondCal> (from <LocationSecondCal>) are joinable.
- The set command tries to join the two calibrations. If successful, it stores the resulting calibration as <OutputCal> in <LocationOutputCal>.

Parameters:

<FirstCal> String parameter with the channel name (for <LocationFirstCal>=CHANnel) or the calibration file name (for <LocationFirstCal>=POOL) of the first calibration.

<LocationFirstCal> CHANnel | POOL

<SecondCal> String parameter with the channel name (for <LocationSecondCal>=CHANnel) or the calibration file name (for <LocationSecondCal>=POOL) of the first calibration.

<LocationSecondCal> CHANnel | POOL

Setting parameters:

<OutputCal> String parameter with the channel name (for <LocationOutputCal>=CHANnel) or the calibration file name (for <LocationOutputCal>=POOL) of the resulting calibration.

Note: If (<OutputCal>, <LocationOutputCal>) matches one of the input calibrations, this input calibration is replaced.

<LocationOutputCal> CHANnel | POOL

Return values:

<Joinable>

Manual operation: See ["Input Calibration1/Input Calibration2/Cal Name"](#) on page 642

SYSTem:CORRection:WIZard[:IMMediate] <Dialogs>

Keysight-compatible command to open the [Start Cal tab](#) or the [Calibration Kits dialog](#).

Tip: When working with the [Chapter 6.1.3, "GPIB Explorer"](#), on page 933, switch to raw mode ("Options">"Raw mode" in the IECWIN32 GUI) before executing this command.

Setting parameters:

<Dialogs> MAIN | CKIT
 MAIN: open the "Calibration > Start Cal" softtool tab
 CKIT: open the "Calibration Kits" dialog

Usage: Setting only

SYSTem:DATE <Year>, <Month>, <Day>

The command queries or defines the instrument's current date setting.

The setting command requires administrator rights; refer to ["User accounts and password protection"](#) on page 30.

Parameters:

<Year> Year, four-digit number
 <Month> Month, two-digit number, 01 (for January) to 12 (for December)
 <Day> Day, two-digit number, 01 to the number of days in the month

Example:

SYST:DATE?
 Response: 2012, 05, 01 - it is the 1st of May, 2012.

SYSTem:DFPRint?

Queries the device footprint. The device footprint contains detailed information about the instrument and is mostly used for service purposes.

Usage: Query only

Manual operation: See ["Save..."](#) on page 874

SYSTem:DISPlay:BAR:HKEY[:STATe] <Boolean>
SYSTem:DISPlay:BAR:MENU[:STATe] <Boolean>
SYSTem:DISPlay:BAR:STATus[:STATe] <Boolean>
SYSTem:DISPlay:BAR:STOols[:STATe] <Boolean>

SYSTem:DISPlay:BAR:TITLe[:STATe] <Boolean>

SYSTem:DISPlay:BAR:TOOLs[:STATe] <Boolean>

Displays or hides the hardkey panel (**HKEY**), the menu bar below the diagram area (**MENU**), the status bar below the diagram area (**STATUS**), the softtool panel (**STOOLs**), the title bar of the main VNA application window (**TITLe**), and the toolbar above the diagram area (**TOOLs**).

Parameters:

<Boolean> ON | OFF
 Display or hide the information elements.

Example:

```
SYSTem:DISPlay:BAR:TOOLs ON; STOOLs ON; STATus
ON
```

Display the toolbar, softtool panel, and status bar.

```
SYSTem:DISPlay:BAR:TITLe OFF; HKEY OFF; MENU
OFF
```

Hide the title bar, hardkey bar, and menu bar.

Manual operation: See "[Tool Bar](#)" on page 853

SYSTem:DISPlay:COLor <ColorScheme>

Selects the color scheme for on-screen display in the active recall set.

Use [HCOpy:PAGE:COLor](#) to select the print color scheme.

Parameters:

<ColorScheme> UDEFined | DBACKground | LBACKground | BWLStyles |
 BWSolid
 UDEFined – user-defined color scheme
 DBACKground – dark background
 LBACKground – light background
 BWLStyles – black and white line styles
 BWSolid – black and white solid

Example:

```
SYST:DISP:COL LBAC
```

Select the "Light Background" color scheme.

Manual operation: See "[Color Scheme](#)" on page 845

SYSTem:DISPlay:CONDuctances <Boolean>

Changes the presentation of "capacitance C<i>" in parallel with resistance R<i>" circuit blocks in lumped de/embedding networks.

Parameters:

<Boolean> ON - display conductances
 OFF - display capacitances

Manual operation: See "[Conductance in Embedding Networks](#)" on page 862

SYSTem:DISPlay:TRACes:CCOunt <ColorCount>

Defines the maximum number of trace colors (trace properties for the user defined color scheme defined using [DISPlay:CMAP<DispEl>:RGB](#)).

Parameters:

<ColorCount> Range: 1 to 100

Manual operation: See "[Number of Trace Colors](#)" on page 862

SYSTem:DISPlay:UPDate <Activate>

Switches the display on or off while the analyzer is in the remote state. The command has no effect while the analyzer is in the local operating state.

Tip: Switching off the display speeds up the measurement. This command may have an impact on the update of trace and channel settings; see [SYSTem:SETTings:UPDate](#).

Parameters:

<Activate> ON | OFF - switch the display on or off. If the display is switched on, the analyzer shows the diagrams and traces like in manual control.
 ONCE - switch the display on and show the current trace. This parameter can be used for occasional checks of the measurement results or settings. The measurement is continued, however, the measurement results are not updated. Compared to the ON setting, ONCE does not slow down the measurement speed.

Example: SYST:DISP:UPD ON
 Switch the display on to view the traces and diagrams.

SYSTem:DISPlay:XLABELs <Boolean>

Enables or disables the display of X-axis grid labels in cartesian diagrams with linear scale.

Parameters:

<Boolean> **ON (1)**
 Show X-axis grid labels
OFF (0)
 Don't show X-axis grid labels
 *RST: OFF

Manual operation: See "[Show X-Axis Grid Labels](#)" on page 862

SYSTem:ERRor:ALL?

Queries and at the same time deletes all entries in the error queue.

The entries consist of an error number and a short description of the error. Positive error numbers are instrument-dependent. Negative error numbers are reserved by the SCPI standard; see section [Error messages and troubleshooting](#).

Example: `SYST:ERR:ALL?`
 Query all entries in the error queue. 0, "No error" is returned if the error queue is empty.

Usage: Query only

SYSTem:ERRor:COUnT?

Gets the current number of entries in the SCPI error queue.

Usage: Query only

SYSTem:ERRor:DISPlay:ERRor <Boolean>

SYSTem:ERRor:DISPlay:INFO <Boolean>

SYSTem:ERRor:DISPlay:WARNings <Boolean>

Selectively disables or enables the display of information popups for the related event type (Information, System Error, Warning).

Note that the display of information popups can be globally disabled/enabled using [SYSTem:ERRor:DISPlay:STATe](#) OFF/ON.

Parameters:

<Boolean> ON | OFF - enable/disable display of information popups for the related event type

*RST: ON

Example: `SYST:ERR:DISP:STATe ON; ERR ON; WARN:OFF; INFO OFF`

Display information popups for system errors, but not for warnings and information messages.

Manual operation: See "[Show Info Messages / Show Warning Messages / Show Error Messages](#)" on page 864

SYSTem:ERRor:DISPlay[:REMote] <Boolean>

Disables or enables the display of information popups for remote control errors. These popups appear at the bottom of the remote screen and the manual screen.

Note

- Display of information popups can be globally disabled/enabled using [SYSTem:ERRor:DISPlay:STATe](#) OFF/ON
- For SCPI error -113, `Undefined header` no tooltip is displayed

Parameters:

<Boolean> ON | OFF - enable/disable display of information popups for remote control errors

*RST: ON

Example:

```
SYST:ERR:DISP:STATE ON; REM ON
```

Switch the display of information popups for remote command errors on.

```
FREQ:STAR -1
```

Generate a Remote Error: -222, "Data out of range; ..." tooltip.

Manual operation: See ["Show Remote Error Info Messages"](#) on page 864

SYSTem:ERRor:DISPlay:STATe <Boolean>

Globally defines whether instrument events shall be indicated by information popups.

Display of popups can be limited to certain event types using commands [SYSTem:ERRor:DISPlay:INFO](#), [SYSTem:ERRor:DISPlay:WARNings](#), [SYSTem:ERRor:DISPlay:ERRor](#), and [SYSTem:ERRor:DISPlay\[:REMote\]](#).

Parameters:

<Boolean> ON | OFF - globally enable or disable the display of information popups

*RST: ON

Example:

See [SYSTem:ERRor:DISPlay:ERRor](#) and [SYSTem:ERRor:DISPlay\[:REMote\]](#).

Manual operation: See ["Show Instrument Messages"](#) on page 864

SYSTem:ERRor[:NEXT]?

Queries and at the same time deletes the oldest entry in the error queue. Operation is identical to that of [STATus:QUEue\[:NEXT\]?](#)

The entry consists of an error number and a short description of the error. Positive error numbers are instrument-dependent. Negative error numbers are reserved by the SCPI standard; see section [Error messages and troubleshooting](#).

Example:

```
SYST:ERR?
```

Query the oldest entry in the error queue. 0, "No error" is returned if the error queue is empty.

Usage:

Query only

SYSTem:FIRMware:UPDate <VNASetupFile>

Installs a firmware version stored in a VNA setup file (*.exe) on the analyzer. The installation is automatic and does not require any further action.

Setting parameters:

<VNASetupFile> String variable for the name and directory of a VNA setup file.

Example:

```
SYST:FIRM:UPD 'C:
\Users\Public\Setup\ZNA_1.95.exe'
```

Install firmware version V1.95 from the setup file stored in the public directory of the analyzer's internal hard disk.

Usage:

Setting only

SYSTem:FORMat:IDENTify <Option>

Defines the format of the factory ID string.

The available formats present the same information in the same order, but differ slightly w.r.t. separator characters:

- LEGacy format:

```
'Rohde&Schwarz,<VNA Type><Max. Freq>-<Ports>Port,
<Order and Serial No>,<FW_Version>
```

e.g.

```
'Rohde-Schwarz,ZNA43-4Port,
1332450044100005,2.70.2.736-22.08.2.55'
```

Order and serial no. are formatted without any separators. The first 10 digits is the order number.

- In NEW format, order and serial no. are separated by a slash, and the order number is presented in "KMAT format", e.g.:

```
Rohde-Schwarz,ZNA43-4Port,
1332.4500K44/100005,2.70.2.736-22.08.2.55
```

Note: To let the instrument identify itself with the factory ID (*IDN?), use **SYSTem:IDENTify:FACTory**

Setting parameters:

<Option> LEGacy | NEW

A *RST does not change the format.

After a factory reset the LEGacy format is used.

Manual operation: See "[Define *IDN + *OPT...](#)" on page 889

SYSTem:FPReset

Performs a factory preset of all instrument settings (i.e. all open recall sets) or of the active recall set, depending on the **SYSTem:PRESet:SCOPE** settings, and deletes channel 1 in the active recall set. As a result, the active recall set contains no channels, traces, and diagram areas.

Example:

```
SYST:PRESet:SCOPE SING
```

Define the scope of a preset: the active recall set is reset only.

```
SYST:FPR
```

Reset the parameters of the current recall set and delete channel 1.

Usage: Event

SYSTem:FREQuency? <MinMax>

Queries the minimum and maximum frequency of the network analyzer. For an overview refer to the tables at the beginning of [Chapter 7.3.14.11](#), "[SENSe:]FRE-Quency...", on page 1421.

Tip: In contrast to [SENSe<Ch>:]FREQuency:STArT? and the other sweep range commands, SYSTem:FREQuency? can be used in all sweep modes.

Query parameters:

<MinMax> MINimum | MAXimum

Return values:

<Frequency> MINimum | MAXimum
Return minimum or maximum frequency.

Example: See [SENSe<Ch>:]FREQuency:CENTer

Usage: Query only

Manual operation: See "Start Frequency / Stop Frequency / Center Frequency / Span Frequency" on page 523

SYSTem:HELP:HEADers? [<ParserName>]

Returns a list of all SCPI commands supported by the related parser (or the default parser, if omitted).

Query parameters:

<ParserName> Parser name

Return values:

<Commands> SCPI command headers, one per line

Usage: Query only

SYSTem:HELP:SYNTax? <Command>

This command returns the full syntax of the specified command.

Query parameters:

<Command>

Return values:

<CommandDesc> String containing the command you want to query.

Example:

SYST:HELP:SYNT? 'SYST:ERR?'
Returns the full syntax. In this case: 'SYSTem:ERRor[:NEXT]'.

Usage: Query only

SYSTem:HELP:SYNTax:ALL?

Queries the implemented SCPI commands and their parameters.

Return values:

<Commands>

Usage: Query only

SYSTem:IDENtify:FACTory

Resets the response to the *IDN? query to the factory ID, overwriting a user-defined identification string ([SYSTem:IDENtify](#)).

Use [SYSTem:FORMat:IDENtify](#) to change the format of the factory ID string.

Example: `SYSTem:IDENtify:STRing 'MyDevice'; *IDN?`

Define an identity string. The response is MyDevice.

`SYSTem:IDENtify:FACTory; *IDN?`

Re-activate the factory setting.

Usage: Event

Manual operation: See "[Define *IDN + *OPT...](#)" on page 889

SYSTem:IDENtify[:STRing] <InstId>

Defines an identity string for the network analyzer. The query is equivalent to *IDN?.

Parameters:

<InstId> String parameter containing the instrument identity

Example: See [SYSTem:IDENtify:FACTory](#)

Manual operation: See "[Define *IDN + *OPT...](#)" on page 889

SYSTem:KLOCK <Boolean>

Locks or unlocks the local controls of the analyzer. This includes the front panel keys, the keyboard, or other local interfaces.

Parameters:

<Boolean> ON | OFF - lock or unlock the local keys.

*RST: OFF

Example: `SYST:KLOCK ON`
Lock the local keys.

SYSTem:LANGUage <Language>

Defines the remote language of the analyzer, i.e. which commands are available and how they are interpreted.

Also sets:

- The (default) byte order for binary data transfer (see [FORMat:BOReR](#))
- The (default) identification (*IDN?) and option (*OPT?) strings (see [SYSTem:IDENtify:FACTory](#) and [SYSTem:OPTions:FACTory](#)).

Parameters:

<Language>

'SCPI'

R&S ZNA-specific command set: the analyzer supports all commands described in this documentation.

Factory default. The byte order is set to SWAPped.

'ZVABT' | 'ZVR'

Compatibility mode for network analyzers of the R&S ZVR and R&S ZVA/B/T families.

The byte order is set to SWAPped.

'ENA' | 'E5071' | 'PNA' | 'HP8510' | 'HP8530' | 'HP8714' | 'HP8720' | 'HP8753'

Compatibility modes for network analyzers from other manufacturers.

The byte order is set to NORMal.

Example:

```
SYST:LANG 'PNA'
```

Select a PNA-compatible command set.

Manual operation: See "[Remote Language](#)" on page 888

SYSTem:LOGGing:REMOte[:STATe] <Boolean>

Enables logging of all remote control commands transferred to the analyzer.

Parameters:

<Boolean>

ON – command sequence stored to file

C:\Users\Public\Documents\Rohde-Schwarz\ZNA\RemoteLog\VNARemote.log.

OFF – command sequence not logged.

Example:

```
SYST:LOGG:REM ON
```

Enable remote logging. The log file

'C:\Users\Public\Documents\Rohde-Schwarz\ZNA\RemoteLog\VNARemote.log' is fixed and does not have to be specified.

SYSTem:OPCHeck:PLEVel:PORT<Port>? <Power>[, <LimitLines>]

Defines and executes a power level operator check on port <Port> and returns its boolean result.

Suffix:

<Port>

Physical VNA port no.

Query parameters:

<Power>	Source power of port <Port> Default unit: dBm
<LimitLines>	String parameter specifying the name and directory of the limit line file to be loaded. The default extension (manual control) for limit line files is *.limit, although other extensions are allowed. If no path is specified the analyzer searches the current directory, which can be set/queried with <code>MMEMory:CDIRectory</code> . If omitted, the firmware applies default limit lines (\pm dBm above/below the specified source <Power>).

Return values:

<Result> 1 = PASSED, 0 = FAILED

Usage: Query only

Manual operation: See "[Execute/Repeat](#)" on page 884

SYSTem:OPCHeck:SELFtest?

Like the [common SCPI command](#) *TST?, this operator check performs a self test of the R&S ZNA and returns its result. However, the role of boolean results 0 and 1 is exactly opposite.

Return values:

<Result> 1 = PASSED, 0 = FAILED

Usage: Query only

Manual operation: See "[Execute/Repeat](#)" on page 882

SYSTem:OPTions:FACTory

Resets the response to the *OPT? query to the factory default value. This command overwrites a user-defined option string; see example.

Example:

```
SYSTem:OPTions:STRing 'MyOptions'; *OPT?
Define an identity string. The response is MyOptions.
SYSTem:OPTions:FACTory; *OPT?
Re-activate the factory setting. The analyzer returns a comma-separated list of software and hardware options.
```

Usage: Event

Manual operation: See "[Define *IDN + *OPT...](#)" on page 889

SYSTem:OPTions[:STRing] <Options>

Defines an option string for the network analyzer. The query is equivalent to *OPT?.

Parameters:

<Options> String parameter containing the available options

Example:

See [SYSTem:OPTions:FACTory](#)

Manual operation:

See "[Define *IDN + *OPT...](#)" on page 889

SYSTem:PASSword[:CENable] <Password>

Sends a password to the analyzer enabling a class of service functions to function (Command ENable). Service functions are activated with the commands of the `DIAGnostic...` system and should be used by a R&S service representative only.

Setting parameters:

<Password> Case-sensitive string variable. Sending an invalid password generates error -221, (settings conflict).

Example:

```
SYST:PASS "XXXX"
Enter password.
```

Usage:

Setting only

Manual operation:

See "[Password](#)" on page 886

SYSTem:PRESet[:DUMMy]

Performs a preset, whose scope is defined using the [SYSTem:PRESet:SCOPE](#) command. The [SYSTem:PRESet:USER\[:STATe\]](#) command determines whether a factory preset or a user-defined preset is performed.

Example:

```
SYST:PRESet:SCOPE SING
Define the scope of a preset: the active recall set is reset only.
SYST:PRESet
Reset the parameters of the current recall set to their factory defaults.
```

SYSTem:PRESet:MODE <PresetMode>

Allows you to select between different preset modes.

GLOBAL and RFOFF presets can only be performed from the analyzer GUI. FILE presets can also be performed via remote commands, if [SYSTem:PRESet:REMOte\[:STATe\]](#) is set to ON.

Parameters:

<PresetMode> NORMAL | FILE | GLOBAL | RFOFF

NORMAL

Factory preset

FILE

User preset file, see [SYSTem:PRESet:USER:NAME](#) on page 1644

GLOBAL

Factory preset + GUI reset + reset RF connection configuration between VNA and external devices

RFOff

Factory preset + `OUTPut<Ch>[:STATe] OFF`

Manual operation: See "[Normal / RF Off / Normal, GUI, Ext Setup / <File Name>](#)" on page 929

SYSTem:PRESet:REMOte[:STATe] <Boolean>

Defines the behavior of the preset commands `*RST` and `SYSTem:PRESet[:DUMMy]`

Parameters:

<Boolean>

OFF (0)

`*RST` and `SYSTem:PRESet` perform a factory preset.

ON (1)

`*RST` and `SYSTem:PRESet` restore the user preset file selected using `SYSTem:PRESet:USER:NAME`, if this file is available and valid. Otherwise, they perform a factory preset.

Manual operation: See "[Remote Preset Configuration](#)" on page 857

SYSTem:PRESet:SCOPE <Scope>

Specifies whether the preset actions affect all open recall sets, or only the active recall set.

Applies to the GUI and the `SYSTem:PRESet[:DUMMy]` command. The `*RST` command always resets all open recall sets.

Parameters:

<Scope>

ALL | SINGle

ALL

All open recall sets are deleted and a new recall set "Set1" is created according to the current preset mode.

See `SYSTem:PRESet:MODE` on page 1642.

SINGle

The active setup is reset according to the current preset mode; the name of the active setup and the parameters of all other setups remain unchanged.

Example: See `SYSTem:PRESet[:DUMMy]`

Manual operation: See "[Preset Scope](#)" on page 857

SYSTem:PRESet:START <Boolean>

Defines whether the analyzer firmware always starts with the configured system preset (factory or user defined) or with the previous state. This is a global setting.

Parameters:

<Boolean>

ON

The FW always starts with the configured system preset.

See `SYSTem:PRESet:USER:NAME` and `SYSTem:PRESet:USER[:STATE]`.

OFF

The analyzer firmware recalls the previous state, i.e. the settings that were persisted during the previous shutdown.

Manual operation: See ["Start in Preset"](#) on page 858

SYSTem:PRESet:USER:CAL <PresetUserCal>

Selects a calibration from the calibration pool that shall be restored during a user-defined preset.

The corresponding cal group file (<PresetUserCal>.cal) must be available in the cal pool directory

C:\Users\Public\Documents\Rohde-Schwarz\ZNA\Calibration\Data\.

Parameters:

<PresetUserCal>

Name of the cal group (i.e. the name of the cal group file without path and extension).

Use the empty string to restore the default behavior (no preset user cal).

Example:

```
MMEMORY:STORE:CORREction 1, 'Ref11
Trans123.cal'
```

Adds the active user calibration to the memory pool

```
SYSTem:PRESet:USER:CAL 'Ref11 Trans123'
```

Sets the newly created cal pool member as the preset user cal.

```
SYSTem:PRESet:USER:CAL?
```

Queries for the preset user cal. Returns 'Ref11 Trans123'

```
SYSTem:PRESet:USER:CAL ''
```

Restores the default behaviour of the instrument: no preset user cal.

Manual operation: See ["Preset User Cal"](#) on page 640

SYSTem:PRESet:USER:NAME <RecallSetFile>

Specifies the name of a recall set file (*.znxml|*.znx) to be used for a user-defined preset.

Parameters:

<RecallSetFile> String parameter to specify the absolute or relative path of the recall set file to be loaded. Relative paths are evaluated relative to the current directory (see [MMEMory:CDIRectory](#)).

Example:

See [SYSTem:PRESet:USER\[:STATe\]](#)

Manual operation: See "[Preset Configuration](#)" on page 857

SYSTem:PRESet:USER[:STATe] <Boolean>

Determines whether a factory or a user-defined preset is performed.

This setting applies to the analyzer GUI and to the remote commands `*RST` and [SYSTem:PRESet\[:DUMMy\]](#), if [SYSTem:PRESet:REMOte\[:STATe\]](#) is set to ON.

Parameters:

<Boolean>

OFF (0)

A factory preset is performed.

ON (1)

A user-defined preset is performed, if the setup file selected using [SYSTem:PRESet:USER:NAME](#) is available and valid. Otherwise, a factory preset is performed.

Example:

```
SYST:PRESet:USER:NAME 'C:\Users\Public\Documents
\Rohde-Schwarz\ZNA\RecallSets\Setup_2.znxml'
```

Select a setup file for the user-defined preset.

```
SYST:PRESet:USER ON
```

Enable the user-defined preset.

```
SYSTem:PRESet:REMOte ON
```

Align `*RST` (and [SYSTem:PRESet](#)) to the user-defined preset.

```
*RST
```

Perform the user-defined preset.

Manual operation: See "[Preset Configuration](#)" on page 857

SYSTem:SETTings:UPDate <Activate>

Initiates an immediate update of the channel or trace settings.

The command has an effect if the analyzer operates in single sweep mode ([INITiate<Ch>:CONTInuous](#) OFF) and if the display update is switched off ([SYSTem:DISPlay:UPDate](#) OFF). In this scenario, a change of the channel or trace settings is usually not taken into account immediately. The analyzer waits until the end of the current sweep sequence and changes all settings made during the last sweep period when the next single sweep sequence is initiated. Several settings can be made en bloc, which generally saves time.

`SYSTem:SETTings:UPDate ONCE` causes the analyzer to apply the settings at once without waiting for the end of the current single sweep sequence. The command has no effect in continuous sweep mode or if the display update is switched on.

The settings are also updated when the continuous sweep mode is activated (`INITiate<Ch>:CONTInuous ON`).

Setting parameters:

`<Activate>` ONCE
Causes an immediate update of the settings.

Example:

```
INIT:CONT OFF
Activate single sweep mode.
SYST:SETT:UPD ONCE
Update the settings made during the current single sweep
period.
```

Usage: Setting only

SYSTem:SMATrix:OPTimization <Unit>

Sets/gets the switch matrix route selection algorithm.

Parameters:

`<Unit>` SPEEd | PRECision
 SPEEd – Optimizes measurement speed by minimizing the total number of switching procedures. This is highly recommended for matrices with mechanical switches.
 PRECision – Optimizes measurement precision by always using best possible routes (according to matrix-specific route prioritization).

SYSTem:SHUTdown [<Unit>]

Performs a shutdown or restart of the FW or OS.

If the optional parameter `<Unit>` is omitted, Windows is shutdown after a time-out period of 10 seconds.

Setting parameters:

`<Unit>` HALT | REBoot | ABORt | CLOSe | REStArt
HALT
 Windows is shutdown after a time-out period of 20 seconds
REBoot
 Windows is restarted after a time-out period of 20 seconds
ABORt
 Abort a Windows shutdown/restart. This can only be used during the time-out period.
CLOSe
 Close the firmware.
REStArt
 Restart the firmware.

Example:

```
SYST:SHUT
Switch the analyzer to standby state.
```

Usage: Setting only

SYSTem:SOUNd:ALARm[:STATe] <Boolean>

SYSTem:SOUNd:STATus[:STATe] <Boolean>

These commands switch alarm or status sounds on or off.

Parameters:

<Boolean> ON | OFF
*RST: ON

Example: SYST:SOUN:ALAR OFF; STAT OFF
Switch alarm and status sounds off.

Manual operation: See "[Sounds](#)" on page 861

SYSTem:TIME <Hours>, <Minutes>, <Seconds>

The command queries or defines the instrument's current time setting.

The setting command requires administrator rights; refer to "[User accounts and password protection](#)" on page 30.

Parameters:

<Hours> Range: 0...23
<Minutes> Range: 0...59
<Seconds> Range: 0...59

Example: SYST:TIME?
Response: 12, 0, 0 - it is precisely 12 pm.

SYSTem:TRESet[:STATe] <Boolean>

Defines the behavior of the [INITiate<Ch>\[:IMMEDIATE\] \[:DUMMY\]](#) and [INITiate\[:IMMEDIATE\]:ALL](#).

Parameters:

<Boolean> **OFF (0)**
Previous trace data are preserved.
ON (1)
Previous trace data are deleted.
This is a global setting that is not affected by an instrument reset. Factory default is OFF (0).

Manual operation: See "[Restart: Set all Traces to 0](#)" on page 862

SYSTem:TSLock <Type>

Locks the touchscreen functionality of the R&S ZNA, e.g. in order to prevent inadvertent entries during remote control.

Parameters:

<Type>

OFF | DIAGrams | SCReen

OFF – touchscreen (e.g. the remote screen) remains active. You can use the buttons in "Remote" softtool panels. If you switch back to manual control, the drag and drop functions (e.g. for markers) are still available.

DIAGrams – lock the drag and drop functions in diagrams .

SCReen – lock the entire screen including the remote screen buttons.

*RST: n/a (*RST does not affect the touchscreen lock setting).

Example:

SYSTem:TSLock SCReen

Lock the entire screen.

Manual operation: See ["Enabled / Lock Diagrams / Lock Screen"](#) on page 854

SYSTem:TTLout<Pt>:STATus[:STATe] <Boolean>

Defines the default values of `CALCulate<Chn>:LIMit:TTLout<Pt>[:STATe]` for new traces.

Suffix:

<Pt>

1 - TTL out pass 1 (pin 13 of User Port connector)

2 - TTL out pass 2 (pin 14 of User Port connector)

Parameters:

<Boolean>

OFF (0)

New traces are created with

`CALCulate<Chn>:LIMit:TTLout<Pt>[:STATe]` set to OFF (0).

ON (1)

New traces are created with

`CALCulate<Chn>:LIMit:TTLout<Pt>[:STATe]` set to ON (1).

*RST: Not affected by *RST; factory default is OFF

Manual operation: See ["TTL Pass Default Values"](#) on page 867

SYSTem:USER:DISPlay:TITLe <String>

Defines a title for the remote display, i.e. for the screen that is shown at the instrument, if a remote session is established and the standard display is switched off.

DON'T TOUCH
Remote test running...

Parameters:

<String> Title string.
 A \n in the string starts a new line; see example.
 *RST: empty string

Example:

```
SYST:USER:DISP:TITL "DON'T TOUCH\nRemote test
running..."
Define a title for the remote display.
```

SYSTem:USER:KEY <Key>[, <Label>]

Labels a user-defined key in the remote display. In the query form the command returns whether or not a user-defined key was tapped or clicked.

Parameters:

<Key> Number of the user key
 0 – Delete all user keys and restore the default keys ("Go to Local", "Display Off").
 1 to 8 – User key numbers
 Range: 0 to 8
 *RST: 0

<Label> Label for user key no. 1 to 8 (string variable)

Example:

```
SYST:USER:KEY 1, 'User S11'
Define a user key no. 1 labeled S11. The user key is only
labeled, no functionality is assigned.
SYST:USER:KEY? 1
Query the label. The response is 1, 'User S11'.
SYST:USER:KEY?
Query the user action. The query returns 0, '', indicating that
no user key has been tapped or clicked. If you tap the user soft-
key no. 1, the response is 1, 'User S11'. Moreover, the ESR
bit no. 6 (User Request) is set.
SYST:USER:KEY 0
Delete the user key and restore the default keys.
```

SYSTem:VERSion?

Returns the SCPI version number to which the analyzer complies. The analyzer complies to the final SCPI version 1999.0

Example:

```
SYST:VERS?
Query the SCPI version. The response is 1999.0.
```

Usage:

Query only

7.3.18 TRACe commands

The TRACe . . . commands handle active trace data and trace data stored in the analyzer's internal memory.



Trace data formats

Trace data is transferred in either ASCII or block data (REAL) format, depending on the `FORMat[:DATA]` setting. If the block data format is used, it is recommended to select EOI as receive terminator (`SYSTem:COMMunicate:GPIB[:SELF]:RTERminator EOI`).

The commands in the TRACe... menu use the following ZVR-compatible parameters to specify traces:

Table 7-18: Reserved Trace Names

Parameter	Meaning	Used in
CH1DATA CH2DATA CH3DATA CH4DATA	Active data trace of channels 1 to 4	<code>TRACe:COPIY</code> <code>TRACe[:DATA]:STIMulus[:ALL]?</code> <code>TRACe[:DATA][:RESPonse][:ALL]?</code> <code>CALCulate<Chn>:MATH[:EXPRession][:DEFine]</code>
CH1MEM CH2MEM CH3MEM CH4MEM	Active memory trace associated to the active data trace CH1DATA, CH2DATA, CH3DATA, CH4DATA, respectively.	<code>TRACe[:DATA]:STIMulus[:ALL]?</code> <code>TRACe[:DATA][:RESPonse][:ALL]?</code>
IMPLied	Active data trace, addressed with <Chn>	<code>CALCulate<Chn>:MATH[:EXPRession][:DEFine]</code>
CHMem	Active memory trace assigned to the IMPLied trace	<code>CALCulate<Chn>:MATH[:EXPRession][:DEFine]</code>
MDATA1 MDATA2 MDATA3 MDATA4 MDATA5 MDATA6 MDATA7 MDATA8	Memory trace named Mem<n> [Trc<m>]. The trace name is unique because <n> counts all data and memory traces in the active setup.	<code>TRACe:CLEAr</code> <code>TRACe:COPIY</code> <code>TRACe[:DATA]:STIMulus[:ALL]?</code> <code>TRACe[:DATA][:RESPonse][:ALL]?</code> <code>CALCulate<Chn>:MATH[:EXPRession][:DEFine]</code>

TRACe:COPIY <MemTraceName>, <DataTraceName>

Copies a data trace to a memory trace. The trace to be copied can be specified by two alternative methods:

- As the active data trace of channels 1 to 4 (CH1DATA, CH2DATA, CH3DATA, CH4DATA). If a mathematical trace is active, the associated data trace is copied.

- As a trace with a name (string variable).

The created memory trace can be specified as follows:

- As the memory trace named `Mem<n>[Trc<m>]`, where $n = 1, \dots, 8$ and `Trc<m>` is the name of the copied data trace (MDATA1, MDATA2, MDATA3, MDATA4, MDATA5, MDATA6, MDATA7, MDATA8).
- As a memory trace with an arbitrary name (string variable).

An existing memory trace with the same name is overwritten.

Note: The copied trace is the data trace which is not modified by any mathematical operations. To copy a mathematical trace to a memory trace, use `TRACe:COPIY:MATH`. To copy the active trace to the memory using an automatic memory trace name, use `CALCulate<Chn>:MATH:MEMorize`.

Setting parameters:

`<MemTraceName>` Name of the memory trace (see also [Table 7-18](#)).

Range: `<memory_trace>` is either a string variable (enclosed in single or double quotes) or one of the following reserved names (no string variables): MDATA1 | MDATA2 | MDATA3 | MDATA4 | MDATA5 | MDATA6 | MDATA7 | MDATA8 (only for memory traces `Mem<n>[Trc<m>]`, where $n = 1, \dots, 8$).

`<DataTraceName>` Name of the data trace (see also [Table 7-18](#)).

Range: `<data_trace>` is either a string variable (enclosed in single or double quotes) or one of the following reserved names (no string variables): CH1DATA | CH2DATA | CH3DATA | CH4DATA (only for the active data trace in channels Ch1, Ch2, Ch3, Ch4).

Example:

```
*RST; :SWE:POIN 20
```

Create a trace with 20 sweep points, making the created trace the active trace of channel 1 (omitted optional mnemonic `SENSe1`).

```
TRAC:COPIY "Mem_Pt20", CH1DATA
```

Copy the current state of the created trace to a memory trace named "Mem_Pt20". The memory trace is not displayed.

```
DISP:WIND:TRAC2:FEED "MEM_PT20"
```

Display the created memory trace in the active diagram area (diagram area no. 1).

Usage: Setting only

Manual operation: See "[Data to <Destination>](#)" on page 438

TRACe:COPIY:MATH <MemTraceName>, <DataTraceName>

Copies a mathematical trace to a memory trace. The trace to be copied can be specified by two alternative methods:

- As the active mathematical trace of channels 1 to 4 (CH1DATA, CH2DATA, CH3DATA, CH4DATA)
- As a trace with a name (string variable).

The created memory trace can be specified as follows:

- As the memory trace named Mem<n>[Trc<m>], where n = 1, ... 8 and Trc<m> is the name of the copied data trace (MDATA1, MDATA2, MDATA3, MDATA4, MDATA5, MDATA6, MDATA7, MDATA8).
- As a memory trace with an arbitrary name (string variable).

An existing memory trace with the same name is overwritten.

Note: To copy a data trace which is not modified by any mathematical operations, use [TRACe:COPIY](#)

Setting parameters:

<MemTraceName>	Name of the memory trace (see also Table 7-18). Range: <memory_trace> is either a string variable (enclosed in single or double quotes) or one of the following reserved names (no string variables):MDATA1 MDATA2 MDATA3 MDATA4 MDATA5 MDATA6 MDATA7 MDATA8 (only for memory traces Mem<n>[Trc<m>], where n = 1, ... 8).
<DataTraceName>	Name of the data trace (see also Table 7-18). Range: <data_trace> is either a string variable (enclosed in single or double quotes) or one of the following reserved names (no string variables):CH1DATA CH2DATA CH3DATA CH4DATA (only for the active data trace in channels Ch1, Ch2, Ch3, Ch4).

Example:

```
*RST; :SWE:POIN 20
```

Create a trace with 20 sweep points, making the created trace the active trace of channel 1 (omitted optional mnemonic SENSE1).

```
CALC:MATH:SDEF 'Trc1 / 2'; :CALC:MATH:STAT ON
```

Define a mathematical trace, dividing the data trace by 2. Activate the mathematical mode and display the mathematical trace instead of the data trace.

```
TRAC:COPIY:MATH 'Mem_Pt20',CH1DATA; :CALC:MATH:STAT OFF
```

Copy the current state of the mathematical trace to a memory trace named "Mem_Pt20". The memory trace is not displayed. Switch the display back to the data trace.

```
DISP:WIND:TRAC2:FEED 'MEM_PT20'
```

Display the created memory trace together with the data trace.

Usage: Setting only
Manual operation: See "Data & Func to <Destination>" on page 438

7.3.19 TRIGger commands

7.3.19.1 TRIGger[:SEQuence]...

The TRIGger[:SEQuence]... commands synchronize the analyzer's measurement sequences to external events. These events are indicated to the VNA by sending trigger signals via Trigger In A to D or the User Port.

TRIGger<Ch>[:SEQuence]:EINPut.....	1653
TRIGger<Ch>[:SEQuence]:HOLDoff.....	1653
TRIGger<Ch>[:SEQuence]:LINK.....	1654
TRIGger[:SEQuence]:LTRigger[:STATe].....	1655
TRIGger[:SEQuence]:LTRigger:COUNT?.....	1655
TRIGger[:SEQuence]:LTRigger:RESet.....	1655
TRIGger<Ch>[:SEQuence]:MULTiple:HOLDoff.....	1655
TRIGger<Ch>[:SEQuence]:MULTiple:LOGic.....	1656
TRIGger<Ch>[:SEQuence]:MULTiple:SLOPe<Num>.....	1656
TRIGger<Ch>[:SEQuence]:MULTiple:SOURce<inp>.....	1657
TRIGger<Ch>[:SEQuence]:SLOPe.....	1658
TRIGger<Ch>[:SEQuence]:SOURce.....	1658

TRIGger<Ch>[:SEQuence]:EINPut <TrigExtInput>

In external trigger mode (TRIGger<Ch>[:SEQuence]:SOURce EXTernal), this command selects one of the available external trigger sources.

Suffix:

<Ch>

Parameters:

<TrigExtInput> EXTA | EXTB | EXTC | EXTD | UPORT2
EXTA
 Trigger In A or Pin 2 of [User Port](#)
EXTB | EXTC | EXTD
 Trigger In B, ..., Trigger In D
 (requires [Trigger board](#) option R&S ZNA-K91)
UPOINT2
 Pin 25 of [User Port](#)

Manual operation: See "Source" on page 562

TRIGger<Ch>[:SEQuence]:HOLDoff <DelayTime>

Sets a delay time between the trigger event and the start of the measurement ("Trigger Delay").

Suffix:

<Ch> Channel number.

Parameters:

<DelayTime> Delay time.
 Range: 0 s to 13680 s
 Increment: 10 ms
 *RST: 0 s
 Default unit: s

Example:

```
TRIG:SOUR MAN
Activate external trigger source.
TRIG:HOLD UP
Set a delay time of 10 ms.
```

Manual operation: See "[Delay](#)" on page 562

TRIGger<Ch>[:SEQUENCE]:LINK <MeasSequence>

Selects the triggered measurement sequence. The identifier for the sequence is a string variable.

Suffix:

<Ch> Channel number

Parameters:

<MeasSequence> Triggered measurement sequence, string variable.
 'SWEep' – trigger event starts an entire sweep.
 'SEGMENT' – trigger event starts a sweep segment, if segmented frequency sweep is active (see example below). If another sweep type is active, the trigger event starts an entire sweep.
 'POINT' – trigger event starts measurement at the next sweep point.
 'PPOINT' – trigger event starts the next partial measurement at the current or at the next sweep point.
 *RST: 'SWEep'

Example:

```
SEGM:ADD; :SWE:TYPE SEGM
Select segmented frequency sweep.
TRIG:LINK 'SEGMENT'
Select a trigger segment as triggered measurement sequence.
TRIG:LINK?
Query the triggered measurement sequence. The response is
'SEGMENT'.
```

Manual operation: See "[Sequence](#)" on page 561

TRIGger[:SEQuence]:LTRigger[:STATe] <Boolean>

Activates/deactivates tracking of lost trigger events.

Parameters:

<Boolean>	ON (1) Lost trigger tracking active
	OFF (0) Lost trigger tracking inactive

Manual operation: See ["Activate Lost Trigger"](#) on page 880

TRIGger[:SEQuence]:LTRigger:COUNT?

Returns the number of lost trigger events the analyzer firmware observed since the last reset of the lost trigger event log (see [TRIGger\[:SEQuence\]:LTRigger:RESet](#) on page 1655).

Usage: Query only

Manual operation: See ["Sequence"](#) on page 561

TRIGger[:SEQuence]:LTRigger:RESet

Clears the lost trigger event log.

Usage: Event

Manual operation: See ["Clear Lost Trigger Log"](#) on page 880

TRIGger<Ch>[:SEQuence]:MULTiple:HOLDoff <MeasSequence>[, <DelayTime>]

Sets a delay time between the trigger event and the start of the measurement ("Trigger Delay") in multiple trigger mode.

Suffix:

<Ch> Channel number

Parameters:

<MeasSequence>	SWEep SEGMENT POINT PPOINT Triggered measurement sequence, PPOINT denotes "partial measurement"; see TRIGger<Ch>[:SEQuence]:LINK .
----------------	-------------------------------------------------------------------------------------------------------------------------------------------------------------------

<DelayTime>	Delay time
	Range: 0 s to 13680 s
	Increment: 10 ms
	*RST: 0 s
	Default unit: s

Example: See [TRIGger<Ch>\[:SEQuence\]:MULTiple:SOURce<inp>](#)

Manual operation: See ["... /Logic/ ..."](#) on page 563

TRIGger<Ch>[:SEQuence]:MULTiple:LOGic <Sequence>[, <TrigLogic>]

Defines the logical combination of the trigger events defined in [TRIGger<Ch>\[:SEQuence\]:MULTiple:SOURce<inp>](#) that will trigger measurement sequence <Sequence>.

Suffix:

<Ch> Channel number

Parameters:

<Sequence> SWEep | SEGMENT | POINT | PPOINT
Triggered measurement sequence
PPOINT denotes "partial measurement"; see [TRIGger<Ch>\[:SEQuence\]:LINK](#).

<TrigLogic> NONE | AND | OR

NONE

only trigger event 1 is considered

AND

logical **AND** of trigger events 1 and 2

OR

logical **OR** of trigger events 1 and 2

Example:

```
TRIGger<Ch>:SOURce MULTiple
Activate multiple trigger mode.
:TRIG:MULTiple:SOUR1 SWE, EXTA; SOUR2 SWE, EXTB
Define Trigger In A and B as trigger sources for sweeps.
TRIG:MULT:SLOP1 SWE, POS; SLOP2 POIN, POS
Trigger on the rising edges of Trigger In A and B.
TRIG<Ch>:MULT:LOG SWE, AND
Trigger a new sweep if both trigger events have occurred.
TRIG:MULT:HOLD POIN, 1ms
Define a trigger delay of 1 ms before each sweep start.
```

Manual operation: See "[... /Logic/ ...](#)" on page 563

TRIGger<Ch>[:SEQuence]:MULTiple:SLOPe<Num> <MeasSequence>[, <Slope>]

Qualifies whether the multiple trigger events occur on the rising or on the falling edge or on the beginning of the high / low level periods of the external TTL trigger signal <Num>.

Suffix:

<Ch> Channel number

<Num> Number of trigger signal (1 or 2)

Parameters:

<MeasSequence> SWEep | SEGMENT | POINT | PPOINT
Triggered measurement sequence, PPOINT denotes "partial measurement"; see [TRIGger<Ch>\[:SEQuence\]:LINK](#).

<Slope>	POSitive NEGative HIGH LOW Trigger slope for the triggered measurement sequence: POSitive NEGative - rising or falling edge HIGH LOW - high or low level
Example:	See <code>TRIGger<Ch>[:SEquence]:MULTiple:SOURce<inp></code>
Manual operation:	See "... /Logic/ ..." on page 563

TRIGger<Ch>[:SEquence]:MULTiple:SOURce<inp> <Sequence>[, <TrigSource>]

Selects the source of the trigger events the analyzer uses to start a measurement sequence in multiple trigger mode (`TRIGger<Ch>[:SEquence]:SOURce MULTiple`).

Suffix:

<Ch>	Channel number
<inp>	1, 2 Distinguishes between the two trigger events that can be logically combined to trigger measurement sequence <Sequence> (see <code>TRIGger<Ch>[:SEquence]:MULTiple:LOGic</code> on page 1656).

Parameters:

<Sequence>	SWEep SEGment POINT PPOINT Triggered measurement sequence PPOINT denotes "partial measurement"; see <code>TRIGger<Ch>[:SEquence]:LINK</code> .
<TrigSource>	IMMediate EXTA EXTB EXTC EXTD MANual UPORT2 Trigger source for the triggered measurement sequence IMMediate Free run measurement (untriggered) EXTA Trigger event at Trigger In A or Pin 2 of User Port EXTB EXTC EXTD Trigger event at Trigger In B, ..., Trigger In D (requires Trigger board hardware option R&S ZNA-B91) UPORT2 Trigger event at pin 25 of User Port MANual Trigger event generated by pressing the "Manual Trigger" soft-key
Example:	See <code>TRIGger<Ch>[:SEquence]:MULTiple:LOGic</code> on page 1656
Manual operation:	See "... /Logic/ ..." on page 563

TRIGger<Ch>[:SEQuence]:SLOPe <Slope>

Qualifies whether the trigger event occurs on the rising or on the falling edge or on the beginning of the high / low level periods of the external TTL trigger signal.

Suffix:

<Ch> Channel number

Parameters:

<Slope> POSitive | NEGative | HIGH | LOW
 Trigger slope for the triggered measurement sequence:
 POSitive | NEGative - rising or falling edge
 HIGH | LOW - high or low level

Example:

```
TRIG:SOUR EXT
Activate external signal as trigger source.
TRIG:SLOP NEG
Trigger on the negative edge of the (external TTL) trigger signal.
```

Manual operation: See "[Signal Type](#)" on page 562

TRIGger<Ch>[:SEQuence]:SOURce <TrigSource>

Selects the source of the trigger events that the analyzer uses to start a measurement sequence.

Suffix:

<Ch> Channel number

Parameters:

<TrigSource> IMMEDIATE | EXTERNAL | MANUAL | MULTIPLE
IMMEDIATE
 Free run measurement (untriggered)
EXTERNAL
 Trigger by external signal applied to the Trigger In connector or pin 2 of the User Port on the rear panel.
MANUAL
 Trigger event generated by pressing the "Manual Trigger" soft-key
MULTIPLE
 Multiple trigger mode, configured by
 TRIGger<Ch>[:SEQuence]:MULTiple... commands

Example:

```
TRIG:SOUR MAN
Activate manual trigger mode. The analyzer starts the next measurement sequence when the "Manual Trigger" button is pressed.
```

Manual operation: See "[FreeRun / External / Manual / Multiple Triggers](#)" on page 560

7.3.19.2 TRIGger:CHANnel:AUXiliary...

The `TRIGger:CHANnel<Ch>:AUXiliary...` commands control the external trigger outputs Trigger Out A to D on the [Trigger board](#) (hardware option R&S ZNA-B91). Each trigger output can generate:

- TTL pulses of configurable duration and polarity which can be sent before or after each sweep, sweep segment, partial measurement or measurement point.
- TTL high/low signals indicating an active sweep, segment, partial measurement or measurement point.

<code>TRIGger:CHANnel<Ch>:AUXiliary<n>:DELay</code>	1659
<code>TRIGger:CHANnel<Ch>:AUXiliary<n>:DURation</code>	1659
<code>TRIGger:CHANnel<Ch>:AUXiliary<n>:INTerval</code>	1660
<code>TRIGger:CHANnel<Ch>:AUXiliary<n>:POSition</code>	1661
<code>TRIGger:CHANnel<Ch>:AUXiliary<n>:STYPe</code>	1661

`TRIGger:CHANnel<Ch>:AUXiliary<n>:DELay <TrigOutDelay>`

Specifies the delay of the trigger out signal relative to the selected sweep interval (see [TRIGger:CHANnel<Ch>:AUXiliary<n>:INTerval](#)).

If pulses are used as trigger out signals (see [TRIGger:CHANnel<Ch>:AUXiliary<n>:STYPe](#)), the delay is defined relative to the start or end of the sweep event (see [TRIGger:CHANnel<Ch>:AUXiliary<n>:POSition](#)).

Suffix:

<code><Ch></code>	Channel number
<code><n></code>	1 = Trigger Out A, ..., 4 = Trigger Out D

Parameters:

<code><TrigOutDelay></code>	Range: 0 to 30 s Default unit: s
-----------------------------------	-------------------------------------

Example: See [TRIGger:CHANnel<Ch>:AUXiliary<n>:INTerval](#) on page 1660.

Options: R&S ZNA-B91

Manual operation: See "[Delay](#)" on page 564

`TRIGger:CHANnel<Ch>:AUXiliary<n>:DURation <TrigOutDuration>`

If pulses are used as trigger out signals (see [TRIGger:CHANnel<Ch>:AUXiliary<n>:STYPe](#)), this setting specifies the width of the output trigger pulses at Trigger Out A to D.

The trigger duration must be shorter than the selected sweep interval (see [TRIGger:CHANnel<Ch>:AUXiliary<n>:INTerval](#)).

If the trigger duration is too long, you can modify one of the following settings:

- Reduce the trigger duration, if possible.

- Slow down the sweep: select a smaller bandwidth or increase the "Sweep Time" setting.

Suffix:

<Ch> Channel number
 <n> 1 = Trigger Out A, ..., 4 = Trigger Out D

Parameters:

<TrigOutDuration> Pulse width between 10 ns (1E-8 s) and 30 s.
 *RST: 1 us
 Default unit: s

Example:

See `TRIGger:CHANnel<Ch>:AUXiliary<n>:SType` on page 1661

Options:

R&S ZNA-B91

Manual operation: See "[Width](#)" on page 564

TRIGger:CHANnel<Ch>:AUXiliary<n>:INTERval <Type>

Selects the sweep interval to be indicated at the related Trigger Out connector.

Suffix:

<Ch> Channel number
 <n> 1 = Trigger Out A, ..., 4 = Trigger Out D

Parameters:

<Type> NONE | SWEEp | SEGMENT | PPOint | POINT | ACQuisition | PGENERator

NONE

No trigger out signal for this channel and Trigger Out connector.

SWEEp | SEGMENT | PPOint | POINT

A trigger out signal is generated for every sweep, segment, partial measurement or sweep point, respectively.

ACQuisition

A trigger out signal is generated for every data acquisition phase

PGENERator

For pulse generator pulses, pulses with identical or opposite polarity can be generated as trigger out signal

*RST: SWEEp

Example:

`TRIGger:CHANnel1:AUXiliary1:SType POSitive`

Generate pulses with positive polarity at Trigger Out A.

`TRIGger:CHANnel:AUXiliary:INTERval SWEEp`

Send one output trigger pulse per sweep.

`TRIGger:CHANnel:AUXiliary:POSition BEFORE`

`TRIGger:CHANnel1:AUXiliary1:DELay 1 us`

`TRIGger:CHANnel:AUXiliary:DURation 10 us`

Send the output trigger 1 µs before sweep start, and with 10 µs pulse width.

Options: R&S ZNA-B91
Manual operation: See "Sequence" on page 564

TRIGger:CHANnel<Ch>:AUXiliary<n>:POSition <Type>

If pulses are used as trigger out signals (see [TRIGger:CHANnel<Ch>:AUXiliary<n>:STYPe](#)), the pulses can either indicate the "Start" or "End" of the related sweep interval (see [TRIGger:CHANnel<Ch>:AUXiliary<n>:INTerval](#)).

Suffix:

<Ch> Channel number
 <n> 1 = Trigger Out A, ..., 4 = Trigger Out D

Parameters:

<Type> BEFore | AFTer
BEFore
 is appropriate if the device needs to be triggered before the data is acquired (typical example: a power meter which is used for power calibration)
AFTer
 is appropriate if the device needs to be triggered just after data acquisition (typical example: an external generator which must be reconfigured to get ready for the next measurement)
 *RST: AFTer

Example: See [TRIGger:CHANnel<Ch>:AUXiliary<n>:STYPe](#) on page 1661

Options: R&S ZNA-B91
Manual operation: See "Position" on page 565

TRIGger:CHANnel<Ch>:AUXiliary<n>:STYPe <Type>

Defines how the selected sweep sequence is indicated at the related Trigger Out connector.

Use [TRIGger:CHANnel<Ch>:AUXiliary<n>:INTerval](#) to select the sweep sequence.

Suffix:

<Ch> Channel number
 <n> 1 = Trigger Out A, ..., 4 = Trigger Out D

Parameters:

<Type> POSitive | NEGative | AHIGH | ALLOW
POSitive | NEGative
 pulses with positive or negative polarity

AHIGH | ALLOW

High (low) voltage level in active state and low (high) level otherwise

Note that pulse generator pulses cannot be indicated using high and low voltage levels.

- Example:** See `TRIGger:CHANnel<Ch>:AUXiliary<n>:INTerval` on page 1660.
- Options:** R&S ZNA-B91
- Manual operation:** See "Signal Type" on page 564

7.3.19.3 Other commands**TRIGger:STATus:READy?** [<TrigSource>]

Queries the current "Ready for Trigger" state

Query parameters:

<TrigSource> ANY
For Keysight PNA Compatibility, ANY (and only ANY) is accepted as parameter.

Usage: Query only

TRIGger:WAIT:READy? [<Timeout>]

Returns 1 when the R&S ZNA is "Ready for Trigger", or 0 after the specified <Timeout>.

Query parameters:

<Timeout> Timeout value (optional, default 1 ms)
Default unit: s

Usage: Query only

7.3.20 New commands for R&S ZNA

- [Mixer phase and delay measurements](#)..... 1663
- [Advanced port settings](#).....1668
- [Internal 2nd LO \(R&S ZNA-B5\)](#).....1670
- [Other](#)..... 1670

7.3.20.1 Mixer phase and delay measurements

Mixer phase calibration (R&S ZNA-K5)

<code>SOURce<Ch>:POWer:CORRection:MIXer:IF[:ACQuire]</code>	1663
<code>SOURce<Ch>:POWer:CORRection:MIXer:LO<Stg>[:ACQuire]</code>	1663
<code>SOURce<Ch>:POWer:CORRection:MIXer:RF[:ACQuire]</code>	1664

`SOURce<Ch>:POWer:CORRection:MIXer:IF[:ACQuire]`

Starts the IF source calibration (2nd power calibration step for vector (not scalar) mixer measurements), stores and applies the calibration data. The external power meter is selected via `SOURce<Ch>:POWer<PhyPt>:CORRection:PMETer:ID`.

The IF source calibration is independent of the RF source and LO source calibration; see description of the mixer calibration procedure.

Suffix:

<Ch> Calibrated channel number

Example:

```
FREQ:CONV VMIX . . .
```

Select a vector mixer measurement; set frequencies, see e.g. example for

```
[SENSe<Ch>:]FREQuency:CONVersion:MIXer:
TFRequency.
```

```
SOUR:POW:CORR:PMET:ID 1
```

Select power meter no. 1 (previously configured in the External Power Meters dialog and properly connected) for the RF source calibration.

```
SOUR:POW:CORR:MIX:RF
```

Start the RF source calibration. Change the test setup for the IF source calibration (see mixer calibration procedure).

```
SOUR:POW:CORR:MIX:IF
```

Start the IF source calibration.

```
FREQ:CONV:MIX:LOIN 3
```

Select port no. 3 as a signal source for the LO signal. Adjust the test setup for the LO source calibration.

```
SOUR:POW:CORR:MIX:LO
```

Start the LO source calibration.

Usage: Event

`SOURce<Ch>:POWer:CORRection:MIXer:LO<Stg>[:ACQuire]`

Starts the LO source calibration (3rd power calibration step for scalar mixer measurements, 4th calibration step for two-stage scalar mixer measurements), stores and applies the calibration data. The external power meter is selected via `SOURce<Ch>:POWer<PhyPt>:CORRection:PMETer:ID`.

Suffix:

<Ch> Calibrated channel number

<Stg>

Example: See `SOURce<Ch>:POWer:CORRection:MIXer:RF[:ACQuire]` on page 1664.

Usage: Event

SOURce<Ch>:POWer:CORRection:MIXer:RF[:ACQuire]

Starts the RF source calibration (1st power calibration step for scalar and vector mixer measurements), stores and applies the calibration data. The external power meter used is selected via `SOURce<Ch>:POWer<PhyPt>:CORRection:PMETer:ID`.

Note: For scalar mixer measurements the command initiates two calibration steps, the first over the RF frequency range, the second over the IF frequency range (for a subsequent receiver power calibration, `[SENSe<Ch>:]CORRection:POWer<PhyPt>:MIXer:IF:ACQuire`). See description of the mixer calibration procedure.

Suffix:

<Ch> Calibrated channel number

Example:

```
FREQ:CONV MIX ...
```

Select a scalar mixer measurement; set frequencies, see e.g. example for

```
[SENSe<Ch>:]FREQuency:CONVersion:MIXer:
```

```
TFRequency.
```

```
SOUR:POW:CORR:PMET:ID 1
```

Select power meter no. 1 (previously configured in the External Power Meters dialog and properly connected) for the RF source calibration.

```
SOUR:POW:CORR:MIX:RF
```

Start the RF source calibration. Change the test setup for the IF receiver calibration (see mixer calibration procedure).

```
CORR:POWer:MIX:IF:ACQuire
```

Start the IF receiver calibration.

```
FREQ:CONV:MIX:LOIN 3
```

Select port no. 3 as a signal source for the LO signal. Adjust the test setup for the LO source calibration.

```
SOUR:POW:CORR:MIX:LO
```

Start the LO source calibration.

Usage: Event

Mixer delay measurements (R&S ZNA-K9)

<code>[SENSe<Ch>:]FREQuency:MDElay:ACQuire</code>	1665
<code>[SENSe<Ch>:]FREQuency:MDElay:APERture</code>	1665
<code>[SENSe<Ch>:]FREQuency:MDElay:CDElay</code>	1666
<code>[SENSe<Ch>:]FREQuency:MDElay:CDMode</code>	1666
<code>[SENSe<Ch>:]FREQuency:MDElay:CONVersion</code>	1666
<code>[SENSe<Ch>:]FREQuency:MDElay:CORRection[:STATE]</code>	1667

[SENSe<Ch>:]FREQUency:MDELay:DIVide.....	1667
[SENSe<Ch>:]FREQUency:MDELay:LTONe.....	1667
[SENSe<Chn>:]FREQUency:MDELay:MSTate?.....	1667
[SENSe<Ch>:]FREQUency:MDELay:RECeiver.....	1667
[SENSe<Ch>:]FREQUency:MDELay:RPORT.....	1668
[SENSe<Ch>:]FREQUency:MDELay:UTONe.....	1668

[SENSe<Ch>:]FREQUency:MDELay:ACQUIRE

Starts a calibration sweep for the mixer delay measurement. As a prerequisite, the calibrated channel must have at least one mixer delay trace.

Suffix:

<Ch> Channel number

Example: See [MMEMory:LOAD:MDCData](#) on page 1290.

Usage: Event

[SENSe<Ch>:]FREQUency:MDELay:APERture <Aperture value>

Defines the frequency difference between the upper and lower tone (aperture).

Suffix:

<Ch> Channel number

Parameters:

<Aperture value> Aperture
 Range: 0 Hz to 50 MHz
 *RST: 0 Hz
 Default unit: Hz

Example:

```
*RST; SENS1:FREQ:STAR 1 GHz; STOP 2 GHz
Select a stimulus range between 1 GHz and 2 GHz.
FREQ:MDEL:APER 1 MHz
Select a 1 MHz aperture.
FREQ:MDEL:UTON PORT, 3
Select NWA port 3 as a source port for the upper tone (no external generator).
FREQ:MDEL:COMB ON
Use the internal combiner to generate the two-tone signal at port 1 (for instruments equipped with the necessary options).
...
(Perform mixer delay measurement, evaluate results.)
FREQ:MDELay:CONV OFF
Disable mixer delay measurement, switch back to normal (non frequency-converting) mode.
```

Manual operation: See ["2 Tone Delta Freq."](#) on page 417

[SENSe<Ch>:]FREQUENCY:MDElay:CDELay <const delay value for ref mixer>

Defines a constant mixer delay value, to be used as a reference for a mixer delay measurement calibration. The setting takes effect after constant mixer delay is enabled; see example below.

Suffix:

<Ch> Channel number

Parameters:

<const delay value for Constant delay
ref mixer> Range: 0 to 1 ms
*RST: 0
Default unit: s

Example:

```
*RST; :FREQ:MDEL:CDEL 1 ns
```

Define a constant mixer delay value of 1 ns.

```
MMEM:LOAD:MDAD 1, CDEL
```

Use constant delay value for mixer delay measurement calibration.

Manual operation: See "[Constant Cal Delay](#)" on page 592

[SENSe<Ch>:]FREQUENCY:MDElay:CDMode <arg0>**Suffix:**

<Ch>

Parameters:

<arg0>

Manual operation: See "[Use Constant Cal Delay](#)" on page 592

[SENSe<Ch>:]FREQUENCY:MDElay:CONVersion <Mixer delay conversion flag>

Disables the mixer delay measurement and switches back to normal (non frequency-converting) mode.

Suffix:

<Ch> Channel number

Setting parameters:

<Mixer delay
conversion flag> OFF
Disable mixer delay measurement
*RST: OFF

Example:

See [\[SENSe<Ch>:\]FREQUENCY:MDElay:APERture](#)
on page 1665

Usage: Setting only

Manual operation: See "[Apply/OK](#)" on page 419

[SENSe<Ch>:]FREQuency:MDELay:CORRection[:STATe] <arg0>

Qualifies whether the analyzer applies the current mixer delay measurement calibration data.

Tip:

The analyzer automatically applies the calibration data when a calibration file is loaded ([MMEMory:LOAD:MDCData](#)) or after a calibration sweep has been completed ([\[SENSe<Ch>:\]FREQuency:MDELay:ACQuire](#)).

Suffix:

<Ch> Channel number.

Parameters:

<arg0> ON | OFF – Apply / ignore calibration data
*RST: OFF

Example: See [MMEMory:LOAD:MDCData](#) on page 1290

[SENSe<Ch>:]FREQuency:MDELay:DIVide <Group Delay Divide by 2 flag>

Suffix:

<Ch>

Parameters:

<Group Delay Divide
by 2 flag>

[SENSe<Ch>:]FREQuency:MDELay:LTONE <lower tone port number>

Suffix:

<Ch>

Parameters:

<lower tone port
number>

Manual operation: See "[Lower Tone](#)" on page 418

[SENSe<Chn>:]FREQuency:MDELay:MSTate?

Suffix:

<Chn>

Usage: Query only

[SENSe<Ch>:]FREQuency:MDELay:RECeiver <Group Delay Receiver Mode>

Suffix:

<Ch>

Parameters:

<Group Delay INTernal | EXTernal
Receiver Mode>

[SENSe<Ch>:]FREQuency:MDELay:RPORT <receiver port number>

Suffix:

<Ch>

Parameters:

<receiver port
number>

Manual operation: See "IF" on page 418

[SENSe<Ch>:]FREQuency:MDELay:UTONE <Upper tone source signal>[, <port
number>]

Selects the source for the upper tone signal that is used for the mixer delay measurement.

Suffix:

<Ch> Channel number.

Parameters:

<Upper tone source PORT | GENerator | NONE
signal>

Upper tone source:

NONE – no source selected

PORT – internal source at port <source_no>

GENerator – external generator no. <source_no>, as defined in the System Configuration – External Generators dialog

Range: 1 to port number of the analyzer/number of external generators

<port number> Number of the port for the internal source or of the generator (to be omitted for source NONE)

Example: See [\[SENSe<Ch>:\]FREQuency:MDELay:LTONE](#)
on page 1667

Manual operation: See "Upper Tone" on page 418

7.3.20.2 Advanced port settings

Access: [Channel Config] > "Port Config" > "Advanced Port Settings".

[SENSe<Ch>:]FREQuency<Pt>:OFFSet:PWAVes	1669
[SENSe<Ch>:]FREQuency:OFFSet:PWAVes:STATE	1669
[SENSe<Ch>:]FREQuency<Pt>:OFFSet:WAVes	1669

[SENSe<Ch>:]FREQUENCY<Pt>:OFFSet:PWAVes <FreqOffset>

Defines the constant receiver frequency offset for primed wave quantities a' and b' relative to the common receiver frequency.

Suffix:

<Ch> Channel number
 <Pt> Physical port number

Parameters:

<FreqOffset> Frequency offset.
 Range: 0 Hz to 25 MHz
 Increment: 1 Hz
 *RST: 0 Hz
 Default unit: Hz

Example:

```
FREQ:STAR 2GHz; STOP 3 GHz
Define a sweep range between 2 GHz and 3 GHz.
FREQ:OFFS:PWAV 10kHz; WAV 20kHz
Modify the receiver frequency settings.
```

[SENSe<Ch>:]FREQUENCY<Pt>:OFFSet:PWAVes:STATe <Boolean>

Enables/disables the calculation of primed wave quantities for two-tone group delay measurements.

Suffix:

<Ch> Channel number

Parameters:

<Boolean> ON | OFF | 0 | 1
 *RST: 1

Options: R&S ZNA-K9

Manual operation: See ["Use Primed Waves"](#) on page 690

[SENSe<Ch>:]FREQUENCY<Pt>:OFFSet:WAVes <FreqOffset>

Defines the constant receiver frequency offset for unprimed wave quantities a, b relative to the common receiver frequency.

Suffix:

<Ch> Channel number.
 <Pt> Test port number of the analyzer.

Parameters:

<FreqOffset> Frequency offset.
 Range: 0 Hz to 25 MHz
 Increment: 1 Hz
 *RST: 0 Hz
 Default unit: Hz

Example: See [\[SENSe<Ch>:\]FREQuency<Pt>:OFFSet:PWAVes](#)

7.3.20.3 Internal 2nd LO (R&S ZNA-B5)

[SENSe<Ch>:]MSMode <LO Sequence Mode>

Suffix:
<Ch>

Parameters:
<LO Sequence Mode> ALTerminated | CHOPped

[SENSe<Ch>:]SLAMode <Port to LO Assignment Mode>

Defines the LO usage for channel <Ch>.

Suffix:
<Ch> Channel number

Parameters:
<Port to LO Assignment Mode> OPTimized | DEFault
OPTimized
Use both LOs, if available
DEFault
Use only one LO
*RST: DEFault

Manual operation: See "[LO Usage](#)" on page 689

7.3.20.4 Other

CALCulate<Chn>:FORMat:WQPNormal	1670
[SENSe<Ch>:]PPORt<PPort>:BSHift	1671
[SENSe<Ch>:]PRANge	1671
SYSTem:CORRection:FMPORt[:STATE]	1671

CALCulate<Chn>:FORMat:WQPNormal <Boolean>

Enables phase normalization for wave quantity traces.

Suffix:
<Chn> Channel number used to identify the active trace

Parameters:
<Boolean> If set to ON, the phase of the measured wave quantity is normalized to the a-wave of the selected driving port.

[SENSe<Ch>:]PPORt<PPort>:BSHift <stimulus settings index>, <buffer shift value>
[SENSe<Ch>:]PPORt<PPort>:BSHift? <stimulus settings index>

Suffix:

<Ch>

<PPort>

Parameters:

<buffer shift value>

Parameters for setting and query:<stimulus settings
index>

[SENSe<Ch>:]PRANge <Power Range, Tmp command>

Suffix:

<Ch>

Parameters:<Power Range, Tmp
command>

SYSTem:CORRection:FMPORt[:STATe] <arg0>

Enables or disables Fast Multiport Correction.

Parameters:

<arg0>

ON | OFF – Enable or disable fast multiport correction.

*RST: *RST has no effect on the calibration algorithm.

Example:

SYST:CORR:FMP ON

Enable fast multiport correction.

7.4 HUMS and service date commands

This section provides the commands that are related to the Rohde & Schwarz [Health and usage monitoring service \(HUMS\)](#), which is available on various Rohde & Schwarz instruments.



For background information, see the R&S HUMS User Manual.

- [SNMP/REST commands](#).....1672
- [System information commands](#).....1675
- [Device tags commands](#).....1685
- [Utilization commands](#).....1686
- [Service date commands](#).....1693

7.4.1 SNMP/REST commands

These commands configure the SNMP and REST interfaces to R&S HUMS.

They all require software option R&S ZNA-980.

SYSTem:COMMunicate:SNMP:COMMunity:RO	1672
SYSTem:COMMunicate:SNMP:COMMunity:RW	1672
SYSTem:COMMunicate:SNMP:CONtact	1673
SYSTem:COMMunicate:SNMP:LOCation	1673
SYSTem:COMMunicate:SNMP:USM:USER	1673
SYSTem:COMMunicate:SNMP:USM:USER:ALL?	1674
SYSTem:COMMunicate:SNMP:USM:USER:DELete	1674
SYSTem:COMMunicate:SNMP:USM:USER:DELete:ALL	1674
SYSTem:COMMunicate:SNMP:VERSion	1674
SYSTem:COMMunicate:REST:ENABle	1675

SYSTem:COMMunicate:SNMP:COMMunity:RO <CommunityString>

Defines the SNMP community string for read-only access.

Prerequisites for this command:

- Select an SNMP version that supports communities ([SYSTem:COMMunicate:SNMP:VERSion](#) on page 1674).

Setting parameters:

<CommunityString> String containing the community name.

Example: //Set community name
 SYST:COMM:SNMP:VERS V12
 SYST:COMM:SNMP:COMM:RO 'ABC'

Usage: Setting only

Manual operation: See "[SNMPv2c Configuration](#)" on page 872

SYSTem:COMMunicate:SNMP:COMMunity:RW <CommunityString>

Defines the SNMP community string for read-write access.

Prerequisites for this command:

- Select an SNMP version that supports communities ([SYSTem:COMMunicate:SNMP:VERSion](#) on page 1674).

Setting parameters:

<CommunityString> String containing the community name.

Example: //Set read-write access
 SYST:COMM:SNMP:VERS V12
 SYST:COMM:SNMP:COMM:RW 'ABC'

Usage: Setting only

Manual operation: See "[SNMPv2c Configuration](#)" on page 872

SYSTem:COMMunicate:SNMP:CONtact <SnmpContact>

Defines the SNMP contact information for the administrator.

You can also set the contact information via SNMP if you do not set it via SCPI.

Parameters for setting and query:

<SnmpContact> String containing SNMP contact.
*RST: "" (empty string)

Example: //Set SNMP contact
SYST:COMM:SNMP:CONT 'ABC'

SYSTem:COMMunicate:SNMP:LOCation <SnmpLocation>

Defines the SNMP location information for the administrator.

You can also set the location information via SNMP if you do not set it via SCPI.

Parameters for setting and query:

<SnmpLocation> String containing SNMP location.
*RST: "" (empty string)

Example: //Return SNMP location
SYST:COMM:SNMP:LOC?

SYSTem:COMMunicate:SNMP:USM:USER <Name>, <Access>, <Level>[, <Auth_pwd>[, <Priv_pwd>]]

Defines an SNMP user profile.

Prerequisites for this command:

- Select SNMPv3 ([SYSTem:COMMunicate:SNMP:VERSion](#) on page 1674).

Setting parameters:

<Name> String containing name of the user.
<Access> RO | RW
Defines the access right a user can have.
<Level> NOAuth | AUTH | PRIVacy
Defines the security level.
<Auth_pwd> String containing the authentication password.
<Priv_pwd> String containing the privacy password.

Example: //Create user profile
SYST:COMM:SNMP:VERS V123
SYST:COMM:SNMP:USM:USER 'Peter', 'RO', 'PRIV',
'1234', 'XYZ'

Usage: Setting only

Manual operation: See "[SNMPv3 Configuration](#)" on page 872

SYSTem:COMMunicate:SNMP:USM:USER:ALL?

Queries the number of users and a list of all SNMP users for SNMPv3.

Prerequisites for this command:

- Select SNMPv3 ([SYSTem:COMMunicate:SNMP:VERSion](#) on page 1674).

Return values:

<Count> Total number of registered SNMP users.

<Name> List of all user names as a comma-separated list.

Example: //Return all SNMP users
SYST:COMM:SNMP:USM:USER:ALL?

Usage: Query only

Manual operation: See "[SNMPv3 Configuration](#)" on page 872

SYSTem:COMMunicate:SNMP:USM:USER:DELeTe <UserName>

Deletes a specific SNMP user profile.

Setting parameters:

<UserName> String containing name of SNMP user profile to be deleted.

Example: //Delete SNMP user profile
SYST:COMM:SNMP:USM:USER:DEL "Peter"

Usage: Setting only

Manual operation: See "[SNMPv3 Configuration](#)" on page 872

SYSTem:COMMunicate:SNMP:USM:USER:DELeTe:ALL

Deletes all SNMP user profiles.

Example: //Delete all SNMP user profiles
SYST:COMM:SNMP:USM:USER:DEL:ALL

Usage: Event

Manual operation: See "[SNMPv3 Configuration](#)" on page 872

SYSTem:COMMunicate:SNMP:VERSion <SnpVersion>

Selects the SNMP version.

Parameters for setting and query:

<SnpVersion> OFF | V12 | V123 | V3 | DEFault

OFF

SNMP communication is off.

V12

SNMP communication with SNMPv2 or lower.

V123

SNMP communication with SNMPv2 and SNMPv3.

V3

SNMP communication with SNMPv3.

*RST: V123

Example: //Select the SNMP version
 SYST:COMM:SNMP:VERS V12

Manual operation: See "SNMP" on page 871

SYSTem:COMMunicate:REST:ENABLE <RestState>

Turns communication via the REST API on and off.

Parameters:

<RestState> ON | OFF | 0 | 1

Example: //Return REST state
 SYST:COMM:REST:ENAB?

Manual operation: See "REST" on page 871

7.4.2 System information commands

Using these commands you can retrieve the system information provided by the R&S HUMS.

They all require software option R&S ZNA-980.

DIAGnostic:HUMS[:ALL]?	1676
DIAGnostic:HUMS:BIOS?	1676
DIAGnostic:HUMS:DELeTe:ALL	1677
DIAGnostic:HUMS:DEVice:HISTory?	1677
DIAGnostic:HUMS:DEVice:HISTory:DELeTe:ALL	1678
DIAGnostic:HUMS:DEVice:HISTory:EVEnt:ADD	1678
DIAGnostic:HUMS:EQUipment?	1678
DIAGnostic:HUMS:FORMat	1679
DIAGnostic:HUMS:SAVE	1679
DIAGnostic:HUMS:SECurity?	1680
DIAGnostic:HUMS:SERVice?	1680
DIAGnostic:HUMS:STATe	1681
DIAGnostic:HUMS:STORAge?	1681
DIAGnostic:HUMS:SW?	1683
DIAGnostic:HUMS:SYSTem:INFO?	1683
DIAGnostic:HUMS:SYSTem:STATus?	1684
DIAGnostic:HUMS:SYSTem:STATus:SUMMary?	1685

DIAGnostic:HUMS[:ALL]?

Queries the REST endpoints for the HUMS application in a single query. This allows you to read all HUMS data stored on the instrument via REST API.

The data can be displayed either in `JSON` or `XML` format. For more information about setting the format, see [DIAGnostic:HUMS:FORMat](#) on page 1679.

Return values:

<Endpoints> **<block_data>**
 String returns REST endpoints as block data in a comma-separated list.
 Binary block data with the following syntax:
 #<Digits><Length><Binarydata>
#
 Indicates the start of the binary block
<Digits>
 Decimal value
 Gives the number of decimal digits used for the <Length> value
<Length>
 Decimal value
 Number of bytes the follow in the <Binary data> part
<Binary data>
 Binary data in ASCII format

Example: //Return complete HUMS data
 DIAG:HUMS?

Usage: Query only

DIAGnostic:HUMS:BIOS?

Queries the BIOS information from the instrument. Depending on the set data format, the queried data is either displayed in `XML` or `JSON` format. For more information about setting the data format, see [DIAGnostic:HUMS:FORMat](#) on page 1679.

Return values:

<BIOSInfo> **<block_data>**
 BIOS information of the connected instrument as block data in a comma-separated list.
 #<manufacturer>,<serialNumber>,<version>,<releaseDate>,<caption>,<isPresent>
 Binary block data with the following syntax:
 #<Digits><Length><Binarydata>
#
 Indicates the start of the binary block
<Digits>
 Decimal value
 Gives the number of decimal digits used for the <Length> value

<Length>

Decimal value

Number of bytes the follow in the <Binary data> part

<Binary data>

Binary data in ASCII format

Example: //Return BIOS information
DIAG:HUMS:BIOS?

Usage: Query only

DIAGnostic:HUMS:DELeTe:ALL

Deletes the complete HUMS data. This includes device history, device tags, SCPI connections, utilization history and utilizations.

Example: //Delete HUMS data
DIAG:HUMS:DEL:ALL

Usage: Event

Manual operation: See "[Delete HUMS History](#)" on page 872

DIAGnostic:HUMS:DEvIce:HISTory?

Queries the device history information of the connected instrument. Depending on the set data format, the queried data is either displayed in XML or JSON format. For more information about setting the data format, see [DIAGnostic:HUMS:FORMat](#) on page 1679.

Return values:

<HistoryInfo>

<block_data>

Device history information of the connected instrument as block data in a comma-separated list:

#blockdata[{event1},{event2},{event3}...]

With the following parameters:

<eventID>,<eventTimestamp>,<eventMessage>,<eventDetails>,<eventSeverity>

Binary block data with the following syntax:
#<Digits><Length><Binarydata>

#

Indicates the start of the binary block

<Digits>

Decimal value

Gives the number of decimal digits used for the <Length> value

<Length>

Decimal value

Number of bytes the follow in the <Binary data> part

<Binary data>

Binary data in ASCII format

Example: //Return device history
 DIAG:HUMS:DEV:HIST?
 Returns for example:
 #44715[{"eventId":32,"eventTimestamp":
 "2021-02-02T17:25:39Z","eventMessage":
 "Deviation from Self Alignment Temperature",
 "eventDetails":
 "Deviations resolved","eventSeverity":0}

Usage: Query only

DIAGnostic:HUMS:DEvIce:HISTory:DELeTe:ALL

Deletes the complete device history information of the connected instrument.

Example: //Delete complete device history
 DIAG:HUMS:DEV:HIST:DEL:ALL

Usage: Event

DIAGnostic:HUMS:DEvIce:HISTory:EVENt:ADD <Severity>, <Message>[, <Detail>]

Adds an event to the event history.

Note that the event ID, time stamp and event source are automatically created when you add the event.

Setting parameters:

<Severity> INFO | WARNing | ERRor
 Severity of the event.

<Message> Short description of the event.

<Detail> More comprehensive description of the event.

Example: //Add an event of the event history
 DIAG:HUMS:DEV:HIST:EVEN:ADD
 INFO,"InfoEvent","An event that has occurred on
 the instrument"

Usage: Setting only

DIAGnostic:HUMS:EQUipment?

Queries the equipment information (device footprint) of the instrument. Depending on the set data format, the queried data is either displayed in XML or JSON format. For more information about setting the data format, see [DIAGnostic:HUMS:FORMat](#) on page 1679.

Return values:

<EquipmentInfo> <block_data>
 Device footprint of the connected instrument as block data in a comma-separated list.

Binary block data with the following syntax:

```
#<Digits><Length><Binarydata>
```

#

Indicates the start of the binary block

<Digits>

Decimal value

Gives the number of decimal digits used for the <Length> value

<Length>

Decimal value

Number of bytes the follow in the <Binary data> part

<Binary data>

Binary data in ASCII format

Example: //Return device footprint
DIAG:HUMS:EQU?

Usage: Query only

DIAGnostic:HUMS:FORMat <DataFormat>

Selects the format for the queried HUMS data. You can query the HUMS data either in JSON format or XML format.

The defined format affects all other commands that return block data.

Parameters:

<DataFormat> JSON | XML

JSON

Returns the HUMS data in JSON format.

XML

Returns the HUMS data in XML format.

*RST: JSON

Example: //Return data in JSON format
DIAG:HUMS:FORM JSON

DIAGnostic:HUMS:SAVE <path>

Saves the HUMS history as a ZIP file to your preferred path.

Setting parameters:

<path>

Example: //Save HUMS history data
DIAG:HUMS:SAVE 'C:\HUMS\hums_2021.zip'

Usage: Setting only

DIAGnostic:HUMS:SECurity?

Queries the security information of the instrument. Depending on the set data format, the queried data is either displayed in XML or JSON format. For more information about setting the data format, see [DIAGnostic:HUMS:FORMat](#) on page 1679.

Return values:

<SecurityInfo> **<block_data>**
 Security information of the connected instrument as block data in a comma-separated list.
 #blockdata{"antimalware":
 {<name>,<enabled>,<upToDate>,<timestamp>},
 "firewallEnabled"}
 Binary block data with the following syntax:
 #<Digits><Length><Binarydata>
#
 Indicates the start of the binary block
<Digits>
 Decimal value
 Gives the number of decimal digits used for the <Length> value
<Length>
 Decimal value
 Number of bytes the follow in the <Binary data> part
<Binary data>
 Binary data in ASCII format

Example:

```
//Return security information
DIAG:HUMS:SEC?
#3133{"antimalware":{"name":
"Windows Defender","enabled":false,"upToDate":
true,"timestamp":
"2018-02-08T10:09:22Z"},"firewallEnabled":true}
```

Usage:

Query only

DIAGnostic:HUMS:SERVICE?

Queries the service information of the instrument. Depending on the set data format, the queried data is either displayed in XML or JSON format. For more information about setting the data format, see [DIAGnostic:HUMS:FORMat](#) on page 1679.

Return values:

<ServiceInfo> **<block_data>**
 Service information of the connected instrument as block data in a comma-separated list:
 #blockdata{<lastdate>,<requiredservice>,<calibration>:
 {<lastcalibration>,<nextDue>,<nextDueExpired>,
 <recommendedCalibrationInterval>},<uptime>}
 Binary block data with the following syntax:
 #<Digits><Length><Binarydata>

#
Indicates the start of the binary block

<Digits>
Decimal value
Gives the number of decimal digits used for the **<Length>** value

<Length>
Decimal value
Number of bytes the follow in the **<Binary data>** part

<Binary data>
Binary data in ASCII format

Example:

```
//Return service information
DIAG:HUMS:SERV?
Returns for example:
#3196{"last":"2021-01-19T23:00:00Z","required":
2,"calibration":{"last":
"2021-01-19T23:00:00Z","nextDue":
"2022-01-19T23:00:00Z","nextDueExpired":
false,"recommendedCalibrationInterval":
"1Y"},"uptime":0}
```

Usage: Query only

DIAGnostic:HUMS:STATe <State>

Turns the HUMS service and data collection on and off.

Parameters:

<State> ON | OFF | 1 | 0
*RST: ON

Example:

```
//Turn on HUMS service
DIAG:HUMS:STAT ON
```

Manual operation: See ["State \(Device Utilization\)/Status"](#) on page 871

DIAGnostic:HUMS:STORage?

Queries the storage information of the instrument. Depending on the set data format, the queried data is either displayed in XML or JSON format. For more information about setting the data format, see [DIAGnostic:HUMS:FORMat](#) on page 1679.

Return values:

<StorageInfo> <block_data>

Returns storage information for each storage device of the connected instrument as block data.

```
#blockdata[{storagedevice1},
{storagedevice2},...]
```

Binary block data with the following syntax:

```
#<Digits><Length><Binarydata>
```

#

Indicates the start of the binary block

<Digits>

Decimal value

Gives the number of decimal digits used for the <Length> value

<Length>

Decimal value

Number of bytes the follow in the <Binary data> part

<Binary data>

Binary data in ASCII format

For each storage device it returns:

```
<diskname>, <temperature>, <type>, <modelfamily>,
<model>, <serialnumber>, <id>, <firmwareversion>,
<capacity>, <sectorsize>, <rotationrate>, <formfactor>,
<ataversion>, <sataversion>, <smartdatatable>.
```

For each value of the smart data table it returns:

```
<id>, <attributename>, <dataflag>, <value>,
<worst>, <threshold>, <type>, <update>,
<whenfailed>, <rawvalue>
```

Example:

//Return storage information

DIAG:HUMS:STOR?

Returns for example:

```
#44620[{"name":"/dev/sda", "temperature":
305, "type":"ata", "modelFamily":null, "model":
"SanDisk SD9SB8W128G", "serialNumber":
"000000000000", "id":
"5 001b44 8b67d0a7d", "firmwareVersion":
"A1234000", "userCapacity":
128035676160, "sectorSizeLogical":
512, "sectorSizePhysical":512, "rotationRate":
"0", "formFactor":"2.5 inches", "ataVersion":
"ACS-4 T13/BSR INCITS 529 revision 5", "sataVersion":
"SATA 3.3", "smartDataTable":[{"id":
5, "attributeName":
"Reallocated_Sector_Ct", "dataFlag":50, "value":
100, "worst":100, "threshold":0, "type":
"Old_age", "updated":
"Always", "whenFailed":null, "rawValue":0}, {"id":
9, "attributeName":"Power_On_Hours", "dataFlag":
50, "value":100, "worst":100, "threshold":
0, "type":"Old_age", "updated":
"Always", "whenFailed":null, "rawValue":16856}]
```

Usage:

Query only

DIAGnostic:HUMS:SW?

Queries information about the installed software on the instrument. Depending on the set data format, the queried data is either displayed in XML or JSON format. For more information about setting the data format, see [DIAGnostic:HUMS:FORMat](#) on page 1679.

Return values:

<SoftwareInfo> <block_data>

For each installed software package it returns the following information as block data in a comma-separated list:
 #blockdata[{<index>, <name>, <softwareType>, <installDate> }]

Binary block data with the following syntax:
 #<Digits><Length><Binarydata>

#
 Indicates the start of the binary block

<Digits>
 Decimal value
 Gives the number of decimal digits used for the <Length> value

<Length>
 Decimal value
 Number of bytes the follow in the <Binary data> part

<Binary data>
 Binary data in ASCII format

Example: //Return installed software information
 DIAG:HUMS:SW?

Usage: Query only

DIAGnostic:HUMS:SYSTEM:INFO?

Queries the system information of the instrument. Depending on the set data format, the queried data is either displayed in XML or JSON format. For more information about setting the data format, see [DIAGnostic:HUMS:FORMat](#) on page 1679.

Return values:

<SystemInfo> <block_data>

Returns system information of the connected instrument as block data.

Binary block data with the following syntax:
 #<Digits><Length><Binarydata>

#
 Indicates the start of the binary block

<Digits>
 Decimal value
 Gives the number of decimal digits used for the <Length> value

<Length>

Decimal value
 Number of bytes the follow in the <Binary data> part
<Binary data>
 Binary data in ASCII format

Example: //Return system information
 DIAG:HUMS:SYST:INFO?

Usage: Query only

DIAGnostic:HUMS:SYSTEM:STATUS?

Queries the complete system status information of the instrument. Depending on the set data format, the queried data is either displayed in XML or JSON format. For more information about setting the data format, see [DIAGnostic:HUMS:FORMat](#) on page 1679.

Return values:

<SystemStatus> <block_data>
 Returns complete system status information of the connected instrument as block data in a comma-separated list:
 #blockdata{<globalStatus>,<tablevalues>:
 [{tablevalue1},{tablevalue2},...]}
 Binary block data with the following syntax:
 #<Digits><Length><Binarydata>
 #
 Indicates the start of the binary block
<Digits>
 Decimal value
 Gives the number of decimal digits used for the <Length> value
<Length>
 Decimal value
 Number of bytes the follow in the <Binary data> part
<Binary data>
 Binary data in ASCII format
 For each table value it returns the following values:
 <id>,<description>,<descriptionExtended>,
 <value>,<unit>,<upperLimit>,<lowerLimit>,
 <reference>,<severity>

Example: //Return system status information
 DIAG:HUMS:SYST:STAT?
 #41874{"globalStatus":3,"values":[{"id":
 31522816,"description":
 "RF Overload","descriptionExtended":
 null,"value":null,"unit":null,"upperLimit":
 null,"lowerLimit":null,"reference":
 null,"severity":1},...}]}

Usage: Query only

DIAGnostic:HUMS:SYSTEM:STATUS:SUMMARY?

Queries the status summary of the complete system.

Return values:

<StatusSummary> **OK**
The system is OK.

WARNING
There are some issues with the system which might be critical later.

ERRor
Problems with the system occurred and the status is critical.

Example: //Return status summary of the system
DIAG:HUMS:SYST:STAT:SUMM?

Usage: Query only

7.4.3 Device tags commands

DIAGnostic:HUMS:TAGS:ALL?.....	1685
DIAGnostic:HUMS:TAGS[:VALue].....	1685
DIAGnostic:HUMS:TAGS:DELeTe.....	1686
DIAGnostic:HUMS:TAGS:DELeTe:ALL.....	1686

DIAGnostic:HUMS:TAGS:ALL?

Queries all key-value tags that you have assigned to the instrument. Depending on the set data format, the queried data is either displayed in XML or JSON format. For more information about setting the data format, see [DIAGnostic:HUMS:FORMat](#) on page 1679.

Return values:

<ID> ID number of the defined tag.

<Key> String containing key name of the defined tag.

<Value> String containing value of the defined tag.

Example: //Return all tags
DIAG:HUMS:TAGS:ALL?
1,"location","building_11",2,"time zone","CET"

Usage: Query only

Manual operation: See ["Add / Delete \(Trash\) / Delete All"](#) on page 873

DIAGnostic:HUMS:TAGS[:VALue] <ID>, <Key>, <Value>

DIAGnostic:HUMS:TAGS[:VALue]? <ID>

Adds or modifies a key-value pair (device tag).

The query returns the key-value pair for a given ID or an empty string if the ID is unknown.

Parameters:

<Key> String containing key name of the queried tag.

<Value> String containing value of the queried tag.

Parameters for setting and query:

<ID> 0 - 31
ID number of the tag you want to modify or query.
To identify the ID number, query all device tags from the system first. For more information, read here [DIAGnostic:HUMS:TAGS:ALL?](#) on page 1685.

Example: //Add or modify a tag (tag 1)
DIAG:HUMS:TAGS 1, 'location', 'building_11'

Manual operation: See "[Add / Delete \(Trash\) / Delete All](#)" on page 873

DIAGnostic:HUMS:TAGS:DELeTe <ID>

Deletes a certain tag you assigned to your instrument, including its key and value.

Setting parameters:

<ID> ID number of the tag you want to delete.
To identify the ID number, query all device tags from the system first. For more information, see [DIAGnostic:HUMS:TAGS:ALL?](#) on page 1685.

Example: //Delete tag
DIAG:HUMS:TAGS:DEL 0

Usage: Setting only

Manual operation: See "[Add / Delete \(Trash\) / Delete All](#)" on page 873

DIAGnostic:HUMS:TAGS:DELeTe:ALL

Deletes all key-value tags you have assigned to the instrument.

Example: //Delete all tags
DIAG:HUMS:TAGS:DEL:ALL

Usage: Event

Manual operation: See "[Add / Delete \(Trash\) / Delete All](#)" on page 873

7.4.4 Utilization commands

Using these commands you can retrieve the utilization information provided by the R&S HUMS.

They all require software option R&S ZNA-980.

DIAGnostic:HUMS:UTILization?.....	1687
DIAGnostic:HUMS:UTILization:ACTivity:TRACking:STATe.....	1688
DIAGnostic:HUMS:UTILization:CUSTom:ADD.....	1688
DIAGnostic:HUMS:UTILization:CUSTom:ALL?.....	1689
DIAGnostic:HUMS:UTILization:CUSTom:DELeTe.....	1689
DIAGnostic:HUMS:UTILization:CUSTom:DELeTe:ALL.....	1690
DIAGnostic:HUMS:UTILization:CUSTom:UPDate.....	1690
DIAGnostic:HUMS:UTILization:HISTory?.....	1690
DIAGnostic:HUMS:UTILization:HISTory:DELeTe:ALL.....	1692
DIAGnostic:HUMS:UTILization:HISTory:DETailEd?.....	1692

DIAGnostic:HUMS:UTILization?

Queries the current utilization data of the instrument.

Depending on the set data format, the queried utilization data is either displayed in XML or JSON format. For more information about setting the data format, see [DIAGnostic:HUMS:FORMat](#) on page 1679.

Return values:

<UtilizationData> **<block_data>**

Returns the current utilization data of the connected instrument as block data.

```
#blockdata[{utilization1},{utilization2},...]
```

Binary block data with the following syntax:

```
#<Digits><Length><Binarydata>
```

#

Indicates the start of the binary block

<Digits>

Decimal value

Gives the number of decimal digits used for the **<Length>** value

<Length>

Decimal value

Number of bytes the follow in the **<Binary data>** part

<Binary data>

Binary data in ASCII format

For each utilization it returns the following values:

```
<id>,<scope>,<reference>,<unit>,<description>,<value>,<startvalue>,<state>
```

Example:

```
//Return utilization data
DIAG:HUMS:UTIL?
Returns for example:
#123456[{"id":31719936,"scope":
"DEVICE_SPECIFIC","reference":null,"name":
"Self alignments","unit":
"counter","description":
"Report number of self alignments","value":
0,"startupValue":
0,"activityTracking":true},...]
```

Usage: Query only

DIAGnostic:HUMS:UTILization:ACTivity:TRACking:STATe <ID>, <State>
DIAGnostic:HUMS:UTILization:ACTivity:TRACking:STATe? <ID>

Turns the activity tracking of utilizations on and off.

Parameters:

<State> ON | OFF | 1 | 0
ON | 1
 Tracking activity = on
OFF | 0
 Tracking activity = off

Parameters for setting and query:

<ID> ID number of the utilization activity.
 To find out the ID of the utilization, you have to query the complete utilization data. For more information, see [DIAGnostic:HUMS:UTILization?](#) on page 1687.

Example: //Set activity tracking state of ID 31719936
 DIAG:HUMS:UTIL:ACT:TRAC:STAT 31719936, '1'

DIAGnostic:HUMS:UTILization:CUSTom:ADD <ID>, <Name>, <Description>, <Unit>, <State>

Creates a custom utilization.

Setting parameters:

<ID> Identifier of the custom utilization.
 Range: 1 to 99

<Name> Name of the custom utilization that appears in the user interface.

<Description> Description of the custom utilization.

<Unit> Unit of the custom utilization that appears in the user interface.

<State> ON | OFF | 1 | 0
 Initial activity state of custom utilization.

Example:

```
//Create a custom utilization
DIAG:HUMS:UTIL:CUST:ADD
1,"TrackingSomething","This utilization tracks
something","Hz",1
//Set an initial absolute value for the utilization with ID = 1; initial
start value = 0
DIAG:HUMS:UTIL:CUST:UPD 1,25,abs
//Upon an event, the utilization changes its value each time the
event occurs
DIAG:HUMS:UTIL:CUST:UPD 1,5,incr
//New value = 30, new start value = 25
//Another event
DIAG:HUMS:UTIL:CUST:UPD 1,5,incr
//New value = 35, new start value = 30 etc.
//Query all available custom utilizations
DIAG:HUMS:UTIL:CUST:ALL
//Delete the custom utilization with ID = 1
DIAG:HUMS:UTIL:CUST:DEL 1
//Delete all custom utilizations
DIAG:HUMS:UTIL:CUST:DEL:ALL
```

Usage: Setting only

DIAGnostic:HUMS:UTILization:CUSTom:ALL?

Queries all custom utilizations currently in use.

Return values:

<block_data> String returns REST endpoints as block data in a comma-separated list.
 Binary block data with the following syntax:
 #<Digits><Length><Binarydata>
 #
 Indicates the start of the binary block
<Digits>
 Decimal value
 Gives the number of decimal digits used for the <Length> value
<Length>
 Decimal value
 Number of bytes the follow in the <Binary data> part
<Binary data>
 Binary data in ASCII format

Example: See [DIAGnostic:HUMS:UTILization:CUSTom:ADD](#)

Usage: Query only

DIAGnostic:HUMS:UTILization:CUSTom:DElete <ID>

Deletes a single custom utilization.

Setting parameters:

<ID> ID of the utilization you want to delete.

Example: See [DIAGnostic:HUMS:UTILization:CUSTom:ADD](#)

Usage: Setting only

DIAGnostic:HUMS:UTILization:CUSTom:DELete:ALL

Deletes all custom utilizations.

Example: See [DIAGnostic:HUMS:UTILization:CUSTom:ADD](#)

Usage: Event

DIAGnostic:HUMS:UTILization:CUSTom:UPDate <ID>, <Value>, <Mode>[, <State>]

Changes the current values of the custom utilization (and indirectly also the start value).

Setting parameters:

<ID> Identifier of the custom utilization.

<Value> Defines the value to be changed.

<Mode> **ABSolute**
Defines an absolute value for the utilization.
For example: Currently, the utilization value = 5. If you define an absolute value of 1, the new value is 1.

INCRement

Increases or decreases the current value by a certain amount.
For example: Currently, the utilization value = 5. If you increment it by 1, the new value is 6.
If you specify a negative number, it decreases the current value.

In both cases, the previous value becomes the new start value.

<State> ON | OFF | 1 | 0

Example: See [DIAGnostic:HUMS:UTILization:CUSTom:ADD](#)

Usage: Setting only

DIAGnostic:HUMS:UTILization:HISTory? [<StartDate>[, <EndDate>[, <TimeResolution>]]]

Queries the history of utilization activity on the connected instrument.

The data format is either XML or JSON, depending on [DIAGnostic:HUMS:FORMat](#).

Timestamps follow the Unix time format.

Query parameters:

<StartDate>	String containing the start date of the evaluation period (ISO8601 format). If you do not define a start date, the command returns data starting with the data acquisition one month before the end date.
<EndDate>	String containing the end date of the evaluation period (ISO8601 format). If you do not define a end date, the command returns data for a month starting on the start date.
<Granularity>	Resolution of the evaluation period (default = usage over a period of 1 day or 86 400 seconds). You can define the resolution directly in terms of seconds as a number or indirectly in terms of SEC, MIN, HOUR or DAY (for example 7DAY results in a resolution of one week). The base unit is seconds. Default unit: s

Return values:

<History>	<p data-bbox="657 896 821 925"><block_data></p> <p data-bbox="657 947 1423 1108">Utilization usage of the connected instrument during the time period you have defined. The number of return values depends on the selected time period and time resolution. For example, if you evaluate over a time period of one week with a resolution of one day, the command returns 7 values.</p> <p data-bbox="657 1115 1173 1144">Binary block data with the following syntax:</p> <pre data-bbox="657 1151 1125 1180">#<Digits><Length><Binarydata></pre> <p data-bbox="657 1187 678 1216">#</p> <p data-bbox="657 1223 1109 1252">Indicates the start of the binary block.</p> <p data-bbox="657 1258 774 1288"><Digits></p> <p data-bbox="657 1294 837 1323">Decimal value</p> <p data-bbox="657 1330 1364 1386">Gives the number of decimal digits used for the <Length> value.</p> <p data-bbox="657 1393 790 1422"><Length></p> <p data-bbox="657 1429 837 1458">Decimal value</p> <p data-bbox="657 1464 1348 1494">Number of bytes that follow in the <Binary data> part.</p> <p data-bbox="657 1500 837 1529"><Binary data></p> <p data-bbox="657 1536 997 1565">Binary data in ASCII format</p> <p data-bbox="657 1572 1423 1659">The binary data represents the utilization activity. Each utilization is assigned a timestamp for when the utilization has been active. Together they form a pair of values.</p> <pre data-bbox="657 1666 1348 1765">#blockdata{"timestamps": [<timestamp1>,<timestamp2>,...],"activity": [<activity1>,<activity2>,...]}</pre> <p data-bbox="657 1771 1316 1800">Each timestamp therefore has a corresponding activity:</p> <pre data-bbox="657 1807 1348 1863"><timestamp1> + <activity1>, <timestamp2> + <activity2></pre>
-----------	----------------------------------------------------------------------------------------------------------------------------------------------------------------------------------------------------------------------------------------------------------------------------------------------------------------------------------------------------------------------------------------------------------------------------------------------------------------------------------------------------------------------------------------------------------------------------------------------------------------------------------------------------------------------------------------------------------------------------------------------------------------------------------------------------------------------------------------------------------------------------------------------------------------------------------------------------------------------------------------------------------------------------------------------------------------------------------------------------------------------------------------------------------------------------------------------------------------------------------------------------------------------------------------------------------------------------------------------------------------------------------------------------------------------------------------------------------------------------------------------------------------------------------------------------------------------------------------------------------------------------------------------------------------------------------------------------------------------------------------------------------------------------------------------------------------------------------------------------------------------------------------------

Example: //Query utilization history for all utilizations
 DIAG:HUMS:UTIL:HIST?
 Returns for example:
 #3440{"timestamps":
 [1612259226,1612345626,1612432026,1612518426],"activity":
 [0,0,66000,81000]}

Usage: Query only

DIAGnostic:HUMS:UTILization:HISTory:DELeTe:ALL

Deletes the complete utilization history information from the instrument.

Alternatively, you can delete:

- device history only with [DIAGnostic:HUMS:DEVIce:HISTory:DELeTe:ALL](#)
- all data with [DIAGnostic:HUMS:DELeTe:ALL](#)

Example: //Delete complete utilization history
 DIAG:HUMS:UTIL:HIST:DEL:ALL

Usage: Event

DIAGnostic:HUMS:UTILization:HISTory:DETAILED? <ID>[, <StartDate>[, <EndDate>[, <TimeResolution>]]]

Query parameters:

<ID> ID of the utilization you want to get information about.

<StartDate> String containing the start date of the evaluation period (ISO8601 format).
 If you do not define a start date, the command returns data starting with the data acquisition one month before the end date.

<EndDate> String containing the end date of the evaluation period (ISO8601 format).
 If you do not define a end date, the command returns data for a month starting on the start date.

<Granularity> Resolution of the evaluation period (default = usage over a period of 1 day or 86 400 seconds).
 You can define the resolution directly in terms of seconds as a number or indirectly in terms of SEC, MIN, HOUR or DAY (for example 7DAY results in a resolution of one week). The base unit is seconds.
 Default unit: s

Return values:

<History> <block_data>

Utilization usage of the connected instrument during the time period you have defined. The number of return values depends on the selected time period and time resolution. For example, if you evaluate over a time period of one week with a resolution of one day, the command returns 7 values.

Binary block data with the following syntax:

```
#<Digits><Length><Binarydata>
```

#

Indicates the start of the binary block.

<Digits>

Decimal value

Gives the number of decimal digits used for the <Length> value.

<Length>

Decimal value

Number of bytes that follow in the <Binary data> part.

<Binary data>

Binary data in ASCII format

The binary data represents the utilization activity. Each utilization is assigned a timestamp for when the utilization has been active. Together they form a pair of values.

```
#blockdata{"timestamps":
[<timestamp1>,<timestamp2>,...],"activity":
[<activity1>,<activity2>,...]}
```

Each timestamp therefore has a corresponding activity:

```
<timestamp1> + <activity1>, <timestamp2> +
<activity2>
```

Example:

```
//Return utilization history for a specific utilization
```

```
DIAG:HUMS:UTIL:HIST? 1
```

Returns for example:

```
#3440{"timestamps":
[1612259226,1612345626,1612432026,1612518426],"activity":
[0,0,6000,18000]}
```

Usage:

Query only

7.4.5 Service date commands

Using these commands you can get and set instrument service dates.

These dates are part of the R&S HUMS information, but do not require software option R&S ZNA-980.

DIAGnostic:SERVice:CALibration:DATE.....	1694
DIAGnostic:SERVice:CALibration:DUE:DATE.....	1694
DIAGnostic:SERVice:CALibration:DUE:STATE?.....	1694
DIAGnostic:SERVice:CALibration:INTerval?.....	1694
DIAGnostic:SERVice:DATE.....	1695
DIAGnostic:SERVice:STATE?.....	1695

DIAGnostic:SERVice:CALibration:DATE <CalibrationDate>

Defines last date and time the instrument was calibrated in ISO 8601 format.

Parameters:

<CalibrationDate> String containing calibration date of the instrument.

Example: //Set calibration date
DIAG:SERV:CAL:DATE "2019-05-05T00:00:00Z"

Manual operation: See "[Last Calibration](#)" on page 881

DIAGnostic:SERVice:CALibration:DUE:DATE <DueDate>

Defines next date and time the instrument needs calibration to be done in ISO 8601 format. The response may be empty in case of no fixed next calibration due.

Parameters:

<DueDate> String containing next calibration due date.
An empty string resets the date (= no due date).

Example: //Set calibration due date
DIAG:SERV:CAL:DUE:DATE "2020-05-12T00:00:00Z"

Manual operation: See "[Next Calibration Due](#)" on page 880

DIAGnostic:SERVice:CALibration:DUE:STATe?

Queries the state if the calibration is OK or the instrument requires calibration.

Return values:

<State> **NAN**
Not a number, e.g. if no due date is set.
OK
Calibration is OK since due date has not expired yet.
EXPIred
Calibration due date has expired. Calibration is needed.

Example: //Return calibration due state
DIAG:SERV:CAL:DUE:STAT?

Usage: Query only

DIAGnostic:SERVice:CALibration:INTerval? <Duration>

Queries the recommended calibration interval, set by Rohde & Schwarz service.

Parameters:

<Duration> String indicating the calibration interval ([ISO 8601 duration](#))

Example: DIAG:SERV:CAL:INT?
returns "P1Y" if the recommended calibration interval is 1 year

Usage: Query only

Manual operation: See ["Recommended Calibration Interval"](#) on page 880

DIAGnostic:SERVice:DATE <ServiceDate>

Defines the last date and time the instrument was serviced (ISO 8601 format).

Parameters:

<ServiceDate> String containing last service date.

Example:

```
//Return last service date
DIAG:SERV:DATE?
```

Manual operation: See ["Last Service"](#) on page 880

DIAGnostic:SERVice:STATe?

Queries the state if the instrument requires service.

Return values:

<ServiceState> **NAN**
Not a number, e.g. if no service date is set.

OK
Instrument is OK. No service is needed.

DEVIations
Deviations have been detected. Service might be required soon.

REQuired
Instrument requires service.

Example:

```
//Return service state
DIAG:SERV:STAT?
```

Usage:

Query only

7.5 R&S ZVR/ZVABT compatible commands

The commands in this chapter are supported for compatibility with analyzers of the R&S ZVR and R&S ZVAB family; they do not introduce any new functionality. For new programs, it is recommended to use the commands in [Chapter 7.3, "SCPI command reference"](#), on page 971.

CALCulate<Chn>:LIMit:CONTRol:DOMain	1696
CALCulate<Chn>:LIMit:RDOMain:COMPLex	1697
CALCulate<Chn>:LIMit:RDOMain:FORMat	1698
CALCulate<Chn>:LIMit:RDOMain:SPACing	1698
CALCulate<Chn>:LIMit:LOWer:STATe	1698
CALCulate<Chn>:LIMit:UPPer:STATe	1698
CALCulate<Ch>:PARAmeter:DEFine	1699
CALCulate<Chn>:MARKer<Mk>:FUNCTion:BWIDth	1700
CALCulate<Chn>:MARKer<Mk>:FUNCTion:DELTA:STATe	1701

CALCulate<Chn>:MARKer<Mk>:FUNcTion[:SElect]	1701
CALCulate<Chn>:MARKer<Mk>:REFerence:FUNcTion[:SElect]	1701
CALCulate<Chn>:MARKer<Mk>:FUNcTion:TARGet	1702
CALCulate<Chn>:MARKer<Mk>:REFerence:FUNcTion:TARGet	1702
CALCulate<Chn>:MARKer<Mk>:MAXimum	1702
CALCulate<Chn>:MARKer<Mk>:MINimum	1702
CALCulate<Chn>:MARKer<Mk>:REFerence:MAXimum	1702
CALCulate<Chn>:MARKer<Mk>:REFerence:MINimum	1702
CALCulate<Chn>:MARKer<Mk>:SEARch:LEFT	1703
CALCulate<Chn>:MARKer<Mk>:SEARch:NEXT	1703
CALCulate<Chn>:MARKer<Mk>:SEARch:RIGHT	1703
CALCulate<Chn>:MARKer<Mk>:REFerence:SEARch:LEFT	1703
CALCulate<Chn>:MARKer<Mk>:REFerence:SEARch:NEXT	1703
CALCulate<Chn>:MARKer<Mk>:REFerence:SEARch:RIGHT	1703
CALCulate<Chn>:MARKer<Mk>:SEARch[:IMMediate]	1703
CALCulate<Chn>:MARKer<Mk>:REFerence:SEARch[:IMMediate]	1703
CALCulate<Chn>:MATH[:EXPRession][:DEFine]	1704
DIAGnostic:SERVice:FUNcTion	1704
FORMat:DEXPort:SOURce	1705
INPut<PhyPt>:ATTenuation	1705
INSTRument[:SElect]	1706
OUTPut<Chn>:DPORt	1706
[SENSe<Ch>]:CORRection:CKIT:<ConnType>:<StandardType>	1707
[SENSe]:CORRection:CKIT:INSTall	1708
[SENSe<Ch>]:CORRection:COLLect[:ACQuire]	1708
[SENSe<Ch>]:CORRection:COLLect:METHOD	1709
[SENSe<Ch>]:CORRection:COLLect:SAVE:DEFault	1710
[SENSe<Ch>]:CORRection:COLLect:SAVE[:DUMMy]	1711
[SENSe<Ch>]:CORRection:DATA	1712
[SENSe<Ch>]:CORRection:OFFSet<PhyPt>:MAGNitude	1714
[SENSe<Ch>]:FREQuency:CONVersion:MIXer:IFFixed	1714
[SENSe<Ch>]:FREQuency:CONVersion:MIXer:LOFixed	1715
[SENSe<Ch>]:FREQuency:CONVersion:MIXer:RFFixed	1715
[SENSe<Ch>]:FREQuency:IMODulation:TTOuTput	1716
[SENSe<Ch>]:FREQuency:MODE	1716
[SENSe<Ch>]:SEGMENT<Seg>:CLEar	1716
[SENSe<Ch>]:SEGMENT<Seg>:OVERlap	1717
[SENSe<Ch>]:SWEep:SPACing	1717
[SENSe<Chn>]:FUNcTion[:ON]	1717
SOURce<Ch>:POWer<PhyPt>:CORRection:COLLect[:ACQuire]	1719
TRACe:CLEar	1719
TRACe[:DATA][:RESPonse][:ALL]?	1720
TRACe[:DATA]:STIMulus[:ALL]?	1721

CALCulate<Chn>:LIMit:CONTRol:DOMain <SweepType>

Deletes the existing limit line and (re-)defines the physical units of the stimulus values of the limit line. The units of the response values and the scaling of the y-axis can be defined via `CALCulate<Ch>:LIMit:RDOMain:...`

Suffix:

<Chn> Channel number used to identify the active trace.

Setting parameters:

<SweepType> FLIN | FLOG | FSEG | FSINgle | TLIN | TLOG | PLIN | PLOG | PSINgle

Keywords for the units of the stimulus values. The selected unit must be compatible with the sweep type ([\[SENSe<Ch>: \]SWEep:TYPE](#)); otherwise the limit line can not be displayed and no limit check is possible.

The parameters form three groups: FLIN, FLOG, FSEG, and FSINgle select frequency units for the limit line. TLIN and TLOG select time units, PLIN, PLOG and PSINgle select power units.

*RST: FLIN
Default unit: Hz (for FLIN, FLOG, FSEG, FSINgle); s (for TLIN, TLOG), dBm (for PLIN, PLOG, PSINgle).

Example:

```
SWE:TYPE POW
Select a power sweep.
CALC:LIM:CONT:DOM PLIN
Delete all existing limit line segments and select level units for
the limit line of the active trace.
CALC:LIM:CONT -20, -10
Define a limit line segment in the stimulus range between -20
dBm and -10 dBm.
```

Usage:

Setting only

CALCulate<Chn>:LIMit:RDOMain:COMPLex <UnitRef>

Deletes the existing limit line and (re-)defines the physical units of the response values of the limit line. The units of the stimulus values are defined via [CALCulate<Chn>:LIMit:CONTrol:DOMain](#).

Tip: This command is complemented by [CALCulate<Chn>:LIMit:RDOMain:FORMat](#) and [CALCulate<Chn>:LIMit:RDOMain:SPACing](#).

Suffix:

<Chn> Channel number used to identify the active trace.

Setting parameters:

<UnitRef> S | SINV | Y | Z | YREL | ZREL

Keyword for the physical unit of the response values. The parameters form four groups: S and SINV select relative units (dB) for the limit line. Y selects admittance units (S/Siemens). Z selects impedance units (Ω). YREL and ZREL select dimensionless numbers (U).

Usage:

Setting only

CALCulate<Chn>:LIMit:RDOMain:FORMat <UnitRef>

Deletes the existing limit line and (re-)defines the physical units of the response values of the limit line. The units of the stimulus values are defined via [CALCulate<Chn>:LIMit:CONTrol:DOMain](#).

Tip: This command is complemented by [CALCulate<Chn>:LIMit:RDOMain:COMPLex](#) and [CALCulate<Chn>:LIMit:RDOMain:SPACing](#).

Suffix:

<Chn> Channel number used to identify the active trace.

Setting parameters:

<UnitRef> COMPLex | MAGNitude | PHASe | REAL | IMAGinary | SWR | GDElay | L | C

Keyword for the physical unit of the response values. The parameters form four groups: COMPLex, REAL, IMAGinary, and SWR select dimensionless numbers (U) for the limit line. MAGNitude selects relative units (dB). PHASe selects phase units (deg). GDElay selects time units (s). L selects inductance units (H/Henry). C selects capacitance units (F/Farad).

Usage: Setting only

CALCulate<Chn>:LIMit:RDOMain:SPACing <Format>

Deletes the existing limit line and (re-)defines the physical units of the response values of the limit line. The units of the stimulus values are defined via [CALCulate<Chn>:LIMit:CONTrol:DOMain](#).

Tip: This command is complemented by [CALCulate<Chn>:LIMit:RDOMain:COMPLex](#) and [CALCulate<Chn>:LIMit:RDOMain:FORMat](#).

Suffix:

<Chn> Channel number used to identify the active trace.

Setting parameters:

<Format> LINear | LOGarithmic | DB | SIC

Keyword for the physical unit of the response values.

Default unit: dB (irrespective of the parameter selected)

Usage: Setting only

CALCulate<Chn>:LIMit:LOWer:STATe <Boolean>**CALCulate<Chn>:LIMit:UPPer:STATe <Boolean>**

These commands switch the lower and upper limit check on or off. Lower limit line segments are assigned even numbers; upper limit line segments are assigned odd numbers; see [CALCulate<Chn>:LIMit:LOWer\[:DATA\]](#) and [CALCulate<Chn>:LIMit:UPPer\[:DATA\]](#). [CALCulate<Chn>:LIMit:LOWer:STATe](#) does not affect segments with odd numbers; [CALCulate<Chn>:LIMit:UPPer:STATe](#) does not affect segments with even numbers.

Note: Use `CALCulate<Ch>:LIMit:STATe` to switch on or off the entire limit check, including upper and lower limit lines.

Suffix:

<Chn> Channel number used to identify the active trace.

Parameters:

<Boolean> ON | OFF - switch limit check on or off.

*RST: OFF

Example:

```
CALC:LIM:LOW -10, 0, 0, -10
```

Define two limit line segments covering the entire sweep range. Two upper limit line segments with default response values are created in addition.

```
CALC:LIM:UPP 0, 5, 5, 0
```

Change the response values of the upper limit line segments.

```
CALC:LIM:LOW:STAT ON; :CALC:LIM:UPP:STAT ON; :
```

```
CALC:LIM:FAIL?
```

Switch the limit check on and query the result.

Manual operation: See "Limit Check" on page 479

CALCulate<Ch>:PARAmeter:DEFine <TraceName>, <Result>[, <TestPortNum>]

Creates a trace and assigns a channel number, a name and a measurement parameter to it. The trace is not displayed. To display a trace defined via

`CALCulate<Ch>:PARAmeter:DEFine`, a window must be created (`DISPlay[:WINDow<Wnd>][:STATe] ON`) and the trace must be assigned to this window (`DISPlay[:WINDow<Wnd>]:TRACe<WndTr>:FEED`); see example below.

Traces must be selected to become active traces; see `CALCulate<Ch>:PARAmeter:SElect`.

Note: The parameter names in this command differ from R&S ZNA conventions; moreover the parameter list is not complete. The alternative command `CALCulate<Ch>:PARAmeter:SDEFine` uses a complete parameter list with compatible names.

Suffix:

<Ch> Channel number. <Ch> may be used to reference a previously defined channel. If <Ch> does not exist, it is generated with default channel settings.

Setting parameters:

<TraceName> Trace name, e.g. 'Trc4'. See "Rules for trace names" in "Table Area" on page 435.

<Result> S11 | S12 | S13 | S14 | S21 | S22 | S23 | S24 | S31 | S32 | S33 | S34 | S41 | S42 | S43 | S44 | A | B | C | D | R1 | R2 | R3 | R4 | AB | AC | AD | BA | BC | BD | CA | CB | CD | DA | DB | DC | AR1 | AR2 | AR3 | AR4 | BR1 | BR2 | BR3 | BR4 | CR1 | CR2 | CR3 | CR4 | DR1 | DR2 | DR3 | DR4 | R1A | R1B | R1C | R1D | R2A | R2B | R2C | R2D | R3A | R3B | R3C | R3D | R4A | R4B | R4C | R4D | R1R2 | R1R3 | R1R4 | R2R1 | R2R3 | R2R4 | R3R1 | R3R2 | R3R4 | R4R1 | R4R2 | R4R3

Measurement parameter; see list of parameters below.

<TestPortNum> Test port number, drive port for wave quantities and ratios, ignored for S-parameters.

Example:

```
CALC4:PAR:DEF 'Ch4Tr1', S11
```

Create channel 4 and a trace named Ch4Tr1 to measure the input reflection coefficient S11.

```
DISP:WIND:STAT ON
```

Create diagram area no. 1.

```
DISP:WIND:TRAC2:FEED 'CH4TR1'
```

Display the generated trace in diagram area no. 1, assigning a trace number 2.

Usage: Setting only

The measurement parameter is selected by means of the following keywords (the selection depends on the number of test ports of the analyzer, e.g. S44 is not available on 2-port analyzers):

S11 S12 S13 S14 S21 S22 S23 S24 S31 S32 S33 S34 S41 S42 S43 S44	S-parameters
A B C D	Wave quantities b_1, b_2, b_3, b_4 (received waves)
R1 R2 R3 R4	Wave quantities a_1, a_2, a_3, a_4 (reference waves)
AB AC AD BA BC BD CA CB CD DA dB DC	Ratio of wave quantities $b_1/b_2, b_1/b_3, \dots, b_4/b_3$ (received waves only)
AR1 AR2 AR3 AR4 BR1 BR2 BR3 BR4 CR1 CR2 CR3 CR4 DR1 DR2 DR3 DR4 R1A R1B R1C R1D R2A R2B R2C R2D R3A R3B R3C R3D R4A R4B R4C R4D	Ratio of wave quantities $b_1/a_1, b_1/a_2, \dots, b_4/a_4, a_1/b_1, a_1/b_2, \dots, A_4/B_4$ (received waves to reference waves or reference waves to received waves)
R1R2 R1R3 R1R4 R2R1 R2R3 R2R4 R3R1 R3R2 R3R4 R4R1 R4R2 R4R3	Ratio of wave quantities $a_1/a_2, a_1/a_3, \dots, a_4/a_3$ (reference waves only)

CALCulate<Chn>:MARKer<Mk>:FUNCtion:BWIDth <Bandwidth>

Defines the bandfilter level, i.e. the minimum excursion for the bandpass and bandstop peaks.

Tip: Use `CALCulate<Chn>:MARKer<Mk>:BWIDth` to set the bandwidth and query the results of a bandfilter search. Note the sign convention for input values.

Suffix:

<Chn> Channel number used to identify the active trace.

<Mk> This numeric suffix is ignored and may be set to any value because the bandfilter search functions always use markers M1 to M4.

Parameters:

<Bandwidth> Range: -100 dB to 100 dB
 Increment: 0.03 dB
 *RST: 3 dB
 Default unit: dB

Example: See [CALCulate<Chn>:MARKer<Mk>:BWIDth](#)

CALCulate<Chn>:MARKer<Mk>:FUNCTION:DELTA:STATE <Boolean>

Switches the delta mode for marker <Mk> on trace no. <Chn> on or off.

Note: This command is the ZVR-compatible equivalent of [CALCulate<Chn>:MARKer<Mk>:DELTA\[:STATE\]](#).

Suffix:

<Chn> Channel number used to identify the active trace.
 <Mk> Marker number.

Parameters:

<Boolean> ON | OFF - enable or disable the delta mode.
 *RST: OFF

CALCulate<Chn>:MARKer<Mk>:FUNCTION[:SElect] <Mode>**CALCulate<Chn>:MARKer<Mk>:REFERENCE:FUNCTION[:SElect] <Mode>**

Selects a search mode for the related marker.

The search can then be initiated using one of the commands:

- [CALCulate<Ch>:MARKer<Mk>:SEARch...](#)
- [CALCulate<Ch>:MARKer:REFerence:SEARch...](#)
- [CALCulate<Ch>:MARKer<Mk>:MAXimum](#) OR
[CALCulate<Ch>:MARKer<Mk>:MINimum](#)
- [CALCulate<Ch>:MARKer:REFerence:MAXimum](#) OR
[CALCulate<Ch>:MARKer:REFerence:MINimum](#)

The marker must be created before using [CALCulate<Chn>:MARKer<Mk>\[:STATE\]](#) ON or [CALCulate<Chn>:MARKer<Mk>:REFerence\[:STATE\]](#) ON.

Note: This command is not needed except for compatibility with ZVR programs. Use [CALCulate<Chn>:MARKer<Mk>:FUNCTION:EXECute](#) or [CALCulate<Chn>:MARKer<Mk>:REFerence:FUNCTION:EXECute](#) to select a search mode and at the same time initiate the search.

Suffix:

<Chn> Channel number used to identify the active trace.

<Mk> Marker number.
Ignored for reference markers and for bandfilter searches (BFILter), because bandfilter searches always use markers M1 to M4.

Parameters:

<Mode> MAXimum | MINimum | RPEak | LPEak | NPEak | TARGet | LTARget | RTARget | BFILter | MMAXimum | MMINimum | SPRogress

See `CALCulate<Chn>:MARKer<Mk>:FUNction:EXECute`

CALCulate<Chn>:MARKer<Mk>:FUNction:TARGet <SearchValue>
CALCulate<Chn>:MARKer<Mk>:REFerence:FUNction:TARGet <SearchValue>

Defines the target value for a target search with the related marker (see "[Marker addressing](#)" on page 1073), which can be activated using `CALCulate<Chn>:MARKer<Mk>:FUNction:EXECute TARGet` or `CALCulate<Chn>:MARKer<Mk>:REFerence:FUNction:EXECute TARGet`.

Note: These commands are the ZVR-compatible equivalents of `CALCulate<Chn>:MARKer<Mk>:TARGet` and `CALCulate<Chn>:MARKer<Mk>:REFerence:TARGet`.

Suffix:

<Chn> Channel number used to identify the active trace.

<Mk> Marker number (ignored for reference markers)

Parameters:

<SearchValue> Target search value of marker no. <Mk>.

Range: Depending on the format of the active trace. For a dB Mag trace the range is -200 dB to +200 dB.

Increment: 0.1 dB

*RST: Depending on the trace format; 0 dB for a dB Mag trace.

Default unit: dB

CALCulate<Chn>:MARKer<Mk>:MAXimum

CALCulate<Chn>:MARKer<Mk>:MINimum

CALCulate<Chn>:MARKer<Mk>:REFerence:MAXimum

CALCulate<Chn>:MARKer<Mk>:REFerence:MINimum

These commands select a search mode for the related marker (see "[Marker addressing](#)" on page 1073) and initiate a maximum or minimum search.

The marker must be created before using `CALCulate<Chn>:MARKer<Mk>[:STATe] ON` or `CALCulate<Chn>:MARKer<Mk>:REFerence[:STATe] ON`.

Note: These commands are the ZVR-compatible equivalents of `CALCulate<Chn>:MARKer<Mk>:FUNction:EXECute MINimum | MAXimum` and `CALCulate<Chn>:MARKer<Mk>:REFerence:FUNction:EXECute MINimum | MAXimum`.

Suffix:
 <Chn> Channel number used to identify the active trace.
 <Mk> Marker number (ignored for reference markers)
Usage: Event

CALCulate<Chn>:MARKer<Mk>:SEARch:LEFT
CALCulate<Chn>:MARKer<Mk>:SEARch:NEXT
CALCulate<Chn>:MARKer<Mk>:SEARch:RIGHT
CALCulate<Chn>:MARKer<Mk>:REFerence:SEARch:LEFT
CALCulate<Chn>:MARKer<Mk>:REFerence:SEARch:NEXT
CALCulate<Chn>:MARKer<Mk>:REFerence:SEARch:RIGHT

These commands selects a search mode for the related marker (see "[Marker addressing](#)" on page 1073), and initiate a search for the next valid peak to the left, the next highest or lowest value among the valid peaks, and the next valid peak to the right.

The marker must be created before using `CALCulate<Chn>:MARKer<Mk>[:STATe] ON` or `CALCulate<Chn>:MARKer<Mk>:REFerence[:STATe] ON`.

Note: These commands are the ZVR-compatible equivalents of `CALCulate<Chn>:MARKer<Mk>:FUNctioN:EXECute LPEak | NPEak | RPEak` and `CALCulate<Chn>:MARKer<Mk>:REFerence:FUNctioN:EXECute LPEak | NPEak | RPEak`.

Suffix:
 <Chn> Channel number used to identify the active trace.
 <Mk> Marker number (ignored for reference markers)
Usage: Event

CALCulate<Chn>:MARKer<Mk>:SEARch[:IMMEDIATE]
CALCulate<Chn>:MARKer<Mk>:REFerence:SEARch[:IMMEDIATE]

Initiates a search for the related marker (see "[Marker addressing](#)" on page 1073).

Before using this command:

- The marker must be created using `CALCulate<Chn>:MARKer<Mk>[:STATe] ON` or `CALCulate<Chn>:MARKer<Mk>:REFerence[:STATe] ON`.
- The search function must be selected using `CALCulate<Chn>:MARKer<Mk>:FUNctioN[:SElect]` or `CALCulate<Chn>:MARKer<Mk>:REFerence:FUNctioN[:SElect]`.

Note: Together with `CALCulate<Chn>:MARKer<Mk>:FUNctioN[:SElect]` and `CALCulate<Chn>:MARKer:REFerence:FUNctioN[:SElect]`, these commands are the ZVR-compatible equivalents of `CALCulate<Chn>:MARKer<Mk>:FUNctioN:EXECute` and `CALCulate<Chn>:MARKer<Mk>:REFerence:FUNctioN:EXECute`.

Suffix:
 <Chn> Channel number used to identify the active trace.

<Mk> Marker number
Ignored not only for reference markers, but also for bandfilter and multiple peak searches, where a whole marker set is calculated for each sweep.

Usage: Event

CALCulate<Chn>:MATH[:EXPRession][:DEFine] <Expression>

Defines a simple mathematical relation between traces. To calculate and display the new mathematical trace, the mathematical mode must be switched on (`CALCulate<Chn>:MARKer<Mk>[:STATE] ON`).

Note: This command places some restrictions on the mathematical expression and the operands. Use `CALCulate<Chn>:MATH[:EXPRession]:SDEFine` to define general expressions.

Suffix:

<Chn> Channel number used to identify the active trace.

Parameters:

<Expression> <expr>
(<operand1><operator1><operand2>[<operator2><operand3>]) The expression must be enclosed in brackets. Operands: See list of trace names in [Chapter 7.3.18, "TRACe commands"](#), on page 1650. Operators: +, -, *, /

Example:

```
*RST; CALC:MATH:MEM
Copy the current state of the default trace Trc1 to a memory trace named "Mem2[Trc1]". The memory trace is not displayed.
CALC:MATH (CH1DATA / MDATA2)
Define a mathematical trace, dividing the data trace by the stored memory trace. The mathematical trace is not displayed
CALC:MATH:STAT ON
Display the mathematical trace instead of the active data trace.
```

DIAGnostic:SERvice:FUNCTion <SFId1>, <SFId2>...

Activates a service function (mainly for internal use). Service functions are identified by groups of numbers, separated by dots.

Parameters:

<SFId1>

<SFId2> Service function identifier entered as a (pseudo-)numeric value, the dots being replaced by commas. Five groups of numbers are allowed at maximum. See also [DIAGnostic:SERvice:SFUNCTion](#).

FORMat:DEXPort:SOURce <Format>

Defines the format for traces retrieved with the R&S ZVR-compatible command [TRACe\[:DATA\]\[:RESPonse\]\[:ALL\]?](#).

This command is not relevant for results read with the [CALCulate<Chn>:DATA...](#) commands.

Parameters:

<Format>

FDATa | SDATa | MDATa

See list of parameters below. The unit is the default unit of the measured parameter; see [CALCulate<Ch>:PARAmeter:SDEFine](#).

Range: Depending on the measured parameter and format.

*RST: SDATa

Example:

See [TRACe\[:DATA\]\[:RESPonse\]\[:ALL\]?](#)

The following parameters are related to trace data:

FDATa	Formatted trace data, according to the selected trace format (CALCulate<Chn>:FORMat). 1 value per trace point for Cartesian diagrams, 2 values for polar diagrams.
SDATa	Unformatted trace data: Real and imaginary part of each measurement point. 2 values per trace point irrespective of the selected trace format. The trace mathematics is not taken into account.
MDATa	Unformatted trace data (see SDATa) after evaluation of the trace mathematics.

INPut<PhyPt>:ATTenuation <Attenuation>

Sets the attenuation for the received waves. This command is available if at least one of the [Receiver step attenuators](#) is installed.

The generated wave is attenuated via [SOURce<Ch>:POWer<PhyPt>:ATTenuation](#).

For redefined physical ports (see [\[SENSe:\]UDSPArAmS<Pt>:PARAm](#)), the respective measurement receiver (b-wave) is significant. E.g. if a receiver step attenuator is installed for physical port 1, then an attenuation factor can be applied to the (redefined) port receiving b1.

Note:

- [INPut<PhyPt>:ATTenuation](#) is not channel-specific; the value is valid for **all channels**. Use [\[SENSe<Ch>:\]POWer:ATTenuation](#) to set or query a channel-specific attenuation value.
- In presence of [External switch matrices](#) all VNA ports have to be equipped with receiver step attenuator option.

Suffix:

<PhyPt>

Physical port number; if unspecified the numeric suffix is set to 1

Parameters:

<Attenuation>

Attenuation factor for the received wave.

Range: 0 dB, 10 dB, 20 dB, 30 dB. UP and DOWN increment/decrement the attenuation in 10 dB steps. The analyzer rounds any entered value below the maximum attenuation to the closest step.

*RST: 0 dB

Default unit: dB

Example:

INP2:ATT 10

Set the step attenuator for the wave received at port 2 and for all channels to 10 dB. The waves at the other test ports are not affected.

SENS1:POW:ATT? BREC

Query the receiver step attenuator setting at port 2 and for channel no. 1. The response is 10.

INSTrument[:SElect] <Channel>

Selects a channel <Ch> as active channel. To select a channel number > 4 use the generalized command `INSTrument:NSElect`.

Parameters:

<Channel>

CHANnel1 | CHANnel2 | CHANnel3 | CHANnel4

Number of the channel to be activated. The channel must be created before using `CONFigure:CHANnel<Ch>[:STATe] ON`.

*RST: CHANNEL1

Example:

CONF:CHAN2:STAT ON; :INST CHANnel2

Create channel no. 2 and select it as the active channel.

OUTPut<Chn>:DPORt <Port>

Selects a source port for the stimulus signal (drive port). The setting acts on the active trace. The effect of the drive port selection depends on the measurement parameter associated to the active trace:

- If an S-parameter $S_{\text{out}<in>}$ is measured, the second port number index <in> (input port of the DUT = drive port of the analyzer) is set equal to the selected drive port: Drive port selection affects the measured quantity.
- If a wave quantity or a ratio is measured, the drive port is independent from the measured quantity:

Note: This command is equivalent to `[SENSe<Chn>:]SWEep:SRCPort`.

Suffix:

<Chn>

Channel number used to identify the active trace

Parameters:

<Port> PORT<no>
Physical port number.
*RST: PORT1

Example:

```
CALC4:PAR:SDEF 'Ch4Tr1', 'A1'
```

Create channel 4 and a trace named "Ch4Tr1" to measure the wave quantity a_1 . The trace automatically becomes the active trace.

```
OUTP4:DPOR PORT2
```

Select drive port 2 for the active trace.

[SENSe<Ch>:]CORRection:CKIT:<ConnType>:<StandardType> <CalkitName>, <Standard>, <MinFreq>, <MaxFreq>, <DelayParam>, <Loss>, <C0>, <L0>, <C1>, <L1>, <C2>, <L2>, <C3>, <L3>, OPEN | SHORT

Defines the parameters of a calibration standard <StandardType> for a specified connector type <ConnType>. A particular physical standard can be selected by specifying the name of the calibration kit and its serial number. Depending on the standard type, only a subset of the parameters may be used; see [Standard types and their parameters](#).

Note: If the specified cal kit does not exist, it is created with the specified calibration standard.

Suffix:

<Ch> Channel number. This suffix is ignored because calibration kits are channel-independent.

Parameters:

<ConnType> Connector type, one of the following identifiers:
N50, N75: N 50 Ω or N 75 Ω connectors
PC7, PC35, PC292: PC 7, PC 3.5 or 2.92 mm connectors
USER<no>: User-defined connectors UserConn1, UserConn2
SMA: User-defined connector type SMA ...

Note: This command only supports ZVR-compatible connector types. For general definitions use [\[SENSe:\]CORRection:CKIT:<StandardType>](#).

<StandardType>

Standard type. For reflection standards, the first character denotes the gender, e.g.:
FOPEN, MOPEM: Open (f) or Open (m) standard.
For transmission standards, the first two characters denotes the genders on both ends, e.g.:
FFSNetwork, MFSNetwork, MMSNetwork: Symm. network (ff), symm. network (mf) or symm. network (mm) standard.
For a complete list of standard types refer to [Standard types and their parameters](#).

Parameter list String parameters to specify the configured standard (<CalkitName>, <StandardLabel>) and numeric parameters defining its properties. See [Parameter list](#).

*RST: n/a

Example:

```
CORR:CKIT:N50:FOPEN 'ZV-Z21', '',
0,1.8E+010,0.0151,0,0,0.22,-0.22,0.0022
```

Define the properties of the open (f) standard for the N 50 Ω connector type contained in the ZV-Z21 calibration kit: Assign a valid frequency range of 0 Hz to 18 GHz, an electrical length of 15.1 mm, 0 dB loss and define the polynomial coefficients of the fringing capacitance as 0 fF, 0.22 fF/GHz, $-0.22 \text{ fF}/(\text{GHz})^2$, $0.0022 \text{ fF}/(\text{GHz})^3$.

[SENSe:]CORRection:CKIT:INSTall <CalKitFile>

Loads cal kit data from a specified R&S ZVR cal kit file.

Setting parameters:

<CalKitFile> String parameter to specify the name and directory of the cal kit file to be loaded.

Note: The loaded file must be a R&S ZVR-specific cal kit file with the extension *.ck. VNA cal kit files (*.calkit) can be imported using the [MMEMory:LOAD:CKIT](#) command. Keysight cal kit files can be imported manually and converted into *.calkit files.

Example:

```
CORR:CKIT:INST 'C:\Users\Public\Documents
\Rohde-Schwarz\ZNA\Calibration\Kits\ZCAN.ck'
```

Load the previously created R&S ZVR cal kit file ZCAN.ck from the default cal kit directory.

```
MMEM:STOR:CKIT 'ZCAN', 'C:
\Users\Public\Documents
\Rohde-Schwarz\ZNA\Calibration\Kits\ZCAN.calkit'
```

Store the imported cal kit data to a VNA cal kit file ZCAN.calkit (assuming that the cal kit name stored in ZCAN.ck reads "ZCAN").

Usage: Setting only

[SENSe<Ch>:]CORRection:COLLect[:ACQuire] <Standard>[, <Dispersion>[, <Delay>]]

Starts a calibration measurement in order to acquire measurement data for the selected standards. The standards are reflection or transmission standards and must be connected to port 1 or 2 of the analyzer.

Tip: Use the generalized command [\[SENSe<Ch>:\]CORRection:COLLect\[:ACQuire\]:SELected](#) to obtain measurement data at arbitrary analyzer ports.

Suffix:

<Ch> Channel number of the calibrated channel.

Setting parameters:

<Standard>

THRough | OPEN1 | OPEN2 | OPEN12 | SHORt1 | SHORt2 | SHORt12 | MATCh1 | MATCh2 | MATCh12 | NET | ATT | IMATCh12 | REFL1 | REFL2 | SLIDe1 | SLIDe2 | SLIDe12 | LINe1 | LINe2 | LINe3 | M1O2 | O1M2 | OSHort1 | OSHort11 | OSHort12 | OSHort13 | OSHort2 | OSHort21 | OSHort22 | OSHort23 | M1S2 | S1M2 | UTHRough

Standard types: Through (between port 1 and 2), Open, Short, Match (MATCh12 and IMATCh12 are synonymous), Symmetric Network (NET), Attenuation (ATT), Reflect, Sliding Match (SLIDe), Line1 (LINe1 and LINE are synonymous), Line2 and Line3 (esp. for TRL calibration), Match/Open (M1O2, O1M2), Match/Short (M1S2, S1M2), Offset Short (OSHort), Unknown Through (UTHRough).

The numbers in the parameter names denote the analyzer ports. Two numbers 12 mean that two separate calibrations are performed at ports 1 and 2. For Offset Short standards, the first number denotes the port (1 or 2), the second number denotes the number of the standard (1 to 3).

*RST: ON

<Dispersion>

Optional status parameter for UTHRough standard:
OFF - unknown through standard is non-dispersive.
ON - unknown through standard is dispersive.

*RST: OFF

<Delay>

Optional entry of delay time or phase for UTHRough standard:
<numeric> - entry of the delay time in ps (for non-dispersive standards) or of an estimate of the phase at the start frequency of the sweep in deg (for dispersive standards). See also background information for [\[SENSe<Ch>:\]CORRection:COLLect\[:ACQuire\]:SELected](#).

AUTO - the analyzer determines the delay time or phase during the calibration sweep.

*RST: AUTO

Example:

See [\[SENSe<Ch>:\]CORRection:COLLect:SAVE\[:DUMMy\]](#)

Usage:

Setting only

[SENSe<Ch>:]CORRection:COLLect:METHod <CalType>

Selects a one-port or two-port calibration type for channel <Ch> at ports 1/2.

Tip: Use the generalized command [\[SENSe<Ch>:\]CORRection:COLLect:METHod:DEFine](#) to select the calibration type for arbitrary analyzer ports or a multiport calibration type.

Suffix:

<Ch> Channel number of the calibrated channel.

Parameters:

<CalType> FRTRans | PFRTrans | FTRans | PFTRans | RTRans | PRTRans | TOM | TSM | TRM | TRL | TNA | TOSM | ETOM | ETSM | FOPort1 | FOPort2 | FOPort12 | FOPTport | ROPTport | REFL1 | REFL2 | REFL12 | TPORT | UOSM

Calibration types, TOM, TRM, TRL, TNA, TOSM, Full One Port, One Path Two Port, Normalization (REFL1, REFL2 and REFL12 for one-port, FRTRans, FTRans, RTRans, and TPORT for two-port), TOSM with unknown through.

The numbers in the parameters denote the analyzer ports.

Parameters for two-port calibration types contain no numbers because the command is only valid for ports 1 and 2.

Example:

See `[SENSe<Ch>:]CORRection:COLLect:SAVE[:DUMMy]`

[SENSe<Ch>:]CORRection:COLLect:SAVE:DEFault

Generates a set of default system error correction data for the selected ports and calibration type. The default data set corresponds to a test setup which does not introduce any systematic errors; none of the measurement results acquired previously (`[SENSe<Ch>:]CORRection:COLLect[:ACQuire]`) is taken into account.

Tip: The main purpose of the default correction data set is to provide a dummy system error correction which you can replace with your own, external correction data. You may have acquired the external data in a previous session or even on an other instrument. If you want to use the external correction data on the analyzer, simply generate the default data set corresponding to your port configuration and calibration type and overwrite the default data. For details refer to the program example below.

Note: This command must be used in combination with the R&S ZVR-compatible commands `[SENSe<Ch>:]CORRection:COLLect:METhod` and `[SENSe<Ch>:]CORRection:DATA`. Use `[SENSe<Ch>:]CORRection:COLLect:SAVE:SELected:DEFault` if you want to use R&S ZNA-specific calibration commands or if you want to calibrate more than 2 ports.

Suffix:

<Ch> Channel number of the calibrated channel

Example:

```
CORR:COLL:METH REFL1
```

Select a one-port normalization at port 1 with an open standard as calibration type.

```
CORR:COLL:SAVE:DEF
```

Calculate a dummy system error correction for the normalization at port 1. The dummy system error correction provides the reflection tracking error term SCORR3.

```
INIT:CONT OFF; :INIT; *WAI
```

Stop the sweep to ensure correct transfer of calibration data.

```
CORR:DATA? 'SCORR3'
```

Query the dummy system error correction term. The response is a 1 (written as 1, 0 for the real and imaginary part) for each sweep point (no attenuation and no phase shift between the analyzer and the calibration plane).

```
CORR:DATA 'SCORR3', <ASCII_data>
```

Replace the dummy system error correction term with your own correction data, transferred in ASCII format.

```
INIT:CONT ON
```

Restart the sweep in continuous mode.

Usage:

Event

[SENSe<Ch>:]CORRection:COLLect:SAVE[:DUMMY]

Calculates the system error correction data from the acquired one or two-port measurement results ([\[SENSe<Ch>:\]CORRection:COLLect\[:ACQuire\]](#)), stores them and applies them to the calibrated channel <Ch>. To avoid incompatibilities, older system error correction data is deleted unless it has been transferred into a cal pool ([MMEMory:STORe:CORRection](#)).

This command is the R&S ZVR-compatible equivalent of [\[SENSe<Ch>:\]CORRection:COLLect:SAVE:SElected\[:DUMMY\]](#). It must be used in combination with the R&S ZVR-compatible commands for calibration method and standard selection; see example below.

Suffix:

<Ch>

Channel number of the calibrated channel.

Example:

```
CORR:COLL:METH REFL1
```

Select a one-port normalization at port 1 as calibration type.

```
CORR:COLL OPEN1
```

Measure an open standard connected to port 1 and store the measurement results of this standard.

```
CORR:COLL:SAVE
```

Calculate the system error correction data and apply it to the active channel.

Usage:

Event

[SENSe<Ch>:]CORRection:DATA <ErrorTerm>, <Parameter>...

Writes or reads system error correction data for a specific channel <Ch> and calibration method ([SENSe<Ch>:]CORRection:COLLect:METhod). The analyzer test ports 1 or 2 are implicitly specified with the correction terms. The setting command can be used to transfer user-defined correction data to the analyzer; the query returns the current correction data set. ASCII or block data can be transferred, depending on the selected data transfer format (FORMat[:DATA])

The sweep must be stopped to transfer calibration data; see program example for [SENSe<Ch>:]CORRection:COLLect:SAVE:DEFault.

Note: This command affects the active calibration of channel no. <Ch> or the factory calibration (if no channel calibration is active). For the factory calibration, the query form is allowed only (no change of factory calibration data).

Tip: Use the generalized command [SENSe<Ch>:]CORRection:CDATa to transfer calibration data for arbitrary analyzer ports. The analyzer provides a default calibration corresponding to a test setup which does not introduce any systematic errors; see [SENSe<Ch>:]CORRection:COLLect:SAVE:DEFault.

G and H matrices

The 7-term calibration types named Txx (e.g. TOM, TSM, TRM, TRL, TNA) are based on a network analyzer with two ports i and j, each equipped with a test receiver and a reference receiver. The system errors are described in terms of two "error two-ports" P_G and P_H:

- The error two-port P_G is assigned to port i of the analyzer. Its transmission matrix G describes how the system errors modify the outgoing and incident waves at port i:

$$\begin{bmatrix} \mathbf{b}_i \\ \mathbf{a}_i \end{bmatrix} = \begin{bmatrix} \mathbf{G}_{11} & \mathbf{G}_{12} \\ \mathbf{G}_{21} & \mathbf{G}_{22} \end{bmatrix} * \begin{bmatrix} \mathbf{m}_{i\text{ref}} \\ \mathbf{m}_{i\text{test}} \end{bmatrix}$$

- The error two-port P_H is assigned to port j of the analyzer. Its transmission matrix H describes how the system errors modify the measured incident and outgoing waves at port j:

$$\begin{bmatrix} \mathbf{a}_j \\ \mathbf{b}_j \end{bmatrix} = \begin{bmatrix} \mathbf{H}_{11} & \mathbf{H}_{12} \\ \mathbf{H}_{21} & \mathbf{H}_{22} \end{bmatrix} * \begin{bmatrix} \mathbf{m}_{j\text{test}} \\ \mathbf{m}_{j\text{ref}} \end{bmatrix}$$

In the two equations above, a and b denote the waves at the calibrated reference plane i and j (e.g. the input and output of the 2-port DUT). The m waves are the raw measured waves of test port i and j. The subscripts "ref" and "test" refer to the reference and test receivers, respectively. During the calibration the network analyzer acquires ratios of wave quantities, which leaves one of non-diagonal matrix elements of G or H as a free normalization factor. The network analyzer uses the normalization H₂₁ = 1.

Suffix:

<Ch> Channel number of the calibrated channel

Parameters:

<ErrorTerm>

String parameters describing the different error terms, depending on the current calibration method; see table below. Each term contains one complex value (real and imaginary part) for each sweep point. The parameters must be transferred in full length. The following strings are allowed:

'SCORR1' - directivity at port 1

'SCORR2' - source match at port 1

'SCORR3' - reflection tracking at port 1

'SCORR4' - reserved for future extensions

'SCORR5' - load match at port 2

'SCORR6' - forward transmission tracking between port 1 and port 2

'SCORR7' - directivity at port 2

'SCORR8' - source match at port 2

'SCORR9' - reflection tracking at port 2

'SCORR10' - reserved for future extensions

'SCORR11' - load match at port 1

'SCORR12' - reverse transmission tracking between port 2 and port 1

'G11' ... 'G22' - G matrix elements; see above

'H22' - H matrix elements; see above

The error terms are dimensionless complex numbers.

*RST: n/a

<Parameter>

Example: See [\[SENSe<Ch>:\]CORRection:COLLect:SAVE:DEFault](#)

The different calibration types of the analyzer provide the following error terms:

Calibration type	Parameter in [SENSe<Ch>:]CORRection:COLLect:MEthod	Available error terms (depending on port numbers)
One-port normalization (reflection) using an open standard	REFL1 REFL2 REFL12	'SCORR3' 'SCORR9' 'SCORR3' and 'SCORR9'
Full one port	FOPort1 FOPort2 FOPort12	'SCORR1' to 'SCORR3' 'SCORR7' to 'SCORR9' 'SCORR1' to 'SCORR3' and 'SCORR7' to 'SCORR9'
Two-port normalization	FTRans RTRans FRTRans	'SCORR6' 'SCORR12' 'SCORR6' and 'SCORR12'
One path two port	FOPTport ROPTport	'SCORR1' to 'SCORR3', 'SCORR6' 'SCORR7' to 'SCORR9', 'SCORR12'

Calibration type	Parameter in [SENSe<Ch>:]CORRection:COLLect:MEtHod	Available error terms (depending on port numbers)
TOSM	TOSM	'SCORR1' to 'SCORR12' (at present the isolation terms 'SCORR4' and 'SCORR10' are not included)
TOM, TSM, TRM, TRL, TNA	TOM TRM TRL TNA	'DIRECTIVITY', 'SRCMATCH', 'REFLTRACK', 'LOADMATCH', 'TRANSTRACK' (for reading and writing) 'G11' ... 'G22' and 'H11', 'H12', 'H22' (for reading only; the 'H21' matrix elements are normalized to 1)

[SENSe<Ch>:]CORRection:OFFSet<PhyPt>:MAGNitude <OffsetLoss>

Defines the frequency-independent part (DC value) of the offset loss.

Tip: Use the [SENSe<Ch>:]CORRection:LOSS<PhyPt>... commands to define the complete set of loss offset parameters.

[SENSe<Ch>:]CORRection:OFFSet<PhyPt>:MAGNitude is equivalent to [SENSe<Ch>:]CORRection:LOSS<PhyPt>:OFFSet.

Suffix:

<Ch> Channel number of the offset-corrected channel

<PhyPt> Port number of the analyzer

Parameters:

<OffsetLoss> Frequency-independent part of the offset loss

Range: -200 dB to +200 dB

Increment: 0.0001 dB

*RST: 0 dB

Default unit: dB

[SENSe<Ch>:]FREQuency:CONVersion:MIXer:IFFixed <FixedFrequency>

Defines a fixed frequency and assigns it to the IF signal (for alternative commands see example below).

Suffix:

<Ch> Channel number.

Parameters:

<FixedFrequency> Fixed frequency.

Range: Depending on the instrument model.

Increment: 0.1 kHz

*RST: Minimum of the analyzer's frequency range, fMIN

Default unit: Hz

Example: ***RST**; **FREQ:CONV:MIX:IFF** 1 GHz
 Reset the analyzer and specify a fixed frequency of 1 GHz, to be assigned to the IF signal.
FREQ:CONV:MIX:FFIX?; **FIX?**
 Query the fixed frequency and the signal assignment using the alternative commands. The response is 1000000000;IF.

[SENSe<Ch>]:FREQuency:CONVersion:MIXer:LOFixed <FixedFrequency>

Defines a fixed frequency and assigns it to the LO signal (for alternative commands see example below).

Suffix:

<Ch> Channel number.

Parameters:

<FixedFrequency> Fixed frequency.
 Range: Depending on the instrument model.
 Increment: 0.1 kHz
 ***RST**: Minimum of the analyzer's frequency range, fMIN
 Default unit: Hz

Example: ***RST**; **FREQ:CONV:MIX:LOF** 1 GHz
 Reset the analyzer and specify a fixed frequency of 1 GHz, to be assigned to the LO signal.
FREQ:CONV:MIX:FFIX?; **FIX?**
 Query the fixed frequency and the signal assignment using the alternative commands. The response is 1000000000;LO.

[SENSe<Ch>]:FREQuency:CONVersion:MIXer:RFFixed <FixedFrequency>

Defines a fixed frequency and assigns it to the RF signal (for alternative commands see example below).

Suffix:

<Ch> Channel number.

Parameters:

<FixedFrequency> Fixed frequency.
 Range: Depending on the instrument model.
 Increment: 0.1 kHz
 ***RST**: Minimum of the analyzer's frequency range, fMIN
 Default unit: Hz

Example: ***RST**; **FREQ:CONV:MIX:RFF** 1 GHz
 Reset the analyzer and specify a fixed frequency of 1 GHz, to be assigned to the RF signal.
FREQ:CONV:MIX:FFIX?; **FIX?**
 Query the fixed frequency and the signal assignment using the alternative commands. The response is 1000000000;RF.

[SENSe<Ch>:]FREQuency:IMODulation:TTOuTput <TwoToneOutput>

Selects the source for the two tone output signal for intermodulation measurements.

Deprecated, superseded by [SOURce<Ch>:COMBiner](#).

Suffix:

<Ch> Channel number.

Parameters:

<TwoToneOutput> PORT | EDEvice

PORT

Analyzer port 1.

Requires a R&S ZNA with [Direct generator/receiver access](#) or with [Internal combiner](#).

EDEvice

External combiner

*RST: EDEvice

Example: See [\[SENSe<Ch>:\]FREQuency:IMODulation:LTONE](#).

[SENSe<Ch>:]FREQuency:MODE <FreqSweep>

Selects the sweep type and defines which set of commands controls the stimulus frequency.

Tip: The command [\[SENSe<Ch>:\]SWEep:TYPE](#) provides a complete list of sweep types.

Suffix:

<Ch> Channel number

Parameters:

<FreqSweep> CW | FIXed | SWEep | SEGment | PULSe

Linear or logarithmic frequency sweep, depending on the selected spacing ([\[SENSe<Ch>:\]SWEep:SPACing](#) LINear | LOGarithmic). The frequency range is set via [\[SENSe<Ch>:\]FREQuency:START](#) etc.

Example:

```
FREQ:MODE CW
```

Activate a time sweep.

```
FREQ:CW 100MHz
```

Set the CW frequency to 100 MHz.

[SENSe<Ch>:]SEGment<Seg>:CLEar

Deletes all sweep segments in the channel. The command is equivalent to [\[SENSe<Ch>:\]SEGment<Seg>:DELeTe:ALL](#).

Suffix:

<Ch> Channel number

<Seg> Sweep segment number. This suffix is ignored; the command deletes all segments.

Usage: Event

[SENSe<Ch>:]SEGMent<Seg>:OVERlap <Boolean>

Queries whether the analyzer supports overlapping sweep segments.

Suffix:

<Ch> Channel number. This suffix is ignored; the command is instrument-specific.

<Seg> Sweep segment number. This suffix is ignored; the command is instrument-specific.

Parameters:

<Boolean> ON | OFF: No effect.

*RST: ON. If used as a query, the command returns the information that overlapping sweep segments are supported (ON).

[SENSe<Ch>:]SWEep:SPACing <StimulusFreq>

Defines the frequency vs. time characteristics of a frequency sweep ("Lin Frequency" or "Log Frequency"). The command has no effect on segmented frequency, power or time sweeps.

Note: Use [SENSe<Ch>:]SWEep:TYPE to select sweep types other than "Lin Frequency" or "Log Frequency".

Suffix:

<Ch> Channel number

Parameters:

<StimulusFreq> LINear | LOGarithmic

The stimulus frequency is swept in equidistant steps over the frequency range. In a Cartesian diagram, the x-axis is a linear frequency axis.

Example:

```
FUNC "XFR:POW:S12"
```

Activate a frequency sweep and select the S-parameter S₁₂ as measured parameter for channel and trace no. 1.

```
SWE:SPAC LOG
```

Change to sweep type "Log Frequency".

[SENSe<Chn>:]FUNCTion[:ON] <SweepType>[, <arg1>[, <arg2>]]

Defines the sweep type and the measurement parameter in a single string.

Note: To select a measurement parameter without changing the sweep type, use `CALCulate<Ch>:PARAmeter:MEASure`. Use the other commands in the `CALCulate<Ch>:PARAmeter...` subsystem to create or delete traces and select measurement parameters.

Suffix:

`<Chn>` Channel number used to identify the active trace. If `[SENSE<Chn>:]FUNCTION[:ON]` is not used as a query, the number must be 1.

Parameters:

`<SweepType>` Single string parameter defining the sweep type and the parameter to be measured:

`<string> = "<sweep_type>:<parameter>"`.

Range: See list of strings below.

*RST: "XFR:POW:S21"

`<arg1>` B1 | B2 | A1 | A2 | ABSa1 | ABSa2 | DCIN1 | DCIN2

`<arg2>` B1 | B2 | A1 | A2 | ABSa1 | ABSa2 | DCIN1 | DCIN2

Example:

`CALC4:PAR:SDEF "Ch4Tr1", "S11"`

Create channel 4 and a trace named "Ch4Tr1" to measure the input reflection coefficient S_{11} . The trace automatically becomes the active trace.

`SENS4:FUNC?`

Check (query) the sweep type and measurement parameter of the active trace. The result is 'XFR:POW:S11'.

The following keywords define the sweep type (see SCPI command reference: presentation layer):

XFRrequency	Frequency sweep (Lin. Frequency/Log. Frequency/Segmented Frequency)
XPOWer	Power sweep
XTIME	Time sweep
XCW?	CW Mode sweep (output variable for query only)

The following keywords define the measurement parameter (see SCPI command reference: function name):

POWer:S<Ptout><Ptin>	S-parameter with output and input port number of the DUT, e.g. S_{11} , S_{21} .
POWer:RATio A<Ptout> B<Ptin>, A<Ptout> B<Ptin> Output: A<Ptout>/B<Ptin>	Ratio, e.g. B2, A1 for b_2/a_1 drive Port 1
POWer:A<Ptout>	Wave quantity with stimulus port number of the analyzer, e.g. a_1 .
POWer:B<Ptin>	Wave quantity with receive port number of the analyzer, e.g. b_2 .

POWer:Z<Ptout><Ptin>	Matched-circuit impedance (converted Z-parameter) with output and input port number of the DUT, e.g. Z_{11} , Z_{21} .
POWer:Y<Ptout><Ptin>	Matched-circuit admittance (converted Y-parameter) with output and input port number of the DUT, e.g. Y_{11} , Y_{21} .
POWer:KFACTOR POWer:MUFactor<Lev>	Stability factor K Stability factors μ_1 or μ_2
VOLTage[:DC] DCIN1 DCIN2 Output: DC 1 V, DC 10 V	DC Input 1 or 2

Note: The mnemonics POWer: and VOLTage: are not used in output strings.

SOURce<Ch>:POWER<PhyPt>:CORREction:COLLEct[:ACQuire] <Sensor>

Initiates a source power calibration for the source port <PhyPt> using an external power meter no. 1 or 2. To initiate a source power calibration for arbitrary power meters, use the alternative commands listed in the program example below.

Note: The command cannot be used unless a power meter is connected via GPIB bus, USB or LAN interface and configured in the "External Power Meters" dialog.

Suffix:

<Ch> Calibrated channel number
<PhyPt> Calibrated port number

Setting parameters:

<Sensor> ASENSor | BSENSor
 ASENSor – external power meter Pmtr 1.
 BSENSor – external power meter Pmtr 2.
*RST: ASENSor

Example:

```
SOUR:POW3:CORR:COLL BSEN
Perform a source power calibration for port 3 using power meter
no. 2.
SOUR:POW:CORR:PMET:ID 2
Select power meter no. 2.
SOUR:POW:CORR:ACQ PORT, 3
Perform a source power calibration for port 3 using the previ-
ously selected power meter no. 2.
```

Usage: Setting only

Manual operation: See "[Start Cal Sweep](#)" on page 600

TRACe:CLEar <MemTrace>

Deletes one of the memory traces Mem<n> [Trc<m>], where n = 1, ... 8.

Setting parameters:

<MemTrace> MDATa1 | MDATa2 | MDATa3 | MDATa4 | MDATa5 | MDATa6 | MDATa7 | MDATa8

Identifier for the memory trace; see [Table 7-18](#).

Range: MDATA<n> where <n> = 1 to 8.

Example:

```
SWE:POIN 20
```

Create a trace with 20 sweep points, making the created trace the active trace of channel 1 (omitted optional mnemonic SENSE1).

```
TRAC:COPY "Mem_Pt20", CH1DATA
```

Copy the current state of the created trace to a memory trace named "Mem_Pt20". The memory trace is not displayed.

```
DISP:WIND:TRAC2:FEED "MEM_PT20"
```

Display the created memory trace in the active diagram area (diagram area no. 1).

Usage:

Setting only

TRACe[:DATA][:RESPonse][:ALL]? <Response>

Returns the response values of the active data trace or memory trace (see [Table 7-18](#)).

Note: To read the response values of an arbitrary data or memory trace, use [CALCulate<Chn>:DATA](#). To read the response values of a trace acquired in single sweep mode ([INITiate<Ch>:CONTinuous OFF](#)), use [CALCulate<Chn>:DATA:NSweep:FIRSt?](#).

Query parameters:

<Response> CH1Data | CH2Data | CH3Data | CH4Data | CH1Mem | CH2Mem | CH3Mem | CH4Mem | MDATa1 | MDATa2 | MDATa3 | MDATa4 | MDATa5 | MDATa6 | MDATa7 | MDATa8

Response data of the selected trace, see [Table 7-18](#).

The data is transferred in the data format defined via [FORMat\[:DATA\]](#) and [FORMat:DEXPort:SOURce](#). The unit is the default unit of the measured parameter; see [CALCulate<Ch>:PARAmeter:SDEFine](#).

Example:

```
SWE:POIN 20
```

Create a trace with 20 sweep points, making the created trace the active trace of channel 1 (omitted optional mnemonic SENSE1).

```
CALC:FORM MLIN; :FORM ASCII; FORM:DEXP:SOUR  
FDAT
```

Select the trace data format: linear magnitude values, ASCII format and formatted trace data (1 value per sweep point).

```
TRAC? CH1DATA
```

Query the 20 response values of the created trace according to the previous format settings.

Usage:

Query only

TRACe[:DATA]:STIMulus[:ALL]? <Stimulus>

Returns the stimulus values of the active data trace or memory trace (see [Table 7-18](#)).

Note: To read the stimulus values of an arbitrary data or memory trace, use

[CALCulate<Chn>:DATA:STIMulus?](#)

Query parameters:

<Stimulus> CH1Data | CH2Data | CH3Data | CH4Data | CH1Mem | CH2Mem | CH3Mem | CH4Mem | MDATa1 | MDATa2 | MDATa3 | MDATa4 | MDATa5 | MDATa6 | MDATa7 | MDATa8

Stimulus data of the selected trace, see [Table 7-18](#).

The data is transferred in the data format defined via [FORMat\[:DATA\]](#).

Example:

```
SWE:POIN 20
```

Create a trace with 20 sweep points, making the created trace the active trace of channel 1 (omitted optional mnemonic SENSE1).

```
TRAC:STIM? CH1DATA
```

Query the 20 stimulus values of the created trace. In the default format setting, the data is returned as a comma-separated list of 10-digit ASCII values.

Usage:

Query only

8 Programming examples

This chapter contains detailed programming examples on various tasks.

The syntax and use of all SCPI commands is described in [Chapter 7, "Command reference"](#), on page 968, where you will also find additional examples. For a general introduction to remote control of the analyzer refer to [Chapter 6, "Remote control"](#), on page 931. For an overview of special remote control features of the network analyzers refer to [Chapter 6.3, "Basic remote control concepts"](#), on page 945.

8.1 Basic tasks

This section presents detailed examples for programming tasks that almost every user will encounter when working with the R&S ZNA.

8.1.1 Typical stages of a remote control program

A typical remote control program comprises the following stages:

1. Performing the basic instrument settings
2. Adjusting the test setup
3. Initiating the measurement, command synchronization
4. Retrieving measurement results

Very often, steps 3 and 4 (or steps 2 to 4) must be repeated several times.



All example programs in this section have been developed and tested by means of the GPIB Explorer provided with the network analyzer. No extra programming environment is needed.

8.1.1.1 Basic instrument settings

Programming task: Adjust the basic network analyzer settings to your measurement tasks, optimizing the instrument for fast measurements.



Considerations for high measurement speed

The measurement speed depends on the sweep time but also on an efficient preparation of the instrument and on proper command synchronization. The following items should be kept in mind:

- For maximum speed the basic channel settings should be set while the sweep is stopped and with a minimum of sweep points. It is advisable to increase the number of points after all instrument settings have been performed, and to initiate the sweep after the test setup has been completed.
- Execution of the `INITiate[:IMMEDIATE]` command is fastest in synchronized mode. Insertion of fixed waiting periods into the command sequence is possible but generally less efficient.
- The sweep time depends on several parameters; see below. In particular it is recommended to select the best set of sweep points, e.g. using the segmented sweep.

```
// Reset the instrument, switch off the measurement (after one sweep),
// reduce the number of sweep points.
*RST
INITiate1:CONTinuous OFF
SENSe1:SWEep:POINts 2
//
// Avoid a delay time between different partial measurements and before the
// start of the sweeps (is default setting).
SENSe1:SWEep:TIME:AUTO ON
TRIGger1:SEQuence:SOURce IMMEDIATE
//
// Select the widest bandwidth compatible with your measurement.
SENSe1:BANDwidth:RESolution 10
//
// Adjust your sweep points to your measurement task, e.g. using a segmented sweep.
SENSe1:SEGment...
```

8.1.1.2 Adjusting the test setup

In general the preparatives described above can be used for a series of measurements. In-between the measurements it is often necessary to change the test setup, e.g. to replace the DUT, change the connected ports, connect external devices etc.

8.1.1.3 Start of the measurement and command synchronization

Programming task: Start a measurement in single sweep mode. Wait until all single sweep data has been acquired before you proceed to the next stage of the measurement.

`INITiate<Ch>[:IMMEDIATE][:DUMMY]` or `INITiate<Ch>[:IMMEDIATE]:ALL` are used to start a single sweep or a group of single sweeps. These commands have

been implemented for overlapped execution. The advantage of overlapped commands is that they allow the program to do other tasks while being executed.

In the present example the sweep must be completed before measurement results can be retrieved. To prevent wrong results (e.g. a mix-up of results from consecutive sweeps) the controller must synchronize its operation to the execution of `INITiate<Ch>[:IMMEDIATE]`. IEEE 488.2 defines three common commands (`*WAI`, `*OPC?`, `*OPC`) for synchronization.

// 1. Start single sweep, use *WAI

```
// *WAI is the easiest method of synchronization. It has no effect when sent
// after sequential commands.
// If *WAI follows INITiate<Ch>[:IMMEDIATE]... (overlapped commands), the analyzer
// executes no further commands or queries until the sweep is terminated.
// *WAI does prevent the controller from sending other commands to the analyzer
// or other devices

// Start single sweep in channel no. 1, wait until the end of the sweep
INITiate1:IMMEDIATE; *WAI
<Continue program sequence>
```

// 2. Start single sweep, use *OPC?

```
// If *OPC follows INITiate<Ch>[:IMMEDIATE]..., it places a 1 into the
// output queue when the sweep is terminated.
// An appropriate condition in the remote control program must cause the
// controller to wait until *OPC? returns one.
// The controller is stopped from the moment when the condition is set.

// Start single sweep in channel no. 1, indicate the end of the sweep
// by a 1 in the output queue.
INITiate1:IMMEDIATE; *OPC?
// So far the controller may still send messages to other connected devices.

// Stop the controller until *OPC? returns one (program syntax depends
// on your programming environment).
<Condition OPC=1>
<Continue program sequence>
```

// 3. Start single sweep, use *OPC

```
// If *OPC follows INITiate<Ch>[:IMMEDIATE]..., it sets the OPC bit in the ESR
// after the sweep is terminated.
// This event can be polled or used to trigger a service request of the analyzer.
// The advantage of *OPC synchronization is that both the controller and the
// analyzer can continue processing commands while the sweep is in progress.

// Enable a service request for the ESR
*SRE 32
// Set event enable bit for operation complete bit
```

```

*ESE 1
// Start single sweep in channel no. 1, set the OPC bit in the ESR
// after the sweep is terminated.
// The controller may still send messages, the analyzer continues to parse
// and execute commands.
INITiate1:IMMEDIATE; *OPC

// Controller waits for service request from the analyzer
// (program syntax depends on your programming environment).
<Wait for service request>
<Continue program sequence>

```

8.1.1.4 Retrieving measurement results

Programming task: Read the results acquired in a single sweep.

// 1. Read single values (-> Markers)

```

// Markers are the most convenient tool for determining and retrieving single
// values on traces.
// The analyzer provides up to ten markers; see Markers and Limit Lines.

```

// 2. Read complete trace

```

// Select a trace format and read formatted trace data.
CALCulate1:FORMat MLINear / Calculate the linear magnitude of z
CALCulate1:DATA? FDATA / Read the formatted trace data

```



Use `CALCulate<Chn>:DATA:NSweep:FIRSt?` to retrieve a particular trace within a group of sweeps.

8.1.2 Channel, trace and diagram handling

The following examples show you how to perform basic tasks related to channel and trace definition and to the display of traces in diagrams.



All example programs in this section have been developed and tested by means of the GPIB Explorer provided with the network analyzer. No extra programming environment is needed.

8.1.2.1 Several traces with equal channel settings

Programming task: Create up to four different traces with equal channel settings, assign the four 2-port standard S-parameters to the traces and display them in up to four diagrams.

Important remote control features for this program example

The following command sequence illustrates the structure of the remote commands discussed in section Basic Remote Control Concepts. In particular it shows that:

- A trace can be created and handled without being displayed.
- Traces are referenced by trace names. The active trace of a channel is often referenced by the channel suffix.
- Diagrams are referenced by a window suffix <Wnd>. An additional suffix <WndTr> in the DISPLAY:WINDOW<Wnd>:TRACE<WndTr>... commands numbers the different traces in a diagram.
- In remote control, it is possible to display the same trace in several diagrams.
- The analyzer provides several commands allowing a smooth transition between remote and manual control.

// 1. One channel, two traces, one diagram

```
// Reset the instrument, creating the default trace Trc1 in channel 1.
// The default measured quantity is the forward transmission S-parameter S21.
// The default format is dB Mag.
*RST

// Create a second trace in channel 1, assign the format Phase,
// and display the new trace in the same diagram.
// the trace becomes the active trace but is not displayed
CALCulate1:PARAMeter:SDEFine 'Trc2', 'S21'

// the trace is referenced by the channel suffix 1
CALCulate1:FORMat PHASE

// display the second trace, numbering it the second trace in diagram no. 1
DISPlay:WINDow1:TRACe2:FEED 'Trc2'
```

// Check the result on the local screen

```
// Go to local
SYSTem:DISPlay:UPDate ONCE
```

// 2. One channel, two traces, two diagrams

```
// Create a second diagram, assign Trc2 to the new area, and remove it
// from the first area.
DISPlay:WINDow2:STATe ON
DISPlay:WINDow2:TRACe2:FEED 'Trc2'
// Trc2 is now displayed in both diagrams
DISPlay:WINDow1:TRACe2:DELeTe
```

// Check the result on the local screen

```
// Go to local
SYSTem:DISPlay:UPDate ONCE
```

// 3. One channel, four traces, four diagrams

```
// Reset the instrument, add diagrams no. 2, 3, 4.
*RST; :DISPlay:WINDow2:STATe ON
DISPlay:WINDow3:STATe ON
DISPlay:WINDow4:STATe ON

// Assign the reflection parameter S11 to the default trace.
:CALCulatel:PARAmeter:MEASure 'Trc1', 'S11'

// Assign the remaining S-parameters to new traces Trc2, Trc3, Tr4;
// select the Smith chart format for the reflection parameters.
CALCulatel:FORMat SMITH // Smith chart for the active trace Trc1
CALCulatel:PARAmeter:SDEFine 'Trc2', 'S21'
CALCulatel:PARAmeter:SDEFine 'Trc3', 'S12'
CALCulatel:PARAmeter:SDEFine 'Trc4', 'S22'
// Smith chart for the active trace Trc4, referenced by the channel number
CALCulatel:FORMat SMITH

// Display the new traces in diagrams no. 2 to 4.
DISPlay:WINDow2:TRACe2:FEED 'Trc2'
DISPlay:WINDow3:TRACe3:FEED 'Trc3'
DISPlay:WINDow4:TRACe4:FEED 'Trc4'
```

// Check the result on the local screen

```
// Go to local
SYSTem:DISPlay:UPDate ONCE
```

8.1.2.2 Several traces with different channel settings...

Programming task: Create three channels with 3, 1 and 2 traces, respectively, and display the traces in two diagrams.

Important remote control features for this program example

The following command sequence illustrates the structure of the remote commands discussed in section Basic Remote Control Concepts. In particular it shows that:

1. Channels are always referenced by a channel suffix.
2. Traces are referenced by trace names. The active trace of a channel is often referenced by the channel suffix.
3. Diagrams are referenced by a window suffix <Wnd>. An additional suffix <WndTr> in the `DISPlay:WINDow<Wnd>:TRACe<WndTr>...` commands numbers the different traces in a diagram.
4. The analyzer provides several commands allowing a smooth transition between remote and manual control.

// 1. Create all channels and traces

```
// Reset the instrument, creating the default trace Trc1 in channel 1.
// The default measured quantity is the forward transmission S-parameter S21.
// The default format is dB Mag.
*RST

// Create two more traces in channel 1, assigning a trace name and a measured
// quantity to each of them. Choose descriptive trace names (instead of the
// short default names used above).
CALCulate1:PARAMeter:SDEFine 'Impedance_trace', 'Z-S21'
// the trace becomes the active trace for channel 1 but is not displayed

CALCulate1:PARAMeter:SDEFine 'Admittance_trace', 'Y-S21'
// the trace becomes the active trace for channel 1

// Create channel 2 with one new trace, channel 3 with two new traces.
CALCulate2:PARAMeter:SDEFine 'Ratio_trace', 'B1/B2'
CALCulate3:PARAMeter:SDEFine 'Z_trace', 'Z21'
CALCulate3:PARAMeter:SDEFine 'Y_trace', 'Y21'
CALCulate3:PARAMeter:SElect 'Z_trace'
// the trace created previously becomes the active trace for channel 3
// So far, only the default trace is displayed.
```

// Check the result on the local screen

```
// Go to local
SYSTEM:DISPLAY:UPDATE ONCE
```

// 2. Create second diagram and display traces

```
DISPLAY:WINDOW2:STATE ON
DISPLAY:WINDOW1:TRACE2:FEED 'Admittance_trace'
DISPLAY:WINDOW1:TRACE3:FEED 'Y_trace'
DISPLAY:WINDOW2:TRACE1:FEED 'Impedance_trace'
DISPLAY:WINDOW2:TRACE2:FEED 'Ratio_trace'
DISPLAY:WINDOW2:TRACE3:FEED 'Z_trace'
```

// Check the result on the local screen

```
// Go to local
SYSTEM:DISPLAY:UPDATE ONCE
```

// 3. Check and modify your configuration

```
// Query the traces in channel 1.
CALCulate1:PARAMeter:CATALOG?
// The response is 'Trc1,S21,Impedance_trace,Z-S21,Admittance_trace,Y-S21'

// Query the reference level for the 'Z_trace'.
// The trace is referenced by its number in diagram no. 2.
DISPLAY:WINDOW2:TRACE3:Y:RLEVEL?
```



```
// Change the display format for the 'Z_trace'. The trace is the active trace
// in channel 3, so it is referenced by the channel suffix 3.
// Update the display
CALCulate3:FORMat PHASe
// Update the display
SYSTem:DISPlay:UPDate ONCE
```

8.1.2.3 Markers and limit lines...

Programming task: Display two traces in a single diagram area, use markers to read results, and perform a limit check.

Important remote control features for this program example

The following command sequence illustrates the structure of the remote commands discussed in section Basic Remote Control Concepts. In particular it shows that:

1. Traces are referenced by trace names. The active trace of a channel is often referenced by the channel suffix. This simplifies the program syntax, e.g. in the commands for marker settings and for the limit check.
2. Diagrams are referenced by a window suffix <Wnd>. An additional suffix <WndTr> in the DISPLAY:WINDow<Wnd>:TRACe<WndTr>... commands numbers the different traces in a diagram.
3. The analyzer provides several commands allowing a smooth transition between remote and manual control.

// 1. Create one channel, two traces, one diagram

```
// Reset the instrument, creating the default trace Trc1 in channel 1.
// The default measured quantity is the forward transmission S-parameter S21.
// The default format is dB Mag.
*RST

// Create a second trace in channel 1, assign the format Phase,
// and display the new trace in the same diagram.

// the trace becomes the active trace but is not displayed
CALCulatel:PARAmeter:SDEFine 'Trc2', 'S21'

// the trace is referenced by the channel suffix 1
CALCulatel:FORMat PHASe

// display the second trace, numbering it the second trace in diagram no. 1
DISPlay:WINDow1:TRACe2:FEED 'Trc2'
```

// Check the result on the local screen

```
// Go to local
SYSTem:DISPlay:UPDate ONCE
```

// 2. Marker settings

```
// Adjust the sweep range to consider an interesting segment of the trace and
// re-scale the diagram.
SENSE1:FREQUENCY:START 4.5 GHz; STOP 5.5 GHz
// in the autoscale command the trace is referenced by its number in the diagram
DISPLAY:WINDOW1:TRACE1:Y:SCALE:AUTO ONCE

// Select trace Trc1 as the active trace of the channel, define a reference
// marker and a delta marker.
// In the marker commands the active trace is referenced by the channel suffix.
CALCULATE1:PARAMETER:SELECT 'Trc1'

// the marker is set to the center of the sweep range
CALCULATE1:MARKER1:STATE ON

// this command also creates the reference marker
CALCULATE1:MARKER1:DELTA:STATE ON

// set the reference marker to the beginning of the sweep range
CALCULATE1:MARKER1:REFERENCE:X 4.5 GHz

// Use the delta marker to search for the minimum of the trace and query the result.
// the query returns the stimulus and the response value at the marker position
CALCULATE1:MARKER1:FUNCTION:EXECUTE MIN; RES?
```

// Check the result on the local screen

```
// Go to local
SYSTEM:DISPLAY:UPDATE ONCE
```



Use the `CALCULATE<Chn>:DATA...` commands to retrieve the complete trace; see [Retrieving Measurement Results](#).

// 3. Limit lines and limit check

```
// Remove all markers and define a limit line for the active trace.
CALCULATE1:MARKER1:AOFF
// define an upper limit line across the entire sweep range
CALCULATE1:LIMIT:DATA 1, 4500000000, 5500000000, -5, -5
CALCULATE1:LIMIT:DATA 2, 4500000000, 5000000000, -10, -15
// define two segments for the lower limit line
CALCULATE1:LIMIT:DATA 2, 5000000000, 5500000000, -15, -10

// Display the limit line and perform the limit check.
CALCULATE1:LIMIT:DISPLAY:STATE ON
CALCULATE1:LIMIT:STATE ON; FAIL?
// if the trace failed the limit check; the response is 1
```

// Check the result on the local screen

```
// Go to local
SYSTem:DISPlay:UPDate ONCE
```

8.2 Condensed programming examples

This section contains short program examples for select issues. The comments have been commented in concise style; for more detailed information on the commands refer to [Chapter 7.3, "SCPI command reference"](#), on page 971.

If the example you are looking for is not in this section, we suggest you to refer to the short command sequences in the reference chapter. Proceed as follows:

1. Find your subject in the help system, preferably using context-sensitivity (of the help system on your network analyzer) or the index:

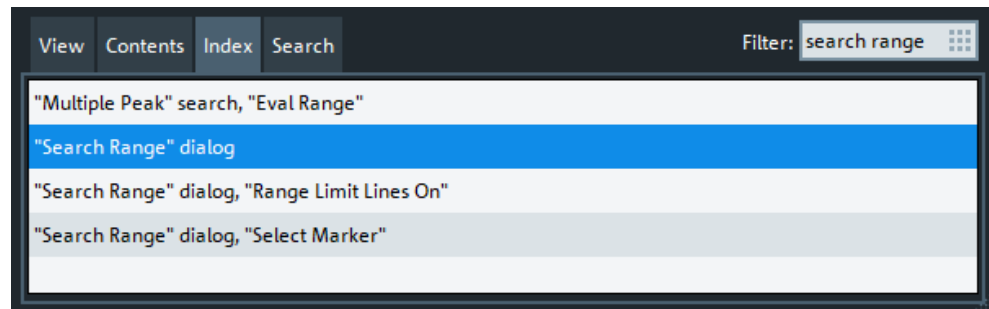

2. Activate the link to the command description:

Remote command:

```
CALCulate<Chn>:MARKer<Mk>:FUNction:DOMain:USER\[:RANGe\]  
CALCulate<Chn>:MARKer<Mk>:FUNction:DOMain:USER:START  
CALCulate<Chn>:MARKer<Mk>:FUNction:DOMain:USER:STOP
```

3. A short example appears at the end of each command description:

```
Example:      CALC1:MARK1:FUNC:DOM:USER 2  
                Select the search range no. 2, assigned to marker no. 1 and trace no. 1.  
                CALC:MARK:FUNC:DOM:USER:START 1GHz  
                Set the start frequency of the search range to 1 GHz.  
                CALC:MARK:FUNC:DOM:USER:STOP 1.2GHz  
                Set the stop frequency of the search range to 1.2 GHz.
```



The command `SYSTem:DISPlay:UPDate` precedes some of the command scripts so that you can watch the progress of the script on the screen. For maximum performance, simply omit this command.

8.2.1 Path-independent remote control programs

The default directory for R&S ZNA user data is

C:\Users\Public\Documents\Rohde-Schwarz\ZNA. Other instruments may use different default directories. To make remote control programs compatible, it is recommended to define all paths relative to the default directory, to be set via `MMEemory:CDIRectory DEFault`.

// Select default directory, change to sub-directory (relative to default directory)

```
MMEemory:CDIRectory DEFault
MMEemory:CDIRectory 'Traces'

MMEemory:STORe:TRACe 'Trc1', 'S21.s1p'
MMEemory:LOAD:TRACe 'Trc1', 'S21.s1p'
```

// Alternative, more compact definition

```
MMEemory:CDIRectory DEFault
MMEemory:STORe:TRACe 'Trc1', 'Traces\S21.s1p'
```

You may also read the default path (`MMEemory:CDIRectory?`) and use the external RC program to build the complete paths.

8.2.2 Trace and diagram handling

The following sections provide examples for efficient channel and trace definition and convenient diagram handling.

8.2.2.1 Assigning channels, traces, and diagrams

The following example is a short version of [Chapter 8.1.2, "Channel, trace and diagram handling"](#), on page 1725.

// Reset the analyzer

```
*RST
:SYSTEM:DISPLAY:UPDATE ON
```

// Create a new trace for S21 with the name TrcDisp

```
:CALCULATE1:PARAMETER:SDEFINE "TrcDisp","S21"
// Display the trace in the display area 1
:DISPLAY:WINDOW1:TRACE9:FEED 'TrcDisp'
:DISPLAY:WINDOW1:TRACE9:DELETE
```

// List the traces, assigned to a certain Channel

```
// format "<trace name>,<meas param>[,<trace name>,<meas param>...]"
:CALCULATE1:PARAMETER:CATALOG?
```

// Channel 4 does not exist, a new channel and trace is created

```
:CALCULATE4:PARAMETER:SDEFINE "Ch4Trc2","S22"
:CALCULATE4:PARAMETER:SDEFINE "Ch4Trc3","S33"
:CALCULATE4:PARAMETER:CATALOG?
```

// Select active traces for channel 4

```
:CALCULATE4:PARAMETER:SELECT "Ch4Trc2"
:CALCULATE4:PARAMETER:SELECT?
//:CALCULATE4:FORMAT POLAR
:CALCULATE4:PARAMETER:SELECT "Ch4Trc3"
//:CALCULATE4:FORMAT DB_LIN
:CALCULATE4:PARAMETER:SELECT?
:CALCULATE4:PARAMETER:SELECT "Ch4Trc2"
:CALCULATE4:FORMAT?
:CALCULATE4:PARAMETER:SELECT "Ch4Trc3"
:CALCULATE4:FORMAT?
```

// Create trace

```
:CALCULATE1:PARAMETER:SDEFINE "Trc2","S21"
:CALCULATE1:PARAMETER:SDEFINE "Trc3","S31"
:CALCULATE1:PARAMETER:CATALOG?
```

// Delete trace

```
:CALCULATE1:PARAMETER:DELETE "Trc2"
:CALCULATE1:PARAMETER:CATALOG?
```

// Assign a trace to a window = diagram, diagram 1 always exists

```
:DISPLAY:WINDOW1:TRACE2:FEED 'TrcDisp'
```

// Create diagram 2

```
:DISPLAY:WINDOW2:STATE?
:DISPLAY:WINDOW2:STATE ON
:DISPLAY:WINDOW2:STATE?
:DISPLAY:WINDOW2:TRACE6:FEED 'Ch4Trc2'
:DISPLAY:WINDOW2:TRACE2:FEED 'Trc1'
:DISPLAY:WINDOW2:TRACE3:FEED 'Ch4Trc3'
```

// Create traces: trace names are not case-sensitive

```
:CALCULATE4:PARAMETER:SELECT "Ch4Trc2"
:CALCULATE4:PARAMETER:SELECT?
:CALCULATE4:PARAMETER:SELECT "CH4TRC3"
:CALCULATE4:PARAMETER:SELECT?
:CALCULATE4:PARAMETER:SELECT "ch4trc2"
:CALCULATE4:PARAMETER:SELECT?
```

8.2.2.2 Memory traces

The following example shows how to save data to memory and work with memory traces.

// Reset the analyzer

```
*RST
:SYSTEM:DISPLAY:UPDATE ON
:SENSE1:SWEEP:POINTS 20
```

// Create memory trace of the "active" trace (active for the parser !)

```
// the name of the created memory trace is "Mem2[Trc1]"
:TRACE:COPY MDATA2,CH1DATA
:SENSE1:FUNCTION:ON 'XFREQUENCY:POWER:S11'
:CALCULATE1:PARAMETER:CATALOG?

// Assign the memory trace to a window = diagram, diagram 1 always exists
:DISPLAY:WINDOW1:TRACE2:FEED 'Mem2[Trc1]'
```

// Create further memory traces and assign them to a window

```
:TRACE:COPY 'Mem3x[Trc1]',CH1DATA // mixed parameters String, Char
:DISPLAY:WINDOW1:TRACE3:FEED 'Mem3x[Trc1]'
:TRACE:COPY MDATA4,CH1DATA
:DISPLAY:WINDOW1:TRACE4:FEED 'Mem4[Trc1]'
```

// Create new normal trace on channel 1, assign it to a window

```
:CALCULATE1:PARAMETER:SDEFINE "Trc2","S22"
:DISPLAY:WINDOW1:TRACE5:FEED 'Trc2'
:CALCULATE1:PARAMETER:SELECT 'Trc2' // now active for channel 1
:CALCULATE1:PARAMETER:SELECT?
:CALCULATE1:PARAMETER:CATALOG?
```

// Create memory trace for 'Trc2',

```
// The memory trace can be assigned to the diagram of the mother trace only
// (diagram 1)
:TRACE:COPY MDATA6,CH1DATA
:DISPLAY:WINDOW1:TRACE6:FEED 'Mem6[Trc2]'
```

// Create new diagram 2 and new channel and trace

```
:DISPLAY:WINDOW2:STATE ON
:CALCULATE2:PARAMETER:SDEFINE "Ch2Trc1","S22"
:CALCULATE2:PARAMETER:SELECT 'Ch2Trc1' // now active for channel 2
:SENSE1:SWEEP:POINTS 21
:TRACE:COPY MDATA1,CH2DATA
:DISPLAY:WINDOW2:TRACE7:FEED 'Mem1[Ch2Trc1]'
```

```
:TRACE:DATA:STIMULUS? CH1DATA
:TRACE:DATA:RESPONSE? MDATA6
```

// Create new channel 3 and new trace

```
:CALCULATE3:PARAMETER:SDEFINE "Ch3Trc1","S21"
:CALCULATE3:PARAMETER:SELECT 'Ch3Trc1' // now active for channel 3
:CALCULATE3:PARAMETER:SELECT? '%Ch3Trc1'
:SENSE1:SWEEP:POINTS 22
:TRACE:COPY MDATA8,CH3DATA
:TRACE:COPY MDATA7,CH3DATA
:DISPLAY:WINDOW2:TRACE1:FEED 'Mem8[Ch3Trc1]'
:TRACE:DATA:RESPONSE? MDATA7 // assigned to no diagram
```

// Copy with arbitrary trace names, no blanks in trace names !!!

```
:TRACE:COPY 'Trace_Name','Ch3Trc1'
:DISPLAY:WINDOW2:TRACE2:FEED 'Trace_Name'
:CALCULATE3:PARAMETER:SELECT 'Trace_Name'
:CALCULATE3:PARAMETER:SELECT?
:TRACE:COPY 'XYZ','Ch2Trc1'
:DISPLAY:WINDOW2:TRACE3:FEED 'XYZ'
:CALCULATE2:PARAMETER:SELECT 'XYZ'
:CALCULATE2:PARAMETER:SELECT?
:TRACE:COPY MDATA4 , 'Ch3Trc1' // mixed parameters Char, String
:DISPLAY:WINDOW2:TRACE4:FEED 'Mem4[Ch3Trc1]'
```

// Copy to existing memory traces = update trace data

```
:TRACE:COPY MDATA6,CH1DATA
:TRACE:COPY 'XYZ','Ch2Trc1'
:CALCULATE1:PARAMETER:CATALOG?
:CALCULATE2:PARAMETER:CATALOG?
:CALCULATE3:PARAMETER:CATALOG?
```

8.2.2.3 Trace mathematics

The following script shows how to define mathematical relations between traces.

// Reset the analyzer

```
*RST
:SYSTEM:DISPLAY:UPDATE ON
```

// Create memory trace on active trace of channel 1,

```
// assign the memory trace to a diagram
:CALCULATE1:MATH:MEMORIZE
:DISPLAY:WINDOW1:TRACE2:FEED 'Mem2[Trc1]'
```

// Define simple trace mathematics

```
:CALCULATE1:MATH:FUNCTION ADD
:CALCULATE1:MATH:FUNCTION?
// Trace mathematics off
:CALCULATE1:MATH:FUNCTION NORMAL
:CALCULATE1:MATH:FUNCTION?
*RST
```

// Create Trc2 in channel 1 and display it in diagram 1

```
:CALCULATE1:PARAMETER:SDEFINE "Trc2","S11"
:DISPLAY:WINDOW1:TRACE2:FEED 'Trc2'
```

// Create diagram 2 and Trc3 in new channel

```
:DISPLAY:WINDOW2:STATE ON
:CALCULATE2:PARAMETER:SDEFINE "Trc3","S11"
:DISPLAY:WINDOW2:TRACE1:FEED 'Trc3'
```

// Select active traces for channels 1 and 2

```
:CALCULATE1:PARAMETER:SELECT "Trc1"
:CALCULATE2:PARAMETER:SELECT "Trc3"
```

// Create memory trace on Trc1 and assign it to a diagram, same for TRC3

```
:TRACE:COPY MDATA7,CH1DATA
:DISPLAY:WINDOW1:TRACE3:FEED 'Mem7[Trc1]'
:TRACE:COPY MDATA8,CH2DATA
:DISPLAY:WINDOW2:TRACE2:FEED 'Mem8[Trc3]'
```

// Examples for Trace Mathematics

```
// Special operands Data and Mem
:CALCULATE1:MATH:SDEFINE "Data * Mem"
:CALCULATE1:MATH:STATE ON
// Constants
:CALCULATE1:MATH:SDEFINE "Pi * e * j"
// Functions
:CALCULATE1:MATH:SDEFINE "linMag (1) + dBMag (2) + Arg (3) + Re (4) + Im (5j)"
:CALCULATE1:MATH:SDEFINE "log (2) * ln (3) * Min (1, 2) * Max (2, 3)"
:CALCULATE1:MATH:SDEFINE "StimVal + asin (sin (3)) + acos (cos (4))
    + atan (tan (4))"
:CALCULATE1:MATH:SDEFINE "(Trc1 + 2) * 1.1"
:CALCULATE1:MATH:SDEFINE "(tRC1 + e) * Pi + STIMVAL - sin (1) + Min (TRC1, Trc1)"
// Imaginary unit j = sqrt (-1)
// j is no ordinary operand: 1j not 1 * j
// magnitude: 1, phase: 60 degrees
:CALCULATE1:MATH:SDEFINE "(1 + 3 ^ (1 / 2) * 1j) / 2"
:CALCULATE1:MATH:SDEFINE "sin (1) + ACOS (0.5)"
// 2 periods for sin (), ... when stop frequency 8 GHz = 8e9 Hz
```



```

:CALCULATE1:MATH:SDEFINE "sin (2 * 2 * Pi * StimVal / 8e9) "
:CALCULATE1:MATH:SDEFINE "cos (2 * 2 * Pi * StimVal / 8e9) "
:CALCULATE1:MATH:SDEFINE "tan (2 * 2 * Pi * StimVal / 8e9) "
:CALCULATE1:MATH:SDEFINE "Min (sin (6 * Pi * StimVal / 8e9),
    cos (6 * Pi * StimVal / 8e9))"
:CALCULATE1:MATH:SDEFINE "Max (sin (6 * Pi * StimVal / 8e9),
    cos (6 * Pi * StimVal / 8e9))"
:CALCULATE1:MATH:SDEFINE "Trc1 ^ 2"
:CALCULATE1:MATH:SDEFINE "Trc1 + Trc2 + Trc3"
:CALCULATE1:MATH:SDEFINE "(Trc1 + e) * Pi + Mem8[Trc3] + StimVal
    + Min (Trc1, Mem7[Trc1])"
:CALCULATE1:MATH:SDEFINE "tan (5 * 2 * Pi * StimVal / 8e9)"

```

8.2.2.4 Trace statistics

The following script shows how to create a trace, select an evaluation range and retrieve statistical results.

// Reset the analyzer

```

*RST
:SYSTEM:DISPLAY:UPDATE ON

```

// Create new channel and trace

```

:CALCULATE2:PARAMETER:SDEFINE 'Trc2', 'S11'
:CALCULATE2:PARAMETER:SELECT 'Trc2'
:DISPLAY:WINDOW2:STATE ON
:DISPLAY:WINDOW2:TRACE1:FEED 'Trc2'
:SENSE1:SWEEP:TIME:AUTO ON
:SENSE2:SWEEP:TIME:AUTO ON

```

// Search full-span evaluation range, display statistical results

```

:CALCULATE1:STATISTICS:DOMAIN:USER 0
:CALCULATE2:STATISTICS:DOMAIN:USER 0
:CALCULATE1:STATISTICS ON
:CALCULATE2:STATISTICS ON

```

// Single sweep, global scope

```

:INITIATE:CONTINUOUS OFF
:INITIATE:IMMEDIATE:SCOPE ALL
:SENSE:SWEEP:COUNT 4
:INITIATE:IMMEDIATE; *WAI

```

// Calculate statistical results (also possible if info field is switched off)

```

:CALCULATE1:STATISTICS:RESULT? MEAN
:CALCULATE1:STATISTICS:RESULT? ELENGth
:CALCULATE1:STATISTICS:RESULT? ALL

```

// Modify evaluation range (is automatically confined to sweep range)

```
:CALCulate1:STATistics:DOMain:USER 1
:CALCulate1:STATistics:DOMain:USER:START 0 HZ
:CALCulate1:STATistics:DOMain:USER:STOP 100 GHZ
:CALCulate1:STATISTICS:RESULT? MEAN

:CALCulate1:STATISTICS:RESULT? MAX
```

8.2.2.5 Bandfilter search

The following example shows how to use markers for a bandpass or bandstop search.

// Reset the analyzer

```
*RST
:SYSTEM:DISPLAY:UPDATE ON

:SENSE1:FREQUENCY:START 1 GHZ
:SENSE1:FREQUENCY:STOP 6 GHZ
```

// Bandpass search ref. to max.

```
:CALCulate1:MARKer:FUNCTion:BWIDth:MODE BPASS
:CALCulate1:MARKer:FUNCTion:BWIDth:MODE? %BPAS

// Measure single sweep, wait until complete sweep is finished
:INITiate:CONTinuous OFF
:INITiate; *WAI;
:CALCulate1:MARKer:FUNCTion:EXECute BFILter

// All markers OFF
:CALCulate1:MARKer:AOFF
```

// Bandpass search ref. to marker

```
:CALCulate1:MARKer1:STATe ON
:CALCulate1:MARKer1:X 3.0 GHz
:CALCulate1:MARKer:FUNCTion:BWIDth:MODE BPRMarker
:CALCulate1:MARKer:FUNCTion:BWIDth:MODE? %BPRM
:INITiate; *WAI;
:CALCulate1:MARKer:FUNCTion:EXECute BFILter
:CALCulate1:MARKer:AOFF
```

// Bandstop search ref. to max.

```
:CALCulate1:MARKer:FUNCTion:BWIDth:MODE BStop
:CALCulate1:MARKer:FUNCTion:BWIDth:MODE? %BST
:INITiate; *WAI;
:CALCulate1:MARKer:FUNCTion:EXECute BFILter
:CALCulate1:MARKer:AOFF
```

// Bandstop search ref. to marker

```

:CALCulate1:MARKer1:STATE ON
:CALCulate1:MARKer1:X 1.7 GHz
:CALCulate1:MARKer:FUNCTION:BWIDth:MODE BsRMarker
:CALCulate1:MARKer:FUNCTION:BWIDth:MODE? %BsRM
:INITiate; *WAI;
:CALCulate1:MARKer:FUNCTION:EXECute BFILter

```

8.2.2.6 Creating diagrams

In the following example, remote control commands are used to position several diagrams on the screen. The remote control commands presented here extend the functionality of the "Display > Diagram" and "Display > Split" softtool tabs.

// Reset the analyzer

```

*RST
:SYSTEM:DISPLAY:UPDATE ON

```

// Define and display a simple horizontal layout (two diagrams side by side)

```

:DISPlay:LAYout:DEFine 1, Horizontal, '1.00,0.30,0.70'
:DISPlay:LAYout:APPLY 1

```

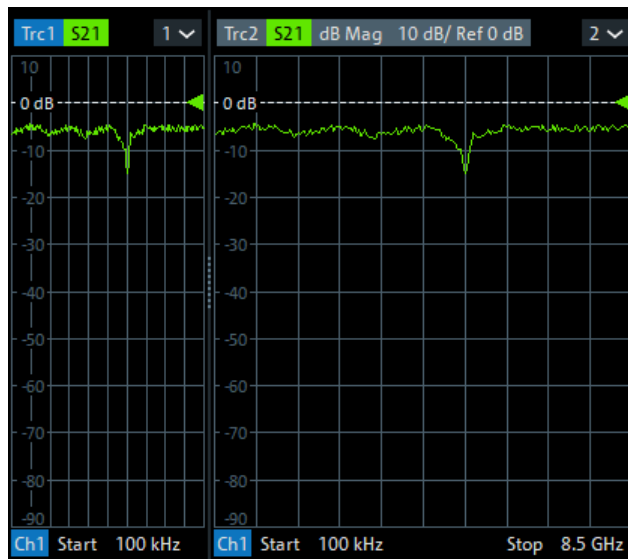
**// Define and display a simple vertical layout (two diagrams, one on top of the other)**

```

:DISPlay:LAYout:DEFine 2, Vertical, '1.00,0.50,0.50'
:DISPlay:LAYout:APPLY 2

```

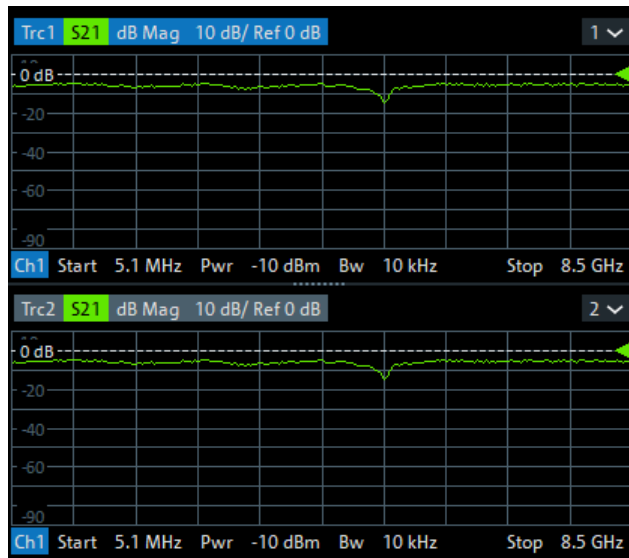

// Check the executable formats of the generated layouts

```
:DISPlay:LAYout:DEFine? 1 %(1,1,0.00,0.00,(1,2,1.00,1.00,[0.30,1.00],[0.70,1.00]))
:DISPlay:LAYout:DEFine? 2 %(1,1,0.00,0.00,(2,1,1.00,1.00,[1.00,0.50],[1.00,0.50]))
```

// Join the 2 layouts, display the nested layout

```
:DISPlay:LAYout:JOIN 1,2,2
:DISPlay:LAYout:APPLY 1
```

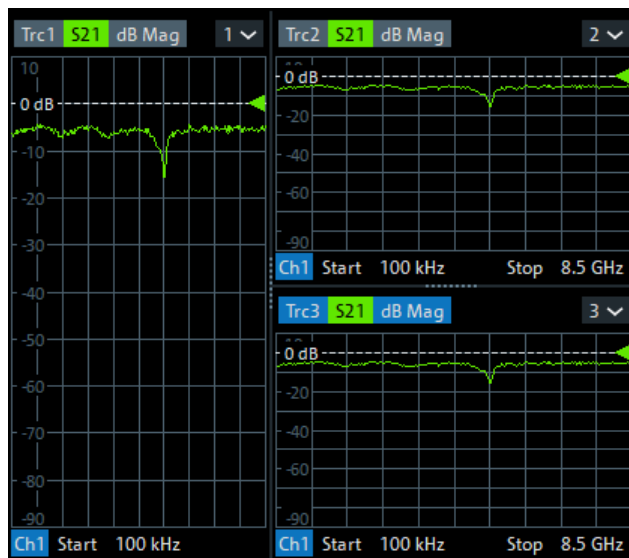

// Check the last applied (i.e. the joined) layout for the correct format

```
:DISPlay:LAYout:EXECute?
  %(1,1,0.00,0.00,(1,2,1.00,1.00,[0.30,1.00],
  %(1,1,0.70,1.00,(2,1,1.00,1.00,[1.00,0.50],[1.00,0.50])))
```

// Set the layout format directly (horizontal, joined layout)

```
:DISPlay:LAYout:EXECute
  '(1,1,0.00,0.00,(1,2,1.00,1.00,[0.30,1.00],
    (1,1,0.70,1.00,(2,1,1.00,1.00,[1.00,0.50],[1.00,0.50])))')'
```

// Alternative direct definition of the joined layout as a vertical layout

```
:DISPlay:LAYout:DEFine 3, VERT, '0.3,1.0;0.7,0.5,0.5'
:DISPlay:LAYout:APPLy 3
:DISPlay:LAYout:EXECute?
  %(1,2,0.00,0.00,(1,1,0.3,1.00,[1.00,1.0]),(2,1,0.7,1.00,[1.00,0.5],[1.00,0.5]))
```

8.2.3 Using markers

The following example shows you how to define markers and use them to read trace values.

// Reset the analyzer

```
*RST
:SYSTEM:DISPLAY:UPDATE ON
```

// Initiate a single sweep

```
:INITiate1:CONTinuous OFF
:INITiate1:IMMediate;*WAI

// The following marker commands have the channel no. as a numeric suffix.
// The parameter belongs to a trace, the assignment channel -> trace
// is done via a "active" trace for each channel
:CALCULATE1:PARAMETER:SELECT 'Trc1'
```

// Marker ON / OFF

```
:CALCULATE1:MARKER1 ON
:CALCULATE1:MARKER1:STATE?
```

// Coupled Markers

```
// All markers belonging to channels with the same sweep type
// (FREQUENCY, TIME, POWER, CW FREQUENCY) are coupled/decoupled
:CALCULATE1:MARKER:COUPLED ON
```

// Marker Continuous / Discrete

```
:CALCULATE1:MARKER1:MODE CONTINUOUS
```

// Normal / Delta / Reference / Fixed Marker

```
:CALCULATE1:MARKER:AOFF // all markers off
:CALCULATE1:MARKER1 ON
:CALCULATE1:MARKER1:X 1GHZ
```

```

:CALCULATE1:MARKER2 ON
:CALCULATE1:MARKER2:X 2GHZ
:CALCULATE1:MARKER3 ON
:CALCULATE1:MARKER3:X 3GHZ
:CALCULATE1:MARKER4:DELTA:STATE ON
:CALCULATE1:MARKER:REFERENCE ON
:CALCULATE1:MARKER:REFERENCE:X 5GHZ
:CALCULATE1:MARKER1:TYPE FIXED

```

// Query marker response values

```

:CALCULATE1:FORMAT MLINEAR
:CALCULATE1:MARKER1 ON
:CALCULATE1:MARKER1:X DEF
:CALCULATE1:MARKER1:FORMAT MLINEAR
// DataBase EMarkerFormat::LIN_MAG
:CALCULATE1:MARKER1:Y?
:CALCULATE1:MARKER1:FORMAT MLOGARITHMIC
//          . . . . . DB_MAG
:CALCULATE1:MARKER1:Y?

```

8.2.3.1 Marker search functions

The following example shows how to search for particular measurement points using markers.

// Reset the analyzer

```

*RST
:SYSTEM:DISPLAY:UPDATE ON

```

// Define marker and stimulus range

```

:CALCULATE1:MARKER1 ON
:SENSE1:FREQUENCY:START 1GHZ
:SENSE1:FREQUENCY:STOP 2GHZ
// Do the marker search in the format DB Magnitude
:CALCULATE1:FORMAT MLOGARITHMIC

```

// Define marker search ranges (stimulus range of the marker search)

```

// Range 0 is always the stimulus range of the trace (can't be changed)
:CALCULATE1:MARKER1:FUNCTION:DOMAIN:USER 0
:CALCULATE1:MARKER1:FUNCTION:DOMAIN:USER:START?
:CALCULATE1:MARKER1:FUNCTION:DOMAIN:USER:STOP?

// Range 1 (within the stimulus range)
:CALCULATE1:MARKER1:FUNCTION:DOMAIN:USER 1
:CALCULATE1:MARKER1:FUNCTION:DOMAIN:USER:START 1.2GHZ
:CALCULATE1:MARKER1:FUNCTION:DOMAIN:USER:STOP 1.8GHZ

```

```
// Range 2 (includes the stimulus range)
:CALCULATE1:MARKER1:FUNCTION:DOMAIN:USER 2
:CALCulate1:MARKer1:FUNction:DOMain:USER:START 0.8GHZ
:CALCulate1:MARKer1:FUNction:DOMain:USER:STOP 2.2GHZ

// Use range 0 (stimulus range of the trace)
:CALCULATE1:MARKER1:FUNCTION:DOMAIN:USER 0
```

// Select linear magnitude scale for diagram

```
:CALCULATE1:FORMAT MLINEAR
```

// Search for global minimum and maximum (MIN, MAX)

```
// (initial marker value may be inside or outside the marker search range)
:CALCULATE1:MARKER1:X 1.5GHZ
:CALCULATE1:MARKER:MIN
:CALCULATE1:MARKER1:X?

:CALCULATE1:MARKER1:X 1.5GHZ
:CALCULATE1:MARKER:MAX
:CALCULATE1:MARKER1:X?
```

// Minimum peak search functions

```
:CALCULATE1:MARKER1:FUNCTION:SELECT MINIMUM
:CALCULATE1:MARKER1:FUNCTION:SELECT?
// NEXT PEAK
:CALCULATE1:MARKER1:X 1.5GHZ
:CALCULATE1:MARKER:SEARCH:NEXT
:CALCULATE1:MARKER1:X?
// PEAK RIGHT
:CALCULATE1:MARKER1:X 1.5GHZ
:CALCULATE1:MARKER:SEARCH:RIGHT
:CALCULATE1:MARKER1:X?
// PEAK LEFT
:CALCULATE1:MARKER1:X 1.5GHZ
:CALCULATE1:MARKER:SEARCH:LEFT
:CALCULATE1:MARKER1:X?
```

// Maximum peak search functions

```
:CALCULATE1:MARKER1:FUNCTION:SELECT MAXIMUM
// Proceed as for minimum search
```

8.2.4 Data handling

The following sections provide examples for efficient sweep definition and data handling. Part of the functionality is not available in manual control.

8.2.4.1 Single sweep mode

The commands `CALCulate<Ch>:DATA:NSweep...? SDATA,` `<Trace_Hist_Count>` retrieve the results of any sweep within a previously defined single sweep group. This means that, in single sweep mode, you can first measure a specified number of sweeps (`SENSe<Ch>:SWEEP:COUNT <sweeps>`) and then read any of the data traces acquired.

This feature has no equivalent in manual control where always the last data trace is displayed.

```
// Reset the analyzer
*RST
:SYSTEM:DISPLAY:UPDATE ON

// Create a second and third channel with new diagrams and traces.
:CALCULATE2:PARAMETER:SDEFINE "Trc2","S11"
:CALCULATE2:PARAMETER:SELECT "Trc2"
:DISPLAY:WINDOW2:STATE ON
:DISPLAY:WINDOW2:TRACE1:FEED 'Trc2'

:CALCULATE3:PARAMETER:SDEFINE "Trc3","S11"
:CALCULATE3:PARAMETER:SELECT "Trc3"
:DISPLAY:WINDOW3:STATE ON
:DISPLAY:WINDOW3:TRACE1:FEED 'Trc3'

// Select sweep time for the channels.
:SENSE1:SWEEP:TIME 1 S
:SENSE2:SWEEP:TIME 1 S
:SENSE3:SWEEP:TIME 1 S

// Enable single sweep mode for all channels so that channel-specific
// sweep count settings are used
:INITIATE:CONTINUOUS:ALL OFF

// Select single sweep mode with channel-specific sweep count settings
// Set sweep counts and start measurement in all channels

:SENSE1:SWEEP:COUNT 1
:SENSE2:SWEEP:COUNT 2
:SENSE3:SWEEP:COUNT 3

:INITIATE1:IMMEDIATE; *WAI
:INITIATE2:IMMEDIATE; *WAI
:INITIATE3:IMMEDIATE; *WAI

// Select single sweep mode with global sweep count settings

:SENSE:SWEEP:COUNT:ALL 2

:INITIATE1:IMMEDIATE; *WAI
:INITIATE2:IMMEDIATE; *WAI
:INITIATE3:IMMEDIATE; *WAI
```

8.2.4.2 Modeling a max hold function

The following example shows you how to emulate a max hold function.

// Reset the analyzer

```
*RST
:SYSTEM:DISPLAY:UPDATE ON
```

// Create a trace with the last extremum as memory trace.

```
:TRACe:COPIY 'LastExtr', 'Trc1'

// Display this last extremum trace.
// Because it's a memory trace it must be displayed in the same diagram
// as the mother trace.
:DISPlay:WINDow1:TRACe2:FEED 'LastExtr'
:CALCulate1:MATH:SDEFine 'Max (Data, Mem)'
:CALCulate1:MATH:STATE ON
```

// Single sweep mode

```
:INITIATE:CONTINUOUS OFF

// Do a single sweep and update trace with the current extremum.
// This is the last extremum for the next sweep
:INITIATE:IMMEDIATE; *WAI
:TRACe:COPIY:MATH 'LastExtr', 'Trc1'

// Loop over these 2 commands
:INITIATE:IMMEDIATE; *WAI
:TRACe:COPIY:MATH 'LastExtr', 'Trc1'
:INITIATE:IMMEDIATE; *WAI
:TRACe:COPIY:MATH 'LastExtr', 'Trc1'
```

// Continuous sweep mode

```
:INITIATE:CONTINUOUS ON
```

8.2.4.3 Retrieving the results of previous sweeps

The commands `CALCulate<Ch>:DATA:NSweep...? SDATa,` `<Trace_Hist_Count>` retrieve the results of any sweep within a previously defined single sweep group. This means that, in single sweep mode, you can first measure a specified number of sweeps (`SENSe<Ch>:SWEep:COUNT <sweeps>`) and then read any of the data traces acquired.

This feature has no equivalent in manual control where always the last data trace is displayed.

// Reset the analyzer

```
*RST
:SYSTEM:DISPLAY:UPDATE ON
```

// Create a second channel with a second trace

```
:CALCULATE2:PARAMETER:SDEFINE "Trc2","S11"
:CALCULATE2:PARAMETER:SELECT "Trc2"
:DISPLAY:WINDOW2:STATE ON
:DISPLAY:WINDOW2:TRACE1:FEED 'Trc2'
```

// Select active trace for the created channel 2. Adjust the number of sweep points.

```
:CALCULATE2:PARAMETER:SELECT "Trc2"
:SENSE1:SWEEP:POINTS 3
:SENSE2:SWEEP:POINTS 4
```

// Set sweep time and sweep count for the channels

(3 traces per single sweep in channel 1, 4 traces in channel 2)

```
:SENSE1:SWEEP:TIME 1 S
:SENSE2:SWEEP:TIME 1 S
:SENSE1:SWEEP:COUNT 3
:SENSE2:SWEEP:COUNT 4
```

// 1st Alternative: Reverse reading with command synchronization

Select single sweep mode and measure a single sweep group for channels no. 1 and 2

```
:INITIATE:CONTInuous:ALL OFF
:INITIATE:IMMEDIATE:ALL; *WAI
```

Read trace data (without history, i.e. the last trace acquired in each channel)

```
:CALCULATE1:DATA? SDATA
:CALCULATE2:DATA? SDATA
```

Read last and previous trace data in channels 1 and 2

```
:CALCULATE1:DATA:NSWEEP? SDATA, 1 // last trace data
:CALCULATE1:DATA:NSWEEP? SDATA, 3 // previous trace data
:CALCULATE2:DATA:NSWEEP? SDATA, 1 // last trace data
:CALCULATE2:DATA:NSWEEP? SDATA, 4 // previous trace data
```

// 2nd Alternative: Forward reading (no command synchronization necessary)

Select single sweep mode and measure a single sweep group for channels no. 1

```
:INITIATE1:CONTInuous OFF
:INITIATE1:IMMEDIATE
```

Read the first and the following trace data in channel 1

```

if (CALCULATE1:DATA:NSWEEP:COUNT? > 2)
:CALCULATE1:DATA:NSWEEP:FIRST? SDATA, 1           // first trace data
:CALCULATE1:DATA:NSWEEP:FIRST? SDATA, 3           // third trace data

```

8.2.4.4 Exporting S-parameters

The calibration defines which S-Parameters are allowed to be exported to a Touchstone file. In the following example, a default (TOSM) calibration is created to make all S-Parameters available.

// Reset the analyzer

```

*RST
:SYSTEM:DISPLAY:UPDATE ON

:SENSE1:CORRECTION:COLLECT:METHOD:DEFINE 'Test', TOSM, 1, 2, 3, 4
:SENSE1:CORRECTION:COLLECT:SAVE:SELECTED:DEFAULT

```

// Initiate a complete sweep

```

:INITIATE1:CONTINUOUS OFF; :INITIATE:IMMEDIATE;*WAI
:MEMORY:STORE:TRACE:PORTS 1, 'ParserTouchstonePorts.s1p', COMPLEX, 2
:MEMORY:STORE:TRACE:PORTS 1, 'ParserTouchstonePorts.s2p', COMPLEX, 3, 2
:MEMORY:STORE:TRACE:PORTS 1, 'ParserTouchstonePorts.s4p', COMPLEX, 1, 4, 3, 2

```

8.2.5 Calibration

The following programming examples are related to system error correction and power calibration.

8.2.5.1 One and two-port calibration

The following example calibrates one or two analyzer ports.

// Reset the analyzer

```

*RST
:SYSTEM:DISPLAY:UPDATE ON

```

// Set cal kit as active kit for N50

```

:SENSE:CORRECTION:CKIT:N50:SELECT 'ZV-Z121'

```

// Select connectors for the ports

```

:SENSE1:CORRECTION:COLLECT:CONNECTION1 N50MALE
:SENSE1:CORRECTION:COLLECT:CONNECTION2 N50MALE

// Don't save the cal standard measurements with apply cal, i.e. with the commands
// :SENSE1:CORRECTION:COLLECT:SAVE or
// :SENSE1:CORRECTION:COLLECT:SAVE:SELECTED

```

```

// Instead, use the global, channel-independent setting:
:SENSe:CORRection:COLLect:ACQuire:RSaVe:DEFault OFF

// Full one port = OSM

// Select cal procedure
:SENSe:CORRection:COLLect:METhod:DEFine      'Test SFK OSM 1', FOPORT, 1

// Measure Standards
:SENSe:CORRection:COLLect:ACQuire:SELEcted  OPEN, 1
:SENSe:CORRection:COLLect:ACQuire:SELEcted  SHORT, 1
:SENSe:CORRection:COLLect:ACQuire:SELEcted  MATCH, 1

// Apply cal
:SENSe:CORRection:COLLect:SAVe:SELEcted

// 2 port TOSM

// Select cal procedure
:SENSe:CORRection:COLLect:METhod:DEFine      'Test SFK TOSM 12', TOSM, 1, 2

// Measure Standards
:SENSe:CORRection:COLLect:ACQuire:SELEcted  THROUGH, 1, 2
:SENSe:CORRection:COLLect:ACQuire:SELEcted  OPEN, 1
:SENSe:CORRection:COLLect:ACQuire:SELEcted  SHORT, 1
:SENSe:CORRection:COLLect:ACQuire:SELEcted  MATCH, 1
:SENSe:CORRection:COLLect:ACQuire:SELEcted  OPEN, 2
:SENSe:CORRection:COLLect:ACQuire:SELEcted  SHORT, 2
:SENSe:CORRection:COLLect:ACQuire:SELEcted  MATCH, 2

// Apply calibration
:SENSe:CORRection:COLLect:SAVe:SELEcted

// Save / load cal files

// Save calibration in calibration file pool
// C:\Users\Public\Documents\Rohde-Schwarz\ZNA\Calibration\Data
// The filename in the following two commands must not contain the path!
:MMEMORY:STORE:CORRection 1, 'OSM1 TOSM12.cal'
// load cal file from calibration file pool
:MMEMORY:LOAD:CORRection 1, 'OSM1 TOSM12.cal'

```

8.2.5.2 MultiCal (with calibration unit)

The following example demonstrates how to create multiple system error corrections on the same channel.

// Reset the analyzer

```
*RST
```

```
////////////////////////////////////////////////////////////////
```

// Connect to the cal unit

```
:SYSTem:COMMunicate:RDEvice:AKAL:ADDRess 'ZN-Z51::999002'
```

```
////////////////////////////////////////////////////////////////
```

// Prepare the multi cal

```
// create the first calibration:
// with full multi port and factory calkit
:SENSE1:CORREction:COLLECT:AUTO:CONFigure FNPort, ''
// the first cal addresses test ports 2,3 and 4 and explicitly
// assigns them to cal unit ports 2,3 and 4, respectively
:SENSE1:CORREction:COLLECT:AUTO:ASSignment1:DEFine 2,2,3,3,4,4
// get the number of port assignments of the current calibration
// expected result: 1
:SENSE1:CORREction:COLLECT:AUTO:ASSignment:COUNT?
// explore port assignment 1
// expected result: 2,2,3,3,4,4
:SENSE1:CORREction:COLLECT:AUTO:ASSignment1:DEFine?
// create the second calibration:
// full one port and factory calkit
:SENSE1:CORREction:COLLECT:AUTO:CONFigure FOPort, ''
// the second cal addresses test port 1
// and explicitly assigns it to cal unit port 1
:SENSE1:CORREction:COLLECT:AUTO:ASSignment2:DEFine 1,1
// get the number of port assignments of the current calibration
// expected result: 1
:SENSE1:CORREction:COLLECT:AUTO:ASSignment:COUNT?
// get the number of port assignments of all calibrations
// expected result: 2
:SENSE1:CORREction:COLLECT:AUTO:ASSignment:ALL:COUNT?
// explore port assignment 2
// expected result: 1,1
:SENSE1:CORREction:COLLECT:AUTO:ASSignment2:DEFine?
```

```
////////////////////////////////////////////////////////////////
```

// Acquire error correction data

```
:SENSE1:CORREction:COLLECT:AUTO:ASSignment1:ACQUIre
:SENSE1:CORREction:COLLECT:AUTO:ASSignment2:ACQUIre
```

```
////////////////////////////////////////////////////////////////
```

// Save the complete Multi-Cal

```
:SENSe1:CORRection:COLLect:AUTO:SAVE
```

```
////////////////////////////////////////////////////////////////////////////////////////////////////////////////////////////////
```

8.2.5.3 Saving and recalling error terms

The following examples show you how to perform a system error correction, save the acquired system error correction data to a file and reload them.

Performing a calibration, saving the error terms**// Reset the analyzer**

```
*RST
:SYSTEM:DISPLAY:UPDATE ON
```

// Set frequency range

```
:SENSe1:FREQuency1:STARt 1GHz
:SENSe1:FREQuency1:STOP 4GHz
:SENSe1:SWEep:POINts 6
```

// Select calibration type: TOSM at ports 1 and 2

```
:SENSe1:CORRection:COLLect:METhod:DEFine 'Test SFK TOSM 12', TOSM, 1, 2

// Measure Standards
:SENSe1:CORRection:COLLect:ACQuire:SELected THROUGH, 1, 2
:SENSe1:CORRection:COLLect:ACQuire:SELected OPEN, 1
:SENSe1:CORRection:COLLect:ACQuire:SELected SHORT, 1
:SENSe1:CORRection:COLLect:ACQuire:SELected MATCH, 1
:SENSe1:CORRection:COLLect:ACQuire:SELected OPEN, 2
:SENSe1:CORRection:COLLect:ACQuire:SELected SHORT, 2
:SENSe1:CORRection:COLLect:ACQuire:SELected MATCH, 2
```

// Apply calibration

```
SENSe1:CORRection:COLLect:SAVE:SELected
```

// Save error terms

```
:FORMAT REAL, 32
@TRACEFILE:scorr1.dat
:CALCulate1:DATA? SCORr1
@TRACEFILE:scorr2.dat
:CALCulate1:DATA? SCORr2
@TRACEFILE:scorr3.dat
:CALCulate1:DATA? SCORr3
// We are omitting the isolation term, as it is not implemented
// @TRACEFILE:scorr4.dat
```

```

// :CALCulate1:DATA? SCORr4
@TRACEFILE:scorr5.dat
:CALCulate1:DATA? SCORr5
@TRACEFILE:scorr6.dat
:CALCulate1:DATA? SCORr6
@TRACEFILE:scorr7.dat
:CALCulate1:DATA? SCORr7
@TRACEFILE:scorr8.dat
:CALCulate1:DATA? SCORr8
@TRACEFILE:scorr9.dat
:CALCulate1:DATA? SCORr9
// We are omitting the isolation term, as it is not implemented
// @TRACEFILE:scorr10.dat
// :CALCulate1:DATA? SCORr10
@TRACEFILE:scorr11.dat
:CALCulate1:DATA? SCORr11
@TRACEFILE:scorr12.dat
:CALCulate1:DATA? SCORr1

```

Performing a new calibration, recalling the error terms

// Reset the analyzer

```
*RST
```

// Set frequency range

```
:SENSE1:FREQuency1:STARt 1GHz
:SENSE1:FREQuency1:STOP 4GHz
:SENSE1:SWEep:POINts 6

```

// Select calibration type: TOSM at ports 1 and 2

```
:SENSE1:CORRection:COLLect:MEthod:DEFine 'XYZ', TOSM, 1, 2

```

// Generate a set of default correction data, switch on user calibration

```
:SENSE1:CORRection:COLLect:SAVE:SElected:DEFault
SENSE1:CORRECTION:STATE ON

```

```

// In the previous section, the following error terms were saved:
// SCORR1 Forward Directivity
// SCORR2 Forward Source Match
// SCORR3 Forward Reflection Tracking
// SCORR4 Forward Isolation
// SCORR5 Forward Load Match
// SCORR6 Forward Transmission Tracking
// SCORR7 Reverse Directivity
// SCORR8 Reverse Source Match
// SCORR9 Reverse Reflection Tracking
// SCORR10 Reverse Isolation

```

```

// SCORR11 Reverse Load Match
// SCORR12 Reverse Transmission Tracking

// Equivalences between the first parameter of CALculate:DATA
// and the first 3 Parameters of SENSE:CORrection:CDAta

// 'SCORR1' 'DIRECTIVITY', 1, 0 <Port 2> = 0 ignored
// 'SCORR2' 'SRCMATCH', 1, 0 <Port 2> = 0 ignored
// 'SCORR3' 'REFLTRACK', 1, 0 <Port 2> = 0 ignored
// 'SCORR4' 'ISOLATION', 1, 2
// 'SCORR5' 'LOADMATCH', 1, 2
// 'SCORR6' 'TRANSTRACK', 1, 2
// 'SCORR7' 'DIRECTIVITY', 2, 0 <Port 2> = 0 ignored
// 'SCORR8' 'SRCMATCH', 2, 0 <Port 2> = 0 ignored
// 'SCORR9' 'REFLTRACK', 2, 0 <Port 2> = 0 ignored
// 'SCORR10' 'ISOLATION', 2, 1
// 'SCORR11' 'LOADMATCH', 2, 1
// 'SCORR12' 'TRANSTRACK', 2, 1

```

// Set format for data transfer

```
:FORMAT REAL,32
```

// !!! Important !!! Stop sweep when loading error terms

```
:INITiate:CONTinuous OFF
```

// Recall error terms

```

// CALCulate:DATA is suitable for 2-port terms;
// use SENSE:CORrection:CDAta for more than 2 ports
:CALCulate1:DATA SCORR1,#@scorr1.dat
:CALCulate1:DATA SCORR2,#@scorr2.dat
:CALCulate1:DATA SCORR3,#@scorr3.dat
// We are omitting the isolation term, as it is not implemented on the ZVAB
//:CALCulate1:DATA SCORR4,#@scorr4.dat
:CALCulate1:DATA SCORR5,#@scorr5.dat
:CALCulate1:DATA SCORR6,#@scorr6.dat
:CALCulate1:DATA SCORR7,#@scorr7.dat
:CALCulate1:DATA SCORR8,#@scorr8.dat
:CALCulate1:DATA SCORR9,#@scorr9.dat
// We are omitting the isolation term, as it is not implemented on the ZVAB
//:CALCulate1:DATA SCORR10,#@scorr10.dat
:CALCulate1:DATA SCORR11,#@scorr11.dat
:CALCulate1:DATA SCORR12,#@scorr12.dat

:INITiate:CONTinuous ON

```

Using calibration data recorded previously

You can reuse any set of correction data that you acquired in earlier sessions on your analyzer. In general you have to carry out the following steps:

1. Create a dummy correction data set and store it to a file.
2. Replace the dummy data with your correction data.
3. Reimport the correction data file and apply it to a channel.

See also the program examples for the following commands:

- [SENSE<Ch>:]CORREction:COLlect:SAVE:SElected:DEFault (dummy system error correction)
- SOURCE<Ch>:POWER<Pt>:CORREction:DEFault (dummy source power calibration without external power meter)

8.2.5.4 Adapter removal

// define calibration method

```
SENSE1:CORREction:COLlect:METHOD:DEFine 'Parser Test SFK', ARTosm, 1, 2
```

// Start with calkit-1 (e.g. 3.5 mm ideal Kit)

```
//adapter side port 1
SENSE1:CORRECTION:COLLECT:ACQUIRE:SElected OPEN, 1, ON
SENSE1:CORRECTION:COLLECT:ACQUIRE:SElected SHORT, 1, ON
SENSE1:CORRECTION:COLLECT:ACQUIRE:SElected MATCH, 1, ON
```

```
//non adapter side port 2
SENSE1:CORRECTION:COLLECT:ACQUIRE:SElected OPEN, 2, OFF
SENSE1:CORRECTION:COLLECT:ACQUIRE:SElected SHORT, 2, OFF
SENSE1:CORRECTION:COLLECT:ACQUIRE:SElected MATCH, 2, OFF
```

// continue with Calkit-1 (e.g. N 50 Ohm ideal Kit)

```
//adapter side port 2
SENSE1:CORRECTION:COLLECT:ACQUIRE:SElected OPEN, 2, ON
SENSE1:CORRECTION:COLLECT:ACQUIRE:SElected SHORT, 2, ON
SENSE1:CORRECTION:COLLECT:ACQUIRE:SElected MATCH, 2, ON
```

```
//non adapter side port 1
SENSE1:CORRECTION:COLLECT:ACQUIRE:SElected OPEN, 1, OFF
SENSE1:CORRECTION:COLLECT:ACQUIRE:SElected SHORT, 1, OFF
SENSE1:CORRECTION:COLLECT:ACQUIRE:SElected MATCH, 1, OFF
```

// connect adapter between port 1 and 2

```
SENSE1:CORRECTION:COLLECT:ACQUIRE:SElected THROUGH, 1, 2
```

// save calibration

```
SENSe1:CORRection:COLLect:SAVE:SElected
```

8.2.5.5 Inline calibration

See [Chapter 4.5.5.4, "Inline calibration"](#), on page 211.

// Select an ICS

```
SYSTem:COMMunicate:RDEvice:AKAL:ADDRess 'ZN-Z30-02::100010'
```

// Query ICU addresses

```
SYST:COMM:RDEV:AKAL:ADDR:SUBM:ALL?
// Returns something like
// '[1]ZN-Z33-02::101325,[2]ZN-Z33-02::101325,[3]ZN-Z33-02::101339'
```

// Perform a complete UOSM calibration

```
SENSe1:CORRection:COLLect:AUTO:CPORT 1
SENSe1:CORRection:COLLect:AUTO:TEMPcomp OFF
SENSe1:CORRection:COLLect:AUTO:CONFigure FNPort, ''
SENSe1:CORRection:COLLect:AUTO:ASSignment:DElete:ALL
// let's assume ICU [i] is connected to VNA port i
SENSe1:CORRection:COLLect:AUTO:ASSignment1:DEFine 1, 1, 2, 2
// Step 1: OSM
SENSe1:CORRection:COLLect:AUTO:ASSignment1:ACQUire
// Step 2: Unknown Through
SENSe1:CORRection:COLLect:AUTO:UTHrough 1, 2
SENSe1:CORRection:COLLect:AUTO:SAVE
```

Repeat OSM only

```
SENSe1:CORRection:COLLect:AUTO:CONFigure FNPort, ''
SENSe1:CORRection:COLLect:AUTO:ASSignment:DElete:ALL
SENSe1:CORRection:COLLect:AUTO:ASSignment1:DEFine 1, 1, 2, 2
SENSe1:CORRection:COLLect:AUTO:REPeat // we will not repeat step 2
SENSe1:CORRection:COLLect:AUTO:ASSignment1:ACQUire
SENSe1:CORRection:COLLect:AUTO:SAVE
```

8.2.5.6 Vector mixer calibration using calibration units**Measurement setup**

Set up a vector mixer measurement on a 4-port R&S ZNA with 4 internal sources.

```
*RST
// suppose a calibration unit (with at least two ports) and a power meter
// are connected and configured
```

```

// make sure to stay within their frequency ranges
:SENSE1:FREQUENCY1:START 1 GHZ
:SENSE1:FREQUENCY1:STOP 3 GHZ
// use a small number of sweep points
:SENSE1:SWEEEP:POINT 20
// Enable coherence, but turn low phase noise off
:SENSE1:PHASE:MODE COHERENT

// use VNA port 1 as RF port
:SENSE1:FREQUENCY1:CONVERSION:MIXER:RFPORT 1
// use VNA port 2 as IF port
:SENSE1:FREQUENCY1:CONVERSION:MIXER:IFPORT 2
// use VNA port 3 as LO port
:SENSE1:FREQUENCY1:CONVERSION:MIXER:LOPORT1 PORT, 3
// provide a fixed LO signal at 50 MHz and 7 dBm
:SENSE1:FREQUENCY1:CONVERSION:MIXER:FIXED1 LO
:SENSE1:FREQUENCY1:CONVERSION:MIXER:MFFIXED 50 MHZ
:SOURCE1:FREQUENCY1:CONVERSION:MIXER:PFXED 7
// activate vector mixer mode
SENSE1:FREQUENCY1:CONVERSION VMIXER

```

VUOSM calibration

UOSM vector mixer calibration using a calibration unit and a calibration mixer.

```

// delete all pre-existing port assignments
:SENSE1:CORRECTION:COLLECT:AUTO:ASSIGNMENT:DELETE:ALL

// UOSM vector mixer cal with calu's factory characterization
:SENSE1:CORRECTION:COLLECT:AUTO:CONFIGURE VUOSM, ''
// connect the RF port (port 1) to calu port 1
// connect the IF port (port 2) to calu port 2
// declare the port assignment
:SENSE1:CORRECTION:COLLECT:AUTO:ASSIGNMENT1:DEFINE 1,1, 2,2
// acquire UOSM calibration data between RF and IF port
:SENSE1:CORRECTION:COLLECT:AUTO:ASSIGNMENT1:ACQUIRE
// connect the calibration mixer and acquire calibration data
// (currently, this must be the last calibration step)
:SENSE1:CORRECTION:COLLECT:AUTO:MIXER 1,2

```

VPUOSM calibration

A SMARTer UOSM vector mixer calibration using a calibration unit, a power meter and a calibration mixer.

```

// delete all pre-existing port assignments
:SENSE1:CORRECTION:COLLECT:AUTO:ASSIGNMENT:DELETE:ALL

```

Preferred procedure:

```

// VPUOSM vector mixer calibration with calu's factory characterization
:SENSE1:CORRECTION:COLLECT:AUTO:CONFIGURE VPUOSM, ''
// connect the RF port (port 1) to calu port 1

```

```

// connect the IF port (port 2) to calu port 2
// declare the port assignment
:SENSE1:CORRECTION:COLLECT:AUTO:ASSIGNMENT1:DEFINE 1,1, 2,2
// Note: the following steps can be performed in any order
// acquire UOSM calibration data between RF and IF port
// currently, this must be the first calibration step
:SENSE1:CORRECTION:COLLECT:AUTO:ASSIGNMENT1:ACQUIRE
// connect the power meter to the RF port (port 1)
// and perform a receiver power calibration
:SENSE1:CORRECTION:COLLECT:AUTO:POWER 1
// connect the calibration mixer and acquire calibration data
:SENSE1:CORRECTION:COLLECT:AUTO:MIXER 1,2

```

This also works, but mind the order!

```

:SENSE1:CORRECTION:COLLECT:AUTO:PORTS:TYPE VPUOSM, '', 1,1, 2,2
:SENSE1:CORRECTION:COLLECT:AUTO:MIXER 1,2
// receiver power cal must be last step!
:SENSE1:CORRECTION:COLLECT:AUTO:POWER 1

```

CPUOSM calibration

A SMARTer UOSM scalar vector mixer calibration using a calibration unit, a power meter and a calibration mixer.

Same procedure as described in "[VPUOSM calibration](#)" on page 1755; just replace VPUOSM by CPUOSM.

8.2.6 Mixer measurement

The following example is a remote implementation of the tasks the [Scalar Mixer Meas setup dialog](#) performs at the GUI.

A power meter and a four-port calibration unit has to be connected and configured beforehand.

// Reset the analyzer

```
*RST
```

// Configure a linear frequency sweep

```

SENSE1:SWEEP:TYPE LINEAR // Sweep type
SENSE1:SWEEP:POINTS 201 // Number of points
SENSE1:FREQUENCY:START 500 MHZ // Start frequency
SENSE1:FREQUENCY:STOP 2.5 GHZ // Stop frequency
SOURCE1:POWER1 0 DBM // Base power

```

// Define the mixer

```
SENSE1:FREQUENCY:CONVERSION:MIXER:STAGES 1 // Single mixer stage
```

Condensed programming examples

```

SENSE:FREQUENCY:CONVERSION:MIXER:RFPORT 1           // RF port = Port 1
SENSE:FREQUENCY:CONVERSION:MIXER:FUND RF           // RF @ channel frequency
SENSE:FREQUENCY:CONVERSION:MIXER:IFPORT 2          // IF port = Port 2
SENSE:FREQUENCY:CONVERSION:MIXER:LOPORT1 PORT,3    // LO1 port = Port 3
SENSE:FREQUENCY:CONVERSION:MIXER:FIXED LO1         // LO1 @ fixed frequency
SENSE:FREQUENCY:CONVERSION:MIXER:MFFIXED LO1, 200 MHz // LO1 frequency
SOURCE:FREQUENCY:CONVERSION:MIXER:PMFIXED LO1, 7 DBM // LO power
SENSE:FREQUENCY:CONVERSION:MIXER:TFFREQUENCY UCON   // IF = RF + LO
SENSE:FREQUENCY:CONVERSION MIXER                   // Activate mixer mode

```

// Perform an automatic SMARTerCal on ports 1, 2 and 3

```

SENSE:CORRECTION:COLLECT:PMETER:ID 1,1           // Power meter 1 @ port 1

//##### Connect VNA-ports 1,2,3 to Calu-ports 1,2,3
SENSE:CORRECTION:COLLECT:AUTO:PORTS:TYPE PFNPORT, '1, 1, 2, 2, 3, 3
// The calibration is performed using the factory calibration

//##### Connect the powermeter to port 1
SENSE:CORRECTION:COLLECT:AUTO:POWER 1

```

// Perform source flatness calcs on ports 1, 2 and 3

```

//##### Connect mixer: RF = port 1, IF = port 2, LO = port3
SOURCE:POWER1:CORRECTION:ACQUIRE PORT, 3 // Calibrate LO port
SOURCE:POWER1:CORRECTION:ACQUIRE PORT, 1 // Calibrate RF port
SOURCE:POWER1:CORRECTION:ACQUIRE PORT, 2 // Calibrate IF port

```

// Measure reflection at RF and IF ports

```

// Channel 1 with active trace 1 (= s21) already exists
// Trace 1 is displayed in diagram area 1
CONFIGURE:CHANNEL1:NAME 'Ch_M' // Rename channel 1
CONFIGURE:CHANNEL1:TRACE:RENAME 'Conv' // Rename trace 1

// Create and display trace 2 'RF_Refl' (S11)
CALCULATE1:PARAMETER:SDEFINE 'RF_Refl','S11' // Create trace 2
DISPLAY:WINDOW1:TRACE2:FEED 'RF_Refl' // --> diagram area 1

// Create and display trace 3 'IF_Refl' (S22)
CALCULATE1:PARAMETER:SDEFINE 'IF_Refl','S22' // Create trace 3
DISPLAY:WINDOW1:TRACE3:FEED 'IF_Refl' // --> diagram area 1

```

// Create a second channel for RF isolation measurements

```

CONFIGURE:CHANNEL2 ON // Create channel 2
CONFIGURE:CHANNEL2:NAME 'CH_RF' // Rename channel 2

```

```

SENSe2:FREQuency:CONVersion FUNDamental           // Reset mixer mode

// RF isolation is measured with active LO (port 3)
// and with the same fixed LO frequency as in mixer channel 1
SOURce2:FREQuency3:CONVersion:ARBitrary:IFREquency 1, 1, 200 MHz, FIXEd
SOURce2:POWer3:PERManent:STATe ON                // LO port: generator port

// Create and display trace 4 'RF_Isol' (S21)
CALCulate2:PARAmeter:SDEFine 'RF_Isol', 'S21' // Create trace 4
DISPlay:WINDow1:TRACe4:FEED 'RF_Isol'          // --> diagram area 1

```

// Create a third channel for LO leakage and feed-through

```

CONFigure:CHANnel3 ON                            // Create channel 3
CONFigure:CHANnel3:NAME 'CH_LO'                 // Rename channel 3
SENSe3:FREQuency:CONVersion FUNDamental         // Reset mixer mode

// Use a fixed channel frequency, set to the LO frequency of mixer channel 1
SENSe3:FREQuency:START 200 MHz // Start frequency =
SENSe3:FREQuency:STOP 200 MHz // Stop frequency = 200 MHz
SENSe3:SWEep:POINts 1 // One sweep point is enough !

// Create and display trace 5 'LO_Leak' (S13)
CALCulate3:PARAmeter:SDEFine 'LO_Leak', 'S13' // Create trace 5
DISPlay:WINDow1:TRACe5:FEED 'LO_Leak'         // --> diagram area 1

// Create and display trace 6 'LO_Thru' (S23)
CALCulate3:PARAmeter:SDEFine 'LO_Thru', 'S23' // Create trace 6
DISPlay:WINDow1:TRACe6:FEED 'LO_Thru'         // --> diagram area 1

```

8.2.7 Two-tone group delay measurement (R&S ZNA-K9)

Suppose you have:

- A 2-port R&S ZNAxx with internal combiner R&S ZNAxx-B212
- A calibration unit with at least two ports, registered by the firmware

Channel setup

```

*RST

// configure the sweep
:SENSe1:FREQuency:START 4 GHz
:SENSe1:FREQuency:STOP 6 GHz
:SENSe1:SWEep:POINts 5

// set up the mixer
:SENSe1:FREQuency1:CONVersion:MIXer:RFPort 1
:SENSe1:FREQuency1:CONVersion:MIXer:IFPort 2

```

```

:SENSe:FREQuency1:CONVersion:MIXer:FIXed1 LO
:SENSe:FREQuency1:CONVersion:MIXer:FFIXed 3 GHZ
:SOURcel:FREQuency1:CONVersion:MIXer:PFIXed 10
:SENSe:FREQuency1:CONVersion MIXer
:SENSe:IFPath WID

// set up the two-tone group delay measurement
:SENSe:FREQuency:MDElay:APERTure 10 MHz
:SENSe:FREQuency:MDElay:LTONE 1
:SENSe:FREQuency:MDElay:UTONE PORT, 3
:SENSe:FREQuency:MDElay:RPORT 2
:SOURcel:COMBiner COUPler

```

Measurements

```

// Example traces:
:CALCulate:PARAmeter:DElete:ALL
:CALCulate1:PARAmeter:SDEFine 'TrcMix_a_LTone', 'Mix_a_LTone'
:CALCulate1:PARAmeter:SDEFine 'TrcMixDly', 'MixDly'
:DISPlay:WINDow1:TRACe1:FEED 'TrcMix_a_LTone'
:DISPlay:WINDow1:TRACe2:FEED 'TrcMixDly'

```

UOSM combined with mixer delay calibration

```

// Define the calibration: UMDelay =
// UOSM calibration for source and receive port
// + delay mixer calibration.
:SENSe:CORRection:COLlect:AUTO:CONFigure UMDelay, ''
:SENSe:CORRection:COLlect:AUTO:ASSignment1:DEFine 1,1, 2,2

// Perform the calibration measurements:
// - Connect the cal unit to ports 1 and 2.
:SENSe:CORRection:COLlect:AUTO:ASSignment1:ACQUire
// - Connect the delay mixer
:SENSe:CORRection:COLlect:AUTO:MDElay 1, 2

```

(Mixer delay calibration only)

```

// Define a pure mixer delay calibration
:SENSe:CORRection:COLlect:METHOD:DEFine 'MyMDC', MDElay, 1,2
// Delay mixer measurement
:SENSe:CORRection:COLlect:ACQUire:SElected MDElay,1,2

:SENSe:CORRection:COLlect:SAVE:SELECTED

```

8.2.8 RFFE/GPIO interface programming

Requires hardware option R&S ZN-B15/-Z15 (see [Chapter 4.7.26, "RFFE GPIO interface"](#), on page 305).

Set GPIO Voltages directly

```
*RST
// Set GPIO voltages
:CONTROL:GPIO1:VOLTAGE:DEF +5V
// Write GPIO configuration into hardware
:CONTROL:GPIO:VOLTAGE:OUTPUT
```

Sending RFFE commands directly

```
*RST
// General configuration of RFFE interface 2
:CONTROL:RFFE2:SETTINGS:FREQUENCY 50 KHZ
:CONTROL:RFFE2:SETTINGS:VOLTAGE:IO 2V
:CONTROL:RFFE2:SETTINGS:VOLTAGE:LOW 0V
:CONTROL:RFFE2:SETTINGS:VOLTAGE:HIGH 1.2V
// Send commands over RFFE interface 2
// Slave address: 0xA; command number: 0xBC; data: 0x0123
:CONTROL:RFFE2:COMMAND:DATA 'ABC0123'
:CONTROL:RFFE2:COMMAND:SEND
```

Reading a Product ID

This example assumes knowledge of the RFFE Specification of the MIPI® Alliance, in particular the "RFFE Supported Command Sequences".

```
*RST
// DUT Power on sequence
:CONTROL1:GPIO1:VOLTAGE 2.5V
:CONTROL1:GPIO:VOLTAGE:OUTPUT
:CONTROL1:GPIO2:VOLTAGE 1.8V
:CONTROL1:GPIO:VOLTAGE:OUTPUT

// Initialization of DUT with Slave Address SA = 0x0B:
// Write 0x38 at register address 0x1C.
// Therefore SA = 0xB; CMD = 0x5C; DATA = 0x38.
//           with CMD =   0010 0000b (see RFFE specification 'Register Write')
//                   | 0001 1100b (register address)
//                   =   0011 1100b
//                   =   0x5C
:CONTROL1:RFFE1:COMMAND:DATA 'B5C38'
:CONTROL1:RFFE1:COMMAND:SEND

// Read Product ID. Register address of product ID is noted in the DUT specification.
// This Example: Product ID is stored at address 0x1D.
// Therefore SA = 0xB; CMD = 0x7D;
//           with CMD =   0110 0000b (see RFFE specification 'Register Read')
//                   | 0001 1101b (register address)
//                   =   0111 1101b
//                   =   0x7D
```



```
:CONTROL1:RFFE1:COMMAND:DATA 'B7D'
:CONTROL1:RFFE1:COMMAND:SEND? 1 // Read 1Byte. Result is the Product ID
```

Configuring RFFE sweep sequencer (non-segmented sweep)

For non-segmented sweeps the RFFE device will be configured in preparation of every sweep.

```
*RST
// Enable GPIO 5 and RFFE interface 2 for Sweep Sequencer
:CONTROL:GPIO5:STATE ON
:CONTROL:RFFE2:SETTINGS:STATE ON

// Step 1
:CONTROL:SEQUENCE1:GPIO5:VOLTAGE 0V
:CONTROL:SEQUENCE1:RFFE2:COMMAND:DATA '12345AF'
// Step 2
:CONTROL:SEQUENCE2:GPIO5:VOLTAGE -1V
// After step 2, wait for 3 ms
:CONTROL:SEQUENCE2:DELAY 3ms
// Step 3
:CONTROL:SEQUENCE3:GPIO5:VOLTAGE 1V
// During sweep, output voltage will be 1V
```

Configuring RFFE sweep Sequencer (segmented sweep)

For segmented sweeps, the RFFE device will be configured in preparation of every segment.

```
*RST
// Define segmented sweep
:SENSE1:SEGMENT1:INSERT 1MHZ, 1.5MHZ, 111, -21DBM, 0.5S, 0, 10KHZ
:SENSE1:SEGMENT2:INSERT 2MHZ, 2.5MHZ, 222, -22DBM, 0.5S, 0, MAX
:SENSE1:SEGMENT3:INSERT 3MHZ, 3.5MHZ, 133, -23DBM, 0.5S, 0, 1KHZ
// Activate segmented sweep
:SENSE:SWEPTYPE SEGMENT

// Enable GPIO 4 and RFFE interfaces 1 for Sweep Sequencer
:CONTROL:GPIO4:STATE ON
:CONTROL:RFFE1:SETTINGS:STATE ON

// Set default voltage for GPIO Sweep Sequencer list
:CONTROL:GPIO4:VOLTAGE:DEF 0.5V

// Define command sequences per sweep segment
// Segment 1: A single step
:CONTROL:SEGMENT1:SEQUENCE1:RFFE1:COMMAND:DATA '12311'
:CONTROL:SEGMENT1:SEQUENCE1:GPIO4:VOLT 1.2V
// Segment 3: Two steps
:CONTROL:SEGMENT3:SEQUENCE1:RFFE1:COMMAND:DATA '3EF11'
:CONTROL:SEGMENT3:SEQUENCE2:RFFE1:COMMAND:DATA '3EF22'
```

8.2.9 Fixture modeling

We create and apply a fixture model for single-ended deembedding at ports 1 and 2 using the ISD tool.

Prepare the channel

```
*RST
:SENSe1:FREQuency:START MINimum
:SENSe1:FREQuency:STOP MAXimum
```

Perform a full two-port calibration at ports 1 and 2

For an example, see "[// 2 port TOSM](#)" on page 1748

Measure the test coupon

We are using a single-ended (2-port) "Symmetric 2x Thru" coupon (balanced). Connect it to ports 1 and 2.

```
:CALCulate:FMODEl:ISD1:COUPon:TYPE SYMMetric2x
:CALCulate:FMODEl:ISD1:COUPon:STATe 1
:CALCulate:FMODEl:ISD2:COUPon:STATe 1
:CALCulate:FMODEl:ISD3:COUPon:STATe 0
:CALCulate:FMODEl:ISD4:COUPon:STATe 0
:CALCulate:FMODEl:ISD:COUPon:MEASure
```

Measure the DUT together with the test fixture

Connect DUT + test fixture to ports 1 and 2.

```
:CALCulate:FMODEl:ISD1:DUT:STATe 1
:CALCulate:FMODEl:ISD2:DUT:STATe 1
:CALCulate:FMODEl:ISD3:DUT:STATe 0
:CALCulate:FMODEl:ISD4:DUT:STATe 0
:CALCulate:FMODEl:ISD1:DUT:MEASure
:CALCulate:FMODEl:ISD1:RUN:STATe 1
:CALCulate:FMODEl:ISD2:RUN:STATe 1
:CALCulate:FMODEl:ISD3:RUN:STATe 0
:CALCulate:FMODEl:ISD4:RUN:STATe 0
:CALCulate:FMODEl:ISD:RUN:RUN
```

Measure the DUT together with the test fixture

Run the ISD tool and apply the generated s2p files to port 1 (unswapped) and port 2 (swapped).

```
:CALCulate:FMODEl:ISD1:RUN:STATe 1
:CALCulate:FMODEl:ISD2:RUN:STATe 1
:CALCulate:FMODEl:ISD3:RUN:STATe 0
:CALCulate:FMODEl:ISD4:RUN:STATe 0
:CALCulate:FMODEl:ISD:RUN:RUN
```

8.2.10 Noise figure measurement of an amplifier

```
*RST

// depending on topology: coupler reversed at port 2
SOURCE:PATH2:DIRECTACCESS REV

// part 1 (content of init of NF channel in Meas Dialog)

// set IF Gain Mode to Manual
SENSE1:POWER:GAINcontrol:GLOBAL MANUAL
// set IF gain on all receivers to Low Noise
SENSE1:POWER:GAINcontrol:ALL LNOise
// couple IF gain mode in sweep segments to channel setting
SENSE1:SEGMENT:POWER:GAINcontrol:CONTROL OFF

// config similar to the one done inside NF Meas Dialog
// define ports for NF
SENSE1:NFIGURE:DEFINE 2, 1 // receiving port 2, driving port 1

// set stimulus
SENSE1:FREQUENCY:START 100MHz
SENSE1:FREQUENCY:STOP 4GHz
SENSE1:SWEEP:POINTS 40

// base power (for DUT Measurement)
SOURCE1:POWER -30dBm

// set RBW (2MHz equivalent bandwidth)
SENS1:BAND:RES 2MHz

// set source step attenuator to 40dB at source port
SOURCE1:POWER1:ATT 40dB

// use LNA with 25dB gain at port 2
SENSE1:PAMPLIFIER2:STATE ON
SENSE1:PAMPLIFIER2:VALUE 25

// noise detector measurement time (for measurement)
SENSE1:NFIGURE:NTIME 50ms

// gain detector measurement time (for measurement)
SENSE1:NFIGURE:GTIME 10ms

// noise detector measurement time (for calibration)
SENSE1:NFIGURE:CALIBRATION:NTIME 50ms

// gain detector measurement time (for calibration)
SENSE1:NFIGURE:CALIBRATION:GTIME 10ms
```

```

// configure harmonic correction
:SENSE1:NFIGure:HARMonic:STate 1
:SENSE1:NFIGure:HARMonic:MAX 5
:SENSE1:NFIGure:HARMonic:MINFrequency 10MHz
:SENSE1:NFIGure:HARMonic:MAXFrequency 20GHz

// reference receiver power calibration: calibration power level of 0dBm
SOURcel:POWer:CORRection:PPOWer 0dBm
SOURcel:POWer:CORRection:PSElect PPOWer

// value for source step attenuator is 0dB by default
SOURcel:POWer:CORRection:PPOWer:PATTenuation 0dB

// set cal power to -40dBm for port 1 (driving port)
// switch state on (i.e. overriding of value from user setup)
SENSE1:CORRection:ADVanced:POWer1:STate ON
// with 40dB step attenuator this gives 0dBm for Source Power:
SENSE1:CORRection:ADVanced:POWer1 0

// begin calibration
SENS1:CORR:COLL:PMET:ID 1, 1
// last parameter: port for power meter measurement during SMARTer Cal

// perform either a manual calibration or a CalUnit calibration

// manual calibration
SENS1:CORR:COLL:METH:DEF 'nf_cal', POPTport, 1, 2
// The first port is the source port.

// power meter
SENSE1:CORRection:COLLect:ACQuire:SElected POWer, 1
// one port standards
SENSE1:CORRection:COLLect:ACQuire:SElected OPEN, 1
SENSE1:CORRection:COLLect:ACQuire:SElected SHORT, 1
SENSE1:CORRection:COLLect:ACQuire:SElected MATCh, 1
// through
SENSE1:CORRection:COLLect:ACQuire:SElected THROugh, 1, 2
// termination for receiver noise cal
SENSE1:CORRection:COLLect:ACQuire:SElected TERMination, 2

SENS1:CORR:COLL:SAVE:SEL

// CalUnit cal
:SENSE1:CORRECTION:COLLECT:AUTO:ASSignment:DElete:ALL
:SENSE1:CORRection:COLLect:AUTO:CONFigure PFNPort, ''
:SENSE1:CORRECTION:COLLECT:AUTO:ASSignment1:DEFine 1,1, 2,2
// measure first with the CalUnit
:SENSE1:CORRECTION:COLLECT:AUTO:ASSignment1:ACQuire
:SENSE1:CORRection:COLLect:AUTO:POWer 1

```

```
:SENSe1:CORRection:COLLect:AUTO:TERMination 2

// end calibration

// Setup Traces
// NF
CALCulatel:PARAmeter:MEASure 'Trc1', 'NF21'
// Gain
:CALCulatel:PARAmeter:SDEFine 'Trc2', 'B2/A1'
:DISPlay:WINDow1:TRACe:EFEEd 'Trc2'
```

9 Error messages and troubleshooting

9.1 Errors during firmware operation

An error generally causes the analyzer to display a tooltip across the lower part of the screen. The tooltip provides a textual description of the error, e.g.:

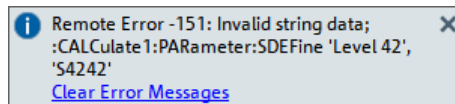

The errors can be divided into four categories:

- Remote errors (SCPI errors) can occur during the execution of a remote control program. They include an error code, followed by the short description of the error. Remote errors are specified and described in the SCPI standard; they are cleared upon *CLS.
- Software errors (setting errors) can occur, e.g., if numeric entries in an analyzer dialog are incompatible with each other or with the current analyzer state. These errors are self-explanatory and easy to correct.
- Hardware errors indicate an incorrect hardware state. Some of the hardware errors cause the instrument to be switched off to avoid damage. Hardware errors with possible causes and remedies are listed in the following sections.
- Exceptions indicate anomalous or exceptional events that were not properly handled by the R&S ZNA firmware.



Troubleshooting SCPI errors

A misspelled command header causes SCPI error -113, "Undefined header;..."; a misspelled parameter causes SCPI error -141, "Invalid character data;...". The GPIB explorer provides a list of all supported commands and their character data parameters; see [Chapter 6.1.3, "GPIB Explorer"](#), on page 933.

Hardware error categories

Hardware errors can be detected at various stages of the start-up or measurement procedure.

- Configuration errors occur on start-up of the analyzer, e.g. if a hardware module or configuration file cannot be detected. Configuration errors cause an entry in the error log (System > [Setup] > "Setup" > "Info" > "Error Log").
- Asynchronous errors can occur at any time while the analyzer is operating. The analyzer is checked periodically for asynchronous errors.
- Measurement errors are due to inadmissible hardware settings and states during the measurement process.

9.1.1 Asynchronous errors

Asynchronous errors can occur at any time while the analyzer is operating. The analyzer is checked periodically for asynchronous errors. Many of these errors also cause an entry in the status reporting system.

Error	Description	Remedy	Bit no.*)
Instrument temperature is too high	The analyzer detects that the instrument temperature is too high. After three warnings, the analyzer is shut down.	Reduce ambient temperature, keep ventilation holes of the casing unobstructed.	7
Receiver overload protection tripped	The analyzer detects an excessive input level at one of the ports. If this condition persists, all internal and external generators are switched off ("RF Off").	Reduce RF input level at the port. Check amplifiers in the external test setup.	3
Reference frequency lock failure	With external reference signal (System – External Reference active) or internal high precision clock, the reference oscillator is phase locked to a 10 MHz signal. The message appears when this phase locked loop (PLL) fails.	For external reference: check frequency and level of the supplied reference signal.	1
Converter clock frequency lock failure	The clock generator for the AD converter clock is phase locked to the reference oscillator. The message appears when this PLL fails.	–	–
OCXO cold	With OCXO option R&S ZNA-B4, the oven temperature is too low.	Wait until the oven has been heated up	8
Internal communication error	A severe unexpected disturbance was observed (e.g. due to ESD). The firmware resets all hardware components to ensure proper instrument functioning and restores the user settings to the state before the event. Finally, it indicates the foregone hardware reset by an information popup "Hardware communication problem detected. Hardware was reset. Measurement data of this sweep may be incorrect. Please contact Rohde & Schwarz if this problem persists."	If this error is raised repeatedly, please contact Rohde & Schwarz service.	6

*) The following bits in the "[STATus:QUEStionable:INTegrity:HARDware](#)" on page 962 register are set when the error occurs.

9.1.2 Errors during measurement

The following errors are due to inadmissible hardware settings and states during the measurement process. Some of the errors also cause an entry in the status reporting system.

Error	Description	Remedy	Bit no.*)
Unstable level control at port <i>	The analyzer detects an excessive source level at one of the ports. The signal is turned off and the sweep halted.	Check signal path for the wave a _i , especially check external components. Then press "Channel > Sweep > Sweep Control > Restart Sweep".	9
Problem concerning external generator Gen<i>	An external generator has been configured, however, it cannot be controlled or provides error messages. If several generators cause problems, the lowest number is indicated.	Check whether the generator is properly connected and switched on. Check the GPIB address; exclude address conflicts when using several external generators or other equipment.	10
Problem concerning external power meter Pmet<i>	An external power meter has been configured, however, it cannot be controlled or provides error messages. If several power meters cause problems, the lowest number is indicated.	Check whether the power meter is properly connected and switched on. Check the GPIB address; exclude address conflicts when using several external power meters or other equipment.	11
Time grid too close	The sweep points for a time sweep are too close, the analyzer cannot process the measurement data until the next sweep point starts.	Increase stop time, reduce no. of points, increase IF bandwidth. If possible reduce number of partial measurements, e.g. by restricting the number of ports measured.	12
Port <i> output power unlevelled	The level control is unsettled or unstable, possibly due to an external disturbing signal.	Change generator level at the port; check external components.	2

*) The following bits in the `STATUS:QUESTIONABLE:INTEGRITY:HARDWARE` register are set when the error occurs.

9.2 Errors during firmware installation/update

During firmware installation or update, if the installer encounters an error, the update is canceled and the analyzer firmware is rolled back to its previous state.

9.3 Collecting information for technical support

If you encounter problems that you cannot solve yourself, contact your Rohde & Schwarz support center, see [Chapter 9.4, "Contacting customer support"](#), on page 1770. Our support center staff is optimally trained to assist you in solving problems.

The support center finds solutions more quickly and efficiently if you provide them with information on the instrument and an error description.

Creating Windows event log Files

Windows records important actions of applications and the operating system in event logs. You can create event log files to summarize and save the existing event logs. You can send these files to Rohde & Schwarz if there is a problem with your device.

To create Windows event log files



1. Select the "Windows Start Button" in the bottom left corner.
2. Type in *Event Viewer* and select "Enter".
3. Select and expand "Windows Logs" in the "Console Tree".
4. Right-click on each subsection and select "Save All Events As...".

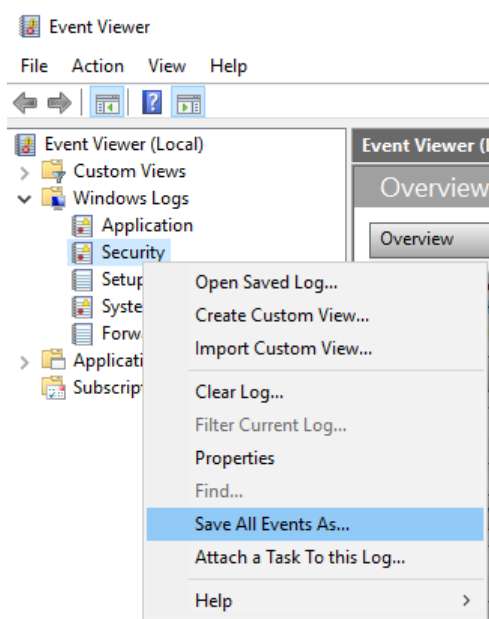

Figure 9-1: Event Viewer

5. Enter a file name and select "Save"

You can now send the Windows Event Log Files to Rohde & Schwarz.

Obtaining information from the R&S ZNA firmware

The instrument generates error messages which are usually sufficient for you to detect the cause of an error and find a remedy. Error message types are described in [Chapter 9, "Error messages and troubleshooting"](#), on page 1766.

In addition, the system **"Info" dialog** offers valuable troubleshooting information. This dialog can be opened via the "Info..." button in the System – [Setup] > "Setup" softtool tab.

For details on the available information, see [Chapter 5.19.1.3, "Info dialog"](#), on page 874.

The required troubleshooting information can also be generated in the system "Info" dialog. **"Create R&S Support Information"** collects the following information:

- Setup, option, and hardware information, error log, and selftest results.
This information can also be retrieved using the "Save..." function of the "Info" dialog.
- Current eeprom data.

- A screenshot of the VNA display.
- The latest 5 exception dumps.

The resulting *.zip file is written to the report directory

C:\Users\Public\Documents\Rohde-Schwarz\ZNA\Report. Its file name contains the current date and time, e.g. report_20200228_1658.zip.

9.4 Contacting customer support

Technical support – where and when you need it

For quick, expert help with any Rohde & Schwarz product, contact our customer support center. A team of highly qualified engineers provides support and works with you to find a solution to your query on any aspect of the operation, programming or applications of Rohde & Schwarz products.

Contact information

Contact our customer support center at www.rohde-schwarz.com/support, or follow this QR code:



Figure 9-2: QR code to the Rohde & Schwarz support page

10 Transporting

Lifting and carrying

See:

- ["Lifting and carrying the product"](#) on page 15
- [Chapter 3.1.1, "Lifting and carrying"](#), on page 24.

Packing

Use the original packaging material. It consists of antistatic wrap for electrostatic protection and packing material designed for the product.

If you do not have the original packaging, use similar materials that provide the same level of protection.

Securing

When moving the product in a vehicle or using transporting equipment, make sure that the product is properly secured. Only use items intended for securing objects.

Transport altitude

Unless otherwise specified in the data sheet, the maximum transport altitude without pressure compensation is 4500 m above sea level.

11 Maintenance, storage and disposal

The product does not require regular maintenance. It only requires occasional cleaning. It is however advisable to check the nominal data from time to time.

11.1 Replacing fuses (R&S ZNA67EXT only)

The frequency converter is protected by a fuse of type IEC60127 T1 L/H, see "[Fuse holder](#)" on page 87.

The diplexer is protected by a fuse of type IEC127-F250L, see "[Fuse panel](#)" on page 92.

To replace a fuse, open the fuse holder by slightly turning the lid counter-clockwise, preferably using a small coin. Replacement fuses are provided with the instrument.

11.2 Recalibration and repair

For accurate measurements, the product must be recalibrated by Rohde & Schwarz service after the calibration interval in the data sheet has elapsed.

R&S ZNA67EXT

Calibration involves all components of the test system, including the R&S ZNA67 network analyzer and all external test sets.



The R&S ZNA67EXT has to be considered a system. For recalibration and repair, all shipped components and cables must be sent to the Rohde & Schwarz service. See [Table 3-7](#).

- Observe the label on the rear panel of the R&S ZNA67, to ensure you include the correct test sets in your shipment. See "[System component information](#)" on page 93.
- Also include additional cable sets ordered with the system. See "[Cable sets \(optional\)](#)" on page 98.

11.3 Cleaning

How to clean the product is described in "[Cleaning the product](#)" on page 17.

Do not use any liquids for cleaning. Cleaning agents, solvents, acids and bases can damage the front panel labeling, plastic parts and display.

11.4 Storage

Protect the product against dust. Ensure that the environmental conditions, e.g. temperature range and climatic load, meet the values specified in the data sheet.

R&S ZNA67EXT

The R&S ZNA67EXT network analyzer unit and the external test sets can be stored in the temperature range quoted in the data sheet. When stored for a longer period of time, the devices must be protected against dust.

Transport and store the external test sets in their original boxes. The 1 mm test port of the diplexer must be protected by its cap; see also [Table 3-7](#).

11.5 Disposal

Rohde & Schwarz is committed to making careful, ecologically sound use of natural resources and minimizing the environmental footprint of our products. Help us by disposing of waste in a way that causes minimum environmental impact.

Disposing electrical and electronic equipment

A product that is labeled as follows cannot be disposed of in normal household waste after it has come to the end of its service life. Even disposal via the municipal collection points for waste electrical and electronic equipment is not permitted.



Figure 11-1: Labeling in line with EU directive WEEE

Rohde & Schwarz has developed a disposal concept for the eco-friendly disposal or recycling of waste material. As a manufacturer, Rohde & Schwarz completely fulfills its obligation to take back and dispose of electrical and electronic waste. Contact your local service representative to dispose of the product.

12 Annexes

The following sections cover mostly hardware and service-related topics.

12.1 Administrative tasks

This chapter describes some topics that are only needed occasionally, or if a special instrument configuration is required.

12.1.1 Firmware installation

Upgrade versions of the analyzer firmware are supplied as single executable setup files (*.exe).



Admin account

You need administrator rights to install a new firmware. See note on "[User accounts and password protection](#)" on page 30 for details.

To perform a firmware update:

1. Copy the setup file to any storage medium accessible from the analyzer. This can be either the internal mass storage drive, an external storage medium (USB memory stick, external CD-ROM drive) or a network connection (LAN).
The default name of the internal drive is C : . External storage devices are automatically mapped to the next free drive, i.e. D : , E : etc.
2. Run the setup file from the Windows® Explorer. Follow the instructions of the setup wizard.
Setup files can be reinstalled.



Factory calibration

A firmware update does not affect the factory calibration.

However, for a R&S ZNA that was factory calibrated with a firmware version < 2.0, an upgrade to a firmware version ≥ 2.0 makes the factory calibration slightly less accurate. A changed signal path in firmware versions ≥ 2.0 can result in an offset of approximately 0.3 dB for uncalibrated wave measurements. Calibrated measurements are not affected. The offset can be eliminated by a new factory calibration at Rohde&Schwarz service.



Downgrade to a firmware version < 1.90

Instruments shipped with a REFBOARD version > 001_000_000 cannot be downgraded to a firmware version < 1.90 simply by executing the related firmware setup file. Please contact R&S service if you plan such a downgrade.

See the [hardware info](#) for the REFBOARD version of your instrument.

12.1.2 Remote operation in a LAN

A LAN connection is used to integrate the analyzer into a home/company network. LAN connectivity offers several applications, e.g.:

- Transfer data between a controller and the analyzer, e.g. to run a remote control program.
- Control the measurement from a remote computer using Remote Desktop or a similar application.
- Use external network devices (e.g. printers).

The analyzer uses a user name and password as credentials for remote access; see note on "[User accounts and password protection](#)" on page 30 for details. To protect the analyzer from unauthorized access, it is recommended to change the factory setting.

12.1.2.1 Assigning an IP address

Depending on the network capacities, the TCP/IP address information for the analyzer can be obtained in different ways.

- If the network supports dynamic TCP/IP configuration using the Dynamic Host Configuration Protocol (DHCP), all address information can be assigned automatically.
- If the network does not support DHCP, or if the analyzer is set to use alternate TCP/IP configuration, the addresses must be set manually.

By default, the analyzer is configured to use dynamic TCP/IP configuration and obtain all address information automatically. Hence it is safe to establish a physical connection to the LAN without any previous analyzer configuration.

NOTICE

Manual TCP/IP configuration

If your network does not support DHCP, or if you choose to disable dynamic TCP/IP configuration, you must assign valid address information **before** you connect the analyzer to the LAN. Contact your network administrator to obtain a valid IP address, because connection errors can affect the entire network.



Admin account

You need administrator rights to change the TCP/IP configuration. See note on "[User accounts and password protection](#)" on page 30 for details.

To enter the TCP/IP address information manually

1. Obtain the IP address and subnet mask for the analyzer and the IP address for the local default gateway from your network administrator. If necessary, also obtain the name of your DNS domain and the IP addresses of the DNS and WINS servers on your network.
2. Use the Windows icon in the toolbar (or the Windows key on an external keyboard) to access Windows®.
3. Open the "Control Panel" > "Network and Sharing Center" > "Change adapter settings" dialog and right-click the local connection.
4. Select "Properties" and confirm the user account control message, depending on your current user account.
 - If your current account is an administrator account, select "Yes".
 - If your account is an account with standard user rights, enter the password of the administrator account and select "Yes".

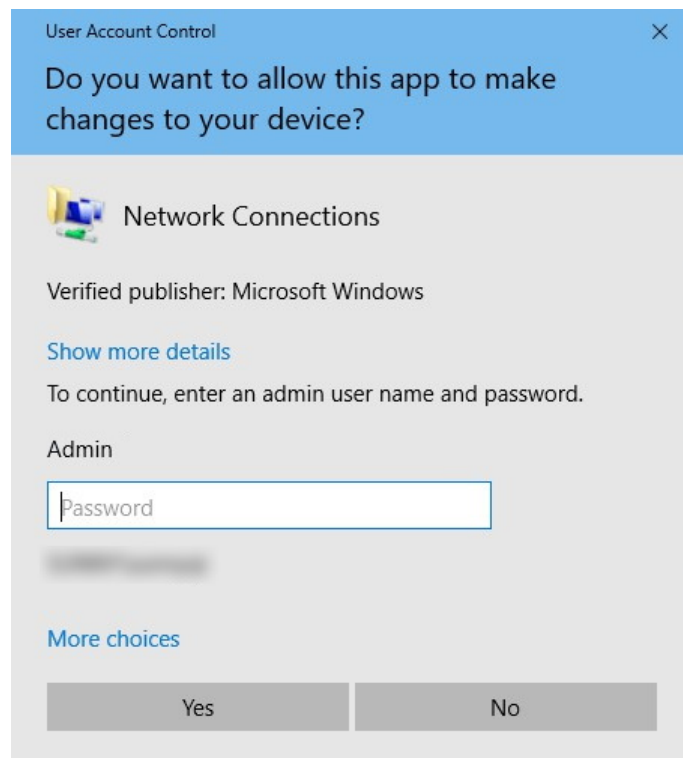
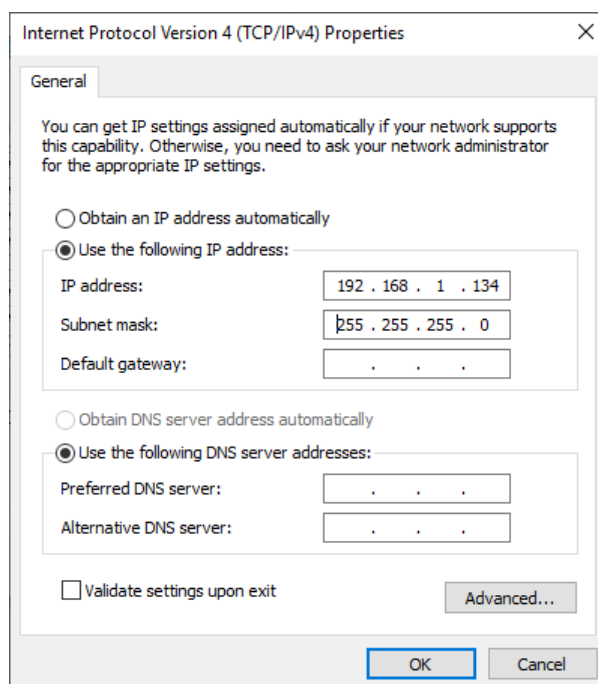

Figure 12-1: User Account Control dialog

5. In the "Connection Properties" dialog opened, select "Internet Protocol Version 4 (TCP/IPv4) > Properties" and enter the IP address information.



12.1.2.2 Using computer names

In a LAN that uses a DNS server (Domain Name System server), each PC or instrument connected in the LAN can be accessed via an unambiguous computer name instead of the IP address. The DNS server translates the host name to the IP address, which is especially useful when a DHCP server is used, as a new IP address can be assigned each time the instrument is restarted.

Each instrument is delivered with an assigned computer name, but this name can be changed. The default instrument name is a case-insensitive string with the following syntax:

ZNA<26|43|67>-<serial_number>

The serial number can be found on the rear panel of the instrument. It is the third part of the device ID printed on the bar code sticker:



ZNA43-102030, for example

12.1.2.3 Remote Desktop connection

Remote Desktop is a Windows® application which you can use to access and control the analyzer from a remote computer through a LAN connection. While the measure-

ment is running, the analyzer screen contents are displayed on the remote computer, and Remote Desktop provides access to all applications, files, and network resources of the analyzer.



At the R&S ZNA, by default remote connections are enabled using a local group policy and remote access is granted to users instrument and administrator.

For detailed information about Remote Desktop and the connection, refer to the Windows® Help ("Windows Start Menu > Help and Support").

To establish a remote desktop connection, proceed as follows:

1. Connect remote Windows PC and VNA to the LAN and make sure that an IP connection can be established.
2. At the remote Windows PC, open a remote desktop connection (type *Remote Desktop Connection* at the Windows Start/Search menu and hit enter).
3. In the "Remote Desktop Connection" dialog, enter the VNA's computer name or IP address and select "Connect"

12.1.2.4 Windows® firewall settings

A firewall protects an instrument by preventing unauthorized users from gaining access to it through a network. In the default configuration of the R&S ZNA, the firewall is enabled. A remote desktop connection does not require any changes in the firewall settings.



Admin account

You need administrator rights to change the firewall settings. See note on "[User accounts and password protection](#)" on page 30 above for details.

Some actions require a different firewall configuration, e.g.:

- To transfer data with other hosts in the LAN, you have to allow "File and Printer Sharing".

To change the firewall settings, proceed as follows:

1. Access the operating system by pressing the Windows® key on the external keyboard. Open the "Control Panel".
2. Select "Windows Defender Firewall"
 - Select "Allow an app or feature through Windows Defender Firewall" to enable "File and Printer Sharing".
 - Select "Turn Windows Firewall on or off" to enable or disable the firewall.

Confirm the user account control message to allow the desired changes (see [Figure 12-1](#)). For detailed information about the firewall, refer to the Windows® Help.

12.2 System recovery

The system drive of the R&S ZNA is delivered with a recovery partition that allows you to restore the original operating system image and firmware.

To access the recovery functionality, open the Windows control panel, select "Update & Security" > "Recovery" > "Restart Now" and wait for the "R&S Recovery Environment" to start.



You can also use the [Recovery tab](#) of the "System Config" dialog to boot into the recovery environment.

To restore the original operating system image and firmware, proceed as follows:

1. In the "R&S Recovery Environment" select "Factory Default Restore"
2. Wait for the reimaging process to complete
3. Reboot the instrument

After the restore, upgrade to the desired firmware version (see [Chapter 12.1.1, "Firmware installation"](#), on page 1774).

12.3 Interfaces and connectors

This chapter provides a detailed description of the rear panel connectors of the R&S ZNA. An overview of the available front and rear panel is given in the Getting Started guide (see [Chapter 3.2, "Instrument tour"](#), on page 34).



EMI Suppression

Notice the instructions in ["Cable selection and electromagnetic interference \(EMI\)"](#) on page 27.

12.3.1 Rear panel connectors

The rear panel of the R&S ZNA provides various connectors for external devices and control signals.

12.3.1.1 User Port

25-pole D-Sub connector used as an input and output for low-voltage (3.3 V) TTL control signals. Some of the lines can be configured (see [CONTrol commands](#) and [OUT-Put commands](#)).



Table 12-1: VNA User Port: Pole Assignment

Pin No.	Name	Input (I) or Output (O)	Function
1	AGND	-	Ground
2	UC_EXT_TRG_IN	I	External trigger 1 input, 5 V tolerant *)
3	AGND	-	Ground
4	UC_BUSY	O	Hardware measurement time
5	AGND	-	Ground
6	READY FOR TRIGGER	O	Measurement completed, ready for new trigger (not available for pulsed measurements)
7	AGND	-	Ground
8	UC_CH_BIT0	O	Channel bit 0; see CONTROL:AUXiliary:C[:DATA] and OUTPut<Ch>:UPORT[:VALue]
9	UC_CH_BIT1	O	Channel bit 1
10	UC_CH_BIT2	O	Channel bit 2
11	UC_CH_BIT3	O	Channel bit 3
12	AGND	-	Ground
13	UC_PASS1	O	Pass/fail result of limit check 1; TTL Out Pass 1 (see TTL1 Pass / TTL2 Pass)
14	UC_PASS2	O	Pass/fail result of limit check 2; TTL Out Pass 2
15	AGND	-	Ground
16	UC_DRV_PORT1	O	Used as drive ports (OUTPut:UPORT:ECBits OFF) or channel bits (OUTPut:UPORT:ECBits ON ; default) If used as drive ports, DRIVE PORT <i>i</i> is active while test port <i>i</i> is the source port. If used as channel bits, the pin states can be defined using OUTPut<Ch>:UPORT[:VALue] .
17	UC_DRV_PORT2	O	
18	UC_DRV_PORT3	O	
19	UC_DRV_PORT4	O	
20	AGND	-	Ground
21	UC_EXT_GEN_TRG	O	Control signal for external generator
22	UC_EXT_GEN_BLANK	I	Handshake signal from external generator
23	AGND	-	Ground
24	UC_FOSW	I	Control input A, 5 V tolerant
25	UC_TRG2	I	External trigger 2 input, 5 V tolerant

*) Feeding in the external trigger signal via the BNC connector Trigger In is equivalent. The minimum pulse width of the trigger signals is 1 μ s.



EMI Suppression

Use only double shielded cables or disconnect the input pins of the User Port connector to avoid spurious input signals which may cause undesirable events.

This is of particular importance for the external trigger input (pin no. 2) if the Trigger In input is used.

12.3.1.2 Trigger In

BNC female connector for external trigger input; see "[FreeRun / External / Manual / Multiple Triggers](#)" on page 560. The external trigger input signal must be a 3.3 V or 5 V TTL signal with a minimum pulse width of 1 μ s. The trigger input has a high input impedance (> 10 k Ω).

12.3.1.3 Trigger Out

BNC female connectors for external trigger output; see "[Output trigger](#)" on page 559. The R&S ZNA trigger output provides a configurable 5 V TTL trigger signal. The output impedance is approximately 50 Ohm.

12.3.2 LAN interface

To be integrated in a LAN, the instrument is equipped with a LAN interface, consisting of an RJ-45 connector, a network interface card and protocols. The network interface card supports IEEE 802.3 for a 10 Mbps Ethernet and IEEE 802.3u for a 100 Mbps Ethernet.

Instrument access is possible via the VXI-11 protocol. It is usually achieved from high level programming platforms by using the Virtual Instrument Software Architecture (VISA) library as an intermediate abstraction layer. VISA encapsulates the low-level function calls and thus makes the transport interface transparent for the user. See also [Chapter 6.1, "Introduction to remote control"](#), on page 931.

12.3.2.1 VXI-11 interface messages

The following VXI-11 interface messages (also termed low-level control messages) are also supported by the GPIB Explorer.

Command	Meaning	Effect on the instrument
@DCL	Device Clear	Aborts the processing of the commands just received and sets the command processing software to a defined initial state. Does not change the instrument settings.
@GET	Group Execute Trigger	Triggers the active measurement sequence (e.g. a sweep). The effect of the command is the same as with that of a pulse at the external trigger signal input.

Command	Meaning	Effect on the instrument
@LOC	Go to Local	Transition to the "local" state (manual control).
@REM	Go to Remote	Transition to the "remote" state (remote control).

12.3.3 GPIB interface

The R&S ZNA is equipped with a GPIB (IEC/IEEE) bus interface. The interface connector is located on the rear panel of the instrument. The GPIB bus interface is intended for remote control of the R&S ZNA from a controller.

Characteristics of the interface

- 8-bit parallel data transfer
- Bidirectional data transfer
- Three-line handshake
- High data transfer rate of max. 1 MByte/s
- Up to 15 devices can be connected
- Wired OR if several instruments are connected in parallel

Pin assignment

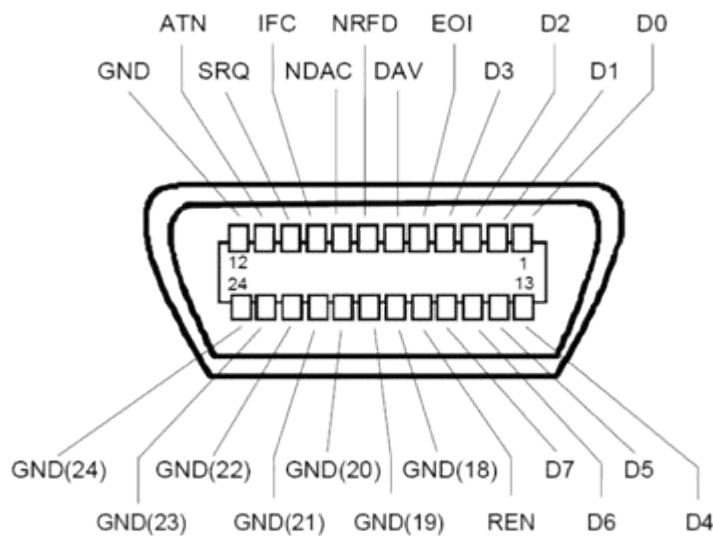

Bus lines

- Data bus with 8 lines D0 to D7:
The transmission is bit-parallel and byte-serial in the ASCII/ISO code. D0 is the least significant bit, D7 the most significant bit.
- Control bus with five lines:

IFC (Interface Clear): active LOW resets the interfaces of the instruments connected to the default setting.

ATN (Attention): active LOW signals the transmission of interface messages, inactive HIGH signals the transmission of device messages.

SRQ (Service Request): active LOW enables the connected device to send a service request to the controller.

REN (Remote Enable): active LOW permits switchover to remote control.

EOI (End or Identify): has two functions in connection with ATN:

- ATN=HIGH active LOW marks the end of data transmission.
- ATN=LOW active LOW triggers a parallel poll.

- Handshake bus with three lines:

DAV (Data Valid): active LOW signals a valid data byte on the data bus.

NRFD (Not Ready For Data): active LOW signals that one of the connected devices is not ready for data transfer.

NDAC (Not Data Accepted): active LOW signals that the instrument connected is accepting the data on the data bus.

The R&S ZNA provides several functions to communicate via GPIB bus. They are described in the following sections.

12.3.3.1 Interface functions

Instruments which can be controlled via GPIB bus can be equipped with different interface functions. The interface functions for the R&S ZNA are listed in the following table.

Control character	Interface function
SH1	Handshake source function (source handshake), full capability
AH1	Handshake sink function (acceptor handshake), full capability
L4	Listener function, full capability, de-addressed by MTA.
T6	Talker function, full capability, ability to respond to serial poll, deaddressed by MLA
SR1	Service request function (Service Request), full capability
PP1	Parallel poll function, full capability
RL1	Remote/Local switch over function, full capability
DC1	Reset function (Device Clear), full capability
DT1	Trigger function (Device Trigger), full capability

12.3.3.2 Interface messages

Interface messages are transmitted to the instrument on the data lines, with the attention line being active (LOW). They serve to communicate between controller and instrument.

Universal commands

Universal commands are encoded in the range 10 through 1F hex. They are effective for all instruments connected to the bus without previous addressing.

Command	QuickBASIC command	Effect on the instrument
DCL (Device Clear)	IBCMD (controller %, CHR\$(20))	Aborts the processing of the commands just received and sets the command processing software to a defined initial state. Does not change the instrument settings.
IFC (Interface Clear)	IBSIC (controller%)	Resets the interfaces to the default setting.
LLO (Local Lockout)	IBCMD (controller %, CHR\$(17))	The LOC/IEC ADDR key is disabled.
SPE (Serial Poll Enable)	IBCMD (controller %, CHR\$(24))	Ready for serial poll
SPD (Serial Poll Disable)	IBCMD (controller %, CHR\$(25))	End of serial poll
PPU (Parallel Poll Unconfigure)	IBCMD (controller %, CHR\$(21))	End of the parallel-poll state

Addressed commands

Addressed commands are encoded in the range 00 through 0F hex. They are only effective for instruments addressed as listeners.

Command	QuickBASIC command	Effect on the instrument
GET (Group Execute Trigger)	IBTRG (device%)	Triggers a previously active device function (e.g. a sweep). The effect of the command is the same as with that of a pulse at the external trigger signal input.
GTL (Go to Local)	IBLOC (device%)	Transition to the "Local" state (manual control)
PPC (Parallel Poll Configure)	IBPPC (device%, data%)	Configures the instrument for parallel poll. Additionally, the QuickBASIC command executes PPE/PPD.
SDC (Selected Device Clear)	IBCLR (device%)	Aborts the processing of the commands just received and sets the command processing software to a defined initial state. Does not change the instrument setting.

12.3.3.3 Instrument messages

Instrument messages (commands) are transferred on the data lines of the GPIB bus while the ATN line is not active. ASCII code is used.

Structure and syntax of the instrument messages are described in [Chapter 7, "Command reference"](#), on page 968. The chapter also provides a detailed description of all messages implemented by the analyzer.

12.3.4 RFFE - GPIO interface

For the R&S ZNA, an optional [RFFE GPIO interface](#) board is available.

12.3.4.1 Pin assignment

This extension board is equipped with a standard 25-pin female D-sub connector providing 2 independent RF Front-End (RFFE) interfaces according to the MIPI® Alliance "System Power Management Interface Specification" and 10 General Purpose Input/Output (GPIO) ports.

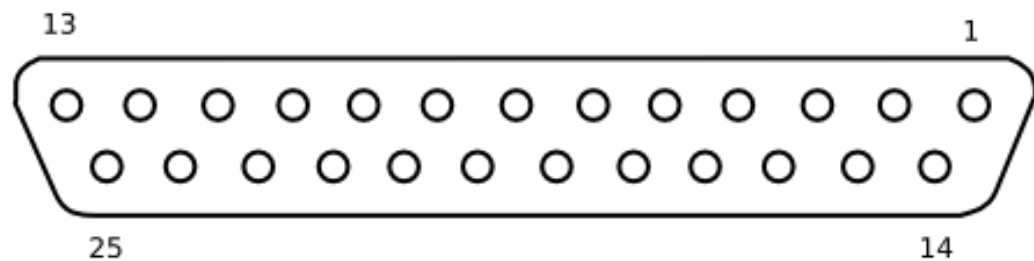

Figure 12-2: D-sub 25-pin female connector, front view

Table 12-2: PIN mapping RFFE - GPIO extension board connector

PIN number	Comment
1,3,5,11,22	Ground
2	RFFE1_VIO
4	RFFE2_VIO
6	GPIO 2
7	GPIO 4
8	GPIO 6
9	GPIO 8
10	GPIO 9
12	For future use, please do not connect
13	For future use, please do not connect
14	RFFE1_CLK
15	RFFE1_DATA
16	RFFE2_CLK
17	RFFE2_DATA
18	GPIO 1

PIN number	Comment
19	GPIO 3
20	GPIO 5
21	GPIO 7
23	GPIO 10
24	For future use, please do not connect
25	For future use, please do not connect

12.3.4.2 Interface description

The values in the table below are typical values. See the R&S ZNA data sheet for details.

Table 12-3: RFFE bus interface

Parameter	MIN [V]	MAX [V]	Step size [V]
IO voltage	0	2.5	0.001
Low voltage	0	2.5	0.001
High voltage	0	2.5	0.001
		MAX [mA]	
Current		20	
	MIN [kHz]	MAX [kHz]	Possible values [kHz]
Clock frequency	31.25	26000	52000/n with n=1664, ..., 2

All remaining data (e.g. rise time) are according to the specification v.1.00 of the MIPI Alliance Group.

Table 12-4: GPIO Interface

Parameter	MIN [V]	MAX [V]	Step size [V]
	-7	+15	0.005
		MAX [mA]	
Current GPIO 1,...,8		20	
Current GPIO 9,10		100	

The output voltages of the RFFE and GPIO signals do not have an offset to compensate additional losses into account. Please adjust the voltage level directly on your board or at the pins of the connected device.

Table 12-5: Voltage/Current Measurement (Variant 03 only)

	Range	Resolution
Voltage		
RFFE 1 and 2 (VIO/DATA/CLK)	0 V to +3 V	100 μ V
GPIO 1 to 10	-5 V to +10 V	100 μ V
Current*		
RFFE 1 and 2 (VIO/DATA/CLK), GPIO 1 to 8		
10 Ω source resistance (shunt)	-20 mA to +20 mA	10 μ A
100 Ω source resistance (shunt)	-2 mA to +2 mA	1 μ A
1 k Ω source resistance (shunt)	-200 μ A to +200 μ A	100 nA
10 k Ω source resistance (shunt)	-20 μ A to +20 μ A	10 nA
100 k Ω source resistance (shunt)	-2 μ A to +2 μ A	1 nA
GPIO 9 and 10		
	-100 mA to +100 mA	10 μ A
* the current values are valid if the GPIO voltages are within -5 V to +9 V		

12.4 Showroom mode

In "Showroom Mode" the R&S ZNA uses a configurable recall set whenever the device is (re-)started or the [Preset] key is pressed. However, it can only be enabled by directly editing the Windows registry.

1. Run the R&S ZNA and configure it as required for the intended showroom operation.
2. Save the configuration as described in [Chapter 5.15.1, "Recall sets tab"](#), on page 772. If necessary, move the recall set file (*.znxml | *.znx) to the appropriate location.
3. Under the registry key
HKEY_LOCAL_MACHINE/SOFTWARE/Rohde-Schwarz/ZNA, create a new subkey ShowroomMode.
4. Within the ShowroomMode-subkey, create the string value ShowroomSetup.

- Modify the value `ShowroomSetup`: set its value data to the full path of the recall set. Use forward slashes as path separators, e.g. "C:/Documents and Settings/All Users/Rohde-Schwarz/ZNA/RecallSets/ShowroomSet1.znxml".

After the analyzer is restarted or "Preset", the specified recall set is loaded.

12.5 ENA emulation commands

The following table lists the commands implemented/overwritten for the ENA remote language.

ENA Emulation Command	R&S ZNA Default Parser Command
<code>CALCulate<Ch>:FSIMulator:SENDEd:DEEMbed:PORT<Pt>[:TYPE] {USER NONE}</code>	<code>CALCulate<Ch>:TRANSform:VNETworks:SENDEd:DEEMbedding<PhyPt>:TNDefinition</code>
<code>CALCulate<Ch>:FSIMulator:SENDEd:DEEMbed:PORT<Pt>:USER:FILEname<string></code>	<code>CALCulate<Ch>:TRANSform:VNETworks:SENDEd:DEEMbedding<PhyPt>:PARAMeters:DATA</code>
<code>CALCulate<Ch>:FSIMulator:SENDEd:DEEMbed:STATe {ON OFF 1 0}</code>	n.a. (enabled channel-by-channel, port-by-port)
<code>CALCulate{1..4}:FSIMulator:SENDEd:PMCircuit:STAT {ON OFF 1 0}</code>	<code>CALCulate<Ch>:TRANSform:VNETworks:SENDEd:EMBedding<PhyPt>[:STATe]</code>
<code>CALCulate{1..4}:FSIMulator:SENDEd:PMCircuit:PORT<Pt>[:TYPE] {NONE PCSC PCSL PLPC PLSC PLSL SCPC SCPL SLPC SLPL USER}</code>	<code>CALCulate<Ch>:TRANSform:VNETworks:SENDEd:EMBedding<PhyPt>:TNDefinition</code>
<code>CALCulate{1..4}:FSIMulator:SENDEd:PMCircuit:PORT<i>:PARAMeter:C<numeric></code>	<code>CALCulate<Ch>:TRANSform:VNETworks:SENDEd:EMBedding<PhyPt>:PARAMeters:C<Cmp></code>
<code>CALCulate{1..4}:FSIMulator:SENDEd:PMCircuit:PORT<i>:PARAMeter:G<numeric></code>	<code>CALCulate<Ch>:TRANSform:VNETworks:SENDEd:EMBedding<PhyPt>:PARAMeters:G<Cmp></code>
<code>CALCulate{1..4}:FSIMulator:SENDEd:PMCircuit:PORT<i>:PARAMeter:L<numeric></code>	<code>CALCulate<Ch>:TRANSform:VNETworks:SENDEd:EMBedding<PhyPt>:PARAMeters:L<Cmp></code>
<code>CALCulate{1..4}:FSIMulator:SENDEd:PMCircuit:PORT<i>:PARAMeter:R<numeric></code>	<code>CALCulate<Ch>:TRANSform:VNETworks:SENDEd:EMBedding<PhyPt>:PARAMeters:R<Cmp></code>
<code>CALCulate{1..4}:FSIMulator:SENDEd:ZCONversion:STATe {ON OFF 1 0}</code>	<code>[SENSe<Ch>:]LPORt<LogPt>:ZDEFault[:STATe]</code>
<code>CALCulate{1..4}:FSIMulator:SENDEd:ZCONversion:PORT<i>:Z0[:R] <numeric></code>	<code>[SENSe<Ch>:]PORt<PhyPt>:ZREFerence</code>
<code>CALCulate<Ch>:FSIMulator:STATe {ON OFF 1 0}</code>	n.a. (enabled channel-by-channel, port-by-port)

ENA Emulation Command	R&S ZNA Default Parser Command
CALCulate{1...4}[:SElected]:DATA: FDATA?	CALCulate<Chn>:DATA
CALCulate{1...4}[:SElected]:DATA: SDATA?	
CALCulate{1...4}[:SElected]:DATA: FMEMory?	
CALCulate<Ch>[:SElected]FORMat	CALCulate<Chn>:FORMat
CALCulate{1..4}[:SElected]:FUNctIon: TYPE {PTPeak STDEV MEAN MAXimum MINimum}	CALCulate<Chn>:STATistics:RESult?
CALCulate{1..4}[:SElected]:FUNctIon: DOMain[:STATe] {ON OFF 1 0}	CALCulate<Chn>:STATistics:DOMain:USER
CALCulate{1..4}[:SElected]:FUNctIon: DOMain:START <value>	CALCulate<Chn>:STATistics:DOMain:USER: START
CALCulate{1..4}[:SElected]:FUNctIon: DOMain:STOP <value>	CALCulate<Chn>:STATistics:DOMain:USER: STOP
CALCulate{1..4}[:SElected]:FUNctIon: DATA?	CALCulate<Chn>:STATistics:RESult?
CALCulate{1..4}[:SElected]:FUNctIon: EXECute	None (no action)
CALCulate{1...4}[:SElected]:LIMit[: STATe] {ON OFF 1 0}	CALCulate<Chn>:LIMit:STATe
CALCulate{1...4}[:SElected]:LIMit: DISPlay[:STATe] {ON OFF 1 0}	CALCulate<Chn>:LIMit:DISPlay[:STATe]
CALCulate{1...4}[:SElected]:LIMit: FAIL?	CALCulate<Chn>:LIMit:FAIL?
CALCulate<Ch>[:SElected]:LIMit<Tr>: DATA	CALCulate<Chn>:LIMit:DATA
CALCulate{1...4}[:SElected]: MARKer{1...10}:COUPle {ON OFF 1 0}	CALCulate:MARKer:COUPled[:STATe]
CALCulate{1...4}[:SElected]: MARKer{1...10}:FUNctIon:TYPE {MAXimum MINimum PEAK LPEak RPEak TARGet LTARget RTARget}	CALCulate<Chn>:MARKer<Mk>:FUNctIon[: SElect]
CALCulate{1...4}[:SElected]: MARKer{1...10}:DISCrete {ON OFF 1 0}	CALCulate<Chn>:MARKer<Mk>:MODE
CALCulate{1...4}[:SElected]: MARKer{1...10}:REFerence[:STATe] {ON OFF 1 0}	CALCulate<Chn>:MARKer<Mk>:REFerence[: STATe]
CALCulate{1...4}[:SElected]: MARKer{1...10}:FUNctIon:EXECute	CALCulate<Chn>:MARKer<Mk>:SEARch[: IMMediate]

ENA emulation commands

ENA Emulation Command	R&S ZNA Default Parser Command
CALCulate{1...4}[:SElected]: MARKer{1...10}[:STATe] {ON OFF 1 0}	CALCulate<Chn>:MARKer<Mk>[:STATe]
CALCulate{1...4}[:SElected]: MARKer{1...10}:X <numeric>	CALCulate<Chn>:MARKer<Mk>:X
CALCulate{1...4}[:SElected]: MARKer{1...10}:Y?	CALCulate<Chn>:MARKer<Mk>:Y
CALCulate{1...4}[:SElected]:MATH: FUNction {NORMal ADD SUBtract MULTIply DIVide}	CALCulate<Chn>:MATH:FUNction
CALCulate{1...4}[:SElected]:MATH: MEMorize	CALCulate<Chn>:MATH:MEMorize
CALCulate{1...4}:PARAMeter:COUNT <numeric>	
CALCulate{1...4}:PARAMeter{1...7}: DEFine {S11 S21 S31 S41 S12 S22 S32 S42 S13 S23 S33 S43 S14 S24 S34 S44}	CALCulate<Ch>:PARAMeter:DEFine
CALCulate{1...4}:PARAMeter{1...7}: SElect [<string>]	CALCulate<Ch>:PARAMeter:SElect
CALCulate{1...4}[:SElected]:SMOothing: APERture <numeric>	CALCulate<Chn>:SMOothing:APERture
CALCulate{1...4}[:SElected]: SMOothing[:STATe] {ON OFF 1 0}	CALCulate<Chn>:SMOothing[:STATe]
DISPlay:ANNotation:FREQuency[:STATe] {ON OFF 1 0}	DISPlay:ANNotation:FREQuency[:STATe]
DISPlay:ANNotation:MESSage:STATe {ON OFF 1 0}	SYSTem:ERRor:DISPlay:STATe
DISPlay:ARRange {TILE CASCade OVERlay STACK SPLit QUAD}	DISPlay:LAYout
DISPlay:CClear	*CLS is th closest, but this will also clear the error queue.
DISPlay:ENABle {ON OFF 1 0}	SYSTem:DISPlay:UPDate
DISPlay:SPLit	DISPlay:LAYout:EXECute
DISPlay:UPDate[:IMMediate]	SYSTem:DISPlay:UPDate
DISPlay:VISible {ON OFF 1 0}	SYSTem:DISPlay:UPDate
DISPlay:WINDow{1...4}:ACTivate <numeric_value>	INSTrument:NSElect
DISPlay:WINDow{1...4}:MAXimize {ON OFF 1 0}	DISPlay[:WINDow<Wnd>]:MAXimize
DISPlay:WINDow:SPLit	
DISPlay:WINDow{1...4}:TITLE:DATA <string>	DISPlay[:WINDow<Wnd>]:TITLE:DATA

ENA emulation commands

ENA Emulation Command	R&S ZNA Default Parser Command
DISPlay:WINDow{1...4}:TITLe[:STATe] {ON OFF 1 0}	DISPlay[:WINDow<Wnd>]:TITLe[:STATe]
DISPlay:WINDow<Ch>:TRACe<Tr>:MEMory[: STATe] {ON OFF 1 0}	TRACe:COPIY
DISPlay:WINDow{1...4}:TRACe{1...7}:Y[: SCALe]:AUTO	DISPlay[:WINDow<Wnd>]:TRACe<WndTr>:Y[: SCALe]:AUTO
DISPlay:WINDow{1...4}:Y[:SCALe]: DIVisions <numeric>	DISPlay[:WINDow<Wnd>]:TRACe<WndTr>:Y[: SCALe]:PDIVision
DISPlay:WINDow{1...4}:Y[:SCALe]:RLEVel <numeric>	DISPlay[:WINDow<Wnd>]:TRACe<WndTr>:Y[: SCALe]:RLEVel
DISPlay:WINDow{1...4}:TRACe{1...7}:Y[: SCALe]:RPOStion <numeric>	DISPlay[:WINDow<Wnd>]:TRACe<WndTr>:Y[: SCALe]:RPOStion
FORMat:BORDer {NORMal SWAPped}	FORMat:BORDer
FORMat:DATA {ASCIi REAL}	FORMat[:DATA]
INITiate{1...4}:CONTInuous {ON OFF 1 0}	INITiate<Ch>:CONTInuous
INITiate{1...4}[:IMMEdiate]	INITiate<Ch>[:IMMEdiate][:DUMMy]
MMEMory:CATalog? <string>	MMEMory:CATalog?
MMEMory:COPIY <string 1> <string 2>	MMEMory:COPIY
MMEMory:DELeTe <string>	MMEMory:DELeTe
MMEMory:LOAD:LIMit <string>	MMEMory:LOAD:LIMit
MMEMory:LOAD:SEGment <string>	MMEMory:LOAD:SEGment
MMEMory:LOAD[:STATe] <string>	MMEMory:LOAD:STATe
MMEMory:MDIRectory <string>	MMEMory:MDIRectory
MMEMory:STORE[:STATe] <string>	MMEMory:STORE:STATe
MMEMory:STORE:FDATA <string>	MMEMory:STORE:TRACe
MMEMory:STORE:LIMit <string>	MMEMory:STORE:LIMit
MMEMory:STORE:SEGment <string>	MMEMory:STORE:SEGment
MMEMory:STORE:SNP:DATA <filename>	MMEMory:STORE:TRACe:PORTs
MMEMory:STORE:SNP:TYPE:S1P <numeric>	MMEMory:STORE:TRACe:PORTs
MMEMory:STORE:SNP:TYPE:S2P <numeric1>, <numeric2>	MMEMory:STORE:TRACe:PORTs
MMEMory:STORE:SNP:TYPE:S3P <numeric1>, <numeric2>, <numeric3>	MMEMory:STORE:TRACe:PORTs
MMEMory:STORE:SNP:TYPE:S4P <numeric3>, <numeric2>, <numeric3>, <numeric4>	MMEMory:STORE:TRACe:PORTs

ENA emulation commands

ENA Emulation Command	R&S ZNA Default Parser Command
MMEMory:STORe:STYPe {STATE CSTate DSTate CDSTate}	MMEMory:STORe:STATe Always saves measurement conditions and calibration state (CSTate), regardless of what you set it to.
SENSe{1...4}:AVERAge:CLEAr	[SENSe<Ch>:]AVERAge:CLEAr
SENSe{1...4}:AVERAge:COUnT <numeric>	[SENSe<Ch>:]AVERAge:COUnT
SENSe{1...4}:AVERAge[:STATe] {ON OFF 1 0}	[SENSe<Ch>:]AVERAge[:STATe]
SENSe{1...4}:BWiDth[:RESolution] <bandwidth>	[SENSe<Ch>:]BWiDth[:RESolution]
SENSe{1...4}:CORRection:COLLect[:ACQuire]:LOAD <numeric> SENSe{1...4}:CORRection:COLLect[:ACQuire]:OPEN <numeric> SENSe{1...4}:CORRection:COLLect[:ACQuire]:SHORt <numeric> SENSe{1...4}:CORRection:COLLect[:ACQuire]:ISOLation <numeric1>, <numeric2> SENSe{1...4}:CORRection:COLLect[:ACQuire]:THRU <numeric1>, <numeric2>	[SENSe<Ch>:]CORRection:COLLect[:ACQuire]:SELected
SENSe{1...4}:CORRection:COLLect:CKIT[:SELect] <integer>	[SENSe:]CORRection:CKIT:SELect
SENSe{1...4}:CORRection:COLLect:ECAL:ISOLation[:STATe] {OFF 0}	None (no action)
SENSe{1...4}:CORRection:COLLect:ECAL:PATH <EcalPort>, <VnaPort>	[SENSe<Ch>:]CORRection:COLLect:AUTO:PORTs
SENSe{1...4}:CORRection:COLLect:ECAL:SOLT1 <numeric> SENSe{1...4}:CORRection:COLLect:ECAL:SOLT2 <numeric1>, <numeric2> SENSe{1...4}:CORRection:COLLect:ECAL:SOLT3 <numeric1>, <numeric2>, <numeric3> SENSe{1...4}:CORRection:COLLect:ECAL:SOLT4 1,2,3,4	[SENSe<Ch>:]CORRection:COLLect:AUTO:TYPE
SENSe{1...4}:CORRection:COLLect:ECAL:UTHR[:STATe] {OFF 0}	
SENSe<ch>:CORRection:COLLect:GUIDed:CKIT:PORT<pt>:CATalog?	[SENSe:]CORRection:CKIT:CATalog?

ENA Emulation Command	R&S ZNA Default Parser Command
SENSe{1..4}:CORRection:COLLect: METHod[:RESPOse]:OPEN <numeric>	[SENSe<Ch>:]CORRection:COLLect:METHod: DEFine
SENSe{1..4}:CORRection:COLLect: METHod[:RESPOse]:SHORT <numeric>	
SENSe{1..4}:CORRection:COLLect: METHod:SOLT1 <numeric>	
SENSe{1..4}:CORRection:COLLect: METHod:SOLT2 <numeric1>, <numeric2>	
SENSe{1..4}:CORRection:COLLect: METHod:SOLT3 <numeric1>, <numeric2>, <numeric3>	
SENSe{1..4}:CORRection:COLLect: METHod:SOLT4 1,2,3,4	
SENSe{1..4}:CORRection:COLLect: METHod[:RESPOse]:THRU <numeric1>, <numeric2>	
SENSe{1..4}:CORRection:COLLect: METHod:TYPE?	
SENSe{1..4}:CORRection:TYPE{1..4}?	
SENSe{1..4}:CORRection:COLLect:SAVE	[SENSe<Ch>:]CORRection:COLLect:SAVE[: DUMMy]
SENSe{1..4}:CORRection:COLLect:UTHRU[: STATe] {OFF 0}	
SENSe<Ch>:CORRection:EXTension[:STATe] {ON OFF 1 0}	[SENSe<Ch>:]CORRection:OFFSet<PhyPt>: COMPensation[:STATe]
SENSe{1..4}:CORRection:EXTension: PORT{[1] 2 3 4}:TIME <numeric>	[SENSe<Ch>:]CORRection:EDElay<PhyPt>[: TIME]
SENSe{1..4}:CORRection:STATe {ON OFF 1 0}	[SENSe<Ch>:]CORRection[:STATe]
SENSe{1..4}:FREQuency:CENTer <numeric>	[SENSe<Ch>:]FREQuency:CENTer
SENSe{1..4}:FREQuency:DATA?	CALCulate<Chn>:DATA:STIMulus?
SENSe{1..4}:FREQuency:SPAN <numeric>	[SENSe<Ch>:]FREQuency:SPAN
SENSe{1..4}:FREQuency:START <numeric>	[SENSe<Ch>:]FREQuency:START
SENSe{1..4}:FREQuency:STOP <numeric>	[SENSe<Ch>:]FREQuency:STOP
SENSe{1..4}:ROSCillator:SOURce?	[SENSe<Ch>:]ROSCillator[:SOURce]
SENSe{1..4}:SEGMENT:SWEep:POINTs?	[SENSe<Ch>:]SEGMENT<Seg>:SWEep:POINTs
SENSe{1..4}:SEGMENT:SWEep:TIME?	[SENSe<Ch>:]SEGMENT<Seg>:SWEep:TIME
SENSe{1..4}:SEGMENT:DATA 5,<mode>, <ifbw>, <pow>, , <time>, <segm>, <star 1>, <stop 1>, <nop 1>, <ifbw 1>, <pow 1>, <del 1>, <time 1>,...	
SENSe{1..4}:SWEep:DElay <numeric>	[SENSe<Ch>:]SWEep:DWELL

ENA emulation commands

ENA Emulation Command	R&S ZNA Default Parser Command
SENSE{1...4}:SWEep:MOD CONTInuous HOLD SINGle SENSE{1...4}:SWEep:MODE CONTInuous HOLD SINGle	
SENSE{1...4}:SWEep:POINts <numeric>	[SENSe<Ch>:]SWEep:POINts
SENSE{1...4}:SWEep:TIME[:DATA] <numeric>	[SENSe<Ch>:]SWEep:TIME
SENSE{1...4}:SWEep:TIME:AUTO {ON OFF 1 0}	[SENSe<Ch>:]SWEep:TIME:AUTO
SENSe{1...4}:SWEep:TYPE {LINear SEGMENT}	[SENSe<Ch>:]SWEep:TYPE
SERVice:CHANnel:COUNT?	n.a. (no limit)
SERVice:CHANnel:TRACe:COUNT?	n.a. (no limit)
SOURce{1...4}:POWer[:LEVel][:IMMediate][:AMPLitude] <numeric>	SOURce<Ch>:POWer<PhyPt>[:LEVel][:IMMediate][:AMPLitude]
SOURce<ch>:POWer<pt>:CORRection[:STATe] {ON OFF 1 0}	SOURce<Ch>:POWer<PhyPt>:CORRection:STATe
SOURce<ch>:POWer<pt>:CORRection:COLLect:AVERAge[:COUNT] <numeric>	SOURce:POWer:CORRection:COLLect:AVERAge[:COUNT]
SOURce:POWer<pt>:CORRection:COLLect:AVERAge:NTOLerance <numeric>	SOURce:POWer:CORRection:COLLect:AVERAge:NTOLerance
SOURce<ch>:POWer<pt>:CORRection:COLLect:SAVE [<RREC>]	n.a. (instrument automatically applies calibration after it is complete)
SOURce{1..4}:POWer:PORT:COUPlE {ON 1}	
STATus:OPERation:CONDition?	STATus:QUEStionable:CONDition?
STATus:OPERation:ENABle <numeric>	STATus:QUEStionable:ENABle
STATus:OPERation[:EVENT]?	STATus:QUEStionable[:EVENT]?
STATus:QUEStionable:NTRansition <numeric>	STATus:QUEStionable:NTRansition
STATus:QUEStionable:PTRansition <numeric>	STATus:QUEStionable:LIMit<Lev>:PTRansition
STATus:QUEStionable:LIMit:CONDition?	STATus:QUEStionable:LIMit<Lev>:CONDition?
STATus:QUEStionable:LIMit:ENABle <numeric>	STATus:QUEStionable:LIMit<Lev>:ENABle
STATus:QUEStionable:LIMit[:EVENT]?	STATus:QUEStionable:LIMit<Lev>[:EVENT]?
STATus:QUEStionable:LIMit:NTRansition <numeric>	STATus:QUEStionable:LIMit<Lev>:NTRansition

ENA emulation commands

ENA Emulation Command	R&S ZNA Default Parser Command
STATus:QUEStionable:LIMit:PTRansition <numeric>	STATus:QUEStionable:LIMit<Lev>: PTRansition
SYSTem:BEEPer:WARning:STATe {ON OFF 1 0}	CALCulate<Chn>:LIMit:SOUNd[:STATe]
SYSTem:KLOCK:kBD {ON OFF 1 0}	SYSTem:KLOCK
TRIGger[:SEquence]:SOURce {INTernal EXTernal MANual BUS}	TRIGger<Ch>[:SEquence]:SOURce

Glossary: Frequently used terms

A

Active channel: Channel belonging to the active trace. The active channel is highlighted in the channel list below the diagram. The active channel is not relevant in remote control where each channel can contain an active trace.

Active marker: Marker that can be changed using the settings of the Marker menu (Delta Mode, Ref. Mkr -> Mkr, Mkr Format). The active marker is also used for the Marker Functions. It appears in the diagram with an enlarged marker symbol and font size and with a dot placed in front of the marker line in the info field.

Active menu: The menu containing the last executed command. If the softkey bar is displayed (Display - Config./View - Softkey Labels on), then the active menu is indicated on top of the softkey bar.

Active trace (manual control): Trace that is selected to apply the settings in the Trace menu. The active trace is highlighted in the trace list of the active diagram area. It can be different from the active trace in remote control.

Active trace (remote control): One trace of each channel that has been selected as the active trace (`CALCulate<Ch>:PARAmeter:SElect <trace name>`). Many commands (e.g. `TRACE . . .`) act on the active trace. It can be different from the active trace in manual control.

C

Cal pool: The cal pool is a collection of correction data sets (cal groups) that the analyzer stores in a common directory. Cal groups in the pool can be applied to different channels and recall sets.

Calibration: The process of removing systematic errors from the measurement (system error correction). See also TOSM, TOM, TRM, TRL, TNA...

Calibration kit: Set of physical calibration standards for a particular connector family.

Calibration standard: Physical device that has a known or predictable magnitude and phase response within a given frequency range. Calibration standards are grouped into several types (open, through, match,...) corresponding to the different input quantities for the analyzer's error models.

Calibration unit: Integrated solution for automatic calibration of multiple ports (accessories R&S ZV-Zxx, R&S ZN-Z5x and R&S ZN-Z15x). The unit contains calibration standards that are electronically switched when a calibration is performed.

Channel: A channel contains hardware-related settings to specify how the network analyzer collects data. Each channel is stored in an independent data set. The channel

settings complement the definitions of the Trace menu; they apply to all traces assigned to the channel.

Compression point: The x-dB compression point of an S-parameter or ratio is the stimulus signal level where the magnitude of the measured quantity has dropped by x dB compared to its value at small stimulus signal levels (small-signal value).

Confirmation dialog box: Standard dialog box that pops up to display an error message or a warning. The current action can be either continued (OK) or canceled (Cancel) on closing the dialog box.

Crosstalk: The occurrence of a signal at the receive port of the analyzer which did not travel through the test setup and the DUT but leaks through other internal paths. Crosstalk causes an isolation error in the measurement which can be corrected by means of a calibration.

CW frequency: Continuous Wave frequency; fixed stimulus frequency used in Power, CW Time and CW Mode sweeps.

D

Data trace: Trace filled with measurement data and updated after each sweep (dynamic trace).

Diagram area: Rectangular portion of the screen used to display traces. Diagram areas are arranged in windows; they are independent of trace and channel settings.

Directivity error: Measurement error caused by a coupler or bridge in the analyzer's source port causing part of the generated signal to leak through the forward path into the receive path instead of being transmitted towards the DUT. The directivity error can be corrected by means of a full one port calibration or one of the two-port calibration methods (except normalization).

Discrete marker: The stimulus value of a discrete marker always coincides with a sweep point so that the marker does not show interpolated measurement values.

DUT: Device under test; generic term for any electrical device or circuit which the vector network analyzer can measure. Typical DUTs are filters, amplifiers, or mixers.

E

Excursion: Difference between the response values at a local maximum (minimum) of the trace and at the two closest local minima (maxima) to the left and to the right.

Extrapolation: Calculation of a numeric value for a new sweep point outside the original sweep range from the numeric values of the existing sweep points. The analyzer can extrapolate calibration data, transmission coefficients etc. to extend the sweep range. If not otherwise stated, the numeric value of the first (last) sweep point is

assigned to all new points below (above) the original sweep range. See also --> interpolation.

F

Forward: A measurement on a two-port DUT is said to be in forward direction if the source signal (stimulus) is applied to port 1 of the DUT.

H

Harmonic: Integer multiple of the fundamental frequency. The fundamental is the first harmonic, the nth harmonic is n times the frequency of the fundamental.

Harmonic distortion: The production of harmonic frequencies (harmonics) by an electronic system when a signal is applied at the input.

Harmonic grid: A set of equidistant frequency points f_i ($i = 1 \dots n$) with spacing $\Delta(f)$ and the additional condition that $f_1 = \Delta(f)$. A harmonic grid is required for low pass time domain transforms.

I

Intercept point: Fictitious lower-tone DUT input/output level where the intermodulation suppression (-->) for a given intermodulation product reaches 0 dB.

Intermodulation measurement: Measurement where the DUT is supplied with two RF signals of equal power but different frequencies termed the upper and lower tone. The analyzer measures the frequency-converting behavior of the DUT (--> intermodulation product).

Intermodulation product: Special type of emissions of a nonlinear DUT that is supplied with a two-tone RF signal (--> intermodulation measurement). The intermodulation products occur at frequencies which correspond to sums and differences of the upper and lower tone frequencies and their integer multiples.

Intermodulation suppression: The ratio of the power of an --> intermodulation product to the power of the lower tone fundamental wave.

Interpolation: Calculation of a numeric value for a specific sweep point from the numeric values of the adjacent points. The analyzer can interpolate calibration data, transmission coefficients etc. to account for a modified set of sweep points. If not otherwise stated, linear interpolation is used. See also --> extrapolation.

Isolation error: Measurement error caused by a crosstalk between the source and receive port of the analyzer.

L

Limit check: Comparison of measurement results with user-defined limits, and display of a pass/fail indication.

An acoustic warning and a TTL signal can be generated in addition, if a limit is violated. A TTL signal can be generated in addition, if a limit is violated.

Limit line: A limit line is a set of data to specify the allowed range for some or all points of a trace. Typically, limit lines are used to check whether a DUT conforms to the rated specifications (conformance testing).

Load match error: Measurement error caused by a mismatch of the analyzer's receive (load) port causing part of the signal transmitted through the DUT to be reflected off the receive port so that it is not measured there. The load match error can be corrected by means of a two-port calibration (except normalization).

M

Marker: Tool for selecting points on the trace and for numerical readout of measured data. A marker is displayed with a symbol (a triangle, a crossbar or a line) on the trace; its coordinates are shown in the marker info field.

Mathematical trace: Trace that is calculated according to a mathematical expression, e.g. the one defined in the Define Math dialog. The expression is a mathematical relation between constants and the data or memory traces of the active recall set.

Measurement point: Result of the measurement at a specified stimulus value (frequency/power/time).

Measurement result: Set of all measurement points acquired in a measurement (e.g. a sweep). The measurement result is displayed in a diagram area and forms a trace.

Memory trace: Trace that is associated to a data trace and stored in the memory. Data traces and the associated memory traces share the same channel and scale settings. Alternatively, memory traces can be imported from a file.

Mixer: Device that converts an RF signal at one frequency into a signal at another frequency. The frequency that is to be shifted is applied at the RF input and the frequency shifting signal (from a local oscillator, LO) is applied to the RF mixer's LO port, resulting in an output signal at the mixer's Intermediate Frequency (IF) port.

P

Partial measurement: Measurement at a specified stimulus value maintaining definite hardware settings. Depending on the measurement type, several partial measurements may be needed to obtain a measurement point. A full n-port S-parameter measurement requires n partial measurements with n different drive ports.

Peak: Local maximum or local minimum (dip) on the trace. In the Trace - Search menu, it is possible to define a minimum excursion that both types of peaks must have to be considered valid.

R

Recall Set: A recall set comprises a set of diagram areas with all displayed information that can be stored to a VNA recall set file (*.znxml | *.znx). Each recall set is displayed in an independent tab.

Reflection tracking error: Frequency-dependent variation of the ratio of the reflected wave to the reference wave at a test port when an ideal reflection coefficient (= 1) is measured. The reflection tracking error can be corrected by means of a reflection normalization or one of the more sophisticated calibration methods.

Reverse: A measurement on a two-port DUT is said to be in reverse direction if the source signal (stimulus) is applied to port 2 of the DUT.

S

Source match error: Measurement error caused by a mismatch of the analyzer's source port causing part of the signal reflected off the DUT to be reflected again off the source port so that it is not measured there. The source match error can be corrected by means of a full one-port calibration or a two-port calibration (except normalization).

Stimulus value: Value of the sweep variable (frequency/power/time/point number) where a measurement is taken. Also termed sweep point.

Sweep: Series of consecutive measurements taken at a specified sequence of stimulus values = series of consecutive measurement points.

Sweep point: Value of the sweep variable (stimulus value: frequency/power/time) where a measurement is taken.

Sweep range: Continuous range of the sweep variable (frequency/power/time) containing the sweep points where the analyzer takes measurements. In a Segmented Frequency sweep the sweep range can be composed of several parameter ranges or single points.

Sweep segment: Continuous frequency range or single frequency point where the analyzer measures at specified instrument settings (generator power, IF bandwidth etc.). In the Segmented Frequency sweep type the entire sweep range can be composed of several sweep segments.

T

TNA: A calibration type using a Through, a symmetric Network and an Attenuation standard. The properties of the Network and the Attenuation don't have to be known exactly. Like TRL and TRM, TNA is especially useful for DUTs in planar line technology.

TOM: A calibration type using three fully known standards (Through, Open, Match), recommended for 2-port measurements on coaxial systems.

Topology: Assignment of the physical ports of the VNA to the logical ports used for the measurement of mixed mode S-parameters (balance-unbalance conversion).

TOSM: A calibration type using a Through plus the one-port standards Open, Short, Match, to be connected to each calibrated port. Classical 12-term error model, also referred to as SOLT. See also UOSM.

TRL: A calibration type using the two-port standards Through and Line, which are both assumed to be ideally matched. Beyond that, the Through must be lossless, and its length must be exactly known. Especially useful for DUTs in planar line technology.

TRM: A calibration type which requires a low-reflection, low-loss Through standard with an electrical length that may be different from zero, a Reflect, and a Match. Especially useful for DUTs in test fixtures.

TSM: A calibration type using three fully known standards (Through, Short, Match), recommended for 2-port measurements on coaxial systems.

U

UOSM: A variant of TOSM calibration using an unknown but reciprocal Through standard. Especially for port combinations with different connector types.

V

VNA: (Vector) Network Analyzer, in particular the R&S ZNA.

List of commands

[SENSe:]CDLL:ADD.....	1326
[SENSe:]CDLL:LIST:TASK?.....	1326
[SENSe:]CDLL:LIST?.....	1326
[SENSe:]CDLL:REMove.....	1328
[SENSe:]CONVerter:DEFinition:CATalog?.....	1330
[SENSe:]CONVerter:DEFinition:COUNT?.....	1330
[SENSe:]CONVerter:DEFinition:DEFine.....	1330
[SENSe:]CONVerter:DEFinition:DELeTe.....	1331
[SENSe:]CONVerter:DEFinition:FREQuency.....	1331
[SENSe:]CONVerter:DEFinition:IFRequency.....	1332
[SENSe:]CONVerter:DEFinition:LMUL.....	1332
[SENSe:]CONVerter:DEFinition:LPOWer.....	1332
[SENSe:]CONVerter:DEFinition:LPOWer:OFFSet.....	1332
[SENSe:]CONVerter:DEFinition:MPOWer.....	1333
[SENSe:]CONVerter:DEFinition:SMUL.....	1333
[SENSe:]CONVerter:DEFinition:SPOWer.....	1333
[SENSe:]CONVerter:DEFinition:SPOWer:OFFSet.....	1334
[SENSe:]CONVerter:SPLitter<Port>:LOPort.....	1336
[SENSe:]CONVerter:SPLitter<Port>:LOSS.....	1337
[SENSe:]CONVerter<Port>:CSLoss.....	1329
[SENSe:]CONVerter<Port>:CSSLope.....	1330
[SENSe:]CONVerter<Port>:IFPort.....	1334
[SENSe:]CONVerter<Port>:IFRequency.....	1334
[SENSe:]CONVerter<Port>:LOLoss.....	1335
[SENSe:]CONVerter<Port>:LOPort.....	1335
[SENSe:]CONVerter<Port>:RFLoss.....	1336
[SENSe:]CONVerter<Port>:RFPort?.....	1336
[SENSe:]CONVerter<Port>:RFSLope.....	1336
[SENSe:]CONVerter<Port>:STATe.....	1337
[SENSe:]CORRection:CKIT:<ConnType>:LSElect.....	1352
[SENSe:]CORRection:CKIT:<ConnType>:SElect.....	1347
[SENSe:]CORRection:CKIT:<OnePortStandardType>:WLAbel:SDATa?.....	1353
[SENSe:]CORRection:CKIT:<StandardType>.....	1341
[SENSe:]CORRection:CKIT:<StandardType>:WLAbel.....	1353
[SENSe:]CORRection:CKIT:<TwoPortStandard>:WLAbel:SDATa?.....	1354
[SENSe:]CORRection:CKIT:CATalog?.....	1345
[SENSe:]CORRection:CKIT:DELeTe.....	1345
[SENSe:]CORRection:CKIT:DMODE.....	1346
[SENSe:]CORRection:CKIT:INSTall.....	1708
[SENSe:]CORRection:CKIT:LABel.....	1346
[SENSe:]CORRection:CKIT:LCATalog?.....	1349
[SENSe:]CORRection:CKIT:LDELeTe.....	1350
[SENSe:]CORRection:CKIT:LLAbel.....	1350
[SENSe:]CORRection:CKIT:LSElect.....	1351
[SENSe:]CORRection:CKIT:SElect.....	1347
[SENSe:]CORRection:CKIT:STANdard:CATalog?.....	1348
[SENSe:]CORRection:CKIT:STANdard:DATA?.....	1348

[SENSe:]CORRection:CKIT:STANdard:LCATalog?	1353
[SENSe:]CORRection:COLLect:AUTO:CKIT	1364
[SENSe:]CORRection:COLLect:AUTO:CKIT:PASSword	1364
[SENSe:]CORRection:COLLect:AUTO:CKIT:PORTs	1365
[SENSe:]CORRection:COLLect:AUTO:CKIT:PORTs:ADD	1366
[SENSe:]CORRection:COLLect:AUTO:MCONnect	1369
[SENSe:]CORRection:COLLect:AUTO:PORTs:CONNection?	1371
[SENSe:]CORRection:COLLect:AVERAge	1376
[SENSe:]CORRection:COLLect:CHANnels:ALL	1376
[SENSe:]CORRection:COLLect:CHANnels:MCTypes	1377
[SENSe:]CORRection:COLLect:CSEtup	1382
[SENSe:]CORRection:COLLect:FIXTure:LMPParameter:LOSS[:STATe]	1386
[SENSe:]CORRection:COLLect:FIXTure:LMPParameter[:STATe]	1386
[SENSe:]CORRection:COLLect:PMETer:ID	1392
[SENSe:]CORRection:EDELay:VNETwork	1409
[SENSe:]CORRection:IMETHod	1410
[SENSe:]CORRection:METas:CABLE:CATalog?	1395
[SENSe:]FREQuency:CONVersion:DEvice<Port>:NAME	1429
[SENSe:]ROSCillator:EXTernal:FREQuency	1476
[SENSe:]ROSCillator:SMA:INPut	1476
[SENSe:]ROSCillator:SMA:OUTPut	1477
[SENSe:]SWEep:COUNT:ALL	1502
[SENSe:]UDSParams:ACTive	1520
[SENSe:]UDSParams<Pt>:PARAM	1520
[SENSe<Ch>:]AVERAge:CLEar	1323
[SENSe<Ch>:]AVERAge:COUNT	1323
[SENSe<Ch>:]AVERAge:MODE	1323
[SENSe<Ch>:]AVERAge[:STATe]	1322
[SENSe<Ch>:]BANDwidth[:RESolution]	1324
[SENSe<Ch>:]BANDwidth[:RESolution]:DREDuction	1325
[SENSe<Ch>:]BANDwidth[:RESolution]:SElect	1325
[SENSe<Ch>:]BWiDth[:RESolution]	1324
[SENSe<Ch>:]BWiDth[:RESolution]:DREDuction	1325
[SENSe<Ch>:]BWiDth[:RESolution]:SElect	1325
[SENSe<Ch>:]CDLL:PERManent:ADditiOnal	1326
[SENSe<Ch>:]CDLL:PERManent:TASK	1327
[SENSe<Ch>:]CDLL:PERManent[:STATe]	1327
[SENSe<Ch>:]CDLL:TASK:ADdReSS	1328
[SENSe<Ch>:]CDLL[:STATe]	1328
[SENSe<Ch>:]CORRection:ADVanced:HARMonic:ORDer:ADd	1338
[SENSe<Ch>:]CORRection:ADVanced:HARMonic:ORDer:REMOve	1339
[SENSe<Ch>:]CORRection:ADVanced:HARMonic:ORDer?	1338
[SENSe<Ch>:]CORRection:ADVanced:POWer<PhyPt>	1339
[SENSe<Ch>:]CORRection:ADVanced:POWer<PhyPt>:STATe	1339
[SENSe<Ch>:]CORRection:ADVanced:SENSe<PhyPt>:ATTenator	1339
[SENSe<Ch>:]CORRection:ADVanced:SENSe<PhyPt>:ATTenator:STATe	1340
[SENSe<Ch>:]CORRection:ADVanced:SENSe<PhyPt>:PREamp	1340
[SENSe<Ch>:]CORRection:ADVanced:SENSe<PhyPt>:PREamp:STATe	1340
[SENSe<Ch>:]CORRection:ADVanced:SOURce<PhyPt>:ATTenator	1340
[SENSe<Ch>:]CORRection:ADVanced:SOURce<PhyPt>:ATTenator:STATe	1341

[SENSe<Ch>:]CORRection:CDATa.....	1399
[SENSe<Ch>:]CORRection:CDATa:PORT<PhyPt>.....	1399
[SENSe<Ch>:]CORRection:CKIT:<ConnType>:<StandardType>.....	1707
[SENSe<Ch>:]CORRection:COLLect:AUTO.....	1358
[SENSe<Ch>:]CORRection:COLLect:AUTO:ASSignment:ALL:COUNT?.....	1359
[SENSe<Ch>:]CORRection:COLLect:AUTO:ASSignment:COUNT?.....	1360
[SENSe<Ch>:]CORRection:COLLect:AUTO:ASSignment:DEFine:DEFault.....	1362
[SENSe<Ch>:]CORRection:COLLect:AUTO:ASSignment:DEFine:TPORt:DEFault.....	1363
[SENSe<Ch>:]CORRection:COLLect:AUTO:ASSignment:DELeTe:ALL.....	1363
[SENSe<Ch>:]CORRection:COLLect:AUTO:ASSignment<Asg>:ACQuire.....	1359
[SENSe<Ch>:]CORRection:COLLect:AUTO:ASSignment<Asg>:DEFine.....	1360
[SENSe<Ch>:]CORRection:COLLect:AUTO:ASSignment<Asg>:DEFine:TPORt.....	1362
[SENSe<Ch>:]CORRection:COLLect:AUTO:CONFIgure.....	1367
[SENSe<Ch>:]CORRection:COLLect:AUTO:CPOrt.....	1368
[SENSe<Ch>:]CORRection:COLLect:AUTO:MDElay.....	1369
[SENSe<Ch>:]CORRection:COLLect:AUTO:MIXer.....	1369
[SENSe<Ch>:]CORRection:COLLect:AUTO:PORtS.....	1370
[SENSe<Ch>:]CORRection:COLLect:AUTO:PORtS:TYPE.....	1371
[SENSe<Ch>:]CORRection:COLLect:AUTO:POWEr.....	1372
[SENSe<Ch>:]CORRection:COLLect:AUTO:REPeat.....	1373
[SENSe<Ch>:]CORRection:COLLect:AUTO:SAVE.....	1373
[SENSe<Ch>:]CORRection:COLLect:AUTO:TEMPcomp.....	1374
[SENSe<Ch>:]CORRection:COLLect:AUTO:TERMination.....	1374
[SENSe<Ch>:]CORRection:COLLect:AUTO:TYPE.....	1374
[SENSe<Ch>:]CORRection:COLLect:AUTO:UTHRough.....	1375
[SENSe<Ch>:]CORRection:COLLect:CHANnels:CSEtup.....	1376
[SENSe<Ch>:]CORRection:COLLect:CKIT:INSTall.....	1379
[SENSe<Ch>:]CORRection:COLLect:CKIT:LOAD.....	1379
[SENSe<Ch>:]CORRection:COLLect:CKIT:PORt<PhyPt>?.....	1379
[SENSe<Ch>:]CORRection:COLLect:CONNection:GENDeRS.....	1381
[SENSe<Ch>:]CORRection:COLLect:CONNection:PORtS.....	1381
[SENSe<Ch>:]CORRection:COLLect:CONNection<PhyPt>.....	1380
[SENSe<Ch>:]CORRection:COLLect:DELeTe.....	1382
[SENSe<Ch>:]CORRection:COLLect:DETEctor.....	1383
[SENSe<Ch>:]CORRection:COLLect:DISC ard.....	1383
[SENSe<Ch>:]CORRection:COLLect:FIXTure:EXPOrt.....	1385
[SENSe<Ch>:]CORRection:COLLect:FIXTure:IMPOrt.....	1385
[SENSe<Ch>:]CORRection:COLLect:FIXTure:SAVE.....	1386
[SENSe<Ch>:]CORRection:COLLect:FIXTure:STARt.....	1386
[SENSe<Ch>:]CORRection:COLLect:FIXTure[:ACQuire].....	1383
[SENSe<Ch>:]CORRection:COLLect:LOAD:SELeCted.....	1387
[SENSe<Ch>:]CORRection:COLLect:METhod.....	1709
[SENSe<Ch>:]CORRection:COLLect:METhod:DEFine.....	1388
[SENSe<Ch>:]CORRection:COLLect:NFIgure:END.....	1391
[SENSe<Ch>:]CORRection:COLLect:NFIgure:SAVE.....	1391
[SENSe<Ch>:]CORRection:COLLect:NFIgure:STARt.....	1392
[SENSe<Ch>:]CORRection:COLLect:NFIgure[:ACQuire].....	1390
[SENSe<Ch>:]CORRection:COLLect:SAVE:DEFault.....	1710
[SENSe<Ch>:]CORRection:COLLect:SAVE:SELeCted:DEFault.....	1393
[SENSe<Ch>:]CORRection:COLLect:SAVE:SELeCted[:DUMMy].....	1394

[SENSe<Ch>:]CORRection:COLLect:SAVE[:DUMMy].....	1711
[SENSe<Ch>:]CORRection:COLLect:SCONnection<PhyPt>.....	1394
[SENSe<Ch>:]CORRection:COLLect[:ACQuire].....	1708
[SENSe<Ch>:]CORRection:COLLect[:ACQuire]:SELEcted.....	1356
[SENSe<Ch>:]CORRection:CONNection.....	1401
[SENSe<Ch>:]CORRection:CONNection:CATalog?.....	1402
[SENSe<Ch>:]CORRection:CONNection:DELEte.....	1403
[SENSe<Ch>:]CORRection:DATA.....	1712
[SENSe<Ch>:]CORRection:DATA:PARAmeter:COUNT?.....	1406
[SENSe<Ch>:]CORRection:DATA:PARAmeter<Sfk>:PORT<PhyPt>?.....	1404
[SENSe<Ch>:]CORRection:DATA:PARAmeter<Sfk>?.....	1404
[SENSe<Ch>:]CORRection:DATE?.....	1406
[SENSe<Ch>:]CORRection:DELEte.....	1407
[SENSe<Ch>:]CORRection:EDELay:AUTO.....	1407
[SENSe<Ch>:]CORRection:EDELay<PhyPt>:DIElectric.....	1408
[SENSe<Ch>:]CORRection:EDELay<PhyPt>:DISTance.....	1408
[SENSe<Ch>:]CORRection:EDELay<PhyPt>:ELENgth.....	1408
[SENSe<Ch>:]CORRection:EDELay<PhyPt>[:TIME].....	1409
[SENSe<Ch>:]CORRection:EWAVE[:STATe].....	1410
[SENSe<Ch>:]CORRection:LOSS:AUTO.....	1411
[SENSe<Ch>:]CORRection:LOSS<PhyPt>.....	1410
[SENSe<Ch>:]CORRection:LOSS<PhyPt>:FREQuency.....	1411
[SENSe<Ch>:]CORRection:LOSS<PhyPt>:OFFSet.....	1411
[SENSe<Ch>:]CORRection:LOSS<PhyPt>:SECond.....	1410
[SENSe<Ch>:]CORRection:LOSS<PhyPt>:SECond:FREQuency.....	1411
[SENSe<Ch>:]CORRection:LOSS<PhyPt>:SECond:STATe.....	1412
[SENSe<Ch>:]CORRection:METas:CABLe:MOVement.....	1396
[SENSe<Ch>:]CORRection:METas:CABLe:REConnection.....	1396
[SENSe<Ch>:]CORRection:METas:CABLe:TYPE.....	1396
[SENSe<Ch>:]CORRection:METas:UNCertainty.....	1397
[SENSe<Ch>:]CORRection:METas[:STATe].....	1397
[SENSe<Ch>:]CORRection:NFIGure[:STATe].....	1412
[SENSe<Ch>:]CORRection:OFFSet<PhyPt>:COMPensation[:STATe].....	1413
[SENSe<Ch>:]CORRection:OFFSet<PhyPt>:DFComp[:STATe]?.....	1413
[SENSe<Ch>:]CORRection:OFFSet<PhyPt>:MAGNitude.....	1714
[SENSe<Ch>:]CORRection:OFFSet<PhyPt>[:STATe].....	1413
[SENSe<Ch>:]CORRection:PCAL.....	1414
[SENSe<Ch>:]CORRection:POWEr:DATA.....	1416
[SENSe<Ch>:]CORRection:POWEr:DATA:PORT<PhyPt>.....	1416
[SENSe<Ch>:]CORRection:POWEr:MIXer:IF:ACQuire.....	1418
[SENSe<Ch>:]CORRection:POWEr<PhyPt>:ACQuire.....	1414
[SENSe<Ch>:]CORRection:POWEr<PhyPt>:AWAVE[:STATe].....	1416
[SENSe<Ch>:]CORRection:POWEr<PhyPt>:HARMonic:ACQuire.....	1417
[SENSe<Ch>:]CORRection:POWEr<PhyPt>:IMODulation:ACQuire.....	1418
[SENSe<Ch>:]CORRection:POWEr<PhyPt>[:STATe].....	1419
[SENSe<Ch>:]CORRection:SMATrix:CDATA.....	1419
[SENSe<Ch>:]CORRection:SMATrix:CDATA:PORT<PhyPt>.....	1419
[SENSe<Ch>:]CORRection:STIMulus:PORT<PhyPt>?.....	1420
[SENSe<Ch>:]CORRection:STIMulus?.....	1420
[SENSe<Ch>:]CORRection[:STATe].....	1420

[SENSe<Ch>:]COUPLE.....	1517
[SENSe<Ch>:]FREQuency:CENTer.....	1423
[SENSe<Ch>:]FREQuency:COMPression:POINt.....	1423
[SENSe<Ch>:]FREQuency:COMPression:POWer:POINts.....	1424
[SENSe<Ch>:]FREQuency:COMPression:POWer:STARt.....	1424
[SENSe<Ch>:]FREQuency:COMPression:POWer:STOP.....	1424
[SENSe<Ch>:]FREQuency:COMPression:RECeiver.....	1425
[SENSe<Ch>:]FREQuency:COMPression:SKIP.....	1425
[SENSe<Ch>:]FREQuency:COMPression:SKIP:OFFSet.....	1425
[SENSe<Ch>:]FREQuency:COMPression:SRCPort.....	1425
[SENSe<Ch>:]FREQuency:CONVersion.....	1426
[SENSe<Ch>:]FREQuency:CONVersion:ARBITrary:PMETer<Pmtr>.....	1428
[SENSe<Ch>:]FREQuency:CONVersion:GAIN:LMCorrecTion.....	1430
[SENSe<Ch>:]FREQuency:CONVersion:MIXer:FIXed<Stg>.....	1430
[SENSe<Ch>:]FREQuency:CONVersion:MIXer:FUNDamental.....	1431
[SENSe<Ch>:]FREQuency:CONVersion:MIXer:IFFixed.....	1714
[SENSe<Ch>:]FREQuency:CONVersion:MIXer:IFPort.....	1431
[SENSe<Ch>:]FREQuency:CONVersion:MIXer:LOFixed.....	1715
[SENSe<Ch>:]FREQuency:CONVersion:MIXer:LOMultiplier<Stg>.....	1431
[SENSe<Ch>:]FREQuency:CONVersion:MIXer:LOPort<Stg>.....	1432
[SENSe<Ch>:]FREQuency:CONVersion:MIXer:MFFixed.....	1432
[SENSe<Ch>:]FREQuency:CONVersion:MIXer:PRFImage.....	1434
[SENSe<Ch>:]FREQuency:CONVersion:MIXer:RFFixed.....	1715
[SENSe<Ch>:]FREQuency:CONVersion:MIXer:RFMultiplier.....	1435
[SENSe<Ch>:]FREQuency:CONVersion:MIXer:RFPort.....	1435
[SENSe<Ch>:]FREQuency:CONVersion:MIXer:STAGes.....	1435
[SENSe<Ch>:]FREQuency:CONVersion:MIXer:TFRequency<Stg>.....	1436
[SENSe<Ch>:]FREQuency:FIXed.....	1436
[SENSe<Ch>:]FREQuency:IMODulation:CONVersion.....	1437
[SENSe<Ch>:]FREQuency:IMODulation:LTONE.....	1437
[SENSe<Ch>:]FREQuency:IMODulation:MSpectrum.....	1438
[SENSe<Ch>:]FREQuency:IMODulation:ORDER<Im>[:STATe].....	1438
[SENSe<Ch>:]FREQuency:IMODulation:RECeiver.....	1439
[SENSe<Ch>:]FREQuency:IMODulation:SPECTrum:MORDER.....	1439
[SENSe<Ch>:]FREQuency:IMODulation:SPECTrum[:STATe].....	1439
[SENSe<Ch>:]FREQuency:IMODulation:TDISTance.....	1440
[SENSe<Ch>:]FREQuency:IMODulation:TTOuTput.....	1716
[SENSe<Ch>:]FREQuency:IMODulation:UTONE.....	1441
[SENSe<Ch>:]FREQuency:MDELay:ACQuire.....	1665
[SENSe<Ch>:]FREQuency:MDELay:APERture.....	1665
[SENSe<Ch>:]FREQuency:MDELay:CDELay.....	1666
[SENSe<Ch>:]FREQuency:MDELay:CDMode.....	1666
[SENSe<Ch>:]FREQuency:MDELay:CONVersion.....	1666
[SENSe<Ch>:]FREQuency:MDELay:CORRection[:STATe].....	1667
[SENSe<Ch>:]FREQuency:MDELay:DIVide.....	1667
[SENSe<Ch>:]FREQuency:MDELay:LTONE.....	1667
[SENSe<Ch>:]FREQuency:MDELay:RECeiver.....	1667
[SENSe<Ch>:]FREQuency:MDELay:RPORT.....	1668
[SENSe<Ch>:]FREQuency:MDELay:UTONE.....	1668
[SENSe<Ch>:]FREQuency:MODE.....	1716

[SENSe<Ch>:]FREQUency:OFFSet:PWAVes:STATE.....	1669
[SENSe<Ch>:]FREQUency:SBANd.....	1441
[SENSe<Ch>:]FREQUency:SEGMENT:AXIS.....	1442
[SENSe<Ch>:]FREQUency:SPAN.....	1443
[SENSe<Ch>:]FREQUency:START.....	1443
[SENSe<Ch>:]FREQUency:STOP.....	1443
[SENSe<Ch>:]FREQUency[:CW].....	1436
[SENSe<Ch>:]FREQUency<Pt>:CONVersion:ARBitrary.....	1426
[SENSe<Ch>:]FREQUency<Pt>:CONVersion:AWReceiver[:STATE].....	1429
[SENSe<Ch>:]FREQUency<Pt>:OFFSet:PWAVes.....	1669
[SENSe<Ch>:]FREQUency<Pt>:OFFSet:WAVes.....	1669
[SENSe<Ch>:]GDEVice:DELeTe.....	1444
[SENSe<Ch>:]GDEVice:MSLEct.....	1444
[SENSe<Ch>:]GDEVice:SELEct.....	1445
[SENSe<Ch>:]HARMonic:AUTO.....	1447
[SENSe<Ch>:]HARMonic:DLENgth:DATA.....	1447
[SENSe<Ch>:]HARMonic:ELENgth:DATA.....	1447
[SENSe<Ch>:]HARMonic:MLENgth:DATA.....	1447
[SENSe<Ch>:]HARMonic:PERMittivity:DATA.....	1448
[SENSe<Ch>:]HARMonic:RTIME:DATA.....	1448
[SENSe<Ch>:]HARMonic:RTIME:THReshold.....	1448
[SENSe<Ch>:]HARMonic:VELocity:DATA.....	1449
[SENSe<Ch>:]HARMonic?.....	1446
[SENSe<Ch>:]IFPath.....	1517
[SENSe<Ch>:]LPORT<LogPt>:ZCOMmon.....	1449
[SENSe<Ch>:]LPORT<LogPt>:ZDEFault[:STATE].....	1450
[SENSe<Ch>:]LPORT<LogPt>:ZDIFferent.....	1449
[SENSe<Ch>:]MSMode.....	1670
[SENSe<Ch>:]NFIGure:CALibration:GTIME.....	1453
[SENSe<Ch>:]NFIGure:CALibration:NTIME.....	1453
[SENSe<Ch>:]NFIGure:DEFine.....	1453
[SENSe<Ch>:]NFIGure:GTIME.....	1454
[SENSe<Ch>:]NFIGure:HARMonic[:MAXFrequency].....	1454
[SENSe<Ch>:]NFIGure:HARMonic[:MAXimumorder].....	1455
[SENSe<Ch>:]NFIGure:HARMonic[:MINFrequency].....	1454
[SENSe<Ch>:]NFIGure:HARMonic[:STATE].....	1455
[SENSe<Ch>:]NFIGure:IFConst.....	1455
[SENSe<Ch>:]NFIGure:IFConst:STATE.....	1455
[SENSe<Ch>:]NFIGure:NTIME.....	1456
[SENSe<Ch>:]NFIGure:QSET:ATTReceiver.....	1451
[SENSe<Ch>:]NFIGure:QSET:ATTSource.....	1451
[SENSe<Ch>:]NFIGure:QSET:DUT:ENFigure.....	1451
[SENSe<Ch>:]NFIGure:QSET:DUT:GAIN.....	1452
[SENSe<Ch>:]NFIGure:QSET:DUT:POWER.....	1452
[SENSe<Ch>:]NFIGure:QSET:TNOise.....	1452
[SENSe<Ch>:]NFIGure:QSET[:EXEC].....	1452
[SENSe<Ch>:]NFIGure:RFICorr.....	1456
[SENSe<Ch>:]NFIGure:TEATenuator.....	1457
[SENSe<Ch>:]NFIGure:VIRejection[:STATE].....	1457
[SENSe<Ch>:]PAMPliFier<Pt>[:STATE].....	1518

[SENSe<Ch>:]PAMPlifier2:VALue.....	1518
[SENSe<Ch>:]PATH<Pt>:DIRectaccess.....	1458
[SENSe<Ch>:]PATH<Pt>:IFINpath.....	1458
[SENSe<Ch>:]PATH<Pt>:IFOutauto.....	1459
[SENSe<Ch>:]PATH<Pt>:IFRequency.....	1459
[SENSe<Ch>:]PATH<Pt>:IFSWitch.....	1460
[SENSe<Ch>:]PATH<Pt>:MEASurement:DIRectaccess?.....	1461
[SENSe<Ch>:]PATH<Pt>:MEASurement:IFINpath?.....	1461
[SENSe<Ch>:]PATH<Pt>:MEASurement:IFOutauto?.....	1462
[SENSe<Ch>:]PATH<Pt>:MEASurement:IFRequency?.....	1462
[SENSe<Ch>:]PATH<Pt>:MEASurement:IFSWitch?.....	1462
[SENSe<Ch>:]PATH<Pt>:REFerence:DIRectaccess?.....	1461
[SENSe<Ch>:]PATH<Pt>:REFerence:IFINpath?.....	1461
[SENSe<Ch>:]PATH<Pt>:REFerence:IFOutauto?.....	1462
[SENSe<Ch>:]PATH<Pt>:REFerence:IFRequency?.....	1462
[SENSe<Ch>:]PATH<Pt>:REFerence:IFSWitch?.....	1462
[SENSe<Ch>:]PHASe:MODE.....	1519
[SENSe<Ch>:]PORT<PhyPt>:ZREFerence.....	1519
[SENSe<Ch>:]POWer:AGCMode<PhyPt>:MEASure.....	1463
[SENSe<Ch>:]POWer:ATTenuation.....	1464
[SENSe<Ch>:]POWer:GAINcontrol.....	1464
[SENSe<Ch>:]POWer:GAINcontrol:ALL.....	1465
[SENSe<Ch>:]POWer:GAINcontrol:GLOBal.....	1466
[SENSe<Ch>:]POWer:IFGain<PhyPt>:MEASure.....	1463
[SENSe<Ch>:]PPORt<PPort>:BSHift.....	1671
[SENSe<Ch>:]PRANge.....	1671
[SENSe<Ch>:]PULSe:ALC:MEASdelay.....	1467
[SENSe<Ch>:]PULSe:ATIME.....	1467
[SENSe<Ch>:]PULSe:COUPled[:STATe].....	1467
[SENSe<Ch>:]PULSe:DUTYcycle.....	1468
[SENSe<Ch>:]PULSe:FXDCycle[:STATe].....	1468
[SENSe<Ch>:]PULSe:GENerator:PERiod.....	1469
[SENSe<Ch>:]PULSe:GENerator:SOURce.....	1469
[SENSe<Ch>:]PULSe:GENerator:TRAI:PERiod.....	1470
[SENSe<Ch>:]PULSe:GENerator<Id>:DELay.....	1469
[SENSe<Ch>:]PULSe:GENerator<Id>:TRAI:DATA.....	1470
[SENSe<Ch>:]PULSe:GENerator<Id>:TRAI:DELete:ALL.....	1470
[SENSe<Ch>:]PULSe:GENerator<Id>:TRAI:SEGment<Seg>:COUNT.....	1470
[SENSe<Ch>:]PULSe:GENerator<Id>:TRAI:SEGment<Seg>:START.....	1471
[SENSe<Ch>:]PULSe:GENerator<Id>:TRAI:SEGment<Seg>:STATe.....	1471
[SENSe<Ch>:]PULSe:GENerator<Id>:TRAI:SEGment<Seg>:STOP.....	1471
[SENSe<Ch>:]PULSe:GENerator<Id>:TRAI[:STATe].....	1472
[SENSe<Ch>:]PULSe:GENerator<Id>:WIDTh.....	1472
[SENSe<Ch>:]PULSe:GENerator<Id>[:STATe].....	1469
[SENSe<Ch>:]PULSe:INTErnal[:STATe].....	1472
[SENSe<Ch>:]PULSe:MEASdelay.....	1472
[SENSe<Ch>:]PULSe:PERiod.....	1473
[SENSe<Ch>:]PULSe:PORT<Pt>:DELay.....	1473
[SENSe<Ch>:]PULSe:PORT<Pt>:EXTernal:INPut:INVerted[:STATe].....	1473
[SENSe<Ch>:]PULSe:PORT<Pt>:EXTernal:OUTPut:INVerted[:STATe].....	1474

[SENSe<Ch>:]PULSe:PORT<Pt>:EXTernal:OUTPut[:STATe].....	1474
[SENSe<Ch>:]PULSe:PORT<Pt>:WIDTh.....	1475
[SENSe<Ch>:]PULSe:PORT<Pt>[:STATe].....	1474
[SENSe<Ch>:]PULSe:SYNCron[:STATe].....	1475
[SENSe<Ch>:]PULSe[:STATe].....	1475
[SENSe<Ch>:]ROSCillator[:SOURce].....	1477
[SENSe<Ch>:]SEGment:COUNT?.....	1481
[SENSe<Ch>:]SEGment:NFIGure:VIRejection:STATe:CONTRol.....	1488
[SENSe<Ch>:]SEGment:POWer[:LEVel]:CONTRol.....	1492
[SENSe<Ch>:]SEGment<Seg>:ADD.....	1478
[SENSe<Ch>:]SEGment<Seg>:BWIDth[:RESolution].....	1479
[SENSe<Ch>:]SEGment<Seg>:BWIDth[:RESolution]:CONTRol.....	1479
[SENSe<Ch>:]SEGment<Seg>:BWIDth[:RESolution]:SElect.....	1480
[SENSe<Ch>:]SEGment<Seg>:BWIDth[:RESolution]:SElect:CONTRol.....	1480
[SENSe<Ch>:]SEGment<Seg>:CLEar.....	1716
[SENSe<Ch>:]SEGment<Seg>:DEFine.....	1482
[SENSe<Ch>:]SEGment<Seg>:DEFine:SElect.....	1483
[SENSe<Ch>:]SEGment<Seg>:DELeTe:ALL.....	1484
[SENSe<Ch>:]SEGment<Seg>:DELeTe[:DUMMy].....	1484
[SENSe<Ch>:]SEGment<Seg>:FREQuency:CENTer?.....	1484
[SENSe<Ch>:]SEGment<Seg>:FREQuency:SPAN?.....	1484
[SENSe<Ch>:]SEGment<Seg>:FREQuency:START.....	1485
[SENSe<Ch>:]SEGment<Seg>:FREQuency:STOP.....	1485
[SENSe<Ch>:]SEGment<Seg>:INSert.....	1485
[SENSe<Ch>:]SEGment<Seg>:INSert:SElect.....	1487
[SENSe<Ch>:]SEGment<Seg>:NFIGure:VIRejection[:STATe].....	1488
[SENSe<Ch>:]SEGment<Seg>:OVERlap.....	1717
[SENSe<Ch>:]SEGment<Seg>:PORT<PortId>:POWer[:LEVel].....	1489
[SENSe<Ch>:]SEGment<Seg>:PORT<PortId>[:STATe].....	1489
[SENSe<Ch>:]SEGment<Seg>:POWer:GAINcontrol.....	1490
[SENSe<Ch>:]SEGment<Seg>:POWer:GAINcontrol:ALL.....	1491
[SENSe<Ch>:]SEGment<Seg>:POWer:GAINcontrol:CONTRol.....	1491
[SENSe<Ch>:]SEGment<Seg>:POWer[:LEVel].....	1492
[SENSe<Ch>:]SEGment<Seg>:SWEep:DWELl.....	1494
[SENSe<Ch>:]SEGment<Seg>:SWEep:DWELl:CONTRol.....	1494
[SENSe<Ch>:]SEGment<Seg>:SWEep:POINts.....	1495
[SENSe<Ch>:]SEGment<Seg>:SWEep:TIME.....	1495
[SENSe<Ch>:]SEGment<Seg>:SWEep:TIME:CONTRol.....	1496
[SENSe<Ch>:]SEGment<Seg>:SWEep:TIME:SUM?.....	1497
[SENSe<Ch>:]SEGment<Seg>[:STATe].....	1493
[SENSe<Ch>:]SLAMode.....	1670
[SENSe<Ch>:]SPECTrum:DETEctor.....	1497
[SENSe<Ch>:]SPECTrum:IREJection.....	1498
[SENSe<Ch>:]SPECTrum:ZPADing.....	1498
[SENSe<Ch>:]SWEep:AXIS:FREQuency.....	1500
[SENSe<Ch>:]SWEep:AXIS:POWer.....	1501
[SENSe<Ch>:]SWEep:COUNT.....	1501
[SENSe<Ch>:]SWEep:CTIMing:CHANnel.....	1502
[SENSe<Ch>:]SWEep:CTIMing:CHANnel:MODE.....	1502
[SENSe<Ch>:]SWEep:CTIMing:COMPReSSion.....	1503

[SENSe<Ch>:]SWEep:CTIMing:COMPReSSion:MODE.....	1503
[SENSe<Ch>:]SWEep:CTIMing:MODE.....	1504
[SENSe<Ch>:]SWEep:CTIMing:OCHannel.....	1504
[SENSe<Ch>:]SWEep:CTIMing:OCHannel:MODE.....	1504
[SENSe<Ch>:]SWEep:CTIMing:PORT:MAX.....	1505
[SENSe<Ch>:]SWEep:CTIMing:PORT:MAX:MODE.....	1505
[SENSe<Ch>:]SWEep:CTIMing:PORT:MIN.....	1505
[SENSe<Ch>:]SWEep:CTIMing:PORT:MIN:MODE.....	1506
[SENSe<Ch>:]SWEep:CTIMing:SEGMENT.....	1506
[SENSe<Ch>:]SWEep:CTIMing:SEGMENT:MODE.....	1507
[SENSe<Ch>:]SWEep:CTIMing:STIME.....	1507
[SENSe<Ch>:]SWEep:CTIMing:STIME:MAX.....	1508
[SENSe<Ch>:]SWEep:CTIMing:STIME:MIN.....	1508
[SENSe<Ch>:]SWEep:CTIMing:STIME:MODE.....	1507
[SENSe<Ch>:]SWEep:CTIMing:VISualize.....	1509
[SENSe<Ch>:]SWEep:DETEctor:TIME.....	1509
[SENSe<Ch>:]SWEep:DWELL.....	1509
[SENSe<Ch>:]SWEep:DWELL:IPoint.....	1510
[SENSe<Ch>:]SWEep:FPOWER.....	1510
[SENSe<Ch>:]SWEep:GENeration.....	1511
[SENSe<Ch>:]SWEep:POINts.....	1511
[SENSe<Ch>:]SWEep:REVerse.....	1512
[SENSe<Ch>:]SWEep:SPACing.....	1717
[SENSe<Ch>:]SWEep:STEP.....	1513
[SENSe<Ch>:]SWEep:TIME.....	1514
[SENSe<Ch>:]SWEep:TIME:AUTO.....	1514
[SENSe<Ch>:]SWEep:TIME:MODE.....	1515
[SENSe<Ch>:]SWEep:TYPE.....	1515
[SENSe<Chn>:]CORRection:PSState?.....	1421
[SENSe<Chn>:]CORRection:SSState?.....	1421
[SENSe<Chn>:]FREQuency:MDELay:MSState?.....	1667
[SENSe<Chn>:]FUNction[:ON].....	1717
[SENSe<Chn>:]SWEep:SRCPort.....	1512
CALCulate:CALValidate:AVERage[:STATE].....	973
CALCulate:CALValidate:CHARacteriza.....	973
CALCulate:CALValidate:FORMat.....	973
CALCulate:CALValidate:RESPonse:IMAGinary:LOWer.....	973
CALCulate:CALValidate:RESPonse:IMAGinary:UPPer.....	973
CALCulate:CALValidate:RESPonse:MAGNitude:LOWer.....	973
CALCulate:CALValidate:RESPonse:MAGNitude:UPPer.....	973
CALCulate:CALValidate:RESPonse:PHASe:LOWer.....	974
CALCulate:CALValidate:RESPonse:PHASe:UPPer.....	974
CALCulate:CALValidate:RESPonse:PRESet.....	974
CALCulate:CALValidate:RESPonse:REAL:LOWer.....	974
CALCulate:CALValidate:RESPonse:REAL:UPPer.....	974
CALCulate:CALValidate:RUN.....	974
CALCulate:CALValidate:RUN:RESult?.....	974
CALCulate:CALValidate:STANdard.....	975
CALCulate:CLIMits:FAIL?.....	1196
CALCulate:DATA:ALL?.....	978

CALCulate:DATA:DALL?	981
CALCulate:DATA:TRACe	984
CALCulate:FILTer[:GATE]:TIME:AOFFset	1012
CALCulate:FMODEl:DEASsistant:COUPon:LEFT:CLEar	1018
CALCulate:FMODEl:DEASsistant:COUPon:LEFT:FILE	1018
CALCulate:FMODEl:DEASsistant:COUPon:LEFT:MEASure	1018
CALCulate:FMODEl:DEASsistant:COUPon:LEFT:PORT	1019
CALCulate:FMODEl:DEASsistant:COUPon:LEFT:TYPE	1019
CALCulate:FMODEl:DEASsistant:COUPon:RIGHT:CLEar	1018
CALCulate:FMODEl:DEASsistant:COUPon:RIGHT:FILE	1018
CALCulate:FMODEl:DEASsistant:COUPon:RIGHT:MEASure	1018
CALCulate:FMODEl:DEASsistant:COUPon:RIGHT:PORT	1019
CALCulate:FMODEl:DEASsistant:COUPon:RIGHT:TYPE	1019
CALCulate:FMODEl:DEASsistant:DUT:MEASure	1020
CALCulate:FMODEl:DEASsistant:DUT:PORT	1020
CALCulate:FMODEl:DEASsistant:DUT:TYPE	1021
CALCulate:FMODEl:DEASsistant:FIXTure:RIGHT:TYPE	1022
CALCulate:FMODEl:DEASsistant:IMPCorrect	1022
CALCulate:FMODEl:DEASsistant:PRESet	1022
CALCulate:FMODEl:DEASsistant:RUN	1022
CALCulate:FMODEl:DEASsistant:SAMCoupon	1023
CALCulate:FMODEl:DEASsistant:TOOL	1023
CALCulate:FMODEl:DEASsistant<Ph_pt>:FIXTure:LEFT:TYPE	1022
CALCulate:FMODEl:DELT:DIRectory	1024
CALCulate:FMODEl:DELT:DIRectory:DEFault	1025
CALCulate:FMODEl:DELT:FREQuencies:CURRent:COUNT?	1025
CALCulate:FMODEl:DELT:FREQuencies:CURRent?	1025
CALCulate:FMODEl:DELT:FREQuencies:DEFault:COUNT?	1026
CALCulate:FMODEl:DELT:FREQuencies:DEFault?	1025
CALCulate:FMODEl:DELT:FREQuencies:USEDefault	1026
CALCulate:FMODEl:DELT:FREQuencies:USER:ADD	1026
CALCulate:FMODEl:DELT:FREQuencies:USER:COUNT?	1027
CALCulate:FMODEl:DELT:FREQuencies:USER:DELeTe	1026
CALCulate:FMODEl:DELT:FREQuencies:USER:DELeTe:ALL	1027
CALCulate:FMODEl:DELT:FREQuencies:USER?	1026
CALCulate:FMODEl:DELT:M1L:CAChE:CLEar:ALL	1027
CALCulate:FMODEl:DELT:M1L:CAChE:CLEar:SELEcted	1028
CALCulate:FMODEl:DELT:M1L:DIFFmode	1028
CALCulate:FMODEl:DELT:M1L:FILEname	1028
CALCulate:FMODEl:DELT:M1L:LENGth	1029
CALCulate:FMODEl:DELT:M1L:MEASure	1029
CALCulate:FMODEl:DELT:M2L:FILEname	1028
CALCulate:FMODEl:DELT:M2L:LENGth	1029
CALCulate:FMODEl:DELT:M2L:MEASure	1029
CALCulate:FMODEl:DELT:M3L:FILEname	1028
CALCulate:FMODEl:DELT:M3L:LENGth	1029
CALCulate:FMODEl:DELT:M3L:MEASure	1029
CALCulate:FMODEl:DELT:MEASurement	1030
CALCulate:FMODEl:DELT:METHod	1030
CALCulate:FMODEl:DELT:PORDer	1030

CALCulate:FModel:DELT:RUN.....	1030
CALCulate:FModel:DELT:SWEep:CONTRol.....	1031
CALCulate:FModel:DELT:SWEep:CONTRol:BWIDth[:RESolution]:DREDuction.....	1031
CALCulate:FModel:DELT:SWEep:CONTRol:IFBW?.....	1031
CALCulate:FModel:DELT:SWEep:CONTRol:STEP?.....	1032
CALCulate:FModel:DELT:SWEep:FREQuency:MAXimum.....	1032
CALCulate:FModel:DELT:SWEep:FREQuency:MINimum.....	1032
CALCulate:FModel:DELT:TCONfig.....	1032
CALCulate:FModel:DELT:TDR.....	1033
CALCulate:FModel:DELT<Ph_pt>:M1L[:STATe].....	1029
CALCulate:FModel:DELT<Ph_pt>:M2L[:STATe].....	1029
CALCulate:FModel:DELT<Ph_pt>:M3L[:STATe].....	1029
CALCulate:FModel:DIRectory.....	1051
CALCulate:FModel:DIRectory:DEFault.....	1052
CALCulate:FModel:DIRectory:DEFault:CLEar.....	1052
CALCulate:FModel:EZD:COUPon:MEASure.....	1033
CALCulate:FModel:EZD:COUPon:MEASure:FILEname.....	1034
CALCulate:FModel:EZD:COUPon:MEASure:FILEname:CLEar.....	1034
CALCulate:FModel:EZD:DCEXtrapolat.....	1034
CALCulate:FModel:EZD:DUT:MEASure.....	1035
CALCulate:FModel:EZD:DUT:MEASure:FILEname.....	1035
CALCulate:FModel:EZD:DUT:MEASure:FILEname:CLEar.....	1035
CALCulate:FModel:EZD:GENerate:SIDE<1 2>.....	1036
CALCulate:FModel:EZD:IMPedance.....	1036
CALCulate:FModel:EZD:IMPedance:BWIDlimit.....	1036
CALCulate:FModel:EZD:IMPedance:REFerence.....	1037
CALCulate:FModel:EZD:PORT:ORDer.....	1037
CALCulate:FModel:EZD:PRESet.....	1037
CALCulate:FModel:EZD:RUN:RUN.....	1037
CALCulate:FModel:EZD<Ph_pt>:COUPon[:STATe].....	1034
CALCulate:FModel:EZD<Ph_pt>:DUT[:STATe].....	1035
CALCulate:FModel:EZD<Pt>:RUN[:STATe].....	1038
CALCulate:FModel:ISD:ATTenuation:BEHavior.....	1039
CALCulate:FModel:ISD:COUPon:MEASure.....	1039
CALCulate:FModel:ISD:COUPon:MEASure:FILEname.....	1039
CALCulate:FModel:ISD:COUPon:MEASure:FILEname:CLEar.....	1040
CALCulate:FModel:ISD:COUPon:MEASure:OPEN.....	1040
CALCulate:FModel:ISD:COUPon:MEASure:OPEN:FILEname.....	1040
CALCulate:FModel:ISD:COUPon:MEASure:SHORT.....	1040
CALCulate:FModel:ISD:COUPon:MEASure:SHORT:FILEname.....	1040
CALCulate:FModel:ISD:COUPon:TYPE.....	1041
CALCulate:FModel:ISD:DCEXtrapolat.....	1041
CALCulate:FModel:ISD:DUT:MEASure.....	1042
CALCulate:FModel:ISD:DUT:MEASure:FILEname.....	1042
CALCulate:FModel:ISD:DUT:MEASure:FILEname:CLEar.....	1042
CALCulate:FModel:ISD:DUT:TYPE.....	1042
CALCulate:FModel:ISD:FTIME:DUT.....	1043
CALCulate:FModel:ISD:FTIME:OVERride.....	1043
CALCulate:FModel:ISD:IMPedance.....	1043
CALCulate:FModel:ISD:OPERation.....	1043

CALCulate:FModel:ISD:PASSivity.....	1044
CALCulate:FModel:ISD:PORT:ORDer.....	1044
CALCulate:FModel:ISD:PORT:SKIP.....	1044
CALCulate:FModel:ISD:PORT:SKIP:LEFT.....	1045
CALCulate:FModel:ISD:PORT:SKIP:NONE.....	1045
CALCulate:FModel:ISD:PORT:SKIP:RIGHT.....	1045
CALCulate:FModel:ISD:PRESet.....	1045
CALCulate:FModel:ISD:RUN:RUN.....	1045
CALCulate:FModel:ISD:SCALe:ATTenuation.....	1046
CALCulate:FModel:ISD:SCALe:FREQUency.....	1046
CALCulate:FModel:ISD:SCALe:FTIME.....	1046
CALCulate:FModel:ISD:SMALlfixtUre.....	1046
CALCulate:FModel:ISD:TRACe:COUPling.....	1047
CALCulate:FModel:ISD<Ph_pt>:COUPon[:STATe].....	1041
CALCulate:FModel:ISD<Ph_pt>:DUT[:STATe].....	1042
CALCulate:FModel:ISD<Pt>:RUN[:STATe].....	1046
CALCulate:FModel:REName.....	1052
CALCulate:FModel:SFD:AUTO.....	1047
CALCulate:FModel:SFD:COUPon:MEASure.....	1048
CALCulate:FModel:SFD:COUPon:MEASure:FILEname.....	1048
CALCulate:FModel:SFD:COUPon:MEASure:FILEname:CLEar.....	1048
CALCulate:FModel:SFD:COUPon:TYPE.....	1049
CALCulate:FModel:SFD:DIFFcFg.....	1049
CALCulate:FModel:SFD:DUT:MEASure.....	1049
CALCulate:FModel:SFD:DUT:MEASure:FILEname.....	1049
CALCulate:FModel:SFD:DUT:MEASure:FILEname:CLEar.....	1050
CALCulate:FModel:SFD:IMPedance.....	1050
CALCulate:FModel:SFD:PRESet.....	1050
CALCulate:FModel:SFD:RUN:RUN.....	1050
CALCulate:FModel:SFD:TOTALdiffcFg.....	1051
CALCulate:FModel:SFD<Ph_pt>:COUPon[:STATe].....	1048
CALCulate:FModel:SFD<Ph_pt>:DUT[:STATe].....	1050
CALCulate:FModel:SFD<Ph_pt>:RUN[:STATe].....	1051
CALCulate:LIMit:CIRClE:FAIL:ALL?.....	1057
CALCulate:LIMit:FAIL:ALL?.....	1063
CALCulate:LIMit:FAIL:DATA?.....	1063
CALCulate:LIMit:POINts:LOWer?.....	1066
CALCulate:LIMit:POINts:UPPer?.....	1066
CALCulate:MARKer:COUPled:TYPE.....	1076
CALCulate:MARKer:COUPled[:STATe].....	1076
CALCulate:MARKer:FUNCTion:BWIDth:GMCenter.....	1080
CALCulate:PARAmeter:DELeTe:ALL.....	1104
CALCulate:PARAmeter:DELeTe:MEMory.....	1105
CALCulate:RIPlle:DISPlay:RESult:ALL[:STATe].....	1114
CALCulate:RIPlle:FAIL:ALL?.....	1115
CALCulate:TDVSwr[:STATe].....	1202
CALCulate<Ch>:DATA:CALL.....	979
CALCulate<Ch>:DATA:CALL:CATalog?.....	980
CALCulate<Ch>:DATA:CHANnel:ALL?.....	980
CALCulate<Ch>:DATA:CHANnel:DALL?.....	980

CALCulate<Ch>:DATA:MDATA:INTERpolate.....	981
CALCulate<Ch>:DATA:SGROUP?.....	983
CALCulate<Ch>:PARAMeter:CATalog:SENDED?.....	1102
CALCulate<Ch>:PARAMeter:CATalog?.....	1101
CALCulate<Ch>:PARAMeter:DEFine.....	1699
CALCulate<Ch>:PARAMeter:DEFine:SGROUP.....	1102
CALCulate<Ch>:PARAMeter:DELeTe.....	1103
CALCulate<Ch>:PARAMeter:DELeTe:CALL.....	1104
CALCulate<Ch>:PARAMeter:DELeTe:CMEMory.....	1104
CALCulate<Ch>:PARAMeter:DELeTe:SGROUP.....	1105
CALCulate<Ch>:PARAMeter:MEASure.....	1105
CALCulate<Ch>:PARAMeter:MEASure:SENDED.....	1106
CALCulate<Ch>:PARAMeter:SDEFine.....	1106
CALCulate<Ch>:PARAMeter:SDEFine:SENDED.....	1110
CALCulate<Ch>:PARAMeter:SELeCt.....	1111
CALCulate<Ch>:TDIF:IMBalance:COMPensation[:STATe].....	1201
CALCulate<Ch>:TRANSform:VNETworks:BALanced:DEEMbedding<LogPt>:PARAMeters:C<Cmp>.....	1152
CALCulate<Ch>:TRANSform:VNETworks:BALanced:DEEMbedding<LogPt>:PARAMeters:DATA<Port>..	1153
CALCulate<Ch>:TRANSform:VNETworks:BALanced:DEEMbedding<LogPt>:PARAMeters:G<Cmp>.....	1154
CALCulate<Ch>:TRANSform:VNETworks:BALanced:DEEMbedding<LogPt>:PARAMeters:L<Cmp>.....	1155
CALCulate<Ch>:TRANSform:VNETworks:BALanced:DEEMbedding<LogPt>:PARAMeters:R<Cmp>.....	1155
CALCulate<Ch>:TRANSform:VNETworks:BALanced:DEEMbedding<LogPt>:TNDefinition.....	1157
CALCulate<Ch>:TRANSform:VNETworks:BALanced:DEEMbedding<LogPt>[:STATe].....	1156
CALCulate<Ch>:TRANSform:VNETworks:BALanced:EMBedding<LogPt>:PARAMeters:C<Cmp>.....	1157
CALCulate<Ch>:TRANSform:VNETworks:BALanced:EMBedding<LogPt>:PARAMeters:DATA<Port>.....	1158
CALCulate<Ch>:TRANSform:VNETworks:BALanced:EMBedding<LogPt>:PARAMeters:G<Cmp>.....	1159
CALCulate<Ch>:TRANSform:VNETworks:BALanced:EMBedding<LogPt>:PARAMeters:L<Cmp>.....	1159
CALCulate<Ch>:TRANSform:VNETworks:BALanced:EMBedding<LogPt>:PARAMeters:R<Cmp>.....	1160
CALCulate<Ch>:TRANSform:VNETworks:BALanced:EMBedding<LogPt>:TNDefinition.....	1162
CALCulate<Ch>:TRANSform:VNETworks:BALanced:EMBedding<LogPt>[:STATe].....	1161
CALCulate<Ch>:TRANSform:VNETworks:DIFFerential:EMBedding<LogPt>:PARAMeters:C<Cmp>.....	1162
CALCulate<Ch>:TRANSform:VNETworks:DIFFerential:EMBedding<LogPt>:PARAMeters:DATA.....	1162
CALCulate<Ch>:TRANSform:VNETworks:DIFFerential:EMBedding<LogPt>:PARAMeters:G<Cmp>.....	1163
CALCulate<Ch>:TRANSform:VNETworks:DIFFerential:EMBedding<LogPt>:PARAMeters:L<Cmp>.....	1164
CALCulate<Ch>:TRANSform:VNETworks:DIFFerential:EMBedding<LogPt>:PARAMeters:R<Cmp>.....	1164
CALCulate<Ch>:TRANSform:VNETworks:DIFFerential:EMBedding<LogPt>:TNDefinition.....	1165
CALCulate<Ch>:TRANSform:VNETworks:DIFFerential:EMBedding<LogPt>[:STATe].....	1165
CALCulate<Ch>:TRANSform:VNETworks:FSIMulator[:STATe].....	1165
CALCulate<Ch>:TRANSform:VNETworks:GLOop:DEEMbedding<group>:PARAMeters:C.....	1166
CALCulate<Ch>:TRANSform:VNETworks:GLOop:DEEMbedding<group>:PARAMeters:G.....	1166
CALCulate<Ch>:TRANSform:VNETworks:GLOop:DEEMbedding<group>:PARAMeters:L.....	1167
CALCulate<Ch>:TRANSform:VNETworks:GLOop:DEEMbedding<group>:PARAMeters:R.....	1168
CALCulate<Ch>:TRANSform:VNETworks:GLOop:DEEMbedding<group>:TNDefinition.....	1169
CALCulate<Ch>:TRANSform:VNETworks:GLOop:DEEMbedding<group>[:STATe].....	1168
CALCulate<Ch>:TRANSform:VNETworks:GLOop:EMBedding<group>:PARAMeters:C.....	1169
CALCulate<Ch>:TRANSform:VNETworks:GLOop:EMBedding<group>:PARAMeters:G.....	1170
CALCulate<Ch>:TRANSform:VNETworks:GLOop:EMBedding<group>:PARAMeters:L.....	1171
CALCulate<Ch>:TRANSform:VNETworks:GLOop:EMBedding<group>:PARAMeters:R.....	1171
CALCulate<Ch>:TRANSform:VNETworks:GLOop:EMBedding<group>:TNDefinition.....	1173
CALCulate<Ch>:TRANSform:VNETworks:GLOop:EMBedding<group>[:STATe].....	1172

CALCulate<Ch>:TRANSform:VNETworks:GLOop:GROup.....	1173
CALCulate<Ch>:TRANSform:VNETworks:PPAir:DEEMbedding:DELeTe.....	1174
CALCulate<Ch>:TRANSform:VNETworks:PPAir:DEEMbedding<ListId>:DEFine.....	1174
CALCulate<Ch>:TRANSform:VNETworks:PPAir:DEEMbedding<ListId>:PARAmeters:C<1 2 3>.....	1174
CALCulate<Ch>:TRANSform:VNETworks:PPAir:DEEMbedding<ListId>:PARAmeters:G<1 2 3>.....	1175
CALCulate<Ch>:TRANSform:VNETworks:PPAir:DEEMbedding<ListId>:PARAmeters:L<1 2 3>.....	1176
CALCulate<Ch>:TRANSform:VNETworks:PPAir:DEEMbedding<ListId>:PARAmeters:R<1 2 3>.....	1177
CALCulate<Ch>:TRANSform:VNETworks:PPAir:DEEMbedding<ListId>:TNDefinition.....	1178
CALCulate<Ch>:TRANSform:VNETworks:PPAir:DEEMbedding<ListId>[:STATe].....	1177
CALCulate<Ch>:TRANSform:VNETworks:PPAir:EMBedding<ListId>:DEFine.....	1178
CALCulate<Ch>:TRANSform:VNETworks:PPAir:EMBedding<ListId>:DELeTe.....	1179
CALCulate<Ch>:TRANSform:VNETworks:PPAir:EMBedding<ListId>:PARAmeters:C<1 2 3>.....	1179
CALCulate<Ch>:TRANSform:VNETworks:PPAir:EMBedding<ListId>:PARAmeters:G<1 2 3>.....	1181
CALCulate<Ch>:TRANSform:VNETworks:PPAir:EMBedding<ListId>:PARAmeters:L<1 2 3>.....	1180
CALCulate<Ch>:TRANSform:VNETworks:PPAir:EMBedding<ListId>:PARAmeters:R<1 2 3>.....	1181
CALCulate<Ch>:TRANSform:VNETworks:PPAir:EMBedding<ListId>:TNDefinition.....	1183
CALCulate<Ch>:TRANSform:VNETworks:PPAir:EMBedding<ListId>[:STATe].....	1182
CALCulate<Ch>:TRANSform:VNETworks:PSET:DEEMbedding<ListId>:DEFine.....	1183
CALCulate<Ch>:TRANSform:VNETworks:PSET:EMBedding<ListId>:DEFine.....	1183
CALCulate<Ch>:TRANSform:VNETworks:SENDEd:DEEMbedding<PhyPt>:PARAmeters:C<Cmp>.....	1184
CALCulate<Ch>:TRANSform:VNETworks:SENDEd:DEEMbedding<PhyPt>:PARAmeters:DATA.....	1184
CALCulate<Ch>:TRANSform:VNETworks:SENDEd:DEEMbedding<PhyPt>:PARAmeters:G<Cmp>.....	1185
CALCulate<Ch>:TRANSform:VNETworks:SENDEd:DEEMbedding<PhyPt>:PARAmeters:L<Cmp>.....	1186
CALCulate<Ch>:TRANSform:VNETworks:SENDEd:DEEMbedding<PhyPt>:PARAmeters:R<Cmp>.....	1187
CALCulate<Ch>:TRANSform:VNETworks:SENDEd:DEEMbedding<PhyPt>:TNDefinition.....	1188
CALCulate<Ch>:TRANSform:VNETworks:SENDEd:DEEMbedding<PhyPt>[:STATe].....	1187
CALCulate<Ch>:TRANSform:VNETworks:SENDEd:EMBedding<PhyPt>:PARAmeters:C<Cmp>.....	1188
CALCulate<Ch>:TRANSform:VNETworks:SENDEd:EMBedding<PhyPt>:PARAmeters:DATA.....	1189
CALCulate<Ch>:TRANSform:VNETworks:SENDEd:EMBedding<PhyPt>:PARAmeters:G<Cmp>.....	1190
CALCulate<Ch>:TRANSform:VNETworks:SENDEd:EMBedding<PhyPt>:PARAmeters:L<Cmp>.....	1190
CALCulate<Ch>:TRANSform:VNETworks:SENDEd:EMBedding<PhyPt>:PARAmeters:R<Cmp>.....	1191
CALCulate<Ch>:TRANSform:VNETworks:SENDEd:EMBedding<PhyPt>:TNDefinition.....	1192
CALCulate<Ch>:TRANSform:VNETworks:SENDEd:EMBedding<PhyPt>[:STATe].....	1192
CALCulate<Ch>:TRANSform:VNETworks:WAVes.....	1193
CALCulate<Chn>:DATA.....	975
CALCulate<Chn>:DATA:NSWeep:COUNT?.....	981
CALCulate<Chn>:DATA:NSWeep:FIRST?.....	982
CALCulate<Chn>:DATA:NSWeep[:LAST]?.....	983
CALCulate<Chn>:DATA:STIMulus?.....	984
CALCulate<Chn>:DLINe.....	1197
CALCulate<Chn>:DLINe:STATe.....	1197
CALCulate<Chn>:DTIME:DATA?.....	985
CALCulate<Chn>:DTIME:LIMit:FAIL:BEEP.....	986
CALCulate<Chn>:DTIME:LIMit:FAIL?.....	985
CALCulate<Chn>:DTIME:LIMit:LIMit.....	986
CALCulate<Chn>:DTIME:LIMit:STATe.....	986
CALCulate<Chn>:DTIME:POSition.....	987
CALCulate<Chn>:DTIME:STATe.....	987
CALCulate<Chn>:DTIME:TARGet.....	987
CALCulate<Chn>:EYE:DUT:MODE.....	989

CALCulate<Chn>:EYE:EMPHasis:CURSor:POST<1 2>.....	989
CALCulate<Chn>:EYE:EMPHasis:CURSor:PRE.....	990
CALCulate<Chn>:EYE:EMPHasis:STATe.....	990
CALCulate<Chn>:EYE:EQUalization:CTLE:DC.....	990
CALCulate<Chn>:EYE:EQUalization:CTLE:POLE<1 2>.....	991
CALCulate<Chn>:EYE:EQUalization:CTLE:ZERO.....	991
CALCulate<Chn>:EYE:EQUalization:STATe.....	992
CALCulate<Chn>:EYE:INPut:BPATtern:TYPE.....	992
CALCulate<Chn>:EYE:INPut:DRATe.....	992
CALCulate<Chn>:EYE:INPut:LENGth:BITS.....	993
CALCulate<Chn>:EYE:INPut:LENGth:PRBS.....	993
CALCulate<Chn>:EYE:INPut:MODulation.....	994
CALCulate<Chn>:EYE:INPut:OLEVel.....	994
CALCulate<Chn>:EYE:INPut:RTIME:DATA.....	995
CALCulate<Chn>:EYE:INPut:RTIME:THReshold.....	995
CALCulate<Chn>:EYE:INPut:XRATe.....	994
CALCulate<Chn>:EYE:INPut:ZLEVel.....	994
CALCulate<Chn>:EYE:JITTer:DIRac:DELTA.....	995
CALCulate<Chn>:EYE:JITTer:DIRac:PROBability.....	996
CALCulate<Chn>:EYE:JITTer:PERiodic:FREQuency.....	996
CALCulate<Chn>:EYE:JITTer:PERiodic:MAGNitude.....	997
CALCulate<Chn>:EYE:JITTer:PERiodic:PHASe.....	997
CALCulate<Chn>:EYE:JITTer:RANDom:STDDeviation.....	997
CALCulate<Chn>:EYE:JITTer:STATe.....	998
CALCulate<Chn>:EYE:JITTer:TYPE:DIRac.....	998
CALCulate<Chn>:EYE:JITTer:TYPE:PERiodic.....	999
CALCulate<Chn>:EYE:JITTer:TYPE:RANDom.....	999
CALCulate<Chn>:EYE:JITTer:TYPE:USER.....	1000
CALCulate<Chn>:EYE:MASK:AUTO.....	1000
CALCulate<Chn>:EYE:MASK:CENTer:HORizontal.....	1000
CALCulate<Chn>:EYE:MASK:CENTer:VERTical.....	1001
CALCulate<Chn>:EYE:MASK:DATA?.....	1001
CALCulate<Chn>:EYE:MASK:FAIL:BEEP.....	1003
CALCulate<Chn>:EYE:MASK:FAIL:CONDition.....	1003
CALCulate<Chn>:EYE:MASK:FAIL?.....	1002
CALCulate<Chn>:EYE:MASK:SHAPe:BOTTom:HORizontal.....	1004
CALCulate<Chn>:EYE:MASK:SHAPe:BOTTom:STATe.....	1004
CALCulate<Chn>:EYE:MASK:SHAPe:BOTTom:VERTical.....	1004
CALCulate<Chn>:EYE:MASK:SHAPe:POLYgon:HORizontal.....	1005
CALCulate<Chn>:EYE:MASK:SHAPe:POLYgon:STATe.....	1004
CALCulate<Chn>:EYE:MASK:SHAPe:POLYgon:TYPE.....	1005
CALCulate<Chn>:EYE:MASK:SHAPe:POLYgon:VERTical.....	1006
CALCulate<Chn>:EYE:MASK:SHAPe:TOP:HORizontal.....	1004
CALCulate<Chn>:EYE:MASK:SHAPe:TOP:STATe.....	1004
CALCulate<Chn>:EYE:MASK:SHAPe:TOP:VERTical.....	1004
CALCulate<Chn>:EYE:MASK:SHOW.....	1006
CALCulate<Chn>:EYE:MASK:STATe.....	1006
CALCulate<Chn>:EYE:MASK:VIOLation:RATE.....	1007
CALCulate<Chn>:EYE:MASK:VIOLation:TOLerance.....	1007
CALCulate<Chn>:EYE:MEASurement:DATA?.....	1007

CALCulate<Chn>:EYE:MEASurement:STATe.....	1009
CALCulate<Chn>:EYE:MEASurement:TTIME:THReshold.....	1009
CALCulate<Chn>:EYE:NOISe:RMS.....	1009
CALCulate<Chn>:EYE:NOISe:STATe.....	1010
CALCulate<Chn>:EYE:STATe.....	1010
CALCulate<Chn>:EYE:STIMulus:ENCOder.....	1010
CALCulate<Chn>:EYE:STIMulus:LOWPass.....	1011
CALCulate<Chn>:EYE:STIMulus:SCRambler.....	1011
CALCulate<Chn>:EYE:VIEW.....	1011
CALCulate<Chn>:FILTer[:GATE]:TIME:CENTer.....	1013
CALCulate<Chn>:FILTer[:GATE]:TIME:DCHebyshev.....	1013
CALCulate<Chn>:FILTer[:GATE]:TIME:LINK.....	1014
CALCulate<Chn>:FILTer[:GATE]:TIME:SHApe.....	1014
CALCulate<Chn>:FILTer[:GATE]:TIME:SHOW.....	1015
CALCulate<Chn>:FILTer[:GATE]:TIME:SPAN.....	1015
CALCulate<Chn>:FILTer[:GATE]:TIME:STARt.....	1015
CALCulate<Chn>:FILTer[:GATE]:TIME:STATe.....	1016
CALCulate<Chn>:FILTer[:GATE]:TIME:STOP.....	1015
CALCulate<Chn>:FILTer[:GATE]:TIME:WINDow.....	1017
CALCulate<Chn>:FILTer[:GATE]:TIME[:TYPE].....	1016
CALCulate<Chn>:FORMat.....	1197
CALCulate<Chn>:FORMat:WQPNormal.....	1670
CALCulate<Chn>:FORMat:WQUType.....	1199
CALCulate<Chn>:GDAPerture:SCOunt.....	1199
CALCulate<Chn>:IAverage:MODE.....	1199
CALCulate<Chn>:IAverage[:STATe].....	1200
CALCulate<Chn>:LDEVIation:AUTO.....	1052
CALCulate<Chn>:LDEVIation:CONStant.....	1053
CALCulate<Chn>:LDEVIation:ELENgth.....	1053
CALCulate<Chn>:LDEVIation:MODE.....	1054
CALCulate<Chn>:LDEVIation:SLOPe.....	1054
CALCulate<Chn>:LIMit:CIRClE:CLEar.....	1055
CALCulate<Chn>:LIMit:CIRClE:DATA.....	1056
CALCulate<Chn>:LIMit:CIRClE:DISPlay[:STATe].....	1056
CALCulate<Chn>:LIMit:CIRClE:FAIL?.....	1057
CALCulate<Chn>:LIMit:CIRClE:SOUNd[:STATe].....	1057
CALCulate<Chn>:LIMit:CIRClE[:STATe].....	1057
CALCulate<Chn>:LIMit:CLEar.....	1058
CALCulate<Chn>:LIMit:CONTRol:DOMain.....	1696
CALCulate<Chn>:LIMit:CONTRol:SHIFt.....	1059
CALCulate<Chn>:LIMit:CONTRol[:DATA].....	1058
CALCulate<Chn>:LIMit:DATA.....	1059
CALCulate<Chn>:LIMit:DCIRclE:CLEar.....	1060
CALCulate<Chn>:LIMit:DCIRclE:DATA.....	1060
CALCulate<Chn>:LIMit:DCIRclE:DISPlay[:STATe].....	1061
CALCulate<Chn>:LIMit:DCIRclE[:STATe].....	1061
CALCulate<Chn>:LIMit:DELeTe:ALL.....	1061
CALCulate<Chn>:LIMit:DISPlay[:STATe].....	1062
CALCulate<Chn>:LIMit:FAIL?.....	1062
CALCulate<Chn>:LIMit:LOWer:FEED.....	1065

CALCulate<Chn>:LIMit:LOWer:SHIFt.....	1066
CALCulate<Chn>:LIMit:LOWer:STATe.....	1698
CALCulate<Chn>:LIMit:LOWer[:DATA].....	1063
CALCulate<Chn>:LIMit:RDOMain:COMPLex.....	1697
CALCulate<Chn>:LIMit:RDOMain:FORMat.....	1698
CALCulate<Chn>:LIMit:RDOMain:SPACing.....	1698
CALCulate<Chn>:LIMit:SEGMent:COUNT?.....	1068
CALCulate<Chn>:LIMit:SEGMent<Seg>:AMPLitude:START.....	1067
CALCulate<Chn>:LIMit:SEGMent<Seg>:AMPLitude:STOP.....	1067
CALCulate<Chn>:LIMit:SEGMent<Seg>:FORMula.....	1068
CALCulate<Chn>:LIMit:SEGMent<Seg>:FORMula:STATe.....	1069
CALCulate<Chn>:LIMit:SEGMent<Seg>:INTerpol.....	1069
CALCulate<Chn>:LIMit:SEGMent<Seg>:STIMulus:START.....	1070
CALCulate<Chn>:LIMit:SEGMent<Seg>:STIMulus:STOP.....	1070
CALCulate<Chn>:LIMit:SEGMent<Seg>:TYPE.....	1070
CALCulate<Chn>:LIMit:SOUNd[:STATe].....	1071
CALCulate<Chn>:LIMit:STATe.....	1071
CALCulate<Chn>:LIMit:STATe:AREA.....	1072
CALCulate<Chn>:LIMit:TTLout<Pt>[:STATe].....	1072
CALCulate<Chn>:LIMit:UPPer:FEED.....	1065
CALCulate<Chn>:LIMit:UPPer:SHIFt.....	1066
CALCulate<Chn>:LIMit:UPPer:STATe.....	1698
CALCulate<Chn>:LIMit:UPPer[:DATA].....	1063
CALCulate<Chn>:MARKer:DEFault:FORMat.....	1077
CALCulate<Chn>:MARKer:MPEak:EXCURsion.....	1087
CALCulate<Chn>:MARKer:MPEak:EXCURsion:STATe.....	1087
CALCulate<Chn>:MARKer:MPEak:THReshold.....	1087
CALCulate<Chn>:MARKer:MPEak:THReshold:STATe.....	1087
CALCulate<Chn>:MARKer:SEARch:BFILter:RESult[:STATe].....	1088
CALCulate<Chn>:MARKer:SEARch:BFILter:RESult[:STATe]:AREA.....	1089
CALCulate<Chn>:MARKer[:STATe]:AREA.....	1091
CALCulate<Chn>:MARKer<Mk>:AOFF.....	1074
CALCulate<Chn>:MARKer<Mk>:BWIDth.....	1075
CALCulate<Chn>:MARKer<Mk>:DELTA[:STATe].....	1079
CALCulate<Chn>:MARKer<Mk>:EXCURsion.....	1079
CALCulate<Chn>:MARKer<Mk>:EXCURsion:STATe.....	1079
CALCulate<Chn>:MARKer<Mk>:FORMat.....	1080
CALCulate<Chn>:MARKer<Mk>:FUNCTion:BWIDth.....	1700
CALCulate<Chn>:MARKer<Mk>:FUNCTion:BWIDth:MODE.....	1081
CALCulate<Chn>:MARKer<Mk>:FUNCTion:CENTer.....	1081
CALCulate<Chn>:MARKer<Mk>:FUNCTion:DELTA:STATe.....	1701
CALCulate<Chn>:MARKer<Mk>:FUNCTion:DOMain:USER:SHOW.....	1082
CALCulate<Chn>:MARKer<Mk>:FUNCTion:DOMain:USER:START.....	1083
CALCulate<Chn>:MARKer<Mk>:FUNCTion:DOMain:USER:STOP.....	1083
CALCulate<Chn>:MARKer<Mk>:FUNCTion:DOMain:USER[:RANGe].....	1082
CALCulate<Chn>:MARKer<Mk>:FUNCTion:EXECute.....	1083
CALCulate<Chn>:MARKer<Mk>:FUNCTion:RESult?.....	1084
CALCulate<Chn>:MARKer<Mk>:FUNCTion:SPAN.....	1085
CALCulate<Chn>:MARKer<Mk>:FUNCTion:SPECTrum.....	1085
CALCulate<Chn>:MARKer<Mk>:FUNCTion:START.....	1085

CALCulate<Chn>:MARKer<Mk>:FUNction:STOP.....	1085
CALCulate<Chn>:MARKer<Mk>:FUNction:TARGet.....	1702
CALCulate<Chn>:MARKer<Mk>:FUNction[:SELEct].....	1701
CALCulate<Chn>:MARKer<Mk>:MAXimum.....	1702
CALCulate<Chn>:MARKer<Mk>:MINimum.....	1702
CALCulate<Chn>:MARKer<Mk>:MODE.....	1086
CALCulate<Chn>:MARKer<Mk>:NAME.....	1088
CALCulate<Chn>:MARKer<Mk>:REFerence:EXCursion.....	1079
CALCulate<Chn>:MARKer<Mk>:REFerence:EXCursion:STATe.....	1079
CALCulate<Chn>:MARKer<Mk>:REFerence:FORMat.....	1080
CALCulate<Chn>:MARKer<Mk>:REFerence:FUNction:CENTer.....	1081
CALCulate<Chn>:MARKer<Mk>:REFerence:FUNction:DOMain:USER:SHOW.....	1082
CALCulate<Chn>:MARKer<Mk>:REFerence:FUNction:DOMain:USER:START.....	1083
CALCulate<Chn>:MARKer<Mk>:REFerence:FUNction:DOMain:USER:STOP.....	1083
CALCulate<Chn>:MARKer<Mk>:REFerence:FUNction:DOMain:USER[:RANGe].....	1082
CALCulate<Chn>:MARKer<Mk>:REFerence:FUNction:EXECute.....	1083
CALCulate<Chn>:MARKer<Mk>:REFerence:FUNction:RESult?.....	1084
CALCulate<Chn>:MARKer<Mk>:REFerence:FUNction:START.....	1085
CALCulate<Chn>:MARKer<Mk>:REFerence:FUNction:STOP.....	1085
CALCulate<Chn>:MARKer<Mk>:REFerence:FUNction:TARGet.....	1702
CALCulate<Chn>:MARKer<Mk>:REFerence:FUNction[:SELEct].....	1701
CALCulate<Chn>:MARKer<Mk>:REFerence:MAXimum.....	1702
CALCulate<Chn>:MARKer<Mk>:REFerence:MINimum.....	1702
CALCulate<Chn>:MARKer<Mk>:REFerence:MODE.....	1086
CALCulate<Chn>:MARKer<Mk>:REFerence:NAME.....	1088
CALCulate<Chn>:MARKer<Mk>:REFerence:SEARch:FORMat.....	1089
CALCulate<Chn>:MARKer<Mk>:REFerence:SEARch:LEFT.....	1703
CALCulate<Chn>:MARKer<Mk>:REFerence:SEARch:NEXT.....	1703
CALCulate<Chn>:MARKer<Mk>:REFerence:SEARch:RIGHT.....	1703
CALCulate<Chn>:MARKer<Mk>:REFerence:SEARch:TRACKing.....	1090
CALCulate<Chn>:MARKer<Mk>:REFerence:SEARch[:IMMEdiate].....	1703
CALCulate<Chn>:MARKer<Mk>:REFerence:TARGet.....	1092
CALCulate<Chn>:MARKer<Mk>:REFerence:THReshold.....	1092
CALCulate<Chn>:MARKer<Mk>:REFerence:THReshold:STATe.....	1093
CALCulate<Chn>:MARKer<Mk>:REFerence:TYPE.....	1093
CALCulate<Chn>:MARKer<Mk>:REFerence:X.....	1094
CALCulate<Chn>:MARKer<Mk>:REFerence:Y.....	1095
CALCulate<Chn>:MARKer<Mk>:REFerence[:STATe].....	1091
CALCulate<Chn>:MARKer<Mk>:SEARch:FORMat.....	1089
CALCulate<Chn>:MARKer<Mk>:SEARch:LEFT.....	1703
CALCulate<Chn>:MARKer<Mk>:SEARch:NEXT.....	1703
CALCulate<Chn>:MARKer<Mk>:SEARch:RIGHT.....	1703
CALCulate<Chn>:MARKer<Mk>:SEARch:TRACKing.....	1090
CALCulate<Chn>:MARKer<Mk>:SEARch[:IMMEdiate].....	1703
CALCulate<Chn>:MARKer<Mk>:TARGet.....	1092
CALCulate<Chn>:MARKer<Mk>:THReshold.....	1092
CALCulate<Chn>:MARKer<Mk>:THReshold:STATe.....	1093
CALCulate<Chn>:MARKer<Mk>:TYPE.....	1093
CALCulate<Chn>:MARKer<Mk>:X.....	1094
CALCulate<Chn>:MARKer<Mk>:Y.....	1095

CALCulate<Chn>:MARKer<Mk>[:STATe].....	1091
CALCulate<Chn>:MATH:FORMatted:FUNctIon.....	1098
CALCulate<Chn>:MATH:FORMatted:STATe.....	1100
CALCulate<Chn>:MATH:FORMatted[:EXPRession]:SDEFine.....	1097
CALCulate<Chn>:MATH:FUNctIon.....	1098
CALCulate<Chn>:MATH:MEMorize.....	1099
CALCulate<Chn>:MATH:STATe.....	1100
CALCulate<Chn>:MATH:WUNit[:STATe].....	1100
CALCulate<Chn>:MATH[:EXPRession]:SDEFine.....	1097
CALCulate<Chn>:MATH[:EXPRession][:DEFine].....	1704
CALCulate<Chn>:PHOLd.....	1200
CALCulate<Chn>:RIPPlE:CLEar.....	1112
CALCulate<Chn>:RIPPlE:CONTRol:DOMain.....	1112
CALCulate<Chn>:RIPPlE:DATA.....	1112
CALCulate<Chn>:RIPPlE:DELeTe:ALL.....	1113
CALCulate<Chn>:RIPPlE:DISPlay[:STATe].....	1114
CALCulate<Chn>:RIPPlE:FAIL?.....	1114
CALCulate<Chn>:RIPPlE:RDOMain:FORMat.....	1115
CALCulate<Chn>:RIPPlE:SEGMENT:COUNT?.....	1116
CALCulate<Chn>:RIPPlE:SEGMENT<Seg>:LIMit.....	1116
CALCulate<Chn>:RIPPlE:SEGMENT<Seg>:RESult?.....	1117
CALCulate<Chn>:RIPPlE:SEGMENT<Seg>:STIMulus:START.....	1118
CALCulate<Chn>:RIPPlE:SEGMENT<Seg>:STIMulus:STOP.....	1118
CALCulate<Chn>:RIPPlE:SEGMENT<Seg>[:STATe].....	1117
CALCulate<Chn>:RIPPlE:SOUND[:STATe].....	1118
CALCulate<Chn>:RIPPlE:STATe.....	1119
CALCulate<Chn>:RIPPlE:STATe:AREA.....	1119
CALCulate<Chn>:SMOothing:APERture.....	1201
CALCulate<Chn>:SMOothing[:STATe].....	1201
CALCulate<Chn>:STATistics:DOMain:USER.....	1120
CALCulate<Chn>:STATistics:DOMain:USER:SHOW.....	1121
CALCulate<Chn>:STATistics:DOMain:USER:START.....	1121
CALCulate<Chn>:STATistics:DOMain:USER:STOP.....	1121
CALCulate<Chn>:STATistics:EPDelay[:STATe].....	1121
CALCulate<Chn>:STATistics:FORMat.....	1122
CALCulate<Chn>:STATistics:MMPtPeak[:STATe].....	1121
CALCulate<Chn>:STATistics:MSTDdev[:STATe].....	1121
CALCulate<Chn>:STATistics:NLINear:COMP:LEVel.....	1122
CALCulate<Chn>:STATistics:NLINear:COMP:PHASe.....	1122
CALCulate<Chn>:STATistics:NLINear:COMP:RDOMain:USER.....	1123
CALCulate<Chn>:STATistics:NLINear:COMP:RDOMain:USER:SHOW.....	1123
CALCulate<Chn>:STATistics:NLINear:COMP:RDOMain:USER:START.....	1124
CALCulate<Chn>:STATistics:NLINear:COMP:RDOMain:USER:STOP.....	1124
CALCulate<Chn>:STATistics:NLINear:COMP:REFerence.....	1124
CALCulate<Chn>:STATistics:NLINear:COMP:RESult?.....	1124
CALCulate<Chn>:STATistics:NLINear:COMP:RLEVel.....	1125
CALCulate<Chn>:STATistics:NLINear:COMP:RMARker.....	1125
CALCulate<Chn>:STATistics:NLINear:COMP:RPHase.....	1126
CALCulate<Chn>:STATistics:NLINear:COMP[:STATe].....	1126
CALCulate<Chn>:STATistics:PRATio:RESult?.....	1127

CALCulate<Chn>:STATistics:PRATio[:STATe].....	1126
CALCulate<Chn>:STATistics:RDOMain:USER.....	1127
CALCulate<Chn>:STATistics:RDOMain:USER:SHOW.....	1128
CALCulate<Chn>:STATistics:RDOMain:USER:START.....	1128
CALCulate<Chn>:STATistics:RDOMain:USER:STOP.....	1128
CALCulate<Chn>:STATistics:RESult?.....	1128
CALCulate<Chn>:STATistics:RMS[:STATe].....	1129
CALCulate<Chn>:STATistics:SFLatness[:STATe].....	1129
CALCulate<Chn>:STATistics[:STATe].....	1129
CALCulate<Chn>:STATistics[:STATe]:AREA.....	1130
CALCulate<Chn>:TRANSform:COMPLex.....	1193
CALCulate<Chn>:TRANSform:DTFault:CENTer.....	1131
CALCulate<Chn>:TRANSform:DTFault:DEFine.....	1131
CALCulate<Chn>:TRANSform:DTFault:DELete.....	1132
CALCulate<Chn>:TRANSform:DTFault:PEAK:COUNT?.....	1133
CALCulate<Chn>:TRANSform:DTFault:PEAK:DATA<FaultNo>.....	1133
CALCulate<Chn>:TRANSform:DTFault:PEAK:STATe.....	1134
CALCulate<Chn>:TRANSform:DTFault:PEAK:THReshold.....	1134
CALCulate<Chn>:TRANSform:DTFault:POINts.....	1134
CALCulate<Chn>:TRANSform:DTFault:SELect.....	1135
CALCulate<Chn>:TRANSform:DTFault:SPAN.....	1131
CALCulate<Chn>:TRANSform:DTFault:STARt.....	1135
CALCulate<Chn>:TRANSform:DTFault:STATe.....	1136
CALCulate<Chn>:TRANSform:DTFault:STOP.....	1135
CALCulate<Chn>:TRANSform:IMPedance:RNORmal.....	1194
CALCulate<Chn>:TRANSform:TIME:CENTer.....	1137
CALCulate<Chn>:TRANSform:TIME:DCHeByshev.....	1137
CALCulate<Chn>:TRANSform:TIME:LPASs.....	1138
CALCulate<Chn>:TRANSform:TIME:LPASs:DCSParam.....	1138
CALCulate<Chn>:TRANSform:TIME:LPASs:DCSParam:CONTInuous.....	1139
CALCulate<Chn>:TRANSform:TIME:LPASs:DCSParam:EXTRApolate.....	1139
CALCulate<Chn>:TRANSform:TIME:LPFRequency.....	1140
CALCulate<Chn>:TRANSform:TIME:RESolution:EFACtor.....	1140
CALCulate<Chn>:TRANSform:TIME:SPAN.....	1140
CALCulate<Chn>:TRANSform:TIME:STARt.....	1141
CALCulate<Chn>:TRANSform:TIME:STATe.....	1141
CALCulate<Chn>:TRANSform:TIME:STIMulus.....	1142
CALCulate<Chn>:TRANSform:TIME:STOP.....	1142
CALCulate<Chn>:TRANSform:TIME:WINDow.....	1143
CALCulate<Chn>:TRANSform:TIME:XAXis.....	1143
CALCulate<Chn>:TRANSform:TIME[:TYPE].....	1142
CALCulate<Chn>:TTIME:DATA?.....	1194
CALCulate<Chn>:TTIME:STATe.....	1195
CALCulate<Chn>:TTIME:THReshold.....	1195
CONFigure:CHANnel:CATalog?.....	1203
CONFigure:CHANnel:MEASure:ACTive[:STATe].....	1203
CONFigure:CHANnel:MEASure:ALL[:STATe].....	1203
CONFigure:CHANnel:MEASure:OPTImized.....	1203
CONFigure:CHANnel<Ch>:MEASure[:STATe].....	1204
CONFigure:CHANnel<Ch>:NAME.....	1205

CONFigure:CHANnel<Ch>:NAME:ID?.....	1205
CONFigure:CHANnel<Ch>:TRACe:CATalog?.....	1206
CONFigure:CHANnel<Ch>:TRACe:REName.....	1206
CONFigure:CHANnel<Ch>[:STATe].....	1206
CONFigure:TRACe:CATalog?.....	1207
CONFigure:TRACe:WINDow:TRACe?.....	1210
CONFigure:TRACe:WINDow?.....	1209
CONFigure:TRACe<Trc>:CHANnel:NAME:ID?.....	1208
CONFigure:TRACe<Trc>:CHANnel:NAME?.....	1208
CONFigure:TRACe<Trc>:NAME.....	1208
CONFigure:TRACe<Trc>:NAME:ID?.....	1209
CONFigure:TRACe<Trc>:REName.....	1209
CONTRol:AUXiliary:C[:DATA].....	1212
CONTRol:GPIO:SENSe:SUMCurrent?.....	1214
CONTRol:GPIO<Port>:SENSe:CURREnt?.....	1214
CONTRol:GPIO<Port>:SENSe:VOLTage?.....	1215
CONTRol:RFFE<Bus>:TEST:CLOCK:CURREnt?.....	1220
CONTRol:RFFE<Bus>:TEST:CLOCK:VOLTage?.....	1222
CONTRol:RFFE<Bus>:TEST:DATA:CURREnt?.....	1220
CONTRol:RFFE<Bus>:TEST:DATA:VOLTage?.....	1222
CONTRol:RFFE<Bus>:TEST:VIO:CURREnt?.....	1220
CONTRol:RFFE<Bus>:TEST:VIO:VOLTage?.....	1222
CONTRol:VSE:ADDReSS.....	1228
CONTRol:VSE:CONFig:LOAD.....	1228
CONTRol:VSE:CONFig:SAVE.....	1228
CONTRol:VSE:CONNect.....	1228
CONTRol:VSE:DISConnect.....	1229
CONTRol:VSE:LOCAl.....	1229
CONTRol:VSE:MODE.....	1229
CONTRol:VSE:TRACe.....	1229
CONTRol<Ch>:GPIO:SENSe:TRIGger.....	1214
CONTRol<Ch>:GPIO:TIME.....	1217
CONTRol<Ch>:GPIO:VOLTage:OUTPut.....	1217
CONTRol<Ch>:GPIO<Port>:RANGe.....	1213
CONTRol<Ch>:GPIO<Port>:SHUNT?.....	1215
CONTRol<Ch>:GPIO<Port>:VOLTage[:DEFault].....	1217
CONTRol<Ch>:GPIO<Port>[:STATe].....	1216
CONTRol<Ch>:RFFE:TEST:OUTPut.....	1222
CONTRol<Ch>:RFFE:TEST:SENSe:TRIGger.....	1223
CONTRol<Ch>:RFFE:TEST:TIME.....	1223
CONTRol<Ch>:RFFE<Bus>:COMMand:DATA.....	1218
CONTRol<Ch>:RFFE<Bus>:COMMand:SEND.....	1218
CONTRol<Ch>:RFFE<Bus>:COMMand:SEND?.....	1218
CONTRol<Ch>:RFFE<Bus>:SETTings:FREQuency.....	1219
CONTRol<Ch>:RFFE<Bus>:SETTings:VOLTage:HIGH.....	1219
CONTRol<Ch>:RFFE<Bus>:SETTings:VOLTage:IO.....	1219
CONTRol<Ch>:RFFE<Bus>:SETTings:VOLTage:LOW.....	1219
CONTRol<Ch>:RFFE<Bus>:SETTings[:STATe].....	1219
CONTRol<Ch>:RFFE<Bus>:TEST:CLOCK.....	1220
CONTRol<Ch>:RFFE<Bus>:TEST:CLOCK:RANGe.....	1221

CONTRol<Ch>:RFFE<Bus>:TEST:CLOCK:SHUNT?.....	1221
CONTRol<Ch>:RFFE<Bus>:TEST:DATA.....	1220
CONTRol<Ch>:RFFE<Bus>:TEST:DATA:RANGe.....	1221
CONTRol<Ch>:RFFE<Bus>:TEST:DATA:SHUNT?.....	1221
CONTRol<Ch>:RFFE<Bus>:TEST:VIO.....	1220
CONTRol<Ch>:RFFE<Bus>:TEST:VIO:RANGe.....	1221
CONTRol<Ch>:RFFE<Bus>:TEST:VIO:SHUNT?.....	1221
CONTRol<Ch>:SEGMENT<Nr>:SEQUence:CLEar:ALL.....	1225
CONTRol<Ch>:SEGMENT<Nr>:SEQUence:COUNT?.....	1225
CONTRol<Ch>:SEGMENT<SegNr>:SEQUence<SeqNr>:DELay.....	1223
CONTRol<Ch>:SEGMENT<SegNr>:SEQUence<SeqNr>:GPIO<Port>:VOLTage.....	1224
CONTRol<Ch>:SEGMENT<SegNr>:SEQUence<SeqNr>:RFFE<Bus>:COMMANd:DATA.....	1224
CONTRol<Ch>:SEQUence:CLEar:ALL.....	1226
CONTRol<Ch>:SEQUence:COUNT?.....	1226
CONTRol<Ch>:SEQUence<Nr>:DELay.....	1226
CONTRol<Ch>:SEQUence<Nr>:GPIO<Port>:VOLTage.....	1227
CONTRol<Ch>:SEQUence<Nr>:RFFE<Bus>:COMMANd:DATA.....	1227
DIAGnostic:DEVIce:STATe.....	1230
DIAGnostic:DUMP:SIZE.....	1230
DIAGnostic:HUMS:BIOS?.....	1676
DIAGnostic:HUMS:DELeTe:ALL.....	1677
DIAGnostic:HUMS:DEVIce:HISTory:DELeTe:ALL.....	1678
DIAGnostic:HUMS:DEVIce:HISTory:EVENT:ADD.....	1678
DIAGnostic:HUMS:DEVIce:HISTory?.....	1677
DIAGnostic:HUMS:EQUipment?.....	1678
DIAGnostic:HUMS:FORMat.....	1679
DIAGnostic:HUMS:SAVE.....	1679
DIAGnostic:HUMS:SECurity?.....	1680
DIAGnostic:HUMS:SERVIce?.....	1680
DIAGnostic:HUMS:STATe.....	1681
DIAGnostic:HUMS:STORage?.....	1681
DIAGnostic:HUMS:SW?.....	1683
DIAGnostic:HUMS:SYSTem:INFO?.....	1683
DIAGnostic:HUMS:SYSTem:STATus:SUMMary?.....	1685
DIAGnostic:HUMS:SYSTem:STATus?.....	1684
DIAGnostic:HUMS:TAGS:ALL?.....	1685
DIAGnostic:HUMS:TAGS:DELeTe.....	1686
DIAGnostic:HUMS:TAGS:DELeTe:ALL.....	1686
DIAGnostic:HUMS:TAGS[:VALue].....	1685
DIAGnostic:HUMS:UTILization:ACTivity:TRACKing:STATe.....	1688
DIAGnostic:HUMS:UTILization:CUSTom:ADD.....	1688
DIAGnostic:HUMS:UTILization:CUSTom:ALL?.....	1689
DIAGnostic:HUMS:UTILization:CUSTom:DELeTe.....	1689
DIAGnostic:HUMS:UTILization:CUSTom:DELeTe:ALL.....	1690
DIAGnostic:HUMS:UTILization:CUSTom:UPDate.....	1690
DIAGnostic:HUMS:UTILization:HISTory:DELeTe:ALL.....	1692
DIAGnostic:HUMS:UTILization:HISTory:DETAiled?.....	1692
DIAGnostic:HUMS:UTILization:HISTory?.....	1690
DIAGnostic:HUMS:UTILization?.....	1687
DIAGnostic:HUMS[:ALL]?.....	1676

DIAGnostic:PRODUct:OPTion:INFO?	1231
DIAGnostic:SERVice:CALibration:DATE	1694
DIAGnostic:SERVice:CALibration:DUE:DATE	1694
DIAGnostic:SERVice:CALibration:DUE:STATe?	1694
DIAGnostic:SERVice:CALibration:INTerval?	1694
DIAGnostic:SERVice:DATE	1695
DIAGnostic:SERVice:FUNCTion	1704
DIAGnostic:SERVice:RFPower	1231
DIAGnostic:SERVice:SFUNCTion	1231
DIAGnostic:SERVice:STATe?	1695
DISPlay:ANNotation:CHANnel[:STATe]	1233
DISPlay:ANNotation:FREQuency[:STATe]	1234
DISPlay:ANNotation:TRACe[:STATe]	1233
DISPlay:CMAP:LIMit:FCOLORize[:STATe]	1234
DISPlay:CMAP:LIMit:FSYMBOL[:STATe]	1234
DISPlay:CMAP:LIMit[:STATe]	1234
DISPlay:CMAP:MARKer[:STATe]	1235
DISPlay:CMAP:TRACe:COLor[:STATe]	1237
DISPlay:CMAP:TRACe:RGB	1237
DISPlay:CMAP<DispEl>:RGB	1235
DISPlay:IWINDow:BFILter[:STATe]	1238
DISPlay:IWINDow:MARKer<Mk>[:STATe]	1238
DISPlay:IWINDow[:STATe]	1239
DISPlay:LAYout	1239
DISPlay:LAYout:APPLY	1239
DISPlay:LAYout:DEFine	1240
DISPlay:LAYout:EXECute	1240
DISPlay:LAYout:GRID	1241
DISPlay:LAYout:JOIN	1242
DISPlay:LAYout:OVERlay	1242
DISPlay:LAYout:SPLit	1242
DISPlay:MENU:KEY:ACTion:CATalog?	1242
DISPlay:MENU:KEY:EXECute	1243
DISPlay:MENU:KEY:SELEct	1243
DISPlay:MENU:KEY:TOOL:CATalog?	1243
DISPlay:RFSize	1243
DISPlay[:WINDow<Wnd>]:CATalog?	1244
DISPlay[:WINDow<Wnd>]:MAXimize	1244
DISPlay[:WINDow<Wnd>]:NAME	1245
DISPlay[:WINDow<Wnd>]:OVERview[:STATe]	1245
DISPlay[:WINDow<Wnd>]:TITLe:DATA	1246
DISPlay[:WINDow<Wnd>]:TITLe[:STATe]	1246
DISPlay[:WINDow<Wnd>]:TRACe<WndTr>:CATalog?	1247
DISPlay[:WINDow<Wnd>]:TRACe<WndTr>:DELEte	1247
DISPlay[:WINDow<Wnd>]:TRACe<WndTr>:EFEed	1248
DISPlay[:WINDow<Wnd>]:TRACe<WndTr>:FEED	1248
DISPlay[:WINDow<Wnd>]:TRACe<WndTr>:LABel:SHOW	1249
DISPlay[:WINDow<Wnd>]:TRACe<WndTr>:SHOW	1249
DISPlay[:WINDow<Wnd>]:TRACe<WndTr>:X:OFFSet	1250
DISPlay[:WINDow<Wnd>]:TRACe<WndTr>:Y:OFFSet	1250

DISPlay[:WINDow<Wnd>]:TRACe<WndTr>:Y[:SCALe]:AUTO.....	1251
DISPlay[:WINDow<Wnd>]:TRACe<WndTr>:Y[:SCALe]:BOTTom.....	1252
DISPlay[:WINDow<Wnd>]:TRACe<WndTr>:Y[:SCALe]:PDIVision.....	1253
DISPlay[:WINDow<Wnd>]:TRACe<WndTr>:Y[:SCALe]:RLEVel.....	1254
DISPlay[:WINDow<Wnd>]:TRACe<WndTr>:Y[:SCALe]:RPOStion.....	1255
DISPlay[:WINDow<Wnd>]:TRACe<WndTr>:Y[:SCALe]:TOP.....	1252
DISPlay[:WINDow<Wnd>]:TRACe<WndTr>:ZOOM:BOTTom.....	1256
DISPlay[:WINDow<Wnd>]:TRACe<WndTr>:ZOOM:STARt.....	1257
DISPlay[:WINDow<Wnd>]:TRACe<WndTr>:ZOOM:STOP.....	1257
DISPlay[:WINDow<Wnd>]:TRACe<WndTr>:ZOOM:TOP.....	1256
DISPlay[:WINDow<Wnd>]:TRACe<WndTr>:ZOOM[:STATe].....	1257
DISPlay[:WINDow<Wnd>][:STATe].....	1246
FORMat:BORDer.....	1258
FORMat:DEXPort:SOURce.....	1705
FORMat[:DATA].....	1259
HCOPy:DESTination.....	1260
HCOPy:DEVice:LANGUage.....	1260
HCOPy:ITEM:ALL.....	1261
HCOPy:ITEM:LOGO[:STATe].....	1261
HCOPy:ITEM:MLISt[:STATe].....	1262
HCOPy:ITEM:TIME[:STATe].....	1262
HCOPy:PAGE:COLor.....	1262
HCOPy:PAGE:MARGin:BOTTom.....	1263
HCOPy:PAGE:MARGin:LEFT.....	1263
HCOPy:PAGE:MARGin:RIGHT.....	1263
HCOPy:PAGE:MARGin:TOP.....	1264
HCOPy:PAGE:ORientation.....	1264
HCOPy:PAGE:WINDow.....	1264
HCOPy[:IMMEdiate].....	1261
INITiate:CONTInuous:ALL.....	1266
INITiate[:IMMEdiate]:ALL.....	1267
INITiate<Ch>:CONTInuous.....	1265
INITiate<Ch>:CTIMing.....	1266
INITiate<Ch>[:IMMEdiate]:SCOPE.....	1267
INITiate<Ch>[:IMMEdiate][:DUMMy].....	1267
INPut<PhyPt>:ATTenuation.....	1705
INSTrument:NSElect.....	1268
INSTrument:PORT:COUNT?.....	1268
INSTrument:SMATrix.....	1268
INSTrument:TPORt:COUNT?.....	1269
INSTrument[:SElect].....	1706
MEMory:CATalog:COUNT?.....	1270
MEMory:CATalog?.....	1269
MEMory:DEFine.....	1270
MEMory:DELeTe:ALL.....	1270
MEMory:DELeTe[:NAME].....	1270
MEMory:SElect.....	1271
MMEMory:AKAL:FACTory:CONVersion.....	1273
MMEMory:AKAL:USER:CONVersion.....	1274
MMEMory:CATalog:ALL?.....	1275

MMEMory:CATalog?	1274
MMEMory:CDIRectory	1275
MMEMory:CKIT:INFO?	1276
MMEMory:COpy	1276
MMEMory:DATA	1277
MMEMory:DELeTe	1277
MMEMory:DELeTe:CORRection	1277
MMEMory:FAVorite<FavId>	1278
MMEMory:LOAD:CABLe	1278
MMEMory:LOAD:CKIT	1279
MMEMory:LOAD:CKIT:SDATa	1279
MMEMory:LOAD:CKIT:SDATa:WLAbel	1280
MMEMory:LOAD:CKIT:UDIRectory	1281
MMEMory:LOAD:CMAP	1282
MMEMory:LOAD:CMAP:HCOPy	1282
MMEMory:LOAD:CORRection	1283
MMEMory:LOAD:CORRection:MERGe	1283
MMEMory:LOAD:CORRection:RESolve	1284
MMEMory:LOAD:CORRection:SLEVeling<PhyPt>	1285
MMEMory:LOAD:CORRection:TCoefficient<Ch>	1285
MMEMory:LOAD:EYE:BPATern	1286
MMEMory:LOAD:EYE:JITTer	1287
MMEMory:LOAD:EYE:MASK	1287
MMEMory:LOAD:LIMit	1287
MMEMory:LOAD:MDAData	1289
MMEMory:LOAD:MDCData	1290
MMEMory:LOAD:RIPPlE	1290
MMEMory:LOAD:SEGMeNt	1291
MMEMory:LOAD:STATe	1292
MMEMory:LOAD:TRACe	1292
MMEMory:LOAD:TRACe:AUTO	1293
MMEMory:LOAD:VNETworks<Ch>:BALanced:DEEMbedding<LogPt>	1294
MMEMory:LOAD:VNETworks<Ch>:BALanced:EMBedding<LogPt>	1294
MMEMory:LOAD:VNETworks<Ch>:DIFFerential:EMBedding<LogPt>	1295
MMEMory:LOAD:VNETworks<Ch>:GLOop:DEEMbedding<group>	1296
MMEMory:LOAD:VNETworks<Ch>:GLOop:EMBedding<group>	1296
MMEMory:LOAD:VNETworks<Ch>:PPAir:DEEMbedding<ListId>	1296
MMEMory:LOAD:VNETworks<Ch>:PPAir:EMBedding<ListId>	1296
MMEMory:LOAD:VNETworks<Ch>:SENDEd:DEEMbedding<PhyPt>	1298
MMEMory:LOAD:VNETworks<Ch>:SENDEd:EMBedding<PhyPt>	1298
MMEMory:MDIRectory	1299
MMEMory:MOVE	1299
MMEMory:MSIS	1299
MMEMory:NAME	1300
MMEMory:RDIRectory	1300
MMEMory:STORe:CABLe	1301
MMEMory:STORe:CKIT	1301
MMEMory:STORe:CKIT:WLAbel	1302
MMEMory:STORe:CMAP	1302
MMEMory:STORe:CMAP:HCOPy	1302

MMEMory:STORe:CORRection.....	1302
MMEMory:STORe:CORRection:SLEVelIng<PhyPt>.....	1303
MMEMory:STORe:CORRection:TCoefficient<Ch>.....	1303
MMEMory:STORe:EYE:MASK.....	1304
MMEMory:STORe:EYE:MASK:RESults.....	1304
MMEMory:STORe:EYE:MEASurements.....	1305
MMEMory:STORe:LIMit.....	1305
MMEMory:STORe:MARKer.....	1306
MMEMory:STORe:MDCData.....	1306
MMEMory:STORe:RIPple.....	1306
MMEMory:STORe:SEGMENT.....	1307
MMEMory:STORe:STATe.....	1307
MMEMory:STORe:TRACe.....	1308
MMEMory:STORe:TRACe:CHANnel.....	1309
MMEMory:STORe:TRACe:OPTion:BALanced.....	1310
MMEMory:STORe:TRACe:OPTion:COMMENT.....	1311
MMEMory:STORe:TRACe:OPTion:DECimals:DATA.....	1311
MMEMory:STORe:TRACe:OPTion:DECimals:STIMulus.....	1311
MMEMory:STORe:TRACe:OPTion:FORMat.....	1311
MMEMory:STORe:TRACe:OPTion:PLUS.....	1312
MMEMory:STORe:TRACe:OPTion:SSEParator.....	1312
MMEMory:STORe:TRACe:OPTion:SYMMetric.....	1310
MMEMory:STORe:TRACe:OPTion:TABS.....	1312
MMEMory:STORe:TRACe:OPTion:TRIM.....	1312
MMEMory:STORe:TRACe:PORTs.....	1312
OUTPut:ULED:STATe.....	1314
OUTPut:UPORt:ECBits.....	1315
OUTPut[:STATe]:TYPE.....	1314
OUTPut<Ch>:UPORt:SEGMENT<Seg>:STATe.....	1315
OUTPut<Ch>:UPORt:SEGMENT<Seg>[:VALue].....	1315
OUTPut<Ch>:UPORt[:VALue].....	1317
OUTPut<Ch>[:STATe].....	1314
OUTPut<Chn>:DPORt.....	1706
PROGram[:SELEcted]:EXECute.....	1319
PROGram[:SELEcted]:INIMessage.....	1320
PROGram[:SELEcted]:INIParameter.....	1320
PROGram[:SELEcted]:NAME.....	1321
PROGram[:SELEcted]:RETVal?.....	1322
PROGram[:SELEcted]:WAIT.....	1322
SENSe:GDEvice:ADDReSS?.....	1444
SOURce:INDEpendent:CLO:FREQUency.....	1529
SOURce:INDEpendent:CLO:OFF.....	1529
SOURce:INDEpendent:CLO:POWEr.....	1529
SOURce:INDEpendent:CLO[:STATe].....	1530
SOURce:INDEpendent<Pt>:ATTenuator.....	1530
SOURce:INDEpendent<Pt>:FREQUency.....	1530
SOURce:INDEpendent<Pt>:OFF.....	1531
SOURce:INDEpendent<Pt>:POWEr.....	1531
SOURce:INDEpendent<Pt>[:STATe].....	1531
SOURce:POWEr:CORRection:COLLect:AVERAge:NTOLerance.....	1550

SOURce:POWer:CORRection:COLLect:AVERage[:COUNT].....	1550
SOURce:POWer:CORRection:COLLect:CFACTOR.....	1550
SOURce:POWer:CORRection:COLLect:FLATness.....	1551
SOURce:POWer:CORRection:COLLect:METHod.....	1551
SOURce:POWer:CORRection:COLLect:RRECeiver.....	1552
SOURce:POWer:CORRection:COLLect:VNETworks.....	1552
SOURce:POWer:CORRection:DEFault.....	1570
SOURce:POWer:CORRection:FAST.....	1570
SOURce:POWer:CORRection:NREadings.....	1574
SOURce:POWer:CORRection:PMETer:ID.....	1575
SOURce:POWer:CORRection:PPOWer.....	1575
SOURce:POWer:CORRection:PPOWer:PATTenuation.....	1576
SOURce:POWer:CORRection:PSElect.....	1576
SOURce:POWer:CORRection:SLEVeling:DATA:CLEar:ALL.....	1554
SOURce:POWer:CORRection:TCoefficient:COUNT?.....	1559
SOURce:POWer:CORRection:TCoefficient:DEFine<ListNo>.....	1560
SOURce:POWer:CORRection:TCoefficient:DELeTe:ALL.....	1560
SOURce:POWer:CORRection:TCoefficient:DELeTe<ListNo>[:DUMMy].....	1561
SOURce:POWer:CORRection:TCoefficient:FEED.....	1562
SOURce:POWer:CORRection:TCoefficient:INSert<ListNo>.....	1562
SOURce:POWer:CORRection:TCoefficient[:STATe].....	1563
SOURce:POWer:GENerator:SDELay.....	1586
SOURce:POWer:REDuce:SDELay.....	1591
SOURce:POWer:SWEEpend:MODE.....	1593
SOURce:POWer:SWEEpend:SDELay.....	1593
SOURce:POWer<PhyPt>:CORRection:SLEVeling:DATA:CLEar.....	1554
SOURce:POWer<PhyPt>:CORRection:SLEVeling:DELeTe.....	1555
SOURce:POWer<PhyPt>:CORRection:SLEVeling:FREQuency:POINts.....	1555
SOURce:POWer<PhyPt>:CORRection:SLEVeling:FREQuency:STOP.....	1555
SOURce:POWer<PhyPt>:CORRection:SLEVeling:POWer:ALC.....	1556
SOURce:POWer<PhyPt>:CORRection:SLEVeling:POWer:STEP.....	1557
SOURce:POWer<PhyPt>:CORRection:SLEVeling:POWer:STOP.....	1556
SOURce:POWer<PhyPt>:CORRection:SLEVeling:STATe?.....	1554
SOURce:POWer<PhyPt>:CORRection:SLEVeling[:ACQuire].....	1553
SOURce<Ch>:CMODE:OPTImized[:STATe].....	1521
SOURce<Ch>:CMODE:PORT<Pt>:PHASe.....	1522
SOURce<Ch>:CMODE:PORT<Pt>:PHASe:SPAN.....	1522
SOURce<Ch>:CMODE:PORT<Pt>[:STATe].....	1522
SOURce<Ch>:CMODE:WCORrection[:STATe].....	1523
SOURce<Ch>:CMODE[:STATe].....	1523
SOURce<Ch>:COMBiner.....	1597
SOURce<Ch>:FREQuency:CONVersion:MIXer:PMFixed.....	1527
SOURce<Ch>:FREQuency:CONVersion:MIXer:PMODE.....	1527
SOURce<Ch>:FREQuency<PhyPt>:CONVersion:ARBItrary:EFREquency<Gen>.....	1524
SOURce<Ch>:FREQuency<PhyPt>:CONVersion:ARBItrary:IFREquency.....	1525
SOURce<Ch>:FREQuency<PhyPt>:FIXed.....	1528
SOURce<Ch>:FREQuency<PhyPt>[:CW].....	1528
SOURce<Ch>:GROup:COUNT?.....	1535
SOURce<Ch>:GROup<Grp>.....	1534
SOURce<Ch>:GROup<Grp>:CLEar.....	1534

SOURce<Ch>:GROup<Grp>:NAME.....	1535
SOURce<Ch>:GROup<Grp>:PORTs.....	1535
SOURce<Ch>:GROup<Grp>:PPORTs.....	1536
SOURce<Ch>:GROup<Grp>:SIMultaneous:FOFFset:CONDition.....	1536
SOURce<Ch>:GROup<Grp>:SIMultaneous:FOFFset:MOFFset:BWFactor.....	1538
SOURce<Ch>:GROup<Grp>:SIMultaneous:FOFFset:MOFFset:DVALue.....	1538
SOURce<Ch>:GROup<Grp>:SIMultaneous:FOFFset:MOFFset:MODE.....	1539
SOURce<Ch>:GROup<Grp>:SIMultaneous:FOFFset:STATE.....	1540
SOURce<Ch>:LOTRack:DFRequency?.....	1598
SOURce<Ch>:LOTRack[:STATE].....	1597
SOURce<Ch>:LPORT<LogPt>.....	1598
SOURce<Ch>:LPORT<LogPt>:CLEar.....	1599
SOURce<Ch>:NFIGure:CALibration:TPOWer.....	1600
SOURce<Ch>:NFIGure:CALibration:TPOWer:STATE.....	1600
SOURce<Ch>:PATH<Pt>:DIRectaccess.....	1600
SOURce<Ch>:POWer:ALC:AUBW.....	1542
SOURce<Ch>:POWer:ALC:BANDwidth.....	1543
SOURce<Ch>:POWer:ALC:CState.....	1544
SOURce<Ch>:POWer:ALC:PIParameter:ASETtling.....	1545
SOURce<Ch>:POWer:ALC:PIParameter:CTIME.....	1546
SOURce<Ch>:POWer:ALC:STOLerance.....	1548
SOURce<Ch>:POWer:CORRection:DATA.....	1567
SOURce<Ch>:POWer:CORRection:DATA:PARAmeter<Wv>?.....	1568
SOURce<Ch>:POWer:CORRection:DATA:PORT<PhyPt>.....	1567
SOURce<Ch>:POWer:CORRection:GENerator<Gen>[:STATE].....	1571
SOURce<Ch>:POWer:CORRection:IMODulation:METHod.....	1573
SOURce<Ch>:POWer:CORRection:IMODulation:PORT.....	1574
SOURce<Ch>:POWer:CORRection:MIXer:IF[:ACQuire].....	1663
SOURce<Ch>:POWer:CORRection:MIXer:LO<Stg>[:ACQuire].....	1663
SOURce<Ch>:POWer:CORRection:MIXer:RF[:ACQuire].....	1664
SOURce<Ch>:POWer:CORRection:OSources[:STATE].....	1575
SOURce<Ch>:POWer:CORRection[:ACQuire].....	1565
SOURce<Ch>:POWer:CPRemeas:CState.....	1578
SOURce<Ch>:POWer:CPRemeas:MODE.....	1578
SOURce<Ch>:POWer<PhyPt>:ATTenuation.....	1581
SOURce<Ch>:POWer<PhyPt>:CONVerter:OFFSet.....	1581
SOURce<Ch>:POWer<PhyPt>:CORRection:COLLect[:ACQuire].....	1719
SOURce<Ch>:POWer<PhyPt>:CORRection:DATA:PARAmeter<Wv>:COUNT?.....	1569
SOURce<Ch>:POWer<PhyPt>:CORRection:GENerator<Gen>:LEVel:OFFSet.....	1582
SOURce<Ch>:POWer<PhyPt>:CORRection:HARMonic[:ACQuire].....	1571
SOURce<Ch>:POWer<PhyPt>:CORRection:IMODulation:LTONe[:ACQuire].....	1572
SOURce<Ch>:POWer<PhyPt>:CORRection:IMODulation:UTONe[:ACQuire].....	1574
SOURce<Ch>:POWer<PhyPt>:CORRection:LEVel:OFFSet.....	1583
SOURce<Ch>:POWer<PhyPt>:CORRection:SLEVeling:FREQuency:START.....	1555
SOURce<Ch>:POWer<PhyPt>:CORRection:SLEVeling:POWer:START.....	1556
SOURce<Ch>:POWer<PhyPt>:CORRection:SLEVeling:STATE.....	1557
SOURce<Ch>:POWer<PhyPt>:CORRection:STATE.....	1577
SOURce<Ch>:POWer<PhyPt>:CORRection:TCOefficient:CALibration.....	1558
SOURce<Ch>:POWer<PhyPt>:CORRection:UPORT:STATE.....	1577
SOURce<Ch>:POWer<PhyPt>:CORRection[:ACQuire]:VERification:RESult?.....	1566

SOURce<Ch>:POWER<PhyPt>:GENerator<Gen>:LLIMit:VALue.....	1587
SOURce<Ch>:POWER<PhyPt>:GENerator<Gen>:LLIMit[:STATe].....	1586
SOURce<Ch>:POWER<PhyPt>:GENerator<Gen>:OFFSet.....	1584
SOURce<Ch>:POWER<PhyPt>:GENerator<Gen>:PERManent[:STATe].....	1585
SOURce<Ch>:POWER<PhyPt>:GENerator<Gen>:STATe.....	1586
SOURce<Ch>:POWER<PhyPt>:PERManent[:STATe].....	1590
SOURce<Ch>:POWER<PhyPt>:REDuce[:STATe].....	1591
SOURce<Ch>:POWER<PhyPt>:START.....	1592
SOURce<Ch>:POWER<PhyPt>:STATe.....	1592
SOURce<Ch>:POWER<PhyPt>:STOP.....	1592
SOURce<Ch>:POWER<PhyPt>[:LEVel][:IMMediate]:LLIMit:VALue.....	1588
SOURce<Ch>:POWER<PhyPt>[:LEVel][:IMMediate]:LLIMit[:STATe].....	1588
SOURce<Ch>:POWER<PhyPt>[:LEVel][:IMMediate]:OFFSet.....	1589
SOURce<Ch>:POWER<PhyPt>[:LEVel][:IMMediate]:SLOPe.....	1590
SOURce<Ch>:POWER<PhyPt>[:LEVel][:IMMediate]:AMPLitude].....	1587
SOURce<Ch>:POWER<Pt>:ALC:CLAMP.....	1543
SOURce<Ch>:POWER<Pt>:ALC:COUPlE.....	1544
SOURce<Ch>:POWER<Pt>:ALC:OPTimize.....	1544
SOURce<Ch>:POWER<Pt>:ALC:PIParameter.....	1545
SOURce<Ch>:POWER<Pt>:ALC:PIParameter:GAIN.....	1546
SOURce<Ch>:POWER<Pt>:ALC:PIParameter:ITime.....	1546
SOURce<Ch>:POWER<Pt>:ALC:RANGe.....	1547
SOURce<Ch>:POWER<Pt>:ALC:RECeiver.....	1547
SOURce<Ch>:POWER<Pt>:ALC:SOFFset.....	1547
SOURce<Ch>:POWER<Pt>:ALC:TPOWER.....	1549
SOURce<Ch>:POWER<Pt>:ALC:TPOWER:DEFault.....	1549
SOURce<Ch>:POWER<Pt>:ALC:VNETwork.....	1549
SOURce<Ch>:POWER<Pt>:ALC[:STATe].....	1548
SOURce<Ch>:POWER<Pt>:CPRemeas:CFACTOR.....	1577
SOURce<Ch>:POWER<Pt>:CPRemeas:DETECTOR.....	1578
SOURce<Ch>:POWER<Pt>:CPRemeas:NREAdings.....	1579
SOURce<Ch>:POWER<Pt>:CPRemeas:NTOLerance.....	1579
SOURce<Ch>:POWER<Pt>:CPRemeas:RECeiver.....	1579
SOURce<Ch>:POWER<Pt>:CPRemeas[:STATe].....	1580
SOURce<Ch>:POWER<Pt>:EATTenuation.....	1583
SOURce<Ch>:POWER<Pt>:EATTenuation:MODE.....	1584
SOURce<Ch>:RLO:FREQuency.....	1532
SOURce<Ch>:RLO:PABSolut.....	1533
SOURce<Ch>:RLO:PERMenable.....	1533
SOURce<Ch>:RLO:POFFset.....	1533
SOURce<Ch>:TDIF:IMBalance:AMPLitude:LPORT.....	1594
SOURce<Ch>:TDIF:IMBalance:AMPLitude:START.....	1595
SOURce<Ch>:TDIF:IMBalance:AMPLitude:STOP.....	1595
SOURce<Ch>:TDIF:IMBalance:PHASe:LPORT.....	1596
SOURce<Ch>:TDIF:IMBalance:PHASe:START.....	1596
SOURce<Ch>:TDIF:IMBalance:PHASe:STOP.....	1596
SOURce<Ch>:TDIF[:STATe].....	1594
STATus:PRESet.....	1601
STATus:QUESTionable:CONDition?.....	1602
STATus:QUESTionable:ENABLE.....	1602

STATus:QUEStionable:INTegrity:CONDition?	1602
STATus:QUEStionable:INTegrity:ENABle	1602
STATus:QUEStionable:INTegrity:HARDware:CONDition?	1602
STATus:QUEStionable:INTegrity:HARDware:ENABle	1602
STATus:QUEStionable:INTegrity:HARDware:NTRansition	1603
STATus:QUEStionable:INTegrity:HARDware:PTRansition	1603
STATus:QUEStionable:INTegrity:HARDware[:EVENT]?	1602
STATus:QUEStionable:INTegrity:NTRansition	1603
STATus:QUEStionable:INTegrity:PTRansition	1603
STATus:QUEStionable:INTegrity[:EVENT]?	1602
STATus:QUEStionable:LIMit<Lev>:CONDition?	1602
STATus:QUEStionable:LIMit<Lev>:ENABle	1602
STATus:QUEStionable:LIMit<Lev>:NTRansition	1603
STATus:QUEStionable:LIMit<Lev>:PTRansition	1603
STATus:QUEStionable:LIMit<Lev>[:EVENT]?	1602
STATus:QUEStionable:NTRansition	1603
STATus:QUEStionable:PTRansition	1603
STATus:QUEStionable[:EVENT]?	1602
STATus:QUEue[:NEXT]?	1604
SYSTem:AGC:GLOBal:METhod	1631
SYSTem:COMMunicate:AKAL:CONNection	1605
SYSTem:COMMunicate:AKAL:MMEMory[:STATe]	1606
SYSTem:COMMunicate:CODEc	1606
SYSTem:COMMunicate:GPIB[:SELF]:ADDReSS	1606
SYSTem:COMMunicate:GPIB[:SELF]:DCLear:SUppress	1607
SYSTem:COMMunicate:GPIB[:SELF]:INIT:WAIT	1607
SYSTem:COMMunicate:GPIB[:SELF]:LPORt:ALIGn	1607
SYSTem:COMMunicate:GPIB[:SELF]:RTERminator	1608
SYSTem:COMMunicate:NET:HOSTname	1608
SYSTem:COMMunicate:RDEvice:AKAL:ADDReSS	1608
SYSTem:COMMunicate:RDEvice:AKAL:ADDReSS:ALL?	1609
SYSTem:COMMunicate:RDEvice:AKAL:ADDReSS:SUBModule:ALL?	1609
SYSTem:COMMunicate:RDEvice:AKAL:CKIT	1609
SYSTem:COMMunicate:RDEvice:AKAL:CKIT:CATalog?	1610
SYSTem:COMMunicate:RDEvice:AKAL:CKIT:STANdard:CATalog?	1611
SYSTem:COMMunicate:RDEvice:AKAL:DATE?	1612
SYSTem:COMMunicate:RDEvice:AKAL:FRANge?	1612
SYSTem:COMMunicate:RDEvice:AKAL:PORtS?	1613
SYSTem:COMMunicate:RDEvice:AKAL:PREdUction[:STATe]	1613
SYSTem:COMMunicate:RDEvice:AKAL:SDATa?	1613
SYSTem:COMMunicate:RDEvice:AKAL:WARMup[:STATe]?	1614
SYSTem:COMMunicate:RDEvice:GDEvice:CATalog?	1614
SYSTem:COMMunicate:RDEvice:GDEvice:DELeTe:ALL	1615
SYSTem:COMMunicate:RDEvice:GDEvice<Gdev>:DEFine	1615
SYSTem:COMMunicate:RDEvice:GDEvice<Gdev>:DELeTe	1616
SYSTem:COMMunicate:RDEvice:GENerator:COUNt?	1617
SYSTem:COMMunicate:RDEvice:GENerator:DELeTe	1618
SYSTem:COMMunicate:RDEvice:GENerator<Gen>:CATalog?	1616
SYSTem:COMMunicate:RDEvice:GENerator<Gen>:DEFine	1617
SYSTem:COMMunicate:RDEvice:GENerator<Gen>:SEPMoDe	1618

SYSTem:COMMunicate:RDEvice:GENerator<Gen>:SEPower.....	1619
SYSTem:COMMunicate:RDEvice:PMETer:CATalog?.....	1619
SYSTem:COMMunicate:RDEvice:PMETer:CONFigure:AUTO[:STATe].....	1620
SYSTem:COMMunicate:RDEvice:PMETer:COUNT?.....	1620
SYSTem:COMMunicate:RDEvice:PMETer:DELeTe.....	1621
SYSTem:COMMunicate:RDEvice:PMETer<Pmtr>:AZERo.....	1619
SYSTem:COMMunicate:RDEvice:PMETer<Pmtr>:DEFine.....	1620
SYSTem:COMMunicate:RDEvice:PMETer<Pmtr>:SPCorrecTion[:STATe].....	1622
SYSTem:COMMunicate:RDEvice:SMATrix:CONFigure:ABORt.....	1622
SYSTem:COMMunicate:RDEvice:SMATrix:CONFigure:END.....	1623
SYSTem:COMMunicate:RDEvice:SMATrix:CONFigure:STARt.....	1623
SYSTem:COMMunicate:RDEvice:SMATrix:CONFigure:TVNA.....	1625
SYSTem:COMMunicate:RDEvice:SMATrix:COUNT?.....	1627
SYSTem:COMMunicate:RDEvice:SMATrix:DELeTe.....	1628
SYSTem:COMMunicate:RDEvice:SMATrix:SCAN?.....	1629
SYSTem:COMMunicate:RDEvice:SMATrix<Matr>:CATalog?.....	1622
SYSTem:COMMunicate:RDEvice:SMATrix<Matr>:CONFigure:MLTest.....	1626
SYSTem:COMMunicate:RDEvice:SMATrix<Matr>:CONFigure:MLVNa.....	1625
SYSTem:COMMunicate:RDEvice:SMATrix<Matr>:CONFigure:MTESt.....	1626
SYSTem:COMMunicate:RDEvice:SMATrix<Matr>:CONFigure:MVNA.....	1627
SYSTem:COMMunicate:RDEvice:SMATrix<Matr>:DEFine.....	1627
SYSTem:COMMunicate:RDEvice:SMATrix<Matr>:RELays:SWITCh:COUNT?.....	1629
SYSTem:COMMunicate:RDEvice:SMATrix<Matr>:SERial?.....	1629
SYSTem:COMMunicate:REST:ENABle.....	1675
SYSTem:COMMunicate:SNMP:COMMunity:RO.....	1672
SYSTem:COMMunicate:SNMP:COMMunity:RW.....	1672
SYSTem:COMMunicate:SNMP:CONtact.....	1673
SYSTem:COMMunicate:SNMP:LOCation.....	1673
SYSTem:COMMunicate:SNMP:USM:USER.....	1673
SYSTem:COMMunicate:SNMP:USM:USER:ALL?.....	1674
SYSTem:COMMunicate:SNMP:USM:USER:DELeTe.....	1674
SYSTem:COMMunicate:SNMP:USM:USER:DELeTe:ALL.....	1674
SYSTem:COMMunicate:SNMP:VERsion.....	1674
SYSTem:CORRection:FMPort[:STATe].....	1671
SYSTem:CORRection:JOINcal.....	1631
SYSTem:CORRection:WIZard[:IMMediate].....	1632
SYSTem:DATE.....	1632
SYSTem:DFPPrint?.....	1632
SYSTem:DISPlay:BAR:HKEY[:STATe].....	1632
SYSTem:DISPlay:BAR:MENU[:STATe].....	1632
SYSTem:DISPlay:BAR:STATus[:STATe].....	1632
SYSTem:DISPlay:BAR:STOols[:STATe].....	1632
SYSTem:DISPlay:BAR:TITLe[:STATe].....	1633
SYSTem:DISPlay:BAR:TOOLs[:STATe].....	1633
SYSTem:DISPlay:COLor.....	1633
SYSTem:DISPlay:CONDUCTances.....	1633
SYSTem:DISPlay:TRACes:CCOunt.....	1634
SYSTem:DISPlay:UPDate.....	1634
SYSTem:DISPlay:XLABels.....	1634
SYSTem:ERRor:ALL?.....	1634

SYSTem:ERRor:COUNT?	1635
SYSTem:ERRor:DISPlay:ERRor	1635
SYSTem:ERRor:DISPlay:INFO	1635
SYSTem:ERRor:DISPlay:STATe	1636
SYSTem:ERRor:DISPlay:WARNings	1635
SYSTem:ERRor:DISPlay[:REMote]	1635
SYSTem:ERRor[:NEXT]?	1636
SYSTem:FIRMware:UPDate	1636
SYSTem:FORMat:IDENtify	1637
SYSTem:FPReset	1637
SYSTem:FREQUency?	1638
SYSTem:HELP:HEADers?	1638
SYSTem:HELP:SYNTax:ALL?	1639
SYSTem:HELP:SYNTax?	1638
SYSTem:IDENtify:FACTory	1639
SYSTem:IDENtify[:STRing]	1639
SYSTem:KLOCK	1639
SYSTem:LANGUage	1639
SYSTem:LOGGing:REMote[:STATe]	1640
SYSTem:OPChEck:PLEVel:PORT<Port>?	1640
SYSTem:OPChEck:SELFtest?	1641
SYSTem:OPTions:FACTory	1641
SYSTem:OPTions[:STRing]	1641
SYSTem:PASSword[:CENable]	1642
SYSTem:PRESet:MODE	1642
SYSTem:PRESet:REMote[:STATe]	1643
SYSTem:PRESet:SCOPE	1643
SYSTem:PRESet:START	1644
SYSTem:PRESet:USER:CAL	1644
SYSTem:PRESet:USER:NAME	1644
SYSTem:PRESet:USER[:STATe]	1645
SYSTem:PRESet[:DUMMy]	1642
SYSTem:SETTings:UPDate	1645
SYSTem:SHUTdown	1646
SYSTem:SMATrix:OPTimization	1646
SYSTem:SOUNd:ALARm[:STATe]	1647
SYSTem:SOUNd:STATus[:STATe]	1647
SYSTem:TIME	1647
SYSTem:TRESet[:STATe]	1647
SYSTem:TSLock	1647
SYSTem:TTLout<Pt>:STATus[:STATe]	1648
SYSTem:USER:DISPlay:TITLe	1648
SYSTem:USER:KEY	1649
SYSTem:VERSion?	1649
TRACe:CLEar	1719
TRACe:COPIY	1650
TRACe:COPIY:MATH	1652
TRACe[:DATA]:STIMulus[:ALL]?	1721
TRACe[:DATA]:RESPonse[:ALL]?	1720
TRIGger:CHANnel<Ch>:AUXiliary<n>:DELay	1659

TRIGger:CHANnel<Ch>:AUXiliary<n>:DURation.....	1659
TRIGger:CHANnel<Ch>:AUXiliary<n>:INTerval.....	1660
TRIGger:CHANnel<Ch>:AUXiliary<n>:POSition.....	1661
TRIGger:CHANnel<Ch>:AUXiliary<n>:STYPe.....	1661
TRIGger:STATus:REAdy?.....	1662
TRIGger:WAIT:REAdy?.....	1662
TRIGger[:SEQuence]:LTRigger:COUnT?.....	1655
TRIGger[:SEQuence]:LTRigger:RESet.....	1655
TRIGger[:SEQuence]:LTRigger[:STATe].....	1655
TRIGger<Ch>[:SEQuence]:EINPut.....	1653
TRIGger<Ch>[:SEQuence]:HOLDoff.....	1653
TRIGger<Ch>[:SEQuence]:LiNK.....	1654
TRIGger<Ch>[:SEQuence]:MULTiple:HOLDoff.....	1655
TRIGger<Ch>[:SEQuence]:MULTiple:LOGic.....	1656
TRIGger<Ch>[:SEQuence]:MULTiple:SLOPe<Num>.....	1656
TRIGger<Ch>[:SEQuence]:MULTiple:SOURce<inp>.....	1657
TRIGger<Ch>[:SEQuence]:SLOPe.....	1658
TRIGger<Ch>[:SEQuence]:SOURce.....	1658

Index

Symbols

@DCL	1781
@GET	1781
@LOC	1781
@REM	1781
*.csv file format	184
*.limit	175
*.ripple	176
*.s<n>p file format	177
*CLS	967, 970
*ESE	970
*ESR?	970
*IDN?	970
*IST?	970
*OPC	970
*OPC (use)	964
*OPT?	971
*PCB	971
*PRE	971
*PSC	971
*RST	971
*SRE	971
*STB?	971
*TRG	971
*TST?	971
*WAI	971

A

a1 Source Port 1	358
a2 Source Port 2	358
AC supply	28
Accessories (connect)	32
Active Diagram	839
Active Power Cals dialog	637
Active Trace	432
Adapter Removal	225
Add Device	
external generators	899
external power meters	894
External switch matrices	912
generic	924
Add Trace	432
Add Trace + Diagram	433
Additional Removable System Drive	308
Addressed command	939, 1783
Adjust Time Gate	718
Administrative tasks	1774
Admittance	157
Advanced (system settings)	865
ALC Config dialog	527
All Channels Continuous	567
All Channels on Hold	567
All Data & Func to <Destination>	440
All Data to <Destination>	440
All Partial Meas'ments	542
All S-Params	346
Annexes	1774
Aperture	167
Aperture Points	424

Applic softtool	797
External Tools application	798
Eye Diag tab	806
Eye Mask Test tab	821
Rise Time tab	826
Skew tab	827
TDR application	799
TDR Setup tab	800
Time Gate tab	829
X Axis tab	830
Y Axis tab	829
Application cards	23
Application notes	23
Apply (calibration)	599
Arbitrary port settings	261
ASCII	855
ASCII (*.csv) file	184
ATN	1782
Attention	1782
Auto Config	895
Auto Length	719
Auto Length and Loss	723
Auto Power Setting for Cal Unit	858
Auto scale	69
Auto Scale Diagram	427
Auto Scale Trace	427
Auto Zero	396
Automatic calibration	206
Automatic Harmonic Grid	452
Average	538
Average tab	538
Averaging mode	539
Auto	539
Flatten Noise	539
Moving Average	539
Reduce Noise	539
Axis Pair	454

B

b1 / a1 Source Port 1	363
b1 / a2 Source Port 2	363
b1 Source Port 1	358
b1 Source Port 2	358
b2 / a1 Source Port 1	363
b2 / a2 Source Port 2	363
b2 Source Port 1	358
b2 Source Port 2	358
Balanced port	162
Balanced Ports dialog	352
Logical Port Config tab	353
Predefined Config tab	352
Reference Impedance tab	355
User Config tab	354
Band pass impulse	248
Bandfilter search	133, 514
Bandpass Ref to Max	516
Bandpass Ref to Mkr	516
Bandstop Ref to Max	517
Bandwidth	515
Result Off	517
Search bandpass or bandstop	517

- Search Mode 517
 - Tracking 518
 - Bandpass 133
 - Bandpass (time gate) 454
 - Bandstop 133
 - Bandwidth 536
 - Bandwidth (bandfilter) 133
 - Bandwidth tab 535
 - Selectivity 537
 - Basic functionality 81
 - Basic instrument concepts 107
 - Basic operation 99
 - Basic tasks 43
 - Black White Scheme 850
 - Block data format 943
 - Boolean parameter 943
 - Brochures 22
 - Buffered Sweep 1745
- C**
- Cal Connector Types dialog 613
 - Char. Imp. 614
 - Cutoff Freq. fc 614
 - Line Type 614
 - Offset model 614
 - Rel. Permittivity ϵ_r 614
 - Cal group 206
 - Cal kit
 - Selection 587
 - Cal Kit
 - Import 589
 - Cal kit file 204
 - Cal Power Config (dialog) 629
 - Cal Power Offset 593, 631, 676
 - Cal Premeas Config dialog 531
 - Cal softtool 569
 - Cal Devices tab 612
 - Pwr Cal Settings tab 626
 - Start Cal tab 570
 - Use Cal tab 634
 - Cal Unit
 - Characterization 587
 - Cal Validation info 879
 - Calibration 105, 186, 569, 1747
 - Cal Devices 612
 - Cal Unit Characterization 587
 - Define Calibration dialog 585
 - Devices 612
 - Mixer 199
 - Ports 585, 645
 - Power calibration settings 626
 - Procedure 570
 - program example 1747
 - Type 585
 - Type (METAS) 645
 - Validation 214
 - Calibration (manual)
 - Connector 584
 - Same Connector All Ports 647
 - Same Gender All Ports 647
 - Sweep 576
 - Calibration (system settings) 858
 - Calibration kit 199
 - Calibration Kits dialog 615
 - Add cal kit 617
 - Available Cal Kits 616
 - Connector Type 616
 - Copy cal kit 617
 - Delete cal kit 617
 - Export Cal Kit 617
 - Import Cal Kit 617
 - Standards 617
 - Calibration labels
 - scalar power calibration 222
 - SMARTerCal 226
 - system error correction 206
 - Calibration Manager dialog 638, 639
 - Add 639
 - Apply 639
 - Apply to All 639
 - Channel and calibration properties 641
 - Channel State 639
 - Delete from Pool 640
 - Pool 640
 - Preset User Cal 640
 - Replace 639
 - Resolve Pool Link 640
 - Calibration pool 206
 - Calibration setup
 - Cal kit selection 587
 - Calibration standard 199
 - Calibration sweep diagrams
 - Automatic calibration 580
 - Manual calibration 575
 - Calibration types 187
 - Calibration unit 206, 214
 - Calibration Unit
 - Detect Port Assignment 581
 - Detect Ports & Start Cal 581
 - Calibration wizard 573, 582
 - Automatic calibration 578
 - Manual calibration 575
 - Calibration wizard (Cal Unit)
 - Apply 582
 - Cartesian diagram 140
 - Casing
 - Labels 80
 - CENTER 113
 - Center (bandfilter) 133
 - Center = Marker 519
 - Center Frequency 523
 - Channel 108, 433
 - programming examples 1725
 - Channel Bits (system settings) 864
 - Decimal 865
 - Pin 16 - 19 865
 - Channel Config
 - Define Parallel Measurement 682
 - Port Config 667
 - Port Settings 668
 - Channel Config softtool 652
 - Channels tab 652
 - Mode tab 686
 - Port Config tab 667
 - Pwr Cal Settings tab 686
 - Channel Info 846
 - Channel keys 37
 - Channel Manager dialog 655
 - Add channel 656
 - Channel table 656
 - Delete channel 656
 - Channel properties 641
 - Channel settings 134

- Channels tab
 - Active Channel 653
 - Channel Manager... 655
 - Channel On 655
 - Controls 653
 - Copy Channel 654
 - Copy Channel + Diagram 654
 - Delete Channel 655
 - Fixture Simulator 655
 - New Channel 654
 - New Channel + Diagram 654
- Characterization
 - Cal Unit 587
- Characterization Data 622
- Characterization wizard 623
 - Test Port Assignment 625
- Characterize Cal Unit dialog 621
 - Authentication 622
 - Set Password 622
- Checking the delivery 82
- Chirp z-transformation 248
- Circle limit 172
- Circle Test 492
 - Clear Test 495
 - Define circle 495
 - Draw Circle 495
 - Limit Check 493
 - Limit Fail Beep 495
 - Show Limit Circle 492
- Circular diagrams 69
- Color Scheme 845
- Colorize Trace when Failed 849
- Command
 - common 939
 - device-specific 939
 - Processing 949
 - Recognition 949
 - Sequence 949
 - structure and syntax 939
 - Synchronization 949
- Command reference 971
- Common commands 968, 970
- Common mode 161, 163
- Common Mode 356
- Compatibility mode
 - Sweep Active Channel 569
 - Sweep All Channels 569
- Compression measurements 391
- Computer name
 - Changing 1777
- CONDition 955, 956
- Configured devices
 - external generators 898, 923
 - external power meters 893
 - External switch matrices 911
- Connector panel
 - Diplexer 91
- Connectors 1779
- Context menu 135
- Continuous data recording
 - Controlled Timing 566
- Continuous sweep 565
- Control bus 1782
- Control elements 48
- Control lines (GPIB bus) 1782
- Controlled Timing 566
- Converter setup 100
- Couple Active Trace 429
- Couple All Traces 429
- Customer support 1770
- CW Frequency 524
- CW Mode Spectrum 381
- CW Mode sweep 549
- D**
 - Data & Func to <Destination> 438
 - Data base 949
 - Data bus (GPIB) 1782
 - Data entry 62
 - Data Entry panel 38
 - Data flow 120
 - Data sheets 22
 - Data Streaming 41
 - Data to <Destination> 438
 - Data Valid 1782
 - DAV 1782
 - dB Mag 420
 - DC bias
 - Force 91
 - GND 91
 - Sense 91
 - DC power 99
 - DC Value 452
 - DCL 1781, 1783
 - DCL, SDC 967
 - Decouple Active Trace 429
 - Decouple All Traces 429
 - Deembedding
 - Balanced 712, 713
 - Ground Loop 713, 714
 - Impedance Renormalization 714, 715
 - Port Sets 710, 711
 - Single Ended 709
 - DEFault 943
 - Default file locations 1271
 - Define Calibration
 - Dialog 585
 - Define Limit Lines dialog 482
 - Define Parallel Measurement dialog 682
 - Balanced Ports tab 684
 - DUT Definition tab 684
 - Frequency Offset tab 685
 - Minimum Offset 685
 - Modify an existing DUT 684
 - Parallel Measurement with Frequency Offset 685
 - Reference Impedance tab 684
 - State indication popup 686
 - Define Physical Ports dialog 919
 - Define Ripple Test dialog 490
 - Define Segments dialog 553
 - Displayed Columns 556
 - Define User Color Scheme dialog 847
 - Delay 167
 - Delay (Offset Embed) 717, 718
 - Delete All Cal Kits 860
 - Delete All Mem 441
 - Delete Cal Pool 860
 - Delete Trace 433
 - Delta Mode 500
 - Delta-L 4.0 PCB characterization 300
 - Denominator 364
 - Destination (memory trace) 439
 - Destination (memory traces) 440

- Detector 160
- Device address 938
- Device Control 42
- Device LAN Configuration dialog 913
- Device message 939
- Device response 939
- Dflt Marker Frmt 425
- DHCP server
 - LAN configuration 1777
- Diagram 58, 108, 433, 839
 - Active Diagram 839
 - Add Tr+Diag 840
 - Delete Diagram 840
 - Maximize Diagram 840
 - Name 840
 - Overlay All 841
 - programming examples 1725
 - Show Title 841
 - Title 840
 - Trace List 839
- Dialog 136
- Dialogs 57
- Differential imbalance measurement 350
- Differential mode 161, 163
- Differential Mode 356
- Diplexer 88
 - Connector panel 91
 - Fuse 92
 - H/L SWITCH 90
 - Test port 90
- Direct Control Interface 42
- Direct generator/receiver access 306
- Direct IF Access 42, 308
- Display 35
 - Diagram 839
- Display Circle 496
- Display Config 844
 - Channel Info 846
 - Color Scheme 845
 - Font Size 847
 - Hide Sensitive Information 846
 - Info Table 846
 - Trace Info 846
- Display elements 124
- Display Port 41
- Display softtool 838
 - Config tab 844
 - Diagram tab 839
 - Split tab 842
 - Touchscreen tab 854
 - View Bar tab 852
- Displayed Columns dialog 556
- Distance Center 534
- Distance Span 534
- Distance Start 534
- Distance Stop 534
- Distance to Fault
 - Sweep points 832
 - Window 832
- Distance to Fault App 830
- Distance-to-fault measurements 255
- DNS server
 - LAN configuration 1777
- Dolph-Chebyshev
 - Side Lobe Level 449
- DOWN 943
- Drag and drop 61
- Driver (remote control) 932
- Driving Mode
 - Alternated 687
 - Auto 687
 - Chopped 687
- DUT 106
- DVI
 - Digital only 41
- E**
- Eazy De-embedding 298
- Electrical Length 167, 717, 718
- Embedding
 - Balanced 712, 713
 - Differential Match 715, 716
 - Ground Loop 713, 714
 - Impedance Renormalization 714, 715
 - Port Sets 710, 711
 - Single Ended 709
- EMI suppression 27
- ENABLE 953, 955
- EOI 1782
- Error log 878
- Error message 1766
- Error queue 953, 966
- Errors 1766
 - Asynchronous 1767
 - During firmware update 1768
 - During measurement 1767
 - FPGA update 1768
- ESB 958
- ESE 953, 959
- ESR 959
- Evaluation of data 76
- Evaluation Range Dialog 461
- EVENT register 955
- Execution (command)
 - Overlapping 949
 - Sequential 949
- Export
 - Sweep segments 555
- Export Data - <File Type> dialog 469
 - Ask Before Overwriting 471
 - Comment Added to File 473
 - Contents 471
 - Output Format 471
- Export Data - ASCII Files dialog
 - Add Ref Impedances 472
 - Decimal Separator 473
 - Field Separator 473
 - Formatted Values 472
- Export Data - MatLab Files dialog
 - Add Ref Impedances 472
 - Field Separator 473
 - Formatted Values 472
- Export Data - Touchstone Files dialog
 - Normalize with Port-Specific Impedances 471
 - Symmetric Params 471
- Export Markers 503
- Export snp Files
 - Active Channel 475
 - All Channels 475
 - Assign port numbers 475
 - Reset Port Assignments 475
 - Select ports 475
 - Select Ports 474

- Extended Time Domain Analysis (R&S ZNA-K20) 256
- External Data Logger
 - Connector 41
- External Frequency 887
- External generator 321
- External Generators dialog 897
- External Handler IO
 - Connector 41
- External Matrices dialog 909
- External power meter 316
- External Power Meter Config dialog 895
- External Power Meters dialog 891
- External reference 886
- Eye Diag 806
- Eye diagram
 - Basic settings 809
 - Display measurements 807
 - DUT 819
 - Emphasis 814
 - Enable/disable 806
 - Equalization 820
 - Export measurements 808
 - Generator bit pattern 813
 - Generator bit stream 809
 - Generator bit stream file 810
 - Generator bit stream length 810
 - Generator encoder 814
 - Generator levels 811, 814
 - Generator low pass 811
 - Generator modulation 811, 813
 - Generator rise time 811, 813
 - Generator scrambler 814
 - Generator settings 813
 - Generator symbol rate 810
 - Jitter 816
 - Mask configuration 823
 - Mask test 821
 - Noise 818
 - Select displayed measurements 807
- Eye Diagram simulation
 - Advanced settings 812
- Eye Mask Test
 - Define Mask Configuration 823
- EZD
 - Advanced settings 741
- F**
- Factor (averaging) 538
- Factory calibration 1774
- Favorites 776
- Feet 84
- File Print softtool 771
 - Favorites tab 776
 - More tab 781
 - Print tab 778
 - Recall Sets tab 772
 - Trace Data tab 781
- Firewall 1778
- Firmware
 - Setup file 1774
- Firmware installation 1774
- First Partial Meas'ment 542
- Fixture Compensation
 - Auto Length 720
 - Auto Length and Loss 720
 - Direct Compensation 720
- Fixture Compensation dialog 719
- Flatness Cal
 - Convergence 628
 - Max Iterations 628
 - Tolerance 628
- Flatness calibration 220
- Font Size 847
- Force
 - DC bias 91
- Format softtool 419
- FPGA update failure 1768
- Freq for Loss 708, 723
- Freq Step Size 540
- Frequency conversion measurements
 - R&S ZNA-K4 261
- Frequency converter
 - Fuse 87
 - IF output connectors 87
 - Input power 87
 - LO IN 87
 - MEAS OUT 87
 - Rear panel 86
 - REF OUT 87
 - RF IN 87
 - RF input connectors 87
- Frequency reference 886
- Frequency Resolution 1 mHz (R&S ZNA-K19) 288
- Front panel 35
- Front panel keys 43
- Fullscreen mode 853
- Function keys 36
 - Channel section 37
 - Stimulus section 37
 - System section 37
 - Trace section 37
- Fuse
 - Diplexer 92
 - Frequency converter 87
 - Replacement 1772
- G**
- Gain Compression tab 391
- Generator (external) 321
- GET 1781, 1783
- Getting started 21
- Global settings 107
- Global Settings 857
- GND
 - DC bias 91
- GPIO
 - Introduction 931
- GPIO Address 888
- GPIO bus interface 1782
- GPIO bus messages 939
- GPIO Explorer 798, 933
- GPIO Interface 41
- GPIO configuration
 - Apply (Set) 663
 - Basic 662
 - Output Voltage 663
 - Seq. 663
 - Voltage 663
 - Voltage and current measurements 663
- GPIO interface
 - R&S ZNA-B15 305
- GPIO Interface 42

- GPIO interface configuration
 - R&S ZN-B15/-Z15 Var. 03 656
- GPIO voltage and current measurements 663
 - Range 664
 - Results 665
 - Shunt 664
 - Start Meas 664
- Graphic zoom 66
- Ground connector 41
- Group Delay 424
 - Aperture Points 424
- GTL 1783
- H**
- H/L SWITCH
 - Diplexer 90
- H/L Switch cable 98
- Handler I/O
 - External 41
- Handshake bus 1782
- Hardkey panel 53
- Hardware 877
- Hardware (connectors) 1779
- Hardware info 877
- Harmonic grid 250
 - Automatic 452
 - Set and keep 451
- Hide All Data 441
- Hide All Mem 441
- Hide All Other Traces 433
- Hide Sensitive Information 846
- HiSLIP 931
- Horiz. Line 497
 - Response Value 498
 - Show Horiz. Line 498
- I**
- Ideal (cal kit) 202
- IEC/IEEE Bus Interface 1782
- IECWIN32 933
- IEEE 370 298
- IEEE 488 CH 1 1782
- IEEE 488 CH 2 1782
- IEEE 488 Interface 41
- IF Gain Mode
 - Low Dist 689
 - Low Noise 689
- IFC 1782, 1783
- Imag 423
- Image Suppr.
 - Auto 687
 - LO < RF 687
 - LO > RF 687
- Imbalance Differential dialog 350
- Imbalance parameters 165
- Impedance 154
- Import
 - Cal Kit 589
 - Sweep segments 555
- Import Complex Data dialog 468
 - Import Data to New Mem 469
 - Import Data to New Mem 469
- Impulse Response 449
- In-situ De-Embedding 299
- Increased IF bandwidth 30 MHz (R&S ZNA-K17) 288
- Increased measurement bandwidth 30 MHz (R&S ZNA-K17) 1324
- Independent Generator Settings dialog 920
- INtinty 943
- Info dialog 874
 - Cal Validation tab 879
 - Hardware tab 877
 - Lost Trigger tab 879
 - Options tab 876
 - Selftest tab 878
 - Setup tab 875
- Info Table 846
- Inline calibration 211, 1754
- Instrument calibration 73
- Instrument hardware 949
- Instrument Messages 890, 1784
- Instrument security procedures 22
- Instrument tour 34
- Instrument-control commands 939
- Interface
 - functions (GPIB bus) 1783
- Interface Clear 1782
- Interface message 939
- Interface messages
 - GPIB 1783
 - VXI-11 1781
- Interfaces 1779
- Intermodulation measurements 380
 - R&S ZNA-K14 262
 - Results 267
- Intermodulation tab 380
- Internal 3rd and 4th source 302
- Internal combiner P1-P2 (2-port R&S ZNA) 311
- Internal combiner P1-P3 (4-port R&S ZNA) 311
- Internal pulse modulators 309
- Internal reference 886
- Internal second LO generator 303
- Internal second source (for 2-port R&S ZNA) 303
- Inv Smith 423
- Inverted Smith chart 146
- IP Address 888
- IP address setting 1775
- ISD
 - Advanced settings 736
- IST flag 953, 959
- K**
- Keyboard 33
- Keyword (SCPI command) 939
- Kit Standards dialog 617
 - Add standard 619
 - Copy... standard 619
 - Delete standard 619
 - One Port Standards 618
 - Read .s1p File... 619
 - Read .s2p File... 619
 - Two Port Standards 618
 - View / Modify... standard 619
- Known devices
 - external generators 898, 923
 - external power meters 892
 - External switch matrices 911
- L**
- Labels on casing 80

LAN	41
connection	34
Remote operation	1775
LAN Detection	
external generators	899, 924
external power meters	894
External switch matrices	912
Language	855
Leveling	102, 283
Light Scheme	850
Limit line	168
files	175
Limit Test	478, 482
Add / Insert / Delete segment	484
Clear Test	481
Delete All segments	484
Limit Check	479
Limit Fail Beep	480
Limit line from trace data	484
Recall limit line	484
Save limit line	484
Segments	483
Shift Lines	482
Show Limit Line	478
Limit Test tab	
Controls	478
Limits	
Global Check	481
TTL1 Pass	481
TTL2 Pass	481
Lin Freq	546
Lin Mag	422
Line Styles Scheme	850
Lines softtool	477
Circle Test tab	492
Display Circle tab	496
Horiz. Line tab	497
Limit Test tab	478
Ripple Test tab	487
LLO	1783
LO Out	305
LO Usage	689
Load Match Correction	636
LOC	1781
Log Errors	891, 897
Log Freq	547
Log Mag	423
Logical Port	
Offset Embed Differential Match	752
Loss	
Active	707
Loss (bandfilter)	133
Loss at DC	708, 723
Loss at Freq	708, 723
Loss parameters	
definition	229
Lost trigger	
tab	879
Lost Trigger info	879
Low noise pre-amplifiers	312
Low pass impulse	248
Low Pass Settings dialog	450
Low pass step	248
Lower edge (bandfilter)	133
Lower limit	168
Lower Tone (intermodulation)	383

M

Maintenance	1772
Marker	58, 128
Delta Mode	500
Discrete	502
Format	502
Info	503
Mkr 1 ... Mkr 10	500
Mode	502
Name	501
On	499
Properties	501
Props	501
Ref Mkr -> Mkr	503
Response	499
Search	498
set by	69
Settings	498
Stimulus	499
Style	502
Marker coupling	132
Marker Format	502
Marker Info	503
Marker info field	129
Marker Mode	
Arbitrary	502
Fixed	502
Normal	502
Marker Name	501
Marker Search	504
Max / Min	504
Next Peak	505
Peak Left / Peak Right	505
Peak Type	505
Search Mode	514
Marker search functions	132
Marker softtool	498
Bandfilter tab	514
Info Field tab	520
Marker Coupling tab	520
Marker Props tab	501
Marker Search tab	504
Markers tab	498
Multiple Peak tab	510
Set by Marker tab	518
Target Search tab	512
Marker Style	502
Markers	
All Off	499
Coupled Markers	501, 521
Decimal Places	503
Export	503
Ref Mkr	500
Max (softkey, trace scale)	428
Max = Marker	519
MAXimum	943
Meas	
Power Sensor	396
S-Params	344
Meas Delay	541
Meas Out Low	91
Meas softtool	341
Intermodulation tab	380
Power Sensor tab	396
S-Params tab	344
Spectrum tab	397

- Time Domain tab 395, 396
 - Wave tab 357
 - Measa softtool
 - Gain Compression tab 391
 - Measure Fixture 720
 - Measurement 106
 - Measurement examples 71
 - Measurement receiver calibration 221
 - Measurement results 149
 - Measurements 341
 - Amplifier compression 391
 - Compression 391
 - Converted admittances 347
 - Converted impedances 346
 - Differential imbalance 350
 - Gain compression 391
 - Intermodulation 380
 - Port activation on demand 341
 - Power (with external power meter) 396
 - S-parameters 344
 - Wave quantities 357
 - Mechanical Length 717, 718
 - Mechanical source attenuator 676
 - Mem Math tab
 - Controls 442
 - Memory extension for data streaming 304
 - Memory Size 566
 - Menu bar 51
 - Menu Bar
 - Show/hide 853
 - Menus 52
 - Messages (system settings) 863
 - Show Error Messages 864
 - Show Info Messages 864
 - Show Instrument Messages 864
 - Show Warning Messages 864
 - METAS Calibration
 - Type 645
 - Min (softkey, trace scale) 428
 - Min = Marker 519
 - Minimize application 31
 - MINimum 943
 - Mixed mode parameters 163
 - Mixer calibration 199
 - Mode conversion factor 163
 - Mode tab
 - Driving Mode 687
 - IF Gain Mode 689
 - Image Suppr. 687
 - LO Usage 689
 - Phase Mode 689
 - Segmented IF Gain 689
 - Wideband IF Gain Manual Configuration dialog 690
 - Modify Frequency Conversion dialog 673
 - Frequency conversion formula 674
 - Monitor 32
 - DisplayPort 41
 - DVI-D 41
 - More Ratios dialog 363
 - More Wave Quantities dialog 359
 - Mouse 33
 - Multiple Peak search 510
 - Eval Range 510
 - Max 510
 - Min 510
 - Tracking 511
 - Multiple triggers
 - Logic 563
 - Multiplication (mixer) 410
- ## N
- NAN (not a number) 943
 - Navigation tools 48
 - NDAC 1782
 - New (recall set) 773
 - New Trace dialog 434
 - NINF (negative infinity) 943
 - Noise figure measurement (option R&S ZNA-K30) 289
 - Notch (time gate) 454
 - NRFD 1782
 - NTR 953
 - NTRansition 955, 957
 - Number of Points 524, 540
 - Numerator 364
 - Numeric Editor (dialog) 63
 - Numeric Suffix (remote control) 969
- ## O
- OCXO Frequency Reference 29
 - Offset
 - Active 707
 - Offset Embed
 - All Offsets Off 708
 - All Offsets On 708
 - Balanced 712
 - Differential Match Embedding 715
 - Fixture Compensation 719
 - Ground Loop 713
 - Impedance Renormalization 714, 715
 - Loss 707
 - Loss active 707
 - Offset active 707
 - Port Pairs 742
 - Port Sets 710
 - Reset Offsets 707
 - Reset Offsets (and losses) 708
 - Single Ended deembedding 709
 - Single Ended embedding 709
 - Offset Embed dock widget 706
 - Balanced panel 712
 - Calculation Flow 706
 - Differential Match panel 715
 - Ground Loop panel 713
 - Impedance Renormalization panel 714
 - Offset 707
 - Overview 706
 - Port Sets panel 710
 - Single Ended panel 709
 - Offset Embed softtool 706
 - Balanced tab 745
 - Delta-L tab 764
 - Differential Match tab 751
 - Ground Loop tab 748
 - Offset tab 716
 - One Way Loss tab 722
 - Port Sets tab 742
 - Single Ended tab 724
 - Offset parameters 228
 - application 233
 - balanced ports 234
 - definition 228

Offset tab	
Fixture Compensation dialog	719
On-screen keyboard	
analyzer	64
Windows	65
Open Recall	773
Operating system	30
Operation complete	959
OPERATION register	953, 960
Option	
R&S ZNA-B4	29, 303
R&S ZNA-B5	303
R&S ZNA-B7	41
R&S ZNA-B8	305
R&S ZNA-B15 (RFFE GPIO Interface)	42
R&S ZNA-B16	308
R&S ZNA-B19	41, 308
R&S ZNA-B26 (Direct IF Access)	42
R&S ZNA-B91	42
R&S ZNA-K2	447, 452
R&S ZNAxx-B2y	308
R&S ZNAxx-B3	302
R&S ZNAxx-B3y	309
R&S ZNAxx-B4y	309
R&S ZNAxx-B16	306
R&S ZNAxx-B212	311
R&S ZNAxx-B213	311
R&S ZNAxx-B302	312
R&S ZNBT-Z14	41
Option R&S ZNA	
Memory extension for data streaming	304
Option R&S ZNA-K2	
Time domain analysis	247
Option R&S ZNA-K30	
Noise figure measurement	289
Options	876
R&S ZNA-K210	298
R&S ZNA-K220	299
R&S ZNA-K230	300
R&S ZNA-K231	300
Options (overview)	246
Options info	876
Output unit	949
Overlapped command execution	949
P	
PAE	334
Parallel Poll	965
Parameter (remote control)	969
Partial measurement	111
Password	1775
Service Function	886
PCIe Interface	42
Permittivity	718
Persistent settings	107
Phase	420
Phase Mode	689
Polar	421
Polar diagram	142
Port	
Gender	584
Offset	717
Port Config	
Define Parallel Measurement	682
Port Settings	668
Port Config tab	667
Port Power Offset	631, 675
Port settings (mixer)	410
Port Settings dialog	668
ALC	676
ALC parameters	676
Arb Frequency tab	669
Arbitrary Power tab	674
Displayed columns	680
Freq. Conversion	672
Frequency results	670
Modify Frequency Conversion dialog	673
Power Result	675
Receiver Freq.	672
Receiver Freq. Conversion	672
Receiver Level tab	677
Reset	680
Slope	676
Source Gen	671
Source RF Off	670
Ports	
Calibration	645
Power	526
Power (system settings)	867
Power added efficiency (dialog)	405
Power added efficiency (PAE)	334
Power Cal dialog	
Leveling Table mode	602
Meas. Receiver mode	600
Power mode	599
Source Flatness mode	604
Power Cal dialog (Leveling Table)	602
Start Cal Sweep	604
Power Cal dialog (Meas. Receiver)	600
Port overview	601
Start Cal Sweep	602
Power Cal dialog (Power)	599
Start Cal Sweep	600
Power Cal dialog (Source Flatness)	604
Start Cal Sweep	605
Power Cal wizard	596
Calibration sweep diagram	596
Screen elements	596
Power calibration	218
measurement receiver	221
Power Meter	629
Procedure	570
reference receiver	220
Settings	626
source	220
Switch Off Other Sources	628
Power Config dialog	527
Power Meter	
Auto Zero	629
Power calibration	629
SMARTerCal	587
Power meter (external)	316
Power Meter Transmission Coefficients dialog	632
Two Port Configuration dialog	633
Power on	93
Power on and off	28
Power Sensor (menu)	396
Power Sensor tab	396
Power supply connector	87
Power sweep	548
Power tab	525, 535
PPC	1783

- PPE 953, 959
 PPU 1783
 Precision Oven Quartz Frequency Reference 303
 Preparing for use 82
 Preset 967
 Preset Configuration 857
 Preset Scope 857
 Presets (system settings) 856
 Print 778
 Printer 33
 Printing data 77
 Program example 1747
 calibration 1747
 Programming examples 1722
 PTNA 225
 PTOM 225
 PTOSM 225
 PTR 956
 PTRansition 955
 PTRL 225
 PTRM 225
 PTSM 225
 Public folder 1271
 Pulse Modulator Control
 Connectors 42
 PUOSM 225
 Pwr Bw Avg softtool 535
 Average tab 538
 Bandwidth tab 535
 Power tab 535
- Q**
- Quality factor (bandfilter) 133
 Query 939
 QUEStionable register 953, 960
 Summary bit 958
 QUEStionable:INTegrity register 961
 QUEStionable:LIMit register 960
- R**
- R&S ZNA-B4 29, 303
 R&S ZNA-B5 303
 R&S ZNA-B7 41
 Memory extension for data streaming 304
 R&S ZNA-B8 305
 R&S ZNA-B15
 RFFE GPIO interface 305
 R&S ZNA-B15 (RFFE GPIO Interface) 42
 R&S ZNA-B16 308
 R&S ZNA-B19 41, 308
 R&S ZNA-B26 (Direct IF Access) 42
 R&S ZNA-B52 303
 R&S ZNA-B91 42
 R&S ZNA-K2 447, 452
 R&S ZNA-K4 (frequency conversion measurements) 261
 R&S ZNA-K14 (intermodulation measurements) 262
 R&S ZNA-K17
 Increased IF bandwidth 30 MHz 288
 Increased measurement bandwidth 30 MHz 1324
 R&S ZNA-K19 (Frequency Resolution 1 mHz) 288
 R&S ZNA-K20 (Extended Time Domain Analysis) 256
 R&S ZNA-K30
 Noise figure measurement 289
 R&S ZNAxx-B2y 308
 R&S ZNAxx-B3 302
 R&S ZNAxx-B3y 309
 R&S ZNAxx-B4y 309
 R&S ZNAxx-B16 306
 R&S ZNAxx-B212 311
 R&S ZNAxx-B213 311
 R&S ZNAxx-B302 312
 R&S ZNBT-Z14 41
 R&S ZVR compatible commands 1695
 Ratio 159
 Read-only folder 1271
 Real 423
 Rear panel 41
 Frequency converter 86
 User Port 1779
 Rear Panel
 Optional Elements 42
 Recall Ripple Test 491
 Recall set 108
 Recall Set functions
 Basic 773
 Recall switch matrix configuration 774
 Receiver step attenuators 527
 Receiver Step Attenuators 309
 Receiving Port (intermodulation) 386
 Recent Files 774
 Reduced Through calibration 197
 Ref Mkr -> Mkr 503
 Ref Out Low 91
 Ref Pos 428
 Ref Val = Marker 519
 Ref Value 428
 Reference Clock (In/Out)
 Connectors 41
 Reference impedance 152
 Reference position 68
 Reference Receiver Cal Power 631
 Reference value 68
 Reflection measurement (example) 78
 Release notes 19, 23
 REM 1781
 Remote control 931, 1731
 Activation 935
 basic concepts 945
 Introduction 931
 Remote Control
 Codec 855
 Combine with manual control 938
 Remote desktop 1777
 Remote Language 888
 Remote Preset Configuration 857
 Remote Settings 888
 Advanced 890
 Define *IDN + *OPT... 889
 GPIB Address 888
 Instrument Messages 890
 IP Address 888
 Remote Language 888
 Removable System Drive 41
 REN 1782
 Renormalization (of port impedances) 152
 Renormalization theory
 Power waves 357
 Travelling waves 357
 Replacing fuses 1772
 Required Equipment 100

- Reset values
 - Status reporting system 966
 - Resolution Enh(ancement) 450
 - Response (to queries) 939
 - Restart Manager dialog 568
 - Sweep Active Channel 569
 - Sweep All Channels 569
 - Restart Sweep 566
 - Restart Sweep on Std. Meas. 578
 - Revision 19
 - RF In Low / High 91
 - RF Off All Channels 526
 - RFFE Config dialog
 - Sweep Sequencer tab 665
 - RFFE Config dialog (R&S ZN-B15/-Z15 Var. 03) 656
 - GPIOs tab 658
 - RFFE tab 657
 - Sweep Sequencer tab 658
 - RFFE interface
 - Configuration 659
 - R&S ZNA-B15 305
 - RFFE Interface 42
 - RFFE interface configuration 659
 - Apply changes (Set) 662
 - Basic 659
 - CLK 660
 - R&S ZN-B15/-Z15 Var. 03 656
 - RFFE Command 660
 - SEND command 661
 - Seq. 659
 - VHigh 660
 - VIO 660
 - VLow 660
 - Voltage and current measurements 661
 - RFFE interface voltage and current measurements 661
 - Apply configuration changes (Set) 662
 - Output Voltage 661
 - Range 661
 - Results 662
 - Shunt 661
 - Start Meas 662
 - RFFE/GPIO interface
 - Sweep Sequencer 665
 - Ripple limit 168
 - files 176
 - Ripple Test 487, 490
 - Clear Test 489
 - Ranges 490
 - Ripple Check 488
 - Ripple Fail Beep 489
 - Show Results All Traces 489
 - Show Ripple Limits 488
 - Rise Time 826
- S**
- S-parameter 149
 - multiport 150
 - S-parameter buttons 346
 - S-Parameter selector 345
 - S-Params tab 344
 - Converted admittances 347
 - Converted impedances 346
 - Safety instructions 15, 22
 - Warning messages 80
 - Same Color all Markers 850
 - Save (recall set) 774
 - Save Ripple Test 491
 - Saving data 77
 - Scalar power calibration 102, 218
 - Scale
 - Scale Coupling 428
 - Scale Coupling tab 428
 - Scale softtool 425
 - Scale Coupling tab 428
 - Scale Values tab 425
 - Zoom tab 429
 - Scale Values tab 425
 - Scale/Div 427
 - Scaling diagrams 66
 - Scan Instruments
 - external generators 899, 923
 - external power meters 893
 - External power meters 911
 - SCPI command structure 939
 - SCPI commands 939
 - SCPI status register 955
 - event status register 959
 - IST flag 959
 - parallel poll enable register 959
 - service request enable register 958
 - status byte 958
 - STATus:OPERation register 960
 - STATus:QUESTionable register 960
 - STATus:QUESTionable:INTegrity 961
 - STATus:QUESTionable:LIMit 960
 - Structure 953
 - Screen elements 124
 - Screen Keyboard 799
 - Screen saver 35
 - SDC 1783
 - Search functions 132
 - Search Path for additional Cal Kits and Connector Types
 - 860
 - Search Range dialog 506
 - Range Limit Lines On 508
 - Search Range 507
 - Select Marker 507
 - Second internal LO generator 303
 - Security procedures 22
 - Seg X-Axis 551
 - Segmented IF Gain 689
 - Segmented sweep 548
 - Define Segments dialog 553
 - Export segments 555
 - Import segments 555
 - Select Parameter dialog 473
 - Select Ports dialog 474
 - Selectivity 537
 - Selftest 878
 - Selftest info 878
 - SENSE
 - DC bias 91
 - Sequential command execution 949
 - Serial poll 965
 - Service
 - Recalibration 1772
 - Service Function 885, 886
 - Password 886
 - Service Function dialog 885
 - Service manual 22
 - Service request 964
 - Service request (SRQ) 931
 - Service Request Enable 953, 958

- Set by Marker 518
 - Center 519
 - Max 519
 - Min 519
 - Ref Value 519
 - Span 519
 - Start 519
 - Stop 519
 - Zero Delay at Marker 520
- Setup
 - Define Physical Ports 919
 - Device LAN Configuration 913
 - External Generators 897
 - External Matrices 909
 - External Power Meter Config 895
 - External Power Meters 891
 - Independent Generator Settings 920
 - Reference 886
 - Switch Matrix RF Connections 914
- Setup info 875
- Setup information 875
- Setup softtool 854
 - Freq. Ref. tab 886
 - Remote Settings tab 888
 - Setup tab 854
- SFD
 - Advanced settings 740
- Shape (time gate) 454
- Shift JIS 855
- Shift trace
 - response 465
 - stimulus 465
- Shift Trace 465
- Show <Trace Name> 433
- Show All Data 441
- Show All Mem 441
- Show All Traces 433
- Show Cal Kit Label 859
- Show Limit Fail Symbols 848
- Show Point List 555
- Show/Hide data trace 439
- Show/Hide memory trace 439
- Side lobe level
 - Frequency window 449
- Side Lobe Level (time gate) 454
- Single sweep 565
- Single sweep mode
 - Sweeps (# of) 566
- Single-ended mode 161, 163
- Skew 827
- Sliding Match 203
- Smart Fixture De-Embedding 300
- Smarter calibration 224
- SMARTerCal 224
 - Power Meter 587
 - Power Sweep Diagram 576, 581
 - Procedure 570
- Smith 421
- Smith chart 143
- Smoothing 463
 - Aperture 464
- Softtool panel
 - Minimize/maximize 854
- Softtools 51
- Software Option Info 877
- Source coherence
 - Tab 702, 703
- Source Port 365
- Source power calibration 220
- Source step attenuators 308
- SPAN 113
- Span = Marker 519
- Span Frequency 523
- SPD 1783
- SPE 1783
- Split All 841
- Split diagrams 842
 - Dual Split 843
 - Quad Split 843
 - Triple Split 843
- Split Type 843
- SRE 953, 958
- SRQ 953, 964, 1782
- Stability factors 166
- Standby and ready state 29
- Standby key 39
- Standby switch 86
- START 113
- Start = Marker 519
- Start Frequency 523
- Start Power 523
- Startup and shutdown 28
- Status bar 54
- Status Bar
 - Show/hide 853
- Status registers 953
- Status reporting system
 - common commands 968, 970
 - Error queue 966
 - Parallel poll 965
 - Queries 966
 - Reset values 966
 - Serial poll 965
 - Service request 964
- STB 953, 958
- Step attenuators
 - Source 308
- Step Size (dialog) 64
- Stimulus Axis 524
- Stimulus keys 37
- Stimulus softtool 522
 - Power tab 525
 - Stimulus tab 522
 - Time Domain X-Axis tab 533
- Stimulus tab 522
 - Center Frequency 523
 - CW Frequency 524
 - Number of Points 524
 - Power 526
 - Span Frequency 523
 - Start Frequency 523
 - Stop Frequency 523
- STOP 113
- Stop = Marker 519
- Stop Frequency 523
- Stop Power 523
- String 943
- Support 1768
- Sweep
 - Sweep Params 539
 - Sweep Active Channel 569
 - Sweep All Channels 569
 - Sweep Control
 - Restart Manager dialog 568

Sweep Control tab	565
Sweep History	1745
Sweep mode	
Continuous	565
Single	565
Sweep range selection	73
Sweep range setting	68
Sweep Sequencer (RFFE/GPIO interface)	665
Sweep settings	539
Sweep softtool	
Sweep Control tab	565
Sweep Type tab	546
Timer Mode Settling dialog	543
Trigger tab	558
Wait Time Control tab	542
Sweep Time	541
Sweep Type	
CW Mode	549
Lin Freq	546
Log Freq	547
Power	548
Segmented	548
Time	550
Sweep Type tab	546
Sweeps (# of)	566
Switch Matrices	
Add Switch Matrix (dialog)	915
Delete Switch Matrix (dialog)	915
Switch Matrix RF Connections dialog	914
SWR	421
Symmetric Params	471
Syntax elements (SCPI, overview)	943
System	37
System Config dialog	856
Advanced tab	865
Calibration tab	858
Channel Bits tab	864
Messages tab	863
Power tab	867
Presets tab	856
User Interface tab	860
System Drive	41
System error correction	105
System keys	37
System settings	854
T	
Target Search	512, 513
Search Left	514
Target Format	513
Target Value	512
Task bar	
Show/hide	853
TDR application	799
TDR Setup tab	800
TDR Stimulus Settings	803
TDR Wizard	801
TDR Application	
Eye Diag tab	806
Eye Diagram dialog	809
Eye Mask Test	821
Rise Time	826
Skew	827
Time Gate	829
X Axis	830
Y Axis	829
TDR Setup	
Stimulus...	803
TDR Wizard	801
TDR Stimulus - Advanced Settings dialog	805
TDR Stimulus Settings	803
Advanced	805
Basic	804
TDR Wizard	801
Test port	40
Diplexer	90
Test set	
Connections	93
Text parameter	943
Time Center	534
Time Domain	448
Time domain analysis	447, 452
Option R&S ZNA-K2	247
Time Domain Signal Integrity Tests	256
Time Domain Transform	247
Time domain transformation	
Impulse Response	449
Type	449
Time Domain X-Axis tab	533
Time Gate	453, 829
Bandpass	454
Notch	454
Shape	454
Show Range Lines	454
Side Lobe Level	454
Time Span	534
Time Start	534
Time Stop	534
Time sweep	550
Time vs. Distance	535
Timer Mode Settling dialog	543
Title (diagram)	125
Title bar	49
Show/hide	853
Title Bar Task Bar	799
Tool 3 ... Tool 8	799
Tool Bar	
Show/hide	853
Toolbar	49
Touchscreen	35
Configuration	854
Enabled	854
Lock Diagrams	854
Lock Screen	854
Touchstone (*.s<n>p) file	177
Trace	58, 108, 125
Dfit Marker Frmt	425
programming examples	1725
Trace Colors per Diagram	849
Trace Data	781
Export	467
Import	467
Import Complex Data	468
Trace Data import	
Auto Distribute traces	474
Deselect All traces	474
Select All traces	474
Select Parameter	473
Trace files	176
Trace format	419
dB Mag	420
Delay	424
Imag	423

Inv Smith	423
Lin Mag	422
Log Mag	423
Phase	420
Polar	421
Real	423
Smith	421
SWR	421
Unwr Phase	422
Trace formats	140
Trace Info	846
Trace keys	37
Trace list	126
Trace Manager dialog	435
Add	436
Couple All Channels	437
Couple All Scales	437
Decouple All Channels	437
Decouple All Scales	437
Delete	436
Trace Math	443
Data - <Mem>	443
Data / <Mem>	443
User Defined	443
Trace Statistics	455
Compr. Point	459
Compr. Val.	459
Evaluation Range	461, 462
Evaluation Range Limit Lines On	462
Flatness/Gain/Slope	458
Format	457
Mean/Std Dev/RMS	456
Min/Max/Peak-Peak	456
Phase/EI Length	457
Traces	
Hold	464
Max Hold	464
Min Hold	464
Shift Trace	465
Smoothing	463
Traces softtool	431
All Mem All Data tab	439
Distance to Fault tab	830
Hold	462
Mem tab	437
Shift Trace	462
Smooth Shift Hold tab	462
Smoothing	462
Time Domain tab	447
Time Gate tab	452
Trace Data tab	467
Trace Statistics tab	455
Traces tab	431
Tracking	
marker search, target search	506
Transmission measurement (example)	71
Trigger	
Delay	562
External	560
FreeRun	560
Manual	560
Manual Trigger	561
Multiple Triggers	560
Sequence	561
Signal Type	562
Source	560, 562
Trigger In	1781
Trigger Out	1781
Trigger In	1781
Connector	41
Trigger In/Out	
Connectors	42
Trigger Manager dialog	562
Logic	563
Trigger Out	1781
Trigger tab	558
Controls	559
Troubleshooting	1766
TTL Pass	867
Two Port Configuration dialog	633
Power loss list	634
Transm. Coefficients	634
Typical (cal kit)	202
U	
Unbalance-balance conversion	161
Universal command	939, 1783
Unpacking	82
Unwr Phase	422
UP	943
Upper edge (bandfilter)	133
Upper limit	168
Upper Tone (intermodulation)	383
Upper/lower case (remote control)	969
USB	
front panel	40
USB Device	41
USB Host	
rear panel	41
USB-to-GPIB Adapter	316
USB-to-IEC/IEEE Adapter	316
Use Cal tab	
All Power Cals Off	636
All Power Cals On	636
Controls	635
Recall Last Cal Set	636
User Cal Active	635
Use Trc Color for Limit Lines	849
User Def Math dialog	443
Expression builder	445
Result is Wave Quantity	446
User Interface (system settings)	860
Conductance in Embedding Networks	862
Decimal Places	863
Reset Colors	863
Reset Decimal Places	863
Reset Dialogs	863
Reset Units Prefix	863
Show Sweep Symbols	862
Sounds	861
Transparent Info Fields	861
Units Prefix	863
Use Default Tab for Hardkey	862
User Port	1779
Connector	41
TTL Pass output	867
UTF-8	855

V

Vector mixer calibration	1754
VPUOSM	1755
VUOSM	1755
Velocity Factor	718
View / Modify Cal Kit Standards dialog	619, 620
Characteristic impedance Z0	620
Delay	620
Electrical Length	620
Load parameters	621
Loss	620
Offset Loss	620
Offset parameters	620
Virtual differential mode	161
Virus protection	1775
VISA	931
VNA Port Assignment	625
VXI-11	931

W

Wait Time Control tab	542
Warning messages	80
Wave quantity	158, 360
Display unit	361
Wave tab	357
White papers	23
Wideband IF Gain Manual Configuration dialog	690
Drive-port specific settings	691
Range	691
Set All Items to Auto	691
Set All Items to Low Distortion	691
Set All Items to Low Noise	691
Window mode	853
Windows	30
Windows Explorer	799

Y

Y <- S-Parameters	347
Y-parameter	157

Z

Z <- S-Parameters	346
Z-parameter	156
Zero Delay at Marker	520
Zoom	66
Max	431
Min	431
Overview On	431
Start	431
Stop	431
Zoom Reset	431
Zoom Select	430
Zoom tab	429