

M981xAS Series

PXIe Vector Component Analyzer

100 kHz to 26.5/32/44/53 GHz

Drive down the size of test

M9815AS 100 kHz to 26.5 GHz

M9816AS 100 kHz to 32 GHz

M9817AS 100 kHz to 44 GHz

M9818AS 100 kHz to 53 GHz



M981xAS Series PXIe Vector Component Analyzer (VCA)

It's not easy to characterize multiport antenna arrays and front-end modules (FEM) with traditional test equipment when they require network measurements like gain and S-parameters along with modulated signal measurements like EVM and ACP. Juggling a network analyzer, signal analyzer, and a switch matrix not only takes up valuable time, but also threatens the integrity of your measurements by introducing extra potential sources of error.

What if you combine all your measurements into a single instrument? The M981xAS PXIe Vector Component Analyzer (VCA) brings flexible component characterization to a scalable PXI form factor. With the capabilities of an advanced network analyzer combined with modulated signal measurements, you can fully characterize highly integrated wireless components. You can use an external signal generator or integrate a PXI vector adapter to add modulated signal stimulus for complete device characterization. Easily perform network and spectrum measurements with wizards to guide you through advanced measurements.

The scalable PXI form factor provides exceptional multiport performance no matter how many ports you use. All test ports are fully synchronous, so multiple ports can be measured simultaneously with multiport error correction applied.

Table of Contents

M981xAS Series PXIe Vector Component Analyzer (VCA)	2
Definitions.....	4
M981xA Receiver Module Specifications.....	5
Uncorrected System Performance	5
Test Port Input.....	6
Dynamic Accuracy	7
Spectrum Analysis (with Option 090 and S95090B)	8
M980xA PXIe VNA Specifications	15
M981xAS Option 750/751 Specifications.....	15
Bypass Path (CW Signal).....	15
Vector Modulation Path.....	18
M981xAS System Performance	22
Multi-module Measurements with S95551B Software	24
General Information	26
Block Diagrams	31
Literature Information	33
Web Resources.....	33

Definitions

Specification (spec) ¹

Warranted performance. Specifications include guardbands to account for the expected statistical performance distribution, measurement uncertainties, and changes in performance due to environmental conditions. All specifications and characteristics apply over a $25\text{ °C} \pm 5\text{ °C}$ range (unless otherwise stated).

The following conditions must be met:

- Module temperature is between 37 to 50 °C (M980xA PXI VNA and M981xA receiver module).
- Instrument has been turned on for 60 minutes with VNA application running.
- Instrument is within its calibration cycle.
- Instrument remains at a stable surrounding environment temperature (between -10 °C to 55 °C) for 60 minutes prior to turn-on.

Characteristics (char.)

A performance parameter that the product is expected to meet before it leaves the factory, but that is not verified in the field and is not covered by the product warranty. A characteristic includes the same guardbands as a specification.

Typical (typ.)

Expected performance of an average unit at a stable temperature between $25\text{ °C} \pm 5\text{ °C}$ for 60 minutes prior to turn-on and during operation; does not include guardbands. It is not covered by the product warranty. The instrument must be within its calibration cycle.

Nominal (nom.)

A general, descriptive term or design parameter. It is not tested, and not covered by the product warranty.

Supplemental Information

A performance parameter that is tested on sampled product during design validation. It does not include guardbands and is not covered by the product warranty.

Calibration

The process of measuring known standards to characterize an instrument's systematic (repeatable) errors.

Corrected (residual)

Indicates performance after error correction (calibration). It is determined by the quality of calibration standards and how well "known" they are, plus system repeatability, stability, and noise.

Uncorrected (raw)

Indicates instrument performance without error correction. The uncorrected performance affects the stability of a calibration.

1. For all tables in this data sheet, the specified performance at the exact frequency of a break is the better value of the two specifications at that frequency.

M981xA Receiver Module Specifications

This section provides specifications of the M981xA receiver module included in the option 491 or 691 of the M981xAS Series Vector Component Analyzer (VCA).

Uncorrected System Performance

Table 1. Uncorrected Error Terms (dB) – Specification ¹

Description	Input return loss
300 kHz to 1 MHz	1
1 MHz to 3 MHz	14
3 MHz to 10 MHz	17
10 MHz to 4 GHz	17
4 GHz to 6 GHz	12
6 GHz to 10 GHz	12
10 GHz to 20 GHz	9
20 GHz to 27 GHz	8
27 GHz to 40 GHz	5
40 GHz to 50 GHz	8
50 GHz to 53 GHz	5

1. Specification apply to following conditions: Factory correction is turned on.

Table 2. Uncorrected Error Terms (dB) – Typical

Description	Input Return Loss
100 kHz to 300 kHz	2
300 kHz to 500 kHz	2
500 kHz to 1 MHz	2
1 MHz to 3 MHz	16
3 MHz to 10 MHz	20
10 MHz to 50 MHz	20
50 MHz to 4 GHz	20
4 GHz to 6 GHz	15
6 GHz to 8 GHz	15
8 GHz to 10 GHz	15
10 GHz to 16 GHz	11
16 GHz to 20 GHz	11
20 GHz to 24 GHz	10
24 GHz to 26 GHz	10
26 GHz to 27 GHz	10
27 GHz to 35 GHz	7
35 GHz to 40 GHz	7
40 GHz to 45 GHz	11
45 GHz to 50 GHz	11
50 GHz to 53 GHz	8

1. It may typically be degraded at 25 MHz.

Test Port Input

Table 3. Test Port Noise Floor (dBm) ¹

Description	Specification	Typical
100 kHz to 300 kHz	-97	-105
300 kHz to 500 kHz	-97	-110
500 kHz to 1 MHz	-110	-120
1 MHz to 10 MHz	-115	-124
10 MHz to 50 MHz ²	-127	-133
50 MHz to 200 MHz	-130	-133
200 MHz to 3 GHz	-130	-137
3 GHz to 6.5 GHz	-130	-135
6.5 GHz to 9 GHz	-128	-134
9 GHz to 17 GHz	-127	-133
17 GHz to 25 GHz	-125	-131
25 GHz to 30 GHz	-122	-129
30 GHz to 45 GHz	-120	-127
45 GHz to 50 GHz	-105	-115
50 GHz to 53 GHz	-95	-113

1. Noise floor in a 10 Hz IF Bandwidth. Measured with 1 kHz IF bandwidth for 30 kHz IF bandwidth for 100 kHz to 53 GHz. Test port terminated.
2. It may typically be degraded at 25 MHz.

Table 4. Receiver Compression at Test Port

Description	Input power at test port (dBm)	Specification		Typical	
		Magnitude (dB)	Phase (°)	Magnitude (dB)	Phase (°)
100 kHz to 300 kHz	-2	0.2	5	0.10	1.0
300 kHz to 1 MHz	+7	0.2	5	0.10	1.0
1 MHz to 17 GHz	+10	0.2	5	0.05	1.0
17 GHz to 20 GHz	+7	0.2	5	0.05	1.0
20 GHz to 30 GHz	+5	0.2	5	0.05	1.0
30 GHz to 45 GHz	+2	0.2	5	0.05	1.0
45 GHz to 50 GHz	-5	0.2	5	0.05	1.0
50 GHz to 53 GHz	-23	0.2	5	0.05	1.0

Table 5. Damage Input Level

Description	
Damage Input Level	+27 dBm or ± 35 VDC (Warranted)

Dynamic Accuracy

Accuracy of the test port input power relative to the reference input power level. Measured with 10 Hz IF bandwidth.

Dynamic accuracy¹ – specification

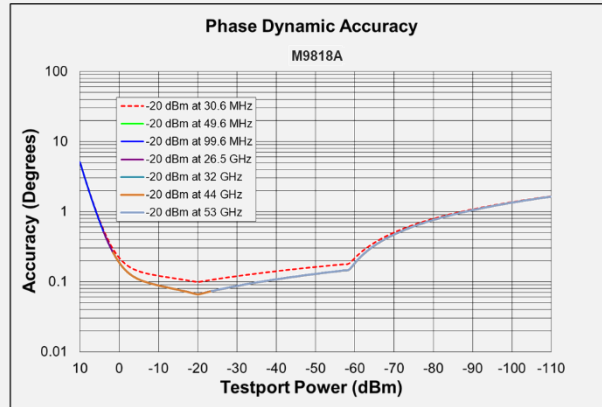
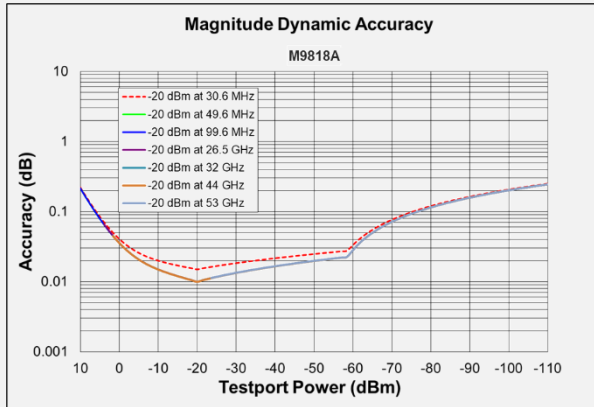

1. Dynamic accuracy is verified with the following measurements:
 - Compression over frequency
 - IF linearity using a reference level of -20 dBm for an input power range of 0 to -60 dBm. Tested at three single frequencies (30.6 MHz, 49.6 MHz and 99.6 MHz) to cover the whole frequency range. The VNA receiver is linear by design when signal levels are below -60 dBm. For more details, refer to [VNA Receiver Dynamic Accuracy Specifications and Uncertainties](#).

Spectrum Analysis (with Option 090 and S95090B)

This section provides specifications for the spectrum analysis Option 090 on the M981xAS Series Vector Component Analyzer. The S95090B Software is required to enable spectrum analysis functions of the M981xAS.

Table 6. Frequency Specifications

Description	Specification	Supplemental information
Frequency Reference ¹		
Accuracy	-	± [(time since last adjustment x aging rate) + temperature stability + calibration accuracy], typical
Aging rate	-	± 3 ppm/year maximum, typical
Temperature stability	-	± 7 ppm (0 to 50 °C)
Achievable initial calibration accuracy	± 7 ppm (25 ± 5 °C)	-
Frequency readout accuracy (Start, Stop, Center, Marker)	-	± [(readout frequency x frequency reference accuracy) + (< 1% x RBW)], nominal
Frequency Span		
Minimum/Maximum	Analyzer's full span	-
Resolution	1 Hz	-
Sweep (Trace) point range	11 to 100,001	-
Resolution Bandwidth (RBW)		
Range (-3 dB bandwidth)	10 Hz to 3 MHz in 10% steps	-
Bandwidth range accuracy	-	± 1%, all RBW, except below 100 MHz with 3 MHz RBW
Selectivity (-60 dB/-3 dB)	-	Gaussian: 4.5:1, Flat top: 2.47:1, Kaiser: 3.82:1, Blackman: 3.58:1
Video Bandwidth (VBW)		
Range	10 Hz to 3 MHz	-

1. Frequency reference accuracy can be improved by using external frequency reference with better accuracy.

Table 7. Time Specifications

Description	Specification	Supplemental information
Sweep Time and Triggering		
Sweep time range	Auto	-
Trigger types	Continuous, Single, Group, Manual, External	-
Trigger delay range	0 to 3 s	-
Trigger delay resolution	1 μ s	-
Measuring and Display Update Rate (milliseconds) ¹		
20 MHz Span, 3 kHz RBW, 3 kHz VBW	-	63
100 MHz Span, Auto RBW, Auto VBW	-	63
1 GHz Span, 3 kHz RBW, 3 kHz VBW	-	344
1 GHz Span, 300 kHz RBW, 300 kHz VBW	-	63
10 GHz Span, 3 kHz RBW, 3 kHz VBW	-	3286
10 GHz Span, 300 kHz RBW, 300 kHz VBW	-	373
10 MHz to 20 GHz, RBW/VBW = 1 MHz	-	782
10 MHz to 50 GHz, RBW/VBW = 1 MHz	-	1807

1. Measured with a 2-port module with firmware revision A.14.10.08.

Table 8. Amplitude Accuracy and Range Specifications

Description	Specification
Amplitude Range	
Measurement range	DANL to maximum input level
Input attenuator range	High attenuation or Low attenuation
Maximum safe input level	+27 dBm
Display Range	
Log scale	0.001 to 500 dB/div in 0.001 steps
Linear scale	10 divisions (default)
Scale units	dBm, mW
Trace detectors types	Average, Sample, Peak, Normal, Negative Peak, Peak sample, Peak average

Table 9. SA Detector Accuracy (dB) ¹ – Specifications

Description	Specification
100 kHz to 10 MHz	± 0.15
10 MHz to 20 GHz	± 0.1
20 GHz to 53 GHz	± 0.15

1. With high attenuation. SA detector accuracy is residual error of IF response calibration. IF response is characterized with M981xAS's standard measurement class after power and S-parameter calibration. Therefore, the SA total absolute amplitude accuracy includes power meter, S-parameter and SA detector accuracies. Add input attenuation switching uncertainty if receiver attenuator is changed after user calibration.

Table 10. Input Attenuation Switching Uncertainty (dB) – Supplemental Information

Description	Supplemental information
100 kHz to 50 MHz	± 0.5
50 MHz to 53 GHz	± 1.0

Table 11. Input VSWR ¹ – Specifications

Description	Specification
1 MHz to 3 MHz	1.499
3 MHz to 4 GHz	1.329
4 GHz to 10 GHz	1.671
10 GHz to 20 GHz	2.100
20 GHz to 27 GHz	2.323
27 GHz to 40 GHz	3.570
40 GHz to 50 GHz	2.323
50 GHz to 53 GHz	3.570

1. Calculated by input return loss of uncorrected error terms (Table 1). $VSWR = \frac{1+10^{(-1 \cdot \text{input return loss}/20)}}{1-10^{(-1 \cdot \text{input return loss}/20)}}$

Table 12. Other Amplitude Accuracy – Supplemental Information

Description	Supplemental information
RBW switching uncertainty	0.02 dB
Display scale fidelity	See dynamic accuracy specification. Specification applied to SA measurement class with user calibration between -10 dBm and -40 dBm input power and measurement between +10 dBm and -120 dBm input power.

Table 13. Spurious Response – Supplemental Information

Description	Supplemental information
Image response	Mostly eliminated. Intermittent image response may be seen when making multi-tone or modulated signal measurements.
LO related spurious	Eliminated

Table 14. Displayed Average Noise Level (DANL) at Test Ports with Low Attenuation (dBm/Hz) ¹ – Specifications

Description	Specification	Typical
100 kHz to 300 kHz	-110	-118
300 kHz to 500 kHz	-110	-120
500 kHz to 1 MHz ²	-123	-130
1 MHz to 10 MHz	-128	-134
10 MHz to 100 MHz	-136	-142
100 MHz to 200 MHz	-144	-146
200 MHz to 3 GHz	-144	-150
3 GHz to 6.5 GHz	-144	-148
6.5 GHz to 9 GHz	-142	-147
9 GHz to 17 GHz	-141	-146
17 GHz to 20 GHz	-139	-146
20 GHz to 25 GHz	-139	-143
25 GHz to 30 GHz	-136	-143
30 GHz to 45 GHz	-134	-141
45 GHz to 50 GHz	-119	-129
50 GHz to 53 GHz	-109	-127

1. Tested with 1 kHz RBW up to 50 MHz and 10 kHz RBW for above 50 MHz, test port terminated, average detector, averaging type = Log, IF gain = Auto, image rejection = normal, random LO OFF.
2. A residual spurious response may be observed around 600 kHz.

Table 15. Displayed Average Noise Level (DANL) at Test Ports with High Attenuation (dBm/Hz) ¹ – Typical

Description	Specification	Typical
100 kHz to 300 kHz	-	-96
300 kHz to 500 kHz	-	-98
500 kHz to 1 MHz ²	-	-108
1 MHz to 10 MHz	-	-112
10 MHz to 100 MHz	-	-112
100 MHz to 200 MHz	-	-124
200 MHz to 3 GHz	-	-128
3 GHz to 6.5 GHz	-	-126
6.5 GHz to 9 GHz	-	-125
9 GHz to 20 GHz	-	-124
20 GHz to 30 GHz	-	-121
30 GHz to 45 GHz	-	-119
45 GHz to 50 GHz	-	-107
50 GHz to 53 GHz	-	-105

1. Tested with 1 kHz RBW up to 50 MHz and 10 kHz RBW for above 50 MHz, test port terminated, average detector, averaging type = Log, IF gain = Auto, image rejection = normal, random LO OFF.
2. A residual spurious response may be observed around 600 kHz.

Table 16. Second Harmonic Distortion with High Attenuation ¹ – Supplemental Information

Description	SHI (dBm)
50 MHz to 1 GHz	+30
1 GHz to 4 GHz	+38
4 GHz to 10 GHz	+47
10 GHz 15 GHz	+44
15 GHz to 26.5 GHz	+40

1. Tested with 0 dBm for 50 MHz to 10 GHz, and -5 dBm for 10 GHz to 26.5 GHz input at test port, 10 MHz tone separations.

Table 17. Second Harmonic Distortion with Low Attenuation ¹ – Supplemental Information

Description	SHI (dBm)
50 MHz to 1 GHz	+10
1 GHz to 4 GHz	+20
4 GHz to 10 GHz	+30
10 GHz 15 GHz	+26
15 GHz to 20 GHz	+21
20 GHz to 26.5 GHz	+16

1. Tested with -25 dBm input at test port, 10 MHz tone separations.

Table 18. Third Order Intermodulation Distortion with High Attenuation ¹ – Characteristic

Description	Distortion (dBc)	TOI (dBm)
50 MHz to 200 MHz	-40	+20
200 MHz to 2 GHz	-44	+22
2 GHz to 5 GHz	-46	+23
5 GHz to 10 GHz	-50	+25
10 GHz to 15 GHz	-56	+23
15 GHz to 20 GHz	-52	+21
20 GHz to 30 GHz	-42	+16
30 GHz to 40 GHz	-48	+14
40 GHz to 53 GHz	-52	+11

1. Tested with 0 dBm for 50 MHz to 10 GHz, -5 dBm for 10 GHz to 30 GHz, -10 dBm for 30 GHz to 40 GHz, and -15 dBm for 40 GHz to 53 GHz input at test port, 10 MHz tone separations.

Table 19. Third Order Intermodulation Distortion with Low Attenuation ¹ – Characteristic

Description	Distortion (dBc)	TOI (dBm)
50 MHz to 5 GHz	-56	+3
5 GHz to 10 GHz	-52	+1
10 GHz to 20 GHz	-66	+7
20 GHz to 30 GHz	-66	+5
30 GHz to 53 GHz	-66	+2

1. Tested with -25 dBm input at test port, 10 MHz tone separations.

Table 18. Third Order Intermodulation Distortion with High Attenuation ¹ – Characteristic

Description	Distortion (dBc)	TOI (dBm)
50 MHz to 200 MHz	-40	+20
200 MHz to 2 GHz	-44	+22
2 GHz to 5 GHz	-46	+23
5 GHz to 10 GHz	-50	+25
10 GHz to 15 GHz	-56	+23
15 GHz to 20 GHz	-52	+21
20 GHz to 30 GHz	-42	+16
30 GHz to 40 GHz	-48	+14
40 GHz to 53 GHz	-52	+11

1. Tested with 0 dBm for 50 MHz to 10 GHz, -5 dBm for 10 GHz to 30 GHz, -10 dBm for 30 GHz to 40 GHz, and -15 dBm for 40 GHz to 53 GHz input at test port, 10 MHz tone separations.

Table 19. Third Order Intermodulation Distortion with Low Attenuation ¹ – Characteristic

Description	Distortion (dBc)	TOI (dBm)
50 MHz to 5 GHz	-56	+3
5 GHz to 10 GHz	-52	+1
10 GHz to 20 GHz	-66	+7
20 GHz to 30 GHz	-66	+5
30 GHz to 53 GHz	-66	+2

1. Tested with -25 dBm input at test port, 10 MHz tone separations.

DANL and Distortion Relative to Test Port Level (dB) ¹ – Nominal

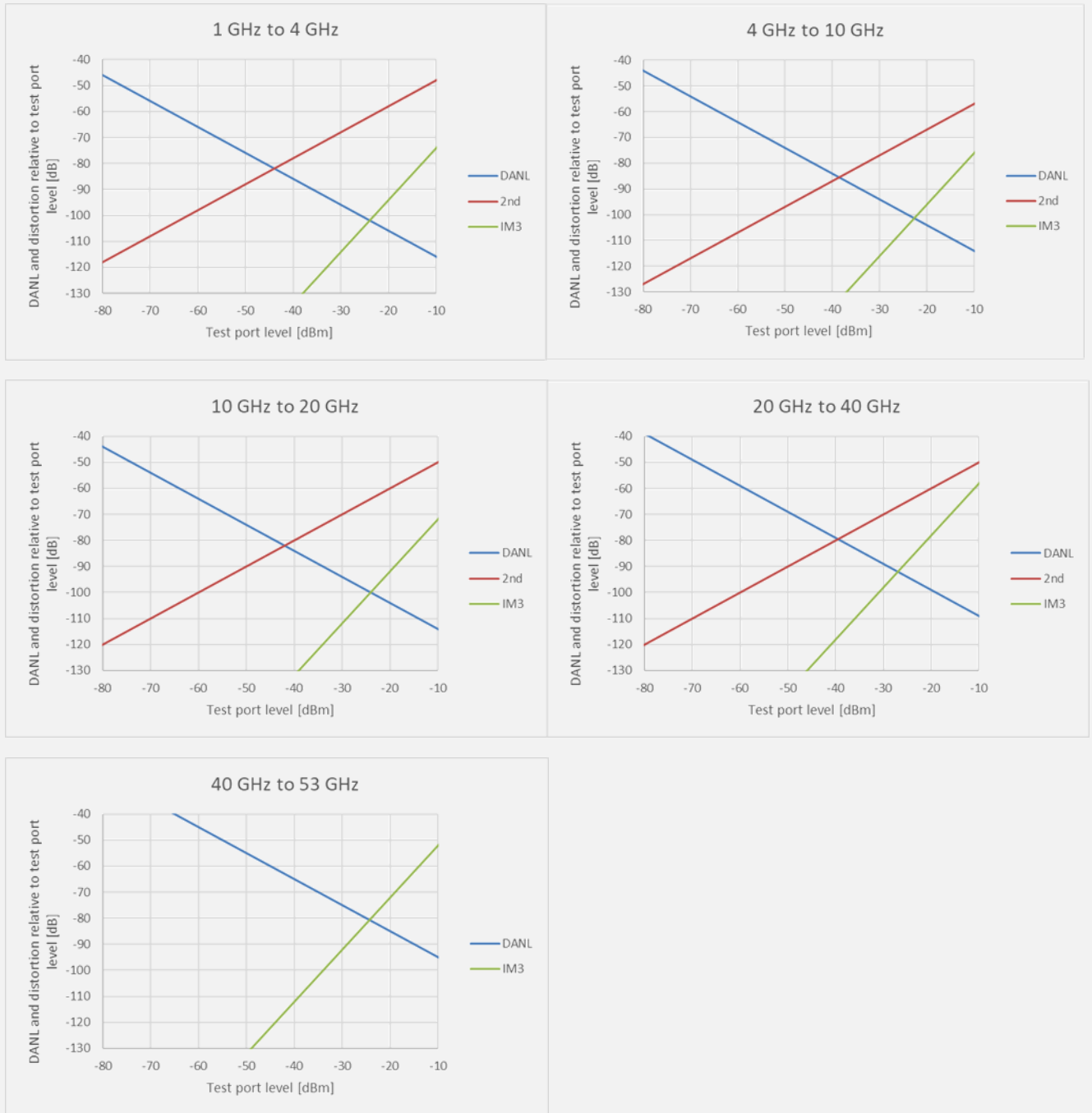

1. With High Attenuation. 2nd harmonic distortion applies up to 26.5 GHz.

Table 20. Receiver Phase Noise (dBc/Hz) ¹ – Typical

Description	1 kHz	10 kHz	100 kHz	1 MHz	10 MHz
CF = 1 GHz	-103	-103	-103	-128	-130
CF = 3 GHz	-96	-96	-96	-120	-130
CF = 10 GHz	-83	-83	-83	-116	-127
CF = 20 GHz ²	-76	-76	-76	-110	-121

1. At maximum specified power. Spurious signals are excluded. With the SA class, the phase noise of VNA's source is equivalent to the receiver phase noise.
2. Tested at 19.99 GHz.

M980xA PXIe VNA Specifications

Refer to M980xA Series PXIe VNA data sheet (literature number: 5992-3596), for the technical specifications of the M980xA included in the option 491 or 691 of the M981xAS Series Vector Component Analyzer (VCA).

M981xAS Option 750/751 Specifications

This section provides specifications of the M9810A PXI Vector Modulator included in the option 750/751 of the M981xAS Series Vector Component Analyzer (VCA).

Refer to M9336A PXIe I/Q Arbitrary Waveform Generator data sheet (literature number: 5992-2140), for the technical specifications of the M9336A included in the option 750/751 of the M981xAS.

Bypass Path (CW Signal)

Table 21. Frequency Range - Specifications

Description	Specification
Frequency range	100 MHz to 53 GHz

Table 22. Input Return Loss (dB) ¹ - Typical

Description	Typical
100 MHz to 300 MHz	1
300 MHz to 500 MHz	3
500 MHz to 44 GHz	4
44 GHz to 53 GHz	3

1. With 0 dB attenuator.

Table 23. Output Return Loss (dB) - Specifications

Description	Specification
100 MHz to 300 MHz	3
300 MHz to 20 GHz	7
20 GHz to 40 GHz	5
40 GHz to 53 GHz	3

Table 24. Gain (dB) ¹

With 0 dB Attenuator

Description	Specification	
	0 dB ATT	
100 MHz to 300 MHz	-14 to 30	
300 MHz to 500 MHz	3 to 32	
500 MHz to 10 GHz	9 to 32	
10 GHz to 20 GHz	2 to 23	
20 GHz to 29 GHz	-8 to 16	
29 GHz to 40 GHz	-17 to 10	
40 GHz to 45 GHz	-29 to 3	
45 GHz to 50 GHz	-35 to -2	
50 GHz to 53 GHz	-42 to -7	

With 10/20/30/40 dB Attenuator

Description	Specification			
	10 dB ATT	20 dB ATT	30 dB ATT	40 dB ATT
100 MHz to 125 MHz	-25 to 21 2	-36 to 11 2	-47 to 1 2	-58 to -9 2
125 MHz to 300 MHz	-25 to 21	-36 to 11	-47 to 1	-58 to -9
300 MHz to 500 MHz	-8 to 22	-19 to 12	-30 to 2	-41 to -8
500 MHz to 10 GHz	-2 to 22	-13 to 12	-24 to 2	-35 to -8
10 GHz to 20 GHz	-9 to 13	-20 to 3	-31 to -7	-42 to -17
20 GHz to 29 GHz	-19 to 6	-30 to -4	-41 to -14	-52 to -24
29 GHz to 40 GHz	-28 to 0	-39 to -10	-50 to -20	-61 to -30
40 GHz to 45 GHz	-40 to -7	-51 to -17	-62 to -27	-73 to -37
45 GHz to 50 GHz	-46 to -12	-57 to -22	-68 to -32	-79 to -42 2
50 GHz to 53 GHz	-53 to -172	-64 to -27 2	-75 to -37 2	-93 to -47 2

With 50/60 dB Attenuator

Description	Typical	
	50 dB ATT	60 dB ATT
100 MHz to 300 MHz	-70 to -19	-82 to -29
300 MHz to 500 MHz	-53 to -19	-65 to -29
500 MHz to 10 GHz	-44 to -19	-56 to -29
10 GHz to 20 GHz	-52 to -28	-64 to -38
20 GHz to 29 GHz	-62 to -35	-74 to -45
29 GHz to 40 GHz	-71 to -41	-83 to -51
40 GHz to 44 GHz	-84 to -48	-93 to -58

1. Attenuation can be set or current setting can be read with a SCPI command, "SOURce<cnum>:M9810:MODule<mod>:ATTenuation[:VALue] <num>"
2. Typical performance.

Table 25. Power Level Accuracy (dB) ¹ – Typical

Description	Typical
100 MHz to 500 MHz 2	± 5.0
500 MHz to 40 GHz 2	± 4.0
40 GHz to 44 GHz 2	± 5.0
40 GHz to 47 GHz 2	± 6.0
47 GHz to 50 GHz 3	± 6.0

1. Power level accuracy can be improved by user power calibration.
2. At -20 dBm source power.
3. At -30 dBm source power.

Table 26. Maximum Output Power (dBm) – Typical

Description	Typical
100 MHz to 500 MHz	12
500 MHz to 20 GHz	14
20 GHz to 29 GHz	6
29 GHz to 40 GHz	-2
40 GHz to 44 GHz	-15
44 GHz to 50 GHz	-25
50 GHz to 53 GHz	-35

Measured Maximum Output Power

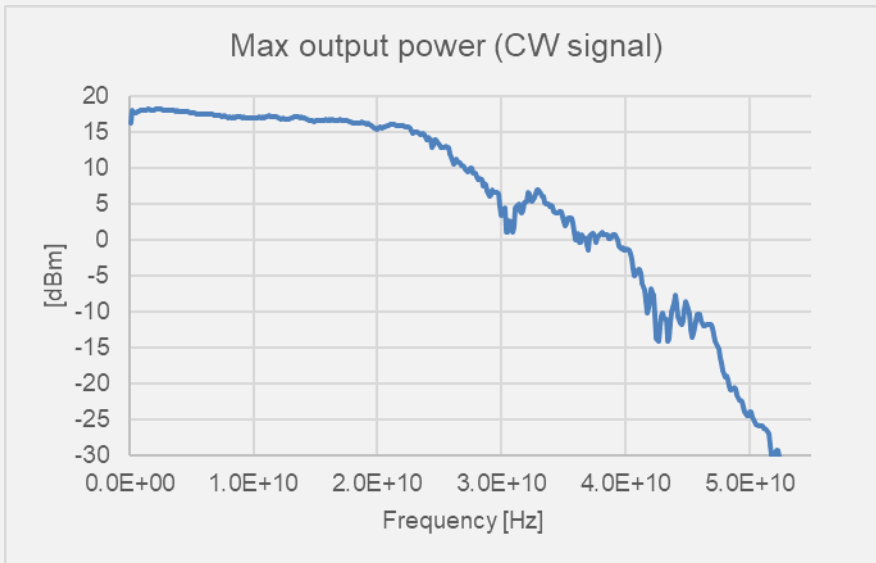

Table 27. Settable Frequency and Power Range

Description	
Settable frequency range	Same as M9806A/M9807A/M9808A
Settable power range	-100 to 20 dBm
Settable power resolution	0.01 dB

Vector Modulation Path

Table 28. Frequency Range - Specifications

Description	Specification
Frequency range	22 GHz to 32 GHz (with M9806A)
	22 GHz to 44 GHz (with M9807A/M9808A)

Table 29. Maximum Modulation Bandwidth - Typical

Description	Opt.750	Opt.751
22 GHz 31.8 GHz	1.08 GHz	1.08 GHz
31.8 GHz to 37 GHz	1.08 GHz	550 MHz
37 GHz to 44 GHz	1.08 GHz	1.08 GHz

Table 30. Input Return Loss (dB) - Typical

Description	Typical
22 GHz to 44 GHz	4

Table 31. Output Return Loss (dB) - Specifications

Description	Specification
22 GHz to 40 GHz	5
40 GHz to 44 GHz	3

Table 32. Power Level Accuracy (dB) ¹ – Typical

Description	Without calibration ²	With calibration ³
22 GHz to 25.6 GHz	± 5.0	± 0.5
25.6 GHz to 40 GHz	± 5.0	± 0.6
40 GHz to 44 GHz	± 5.0	± 0.8

1. At -10 dBm source power.
2. Without user power calibration. Power level accuracy can be improved by user power calibration.
3. Expected power level accuracy for DUT with SWR of < 2. Source power calibration is performed with the U8487A power sensor over a 25 °C ± 3 °C range, and the instrument remains at a stable surrounding environment temperature with < 1 °C from calibration temperature. A high pass filter (HPF) is inserted before the power sensor during power calibration.

Table 33. Maximum Output Power (dBm) – Typical

Description	Two-tone modulation ¹	Flat Tone modulation ²
22 GHz to 30 GHz	6	5
30 GHz to 40 GHz	0	-3
40 GHz to 44 GHz	-5	-8

1. Tone separation of 20 MHz.
2. 100 MHz modulation bandwidth, 1,001 tones, PAPR = 9.2 dB.

Measured Maximum Output Power

Two-tone modulation

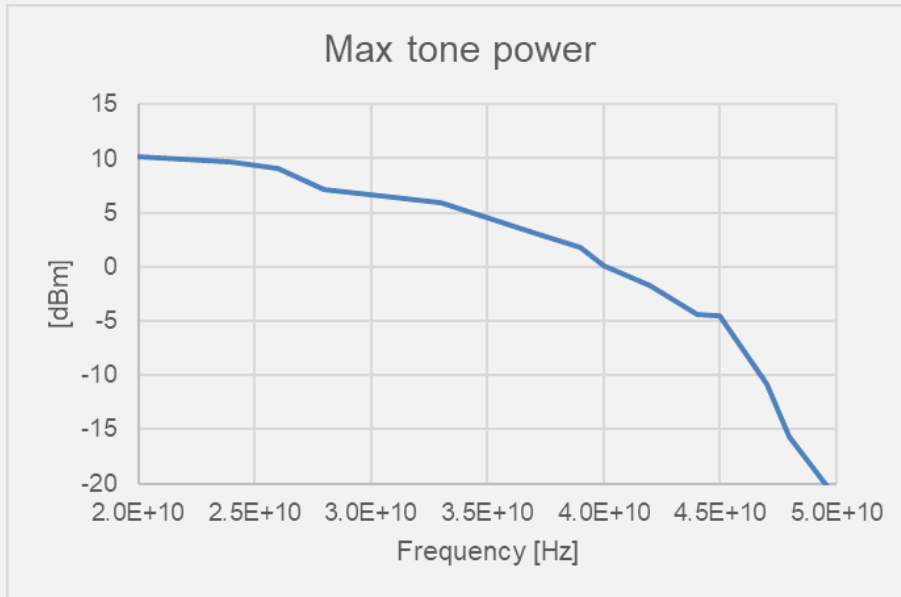

Flat Tone modulation

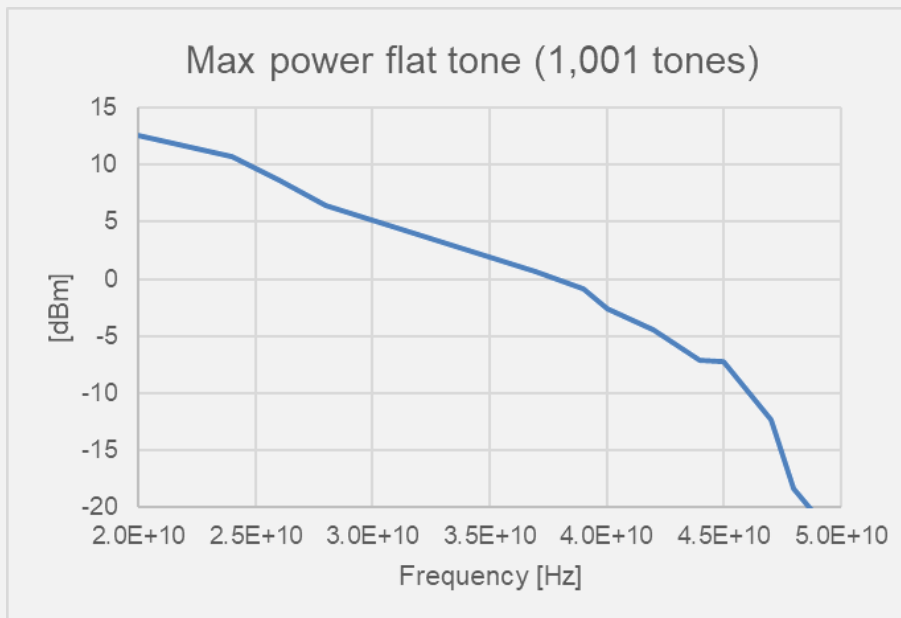

Table 34. Settable Frequency and Power Range

Description	
Settable frequency range	Same as M9806A/M9807A/M9808A
Settable power range	-100 to 20 dBm
Settable power resolution	0.01 dB

Table 35. Third Order Intermodulation Distortion (IM3) (dBc) ¹ - Typical

Description	Typical
22 GHz to 40 GHz	-57
40 GHz to 44 GHz	-50

1. Tone-tone modulation, 20 MHz tone separation, -15 dBm tone power.

Measured IM3 ¹

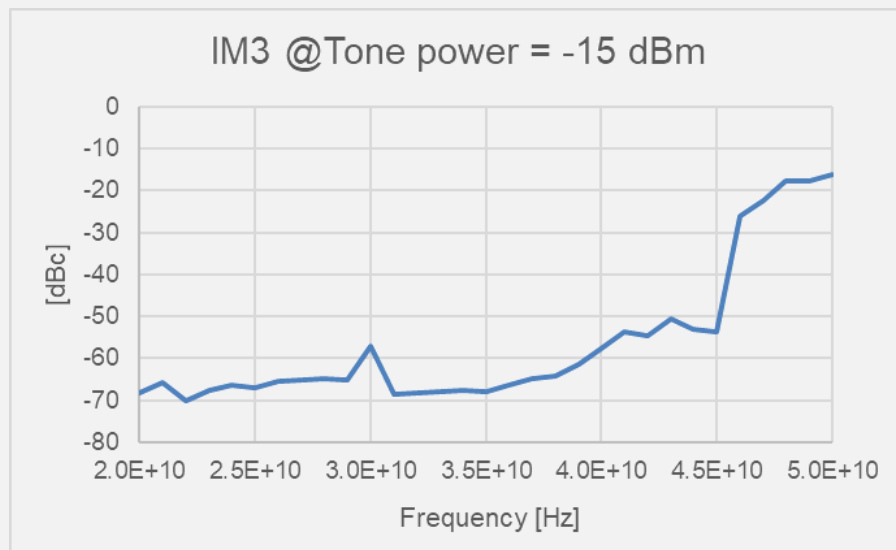

1. Tone-tone modulation, 20 MHz tone separation, -15 dBm tone power.

Table 36. Adjacent Channel Power Ratio (ACPR) (dBc) ¹ - Typical

Description	Typical
22 GHz to 25 GHz	-45
25 GHz to 40 GHz	-52
40 GHz to 44 GHz	-46

1. Flat tone modulation, 100 MHz modulation bandwidth, 1,001 tones, -10 dBm band power, PAPR = 9.2 dB.

Measured ACPR ^{1,2}

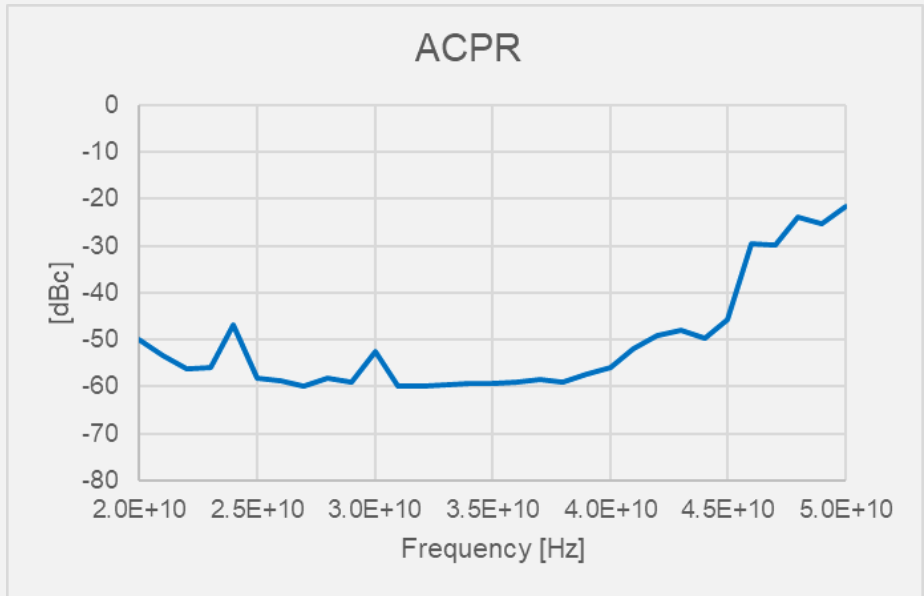

1. Output power is set to -10 dBm for 20 GHz to 44 GHz, and -15 dBm above 44 GHz.
2. Flat tone modulation, 100 MHz modulation bandwidth, 1,001 tones, -10 dBm band power, PAPR = 9.2 dB.

Measured LO Feedthrough ^{1,2} – Typical

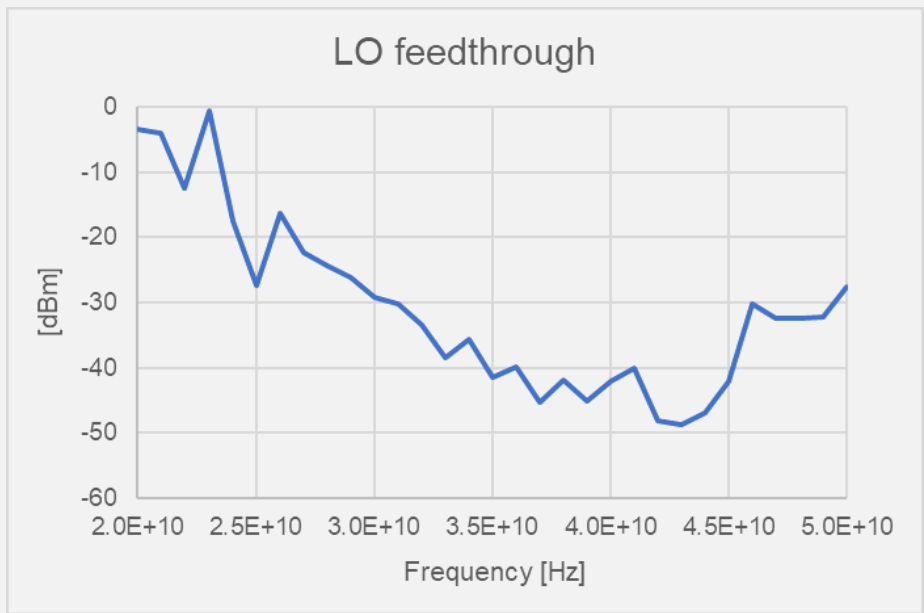

1. Output power is set to -12 dBm. Two-tone modulation with 20 MHz tone separation.
2. With 0 dB attenuator, without user calibration. User calibration can minimize effects of LO feedthrough.

Table 37. Damage Input Level - Typical

Description	Typical
Maximum reverse power level at RF Output	27 dBm
Maximum input power level at RF Input	16 dBm
Maximum input power level at I, Q input	12 dBm
DC damage level at RF ports (RF Input / RF Output)	± 35 V

M981xAS System Performance

This section provides typical measured EVM performance using the M9818AS including option 691 (direct receiver access configuration on port 1 and port 2, up to 53 GHz), option 750 or 751 (PXI vector adapter), and option 870 (with 87301E directional couplers). EVM of a thru adapter and N4985A power amp is measured at 28 GHz and 39 GHz.

Configuration using M9818AS

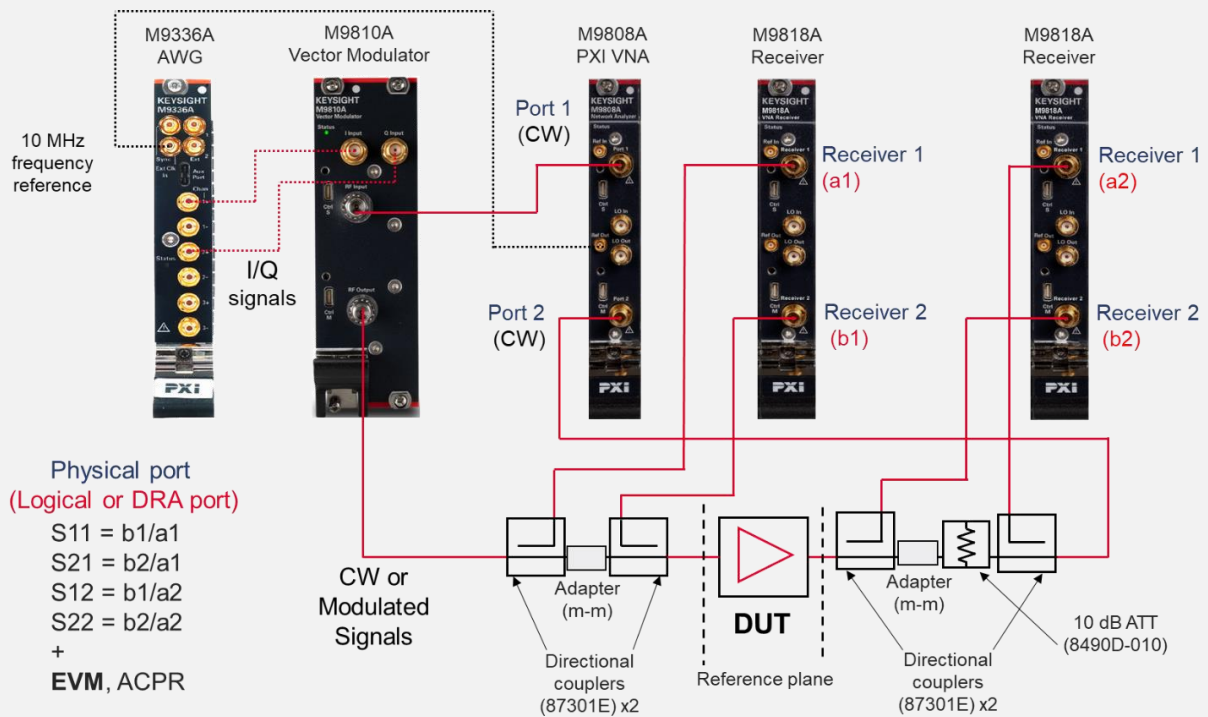

Measured Error Vector Magnitude (EVM) ^{1,2} – Typical

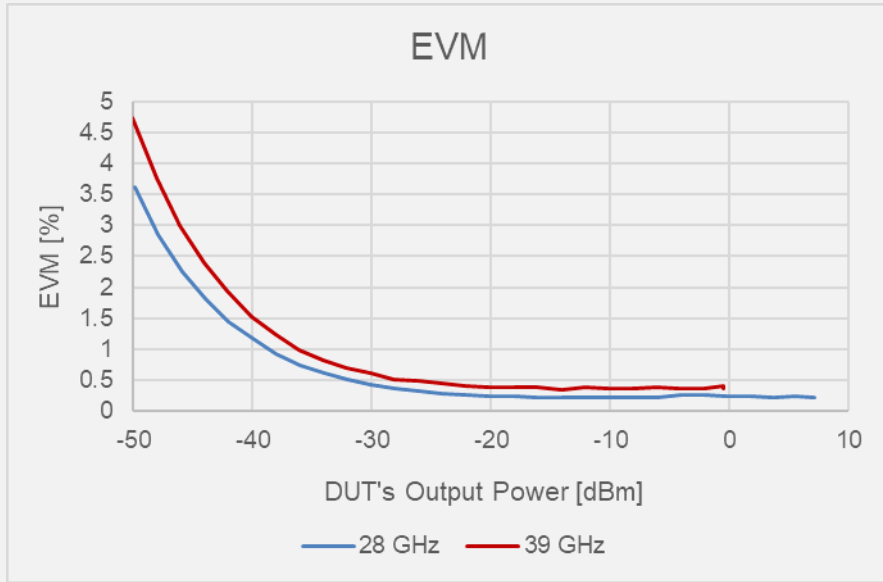

1. Measured EVM of 11900B adapter (female-female, 2.4-mm connectors) using a compact waveform of 5G NR (8 usec period). 100 MHz bandwidth, 64QAM, 120 kHz SCS, 2,972 Number of tones.
2. Noise bandwidth = 10 Hz. Receiver attenuator on port 1 & 2: 0 dB (output power < -5 dBm), 20 dB (output power >= -5 dBm).

Measured Error Vector Magnitude (EVM) ^{1,2} – Typical

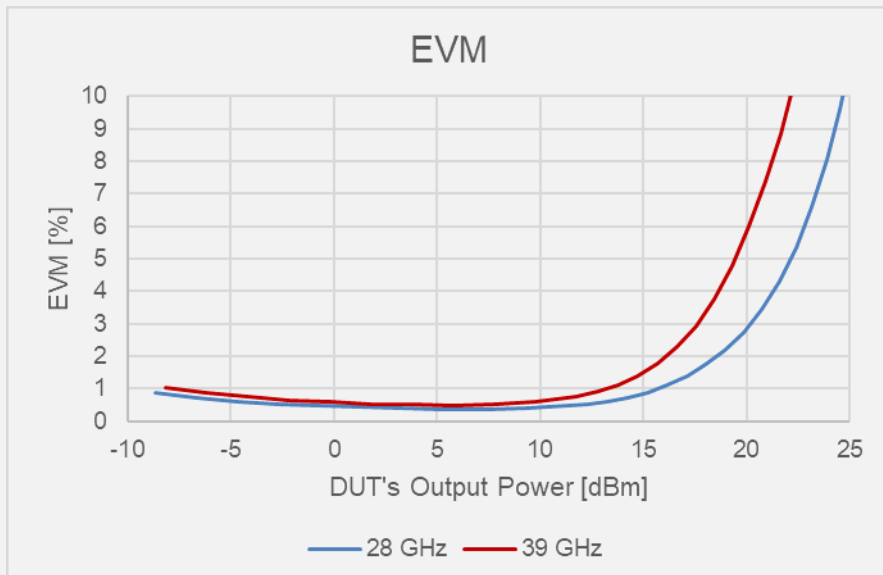

1. Measured EVM of Keysight N4985A (power amplifier, 2 GHz to 50 GHz with option P25) using a compact waveform of 5G NR (8 usec period). 400 MHz bandwidth, 64QAM, 120 kHz SCS, 2,972 Number of tones.
2. Noise bandwidth = 10 Hz. Receiver attenuator on port 1 with 0 dB, and port 2 with 20 dB.

Multi-module Measurements with S9551B Software

When the S9551B software is installed, the M981xAS PXIe VCA has the ability to extend the number of test ports using multiple M980xA PXIe VNAs or M981xA PXIe receiver modules. Adding a second module to the PXI chassis would provide additional test ports to the VNA. This configuration provides a full featured multiport vector network analyzer capability with full crossbar S-parameter measurement capability.

Multiport configurations using up to 17 modules have been evaluated.

For multi-module operation, all single-module specifications apply except trace noise, test port noise floor, system dynamic range, Displayed Average Noise Level (DANL) and SA detector accuracy. The other performance of multi-module configurations will meet the single-module specifications in the data sheet.

The guidance provided here is given as general reference based on Keysight’s internal evaluation of multiport PXIe VNA configurations. Not all multiport setups using multiple PXIe VNAs are tested as a multiport instrument in the factory. Interconnect cables included in the Y1730A must be used for connection among multiple M980xA and M981xA modules. For more detail of multi-module configurations, refer to “M980xA Multi-module Installation Guide” at www.keysight.com/find/m980xa-mm.

Table 38. Multi-module Performance

- A check mark, ✓, indicates the performance parameter is the same as the corresponding single-module performance.
- An empty diamond, ◇, indicates that the performance parameter may be degraded as the number of modules increases.

Description	Setups with 2 to 17 modules
Frequency accuracy	✓
Uncorrected input return loss	✓
Noise floor	◇ (see Table 39)
Receiver compression	✓
Dynamic accuracy	✓
Crosstalk	✓

Table 39. Test Port Noise Floor of Multi-module Configurations (dBm) ¹

Description	2 to 12 modules		13 to 17 modules	
	Char.	Typical	Char.	Typical
100 kHz to 300 kHz	-97	-105	-97	-105
300 kHz to 500 kHz	-97	-110	-97	-110
500 kHz to 1 MHz	-110	-120	-110	-120
1 MHz to 10 MHz	-115	-124	-115	-124
10 MHz to 50 MHz ²	-127	-133	-127	-133
50 MHz to 200 MHz	-130	-133	-130	-133
200 MHz to 3 GHz	-130	-137	-130	-137
3 GHz to 6.5 GHz	-130	-135	-130	-135
6.5 GHz to 9 GHz	-128	-134	-128	-134
9 GHz to 17 GHz	-127	-133	-127	-133
17 GHz to 25 GHz	-125	-131	-125	-131
25 GHz to 30 GHz	-122	-129	-122	-129
30 GHz to 45 GHz	-120	-127	-120	-127
45 GHz to 50 GHz	-105	-115	-105	-115
50 GHz to 53 GHz	-95	-113	-95	-113

1. Noise floor in a 10 Hz IF Bandwidth. Measured with 1 kHz IF bandwidth for 9 kHz to < 100 kHz, and 30 kHz IF bandwidth for 100 kHz to 53 GHz. Test port terminated.
2. It may typically be degraded at 25 MHz.

General Information

Table 40. Miscellaneous Information

Description	Specifications
System IF bandwidth range	1 Hz to 15 MHz
Number of points	1 to 100,003





Table 41. System Requirements

PC System Requirement	
Hardware requirements	M9037A PXIe High performance embedded controller recommended
Operating systems	Windows 7 SP1 and Windows 10 (64-bit only)
Processor speed	Intel i5 6th generation or newer/Intel Xeon 3E v3 or newer
Available memory	16 GB recommended; 4 GB minimum
Available disk space	2 GB available disk space minimum
Display resolution	1024 x 768 minimum
Instrument Drivers	
Keysight IO libraries	IO Libraries Suite 2018 Update 1 (18.1.23218) or later

Table 42. Environmental and Physical Specifications

Descriptions	Samples of this product have been type tested in accordance with the Keysight Environmental Test Manual and verified to be robust against the environmental stresses of Storage, Transportation and End-use; those stresses include, but are not limited to, temperature, humidity, shock, vibration, altitude, and power line conditions. Test Methods are aligned with IEC 60068-2 and levels are similar to MIL-PRF-28800F Class 3.	
Temperature	Operating	0 to 50 °C ambient 10 to 70 °C module temperature
	Non-operating	-40 to 70 °C
Humidity	Operating	Type tested at 20 to 80 %, wet bulb temperature < 29 °C (non-condensing)
	Non-operating	Type tested at 20 to 90 %, wet bulb temperature < 40 °C (non-condensing)
Altitude	Operating	Up to 2,000 meters (6,561 feet)
	Non-operating	Up to 4,572 meters (15,000 feet)
Vibration	Operating	0.3 G maximum, 5 Hz to 500 Hz
	Non-operating	0.75 G maximum, 5 Hz to 500 Hz
Instrument protection	IP 30 IEC/EN 60529	
Warm-up time	60 minutes	

Table 43. Regulatory and Safety Compliance

EMC ¹	
Complies with the essential requirements of the European EMC Directive as well as current editions of the following standards (dates and editions are cited in the Declaration of Conformity).	
	<p>The CE mark is a registered trademark of the European Community (if accompanied by a year, it is the year when the design was proven). This product complies with all relevant directives.</p> <ul style="list-style-type: none"> • IEC 61326-1 • CISPR 11 Group 1, Class A
	UK conformity mark is a UK government owned mark. When affixed to the product is declaring all applicable Directives and Regulations have been met in full.
CAN ICES/NMB-001(A)	This ISM device complies with Canadian ICES-001. Cet appareil ISM est conforme a la norme NMB du Canada.
	<p>The RCM mark is a registered trademark of the Australian Communications and Media Authority.</p> <ul style="list-style-type: none"> • AS/NZS CISPR 11
	<p>South Korean Certification (KC) mark; includes the marking's identifier code: R-R-Kst-xxxxxxx</p> <p>South Korean Class A EMC declaration: Information to the user: This equipment has been conformity assessed for use in business environments. In a residential environment this equipment may cause radio interference. ※ This EMC statement applies to the equipment only for use in business environment.</p> <div style="border: 1px solid black; padding: 5px; margin-top: 10px;"> <p style="text-align: center; background-color: #e1eef6;">사 용 자 안 내 문</p> <p>이 기기는 업무용 환경에서 사용할 목적으로 적합성평가를 받은 기기로서 가정용 환경에서 사용하는 경우 전파간섭의 우려가 있습니다.</p> </div> <p>※ 사용자 안내문은 “업무용 방송통신기자재”에만 적용한다.</p>
Instrument calibration cycle	1 year

1. To find a current Declaration of Conformity for a specific Keysight product, go to: <http://www.keysight.com/go/conformity>.

Table 44. Physical Size and Weight

M9815A, M9816A, M9817A, M9818A PXI Receiver Module

Description		Note
Width	22 mm (0.87 in.)	Including the backplane connector alignment tabs, and front panel ground clip in free state
Height	130 mm (5.12 in.)	Including the ejector hook
Depth	210 mm (8.27 in.)	From tip of ejector to tip of backplane connector
Weight	685 g (1.5 lbs)	

M9810A PXI Vector Modulator

Description		Note
Width	42 mm (1.65 in.)	Including the backplane connector alignment tabs, and front panel ground clip in free state
Height	130 mm (5.12 in.)	Including the ejector hook
Depth	210 mm (8.27 in.)	From tip of ejector to tip of backplane connector
Weight	800 g (1.76 lbs)	

Table 45. Electrical Power

M9815A, M9816A, M9817A, M9818A PXI Receiver Module

Description				
Total power dissipation	36.8 watts (maximum)			
Supply voltage	+3.3 V	+5 V	+12 V	-12 V
Nominal current	2.9 amps	0 amps	2.3 amps	0 amps

M9810A PXI Vector Modulator

Description				
Total power dissipation	13.2 watts (maximum)			
Supply voltage	+3.3 V	+5 V	+12 V	-12 V
Nominal current	0.7 amps	0 amps	0.9 amps	0 amps

Table 46. Front Panel Information

M9815A, M9816A, M9817A, M9818A PXI Receiver Module

Description	
Test Port	
Connector type	3.5 mm female (M9815A)
	2.4 mm female (M9816A, M9817A)
	1.85 mm female (M9818A)
Impedance	50 ohm (nominal)
External Reference Input	
Connector type	MCX
Input amplitude range	-3 to +10 dBm
Input frequency	10 MHz \pm 10 ppm
Impedance	50 Ω (nominal)
External Reference Output	
Connector type	MCX
Output amplitude range	0 to \pm 3 dBm
Output frequency	10 MHz \pm 7 ppm (specification)
	\pm 3 ppm/year maximum (typical)
Impedance	50 Ω (nominal)

M9810A PXI Vector Modulator

Description	
Test Port	
RF Input / RF Output	1.85 mm female
I Input / Q input	SMA female
Ctrl M, Ctrl S	Reserved

Table 47. Software

Description	Information
Keysight IO library	<p>The IO library suite offers a single entry point for connection to the most common instruments including AXIe, PXI, GPIB, USB, Ethernet/LAN, RS-232, and VXI test instrument from Keysight and other vendors. It automatically discovers interfaces, chassis, and instruments. The graphical user interface allows you to search for, verify, and update IVI instrument and soft front panel drivers for modular and traditional instruments. The IO suite safely installs in side-by-side mode with NI I/O software. Free software download at www.keysight.com/find/iosuite</p>
Keysight soft front panel	<p>The PXI module includes a soft front panel (SFP), a software based graphical user interface (GUI) which enables the instrument’s capabilities from your PC.</p>
Command Expert	<p>Assists in finding the right instrument commands and setting correct parameters. A simple interface includes documentation, examples, syntax checking, command execution, and debug tools to build sequences for integration in Excel, MATLAB, LabVIEW, VEE, and System VUE. Free software download at www.keysight.com/find/commandexpert</p>
Example programs	Setting up a measurement
	Guided calibration
	Data acquisition
	Data transfer
Example programming languages	C, C++, C#, VB, LabVIEW

Block Diagrams

Legend

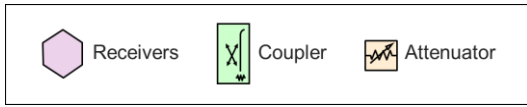

M980xA PXIe VNA (Included in Option 491 or 691)

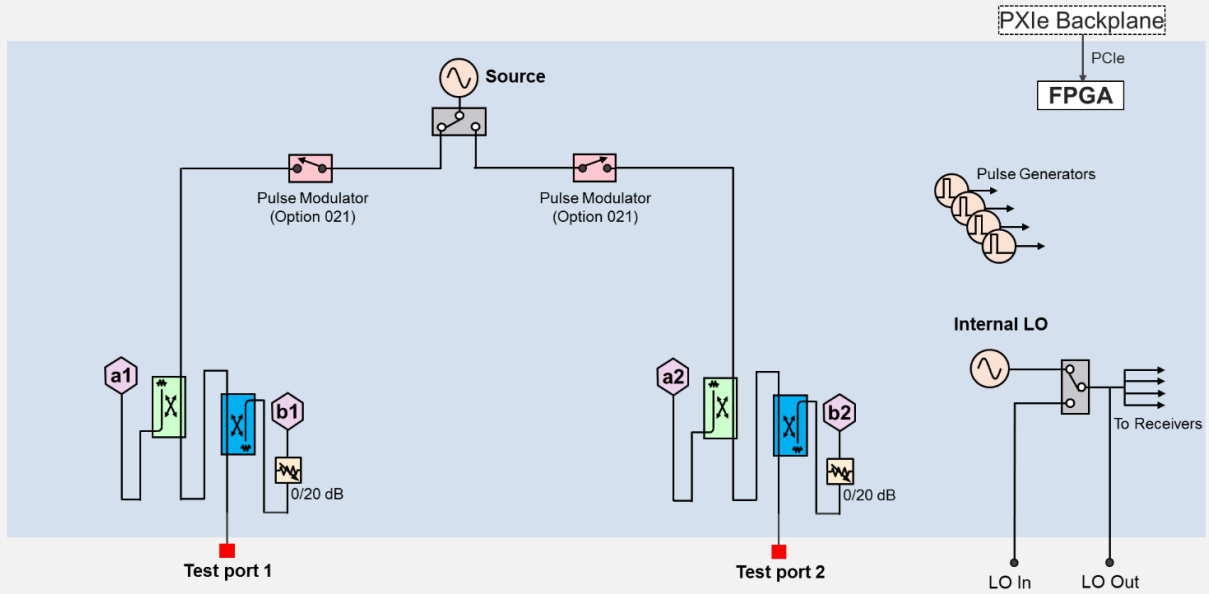

M981xA PXIe Receiver Module (Included in Option 491 or 691)

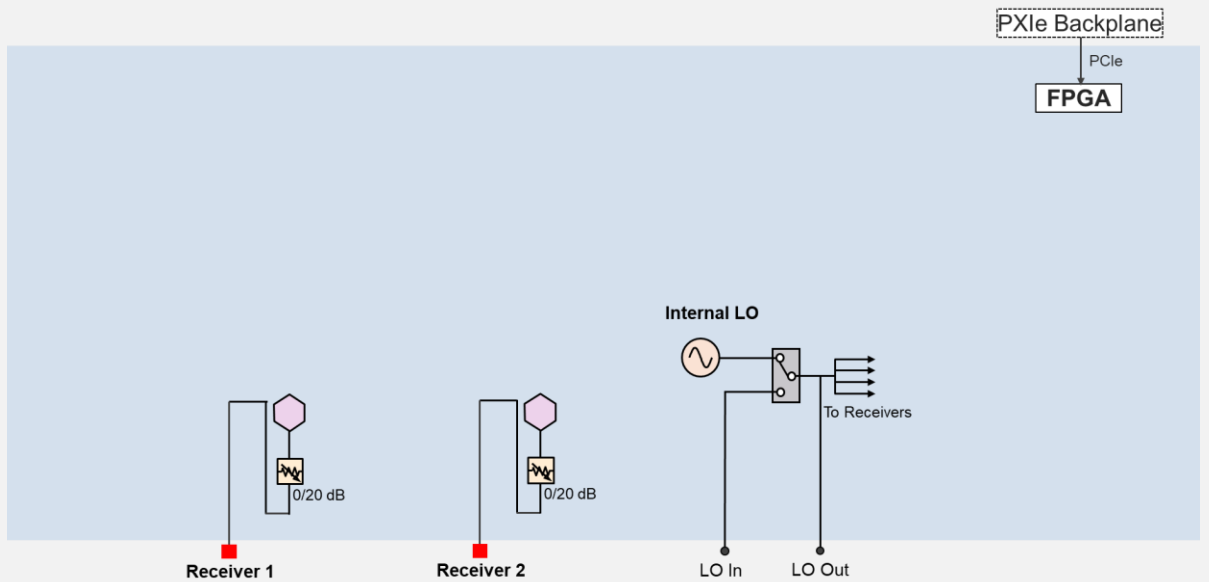

M981xAS Option 750 or 751 (PXI Vector Adapter)

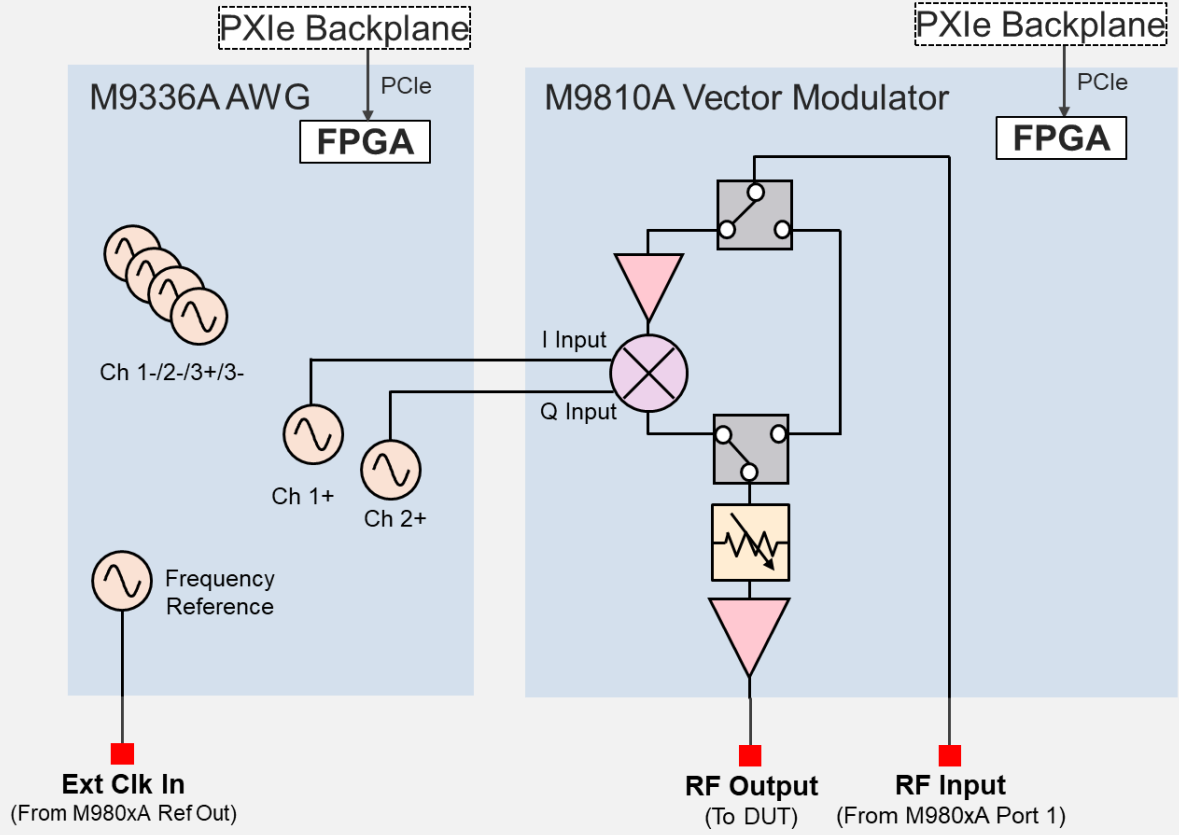

Literature Information

Publication title	Publication number
M981xAS PXIe Vector Component Analyzer – Configuration Guide	3120-1344EN
M980xA PXIe Vector Network Analyzer – Data Sheet	5992-3596EN
M980xA PXIe Vector Network Analyzer – Configuration Guide	5992-3597EN
Keysight Network Analyzer – Selection Guide	5989-7603EN
Electronic Calibration (ECal) Modules for Network Analyzer – Technical Overview	5963-3743E

Web Resources

- www.keysight.com/find/pxivna
- www.keysight.com/find/na
- www.keysight.com/find/vnasoftware
- www.keysight.com/find/ecal

Learn more at: www.keysight.com

For more information on Keysight Technologies' products, applications, or services, please contact your local Keysight office. The complete list is available at: www.keysight.com/find/contactus

