



Electrical

Impedance	50 ohm					
Frequency Range	DC-4 GHz					
VSWR	1.2 max					
Input Avg Power	10W@ 25°C ambient, derating linearly to 1W at 100°C					
Peak Power	500W (5 micro-sec pulse width, 1% duty cycle)					
Direction	Bidirectional, N female to N male (other configurations available)					

Attenuation(dB)	1-10	11-20	21-30	31-40	41-50	51-60
Accuracy(dB)	±0.4	±0.5	±0.6	±0.7	±0.8	±0.9

Mechanical

Connector Body	Ternary alloy plated brass
Heat Sink	Black anodized aluminum
Center Contact	Gold plated beryllium copper/brass
Net Weight	Approx 90 g

Environmental

Operating Temperature	-55°C to 100°C
Storage Temperature	-55°C to 125°C
RoHS	Compliant
Temperature Coefficient	<0.0004 dB/dB/°C

Dimensions(mm)

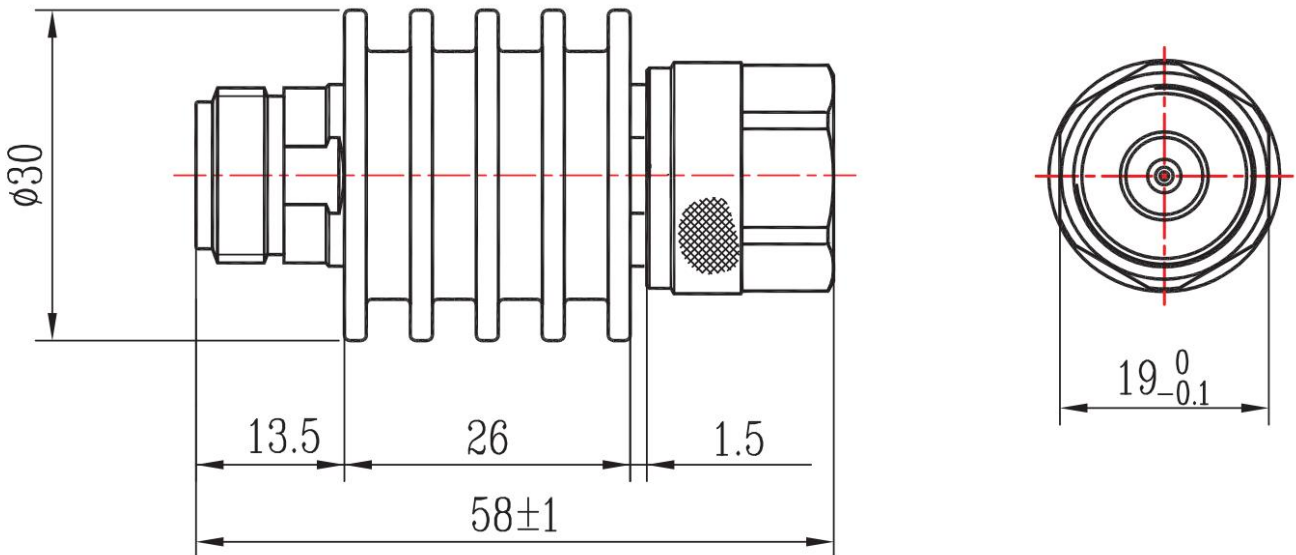

Notes

- 1.To maintain best performance, recommended to use fan to keep the case temperature under 85°C.
- 2.Customized dB values, outlines and optimal accuracy/VSWR available.

Model Description

RFHB04XXNC10

- 1.XX for dB value: 06=6dB,30=30dB
- 2.Code for connector configuration:
A=female for two ends; B=male for two ends
C=female for one end and male for the other.