

RIGOL

Programming Guide

DSA800E Series Spectrum Analyzer

May 2016
RIGOL TECHNOLOGIES, INC.

Guaranty and Declaration

Copyright

© 2016 **RIGOL** TECHNOLOGIES, INC. All Rights Reserved.

Trademark Information

RIGOL is a registered trademark of **RIGOL** TECHNOLOGIES, INC.

Publication Number

PGD17100-1110

Software Version

DSA832E:00.01.02

Software upgrade might change or add product features. Please acquire the latest version of the manual from **RIGOL** website or contact **RIGOL** to upgrade the software.

Notices

- **RIGOL** products are covered by P.R.C. and foreign patents, issued and pending.
- **RIGOL** reserves the right to modify or change parts of or all the specifications and pricing policies at the company's sole decision.
- Information in this publication replaces all previously released materials.
- Information in this publication is subject to change without notice.
- **RIGOL** shall not be liable for either incidental or consequential losses in connection with the furnishing, use or performance of this manual as well as any information contained.
- Any part of this document is forbidden to be copied, photocopied or rearranged without prior written approval of **RIGOL**.

Product Certification

RIGOL guarantees that this product conforms to the national and industrial standards in China as well as the ISO9001:2008 standard and the ISO14001:2004 standard. Other international standard conformance certifications are in progress.

Contact Us

If you have any problem or requirement when using our products or this manual, please contact **RIGOL**.

E-mail: service@rigol.com

Website: www.rigol.com

Safety Requirement

General Safety Summary

Please review the following safety precautions carefully before putting the instrument into operation so as to avoid any personal injury or damage to the instrument and any product connected to it. To prevent potential hazards, please follow the instructions specified in this manual to use the instrument properly.

Use Proper Power Cord.

Only the exclusive power cord designed for the instrument and authorized for use within the local country could be used.

Ground the Instrument.

The instrument is grounded through the Protective Earth lead of the power cord. To avoid electric shock, connect the earth terminal of the power cord to the Protective Earth terminal before connecting any input or output terminals.

Connect the Probe Correctly.

If a probe is used, the probe ground lead must be connected to earth ground. Do not connect the ground lead to high voltage. Improper way of connection could result in dangerous voltages being present on the connectors, controls or other surfaces of the oscilloscope and probes, which will cause potential hazards for operators.

Observe All Terminal Ratings.

To avoid fire or shock hazard, observe all ratings and markers on the instrument and check your manual for more information about ratings before connecting the instrument.

Use Proper Overvoltage Protection.

Ensure that no overvoltage (such as that caused by a bolt of lightning) can reach the product. Otherwise, the operator might be exposed to the danger of an electric shock.

Do Not Operate Without Covers.

Do not operate the instrument with covers or panels removed.

Do Not Insert Objects Into the Air Outlet.

Do not insert objects into the air outlet, as doing so may cause damage to the instrument.

Use Proper Fuse.

Please use the specified fuses.

Avoid Circuit or Wire Exposure.

Do not touch exposed junctions and components when the unit is powered on.

Do Not Operate With Suspected Failures.

If you suspect damage occurs to the instrument, have it inspected by **RIGOL** authorized personnel before further operations. Any maintenance, adjustment or replacement especially to circuits or accessories must be performed by **RIGOL** authorized personnel.

Provide Adequate Ventilation.

Inadequate ventilation may cause an increase of temperature in the instrument, which would cause damage to the instrument. So please keep the instrument well ventilated and inspect the air outlet and the fan regularly.

Do Not Operate in Wet Conditions.

To avoid short circuit inside the instrument or electric shock, never operate the instrument in a humid

environment.

Do Not Operate in an Explosive Atmosphere.

To avoid personal injuries or damage to the instrument, never operate the instrument in an explosive atmosphere.

Keep Instrument Surfaces Clean and Dry.

To avoid dust or moisture from affecting the performance of the instrument, keep the surfaces of the instrument clean and dry.

Prevent Electrostatic Impact.

Operate the instrument in an electrostatic discharge protective environment to avoid damage induced by static discharges. Always ground both the internal and external conductors of cables to release static before making connections.

Use the Battery Properly.

Do not expose the battery (if available) to high temperature or fire.
Keep it out of the reach of children. Improper change of a battery (lithium battery) may cause an explosion.
Use the **RIGOL** specified battery only.

Handle with Caution.

Please handle with care during transportation to avoid damage to keys, knobs, interfaces and other parts on the panels.

Safety Notices and Symbols

Safety Notices in this Manual:



WARNING

Indicates a potentially hazardous situation or practice which, if not avoided, will result in serious injury or death.



CAUTION

Indicates a potentially hazardous situation or practice which, if not avoided, could result in damage to the product or loss of important data.

Safety Terms on the Product:

DANGER It calls attention to an operation, if not correctly performed, could result in injury or hazard immediately.

WARNING It calls attention to an operation, if not correctly performed, could result in potential injury or hazard.

CAUTION It calls attention to an operation, if not correctly performed, could result in damage to the product or other devices connected to the product.

Safety Symbols on the Product:



Hazardous Voltage



Safety Warning



Protective Earth Terminal



Chassis Ground



Test Ground

Allgemeine Sicherheits Informationen

Überprüfen Sie die folgenden Sicherheitshinweise sorgfältig um Personenschäden oder Schäden am Gerät und an damit verbundenen weiteren Geräten zu vermeiden. Zur Vermeidung von Gefahren, nutzen Sie bitte das Gerät nur so, wie in diesem Handbuch angegeben.

Um Feuer oder Verletzungen zu vermeiden, verwenden Sie ein ordnungsgemäßes Netzkabel.

Verwenden Sie für dieses Gerät nur das für ihr Land zugelassene und genehmigte Netzkabel.

Erden des Gerätes.

Das Gerät ist durch den Schutzleiter im Netzkabel geerdet. Um Gefahren durch elektrischen Schlag zu vermeiden, ist es unerlässlich, die Erdung durchzuführen. Erst dann dürfen weitere Ein- oder Ausgänge verbunden werden.

Anschluss eines Tastkopfes.

Die Erdungsklemmen der Sonden sind auf dem gleichen Spannungspegel des Instruments geerdet. Schließen Sie die Erdungsklemmen an keine hohe Spannung an.

Beachten Sie alle Anschlüsse.

Zur Vermeidung von Feuer oder Stromschlag, beachten Sie alle Bemerkungen und Markierungen auf dem Instrument. Befolgen Sie die Bedienungsanleitung für weitere Informationen, bevor Sie weitere Anschlüsse an das Instrument legen.

Verwenden Sie einen geeigneten Überspannungsschutz.

Stellen Sie sicher, daß keinerlei Überspannung (wie z.B. durch Gewitter verursacht) das Gerät erreichen kann. Andernfalls besteht für den Anwender die Gefahr eines Stromschlages.

Nicht ohne Abdeckung einschalten.

Betreiben Sie das Gerät nicht mit entfernten Gehäuse-Abdeckungen.

Betreiben Sie das Gerät nicht geöffnet.

Der Betrieb mit offenen oder entfernten Gehäuseteilen ist nicht zulässig. Nichts in entsprechende Öffnungen stecken (Lüfter z.B.)

Passende Sicherung verwenden.

Setzen Sie nur die spezifikationsgemäßen Sicherungen ein.

Vermeiden Sie ungeschützte Verbindungen.

Berühren Sie keine unisolierten Verbindungen oder Baugruppen, während das Gerät in Betrieb ist.

Betreiben Sie das Gerät nicht im Fehlerfall.

Wenn Sie am Gerät einen Defekt vermuten, sorgen Sie dafür, bevor Sie das Gerät wieder betreiben, dass eine Untersuchung durch **RIGOL** autorisiertem Personal durchgeführt wird. Jedwede Wartung, Einstellarbeiten oder Austausch von Teilen am Gerät, sowie am Zubehör dürfen nur von **RIGOL** autorisiertem Personal durchgeführt werden.

Belüftung sicherstellen.

Unzureichende Belüftung kann zu Temperaturanstiegen und somit zu thermischen Schäden am Gerät führen. Stellen Sie deswegen die Belüftung sicher und kontrollieren regelmäßig Lüfter und Belüftungsöffnungen.

Nicht in feuchter Umgebung betreiben.

Zur Vermeidung von Kurzschluß im Geräteinneren und Stromschlag betreiben Sie das Gerät bitte niemals in feuchter Umgebung.

Nicht in explosiver Atmosphäre betreiben.

Zur Vermeidung von Personen- und Sachschäden ist es unumgänglich, das Gerät ausschließlich fernab

jedweder explosiven Atmosphäre zu betreiben.

Geräteoberflächen sauber und trocken halten.

Um den Einfluß von Staub und Feuchtigkeit aus der Luft auszuschließen, halten Sie bitte die Geräteoberflächen sauber und trocken.

Schutz gegen elektrostatische Entladung (ESD).

Sorgen Sie für eine elektrostatisch geschützte Umgebung, um somit Schäden und Funktionsstörungen durch ESD zu vermeiden. Erden Sie vor dem Anschluß immer Innen- und Außenleiter der Verbindungsleitung, um statische Aufladung zu entladen.

Die richtige Verwendung des Akku.

Wenn eine Batterie verwendet wird, vermeiden Sie hohe Temperaturen bzw. Feuer ausgesetzt werden. Bewahren Sie es außerhalb der Reichweite von Kindern auf. Unsachgemäße Änderung der Batterie (Anmerkung: Lithium-Batterie) kann zu einer Explosion führen. Verwenden Sie nur von **RIGOL** angegebenen Akkus.

Sicherer Transport.

Transportieren Sie das Gerät sorgfältig (Verpackung!), um Schäden an Bedienelementen, Anschlüssen und anderen Teilen zu vermeiden.

Sicherheits Begriffe und Symbole

Begriffe in diesem Guide:



WARNING

Die Kennzeichnung WARNING beschreibt Gefahrenquellen die leibliche Schäden oder den Tod von Personen zur Folge haben können.



CAUTION

Die Kennzeichnung Caution (Vorsicht) beschreibt Gefahrenquellen die Schäden am Gerät hervorrufen können.

Begriffe auf dem Produkt:

DANGER

weist auf eine Verletzung oder Gefährdung hin, die sofort geschehen kann.

WARNING

weist auf eine Verletzung oder Gefährdung hin, die möglicherweise nicht sofort geschehen.

CAUTION

weist auf eine Verletzung oder Gefährdung hin und bedeutet, dass eine mögliche Beschädigung des Instruments oder anderer Gegenstände auftreten kann.

Symbole auf dem Produkt:



Gefährliche
Spannung



Sicherheits-
Hinweis



Schutz-erde



Gehäusemasse



Erde

Document Overview

This manual introduces how to program and control **RIGOL** DSA800E series spectrum analyzer using SCPI commands through USB, LAN or GPIB (via USB-GPIB interface converter) interface.

Main Topics in this Manual:

Chapter 1 SCPI Overview

This chapter provides a brief introduction of the SCPI commands.

Chapter 2 Command System

This chapter introduces the syntax, function, parameter and using instruction of each DSA800E command in alphabetical order (from A to Z).

Chapter 3 Programming Demos

This chapter introduces how to program and control DSA800E using development tools, such as Visual C++, Visual Basic and LabVIEW.

Tip

The latest version of this manual can be downloaded from www.rigol.com.

Format Conventions in this Manual:

- Key:**
The key at the front panel is denoted by the format of "Key Name (Bold) + Text Box" in the manual. For example, **FREQ** denotes the **FREQ** key.
- Menu:**
The menu is denoted by the format of "Menu Word (Bold) + Character Shading" in the manual. For example, **Center Freq** denotes the center frequency menu item under the **FREQ** function key.
- Connector:**
The connector at the front or rear panel is denoted by the format of "Connector Name (Bold) + Square Brackets (Bold)" in the manual. For example, **[GEN OUTPUT 50Ω]**.
- Operation step:**
The operation for the next step is denoted by an arrow "→" in the manual. For example, **FREQ** → **Center Freq** denotes that you first press **FREQ** on the front panel and then press **Center Freq**.

Content Conventions in this Manual:

DSA800E series spectrum analyzer includes the following two models.

Model	Frequency Range	Tracking Generator
DSA832E	9 kHz to 3.2 GHz	None
DSA832E-TG	9 kHz to 3.2 GHz	3.2 GHz

Contents

Guaranty and Declaration	I
Safety Requirement.....	II
General Safety Summary.....	II
Safety Notices and Symbols.....	IV
Allgemeine Sicherheits Informationen	V
Sicherheits Begriffe und Symbole.....	VII
Document Overview	VIII
Chapter 1 SCPI Overview.....	1-1
Syntax	1-2
Symbol Description	1-2
Parameter Type	1-3
Command Abbreviation	1-3
Chapter 2 Command System.....	2-1
:ABORT.....	2-2
:CALCulate Subsystem	2-2
:CALCulate:BANDwidth:NDB	2-4
:CALCulate:BANDwidth:RESult?.....	2-4
:CALCulate:LLINe:ALL:DELeTe.....	2-4
:CALCulate:LLINe:CONTRol:DOMain	2-5
:CALCulate:LLINe:FAIL?.....	2-5
:CALCulate:LLINe:FAIL:RATIo?.....	2-6
:CALCulate:LLINe:FAIL:STOP:STATe	2-6
:CALCulate:LLINe<n>:CONTRol:INTerpolate:TYPE	2-7
:CALCulate:LLINe<n>:DATA	2-7
:CALCulate:LLINe<n>:DATA:MERGe	2-8
:CALCulate:LLINe<n>:DELeTe	2-9
:CALCulate:LLINe<n>:RELAmpt[:STATe]	2-9
:CALCulate:LLINe<n>:RELFreq[:STATe]	2-10
:CALCulate:LLINe<n>:STATe	2-10
:CALCulate:MARKer:AOFF	2-11
:CALCulate:MARKer:FCOunt:RESolution	2-11
:CALCulate:MARKer:FCOunt:RESolution:AUTO	2-12
:CALCulate:MARKer:FCOunt:X?	2-12
:CALCulate:MARKer:FCOunt[:STATe]	2-13
:CALCulate:MARKer<n>:CPEak[:STATe]	2-13
:CALCulate:MARKer<n>:DELTa[:SET]:CENTer	2-14
:CALCulate:MARKer<n>:DELTa[:SET]:SPAN.....	2-14
:CALCulate:MARKer<n>:FUNCTion	2-15
:CALCulate:MARKer<n>:MAXimum:LEFT	2-15
:CALCulate:MARKer<n>:MAXimum:MAX.....	2-16
:CALCulate:MARKer<n>:MAXimum:NEXT	2-16
:CALCulate:MARKer<n>:MAXimum:RIGHT	2-16
:CALCulate:MARKer<n>:MINimum.....	2-17
:CALCulate:MARKer<n>:MODE	2-17
:CALCulate:MARKer<n>:PEAK:EXCURsion	2-18
:CALCulate:MARKer<n>:PEAK:SEARch:MODE.....	2-18
:CALCulate:MARKer<n>:PEAK[:SET]:CF	2-19
:CALCulate:MARKer<n>:PEAK:THReshold	2-19
:CALCulate:MARKer<n>:PTPeak	2-20
:CALCulate:MARKer<n>[:SET]:CENTer	2-20
:CALCulate:MARKer<n>[:SET]:RLEVel.....	2-21
:CALCulate:MARKer<n>[:SET]:START.....	2-21

:CALCulate:MARKer<n>[:SET]:STEP	2-22
:CALCulate:MARKer<n>[:SET]:STOP	2-22
:CALCulate:MARKer<n>:STATE	2-23
:CALCulate:MARKer<n>:TRACe	2-23
:CALCulate:MARKer<n>:TRACe:AUTO	2-24
:CALCulate:MARKer<n>:VSRef?	2-25
:CALCulate:MARKer<n>:VSValue?	2-25
:CALCulate:MARKer<n>:X	2-26
:CALCulate:MARKer<n>:X:CENTer	2-27
:CALCulate:MARKer<n>:X:POSition	2-28
:CALCulate:MARKer<n>:X:POSition:CENTer	2-28
:CALCulate:MARKer<n>:X:POSition:SPAN	2-29
:CALCulate:MARKer<n>:X:POSition:STARt	2-29
:CALCulate:MARKer<n>:X:POSition:STOP	2-30
:CALCulate:MARKer<n>:X:READout	2-30
:CALCulate:MARKer<n>:X:SPAN	2-31
:CALCulate:MARKer<n>:X:STARt	2-31
:CALCulate:MARKer<n>:X:STOP	2-32
:CALCulate:MARKer<n>:Y?	2-33
:CALCulate:MARKer:TABLE:STATE	2-33
:CALCulate:MARKer:TRACking:STATE	2-34
:CALCulate:NTData[:STATE]	2-34
:CALibration Subsystem	2-35
:CALibration:[ALL]	2-35
:CALibration:AUTO	2-35
:CONFigure Subsystem	2-36
:CONFigure?	2-36
:CONFigure:ACPower	2-36
:CONFigure:CHPower	2-37
:CONFigure:CNRatio	2-37
:CONFigure:EBWidth	2-37
:CONFigure:HDISt	2-38
:CONFigure:OBWidth	2-38
:CONFigure:PF	2-38
:CONFigure:SANalyzer	2-38
:CONFigure:TOI	2-39
:CONFigure:TPOWER	2-39
:COUple Subsystem	2-40
:COUple	2-40
:DISPlay Subsystem	2-41
:DISPlay:AFUnction:POSition	2-42
:DISPlay:ANNotation:CLOCK[:STATE]	2-42
:DISPlay:BRIGhtness	2-43
:DISPlay:ENABle	2-43
:DISPlay:MSGswitch:STATE	2-44
:DISPlay:UKEY:STATE	2-44
:DISPlay:WINDow:TRACe:GRATicule:GRID	2-45
:DISPlay:WINDow:TRACe:X[:SCALE]:SPACing	2-45
:DISPlay:WINDow:TRACe:Y:DLINe	2-46
:DISPlay:WINDow:TRACe:Y:DLINe:STATE	2-46
:DISPlay:WINDow:TRACe:Y[:SCALE]:NRLevel	2-47
:DISPlay:WINDow:TRACe:Y[:SCALE]:NRPosition	2-47
:DISPlay:WINDow:TRACe:Y[:SCALE]:PDIVision	2-48
:DISPlay:WINDow:TRACe:Y[:SCALE]:RLEVel	2-48
:DISPlay:WINDow:TRACe:Y[:SCALE]:RLEVel:OFFSet	2-49
:DISPlay:WINDow:TRACe:Y[:SCALE]:SPACing	2-49
:FETCh Subsystem	2-50
:FETCh:ACPower?	2-51

:FETCh:ACPower:LOWer?	2-51
:FETCh:ACPower:MAIN?	2-52
:FETCh:ACPower:UPPer?	2-52
:FETCh:CHPower?	2-53
:FETCh:CHPower:CHPower?	2-53
:FETCh:CHPower:DENSity?	2-54
:FETCh:CNRatio?	2-54
:FETCh:CNRatio:CARRier?	2-55
:FETCh:CNRatio:CNRatio?	2-55
:FETCh:CNRatio:NOISe?	2-56
:FETCh:EBWidth?	2-56
:FETCh:HARMonics:AMPLitude:ALL?	2-57
:FETCh:HARMonics:AMPLitude? <n>	2-57
:FETCh:HARMonics[:DISTortion]?	2-58
:FETCh:HARMonics:FREQuency:ALL?	2-58
:FETCh:HARMonics:FREQuency? <n>	2-59
:FETCh:HARMonics:FUNDamental?	2-59
:FETCh:OBWidth?	2-60
:FETCh:OBWidth:OBWidth?	2-60
:FETCh:OBWidth:OBWidth:FERRor?	2-61
:FETCh:TOIntercept?	2-61
:FETCh:TOIntercept:IP3?	2-62
:FETCh:TPOWER?	2-62
:FORMat Subsystem	2-63
:FORMat:BORDER	2-63
:FORMat[:TRACe][:DATA]	2-64
:HCOpy Subsystem	2-65
:HCOpy:ABORT	2-65
:HCOpy:IMAGe:COLor[:STATe]	2-65
:HCOpy:IMAGe:FTYPE	2-66
:HCOpy:IMAGe:INVert	2-66
:HCOpy:IMAGe:PTIME	2-67
:HCOpy:IMAGe:QUALity	2-67
:HCOpy[:IMMediate]	2-68
:HCOpy:PAGE:ORientation	2-68
:HCOpy:PAGE:PRINTs	2-69
:HCOpy:PAGE:SIZE	2-69
:HCOpy:RESume	2-70
IEEE 488.2 Common Commands	2-71
*CLS	2-71
*ESE	2-71
*ESR?	2-72
*IDN?	2-72
*OPC	2-73
*RST	2-73
*SRE	2-73
*STB?	2-74
*TRG	2-74
*TST?	2-74
*WAI	2-74
:INITiate Subsystem	2-75
:INITiate:CONTInuous	2-75
:INITiate[:IMMediate]	2-76
:INITiate:PAUSE	2-76
:INITiate:REStart	2-76
:INITiate:RESume	2-76
:INPut Subsystem	2-77
:INPut:IMPedance	2-77

:MMEMory Subsystem	2-78
:MMEMory:DELeTe	2-78
:MMEMory:DISK:INFormation?	2-79
:MMEMory:LOAD:CORRection	2-79
:MMEMory:LOAD:LIMit	2-80
:MMEMory:LOAD:MTABLE	2-80
:MMEMory:LOAD:SETUp	2-81
:MMEMory:LOAD:STATe	2-81
:MMEMory:LOAD:TRACe	2-82
:MMEMory:MOVE	2-82
:MMEMory:STORe:CORRection	2-83
:MMEMory:STORe:LIMit	2-83
:MMEMory:STORe:MTABLE	2-84
:MMEMory:STORe:PTABLE	2-84
:MMEMory:STORe:RESuLts	2-85
:MMEMory:STORe:SCReen	2-85
:MMEMory:STORe:SETUp	2-86
:MMEMory:STORe:STATe	2-86
:MMEMory:STORe:TRACe	2-87
:OUTPut Subsystem	2-88
:OUTPut[:STATe]	2-88
:READ Subsystem	2-89
:READ:ACPower?	2-90
:READ:ACPower:LOWer?	2-90
:READ:ACPower:MAIN?	2-90
:READ:ACPower:UPPer?	2-91
:READ:CHPower?	2-91
:READ:CHPower:CHPower?	2-91
:READ:CHPower:DENSity?	2-92
:READ:CNRatio?	2-92
:READ:CNRatio:CARRier?	2-92
:READ:CNRatio:CNRatio?	2-93
:READ:CNRatio:NOISe?	2-93
:READ:EBWidth?	2-93
:READ:HARMonics:AMPLitude:ALL?	2-94
:READ:HARMonics:AMPLitude? <n>	2-94
:READ:HARMonics[:DISTortion]?	2-95
:READ:HARMonics:FREQuency:ALL?	2-95
:READ:HARMonics:FREQuency? <n>	2-96
:READ:HARMonics:FUNDamental?	2-96
:READ:OBWidth?	2-96
:READ:OBWidth:OBWidth?	2-97
:READ:OBWidth:OBWidth:FERRor?	2-97
:READ:TOIntercept?	2-97
:READ:TOIntercept:IP3?	2-98
:READ:TPOWer?	2-98
[:SENSe] Subsystem	2-99
[:SENSe]:ACPower:AVERage:COUNT	2-102
[:SENSe]:ACPower:AVERage[:STATe]	2-102
[:SENSe]:ACPower:AVERage:TCONTROL	2-103
[:SENSe]:ACPower:BANDwidth:ACHannel	2-103
[:SENSe]:ACPower:BANDwidth:INTegration	2-104
[:SENSe]:ACPower:CSPacing	2-105
[:SENSe]:BANDwidth:EMIFilter:STATe	2-105
[:SENSe]:BANDwidth[:RESolution]	2-106
[:SENSe]:BANDwidth[:RESolution]:AUTO	2-106
[:SENSe]:BANDwidth:VIDeo	2-107
[:SENSe]:BANDwidth:VIDeo:AUTO	2-107

[:SENSe]:BANDwidth:VIDeo:RATio	2-108
[:SENSe]:CHPower:AVERAge:COUNT	2-108
[:SENSe]:CHPower:AVERAge[:STATe]	2-109
[:SENSe]:CHPower:AVERAge:TCONtrol	2-109
[:SENSe]:CHPower:BANDwidth:INTegration	2-110
[:SENSe]:CHPower:FREQuency:SPAN	2-110
[:SENSe]:CNRatio:AVERAge:COUNT	2-111
[:SENSe]:CNRatio:AVERAge[:STATe]	2-112
[:SENSe]:CNRatio:AVERAge:TCONtrol	2-112
[:SENSe]:CNRatio:BANDwidth:INTegration	2-113
[:SENSe]:CNRatio:BANDwidth:NOISe	2-114
[:SENSe]:CNRatio:OFFSet	2-114
[:SENSe]:CORRection:CSET:ALL:DELeTe	2-115
[:SENSe]:CORRection:CSET:ALL[:STATe]	2-115
[:SENSe]:CORRection:CSET<n>:DATA	2-116
[:SENSe]:CORRection:CSET<n>:DATA:MERGe	2-116
[:SENSe]:CORRection:CSET<n>:DELeTe	2-117
[:SENSe]:CORRection:CSET<n>[:STATe]	2-117
[:SENSe]:CORRection:CSET<n>:X:SPACIng	2-118
[:SENSe]:CORRection:CSET:TABLE:STATe	2-118
[:SENSe]:DEMod	2-119
[:SENSe]:DEMod:GAIN:AUTO	2-119
[:SENSe]:DEMod:GAIN:INCRement	2-120
[:SENSe]:DEMod:STATe	2-121
[:SENSe]:DEMod:TIME	2-121
[:SENSe]:DETEctor[:FUNctIon]	2-122
[:SENSe]:EBWidth:AVERAge:COUNT	2-122
[:SENSe]:EBWidth:AVERAge[:STATe]	2-123
[:SENSe]:EBWidth:AVERAge:TCONtrol	2-123
[:SENSe]:EBWidth:FREQuency:SPAN	2-124
[:SENSe]:EBWidth:MAXHold:STATe	2-125
[:SENSe]:EBWidth:XDB	2-125
[:SENSe]:EXTRef[:STATe]?	2-126
[:SENSe]:FREQuency:CENTer	2-126
[:SENSe]:FREQuency:CENTer:DOWN	2-127
[:SENSe]:FREQuency:CENTer:SET:STEP	2-127
[:SENSe]:FREQuency:CENTer:STEP:AUTO	2-127
[:SENSe]:FREQuency:CENTer:STEP[:INCRement]	2-128
[:SENSe]:FREQuency:CENTer:UP	2-128
[:SENSe]:FREQuency:OFFSet	2-128
[:SENSe]:FREQuency:SPAN	2-129
[:SENSe]:FREQuency:SPAN:FULL	2-129
[:SENSe]:FREQuency:SPAN:PREVious	2-130
[:SENSe]:FREQuency:SPAN:ZIN	2-130
[:SENSe]:FREQuency:SPAN:ZOUT	2-130
[:SENSe]:FREQuency:START	2-130
[:SENSe]:FREQuency:STOP	2-131
[:SENSe]:HDISt:AVERAge:COUNT	2-131
[:SENSe]:HDISt:AVERAge[:STATe]	2-132
[:SENSe]:HDISt:AVERAge:TCONtrol	2-132
[:SENSe]:HDISt:NUMBers	2-133
[:SENSe]:HDISt:TIME	2-134
[:SENSe]:HDISt:TIME:AUTO[:STATe]	2-134
[:SENSe]:OBWidth:AVERAge:COUNT	2-135
[:SENSe]:OBWidth:AVERAge[:STATe]	2-135
[:SENSe]:OBWidth:AVERAge:TCONtrol	2-136
[:SENSe]:OBWidth:FREQuency:SPAN	2-136
[:SENSe]:OBWidth:MAXHold:STATe	2-137

[:SENSe]:OBWidth:PERCent	2-138
[:SENSe]:POWer:ARANge	2-138
[:SENSe]:POWer:AScale	2-138
[:SENSe]:POWer:ATUNe	2-139
[:SENSe]:POWer[:RF]:ATTenuation	2-139
[:SENSe]:POWer[:RF]:ATTenuation:AUTO	2-140
[:SENSe]:POWer[:RF]:GAIN[:STATe]	2-140
[:SENSe]:POWer[:RF]:MIXer:RANGe[:UPPer]	2-141
[:SENSe]:SWEep:COUNT	2-141
[:SENSe]:SWEep:COUNT:CURRent?	2-142
[:SENSe]:SWEep:POINTs	2-142
[:SENSe]:SWEep:TIME	2-143
[:SENSe]:SWEep:TIME:AUTO	2-143
[:SENSe]:SWEep:TIME:AUTO:RULEs	2-144
[:SENSe]:TOI:AVERAge:COUNT	2-144
[:SENSe]:TOI:AVERAge[:STATe]	2-145
[:SENSe]:TOI:AVERAge:TCONtrol	2-145
[:SENSe]:TOI:FREQuency:SPAN	2-146
[:SENSe]:TPOWer:AVERAge:COUNT	2-147
[:SENSe]:TPOWer:AVERAge[:STATe]	2-147
[:SENSe]:TPOWer:AVERAge:TCONtrol	2-148
[:SENSe]:TPOWer:LLIMit	2-148
[:SENSe]:TPOWer:MODE	2-149
[:SENSe]:TPOWer:RLIMit	2-150
[:SENSe]:VSWR:FREFlect	2-150
[:SENSe]:VSWR:NREFlect	2-150
[:SENSe]:VSWR:RESet	2-151
[:SENSe]:VSWR:STATe	2-151
:SOURce Subsystem	2-152
:SOURce:CORRection:OFFSet	2-152
:SOURce:POWer:LEVel:IMMEdiate:AMPLitude	2-153
:SOURce:TRACe:REF:STATe	2-153
:SOURce:TRACe:STORref	2-154
:STATus Subsystem	2-155
:STATus:OPERation:CONDition?	2-156
:STATus:OPERation:ENABLE	2-156
:STATus:OPERation[:EVENT]?	2-157
:STATus:PRESet	2-157
:STATus:QUEStionable:CONDition?	2-157
:STATus:QUEStionable:ENABLE	2-158
:STATus:QUEStionable[:EVENT]?	2-158
:SYSTem Subsystem	2-159
:SYSTem:BEEPer:STATe	2-160
:SYSTem:CLEar	2-160
:SYSTem:COMMunicate:APORt	2-161
:SYSTem:COMMunicate:GPIB[:SELF]:ADDReSS	2-161
:SYSTem:COMMunicate:LAN[:SELF]:AUToip:STATe	2-162
:SYSTem:COMMunicate:LAN[:SELF]:DHCP:STATe	2-162
:SYSTem:COMMunicate:LAN[:SELF]:IP:ADDReSS	2-163
:SYSTem:COMMunicate:LAN[:SELF]:IP:DNSServer	2-163
:SYSTem:COMMunicate:LAN[:SELF]:IP:GATeway	2-164
:SYSTem:COMMunicate:LAN[:SELF]:IP:SUBMAsk	2-164
:SYSTem:COMMunicate:LAN[:SELF]:MANuip:STATe	2-165
:SYSTem:COMMunicate:LAN[:SELF]:RESet	2-165
:SYSTem:COMMunicate:USB[:SELF]:ADDReSS?	2-165
:SYSTem:COMMunicate:USB[:SELF]:CLASs	2-166
:SYSTem:CONFigure:INFormation?	2-166
:SYSTem:CONFigure:MESSAge?	2-167

:SYSTem:DATE.....	2-167
:SYSTem:ERRor[:NEXT]?	2-168
:SYSTem:FSWItch[:STATe].....	2-168
:SYSTem:KLOCK.....	2-169
:SYSTem:LANGuage	2-170
:SYSTem:LINemod:STATe?.....	2-170
:SYSTem:LINemod:TYPe.....	2-171
:SYSTem:LKEY	2-171
:SYSTem:OPTions?.....	2-172
:SYSTem:PON:TYPE	2-172
:SYSTem:PRESet	2-173
:SYSTem:PRESet:SAVE	2-173
:SYSTem:PRESet:TYPE	2-173
:SYSTem:SPEaker[:STATe]	2-174
:SYSTem:SPEaker:VOLume	2-174
:SYSTem:TIME	2-175
:SYSTem:TX:STATe?	2-175
:SYSTem:TX:SWset	2-176
:SYSTem:TX:SWSTa?.....	2-176
:SYSTem:USERkey:CONFirm	2-177
:SYSTem:USERkey:KEYCmd	2-177
:SYSTem:USERkey:STATe	2-178
:SYSTem:VERSion?.....	2-178
:TRACe Subsystem	2-179
:TRACe:AVERage:CLEar.....	2-179
:TRACe:AVERage:COUNt	2-179
:TRACe:AVERage:COUNt:CURRent?.....	2-180
:TRACe:AVERage:RESet	2-180
:TRACe:CLEar:ALL	2-180
:TRACe[:DATA]	2-181
:TRACe:MATH:A.....	2-182
:TRACe:MATH:B.....	2-183
:TRACe:MATH:CONSt	2-183
:TRACe:MATH:PEAK[:DATA]?.....	2-184
:TRACe:MATH:PEAK:POINts?.....	2-184
:TRACe:MATH:PEAK:SORT.....	2-184
:TRACe:MATH:PEAK:TABLE:STATe.....	2-185
:TRACe:MATH:PEAK:THReshold	2-185
:TRACe:MATH:STATe	2-186
:TRACe:MATH:TYPE	2-186
:TRACe<n>:AVERage:TYPE	2-187
:TRACe<n>:MODE.....	2-188
:TRIGger Subsystem	2-189
:TRIGger:SEQuence:EXTernal:READy?.....	2-189
:TRIGger:SEQuence:EXTernal:SLOPe.....	2-189
:TRIGger:SEQuence:SOURce	2-190
:TRIGger:SEQuence:VIDeo:LEVel.....	2-191
:UNIT Subsystem.....	2-192
:UNIT:POWer.....	2-192
Chapter 3 Programming Demos.....	3-1
Programming Instructions	3-2
Programming Preparations	3-2
Visual C++ 6.0 Programming Demo.....	3-4
Visual Basic 6.0 Programming Demo	3-13
LabVIEW 8.6 Programming Demo.....	3-17
Linux Programming Demo	3-21
Linux Programming Preparations.....	3-21

Linux Programming Procedures 3-24

Chapter 1 SCPI Overview

SCPI (Standard Commands for Programmable Instruments) is standardized instrument programming language that is based on the standard IEEE488.1 and IEEE 488.2 and conforms to various standards (such as the floating point operation rule in IEEE754 standard, ISO646 7-bit coded character for information interchange (equivalent to ASCII programming)).

Main topics of this chapter:

- ◆ [Syntax](#)
- ◆ [Symbol Description](#)
- ◆ [Parameter Type](#)
- ◆ [Command Abbreviation](#)

Syntax

SCPI commands present a hierarchical tree structure and contain multiple sub-systems, each of which is made up of a root keyword and one or more sub-keywords. The command string usually starts with ":", the keywords are separated by ":" and are followed by the parameter settings available, "?" is added at the end of the command string to indicate query and the command and parameter are separated by a space.

For example,

```
:CALCulate:BANDwidth:NDB <rel_ampl>
:CALCulate:BANDwidth:NDB?
```

CALCulate is the root keyword of the command. **BANDwidth** and **NDB** are the second-level and third-level keywords respectively. The command string starts with ":" which separates the multiple-level keywords. **<rel_ampl>** represents the parameter available for setting, "?" represents query and the command **:CALCulate:BANDwidth:NDB** and parameter **<rel_ampl>** are separated by a space.

"," is generally used for separating different parameters contained in the same command, for example, :SYSTEM:DATE <year>,<month>,<day>

Symbol Description

The following four symbols are not the content of SCPI commands and will not be sent with the commands, but are usually used to describe the parameters in the commands.

Braces { }

The parameters enclosed in the braces are optional and can be ignored or set for one or more times. For example,

In the [:SENSe]:CORRection:CSET<n>:DATA <freq>,<rel_ampl>{,<freq>,<rel_ampl>} command, the frequency and amplitude in {,<freq>,<rel_ampl>} can be omitted or be set to one or more values.

Vertical Bar |

The vertical bar is used to separate multiple parameters and one of the parameters must be selected when sending the command. For example,

In the :DISPlay:ANNOtation:CLOCK[:STATe] OFF|ON|0|1 command, the command parameters available are "OFF", "ON", "0" or "1".

Square Brackets []

The content (command keyword) enclosed in the square brackets can be omitted. For example, for the [:SENSe]:POWer[:RF]:ATTenuation? command, sending any of the four commands below can generate the same effect:

```
:POWer:ATTenuation?
:POWer:RF:ATTenuation?
:SENSe:POWer:ATTenuation?
:SENSe:POWer:RF:ATTenuation?
```

Triangle Brackets < >

The parameter enclosed in the triangle brackets must be replaced by an effective value. For example, send the :DISPlay:BRIGhtness <integer> command in **:DISPlay:BRIGhtness 5** format.

Parameter Type

The command parameters introduced in this manual include 6 types: Bool, Keyword, Integer, Consecutive Real Number, Discrete and ASCII String.

Bool

The parameter could be "OFF", "ON", "0" or "1". For example,
:DISPlay:ANNotation:CLOCK[:STATe] OFF|ON|0|1

Keyword

The parameter could be any of the values listed. For example,
:DISPlay:AFUnction:POSITION BOTTOm|CENTer|TOP
The parameter could be "BOTTOm", "CENTer" or "TOP".

Integer

Unless otherwise noted, the parameter can be any integer within the effective value range. Note that do not set the parameter to a decimal; otherwise errors will occur. For example,
:DISPlay:BRIGhtness <integer>
<integer> can be set to any integer between 0 and 10.

Consecutive Real Number

The parameter could be any value within the effective value range according to the accuracy requirement (by default, there are 6 digits after the decimal points). For example,
:CALCulate:BANDwidth:NDB <rel_ampl>
<rel_ampl> can be set to any real number between -100 and 100.

Discrete

The parameter could only be one of the specified values and these values are discontinuous. For example,
:CALCulate:MARKer<n>:MAXimum:MAX
<n> could only be set to 1, 2, 3 or 4.

ASCII String

The parameter should be the combinations of ASCII characters. For example,
:SYSTem:DATE <year>,<month>,<day>
The parameter is a string in the specified date format.

Command Abbreviation

Since all the commands are case-insensitive, you can use any of them. But if abbreviation is used, all the capital letters in the command must be written completely. For example,
:CALCulate:BANDwidth:NDB? can be abbreviated to :CALC:BAND:NDB?

Chapter 2 Command System

In this chapter, the DSA800E series spectrum analyzer command subsystems are introduced in alphabetical order (from A to Z).

Main topics of this chapter:

- ◆ [:ABORt](#)
- ◆ [:CALCulate Subsystem](#)
- ◆ [:CALibration Subsystem](#)
- ◆ [:CONFigure Subsystem](#)
- ◆ [:COUPle Subsystem](#)
- ◆ [:DISPlay Subsystem](#)
- ◆ [:FETCh Subsystem](#)
- ◆ [:FORMat Subsystem](#)
- ◆ [:HCOPy Subsystem](#)
- ◆ [IEEE 488.2 Common Commands](#)
- ◆ [:INITiate Subsystem](#)
- ◆ [:INPut Subsystem](#)
- ◆ [:MMEMory Subsystem](#)
- ◆ [:OUTPut Subsystem](#)
- ◆ [:READ Subsystem](#)
- ◆ [\[:SENSe\] Subsystem](#)
- ◆ [:SOURce Subsystem](#)
- ◆ [:STATus Subsystem](#)
- ◆ [:SYSTem Subsystem](#)
- ◆ [:TRACe Subsystem](#)
- ◆ [:TRIGger Subsystem](#)
- ◆ [:UNIT Subsystem](#)

Explanation:

1. In this command set, commands relating to Quasi-peak detector, EMI filter, VSWR measurement, advanced measurement and TX1000 are only applicable to DSA800E installed with the corresponding options. For the details, refer to the explanation in each command subsystem.
2. In this command set, commands relating to the tracking generator are only applicable to DSA832E-TG.
3. In this command set, unless otherwise noted, the query returns "N/A" (quotation marks excluded) if the corresponding option is not installed and returns "ERR" (quotation marks excluded) if the corresponding function is not enabled or the type does not match.

:ABORt

Syntax

:ABORt

Description

Give up the current operation and restart the sweep.

:CALCulate Subsystem

Command List:

- ◆ [:CALCulate:BANDwidth:NDB](#)
- ◆ [:CALCulate:BANDwidth:RESult?](#)
- ◆ [:CALCulate:LLINe:ALL:DELete](#)
- ◆ [:CALCulate:LLINe:CONTRol:DOMain](#)
- ◆ [:CALCulate:LLINe:FAIL?](#)
- ◆ [:CALCulate:LLINe:FAIL:RATIo?](#)
- ◆ [:CALCulate:LLINe:FAIL:STOP:STATe](#)
- ◆ [:CALCulate:LLINe<n>:CONTRol:INTerpolate:TYPE](#)
- ◆ [:CALCulate:LLINe<n>:DATA](#)
- ◆ [:CALCulate:LLINe<n>:DATA:MERGE](#)
- ◆ [:CALCulate:LLINe<n>:DELete](#)
- ◆ [:CALCulate:LLINe<n>:RELAmp\[:STATe\]](#)
- ◆ [:CALCulate:LLINe<n>:RELFreq\[:STATe\]](#)
- ◆ [:CALCulate:LLINe<n>:STATe](#)
- ◆ [:CALCulate:MARKer:AOFF](#)
- ◆ [:CALCulate:MARKer:FCOunt:RESolution](#)
- ◆ [:CALCulate:MARKer:FCOunt:RESolution:AUTO](#)
- ◆ [:CALCulate:MARKer:FCOunt:X?](#)
- ◆ [:CALCulate:MARKer:FCOunt\[:STATe\]](#)
- ◆ [:CALCulate:MARKer<n>:CPEak\[:STATe\]](#)
- ◆ [:CALCulate:MARKer<n>:DELTA\[:SET\]:CENTer](#)
- ◆ [:CALCulate:MARKer<n>:DELTA\[:SET\]:SPAN](#)
- ◆ [:CALCulate:MARKer<n>:FUNCTion](#)
- ◆ [:CALCulate:MARKer<n>:MAXimum:LEFT](#)
- ◆ [:CALCulate:MARKer<n>:MAXimum:MAX](#)
- ◆ [:CALCulate:MARKer<n>:MAXimum:NEXT](#)
- ◆ [:CALCulate:MARKer<n>:MAXimum:RIGHT](#)
- ◆ [:CALCulate:MARKer<n>:MINimum](#)
- ◆ [:CALCulate:MARKer<n>:MODE](#)

- ◆ [:CALCulate:MARKer<n>:PEAK:EXCursion](#)
- ◆ [:CALCulate:MARKer<n>:PEAK:SEARCh:MODE](#)
- ◆ [:CALCulate:MARKer<n>:PEAK\[:SET\]:CF](#)
- ◆ [:CALCulate:MARKer<n>:PEAK:THReshold](#)
- ◆ [:CALCulate:MARKer<n>:PTPeak](#)
- ◆ [:CALCulate:MARKer<n>\[:SET\]:CENTer](#)
- ◆ [:CALCulate:MARKer<n>\[:SET\]:RLEVel](#)
- ◆ [:CALCulate:MARKer<n>\[:SET\]:STARt](#)
- ◆ [:CALCulate:MARKer<n>\[:SET\]:STEP](#)
- ◆ [:CALCulate:MARKer<n>\[:SET\]:STOP](#)
- ◆ [:CALCulate:MARKer<n>:STATe](#)
- ◆ [:CALCulate:MARKer<n>:TRACe](#)
- ◆ [:CALCulate:MARKer<n>:TRACe:AUTO](#)
- ◆ [:CALCulate:MARKer<n>:VSRef?*](#)
- ◆ [:CALCulate:MARKer<n>:VSValue?*](#)
- ◆ [:CALCulate:MARKer<n>:X](#)
- ◆ [:CALCulate:MARKer<n>:X:CENTer](#)
- ◆ [:CALCulate:MARKer<n>:X:POSition](#)
- ◆ [:CALCulate:MARKer<n>:X:POSition:CENTer](#)
- ◆ [:CALCulate:MARKer<n>:X:POSition:SPAN](#)
- ◆ [:CALCulate:MARKer<n>:X:POSition:STARt](#)
- ◆ [:CALCulate:MARKer<n>:X:POSition:STOP](#)
- ◆ [:CALCulate:MARKer<n>:X:READout](#)
- ◆ [:CALCulate:MARKer<n>:X:SPAN](#)
- ◆ [:CALCulate:MARKer<n>:X:STARt](#)
- ◆ [:CALCulate:MARKer<n>:X:STOP](#)
- ◆ [:CALCulate:MARKer<n>:Y?](#)
- ◆ [:CALCulate:MARKer:TABLE:STATe](#)
- ◆ [:CALCulate:MARKer:TRACking:STATe](#)
- ◆ [:CALCulate:NTData\[:STATe\]](#)

Explanation:

Commands marked with "*" are only available for DSA800E installed with the VSWR measurement kit (option).

:CALCulate:BANDwidth:NDB

Syntax

```
:CALCulate:BANDwidth:NDB <rel_ampl>
:CALCulate:BANDwidth:NDB?
```

Description

Set the value of N in N dB bandwidth measurement.
Query the value of N in N dB bandwidth measurement.

Parameter

Name	Type	Range	Default
<rel_ampl>	Consecutive Real Number	-100 dB to 100 dB	-3 dB

Return Format

The query returns the value of N in scientific notation.

Example

The command below sets N to -4.

```
:CALCulate:BANDwidth:NDB -4
```

The query below returns -4.000000E+00.

```
:CALCulate:BANDwidth:NDB?
```

:CALCulate:BANDwidth:RESult?

Syntax

```
:CALCulate:BANDwidth:RESult?
```

Description

Query the measurement result of N dB bandwidth and the unit is Hz.

Return Format

The query returns the bandwidth in integer (in Hz).

If points that are located on both sides of the current marker and with N dB fall or rise in amplitude are not found, the query returns ----.

:CALCulate:LLINe:ALL:DELeTe

Syntax

```
:CALCulate:LLINe:ALL:DELeTe
```

Description

Delete the limit line currently edited.

:CALCulate:LLINe:CONTrol:DOMain

Syntax

```
:CALCulate:LLINe:CONTrol:DOMain FREQuency|TIME
:CALCulate:LLINe:CONTrol:DOMain?
```

Description

Set the X axis to denote frequency or time in the Pass/Fail test.
Query the type of the X axis in the Pass/Fail test.

Parameter

Name	Type	Range	Default
--	Keyword	FREQuency TIME	FREQuency

Explanation

This setting is applicable to both the upper and lower limit lines.
All the points of the current limit line will be deleted when the X axis type is changed.

Return Format

The query returns FREQ or TIME.

Example

The command below sets the X axis to time.

```
:CALCulate:LLINe:CONTrol:DOMain TIME
```

The query below returns TIME.

```
:CALCulate:LLINe:CONTrol:DOMain?
```

:CALCulate:LLINe:FAIL?

Syntax

```
:CALCulate:LLINe:FAIL?
```

Description

Query the result of the Pass/Fail test.

Return Format

The query returns PASS or FAIL. The query returns UNMEAS if the test is not finished.

:CALCulate:LLINe:FAIL:RATIo?

Syntax

:CALCulate:LLINe:FAIL:RATIo?

Description

Query the fail ratio of the Pass/Fail test.

Return Format

The query returns the fail ratio in scientific notation.

Example

The query below returns 5.490000E+00.

```
:CALCulate:LLINe:FAIL:RATIo?
```

:CALCulate:LLINe:FAIL:STOP:STATe

Syntax

```
:CALCulate:LLINe:FAIL:STOP:STATe OFF|ON|0|1
:CALCulate:LLINe:FAIL:STOP:STATe?
```

Description

Set whether to stop the test if the test fails.

Query whether to stop the test if the test fails.

Parameter

Name	Type	Range	Default
--	Bool	OFF ON 0 1	ON 1

Explanation

If the parameter is set to ON or 1, the test stops when the test fails and the test continues if the parameter is set to OFF or 0.

Return Format

The query returns 0 or 1.

Example

The command below sets the instrument to stop the test when the test fails.

```
:CALCulate:LLINe:FAIL:STOP:STATe ON or :CALCulate:LLINe:FAIL:STOP:STATe 1
```

The query below returns 1.

```
:CALCulate:LLINe:FAIL:STOP:STATe?
```

:CALCulate:LLINE<n>:CONTrol:INTerpolate:TYPE

Syntax

```
:CALCulate:LLINE<n>:CONTrol:INTerpolate:TYPE LOGarithmic|LINear
:CALCulate:LLINE<n>:CONTrol:INTerpolate:TYPE?
```

Description

Set the frequency interpolation mode in the Pass/Fail test to log or linear.
Query the frequency interpolation mode.

Parameter

Name	Type	Range	Default
<n>	Discrete	1 2	--
--	Keyword	LOGarithmic LINear	LINear

Explanation

<n> denotes the lower limit line (1) or upper limit line (2).

In log mode, both the frequency and amplitude use log unit to make interpolation operation.

In linear mode, the frequency uses a linear unit and the amplitude uses a log unit for interpolation operation.

Return Format

The query returns LOG or LIN.

Example

The command below sets the frequency interpolation mode of the lower limit line to log.

```
:CALCulate:LLINE1:CONTrol:INTerpolate:TYPE LOGarithmic
```

The query below returns LOG.

```
:CALCulate:LLINE1:CONTrol:INTerpolate:TYPE?
```

:CALCulate:LLINE<n>:DATA

Syntax

```
:CALCulate:LLINE<n>:DATA <x-axis>,<ampl>,<connected>{,<x-axis>,<ampl>,<connected>}
:CALCulate:LLINE<n>:DATA?
```

Description

Create a limit line of the Pass/Fail test.

Query the limit line information.

Parameter

Name	Type	Range	Default
<n>	Discrete	1 2	2
<x-axis>	Consecutive Real Number	0 Hz to 3.2 GHz (the X axis denotes frequency) 0 us to 3.2 ks (the X axis denotes time)	--
<ampl>	Consecutive Real Number	-400 dBm to 320 dBm	--
<connected>	Discrete	0 1	0

Explanation

<n>: denote the lower limit line (1) or upper limit line (2).

<x-axis>: the frequency or time (depend on the X axis type) of the point being edited.

<ampl>: the amplitude of the point being edited.

<connected>: whether to connect the current point with the previous one. 1 denotes yes and 0 denotes no. Note that for the first point, only 0 is available.
Up to 200 points can be edited for each limit line.

Return Format

The query returns the specified limit line information in

<x-axis>,<ampl>,<connected>{,<x-axis>,<ampl>,<connected>} format.

If no point is edited of the specified limit line, the query returns NULL.

Example

The command below creates an upper limit line with 3 points.

```
:CALCulate:LLINe2:DATA 50,100,0,100,150,1,200,200,1
```

The query below returns 50,100.000000,0,100,150.000000,1,200,200.000000,1.

```
:CALCulate:LLINe2:DATA?
```

:CALCulate:LLINe<n>:DATA:MERGe

Syntax

```
:CALCulate:LLINe<n>:DATA:MERGe <x-axis>,<ampl>,<connected>{,<x-axis>,<ampl>,<connected>}
```

Description

In the Pass/Fail test, add points onto the limit line being edited.

Parameter

Name	Type	Range	Default
<n>	Discrete	1 2	2
<x-axis>	Consecutive Real Number	0 Hz to 3.2 GHz (X axis denotes frequency) 0 us to 3.2 ks (X axis denotes time)	--
<ampl>	Consecutive Real Number	-400 dBm to 320 dBm	--
<connected>	Discrete	0 1	0

Explanation

<n>: denote the lower limit line (1) or upper limit line (2).

<x-axis>: the frequency or time (depend on the X axis type) of the point being edited.

<ampl>: the amplitude of the point being edited.

<connected>: whether to connect the current point with the previous one. 1 denotes yes and 0 denotes no. Note that for the first point, only 0 is available.

Up to 200 points can be edited for each limit line.

Example

The command below adds two points onto the upper limit line.

```
:CALCulate:LLINe2:DATA:MERG 250,200,1,300,250,1
```

:CALCulate:LLINe<n>:DELeTe**Syntax**

```
:CALCulate:LLINe<n>:DELeTe
```

Description

Delete the specified limit line of the Pass/Fail test.

Parameter

Name	Type	Range	Default
<n>	Discrete	1 2	--

Explanation

<n> denotes the lower limit line (1) or the upper limit line (2).

Example

The command below deletes the lower limit line.

```
:CALCulate:LLINe1:DELeTe
```

:CALCulate:LLINe<n>:RELAmpT[:STATe]**Syntax**

```
:CALCulate:LLINe<n>:RELAmpT[:STATe] OFF|ON|0|1
```

```
:CALCulate:LLINe<n>:RELAmpT?
```

Description

Enable or disable the REL Amplitude.

Query the status of the REL Amplitude.

Parameter

Name	Type	Range	Default
<n>	Discrete	1 2	--
--	Bool	OFF ON 0 1	OFF 0

Explanation

<n> denotes the lower limit line (1) or upper limit line (2).

When the REL Amplitude is enabled, the amplitude set is the difference between the amplitude of the current point and the current reference level.

Return Format

The query returns 0 or 1.

Example

The command below enables the REL Amplitude.

```
:CALCulate:LLINe1:RELAmpT:STATe ON or :CALCulate:LLINe1:RELAmpT:STATe 1
```

The query below returns 1.

```
:CALCulate:LLINe1:RELAmpT?
```

:CALCulate:LLINE<n>:RELFreq[:STATE]

Syntax

```
:CALCulate:LLINE<n>:RELFreq[:STATE] OFF|ON|0|1
:CALCulate:LLINE<n>:RELFreq?
```

Description

Enable or disable the REL Frequency.
Query the status of the REL Frequency.

Parameter

Name	Type	Range	Default
<n>	Discrete	1 2	--
--	Bool	OFF ON 0 1	OFF 0

Explanation

<n> denotes the lower limit line (1) or upper limit line (2).

When the REL Frequency is enabled, the frequency set is the difference between the frequency of the current point and the current center frequency.

Return Format

The query returns 0 or 1.

Example

The command below enables the REL Frequency.

```
:CALCulate:LLINE1:RELFreq:STATE ON or :CALCulate:LLINE1:RELFreq:STATE 1
```

The query below returns 1.

```
:CALCulate:LLINE1:RELFreq?
```

:CALCulate:LLINE<n>:STATE

Syntax

```
:CALCulate:LLINE<n>:STATE OFF|ON|0|1
:CALCulate:LLINE<n>:STATE?
```

Description

Enable or disable the upper/lower limit line.
Query the status of the limit lines.

Parameter

Name	Type	Range	Default
<n>	Discrete	1 2	--
--	Bool	OFF ON 0 1	OFF 0

Explanation

<n> denotes the lower limit line (1) or upper limit line (2).

Return Format

The query returns 0 or 1.

Example

The command below enables the upper limit line.

```
:CALCulate:LLINe2:STATe ON or :CALCulate:LLINe2:STATe 1
```

The query below returns 1.

```
:CALCulate:LLINe2:STATe?
```

:CALCulate:MARKer:AOff**Syntax**

```
:CALCulate:MARKer:AOff
```

Description

Disable all the markers currently enabled as well as all the functions based on the markers.

:CALCulate:MARKer:FCOunt:RESolution**Syntax**

```
:CALCulate:MARKer:FCOunt:RESolution <freq>
:CALCulate:MARKer:FCOunt:RESolution?
```

Description

Set the resolution of the frequency counter.

Query the resolution of the frequency counter.

Parameter

Name	Type	Range	Default
<freq>	Discrete	1 Hz 10 Hz 100 Hz 1 kHz 10 kHz 100 kHz	1 kHz

Explanation

When <freq> is set in "Number" format, the default unit is Hz. It can also be set in "Number+Unit" format; for example, 1 kHz.

Use the [:CALCulate:MARKer:FCOunt:RESolution:AUTO](#) command to set the resolution setting to auto mode.

Return Format

The query returns the resolution in integer and the unit is Hz.

Example

The command below sets the resolution of the frequency counter to 1 kHz.

```
:CALCulate:MARKer:FCOunt:RESolution 1000 or :CALCulate:MARKer:FCOunt:RESolution 1kHz
```

The query below returns 1000.

```
:CALCulate:MARKer:FCOunt:RESolution?
```

:CALCulate:MARKer:FCOunt:RESolution:AUTO

Syntax

```
:CALCulate:MARKer:FCOunt:RESolution:AUTO OFF|ON|0|1
:CALCulate:MARKer:FCOunt:RESolution:AUTO?
```

Description

Set the resolution of the frequency counter automatically.
Query the status of the auto setting of the resolution of the frequency counter.

Parameter

Name	Type	Range	Default
--	Bool	OFF ON 0 1	ON 1

Return Format

The query returns 0 or 1.

Example

The command below disables the auto setting of the resolution of the frequency counter.

```
:CALCulate:MARKer:FCOunt:RESolution:AUTO OFF or :CALCulate:MARKer:FCOunt:RESolution:AUTO 0
```

The query below returns 0.

```
:CALCulate:MARKer:FCOunt:RESolution:AUTO?
```

:CALCulate:MARKer:FCOunt:X?

Syntax

```
:CALCulate:MARKer:FCOunt:X?
```

Description

Query the reading of the frequency counter.

Return Format

The query returns the reading in integer and the unit is Hz.
The query returns 9000000000000000 when the frequency counter is disabled.

:CALCulate:MARKer:FCOunt[:STATe]**Syntax**

```
:CALCulate:MARKer:FCOunt[:STATe] OFF|ON|0|1
:CALCulate:MARKer:FCOunt[:STATe]?
```

Description

Enable or disable the frequency counter.
Query the status of the frequency counter.

Parameter

Name	Type	Range	Default
--	Bool	OFF ON 0 1	OFF 0

Explanation

Use the [:CALCulate:MARKer:FCOunt:X?](#) command to query the reading of the frequency counter.

Return Format

The query returns 0 or 1.

Example

The command below enables the frequency counter.

```
:CALCulate:MARKer:FCOunt:STATe ON or :CALCulate:MARKer:FCOunt:STATe 1
```

The query below returns 1.

```
:CALCulate:MARKer:FCOunt:STATe?
```

:CALCulate:MARKer<n>:CPEak[:STATe]**Syntax**

```
:CALCulate:MARKer<n>:CPEak[:STATe] OFF|ON|0|1
:CALCulate:MARKer<n>:CPEak[:STATe]?
```

Description

Enable continuous peak search and mark the peak using the specified marker or disable continuous peak search.

Query the status of continuous peak search.

Parameter

Name	Type	Range	Default
<n>	Discrete	1 2 3 4	1
--	Bool	OFF ON 0 1	OFF 0

Return Format

The query returns 0 or 1.

Example

The command below enables continuous peak search and marks the peak using marker 2.

```
:CALCulate:MARKer2:CPEak:STATe ON or :CALCulate:MARKer2:CPEak:STATe 1
```

The query below returns 1.

```
:CALCulate:MARKer2:CPEak:STATe?
```

:CALCulate:MARKer<n>:DELTA[:SET]:CENTer

Syntax

:CALCulate:MARKer<n>:DELTA[:SET]:CENTer

Description

Set the center frequency of the spectrum analyzer to the frequency difference of the specified Delta, Delta Pair or Span Pair marker.

Parameter

Name	Type	Range	Default
<n>	Discrete	1 2 3 4	--

Explanation

Use the [:CALCulate:MARKer<n>:MODE](#) command to select Delta, Delta Pair or Span Pair marker. This function is invalid in zero span mode.

Example

The command below sets the center frequency to the frequency difference of marker 1 (Delta Pair marker).

```
:CALCulate:MARKer1:DELTA:SET:CENTer
```

:CALCulate:MARKer<n>:DELTA[:SET]:SPAN

Syntax

:CALCulate:MARKer<n>:DELTA[:SET]:SPAN

Description

Set the span of the spectrum analyzer to the frequency difference of the specified Delta, Delta Pair or Span Pair marker.

Parameter

Name	Type	Range	Default
<n>	Discrete	1 2 3 4	--

Explanation

Use the [:CALCulate:MARKer<n>:MODE](#) command to select Delta, Delta Pair or Span Pair marker. This function is not available in zero span mode.

Example

The command below sets the span of the spectrum analyzer to the frequency difference of marker 1 (Delta Pair marker).

```
:CALCulate:MARKer1:DELTA:SET:SPAN
```

:CALCulate:MARKer<n>:FUNction

Syntax

```
:CALCulate:MARKer<n>:FUNction NDB|NOISe|OFF
:CALCulate:MARKer<n>:FUNction?
```

Description

Select special measurement type for the specified marker.
Query the special measurement type of the specified marker.

Parameter

Name	Type	Range	Default
<n>	Discrete	1 2 3 4	--
--	Keyword	NDB NOISe OFF	OFF

Explanation

NDB: N dB bandwidth.
NOISe: noise marker.
OFF: disable all the measurements.

Return Format

The query returns NDB, NOIS or OFF.

Example

The command below sets the measurement type of marker 1 to N dB bandwidth.

```
:CALCulate:MARKer1:FUNction NDB
```

The query below returns NDB.

```
:CALCulate:MARKer1:FUNction?
```

:CALCulate:MARKer<n>:MAXimum:LEFT

Syntax

```
:CALCulate:MARKer<n>:MAXimum:LEFT
```

Description

Search and mark the nearest peak which is located at the left side of the current peak on the trace and meets the peak search condition.

Parameter

Name	Type	Range	Default
<n>	Discrete	1 2 3 4	--

Explanation

When no peak is found, "No peak found" is displayed on the screen.

:CALCulate:MARKer<n>:MAXimum:MAX**Syntax**

:CALCulate:MARKer<n>:MAXimum:MAX

Description

Execute a peak search according to the search mode set by the [:CALCulate:MARKer<n>:PEAK:SEARCH:MODE](#) command and mark the peak using the specified marker.

Parameter

Name	Type	Range	Default
<n>	Discrete	1 2 3 4	--

Example

The command below executes a peak search and marks the peak using marker 2.

:CALCulate:MARKer2:MAXimum:MAX

:CALCulate:MARKer<n>:MAXimum:NEXT**Syntax**

:CALCulate:MARKer<n>:MAXimum:NEXT

Description

Search and mark the peak whose amplitude is closest to that of the current peak and which meets the peak search condition.

Parameter

Name	Type	Range	Default
<n>	Discrete	1 2 3 4	--

Explanation

When no peak is found, "No peak found" is displayed on the screen.

:CALCulate:MARKer<n>:MAXimum:RIGHT**Syntax**

:CALCulate:MARKer<n>:MAXimum:RIGHT

Description

Search and mark the nearest peak which is located at the right side of the current peak and meets the peak search condition.

Parameter

Name	Type	Range	Default
<n>	Discrete	1 2 3 4	--

Explanation

When no peak is found, "No peak found" is displayed on the screen.

:CALCulate:MARKer<n>:MINimum**Syntax**

```
:CALCulate:MARKer<n>:MINimum
```

Description

Search and mark the peak on the trace with the minimum amplitude.

Parameter

Name	Type	Range	Default
<n>	Discrete	1 2 3 4	--

Explanation

When no peak is found, "No peak found" is displayed on the screen.

:CALCulate:MARKer<n>:MODE**Syntax**

```
:CALCulate:MARKer<n>:MODE POSition|DELTA|BAND|SPAN
:CALCulate:MARKer<n>:MODE?
```

Description

Set the type of the specified marker.

Query the type of the specified marker.

Parameter

Name	Type	Range	Default
<n>	Discrete	1 2 3 4	--
--	Keyword	POSition DELTA BAND SPAN	POSition

Explanation

POSition: Normal

DELTA: Delta

BAND: Delta Pair

SPAN: Span Pair

Return Format

The query returns POS, DELT, BAND or SPAN.

Example

The command below sets the type of marker 1 to Normal.

```
:CALCulate:MARKer1:MODE POSition
```

The query below returns POS.

```
:CALCulate:MARKer1:MODE?
```

:CALCulate:MARKer<n>:PEAK:EXCursion

Syntax

```
:CALCulate:MARKer<n>:PEAK:EXCursion <rel_ampl>
:CALCulate:MARKer<n>:PEAK:EXCursion?
```

Description

Set the peak excursion and the unit is dB.
Query the peak excursion.

Parameter

Name	Type	Range	Default
<n>	Discrete	1 2 3 4	--
<rel_ampl>	Consecutive Real Number	0 dB to 200 dB	10 dB

Return Format

The query returns the peak excursion in scientific notation.

Example

The command below sets the peak excursion to 12 dB.

```
:CALCulate:MARKer1:PEAK:EXCursion 12
```

The query below returns 1.200000E+01.

```
:CALCulate:MARKer1:PEAK:EXCursion?
```

:CALCulate:MARKer<n>:PEAK:SEARch:MODE

Syntax

```
:CALCulate:MARKer<n>:PEAK:SEARch:MODE PARAmeter|MAXimum
:CALCulate:MARKer<n>:PEAK:SEARch:MODE?
```

Description

Set the peak search mode.
Query the peak search mode.

Parameter

Name	Type	Range	Default
<n>	Discrete	1 2 3 4	--
--	Keyword	PARAmeter MAXimum	MAXimum

Explanation

PARAmeter: parameter. Search and mark the peak which meets the search parameter conditions (peak excursion and peak threshold).

MAXimum: maximum. Search and mark the maximum on the trace.

This command applies only to the peak search executed by sending the [:CALCulate:MARKer<n>:MAXimum:MAX](#) command, while other searches (Next Peak, Peak Right, Peak Left and Min Search) are not limited by it.

Return Format

The query returns PAR or MAX.

Example

The command below sets the peak search mode of trace 1 to parameter and marks the peak using marker 1.

```
:CALCulate:MARKer1:PEAK:SEARch:MODE PARAmeter
```

The query below returns PAR.

```
:CALCulate:MARKer1:PEAK:SEARch:MODE?
```

:CALCulate:MARKer<n>:PEAK[:SET]:CF**Syntax**

```
:CALCulate:MARKer<n>:PEAK[:SET]:CF
```

Description

Execute a peak search (mark the peak using the specified marker) and set the center frequency of the spectrum analyzer to the frequency of the current peak.

Parameter

Name	Type	Range	Default
<n>	Discrete	1 2 3 4	--

Example

The command below executes a peak search (marks the peak using marker 1) and sets the center frequency of the spectrum analyzer to the frequency of the current peak.

```
:CALCulate:MARKer1:PEAK:SET:CF
```

:CALCulate:MARKer<n>:PEAK:THReshold**Syntax**

```
:CALCulate:MARKer<n>:PEAK:THReshold <ampl>
```

```
:CALCulate:MARKer<n>:PEAK:THReshold?
```

Description

Set the peak threshold and the unit is dBm.

Query the peak threshold.

Parameter

Name	Type	Range	Default
<n>	Discrete	1 2 3 4	--
<ampl>	Consecutive Real Number	-200 dBm to 0 dBm	-90 dBm

Return Format

The query returns the peak threshold in scientific notation.

Example

The command below sets the peak threshold of marker 1 to -100 dBm.

```
:CALCulate:MARKer1:PEAK:THReshold -100
```

The query below returns -1.000000E+02.

```
:CALCulate:MARKer1:PEAK:THReshold?
```

:CALCulate:MARKer<n>:PTPeak

Syntax

```
:CALCulate:MARKer<n>:PTPeak
```

Description

Execute peak-peak search and mark the peak using the specified marker.

Parameter

Name	Type	Range	Default
<n>	Discrete	1 2 3 4	--

Explanation

The marker type of the specified marker will automatically change to Delta Pair after executing this command. The reference marker and delta marker are used to mark the peak-peak positions respectively.

Example

The command below executes peak-peak search. The reference marker 1R and delta marker 1 mark the peak-peak positions respectively.

```
:CALCulate:MARKer1:PTPeak
```

:CALCulate:MARKer<n>[:SET]:CENTER

Syntax

```
:CALCulate:MARKer<n>[:SET]:CENTER
```

Description

Set the center frequency of the spectrum analyzer to the frequency of the specified marker.

Parameter

Name	Type	Range	Default
<n>	Discrete	1 2 3 4	--

Explanation

If the specified marker is Normal marker, the center frequency will be set to the frequency of the marker. If the specified marker is Delta, Delta Pair or Span Pair marker, the center frequency will be set to the frequency of the delta marker.

This command is only available when the specified marker is enabled.

This function is invalid in zero span mode.

Example

The command below sets the center frequency of the spectrum analyzer to the frequency of marker 1 (Normal marker).

```
:CALCulate:MARKer1:SET:CENTer
```

:CALCulate:MARKer<n>[:SET]:RLEVel

Syntax

```
:CALCulate:MARKer<n>[:SET]:RLEVel
```

Description

Set the reference level of the spectrum analyzer to the amplitude of the specified marker.

Parameter

Name	Type	Range	Default
<n>	Discrete	1 2 3 4	--

Explanation

If the specified marker is Normal marker, the reference level will be set to the amplitude of the marker.

If the specified marker is Delta, Delta Pair or Span Pair marker, the reference level will be set to the amplitude of the delta marker.

This command is only available when the specified marker is enabled.

Example

The command below sets the reference level of the spectrum analyzer to the amplitude of marker 2 (Normal marker).

```
:CALCulate:MARKer2:SET:RLEVel
```

:CALCulate:MARKer<n>[:SET]:START

Syntax

```
:CALCulate:MARKer<n>[:SET]:START
```

Description

Set the start frequency of the spectrum analyzer to the frequency of the specified marker.

Parameter

Name	Type	Range	Default
<n>	Discrete	1 2 3 4	--

Explanation

If the specified marker is Normal marker, the start frequency will be set to the frequency of the marker.

If the specified marker is Delta, Delta Pair or Span Pair marker, the start frequency will be set to the frequency of the delta marker.

This command is only available when the specified marker is enabled.

This function is invalid in zero span mode.

Example

The command below sets the start frequency of the spectrum analyzer to the frequency of marker 3 (Normal marker).

```
:CALCulate:MARKer3:SET:START
```

:CALCulate:MARKer<n>[:SET]:STEP

Syntax

```
:CALCulate:MARKer<n>[:SET]:STEP
```

Description

Set the center frequency step of the spectrum analyzer to the frequency of the specified marker.

Parameter

Name	Type	Range	Default
<n>	Discrete	1 2 3 4	--

Explanation

If the specified marker is Normal marker, the center frequency step will be set to the frequency of the marker.

If the specified marker is Delta, Delta Pair or Span Pair marker, the center frequency step will be set to the frequency of the delta marker.

This command is only available when the specified marker is enabled.

This function is invalid in zero span mode.

Example

The command below sets the center frequency step of the spectrum analyzer to the frequency of marker 4 (Normal marker).

```
:CALCulate:MARKer4:SET:STEP
```

:CALCulate:MARKer<n>[:SET]:STOP

Syntax

```
:CALCulate:MARKer<n>[:SET]:STOP
```

Description

Set the stop frequency of the spectrum analyzer to the frequency of the specified marker.

Parameter

Name	Type	Range	Default
<n>	Discrete	1 2 3 4	--

Explanation

If the specified marker is Normal marker, the stop frequency will be set to the frequency of the marker.

If the specified marker is Delta, Delta Pair or Span Pair marker, the stop frequency will be set to the frequency of the delta marker.

This command is only available when the specified marker is enabled.

This function is invalid in zero span mode.

Example

The command below sets the stop frequency of the spectrum analyzer to the frequency of marker 2 (Normal marker).

```
:CALCulate:MARKer2:SET:STOP
```

:CALCulate:MARKer<n>:STATe**Syntax**

```
:CALCulate:MARKer<n>:STATe OFF|ON|0|1
:CALCulate:MARKer<n>:STATe?
```

Description

Enable or disable the specified marker.
Query the status of the specified marker.

Parameter

Name	Type	Range	Default
<n>	Discrete	1 2 3 4	--
--	Bool	OFF ON 0 1	OFF 0

Explanation

If the specified marker is not enabled currently, it will be set to Normal marker (POSITION) when this command is sent to enable it.

Return Format

The query returns 0 or 1.

Example

The command below enables marker 1.

```
:CALCulate:MARKer1:STATe ON or :CALCulate:MARKer1:STATe 1
```

The query below returns 1.

```
:CALCulate:MARKer1:STATe?
```

:CALCulate:MARKer<n>:TRACe**Syntax**

```
:CALCulate:MARKer<n>:TRACe <integer>
:CALCulate:MARKer<n>:TRACe?
```

Description

Set the trace to be marked by the specified marker.
Query the marker trace of the specified marker.

Parameter

Name	Type	Range	Default
<n>	Discrete	1 2 3 4	--
<integer>	Discrete	1 2 3 4	1

Explanation

<integer> denotes the trace selected and can be trace 1, trace 2, trace 3 or trace 4 (math trace). The trace selected must have been enabled.

You can also use the [:CALCulate:MARKer<n>:TRACe:AUTO](#) command to set the marker trace of the specified marker to Auto.

Return Format

The query returns 1, 2, 3 or 4.

If the marker trace is set to Auto, the query returns the number of the trace marked by the marker.

Example

The command below sets the marker trace of marker 1 to trace 2.

```
:CALCulate:MARKer1:TRACe 2
```

The query below returns 2.

```
:CALCulate:MARKer1:TRACe?
```

:CALCulate:MARKer<n>:TRACe:AUTO**Syntax**

```
:CALCulate:MARKer<n>:TRACe:AUTO OFF|ON|0|1
```

```
:CALCulate:MARKer<n>:TRACe:AUTO?
```

Description

Set the marker trace of the specified marker to Auto.

Query whether the marker trace is set to Auto.

Parameter

Name	Type	Range	Default
<n>	Discrete	1 2 3 4	--
--	Bool	OFF ON 0 1	ON 1

Explanation

When AUTO is disabled, the current marker will hold on the corresponding trace.

Return Format

The query returns 0 or 1.

Example

The command below sets the marker trace of marker 1 to Auto.

```
:CALCulate:MARKer1:TRACe:AUTO ON or :CALCulate:MARKer1:TRACe:AUTO 1
```

The query below returns 1.

```
:CALCulate:MARKer1:TRACe:AUTO?
```

:CALCulate:MARKer<n>:VSRefI?**Syntax**

:CALCulate:MARKer<n>:VSRefI?

Description

Query the reflection coefficient at the specified marker.

Parameter

Name	Type	Range	Default
<n>	Discrete	1 2 3 4	--

Return Format

The query returns the reflection coefficient in scientific notation.

Example

The command below returns 0.600118E+00.

:CALCulate:MARKer1:VSRefI?

:CALCulate:MARKer<n>:VSValue?**Syntax**

:CALCulate:MARKer<n>:VSValue?

Description

Query the VSWR at the specified marker.

Parameter

Name	Type	Range	Default
<n>	Discrete	1 2 3 4	--

Return Format

The query returns the VSWR in scientific notation.

Example

The command below returns 1.390118E+00.

:CALCulate:MARKer1:VSValue?

:CALCulate:MARKer<n>:X

Syntax

```
:CALCulate:MARKer<n>:X <param>
:CALCulate:MARKer<n>:X?
```

Description

Set the X-axis value of the specified marker and the default unit is Hz.
Query the X-axis value of the specified marker.

Parameter

Name	Type	Range	Default
<n>	Discrete	1 2 3 4	--
<param>	Consecutive Real Number	Refer to Explanation	--

Explanation

<param> can be any value within the range currently available of the X axis.

If the readout mode is frequency, it cannot exceed the frequency range of the sweep and the units available are Hz (default), kHz, MHz and GHz.

If the readout mode is time, it cannot exceed the time range of the sweep and the units available are s (default), us, ms and ks.

If the specified marker type is Normal, this command sets the X value of the marker.

If the specified marker type is Delta, this command sets the X value of the delta marker relative to the reference marker.

If the specified marker type is Delta Pair, this command sets the X value of the reference or delta marker according to the current menu state.

If the specified marker type is Span Pair, this command sets the X value of the span or center of the reference marker and delta marker according to the current menu state.

Return Format

When the readout mode is frequency or the reciprocal of time, the query returns the X-axis value of the marker in integer.

When the readout mode is time or period, the query returns the X-axis value of the marker in scientific notation.

Example

The command below sets the X-axis value of marker 1 to 150 MHz (the readout mode is frequency).

```
:CALCulate:MARKer1:X 15000000
```

The query returns 15000000.

```
:CALCulate:MARKer1:X?
```

:CALCulate:MARKer<n>:X:CENTer

Syntax

```
:CALCulate:MARKer<n>:X:CENTer <param>
:CALCulate:MARKer<n>:X:CENTer?
```

Description

Set the X-axis center value of the specified Span Pair marker.
Query the X-axis center value of the specified Span Pair marker.

Parameter

Name	Type	Range	Default
<n>	Discrete	1 2 3 4	--
<param>	Consecutive Real Number	Refer to Explanation	--

Explanation

<param> can be any value within the range currently available of the X axis.

If the readout mode is frequency, it cannot exceed the frequency range of the sweep and the units available are Hz (default), kHz, MHz and GHz.

If the readout mode is time, it cannot exceed the time range of the sweep and the units available are s (default), us, ms and ks.

Return Format

When the readout mode is frequency, the query returns the X-axis center value of the marker in integer and the unit is Hz.

When the readout mode is time or period, the query returns the X-axis center value of the marker in scientific notation and the unit is s.

Example

The command below sets the X-axis center value of marker 1 (Span Pair marker) to 1500000000 Hz (the readout mode is frequency).

```
:CALCulate:MARKe1:X:CENTer 1500000000 or :CALCulate:MARKe1:X:CENTer 1.5GHZ
```

The query below returns 1500000000.

```
:CALCulate:MARKe1:X:CENTer?
```

:CALCulate:MARKer<n>:X:POSition

Syntax

```
:CALCulate:MARKer<n>:X:POSition <integer>
:CALCulate:MARKer<n>:X:POSition?
```

Description

Set the position of the specified Normal marker.
Query the position of the specified Normal marker.

Parameter

Name	Type	Range	Default
<n>	Discrete	1 2 3 4	--
<integer>	Integer	0 to 600	300

Return Format

The query returns the position of the marker in integer.

Example

The command below sets the position of marker 1 (Normal marker) to 100.

```
:CALCulate:MARKer1:X:POSition 100
```

The query below returns 100.

```
:CALCulate:MARKer1:X:POSition?
```

:CALCulate:MARKer<n>:X:POSition:CENTer

Syntax

```
:CALCulate:MARKer<n>:X:POSition:CENTer <param>
:CALCulate:MARKer<n>:X:POSition:CENTer?
```

Description

Set the center position of the specified Span Pair marker.
Query the center position of the specified Span Pair marker.

Parameter

Name	Type	Range	Default
<n>	Discrete	1 2 3 4	--
<param>	Integer	0 to 600	300

Return Format

The query returns the center position of the specified marker in integer.

Example

The command below sets the center position of marker 1 (Span Pair marker) to 200.

```
:CALCulate:MARKer1:X:POSition:CENTer 200
```

The query below returns 200.

```
:CALCulate:MARKer1:X:POSition:CENTer?
```

:CALCulate:MARKer<n>:X:POStion:SPAN**Syntax**

```
:CALCulate:MARKer<n>:X:POStion:SPAN <param>
:CALCulate:MARKer<n>:X:POStion:SPAN?
```

Description

Set the number of points corresponding to the span of the specified Span Pair marker.
Query the number of points corresponding to the span of the specified Span Pair marker.

Parameter

Name	Type	Range	Default
<n>	Discrete	1 2 3 4	--
<param>	Integer	0 to 600	0

Return Format

The query returns the number of points corresponding to the span of the specified Span Pair marker in integer.

Example

The command below sets the number of points corresponding to the span of marker 1 (Span Pair marker) to 150.

```
:CALCulate:MARKer1:X:POStion:SPAN 150
```

The query below returns 150.

```
:CALCulate:MARKer1:X:POStion:SPAN?
```

:CALCulate:MARKer<n>:X:POStion:START**Syntax**

```
:CALCulate:MARKer<n>:X:POStion:START <param>
:CALCulate:MARKer<n>:X:POStion:START?
```

Description

Set the position of the reference marker of the specified Delta Pair marker.
Query the position of the reference marker of the specified Delta Pair marker.

Parameter

Name	Type	Range	Default
<n>	Discrete	1 2 3 4	--
<param>	Integer	0 to 600	300

Return Format

The query returns the position of the reference marker in integer.

Example

The command below sets the position of the reference marker of marker 1 (Delta Pair marker) to 100.

```
:CALCulate:MARKer1:X:POStion:START 100
```

The query below returns 100.

```
:CALCulate:MARKer1:X:POStion:START?
```

:CALCulate:MARKer<n>:X:POSition:STOP

Syntax

```
:CALCulate:MARKer<n>:X:POSition:STOP <param>
:CALCulate:MARKer<n>:X:POSition:STOP?
```

Description

Set the position of the delta marker of the specified Delta Pair marker.
Query the position of the delta marker of the specified Delta Pair marker.

Parameter

Name	Type	Range	Default
<n>	Discrete	1 2 3 4	--
<param>	Integer	0 to 600	300

Return Format

The query returns the position of the delta marker in integer.

Example

The command below sets the position of the delta marker of marker 1 (Delta Pair marker) to 300.

```
:CALCulate:MARKer1:X:POSition:STOP 300
```

The query below returns 300.

```
:CALCulate:MARKer1:X:POSition:STOP?
```

:CALCulate:MARKer<n>:X:READout

Syntax

```
:CALCulate:MARKer<n>:X:READout FREQuency|TIME|ITIME|PERiod
:CALCulate:MARKer<n>:X:READout?
```

Description

Set the readout mode of the X axis of the specified marker.
Query the readout mode of the X axis of the specified marker.

Parameter

Name	Type	Range	Default
<n>	Discrete	1 2 3 4	--
--	Keyword	FREQuency TIME ITIME PERiod	Refer to Explanation

Explanation

FREQuency: frequency. The default readout mode in non-zero span mode.

TIME: time. The default readout mode in zero span mode.

ITIME: the reciprocal of time. Only available in zero span mode when Delta Pair marker is used.

PERiod: period. Not available in zero span mode.

Return Format

The query returns FREQ, TIME, ITIM or PER.

Example

The command below sets the readout mode of the X axis of marker 1 to time.

```
:CALCulate:MARKer1:X:READout TIME
```

The query below returns TIME.

```
:CALCulate:MARKer1:X:READout?
```

:CALCulate:MARKer<n>:X:SPAN

Syntax

```
:CALCulate:MARKer<n>:X:SPAN <param>
:CALCulate:MARKer<n>:X:SPAN?
```

Description

Set the X value corresponding to the span of the specified Span Pair marker.
Query the X value corresponding to the span of the specified Span Pair marker.

Parameter

Name	Type	Range	Default
<n>	Discrete	1 2 3 4	--
<param>	Consecutive Real Number	Refer to Explanation	0

Explanation

<param> can be any value within the range currently available of the X axis.

If the current readout mode is frequency, it cannot exceed the frequency range of the sweep and the units available are Hz (default), kHz, MHz and GHz.

If the current readout mode is time, it cannot exceed the time range of the sweep and the units available are s (default), us, ms and ks.

Return Format

When the readout mode is frequency, the query returns the X value of the span of the marker in integer and the unit is Hz.

When the readout mode is time or period, the query returns the X value of the span of the marker in scientific notation and the unit is s.

Example

The command below sets the X value of the span of marker 1 (Span Pair marker) to 500 MHz (the readout mode is frequency).

```
:CALCulate:MARKer1:X:SPAN 500000000
```

The query below returns 500000000.

```
:CALCulate:MARKer1:X:SPAN?
```

:CALCulate:MARKer<n>:X:START

Syntax

```
:CALCulate:MARKer<n>:X:START <param>
:CALCulate:MARKer<n>:X:START?
```

Description

Set the X value of the reference marker of the specified Delta Pair marker.
Query the X value of the reference marker of the specified Delta Pair marker.

Parameter

Name	Type	Range	Default
<n>	Discrete	1 2 3 4	--
<param>	Consecutive Real Number	Refer to Explanation	--

Explanation

<param> can be any value within the range currently available of the X axis.

If the current readout mode is frequency, it cannot exceed the frequency range of the sweep and the units available are Hz (default), kHz, MHz and GHz.

If the current readout mode is time, it cannot exceed the time range of the sweep and the units available are s (default), us, ms and ks.

Return Format

When the readout mode is frequency, the query returns the X value of the reference marker in integer and the unit is Hz.

When the readout mode is time or period, the query returns the X value of the reference marker in scientific notation and the unit is s.

Example

The command below sets the X value of the reference marker of marker 1 (Delta Pair marker) to 750 MHz (the readout mode is frequency).

```
:CALCulate:MARKer1:X:START 750000000
```

The query below returns 750000000.

```
:CALCulate:MARKer1:X:START?
```

:CALCulate:MARKer<n>:X:STOP

Syntax

```
:CALCulate:MARKer<n>:X:STOP <param>
```

```
:CALCulate:MARKer<n>:X:STOP?
```

Description

Set the X value of the delta marker of the specified Delta Pair marker.

Query the X value of the delta marker of the specified Delta Pair marker.

Parameter

Name	Type	Range	Default
<n>	Discrete	1 2 3 4	--
<param>	Consecutive Real Number	Refer to Explanation	--

Explanation

<param> can be any value within the range currently available of the X axis.

If the current readout mode is frequency, it cannot exceed the frequency range of the sweep and the units available are Hz (default), kHz, MHz and GHz.

If the current readout mode is time, it cannot exceed the time range of the sweep and the units available are s (default), us, ms and ks.

Return Format

When the readout mode is frequency, the query returns the X value of the delta marker in integer and the unit is Hz.

When the readout mode is time or period, the query returns the X value of the delta marker in scientific notation and the unit is s.

Example

The command below sets the X value of the delta marker of marker 1 (Delta Pair marker) to 350 MHz (the readout mode is frequency).

```
:CALCulate:MARKer1:X:STOP 350000000
```

The query below returns 350000000.

```
:CALCulate:MARKer1:X:STOP?
```

:CALCulate:MARKer<n>:Y?**Syntax**

```
:CALCulate:MARKer<n>:Y?
```

Description

Query the Y-axis value of the specified marker and the default unit is dBm.

Parameter

Name	Type	Range	Default
<n>	Discrete	1 2 3 4	--

Explanation

If the specified marker is normal marker, query the Y value of the marker.

If the specified marker is Delta, Delta Pair or Span Pair marker, query the Y-axis difference between the reference marker and the delta marker.

Return Format

The query returns the Y-axis value in scientific notation.

Example

The query below returns 5.960000E+00.

```
:CALCulate:MARKer1:Y?
```

:CALCulate:MARKer:TABLE:STATe**Syntax**

```
:CALCulate:MARKer:TABLE:STATe OFF|ON|0|1
:CALCulate:MARKer:TABLE:STATe?
```

Description

Enable or disable the marker table.

Query the status of the marker table.

Parameter

Name	Type	Range	Default
--	Bool	OFF ON 0 1	OFF 0

Return Format

The query returns 0 or 1.

Example

The command below disables the marker table.

```
:CALCulate:MARKer:TABLE:STATe OFF or :CALCulate:MARKer:TABLE:STATe 0
```

The query below returns 0.

```
:CALCulate:MARKer:TABLE:STATe?
```

:CALCulate:MARKer:TRACking:STATe

Syntax

```
:CALCulate:MARKer:TRACking:STATe OFF|ON|0|1
:CALCulate:MARKer:TRACking:STATe?
```

Description

Enable or disable the signal track.
Query the status of the signal track.

Parameter

Name	Type	Range	Default
--	Bool	OFF ON 0 1	OFF 0

Explanation

When signal track is enabled, the instrument will execute a peak search after each sweep and set the center frequency to the frequency of the current peak to hold the signal at the center of the screen.

Return Format

The query returns 0 or 1.

Example

The command below enables the signal track.

```
:CALCulate:MARKer:TRACking:STATe ON or :CALCulate:MARKer:TRACking:STATe 1
```

The query below returns 1.

```
:CALCulate:MARKer:TRACking:STATe?
```

:CALCulate:NTData[:STATe]

Syntax

```
:CALCulate:NTData[:STATe] OFF|ON|0|1
:CALCulate:NTData[:STATe]?
```

Description

Enable or disable normalization.
Query the status of normalization.

Parameter

Name	Type	Range	Default
--	Bool	OFF ON 0 1	OFF 0

Explanation

This command is only applicable to DSA832E-TG.

Return Format

The query returns 0 or 1.

Example

The command below enables normalization.

```
:CALCulate:NTData:STATe ON or :CALCulate:NTData:STATe 1
```

The query below returns 1.

```
:CALCulate:NTData:STATe?
```

:CALibration Subsystem

Command List:

- ◆ [:CALibration:\[ALL\]](#)
- ◆ [:CALibration:AUTO](#)

:CALibration:[ALL]

Syntax

:CALibration:[ALL]

Description

Execute self-calibration immediately.

Example

The command below makes the instrument execute self-calibration immediately.

```
:CALibration:ALL
```

:CALibration:AUTO

Syntax

:CALibration:AUTO OFF|ON|0|1
:CALibration:AUTO?

Description

Enable or disable auto calibration.
Query the status of auto calibration.

Parameter

Name	Type	Range	Default
--	Bool	OFF ON 0 1	ON 1

Explanation

By default, auto calibration is enabled. But the instrument will use the last setting at the next power-on if users change this setting.

Return Format

The query returns 0 or 1.

Example

The command below enables auto calibration.

```
:CALibration:AUTO ON or :CALibration:AUTO 1
```

The query below returns 1.

```
:CALibration:AUTO?
```

:CONFigure Subsystem

Command List:

- ◆ [:CONFigure?](#)
- ◆ [:CONFigure:ACPower*](#)
- ◆ [:CONFigure:CHPower*](#)
- ◆ [:CONFigure:CNRatio*](#)
- ◆ [:CONFigure:EBWidth*](#)
- ◆ [:CONFigure:HDISt*](#)
- ◆ [:CONFigure:OBWidth*](#)
- ◆ [:CONFigure:PF](#)
- ◆ [:CONFigure:SANalyzer*](#)
- ◆ [:CONFigure:TOI*](#)
- ◆ [:CONFigure:TPOWer*](#)

Explanation:

Commands marked with "*" are only available for DSA800E installed with the advanced measurement kit (option).

:CONFigure?

Syntax

:CONFigure?

Description

Query the current measurement function.

Return Format

The query returns OFF, TPOW, ACP, CHP, OBW, EBW, CNR, HD, TOI or PF.

:CONFigure:ACPower

Syntax

:CONFigure:ACPower

Description

Set the spectrum analyzer to the adjacent channel power measurement state.

Explanation

This command stops the current measurement and sets the instrument to the default state of the specified measurement.

When any of the measurement settings is changed, use the [:READ](#) command to initialize the measurement without restoring it to the default value.

:CONFigure:CHPower

Syntax

:CONFigure:CHPower

Description

Set the spectrum analyzer to the channel power measurement state.

Explanation

This command stops the current measurement and sets the instrument to the default state of the specified measurement.

When any of the measurement settings is changed, use the [:READ](#) command to initialize the measurement without restoring it to the default value.

:CONFigure:CNRatio

Syntax

:CONFigure:CNRatio

Description

Set the spectrum analyzer to the C/N ratio measurement state.

Explanation

This command stops the current measurement and sets the instrument to the default state of the specified measurement.

When any of the measurement settings is changed, use the [:READ](#) command to initialize the measurement without restoring it to the default value.

:CONFigure:EBWidth

Syntax

:CONFigure:EBWidth

Description

Set the spectrum analyzer to the emission bandwidth measurement state.

Explanation

This command stops the current measurement and sets the instrument to the default state of the specified measurement.

When any of the measurement settings is changed, use the [:READ](#) command to initialize the measurement without restoring it to the default value.

:CONFigure:HDISt

Syntax

:CONFigure:HDISt

Description

Set the spectrum analyzer to the harmonic distortion measurement state.

Explanation

This command stops the current measurement and sets the instrument to the default state of the specified measurement.

When any of the measurement settings is changed, use the [:READ](#) command to initialize the measurement without restoring it to the default value.

:CONFigure:OBWidth

Syntax

:CONFigure:OBWidth

Description

Set the spectrum analyzer to the occupied bandwidth measurement state.

Explanation

This command stops the current measurement and sets the instrument to the default state of the specified measurement.

When any of the measurement settings is changed, use the [:READ](#) command to initialize the measurement without restoring it to the default value.

:CONFigure:PF

Syntax

:CONFigure:PF

Description

Enable the Pass/Fail test function.

:CONFigure:SANalyzer

Syntax

:CONFigure:SANalyzer

Description

This command will disable the current measurement function and set the spectrum analyzer to sweep mode.

:CONFigure:TOI

Syntax

:CONFigure:TOI

Description

Set the spectrum analyzer to the TOI measurement state.

Explanation

This command stops the current measurement and sets the instrument to the default state of the specified measurement.

When any of the measurement settings is changed, use the [:READ](#) command to initialize the measurement without restoring it to the default value.

:CONFigure:TPOWer

Syntax

:CONFigure:TPOWer

Description

Set the spectrum analyzer to the T-power measurement state.

Explanation

This command stops the current measurement and sets the instrument to the default state of the specified measurement.

When any of the measurement settings is changed, use the [:READ](#) command to initialize the measurement without restoring it to the default value.

:COUPle Subsystem

Command List:

◆ [:COUPle](#)

:COUPle

Syntax

:COUPle ALL|NONE

:COUPle?

Description

Set all the related parameters automatically according to the coupling relationship.

Query the status of the coupling linked setting.

Parameter

Name	Type	Range	Default
--	Keyword	ALL NONE	ALL

Explanation

The following parameters have coupling relationships.

CF step

Reference level

Input attenuation

Resolution bandwidth (RBW)

Video bandwidth (VBW)

Sweep time

Return Format

The query returns ALL or NONE.

Example

The command below disables the linked setting of parameters that have coupling relationships.

```
:COUPle NONE
```

The query below returns NONE.

```
:COUPle?
```

:DISPlay Subsystem

Command List:

- ◆ [:DISPlay:AFUnction:POStion](#)
- ◆ [:DISPlay:ANNotation:CLOCK\[:STATe\]](#)
- ◆ [:DISPlay:BRIGhtness](#)
- ◆ [:DISPlay:ENABle](#)
- ◆ [:DISPlay:MSGswitch:STATe](#)
- ◆ [:DISPlay:UKEY:STATe](#)
- ◆ [:DISPlay:WINDow:TRACe:GRATicule:GRID](#)
- ◆ [:DISPlay:WINDow:TRACe:X\[:SCALe\]:SPACing](#)
- ◆ [:DISPlay:WINDow:TRACe:Y:DLINe](#)
- ◆ [:DISPlay:WINDow:TRACe:Y:DLINe:STATe](#)
- ◆ [:DISPlay:WINDow:TRACe:Y\[:SCALe\]:NRLevel*](#)
- ◆ [:DISPlay:WINDow:TRACe:Y\[:SCALe\]:NRPosition*](#)
- ◆ [:DISPlay:WINDow:TRACe:Y\[:SCALe\]:PDIVision](#)
- ◆ [:DISPlay:WINDow:TRACe:Y\[:SCALe\]:RLEVel](#)
- ◆ [:DISPlay:WINDow:TRACe:Y\[:SCALe\]:RLEVel:OFFSet](#)
- ◆ [:DISPlay:WINDow:TRACe:Y\[:SCALe\]:SPACing](#)

Explanation:

Commands marked with "*" are only available for DSA832E-TG.

:DISPlay:AFUnction:POSition

Syntax

```
:DISPlay:AFUnction:POSition BOTTOm|CENTer|TOP
:DISPlay:AFUnction:POSition?
```

Description

Set the position of the active function area on the screen.
Query the position of the active function area on the screen.

Parameter

Name	Type	Range	Default
--	Keyword	BOTTOm CENTer TOP	TOP

Explanation

BOTTOm: bottom
CENTer: center
TOP: top

Return Format

The query returns BOTT, CENT or TOP.

Example

The command below sets the position of the active function area to the screen center.
:DISPlay:AFUnction:POSition CENTER

The query below returns CENT.
:DISPlay:AFUnction:POSition?

:DISPlay:ANNotation:CLOCK[:STATe]

Syntax

```
:DISPlay:ANNotation:CLOCK[:STATe] OFF|ON|0|1
:DISPlay:ANNotation:CLOCK[:STATe]?
```

Description

Enable or disable the display of the time and date.
Query the status of the display of the time and date.

Parameter

Name	Type	Range	Default
--	Bool	OFF ON 0 1	ON 1

Return Format

The query returns 0 or 1.

Example

The command below enables the display of the time and date.
:DISPlay:ANNotation:CLOCK:STATe ON or :DISPlay:ANNotation:CLOCK:STATe 1

The query below returns 1.
:DISPlay:ANNotation:CLOCK:STATe?

:DISPlay:BRIGhtness

Syntax

```
:DISPlay:BRIGhtness <integer>
:DISPlay:BRIGhtness?
```

Description

Set the screen brightness.
Query the screen brightness.

Parameter

Name	Type	Range	Default
<integer>	Integer	1 to 10	2

Return Format

The query returns the brightness in integer.

Example

The command below sets the brightness to 6.

```
:DISPlay:BRIGhtness 6
```

The query below returns 6.

```
:DISPlay:BRIGhtness?
```

:DISPlay:ENABLE

Syntax

```
:DISPlay:ENABLE OFF|ON|0|1
:DISPlay:ENABLE?
```

Description

Set the on/off state of the screen.
Query the on/off state of the screen.

Parameter

Name	Type	Range	Default
--	Bool	OFF ON 0 1	ON 1

Explanation

When OFF|0 is selected, the screen is locked. At this point, the screen stops refreshing and the measurement speed is improved. You can press **Esc** to unlock the screen.

Return Format

The query returns 0 or 1.

Example

The command below locks the screen.

```
:DISPlay:ENABLE OFF or :DISPlay:ENABLE 0
```

The query below returns 0.

```
:DISPlay:ENABLE?
```

:DISPlay:MSGswitch:STATe

Syntax

```
:DISPlay:MSGswitch:STATe OFF|ON|0|1
:DISPlay:MSGswitch:STATe?
```

Description

Enable or disable the message display.
Query the status of message display.

Parameter

Name	Type	Range	Default
--	Bool	OFF ON 0 1	ON 1

Return Format

The query returns 0 or 1.

Example

The command below disables the message display.

```
:DISPlay:MSGswitch:STATe OFF or :DISPlay:MSGswitch:STATe 0
```

The query below returns 0.

```
:DISPlay:MSGswitch:STATe?
```

:DISPlay:UKEY:STATe

Syntax

```
:DISPlay:UKEY:STATe OFF|ON|0|1
:DISPlay:UKEY:STATe?
```

Description

Enable or disable the display of the UserKey definition in the user interface.
Query whether the UserKey definition is displayed in the user interface.

Parameter

Name	Type	Range	Default
--	Bool	OFF ON 0 1	ON 1

Return Format

The query returns 0 or 1.

Example

The command below enables the display of the UserKey definition in the user interface.

```
:DISPlay:UKEY:STATe ON or :DISPlay:UKEY:STATe 1
```

The query below returns 1.

```
:DISPlay:UKEY:STATe?
```

:DISPlay:WINDow:TRACe:GRATicule:GRID**Syntax**

:DISPlay:WINDow:TRACe:GRATicule:GRID <integer>
 :DISPlay:WINDow:TRACe:GRATicule:GRID?

Description

Set the brightness of the screen grid.
 Query the brightness of the screen grid.

Parameter

Name	Type	Range	Default
<integer>	Integer	0 to 10	3

Return Format

The query returns the brightness of the screen grid in integer.

Example

The command below sets the screen grid brightness to 2.

```
:DISPlay:WINDow:TRACe:GRATicule:GRID 2
```

The query below returns 2.

```
:DISPlay:WINDow:TRACe:GRATicule:GRID?
```

:DISPlay:WINDow:TRACe:X[:SCALe]:SPACing**Syntax**

:DISPlay:WINDow:TRACe:X[:SCALe]:SPACing LINear|LOGarithmic
 :DISPlay:WINDow:TRACe:X[:SCALe]:SPACing?

Description

Set the scale type of X-axis.
 Query the scale type of X-axis.

Parameter

Name	Type	Range	Default
--	Keyword	LINear LOGarithmic	LINear

Explanation

LINear: linear
 LOGarithmic: log

Return Format

The query returns LIN or LOG.

Example

The command below sets the scale type of X-axis to LOG.

```
:DISPlay:WINDow:TRACe:X:SCALe:SPACing LOGarithmic
```

The query below returns LOG.

```
:DISPlay:WINDow:TRACe:X:SCALe:SPACing?
```

:DISPlay:WINDow:TRACe:Y:DLINe

Syntax

```
:DISPlay:WINDow:TRACe:Y:DLINe <ampl>
:DISPlay:WINDow:TRACe:Y:DLINe?
```

Description

Set the position of the display line on the screen and the default unit is dBm.
Query the position of the display line.

Parameter

Name	Type	Range	Default
<ampl>	Consecutive Real Number	The current amplitude range	0 dBm

Explanation

By default, the display line is disabled. When the display line is enabled for the first time, its position is 0 dBm. This parameter is not affected by the preset setting and always uses the last setting.

Return Format

The query returns the position of the display line in scientific notation.

Example

The command below sets the position of the display line to -10 dBm.
:DISPlay:WINDow:TRACe:Y:DLINe -10

The query below returns -1.000000E+01.
:DISPlay:WINDow:TRACe:Y:DLINe?

:DISPlay:WINDow:TRACe:Y:DLINe:STATe

Syntax

```
:DISPlay:WINDow:TRACe:Y:DLINe:STATe OFF|ON|0|1
:DISPlay:WINDow:TRACe:Y:DLINe:STATe?
```

Description

Enable or disable the display line.
Query the status of the display line.

Parameter

Name	Type	Range	Default
--	Bool	OFF ON 0 1	OFF 0

Return Format

The query returns 0 or 1.

Example

The command below enables the display line.
:DISPlay:WINDow:TRACe:Y:DLINe:STATe ON or :DISPlay:WINDow:TRACe:Y:DLINe:STATe 1

The query below returns 1.
:DISPlay:WINDow:TRACe:Y:DLINe:STATe?

:DISPlay:WINDow:TRACe:Y[:SCALe]:NRLevel

Syntax

```
:DISPlay:WINDow:TRACe:Y[:SCALe]:NRLevel <rel_ampl>
:DISPlay:WINDow:TRACe:Y[:SCALe]:NRLevel?
```

Description

Set the reference level of normalization.
Query the reference level of normalization.

Parameter

Name	Type	Range	Default
<rel_ampl>	Consecutive Real Number	-200 dB to 200 dB	0 dB

Explanation

This command changes the reference level of VSWR at the same time.

Return Format

The query returns the reference level of normalization in scientific notation.

Example

The command below sets the reference level of normalization to -20 dB.

```
:DISPlay:WINDow:TRACe:Y:SCALe:NRLevel -20
```

The query below returns -2.000000E+01.

```
:DISPlay:WINDow:TRACe:Y:SCALe:NRLevel?
```

:DISPlay:WINDow:TRACe:Y[:SCALe]:NRPosition

Syntax

```
:DISPlay:WINDow:TRACe:Y[:SCALe]:NRPosition <integer>
:DISPlay:WINDow:TRACe:Y[:SCALe]:NRPosition?
```

Description

Set the reference position of normalization.
Query the reference position of normalization.

Parameter

Name	Type	Range	Default
<integer>	Integer	0% to 100%	100%

Return Format

The query returns the reference position of normalization in scientific notation.

Example

The command below sets the reference position of normalization to 50%.

```
:DISPlay:WINDow:TRACe:Y:SCALe:NRPosition 50
```

The query below returns 5.000000E+01.

```
:DISPlay:WINDow:TRACe:Y:SCALe:NRPosition?
```

:DISPlay:WINDow:TRACe:Y[:SCALe]:PDIVision

Syntax

```
:DISPlay:WINDow:TRACe:Y[:SCALe]:PDIVision <rel_ampl>
:DISPlay:WINDow:TRACe:Y[:SCALe]:PDIVision?
```

Description

Set the Y-axis scale.
Query the Y-axis scale.

Parameter

Name	Type	Range	Default
<rel_ampl>	Consecutive Real Number	0.1 dB to 20 dB	10 dB

Return Format

The query returns the Y-axis scale in scientific notation.

Example

The command below sets the Y-axis scale to 15 dB.
:DISPlay:WINDow:TRACe:Y:SCALe:PDIVision 15

The query below returns 1.500000E+01.
:DISPlay:WINDow:TRACe:Y:SCALe:PDIVision?

:DISPlay:WINDow:TRACe:Y[:SCALe]:RLEVEL

Syntax

```
:DISPlay:WINDow:TRACe:Y[:SCALe]:RLEVEL <ampl>
:DISPlay:WINDow:TRACe:Y[:SCALe]:RLEVEL?
```

Description

Set the reference level.
Query the reference level.

Parameter

Name	Type	Range	Default
<rel_ampl>	Consecutive Real Number	-100 dBm to 20 dBm	0 dBm

Return Format

The query returns the reference level in scientific notation.

Example

The command below sets the reference level to -10 dBm.
:DISPlay:WINDow:TRACe:Y:SCALe:RLEVEL -10

The query below returns -1.000000E+01.
:DISPlay:WINDow:TRACe:Y:SCALe:RLEVEL?

:DISPlay:WINDow:TRACe:Y[:SCALe]:RLEVel:OFFSet

Syntax

```
:DISPlay:WINDow:TRACe:Y[:SCALe]:RLEVel:OFFSet <rel_ampl>
:DISPlay:WINDow:TRACe:Y[:SCALe]:RLEVel:OFFSet?
```

Description

Set the offset of the reference level.
Query the offset of the reference level.

Parameter

Name	Type	Range	Default
<rel_ampl>	Consecutive Real Number	-300 dB to 300 dB	0 dB

Explanation

The offset of the reference level modifies the reference level and amplitude readout of the marker; but does not change the position of the curve.

Return Format

The query returns the offset of the reference level in scientific notation.

Example

The command below sets the offset of the reference level to 10 dB.

```
:DISPlay:WINDow:TRACe:Y:SCALe:RLEVel:OFFSet 10
```

The query below returns 1.000000E+01.

```
:DISPlay:WINDow:TRACe:Y:SCALe:RLEVel:OFFSet?
```

:DISPlay:WINDow:TRACe:Y[:SCALe]:SPACing

Syntax

```
:DISPlay:WINDow:TRACe:Y[:SCALe]:SPACing LINear|LOGarithmic
:DISPlay:WINDow:TRACe:Y[:SCALe]:SPACing?
```

Description

Set the scale type of Y-axis.
Query the scale type of Y-axis.

Parameter

Name	Type	Range	Default
--	Keyword	LINear LOGarithmic	LOGarithmic

Explanation

LINear: linear
LOGarithmic: log

Return Format

The query returns LIN or LOG.

Example

The command below sets the scale type of Y-axis to log.

```
:DISPlay:WINDow:TRACe:Y:SCALe:SPACing LOGarithmic
```

The query below returns LOG.

```
:DISPlay:WINDow:TRACe:Y:SCALe:SPACing?
```

:FETCh Subsystem

Command List:

- ◆ [:FETCh:ACPower?](#)
- ◆ [:FETCh:ACPower:LOWer?](#)
- ◆ [:FETCh:ACPower:MAIN?](#)
- ◆ [:FETCh:ACPower:UPPer?](#)
- ◆ [:FETCh:CHPower?](#)
- ◆ [:FETCh:CHPower:CHPower?](#)
- ◆ [:FETCh:CHPower:DENSity?](#)
- ◆ [:FETCh:CNRatio?](#)
- ◆ [:FETCh:CNRatio:CARRier?](#)
- ◆ [:FETCh:CNRatio:CNRatio?](#)
- ◆ [:FETCh:CNRatio:NOISe?](#)
- ◆ [:FETCh:EBWidth?](#)
- ◆ [:FETCh:HARMonics:AMPLitude:ALL?](#)
- ◆ [:FETCh:HARMonics:AMPLitude? <n>](#)
- ◆ [:FETCh:HARMonics\[:DISTortion\]?](#)
- ◆ [:FETCh:HARMonics:FREQuency:ALL?](#)
- ◆ [:FETCh:HARMonics:FREQuency? <n>](#)
- ◆ [:FETCh:HARMonics:FUNDamental?](#)
- ◆ [:FETCh:OBWidth?](#)
- ◆ [:FETCh:OBWidth:OBWidth?](#)
- ◆ [:FETCh:OBWidth:OBWidth:FERRor?](#)
- ◆ [:FETCh:TOIntercept?](#)
- ◆ [:FETCh:TOIntercept:IP3?](#)
- ◆ [:FETCh:TPOWer?](#)

Explanation:

The :FETCh commands are only available for DSA800E installed with the advanced measurement kit (option).

:FETCh:ACPower?

Syntax

:FETCh:ACPower?

Description

Query the results of adjacent channel power measurement.

Explanation

This command is only available when the adjacent channel power measurement is enabled.

The power unit of the return values is the same with the current Y-axis unit.

This command will select data from the latest measurement results and transmit the data to the output buffer.

Return Format

The query returns 5 values (main channel power, upper channel power as well as the power difference between the upper channel and main channel (in dBc), the lower channel power as well as the power difference between the lower channel and the main channel (in dBc)) in scientific notation (separated by commas).

Example

The query below returns -5.150423E+01,-5.173441E+01, -2.301865E-01,-5.142665E+01,7.757568E-02.

```
:FETCh:ACPower?
```

:FETCh:ACPower:LOWer?

Syntax

:FETCh:ACPower:LOWer?

Description

Query the lower channel power of adjacent channel power measurement.

Explanation

This command is only available when the adjacent channel power measurement is enabled.

The power unit of the return value is the same with the current Y-axis unit.

This command will select data from the latest measurement results and transmit the data to the output buffer.

Return Format

The query returns the lower channel power in scientific notation.

Example

The query below returns -5.142665E+01.

```
:FETCh:ACPower:LOWer?
```

:FETCh:ACPower:MAIN?

Syntax

:FETCh:ACPower:MAIN?

Description

Query the main channel power of adjacent channel power measurement.

Explanation

This command is only available when the adjacent channel power measurement is enabled.

The power unit of the return value is the same with the current Y-axis unit.

This command will select data from the latest measurement results and transmit the data to the output buffer.

Return Format

The query returns the main channel power in scientific notation.

Example

The query below returns -5.150423E+01.

```
:FETCh:ACPower:MAIN?
```

:FETCh:ACPower:UPPer?

Syntax

:FETCh:ACPower:UPPer?

Description

Query the upper channel power of adjacent channel power measurement.

Explanation

This command is only available when the adjacent channel power measurement is enabled.

The power unit of the return value is the same with the current Y-axis unit.

This command will select data from the latest measurement results and transmit the data to the output buffer.

Return Format

The query returns the upper channel power in scientific notation.

Example

The query below returns -5.173441E+01.

```
:FETCh:ACPower:UPPer?
```

:FETCh:CHPower?

Syntax

:FETCh:CHPower?

Description

Query the results of channel power measurement.

Explanation

This command is only available when the channel power measurement is enabled.

The power unit of the return values is the same with the current Y-axis unit.

This command will select data from the latest measurement results and transmit the data to the output buffer.

Return Format

The query returns the channel power and the power spectral density in scientific notation (separated by comma).

Example

The query below returns -1.599480E+01,-7.900511E+01.

```
:FETCh:CHPower?
```

:FETCh:CHPower:CHPower?

Syntax

:FETCh:CHPower:CHPower?

Description

Query the channel power.

Explanation

This command is only available when the channel power measurement is enabled.

The power unit of the return value is the same with the current Y-axis unit.

This command will select data from the latest measurement results and transmit the data to the output buffer.

Return Format

The query returns the channel power in scientific notation.

Example

The query below returns -1.599480E+01.

```
:FETCh:CHPower:CHPower?
```

:FETCh:CHPower:DENSity?

Syntax

:FETCh:CHPower:DENSity?

Description

Query the channel power spectral density.

Explanation

This command is only available when the channel power measurement is enabled.

The power unit of the return value is the same with the current Y-axis unit.

This command will select data from the latest measurement results and transmit the data to the output buffer.

Return Format

The query returns the channel power spectral density in scientific notation.

Example

The query below returns -7.900511E+01.

```
:FETCh:CHPower:DENSity?
```

:FETCh:CNRatio?

Syntax

:FETCh:CNRatio?

Description

Query the results of C/N ratio measurement.

Explanation

This command is only available when the C/N ratio measurement is enabled.

The power unit of the return values is the same with the current Y-axis unit.

This command will select data from the latest measurement results and transmit the data to the output buffer.

Return Format

The query returns the carrier power, noise power and C/N ratio (in dB) in scientific notation (separated by commas).

Example

The query below returns -6.048788E+01,-6.186192E+01,1.374039E+00.

```
:FETCh:CNRatio?
```

:FETCh:CNRatio:CARRier?

Syntax

:FETCh:CNRatio:CARRier?

Description

Query the carrier power.

Explanation

This command is only available when the C/N ratio measurement is enabled.

The power unit of the return value is the same with the current Y-axis unit.

This command will select data from the latest measurement results and transmit the data to the output buffer.

Return Format

The query returns the carrier power in scientific notation.

Example

The query below returns -1.484203E+01.

```
:FETCh:CNRatio:CARRier?
```

:FETCh:CNRatio:CNRatio?

Syntax

:FETCh:CNRatio:CNRatio?

Description

Query the C/N ratio.

Explanation

This command is only available when the C/N ratio measurement is enabled.

This command will select data from the latest measurement results and transmit the data to the output buffer.

Return Format

The query returns the C/N ratio in scientific notation.

Example

The query below returns 8.956909E-02.

```
:FETCh:CNRatio:CNRatio?
```

:FETCh:CNRatio:NOISe?

Syntax

:FETCh:CNRatio:NOISe?

Description

Query the noise power.

Explanation

This command is only available when the C/N ratio measurement is enabled.

The power unit of the return value is the same with the current Y-axis unit.

This command will select data from the latest measurement results and transmit the data to the output buffer.

Return Format

The query returns the noise power in scientific notation.

Example

The query below returns -1.442294E+01.

```
:FETCh:CNRatio:NOISe?
```

:FETCh:EBWidth?

Syntax

:FETCh:EBWidth?

Description

Query the result of emission bandwidth measurement.

Explanation

This command is only available when the emission bandwidth measurement is enabled.

This command will select data from the latest measurement results and transmit the data to the output buffer.

Return Format

The query returns the emission bandwidth in integer and the unit is Hz.

Example

The query below returns 50000.

```
:FETCh:EBWidth?
```

:FETCh:HARMonics:AMPLitude:ALL?**Syntax**

```
:FETCh:HARMonics:AMPLitude:ALL?
```

Description

Query the amplitudes of the first 10 harmonics and the first harmonic is the fundamental waveform.

Explanation

This command is only available when the harmonic distortion measurement is enabled.

The amplitude unit of the return values is the same with the current Y-axis unit.

This command will select data from the latest measurement results and transmit the data to the output buffer.

Return Format

The query returns the amplitudes of the first 10 harmonics in scientific notation (separated by commas). If the number of harmonics under measurement is less than 10, the harmonics that are not measured do not have return values.

Example

The query below returns

```
-1.692102E+01,-6.458423E+01,-7.509421E+01,-7.924328E+01,-7.847027E+01,-7.885457E+01,-7.882358E+01,-7.921457E+01,-7.923057E+01,-7.915358E+01.
```

```
:FETCh:HARMonics:AMPLitude:ALL?
```

:FETCh:HARMonics:AMPLitude? <n>**Syntax**

```
:FETCh:HARMonics:AMPLitude? <n>
```

Description

Query the amplitude of the specified harmonic.

Parameter

Name	Type	Range	Default
<n>	Integer	1 to 10	--

Explanation

This command is only available when the harmonic distortion measurement is enabled.

The amplitude unit of the return value is the same with the current Y-axis unit.

The query returns --- when the harmonic read does not have data.

This command will select data from the latest measurement results and transmit the data to the output buffer.

Return Format

The query returns the amplitude of the specified harmonic in scientific notation.

Example

The query below returns -1.692102E+01.

```
:FETCh:HARMonics:AMPLitude? 1
```

:FETCh:HARMonics[:DIStortion]?

Syntax

`:FETCh:HARMonics[:DIStortion]?`

Description

Query the percentage of the total harmonic distortion.

Explanation

This command is only available when the harmonic distortion measurement is enabled.

This command will select data from the latest measurement results and transmit the data to the output buffer.

Return Format

The query returns the percentage of the total harmonic distortion in scientific notation.

Example

The query below returns 2.490393E+02.

```
:FETCh:HARMonics:DIStortion?
```

:FETCh:HARMonics:FREQuency:ALL?

Syntax

`:FETCh:HARMonics:FREQuency:ALL?`

Description

Query the frequencies of the first 10 harmonics and the first harmonic is the fundamental waveform.

Explanation

This command is only available when the harmonic distortion measurement is enabled.

This command will select data from the latest measurement results and transmit the data to the output buffer.

Return Format

The query returns the frequencies of the first 10 harmonics in integer (separated by commas) and the unit is Hz.

If the number of harmonics under measurement is less than 10, the harmonics that are not measured do not have return values.

Example

The query below returns

```
45500000,91000000,136500000,182000000,227500000,273000000,318500000,364000000,409500000,455000000.
```

```
:FETCh:HARMonics:FREQuency:ALL?
```

:FETCh:HARMonics:FREQuency? <n>

Syntax

:FETCh:HARMonics:FREQuency? <n>

Description

Query the frequency of the specified harmonic.

Parameter

Name	Type	Range	Default
<n>	Integer	1 to 10	--

Explanation

This command is only available when the harmonic distortion measurement is enabled.

The query returns --- when the harmonic read does not have data.

This command will select data from the latest measurement results and transmit the data to the output buffer.

Return Format

The query returns the frequency of the specified harmonic in integer and the unit is Hz.

Example

The query below returns 45500000.

```
:FETCh:HARMonics:FREQuency? 1
```

:FETCh:HARMonics:FUNDamental?

Syntax

:FETCh:HARMonics:FUNDamental?

Description

Query the frequency of the fundamental waveform.

Explanation

This command is only available when the harmonic distortion measurement is enabled.

This command is equivalent to the [:FETCh:HARMonics:FREQuency? 1](#) command.

This command will select data from the latest measurement results and transmit the data to the output buffer.

Return Format

The query returns the frequency of the fundamental waveform in integer and the unit is Hz.

Example

The query below returns 45500000.

```
:FETCh:HARMonics:FUNDamental?
```

:FETCh:OBWidth?

Syntax

:FETCh:OBWidth?

Description

Query the results of occupied bandwidth measurement.

Explanation

This command is only available when the occupied bandwidth measurement is enabled.

This command will select data from the latest measurement results and transmit the data to the output buffer.

Return Format

The query returns the occupied bandwidth (Hz) and the transmit frequency error (Hz) in integer (separated by comma).

Example

The query below returns 1860000,20000.

```
:FETCh:OBWidth?
```

:FETCh:OBWidth:OBWidth?

Syntax

:FETCh:OBWidth:OBWidth?

Description

Query the occupied bandwidth.

Explanation

This command is only available when the occupied bandwidth measurement is enabled.

This command will select data from the latest measurement results and transmit the data to the output buffer.

Return Format

The query returns the occupied bandwidth in integer and the unit is Hz.

Example

The query below returns 1860000.

```
:FETCh:OBWidth:OBWidth?
```

:FETCh:OBWidth:OBWidth:FERRor?

Syntax

:FETCh:OBWidth:OBWidth:FERRor?

Description

Query the transmit frequency error.

Explanation

This command is only available when the occupied bandwidth measurement is enabled.

This command will select data from the latest measurement results and transmit the data to the output buffer.

Return Format

The query returns the transmit frequency error in integer and the unit is Hz.

Example

The query below returns 20000.

```
:FETCh:OBWidth:OBWidth:FERRor?
```

:FETCh:TOIntercept?

Syntax

:FETCh:TOIntercept?

Description

Query the results of TOI measurement.

Explanation

This command is only available when the TOI measurement is enabled.

The amplitude unit of the return values is the same with the current Y-axis unit.

This command will select data from the latest measurement results and transmit the data to the output buffer.

Return Format

The query returns the measurement results of TOI in the following format:

the Base Lower frequency (Hz), amplitude, the Base Upper frequency (Hz), amplitude, the 3rd Order Lower frequency (Hz), amplitude, intercept, the 3rd Order Upper frequency (Hz), amplitude, intercept.

Example

The query below returns

```
1500450000,-8.131735E+01,1500450000,-8.131735E+01,1500450000,-8.131735E+01,-8.131735E+01,1500450000,-8.131735E+01,-8.131735E+01.
```

```
:FETCh:TOIntercept?
```

:FETCh:TOIntercept:IP3?

Syntax

:FETCh:TOIntercept:IP3?

Description

Query the minor one of the intercepts of the Third Order Lower and the Third Order Upper.

Explanation

This command is only available when the TOI measurement is enabled.

This command will select data from the latest measurement results and transmit the data to the output buffer.

Return Format

The query returns the minor one in scientific notation.

Example

The query below returns -8.131735E+01.

```
:FETCh:TOIntercept:IP3?
```

:FETCh:TPOWer?

Syntax

:FETCh:TPOWer?

Description

Query the result of T-power measurement.

Explanation

This command is only available when the T-power measurement is enabled.

The power unit of the return value is the same with the current Y-axis unit.

This command will select data from the latest measurement results and transmit the data to the output buffer.

Return Format

The query returns the T-power measurement result in scientific notation.

Example

The query below returns -1.658941E+01.

```
:FETCh:TPOWer?
```

:FORMat Subsystem

Command List:

- ◆ [:FORMat:BORDER](#)
- ◆ [:FORMat\[:TRACe\]\[:DATA\]](#)

:FORMat:BORDER

Syntax

```
:FORMat:BORDER NORMal|SWAPped
:FORMat:BORDER?
```

Description

Set the byte order of binary data transmission.
Query the byte order of binary data transmission.

Parameter

Name	Type	Range	Default
--	Keyword	NORMal SWAPped	NORMal

Explanation

NORMal: the transmission starts with the MSB (Most Significant Byte) and ends with the LSB (Least Significant Byte).
SWAPped: the transmission starts with the LSB (Least Significant Byte) and ends with the MSB (Most Significant Byte).

Return Format

The query returns NORM or SWAP.

Example

The command below sets the byte order of binary data transmission to NORMal.

```
:FORMat:BORDER NORMal
```

The query below returns NORM.

```
:FORMat:BORDER?
```

:FORMat[:TRACe][:DATA]**Syntax**

```
:FORMat[:TRACe][:DATA] ASCii|REAL[,32]
:FORMat[:TRACe][:DATA]?
```

Description

Set the input/output format of the trace data.
Query the input/output format of the trace data.

Parameter

Name	Type	Range	Default
--	Keyword	ASCii REAL[,32]	ASCii

Explanation

ASCii: the data points are ASCII characters separated by commas.
REAL[,32]: the data points are a 32 bit binary number.

Return Format

The query returns ASCII or REAL,32.

Example

The command below sets the input/output format of the trace data to REAL,32.

```
:FORMat:TRACe:DATA REAL,32
```

The query below returns REAL,32.

```
:FORMat:TRACe:DATA?
```

:HCOPY Subsystem

Command List:

- ◆ [:HCOPY:ABORt](#)
- ◆ [:HCOPY:IMAGe:COLor\[:STATe\]](#)
- ◆ [:HCOPY:IMAGe:FTYPe](#)
- ◆ [:HCOPY:IMAGe:INVert](#)
- ◆ [:HCOPY:IMAGe:PTIMe](#)
- ◆ [:HCOPY:IMAGe:QUALity](#)
- ◆ [:HCOPY\[:IMMediate\]](#)
- ◆ [:HCOPY:PAGE:ORientation](#)
- ◆ [:HCOPY:PAGE:PRINts](#)
- ◆ [:HCOPY:PAGE:SIZE](#)
- ◆ [:HCOPY:RESume](#)

:HCOPY:ABORt

Syntax

:HCOPY:ABORt

Description

Cancel the current print operation.

:HCOPY:IMAGe:COLor[:STATe]

Syntax

:HCOPY:IMAGe:COLor[:STATe] OFF|ON|0|1

:HCOPY:IMAGe:COLor[:STATe]?

Description

Set the print color to gray or color.

Query the print color.

Parameter

Name	Type	Range	Default
--	Bool	OFF ON 0 1	OFF 0

Explanation

OFF|0: gray

ON|1: color

Return Format

The query returns 0 or 1.

Example

The command below sets the print color to gray.

```
:HCOPY:IMAGe:COLor:STATe OFF or :HCOPY:IMAGe:COLor:STATe 0
```

The query below returns 0.

```
:HCOPY:IMAGe:COLor:STATe?
```

:HCOPY:IMAGe:FTYPE

Syntax

```
:HCOPY:IMAGe:FTYPE DEFault|EXIFjpeg
:HCOPY:IMAGe:FTYPE?
```

Description

Set the image type of the print to default or Exif/JPEG.

Parameter

Name	Type	Range	Default
--	Keyword	DEFault EXIFjpeg	DEFault

Return Format

The query returns DEF or EXIF.

Example

The command below sets the image type of the print to Exif/JPEG.

```
:HCOPY:IMAGe:FTYPE EXIFjpeg
```

The query below returns EXIF.

```
:HCOPY:IMAGe:FTYPE?
```

:HCOPY:IMAGe:INVert

Syntax

```
:HCOPY:IMAGe:INVert OFF|ON|0|1
:HCOPY:IMAGe:INVert?
```

Description

Enable or disable inverted print.

Query the status of inverted print.

Parameter

Name	Type	Range	Default
--	Bool	OFF ON 0 1	OFF 0

Explanation

OFF|0: disable inverted print.

ON|1: enable inverted print.

Return Format

The query returns 0 or 1.

Example

The command below enables inverted print.

```
:HCOPY:IMAGe:INVert ON or :HCOPY:IMAGe:INVert 1
```

The query below returns 1.

```
:HCOPY:IMAGe:INVert?
```

:HCOPY:IMAGe:PTIME

Syntax

```
:HCOPY:IMAGe:PTIME OFF|ON|0|1
:HCOPY:IMAGe:PTIME?
```

Description

Enable or disable date print.
Query the status of date print.

Parameter

Name	Type	Range	Default
--	Bool	OFF ON 0 1	OFF 0

Explanation

OFF|0: disable date print.
ON|1: enable date print.

Return Format

The query returns 0 or 1.

Example

The command below enables date print.

```
:HCOPY:IMAGe:PTIME ON or :HCOPY:IMAGe:PTIME 1
```

The query below returns 1.

```
:HCOPY:IMAGe:PTIME?
```

:HCOPY:IMAGe:QUALity

Syntax

```
:HCOPY:IMAGe:QUALity DEFault|NORMal|DRAFT|FINE
:HCOPY:IMAGe:QUALity?
```

Description

Set the print quality.
Query the print quality.

Parameter

Name	Type	Range	Default
--	Keyword	DEFault NORMal DRAFT FINE	DEFault

Explanation

DEFault: default
NORMal: normal
DRAFT: draft
FINE: fine

Return Format

The query returns DEF, NORM, DRAF or FINE.

Example

The command below sets the print quality to draft.

```
:HCOPY:IMAGe:QUALity DRAFt
```

The query below returns DRAF.

```
:HCOPY:IMAGe:QUALity?
```

:HCOPY[:IMMEDIATE]**Syntax**

```
:HCOPY[:IMMEDIATE]
```

Description

Execute the print operation.

:HCOPY:PAGE:ORIENTATION**Syntax**

```
:HCOPY:PAGE:ORIENTATION LANDscape|PORTRait
```

```
:HCOPY:PAGE:ORIENTATION?
```

Description

Set the print orientation to landscape or portrait.

Query the print orientation.

Parameter

Name	Type	Range	Default
--	Keyword	LANDscape PORTRait	LANDscape

Explanation

LANDscape: landscape

PORTRait: portrait

Return Format

The query returns LAND or PORT.

Example

The command below sets the print orientation to portrait.

```
:HCOPY:PAGE:ORIENTATION PORTRait
```

The query below returns PORT.

```
:HCOPY:PAGE:ORIENTATION?
```

:HCOPY:PAGE:PRINTs

Syntax

```
:HCOPY:PAGE:PRINTs <integer>
:HCOPY:PAGE:PRINTs?
```

Description

Set the print copies.
Query the print copies.

Parameter

Name	Type	Range	Default
<integer>	Integer	1 to 999	1

Return Format

The query returns the print copies in integer.

Example

The command below sets the print copies to 10.

```
:HCOPY:PAGE:PRINTs 10
```

The query below returns 10.

```
:HCOPY:PAGE:PRINTs?
```

:HCOPY:PAGE:SIZE

Syntax

```
:HCOPY:PAGE:SIZE DEFault|A4|A5|A6|B5
:HCOPY:PAGE:SIZE?
```

Description

Set the page size of the print.
Query the page size of the print.

Parameter

Name	Type	Range	Default
--	Keyword	DEFault A4 A5 A6 B5	DEFault

Return Format

The query returns DEF, A4, A5, A6 or B5.

Example

The command below sets the page size of the print to A5.

```
:HCOPY:PAGE:SIZE A5
```

The query below returns A5.

```
:HCOPY:PAGE:SIZE?
```

:HCOPY:RESume

Syntax

:HCOPY:RESume

Description

Resume the paused print task.

IEEE 488.2 Common Commands

IEEE 488.2 common commands are used to operate or query the status registers. About the structure of the status registers, please refer to [:STATus Subsystem](#).

Command List:

- ◆ [*CLS](#)
- ◆ [*ESE](#)
- ◆ [*ESR?](#)
- ◆ [*IDN?](#)
- ◆ [*OPC](#)
- ◆ [*RST](#)
- ◆ [*SRE](#)
- ◆ [*STB?](#)
- ◆ [*TRG](#)
- ◆ [*TST?](#)
- ◆ [*WAI](#)

*CLS

Syntax

*CLS

Description

Clear all the event registers and clear the error queue.

*ESE

Syntax

*ESE <value>

*ESE?

Description

Set the enable register for the standard event status register.
Query the enable register for the standard event status register.

Parameter

Name	Type	Range	Default
<value>	Integer	Refer to Explanation	0

Explanation

The bit 2, bit 3, bit 4 and bit 7 are reserved; you can set their values but they will not affect the instrument. The bit 1 and bit 6 are not used and are always treated as 0; therefore, the range of <value> are the decimal numbers corresponding to the binary numbers ranging from 00000000 (0 in decimal) to 11111111 (255 in decimal) and of which the bit 1 and bit 6 are 0.

Return Format

The query returns an integer which equals the sum of the weights of all the bits that have already been set in the register. For example, the query returns 144 if bit 4 (16 in decimal) and bit 7 (128 in decimal) are enabled.

Example

The command below sets the enable register of the standard event status register to 16.

```
*ESE 16
```

The query below returns 16.

```
*ESE?
```

ESR?*Syntax**

```
*ESR?
```

Description

Query and clear the event register for the standard event status register.

Explanation

The bit 1 and bit 6 of the standard event status register are not used and are always treated as 0; therefore, the range of <value> are the decimal numbers corresponding to the binary numbers ranging from 00000000 (0 in decimal) to 11111111 (255 in decimal) and of which the bit 1 and bit 6 are 0.

Return Format

The query returns an integer which equals the sum of the weights of all the bits that have already been set in the register. For example, the query returns 144 if bit 4 (16 in decimal) and bit 7 (128 in decimal) are enabled.

Example

The query below returns 24 (bit 3 and bit 4 have already been set).

```
*ESR?
```

IDN?*Syntax**

```
*IDN?
```

Description

Query the ID string of the instrument.

Return Format

The query returns the ID string in the format below.

Rigol Technologies,<model>,<serial number>,XX.XX.XX.XX.XX

<model>: instrument model

<serial number>: serial number of the instrument

XX.XX.XX.XX.XX: software version of the instrument

Example

The query below returns Rigol Technologies,DSA832E,DSA8A134400008,00.00.00.00.03.

```
*IDN?
```

*OPC

Syntax

*OPC
*OPC?

Description

The *OPC command sets bit 0 of the standard event status register to 1 after the current operation is finished.

The *OPC? command queries whether the current operation is finished.

Return Format

The query returns 1 if the current operation is finished, otherwise returns 0.

*RST

Syntax

*RST

Description

Restore the instrument to its default state.

*SRE

Syntax

*SRE <value>
*SRE?

Description

Set the enable register for the status byte register.

Query the enable register for the status byte register.

Parameter

Name	Type	Range	Default
<value>	Integer	Refer to Explanation	0

Explanation

The bit 0 and bit 1 of the status byte register are not used and are always treated as 0; therefore, the range of <value> are the decimal numbers corresponding to the binary numbers ranging from 00000000 (0 in decimal) to 11111111 (255 in decimal) and of which the bit 0 and bit 1 are 0.

Return Format

The query returns an integer which equals the sum of the weights of all the bits that have already been set in the register. For example, the query returns 144 if bit 4 (16 in decimal) and bit 7 (128 in decimal) are enabled.

Example

The command below sets the enable register of the status byte register to 16.

```
*SRE 16
```

The query below returns 16.

```
*SRE?
```

***STB?**

Syntax

*STB?

Description

Query the event register for the status byte register.

Explanation

The bit 0 and bit 1 of the status byte register are not used and are always treated as 0; therefore, the query returns the decimal numbers corresponding to the binary numbers ranging from 00000000 (0 in decimal) to 11111111 (255 in decimal) and of which the bit 0 and bit 1 are 0.

Return Format

The query returns an integer which equals the sum of the weights of all the bits set in the register. For example, the query returns 144 if bit 4 (16 in decimal) and bit 7 (128 in decimal) are enabled.

Example

The query below returns 24 (bit 3 and bit 4 have already been set).

```
*STB?
```

***TRG**

Syntax

*TRG

Description

Trigger a sweep or measurement immediately.

***TST?**

Syntax

*TST?

Description

Query whether the self-check operation is finished.

***WAI**

Syntax

*WAI

Description

Wait for the operation to finish.

:INITiate Subsystem

Command List:

- ◆ [:INITiate:CONTInuous](#)
- ◆ [:INITiate\[:IMMediate\]](#)
- ◆ [:INITiate:PAUSe*](#)
- ◆ [:INITiate:REStart*](#)
- ◆ [:INITiate:RESume*](#)

Explanation:

Commands marked with "*" are only available for DSA800E installed with the advanced measurement kit (option).

:INITiate:CONTInuous

Syntax

```
:INITiate:CONTInuous OFF|ON|0|1
:INITiate:CONTInuous?
```

Description

In non-measurement state, select continuous (ON|1) or single (OFF|0) sweep. In measurement state, select continuous (ON|1) or single (OFF|0) measurement. Query the sweep or measurement mode.

Parameter

Name	Type	Range	Default
--	Bool	OFF ON 0 1	ON 1

Return Format

The query returns 0 or 1.

Example

The command below sets the instrument to sweep continuously (the instrument is in non-measurement state).

```
:INITiate:CONTInuous ON or :INITiate:CONTInuous 1
```

The query below returns 1.

```
:INITiate:CONTInuous?
```

:INITiate[:IMMediate]

Syntax

:INITiate[:IMMediate]

Description

In non-measurement state, initialize a sweep.
In measurement state, trigger a measurement.

Explanation

The instrument must be in single measurement mode. This command will be ignored if the [:INITiate:CONTinuous](#) command is set to ON or 1.
Use the [:FETCh?](#) command to transmit a measurement result from the internal memory to the output buffer.

:INITiate:PAUSE

Syntax

:INITiate:PAUSE

Description

Switch the measurement state of the instrument from "Wait for Trigger" to "Pause".

Explanation

This command is only available when the measurement function is enabled and continuous measurement mode is selected.

:INITiate:REStart

Syntax

:INITiate:REStart

Description

Restart the current measurement when the instrument is in idle state.

Explanation

This command is only available when the measurement function is enabled.

:INITiate:RESume

Syntax

:INITiate:RESume

Description

Restore the measurement state of the instrument from "Pause" to "Wait for Trigger".

Explanation

This command is only available when the measurement function is enabled and continuous measurement mode is selected.

:INPut Subsystem

Command List:

◆ [:INPut:IMPedance](#)

:INPut:IMPedance

Syntax

:INPut:IMPedance 50|75

:INPut:IMPedance?

Description

Set the input impedance for the voltage-to-power conversion and the unit is Ω .

Query the input impedance for the voltage-to-power conversion.

Parameter

Name	Type	Range	Default
--	Discrete	50 75	50

Explanation

If the output impedance of the system under measurement is 75Ω , you should use a 75Ω to 50Ω adapter (option) supplied by **RIGOL** to connect the spectrum analyzer with the system under test and then set the input impedance of the spectrum analyzer to 75Ω .

Return Format

The query returns 50 or 75.

Example

The command below sets the input impedance to 75Ω .

```
:INPut:IMPedance 75
```

The query below returns 75.

```
:INPut:IMPedance?
```

:MMEMory Subsystem

Command List:

- ◆ [:MMEMory:DELeTe](#)
- ◆ [:MMEMory:DISK:INFormation?](#)
- ◆ [:MMEMory:LOAD:CORRection](#)
- ◆ [:MMEMory:LOAD:LIMit](#)
- ◆ [:MMEMory:LOAD:MTABLE](#)
- ◆ [:MMEMory:LOAD:SETUp](#)
- ◆ [:MMEMory:LOAD:STATe](#)
- ◆ [:MMEMory:LOAD:TRACe](#)
- ◆ [:MMEMory:MOVE](#)
- ◆ [:MMEMory:STORE:CORRection](#)
- ◆ [:MMEMory:STORE:LIMit](#)
- ◆ [:MMEMory:STORE:MTABLE](#)
- ◆ [:MMEMory:STORE:PTABLE](#)
- ◆ [:MMEMory:STORE:RESults](#)
- ◆ [:MMEMory:STORE:SCReen](#)
- ◆ [:MMEMory:STORE:SETUp](#)
- ◆ [:MMEMory:STORE:STATe](#)
- ◆ [:MMEMory:STORE:TRACe](#)

:MMEMory:DELeTe

Syntax

:MMEMory:DELeTe <file_name>

Description

Delete the file with the specified filename.

Parameter

Name	Type	Range	Default
<file_name>	ASCII String	--	--

Explanation

<file_name> should contain the path and the filename; for example, E:\Rigo\Trace1.trc. This operation fails if the file with the specified filename does not exist.

Example

The command below deletes the Trace1.trc file under the Rigo folder in the USB storage device.

```
:MMEMory:DELeTe E:\Rigo\Trace1.trc
```

:MMEMory:DISK:INFormation?

Syntax

:MMEMory:DISK:INFormation?

Description

Query the disk information of the current USB storage device.

Return Format

The query returns the disk information (include the disk name, type, file system, space used and total capacity) in string.

Example

The return values of the query below are as follows.

Disk Name: E
 Type: Mobile Disk
 File System: FAT32
 Space Used: 2.15 MB
 Total Capacity: 3.73 GB

```
:MMEMory:DISK:INFormation?
```

:MMEMory:LOAD:CORRection

Syntax

:MMEMory:LOAD:CORRection ANTenna|CABLe|OTHer|USER,<file_name>

Description

Load the data of the specified file (.cbl) and execute amplitude correction.

Parameter

Name	Type	Range	Default
--	Keyword	ANTenna CABLe OTHer USER	--
<file_name>	ASCII String	--	--

Explanation

<file_name> should contain the path and the filename.
 This operation fails when the specified file does not exist.

Example

The command below loads the 123.cbl file in the D disk and executes amplitude correction.

```
:MMEMory:LOAD:CORRection ANT,D:\Corr0:123.cbl
```

:MMEMory:LOAD:LIMit

Syntax

:MMEMory:LOAD:LIMit <file_name>

Description

Load the edited limit line file (.lim) into the instrument.

Parameter

Name	Type	Range	Default
<file_name>	ASCII String	--	--

Explanation

<file_name> should contain the path and the filename.

This operation fails when the specified file does not exist.

Example

The command below loads the limit line file upp1.lim in the D disk into the instrument.

```
:MMEM:LOAD:LIM D:\Limit1:upp1.lim
```

:MMEMory:LOAD:MTABLE

Syntax

:MMEMory:LOAD:MTABLE <file_name>

Description

Load the stored marker table file (.mkr) into the instrument.

Parameter

Name	Type	Range	Default
<file_name>	ASCII String	--	--

Explanation

<file_name> should contain the path and the filename.

The marker table file can only be stored in external memory and can only be loaded into the instrument from external memory.

This operation fails if the specified file does not exist.

Example

The command below loads the marker table file Mark.mkr in the USB storage device into the instrument.

```
:MMEMory:LOAD:MTABLE E:\Mak.mkr
```

:MMEMory:LOAD:SETUp

Syntax

:MMEMory:LOAD:SETUp <file_name>

Description

Load the specified setup file (.set).

Parameter

Name	Type	Range	Default
<file_name>	ASCII String	--	--

Explanation

<file_name> should contain the path and the filename.

This operation fails if the specified file does not exist.

Example

The command below loads the setup file pf.set in the D disk into the instrument.

```
:MMEMory:LOAD:SETUp D:\Setup0:pf.set
```

:MMEMory:LOAD:STATe

Syntax

:MMEMory:LOAD:STATe 1,<file_name>

Description

Load the specified state file (.sta).

Parameter

Name	Type	Range	Default
<file_name>	ASCII String	--	--

Explanation

<file_name> should contain the path and the filename.

This operation fails if the specified file does not exist.

Example

The command below loads the state file default.sta in the D disk into the instrument.

```
:MMEMory:LOAD:STATe 1,D:\State0:default.sta
```

:MMEMory:LOAD:TRACe

Syntax

:MMEMory:LOAD:TRACe <file_name>

Description

Load the specified trace file (.trc).

Parameter

Name	Type	Range	Default
<file_name>	ASCII String	--	--

Explanation

<file_name> should contain the path and the filename.

This operation fails if the specified file does not exist.

Example

The command below loads the trace file t1.trc in the D disk into the instrument.

```
:MMEMory:LOAD:TRACe D:\Trace0:t1.trc
```

:MMEMory:MOVE

Syntax

:MMEMory:MOVE <file_name1>,<file_name2>

Description

Rename the file specified in <file_name1> as <file_name2>.

Parameter

Name	Type	Range	Default
<file_name1>	ASCII String	--	--
<file_name2>	ASCII String	--	--

Explanation

<file_name1> and <file_name2> should contain the path and the filename.

This operation fails if the specified file does not exist.

Example

The command below rename file1.bmp in the USB storage device as file2.bmp.

```
:MMEM:MOVE E:\file1.bmp, E:\file2.bmp
```

:MMEMory:STORE:CORRection

Syntax

```
:MMEMory:STORE:CORRection ANTenna|CABLe|OTHer|USER,<file_name>
```

Description

Save the amplitude correction data file with the specified filename (.cbl or .csv).

Parameter

Name	Type	Range	Default
--	Keyword	ANTenna CABLe OTHer USER	--
<file_name>	ASCII String	--	--

Explanation

<file_name> should contain the path and the filename.

You can save the amplitude correction file in the D disk or E disk. The .csv format file can only be stored in the E disk.

If the specified file already exists, it will be overwritten.

Example

The command below store the amplitude correction file to the D disk with the filename ANT.cbl.

```
:MMEMory:STORE:CORRection ANT,D:\Corr1:ANT.cbl
```

:MMEMory:STORE:LIMit

Syntax

```
:MMEMory:STORE:LIMit <file_name>
```

Description

Save the limit line currently edited with the specified filename (.lim).

Parameter

Name	Type	Range	Default
<file_name>	ASCII String	--	--

Explanation

<file_name> should contain the path and the filename.

You can save the limit file in the D disk or E disk.

If the specified file already exists, it will be overwritten.

Example

The command below stores the limit line currently edited in the D disk with the filename low.liml.

```
:MMEMory:STORE:LIMit D:\Limit0:low.lim
```

:MMEMory:STORe:MTABLE

Syntax

:MMEMory:STORe:MTABLE <file_name>

Description

Save the marker table in the USB storage device with the specified filename (.mkr or .csv).

Parameter

Name	Type	Range	Default
<file_name>	ASCII String	--	--

Explanation

<file_name> should contain the path and the filename.
If the specified file already exists, it will be overwritten.

Example

The command below stores the marker table to the USB storage device with the filename MAK1.mkr.

```
:MMEMory:STORe:PTABLE E:\MAK1.mkr
```

:MMEMory:STORe:PTABLE

Syntax

:MMEMory:STORe:PTABLE <file_name>

Description

Save the peak table in the USB storage device with the specified filename (.csv).

Parameter

Name	Type	Range	Default
<file_name>	ASCII String	--	--

Explanation

<file_name> should contain the path and the filename.
If the specified file already exists, it will be overwritten.

Example

The command below stores the peak table in the USB storage device with the filename PT1.csv.

```
:MMEMory:STORe:PTABLE E:\PT1.csv
```

:MMEMory:STORe:RESults

Syntax

:MMEMory:STORe:RESults <file_name>

Description

Save the current measurement results in the USB storage device with the specified filename (.csv).

Parameter

Name	Type	Range	Default
<file_name>	ASCII String	--	--

Explanation

<file_name> should contain the path and the filename.

If the specified file already exists, it will be overwritten.

Example

The command below stores the current measurement results in the USB storage device with the filename ACP.csv.

```
:MMEMory:STORe:RESults E:\ACP.csv
```

:MMEMory:STORe:SCREen

Syntax

:MMEMory:STORe:SCREen <file_name>

Description

Save the current screen image in the USB storage device with the specified filename (.bmp).

Parameter

Name	Type	Range	Default
<file_name>	ASCII String	--	--

Explanation

<file_name> should contain the path and the filename.

If the specified file already exists, it will be overwritten.

Example

The command below stores the current screen image in the USB storage device with the filename screen.bmp.

```
:MMEMory:STORe:SCREen E:\screen.bmp
```

:MMEMory:STORe:SETUp

Syntax

:MMEMory:STORe:SETUp <file_name>

Description

Save the current setting with the specified filename (.set).

Parameter

Name	Type	Range	Default
<file_name>	ASCII String	--	--

Explanation

<file_name> should contain the path and the filename.

You can save the setup file in the D disk or E disk.

If the specified file already exists, it will be overwritten.

Example

The command below stores the current setting in the USB storage device with the filename ST1.set.

```
:MMEMory:STORe:SETUp D:\Setup1:ST1.set
```

:MMEMory:STORe:STATe

Syntax

:MMEMory:STORe:STATe 1,<file_name>

Description

Save the current instrument state with the specified filename (.sta).

Parameter

Name	Type	Range	Default
<file_name>	ASCII String	--	--

Explanation

<file_name> should contain the path and the filename.

You can save the state file in the C disk, D disk or E disk.

If the specified file already exists, it will be overwritten.

Example

The command below stores the current instrument state in the USB storage device with the filename state.sta.

```
:MMEMory:STORe:STATe 1,E:\state.sta
```

:MMEMory:STORe:TRACe

Syntax

:MMEMory:STORe:TRACe <label>, <file_name>

Description

Save the specified trace with the specified filename (.trc or .csv).

Parameter

Name	Type	Range	Default
<label>	Keyword	TRACE1 TRACE2 TRACE3 MATH ALL	--
<file_name>	ASCII String	--	--

Explanation

<file_name> should contain the path and the filename.

You can save the trace file in the D disk or E disk. The .csv format file can only be stored in the E disk.

If the specified file already exists, it will be overwritten.

Example

The command below stores trace 1 in the D disk with the filename T1.trc.

```
:MMEMory:STORe:TRACe TRACE1,D:\Trace1:T1.trc
```

:OUTPut Subsystem

Command List:

◆ [:OUTPut\[:STATe\]](#)

:OUTPut[:STATe]

Syntax

:OUTPut[:STATe] OFF|ON|0|1

:OUTPut[:STATe]?

Description

Enable or disable the output of the tracking generator.

Query the on/off status of the tracking generator.

Parameter

Name	Type	Range	Default
--	Bool	OFF ON 0 1	OFF 0

Explanation

This command is only available for DSA832E-TG.

Return Format

The query returns 0 or 1.

Example

The command below enables the output of the tracking generator.

```
:OUTPut:STATe ON or :OUTPut:STATe 1
```

The query below returns 1.

```
:OUTPut:STATe?
```

:READ Subsystem

Both the :READ commands and the :FETCh commands are used to acquire the measurement results. The difference between them lies in that the :FETCh commands acquire the measurement results immediately while the :READ commands start a measurement and return the measurement results after the measurement finishes.

Command List:

- ◆ [:READ:ACPower?](#)
- ◆ [:READ:ACPower:LOWer?](#)
- ◆ [:READ:ACPower:MAIN?](#)
- ◆ [:READ:ACPower:UPPer?](#)
- ◆ [:READ:CHPower?](#)
- ◆ [:READ:CHPower:CHPower?](#)
- ◆ [:READ:CHPower:DENSity?](#)
- ◆ [:READ:CNRatio?](#)
- ◆ [:READ:CNRatio:CARRier?](#)
- ◆ [:READ:CNRatio:CNRatio?](#)
- ◆ [:READ:CNRatio:NOISe?](#)
- ◆ [:READ:EBWidth?](#)
- ◆ [:READ:HARMonics:AMPLitude:ALL?](#)
- ◆ [:READ:HARMonics:AMPLitude? <n>](#)
- ◆ [:READ:HARMonics\[:DISTortion\]?](#)
- ◆ [:READ:HARMonics:FREQuency:ALL?](#)
- ◆ [:READ:HARMonics:FREQuency? <n>](#)
- ◆ [:READ:HARMonics:FUNDamental?](#)
- ◆ [:READ:OBWidth?](#)
- ◆ [:READ:OBWidth:OBWidth?](#)
- ◆ [:READ:OBWidth:OBWidth:FERRor?](#)
- ◆ [:READ:TOIntercept?](#)
- ◆ [:READ:TOIntercept:IP3?](#)
- ◆ [:READ:TPOWER?](#)

Explanation:

The :READ commands are only available for DSA800E installed with the advanced measurement kit (option).

:READ:ACPower?

Syntax

:READ:ACPower?

Description

Execute an adjacent channel power measurement and return the measurement results.

Explanation

The power unit of the return values is the same with the current Y-axis unit.

This command will select data from the latest measurement results and transmit the data to the output buffer.

Return Format

The query returns 5 values (main channel power, upper channel power as well as the power difference between the upper channel and main channel (in dBc), the lower channel power as well as the power difference between the lower channel and the main channel (in dBc)) in scientific notation (separated by commas). For example, -5.150423E+01,-5.173441E+01, -2.301865E-01,-5.142665E+01,7.757568E-02.

:READ:ACPower:LOWer?

Syntax

:READ:ACPower:LOWer?

Description

Execute an adjacent channel power measurement and return the lower channel power.

Explanation

The power unit of the return value is the same with the current Y-axis unit.

This command will select data from the latest measurement results and transmit the data to the output buffer.

Return Format

The query returns the lower channel power in scientific notation. For example, -5.142665E+01.

:READ:ACPower:MAIN?

Syntax

:READ:ACPower:MAIN?

Description

Execute an adjacent channel power measurement and return the main channel power.

Explanation

The power unit of the return value is the same with the current Y-axis unit.

This command will select data from the latest measurement results and transmit the data to the output buffer.

Return Format

The query returns the main channel power in scientific notation. For example, -5.150423E+01.

:READ:ACPower:UPPer?

Syntax

:READ:ACPower:UPPer?

Description

Execute an adjacent channel power measurement and return the upper channel power.

Explanation

The power unit of the return value is the same with the current Y-axis unit.

This command will select data from the latest measurement results and transmit the data to the output buffer.

Return Format

The query returns the upper channel power in scientific notation. For example, -5.173441E+01.

:READ:CHPower?

Syntax

:READ:CHPower?

Description

Execute a channel power measurement and return the measurement results.

Explanation

The power unit of the return values is the same with the current Y-axis unit.

This command will select data from the latest measurement results and transmit the data to the output buffer.

Return Format

The query returns the channel power and the power spectral density in scientific notation (separated by comma). For example, -1.599480E+01,-7.900511E+01.

:READ:CHPower:CHPower?

Syntax

:READ:CHPower:CHPower?

Description

Execute a channel power measurement and return the channel power.

Explanation

The power unit of the return value is the same with the current Y-axis unit.

This command will select data from the latest measurement results and transmit the data to the output buffer.

Return Format

The query returns the channel power in scientific notation. For example, -1.599480E+01.

:READ:CHPower:DENSity?

Syntax

:READ:CHPower:DENSity?

Description

Execute a channel power measurement and return the channel power spectral density.

Explanation

The power unit of the return value is the same with the current Y-axis unit.

This command will select data from the latest measurement results and transmit the data to the output buffer.

Return Format

The query returns the channel power spectral density in scientific notation. For example, -7.900511E+01.

:READ:CNRatio?

Syntax

:READ:CNRatio?

Description

Execute a C/N ratio measurement and return the measurement results.

Explanation

The power unit of the return values is the same with the current Y-axis unit.

This command will select data from the latest measurement results and transmit the data to the output buffer.

Return Format

The query returns the carrier power, noise power and C/N ratio (in dB) in scientific notation (separated by commas).

For example, -6.048788E+01,-6.186192E+01,1.374039E+00.

:READ:CNRatio:CARRier?

Syntax

:READ:CNRatio:CARRier?

Description

Execute a C/N ratio measurement and return the carrier power.

Explanation

The power unit of the return value is the same with the current Y-axis unit.

This command will select data from the latest measurement results and transmit the data to the output buffer.

Return Format

The query returns the carrier power in scientific notation. For example, -1.484203E+01.

:READ:CNRatio:CNRatio?

Syntax

:READ:CNRatio:CNRatio?

Description

Execute a C/N ratio measurement and return the C/N ratio.

Explanation

This command will select data from the latest measurement results and transmit the data to the output buffer.

Return Format

The query returns the C/N ratio in scientific notation. For example, 8.956909E-02.

:READ:CNRatio:NOISe?

Syntax

:READ:CNRatio:NOISe?

Description

Execute a C/N ratio measurement and return the noise power.

Explanation

The power unit of the return value is the same with the current Y-axis unit.

This command will select data from the latest measurement results and transmit the data to the output buffer.

Return Format

The query returns the noise power in scientific notation. For example, -1.442294E+01.

:READ:EBWidth?

Syntax

:READ:EBWidth?

Description

Execute an emission bandwidth measurement and return the measurement result.

Explanation

This command will select data from the latest measurement results and transmit the data to the output buffer.

Return Format

The query returns the emission bandwidth in integer and the unit is Hz. For example, 50000.

:READ:HARMonics:AMPLitude:ALL?

Syntax

:READ:HARMonics:AMPLitude:ALL?

Description

Execute a harmonic distortion measurement and return the amplitudes of the first 10 harmonics.

Explanation

If the number of harmonics under measurement is less than 10, the harmonics that are not measured do not have return values.

The amplitude unit of the return values is the same with the current Y-axis unit.

This command will select data from the latest measurement results and transmit the data to the output buffer.

Return Format

The query returns the amplitudes of the first 10 harmonics in scientific notation (separated by commas).

For example,

-1.692102E+01,-6.458423E+01,-7.509421E+01,-7.924328E+01,-7.847027E+01,-7.885457E+01,-7.882358E+01,-7.921457E+01,-7.923057E+01,-7.915358E+01.

:READ:HARMonics:AMPLitude? <n>

Syntax

:READ:HARMonics:AMPLitude? <n>

Description

Execute a harmonic distortion measurement and return the amplitude of the specified harmonic.

Parameter

Name	Type	Range	Default
<n>	Integer	1 to 10	--

Explanation

The amplitude unit of the return value is the same with the current Y-axis unit.

The query returns --- when the harmonic read does not have data.

This command will select data from the latest measurement results and transmit the data to the output buffer.

Return Format

The query returns the amplitude of the specified harmonic in scientific notation. For example,

-1.692102E+01.

:READ:HARMonics[:DIStortion]?

Syntax

:READ:HARMonics[:DIStortion]?

Description

Execute a harmonic distortion measurement and return the percentage of the total harmonic distortion.

Explanation

This command will select data from the latest measurement results and transmit the data to the output buffer.

Return Format

The query returns the percentage of the total harmonic distortion in scientific notation. For example, 2.490393E+02.

:READ:HARMonics:FREQuency:ALL?

Syntax

:READ:HARMonics:FREQuency:ALL?

Description

Execute a harmonic distortion measurement and return the frequencies of the first 10 harmonics.

Explanation

If the number of harmonics under measurement is less than 10, the harmonics that are not measured do not have return values.

This command will select data from the latest measurement results and transmit the data to the output buffer.

Return Format

The query returns the frequencies in integer (separated by commas) and the unit is Hz.

For example, 45500000,91000000,136500000,182000000,
227500000,273000000,318500000,364000000,409500000,455000000.

:READ:HARMonics:FREQuency? <n>**Syntax**

:READ:HARMonics:FREQuency? <n>

Description

Execute a harmonic distortion measurement and return the frequency of the specified harmonic.

Parameter

Name	Type	Range	Default
<n>	Integer	1 to 10	--

Explanation

The query returns --- when the harmonic read does not have data.

This command will select data from the latest measurement results and transmit the data to the output buffer.

Return Format

The query returns the frequency of the specified harmonic in integer and the unit is Hz. For example, 45500000.

:READ:HARMonics:FUNDamental?**Syntax**

:READ:HARMonics:FUNDamental?

Description

Execute a harmonic distortion measurement and return the frequency of the fundamental waveform.

Explanation

This command is equivalent to the :READ:HARMonics:FREQuency? 1 command.

This command will select data from the latest measurement results and transmit the data to the output buffer.

Return Format

The query returns the frequency of the fundamental waveform in integer and the unit is Hz. For example, 45500000.

:READ:OBWidth?**Syntax**

:READ:OBWidth?

Description

Execute an occupied bandwidth measurement and return the measurement results.

Explanation

This command will select data from the latest measurement results and transmit the data to the output buffer.

Return Format

The query returns the occupied bandwidth (Hz) and the transmit frequency error (Hz) in integer (separated by comma). For example, 1860000,20000.

:READ:OBWidth:OBWidth?

Syntax

:READ:OBWidth:OBWidth?

Description

Execute an occupied bandwidth measurement and return the occupied bandwidth.

Explanation

This command will select data from the latest measurement results and transmit the data to the output buffer.

Return Format

The query returns the occupied bandwidth in integer and the unit is Hz. For example, 1860000.

:READ:OBWidth:OBWidth:FERRor?

Syntax

:READ:OBWidth:OBWidth:FERRor?

Description

Execute an occupied bandwidth measurement and return the transmit frequency error.

Explanation

This command will select data from the latest measurement results and transmit the data to the output buffer.

Return Format

The query returns the transmit frequency error in integer and the unit is Hz. For example, 20000.

:READ:TOIntercept?

Syntax

:READ:TOIntercept?

Description

Execute a TOI measurement and return the measurement results.

Explanation

The power unit of the return value is the same with the current Y-axis unit.

This command will select data from the latest measurement results and transmit the data to the output buffer.

Return Format

The query returns the measurement results of TOI in the following format:

the Base Lower frequency (Hz), amplitude, the Base Upper frequency (Hz), amplitude, the 3rd Order Lower frequency (Hz), amplitude, intercept, the 3rd Order Upper frequency (Hz), amplitude, intercept.

For example,

1500450000,-8.131735E+01,1500450000,-8.131735E+01,1500450000,-8.131735E+01,-8.131735E+01,1500450000,-8.131735E+01,-8.131735E+01.

:READ:TOIntercept:IP3?

Syntax

:READ:TOIntercept:IP3?

Description

Execute a TOI measurement and return the minor one of the intercepts of the 3rd Order Lower and the 3rd Order Upper.

Explanation

This command will select data from the latest measurement results and transmit the data to the output buffer.

Return Format

The query returns the minor one in scientific notation. For example, -8.131735E+01.

:READ:TPOWer?

Syntax

:READ:TPOWer?

Description

Execute a T-power measurement and return the measurement result.

Explanation

The power unit of the return value is the same with the current Y-axis unit.

This command will select data from the latest measurement results and transmit the data to the output buffer.

Return Format

The query returns the T-power measurement result in scientific notation. For example, -1.658941E+01.

[[:SENSe] Subsystem

Command List:

- ◆ [\[:SENSe\]:ACPower:AVERage:COUNT*](#)
- ◆ [\[:SENSe\]:ACPower:AVERage\[:STATe\]*](#)
- ◆ [\[:SENSe\]:ACPower:AVERage:TCONtrol*](#)
- ◆ [\[:SENSe\]:ACPower:BANDwidth:ACHannel*](#)
- ◆ [\[:SENSe\]:ACPower:BANDwidth:INTEgration*](#)
- ◆ [\[:SENSe\]:ACPower:CSPacing*](#)
- ◆ [\[:SENSe\]:BANDwidth:EMIFilter:STATe](#)
- ◆ [\[:SENSe\]:BANDwidth\[:RESolution\]](#)
- ◆ [\[:SENSe\]:BANDwidth\[:RESolution\]:AUTO](#)
- ◆ [\[:SENSe\]:BANDwidth:VIDeo](#)
- ◆ [\[:SENSe\]:BANDwidth:VIDeo:AUTO](#)
- ◆ [\[:SENSe\]:BANDwidth:VIDeo:RATio](#)
- ◆ [\[:SENSe\]:CHPower:AVERage:COUNT*](#)
- ◆ [\[:SENSe\]:CHPower:AVERage\[:STATe\]*](#)
- ◆ [\[:SENSe\]:CHPower:AVERage:TCONtrol*](#)
- ◆ [\[:SENSe\]:CHPower:BANDwidth:INTEgration*](#)
- ◆ [\[:SENSe\]:CHPower:FREQuency:SPAN*](#)
- ◆ [\[:SENSe\]:CNRatio:AVERage:COUNT*](#)
- ◆ [\[:SENSe\]:CNRatio:AVERage\[:STATe\]*](#)
- ◆ [\[:SENSe\]:CNRatio:AVERage:TCONtrol*](#)
- ◆ [\[:SENSe\]:CNRatio:BANDwidth:INTEgration*](#)
- ◆ [\[:SENSe\]:CNRatio:BANDwidth:NOISe*](#)
- ◆ [\[:SENSe\]:CNRatio:OFFSet*](#)
- ◆ [\[:SENSe\]:CORRection:CSET:ALL:DELeTe](#)
- ◆ [\[:SENSe\]:CORRection:CSET:ALL\[:STATe\]](#)
- ◆ [\[:SENSe\]:CORRection:CSET<n>:DATA](#)
- ◆ [\[:SENSe\]:CORRection:CSET<n>:DATA:MERGe](#)
- ◆ [\[:SENSe\]:CORRection:CSET<n>:DELeTe](#)
- ◆ [\[:SENSe\]:CORRection:CSET<n>\[:STATe\]](#)
- ◆ [\[:SENSe\]:CORRection:CSET<n>:X:SPACing](#)
- ◆ [\[:SENSe\]:CORRection:CSET:TABLE:STATe](#)
- ◆ [\[:SENSe\]:DEMod](#)
- ◆ [\[:SENSe\]:DEMod:GAIN:AUTO](#)
- ◆ [\[:SENSe\]:DEMod:GAIN:INCRement](#)
- ◆ [\[:SENSe\]:DEMod:STATe](#)
- ◆ [\[:SENSe\]:DEMod:TIME](#)

- ◆ [\[:SENSe\]:DETEctor\[:FUNction\]](#)
- ◆ [\[:SENSe\]:EBWidth:AVERage:COUNT*](#)
- ◆ [\[:SENSe\]:EBWidth:AVERage\[:STATe\]*](#)
- ◆ [\[:SENSe\]:EBWidth:AVERage:TCONtrol*](#)
- ◆ [\[:SENSe\]:EBWidth:FREQuency:SPAN*](#)
- ◆ [\[:SENSe\]:EBWidth:MAXHold:STATe*](#)
- ◆ [\[:SENSe\]:EBWidth:XDB*](#)
- ◆ [\[:SENSe\]:EXTRef\[:STATe\]?](#)
- ◆ [\[:SENSe\]:FREQuency:CENTer](#)
- ◆ [\[:SENSe\]:FREQuency:CENTer:DOWN](#)
- ◆ [\[:SENSe\]:FREQuency:CENTer:SET:STEP](#)
- ◆ [\[:SENSe\]:FREQuency:CENTer:STEP:AUTO](#)
- ◆ [\[:SENSe\]:FREQuency:CENTer:STEP\[:INCRement\]](#)
- ◆ [\[:SENSe\]:FREQuency:CENTer:UP](#)
- ◆ [\[:SENSe\]:FREQuency:OFFSet](#)
- ◆ [\[:SENSe\]:FREQuency:SPAN](#)
- ◆ [\[:SENSe\]:FREQuency:SPAN:FULL](#)
- ◆ [\[:SENSe\]:FREQuency:SPAN:PREVious](#)
- ◆ [\[:SENSe\]:FREQuency:SPAN:ZIN](#)
- ◆ [\[:SENSe\]:FREQuency:SPAN:ZOUT](#)
- ◆ [\[:SENSe\]:FREQuency:START](#)
- ◆ [\[:SENSe\]:FREQuency:STOP](#)
- ◆ [\[:SENSe\]:HDISt:AVERage:COUNT*](#)
- ◆ [\[:SENSe\]:HDISt:AVERage\[:STATe\]*](#)
- ◆ [\[:SENSe\]:HDISt:AVERage:TCONtrol*](#)
- ◆ [\[:SENSe\]:HDISt:NUMBers*](#)
- ◆ [\[:SENSe\]:HDISt:TIME*](#)
- ◆ [\[:SENSe\]:HDISt:TIME:AUTO\[:STATe\]*](#)
- ◆ [\[:SENSe\]:OBWidth:AVERage:COUNT*](#)
- ◆ [\[:SENSe\]:OBWidth:AVERage\[:STATe\]*](#)
- ◆ [\[:SENSe\]:OBWidth:AVERage:TCONtrol*](#)
- ◆ [\[:SENSe\]:OBWidth:FREQuency:SPAN*](#)
- ◆ [\[:SENSe\]:OBWidth:MAXHold:STATe*](#)
- ◆ [\[:SENSe\]:OBWidth:PERCent*](#)
- ◆ [\[:SENSe\]:POWer:ARANge](#)
- ◆ [\[:SENSe\]:POWer:ASCale](#)
- ◆ [\[:SENSe\]:POWer:ATUNe](#)
- ◆ [\[:SENSe\]:POWer\[:RF\]:ATTenuation](#)
- ◆ [\[:SENSe\]:POWer\[:RF\]:ATTenuation:AUTO](#)

- ◆ [\[:SENSe\]:POWer\[:RF\]:GAIN\[:STATe\]](#)
- ◆ [\[:SENSe\]:POWer\[:RF\]:MIXer:RANGe\[:UPPer\]](#)
- ◆ [\[:SENSe\]:SWEep:COUNT](#)
- ◆ [\[:SENSe\]:SWEep:COUNT:CURRent?](#)
- ◆ [\[:SENSe\]:SWEep:POINts](#)
- ◆ [\[:SENSe\]:SWEep:TIME](#)
- ◆ [\[:SENSe\]:SWEep:TIME:AUTO](#)
- ◆ [\[:SENSe\]:SWEep:TIME:AUTO:RULEs](#)
- ◆ [\[:SENSe\]:TOI:AVERAge:COUNT*](#)
- ◆ [\[:SENSe\]:TOI:AVERAge\[:STATe\]*](#)
- ◆ [\[:SENSe\]:TOI:AVERAge:TCONtrol*](#)
- ◆ [\[:SENSe\]:TOI:FREQuency:SPAN*](#)
- ◆ [\[:SENSe\]:TPOWer:AVERAge:COUNT*](#)
- ◆ [\[:SENSe\]:TPOWer:AVERAge\[:STATe\]*](#)
- ◆ [\[:SENSe\]:TPOWer:AVERAge:TCONtrol*](#)
- ◆ [\[:SENSe\]:TPOWer:LLIMit*](#)
- ◆ [\[:SENSe\]:TPOWer:MODE*](#)
- ◆ [\[:SENSe\]:TPOWer:RLIMit*](#)
- ◆ [\[:SENSe\]:VSWR:FREFlect**](#)
- ◆ [\[:SENSe\]:VSWR:NREFlect**](#)
- ◆ [\[:SENSe\]:VSWR:RESet**](#)
- ◆ [\[:SENSe\]:VSWR:STATe**](#)

Explanation:

Commands marked with "*" are only available for DSA800E installed with the advanced measurement kit (option) and those marked with "**" are only available for DSA800E installed with the VSWR measurement kit (option).

[:SENSe]:ACPower:AVERage:COUNT

Syntax

```
[:SENSe]:ACPower:AVERage:COUNT <integer>
[:SENSe]:ACPower:AVERage:COUNT?
```

Description

Set the number of averages of the adjacent channel power measurement.
Query the number of averages of the adjacent channel power measurement.

Parameter

Name	Type	Range	Default
<integer>	Integer	1 to 1000	10

Explanation

This command is only available when the adjacent channel power function is enabled.

Return Format

The query returns the number of averages in integer.

Example

The command below sets the number of averages to 100.
:SENSe:ACPower:AVERage:COUNT 100

The query below returns 100.
:SENSe:ACPower:AVERage:COUNT?

[:SENSe]:ACPower:AVERage[:STATe]

Syntax

```
[:SENSe]:ACPower:AVERage[:STATe] OFF|ON|0|1
[:SENSe]:ACPower:AVERage[:STATe]?
```

Description

Enable or disable the average measurement function of the adjacent channel power measurement.
Query the status of the average measurement function of the adjacent channel power measurement.

Parameter

Name	Type	Range	Default
--	Bool	OFF ON 0 1	OFF 0

Explanation

This command is only available when the adjacent channel power measurement is enabled.
The number of averages of the average measurement function can be set through the [\[:SENSe\]:ACPower:AVERage:COUNT](#) command.

Return Format

The query returns 0 or 1.

Example

The command below enables the average measurement function.
:SENSe:ACPower:AVERage:STATe ON or :SENSe:ACPower:AVERage:STATe 1

The query below returns 1.
:SENSe:ACPower:AVERage:STATe?

[[:SENSe]:ACPower:AVERage:TCONtrol]

Syntax

```
[[:SENSe]:ACPower:AVERage:TCONtrol EXPonential|REPeat
[:SENSe]:ACPower:AVERage:TCONtrol?
```

Description

Set the average mode of the adjacent channel power measurement.
Query the average mode of the adjacent channel power measurement.

Parameter

Name	Type	Range	Default
--	Keyword	EXPonential REPeat	EXPonential

Explanation

EXPonential: exponential average

REPeat: repeat average

When exponential average is selected, the result is the exponential average of the latest N (specified by the [\[:SENSe\]:ACPower:AVERage:COUNt](#) command) measurement results.

When repeat average is selected, the result is the arithmetic average of the latest N (specified by the [\[:SENSe\]:ACPower:AVERage:COUNt](#) command) measurement results.

This command is only available when the adjacent channel power measurement is enabled.

Return Format

The query returns EXP or REP.

Example

The command below sets the average mode to repeat average.

```
[[:SENSe]:ACPower:AVERage:TCONtrol REPeat
```

The query below returns REP.

```
[[:SENSe]:ACPower:AVERage:TCONtrol?
```

[[:SENSe]:ACPower:BANDwidth:ACHannel]

Syntax

```
[[:SENSe]:ACPower:BANDwidth:ACHannel <freq>
[:SENSe]:ACPower:BANDwidth:ACHannel?
```

Description

Set the adjacent channel bandwidth.
Query the adjacent channel bandwidth.

Parameter

Name	Type	Range	Default
<freq>	Consecutive Real Number	33 Hz to 2.5 GHz	2 MHz

Explanation

This command is only available when the adjacent channel power measurement is enabled.

The adjacent channel bandwidth is related to the main channel bandwidth. Its range is from Main Channel Bandwidth/20 to Main Channel Bandwidth×20.

Return Format

The query returns the adjacent channel bandwidth in integer and the unit is Hz.

Example

The command below sets the adjacent channel bandwidth to 1 MHz.

```
:SENSe:ACPower:BANDwidth:ACHannel 1000000
```

The query below returns 1000000.

```
:SENSe:ACPower:BANDwidth:ACHannel?
```

[[:SENSe]:ACPower:BANDwidth:INTegration**Syntax**

```
[[:SENSe]:ACPower:BANDwidth:INTegration <freq>
```

```
[[:SENSe]:ACPower:BANDwidth:INTegration?
```

Description

Set the main channel bandwidth.

Query the main channel bandwidth.

Parameter

Name	Type	Range	Default
<freq>	Consecutive Real Number	33 Hz to 2.5 GHz	2 MHz

Explanation

This command is only available when the adjacent channel power measurement is enabled.

Return Format

The query returns the main channel bandwidth in integer and the unit is Hz.

Example

The command below sets the main channel bandwidth to 1 MHz.

```
:SENSe:ACPower:BANDwidth:INTegration 1000000
```

The query below returns 1000000.

```
:SENSe:ACPower:BANDwidth:INTegration?
```

[[:SENSe]:ACPower:CSPacing

Syntax

```
[[:SENSe]:ACPower:CSPacing <freq>
[:SENSe]:ACPower:CSPacing?
```

Description

Set the center frequency difference (channel spacing) between the main channel and the adjacent channels. Query the channel spacing.

Parameter

Name	Type	Range	Default
<freq>	Consecutive Real Number	33 Hz to 2.5 GHz	2 MHz

Explanation

This command is only available when the adjacent channel power measurement is enabled.

Return Format

The query returns the channel spacing in integer and the unit is Hz.

Example

The command below sets the channel spacing to 1 MHz.

```
:SENSe:ACPower:CSPacing 1000000
```

The query below returns 1000000.

```
:SENSe:ACPower:CSPacing?
```

[[:SENSe]:BANDwidth:EMIFilter:STATE

Syntax

```
[[:SENSe]:BANDwidth:EMIFilter:STATE OFF|ON|0|1
[:SENSe]:BANDwidth:EMIFilter:STATE?
```

Description

Enable or disable the EMI filter.
Query the status of the EMI filter.

Parameter

Name	Type	Range	Default
--	Bool	OFF ON 0 1	OFF 0

Explanation

ON: select the EMI filter (-6 dB bandwidth).
OFF: select the Gauss filter (-3 dB bandwidth).

Return Format

The query returns 0 or 1.

Example

The command below selects the EMI filter.

```
:SENSe:BANDwidth:EMIFilter:STATE ON or :SENSe:BANDwidth:EMIFilter:STATE 1
```

The query below returns 1.

```
:SENSe:BANDwidth:EMIFilter:STATE?
```

[[:SENSe]:BANDwidth[:RESolution]

Syntax

```
[[:SENSe]:BANDwidth[:RESolution] <freq>
[:SENSe]:BANDwidth[:RESolution]?
```

Description

Set the resolution bandwidth (RBW).
Query the resolution bandwidth.

Parameter

Name	Type	Range	Default
<freq>	Discrete	10 Hz to 1 MHz, at 1-3-10 step	1 MHz

Explanation

When the detector type is Quasi-Peak (refer to the [\[:SENSe\]:DETECTOR\[:FUNCTION\]](#) command) or the filter type is EMI (refer to the [\[:SENSe\]:BANDwidth:EMIFilter:STATE](#) command), the resolution bandwidth could only be 200 Hz, 9 kHz or 120 kHz.

Return Format

The query returns the resolution bandwidth in integer and the unit is Hz.

Example

The command below sets the RBW to 1000 Hz.

```
:SENSe:BANDwidth:RESolution 1000
```

The query below returns 1000.

```
:SENSe:BANDwidth:RESolution?
```

[[:SENSe]:BANDwidth[:RESolution]:AUTO

Syntax

```
[[:SENSe]:BANDwidth[:RESolution]:AUTO OFF|ON|0|1
[:SENSe]:BANDwidth[:RESolution]:AUTO?
```

Description

Enable or disable the auto setting mode of RBW.
Query the status of the auto setting mode of RBW.

Parameter

Name	Type	Range	Default
--	Bool	OFF ON 0 1	ON 1

Explanation

In auto mode, the resolution bandwidth changes with the span (non-zero span).

Return Format

The query returns 0 or 1.

Example

The command below enables the auto setting mode of RBW.

```
:SENSe:BANDwidth:RESolution:AUTO ON or :SENSe:BANDwidth:RESolution:AUTO 1
```

The query below returns 1.

```
:SENSe:BANDwidth:RESolution:AUTO?
```

[[:SENSe]:BANDwidth:VIDeo

Syntax

```
[[:SENSe]:BANDwidth:VIDeo <freq>
[:SENSe]:BANDwidth:VIDeo?
```

Description

Set the video bandwidth (VBW).
Query the video bandwidth.

Parameter

Name	Type	Range	Default
<freq>	Discrete	1 Hz to 3 MHz, at 1-3-10 step	1 MHz

Return Format

The query returns the video bandwidth in integer and the unit is Hz.

Example

The command below sets the video bandwidth to 1000 Hz.

```
:SENSe:BANDwidth:VIDeo 1000
```

The query below returns 1000.

```
:SENSe:BANDwidth:VIDeo?
```

[[:SENSe]:BANDwidth:VIDeo:AUTO

Syntax

```
[[:SENSe]:BANDwidth:VIDeo:AUTO OFF|ON|0|1
[:SENSe]:BANDwidth:VIDeo:AUTO?
```

Description

Enable or disable the auto setting mode of VBW.
Query the status of the auto setting mode of VBW.

Parameter

Name	Type	Range	Default
--	Bool	OFF ON 0 1	ON 1

Return Format

The query returns 0 or 1.

Example

The command below enables the auto setting mode of VBW.

```
:SENSe:BANDwidth:VIDeo:AUTO ON or :SENSe:BANDwidth:VIDeo:AUTO 1
```

The query below returns 1.

```
:SENSe:BANDwidth:VIDeo:AUTO?
```

[:SENSe]:BANDwidth:VIDeo:RATio

Syntax

```
[:SENSe]:BANDwidth:VIDeo:RATio <number>
[:SENSe]:BANDwidth:VIDeo:RATio?
```

Description

Set the V/R ratio, namely the ratio of VBW to RBW.
Query the V/R ratio.

Parameter

Name	Type	Range	Default
<number>	Discrete	0.000001 to 30000, at 1-3-10 step	1

Return Format

The query returns the V/R ratio in scientific notation.

Example

The command below sets the V/R ratio to 0.01.

```
[:SENSe]:BANDwidth:VIDeo:RATio 0.01
```

The query below returns 1.000000E-02.

```
[:SENSe]:BANDwidth:VIDeo:RATio?
```

[:SENSe]:CHPower:AVERage:COUNT

Syntax

```
[:SENSe]:CHPower:AVERage:COUNT <integer>
[:SENSe]:CHPower:AVERage:COUNT?
```

Description

Set the number of averages of the channel power measurement.
Query the number of averages of the channel power measurement.

Parameter

Name	Type	Range	Default
<integer>	Integer	1 to 1000	10

Explanation

This command is only available when the channel power measurement is enabled.

Return Format

The query returns the number of averages in integer.

Example

The command below sets the number of averages to 100.

```
[:SENSe]:CHPower:AVERage:COUNT 100
```

The query below returns 100.

```
[:SENSe]:CHPower:AVERage:COUNT?
```

[[:SENSe]:CHPower:AVERage[:STATe]]

Syntax

```
[[:SENSe]:CHPower:AVERage[:STATe] OFF|ON|0|1
[:SENSe]:CHPower:AVERage[:STATe]?
```

Description

Enable or disable the average measurement function of the channel power measurement.
Query the status of the average measurement function of the channel power measurement.

Parameter

Name	Type	Range	Default
--	Bool	OFF ON 0 1	OFF 0

Explanation

This command is only available when the channel power measurement function is enabled.

Return Format

The query returns 0 or 1.

Example

The command below enables the average measurement function.

```
:SENSe:CHPower:AVERage:STATe ON or :SENSe:CHPower:AVERage:STATe 1
```

The query below returns 1.

```
:SENSe:CHPower:AVERage:STATe?
```

[[:SENSe]:CHPower:AVERage:TCONtrol]

Syntax

```
[[:SENSe]:CHPower:AVERage:TCONtrol EXPonential|REPeat
[:SENSe]:CHPower:AVERage:TCONtrol?
```

Description

Set the average mode of the channel power measurement.
Query the average mode of the channel power measurement.

Parameter

Name	Type	Range	Default
--	Keyword	EXPonential REPeat	EXPonential

Explanation

EXPonential: exponential average

REPeat: repeat average

When exponential average is selected, the result is the exponential average of the latest N (specified by the [\[:SENSe\]:CHPower:AVERage:COUNT](#) command) measurement results.

When repeat average is selected, the result is the arithmetic average of the latest N (specified by the [\[:SENSe\]:CHPower:AVERage:COUNT](#) command) measurement results.

This command is only available when the channel power measurement is enabled.

Return Format

The query returns EXP or REP.

Example

The command below sets the average mode to repeat average.

```
:SENSe:CHPower:AVERage:TCONtrol REPeat
```

The query below returns REP.

```
:SENSe:CHPower:AVERage:TCONtrol?
```

[[:SENSe]:CHPower:BANDwidth:INTegration**Syntax**

```
[[:SENSe]:CHPower:BANDwidth:INTegration <freq>
```

```
[[:SENSe]:CHPower:BANDwidth:INTegration?
```

Description

Set the integration bandwidth of the channel power measurement.

Query the integration bandwidth.

Parameter

Name	Type	Range	Default
<freq>	Consecutive Real Number	100 Hz to 3.2 GHz	2 MHz

Explanation

This command is only available when the channel power measurement is enabled.

Return Format

The query returns the integration bandwidth in integer and the unit is Hz.

Example

The command below sets the integration bandwidth to 1 MHz.

```
:SENSe:CHPower:BANDwidth:INTegration 1000000
```

The query below returns 1000000.

```
:SENSe:CHPower:BANDwidth:INTegration?
```

[[:SENSe]:CHPower:FREQuency:SPAN**Syntax**

```
[[:SENSe]:CHPower:FREQuency:SPAN <freq>
```

```
[[:SENSe]:CHPower:FREQuency:SPAN?
```

Description

Set the channel span of the channel power measurement.

Query the channel span of the channel power measurement.

Parameter

Name	Type	Range	Default
<freq>	Consecutive Real Number	100 Hz to 3.2 GHz	3 MHz

Explanation

This command is only available when the channel power measurement is enabled.

The channel span is related to the integration bandwidth and the range is from integration bandwidth to integration bandwidth×20.

Return Format

The query returns the channel span in integer and the unit is Hz.

Example

The command below sets the channel span to 1 MHz.

```
:SENSe:CHPower:FREQuency:SPAN 1000000
```

The query below returns 1000000.

```
:SENSe:CHPower:FREQuency:SPAN?
```

[[:SENSe]:CNRatio:AVERage:COUNT**Syntax**

```
[[:SENSe]:CNRatio:AVERage:COUNT <integer>
```

```
[[:SENSe]:CNRatio:AVERage:COUNT?
```

Description

Set the number of averages of the C/N ratio measurement.

Query the number of averages of the C/N ratio measurement.

Parameter

Name	Type	Range	Default
<integer>	Integer	1 to 1000	10

Explanation

This command is only available when the C/N ratio measurement is enabled.

Return Format

The query returns the number of averages in integer.

Example

The command below sets the number of averages to 100.

```
:SENSe:CNRatio:AVERage:COUNT 100
```

The query below returns 100.

```
:SENSe:CNRatio:AVERage:COUNT?
```

[[:SENSe]:CNRatio:AVERage[:STATe]]

Syntax

```
[[:SENSe]:CNRatio:AVERage[:STATe] OFF|ON|0|1
[:SENSe]:CNRatio:AVERage[:STATe]?
```

Description

Enable or disable the average measurement function of the C/N ratio measurement.
Query the status of the average measurement function of the C/N ratio measurement.

Parameter

Name	Type	Range	Default
--	Bool	OFF ON 0 1	OFF 0

Explanation

This command is only available when the C/N ratio measurement is enabled.

Return Format

The query returns 0 or 1.

Example

The command below enables the average measurement function.

```
:SENSe:CNRatio:AVERage:STATe ON or :SENSe:CNRatio:AVERage:STATe 1
```

The query below returns 1.

```
:SENSe:CNRatio:AVERage:STATe?
```

[[:SENSe]:CNRatio:AVERage:TCONtrol]

Syntax

```
[[:SENSe]:CNRatio:AVERage:TCONtrol EXPonential|REPeat
[:SENSe]:CNRatio:AVERage:TCONtrol?
```

Description

Set the average mode of the C/N ratio measurement.
Query the average mode of the C/N ratio measurement.

Parameter

Name	Type	Range	Default
--	Keyword	EXPonential REPeat	EXPonential

Explanation

EXPonential: exponential average

REPeat: repeat average

When exponential average is selected, the result is the exponential average of the latest N (specified by the [\[:SENSe\]:CNRatio:AVERage:COUNT](#) command) measurement results.

When repeat average is selected, the result is the arithmetic average of the latest N (specified by the [\[:SENSe\]:CNRatio:AVERage:COUNT](#) command) measurement results.

This command is only available when the C/N ratio measurement is enabled.

Return Format

The query returns EXP or REP.

Example

The command below sets the average mode to repeat average.

```
:SENSe:CNRatio:AVERAge:TCONtrol REPeat
```

The query below returns REP.

```
:SENSe:CNRatio:AVERAge:TCONtrol?
```

[[:SENSe]:CNRatio:BANDwidth:INTegration**Syntax**

```
[[:SENSe]:CNRatio:BANDwidth:INTegration <freq>
```

```
[[:SENSe]:CNRatio:BANDwidth:INTegration?
```

Description

Set the carrier bandwidth.

Query the carrier bandwidth.

Parameter

Name	Type	Range	Default
<freq>	Consecutive Real Number	33 Hz to 2.5 GHz	2 MHz

Explanation

This command is only available when the C/N ratio measurement is enabled.

The Carrier bandwidth is related to the noise bandwidth. Its range is from noise bandwidth/20 to noise bandwidth×20.

Return Format

The query returns the carrier bandwidth in integer and the unit is Hz.

Example

The command below sets the carrier bandwidth to 1 MHz.

```
:SENSe:CNRatio:BANDwidth:INTegration 1000000 or :SENSe:CNRatio:BANDwidth:INTegration 1MHz
```

The query below returns 1000000.

```
:SENSe:CNRatio:BANDwidth:INTegration?
```

[[:SENSe]:CNRatio:BANDwidth:NOISe

Syntax

```
[[:SENSe]:CNRatio:BANDwidth:NOISe <freq>
[:SENSe]:CNRatio:BANDwidth:NOISe?
```

Description

Set the noise bandwidth.
Query the noise bandwidth.

Parameter

Name	Type	Range	Default
<freq>	Consecutive Real Number	33 Hz to 2.5 GHz	2 MHz

Explanation

This command is only available when the C/N ratio measurement is enabled.

Return Format

The query returns the noise bandwidth in integer and the unit is Hz.

Example

The command below sets the noise bandwidth to 1 MHz.

```
:SENSe:CNRatio:BANDwidth:NOISe 1000000
```

The query below returns 1000000.

```
:SENSe:CNRatio:BANDwidth:NOISe?
```

[[:SENSe]:CNRatio:OFFSet

Syntax

```
[[:SENSe]:CNRatio:OFFSet <freq>
[:SENSe]:CNRatio:OFFSet?
```

Description

Set the center frequency difference (offset frequency) between the carrier waveform and the noise.
Query the offset frequency.

Parameter

Name	Type	Range	Default
<freq>	Consecutive Real Number	33 Hz to 2.5 GHz	2 MHz

Explanation

This command is only available when the C/N ratio measurement is enabled.

Return Format

The query returns the offset frequency in integer and the unit is Hz.

Example

The command below sets the offset frequency to 1 MHz.

```
:SENSe:CNRatio:OFFSet 1000000
```

The query below returns 1000000.

```
:SENSe:CNRatio:OFFSet?
```

[[:SENSe]:CORRection:CSET:ALL:DELeTe

Syntax

[[:SENSe]:CORRection:CSET:ALL:DELeTe

Description

Delete all the amplitude correction data.

[[:SENSe]:CORRection:CSET:ALL[:STATe]

Syntax

[[:SENSe]:CORRection:CSET:ALL[:STATe] OFF|ON|0|1
[[:SENSe]:CORRection:CSET:ALL[:STATe]?

Description

Enable or disable the amplitude correction function.
Query the status of the amplitude correction function.

Parameter

Name	Type	Range	Default
--	Bool	OFF ON 0 1	OFF 0

Explanation

When the function is enabled, all the correction settings are enabled and by default, Antenna correction is used.

When the function is disabled, all the correction settings are disabled.

To enable or disable a single correction setting, refer to the [\[:SENSe\]:CORRection:CSET<n>\[:STATe\]](#) command.

Return Format

The query returns 0 or 1.

Example

The comamnd below enables the amplitude correction function.

```
[[:SENSe]:CORRection:CSET:ALL:STATe ON or [[:SENSe]:CORRection:CSET:ALL:STATe 1
```

The query below returns 1.

```
[[:SENSe]:CORRection:CSET:ALL:STATe?
```

[[:SENSe]:CORRection:CSET<n>:DATA

Syntax

```
[[:SENSe]:CORRection:CSET<n>:DATA <freq>,<rel_ampl>{,<freq>,<rel_ampl>}
[:SENSe]:CORRection:CSET<n>:DATA?
```

Description

Create an amplitude correction curve using the specified data.
Query the specified amplitude correction data.

Parameter

Name	Type	Range	Default
<n>	Discrete	1 2 3 4	--
<freq>	Consecutive Real Number	0 Hz to 3.2 GHz	--
<rel_ampl>	Consecutive Real Number	-120 dB to 100 dB	--

Explanation

<n>: 1 denotes Antenna, 2 denotes Cable, 3 denotes Other and 4 denotes User.
The range of the number of points for editing is from 1 to 200.

Return Format

The query returns the specified amplitude correction data in <freq>,<rel_ampl>{,<freq>,<rel_ampl>} format.

Example

The command below creates an amplitude correction curve.

```
:SENSe:CORRection:CSET1:DATA 900E6,0.3,1.0E9,0.35,1.3E9,0.2
```

The query below returns 900000000,0.300000,1000000000,0.350000,1300000000,0.200000.

```
:SENSe:CORRection:CSET1:DATA?
```

[[:SENSe]:CORRection:CSET<n>:DATA:MERGe

Syntax

```
[[:SENSe]:CORRection:CSET<n>:DATA:MERGe <freq>,<rel_ampl>{,<freq>,<rel_ampl>}
```

Description

Add correction data onto the current correction curve.

Parameter

Name	Type	Range	Default
<n>	Discrete	1 2 3 4	--
<freq>	Consecutive Real Number	0 Hz to 3.2 GHz	--
<rel_ampl>	Consecutive Real Number	-120 dB to 100 dB	--

Explanation

<n>: 1 denotes Antenna, 2 denotes Cable, 3 denotes Other and 4 denotes User.
The range of the number of points for editing is from 1 to 200.

Example

The command below adds two points onto the current correction curve.

```
:SENSe:CORRection:CSET1:DATA:MERGe 950E6,0.32,1.4E9,0.1
```

[[:SENSe]:CORRection:CSET<n>:DELeTe

Syntax

```
[[:SENSe]:CORRection:CSET<n>:DELeTe
```

Description

Delete the specified amplitude correction setting.

Parameter

Name	Type	Range	Default
<n>	Discrete	1 2 3 4	--

Explanation

<n>: 1 denotes Antenna, 2 denotes Cable, 3 denotes Other and 4 denotes User.

Example

The command below deletes the Antenna correction setting.

```
:SENSe:CORRection:CSET1:DELeTe
```

[[:SENSe]:CORRection:CSET<n>[:STATe]

Syntax

```
[[:SENSe]:CORRection:CSET<n>[:STATe] OFF|ON|0|1
```

```
[[:SENSe]:CORRection:CSET<n>[:STATe]?
```

Description

Enable or disable the specified amplitude correction function.

Query the status of the specified amplitude correction function.

Parameter

Name	Type	Range	Default
<n>	Discrete	1 2 3 4	--
--	Bool	OFF ON 0 1	OFF 0

Explanation

<n>: 1 denotes Antenna, 2 denotes Cable, 3 denotes Other and 4 denotes User.

Return Format

The query returns 0 or 1.

Example

The command below disables the Antenna amplitude correction function.

```
:SENSe:CORRection:CSET1:STATe OFF or :SENSe:CORRection:CSET1:STATe 0
```

The query below returns 0.

```
:SENSe:CORRection:CSET1:STATe?
```

[[:SENSe]:CORRection:CSET<n>:X:SPACing

Syntax

```
[[:SENSe]:CORRection:CSET<n>:X:SPACing LINear|LOGarithmic
[:SENSe]:CORRection:CSET<n>:X:SPACing?
```

Description

Set the frequency interpolation mode of the amplitude correction.
Query the frequency interpolation mode of the amplitude correction.

Parameter

Name	Type	Range	Default
<n>	Discrete	1 2 3 4	--
--	Keyword	LINear LOGarithmic	LINear

Explanation

<n>: 1 denotes Antenna, 2 denotes Cable, 3 denotes Other and 4 denotes User.
In linear (LINear) mode, the frequency uses a Lin unit and the amplitude uses a Log unit to perform interpolation.
In log (LOGarithmic) mode, both of the frequency and amplitude use a Log unit to perform interpolation.

Return Format

The query returns LIN or LOG.

Example

The command below sets the frequency interpolation mode to linear.
:SENSe:CORRection:CSET1:X:SPACing LINear

The query below returns LIN.
:SENSe:CORRection:CSET1:X:SPACing?

[[:SENSe]:CORRection:CSET:TABLE:STATe

Syntax

```
[[:SENSe]:CORRection:CSET:TABLE:STATe OFF|ON|0|1
[:SENSe]:CORRection:CSET:TABLE:STATe?
```

Description

Enable or disable the correction table.
Query the status of the correction table.

Parameter

Name	Type	Range	Default
--	Bool	OFF ON 0 1	OFF 0

Return Format

The query returns 0 or 1.

Example

The command below enables the correction table.
:SENSe:CORRection:CSET:TABLE:STATe ON or :SENSe:CORRection:CSET:TABLE:STATe 1

The query below returns 1.
:SENSe:CORRection:CSET:TABLE:STATe?

[:SENSe]:DEMod

Syntax

```
[:SENSe]:DEMod AM|FM|OFF
[:SENSe]:DEMod?
```

Description

Set the demodulation type or disable the demodulation.
Query the demodulation type.

Parameter

Name	Type	Range	Default
--	Keyword	AM FM OFF	OFF

Explanation

AM: amplitude modulation
FM: frequency modulation
OFF: off

When AM or FM is selected, the spectrum analyzer enables the demodulation function automatically. At this point, the [\[:SENSe\]:DEMod:STATe?](#) command returns 1.

When OFF is selected (equivalent to the [\[:SENSe\]:DEMod:STATe OFF|0](#) command), the spectrum analyzer disables the demodulation function. At this point, the command [\[:SENSe\]:DEMod:STATe?](#) returns 0.

Return Format

The query returns AM, FM or OFF.

Example

The command below sets the demodulation type to AM.

```
[:SENSe]:DEMod AM
```

The query below returns AM.

```
[:SENSe]:DEMod?
```

[:SENSe]:DEMod:GAIN:AUTO

Syntax

```
[:SENSe]:DEMod:GAIN:AUTO OFF|ON|0|1
[:SENSe]:DEMod:GAIN:AUTO?
```

Description

Enable or disable the auto setting mode of the signal gain.
Query the status of the auto setting mode of the signal gain.

Parameter

Name	Type	Range	Default
--	Bool	OFF ON 0 1	ON 1

Explanation

When the demodulation function is enabled (namely AM or FM is selected), this command is valid.

Return Format

The query returns 0 or 1.

Example

The command below enables the auto setting mode of the signal gain.

```
:SENSe:DEMod:GAIN:AUTO ON or :SENSe:DEMod:GAIN:AUTO 1
```

The query below returns 1.

```
:SENSe:DEMod:GAIN:AUTO?
```

[[:SENSe]:DEMod:GAIN:INCRement**Syntax**

```
[[:SENSe]:DEMod:GAIN:INCRement <integer>
```

```
[[:SENSe]:DEMod:GAIN:INCRement?
```

Description

Set the signal gain.

Query the signal gain.

Parameter

Name	Type	Range	Default
<integer>	Integer	1 to 7	7

Explanation

When the demodulation function is enabled (namely AM or FM is selected), this command is valid.

Return Format

The query returns the signal gain in integer.

Example

The command below sets the signal gain to 4.

```
:SENSe:DEMod:GAIN:INCRement 4
```

The query below returns 4.

```
:SENSe:DEMod:GAIN:INCRement?
```

[:SENSe]:DEMod:STATe

Syntax

```
[:SENSe]:DEMod:STATe OFF|ON|0|1
[:SENSe]:DEMod:STATe?
```

Description

Enable or disable the demodulation function.
Query the status of the demodulation function.

Parameter

Name	Type	Range	Default
--	Bool	OFF ON 0 1	OFF 0

Explanation

When the demodulation function is enabled, AM demodulation is selected by default.

Return Format

The query returns 0 or 1.

Example

The command below enables the demodulation function.

```
:SENSe:DEMod:STATe ON or :SENSe:DEMod:STATe 1
```

The query below returns 1.

```
:SENSe:DEMod:STATe?
```

[:SENSe]:DEMod:TIME

Syntax

```
[:SENSe]:DEMod:TIME <time>
[:SENSe]:DEMod:TIME?
```

Description

Set the demodulation time.
Query the demodulation time.

Parameter

Name	Type	Range	Default
<time>	Consecutive Real Number	5 ms to 1000 s	100 ms

Explanation

When the demodulation function is enabled (namely AM or FM is selected), this command is valid.

Return Format

The query returns the demodulation time in scientific notation and the unit is s.

Example

The command below sets the demodulation time to 500 ms.

```
:SENSe:DEMod:TIME 0.5 or :SENSe:DEMod:TIME 500ms
```

The query below returns 5.000000E-01.

```
:SENSe:DEMod:TIME?
```

[[:SENSe]:DETEctor[:FUNction]]

Syntax

```
[[:SENSe]:DETEctor[:FUNction] NEGative|NORMal|POSitive|RMS|SAMPlE|VAVerage|QPEak
[:SENSe]:DETEctor[:FUNction]?
```

Description

Set the detector type.
Query the detector type.

Parameter

Name	Type	Range	Default
--	Keyword	NEGative NORMal POSitive RMS SAMPlE VAVerage QPEak	POSitive

Explanation

NEGative: negative peak
NORMal: normal detector
POSitive: positive peak
RMS: RMS average
SAMPlE: sample detector
VAVerage: voltage average
QPEak: Quasi-Peak

Return Format

The query returns NEG, NORM, POS, RMS, SAMP, VAV or QPEAK.

Example

The command below sets the detector type to Quasi-Peak.
[:SENSe:DETEctor:FUNCTion QPEak

The query below returns QPEAK.
[:SENSe:DETEctor:FUNCTion?

[[:SENSe]:EBWidth:AVERage:COUNT]

Syntax

```
[[:SENSe]:EBWidth:AVERage:COUNT <integer>
[:SENSe]:EBWidth:AVERage:COUNT?
```

Description

Set the number of averages of the emission bandwidth measurement.
Query the number of averages of the emission bandwidth measurement.

Parameter

Name	Type	Range	Default
<integer>	Integer	1 to 1000	10

Explanation

This command is only available when the emission bandwidth measurement is enabled.

Return Format

The query returns the number of averages in integer.

Example

The command below sets the number of averages to 100.

```
:SENSe:EBWidth:AVERAge:COUnT 100
```

The query below returns 100.

```
:SENSe:EBWidth:AVERAge:COUnT?
```

[[:SENSe]:EBWidth:AVERAge[:STATe]]**Syntax**

```
[[:SENSe]:EBWidth:AVERAge[:STATe] OFF|ON|0|1
```

```
:SENSe]:EBWidth:AVERAge[:STATe]?
```

Description

Enable or disable the average measurement function of the emission bandwidth measurement.

Query the status of the average measurement function of the emission bandwidth measurement.

Parameter

Name	Type	Range	Default
--	Bool	OFF ON 0 1	OFF 0

Explanation

This command is only available when the emission bandwidth measurement is enabled.

Return Format

The query returns 0 or 1.

Example

The command below enables the average measurement function.

```
:SENSe:EBWidth:AVERAge:STATe ON or :SENSe:EBWidth:AVERAge:STATe 1
```

The query below returns 1.

```
:SENSe:EBWidth:AVERAge:STATe?
```

[[:SENSe]:EBWidth:AVERAge:TCONtrol]**Syntax**

```
[[:SENSe]:EBWidth:AVERAge:TCONtrol EXPOnential|REPeat
```

```
:SENSe]:EBWidth:AVERAge:TCONtrol?
```

Description

Set the average mode of the emission bandwidth measurement.

Query the average mode of the emission bandwidth measurement.

Parameter

Name	Type	Range	Default
--	Keyword	EXPOnential REPeat	EXPOnential

Explanation

EXPOnential: exponential average

REPeat: repeat average

When exponential average is selected, the result is the exponential average of the latest N (specified by the

`[[:SENSe]:EBWidth:AVERage:COUNT` command) measurement results.

When repeat average is selected, the result is the arithmetic average of the latest N (specified by the `[[:SENSe]:EBWidth:AVERage:COUNT` command) measurement results.

This command is only available when the emission bandwidth measurement is enabled.

Return Format

The query returns EXP or REP.

Example

The command below sets the average mode to repeat average.

```
:SENSe:EBWidth:AVERage:TCONtrol REPeat
```

The query below returns REP.

```
:SENSe:EBWidth:AVERage:TCONtrol?
```

`[[:SENSe]:EBWidth:FREQuency:SPAN`

Syntax

```
[[:SENSe]:EBWidth:FREQuency:SPAN <freq>
```

```
[[:SENSe]:EBWidth:FREQuency:SPAN?
```

Description

Set the span of the emission bandwidth measurement.

Query the span of the emission bandwidth measurement.

Parameter

Name	Type	Range	Default
<freq>	Consecutive Real Number	100 Hz to 3.2 GHz	2 MHz

Explanation

This command is only available when the emission bandwidth measurement is enabled.

This setting changes the span of the spectrum analyzer.

Return Format

The query returns the span in integer and the unit is Hz.

Example

The command below sets the span to 10 MHz.

```
:SENSe:EBWidth:FREQuency:SPAN 10000000
```

The query below returns 10000000.

```
:SENSe:EBWidth:FREQuency:SPAN?
```

[[:SENSe]:EBWidth:MAXHold:STATe

Syntax

```
[[:SENSe]:EBWidth:MAXHold:STATe OFF|ON|0|1
[:SENSe]:EBWidth:MAXHold:STATe?
```

Description

Enable or disable the Max Hold.
Query the status of the Max Hold.

Parameter

Name	Type	Range	Default
--	Bool	OFF ON 0 1	OFF 0

Explanation

This command is only available when the emission bandwidth measurement is enabled.
When Max Hold is enabled, each measurement result is compared with the previous result and the maximum is displayed.
When Max Hold is disabled, the current measurement result is displayed.
Max Hold and the average measurement function are mutually exclusive and the average measurement function will be automatically disabled when Max Hold is enabled.

Return Format

The query returns 0 or 1.

Example

The command below enables the Max Hold.

```
:SENSe:EBWidth:MAXHold:STATe ON or :SENSe:EBWidth:MAXHold:STATe 1
```

The query below returns 1.

```
:SENSe:EBWidth:MAXHold:STATe?
```

[[:SENSe]:EBWidth:XDB

Syntax

```
[[:SENSe]:EBWidth:XDB <real_amp>
[:SENSe]:EBWidth:XDB?
```

Description

Set the value of X dB of the EBW measurement.
Query the value of X dB of the EBW measurement.

Parameter

Name	Type	Range	Default
<real_amp>	Consecutive Real Number	-100 dB to -0.1 dB	-10 dB

Explanation

This command is only available when the emission bandwidth measurement is enabled.

Return Format

The query returns the value of X dB in scientific notation.

Example

The command below sets the value of X dB to -20 dB.

```
:SENSe:EBWidth:XDB -20
```

The query below returns -2.000000E+01.

```
:SENSe:EBWidth:XDB?
```

[[:SENSe]:EXTRef[:STATe]]?**Syntax**

```
[[:SENSe]:EXTRef[:STATe]]?
```

Description

Query the reference state of the instrument.

Explanation

The query returns 1: the instrument is using external reference oscillator.

The query returns 0: the instrument is using internal reference oscillator.

This command is only available for DSA810/DSA815.

Return Format

The query returns 1 or 0.

[[:SENSe]:FREQuency:CENTer]**Syntax**

```
[[:SENSe]:FREQuency:CENTer <freq>
```

```
[[:SENSe]:FREQuency:CENTer?
```

Description

Set the center frequency.

Query the center frequency.

Parameter

Name	Type	Range	Default
<freq>	Consecutive Real Number	0 Hz to 3.2 GHz	1.6 GHz

Return Format

The query returns the center frequency in integer and the unit is Hz.

Example

The command below sets the center frequency to 1 MHz.

```
:SENSe:FREQuency:CENTer 1000000
```

The query below returns 1000000.

```
:SENSe:FREQuency:CENTer?
```

[[:SENSe]:FREQuency:CENTer:DOWN**Syntax**

[:SENSe]:FREQuency:CENTer:DOWN

Description

Decrease the center frequency at the center frequency step.

[[:SENSe]:FREQuency:CENTer:SET:STEP**Syntax**

[:SENSe]:FREQuency:CENTer:SET:STEP

Description

Set the CF step to the current center frequency.

[[:SENSe]:FREQuency:CENTer:STEP:AUTO**Syntax**

[:SENSe]:FREQuency:CENTer:STEP:AUTO OFF|ON|0|1

[:SENSe]:FREQuency:CENTer:STEP:AUTO?

Description

Enable or disable the auto setting mode of the CF step.

Query the status of the auto setting mode of the CF step.

Parameter

Name	Type	Range	Default
--	Bool	OFF ON 0 1	ON 1

Return Format

The query returns 0 or 1.

Example

The command below enables the auto setting mode.

[:SENSe:FREQuency:CENTer:STEP:AUTO ON or :SENSe:FREQuency:CENTer:STEP:AUTO 1

The query below returns 1.

[:SENSe:FREQuency:CENTer:STEP:AUTO?

[[:SENSe]:FREQuency:CENTer:STEP[:INCRement]]

Syntax

```
[[:SENSe]:FREQuency:CENTer:STEP[:INCRement] <freq>
[:SENSe]:FREQuency:CENTer:STEP[:INCRement]?
```

Description

Set the CF step.
Query the CF step.

Parameter

Name	Type	Range	Default
<freq>	Consecutive Real Number	1 Hz to 3.2 GHz	320 MHz

Return Format

The query returns the CF step in integer and the unit is Hz.

Example

The command below sets the CF step to 100 kHz.

```
:SENSe:FREQuency:CENTer:STEP:INCRement 100000 or :SENSe:FREQuency:CENTer:STEP:INCRement 100KHz
```

The query below returns 100000.

```
:SENSe:FREQuency:CENTer:STEP:INCRement?
```

[[:SENSe]:FREQuency:CENTer:UP

Syntax

```
[[:SENSe]:FREQuency:CENTer:UP
```

Description

Increase the center frequency at the center frequency step.

[[:SENSe]:FREQuency:OFFSet

Syntax

```
[[:SENSe]:FREQuency:OFFSet <freq>
[:SENSe]:FREQuency:OFFSet?
```

Description

Set the frequency offset.
Query the frequency offset.

Parameter

Name	Type	Range	Default
<freq>	Consecutive Real Number	-100 GHz to 100 GHz	0 Hz

Return Format

The query returns the frequency offset in integer and the unit is Hz.

The frequency offset changes the display values of the center frequency, start frequency and stop frequency; but does not affect the hardware setting of the spectrum analyzer.

Example

The command below sets the frequency offset to 1 MHz.

```
:SENSe:FREQuency:OFFSet 1000000
```

The query below returns 1000000.

```
:SENSe:FREQuency:OFFSet?
```

[:SENSe]:FREQuency:SPAN**Syntax**

```
[:SENSe]:FREQuency:SPAN <freq>
```

```
[:SENSe]:FREQuency:SPAN?
```

Description

Set the span.

Query the span.

Parameter

Name	Type	Range	Default
<freq>	Consecutive Real Number	0 Hz to 3.2 GHz	3.2 GHz

Explanation

When the span is set to 0, the instrument enters the zero span mode; the X axis changes from frequency to time and the instrument only displays signals of which the frequency equals the center frequency.

Return Format

The query returns the span in integer and the unit is Hz.

Example

The command below sets the span to 20 MHz.

```
:SENSe:FREQuency:SPAN 20000000
```

The query below returns 20000000.

```
:SENSe:FREQuency:SPAN?
```

[:SENSe]:FREQuency:SPAN:FULL**Syntax**

```
[:SENSe]:FREQuency:SPAN:FULL
```

Description

Set the span to its maximum (full span).

[[:SENSe]:FREQuency:SPAN:PREVious**Syntax**

[:SENSe]:FREQuency:SPAN:PREVious

Description

Set the span to the previous span setting.

[[:SENSe]:FREQuency:SPAN:ZIN**Syntax**

[:SENSe]:FREQuency:SPAN:ZIN

Description

Set the span to half of the current value.

[[:SENSe]:FREQuency:SPAN:ZOUT**Syntax**

[:SENSe]:FREQuency:SPAN:ZOUT

Description

Set the span to twice of the current value.

[[:SENSe]:FREQuency:START**Syntax**

[:SENSe]:FREQuency:START <freq>

[:SENSe]:FREQuency:START?

Description

Set the start frequency.

Query the start frequency.

Parameter

Name	Type	Range	Default
<freq>	Consecutive Real Number	0 Hz to 3.2 GHz	0 Hz

Return Format

The query returns the start frequency in integer and the unit is Hz.

Example

The command below sets the start frequency to 10 MHz.

[:SENSe]:FREQuency:START 10000000

The query below returns 10000000.

[:SENSe]:FREQuency:START?

[[:SENSe]:FREQuency:STOP

Syntax

```
[[:SENSe]:FREQuency:STOP <freq>
[:SENSe]:FREQuency:STOP?
```

Description

Set the stop frequency.
Query the stop frequency.

Parameter

Name	Type	Range	Default
<freq>	Consecutive Real Number	0 Hz to 3.2 GHz	3.2 GHz

Return Format

The query returns the stop frequency in integer and the unit is Hz.

Example

The command below sets the stop frequency to 10 MHz.

```
:SENSe:FREQuency:STOP 10000000
```

The query below returns 10000000.

```
:SENSe:FREQuency:STOP?
```

[[:SENSe]:HDISt:AVERAge:COUNT

Syntax

```
[[:SENSe]:HDISt:AVERAge:COUNT <integer>
[:SENSe]:HDISt:AVERAge:COUNT?
```

Description

Set the number of averages of the harmonic distortion measurement.
Query the number of averages of the harmonic distortion measurement.

Parameter

Name	Type	Range	Default
<integer>	Integer	1 to 1000	10

Explanation

This command is only available when the harmonic distortion measurement is enabled.

Return Format

The query returns the number of averages in integer.

Example

The command below sets the number of averages to 100.

```
:SENSe:HDISt:AVERAge:COUNT 100
```

The query below returns 100.

```
:SENSe:HDISt:AVERAge:COUNT?
```

[[:SENSe]:HDISt:AVERage[:STATe]

Syntax

```
[[:SENSe]:HDISt:AVERage[:STATe] OFF|ON|0|1
[:SENSe]:HDISt:AVERage[:STATe]?
```

Description

Enable or disable the average measurement function of the harmonic distortion measurement.
Query the status of the average measurement function of the harmonic distortion measurement.

Parameter

Name	Type	Range	Default
--	Bool	OFF ON 0 1	OFF 0

Explanation

This command is only available when the harmonic distortion measurement is enabled.

Return Format

The query returns 0 or 1.

Example

The command below enables the average measurement function.

```
:SENSe:HDISt:AVERage:STATe ON or :SENSe:HDISt:AVERage:STATe 1
```

The query below returns 1.

```
:SENSe:HDISt:AVERage:STATe?
```

[[:SENSe]:HDISt:AVERage:TCONtrol

Syntax

```
[[:SENSe]:HDISt:AVERage:TCONtrol EXPonential|REPeat
[:SENSe]:HDISt:AVERage:TCONtrol?
```

Description

Set the average mode of the harmonic distortion measurement.
Query the average mode of the harmonic distortion measurement.

Parameter

Name	Type	Range	Default
--	Keyword	EXPonential REPeat	EXPonential

Explanation

EXPonential: exponential average

REPeat: repeat average

When exponential average is selected, the result is the exponential average of the latest N (specified by the [\[:SENSe\]:HDISt:AVERage:COUNt](#) command) measurement results.

When repeat average is selected, the result is the arithmetic average of the latest N (specified by the [\[:SENSe\]:HDISt:AVERage:COUNt](#) command) measurement results.

This command is only available when the harmonic distortion measurement is enabled.

Return Format

The query returns EXP or REP.

Example

The command below sets the average mode to repeat average.

```
:SENSe:HDISt:AVERAge:TCONtrol REPeat
```

The query below returns REP.

```
:SENSe:HDISt:AVERAge:TCONtrol?
```

[[:SENSe]:HDISt:NUMBers**Syntax**

```
[[:SENSe]:HDISt:NUMBers <integer>
```

```
[[:SENSe]:HDISt:NUMBers?
```

Description

Set the number of the harmonics to be measured.

Query the number of the harmonics to be measured.

Parameter

Name	Type	Range	Default
<integer>	Integer	2 to 10	10

Explanation

This command is only available when the harmonic distortion measurement is enabled.

Return Format

The query returns the number of harmonics in integer.

Example

The command below sets the number of harmonics to 5.

```
:SENSe:HDISt:NUMBers 5
```

The query below returns 5.

```
:SENSe:HDISt:NUMBers?
```

[:SENSe]:HDISt:TIME

Syntax

```
[:SENSe]:HDISt:TIME <time>
[:SENSe]:HDISt:TIME?
```

Description

Set the sweep time of the harmonic distortion measurement.
Query the sweep time of the harmonic distortion measurement.

Parameter

Name	Type	Range	Default
<time>	Consecutive Real Number	20 us to 3.2 ks	16 ms

Explanation

This command is only available when the harmonic distortion measurement is enabled.

Return Format

The query returns the sweep time in scientific notation and the unit is s.

Example

The command below sets the sweep time to 100 ms.

```
[:SENSe]:HDISt:TIME 0.1
```

The query below returns 1.000000E-01.

```
[:SENSe]:HDISt:TIME?
```

[:SENSe]:HDISt:TIME:AUTO[:STATe]

Syntax

```
[:SENSe]:HDISt:TIME:AUTO[:STATe] OFF|ON|0|1
[:SENSe]:HDISt:TIME:AUTO[:STATe]?
```

Description

Enable or disable the auto setting mode of the sweep time of the harmonic distortion measurement.
Query the status of the auto setting mode of the sweep time of the harmonic distortion measurement.

Parameter

Name	Type	Range	Default
--	Bool	OFF ON 0 1	ON 1

Explanation

This command is only available when the harmonic distortion measurement is enabled.
This setting changes the sweep time of the spectrum analyzer.

Return Format

The query returns 0 or 1.

Example

The command below enables the auto setting mode of the sweep time.

```
[:SENSe]:HDISt:TIME:AUTO:STATe ON or :SENSe:HDISt:TIME:AUTO:STATe 1
```

The query below returns 1.

```
[:SENSe]:HDISt:TIME:AUTO:STATe?
```

[[:SENSe]:OBWidth:AVERage:COUNT

Syntax

```
[[:SENSe]:OBWidth:AVERage:COUNT <integer>
[:SENSe]:OBWidth:AVERage:COUNT?
```

Description

Set the number of averages of the occupied bandwidth measurement.
Query the number of averages of the occupied bandwidth measurement.

Parameter

Name	Type	Range	Default
<integer>	Integer	1 to 1000	10

Explanation

This command is only available when the occupied bandwidth measurement is enabled.

Return Format

The query returns the number of averages in integer.

Example

The command below sets the number of averages to 100.

```
[:SENSe:OBWidth:AVERage:COUNT 100
```

The query below returns 100.

```
[:SENSe:OBWidth:AVERage:COUNT?
```

[[:SENSe]:OBWidth:AVERage[:STATe]

Syntax

```
[[:SENSe]:OBWidth:AVERage[:STATe] OFF|ON|0|1
[:SENSe]:OBWidth:AVERage[:STATe]?
```

Description

Enable or disable the average measurement function of the occupied bandwidth measurement.
Query the status of the average measurement function of the occupied bandwidth measurement.

Parameter

Name	Type	Range	Default
--	Bool	OFF ON 0 1	OFF 0

Explanation

This command is only available when the occupied bandwidth measurement is enabled.

Return Format

The query returns 0 or 1.

Example

The command below enables the average measurement function.

```
[:SENSe:OBWidth:AVERage:STATe ON or [:SENSe:OBWidth:AVERage:STATe 1
```

The query below returns 1.

```
[:SENSe:OBWidth:AVERage:STATe?
```

[:SENSe]:OBWidth:AVERage:TCONtrol

Syntax

```
[:SENSe]:OBWidth:AVERage:TCONtrol EXPonential|REPeat
[:SENSe]:OBWidth:AVERage:TCONtrol?
```

Description

Set the average mode of the occupied bandwidth measurement.
Query the average mode of the occupied bandwidth measurement.

Parameter

Name	Type	Range	Default
--	Keyword	EXPonential REPeat	EXPonential

Explanation

EXPonential: exponential average

REPeat: repeat average

When exponential average is selected, the result is the exponential average of the latest N (specified by the [\[:SENSe\]:OBWidth:AVERage:COUNT](#) command) measurement results.

When repeat average is selected, the result is the arithmetic average of the latest N (specified by the [\[:SENSe\]:OBWidth:AVERage:COUNT](#) command) measurement results.

This command is only available when the occupied bandwidth measurement is enabled.

Return Format

The query returns EXP or REP.

Example

The command below sets the average mode to repeat average.

```
[:SENSe]:OBWidth:AVERage:TCONtrol REPeat
```

The query below returns REP.

```
[:SENSe]:OBWidth:AVERage:TCONtrol?
```

[:SENSe]:OBWidth:FREQuency:SPAN

Syntax

```
[:SENSe]:OBWidth:FREQuency:SPAN <freq>
[:SENSe]:OBWidth:FREQuency:SPAN?
```

Description

Set the span of the occupied bandwidth measurement.
Query the span of the occupied bandwidth measurement.

Parameter

Name	Type	Range	Default
<freq>	Consecutive Real Number	100 Hz to 3.2 GHz	2 MHz

Explanation

This command is only available when the occupied bandwidth measurement is enabled.

This setting changes the span of the spectrum analyzer.

Return Format

The query returns the span in integer and the unit is Hz.

Example

The command below sets the span to 1 MHz.

```
:SENSe:OBWidth:FREQuency:SPAN 1000000
```

The query below returns 1000000.

```
:SENSe:OBWidth:FREQuency:SPAN?
```

[[:SENSe]:OBWidth:MAXHold:STATe**Syntax**

```
[[:SENSe]:OBWidth:MAXHold:STATe OFF|ON|0|1
```

```
[[:SENSe]:OBWidth:MAXHold:STATe?
```

Description

Enable or disable the Max Hold of the occupied bandwidth measurement.

Query the status of the Max Hold of the occupied bandwidth measurement.

Parameter

Name	Type	Range	Default
--	Bool	OFF ON 0 1	OFF 0

Explanation

This command is only available when the occupied bandwidth measurement is enabled.

When Max Hold is enabled, each measurement result is compared with the previous result and the maximum is displayed.

When Max Hold is disabled, the current measurement result is displayed.

Max Hold and the average measurement function are mutually exclusive and the average measurement function will be automatically disabled when Max Hold is enabled.

Return Format

The query returns 0 or 1.

Example

The command below enables the Max Hold.

```
:SENSe:OBWidth:MAXHold:STATe ON or :SENSe:OBWidth:MAXHold:STATe 1
```

The query below returns 1.

```
:SENSe:OBWidth:MAXHold:STATe?
```

[[:SENSe]:OBWidth:PERCent

Syntax

```
[[:SENSe]:OBWidth:PERCent <real>
[:SENSe]:OBWidth:PERCent?
```

Description

Set the percentage (power ratio) the signal power takes up in the whole span power.
Query the power ratio of the occupied bandwidth measurement.

Parameter

Name	Type	Range	Default
<real>	Consecutive Real Number	1 to 99.99	99

Explanation

This command is only available when the occupied bandwidth measurement is enabled.
The range (1 to 99.99) of <real> corresponds to the 1% to 99.99% of the instrument setting.

Return Format

The query returns the percentage in scientific notation.

Example

The command below sets the power ratio to 90%.

```
:SENSe:OBWidth:PERCent 90
```

The query below returns 9.000000E+01.

```
:SENSe:OBWidth:PERCent?
```

[[:SENSe]:POWer:ARANge

Syntax

```
[[:SENSe]:POWer:ARANge
```

Description

Execute auto range; namely adjust the amplitude-related parameters within the current span for easy observation of the signal.

[[:SENSe]:POWer:AScale

Syntax

```
[[:SENSe]:POWer:AScale
```

Description

Execute auto scale; namely adjust the reference level and scale automatically to display the peak of the signal in the upmost grid as far as possible for easy observation of the trace.

[[:SENSE]:POWER:ATUNE

Syntax

[[:SENSE]:POWER:ATUNE

Description

Search for signals within the full frequency range and adjust the frequency and amplitude for optimum display effect of the signal.

[[:SENSE]:POWER[:RF]:ATTenuation

Syntax

[[:SENSE]:POWER[:RF]:ATTenuation <rel_amp>

[[:SENSE]:POWER[:RF]:ATTenuation?

Description

Set the attenuation of the RF attenuator.

Query the attenuation of the RF attenuator.

Parameter

Name	Type	Range	Default
<rel_amp>	Integer	0 dB to 30 dB	10 dB

Return Format

The query returns the attenuation in integer and the unit is dB.

Example

The command below sets the attenuation to 20 dB.

```
[[:SENSE]:POWER:RF:ATTenuation 20
```

The query below returns 20.

```
[[:SENSE]:POWER:RF:ATTenuation?
```

[[:SENSe]:POWer[:RF]:ATTenuation:AUTO

Syntax

```
[[:SENSe]:POWer[:RF]:ATTenuation:AUTO OFF|ON|0|1
[:SENSe]:POWer[:RF]:ATTenuation:AUTO?
```

Description

Enable or disable the auto setting mode of the input attenuation.
Query the status of the auto setting mode of the input attenuation.

Parameter

Name	Type	Range	Default
--	Bool	OFF ON 0 1	ON 1

Return Format

The query returns 0 or 1.

Example

The command below disables the auto setting mode of the input attenuation.

```
:SENSe:POWer:RF:ATTenuation:AUTO OFF or :SENSe:POWer:RF:ATTenuation:AUTO 0
```

The query below returns 0.

```
:SENSe:POWer:RF:ATTenuation:AUTO?
```

[[:SENSe]:POWer[:RF]:GAIN[:STATe]

Syntax

```
[[:SENSe]:POWer[:RF]:GAIN[:STATe] OFF|ON|0|1
[:SENSe]:POWer[:RF]:GAIN[:STATe]?
```

Description

Enable or disable the preamplifier.
Query the status of the preamplifier.

Parameter

Name	Type	Range	Default
--	Bool	OFF ON 0 1	OFF 0

Return Format

The query returns 0 or 1.

Example

The command below enables the preamplifier.

```
:SENSe:POWer:RF:GAIN:STATe ON or :SENSe:POWer:RF:GAIN:STATe 1
```

The query below returns 1.

```
:SENSe:POWer:RF:GAIN:STATe?
```

[[:SENSe]:POWer[:RF]:MIXer:RANGe[:UPPer]

Syntax

```
[[:SENSe]:POWer[:RF]:MIXer:RANGe[:UPPer] <ampl>
[:SENSe]:POWer[:RF]:MIXer:RANGe[:UPPer]?
```

Description

Set the maximum power of the input mixer.
Query the maximum power of the input mixer.

Parameter

Name	Type	Range	Default
<ampl>	Integer	-30 dBm to 0 dBm	-10 dBm

Return Format

The query returns the maximum power of the input mixer in scientific notation and the unit is dBm.

Example

The command below sets the maximum power of the input mixer to -20 dBm.

```
:SENSe:POWer:RF:MIXer:RANGe:UPPer -20
```

The query below returns -2.000000E+01.

```
:SENSe:POWer:RF:MIXer:RANGe:UPPer?
```

[[:SENSe]:SWEep:COUNT

Syntax

```
[[:SENSe]:SWEep:COUNT <integer>
[:SENSe]:SWEep:COUNT?
```

Description

Set the number of sweeps for a single sweep.
Query the number of sweeps for a single sweep.

Parameter

Name	Type	Range	Default
<integer>	Integer	1 to 9999	1

Return Format

The query returns the number of sweeps in integer.

Example

The command below sets the number of sweeps to 10.

```
:SENSe:SWEep:COUNT 10
```

The query below returns 10.

```
:SENSe:SWEep:COUNT?
```

[[:SENSE]:SWEep:COUNT:CURRENT?]

Syntax

[[:SENSE]:SWEep:COUNT:CURRENT?

Description

Query the number of sweeps that have been finished in single sweep.

Explanation

The [\[:SENSE\]:SWEep:COUNT?](#) command queries the number of sweeps to be executed in a single sweep. While, this command queries the number of sweeps that have been finished in single sweep.

Return Format

The query returns the number in integer

[[:SENSE]:SWEep:POINTS]

Syntax

[[:SENSE]:SWEep:POINTS <number of points>
[:SENSE]:SWEep:POINTS?

Description

Set the sweep points.
Query the sweep points.

Parameter

Name	Type	Range	Default
<number of points>	Integer	101 to 3001	601

Return Format

The query returns the sweep points in integer.

Example

The command below sets the sweep points to 650.

```
[[:SENSE]:SWEep:POINTS 650
```

The query below returns 650.

```
[[:SENSE]:SWEep:POINTS?
```

[[:SENSe]:SWEep:TIME

Syntax

```
[[:SENSe]:SWEep:TIME <time>
[:SENSe]:SWEep:TIME?
```

Description

Set the sweep time.
Query the sweep time.

Parameter

Name	Type	Range	Default
<time>	Consecutive Real Number	20 us to 3200 s	16 ms

Return Format

The query returns the sweep time in scientific notation and the unit is s.

Example

The command below sets the sweep time to 0.1 s.

```
:SENSe:SWEep:TIME 0.1
```

The query below returns 1.000000E-01.

```
:SENSe:SWEep:TIME?
```

[[:SENSe]:SWEep:TIME:AUTO

Syntax

```
[[:SENSe]:SWEep:TIME:AUTO OFF|ON|0|1
[:SENSe]:SWEep:TIME:AUTO?
```

Description

Enable or disable the auto sweep time.
Query the status of the auto sweep time.

Parameter

Name	Type	Range	Default
--	Bool	OFF ON 0 1	ON 1

Return Format

The query returns 0 or 1.

Example

The command below enables the auto sweep time.

```
:SENSe:SWEep:TIME:AUTO ON or :SENSe:SWEep:TIME:AUTO 1
```

The query below returns 1.

```
:SENSe:SWEep:TIME:AUTO?
```

[[:SENSe]:SWEep:TIME:AUTO:RULEs

Syntax

```
[[:SENSe]:SWEep:TIME:AUTO:RULEs NORMAl|ACCuracy
[:SENSe]:SWEep:TIME:AUTO:RULEs?
```

Description

Set the setting method of the auto sweep time.
Query the setting method of the auto sweep time.

Parameter

Name	Type	Range	Default
--	Keyword	NORMAl ACCuracy	NORMAl

Return Format

The query returns NORM or ACC.

Example

The command below sets the setting method of the auto sweep time to accuracy.
[:SENSe:SWEep:TIME:AUTO:RULEs ACCuracy

The query below returns ACC.
[:SENSe:SWEep:TIME:AUTO:RULEs?

[[:SENSe]:TOI:AVERAge:COUNT

Syntax

```
[[:SENSe]:TOI:AVERAge:COUNT <integer>
[:SENSe]:TOI:AVERAge:COUNT?
```

Description

Set the number of averages of the TOI measurement.
Query the number of averages of the TOI measurement.

Parameter

Name	Type	Range	Default
<integer>	Integer	1 to 1000	10

Explanation

This command is only available when the TOI measurement is enabled.

Return Format

The query returns the number of averages in integer.

Example

The command below sets the number of averages to 100.
[:SENSe:TOI:AVERAge:COUNT 100

The query below returns 100.
[:SENSe:TOI:AVERAge:COUNT?

[[:SENSe]:TOI:AVERage[:STATe]

Syntax

```
[[:SENSe]:TOI:AVERage[:STATe] OFF|ON|0|1
[:SENSe]:TOI:AVERage[:STATe]?
```

Description

Enable or disable the average measurement function of the TOI measurement.
Query the status of the average measurement function of the TOI measurement.

Parameter

Name	Type	Range	Default
--	Bool	OFF ON 0 1	OFF 0

Explanation

This command is only available when the TOI measurement is enabled.

Return Format

The query returns 0 or 1.

Example

The command below enables the average measurement.

```
:SENSe:TOI:AVERage:STATe ON or :SENSe:TOI:AVERage:STATe 1
```

The query below returns 1.

```
:SENSe:TOI:AVERage:STATe?
```

[[:SENSe]:TOI:AVERage:TCONtrol

Syntax

```
[[:SENSe]:TOI:AVERage:TCONtrol EXPonential|REPeat
[:SENSe]:TOI:AVERage:TCONtrol?
```

Description

Set the average mode of the TOI measurement.
Query the average mode of the TOI measurement.

Parameter

Name	Type	Range	Default
--	Keyword	EXPonential REPeat	EXPonential

Explanation

EXPonential: exponential average

REPeat: repeat average

When exponential average is selected, the result is the exponential average of the latest N (specified by the [\[:SENSe\]:TOI:AVERage:COUNt](#) command) measurement results.

When repeat average is selected, the result is the arithmetic average of the latest N (specified by the [\[:SENSe\]:TOI:AVERage:COUNt](#) command) measurement results.

This command is only available when the TOI measurement is enabled.

Return Format

The query returns EXP or REP.

Example

The command below sets the average mode to repeat average.

```
:SENSe:TOI:AVERAge:TCONtrol REPeat
```

The query below returns REP.

```
:SENSe:TOI:AVERAge:TCONtrol?
```

[[:SENSe]:TOI:FREQuency:SPAN**Syntax**

```
[[:SENSe]:TOI:FREQuency:SPAN <freq>
```

```
[[:SENSe]:TOI:FREQuency:SPAN?
```

Description

Set the span of the TOI measurement.

Query the span of the TOI measurement.

Parameter

Name	Type	Range	Default
<freq>	Consecutive Real Number	100 Hz to 3.2 GHz	2 MHz

Explanation

This command is only available when the TOI measurement is enabled.

This setting changes the span of the spectrum analyzer.

Return Format

The query returns the span in integer and the unit is Hz.

Example

The command below sets the span to 1 MHz.

```
:SENSe:TOI:FREQuency:SPAN 1000000
```

The query below returns 1000000.

```
:SENSe:TOI:FREQuency:SPAN?
```

[[:SENSe]:TPOWer:AVERage:COUNT

Syntax

```
[[:SENSe]:TPOWer:AVERage:COUNT <integer>
[:SENSe]:TPOWer:AVERage:COUNT?
```

Description

Set the number of averages of the T-power measurement.
Query the number of averages of the T-power measurement.

Parameter

Name	Type	Range	Default
<integer>	Integer	1 to 1000	10

Explanation

This command is only available when the T-power measurement is enabled.

Return Format

The query returns the number of averages in integer.

Example

The command below sets the number of averages to 100.

```
[[:SENSe]:TPOWer:AVERage:COUNT 100
```

The query below returns 100.

```
[[:SENSe]:TPOWer:AVERage:COUNT?
```

[[:SENSe]:TPOWer:AVERage[:STATe]

Syntax

```
[[:SENSe]:TPOWer:AVERage[:STATe] OFF|ON|0|1
[:SENSe]:TPOWer:AVERage[:STATe]?
```

Description

Enable or disable the average measurement function of the T-power measurement.
Query the status of the average measurement function of the T-power measurement.

Parameter

Name	Type	Range	Default
--	Bool	OFF ON 0 1	OFF 0

Explanation

This command is only available when the T-power measurement is enabled.

Return Format

The query returns 0 or 1.

Example

The command below enables the average measurement.

```
[[:SENSe]:TPOWer:AVERage:STATe ON or [[:SENSe]:TPOWer:AVERage:STATe 1
```

The query below returns 1.

```
[[:SENSe]:TPOWer:AVERage:STATe?
```

[:SENSe]:TPOWer:AVERAge:TCONtrol

Syntax

```
[:SENSe]:TPOWer:AVERAge:TCONtrol EXPonential|REPeat
[:SENSe]:TPOWer:AVERAge:TCONtrol?
```

Description

Set the average mode of the T-power measurement.
Query the average mode of the T-power measurement.

Parameter

Name	Type	Range	Default
--	Keyword	EXPonential REPeat	EXPonential

Explanation

EXPonential: exponential average

REPeat: repeat average

When exponential average is selected, the result is the exponential average of the latest N (specified by the [\[:SENSe\]:TPOWer:AVERAge:COUNt](#) command) measurement results.

When repeat average is selected, the result is the arithmetic average of the latest N (specified by the [\[:SENSe\]:TPOWer:AVERAge:COUNt](#) command) measurement results.

This command is only available when the T-power measurement is enabled.

Return Format

The query returns EXP or REP.

Example

The command below sets the average mode to repeat average.

```
[:SENSe]:TPOWer:AVERAge:TCONtrol REPeat
```

The query below returns REP.

```
[:SENSe]:TPOWer:AVERAge:TCONtrol?
```

[:SENSe]:TPOWer:LLIMit

Syntax

```
[:SENSe]:TPOWer:LLIMit <time>
[:SENSe]:TPOWer:LLIMit?
```

Description

Set the start line of the T-power measurement.
Query the start line of the T-power measurement.

Parameter

Name	Type	Range	Default
<time>	Consecutive Real Number	0 us to the stop line	0 us

Explanation

This command is only available when the T-power measurement is enabled.

Return Format

The query returns the start line in scientific notation and the unit is s.

Example

The command below sets the start line to 5 ms.

```
:SENSe:TPOWer:LLIMit 0.005
```

The query below returns 5.000000E-03.

```
:SENSe:TPOWer:LLIMit?
```

[[:SENSe]:TPOWer:MODE**Syntax**

```
[[:SENSe]:TPOWer:MODE AVERAge|PEAK|RMS
```

```
[[:SENSe]:TPOWer:MODE?
```

Description

Set the power type of the T-power measurement.

Query the power type of the T-power measurement.

Parameter

Name	Type	Range	Default
--	Keyword	AVERAge PEAK RMS	PEAK

Explanation

AVERAge: average power

PEAK: peak power

RMS: RMS power

This command is only available when the T-power measurement is enabled.

Return Format

The query returns AVER, PEAK or RMS.

Example

The command below sets the power type to average power.

```
:SENSe:TPOWer:MODE AVERAge
```

The query below returns AVER.

```
:SENSe:TPOWer:MODE?
```

[[:SENSe]:TPOWer:RLIMit

Syntax

```
[[:SENSe]:TPOWer:RLIMit <time>
[:SENSe]:TPOWer:RLIMit?
```

Description

Set the stop line of the T-power measurement.
Query the stop line of the T-power measurement.

Parameter

Name	Type	Range	Default
<time>	Consecutive Real Number	Start line to the sweep time	50 ms

Explanation

This command is only available when the T-power measurement is enabled.

Return Format

The query returns the stop line in scientific notation and the unit is s.

Example

The command below sets the stop line to 10 ms.

```
[[:SENSe]:TPOWer:RLIMit 0.01
```

The query below returns 1.000000E-02.

```
[[:SENSe]:TPOWer:RLIMit?
```

[[:SENSe]:VSWR:FREFlect

Syntax

```
[[:SENSe]:VSWR:FREFlect
```

Description

The spectrum analyzer executes the first measurement (with the device under test disconnected) of the VSWR measurement.

Explanation

This command is only available when the VSWR measurement is enabled.
Disconnect the device under test before sending this command.

[[:SENSe]:VSWR:NREFlect

Syntax

```
[[:SENSe]:VSWR: NREFlect
```

Description

The spectrum analyzer executes the second measurement of the VSWR measurement.

Explanation

This command is only available when the VSWR measurement is enabled.
Disconnect the device under test and send the [\[:SENSe\]:VSWR:FREFlect](#) command; then connect the the device under test and send this command.

[[:SENSe]:VSWR:RESet**Syntax**

[:SENSe]:VSWR:RESet

Description

Restore the parameters of the VSWR measurement to their initial states.

[[:SENSe]:VSWR:STATe**Syntax**

[:SENSe]:VSWR:STATe OFF|ON|0|1

[:SENSe]:VSWR:STATe?

Description

Enable or disable the VSWR measurement.

Query the status of the VSWR measurement.

Parameter

Name	Type	Range	Default
--	Bool	OFF ON 0 1	OFF 0

Return Format

The query returns 0 or 1.

Example

The command below enables the VSWR measurement.

[:SENSe]:VSWR:STATe ON or :SENSe:VSWR:STATe 1

The query below returns 1.

[:SENSe]:VSWR:STATe?

:SOURce Subsystem

Command List:

- ◆ [:SOURce:CORRection:OFFSet](#)
- ◆ [:SOURce:POWer:LEVel:IMMEDIATE:AMPLitude](#)
- ◆ [:SOURce:TRACe:REF:STATe](#)
- ◆ [:SOURce:TRACe:STORref](#)

Explanation:

The :SOURce commands are only available for DSA832E-TG.

:SOURce:CORRection:OFFSet

Syntax

```
:SOURce:CORRection:OFFSet <rel_ampl>
:SOURce:CORRection:OFFSet?
```

Description

Set the offset of the output amplitude of the tracking generator.
Query the offset of the output amplitude of the tracking generator.

Parameter

Name	Type	Range	Default
<rel_ampl>	Integer	-200 dB to 200 dB	0 dB

Return Format

The query returns the offset in scientific notation.
The amplitude offset changes the power readout of the tracking generator but does not change the actual output power of the tracking generator.

Example

The command below sets the offset to 10 dB.

```
:SOURce:CORRection:OFFSet 10
```

The query below returns 1.000000E+01.

```
:SOURce:CORRection:OFFSet?
```

:SOURce:POWer:LEVel:IMMediate:AMPLitude

Syntax

```
:SOURce:POWer:LEVel:IMMediate:AMPLitude <ampl>
:SOURce:POWer:LEVel:IMMediate:AMPLitude?
```

Description

Set the output amplitude of the tracking generator in fixed power output mode.
Query the output amplitude of the tracking generator in fixed power output mode.

Parameter

Name	Type	Range	Default
<ampl>	Integer	-40 dBm to 0 dBm	-20 dBm

Return Format

The query returns the output amplitude in scientific notation.

Example

The command below sets the output amplitude to -10 dBm.

```
:SOURce:POWer:LEVel:IMMediate:AMPLitude -10
```

The query below returns -1.000000E+01.

```
:SOURce:POWer:LEVel:IMMediate:AMPLitude?
```

:SOURce:TRACe:REF:STATe

Syntax

```
:SOURce:TRACe:REF:STATe OFF|ON|0|1
:SOURce:TRACe:REF:STATe?
```

Description

Set whether to display the reference trace of normalization.
Query whether to display the reference trace of normalization.

Parameter

Name	Type	Range	Default
--	Bool	OFF ON 0 1	OFF 0

Explanation

This command is only available when the normalization is enabled.

Return Format

The query returns 0 or 1.

Example

The command below enables the reference trace.

```
:SOURce:TRACe:REF:STATe ON or :SOURce:TRACe:REF:STATe 1
```

The query below returns 1.

```
:SOURce:TRACe:REF:STATe?
```

:SOURce:TRACe:STORref**Syntax**

:SOURce:TRACe:STORref

Description

Save the reference trace of normalization.

:STATus Subsystem

The :STATus command system and [IEEE 488.2 Common Commands](#) are used to operate and query the status registers. The structure of the status registers, including Questionable Status Register, Operation Status Register, Standard Event Status Register, Status Byte Register and Error Queue, is shown below. The :STATus commands are used to set and query the Questionable Status Register and Operation Status Register. IEEE488.2 common commands are used to operate the Standard Event Status Register and Status Byte Register. The [:SYSTem:ERRor\[:NEXT\]?](#) command is used to query and delete the error messages in the error queue.

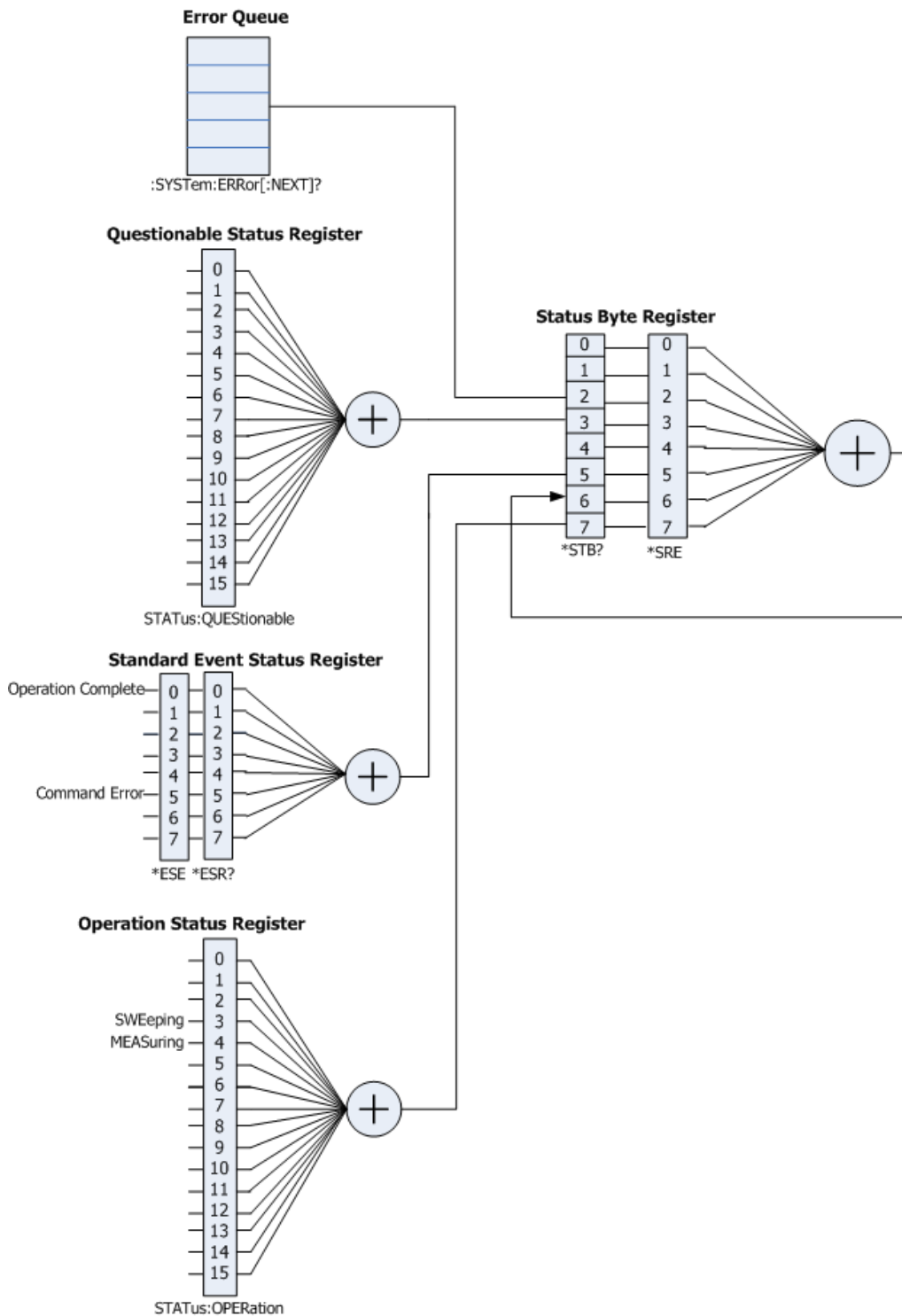

Command List:

- ◆ [:STATus:OPERation:CONDition?](#)
- ◆ [:STATus:OPERation:ENABle](#)
- ◆ [:STATus:OPERation\[:EVENT\]?](#)
- ◆ [:STATus:PRESet](#)
- ◆ [:STATus:QUEStionable:CONDition?](#)
- ◆ [:STATus:QUEStionable:ENABle](#)
- ◆ [:STATus:QUEStionable\[:EVENT\]?](#)

:STATus:OPERation:CONDition?**Syntax**

:STATus:OPERation:CONDition?

Description

Query the value of the condition register for the operation status register.

Return Format

The query returns the value of the condition register in integer. For example, 24.

:STATus:OPERation:ENABle**Syntax**

:STATus:OPERation:ENABle <integer>
:STATus:OPERation:ENABle?

Description

Set the value of the enable register for the operation status register.
Query the value of the enable register for the operation status register.

Parameter

Name	Type	Range	Default
<integer>	Integer	Refer to Explanation	0

Explanation

The following table lists the bit definitions for the operation status register. The bit 0 to bit 2, bit 5 to bit 7, bit 13 and bit 14 are reserved; they can be set but will not affect the instrument. The bit 15 and bit 12 to bit 8 are not used and are always treated as 0; therefore, the range of <integer> are the decimal numbers corresponding to the binary numbers ranging from 0000000000000000 (0 in decimal) to 1111111111111111 (32767 in decimal) and of which the bit 15 and bit 12 to bit 8 are 0.

Bit	Value	Definition
0	1	Reserved
1	2	Reserved
2	4	Reserved
3	8	SWEEping
4	16	MEASuring
5	32	Reserved
6	64	Reserved

7	128	Reserved
8	0	Not Used
9	0	Not Used
10	0	Not Used
11	0	Not Used
12	0	Not Used
13	8192	Reserved
14	16384	Reserved
15	0	Not Used

Return Format

The query returns the value of the enable register of the operation status register in integer.

Example

The command below sets the value of the enable register of the operation status register to 100.

```
:STATus:OPERation:ENABle 100
```

The query below returns 100.

```
:STATus:OPERation:ENABle?
```

:STATus:OPERation[:EVENT]?**Syntax**

```
:STATus:OPERation[:EVENT]?
```

Description

Query the value of the event register for the operation status register.

Return Format

The query returns the value of the event register in integer. For example, 24.

:STATus:PRESet**Syntax**

```
:STATus:PRESet
```

Description

Clear the enable registers of the operation status register and the questionable status register.

:STATus:QUESTionable:CONDition?**Syntax**

```
:STATus:QUESTionable:CONDition?
```

Description

Query the value of the condition register for the questionable status register.

Return Format

The query returns the value of the condition register of the questionable status register in integer. For example, 0.

:STATus:QUEStionable:ENABle

Syntax

:STATus:QUEStionable:ENABle <integer>

:STATus:QUEStionable:ENABle?

Description

Set the value of the enable register for the questionable status register.

Query the value of the enable register for the questionable status register.

Parameter

Name	Type	Range	Default
<integer>	Integer	Refer to Explanation	0

Explanation

The following table lists the bit definitions for the questionable status register. The bit 0 to bit 8, bit 13 and bit 14 are reserved; they can be set but will not affect the instrument. The bit 15 and bit 12 to bit 9 are not used and are always treated as 0; therefore, the range of <integer> are the decimal numbers corresponding to the binary numbers ranging from 0000000000000000 (0 in decimal) to 1111111111111111 (32767 in decimal) and of which the bit 15 and bit 12 to bit 9 are 0.

Bit	Value	Definition
0	1	Reserved
1	2	Reserved
2	4	Reserved
3	8	Reserved
4	16	Reserved
5	32	Reserved
6	64	Reserved
7	128	Reserved
8	256	Reserved
9	0	Not Used
10	0	Not Used
11	0	Not Used
12	0	Not Used
13	8192	Reserved
14	16384	Reserved
15	0	Not Used

Return Format

The query returns the value of the enable register of the questionable status register in integer.

:STATus:QUEStionable[:EVENT]?

Syntax

:STATus:QUEStionable[:EVENT]?

Description

Query the value of the event register for the questionable status register.

Return Format

The query returns the value of the event register of the questionable status register in integer. For example, 0.

:SYSTem Subsystem

Command List:

- ◆ [:SYSTem:BEEPer:STATe](#)
- ◆ [:SYSTem:CLear](#)
- ◆ [:SYSTem:COMMunicate:APORt](#)
- ◆ [:SYSTem:COMMunicate:GPIB\[:SELF\]:ADDRess](#)
- ◆ [:SYSTem:COMMunicate:LAN\[:SELF\]:AUToip:STATe](#)
- ◆ [:SYSTem:COMMunicate:LAN\[:SELF\]:DHCP:STATe](#)
- ◆ [:SYSTem:COMMunicate:LAN\[:SELF\]:IP:ADDRess](#)
- ◆ [:SYSTem:COMMunicate:LAN\[:SELF\]:IP:DNSServer](#)
- ◆ [:SYSTem:COMMunicate:LAN\[:SELF\]:IP:GATeway](#)
- ◆ [:SYSTem:COMMunicate:LAN\[:SELF\]:IP:SUBMAsk](#)
- ◆ [:SYSTem:COMMunicate:LAN\[:SELF\]:MANuip:STATe](#)
- ◆ [:SYSTem:COMMunicate:LAN\[:SELF\]:RESet](#)
- ◆ [:SYSTem:COMMunicate:USB\[:SELF\]:ADDRess?](#)
- ◆ [:SYSTem:COMMunicate:USB\[:SELF\]:CLASs](#)
- ◆ [:SYSTem:CONFigure:INFormation?](#)
- ◆ [:SYSTem:CONFigure:MESSAge?](#)
- ◆ [:SYSTem:DATE](#)
- ◆ [:SYSTem:ERRor\[:NEXT\]?](#)
- ◆ [:SYSTem:FSWIth\[:STATe\]](#)
- ◆ [:SYSTem:KLOCK](#)
- ◆ [:SYSTem:LANGuage](#)
- ◆ [:SYSTem:LINemod:STATe?](#)
- ◆ [:SYSTem:LINemod:TYPE](#)
- ◆ [:SYSTem:LKEY](#)
- ◆ [:SYSTem:OPTions?](#)
- ◆ [:SYSTem:PON:TYPE](#)
- ◆ [:SYSTem:PRESet](#)
- ◆ [:SYSTem:PRESet:SAVE](#)
- ◆ [:SYSTem:PRESet:TYPE](#)
- ◆ [:SYSTem:SPEaker\[:STATe\]](#)
- ◆ [:SYSTem:SPEaker:VOLume](#)
- ◆ [:SYSTem:TIME](#)
- ◆ [:SYSTem:TX:STATe?*](#)
- ◆ [:SYSTem:TX:SWset**](#)
- ◆ [:SYSTem:TX:SWSTa?*](#)
- ◆ [:SYSTem:USERkey:CONFirm](#)

- ◆ [:SYSTem:USERkey:KEYCmd](#)
- ◆ [:SYSTem:USERkey:STATe](#)
- ◆ [:SYSTem:VERsion?](#)

Explanation:

Commands marked with "***" are only available for DSA800E installed with the RF Demo kit (option).

:SYSTem:BEEPer:STATe**Syntax**

```
:SYSTem:BEEPer:STATe OFF|ON|0|1
:SYSTem:BEEPer:STATe?
```

Description

Enable or disable the beeper in Pass/Fail test.
Query the status of the beeper.

Parameter

Name	Type	Range	Default
--	Bool	OFF ON 0 1	OFF 0

Return Format

The query returns 0 or 1.

Example

The command below enables the beeper.

```
:SYSTem:BEEPer:STATe ON or :SYSTem:BEEPer:STATe 1
```

The query below returns 1.

```
:SYSTem:BEEPer:STATe?
```

:SYSTem:CLEAr**Syntax**

```
:SYSTem:CLEAr
```

Description

Clear all the data of user settings.

Explanation

After clearing the user data, restore the settings to the factory state, including:

- Restore the user data stored in NVRAM and NorFlash to factory settings.
- restore the HOST NAME, IP address and password in the LXI to factory settings.

:SYSTem:COMMunicate:APORT

Syntax

```
:SYSTem:COMMunicate:APORT GPIB|LAN|USB|OFF
:SYSTem:COMMunicate:APORT?
```

Description

Select the current communication port or disable all the communication ports.
Query the communication port currently selected.

Parameter

Name	Type	Range	Default
--	Keyword	GPIB LAN USB OFF	OFF

Return Format

The query returns GPIB, LAN, USB or OFF.

Example

The command below set the communication port to LAN.

```
:SYSTem:COMMunicate:APORT LAN
```

The query below returns LAN.

```
:SYSTem:COMMunicate:APORT?
```

:SYSTem:COMMunicate:GPIB[:SELF]:ADDRESS

Syntax

```
:SYSTem:COMMunicate:GPIB[:SELF]:ADDRESS <integer>
:SYSTem:COMMunicate:GPIB[:SELF]:ADDRESS?
```

Description

Set the GPIB address.
Query the GPIB address.

Parameter

Name	Type	Range	Default
<integer>	Integer	0 to 30	18

Return Format

The query returns the GPIB address in integer.

Example

The command below sets the GPIB address to 16.

```
:SYSTem:COMMunicate:GPIB:SELF:ADDRESS 16
```

The query below returns 16.

```
:SYSTem:COMMunicate:GPIB:SELF:ADDRESS?
```

:SYSTem:COMMunicate:LAN[:SELF]:AUTOip:STATe

Syntax

```
:SYSTem:COMMunicate:LAN[:SELF]:AUTOip:STATe OFF|ON|0|1
:SYSTem:COMMunicate:LAN[:SELF]:AUTOip:STATe?
```

Description

Enable or disable the auto IP setting mode.
Query the status of the auto IP setting mode.

Parameter

Name	Type	Range	Default
--	Bool	OFF ON 0 1	ON 1

Explanation

The spectrum analyzer always tries to get the IP address configuration in the order of DHCP, auto IP and manual IP. The three setting modes cannot be turned off at the same time.

Return Format

The query returns 0 or 1.

Example

The command below disables the auto IP setting mode.

```
:SYSTem:COMMunicate:LAN:SELF:AUTOip:STATe OFF
or :SYSTem:COMMunicate:LAN:SELF:AUTOip:STATe 0
```

The query below returns 0.

```
:SYSTem:COMMunicate:LAN:SELF:AUTOip:STATe?
```

:SYSTem:COMMunicate:LAN[:SELF]:DHCP:STATe

Syntax

```
:SYSTem:COMMunicate:LAN[:SELF]:DHCP:STATe OFF|ON|0|1
:SYSTem:COMMunicate:LAN[:SELF]:DHCP:STATe?
```

Description

Enable or disable the DHCP mode.
Query the status of the DHCP mode.

Parameter

Name	Type	Range	Default
--	Bool	OFF ON 0 1	ON 1

Explanation

The spectrum analyzer always tries to get the IP address configuration in the order of DHCP, auto IP and manual IP. The three setting modes cannot be turned off at the same time.

Return Format

The query returns 0 or 1.

Example

The command below disables the DHCP mode.

```
:SYSTem:COMMunicate:LAN:SELF:DHCP:STATe OFF or :SYSTem:COMMunicate:LAN:SELF:DHCP:STATe 0
```

The query below returns 0.

```
:SYSTem:COMMunicate:LAN:SELF:DHCP:STATe?
```

:SYSTem:COMMunicate:LAN[:SELF]:IP:ADDRESS

Syntax

```
:SYSTem:COMMunicate:LAN[:SELF]:IP:ADDRESS <ip_address>
:SYSTem:COMMunicate:LAN[:SELF]:IP:ADDRESS?
```

Description

Set the IP address.
Query the IP address.

Parameter

Name	Type	Range	Default
<ip_address>	ASCII STRING	Refer to Explanation	--

Explanation

The format of <ip_address> is nnn.nnn.nnn.nnn; wherein, the range of the first nnn is from 1 to 223 (except 127) and the ranges of the other three nnn are from 0 to 255.

Return Format

The query returns the current IP address in nnn.nnn.nnn.nnn format.

Example

The command below sets the IP address to 172.16.3.199.
:SYSTem:COMMunicate:LAN:SELF:IP:ADDRESS 172.16.3.199

The query below returns 172.16.3.199.
:SYSTem:COMMunicate:LAN:SELF:IP:ADDRESS?

:SYSTem:COMMunicate:LAN[:SELF]:IP:DNSServer

Syntax

```
:SYSTem:COMMunicate:LAN[:SELF]:IP:DNSServer <ip_address>
:SYSTem:COMMunicate:LAN[:SELF]:IP:DNSServer?
```

Description

Set the DNS address.
Query the DNS address.

Parameter

Name	Type	Range	Default
<ip_address>	ASCII STRING	Refer to Explanation	--

Explanation

The format of <ip_address> is nnn.nnn.nnn.nnn; wherein, the range of the first nnn is from 1 to 223 (except 127) and the ranges of the other three nnn are from 0 to 255.

Return Format

The query returns the current DNS address in nnn.nnn.nnn.nnn format.

Example

The command below sets the DNS address to 172.16.2.2.
:SYSTem:COMMunicate:LAN:SELF:IP:DNSServer 172.16.2.2

The query below returns 172.16.2.2.
:SYSTem:COMMunicate:LAN:SELF:IP:DNSServer?

:SYSTem:COMMunicate:LAN[:SELF]:IP:GATeway

Syntax

```
:SYSTem:COMMunicate:LAN[:SELF]:IP:GATeway <ip_address>
:SYSTem:COMMunicate:LAN[:SELF]:IP:GATeway?
```

Description

Set the default gateway.
Query the default gateway.

Parameter

Name	Type	Range	Default
<ip_address>	ASCII STRING	Refer to Explanation	--

Explanation

The format of <ip_address> is nnn.nnn.nnn.nnn; wherein, the range of the first nnn is from 1 to 223 (except 127) and the ranges of the other three nnn are from 0 to 255.

Return Format

The query returns the current default gateway in nnn.nnn.nnn.nnn format.

Example

The command below sets the default gateway to 172.16.3.1.
:SYSTem:COMMunicate:LAN:SELF:IP:GATeway 172.16.3.1

The query below returns 172.16.3.1.
:SYSTem:COMMunicate:LAN:SELF:IP:GATeway?

:SYSTem:COMMunicate:LAN[:SELF]:IP:SUBMask

Syntax

```
:SYSTem:COMMunicate:LAN[:SELF]:IP:SUBMask<ip_address>
:SYSTem:COMMunicate:LAN[:SELF]:IP:SUBMask?
```

Description

Set the subnet mask.
Query the subnet mask.

Parameter

Name	Type	Range	Default
<ip_address>	ASCII STRING	Refer to Explanation	--

Explanation

The format of <ip_address> is nnn.nnn.nnn.nnn and the range of the nnn is from 0 to 255.

Return Format

The query returns the current subnet mask in nnn.nnn.nnn.nnn format.

Example

The command below sets the subnet mask to 255.255.255.0.
:SYSTem:COMMunicate:LAN:SELF:IP:SUBMask 255.255.255.0

The query below returns 255.255.255.0.
:SYSTem:COMMunicate:LAN:SELF:IP:SUBMask?

:SYSTem:COMMunicate:LAN[:SELF]:MANuip:STATe**Syntax**

```
:SYSTem:COMMunicate:LAN[:SELF]:MANuip:STATe OFF|ON|0|1
:SYSTem:COMMunicate:LAN[:SELF]:MANuip:STATe?
```

Description

Enable or disable the manual IP setting mode.
Query the status of the manual IP setting mode.

Parameter

Name	Type	Range	Default
--	Bool	OFF ON 0 1	OFF 0

Explanation

The spectrum analyzer always tries to get the IP address configuration in the order of DHCP, auto IP and manual IP. The three setting modes cannot be turned off at the same time.

Return Format

The query returns 0 or 1.

Example

The command below enables the manual IP setting mode.

```
:SYSTem:COMMunicate:LAN:SELF:MANuip:STATe ON
or :SYSTem:COMMunicate:LAN:SELF:MANuip:STATe 1
```

The query below returns 1.

```
:SYSTem:COMMunicate:LAN:SELF:MANuip:STATe?
```

:SYSTem:COMMunicate:LAN[:SELF]:RESet**Syntax**

```
:SYSTem:COMMunicate:LAN[:SELF]:RESet
```

Description

Reset the LAN setting: enable the DHCP and Auto IP, disable the Manual IP.

:SYSTem:COMMunicate:USB[:SELF]:ADDRess?**Syntax**

```
:SYSTem:COMMunicate:USB[:SELF]:ADDRess?
```

Description

Query the USB device address.

Return Format

The query returns the USB device address; for example, 1.

:SYSTem:COMMunicate:USB[:SELF]:CLASs

Syntax

```
:SYSTem:COMMunicate:USB[:SELF]:CLASs TMC|PRINter|AUTO
:SYSTem:COMMunicate:USB[:SELF]:CLASs?
```

Description

Set the USB device class.
Query the USB device class.

Parameter

Name	Type	Range	Default
--	Keyword	TMC PRINter AUTO	TMC

Explanation

When AUTO is selected, the device class is decided by the USB main device.
When TMC is selected, the spectrum analyzer is used as Test & Measurement Class device.
When PRINter is selected, the spectrum analyzer is used as Printer Class device. At this point, the instrument is disconnected from the PC. To control the instrument remotely, you need to connect them again.

Return Format

The query returns TMC or PRIN.

Example

The command below sets the USB device class to printer.
:SYSTem:COMMunicate:USB:SELF:CLASs PRINter

The query below returns PRIN.
:SYSTem:COMMunicate:USB:SELF:CLASs?

:SYSTem:CONFigure:INFormation?

Syntax

```
:SYSTem:CONFigure:INFormation?
```

Description

Query the system information of the spectrum analyzer.

Explanation

The system information includes the model, serial number, software and hardware versions.

Return Format

The query returns the system information (the language depends on the current system language). For example,

```
Model: DSA832E
Serial Number: DSA8A134400008
```

```
Version of Main Board: 00.10
Version of Radio Frequency Board FPGA: 00.01
Version of Digital Board FPGA: 00.04
Version of Firmware: 00.00.00
Version of Boot: 00.00.00
```

Note: For DSA832E-TG, the system information returned also includes the "Version of TG Board FPGA".

:SYSTem:CONFigure:MESSage?

Syntax

```
:SYSTem:CONFigure:MESSage?
```

Description

Query the system message displayed lately.

Explanation

Up to 71 history messages can be displayed.

Return Format

The query returns the system messages lately displayed (the language depends on the current system language). For example,

```
470|Calibration memory lost.|2014-05-16 09:38:36
```

```
10|U Disk connected.|2014-05-16 09:49:48
```

:SYSTem:DATE

Syntax

```
:SYSTem:DATE <year>,<month>,<day>
```

```
:SYSTem:DATE?
```

Description

Set the date of the instrument.

Query the date of the instrument.

Parameter

Name	Type	Range	Default
<year>	ASCII String	2000 to 2099	--
<month>	ASCII String	01 to 12	--
<day>	ASCII String	01 to 31	--

Return Format

The query returns the current date in YYYY,MM,DD format.

Example

The command below sets the date of the instrument to 2016/05/16.

```
:SYSTem:DATE 2016,05,16
```

The query below returns 2016,05,16.

```
:SYSTem:DATE?
```

:SYSTem:ERRor[:NEXT]?

Syntax

:SYSTem:ERRor[:NEXT]?

Description

Query and delete the last message that entered the error queue.

Explanation

If no error currently exists, the query returns 0, "No Error".

Use the [*CLS](#) command to delete all the messages in the error queue.

Return Format

The query returns the error message in "Error Number,"Error Message"" format. For example, -110,"Command header error".

:SYSTem:FSWItch[:STATe]

Syntax

:SYSTem:FSWItch[:STATe] OFF|ON|0|1

:SYSTem:FSWItch[:STATe]?

Description

Enable or disable the front panel power switch.

Query the status of the front panel power switch.

Parameter

Name	Type	Range	Default
--	Bool	OFF ON 0 1	ON 1

Return Format

The query returns 0 or 1.

Example

The command below disables the front panel power switch.

```
:SYSTem:FSWItch:STATe OFF or :SYSTem:FSWItch:STATe 0
```

The query below returns 0.

```
:SYSTem:FSWItch:STATe?
```

:SYSTem:KLOCK

Syntax

```
:SYSTem:KLOCK OFF|ON|0|1,<key>
:SYSTem:KLOCK? <key>
```

Description

Lock or unlock the specified function key.
Query whether the specified key is locked.

Parameter

Name	Type	Range	Default
--	Bool	OFF ON 0 1	OFF 0
<key>	Keyword	Refer to Explanation	--

Explanation

The parameter <key> is used to specify the keys. The range of this parameter is as follows.

FREQ SPAN AMP	/*FREQ, SPAN, AMPT keys*/
BW SWEEP TRACE TG	/*BW/Det, Sweep/Trig, Trace/P/F, TG keys*/
MARK MARKFUNC MARKTO PEAK	/*Marker, Marker Fctn, Marker->, Peak keys*/
TUNE	/*Auto key*/
MEAS MEASSET DEMODO	/*Meas, Meas Setup, Demod keys*/
SYSTEM PRINTSETUP STORAGE	/*System, Print Setup, Storage keys*/
PRESET PRINT	/*Preset, Print keys*/

ON|1: lock the specified key.

OFF|0: unlock the specified key.

When more than one key is locked or unlocked at the same time, please use "," to separate the keys.

To lock all keys at the front panel (except power switch), please use **:SYSTem:KLOCK ON | 1,ALL** command; to unlock all keys, please use **:SYSTem:KLOCK OFF | 0,ALL** command.

Return Format

The query returns "keyname 0" or "keyname 1".

Example

The command below locks the FREQ key.

```
:SYSTem:KLOCK ON,FREQ or :SYSTem:KLOCK 1,FREQ
```

The query below returns FREQ 1.

```
:SYSTem:KLOCK? FREQ
```

:SYSTem:LANGuage

Syntax

```
:SYSTem:LANGuage ENGLISH|CHINEse|JAPan|PORTugese|GERMan|POLish|KORea|TCHinese
:SYSTem:LANGuage?
```

Description

Set the language of the instrument.
Query the language of the instrument.

Parameter

Name	Type	Range	Default
--	Keyword	ENGLISH CHINEse JAPan PORTugese GERMan POLish KORea TCHinese	ENGLISH

Return Format

The query returns ENGL, CHIN, JAP, PORT, GERM, POL, KOR or TCHinese.

Example

The command below sets the language to Chinese.

```
:SYSTem:LANGuage CHINEse
```

The query below returns CHIN.

```
:SYSTem:LANGuage?
```

:SYSTem:LINemod:STATe?

Syntax

```
:SYSTem:LINemod:STATe?
```

Description

Query the status of line mode.

Return Format

The query returns 0 (non-line mode) or 1 (line mode).

Example

The query below returns 1.

```
:SYSTem:LINemod:STATe?
```

:SYSTem:LINemod:TYPE

Syntax

```
:SYSTem:LINemod:TYPE FACTory|USER1|USER2|USER3|USER4|USER5|USER6|OFF
```

Description

Set the preset setting used in line mode or exit line mode.

Parameter

Name	Type	Range	Default
--	Keyword	FACTory USER1 USER2 USER3 USER4 USER5 USER6 OFF	OFF

Example

The command below sets the preset setting used in line mode to USER4.

```
:SYSTem:LINemod:TYPE USER4
```

:SYSTem:LKEY

Syntax

```
:SYSTem:LKEY <license key>
:SYSTem:LKEY? <option>
```

Description

Install and activate the specified option.
Query the serial number of the specified option.

Parameter

Name	Type	Range	Default
<license key>	ASCII STRING	--	--
<option>	Integer	1 to 4	--

Explanation

<option> denotes the number of the option. The numbers of the options and the corresponding order numbers are as shown below.

Number of Option	Order Number of Option
1	AMK-DSA800
2	EMI-DSA800
3	VSWR-DSA800
4	PA-DSA832

Return Format

The query returns the serial number.

Example

The command below installs the option (the corresponding option number is 1) of which the serial number is UADEYSACMA6RJACQTAWJZLLPBCVA.

```
:SYSTem:LKEY UADEYSACMA6RJACQTAWJZLLPBCVA
```

The query below returns UADEYSACMA6RJACQTAWJZLLPBCVA.

```
:SYSTem:LKEY? 0001
```

:SYSTem:OPTions?

Syntax

:SYSTem:OPTions?

Description

Query the option status (include the option number, order number, type and activation status) of the spectrum analyzer.

Return Format

The query returns the option status (include the option number, order number, type and activation status) of the spectrum analyzer. For example,

Serial NO.|Option|Option Type|Active

1| AMK-DSA800|Official|Y

2| EMI-DSA800|None|N

3| VSWR-DSA800|Official|Y

4| PA-DSA832|Official|Y

:SYSTem:PON:TYPE

Syntax

:SYSTem:PON:TYPE PRESet|LAST

:SYSTem:PON:TYPE?

Description

Set the instrument to recall the last setting or the preset setting at power-on.

Query the setting recalled by the instrument at power-on.

Parameter

Name	Type	Range	Default
--	Keyword	PRESet LAST	PRESet

Explanation

PRESet: preset setting, including factory setting and six user settings. Use the [:SYSTem:PRESet:TYPE](#) command to select the desired setting.

LAST: the last setting.

Return Format

The query returns PRES or LAST.

Example

The command below sets the instrument to recall the last setting.

```
:SYSTem:PON:TYPE LAST
```

The query below returns LAST.

```
:SYSTem:PON:TYPE?
```

:SYSTem:PRESet

Syntax

```
:SYSTem:PRESet
```

Description

Recall the preset setting of the system to restore the instrument to the state specified by the [:SYSTem:PRESet:TYPE](#) command.

:SYSTem:PRESet:SAVE

Syntax

```
:SYSTem:PRESet:SAVE <type>,<name>
```

Description

Save the user setting.

Parameter

Name	Type	Range	Default
<type>	Keyword	USER1 USER2 USER3 USER4 USER5 USER6	--
<name>	ASCII String	The name (not include the path and the suffix) of the file to be saved	--

Explanation

This command is only available when USER1, USER2, USER3, USER4, USER5 or USER6 is selected using the [:SYSTem:PRESet:TYPE](#) command.

Example

The command below saves the current instrument setting in USER2 using the filename def2.sta.

```
:SYSTem:PRESet:SAVE USER2,def2
```

:SYSTem:PRESet:TYPE

Syntax

```
:SYSTem:PRESet:TYPe FACTory|USER1|USER2|USER3|USER4|USER5|USER6  
:SYSTem:PRESet:TYPe?
```

Description

Set the preset type of the system to preset or one of USER1 to USER6.

Query the preset type of the system.

Parameter

Name	Type	Range	Default
--	Keyword	FACTory USER1 USER2 USER3 USER4 USER5 USER6	FACTory

Return Format

The query returns FACT, USER1, USER2, USER3, USER4, USER5 or USER6.

Example

The command below sets the preset type of the system to USER5.

```
:SYSTem:PRESet:TYPe USER5
```

The query below returns USER5.

```
:SYSTem:PRESet:TYPe?
```

:SYSTem:SPEaker[:STATe]

Syntax

```
:SYSTem:SPEaker[:STATe] OFF|ON|0|1
:SYSTem:SPEaker[:STATe]?
```

Description

Enable or disable the earphone in demodulation.
Query the status of the earphone in demodulation.

Parameter

Name	Type	Range	Default
--	Bool	OFF ON 0 1	OFF 0

Explanation

This command is only available when the AM or FM demodulation is enabled.

Return Format

The query returns 0 or 1.

Example

The command below enables the earphone.

```
:SYSTem:SPEaker:STATe ON or :SYSTem:SPEaker:STATe 1
```

The query below returns 1.

```
:SYSTem:SPEaker:STATe?
```

:SYSTem:SPEaker:VOLume

Syntax

```
:SYSTem:SPEaker:VOLume <integer>
:SYSTem:SPEaker:VOLume?
```

Description

Set the volume of the earphone in demodulation.
Query the volume of the earphone in demodulation.

Parameter

Name	Type	Range	Default
<integer>	Integer	0 to 255	100

Explanation

This command is only available when the AM or FM demodulation is enabled.

Return Format

The query returns the volume of the earphone in integer.

Example

The command below sets the volume of the earphone to 100.

```
:SYSTem:SPEaker:VOLume 100
```

The query below returns 100.

```
:SYSTem:SPEaker:VOLume?
```

:SYSTem:TIME

Syntax

:SYSTem:TIME <hour>,<minute>,<second>
:SYSTem:TIME?

Description

Set the time of the instrument.
Query the time of the instrument.

Parameter

Name	Type	Range	Default
<hour>	ASCII String	00 to 23	--
<minute>	ASCII String	00 to 59	--
<second>	ASCII String	00 to 59	--

Return Format

The query returns the current time in HH,MM,SS format.

Example

The command below sets the time to 15:10:30.

```
:SYSTem:TIME 15,10,30
```

The query below returns 15,10,30.

```
:SYSTem:TIME?
```

:SYSTem:TX:STATe?

Syntax

:SYSTem:TX:STATe?

Description

Query the connection status of TX1000.

Return Format

The query returns 0 or 1.

:SYSTem:TX:SWset

Syntax

:SYSTem:TX:SWset <SW1|SW2|SW3|SW4|SW5>,OFF|ON|0|1

Description

Set the on/off status of TX1000.

Parameter

Name	Type	Range	Default
--	Keyword	SW1 SW2 SW3 SW4 SW5	--
--	Bool	OFF ON 0 1	OFF 0

Explanation

SW1 to SW5 represents the 5 switches of TX1000 respectively.
This command is only available when TX1000 is connected.

Example

The command below sets switch 1 to on.

:SYSTem:TX:SWset SW1,ON or :SYSTem:TX:SWset SW1,1

:SYSTem:TX:SWSTa?

Syntax

:SYSTem:TX:SWSTa? <SW1|SW2|SW3|SW4|SW5>

Description

Query the on/off status of TX1000.

Parameter

Name	Type	Range	Default
--	Keyword	SW1 SW2 SW3 SW4 SW5	--

Explanation

SW1 to SW5 represents the 5 switches of TX1000 respectively.
This command is only available when TX1000 is connected.

Return Format

The query returns 0 or 1.

:SYSTem:USERkey:CONFirm

Syntax

```
:SYSTem:USERkey:CONFirm
```

Description

Confirm and validate the definition of UserKey.

Explanation

The definition of UserKey is only valid when the UserKey setting is enabled (refer to the [:SYSTem:USERkey:STATe](#) command) and this command is sent after sending the defining command (refer to the [:SYSTem:USERkey:KEYCmd](#) command).

:SYSTem:USERkey:KEYCmd

Syntax

```
:SYSTem:USERkey:KEYCmd <key_value>{,<key_value>}
:SYSTem:USERkey:KEYCmd?
```

Description

Define a related function for UserKey.
Query the function currently related to UserKey.

Parameter

Name	Type	Range	Default
<key_value>	Keyword	FREQ SPAN AMP BW SWEep TUNE DEMod TRACe TG MEAS MEASset MARK MARKfunc MARKto PEAK PRESet SYSTem STORAge PRINT PRINTsetup HELP F1 F2 F3 F4 F5 F6 F7 RETUrn PAGEdown	SYSTem

Explanation

The following parameters correspond to the front panel keys:

FREQ|SPAN|AMP|BW|SWEep|TUNE|DEMod|TRACe|TG|MEAS|MEASset|MARK|MARKfunc|MARKto|PEAK|PRESet|SYSTem|STORAge|PRINT|PRINTsetup|HELP|

The following parameters correspond to the front panel menu softkeys and menu control keys:

F1|F2|F3|F4|F5|F6|F7|RETUrn|PAGEdown

The definition of UserKey is only valid when the UserKey setting is enabled (refer to the [:SYSTem:USERkey:STATe](#) command) and this command is sent after sending the defining command (refer to the [:SYSTem:USERkey:CONFirm](#) command).

Example

The command below defines the related function of UserKey to System → Self-Test → Key Test. The query command returns System,Self-Test,Key Test.

```
:SYSTem:USERkey:STATe ON
:SYSTem:USERkey:KEYCmd SYSTem,PAGEdown,F2,F2
:SYSTem:USERkey:CONFirm
:SYSTem:USERkey:KEYCmd?
```

:SYSTem:USERkey:STATe

Syntax

:SYSTem:USERkey:STATe OFF|ON|0|1
:SYSTem:USERkey:STATe?

Description

Enable or disable the UserKey setting.
Query the status of the UserKey setting.

Parameter

Name	Type	Range	Default
--	Bool	OFF ON 0 1	OFF 0

Example

The command below enables the UserKey setting.

```
:SYSTem:USERkey:STATe ON or :SYSTem:USERkey:STATe 1
```

The query below returns 1.

```
:SYSTem:USERkey:STATe?
```

:SYSTem:VERSion?

Syntax

:SYSTem:VERSion?

Description

Query the SCPI version of the instrument.

Return Format

The query returns the SCPI version. For example, 1999.0.

:TRACe Subsystem

Command List:

- ◆ [:TRACe:AVERAge:CLEar](#)
- ◆ [:TRACe:AVERAge:COUNT](#)
- ◆ [:TRACe:AVERAge:COUNT:CURRENT?](#)
- ◆ [:TRACe:AVERAge:RESet](#)
- ◆ [:TRACe:CLEar:ALL](#)
- ◆ [:TRACe\[:DATA\]](#)
- ◆ [:TRACe:MATH:A](#)
- ◆ [:TRACe:MATH:B](#)
- ◆ [:TRACe:MATH:CONST](#)
- ◆ [:TRACe:MATH:PEAK\[:DATA\]?](#)
- ◆ [:TRACe:MATH:PEAK:POINTs?](#)
- ◆ [:TRACe:MATH:PEAK:SORT](#)
- ◆ [:TRACe:MATH:PEAK:TABLE:STATE](#)
- ◆ [:TRACe:MATH:PEAK:THReshold](#)
- ◆ [:TRACe:MATH:STATE](#)
- ◆ [:TRACe:MATH:TYPE](#)
- ◆ [:TRACe<n>:AVERAge:TYPE](#)
- ◆ [:TRACe<n>:MODE](#)

:TRACe:AVERAge:CLEar

Syntax

:TRACe:AVERAge:CLEar

Description

Clear the number of trace averages currently executed.

:TRACe:AVERAge:COUNT

Syntax

:TRACe:AVERAge:COUNT <integer>

:TRACe:AVERAge:COUNT?

Description

Set the number of averages of the trace.

Query the number of averages of the trace.

Parameter

Name	Type	Range	Default
<integer>	Integer	1 to 1000	100

Return Format

The query returns the number of averages of the trace in integer.

Example

The command below sets the number of averages to 200.

```
:TRACe:AVERAge:COUNT 200
```

The query below returns 200.

```
:TRACe:AVERAge:COUNT?
```

:TRACe:AVERAge:COUNT:CURRent?**Syntax**

```
:TRACe:AVERAge:COUNT:CURRent?
```

Description

Query the number of averages currently executed of the trace.

Return Format

The query returns the number of averages currently executed of the trace in integer.

:TRACe:AVERAge:RESet**Syntax**

```
:TRACe:AVERAge:RESet
```

Description

Execute the trace average reset operation.

Explanation

This command is valid when the trace type is set to "Video Avg" or "Power Avg".

:TRACe:CLEAr:ALL**Syntax**

```
:TRACe:CLEAr:ALL
```

Description

Clear all the traces; namely set the type of all the traces to BLANK (Off).

Note: As the PC software converts the binary data returned to ASCII character, the return value is unrecognizable code when the PC software is used to execute the query command.

```
:TRACe:DATA? TRACE2
```

Remark:

[1] The format of the data block is "Data Block Header + Data Block"; wherein, the format of the data block header is as follows.

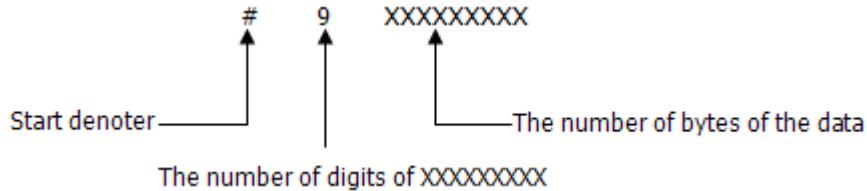

The first figure (9) following # denotes the number of digits of the number in the data block header; this number denotes the number of bytes of the data in this transmission (add 0 before the number when the number of digits is less than 9). For example, the data block header is #9000000100 when 100 bytes of data is transmitted.

[2] In the two examples here, 601 points are transmitted and the queries return 601 points. However, due to the limited space, the succeeding data is omitted here. The return values in the above examples are acquired when the trace stops sweeping.

:TRACe:MATH:A

Syntax

```
:TRACe:MATH:A T1|T2|T3
:TRACe:MATH:A?
```

Description

Set A in the trace math expression to denote trace 1, trace 2 or trace 3. Query the trace represented by A in the trace math expression.

Parameter

Name	Type	Range	Default
--	Keyword	T1 T2 T3	T1

Return Format

The query returns T1, T2 or T3.

Example

The command below sets A to trace 2.

```
:TRACe:MATH:A T2
```

The query below returns T2.

```
:TRACe:MATH:A?
```

:TRACe:MATH:B**Syntax**

```
:TRACe:MATH:B T1|T2|T3
:TRACe:MATH:B?
```

Description

Set B in the trace math expression to denote trace 1, trace 2 or trace 3.
Query the trace represented by B in the trace math expression.

Parameter

Name	Type	Range	Default
--	Keyword	T1 T2 T3	T2

Return Format

The query returns T1, T2 or T3.

Example

The command below sets B to trace 1.

```
:TRACe:MATH:B T1
```

The query below returns T1.

```
:TRACe:MATH:B?
```

:TRACe:MATH:CONST**Syntax**

```
:TRACe:MATH:CONST <integer>
:TRACe:MATH:CONST?
```

Description

Set the constant in the trace math expression.
Query the constant in the trace math expression.

Parameter

Name	Type	Range	Default
<integer>	Consecutive Real Number	-300 dB to 300 dB	0 dB

Return Format

The query returns the constant in scientific notation.

Example

The command below sets the constant to 50 dB.

```
:TRACe:MATH:CONST 50
```

The query below returns 5.000000E+01.

```
:TRACe:MATH:CONST?
```

:TRACe:MATH:PEAK[:DATA]?**Syntax**

```
:TRACe:MATH:PEAK[:DATA]?
```

Description

Query the frequencies (Hz) and amplitudes (the unit is the same with the current Y-axis unit) of the peaks in the peak table.

Explanation

This command only queries trace 1.

Return Format

The query returns the frequencies and amplitudes of the peaks in the peak table in the following format and up to 10 frequencies and amplitudes can be returned.

For example, 43500000,-7.253288E+01,43950000,-7.169086E+01.

:TRACe:MATH:PEAK:POINTs?**Syntax**

```
:TRACe:MATH:PEAK:POINTs?
```

Description

Query the number of peaks in the peak table.

Return Format

The query returns an integer between 0 and 10.

:TRACe:MATH:PEAK:SORT**Syntax**

```
:TRACe:MATH:PEAK:SORT AMPLitude|FREQuency
:TRACe:MATH:PEAK:SORT?
```

Description

Set the sorting rule of the peak table.

Query the sorting rule of the peak table.

Parameter

Name	Type	Range	Default
--	Keyword	AMPLitude FREQuency	FREQuency

Return Format

The query returns AMPL or FREQ.

Example

The command below sets the sorting rule of the peak table to amplitude.

```
:TRACe:MATH:PEAK:SORT AMPLitude
```

The query below returns AMPL.

```
:TRACe:MATH:PEAK:SORT?
```

:TRACe:MATH:PEAK:TABLE:STATe

Syntax

```
:TRACe:MATH:PEAK:TABLE:STATe OFF|ON|0|1
:TRACe:MATH:PEAK:TABLE:STATe?
```

Description

Enable or disable the peak table.
Query the status of the peak table.

Parameter

Name	Type	Range	Default
--	Bool	OFF ON 0 1	OFF 0

Return Format

The query returns 0 or 1.

Example

The command below enables the peak table.

```
:TRACe:MATH:PEAK:TABLE:STATe ON or :TRACe:MATH:PEAK:TABLE:STATe 1
```

The query below returns 1.

```
:TRACe:MATH:PEAK:TABLE:STATe?
```

:TRACe:MATH:PEAK:THReshold

Syntax

```
:TRACe:MATH:PEAK:THReshold NORMAl|DLMore|DLLess
:TRACe:MATH:PEAK:THReshold?
```

Description

Set the display mode of the peak in the peak table.
Query the display mode of the peak in the peak table.

Parameter

Name	Type	Range	Default
--	Keyword	NORMAl DLMore DLLess	NORMAl

Explanation

NORMAl: normal. Display the first 10 peaks that meet the search parameters.

DLMore: >display line. Display the first 10 peaks that not only meet the search parameters but also have amplitudes greater than the specified display line.

DLLess: <display line. Display the first 10 peaks that not only meet the search parameters but also have amplitudes lower than the specified display line.

Return Format

The query returns NORM, DLM or DLL.

Example

The command below sets the display mode of the peaks in the peak table to normal.

```
:TRACe:MATH:PEAK:THReshold NORMAl
```

The query below returns NORM.

```
:TRACe:MATH:PEAK:THReshold?
```

:TRACe:MATH:STATe

Syntax

```
:TRACe:MATH:STATe OFF|ON|0|1
:TRACe:MATH:STATe?
```

Description

Enable or disable the math operation of the trace.
Query the status of the math operation of the trace.

Parameter

Name	Type	Range	Default
--	Bool	OFF ON 0 1	OFF 0

Return Format

The query returns 0 or 1.

Example

The command below enables the math operation of the trace.

```
:TRACe:MATH:STATe ON or :TRACe:MATH:STATe 1
```

The query below returns 1.

```
:TRACe:MATH:STATe?
```

:TRACe:MATH:TYPE

Syntax

```
:TRACe:MATH:TYPE A-B|A+CONST|A-CONST
:TRACe:MATH:TYPE?
```

Description

Set the operation type of the trace.
Query the operation type of the trace.

Parameter

Name	Type	Range	Default
--	Keyword	A-B A+CONST A-CONST	A-B

Return Format

The query returns A-B, A+CONST or A-CONST.

Example

The command below sets the operation type of the trace to A+constant.

```
:TRACe:MATH:TYPE A+CONST
```

The query below returns A+CONST.

```
:TRACe:MATH:TYPE?
```

:TRACe<n>:AVERAge:TYPE**Syntax**

```
:TRACe<n>:AVERAge:TYPE VIDEo|RMS
```

```
:TRACe<n>:AVERAge:TYPE?
```

Description

Set the average type of the trace.

Query the average type of the trace.

Parameter

Name	Type	Range	Default
<n>	Discrete	1 2 3	--
--	Keyword	VIDeo RMS	VIDeo

Explanation

VIDeo: video average

RMS: power average

When the Pass/Fail test is enabled, both the **:TRACe2:AVERAge:TYPE?** command and **:TRACe3:AVERAge:TYPE?** command return ERR.

When VSWR measurement is enabled, the **:TRACe1:AVERAge:TYPE?**

command, **:TRACe2:AVERAge:TYPE?** command and **:TRACe3:AVERAge:TYPE?** command all return ERR.

Return Format

The query returns VID or RMS.

Example

The command below sets the average type of trace 1 to video average.

```
:TRACe1:AVERAge:TYPE VIDEo
```

The query below returns VID.

```
:TRACe1:AVERAge:TYPE?
```

:TRACe<n>:MODE**Syntax**

:TRACe<n>:MODE WRITe|MAXHold|MINHold|VIEW|BLANK|VIDeoavg|POWeravg
 :TRACe<n>:MODE?

Description

Set the type of the specified trace.
 Query the type of the specified trace.

Parameter

Name	Type	Range	Default
<n>	Discrete	1 2 3	--
--	Keyword	WRITe MAXHold MINHold VIEW BLANK VIDeoavg POWeravg	WRITe

Explanation

WRITe: clear write
 MAXHold: max hold
 MINHold: min hold
 VIEW: view
 BLANK: off
 VIDeoavg: video average
 POWeravg: power average

Return Format

The query returns WRIT, MAXH, MINH, VIEW, BLANK, VID or POW.

Example

The command below sets the type of trace 1 to video average.
 :TRACe1:MODE VIDeoavg

The query below returns VID.
 :TRACe1:MODE?

:TRIGger Subsystem

Command List:

- ◆ [:TRIGger:SEQuence:EXTernal:READy?](#)
- ◆ [:TRIGger:SEQuence:EXTernal:SLOPe](#)
- ◆ [:TRIGger:SEQuence:SOURce](#)
- ◆ [:TRIGger:SEQuence:VIDeo:LEVel](#)

:TRIGger:SEQuence:EXTernal:READy?

Syntax

:TRIGger:SEQuence:EXTernal:READy?

Description

Query whether the current trigger is ready.

Explanation

This command is valid only when the external trigger is selected.

Return Format

Return 1 -- the trigger is ready.

Return 0 -- the trigger is being prepared.

:TRIGger:SEQuence:EXTernal:SLOPe

Syntax

:TRIGger:SEQuence:EXTernal:SLOPe POSitive|NEGative

:TRIGger:SEQuence:EXTernal:SLOPe?

Description

Set the trigger edge of external trigger.

Query the trigger edge of external trigger.

Parameter

Name	Type	Range	Default
--	Keyword	POSitive NEGative	POSitive

Explanation

POSitive: rising edge

NEGative: falling edge

Return Format

The query returns POS or NEG.

Example

The command below sets the trigger edge of external trigger to the rising edge.

```
:TRIGger:SEQuence:EXTernal:SLOPe POSitive
```

The query below returns POS.

```
:TRIGger:SEQuence:EXTernal:SLOPe?
```

:TRIGger:SEQuence:SOURce

Syntax

```
:TRIGger:SEQuence:SOURce IMMEDIATE|VIDeo|EXTernal
:TRIGger:SEQuence:SOURce?
```

Description

Set the trigger type.
Query the trigger type.

Parameter

Name	Type	Range	Default
--	Keyword	IMMEDIATE VIDeo EXTernal	IMMEDIATE

Explanation

IMMEDIATE: free run trigger

VIDeo: video trigger. This trigger type is not available in non-zero span mode as well as RMS Avg detection or Voltage Avg detection in zero span mode.

EXTernal: external trigger

Return Format

The query returns IMM, VID or EXT.

Example

The command below sets the trigger type to external trigger.

```
:TRIGger:SEQuence:SOURce EXTernal
```

The query below returns EXT.

```
:TRIGger:SEQuence:SOURce?
```

:TRIGger:SEQuence:VIDeo:LEVel

Syntax

:TRIGger:SEQuence:VIDeo:LEVel <ampl>
:TRIGger:SEQuence:VIDeo:LEVel?

Description

Set the trigger level of video trigger.
Query the trigger level of video trigger.

Parameter

Name	Type	Range	Default
<ampl>	Consecutive Real Number	-300 dBm to 50 dBm	0 dBm

Explanation

This command is only valid when video trigger is selected. You can use the [:TRIGger:SEQuence:SOURce](#) command to select video trigger.

Note: Video trigger is not available in non-zero span mode as well as RMS Avg detection or Voltage Avg detection in zero span mode.

Return Format

The query returns the trigger level in scientific notation.

Example

The command below sets the trigger level to 10 dBm.

```
:TRIGger:SEQuence:VIDeo:LEVel 10
```

The query below returns 1.000000E+01.

```
:TRIGger:SEQuence:VIDeo:LEVel?
```

:UNIT Subsystem

Command List:

◆ [:UNIT:POWer](#)

:UNIT:POWer

Syntax

```
:UNIT:POWer DBM|DBMV|DBUV|V|W
:UNIT:POWer?
```

Description

Set the unit of the Y axis.
Query the unit of the Y axis.

Parameter

Name	Type	Range	Default
--	Keyword	DBM DBMV DBUV V W	Refer to Explanation

Explanation

The default log unit is dBm.
The default linear unit is V.

Return Format

The query returns DBM, DBMV, DBUV, V or W.

Example

The command below sets the amplitude unit to Watts.
:UNIT:POWer W

The query below returns W.
:UNIT:POWer?

Chapter 3 Programming Demos

This chapter lists some programming demos to illustrate how to use commands to realize the common functions of the spectrum analyzer in the development environments of Visual C++ 6.0, Visual Basic 6.0 and LabVIEW 8.6 as well as the programming demo to illustrate how to control the spectrum analyzer to realize the common functions in Linux operation system. All the demos are based on NI (National Instrument)-VISA (Virtual Instrument Software Architecture).

NI-VISA (National Instrument-Virtual Instrument Software Architecture) is an API (application programming interface) written by NI based on VISA standards. You can use NI-VISA to realize the communication between the spectrum analyzer and the PC via instrument buses such as USB. As VISA has defined a set of software commands, users can control the instrument without understanding the working state of the interface bus. For more details, please refer to the NI-VISA Help.

Main topics of this chapter:

- ◆ [Programming Instructions](#)
- ◆ [Programming Preparations](#)
- ◆ [Visual C++ 6.0 Programming Demo](#)
- ◆ [Visual Basic 6.0 Programming Demo](#)
- ◆ [LabVIEW 8.6 Programming Demo](#)
- ◆ [Linux Programming Demo](#)

Programming Instructions

This section introduces the problems that might occur during the programming process as well as their solutions. If these problems occur, please solve them according to the corresponding instructions.

1. When you use a working environment built via network, it is recommended that you build a pure local network environment.
2. If the local network environment is complicated (such as it contains lots of devices and broadcast messages), it is recommended that you add some fault tolerance during the programming process. For the details, refer to the instrument write/read operations with exception handling functions "[InstrWriteEx\(\)](#)" and "[InstrReadEx\(\)](#)" in "[Visual C++ 6.0 Programming Demo](#)".
3. The number of the Socket programming port of this device is 5555.

Programming Preparations

The programming preparations introduced here are only applicable to programming under Windows operation system using Visual C++ 6.0, Visual Basic 6.0 and LabVIEW 8.6 development tools. For the programming preparations under Linux operation system, refer to "[Linux Programming Preparations](#)" in "[Linux Programming Demo](#)".

First make sure your PC has installed the VISA library of NI (download it from <http://www.ni.com/visa/>). Here, the default installation path is C:\Program Files\IVI Foundation\VISA.

The USB interface of the spectrum analyzer is used to communicate with the PC and please use a USB cable to connect the USB Device interface at the rear panel of the spectrum analyzer to the USB interface of the PC.

After successful connection, turn on the instrument. A "**Found New Hardware Wizard**" dialog box appears on the PC. Please follow the instructions to install the "USB Test and Measurement Device (IVI)" (the installation procedures are as follows).

1. Select "Install from a list or specific location (Advanced)";
2. Click "Next";



3. Select "Don't search. I will choose the device to install.";

- 4. Click "Next";

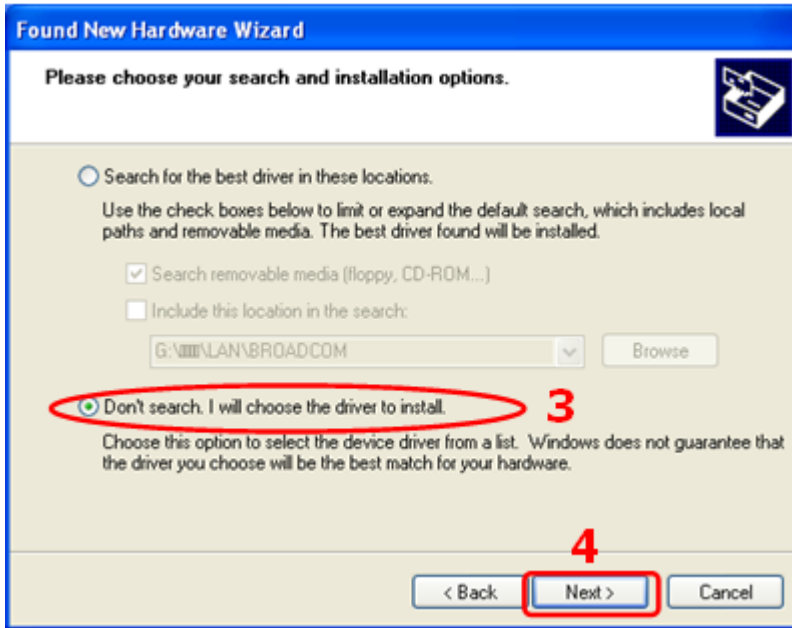

- 5. Select "USB Test and Measurement Device (IVI)";
- 6. Click "Next";



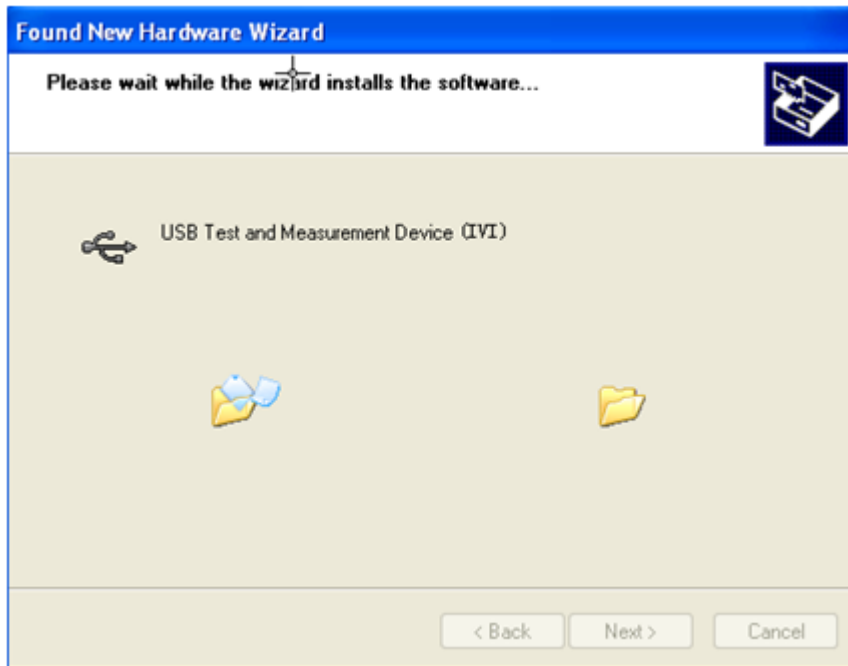

7. When the installation finishes, click "Finish".



By now, the programming preparations are finished. In the following part, the programming demos in Visual C++ 6.0, Visual Basic 6.0 and LabVIEW 8.6 development environments are introduced in detail.

Visual C++ 6.0 Programming Demo

Enter the Visual C++ 6.0 programming environment and follow the steps below.

1. Build a MFC project based on dialog box and name it as DemoForDSA.
2. Open the **Link** tab in **Project** → **Settings** and add **visa32.lib** to the **Object/library modules** manually.

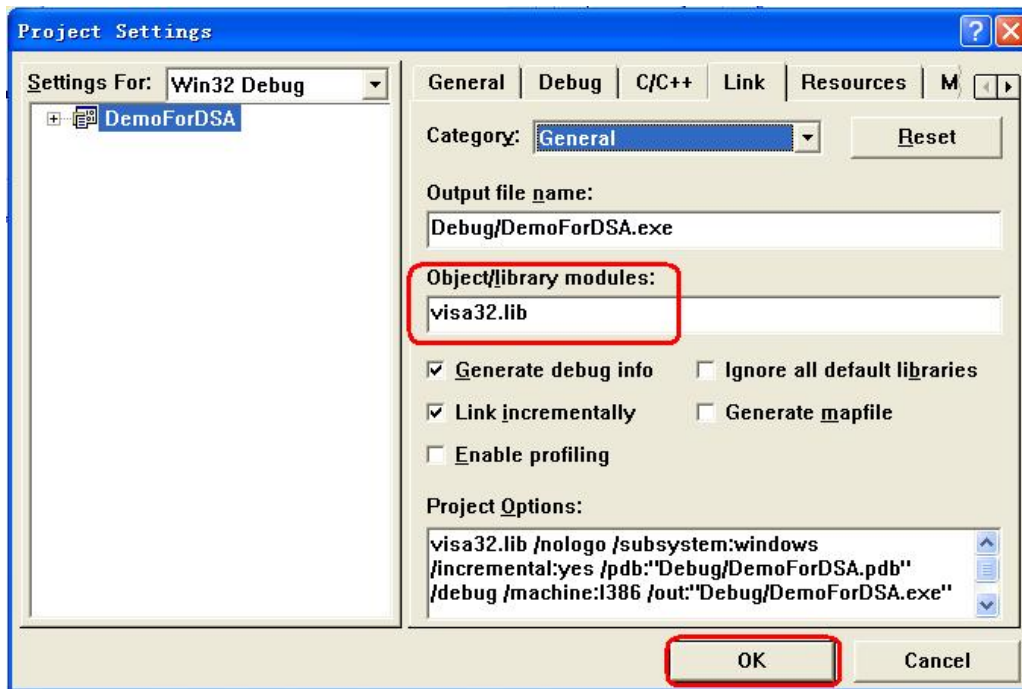

- Open the **Directories** tab in **Tools** → **Options**.
 Select **Include files** in **Show directories for** and double-click at the blank in **Directories** to add the path of **Include**: C:\Program Files\IVI Foundation\VISA\WinNT\include.
 Select **Library files** in **Show directories for** and double-click at the blank in **Directories** to add the path of **Lib**: C:\Program Files\IVI Foundation\VISA\WinNT\lib\msc.

Note: The two paths added here are related to the installation directory of NI-VISA on your PC. Here, NI-VISA is installed under C:\Program Files\IVI Foundation\VISA by default.

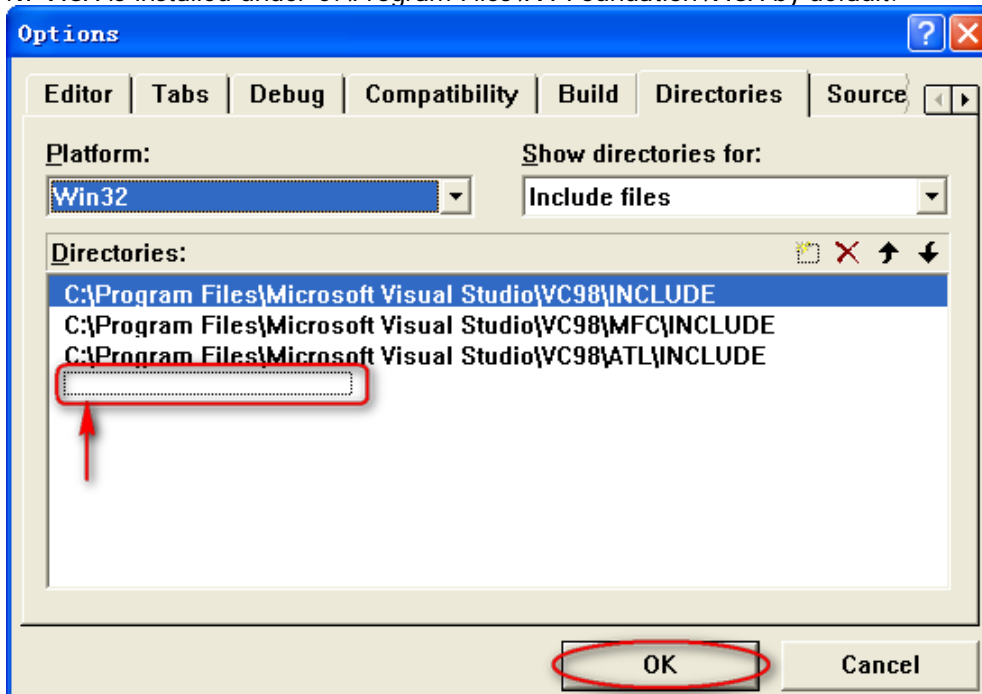

At present, VISA library has been added.

- Add the **Text**, **Edit** and **Button** controls as shown in the figure below.

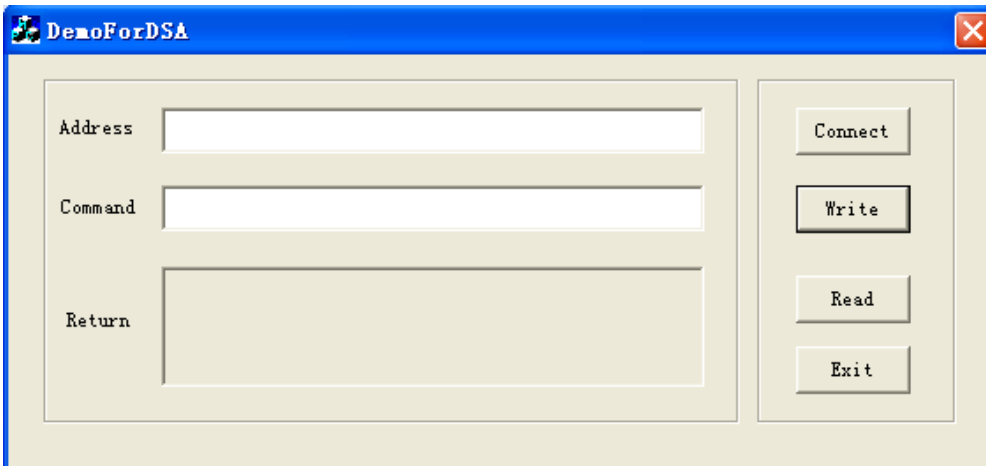

5. Add the control variables.
Open the **Member Variables** tab in **View → ClassWizard** and add the following three variables:
Instrument Address: CString m_strInstrAddr
Command: CString m_strCommand
Return Value: CString m_strResult

6. Encapsulate the read and write operations of VISA.

- 1) Encapsulate the write operation of VISA for easier operation.

```
bool CDemoForDSADlg::InstrWrite(CString strAddr, CString strContent) //Write operation
{
    ViSession defaultRM,instr;
    ViStatus status;
    ViUInt32 retCount;
    char * SendBuf = NULL;
    char * SendAddr = NULL;
    bool bWriteOK = false;
    CString str;

    // Change the address's data style from CString to char*
    SendAddr = strAddr.GetBuffer(strAddr.GetLength());
    strcpy(SendAddr,strAddr);
    strAddr.ReleaseBuffer();

    // Change the command's data style from CString to char*
    SendBuf = strContent.GetBuffer(strContent.GetLength());
    strcpy(SendBuf,strContent);
    strContent.ReleaseBuffer();

    //open a VISA resource
    status = viOpenDefaultRM(&defaultRM);
    if (status < VI_SUCCESS)
    {
        AfxMessageBox("No VISA resource was opened!");
        return false;
    }

    status = viOpen(defaultRM, SendAddr, VI_NULL, VI_NULL, &instr);

    //Write command to the instrument
    status = viWrite(instr, (unsigned char *)SendBuf, strlen(SendBuf), &retCount);
```

- ```

//Close the system
status = viClose(instr);
status = viClose(defaultRM);

return bWriteOK;
}

```
- 2) Encapsulate the read operation of VISA for easier operation.
- ```

bool CDemoForDSADlg::InstrRead(CString strAddr, CString *pstrResult) //Read operation
{
    ViSession defaultRM,instr;
    ViStatus status;
    ViUInt32 retCount;
    char * SendAddr = NULL;
    unsigned char RecBuf[MAX_REC_SIZE];
    bool bReadOK = false;
    CString str;

    // Change the address's data style from CString to char*
    SendAddr = strAddr.GetBuffer(strAddr.GetLength());
    strcpy(SendAddr,strAddr);
    strAddr.ReleaseBuffer();

    memset(RecBuf,0,MAX_REC_SIZE);

    //Open a VISA resource
    status = viOpenDefaultRM(&defaultRM);
    if (status < VI_SUCCESS)
    {
        // Error Initializing VISA...exiting
        AfxMessageBox("No VISA resource was opened!");
        return false;
    }

    //Open the instrument
    status = viOpen(defaultRM, SendAddr, VI_NULL, VI_NULL, &instr);

    //Read from the instrument
    status = viRead(instr, RecBuf, MAX_REC_SIZE, &retCount);

    //close the system
    status = viClose(instr);
    status = viClose(defaultRM);

    (*pstrResult).Format("%s",RecBuf);

    return bReadOK;
}

```
- 3) Encapsulate the the read operation with exception handling function of VISA.
- ```

ViStatus CDemoForDSADlg::OpenVisaDevice(CString strAddr) //Open a VISA device
{
 ViStatus status;
 char * SendAddr = NULL;

 // Change the address's data style from CString to char*
 SendAddr = strAddr.GetBuffer(strAddr.GetLength());
 strcpy(SendAddr,strAddr);

```

```

strAddr.ReleaseBuffer();

//Open a VISA resource
status = viOpenDefaultRM(&m_SessRM);

if (status == 0)
{
 //Open the device
 status = viOpen(m_SessRM, SendAddr, VI_NULL, VI_NULL, &m_SessInstr);

 //If you fails to open the connection, close the resource
 if (status != 0)
 {
 viClose(m_SessRM);
 }
}

return status;
}

ViStatus CDemoForDSADlg::CloseVisaDevice() //Close a VISA device
{
 ViStatus status;

 //Close the device
 status = viClose(m_SessInstr);

 if (status == 0)
 {
 //close the resource
 status = viClose(m_SessRM);
 }

 return status;
}

bool CDemoForDSADlg::InstrWriteEx(CString strAddr, CString strContent) //Write operation with
exception handling
{
 ViStatus status;
 ViUInt32 retCount;
 char * SendBuf = NULL;
 bool bWriteOK = true;

 // Change the address's data style from CString to char*
 SendBuf = strContent.GetBuffer(strContent.GetLength());
 strcpy(SendBuf, strContent);
 strContent.ReleaseBuffer();

 do
 {
 //Write command to the instrument
 status = viWrite(m_SessInstr, (unsigned char *)SendBuf, strlen(SendBuf), &retCount);

 //If an error occurs, perform error handling
 if (status < 0)

```

```

 {
 //If the time exceed the limit value, resend the command after a delay of 1s
 if (VI_ERROR_TMO == status)
 {
 Sleep(1000);
 status = viWrite(m_SessInstr, (unsigned char *)SendBuf, strlen(SendBuf),
 &retCount);
 }
 else
 {
 //If another error occurs, reopen the connection after the connection is closed and
 //resend the command
 status = CloseVisaDevice();
 Sleep(1000);
 status = OpenVisaDevice(m_strInstrAddr);
 if (status == 0)
 {
 status = viWrite(m_SessInstr, (unsigned char *)SendBuf, strlen(SendBuf),
 &retCount);
 }
 }
 }
} while (status < 0);

return bWriteOK;
}

```

bool CDemoForDSADlg::InstrReadEx(CString strAddr, CString \*pstrResult) //Read operation with exception handling

```

{
 ViStatus status;
 ViUInt32 retCount;
 char * SendAddr = NULL;
 unsigned char RecBuf[MAX_REC_SIZE];
 bool bReadOK = true;

 // Change the address's data style from CString to char*
 SendAddr = strAddr.GetBuffer(strAddr.GetLength());
 strcpy(SendAddr, strAddr);
 strAddr.ReleaseBuffer();

 memset(RecBuf, 0, MAX_REC_SIZE);

 do
 {
 //Read from the instrument
 status = viRead(m_SessInstr, RecBuf, MAX_REC_SIZE, &retCount);
 if (status < 0)
 {
 //If the time exceed the limit value, read from the instrument after a delay of 1s
 if (VI_ERROR_TMO == status)
 {
 Sleep(1000);
 status = viRead(m_SessInstr, RecBuf, MAX_REC_SIZE, &retCount);
 }
 else
 {

```

```

 //If another error occurs, reopen the connection after the connection is closed and
 //reread from instrument
 status = CloseVisaDevice();
 Sleep(1000);
 status = OpenVisaDevice(m_strInstrAddr);
 if (status == 0)
 {
 status = viRead(m_SessInstr, RecBuf, MAX_REC_SIZE, &retCount);
 }
 }
}

} while (status < 0);

(*pstrResult).Format("%s",RecBuf);

return bReadOK;
}

```

7. Add the control message response codes.

1) Connect to the instrument

```

void CDemoForDSADlg::OnBtConnectInstr() // Connect to the instrument
{
 // TODO: Add your control notification handler code here
 ViStatus status;
 ViSession defaultRM;
 ViString expr = "?*";
 ViPFindList findList = new unsigned long;
 ViPUInt32 retcnt = new unsigned long;
 ViChar instrDesc[1000];
 CString strSrc = "";
 CString strInstr = "";
 unsigned long i = 0;
 bool bFindDSA = false;

 status = viOpenDefaultRM(&defaultRM);
 if (status < VI_SUCCESS)
 {
 // Error Initializing VISA...exiting
 MessageBox("No VISA instrument was opened ! ");
 return ;
 }

 memset(instrDesc,0,1000);

 // Find resource
 status = viFindRsrc(defaultRM,expr,findList, retcnt, instrDesc);

 for (i = 0;i < (*retcnt);i++)
 {
 // Get instrument name
 strSrc.Format("%s",instrDesc);
 InstrWrite(strSrc,"*IDN?");
 ::Sleep(200);
 InstrRead(strSrc,&strInstr);

 // If the instrument(resource) belongs to the DSA series then jump out //from the loop
 }
}

```



```

 strInstr.MakeUpper();
 if (strInstr.Find("DSA") >= 0)
 {
 bFindDSA = true;
 m_strInstrAddr = strSrc;
 break;
 }

 //Find next instrument
 status = viFindNext(*findList,instrDesc);
 }

 if (bFindDSA == false)
 {
 MessageBox("Didn't find any DSA!");
 }
 UpdateData(false);
}

2) Write Operation
void CDemoForDSADlg::OnBtWrite() //Write operation
{
 // TODO: Add your control notification handler code here
 UpdateData(true);
 if (m_strInstrAddr.IsEmpty())
 {
 MessageBox("Please connect to the instrument first!");
 }
 InstrWrite(m_strInstrAddr,m_strCommand);
 m_strResult.Empty();
 UpdateData(false);
}

3) Read Operation
void CDemoForDSADlg::OnBtRead() //Read operation
{
 // TODO: Add your control notification handler code here
 UpdateData(true);
 InstrRead(m_strInstrAddr,&m_strResult);
 UpdateData(false);
}

8. Execution Result
1) Click "Connect" to search for the spectrum analyzer;
2) Input "*IDN?" in the "Command" edit box;
3) Click "Write" to write the command into the spectrum analyzer;
4) Click "Read" to read the return value.

```

The execution result is as shown in the figure below.

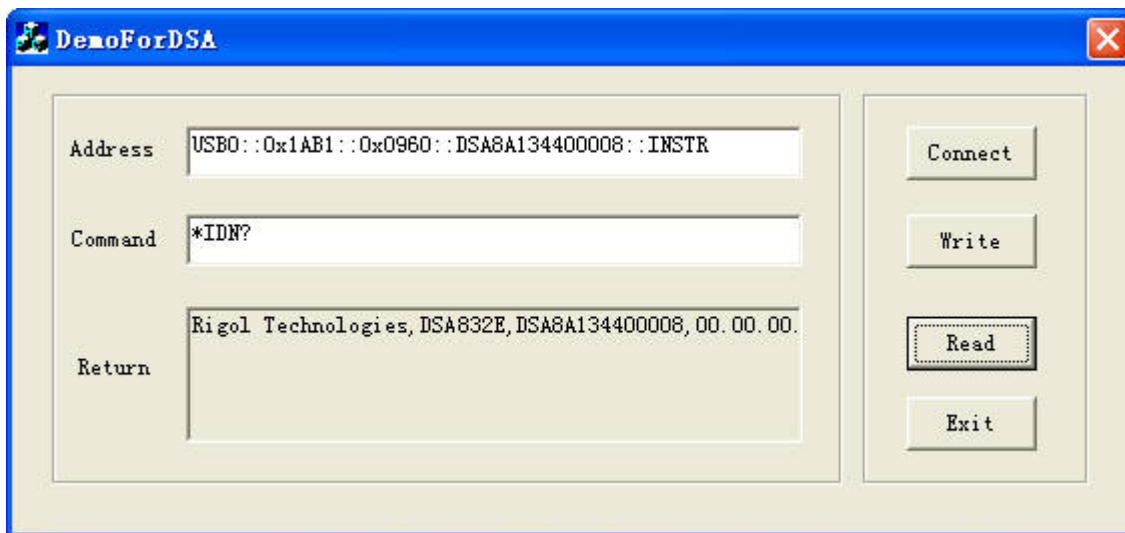

## Visual Basic 6.0 Programming Demo

Enter the Visual Basic 6.0 programming environment and follow the steps below.

1. Build a standard application program project (Standard EXE) and name it as DemoForDSA.
2. Open **Project** → **Add File...** . Search for the **visa32.bas** file under the **include** folder under the installation path of NI-VISA and add the file which contains all VISA functions and constant statements to the project.

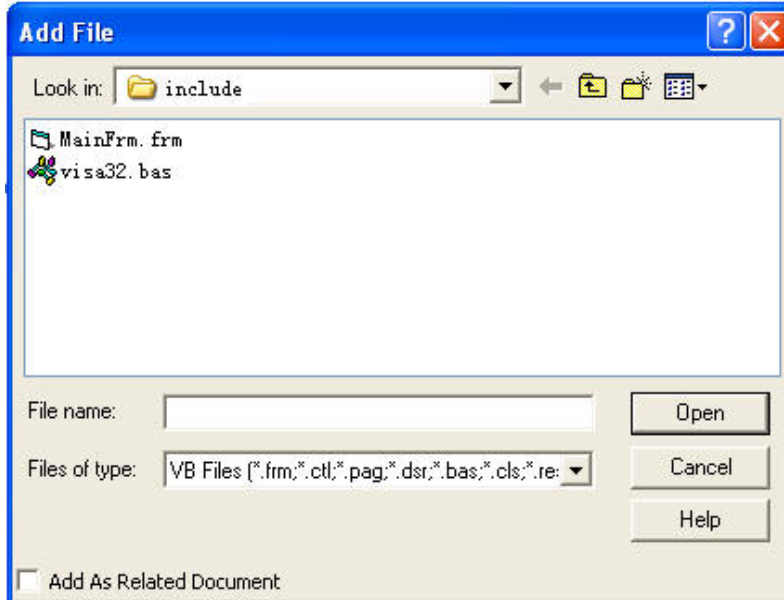

Then add the **Declare Sub Sleep Lib "kernel32" (ByVal dwMilliseconds As Long) statement** into the **visa32.bas**, or create a new module to declare the **Sleep** function.

3. Add the **Label**, **Text** and **Button** controls as shown in the figure below.



4. Encapsulate the write and read operations of VISA.
  - 1) Encapsulate the write operation of VISA for easier operation.

```

'-----
'Function Name: InstrWrite
'Function: Send command to the instrument
'Input: rsrcName,instrument(resource) name
strCmd,Command
'-----
Public Sub InstrWrite(rsrcName As String, strCmd As String)
 Dim status As Long

```

```

Dim dfltRM As Long
Dim sesn As Long
Dim rSize As Long

'Initialize the system
status = viOpenDefaultRM(dfltRM)
'Failed to initialize the system
If (status < VI_SUCCESS) Then
 MsgBox " No VISA resource was opened!"
 Exit Sub
End If
'Open the VISA instrument
status = viOpen(dfltRM, rsrcName, VI_NULL, VI_NULL, sesn)
'Failed to open the instrument
If (status < VI_SUCCESS) Then
 MsgBox "Failed to open the instrument!"
 Exit Sub
End If

'Write command to the instrument
status = viWrite(sesn, strCmd, Len(strCmd), rSize)
'Failed to write to the instrument
If (status < VI_SUCCESS) Then
 MsgBox " Failed to write to the instrument!"
 Exit Sub
End If

'Close the system
status = viClose(sesn)
status = viClose(dfltRM)

End Sub

```

- 2) Encapsulate the read operation of VISA for easier operation.

```

'-----
'Function Name: InstrRead
'Function: Read the return value from the instrument
'Input: rsrcName, Resource name
'Return: The string gotten from the instrument
'-----
Public Function InstrRead(rsrcName As String) As String
 Dim status As Long
 Dim dfltRM As Long
 Dim sesn As Long
 Dim strTemp0 As String * 256
 Dim strTemp1 As String
 Dim rSize As Long

 'Begin by initializing the system
 status = viOpenDefaultRM(dfltRM)
 'Initial failed
 If (status < VI_SUCCESS) Then
 MsgBox " Failed to open the instrument! "
 Exit Function
 End If
 'Open the instrument
 status = viOpen(dfltRM, rsrcName, VI_NULL, VI_NULL, sesn)

```

```

'Open instrument failed
If (status < VI_SUCCESS) Then
 MsgBox " Failed to open the instrument! "
 Exit Function
End If

' Read from the instrument
status = viRead(sesn, strTemp0, 256, rSize)
' Read failed
If (status < VI_SUCCESS) Then
 MsgBox " Failed to read from the instrument! "
 Exit Function
End If

'Close the system
status = viClose(sesn)
status = viClose(dfiltRM)

' Remove the space at the end of the string
strTemp1 = Left(strTemp0, rSize)
InstrRead = strTemp1
End Function

```

5. Add the control event codes.

- 1) Connect to the instrument

```

' Connect to the instrument
Private Sub CmdConnect_Click()
 Const MAX_CNT = 200
 Dim status As Long
 Dim dfiltRM As Long
 Dim sesn As Long
 Dim fList As Long
 Dim buffer As String * MAX_CNT, Desc As String * 256
 Dim nList As Long, retCount As Long
 Dim rsrcName(19) As String * VI_FIND_BUFLen, instrDesc As String * VI_FIND_BUFLen
 Dim i, j As Long
 Dim strRet As String
 Dim bFindDSA As Boolean

' Initialize the system
status = viOpenDefaultRM(dfiltRM)
' Initialize failed
If (status < VI_SUCCESS) Then
 MsgBox " No VISA resource was opened !"
 Exit Sub
End If

' Find instrument resource
Call viFindRsrc(dfiltRM, "USB?*INSTR", fList, nList, rsrcName(0))
' Get the list of the instrument(resource)
strRet = ""
bFindDSA = False
For i = 0 To nList - 1
 ' Get the instrument name
 InstrWrite rsrcName(i), "*IDN?"
 Sleep 200
 strRet = InstrRead(rsrcName(i))

```

```

' Continue to switch the resource until find a DSA instrument
strRet = UCase(strRet)
j = InStr(strRet, "DSA")
If (j >= 0) Then
 bFindDSA = True
 Exit For
End If

Call viFindNext(fList + i - 1, rsrcName(i))
Next i
'Display
If (bFindDSA = True) Then
 TxtInsAddr.Text = rsrcName(i)
Else
 TxtInsAddr.Text = ""
End If
End Sub

```

## 2) Write Operation

'Write the command to the instrument

```

Private Sub CmdWrite_Click()
 If (TxtInsAddr.Text = "") Then
 MsgBox ("Please write the instrument address!")
 End If

```

```

InstrWrite TxtInsAddr.Text, TxtCommand.Text
End Sub

```

## 3) Read Operation

'Read the return value from the instrument

```

Private Sub CmdRead_Click()
 Dim strTemp As String
 strTemp = InstrRead(TxtInsAddr.Text)
 TxtReturn.Text = strTemp
End Sub

```

## 6. Execution Result

- 1) Click "Connect" to search for the spectrum analyzer;
- 2) Input "\*IDN?" in the "Command" edit box;
- 3) Click "Write" to write the command into the spectrum analyzer;
- 4) Click "Read" to read the return value.

The execution result is as shown in the figure below.

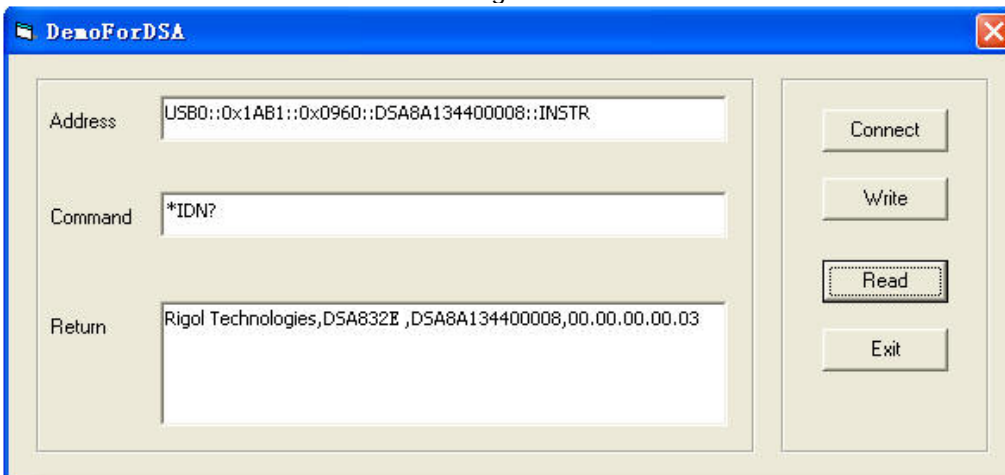

## LabVIEW 8.6 Programming Demo

Enter the Labview 8.6 programming environment and follow the steps below.

1. Create a new VI file and name it as DemoForDSA LV86.
2. Add controls in the front panel interface, including the **Address** bar, **Command** bar and **Return** bar as well as the **Connect**, **Write**, **Read** and **Exit** buttons.

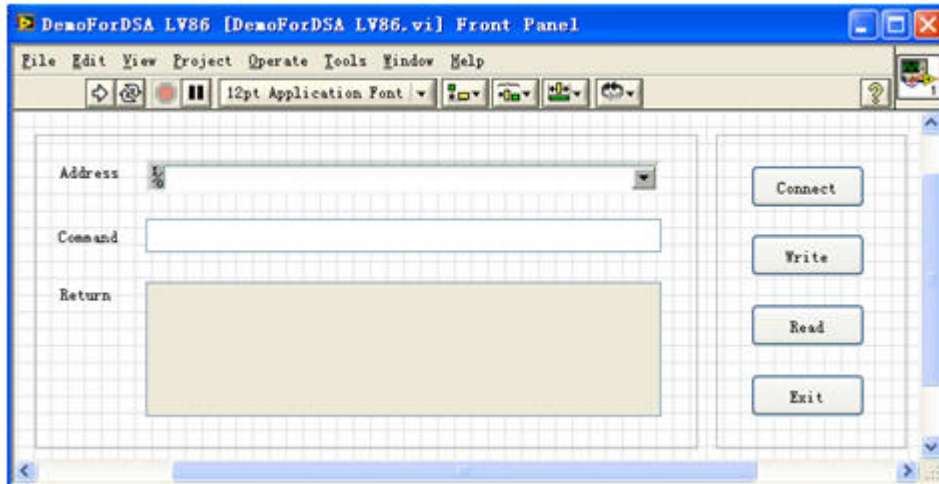

3. Create the event structure in **Show block Diagram** under the **Window** menu.

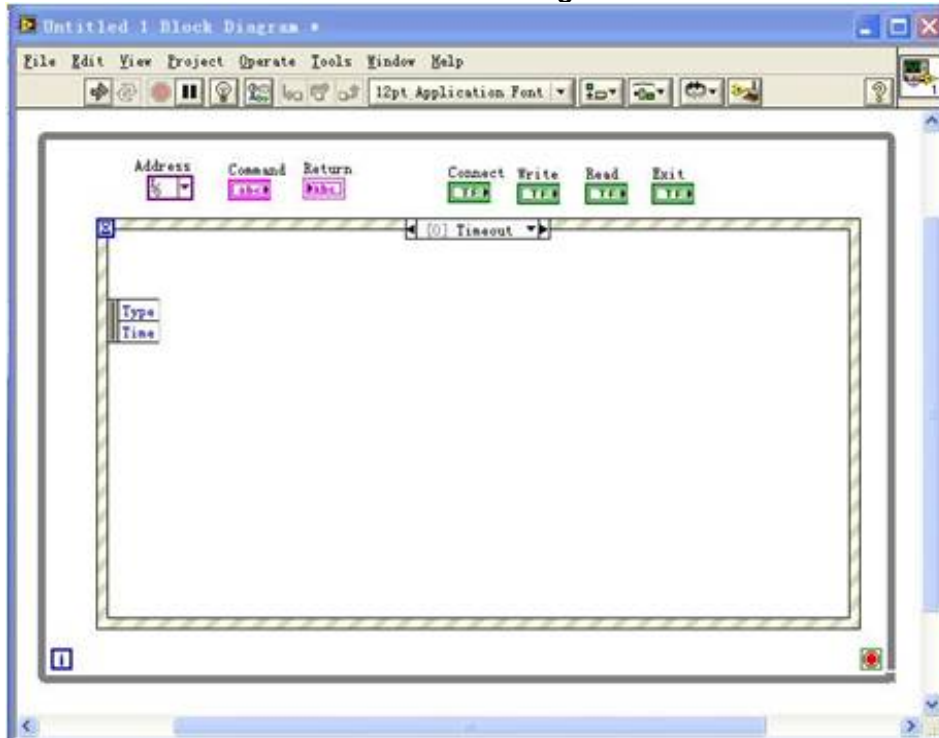

4. Add the events (including connect to the instrument, write operation, read operation and exit).
  - 1) Connect to the instrument

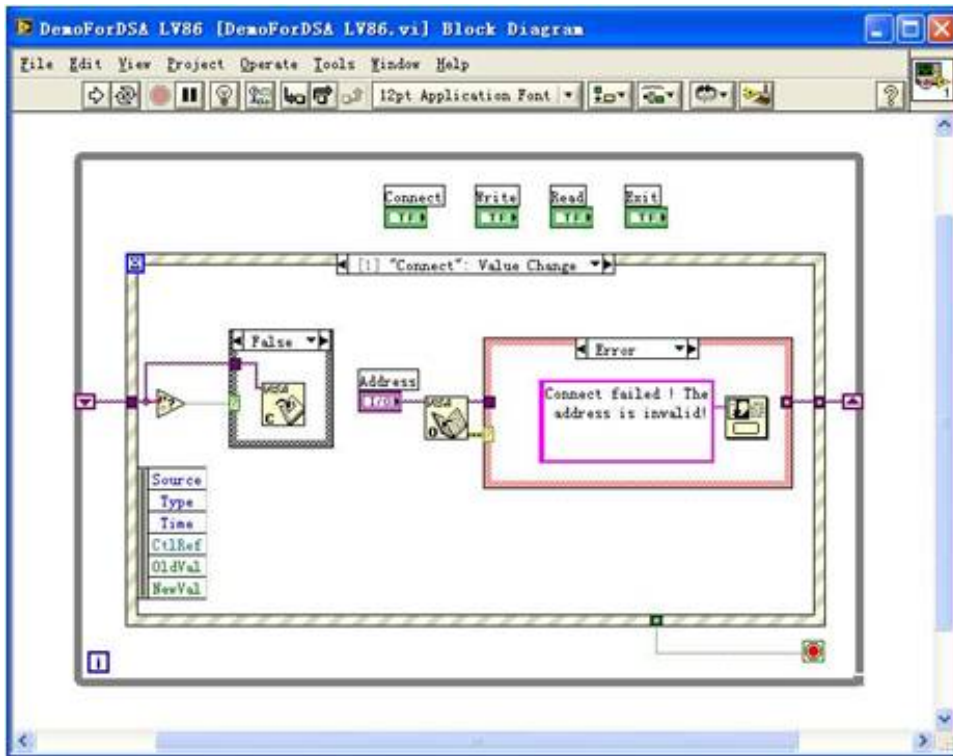

2) Write operation (include error judgment)

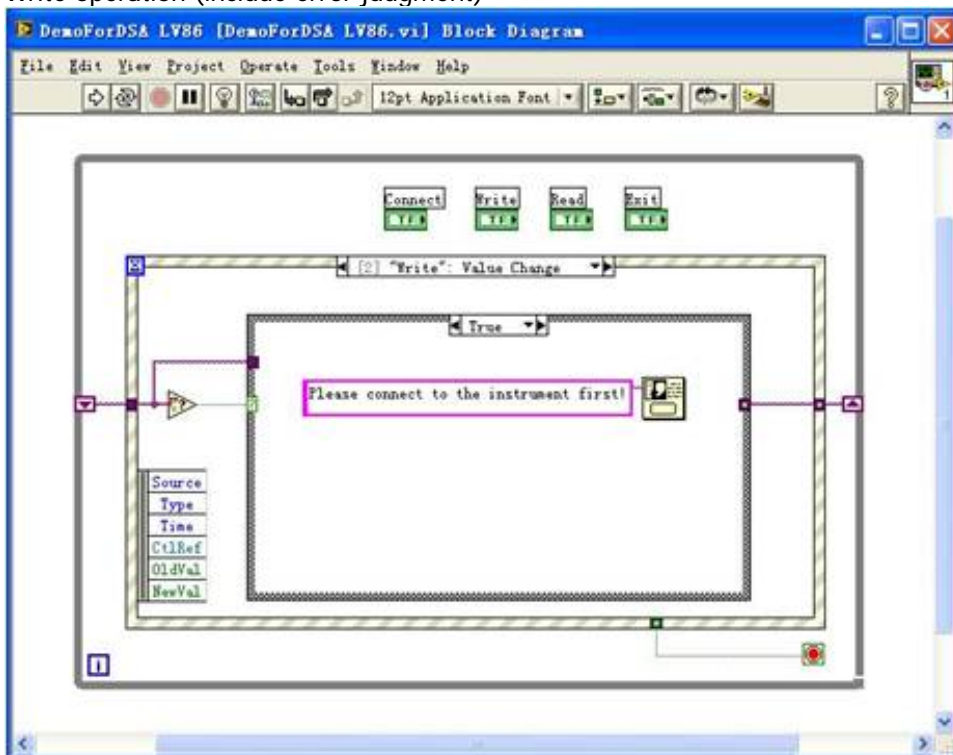



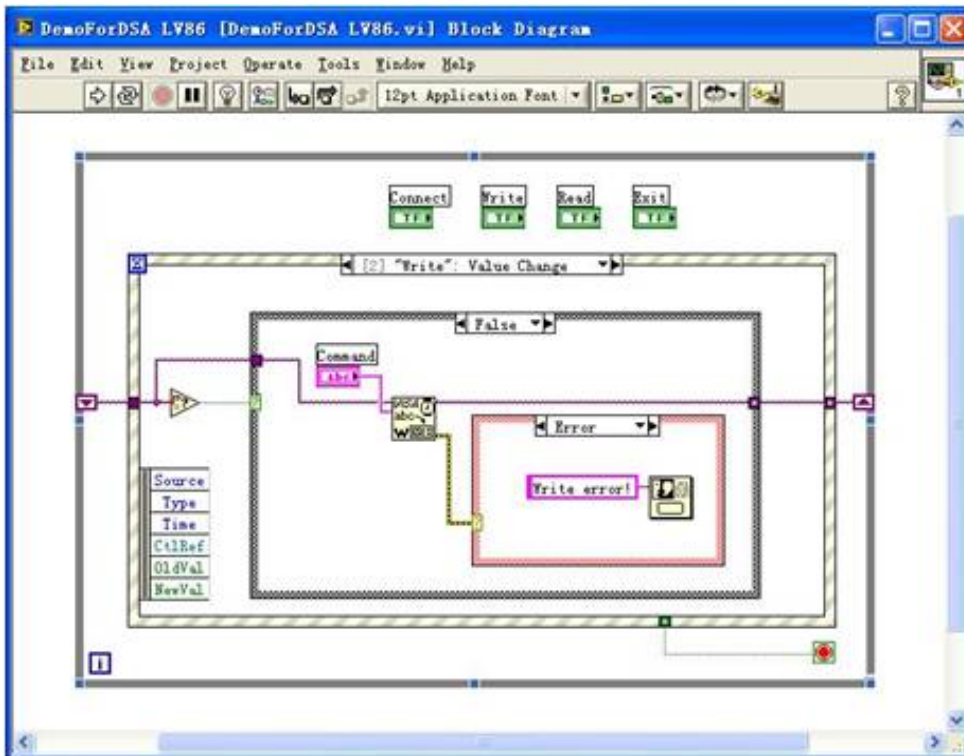

3) Read operation (include error processing)

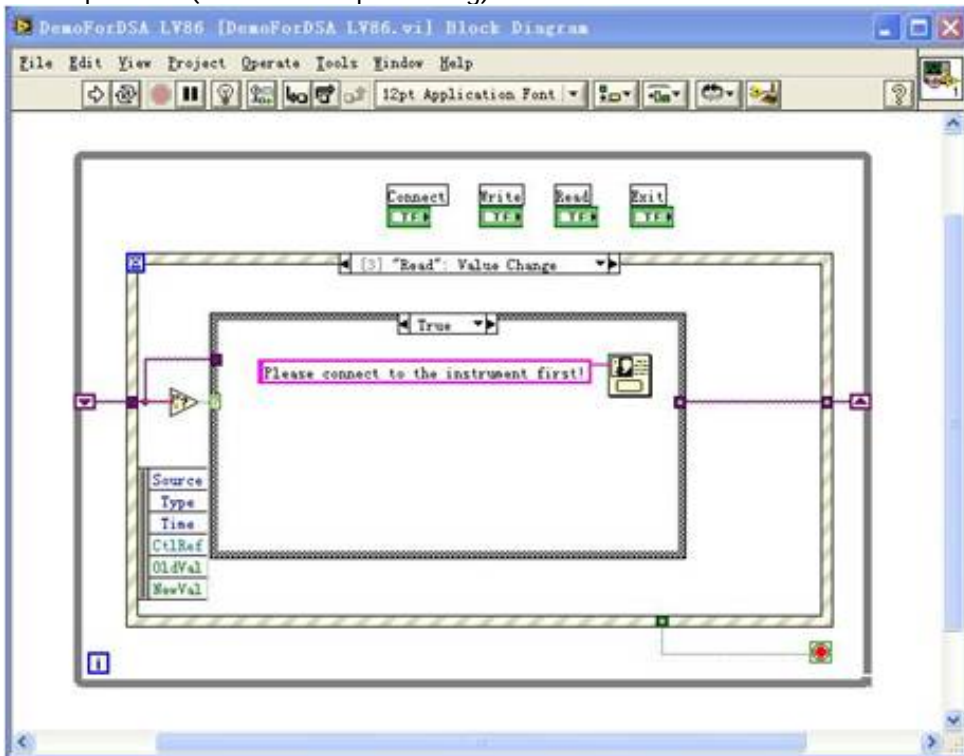

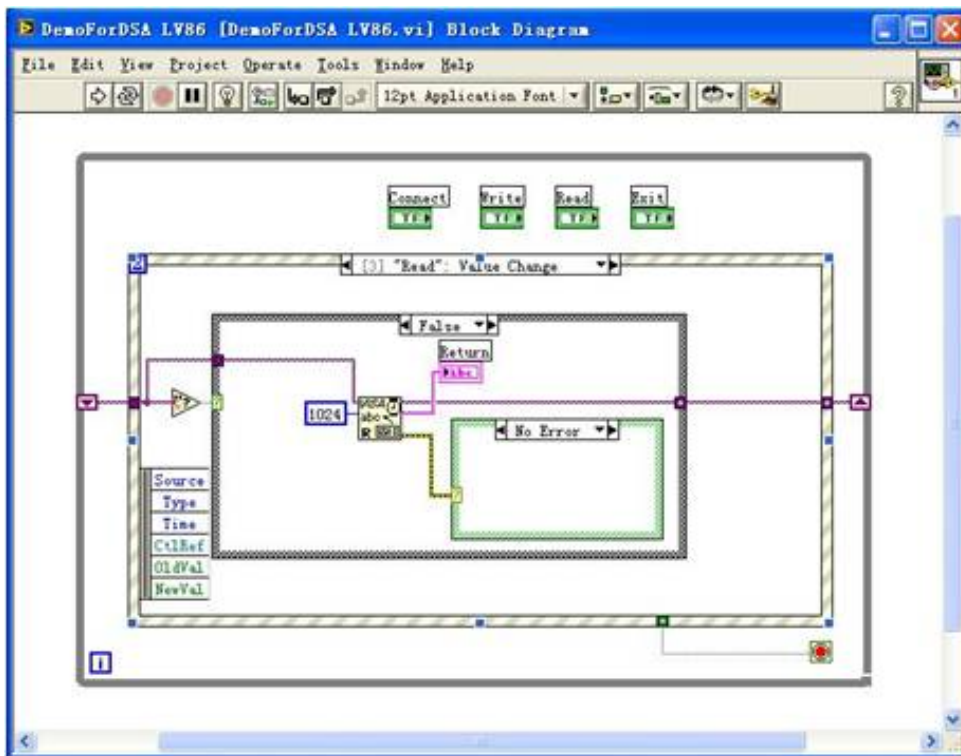

## 4) Exit

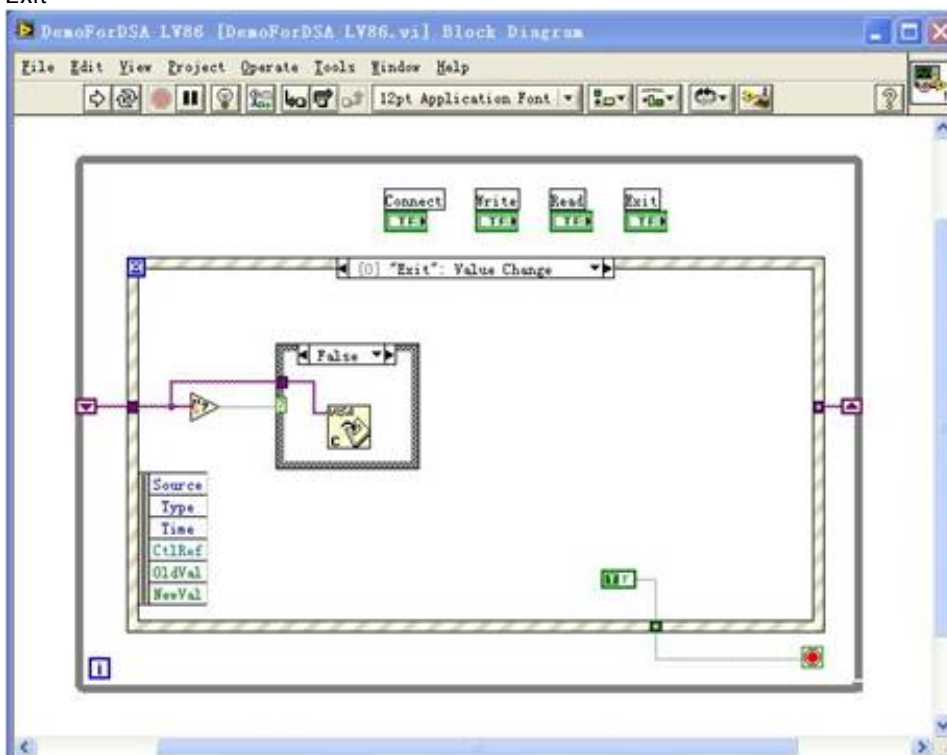

- 5) Run the program and the interface as shown below is displayed. Click the **Address** dropdown box and select the VISA resource name. Click **Connect** to connect the instrument, input the command in the **Command** box and click **Write** to write the command into the instrument. If a query command is used (for example, \*IDN?), click **Write** to write the command into the instrument and click **Read**; the return value is displayed in the **Return** box. Click **Exit** to exit the program.

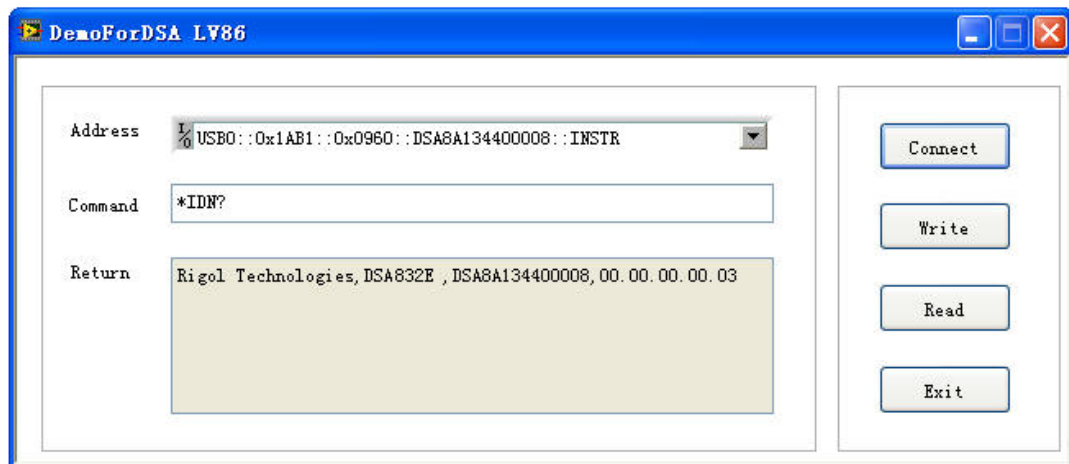

## Linux Programming Demo

This section illustrates how to program and control the spectrum analyzer to realize the common functions under Linux operation system.

### Linux Programming Preparations

1. programming environment used here:  
Operation System: Fedroa 8 (Linux-2.6.23)  
GCC Version: gcc-4.1.2
2. Install the VISA library: make sure your PC has installed the VISA library of NI (download it from <http://www.ni.com/visa/>). The installation procedures are as follows.  
First download the VISA library **NI-VISA-4.4.0.ISO** from the NI network.

Create a new directory

```
#mkdir NI_VISA
```

Mount the iso file

```
#mount -o loop -t iso9660 NI-VISA-4.4.0.iso NI_VISA
```

Enter the NI\_VISA directory to install

```
#cd NI_VISA
```

```
#./INSTALL
```

Unmount the iso file

```
#umount NI_VISA
```

After the installation is finished, the default installation path is **/usr/local**.

3. Here, the LAN interface of the spectrum analyzer is used to communicate with the PC. Please use a network cable to connect the LAN interface at the rear panel of the spectrum analyzer with the LAN interface of the PC. You can also use a network cable to connect the spectrum analyzer to the local area network of the PC.

After the spectrum analyzer is correctly connected to the PC, configure the network address of the spectrum analyzer to make it be within the same network segment with the network address of the PC. For example, if the network address and DNS setting of the PC are as shown in the figures below, the network address of the spectrum analyzer should be configured as follows.

IP Address: 172.16.3.X\*

Default Gateway: 172.16.3.1

Subnet Mask: 255.255.255.0

DNS: 172.16.2.2

Remark\*: X can be any value between 2 and 254 that has not been used.

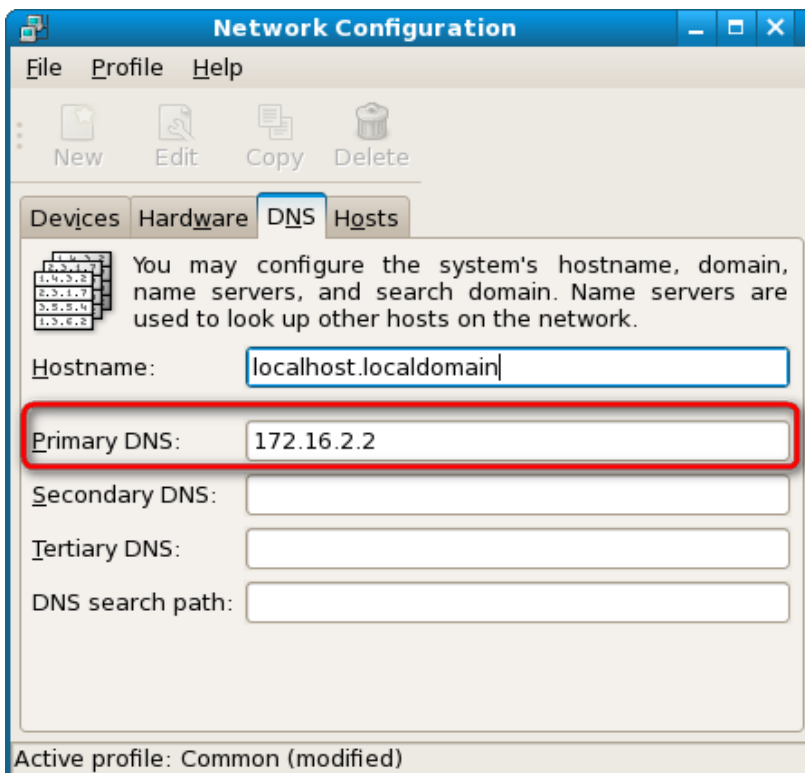
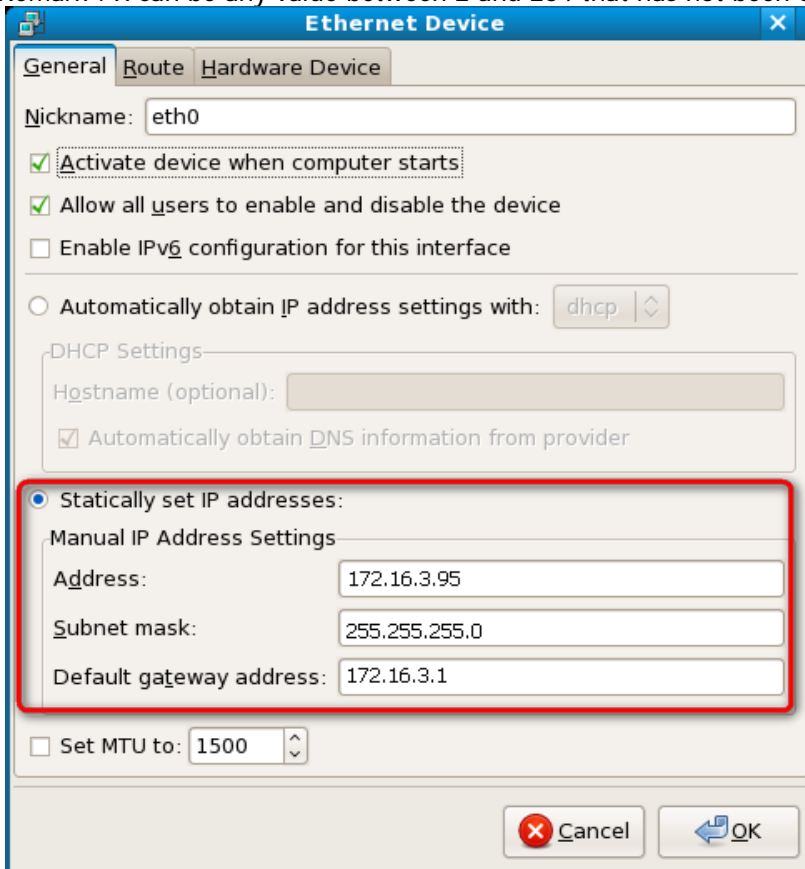

4. Use any of the two methods below to add the library location to the search path of the library so that the program can load the library file installed automatically.



## Linux Programming Procedures

1. Edit the **DemoForDSA.h** header file and declare a class to encapsulate the operation and property of the instrument.

```
#ifndef DEMO_FOR_DSA_H
#define DEMO_FOR_DSA_H

#include <stdio.h>
#include <string.h>
#include <stdlib.h>
#include <iostream>
// #include <syswait.h>
using namespace std;

#define MAX_SEND_BUF_SIZE 50
#define MAX_REC_SIZE 300

class DemoForDSA
{
// Construction
public:
DemoForDSA();
bool InstrRead(string strAddr, string & pstrResult);
bool InstrWrite(string strAddr, string strContent);
bool ConnectInstr();

string m_strInstrAddr;
string m_strResult;
string m_strCommand;

};

void makeupper(string & instr);

#endif
```

2. Edit the **DemoForDSA.cpp** file to realize various operations of the instrument.

```
#include "visa.h"
#include "DemoForDSA.h"

DemoForDSA::DemoForDSA()
{
m_strInstrAddr = "";
m_strResult = "";
m_strCommand = "";
}

bool DemoForDSA::ConnectInstr()

{
ViUInt32 retCount;
ViStatus status;
ViSession defaultRM;
ViString expr = "?*";
ViPFindList findList = new unsigned long;
ViPUInt32 retcnt = new unsigned long;
string strSrc = "";
```

```

string strInstr = "";
ViChar instrDesc[1000];

unsigned long i = 0;
bool bFindDSA = false;
memset(instrDesc,0,1000);

//Turn on the VISA device
status = viOpenDefaultRM(&defaultRM);

if (status < VI_SUCCESS)
{
 cout<<"No VISA equipment!"<<endl;
 return false;
}

//Search for resource
status = viFindRsrc(defaultRM,expr,findList, retcnt, instrDesc);

for (i = 0;i < (*retcnt);i++)
{
 //Acquire the instrument name
 strSrc=

 InstrWrite(strSrc,"*IDN?");
 usleep(200);
 InstrRead(strSrc,strInstr);

 //If the instrument is DSA series, the desired instrument is found and exit
 makeupper(strInstr);
 if (strInstr.find("DSA",0) > 0)
 {
 bFindDSA = true;
 m_strInstrAddr = strSrc;
 break;
 }

 //Acquire the next device
 status = viFindNext(*findList,instrDesc);
}

if (bFindDSA == false)
{
 printf("DSA device not found!\n");
 return false;
}

return true;
}

bool DemoForDSA::InstrWrite(string strAddr, string strContent) //Write operation
{
ViSession defaultRM,instr;
ViStatus status;
ViUInt32 retCount;
char * SendBuf = NULL;
char * SendAddr = NULL;
bool bWriteOK = false;

```

```

string str;

 //Address conversion, convert the strig type to char*
SendAddr = const_cast<char*>(strAddr.c_str());

 //Address conversion, convert the strig type to char*
SendBuf = const_cast<char*>(strContent.c_str());

//Turn on the actual device
status = viOpenDefaultRM(&defaultRM);
if (status < VI_SUCCESS)
{
 cout<<"No VISA equipment!"<<endl;
 return false;
}

status = viOpen(defaultRM, SendAddr, VI_NULL, VI_NULL, &instr);

//Write command into the device
status = viWrite(instr, (unsigned char *)SendBuf, strlen(SendBuf), &retCount);

 //Turn off the device
status = viClose(instr);
status = viClose(defaultRM);
return bWriteOK;
}

bool DemoForDSA::InstrRead(string strAddr, string & pstrResult) //Instrument reads
{
ViSession defaultRM,instr;
ViStatus status;
ViUInt32 retCount;
char* SendAddr = NULL;
char * result = NULL;
bool bReadOK = false;
unsigned char RecBuf[MAX_REC_SIZE];
string str;
memset(RecBuf,0,MAX_REC_SIZE);

result=(char*)malloc(MAX_REC_SIZE*sizeof(char));
memset(result,0,MAX_REC_SIZE);

//Address conversion, convert the strig type to char*
SendAddr=const_cast<char*>(strAddr.c_str());

//Turn on the VISA device
status = viOpenDefaultRM(&defaultRM);
if (status < VI_SUCCESS)
{
 // Error Initializing VISA...exiting
 cout<<"No VISA equipment!"<<endl;
 return false;
}

 //Turn on the actual device□
status = viOpen(defaultRM, SendAddr, VI_NULL, VI_NULL, &instr);

//Read the device□

```



```

status = viRead(instr, RecBuf, MAX_REC_SIZE, &retCount);

 //Turn off the device
status = viClose(instr);
status = viClose(defaultRM);
sprintf(result, "%s", RecBuf);
pstrResult = result;
free(result);
return bReadOK;
}

```

```

void makeupper(string &instr)
{
 string outstr = "";
 if(instr == "")
 {
 exit(0);
 }

 for(int i = 0; i < instr.length(); i++)
 {
 instr[i] = toupper(instr[i]);
 }
}

```

3. Edit the function file **mainloop.cpp** to complete the flow control.

```
#include "DemoForDSA.h"
```

```

void menudisplay()
{
 cout<<"\t\t Please operate the instrument:\n read write quit" <<endl;
}

int main()
{
 DemoForDSA demo;
 char temp[50];
 if(!demo.ConnectInstr())
 {
 cout<<"can not connect the equipment!" <<endl;
 return 0;
 }
 else
 {
 cout<<"\n connect equipment success!" <<endl;
 cout<<" the equipment address is : " <<demo.m_strInstrAddr<<endl;
 }

 while(1)
 {
 menudisplay();
 //cin>>demo.m_strCommand;
 cin.getline(temp,50);
 demo.m_strCommand=
 if(demo.m_strCommand[0]='r' && demo.m_strCommand[1]='e'

```

```

 && demo.m_strCommand[2]='a' && demo.m_strCommand[3]='d')
 {
 //demo.InstrWrite(demo.m_strInstrAddr,"*IDN?");
 //demo.InstrRead(demo.m_strInstrAddr,demo.m_strResult);
 cout<<"read result:"<<demo.m_strResult<<endl;
 demo.m_strResult="";
 }

else if (demo.m_strCommand[0]='w' && demo.m_strCommand[1]='r'
 && demo.m_strCommand[2]='i' && demo.m_strCommand[3]='t' &&
demo.m_strCommand[4]='e')
 {
 if (demo.m_strInstrAddr="")
 {
 cout<<"Please connect the instrument!\n";
 }
 demo.InstrWrite(demo.m_strInstrAddr,demo.m_strCommand.substr(5,40));
 usleep(200);

 //Read the instrument
 demo.InstrRead(demo.m_strInstrAddr,demo.m_strResult);
 }

else if (demo.m_strCommand[0] == 'q' && demo.m_strCommand[1] == 'u'
 && demo.m_strCommand[2] == 'i' && demo.m_strCommand[3] == 't')
 {
 break;
 }
else if(demo.m_strCommand != "")
 {
 cout<<"Bad command!"<<endl;
 }
}
return 1;
}
}

```

#### 4. **makefile** file

```
src = DemoForDSA.cpp mainloop.cpp DemoForDSA.h
```

```
obj = DemoForDSA.o mainloop.o
```

```
INCLUDE= -I/usr/local/vxipnp/linux/include
```

```
LIB= -lvisa -lc -lpthread
```

```
CC=
```

```
demo : $(obj)
```

```
 $(CC) $(INCLUDE) $(LIB) -o demo $(obj)
```

```
mainloop.o : mainloop.cpp DemoForDSA.h
```

```
 $(CC) -c $< -o $@
```

```
DemoForDSA.o: DemoForDSA.cpp DemoForDSA.h
```

```
 $(CC) -c $< -o $@
```

```
.PHONY : clean
```

```
clean:
```

```
rm demo $(obj)
```

#### 5. Execution Result

- 1) #make
- 2) ./demo
- 3) When the program runs, the instrument is connected automatically. If no instrument is found, "No VISA equipment!" is displayed and the system exits the program. If the instrument is found and successfully connected, the interface as shown in the figure below is displayed.
- 4) Input **write<command>** (for example, **write< \*IDN?>**) to write the command into the spectrum analyzer.
- 5) Input **read** to read the return value as shown in the figure below.

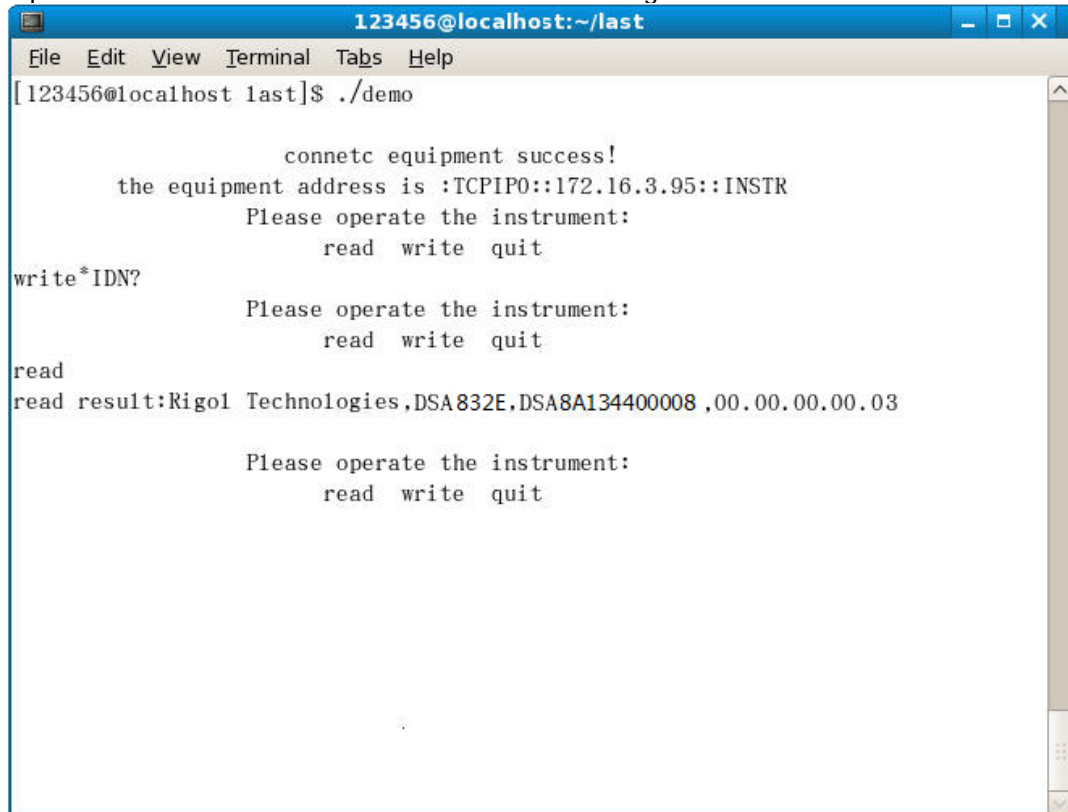

```
123456@localhost:~/last
File Edit View Terminal Tabs Help
[123456@localhost last]$./demo

 connetc equipment success!
the equipment address is :TCPIP0::172.16.3.95::INSTR
Please operate the instrument:
 read write quit
write*IDN?
 Please operate the instrument:
 read write quit
read
read result:Rigol Technologies,DSA832E,DSA8A134400008 ,00.00.00.00.03

 Please operate the instrument:
 read write quit
```