



2438

Series Microwave Power Meter User Manual



China Electronics Technology Instruments Co., Ltd

This manual is applicable to the following microwave power meters:

- 2438CA microwave power meter (CW single channel).
- 2438CB microwave power meter (CW double channel).
- 2438PA microwave power meter (CW/peak single channel).
- 2438PB microwave power meter (CW/peak double channel).

Options for 2348 series microwave power meter are as follows:

- 2438-001, 71710A CW power sensor, with a frequency range of 9 kHz~12 GHz and a power range of - 60 dBm~+ 20 dBm.
- 2438-002, 71710D CW power sensor, with a frequency range of 10 MHz~18 GHz and a power range of - 70 dBm~+ 20 dBm.
- 2438-003, 71710E CW power sensor, with a frequency range of 50 MHz~26.5 GHz and a power range of - 70 dBm~+ 20 dBm.
- 2438-004, 71710F CW power sensor, with a frequency range of 50 MHz~40 GHz and a power range of - 70 dBm~+ 20 dBm.
- 2438-005, 71710L CW power sensor, with a frequency range of 50 MHz~67 GHz and a power range of - 70 dBm~+ 20 dBm.
- 2438-006, 81702D peak power sensor, with a frequency range of 50 MHz~18 GHz, a pulse power range of - 20 dBm~+ 20 dBm and Rise time less than or equal to 10 ns.
- 2438-007, 81702E peak power sensor, with a frequency range of 500 MHz~26.5 GHz, a pulse power range of - 20 dBm~+ 20 dBm and Rise time less than or equal to 10 ns.
- 2438-008, 81702F peak power sensor, with a frequency range of 500 MHz~40 GHz, a pulse power range of - 20 dBm~+ 20 dBm and Rise time less than or equal to 10 ns.
- 2438-009, 81702L peak power sensor, with a frequency range of 500 MHz~67 GHz, a pulse power range of - 20 dBm~+ 20 dBm and Rise time less than or equal to 10 ns.
- 2438-010, 81703D peak power sensor, with a frequency range of 50 MHz~18 GHz, a pulse power range of - 40 dBm~+ 20 dBm and Rise time less than or equal to 100 ns.
- 2438-011, 81703E peak power sensor, with a frequency range of 500 MHz~26.5 GHz, a pulse power range of - 40 dBm~+ 20 dBm and Rise time less than or equal to 100 ns.
- 2438-012, 81703F peak power sensor, with a frequency range of 500 MHz~40 GHz, a pulse power range of - 40 dBm~+ 20 dBm and Rise time less than or equal to 100 ns.
- 2438-013, 81703L peak power sensor, with a frequency range of 500 MHz~67 GHz, a pulse power range of - 40 dBm~+ 20 dBm and Rise time less than or equal to 100 ns.
- 2438-030, 71716 MMW power sensor, with a frequency range of 50 GHz~75 GHz and a power range of - 30 dBm~+ 20 dBm.
- 2438-031, 71717 MMW power sensor, with a frequency range of 75GHz~110GHz and a power range of - 30 dBm~+ 20 dBm.
- 2438-032, 71718 MMW (THz) power sensor, with a frequency range of 110 GHz~170 GHz and a power range of - 30 dBm~+ 20 dBm.
- 2438-033, 87106A MMW (THz) power sensor, with a frequency range of 170 GHz~220 GHz and a power range of - 30 dBm~+ 20 dBm.
- 2438-034, 87106B MMW (THz) power sensor, with a frequency range of 220GHz~325GHz and a power range of - 30 dBm~+ 20 dBm.
- 2438-035, 87108B MMW (THz) power sensor, with a frequency range of 325GHz~500GHz and a power range of - 30 dBm~+ 20 dBm.

- 2438-021, 2U-213 upper frame set, upper cabinet option.
- 2438-022, rear panel equipped with the sensor input measurement option.
- 2438-023, English kit: English panel, operation interface, instructions and programming manual
- 2438-024, multi-core cable, used to connect the power meter and sensor.
- 2438-025, aluminium alloy case.

NOTE: The 2438CA/CB microwave power meter can only be equipped with the CW or MMW power sensor option, and the 2438PA/PB microwave power meter can be connected to all power sensor options.

Version: A.1 November 2017, China Electronics Technology Instruments Co., Ltd (CETI)
Address: No.98, Xiangjiang Road, Qingdao City, China
Technical Support: +86-532-86896691
Website: www.ceyear.com
E-mail: sales@ceyear.com
Postal code: 266555

Foreword

Thank you for choosing the 2348 series microwave power meter developed and manufactured by China Electronics Technology Instruments Co., Ltd. (CETI). Our product is high-end, precise and sophisticated, and embraces a high cost performance among the competitors of the same class.

We are devoted to providing for you high-quality products and first-class after-sales service with your most concerns and demands in mind. Our consistent aim is providing excellent quality and good service, and this is our sincere commitment for all users.

Manual No.

AV2.715.1009/1010/1015/1016
SS

Version

A.1 2017.12

China Electronics Technology
Instruments Co., Ltd.

Manual Authorization

This manual may be subject to change without notice. CETI reserves all the rights to the final explanation for all the information and terminologies referred to in this manual.

This manual is the property of CETI. Without CETI's permission, any organizations or individuals shall neither alter/temper nor duplicate/transmit this manual for profits; otherwise, CETI reserves the right to pursue any liabilities therefrom.

Product Warranty

The warranty period of this product is 18 months from the date of delivery. Instrument manufacturer will repair or replace the damaged parts according to the user's requirements and actual situation in the warranty period. The specific maintenance matters should be subject to the contract.

Product Quality Certification

This product is certified to fulfill the standards indicated in this manual from the day of delivery. Calibration measurements have been carried out based on national standards. Related information is available to the user for reference.

Quality/Environmental Management

The quality and environmental management systems have always been implemented during development, manufacturing and test of this product. The China Electronics Technology Instruments Co., Ltd is properly qualified and certified by the ISO 9001 and ISO 14001 management system standards.

Safety Precautions



WARNING indicates a danger. It reminds the user to be cautious of a certain operation process, operation method or the similar. Failure to follow the rules or operate correctly may result in the personal injury. The conditions indicated by WARNING should be fully understood and met before the next operation.



CAUTION indicates an important information rather than danger. It reminds the user to be cautious of a certain operation process, operation method or the similar. Failure to follow the rules or operate correctly may cause the damage to the instrument or loss of important data. The conditions indicated by CAUTION should be fully understood and met before the next operation.

Table of Contents

1	About This Manual.....	1
1.1	About This Manual	1
1.2	Related Documents.....	2
2	Overview	3
2.1	General.....	3
2.2	Safety guide	3
2.2.1	Safety signs	4
2.2.2	Operation status and position	5
2.2.3	Electrical safety.....	5
2.2.4	Operation precautions	6
2.2.5	Maintenance	7
2.2.6	Transport.....	7
2.2.7	Waste management/environmental protection.....	8
3.	Start Guide.....	9
3.1	Preparation before Use	9
3.1.1	Preparations before operation	9
3.1.2	Configuration of operating system.....	19
3.1.3	Routine maintenance.....	20
3.2	Description of front and rear panels.....	21
3.2.1	Description of front panel.....	21
3.2.2	Description of rear panel.....	23
3.3	Basic measurement methods	24
3.3.1	Description of basic operation	24
3.3.2	Example of operation.....	27
4	Operation guide	31
4.1	Model selection of power sensor	31
4.2	Zeroing and calibration before measurement.....	32
4.2.1	Zeroing and calibration of the 71710 series CW sensor	33
4.2.2	Zeroing and calibration of the 81702 or 81703 series peak power sensor.....	33
4.3	CW power measurement	34
4.4	Peak power measurement	34
4.4.1	Definitions of pulse measurement parameters.....	35
4.4.2	Peak power measurement and waveform display	37
4.5	Switching of display window	39
4.6	Setting of trigger position	40
4.7	Test methods for stability of pulse strings in different periods.....	42
4.8	Setting and use of “Gate”	43

Table of Contents

- 4.8.1 Basic concept of gate 43
- 4.8.2 Setting of the gate position 44
- 4.8.3 Gate setting in the trace display mode 45
- 4.8.4 Gate setting in the digit display mode..... 45
- 4.9 Setting and use of“Offset” 46
 - 4.9.1 Setting of channel offset 46
 - 4.9.2 Setting of display offset..... 46
 - 4.9.3 Setting of FDO 46
- 4.10 Statistic analysis of power measurement 48
 - 4.10.1 CCDF definition 48
 - 4.10.2 Operation of CCDF power statistic trace 49
- 4.11 How to enter the [Trace Ctrl] menu quickly..... 50
- 4.12 Test of low power signal 50
 - 4.12.1 Measurement of low power signal with a 71710 series CW sensor 50
 - 4.12.2 Measurement of low power signal with a 81702 or 81703 series peak power sensor51
- 4.13 Text display mode 51
- 4.14 Description of“Preset” 52
- 4.15 How to modify the sensor calibration factor..... 53
- 5 Menu 55
 - 5.1 Menu structure 55
 - 5.1.1 Main interface 55
 - 5.1.2 Menu 56
 - 5.1.3 Measure 56
 - 5.1.4 Trigger..... 57
 - 5.1.5 Display 58
 - 5.1.6 System 59
 - 5.1.7 Channel..... 60
 - 5.1.8 Window 62
 - 5.1.9 Calibration..... 62
 - 5.1.10 Frequency 63
 - 5.2 Menu description..... 63
 - 5.2.1 Main interface 63
 - 5.2.2 Menu 64
 - 5.2.3 Measure 64
 - 5.2.4 Trigger..... 67
 - 5.2.5 Display 68
 - 5.2.6 System 72
 - 5.2.7 Channel..... 74

5.2.8	Window	79
5.2.9	Calibration.....	79
5.2.10	Frequency	79
6	Remote Control.....	81
6.1	Remote control basis	81
6.1.1	Remote interface.....	81
6.1.2	Message.....	84
6.1.3	SCPI.....	84
6.1.4	Command sequence and synchronization	91
6.1.5	Status reporting system	92
6.1.6	Programming considerations	95
6.2	Remote interface and its configuration	95
6.2.1	LAN	95
6.2.2	GPIB.....	96
6.3	Basic programming method of the VISA interface	96
6.3.1	Installation of VISA library.....	97
6.3.2	Initialization of controller	97
6.3.3	Initialization of instrument	97
6.3.4	Sending of setting command	97
6.3.5	Reading of instrument status	98
6.3.6	Synchronization of command	98
6.4	I/O library.....	99
6.4.1	Overview of I/O library	99
6.4.2	Installation and configuration of I/O library	100
7	Fault Diagnosis and Repair	103
7.1	Working principle.....	103
7.2	Fault diagnosis and troubleshooting	104
7.2.1	Basic fault diagnosis process	104
7.2.2	Common faults and troubleshooting methods.....	104
7.3	Error information	105
7.4	Repair Method.....	106
7.4.1	Contact us.....	106
7.4.2	Packaging and delivery.....	106
8	Specifications and Test Methods	107
8.1	Statement.....	107
8.2	Product features.....	107
8.3	Specifications	108
8.3.1	Main specifications of 2438CA/CB power meter	108

2438 Series Microwave Power Meter

Table of Contents

8.3.2	Main specifications of the 2438PA/PB power meter	109
8.3.3	71710 series CW power sensor	110
8.3.4	81702/81703 series peak power sensor	111
8.3.5	MMW (THz) power sensor.....	112
8.4	Test of main performance characteristics.....	113
8.4.1	Recommended test methods.....	113
8.4.2	Performance test record of microwave power meter	122
8.4.3	Auxiliary tables of the microwave power meter performance test.....	126
8.4.4	Recommended instruments of the performance characteristic test.....	135

1 About This Manual

This chapter introduces the function, composition and main content of the User's Manual of the 2438 series microwave power meter as well as other related documents provided to the user.

- [About This Manual](#)..... 1
- [Related Documents](#)..... 2

1.1 About This Manual

This manual introduces the basic functions and operation methods of the 2438 series microwave power meter, and describes the features, basic usage, measurement, configuration and operation manuals, menus, remote control, maintenance, specifications and test methods of the instrument to help you familiarize yourself with and master the operation methods and essentials as soon as possible. To facilitate your familiarity with the instrument, please read this manual carefully before operating the instrument, and then follow the instructions of manual.

The chapters included in this User's Manual are as follows:

- **Overview**

This chapter generally introduces the main performance characteristics, typical application and operational safety precautions of the 2438 series microwave power meter, so that the user can know about the main performance characteristics of the instrument and operate the instrument safely in accordance with the instructions.

- **Start Guide**

This chapter introduces the checks before operation inspection, instrument browsing, basic measurement methods and data management of the 2438 series microwave power meter to allow the user to know about the instrument and measurement process and make preliminary preparations for comprehensive introduction of measurement and operation manuals of the instrument. The content contained in this chapter is consistent with that in relevant chapters of Quick Start Guide.

- **Operation Guide**

This chapter detailedly introduces the operation methods of various measurement functions of the instrument, including configuration, measurement process start and measurement result acquisition. It mainly consists of two parts: functional operation manual and advanced operation manual. The function operation manual is prepared for users who are not familiar with the methods for use of the 2438 series microwave power meter. It systematically describes and lists each setting in detail so that the user can understand and master some basic usages of this product, e.g. setting of frequency, average, display, etc. The advanced operation manual is prepared for users who have general knowledge about the use of microwave power meter but are not familiar with some special usages. It introduces the relatively complicated test process and high-level use techniques and guides the user to implement the measurement process, e.g. peak power measurement, trigger position setting and "gate" setting and use.

- **Menu**

This chapter introduces the menu structure and items by function for user's query and reference.

- **Remote Control**

This chapter introduces the remote control methods of the instrument so that the user can rapidly master the method to control the instrument in a remote way. It is further divided into the following sections: remote control basis, which introduces the concepts related to remote control, software configuration, remote interface, SCPI, etc.; instrument interface configuration methods, which introduces the remote interface connection methods and software configuration methods of the 2438 series microwave power meter; basic programming methods of the VISA interface, which gives a basic programming example in the form of text description plus programming examples so that the user can quickly grasp the programming methods.

1.2 Related Documents

● **Fault Diagnosis and Repair**

This chapter introduces the working principles, fault diagnosis and troubleshooting methods, error message description and repair methods of the unit.

● **Specifications and Test Methods**

This chapter introduces the features and main specifications of the 2438 series microwave power meter as well as the test methods recommended for the user.

1.2 Related Documents

The documents associated with the 2348 series microwave power meter include:

- User Manual
- Programming Manual
- Quick Start Guide

User Manual

This manual gives a detailed introduction of features and operation methods of the instrument, including information about configuration, measurement, remote control, maintenance, etc. for the purpose of guiding the user to fully understand the features of the product and master the common instrument test methods. Main chapters included in this manual are as follows:

- About This Manual
- Overview
- Start Guide
- Operation Instructions
- Menu
- Remote Control
- Fault Diagnosis and Repair
- Specifications and Test Methods

Programming Manual

This manual describes in detail the basics of remote control, SCPI basics, SCPI, programming examples, I/O driver library, etc. for the purpose of guiding the user to master the SCPIs and methods of the instrument quickly and comprehensively. Main chapters included in this manual are as follows:

- Remote Control
- SCPI
- Programming Examples
- Error Description
- Appendixes

Quick Start Guide

This manual introduces the set-up of the instrument as well as the basic operating methods of measurement with the aim of enabling users to quickly understand the features and operational procedures of the instrument. Main chapters included in this manual are as follows:

- Preparation before Use
- Typical Applications
- Getting Help

2 Overview

This chapter introduces the main performance characteristics and application scope of the 2438 series microwave power meter, as well as the methods for proper operation and precautions for electrical safety.

- [General.....](#) 3
- [Safety guide.....](#) 3

2.1 General

With the capability of covering a frequency range of 9 kHz ~ 500 GHz and a power range of -70 dBm ~ +50 dBm, good dynamic range, power accuracy and test speed performance and as well as the function of measuring various pulse parameters including pulse width, pulse period, top power, bottom power, Rise time, falling time and peak power, the 2438 series microwave power meter can provide you with reliable high-performance test services. It can be equipped with the 71710 series CW power sensor, 81702 or 81703 series peak power sensor and THz power sensor to give you the most suitable selection. The instrument can be widely applied to measurement and test of average power, peak power and other parameters of microwave signal in the fields of aviation, aerospace, radar, communication, ECM, navigation, etc.

2.2 Safety guide

Please carefully read and strictly follow the precautions below!

We will spare no effort to ensure that all production processes meet the latest safety standards to give the user safety guarantee at the highest level. Our product and its auxiliary device have been designed and tested in accordance with relevant safety standards, and a quality assurance system has been established for product quality monitoring to ensure that the product complies with these standards. To keep the device in good condition and ensure safe operation, please observe the precautions in this manual. In case of any doubt, please contact us for consultation.

In addition, it is your responsibility to use this product properly. Please carefully read and follow safety instructions prior to use. This product is applicable to measurement in industrial and laboratory environments or on the site. Always remember to use this product within its restricted conditions to avoid personal injury or property damage. Any problems caused by failure to use this product properly or as required are to be accounted by yourself, and we will not bear any responsibility therefrom. **Therefore, please always follow the safety instructions to prevent any risks of personal injury or property damage.** Please keep the basic safety instructions and product document properly and deliver them to the end user.

- [Safety signs.....](#) 4
- [Operation status and position.....](#) 5
- [Electrical safety.....](#) 5
- [Operation precautions.....](#) 6
- [Maintenance.....](#) 7
- [Transport.....](#) 7
- [Waste management/environmental protection.....](#) 8











2.2 Safety guide

2.2.1 Safety signs

2.2.1.1 Safety signs on the product

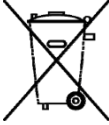
The warning signs on the product are given as follows (see Table 2.1):

Table 2.1 Safety Signs on the Product

Symbol	Meaning	Symbol	Meaning
	CAUTION, which indicates information that requires special attention from the user, or operation information or instructions require attention from the user.	○	Power ON/OFF
	ATTENTION, which represents handling of heavy device.	⏻	Readiness Indicator
	DANGER! Risk of electric shock.	≡	Direct current (DC)
	WARNING! Risk of scalding.	~	Alternating current (AC)
	Protection of conductive terminal	⎓	Direct/alternating current (DC/AC)
	Ground	□	Reinforced insulation protection of instrument
	Grounding terminal		EU mark of battery For detailed description, please refer to Paragraph 1 of "2.2.8 Disposal/environmental protection".
	ATTENTION, care should be taken to handle the electrostatic sensitive device.		EU mark of separate collection of electronic device For detailed description, please refer to Paragraph 2 of "2.2.8 Disposal/environmental protection".
	WARNING! Risk of radiation. For detailed description, please refer to Paragraph 7 of "2.2.4 Operation precautions".		

2.2.1.2 Safety signs in the manual

For the purpose of this manual, the following safety warning signs are used to remind the user of operating the instrument safely and paying attention to relevant information:



DANGER indicates a situation which, if not being avoided, will lead to personal injury or device damage.



WARNING indicates a situation which, if not being avoided, will lead to personal injury or device damage.



CAUTION indicates a situation which, if not being avoided, will lead to minor or moderate personal injury or device damage.



ATTENTION indicates an important information rather than a danger.



NOTE indicates information about the instrument and its operation.

2.2.2 Operation status and position

Before instrument operation, please pay attention to the followings:

- 1) Unless otherwise stated, the 2438 series microwave power meter should be operated in such an environment that it can be placed steadily for indoor operation. The maximum altitude at which the instrument is operated and transported should not be greater than 4,600 m. The actual supply voltage is allowed to vary within $\pm 10\%$ of the specified voltage, and the supply frequency is allowed to vary within $\pm 5\%$ of the specified frequency.
- 2) Unless otherwise stated, the instrument not subject to waterproof treatment should not be placed on a watery surface, vehicle, cabinet, table or other unfixed objects that don't meet the load-bearing condition. Please place and fix the instrument reliably on the surface of a solid object (e.g. anti-static workbench).
- 3) Do not place the instrument in an environment that is prone to fogging. For example, if the instrument is moved in an alternate cooling and heating environment, water droplets will be formed on the instrument, causing electric shock and other hazards.
- 4) Do not place the instrument on the surface of a radiating object (e.g. radiator). The ambient temperature in which the instrument works should not exceed the value given in the section regarding description of relevant indicators of the product. Overheating of the product will result in electric shock, fire and other hazards.
- 5) Do not insert anything into the instrument through the openings on the housing or cover the notches or openings on the instrument because they are designed for internal ventilation to prevent the instrument from overheating.

2.2.3 Electrical safety

Electrical safety precautions of the instrument:

- 1) Before turning on the instrument, ensure that the supply voltage matches the indicated supply voltage of the apparatus. If the supply voltage changes, it is necessary to replace the instrument fuse simultaneously.

2.2 Safety guide

- 2) With reference to the power requirements on the instrument's rear panel, a three-core power cord is used to ensure reliable grounding of the power wire during use. Poor floating or grounding may cause damage to the instrument or harm to the user.
- 3) Do not damage the power cord; otherwise leakage will occur, which may damage the instrument and even cause injury to the operator. If an external power cord or terminal board is used, check it before use to ensure the electrical safety.
- 4) If the power outlet is not equipped with ON/OFF switch, the instrument can be directly unplugged for deenergization. For this purpose, it is necessary to ensure that the instrument can be plugged and unplugged conveniently.
- 5) Do not use a damaged power cord. It is necessary to check the integrity and safety of the power cord before connecting it to the instrument, and place it reasonably to avoid the influence due to human factors, e.g. the operator is tripped by an excessively long power cord.
- 6) The instrument should be connected with the TN/TT power network, and the fuse should have a maximum rated current of 16 A (the necessity for use of a fuse with a larger rated current should be determined through consultation with the manufacturer).
- 7) The outlet should be kept clean and tidy, and the plug and outlet should be contacted properly and firmly.
- 8) The outlet and power cord should not be overloaded; otherwise, fire or electric shock will be caused.
- 9) If the test is carried out in a circuit with Vrms greater than 30 V, appropriate protective measures (e.g. use of proper tester, installation of fuse, limitation of current value, electrical isolation and insulation) should be taken to avoid instrument damage.
- 10) The instrument should comply with IEC60950-1/EN60950-1 or IEC61010-1/EN 61010-1 for connection with a PC or an IPC.
- 11) Unless otherwise permitted, the instrument enclosure should not be opened; otherwise, the internal circuits and components will be exposed, causing unnecessary damage or injury.
- 12) If the instrument needs to be fixed at the test site, a protective ground wire should be installed between the test site and the instrument by a qualified electrician.
- 13) Appropriate overload protection measures should be taken to avoid instrument damage or personal injury caused by overload voltage (in the event of lightning for example).
- 14) When the instrument enclosure is opened, do not place other foreign objects into the case; otherwise a short circuit may be easily caused, resulting in instrument damage or personal injury.
- 15) Unless otherwise stated, the instrument not subject to waterproof treatment should not be exposed to liquid, lest instrument damage or even personal injury should occur.
- 16) Do not place the instrument in an environment that is prone to fogging. For example, if the instrument is moved in an alternate cooling and heating environment, water droplets will be formed on the instrument, causing electric shock and other hazards.

2.2.4 Operation precautions

- 1) The instrument operator should have certain professional technical knowledge, good psychological quality and certain ability of emergency response.
- 2) Before moving or transporting the instrument, please refer to the relevant instructions in “[2.2.6 Transport](#)” of this section.

2.2 Safety guide

- 3) If the instrument operator suffers from allergy (e.g. rash, frequent sneezing, red eyes, or breathing difficulty) during operation due to the inevitable use of substances (such as nickel) that may cause personal allergy in the process of production of the instrument, please seek medical advice promptly to find the cause and resolve the symptom.
- 4) Before disassembling the instrument for disposal, please refer to the relevant instructions of “[2.2.7 Waste management/environmental protection](#)” of this section.
- 5) As the radio frequency instrument will produce a high level of electromagnetic radiation, a pregnant woman and an operator with a heart pacemaker need special protection. If the radiation level is high, appropriate measures can be taken to remove the radiation source to avoid personal injury.
- 6) The instrument will release toxic substances once catching fire. For this reason, the operator should wear suitable PPEs (such as protective mask and cloth), just in case.
- 7) Laser products should be provided with warning signs by type, because the radiation and high-intensity electromagnetic power from such products may be harmful to the human body. If this product is integrated with other laser products (such as CD/DVD driver), functions except those described in the product manual will not be provided, so as to prevent personal injury due to laser beam.
- 8) Electromagnetic compatibility class (in accordance with EN 55011/CISPR 11, EN 55022/CISPR 22 and EN 55032/CISPR 32)
 - Class A:

Device that can be used in the areas, except the residential area or environments, subject to low voltage power supply.

Note: Class A device is applicable to industrial environment, as it will disturb the wireless communication in residential areas. For this reason, the operator should take relevant measures to reduce the impact of such disturbances.
 - Class B:

Device suitable for residential areas and environments subjects to low-voltage power supply.

2.2.5 Maintenance

- 1) Other persons than those authorized technicians who have received professional technical trainings are not allowed to open the instrument case. Before performing such operation, it is necessary to disconnect the power cord to prevent instrument or even personal injury.
- 2) The instrument should be repaired, replaced or maintained by a professional electronic engineer designated by the manufacturer. The replaced and maintained part should be subject to safety test to ensure safe use of the product in the future.

2.2.6 Transport

- 1) If the instrument is heavy, please move it carefully, and if necessary, use an aid (such as crane) to move the instrument so as to avoid body damage.
- 2) The instrument handle is suitable for personal handling, and it should not be used to fix the instrument on the carrier for transportation. To prevent property damage or personal injury, please transport the device based on the safety regulations specified by the manufacturer.
- 3) When operating the device on a transport vehicle, the driver must be cautious to ensure the safety of transport. The manufacturer is not responsible for any unforeseen circumstances during the transport process. Therefore, please do not operate the apparatus when it is being transported. In addition, safety measures should be reinforced in order to ensure that the product is transported safely.

2.2 Safety guide

2.2.7 Waste management/environmental protection

- 1) Please do not dispose of device marked with batteries or rechargeable batteries with unsorted waste. These wastes should be individually collected and disposed of at an appropriate collection point or through the customer service center of the manufacturer.
- 2) Please do not dispose of electronic device with unsorted waste. These wastes should be individually collected. The manufacturer has the right and responsibility to aid the end user in managing waste products. If necessary, please contact the customer service center of the manufacturer for the corresponding procedures in order to avoid environmental harm.
- 3) When the product or the internal components are subjected to mechanical or thermal reprocessing, toxic substances may be released (e.g. lead, niobium, nickel, etc.) To avoid causing harm to the user, the device must only be disassembled by technical personnel who have received professional training and have the relevant experience in handling the device.
- 4) During reprocessing, the product may release toxic material or fuel. Please refer to the operational safety procedures outlined by the manufacturer and use specific measures for processing in order to avoid causing harm to the user.

3. Start Guide

This chapter introduces the precautions before operation, description of front and rear panels, basic measurement methods and data file management of the 2438 series microwave power meter so that the user can have a preliminary knowledge about the instrument and measurement process. The content contained in this chapter is consistent with that in relevant chapters of Quick Start Guide.

- [Preparation before Use](#)..... 9
- [Description of front and rear panels](#).....21
- [Basic measurement methods](#)..... 24

3.1 Preparation before Use

- [Preparations before operation](#).....9
- [Configuration of operating system](#).....19
- [Routine maintenance](#) 20

3.1.1 Preparations before operation

This chapter introduces the precautions before initial setting and use of the 2438 series microwave power meter.

WARNING

Damage prevention

To avoid the electric shock, fire and personal injury:

- Do not open the chassis without authorization;
 - Do not attempt to dismantle or modify any part not described in this manual. Improper removal may cause the deterioration of electromagnetic shielding effectiveness, damage of internal parts, etc. and affect the reliability of product. If the product is under warranty, we will no longer provide the unpaid repairs.
 - Carefully read the relevant content in “[2.2 Safety guide](#)” and the following precautions for operational safety, and pay attention to the specific operating environment requirements involved on the data page.
-

Attention

ESD protection

Pay attention to the ESD protection measures in the workplace to avoid the damage to instrument. For details, please refer to the relevant content in “[2.2 Safety guide](#)”.

3.1 Preparation before Use

Attention

During instrument operation, please pay attention to the following aspects:

An improper operating position or measurement setting can damage the instrument or appliances connected to it. Before powering on the instrument, please pay attention to the followings:

- To ensure that the fan blade and radiating hole are unobstructed, keep the instrument at least 10 cm away from the wall, and ensure that all ventilation holes of the fan are unobstructed;
- Keep the instrument dry;
- Place the instrument horizontally and reasonably;
- Ensure that the surrounding temperature is in accordance with the requirements on the reference data page.
- Ensure that the port input signal power is within the indicated range;
- Ensure that the signal output port is properly connected and isn't overloaded.

NOTE

Effect of electromagnetic interference (EMI):

The electromagnetic interference can affect the measurement results, therefore, it is necessary to:

- select appropriate shielded cables, For example, use RF shielded twisted pair/network connection cable.
- close the opened and temporarily unused cable connection port or connect the matched load to the connection port in time;
- Take note of the electromagnetic compatibility (EMC) grade in the reference data pages.

- [Unpacking.....](#) 10
- [Environmental requirements.....](#) 11
- [Power on/off.....](#) 12
- [Correct use of connector.....](#) 15
- [User checks.....](#) 18

3.1.1.1 Unpacking

1) Visual inspection

Step 1 Check if there is any damage in the outer packaging and the anti-vibration packaging of the instrument. If no damage is found, keep the packaging in case of future need and continue the inspection as per the following steps.

Step 2 Unpack the instrument and check for any damage to the main unit and attached items.

Step 3 Verify the items in the packaging box carefully by cross-checking with Table 3.1;

Step 4 If the outer packing box, instrument or any attached item is damaged or incorrect, it is forbidden to power on! Please contact our service center via the service hotline indicated on the cover, and we will make repairs and replacements rapidly based on individual circumstances.

Attention

Handling and movement: When moving the instrument and packing box, please pay attention to safety and handle with care.

2) Model confirmation

Table 1 Packing List

Name	Quantity	Function
Main unit:		
◇ 2438CA/CB/PA/PB	1	—
Standards:		
◇ 3-core power cord	1	—
◇ 12-core cable	1	—
◇ User Manual	1	—
◇ Programming Manual	1	—
◇ Packing list	1	—
◇ Certificate of Conformity	1	—
Option:		
◇ Various power sensors	1	Determined based on the user's actual use demand

3.1.1.2 Environmental requirements

The operating place of the 2438 series microwave power meter should meet the following environmental requirements:

1) Operating environment

The operating environment should satisfy the following requirements:

Table 3.2 Operating Environment Requirements

Working temperature	0°C~50°C
Relative humidity	(95%±5%)RH at a temperature greater than or equal to +10°C (75%±5%)RH at a temperature greater than or equal to +30°C (45%±5%)RH at a temperature greater than or equal to +40°C
Altitude	0~4,600 m

Attention

The above environmental requirements are only defined for the operating environment of the instrument and are not within the scope of specifications.

2) Radiation requirements

To ensure that the operating environment temperature of the instrument is within the required range, the following radiation requirements should be met:

3.1 Preparation before Use

Table 3.3 Radiation Requirements

Instrument Part	Radiation Distance
Rear part	≥180 mm
Left and right parts	≥60 mm

3) ESD protection

The static electricity is destructive to electronic components and device. Generally, we will use two anti-static measures, including combination of conductive table mat and wrist combination as well as combination of conductive floor mat and ankle strap. If these two combinations are used together, a good anti-static protection can be provided. If the combination is used separately, only the former can provide protection. In order to ensure user safety, anti-static parts shall provide at least 1MΩ isolation resistance to ground.

Please correctly use the following anti-static measures to reduce electrostatic damage:

- Ensure that all instruments are properly grounded to avoid generating static electricity;
- Before connecting the coaxial cable to the instrument, contact its inner and outer conductors with the ground temporarily;
- The staff shall wear anti-static wrist straps or adopt other anti-static measures before contacting joints and core wires or carrying out any assembly operation.

**WARNING****Operating voltage range**

The above anti-static measures can't be taken in a place where the voltage exceeds 500 V.

3.1.1.3 Power on/off**1) Precautions before power-on**

It is necessary to check the following items before powering on the instrument:

a) Confirmation of power supply parameters

The 2438 series microwave power meter is equipped with a 110 V/220 V adaptive AC power supply module (the internal AC power supply module adopts the adaptive working mode and automatically switches the working status according to the voltage of the external AC power supply). The requirements for the external power supply during normal operation of the microwave power meter are listed in Table 3.4.

Table 3.4 Requirements for Working Power Supply Parameters

Power Supply Parameter	Applicable Scope	
Voltage, frequency	220 V±10%, 50-60 Hz	110 V±10%, 50-60 Hz/400 Hz
Power consumption (power-on)	<50 W	<50 W
Power consumption (standby)	<5W	<5W

NOTE**Prevention against mutual interference of power supplies**

To avoid instrument hardware damage caused by the interference by the power supply of other device, especially the spike pulse interference generated by high-power device, it is recommended to use a 220 V or 110 V AC regulated power supply to power the microwave power meter.

b) Confirmation and connection of power cord

The 2438 series microwave power meter uses a 3-core power cord interface that complies with the national safety standard. Before the microwave power meter is powered on, it must be confirmed that the **protective ground wire of the power cord has been reliably grounded**. Floating or poor grounding may damage the instrument and even injure the operator. It is prohibited to use a power cord without a protective ground. When connected to a suitable power socket, the power cord realizes grounding of the instrument enclosure. The power cord should be have a rated voltage greater than or equal to 250 V and a rated current greater than or equal to 2 A.

When connecting the instrument to the power cord:

Step 1. Confirm that the power cord is undamaged;

Step 2. Use the power cord to connect the rear panel power plug and the properly-grounded 3-core power socket.

**WARNING****Grounding**

Poor or incorrect grounding may cause instrument damage and even personal injury. Before powering on the microwave power meter, make sure that the ground wire is in good contact with the power supply ground wire.

Please use the power socket with a protective ground. Do not replace the protective ground wire with an external cable, power cord or autotransformer without grounding protection. If an autotransformer is required, the common terminal must be connected to the protective ground of the power connector.

c) Fuse

The specifications of the fuse are printed on the rear panel power outlet: fast-blow type, length: 20 mm, diameter: 5 mm, rated current: 1 A, rated voltage: 250 V. The fuse should be replaced as per the following steps if required:

Step 1. Power off the instrument;

Step 2. Disconnect the power cord;

Step 3. Unscrew the fuse holder;

Step 4. Replace the fuse;

Step 5. Reinstall the fuse into the fuse holder;

Step 6. Reconnect the power cord.

**WARNING****Replacement of fuse**

When replacing the fuse, please use a fuse (250 V/F1A) of the same model and parameters so as to prevent a fire. Do not use the fuse of other materials or types.

3. Start Guide

3.1 Preparation before Use

2) First power-on

The methods and precautions for instrument power-on/power-off are as follows:

a) Connection of power supply

Before power-on for the first time, please conform the power supply parameters and power cord. For details, please refer to the section “[3.1.1.3 Precautions before power-on](#)” in this manual.

Step1. Connect the power cord: Connect one end of the power cord which is provided together with the microwave power meter in the packing box or 3-core power cord in conformity with the requirement to the rear panel power outlet of the microwave power meter (as shown in Fig. 3.1). Mark the voltage parameter required by the microwave power meter near the power outlet to remind the user of the fact that the applied voltage should meet the requirement. Connect the other end of the power cord to a conforming AC power supply;

Step 2. Check the front panel power button: The readiness indicator lamp turns yellow (as shown in Fig. 3.2)

Step 3. Turn on the power button on the front panel: Do not connect any device to the microwave power meter before power-on. If everything is OK, power on the instrument, and the indicator lamp on the power button on the front panel will turn green as shown in Fig.3. 2.



Fig. 3.1 Power Outlet on the Rear Panel of 2438 Microwave Power Meter



Fig. 3.2 Power Outlet on the Rear Panel of 2438 Microwave Power Meter

b) Power-on/power-off

i. Power-on

Step 1. Insert the power cord cable into the rear panel power outlet. At this time, the power indicator lamp above the power button on the front panel will turn yellow, and the instrument will be standby;

Step 2. Turn on the power button at the right bottom corner of the front panel. At this time, the indicator lamp on the power button will turn from yellow to green;

Step 3. The front panel user interface of the microwave power meter will display the relevant information about the instrument start process: First, temporarily display the manufacturer's name and logo, and then enter the WinCE operating system menu to enable the instrument interface;

3.1 Preparation before Use

Step 4. After successful activation of WinCE, the system will automatically run the initialization program of the microwave power meter and display the main operating interface of the microwave power meter.

The instrument is ready for operation.

NOTE**Warm-up**

When the 2438 series microwave power meter is subject to cold start (i.e. the instrument is started in the complete OFF state), it needs to warm up for a period of time in order to ensure accurate power measurement. When the specifications are tested, the instrument should warm up for 0.5 h (please refer to the relevant instructions for specifications in the specifications for details).

With the WinCE operating platform, the instrument should be used without user intervention or deenergization.

ii. Power-off

Turn off the power button at the right bottom corner of the front panel, and the system will be shut down rapidly and the instrument will be powered off. At this time, the indicator lamp on the power button will turn from green to yellow;

The instrument is switched off.

Attention**Power-off**

When the instrument is in normal working status, it can only be powered off through operation of the front panel power button. **Do not directly operate the rear panel power button or disconnect the power supply directly from the instrument;** Doing so may prevent the instrument from being shut down properly, damage the instrument, or cause loss of current instrument status/measurement data. Please shut down the analyzer properly.

c) Disconnection of power supply

The microwave power meter should be subjected to emergency power-off to avoid personal injury under abnormal conditions. At this time, just disconnect the power cord (from the AC power outlet or rear panel power outlet of the instrument). Therefore, a sufficient operating space should be reserved during instrument operation so that the power supply can be disconnected directly when necessary.

3.1.1.4 Correct use of connector

In performing various tasks, the connector is often used to connect the test signal to the power sensor. The following points need to be taken into consideration when using the connector:

1) Check of connectors

It is necessary to wear an anti-static wrist strap when checking the connectors. It is recommended to use a magnifier to check:

- 1) the electroplated surface for wear and deep scratches;
- 2) the thread for deformation;
- 3) the thread and joint surface for metallic particles;
- 4) the inner conductor for bending and breakage;

3.1 Preparation before Use

- 5) the screw for improper rotation.



Check the connectors so as not to damage the instrument ports

Any damaged connector may damage the good one connected to it even if it is connected for the first time. To protect the ports of the microwave power meter, it is necessary to check the connectors before operating them.

2) Connection

The connectors should be checked and cleaned before measurement and connection to ensure that they are clean and undamaged. It is necessary to wear an anti-static wrist strap during connection. The correct connection methods and procedures are as follows:

Step 1. As shown in Figure 3.3, align the axes of the two interconnected connectors to ensure that the pin of the male connector slides concentrically into the hole of the female connector.



Fig. 3.3 Coaxial Alignment of Interconnected Connectors

Step 2. Move the two connectors together in parallel so that they can be joined smoothly. Rotate the connector screw (rather than the connector body) until it is tightened. The connectors should not rotate relative to each other during connection, as shown in Fig. 3.4.

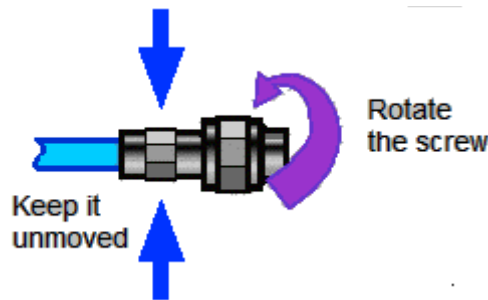

Fig. 3.4 Connection

Step 3. Tighten the connectors with a torque wrench to complete the final connection. Note that the torque wrench should not go beyond the initial breakout torque. An auxiliary wrench can be used to prevent the connector from turning.

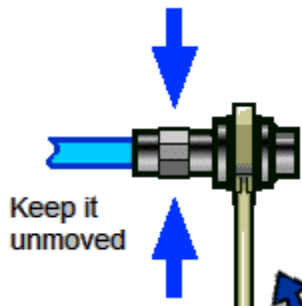

Fig. 3.5 Completion of Final Connection with a Torque Wrench

3) Disconnection

Step 1. Support the connector to prevent any part from being shaken, distorted, or bent;

Step 2. Use an open-end wrench to prevent the main connector from rotating.

Step 3. Use another wrench to loosen the screw on the connector.

Step 4. Loosen the screw by hand until the connection is completely broken.

Step 5. Separate the connectors by pulling them apart in parallel.

4) Use of the torque wrench

The torque wrench should be used as indicated in Figure 3.6. Please pay attention to the following points when using the torque wrench:

- Confirm that the torque of the torque wrench is set correctly before use;
- Ensure that the angle between the torque wrench and the other wrench (used to support the connector or cable) is less than 90° before applying a force;
- Gently grasp the end of the torque wrench handle and apply a force in the direction perpendicular to the handle until the breakout torque of the wrench is reached.

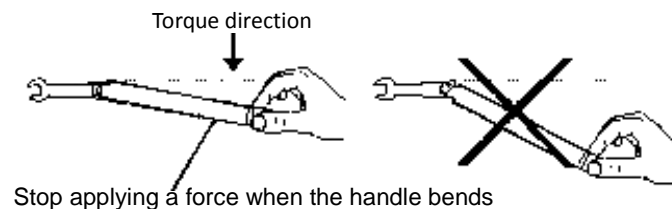

Fig. 3.6 Use of Torque Wrench

5) Use and preservation of connectors

- 1) Protect the connectors with a protective sheath when not used;
- 2) Do not place the various connectors, air lines and calibration standards disorderly in a box; otherwise the connectors will be damaged;
- 3) Keep the connector and power meter at the same temperature. If the connector is held by hand or cleaned with compressed air, the temperature will be significantly changed. The connector can be used for calibration only after its temperature is stabilized;
- 4) Do not touch the joint surface of the connector because it is difficult to remove skin oil and dust particles from the joint surface;
- 5) Do not place the contact surface of the connector downwards onto a hard surface; otherwise, the electroplated layer and joint surface of the connector may be damaged.
- 6) Wear an anti-static wrist strap and work on a grounded conductive workbench mat to protect the power meter and connector against electrostatic discharge.

6) Cleaning of connectors

It is necessary to wear an anti-static wrist strap when cleaning the connectors as per the following steps:

- 1) Use clean low-pressure air to remove the loose particles on the thread and joint surface of the connector and check the connectors thoroughly. If further cleaning is required, proceed as follows;
- 2) Wet (but not soak) a lint-free cotton swab with isopropyl alcohol;
- 3) Use a cotton swab to remove dirt and debris from the joint surface and thread of the connector. When cleaning the inner surface, be careful not to apply an external force to the central inner conductor or leave the cotton swab fibers on the central conductor of the connector;

3. Start Guide

3.1 Preparation before Use

- 4) Evaporate the alcohol and then blow the surface clean with compressed air;
- 5) Check the connectors to confirm that they are free of particles and residues;
- 6) If the connector still has visible defects after cleaning, it indicates that the connector may be damaged. Never use a damaged connector, and confirm the causes of damage before measurement and connection.

7) Use of adapter

When the measuring port of power meter is different from the type of connector used, an adapter must be adopted for measurement connection. In addition, even if the measurement port of the power meter is the same as the type of connector for the port of tested part, it is also a good idea to use an adapter. Under these two conditions, the measuring port can be protected, thus extending its service life and reducing the maintenance cost. Before connecting the adapter to the measuring port of power meter, it should be carefully checked and cleaned. A high-quality adapter should be used to reduce the impact of mismatch on the measurement accuracy.

8) Joint surface of connector

An important concept in microwave measurement is the reference surface for all measurement. In the case of calibration, the reference surface is defined as the surface on which the measuring port and the calibration standard are jointed. Proper connection and calibration depend on whether the connectors can be completely and straightly contact with each other at each point of the joint surface.

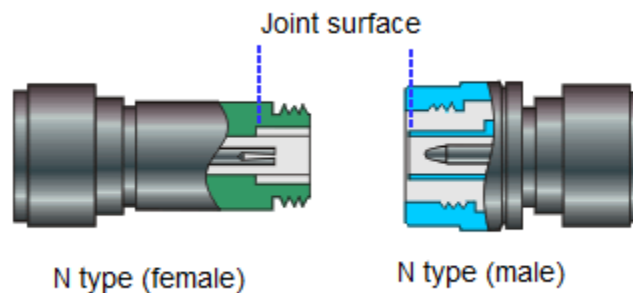

Fig.3.7 Calibration Surface

3.1.1.5 User checks

After the initial power-up of the 2438 series microwave power meter, it is necessary to check whether the instrument is functioning properly in order to continue measurements.

NOTE

Instructions on using the hard keys on the front panel and the soft menu keys.

Hard keys on the front panel and soft keys of the menu are described in the following forms:

- 1) Hard key: [XXX], XXX denotes the name of the hard key.
- 2) Soft key: [XXX], XXX denotes the name of the soft key

If a soft key corresponds to several parameters, , the selected value will be framed with a rectangular box, which indicates that the state is valid. For example: [Average ON OFF] that “channel average” is “ON”.

1) Zeroing and calibration

After the instrument is used for the first time or the power meter sensor is replaced, it is recommended that the power meter should be zeroed and calibrated. Connect the power sensor to the channel interface on the front panel of the main unit using a multi-core cable. Connect the power meter to the power supply and wait until the indicator lamp on the bottom right corner of the front panel turns yellow to indicate proper function of stand-by power. Press the power button on the front panel, observe that the power indicator lamp on the front panel turns green and the display backlight lights up, and wait for about 40 s to display the power-on status interface.

Set the microwave power meter as follows:

Step 1. Press the [Cal] key on the front panel to access the calibration menu. Select [Channel A] > [Zero + Cal]. Zeroing and calibration begins. The screen displays the “Zero calibration in progress, please wait...” dialog. A scroll bar at the bottom indicates the progress of the calibration. The 71710 series CW power sensor, if used, should be connected to the calibrator for calibration, but the 81702 or 81703 series peak power sensor has no such demand as they are built-in with a calibration circuit.

Step 2. Wait for the calibration to finish. When the dialog disappears, this indicates that the calibration is complete. If no errors are shown at the bottom of the screen, then the instrument is functioning properly. If an error message is shown at the bottom of the screen, if this is the case, please contact our service center via the service hotline in this manual. We will make repairs and replacements rapidly based on individual circumstances.

2) Self-test

Self-test is not necessary every time the instrument is turned on. It is only performed when malfunction is suspected in the instrument.

Step 1. Press the [Menu] > [System] > [Service] > [Test] on the front panel to access the test menu;

Step 2. Select the [Self-test] from the soft menu to access the self-test interface;

Step 3. Run self-test. The results of the test will be displayed on the screen when it is complete. Observe the test results: if the test has passed, then the instrument is functioning properly. If any test item has failed, it indicates a malfunction of the instrument in that specific area. If this is the case, please contact our service center via the service hotline in this manual. We will make repairs and replacements rapidly based on individual circumstances.

After successful completion of the above two steps, the instrument is ready for operation.

3.1.2 Configuration of operating system

This chapter introduces the methods for configuration and maintenance of the 2438 series microwave power meter. To ensure normal operation of instrument software, please refer to the precautions for configuration of the microwave power meter below.

- [Description of instrument software](#).....19
- [Configuration of remote interface](#).....19

3.1.2.1 Description of instrument software

The WinCE operating system is adopted for operation of the software of the 2438 series microwave power meter. This system has been installed and configured based on the characteristics of the microwave power meter.

3.1.2.2 Configuration of remote interface

Remote control of the 2438 series microwave power meter can be achieved via the GPIB, network interface or USB interface. The specific methods for configuration and operation are as follows:

3.1 Preparation before Use

Step 1. Press [Menu] >[Remote Control Interface] on the front panel to enter the interface configuration menu as shown in Fig. 3.8;

Step 2. Press [Up] or [Down], or [UP], [Down], [Left] or [Right] arrow keys on the panel to select the option to be modified;

Step 3. Modify the parameter setting through the numeric keys;

Step 4. After modification, press [Apply] to save the modified configuration in the microwave power meter.

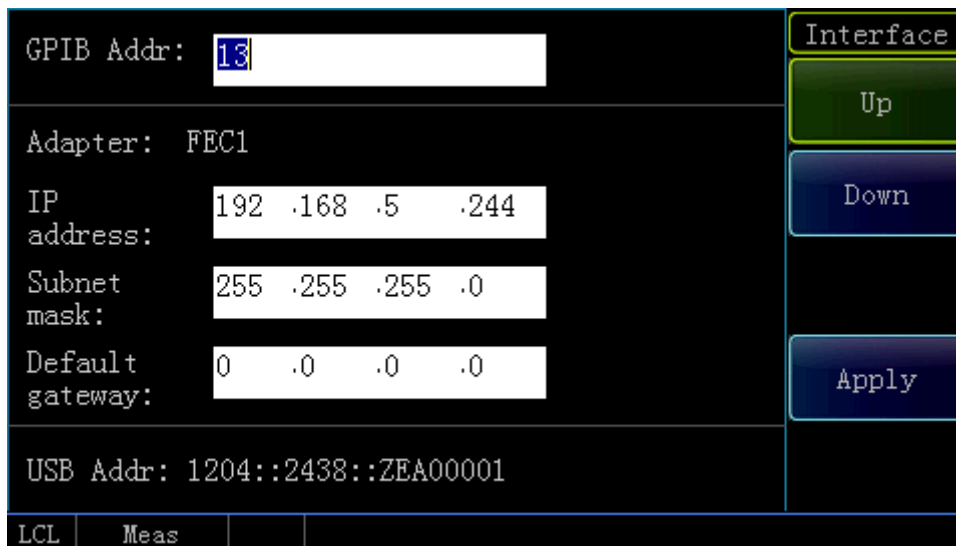

Fig. 3.8 Remote Control Interface Configuration Interface

Attention

The GPIB address of the 2438 series microwave power meter should not be the same as that of other instruments in the networking system;

The IP addresses of the 2438 series microwave power meter and other instruments in the networking system must be within the same segment.

3.1.3 Routine maintenance

This section describes the methods for routine maintenance of the 2438 series microwave power meter.

1) Cleaning of instrument surface

Clean the instrument surface as per the following steps:

Step 1. Power off the instrument, and disconnect the power cord from the instrument;

Step 2. Gently wipe the surface with dry or slightly moistened soft cloth. Do not wipe the inside of the instrument.

Step 3. Do not use chemical cleaning agents such as alcohol, acetone, or dilutable cleaning agents.

2) Cleaning of display

After the instrument is used for a period of time, it is necessary to clean the LCD. Please operate according to the following steps:

Step 1. Power off the instrument, and disconnect the power cord from the instrument;

Step 2. Use clean soft cotton cloth dampened with cleaning agents to gently wipe the display panel;

Step 3. Dry the display with clean soft cotton cloth;

Step 4. Connect the power cord after the display is dried completely.

Attention

Clean the display

There is a layer of ESD protection coating on the surface of the display, so never use any cleaning agent containing fluoride, acid or alkali. Do not spray the cleaning agent directly onto the display panel, otherwise the cleaning agent may leak into the internal of the instrument, causing damages.

3.2 Description of front and rear panels

In this section, the elemental compositions and functions of front and rear panels and operation interface of the 2438 series microwave power meter are described.

- [Description of front panel](#).....21
- [Description of rear panel](#).....23

3.2.1 Description of front panel

This section introduces the composition and functions of front panel of the 2438 series microwave power meter, as shown in Fig. 3.9.

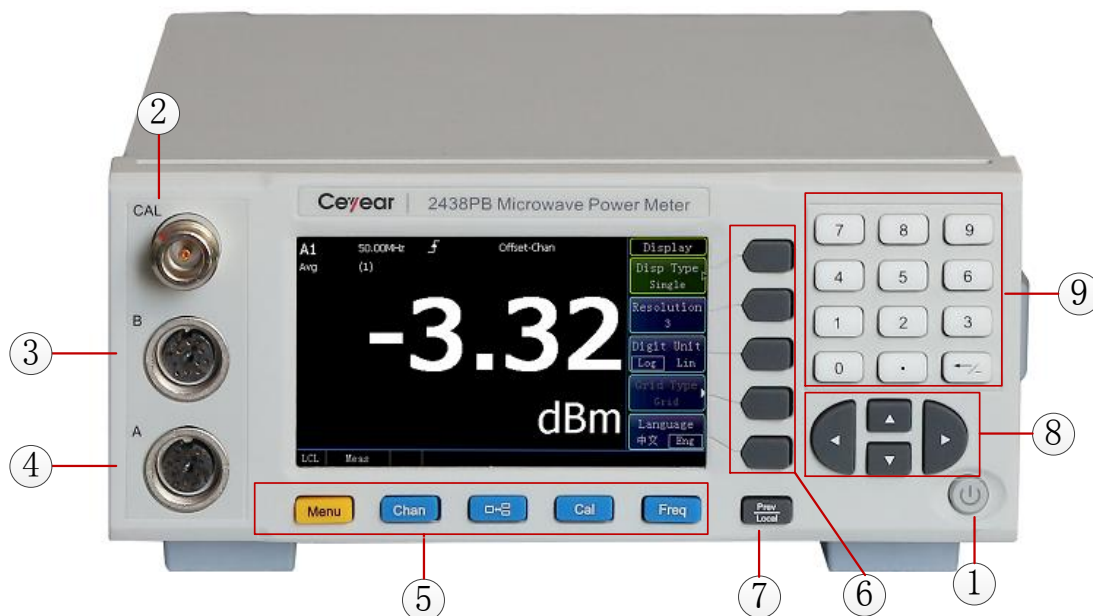

Fig. 3.9 Front Panel of Instrument

3.2 Description of front and rear panels

Table 3.5 Description of Front Panel

No.	Name	Description
1	Power button	The power button is located at the right bottom corner of the front panel and used to power on and off the instrument.
2	Calibrator output interface	It is a N-type interface for calibrator output of a 50 MHz, 0 dBm reference power.
3	Channel B input interface	It is a multi-core interface connected to the sensor for Channel B input.
4	Channel A input interface	It is a multi-core interface connected to the sensor for Channel A input.
5	Menu buttons	The 2438 series microwave power meter includes five menu keys used as an entry for all operations as shown in Table 3.6. For the specific functional description, please refer to “5.2 Menu description” in this manual.
6	Soft keys	Five unlabeled black keys to the right of the front panel display of the 2438 series microwave power meter are known as “soft keys” . The corresponding commands of these soft keys are dynamic, and the displayed functions depend on the current selected mode and measurement and are directly related to the recently used keys. “Next Page” indicates that the menu contains multiple soft keys that can’t be displayed at one time. After the menu is pressed, the next set of soft keys will be displayed; if the soft key tab contains the “▷” symbol, it means that there is a submenu with more soft keys. Press this soft key to display the submenu; switch to the previous menu through the [Back] key.
7	Back/Local key	Press the Back key to return to the corresponding previous soft menu.
8	Arrow keys	There are four arrow keys in this area, i.e.[Up], [Down], [Left] and [Right] which mainly have the following functions: 1) Connect the peak power sensor and move the mark line through the[Left] and [Right] keys during waveform display. 2) Open the dialog for setting and move the focus to the option to be modified through the four arrow keys.
9	Numeric key area	Use the numeric keys to set the parameters in the menu or window. After entering the number, the corresponding unit soft key will appear in the window. Press the unit soft key to save the input parameters to the power meter.

Table 3.6 Description of Hard Key Area

Key Name	Functional Description
Menu	The menu includes the following function menus: Measure, Trigger, Display, System and Stat. The above menus are parallel to other menus in the hard key area with respect to the function, but are applied less frequently, so they are placed below the [Menu] key.
Channel	Set channel-related parameters such as Average, channel offset, trace control, gate setting, video bandwidth, FDO and pulse definition of Channel A and Channel B.
Window	Press [Window] to switch among small, medium and large display windows.
Calibration	Zero and calibrate Channel A and Channel B and set the ON/OFF state of the calibrator.
Frequency	Set the carrier frequency of measurement signals of Channel A and Channel B.

3.2 Description of front and rear panels

3.2.2 Description of rear panel

In this section, the composition and functions of rear panel of the 2438 Series microwave power meter are described as shown in Fig. 3.10.

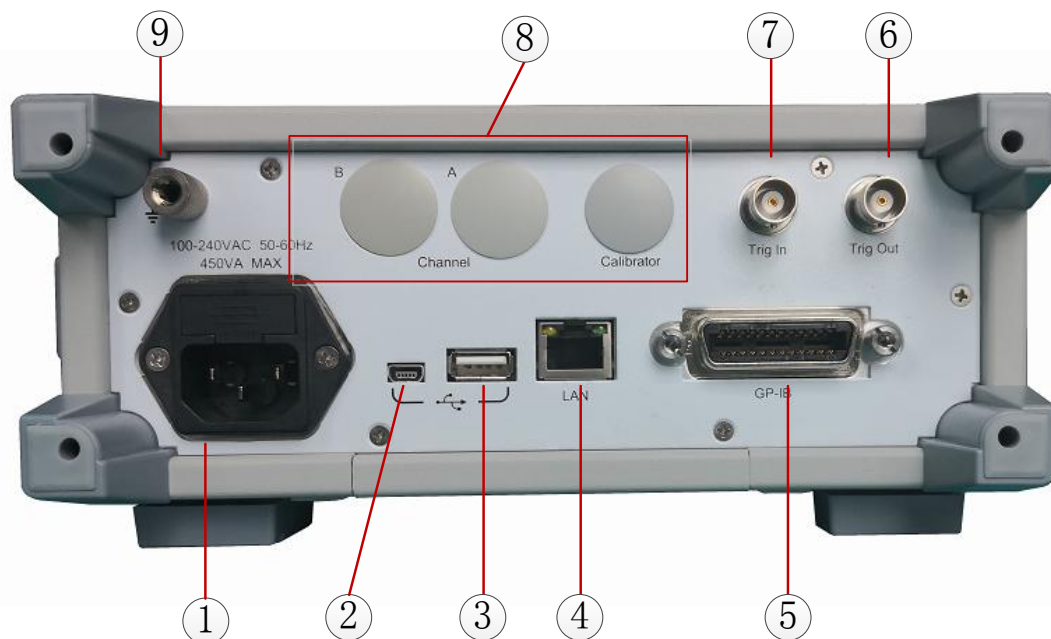

Fig. 3.10 Rear Panel of Instrument

Table 3.7 Description of Rear Panel

No.	Name	Description
1	Power input interface	Instrument AC power input.
2	Slave USB interface	The computer can perform remote control of the instrument through the slave USB port.
3	Master USB interface	It is connected to the USB program disk to update the instrument program.
4	Network port	The computer can perform remote control of the instrument through the network port.
5	GPIB interface	The computer can perform remote control of the instrument through the GPIB interface.
6	Trigger output interface	The instrument is connected to a peak power sensor to measure the pulse modulation signal and output the TTL level signal synchronized with the pulse envelope.
7	Trigger input interface	The instrument is connected to a peak power sensor to measure the pulse modulation signal. If the measured signal has a relatively small power and the internal trigger signal is weak, trigger can't be achieved. At this time, the pulse envelope signal synchronized with the measured signal can be connected to the inside of the instrument via the trigger input interface. Through selection of external trigger as the trigger source, the pulse envelope signal will be displayed stably on the screen.
8	Rear panel input option interface	The "Calibrator", "Channel A" and "Channel B" interfaces are reserved so that the rear panel can be connected to a sensor for measurement to facilitate system building.
9	Grounding terminal	It facilitates common ground connection with other device.

3.3 Basic measurement methods

3.3 Basic measurement methods

- [Description of basic operation](#).....24
- [Example of basic operation](#).....27

3.3.1 Description of basic operation

In this section, the methods for use of the 2438 series microwave power meter are generally introduced, including information in the window display area and methods for use of the 2438 series microwave power meter through the keys on the front panel and other interactive operations.

3.3.1.1 Value display information in case of connection with a peak power sensor

The measurement interface of the 2438 series microwave power meter connected to the peak power sensor is shown in Fig. 3. 11. All information areas are marked and the operation interface is described in Table 3.8. A detailed introduction is given hereinafter.

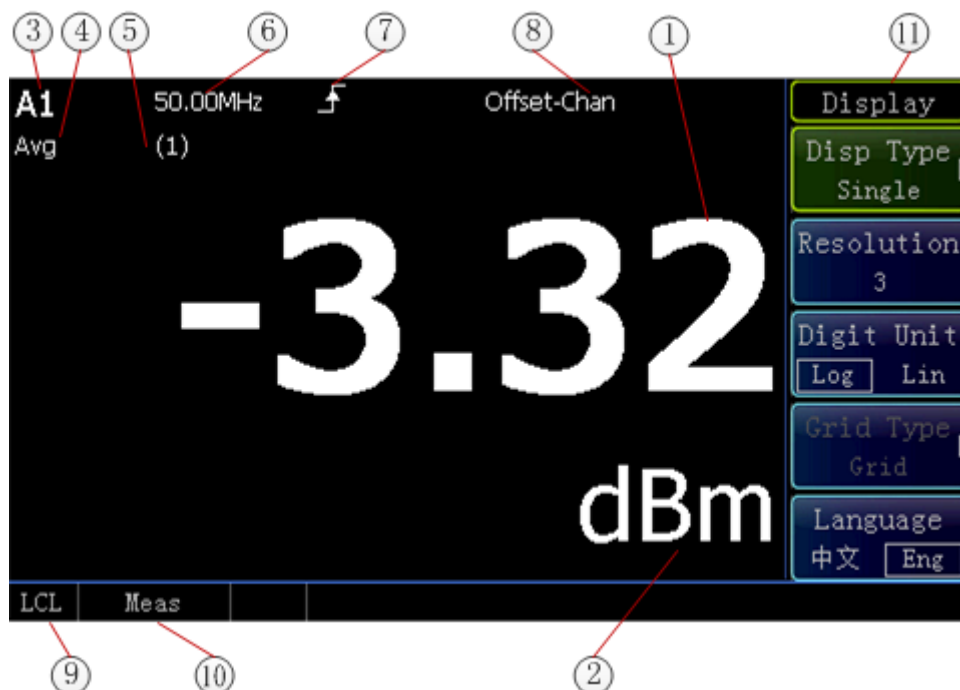



Fig. 3.11 Measurement Interface in case of Connection with a Peak Power Sensor

3.3 Basic measurement methods

Table 3.8 Description of Operation Interface

Graphic Number	Information Content	Meaning
1	Power display	It displays the current measured power value.
2	Power unit	It displays the current power unit including dBm and W.
3	Now gate	It displays the gate shown by the current measurement result, A1 for Gate 1 of Channel A.
4	Numeric measurement type	It displays the measurement type of the gate shown by the current measurement result, including "AVG PWR", "Peak PWR", "PAR", "Min PWR" and "Max/min", "AVG" indicates that the numeric measurement type is "AVG PWR".
5	FDO table	It displays the called FDO table shown by the current measurement result. There are ten optional FDO tables. The FDO table is a frequency factor correction table defined by the user. (1) represents calling of the first FDO table.
6	Frequency value	It is the carrier frequency value of the current measured signal, which should be manually set the user.
7	Trigger mode	It displays the trigger mode. It sets the trigger mode for the current measurement, including "Free Run", "Continue Trig" and "Single Trig".  represents "Continue Trig".
8	Offset state	There are two offset states. If the display offset is enabled, the "Disp Offset On" will be displayed. If the channel offset is enabled, the "Channel Offset ON" will be displayed. If both offsets are enabled, "Offsets ON" will be displayed. The display offset is used for the current window; the channel offset is used for the selected channel.
9	Instrument state	It displays the instrument is in local or remote control state currently.
10	Measurement state	It prompts the current measurement state. "Meas" indicates that the instrument is in normal measurement state.
11	Soft key menu	It displays the menu option represented by the current soft key.

3.3.1.2 Waveform display on peak power sensor connection

When the 2438 series microwave power meter is connected to a peak power sensor for waveform display, waveforms and some key parameters can be displayed simultaneously. Fig. 3.12 shows the interface on which the waveforms and power parameters are displayed simultaneously.

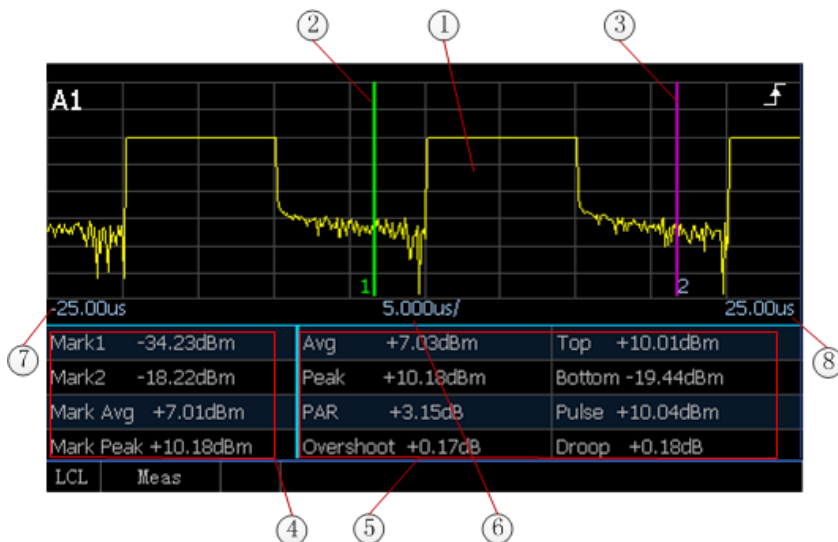

Fig. 3.12 Waveform and Power Parameter Display on Peak Power Sensor Connection

3.3 Basic measurement methods

Table 3.9 Description of Operation Interface

Graphic Number	Information Content	Meaning
1	Display waveform	The currently measured pulse waveform is displayed.
2	Mark 1	The starting position of time corresponding to the current gate is displayed in the window as a vertical line below which the value "1" is displayed.
3	Mark 2	The ending position of time corresponding to the current gate is displayed in the window as a vertical line below which the value "2" is displayed. The time between Mark 1 and Mark 2 is the time length of the gate.
4	Mark power parameter	The current measured power values of Mark 1 and Mark 2 as well as the average power and peak power between Mark 1 and Mark 2 are displayed.
5	Window power parameter	The current window waveform power parameters are displayed, including "Avg", "Peak", "Top", "Bottom", "PRA", "Overshoot", "Pulse" and "Droop".
6	X scale	The X scale of waveform display is set. "5.000us/" means that the time for the each X scale division is 5 us and there are 10 X scale divisions in the window.
7	Time on the left side of the window	It is the time on the leftmost side of the waveform display window.
8	Time on the right side of the window	It is the time on the rightmost side of the waveform display window.

Fig. 3.13 shows the interface on which the waveforms and time parameters are displayed simultaneously.

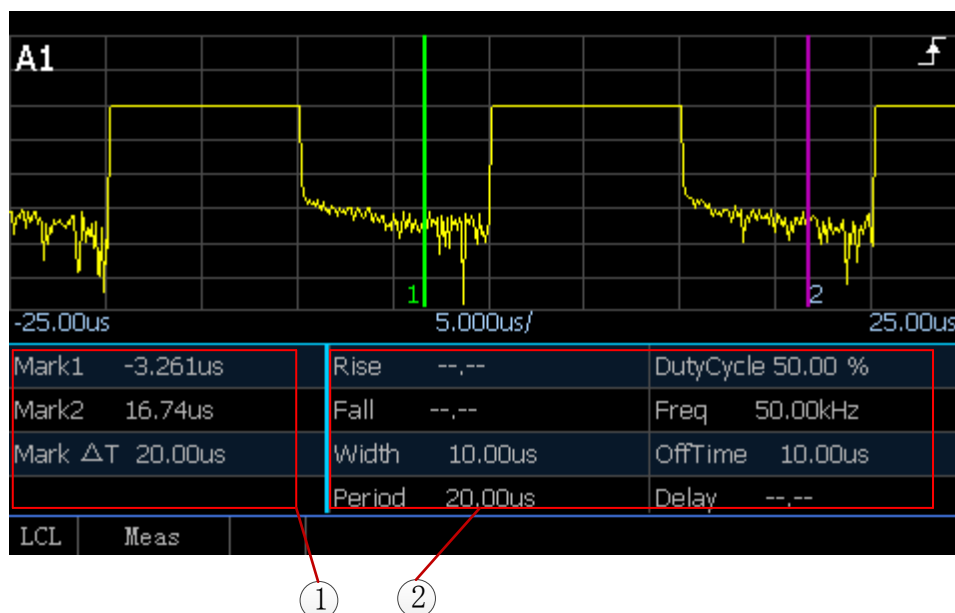

Fig. 3.13 Waveform and Time Parameter Display on Peak Power Sensor Connection

Table 3.8 Description of Operation Interface

Graphic Number	Information Content	Meaning
1	Mark time parameter	The current time of Mark 1 and Mark 2 as well as the time difference between Mark 1 and Mark 2 are displayed.
2	Window time parameter	The current window waveform time parameters are displayed, including "Rise", "Fall", "Width", "Period", "Duty Cycle", "Freq", "Off Time" and "Delay".

3.3.2 Example of operation

This section demonstrates step-by-step through examples the most frequently used and most important basic settings and functions of the 2438 series microwave power meter so that users can quickly understand the features of the instrument and be able to perform basic measurements.

The preparations before operation of the 2438 series microwave power meter should be completed as per the following steps:

Step 1. Power on the instrument;

Step 2. Start the application after entry into the system;

Step 3. Confirm that there is no error prompt on the main operation interface of the front panel before the next operation.

3.3.2.1 Measurement of average power of signal

The power meter is commonly used to measure the average power of the signal. When measuring an unknown signal, you can usually use the [Preset] key to switch the instrument to the preset state and start measurement.

Attention

If the signal level is possibly higher than the upper limit of the measured power level of the power sensor, a power attenuator must be added at the input end of the power sensor; otherwise the sensor will be damaged.

Step 1. Return to the root menu: Press [Back/Local] for several times to return to the root menu;

Step 2. Preset the instrument state: Press [Preset], and the state selection window will pop up; select "Default", and press [OK] to set the power meter in the preset state;

Step 3. Set the frequency: Press [Frequency]>[CHA Freq], and enter the frequency of the measured signal through the numeric key.

At this time, the accurate measured power value can be observed on the screen as shown in Fig. 3.14.

3.3 Basic measurement methods



Fig. 3.14 CW Test

3.3.2.2 Measurement of Rise time of pulse modulation signal

The Rise time and falling time of the pulse modulation signal envelope are parameters that attract the attention of many users and can be quickly measured through the following simple parameter settings.

Step 1. Set the trigger mode: Press [Menu]>[Trigger]>[A TrigMode]>[Continue Trig] to set the trigger mode as “Continue Trig”;

Step 2. Set the display mode: Press [Menu]>[Display]>[Disp Type]>[Trace A] to set the display mode as waveform display; Press [Channel]>[Trace Ctrl]> [Trace Set]> [X scale] to set the X scale as 20 ns/div;

Step 3. Set the trigger level: Press [Menu]>[Trigger]>[Settings]>[Trig Level] to set the trigger level to a value that is 3 dB less than the peak power of the measured signal. For example, if the peak power of the measured signal is +10 dBm, the trigger level should be set to below +7 dBm.

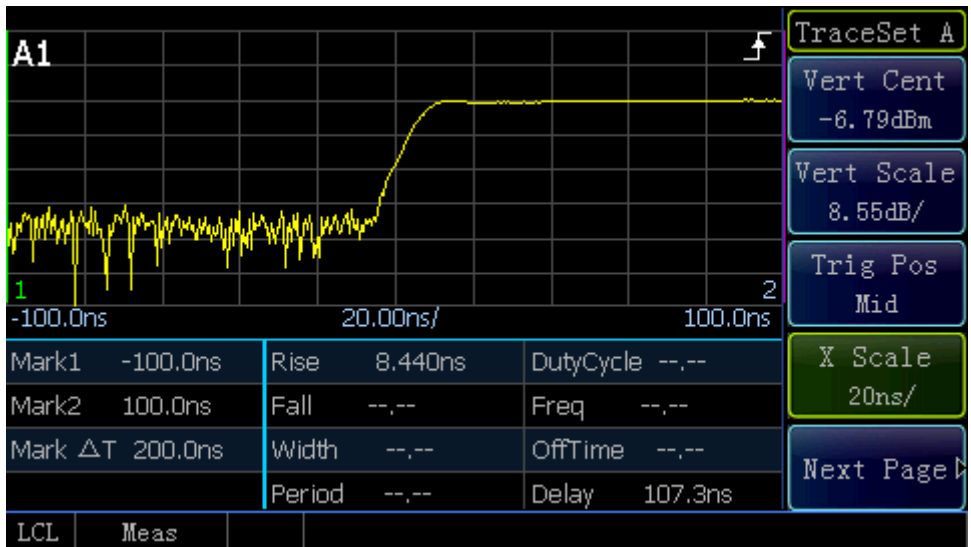

Fig. 3.15 Rise time Test

3.3 Basic measurement methods

The display will show the measured waveform and the automatically measured Rise time. If the falling time is measured, just change [Trig Slope] to "-".

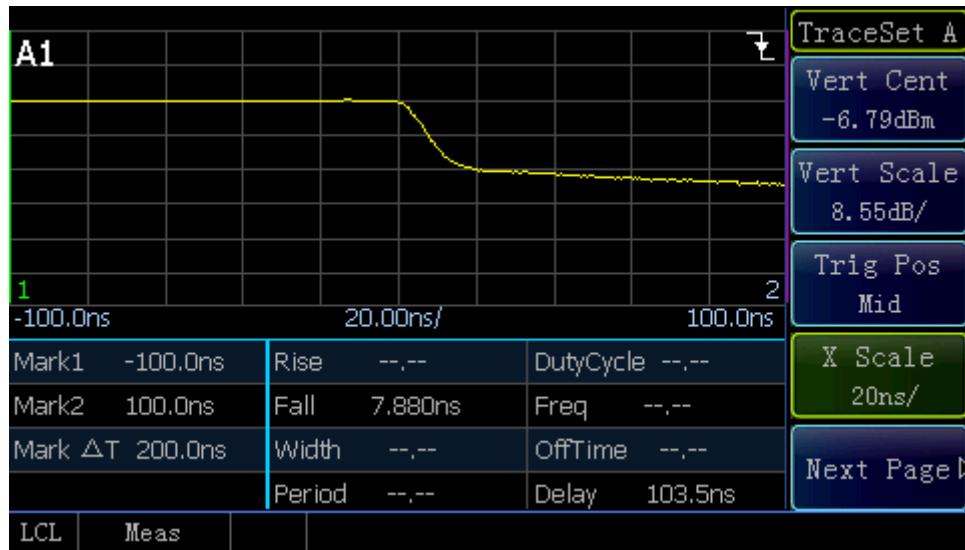

Fig. 3.16 Falling time Test

4 Operation guide

This chapter introduces the operation methods of different measurement functions of the 2438 series microwave power meter and describes in detail the measurement steps.

●	Model selection of power sensor	31
●	Zeroing and calibration before measurement	32
●	CW power measurement	34
●	Peak power measurement	34
●	Switching of display window	39
●	Setting of trigger position	40
●	Test methods for stability of pulse strings in different periods	42
●	Setting and use of “Gate”	43
●	Setting and use of “Offset”	46
●	Statistic analysis of power measurement	48
●	How to enter the [Trace Ctrl] menu quickly	50
●	Test of low power signal	50
●	Text display mode	51
●	Description of “Preset”	52
●	How to modify the sensor calibration factor	53

4.1 Model selection of power sensor

The 2438 series microwave power meter is compatible with the 71710, 81702 and 81703 series power sensors and the waveguide series MMW power sensor. The specific models and main specifications are shown in Tables 4.1 and 4.2.

The 2438 series microwave power meter includes 4 models, i.e. 2438CA (CW single channel), 2438CB (CW double channel), 2438PA (CW/peak single channel) and 2438PB (CW/peak double channel), among which 2438CA and 2438CB can only be connected to the 71710 series CW power sensor while 2438PA and 2438PB can be connected to all sensors.

Table 4.1 Main Unit Model Selection

No.	Main Unit Model	Model Description	Matching Sensor
1	2438CA	CW single channel	71710 series CW power sensor MMW sensor
2	2438CB	CW double channel	
3	2438PA	CW/peak single channel	71710 series CW power sensor 81702/ 81703 series peak power sensor MMW sensor
4	2438PB	CW/peak double channel	

4.2 Zeroing and calibration before measurement

Table 4.2 Model Selection of Power Sensors Compatible with 2438 Series Microwave Power Meter

No.	Sensor Model	Sensor Type	Frequency range	Power Range
1	71710A	CW power sensor	9kHz to 12GHz	-60 dBm to + 20 dBm
2	71710D		10MHz to 18GHz	-70 dBm to + 20 dBm
3	71710E		50MHz to 26.5GHz	
4	71710F		50MHz to 40GHz	
5	71710L		50MHz to 67GHz	
6	81702D	Broadband peak power sensor	50MHz to 18GHz	-20 dBm to + 20 dBm
7	81702E		500MHz to 26.5GHz	
8	81702F		500MHz to 40GHz	
9	81702L		500MHz to 67GHz	
10	81703D	Wide dynamic range peak power sensor	50MHz to 18GHz	-40 dBm to + 20 dBm
11	81703E		500MHz to 26.5GHz	
12	81703F		500MHz to 40GHz	
13	81703L		500MHz to 67GHz	
14	71716	MMW (THz) power sensor	50GHz to 75GHz	-30 dBm to + 20 dBm
15	71717		75GHz to 110GHz	
16	71718		110GHz to 170GHz	
17	87106A		170GHz to 220GHz	
18	87106B		220GHz to 325GHz	
19	87108B		325GHz to 500GHz	

The user can select the appropriate sensor according to the characteristics and measurement requirements of the measured signal and the specifications of each sensor. The main unit and power sensor models are shown in Tables 4.1 and 4.2. Please refer to Chapter 8 “Main specifications” for detailed description of specifications of each sensor.

4.2 Zeroing and calibration before measurement

To improve the power measurement accuracy, the power sensor should be zeroed and calibrated during power measurement.

The 2438 series microwave power meter contains a calibrator with a frequency of 50 MHz and power of 0 dBm which can be traced back to national standards.

The 71710 series CW power sensor, if used, should be connected to the calibrator for calibration, but the 81702 or 81703 series peak power sensor has no such demand as they are built-in with a calibration circuit and can be calibrated online during use.

4.2 Zeroing and calibration before measurement

After the user performs regular maintenance according to the recommended calibration interval, the calibrator can enable the user to measure the CW power more accurately.

It is recommended to zero and calibrate the power sensor:

- 1) every time the sensor is replaced. The sensor needs to warm up for 15 minutes for stabilization before auto-calibration.
- 2) when the prompt "Channel A/B requires zeroing and calibration" is displayed in the system state area;
- 3) when the temperature drift warning message is displayed in the system message area on the screen. If the surrounding ambient temperature of the sensor changes too much, the system will display an excessive temperature drift message. When the temperature returns to the specified range, the system will automatically clear the warning message.
- 4) when the 71710 series CW sensor is used for measurement if the power of the measured object is relatively low (<-40 dBm). After the 71710 power sensor is connected to the device under test, disable the output of the device under test, perform zeroing operation for the 71710 power sensor and eliminate the error caused by ground noise between the microwave power meter and the device under test.
- 5) after the 81702 or 81703 series peak power sensor with a built-in zeroing and calibration function is connected to the device under test. The online zeroing and calibration can be performed without disablement of output of the device under test.

Attention

When the "Calibration required" function is activated, if the user is unable to perform calibration because of the above-mentioned circumstances, then measurement cannot be carried out. Normal measurement can only continue once auto-calibration is complete.

4.2.1 Zeroing and calibration of the 71710 series CW sensor

The zeroing operation of the 71710 series power sensor refers to measurement and storage of the noise of the entire measurement channel. In the measurement process, the zeroed value should be subtracted from the actual measured value, that is, the channel noise should be subtracted, and the reading obtained at this time is the true channel input signal level.

With regard to the zeroing operation of the 71710 series sensor, if the sensor is connected to the port of the device under test, it is necessary to disable the power output of the device under test.

The zeroing operation should be performed as per the following steps:

- 1) Disable the signal output of the device under test;
- 2) Press [Cal]>[Channel A] >[Zero];
- 3) Wait for 30 s and complete zeroing.

During calibration of the 71710 series power sensor, it is necessary to connect the sensor to the calibrator port of the device under test as per the following steps:

- 1) Connect the 71710 series power sensor to the calibrator output port;
- 2) Press [Cal]>[Channel A] >[Cal];
- 3) Wait for 30 s to complete calibration.

Alternatively, press [Cal]>[Channel A] >[Zero+Cal] and complete zeroing and calibration simultaneously.

4.2.2 Zeroing and calibration of the 81702 or 81703 series peak power sensor

With a built-in calibration circuit, the 81702 or 81703 series peak power sensor can be calibrated without being connected to the calibrator output port of the 2438 microwave power meter.

The zeroing and calibration steps of the 81702 or 81703 series peak power sensor are the same as those of the 71710 series power sensor. Please refer to the zeroing and calibration process of the 71710 series power sensors.

4.3 CW power measurement

4.3 CW power measurement

The 2438 series microwave power meter is connected to a 71710 series CW power sensor to measure the average power of the CW signal power within the dynamic range of -70 dBm ~ +50 dBm.

The CW power is measured as per the following three steps:

- 1) Perform zeroing and calibration;
- 2) Set the frequency of the signal to be measured;
- 3) Measure the CW power using a CW sensor.

Take Channel A as an example, the specific operation process is as follows:

- 1) Connect one end of the multi-core cable to the Channel A port of the front panel and the other end to the 71710 sensor, and then power on the instrument;
- 2) After warm-up for 15 min, connect the 71710 series sensor to the calibrator port of the 2438 microwave power meter. After power-on, set [Cal]> [Channel A] > [Zero+Cal], and wait for 30 s to complete zeroing;
- 3) Set [Frequency]>[CHA Freq], input the frequency value of the measured signal, and make sure that the system calls the correct calibration factor to ensure the measurement accuracy;
- 4) Connect the 71710 series sensor to the output port of the measured signal, and the average power level of the signal will be displayed on the system screen.
- 5) Press [Menu]>[Display] >[Digit Unit], and select the current measured power value as “Log” or “Lin”;
- 6) Press [Window]to switch to the extended window display mode, and press [Window]again to switch to the full-screen display mode.

In practical application, zeroing and calibration are not always required for every measurement. Refer to Section 4.2 “Zeroing and calibration before measurement” in this chapter.

Attention

When a lower level signal is measured, it is necessary to carry out automatic zeroing and calibration and then perform measurement so as to ensure the measurement accuracy.

When the power is lower than -50 dBm, it is necessary to set [Step Detect] to “Off” and [Average] to “Man”, and the average count will be more than 200 times. If the power is lower than -60 dBm, the average count will be more than 500 times.

4.4 Peak power measurement

The 2438 series microwave power meter can measure the peak power of the pulse modulation signal after being connected to the 81702 or 81703 series peak power sensor and display the measured peak power in the form of an envelope diagram. The 81702 series power sensor has a pulse power range of -20 dBm ~ +20 dBm and a frequency range of 50 MHz ~ 67 GHz; the 81703 series power sensor has a pulse power range of -40 dBm ~ +20 dBm and a frequency range of 50 MHz ~ 67 GHz. The peak power, average power, overshoot, rising/falling time, top power, bottom power, pulse width, pulse period, duty cycle, off time, pulse repetition frequency and other pulse modulation signal envelope parameters can be measured.

The definitions of the pulse waveform and automatic measurement parameters as well as the detailed pulse power measurement steps are introduced respectively hereinafter.

4.4.1 Definitions of pulse measurement parameters

In this section, the definitions of pulse parameters of the 2438 series microwave power meter are introduced in detail.

The pulse envelope parameters are graphically described as shown in Fig. 4.1, the IEEE 194-1977 pulse terms and definitions are introduced in Table 4.3, and the definitions of various pulse parameters are detailed in Table 4.4.

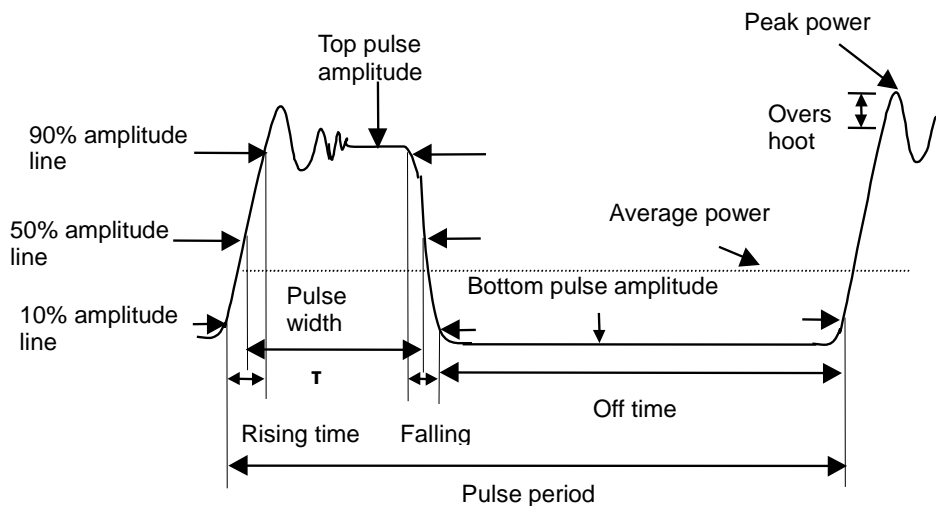

Fig. 4.1 Schematic Diagram of Pulse Envelope Amplitude and Time Domain Parameter Definitions

Table 4.3 IEEE Pulse Terms

English Term	Definition
Base Line	The standard pulse waveform consists of two normal states - high and low levels. The base line represents the low level, which is expressed as an equivalent reference line.
Top Line	The top line represents the high level, which is also expressed as an equivalent reference line. In practical application, the base line and top line are defined using the histogram. The specific definition is as follows: Taking the first transition mesial line power and last transition mesial line power as the reference, the power value with the most power points between the top transition and the last transition is defined as the base line.
First Transition	It refers to the main transition area between the base line and the top line of the waveform.
Last Transition	It refers to the main transition area between the top line and the base line of the waveform.
Proximal Line	It refers to an equivalent reference line with its value equal to a certain percentage (usually 10%) of pulse amplitude near the base line.
Distal Line	It refers to an equivalent reference line with its value equal to a certain percentage (usually 90%) of pulse amplitude near the top line.
Mesial Line	It refers to an equivalent reference line with its value equal to a certain percentage (usually 50%) of pulse amplitude in the middle of pulse.

The 2438PA/PB microwave power meter can automatically measure 14 parameters of the pulse power envelope, including time parameters and power amplitude parameters. The specific meanings are shown in Table 4.4.

4.4 Peak power measurement

Table 4.4 Definitions of Pulse Measurement Parameters

Term		Definition
Time Parameter	Pulse width	It is time interval between the first transition mesial line and the last transmission mesial line of the pulse. It is usually defined as the time interval between the first transition 50% power cord and the last transmission 50% power cord of the pulse. ATTENTION: If the waveform display is less than a pulse width, the “Width” value can’t be displayed for automatic measurement in the medium window.
	Pulse period	It refers to the time interval between two consecutive pulses, i.e. the reciprocal of the pulse repetition frequency. ATTENTION: If the waveform display is less than a pulse period, the “Period” value can’t be displayed for automatic measurement in the medium window.
	Pulse repetition frequency	It refers to the number of times for generation of the repetitive signal within one second. ATTENTION: If the waveform display is less than a pulse period, the “Rpt Freq” value can’t be displayed for automatic measurement in the medium window.
	Rise time	It is time interval between proximal line and distal line of the first transition of the pulse. The proximal line is usually defined as 10% of pulse power while the distal line is usually defined as 90% of pulse power. Alternatively, both of them can be defined by the user. ATTENTION: With regard to automatic measurement of “Rise time”, the first transition of waveform must be displayed in the window.
	Falling time	It refers to the time interval between proximal line and distal line of the last transition of the pulse. ATTENTION: With regard to automatic measurement of “Falling time”, the last transition of waveform must be displayed in the window.
	Duty Cycle	It refers to the ratio of the pulse width to the pulse period ATTENTION: If the waveform display is less than a pulse period, the “Duty Cycle” value can’t be displayed for automatic measurement in the medium window.
	Off time	It refers to the time of periodical pulse off, which is equal to the pulse period minus the pulse width. ATTENTION: If the waveform display is less than a pulse period, the “Off Time” value can’t be displayed for automatic measurement in the medium window.
	Delay	It refers to the time interval between the leftmost end of the screen and the 1 st first or last transition of waveform from left to right on the mesial line of pulse.
Power Parameter	Peak power	The maximum pulse waveform power in the window is displayed.
	Average power	The average pulse waveform power in the window is displayed. ATTENTION: In the trace display window, the “AVG PWR” can be measured on the premise that the waveform display must be greater than one pulse period; otherwise it can’t be measured automatically.
	Top Power	It refers to the top pulse power. The top pulse power is defined statistically. With the peak power as the reference, the point with the highest frequency in the range of 5 dB below the peak power is defined as the top power.
	Bottom Power	It refers to the bottom pulse power.

4.4 Peak power measurement

		The bottom power is calculated as per the same method as the top power. With the minimum pulse power as the reference, the point with the highest probability in the range of 12 dB below the minimum power is defined as the top power.
	PAR	The ratio of the peak power to the average power in the window is displayed. In the log display mode, it is equal to the peak power minus the average power.
	Overshoot	It refers to the difference between the peak power and the top power.

Attention

The measurement of pulse parameters is based on that of waveform display parameters in the window. Not all the parameters can be displayed in one mode. During test, please pay attention to the restricted conditions for automatic measurement of various parameters in Table 4.4, and refer to relevant settings in “4.4.2 Peak power measurement and waveform display” to complete the accurate test of various pulse parameters.

4.4.2 Peak power measurement and waveform display

This section introduces in detail the methods for measurement of the pulse signals and rapid observation of the parameters of various pulse envelopes with the 2438 microwave power meter set at Channel A and connected to a 81703D power sensor.

The signal generator is set with a frequency of 5 GHz, a power of +10 dBm, a pulse period of 20 us and a pulse width of 10 us.

The specific operation steps are as follows:

- 1) Connect the zeroed and calibrated 81703D power sensor to the signal generator output port;
- 2) Set [Menu]>[Display] >[Disp Mode] >[Trace A] to display the waveform;
- 3) Set [Menu]>[Trigger] >[A TrigMode] >[Continue Trig], [Settings] >[Trig Source] >[Chan A], [Trig Mode] >[Auto], [Trig Level] > [0dBm], [Trig Slope] >[-] to complete the setting of the trigger menu;
- 4) Set [Window] to switch from small window display to medium window display;
- 5) Set [Trace Set] >[Vert Cent] >[-10dBm], [Vert Scale] >[10dB/], [Trig Pos] >[Mid], [X Scale] >[5us/] to complete display of several waveforms;

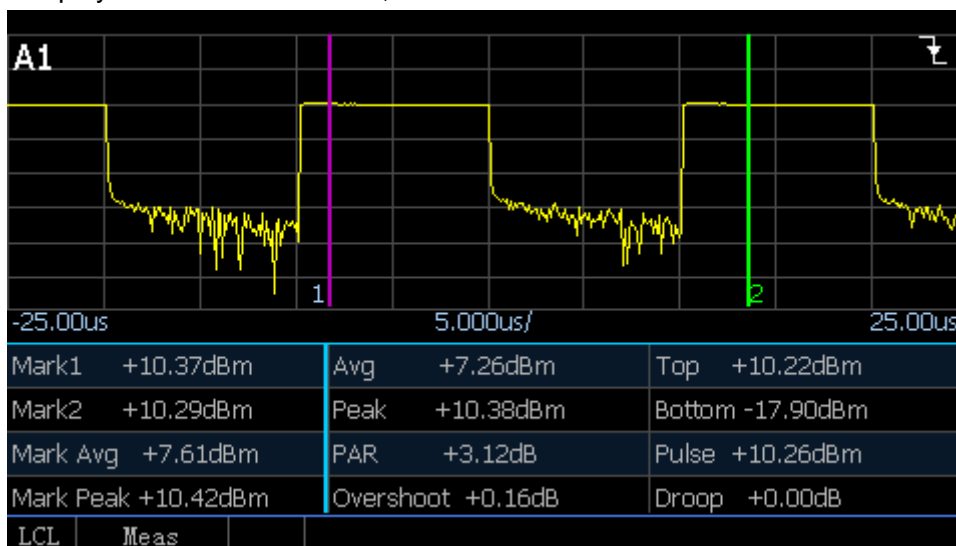

Fig. 4.2 Automatic Measurement of Power Parameters in Several Periods

- 6) Set [Channel]>[Trace Ctrl] to enter the trace control interface and set [Meas Para] >[Pwr] to obtain display of several waveforms and automatic measurement of power parameters as shown in Fig. 4.2 ;

4.4 Peak power measurement

- 7) Set [Meas Para] >[Time] to obtain display of several waveforms and automatic measurement of time parameters as shown in Fig. 4.3. At this time, the X scale is relatively large, so the Rise time and falling time can't be observed. In this case, the X scale and trig slope can be modified for the Rise time and falling time tests;

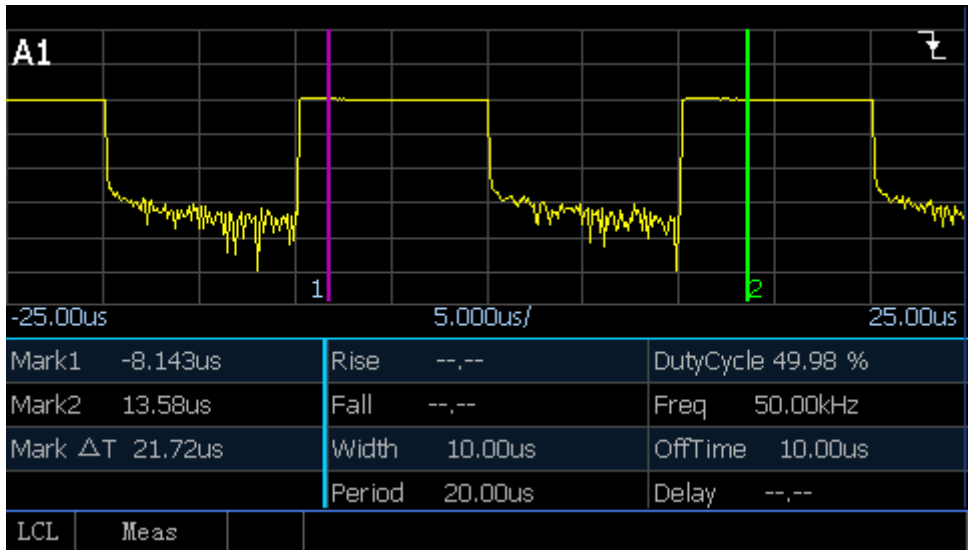

Fig. 4.3 Automatic Measurement of Time Parameters in Several Periods

- 8) Set [Trace Set] >[X Scale] >[20ns/] to obtain the Rise time of pulse signal as shown in Fig. 4.4;
- 9) Set [Menu]>[Trigger] >[Trig Pos] >[Trig Slope] >[-] and use the last transition trigger to obtain the falling time of pulse signal.

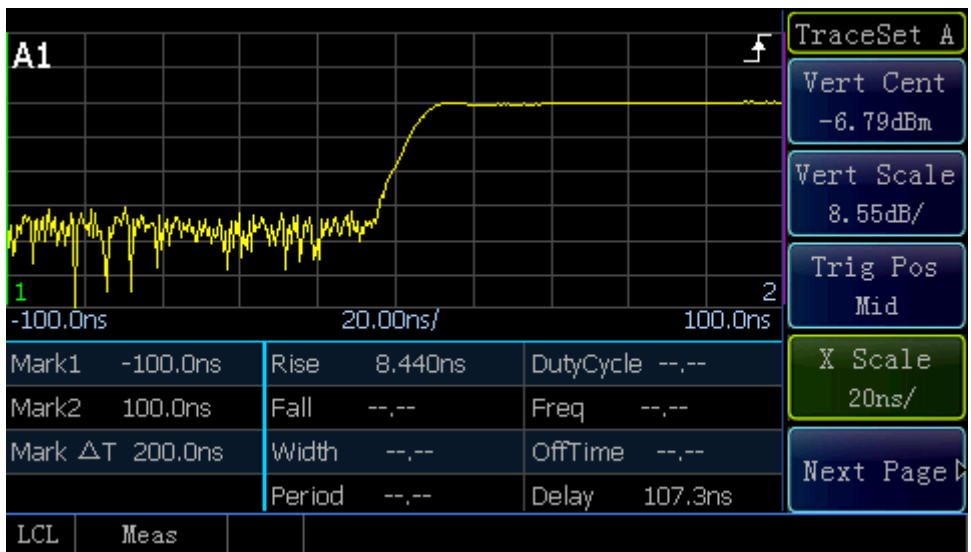

Fig. 4.4 Rise time Test

4.5 Switching of display window

The 2438 series microwave power meter has three window display modes, i.e. small window display, medium window display and large window display, which can be switched through the [Window] key.

Fig. 4.5 shows small window display. The small window is divided into upper and lower parts each of which displays independent content. In the small window, simple content rather than detailed pulse envelopes can be displayed in the two parts simultaneously.



Fig. 4.5 Small Window Display

In the small window display mode, the current window is selected through the “Up” or “Down” key, and a blue-grey background indicates that the current window is selected. Press [Window] to switch to the medium window display as shown in Fig. 4.6.

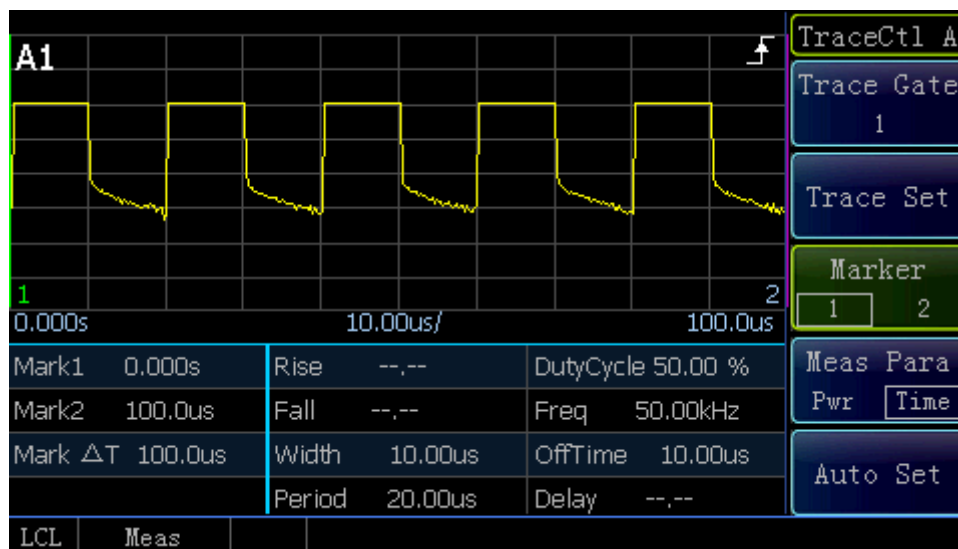

Fig. 4.6 Medium Window Display

In the medium window, the upper part shows the waveform while the lower part displays the waveform parameters including power and time parameters. Below [Trace Ctrl], select [Meas Para] as “Pwr” or “Time”. For specific setting of time and power parameters, please refer to “4.4 Peak power measurement”.

In the medium window display mode, press [Window] to switch to large window display. The content displayed in the large window is the same as that in the medium window. The window is only enlarged to

4.6 Setting of trigger position

cover the soft menu on the right side as shown in Fig. 4.7.

The small, medium and large windows can be switched cyclically through the [Window] key.

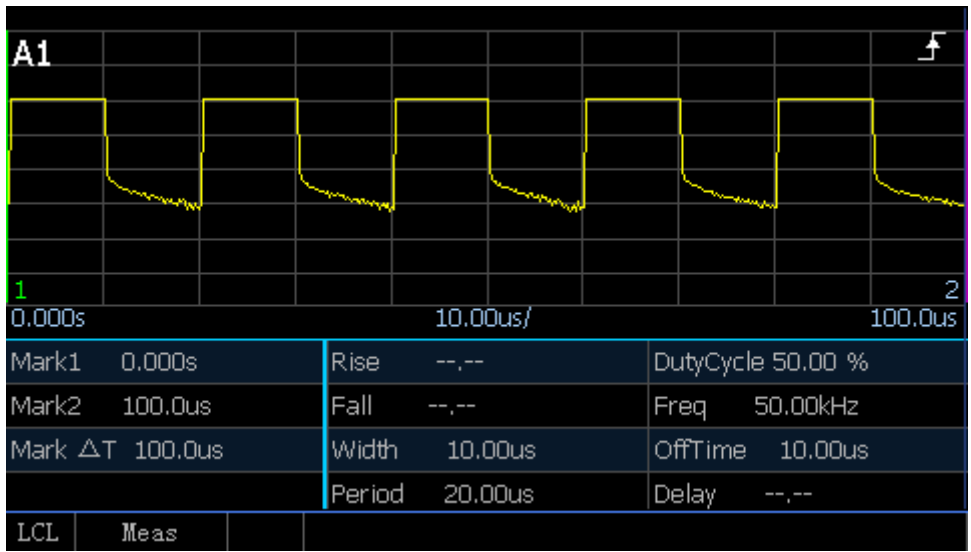

Fig. 4.7 Large Window Display

4.6 Setting of trigger position

Trigger is the basis for stable measurement of a pulse. The pulse envelope is shaped to generate a trigger signal that is synchronized with the measured signal, and the first or last transition of the trigger signal is used as the trigger position. The trigger position is the sampling reference. According to the "Trig Pos" and "Trig Delay", the waveform is displayed at the corresponding position on the screen.

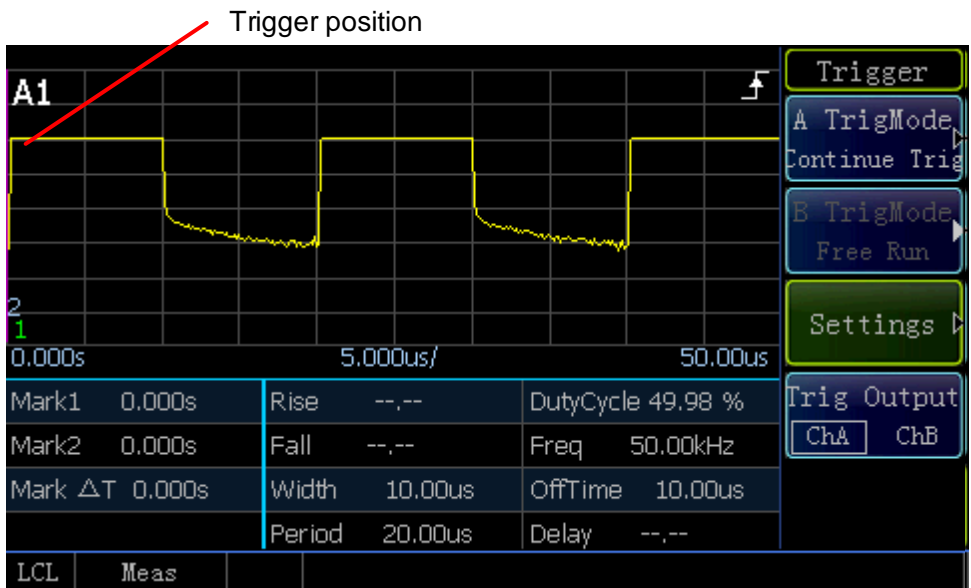

Fig. 4.8 Trigger Position on the Left Side of the Screen

4.6 Setting of trigger position

Fig. 4.8 displays the waveform with the trigger position on the left side of the screen. The trigger position can be set through [Settings] and [Trace Set]. As shown in Fig. 4.8, the trigger position is on the left side of the screen and the first transition is used as the trigger position. The specific settings are as follows:

- 1) Set [Menu]>[Trigger] >[Trig Pos] >[Trig Slope] >[+];
- 2) Set [Channel]>[Channel A] >[Trace Ctrl] >[Trace Set] >[Trig Pos] >[Left];

The trigger position can be controlled through “Trig Pos” and “Trig Delay”.

The waveform with the “Trig Pos” set to “Mid” is displayed in Fig. 4.9.

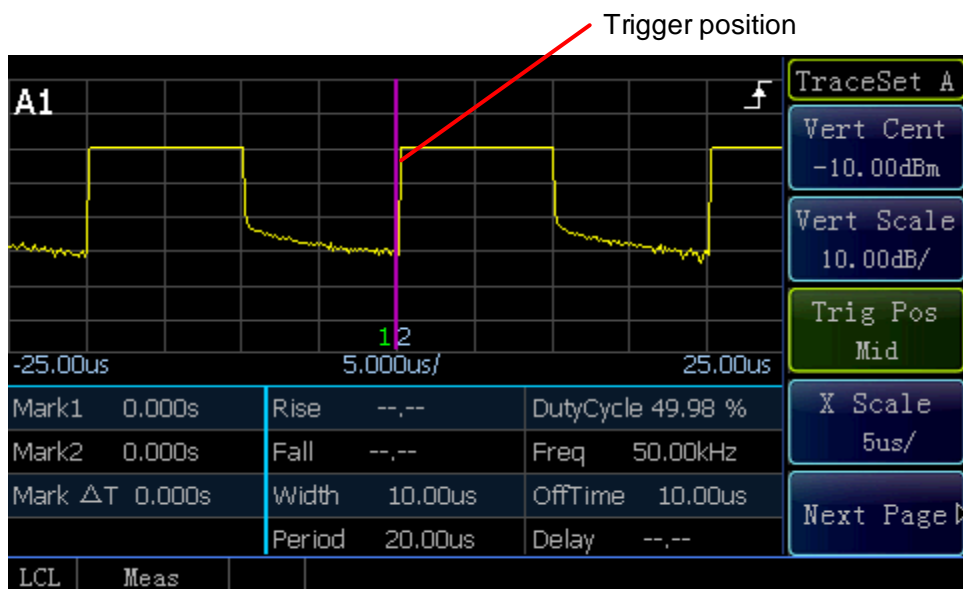

Fig. 4.9 Trigger Position in the Middle of the Screen

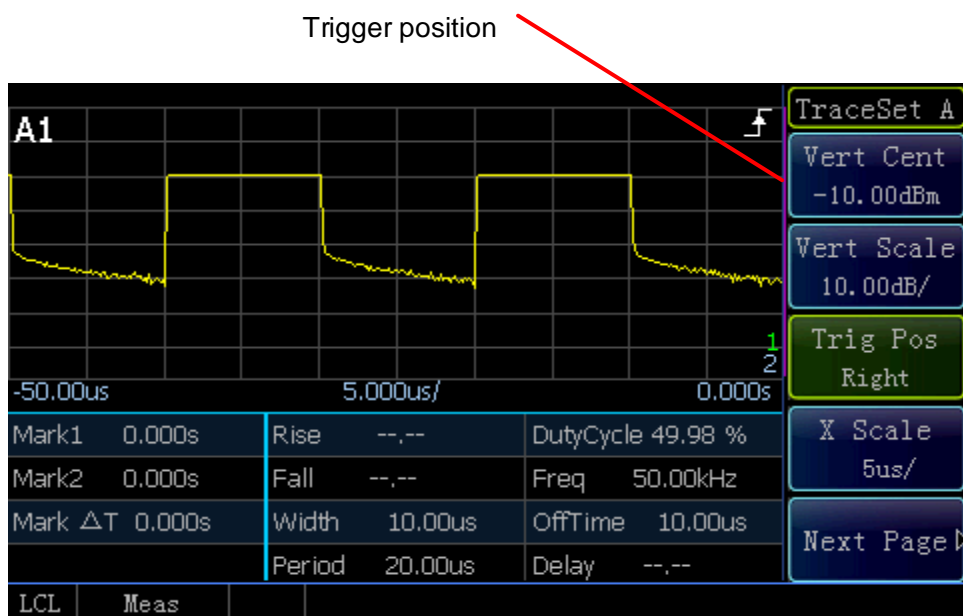

Fig. 4.10 Trigger Position on the Right Side of the Screen

4.7 Test methods for stability of pulse strings in different periods

Through “Trig Delay”, the trigger position can be set at any position on the screen or even outside the screen. Fig. 4.11 shows the signal’s rising edge, with [Trig Pos] set to “Mid” , [Trig Delay] set to “8us” and waveform moved leftwards by 8 us relative to the screen center. Similarly, if [Trig Delay] is set to a negative value, the waveform will be moved rightwards relative to the screen center.

The waveform displayed on the screen can also be triggered through the last transition of the pulse. Set [Trig Slope] >[-], and the last transition trigger will be adopted.

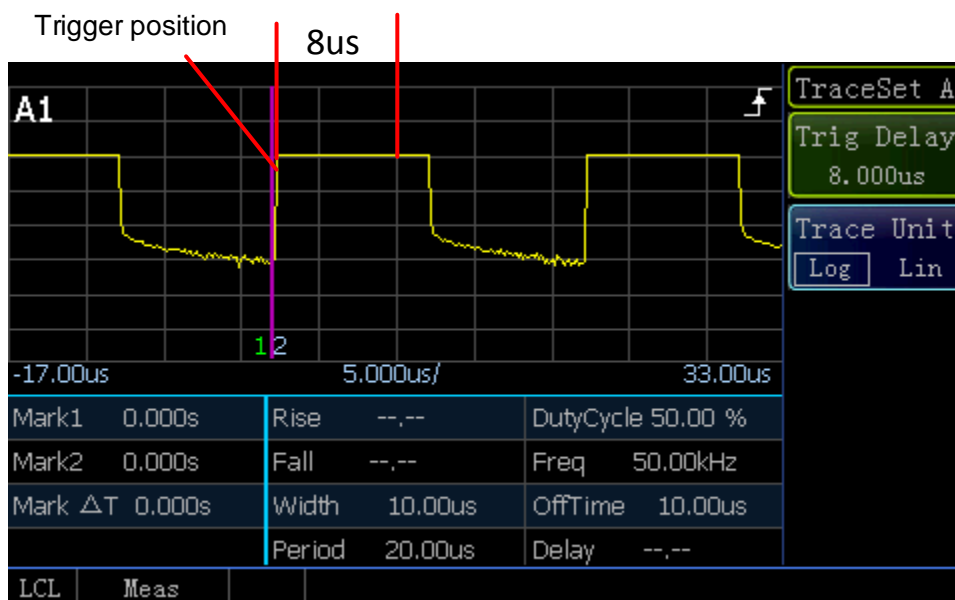

Fig. 4.11 Trigger Delay of 8 us

4.7 Test methods for stability of pulse strings in different periods

The pulse strings can be measured through “HoldOff”

After trigger is performed each time, it is necessary to add a certain time interval during which pulse trigger is prohibited. This time period should be shorter than the period of the pulse string but longer than the “Pulse Width Excluding the Maximum Period in the Pulse String”. For example, if a pulse string includes five pulses with the periods of “2us, 4us, 6us, 8us, 10us” respectively, then “HoldOff” should be set between 20.1 us and 29.9 us so that the pulse sequence can be triggered stably.

In this section, the methods for measurement of the pulse strings in different periods through the trigger holdoff function are described in detail by taking the Channel A of the 2438 microwave power meter connected to a 81702D peak power sensor for example.

The signal generator is set with a frequency of 1 GHz and a power of 10 dBm, the pulse modulation mode is adopted, and the output signal is a pulse sequence including five pulse with the periods of 2 us, 4 us, 6 us, 8 us and 10 us respectively and a duty cycle of 50%.

The specific settings are as follows:

- 1) Connect the zeroed and calibrated 81702L power sensor to the signal generator output port;
- 2) Set [Menu]>[Trigger] >[Trig Pos] >[Trig Slope] >[+], [Trig Source Chan A] and [Trig Level -5dBm];
- 3) Set [HoldOff 21us];
- 4) Set [Menu]>[Display] >[Disp Mode] >[Trace A];
- 5) Set [Channel]>[Trace Ctrl] >[Trace Set] >[X Scale 10us/], [Trig Pos Mid], [Vert Scale 10.00dB/];

4.8 Setting and use of “Gate”

The pulse strings in different periods can be stably displayed on the screen through the above steps.

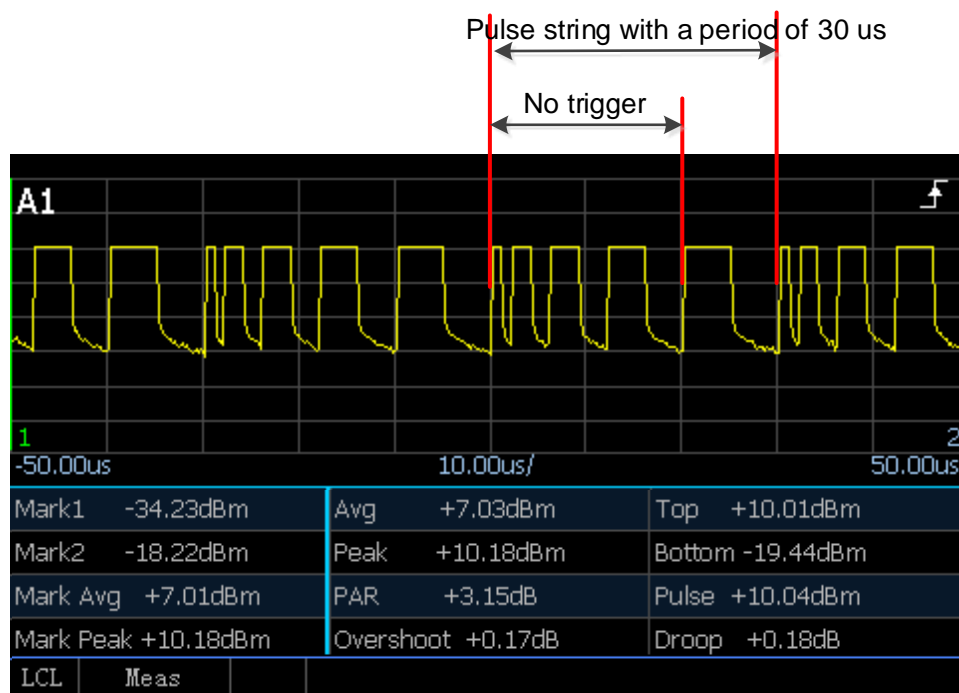

Fig. 4.12 Stability Test of Pulse Strings in Different Periods

4.8 Setting and use of “Gate”

For the 2438 series microwave power meter, the “Gate” is an important auxiliary measurement method. A good familiarity with the setting of the “Gate” will make many pulse parameter tests easier.

4.8.1 Basic concept of gate

The “Gate” method is only applicable for measurement with a peak power sensor. Relative to the trigger position method (see the section “4.6 Setting of trigger position”), the gate is used to display the measurement information of the trace within a specific period of time. Every peak measurement channel can be set with four gates at most each of which can define five types of measurement, namely “AVG PWR”, “Peak PWR”, “PAR”, “Min PWR” and “Max/min”.

The specific definitions are as follows:

AVG PWR: Average power of the current gate;

Peak PWR: Maximum power of the current gate;

PAR: Ratio of the peak power to the average power of the current gate;

Min PWR: Minimum power of the current gate;

Max/min: Ratio of the maximum power to the minimum power of the current gate.

4.8 Setting and use of “Gate”

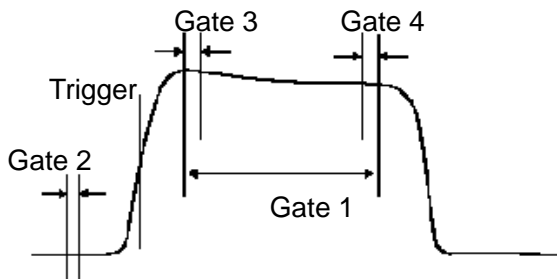

Fig. 4.13 Schematic Diagram of Gates

For example, set the gate as shown in Fig. 4.13 to perform the following measurement:

- 1) Average power level of pulse: Measurement of average value of Gate 1;
- 2) Peak-to-average ratio: Measurement of peak value - average value of gate 1;
- 3) Pulse droop: Measurement of average value of Gate 3 minus average value of Gate 4;
- 4) Average noise: Measurement of average value of Gate 2.

Attention

The concept of “Gate” is only applicable to the 81702 or 81703 series peak power sensor, while the “Gate”-related operation isn't involved for the 71710 series CW sensor;

When the sampling mode of the 81702 or 81703 series peak power sensor is set as “Free Run”, there will be no “Gate”-related operation, therefore, please set the trigger mode as “Continue Trig” when setting the “Gate”.

For the Gate measurement method, the “Trace Disp” and “Digit Disp” input modes are different!

If the trace display mode is adopted, the “Gate” can only be modified by selecting [Trace Ctrl] > [Trace Gate] > gate or the position and length of the gate can be modified through “Gates Set” or the [Left] and [Right] keys.

In the trace display mode, the average power and peak power of only one gate can be measured, which corresponds to the mark average and mark peak automatically measured in the medium and large window display modes respectively.

In the digit display mode, the gate should be set through [Menu]>[Meas]>[Feed];

In the case of single channel, it is not allowed to modify “Channel” because the default mode is “Channel A”. In the digit display mode, two gates can be tested in combination. There are two combinations, i.e. “F1/F2” and “F1-F2”. Users can freely define the measurement types of gate 1 and gate 2 and freely combine various measurement types.

4.8.2 Setting of the gate position

Four gates can be set at most. The gate position relative to the trigger position is set as follows:

- 1) Set [Channel] > [Channel A] > [Gates Set] > [Gate Number] to select the gate setting. There are four gates in total. If “1” is selected, the setting is applicable to “Gate 1”;
- 2) Use [Start Pos] to set the start position of gate 1, which corresponds to the position of “Mark 1” displayed on the screen;
- 3) Use [Length] to set the length of gate 1, which corresponds to the time length between “Mark 1” and “Mark 2” displayed on the screen, therefore, the position of “Mark 2” is “Mark 1” + “Length”;

- 4) For a more intuitive setting of the gate, the "Trace Gate" can also be used, e.g. if [Gate Number] is set as "1" and [Trace Gate] is also set as "1", the position of Mark 1 and Mark 2 that correspond to the gate relative to the waveform position can be seen in the waveform. According to the positions of Mark 1 and Mark 2, the start time and length of the gate can be called in an intuitive way;

In the trace display window, enter the [Trace Ctrl] menu, select [Marker 1, 2], and move through the [Left] and [Right] keys.

Attention

If the display capacity becomes insufficient for the gate measurement display when the parameters such as the X scale and trigger delay are changed, the system will automatically adjust the gate setting within the screen range. The measurement of gate parameters is based on the range that between the current markers!

4.8.3 Gate setting in the trace display mode

In the trace display mode, the average power and peak power of only one gate can be measured, which corresponds to the values of Mark 1 and Mark 2 automatically measured below the waveform in the medium and large window display modes respectively.

The gate in the trace display mode is set as per the following steps:

- 1) Set [Trace Ctrl] >[Trace Gate] >[1] to select the gate corresponding to the mark below the current trace as 1, and A1 will be displayed correspondingly at the upper right corner of the trace display window; if the trace gate is selected as 2, A2 will be displayed at the upper right corner;
- 2) Set [Meas Para] >[Pwr] to set the power measurement parameter, the power of Mark 1 and Mark 2 that correspond to the current gate as well as the mark average and mark peak will be displayed in the left column below the trace display;
- 3) Set [Meas Para] >[Time] to set the time measurement parameter, the time of Mark 1 and Mark 2 that correspond to the current gate as well as the time length between Mark 1 and Mark 2 will be displayed in the left column below the trace display;

4.8.4 Gate setting in the digit display mode

In the digit display mode, the displayed value is a setting of the gate. When the measured result is 2 in the digit display mode: (1) measured result of a single parameter setting, such as "AVG PWR" and "Peak PWR" of a gate; (2) combined measured results of 2 gates, such as the ratio of "AVGPWR of Gate 1" to "AVG PWR of Gate 2".

The single and combined gate settings are described respectively hereinafter.

Single gate setting steps:

- 1) Set [Menu] >[Measure] >[Feed]. In the case of single channel measurement, the default channel is "Channel A"; in the case of double channel measurement, "Channel A" or "Channel B" can be selected. Take [Channel A] as an example;
- 2) Set [Comb Mode] >[Sing] to select the single gate measurement mode;
- 3) Set [Gate] >[1] to set the current gate as 1, and A1 will be displayed at the upper right corner of the digit display window, which indicates that the current gate is Gate 1;
- 4) Set [Meas] >[AVG PWR], the average power of Gate 1 will be displayed in the digit display window;
- 5) Alternatively, set [Meas] as "Peak PWR", "PAR", "Min PWR" or "Max/min", the corresponding measured value will be displayed in the digit display window.

Combined gate setting steps:

- 1) According to the single gate setting steps, set the "Feed1" as "Channel A" to set the "AVG PWR" of "Gate 1";

4.9 Setting and use of “Offset”

- 2) Set [Comb] >[Comb], and [Feed2] will light up and the operation of [Feed2] will be allowed;
- 3) Set [Feed2] >[Channel] >[Channel A], [Gate] >[2] to set the second data of “Comb Meas” as Gate 2 of Channel A;
- 4) Set [Comb] >[F1/F2], A1/A2 will be displayed at the upper right corner of the digit display window, which indicates that the measured result is the ratio of gate 1 to gate 2;
- 5) Set [Meas] >[AVG PWR] to set “Meas” of “Gate 2” as “AVG PWR”, the measurement result in the digit display window will be the ratio of “AVG PWR of Gate 1” to “AVG PWR of Gate 2” in dB.
- 6) If [Comb] is set as [F1-F2], A1-A2 will be displayed at the upper right corner of the digit display window, and the measured result in the digit display window will be the difference between “AVG PWR of Gate 1” and “AVG PWR of Gate 2” in dBm.

4.9 Setting and use of “Offset”

The 2438 series microwave power meter can compensate signal attenuation or gain in the test path. Offset can be set in three different positions in the measurement channel, i.e. “Chan Offset”, “Disp Offset” and “FDO”, among which “Chan Offset” and “FDO” act on the entire channel and can perform compensation independent of Channel A or Channel B; while “Disp Offset” only acts on the current window and compensates the measured value in a certain display window.

4.9.1 Setting of channel offset

If an amplifier or attenuator circuit is contained in the measurement path, the gain and attenuation are inherent to the measurement channel. The channel offset is expressed in dB with the range of -100 dB ~ +100 dB of which the positive value compensates the attenuation of the attenuator and the negative value compensates the gain of the amplifier.

The channel offset is set as per the following steps:

- 1) Select [Channel]>[Channel A] >[Chan Offset] >[State] >[On] to enable the channel offset function, and the prompt “Offset On” will be displayed on the screen;
- 2) Set [Chan Offset] >[Offset] to input the offset value.

If the input offset is positive, the measurement result plus offset will be displayed. If the input offset is negative, the measurement result minus offset will be displayed.

If the channel or display offset is set, the system will display “Offset On”.

4.9.2 Setting of display offset

The display offset increases the offset of the measurement result in the current window and only acts on the current window. In the small window display, the window can be selected through the “Up” and “Down” keys, and then the display offset can be changed. The display offset is expressed in dB with the range of -100 dB ~ +100 dB of which the positive value compensates the attenuation and the negative value compensates the gain.

The display offset is set as per the following steps:

- 1) Select [Menu]>[Measure] >[Disp Offset] >[State] >[On] to enable the display offset function, and the prompt “Offset On” will be displayed on the screen;
- 2) Set [Disp Offset] >[Offset] to input the offset value.

If the input offset is positive, the measurement result plus offset will be displayed. If the input offset is negative, the measurement result minus offset will be displayed.

If the channel or display offset is set, the system will display “Offset On”.

4.9.3 Setting of FDO

The FDO varies with the frequency. It provides a fast and effective method for compensation of the frequency change in the response of the test system and acts on the power sensor. The microwave power meter can store 10 FDO tables each of which can set 80 frequency points at most.

4.9 Setting and use of "Offset"

After the frequency offset function is enabled, the power meter will automatically set the calibration factor according to the sensor calibration table and FDO table during measurement and correct the measured result to ensure the measurement accuracy.

The FDO is set as per the following steps:

- 1) Confirm that the power meter/sensor has been zeroed and calibrated;
- 2) Press [Channel]>[Channel A] >[Next Page] >[FDO] to enter the FDO setup window;
- 3) Press the [Up] and [Down] keys or the [Up] and [Down] soft keys to select the FDO table to be set. The selected FDO table will be displayed in dark blue;
- 4) Press the [State] soft key to open the FDO table;
- 5) Press the [Edit] soft key to enter the FDO table edit menu;
- 6) Press the [Insert] soft key to make the frequency dialog pop up. You can input the frequency point to be inserted through the numeric key and set the unit using the soft key on the right side;
- 7) After the frequency unit is input, the offset dialog will pop up automatically. You can input the offset value in dB at the inserted frequency point;
- 8) Press [Up] and [Down] to select the frequency point to be modified, and then press the [Edit] soft key to modify the FDO at the current frequency point;
- 9) If the FDO at a certain frequency point needs to be deleted, it can be done through the [Delete] soft key;
- 10) The offset unit in FDO table can be logarithmic or linear of which the former is dB and the latter is %. Press [Edit Unit] soft key to switch the unit.

When the FDO table is valid, the system displays the mark (1) in all measurement windows that use this channel.

If the frequency entered in the FDO table exceeds the frequency range defined in the sensor calibration table or FDO table, the microwave power meter will use the highest or lowest frequency point in the corresponding table to set the calibration factor and offset.

In practical application, if the frequency of the signal to be measured is different from the frequency point in the sensor calibration table and the effective FDO table, the microwave power meter will use the linear interpolation method to calculate the calibration factor and offset at that frequency point.

Fig. 4.14 shows the frequency offset edit window in which you can input the frequency point, offset value, etc.

FDO1 Name : User1		FDO
Frequency	Offset	Edit
1.000GHz	3.01dB	
2.000GHz	2.50dB	
3.000GHz	1.80dB	
4.000GHz	1.90dB	
5.000GHz	2.00dB	
6.000GHz	2.10dB	
7.000GHz	1.80dB	
8.000GHz	2.00dB	
9.000GHz	1.60dB	

Buttons: Edit, Insert, Delete, Edit Unit (Log, Lin)

Bottom bar: LCL Meas

Fig. 4.14 FDO Edit Window

4.10 Statistic analysis of power measurement

4.10 Statistic analysis of power measurement

The digital vector modulation method integrates amplitude modulation and phase modulation into a multi-level structure to represent the bits of a data stream such as CDMA. These modulated signals and noises are very similar no matter whether in the time domain or in the frequency domain, which leads to new measurement problems especially at the transmitter end of a digital communication system. Since the peak-to-average power ratio of the modulated signal is a complex function of the transmitted data rather than a function of the amplitude of the modulated signal, the original definitions of modulation depth and index make no sense. The encoding and multiplexing methods used further improve the similarity between the modulated signal and the noise. All these problems require the use of statistic measurement methods to detect and control the design parameters of the transmitter.

This requirement can be met by the CCDF statistic power analysis function of the 2438PA/PB microwave power meter. In the statistic measurement mode, the instrument doesn't need to trigger an event for measurement, instead, it continuously samples the signal for measurement. In this section, the statistic power analysis function is briefly introduced, and then the operation of the statistic analysis function is explained in detail.

4.10.1 CCDF definition

The peak-to-average power ratio of the acquired input signal of the sensor is taken as a discrete random variable Y, and a probability density function (PDF) of the variable is generated accordingly. The PDF graph can be seen as a power histogram which represents the percentage of a PRD in the entire power reading sample.

Another means of pulse modulation signal control of a transmitter is a cumulative distribution function (CDF) graph and a complementary cumulative distribution function (CCDF) graph. CDF represents the percentage of a sampling point in a specific sample where the power level is less than or equal to a certain value in the entire sample; while CCDF represents the percentage of a sampling point in a specific sample where the power level is greater than or equal to a certain value in the entire sample or can be expressed as 1 - CDF (1 minus CDF). **In a CCDF graph, the X-axis represents the peak-to-average power ratio in dB; the Y-axis represents the probability of occurrence of the power level greater than or equal to a certain value in dB.** CCDF is mainly designed for signal mixing, power amplification and signal decoding in the communication system. It can be used to check the effect of modulation mode, mix signals, evaluate the spread spectrum system and design and manufacture the RF microwave components.

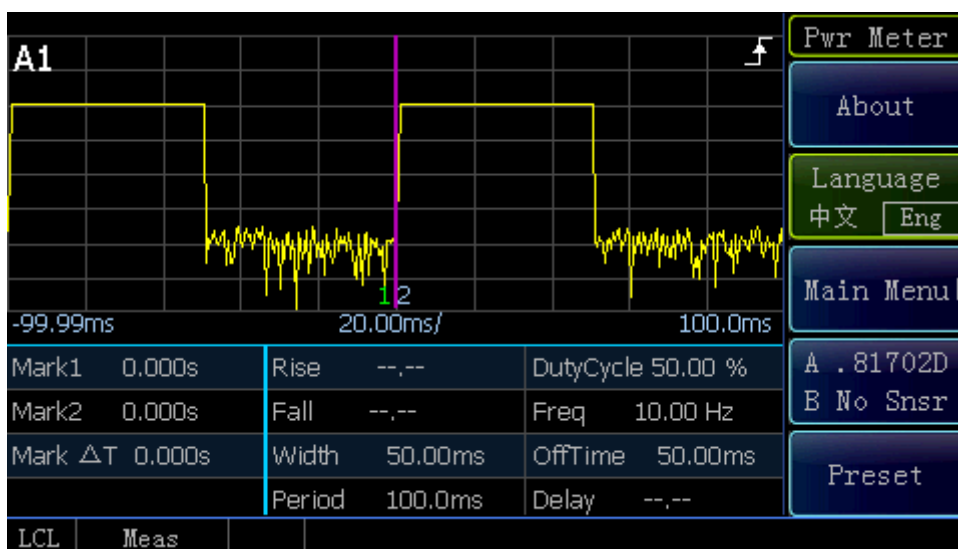

Fig. 4.15 Trace Display

Fig. 4.15 shows the trace display of the pulse modulation signal with a period of 100 ms, a pulse width of 50 ms and a peak power of 16.5 dBm.

4.10 Statistic analysis of power measurement

Fig. 4.16 is a typical CCDF measurement graph. In the figure, the horizontal coordinate of the curve represents the probability in %; the vertical coordinate represents the peak-to-average power ratio in dB. The pink curve Ref represents the reference curve. The Ref curve can be saved as the reference curve by selecting “CHA” or “CHB” below the [Ref Line] soft menu. The blue curve Gauss refers to the Gauss curve which represents the probability density distribution function of Gauss noise.

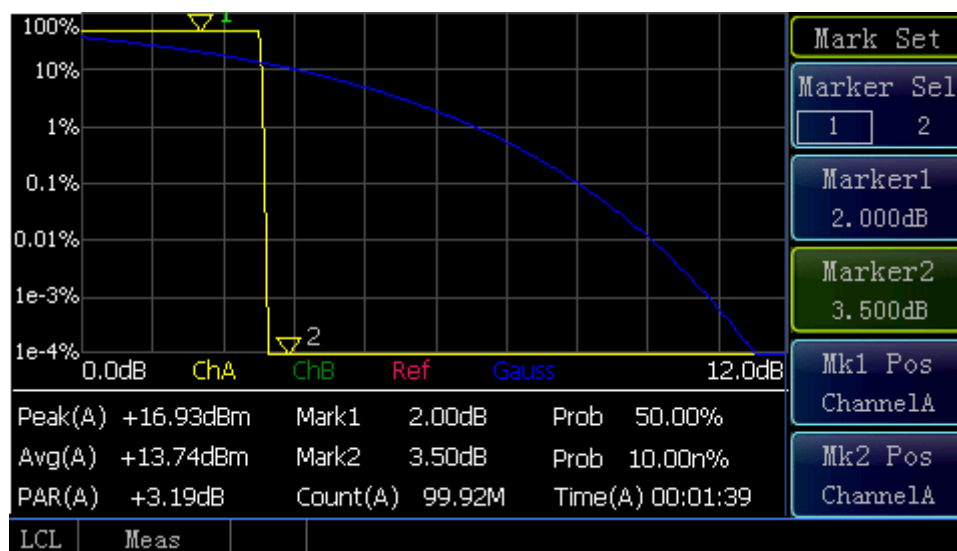

Fig. 4.16 CCDF Display

The yellow trace is the CCDF graph of the measured signal. Mark 1 and Mark 2 indicate the corresponding probability of the current peak-to-average ratio as shown in Fig. 4.15. Mark 1 has a horizontal coordinate of 2 dB and its probability of occurrence is 50.00%, which means the probability that the peak-to-average ratio is greater than 2 dB is 50.00%; similarly, Mark 2 means the probability that the peak-to-average ratio is greater than 3.5 dB is 10.00n% (“n” stands for 10⁻⁹, which means the probability of occurrence is infinitely small). Based on the definition of CCDF, the number of sampling points that are greater than the peak power level is 0, so the maximum peak-to-average ratio occurs at 0%.

4.10.2 Operation of CCDF power statistic trace

In this section, the detailed operation steps of CCDF waveform display is introduced. Take Channel A as an example. The detailed operational description is as follows:

- 1) After properly connecting the peak power sensor to the instrument with the accompanied 12-core cable, power on the instrument for start.
- 2) Press [Cal]>[Channel A] >[Zero+Cal] to start the automatic calibration program of Channel A;
- 3) Press [Back]for several times, press [Preset] , select “Default”, and press [Ok] to exit from the preset interface;
- 4) Press [Menu]>[Display]>[Disp Type]>[Next Page] >[Stat Trace], and the system will enter the CCDF statistic measurement window;
- 5) Scale setting: Press [Scale Set] >[X scale], enter 1.2 through the numeric key, set the X scale to 1.2 dB/div; press [Max Prob], and set the maximum percentage scale in the Y-direction; press [Scale Set] >[100%], [Decades], enter 6 through the numeric key, and set the vertical scale between 1e-4% and 100%;
- 6) Mark setting: Press [Mark Set] >[Marker 1], enter 2 dB through the numeric key; select [Marker 2], enter 3.5 dB through the numeric key, or select Marker 1 or Marker 2 in [Marker Sel], and move the mark through the [Left] and [Right] keys;
- 7) Terminate setting. To set the operation after completion of specified time or statistic sample, press [Term Set] >[Term Action Half], and the system will collect new samples continuously.

4.11 How to enter the [Trace Ctrl] menu quickly

The setting of CCDF statistic table is similar to trace setting: Press [Menu]>[Display]>[Disp Type]>[Next Page] >[Stat Table], and the system will enter the CCDF statistic table to display the values at several critical PAR positions in the form of table for user's use.

	Channel A	Channel B	
10%	3.30dB		Power Set 1.00dB
1%	3.36dB		Prob Set 10.00 %
0.1%	3.37dB		Terminate Set
0.01%	3.37dB		
0.001%	3.37dB		
> 10%	3.30dB		
> 1.00dB	50%		
Avg Power	7.32dBm		
Peak Power	10.68dBm		
LCL	Meas		

Fig. 4.17 Example of CCDF Statistic Table

The measured results at several key points are given in the form of statistic table in Fig. 4.17.

4.11 How to enter the [Trace Ctrl] menu quickly

During pulse signal measurement, the trace display can facilitate the observation of the shape of pulse envelopes, the required parameters can be quickly observed through setting of trace parameters, and the trace display is mainly set below the [Trace Ctrl] menu, therefore, the product is provided with a variety of methods for quick entry into the [Trace Ctrl] menu. The specific operation methods are as follows:

- 1) Entry through [Window] switching: Press [Up] and [Down] to select the trace display window, press [Window] to switch to the medium window, and the [Trace Ctrl] menu will be displayed in the soft key area on the right side.
- 2) Entry into the [Trace Set] menu through [Channel] for setting below the [Trace Ctrl] menu: Press [Channel] >[Channel A] >[Trace Set] to enter the [Trace Set] menu.

4.12 Test of low power signal

When the 2438 microwave power meter is connected to a 71710 series CW power sensor and a 81702 or 81703 series peak power sensor to measure low power signals, additional settings are required to ensure the power measurement accuracy.

4.12.1 Measurement of low power signal with a 71710 series CW sensor

When the 71710 series CW power sensor is used for power measurement of the signal with a power less than -60dBm, the following operations are required:

- 1) Warm up the instrument for at least 15 min after powering it on to ensure a stable temperature for the microwave power meter and power sensor;
- 2) Manually set the average count, press[Channel]>[Channel A] >[Average] >[Manu], and set [Avg Count] to 1,000;

4.13 Text display mode

- 3) Set [ChA Set] >[Step Detect Off];
- 4) Zero the sensor, connect the sensor to the device under test, disable its output, and press [Cal]>[Channel A] >[Zero];
- 5) Observe the power displayed on the screen after zeroing. When the displayed noise is below -75 dBm, enable the power output of the device under test, wait for about 20 s, and read the displayed power value.

If the measurement is performed for a long time, it is recommended to perform the zeroing and calibration operation again according to the above steps.

4.12.2 Measurement of low power signal with a 81702 or 81703 series peak power sensor

When the 81702 series peak power sensor is used to measure the pulse signal with a power less than -10 dBm, internal trigger will fail, and external trigger will be required at this time; the 81703 series peak power sensor has an internal trigger level of -25 dBm.

Taking the 81703 series power sensor with a measurement period of 100 us, a pulse width of 50 us and a peak power of -26 dBm as an example, the measurement process of low peak power signals is illustrated hereinafter.

- 1) Connect “Pulse Sync Output” of the signal generator to “Trig Input” of the instrument with a BNC cable;
- 2) Set the trigger source as ‘Ext’: press [Menu]>[Trigger] >[Trig Set] >[Trig Source Ext], and set [Trig Level 1V];
- 3) Set [Average] as “On”, and set the average count to 50;
- 4) Set the channel trace: press [Channel]>[Trace Ctrl] >[Trace Set] >[Vert Cent -30dBm], and set [Vert Scale 2dB/] and [X Scale 20us/].

Fig. 4.18 shows the test graph.

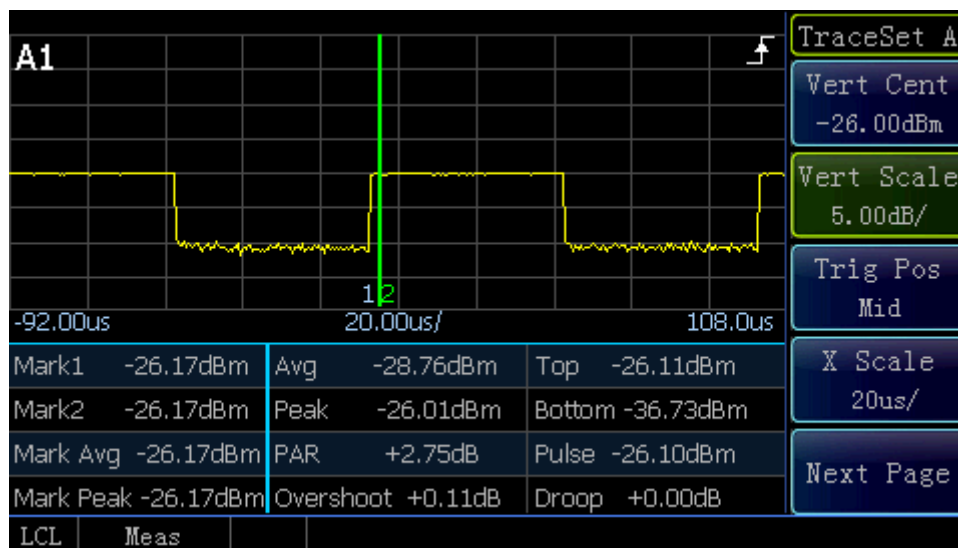

Fig. 4.18 Measurement of Low Peak Power Signal

4.13 Text display mode

Press [Menu]>[Display] >[Disp Type] >[Next Page] >[Text] to enter the text display window. Fig. 4.19 shows the text display window in which the results of all parameters of the pulse power test can be displayed simultaneously to facilitate observation.

4.14 Description of “Preset”

Param	Chan A	Chan B	Disp Type
R Time	--,--	--,--	Statistic Table
F Time	--,--	--,--	
Width	50.00us	--,--	Statistic Trace
Period	100.0us	--,--	
Freq	10.00kHz	--,--	Text
D Cyc	50.00 %	--,--	
PulsePwr	-26.03dBm	--,--	
P Avg	-28.67dBm	--,--	
P Peak	-25.95dBm	--,--	
Overshoot	+0.08dB	--,--	
Top	-26.03dBm	--,--	
Bottom	-36.37dBm	--,--	
P Droop	+0.00dB	--,--	
EdgeDelay	--,--	--,--	
LCL	Meas		

Fig. 4.19 Text Display Window

4.14 Description of “Preset”

With the preset function, the measurement settings in common wireless communication formats such as GSM900, EDGE, NADC, iDEN, Bluetooth, cdmaOne, and cdma2000 can be directly called, reducing the user’s setup time.

Press [Back] below any menu for several times, the system will finally return to the root menu of the power meter, and press [Preset] to open the “Preset State Sel” list as shown in Fig. 4.20.

Param	Chan A	Chan B	Disp Type
R Time	--,--	--,--	Statistic Table
F Time	--,--	--,--	
Width	50.00us	--,--	Statistic Trace
Period	100.0us	--,--	
Freq	10.00kHz	--,--	Text
D Cyc	50.00 %	--,--	
PulsePwr	-26.03dBm	--,--	
P Avg	-28.67dBm	--,--	
P Peak	-25.95dBm	--,--	
Overshoot	+0.08dB	--,--	
Top	-26.03dBm	--,--	
Bottom	-36.37dBm	--,--	
P Droop	+0.00dB	--,--	
EdgeDelay	--,--	--,--	
LCL	Meas		

Fig. 4.20 Preset State Selection Window

When the default state is selected, the system will restore some of the parameters except GPIB configuration, LAN configuration and FDO setting required for measurement to the factory default values.

When other test configurations are selected, the system will automatically set the parameters including measurement frequency, X scale, vertical scale, gate and trigger. For the detailed configuration of the default settings and other various communication formats, please refer to the “:SYSTem:PRESet” command in the 2438 Series Microwave Power Meter Programming Manual.

4.15 How to modify the sensor calibration factor

Since the power standard has a certain error during transfer, the power value at a certain frequency point measured by the 71710, 81702 or 81703 series power sensor connected to the 2438 microwave power meter may have a certain deviation from the power standard. For the purpose of convenient use, you are allowed to manually modify the calibration factor of the power sensor connected to the 2438 microwave power meter.

Attention

Always be careful when modifying the power sensor calibration factor!!!

The reason is that the modified data will be written into the sensor and substitute for the factory calibration factor. In case of wrong modification, please return the sensor to the manufacturer for repair or perform manual modification according to your power standard!

The sensor calibration factor should be modified as per the following steps:

- 1) Press [Menu]>[System] >[Service] >[System] >[Debug Mode] and enter the password "412438" to enter the calibration factor modification interface;
- 2) Press [Channel Sel] to select the channel accommodating the sensor with the calibration factor to be modified. If "A" is selected, the calibration factor of Channel A will be modified; if the calibration factor of Channel B needs to be modified, "B" should be selected.
- 3) Move the focus to the frequency point to be modified through the "Up" and "Down" keys, and the selected frequency point will turn blue.
- 4) Modify the calibration factor at two power points, i.e. 0 dBm and +15 dBm. "Calibration Factor 1" and "Calibration Factor 2" represent the compensation values at the 0 dBm and +15dBm power points respectively;
- 5) If the measured power is 0 dBm and the standard power is +0.5 dBm at the 1GHz frequency point, it indicates that the power of the power sensor connected to the 2438 microwave power meter is 0.5 dB lower than the standard value at the 1GHz and 0dBm frequency point, therefore 0.5 dB should be added.
- 6) If the frequency response of the power sensor at 1 GHz is 0.05 dB, add 0.5 dB based on 0.05 dB to obtain the value of 0.55 dB, and press the [Calibration Factor 1] soft menu to enter 0.55 dB;
- 7) In the same way, modify the calibration factor at +15 dBm, press the [Calibration Factor 2] soft menu, and write in the corrected data at +15 dBm.
- 8) After modifying all the frequency points that need to be modified in the power sensor, press [Write into Sensor], and a prompt dialog will pop up. If you confirm to write the modified data into the sensor, press [Ok];
- 9) It will take 6 s to write the modified data into the sensor during which it is forbidden to operate or power off the instrument and plug or unplug the sensor. After the prompt dialog disappears, writing of modified data into the sensor will be completed, and the instrument can be restarted for verification.

4.15 How to modify the sensor calibration factor

5 Menu

The 2438 series microwave power meter menu includes: Menu, Channel, Window, Calibration and Frequency. The menu structure and description of the microwave power meter are given hereinafter.

- [Menu structure](#)..... 55
- [Menu description](#)..... 63

5.1 Menu structure

- [Main interface](#)..... 55
- [Menu](#)..... 56
- [Measure](#)..... 56
- [Trigger](#)..... 57
- [Display](#)..... 58
- [System](#)..... 59
- [Channel](#)..... 60
- [Window](#)..... 62
- [Calibration](#)..... 62
- [Frequency](#)..... 63

5.1.1 Main interface

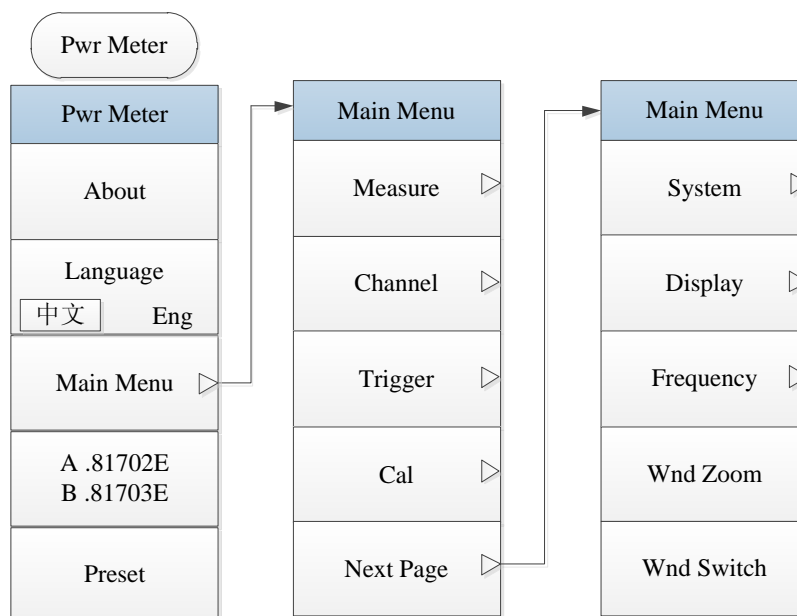

Fig. 5.1 Main Interface

NOTE: After the instrument is powered on, the main interface menu will be entered. Below the [Main Menu] are function menus which can be found through [Menu], [Channel], [Window], [Cal], [Frequency] and other keys.

5.1 Menu structure

5.1.2 Menu

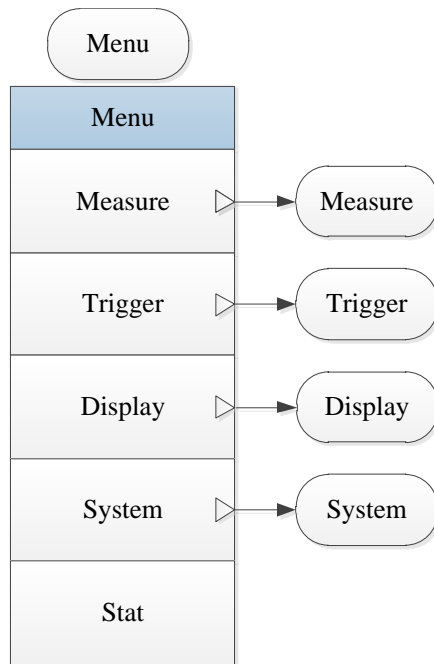
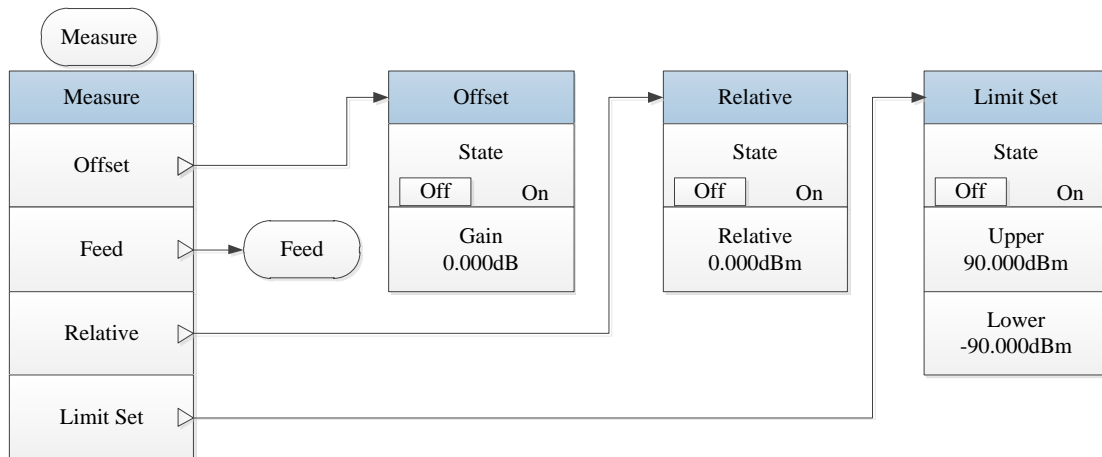

Fig. 5.2 Menu

NOTE: Below the [Menu] are [Measure], [Trigger], [Display] and [System] which can be used to achieve a certain setting. Therefore, just as the [Channel], [Window], [Cal] and [Frequency] keys, the [Measure], [Trigger], [Display] and [System] menus are described in individual chapters in this User Manual.

5.1.3 Measure



5.1 Menu structure

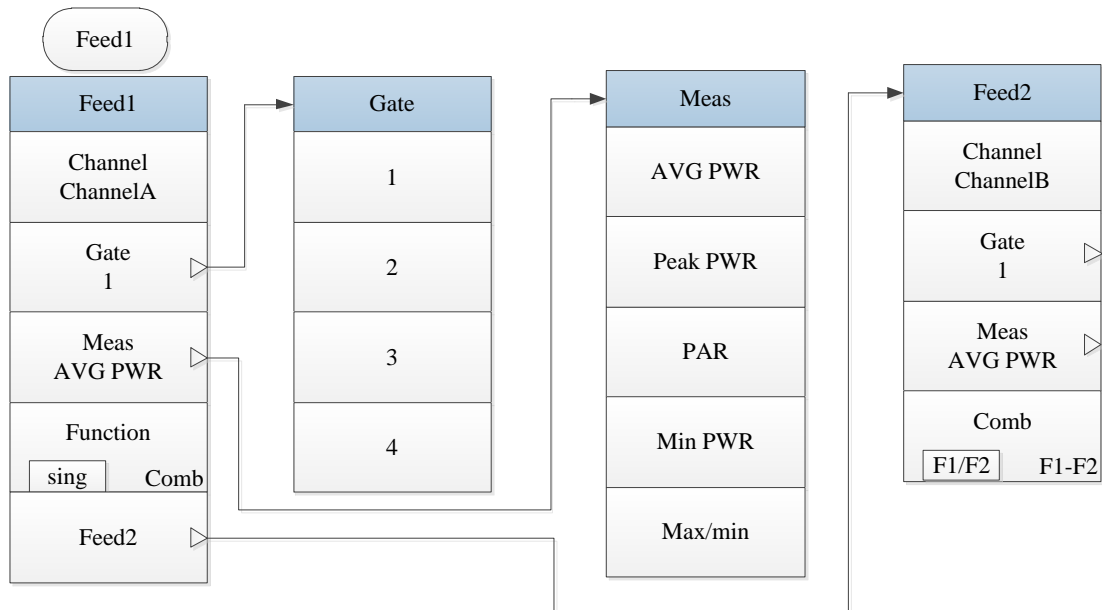

Fig. 5.3 Measure

5.1.4 Trigger

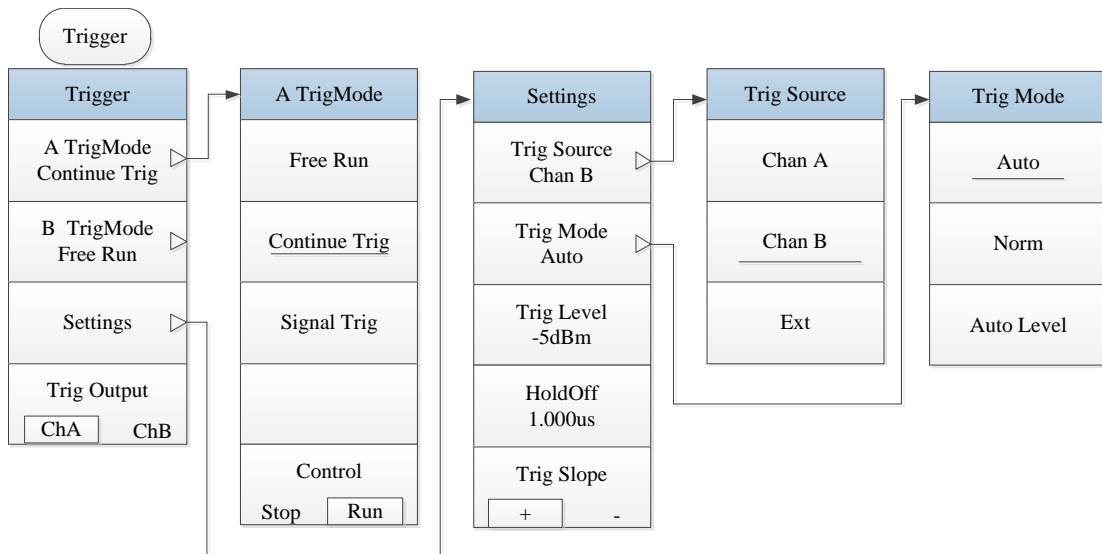
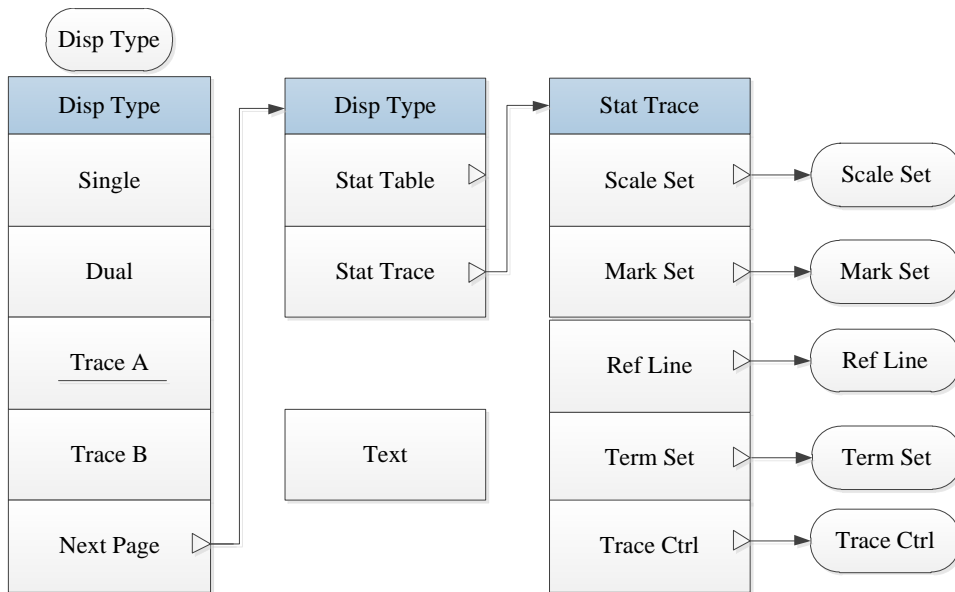
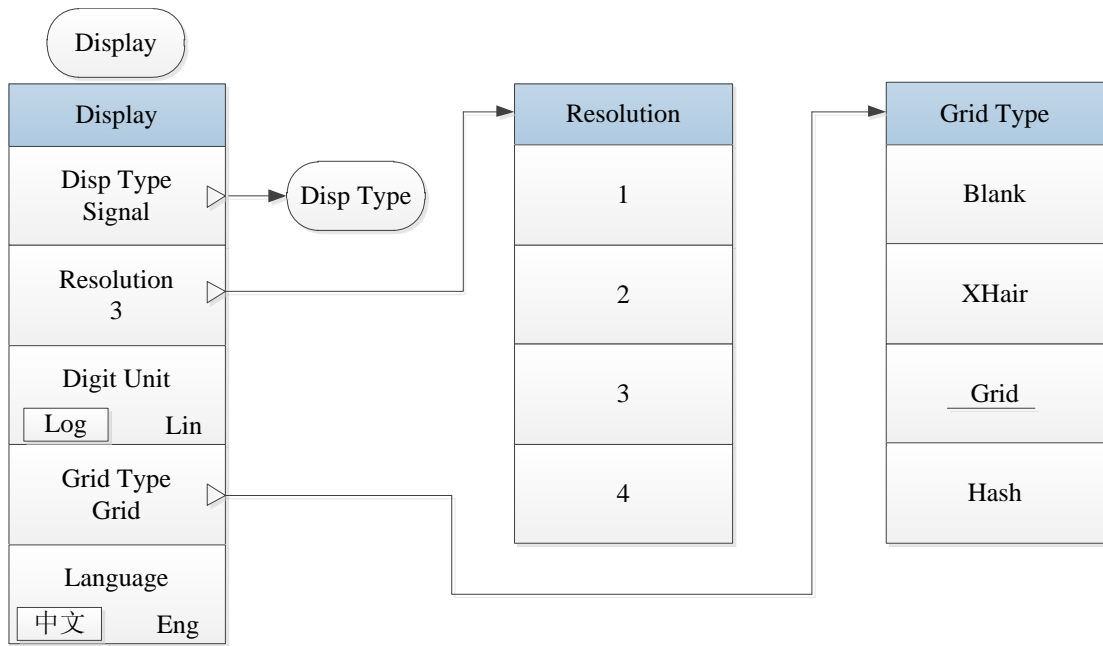

Fig. 5.4 Trigger

5.1 Menu structure

5.1.5 Display



5.1 Menu structure

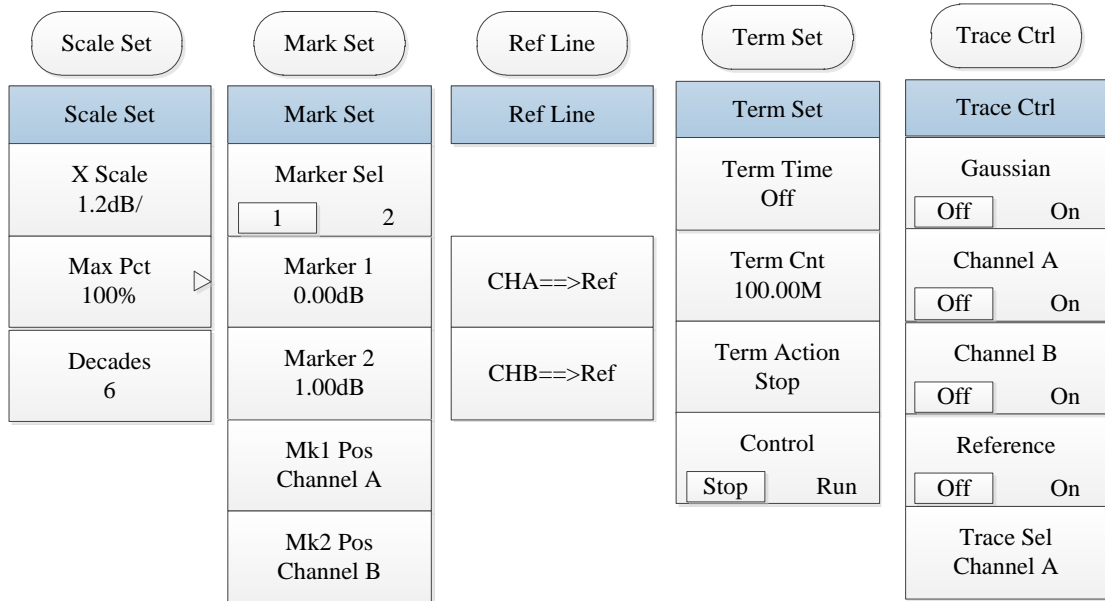
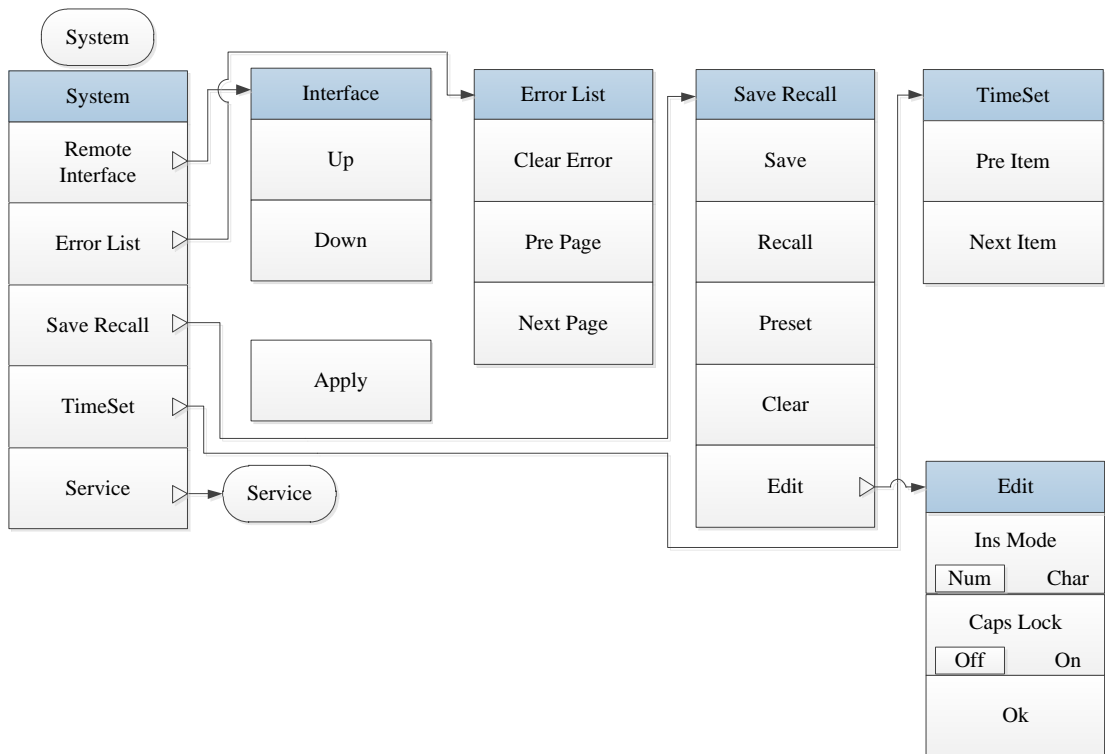

Fig. 5.5 Display

5.1.6 System



5.1 Menu structure

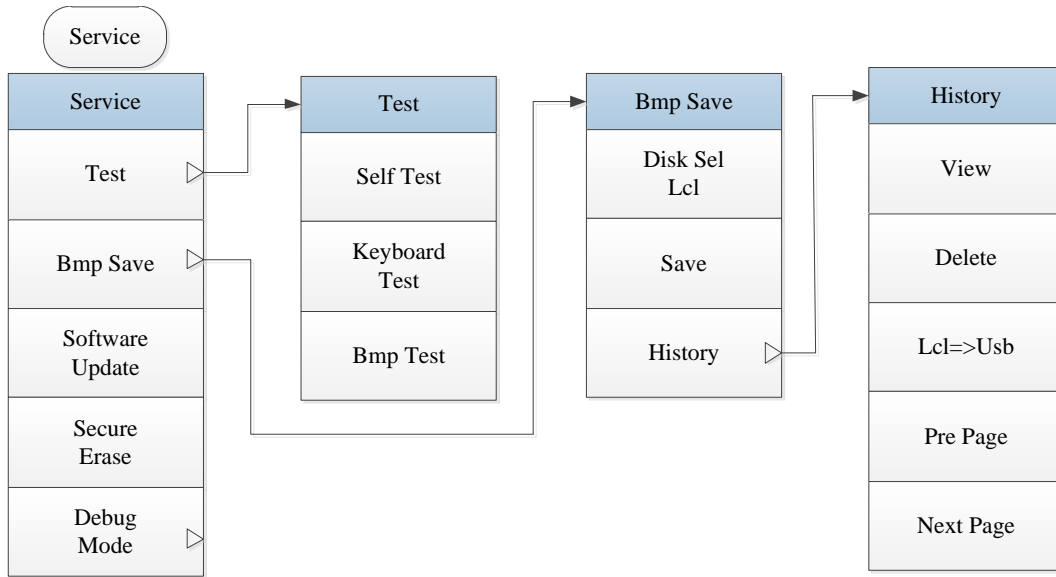
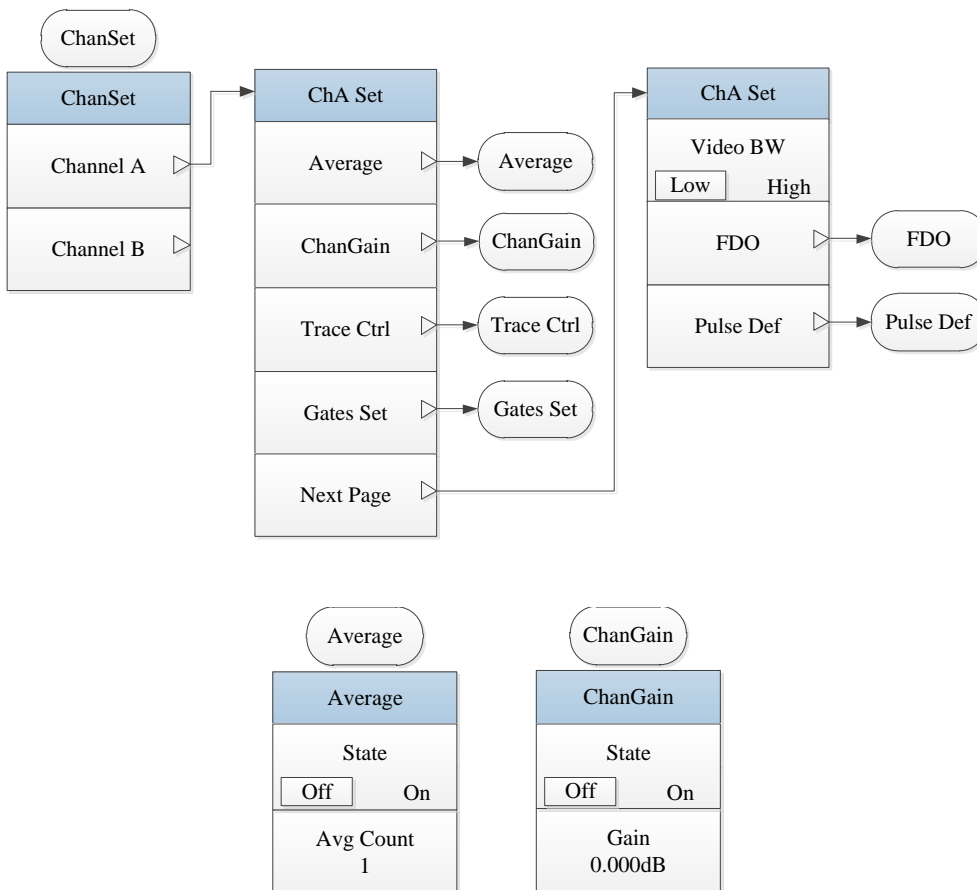
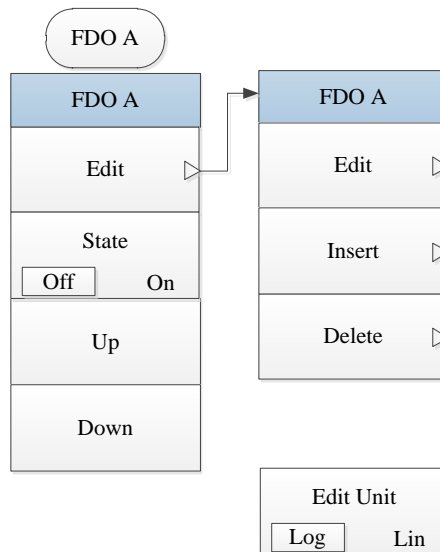
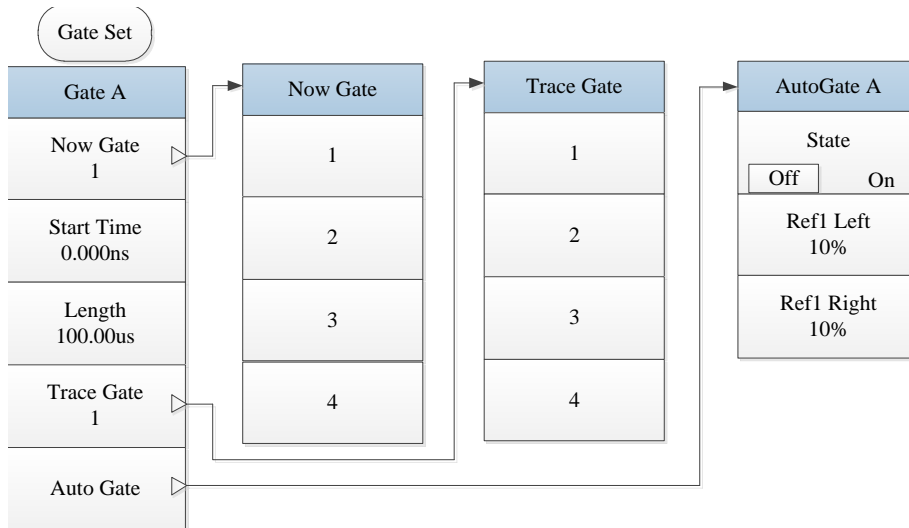
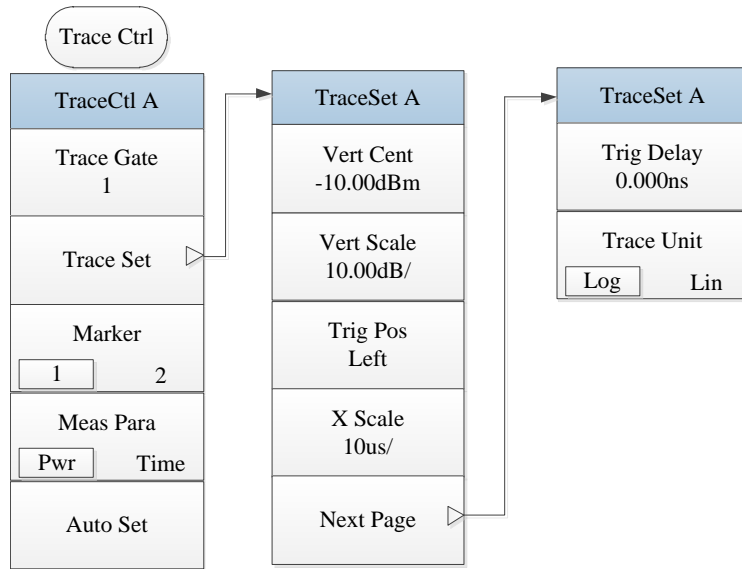

Fig. 5.6 System

5.1.7 Channel



5.1 Menu structure



5.1 Menu structure



Fig. 5.7 Channel

5.1.8 Window

5.1.9 Calibration

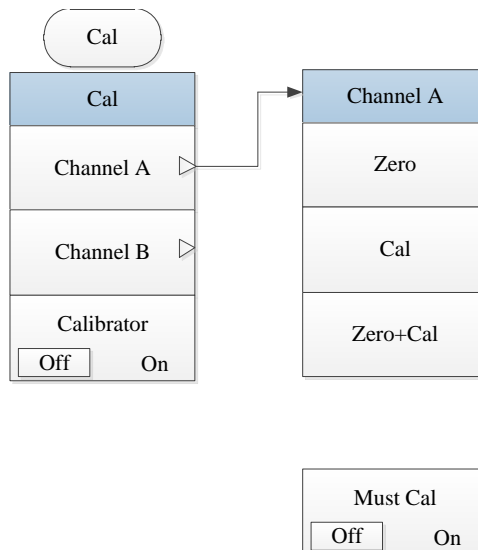

Fig. 5.8 Calibration

5.1.10 Frequency

Frequency
Frequency
CHA Freq 1.000GHz
CHB Freq 1.000GHz

Fig. 5.9 Frequency

5.2 Menu description

In this section, the functions, parameters and other information about the menu items are described in detail.

● Main interface	63
● Menu	64
● Measure	64
● Trigger	67
● Display	68
● System	72
● Channel	74
● Window	79
● Calibration	79
● Frequency	79

5.2.1 Main interface

After starting the instrument or pressing [Back/Local] for several times to enter the main interface which includes [About], [Language], [Main Menu▶], [Sensor Model] and [Preset].

[About]

The model, software version, production unit and other information of the 2438 series microwave power meter pop up.

Press any keys except [About] to exit from the [About] interface.

[Language]

Select the language for menu display, i.e. “中文” or “Eng”. Select “中文”, and the menus and information on the screen will be in Chinese; select "Eng", and the menus and information on the screen will be displayed in English.

[Main Menu▶]

Below the [Main Menu▶] are all main function menus including [Measure▶], [Channel▶], [Trigger▶], [Cal▶], [System▶], [Display▶], [Frequency▶], [Wnd Zoom] and [Wnd Switch].

The function menus below the [Main Menu▶] correspond to [Menu], [Channel], [Window], [Cal] and [Frequency].

The main menus including [Measure▶], [Channel▶], [Trigger▶], [Cal▶], [System▶], [Display▶] and [Frequency▶] are introduced in the sections hereinafter in this User Manual.

5.2 Menu description

[Sensor Model]

The models of sensors connected to Channel A and Channel B are displayed. For example, "A .81703E" and "B .81702D" indicate that the models of sensors connected to Channel A and Channel B are 81703E and 81702D respectively.

If only Channel A is connected to the 81703E sensor while Channel B is not connected to the sensor, "A .81703E" and "B No Snsr" will be displayed below the menu.

[Preset]

Set the instrument to a fixed state.

In the preset window, various setting states can be selected through the [Up], [Down], [Left] and [Right] keys.

Select "Default" to set the instrument to the default state. When the instrument is connected to the 81702 or 81703 series peak power sensor, select "Default", and the default settings include: "Continue Trig" for "Trigger/Sampling", "Auto" for "Trig Mode", "-5dBm" for "Trig level", "Single" for "Disp Type", "3" for "Resolution", "Log" for "Digit Unit", "1" for "Gate", "AVG PWR" for "Meas Type" and "1.000 GHz" for "Frequency".

When the 2438 series microwave power meter is connected to the 71710 series CW power sensor, the [Preset] menu only includes "Default". Press [Ok] to set the power meter to the default state. The default settings include: "Single" for "Disp Type", "3" for "Resolution", "Log" for "Digit Unit" and "50MHz" for "Frequency".

When the 2438PA/PB microwave power meter is connected to the 81702 or 81703 series peak power sensor, the [Preset] menu also includes other options. You can select the appropriate preset state according to the tested object and quickly configure the parameters such as "Disp Type", "X scale", "Vert Scale", "Gate" and "Frequency" so as to achieve rapid accurate measurement of various power and time parameters.

5.2.2 Menu

NOTE: Below the [Menu] are [Measure], [Trigger], [Display] and [System] which can be used to achieve a certain setting. Therefore, just as the [Channel], [Window], [Cal] and [Frequency] keys, the [Measure], [Trigger], [Display] and [System] menus are described in individual chapters in this User Manual.

5.2.3 Measure

Press [Menu]>[Measure] to enter the measurement menu. The settings below the [Measure] menu are only applicable to digit display, and they don't work in the waveform display mode.

[Disp Offset]

It is used to set the offset value of the current measurement window. "Disp Offset" is only valid for the current measurement window. When the "Disp Offset" is enabled, the prompt "Disp Offset On" will be displayed at the upper right corner of the screen.

"Disp Offset" is only valid for digit display, and it doesn't work in the waveform display mode. All settings below the [Measure] menu don't work in the waveform display mode.

[Chan Offset] below [Channel] is valid for the current channel. The effects of "Chan Offset" and "Disp Offset" can be superimposed, e.g. when the current sensor is used to measure a 0.0 dBm signal: if "Chan Offset" is set at 10.0 dBm and "Chan Offset" is in On state, the power result will be displayed as 10.0 dBm; if "Disp Offset" is set at 10.0 dBm and "Disp Offset" is in On state, the power result will be displayed as 20.0 dBm.

[State Off On]

It is used to enable or disable the display offset in the current measurement window.

[Offset]

It is used to set the display offset of the current measurement window.

To increase the measurement result, the "Offset" should be positive; otherwise it should be negative.

[Feed]

It is used to select which channel is involved in the result displayed in the current measurement window. At the same time, it displays "Gate", "Meas", "Comb", etc.

[Channel]

It is used to select the channel corresponding to the current window. Press [Channel] to switch between Channel A and Channel B.

[Gate]

It is used to select the gate for the current measurement window. Press [Gate] to enter the next menu. There are four optional gates in total. A prompt of the gate is displayed in the measurement window. For example, when Gate 1 of Channel A is selected, "A1" will be displayed at the upper left corner of the digit display window.

At most four different gates are available. The specific settings area completed through [Channel]>[Channel A]>[Gates Set].

The "Gate" is defined for waveform display, and can be used to set various power parameters of the waveform relative to the trigger position within a certain period of time

[Meas]

It is used to select the result displayed in the current window as the measurement type corresponding to the current gate. The menu includes five options, i.e. "AVG PWR", "Peak PWR", "PAR", "Min PWR" and "Max/min", with "AVG", "Peak", "PAR", "Min" and "Max/min" marked at the upper left corner of the current digit display window.

[AVG PWR]

The result displayed in the current digit window is the average power at all power points of the current gate. The measurement result is expressed in dBm or W.

[Peak PWR]

The result displayed in the current digit window is the maximum power at all power points of the current gate. The measurement result is expressed in dBm or W.

[PAR]

The result displayed in the current digit window is the ratio of the maximum power to the average power at all power points of the current gate. The measurement result is expressed in dBm or %.

[Min PWR]

The result displayed in the current digit window is the minimum power at all power points of the current gate. The measurement result is expressed in dBm or W.

[Max/min]

The result displayed in the current digit window is the ratio of the maximum power to the minimum power at all power points of the current gate. The measurement result is expressed in dBm or %.

[Function]

The result displayed in the current digit window is a single result or an operation result of two measurements. Press [Function] to switch between "Sing" and "Comb".

If the "Sing" mode is selected, then [Feed2] can't be operated, the result displayed in the current digit window will be a single result which will be the displayed result of the measurement type corresponding to the current gate.

If the "Comb" mode is selected, then [Feed2] can be operated, the settings below "Feed2" are the same as those below "Feed1". Channel A or B, four gates and five types of measurement can be selected.

In the "Comb" mode, the "AVG PWR", "Peak PWR" and "Min PWR" of four gates in two channels can be selected for calculation through comparison.

In the "Comb" mode, a prompt is displayed at the upper right corner of the previous digit window, e.g. Set the average power of Gate 1 in Channel A and the average power of Gate 2 in Channel 2 for calculation of the "Ratio", the prompt "A1/A2" will be displayed.

[Feed2]

Select "Comb" below [Comb], and [Feed2] will be effective and the combined measurement mode will be enabled.

[Channel]

5.2 Menu description

It is used to select the channel corresponding to the current window. Press [Channel] to switch between Channel A and Channel B.

The setting is the same as that of the [Channel] menu below [Feed1].

[Gate]

It is used to select the gate for the current measurement window.

The setting is the same as that of the [Gate] menu below [Feed1].

[Meas]

It is used to select the result displayed in the current window as the measurement type corresponding to the current gate.

The setting is the same as that of the [Meas] menu below [Feed1].

In the "Comb" measurement mode, the "Meas" menus of "Feed1" and "Feed2" must be the same. For example, if "AVG PWR", "Peak PWR" and "Min PWR" are included below "Meas" of "Feed1", "AVG PWR", "Peak PWR" or "Min PWR" rather than "PRA" and "Max/min" can be selected below "Meas" of "Feed2".

However, if "Meas" of "Feed1" is set as "PAR", "Meas" of "Feed2" will also be set as "PAR"; similarly, with regard to "Max/min", "Feed1" and "Feed2" should strictly correspond to each other.

[Comb]

It is used to set the operation form of [Feed1] and [Feed2]. Press [Comb] continuously to switch between "F1/F2" and "F1-F2".

If "AVG PWR", "Peak PWR" and "Min PWR" are included below "Meas" and "F1/F2" is selected below [Comb], the result will be the ratio of measurements of "Feed1" and "Feed2". For example, if "Digit Unit" is set as "Log", the result will be the ratio of measurements of two gates, which is expressed in dB; if the average power of Gate 1 below "Feed1" is 20 dBm and that of Gate 1 below "Feed2" is 10dBm, the ratio A1/B1 will be 10 dB; if "Digit Unit" is set as "Lin", the result will be the ratio of measurements of two gates, which is expressed in %. If the average power of Gate 1 below "Feed1" is 100 mW and that of Gate 1 below "Feed2" is 10 mW, the ratio A1/B1 will be 1.0k%, i.e. 1000%.

If "AVG PWR", "Peak PWR" and "Min PWR" are included below "Meas" and "F1-F2" is selected below [Comb], the result will be the difference between measurements of "Feed1" and "Feed2". For example, if the "Digit Unit" is set as "Lin", the result will be the difference between measurements of two gates, which is expressed in W. If the average power of Gate 1 below "Feed1" is 100 mW and that of Gate 1 below "Feed2" is 50 mW, the result A1-B1 will be 50 mW; if the "Digit Unit" is set as "Log", the result will be 17dBm. If A1 is greater than B1, A1 is 50 mW and B1 is 100 mW, the result A1-B1 will be -50 mW. If the "Digit Unit" is set as "Log", the measurement result will still be 17 dBm.

If "PAR" is selected below "Meas" of "Feed2", "PAR" will be automatically set below "Meas" of "Feed1", in this way, the same type of combined operation is guaranteed. Similarly, the combined operation of "Feed1" with "Max/min" selected should correspond to that of "Feed2" with "Max/min" selected. With regards to the operation form of "PAR" and "Max/min", only "F1/F2" rather than "F1-F2" can be selected. If "Digit Unit" is set as "Log", the combined measurement result will be expressed in dB; if "Digit Unit" is set as "Lin", the combined measurement result will be expressed in %.

[Relative]

It is used to set the relative measurement relative to the current measured value.

[State]

Press [State] continuously to disable or enable the relative measurement. If the relative measurement is enabled, "Relative" will be displayed at the upper right corner of the window.

[Reference]

Press [Reference] to save the current measurement result in the [Reference] menu and display the power as 0.00 dB in the window, i.e., record the current measured value as a reference value. The reference value is subtracted from the measured value in the window, which is expressed in dB.

[Limit Set]

It is used to set the measurement limit of the current window. When the measured value exceeds the set

5.2 Menu description

limit, the system will give a red prompt “Above Upper Limit” or “Below Lower Limit” at the upper right corner of the window.

[State]

Press [State] continuously to disable or enable the limit set.

[Upper]

It is used to set the upper power level limit in the limit zone. When the upper power level limit is exceeded, the system will give a red prompt “Above Upper Limit” at the upper right corner of the window.

[Lower]

It is used to set the lower power level limit in the limit zone. When the lower power level limit is exceeded, the system will give a red prompt “Below Lower Limit” at the upper right corner of the window.

5.2.4 Trigger

Press [Menu]>[Trigger] to enter the trigger menu.



[A TrigMode]

It is used to set the trigger/sampling mode of Channel A.



[Free Run]

It is used to set the current sampling mode as “Free Run”. In the “Free Run” mode, sampling is performed at a fixed rate, without being affected by trigger.

[Continue Trig]

It is used to set the current sampling mode as “Continue Trig”. In the “Continue Trig” mode, sampling is under the control of trigger signal. When the 81702 or 81703 series peak power sensor is used to measure the pulse modulation signal, a trigger signal that is synchronized with the pulse modulation envelope can be generated through setting of an appropriate trigger level. When the “Continue Trig” mode is set, the pulse envelope waveform can be displayed stably. “Continue Trig” in the digit display and trace display modes will be indicated by  on the screen. When “Disp Type” is set as “Single”, a prompt indicated by  will be displayed in the upper middle part of the screen; when “Disp Type” is set as “Trace”, a prompt indicated by  will be displayed at the upper right corner of the screen.

[Single Trig]

It is used to set the current sampling mode as “Single Trig”. After “Single Trig” is set, sampling will be performed every time [Single Trig] is pressed if there is a trigger signal; the waveform won't be changed when [Single Trig] is pressed if there isn't a trigger signal. “Single Trig” in the digit display and trace display modes will be indicated by  on the screen. When “Disp Type” is set as “Single”, a prompt indicated by  will be displayed in the upper middle part of the screen; when “Disp Type” is set as “Trace”, a prompt indicated by  will be displayed at the upper right corner of the screen.

[Control]

It is used to set the Stop or Run state of sampling. “Stop” and “Run” can be switched when the [Control] key is pressed. If “Stop” is set, sampling will be stopped, and the data or waveform on the screen will remain unchanged. When “Run” is set, the data and waveform on the screen will be continuously refreshed.

[B TrigMode]

It is used to set the trigger/sampling mode of Channel B. If the instrument is of single channel type, this menu can't be operated.

[Settings]

It includes all settings related to trigger.

[Trig Source]

It is used to select the current trigger source including “Chan A”, “Chan B” and “Ext” .

[Chan A]

Press the [Chan A] menu to select the current trigger signal internally generated by Channel A. When the

5.2 Menu description

measured signal is a pulse modulation signal, a trigger signal synchronized with the Channel A pulse envelope can be generated by through adjustment of the trigger level. If the measured signal is a continuous wave signal, the trigger signal will be a 3.3 V or 0 V DC level.

[Chan B]

Press the [Chan B] menu to select the current trigger signal internally generated by Channel B. The generation method and signal definition are the same as those of Channel A.

[Ext]

Press the [Ext] menu to select the current trigger signal imported externally. External trigger is imported from the "Trig Input" interface on the rear panel.

[Trig Mode]

It is used to select the trigger/sampling mode.

[Auto]

It is used to select the current trigger/sampling mode as "Auto". In the "Auto" trigger mode, if there is no trigger signal within the preset time period, the instrument will perform sampling automatically and display the waveform; if there is a trigger signal within the preset time period, the waveform will be displayed stably.

[Norm]

It is used to select the current trigger/sampling mode as "Norm". In the "Norm" trigger mode, it is necessary to wait for the trigger signal before sampling. If there is no trigger signal, wait until the trigger signal arrives.

[Auto Level]

It is used to select the current trigger/sampling mode as "Auto Level". In the "Auto Level" trigger mode, the trigger level is automatically set to be 3 dB lower than the top power according to the amplitude of the measured pulse, so as to ensure that the waveform can be displayed stably.

[Trig Level]

It is used to select the trigger signal threshold level, which can vary continuously between -40 dBm and +20 dBm. When the pulse modulation signal is measured, the trigger level must be between the top power and the bottom power to achieve effective trigger.

In the "Auto Level" trigger mode, the "Trig Level" can't be operated, and the trigger level value calculated by the instrument will be automatically displayed below "Trig Level".

[HoldOff]

It is used to test the pulse strings in different periods.

After trigger is performed each time, it is necessary to add a certain time interval during which pulse trigger is prohibited. This time period should be shorter than the period of the pulse string but longer than the "Pulse Width Excluding the Maximum Period in the Pulse String". For example, if a pulse string includes five pulses with the periods of "2us, 4us, 6us, 8us, 10us" respectively, then "HoldOff" should be set between 20.1 us and 29.9 us so that the pulse sequence can be triggered stably.

[Trig Slope]

Press [Trig Slope] to switch between "+" and "-".

"+" represents the signal's rising edge. When the trigger position is "Mid" and the trigger delay is 0, the first transition of the pulse waveform is in the middle of the screen; "-" represents the last transition trigger. When the trigger position is "Mid" and the trigger delay is 0, the last transition of the pulse waveform is in the middle of the screen;

[Trig Output]

Press [Trig output] to select the trigger signal of Channel A or Channel B to output it to the "Trig Output" interface on the rear panel. The trigger output signal is a pulse signal with TTL level.

5.2.5 Display

Press [Menu]>[Display] to enter the display menu.

[Disp Type]

5.2 Menu description

It is used to select the display mode of the power measurement result, including Single, Dual, Trace, Stat Table, Stat Trace and Text.

[Single]

In the single display mode: when the small window display mode is adopted, the data will be displayed on half of the screen; when the middle or large window display mode is adopted, the data will be displayed on the whole screen;

[Dual]

In the dual display mode: when the small window display mode is adopted, the data will be displayed on 1/4 of the screen; when the middle or large window display mode is adopted, the data will be displayed on the whole screen;

[Trace A]

It displays the trace of Channel A. Once [Trace A] is pressed, the waveform display mode will be entered.

[Stat Table]

The CCDF statistic measurement results are displayed in the form of table, including average power, peak power, peak-to-average ratio and power parameters corresponding to six probabilities, i.e. 0.0001%, 0.001%, 0.01%, 0.1%, 1%, and 10% , and the probability corresponding to the power set by the user and the power corresponding to the probability set by the user are given.

[Power Set]

When the user sets a certain power, the system will automatically give the probability corresponding to the power in the CCDF in the row with an arrow mark in the lower part of the table.

[Prob Set]

When the user sets a certain probability, the system will automatically give the probability corresponding to the power in the CCDF in the row with an arrow mark in the lower middle part of the table.

[Term Set]

Statistic measurement is usually an independent operation with starting and end time. This menu can be used to set the termination condition and operation upon termination.

[Term Time]

It is used to set the time of CCDF statistic measurement The longest time can be up to 1 h.

[Term Cnt]

It is used to set the cumulative number of points of CCDF statistic measurement. There can be 4200.0M points at most. When "Term Time" and "Term Cnt" are set at the same time, the one that comes first should prevail.

[Term Action]

When the preset time or number of points are reached during statistic measurement, the operation performed by CCDF statistic measurement will be stopped, including statistics stop, statistic data clearing or reduction of data by half.

Statistics stop means that the CCDF statistic waveform will stop using new measurement data; clearing indicates that the original CCDF waveform will be cleared and the CCDF waveform will be redrawn with new data; reduction by half indicates that the second half of historical data will be discarded and the first half of data and the newly acquired data will be used to draw the CCDF waveform, which will be performed in cycle continuously.

[Control Stop|Run]

It is used to stop or run CCDF statistic measurement.

5.2 Menu description

	Channel A	Channel B	
10%	3.30dB		Table
1%	3.36dB		Power Set 1.00dB
0.1%	3.37dB		Prob Set 10.00 %
0.01%	3.37dB		Terminate Set
0.001%	3.37dB		
0.0001%	3.37dB		
> 10%	3.30dB		
> 1.00dB	50%		
Avg Power	7.32dBm		
Peak Power	10.68dBm		
LCL	Meas		

Fig. 5.10 Statistic Table

[Stat Trace]

It is used to display the CCDF measurement result in the form of trace.

[Scale Set]

It is used to set the X scale, vertical scale and decimal digits of the statistic trace.

[X scale]

It is used to set the X scale of the statistic trace. The minimum scale can be 0.1 dB/div and the maximum scale can be 5 dB/div, with 0.1 dB as a step.

[Max Pct]

It is used to set the maximum vertical proportional scale of the statistic trace. Once this software is clicked, the system will automatically switch among 0.01%, 0.1%, 1%, 10%, and 100%.

[Decades]

It is used to set the density of the vertical scale. The system can switch among 1~6.

[Mark Set]

It provides two marks for accurate measurement of the CCDF probability corresponding to the key power level.

[Marker 1]

It is used to set the PRA corresponding to Mark 1. The minimum value is 0dB. The maximum value is related to the horizontal scale and is the maximum scale displayed by the horizontal line.

[Marker 2]

It is used to set the PRA corresponding to Mark 2. The minimum value is 0dB. The maximum value is related to the horizontal scale and is the maximum scale displayed by the horizontal line.

[Mk 1 Pos]

It is used to determine the trace to which Mark 1 belongs, which can be Channel A, Channel B, reference line or Gaussian curve.

[Mk 2 Pos]

It is used to determine the trace to which Mark 2 belongs, which can be Channel A, Channel B, reference line or Gaussian curve.

[Ref Line]

It is used to store the data of the reference line.

[Chan A]

It is used to save the statistic measurements of Channel A on the reference line.

[Chan B]

It is used to save the statistic measurements of Channel B on the reference line.

[Term Set]

Statistic measurement is usually an independent operation with starting and end time. This menu can be used to set the termination condition and operation upon termination.

[Term Time]

It is used to set the time of CCDF statistic measurement. The longest time can be up to 1 h.

[Term Cnt]

It is used to set the cumulative number of points of CCDF statistic measurement. There can be 4200.0M points at most. When "Term Time" and "Term Cnt" are set at the same time, the one that comes first should prevail.

[Term Action]

When the preset time or number of points are reached during statistic measurement, the operation performed by CCDF statistic measurement will be stopped, including statistics stop, statistic data clearing or reduction of data by half.

Statistics stop means that the CCDF statistic waveform will stop using new measurement data; clearing indicates that the original CCDF waveform will be cleared and the CCDF waveform will be redrawn with new data; reduction by half indicates that the second half of historical data will be discarded and the first half of data and the newly acquired data will be used to draw the CCDF waveform, which will be performed in cycle continuously.

[Control]

It is used to stop or run CCDF statistic measurement.

[Trace Ctrl]

It is used to enable, disable or select each display trace.

[Gaussian]

It is used to enable or disable the Gaussian curve in the window.

[Chan A]

It is used to enable or disable the CCDF statistic measurement trace of Channel A in the window.

[Chan B]

It is used to enable or disable the CCDF statistic measurement trace of Channel B in the window.

[Reference]

It is used to enable or disable the saved reference trace in the window.

[Trace Sel]

It is used to select the object towards which the parameter in the lower part of the current trace display window points, e.g. Channel A, Channel B or reference trace.

[Text]

It is used to report the measurement results of Channel A and Channel B in the form of text, e.g. Rise time, pulse width, pulse period and peak power.

[Resolution]

It is used to set the digit display resolution in the digit display window, which can be selected from 1 to 4. If the measurement unit is dBm or dB, the resolution will be 1, 0.1, 0.01 or 0.001 dB; if the measurement unit is W or %, the resolution will be the significant figure 1, 2, 3, or 4.

[Digit Unit]

5.2 Menu description

It is used to set the digit unit of the current window, including "Log" and "Lin". If "Log" is set, the unit will be dBm or dB; if "Lin" is set, the unit will be W or %.

[Grid Type]

It is used to set the grid type of waveform display in the trace display mode. The user can select "Blank", "XHair", "Grid" or "Hash".

[Language]

It is used to select the window display language including "中文" and "Eng". If "中文" is selected, the interface and menu will be displayed in Chinese; if "Eng" is selected, the interface and menu will be displayed in English.

5.2.6 System

Press [Menu]>[System] to enter the [System] menu.

[Remote Interface]

It is used to configure the GPIB address and network address of the instrument.

[Up]

It is used to move the focus to the previous item.

[Down]

It is used to move the focus to the next item.

[Apply]

It is used to apply the modified setting. For the option to be modified, the focus can be moved through the [Up], [Down], [Left] and [Right] keys. When the focus is moved to the position to be modified, the value can be entered directly. After modification, it is necessary to press [Apply] to validate the modified option.

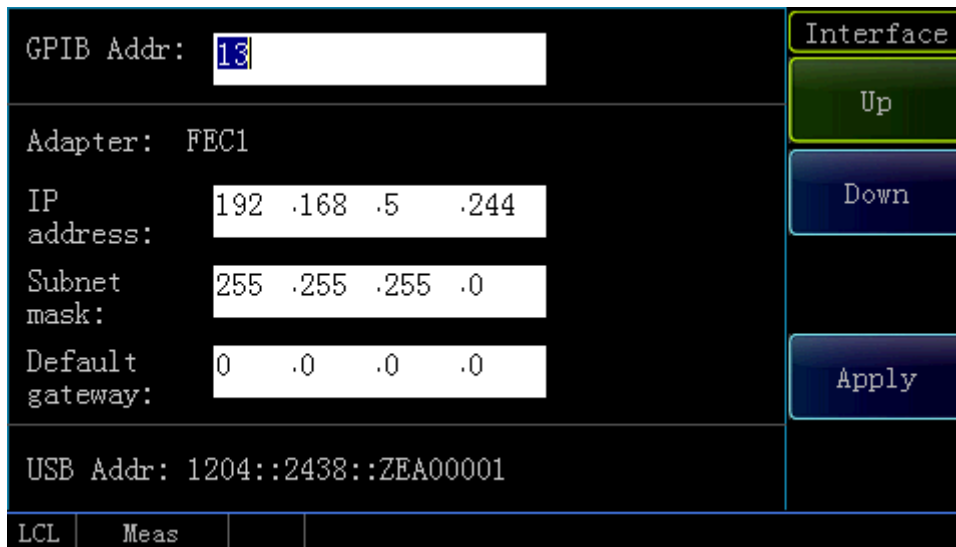

Fig. 5.2 Remote Interface

[Error List]

It is used to display the errors during measurement in the form of list. The problem can be determined based on the error prompt mark.

[Clear Error]

It is used to clear all error information displayed currently.

[Pre Page]

It is used to switch to the previous page to view other error information.

[Next Page]

It is used to switch to the next page to view other error information.

[Save Recall]

It is used to save and recall the current setting state of the power meter.

[Save]

It is used to save the current state of the power meter in an item in the list. Select the state item through the [Up] and [Down] keys and save the current state in the current item after pressing [Save].

[Recall]

It is used to recall the current setting state of the power meter.

[Default]

It is used to restore the default setting of the power meter upon delivery.

[Clear]

It is used to clear the selected save state.

[Edit]

It is used to edit state name of the current saved item.

[Ins Mode]

It is used to set a character or number is inserted to the state name. If "Num" is selected, press the numeric key to enter the number; if "Char" is selected, press the numeric key to enter the character.

[Caps Lock]

When [Caps Lock] is enabled, a capital character will be entered.

[OK]

It is used to complete the modification of the state name.

[Time Set]

It is used to set the system time of the instrument.

[Pre Item]

It is used to move the focus to the previous item.

[Next Item]

It is used to move the focus to the next item.

[Service]

It is used to facilitate system debugging and fault location, e.g. circuit self test, keyboard self test, bitmap self test and menu management.

[Test]

It is used to automatically test major circuit functions, display and keyboard and facilitate fault location.

[Self Test]

It is used to automatically test major circuit functions and facilitate fault location.

[Keyboard Test]

It is used to check whether each key is effective. When the user presses a key on the front panel, the pressed key will be displayed in the window.

[Bmp test]

The system displays red, green and blue on full screen respectively to facilitate inspection and display of dead pixels. After the display is completed, the system will automatically exit from this menu.

[Software Update]

It is used to update the software program.

Insert the USB disk for update into the USB interface on the rear panel, wait for about 5 s, and then the [Software Update] menu can be operated. At this time, press [Software Update], and the system will give

5.2 Menu description

the prompt "Software update, please wait ...". After the software upgrade is completed, the system will give the prompt "System update is successful. Please restart". In this case, restart the instrument, and the software update will be completed successfully.

[Debug Mode]

The user can access by password. Enter the password "412438" to enter the calibration factor modification interface.

5.2.7 Channel

Press [Channel] to enter the [Channel] menu.

[Chan A]

Press [Channel A] to enter the settings related to Channel A. As the settings of Channel A are similar to those of Channel B, Channel B is illustrated hereinafter.

[Chan B]

It is used to configure the content related to Channel B. The configuration content of Channel A and Channel B are the same.

[Average]

It is used to set the average strategy of the measured value for the current channel. The average state can be disabled or set automatically or manually. If the 81702 or 81703 series peak power sensor is connected, the average state can only be set manually; if the 71710 series CW power sensor is connected, the average setting can be "Auto" and "Manu". By default, the average setting of the 71710 series CW power sensor is "Auto". A proper average count is automatically set based on the measured power.

[Off]

It is used to disable the average setting.

[Auto]

The 71710 series CW power sensor is capable of automatic setting of average count. The number of automatic settings is related to the measured power.

[Manu]

It is used to set the average count manually.

[Avg Count]

It is used to set the average count from 1 to 1,024.

[Chan Offset]

The channel offset refers to setting of a relative offset for power measurement to compensate for a fixed attenuator or amplifier between the power sensor and the tested object so as to truly reflect the power value of the measured signal. The channel offset is valid for all measurement windows using the current channel.

It is usually used to compensate for the attenuator or amplifier between the sensor and the device under test. The attenuator can attenuate the high power level signal while the amplifier can increase the low power level signal so that the level input into the instrument is within the specified range. A positive offset will move the waveform upwards, and a negative offset will move the waveform downwards. The parameter can be modified within the range of -100 dB ~ +100 dB through numeric input.

[State]

Press [State] to switch the channel offset between "ON" and "OFF". If the channel offset is in "ON" state, the prompt "Channel Offset On" will be displayed at the upper right corner of the digit display window.

[Offset]

It is used to set the channel offset within the range of -100 dB ~ +100 dB. After the offset is set in On state: when the digit unit is set as "Log", the displayed power will be equal to the measured power plus the offset power; if the current measured power is 0 dBm and the channel offset is +20 dB, the measurement result will be +20 dBm; when the digit unit is set as "Lin", if the displayed power is 1.0 mW and the channel offset is +20 dB, the measurement result will be 100 mW.

[Trace Ctrl]

When the 81702 or 81703 peak power sensor is connected and "Trace" is displayed, [Trace Ctrl] can be operated. At this time, parameters related to the trace can be set.

[Trace Gate]

It is the sampling point between two vertical lines in the waveform display mode. There are four trace gates to be selected. Press [Trace Ctrl] to enter the next menu for selection. The start position and length of the trace gate can be set by selecting [Channel]> [Channel A]> [Gates Set] or through the [Left] and [Right] keys. Hold the [Left] or [Right] key, and the marker of the current gate will move leftwards or rightwards on the screen. You can move the gate to the desired position as required.

[Trace Set]

It is the settings related to the current channel trace display. Press [Trace Set] to enter the detailed setting menu.

[Vert Cent]

It is used to set the power corresponding to the vertical center position of the current waveform display window. For example, if the "Vert Cent" is set as 0 dBm, the power corresponding to the center line of the waveform display window will be 0 dBm. When the peak power of the input pulse modulation signal is 0 dBm, the top amplitude of the pulse waveform will be located in the middle of the waveform display window; if the "Vert Cent" is set as 10 dBm, the top amplitude of the pulse waveform will be located at the grid below the middle of the waveform display window; if the "Vert Cent" is set as -10 dBm, the top amplitude of the pulse waveform will be located at the grid above the middle of the waveform display window.

In the logarithmic display mode, "Vert Cent" can be continuously changed from -150 dBm to 210 dBm; in the linear display mode, this parameter can be continuously changed from 0 nW to 10 kW.

In the logarithmic display mode, the value in dBm can be directly entered below "Vert Cent"; in the linear display mode, press [Vert Cent] to enter the next menu. After inputting the value, it is necessary to select the linear unit including "uW", "mW" and "W".

[Vert Scale]

It is used to set the amplitude represented by each division in the vertical direction of the current waveform display window. For example, if the "Vert Scale" is set as 20.00 dB/, it indicates that each division in the vertical direction represents an amplitude of 20 dBm.

In the logarithmic display mode, this parameter can be freely set from 0.1 dB/div to 20 dB/div; in the linear display mode, this parameter can be freely set from 1 nW/div to 50 MW/div.

Through adjustment of this parameter, vertical amplitude of the displayed graph can be adjusted to make better use of the whole display area or enlarge part of the waveforms you are interested in. A large vertical scale will reduce the height of the waveform, while a small one will increase the height of the waveform.

[Trig Pos]

Press [Trig Pos] to switch among "Left", "Mid" and "Right".

Set the position on the horizontal axis at the time of trigger, including "Left", "Mid" and "Right". The default trigger position is in the middle of the graph.

Select "Left" to observe the waveform immediately after trigger. Select "Right" to observe the waveform before trigger. Select "Mid" to observe the waveform before and after the trigger.

[X scale]

It is used to select the time represented by each division (10 divisions in total) in the waveform display mode. This parameter can be switched continuously from 5 ns/div to 3,600 s/div, with 1-2-5 as a step.

If the input value isn't the standard effective X scale when the numeric keypad is used for setting, the system will automatically correct the value to the first effective setting smaller than the input value.

[Next Page]

Press [Next Page] to enter the next menu.

[Trig Delay]

5.2 Menu description

It is used to set the position of the trigger point on the screen. A positive trigger delay indicates that the trigger point is moved leftwards on the screen to display more data behind it; a negative trigger delay indicates that the trigger point is moved rightwards on the screen to display more data in front of it;

[Trace Unit]

It is used to set the unit of the current trace. Press [Trace Unit] to switch between "Log" and "Lin".

[Mark]

Press [Mark] to select Marker 1 or Marker 2 corresponding to the current gate. When "Marker 1" is selected, the number "1" below the purple vertical line on the screen will turn green, and "Marker 1" can be moved on the screen through the [Left] and [Right] keys; similarly, "Marker 2" can also be selected, and the position of "Marker 2" of the current gate can be changed.

[Meas Para]

It is used to set the power or time parameter displayed in the lower part of the medium window.

[Auto Set]

The system automatically determines the vertical center, vertical scale, X scale and other parameters based on the displayed trace to facilitate the user's observation.

[Trace B]

If Channel B is connected to the peak power sensor, the settings of its relevant parameters in the trace display mode are the same as those of [Trace A], therefore, they aren't introduced in detail herein.

[Step Detect]

When the 71710 series CW power sensor is connected, [Step Detect] will be displayed below the current menu. When the average setting is provided for measurement with the CW power sensor, the "Step Detect" will be set in "On" state. If the power changes significantly, the data in the buffer zone will be completely cleared, the average setting will be restarted, and the power displayed on the screen can quickly change to the newly measured value; when "Step Detect" is set in "Off" state, the data in the average buffer zone won't be cleared. If the power changes greatly, the power displayed on the screen will slowly change to the newly measured value.

By default, "Step Detect" is in "ON" state. Only when the measured power value is relatively small, e.g. the signal with a power less than -50 dBm is measured, the average count will be increased and "Step Detect" will be set to "OFF". After a long period of time, the power of the low power level signal can be measured stably.

[Range]

When the 71710 series CW power sensor is connected, the [Range] will be displayed. The 71710 series CW power sensor has "High" and "Low" ranges. When the power of the measured signal is greater than -14 dBm, the high range will be adopted. When the power of the measured signal is less than -13 dBm, the low range will be adopted.

[Range] includes three setting options: "Low", "High" and "Auto". If [Range] is set as "Low", the low range will be forcibly adopted, and when the input power is greater than the low range, an error prompt will be given; If [Range] is set as "High", the high range will be forcibly adopted, and when the input power is less than the low range, the accuracy of the measurement result can't be guaranteed. By default, [Range] is set as "Auto", therefore, an appropriate range is automatically selected based on the measured power value.

[Gate Set]

When the 81702 or 81803 series peak power sensor is connected, four gates can be set at most.

[Gate Number]

It is used to select the number of gate to be set. There are four gates in each channel.

[Start Time]

It is used to set the start time of the currently selected gate relative to the trigger time. For example, if the current trace is triggered in the middle position, the trigger delay is 0, and the "Start time" is set as 0, the vertical line of Mark 1 of the current gate will be located in the middle of the screen. When the trigger position is changed, the position of Mark 1 will be changed.

[Length]

It is used to set the time length of the current gate, i.e. the time interval between Mark 1 and Mark 2.

The length of the current gate can't exceed the screen. If the set length exceeds the screen, the set value will be automatically defined to the rightmost length of the screen.

If the trigger position is changed, the "Start Time" and "Length" of the gate will also be changed and the two marks of the gate can't go beyond the screen.

Please note that the "Start Time" and "Length" of the gate don't have a memory function so that they can't be restored to the set value after change.

The current gate can also be set through the [Left] and [Right] keys.

[Trace Gate]

It is used to set the gate displayed by the current trace, with four options in total. A prompt is given at the upper right corner of the trace display window. For example, when Channel A is set as Gate 2, "A2" will be displayed.

[Auto Gate]

When the automatic gate setting menu is entered, the automatic gate can be set for the currently selected gate. After the automatic gate is opened, Mark 1 and Mark 2 of the gate can't be modified. With regard to the position of Mark 1 and Mark 2, the gate will be automatically set to the corresponding position of the first pulse displayed on the screen based on the left and right reference ratios of the gate.

For example, when the left and right reference ratios of the gate are set as 10%, Mark 1 will be set to position corresponding to 10% of the first pulse and Mark 2 will be set to the position corresponding to 90% of the first pulse.

[State]

It is used to enable or disable the automatic gate state. For an automatic gate, the position is set based on the pulse signal duration, i.e. pulse width. When the automatic gate is opened, Mark 1 and Mark 2 can't be set directly and can only be set based on the left and right reference ratios.

[Ref1 Left]

It is used to set the position of the left side of automatic Gate 1 relative to the pulse signal width. The system will automatically set the position based on the pulse width. When "Gate Number" is set as 2, [Ref2 Left] will be displayed below the current menu.

[Ref1 Right]

It is used to set the position of the right side of automatic Gate 1 relative to the pulse signal width. The system will automatically set the position based on the pulse width. When "Gate Number" is set as 2, [Ref2 Left] will be displayed below the current menu.

[Next Page]

When the 81702 or 81703 series peak power sensor is connected, this menu will be [Next Page]. Enter the [Next Page] menu for settings related to the peak channel. If the 71710 series CW sensor is connected, this menu will be [FDO].

[Video BW]

It is used to select high or low video bandwidth. For high-bandwidth measurement, the Rise time is shorter, while for low-bandwidth measurement, the power is more stable.

[FDO]

It is used to set the frequency response at a specific frequency point as required by the user.

At most ten FDO tables are supported. The offset of 80 points can be set in each FDO table at most. Only one FDO table can be opened in each channel every time. When a FDO table is opened, the other ones will be closed automatically.

[Edit]

It is used to edit the offset value at a frequency point in the FDO table.

The specific operation process is as follows: Select the frequency point at which the offset needs to be modified through the [Up] and [Down] keys, press [Edit] to enter the modification menu, and the

5.2 Menu description

frequency at the current point will pop up. If the frequency remains unchanged, press the unit corresponding to the current frequency point, for example, if the offset at the 50 MHz frequency point needs to be modified, after the 50 dialog pops up, press [MHz] to enter the "Offset" dialog, and enter a new offset value through the numeric key on the interface.

If a new frequency value is entered, a new frequency point will be added in the FDO table.

[Insert]

It is used to insert new frequency points and offset values in the FDO table. The specific operation is the same as that of the [Edit] menu. The newly inserted frequency points are automatically sorted in the ascending order.

[Delete]

It is used to delete the frequency point in the current FDO table. Select the frequency to be deleted through the [Up] and [Down] keys. Press [Delete], and the prompt window "Delete current FDO item?" will pop up. Press [OK] to complete the deletion; press [Back/Local] to cancel deletion.

[Edit Unit]

It is used to set the current FDO table unit as "Lin" or "Log". If the unit is as "Lin", the value will be expressed in %; if the unit is set as "Log", the value will be expressed in dB.

[State]

It is used to set the state of the current FDO table. In the On state, the "Enable State" of the current FDO table will be "On" and of other FDO tables will be "Off".

[Up]

It is used to select the previous item. Alternatively, the [Up] key can be used for selection.

[Down]

It is used to select the next item. Alternatively, the [Down] key can be used for selection.

[Video BW]

It is used to set the video bandwidth of the 81702 or 81703 series peak power sensor. A low video bandwidth can reduce the RF noise level while a high video bandwidth is used to measure the pulse waveforms with fast rise and falling time. By default, the video bandwidth is set as "High".

[FDO]

The setting method is the same as that of [FDO Table] for the 71710 series CW sensor.

[Pls Def]

It is used to define the parameters such as proximal, mesial and distal lines of the pulse waveform. The user can define these parameters as required.

[Proximal]

It is the proximal power level between top and bottom amplitudes. It is used to define the start level at Rise time and the end level at falling time of the pulse. These levels are generally set at 10% of the power level amplitude.

[Mesial]

It is the mesial power level between top and bottom amplitudes. It is used to define the power level of pulse width. This level is generally set at 50% of the power level amplitude.

[Distal]

It is the distal power level between top and bottom amplitudes. It is used to define the end level at Rise time and the start level at falling time of the pulse. These levels are generally set at 90% of the power level amplitude.

[Default]

It is used to select the default proximal, mesial and distal settings which are 10%, 50% and 90% respectively.

[Meas Mode]

It is used to define the pulse mode as "Pwr" or "Volt".

5.2 Menu description

If the pulse mode is defined as “Pwr”, the proximal and distal power levels of the waveform are calculated to be 10%~90% of the power. If the pulse mode is defined as “Volt”, the proximal and distal power levels of the waveform are calculated to be 10%~90 of the voltage.

The default mode is “Pwr”.

5.2.8 Window

Press [Window] to switch among “Small Window”, “Medium Window” and “Large Window”. In the “Small Window” mode, the upper and lower windows are displayed on the left side and the menu bar is displayed on the right side; in the “Medium Window” mode, one window is displayed on the left side and the menu bar is displayed on the right side; in the “Large Window” mode, one window is displayed on the entire screen and no menu bar is displayed.

The windows can be switched through the [Up] and [Down] keys. In the “Small Window” mode, the selected window is blue grey while the unselected one is black.

In the “Medium Window” and “Large Window” display modes, the selected window can be displayed through the [Up] and [Down] keys.

5.2.9 Calibration

Press [Cal], and the system will enter the calibration and calibrator setting menu. Below this menu, zeroing and calibration of each channel can be performed, and the calibrator can be set at the same time.

[Chan A]

It is used to zero and calibrate Channel A.

[Zero]

It is used to zero Channel A. Through zeroing, the sensitivity of the power sensor can be improved.

It is recommended that the zero calibration operation should be performed once:

- 1) when the temperature equilibrium is reached after power-on and warm-up for 10 min;
- 2) when there is no signal output from the output device connected to the 71710 series CW power sensor, so as to eliminate the influence caused by different ground levels between the power meter and the tested device;
- 3) when the power output of the device under test is disabled if the measured power of the 71710 series CW power sensor is less than -50 dBm, so as to improve the power measurement accuracy.
- 4) in case that the measured power is too low, for example, the measured power of 71710, 81702 and 81703 series power sensors are less than -50 dBm, -15dBm and -30 dBm respectively after the power sensors are used for a long time, so as to improve the power measurement accuracy.

[Cal]

It is used to calibrate Channel A. The 71710 series CW power sensor should be calibrated through connection to the 2438 calibrator. But the 81702 or 81703 series peak power sensor with a built-in calibration circuit can be calibrated online during measurement without being connected to the 2438 calibrator.

[Zero+Cal]

It is used to zero and calibrate Channel A. The 71710 series CW power sensor should be zeroed and calibrated through connection to the power meter calibrator. But the 81702 or 81703 series peak power sensor with a built-in calibration circuit can be power meter calibrator.

[Must Cal]

When [Must Cal] is set in “On” state, the calibration operation must first be performed after the power meter is powered on; otherwise the instrument can't perform power measurement.

5.2.10 Frequency

Press [Frequency], and the system will enter the frequency setting menu. Below this menu, the frequency values of Channel A and Channel B can be set.

Press [CHA Freq], and a dialog will pop up. Enter the frequency value using the numeric keys. Select the unit in the right soft key area to complete setting the frequency of Channel A.

5.2 Menu description

The frequency setting of Channel B is the same as that of Channel A.

[CHA Freq]

It is used to set the frequency value of Channel A.

[CHB Freq]

It is used to set the frequency value of Channel B.

6 Remote Control

This chapter introduces the remote control basis as well as the remote interface and its configuration method of the 2438 series microwave power meter, and also briefly describes the concept and classification of the I/O driver library so that the user can have a preliminary knowledge about the remote control of this instrument. The specific content includes:

- [Remote control basis](#)..... 81
- [Remote interface and its configuration](#)..... 95
- [Basic programming method of the VISA interface](#)..... 96
- [I/O library](#)..... 99

6.1 Remote control basis

- [Remote interface](#)..... 81
- [Message](#)..... 84
- [SCPI](#)..... 84
- [Command sequence and synchronization](#)..... 91
- [Status reporting system](#)..... 92
- [Programming Considerations](#)..... 95

6.1.1 Remote interface

The instrument with the remote control function generally supports three remote interfaces: LAN, GPIB and USB. The type of the port supported by the instrument of a specific model is determined by the function of the instrument.

Table 6.1 Remote Interface Type and VISA Addressing String

Remote Interface	VISA Addressing String (Note 1)	Description
LAN (Local Area Network)	Raw socket protocol: TCPIP::host_address::port::SOCKET	Controller realizes remote control by connecting the instrument via the network port on the rear panel of the instrument. For the specific protocol, please refer to: 6.1.1.1 LAN interface
GPIB (IEC/IEEE Bus Interface)	GPIB::primary address[::INSTR]	Controller realizes remote control by connecting the instrument via the port on the rear panel of the instrument. The IEC 625.1/IEEE 418 bus interface standard is observed. For details, please refer to: 6.1.1.2 GPIB interface
USB (Universal Serial Bus)	USB::<vendor ID>::<product_ID>::<serial_number>[::INSTR]	Instrument's rear panel port For details, please refer to: 6.1.1.3 USB interface

Note 1: VISA or Virtual Instrumentation Software Architecture is a standard software interface function library which can be used by the user to control the instrument through GPIB, RS232, LAN and USB interfaces. The user should first install the VISA library on the control computer and use it to implement remote control of the instrument. For details, please refer to the user manual of the installed VISA library.

6.1 Remote control basis

● LAN interface	82
● GPIB interface	83
● USB interface	83

6.1.1.1 LAN interface

The microwave power meter can be accessed to the 10 Mbps/100 Mbps/1,000 Mbps Ethernet through a RJ45 communication cable (shielded or unshielded CAT 5 twisted pair) for remote control via the LAN control computer. To achieve LAN remote control, the microwave power meter has been provided with an interface adapter and a TCP / IP network protocol and configured with the corresponding TCP-based network service.

The network interface adapter for the 2438 series microwave power meter can work in the following three modes:

- 10 Mbps Ethernet (IEEE802.3);
- 100 Mbps Ethernet (IEEE802.3);
- 1,000 Mbps Ethernet (IEEE802.3ab).

The interface adapter can automatically match with the appropriate network speed based on link condition. In general, the length of the cable connecting the microwave power meter should not exceed 100 m. For more information about Ethernet, please refer to: <http://www.ieee.org>.

The knowledge of LAN interface is introduced hereinafter.

1) IP address

When remote control of the microwave power meter is achieved through LAN, unblocked physical connection of the network should be guaranteed. The address is set within the subnet where the main control computer is located through the "Local IP" menu of the microwave power meter. For example, if the IP address of the main control computer is 192.168.12.0, the IP address of the microwave power meter should be set as 192.168.12.XXX, where XXX is a number between 1 and 255.

Only the IP address is required to establish a network connection. The VISA addressing string is as follows:

TCPIP::host address::port::SOCKET

Where,

- TCPIP - network protocol used;
- host address - IP address or host name of the instrument, for identification and control of the controlled instrument;
- port - socket port number, 5000 for the socket port of the 2438 series microwave power meter;
- SOCKET - raw socket resource class.

Example:

When the raw socket connection is created, the following addressing string can be used:

TCPIP::192.1.2.3::5000::SOCKET

NOTE**Method for identification of multiple instruments in the remote control system**

If multiple instruments are connected to the network, they can be identified by their individual IP address and associated resource string. The main control computer uses the respective VISA resource string for instrument identification.

2) Socket communication

The TCP/IP protocol connects the signal generators in the network through the LAN socket. As a basic computer network programming method, the socket enables applications with different hardware and operating systems to communicate in the network, which achieves two-way communication between the microwave power meter and the computer through the port.

The socket is a special software class that defines the necessary information for network communication such as IP address and device port number and integrates some basic network programming operations. Sockets can be used in the operating system installed with a packaged library. UNIX Berkeley socket and Winsock are commonly used.

Berkeley socket and Winsock are compatible in the microwave power meter through the application program interface (API). In addition, other standard sockets are also compatible through the API. When the microwave power meter timing is controlled by the SCPI, the socket program will give a command. The microwave power meter has a fixed socket port number of 5000.

6.1.1.2 GPIB interface

As the unique bus specifically designed for instrument control, GPIB is still widely used in the automatic test system. The 2438 series microwave power meter integrates a GPIB interface on the rear panel. For remote control, the main control computer should first be installed with the GPIB bus card, driver and VISA library. During communication, the main control computer achieves addressing of the controlled instrument through the GPIB address. The user can modify the GPIB address of the controlled instrument to avoid communication failure caused by an address conflict in the whole system.

The definitions of GPIB and its associated interface are described in detail in the standards ANSI/IEEE 488.1-1987 and ANSI/IEEE 488.2-1992. For details of the standards, please visit the IEEE website: <http://www.ieee.org>.

When GPIB is connected, please pay attention to the following items:

- Up to 15 device can be incorporated in the test system through the GPIB bus component;
- The total length of the transmission cable should not be more than 20 m or twice the number of instruments in the system;
- Generally, the maximum length of the transmission cable between device should not exceed 2 m;
- If multiple instruments are connected in parallel, the “Or” connecting cables should be used;
- The IEC bus cable terminal should be connected to the instrument or controller computer.

6.1.1.3 USB interface

To achieve remote control through the USB interface, the computer and the microwave power meter should be connected via a USB B-type interface, and the VISA library should be installed in advance. VISA automatically tests and configures the instrument to establish a USB connection, without the necessity of entry of the instrument address string or installation of an individual driver.

USB address:

Addressing string format: USB::::<product ID>::

Where,

- <vendor ID> ID of vendor;
- <product ID> ID of instrument;
- <serial number> Serial number of instrument.

Example:

USB::0x0AAD::0x00C6::100001::INSTR

0x0AAD: ID of vendor;

0xC6: ID of instrument;

6.1 Remote control basis

100001: Serial number of instrument.

6.1.2 Message

Messages transmitted by data cable fall into the following two categories:

1) Interface message

The interface message is specific to the GPIB bus. Only the instrument with the GPIB bus function can respond to the interface message. When the main control computer sends an interface message to the instrument, the attention line should be pulled down at first, and then the interface message can be transmitted to the instrument through the USB cable.

2) Device message

For the structure and syntax of device message, refer to Section "6.1.3 SCPI". Device message can be divided into command and instrument response according to the different transmission directions. All remote control interfaces use device message in the same method unless otherwise stated.

a) Commands:

A command (program message) is a message transmitted from the main control computer to the instrument for remote control of instrument functions and query of status information. It falls into the following two categories:

- Based on the impact on the instrument:
 - Setting command: Change the instrument setting status, e.g. reset the instrument or set the frequency.
 - Query command: Query and return the data, e.g. identify the instrument or query the parameter values. The query command is always ended with a question mark.
- Based on the definition in the standard:
 - Common command: Function and syntax defined by IEEE 488.2, which is applicable to all types of instruments (if implemented) for standard status register management, resetting, self-test, etc.
 - Instrument control command: Instrument-specific command, for realization of instrument functions. For example: set the frequency. The syntax also follows SCPI specification.

b) Instrument response:

The instrument response (response message and service request) is the query result information sent by the instrument to the computer. This information includes measurement result and instrument status.

6.1.3 SCPI

- [Brief introduction to SCPI](#) 84
- [SCPI description](#) 85

6.1.3.1 Brief introduction to SCPI

SCPI (Standard Commands for Programmable Instruments) is a set of commands established for all instruments based on IEEE488.2 mainly to achieve the universality of SCPI, i.e. the same SCPI is generated and issued for the same function.

The SCPI consists of a command header and one or more parameters which are separated by a space. The command header contains one or more key fields. The command with question mark as postfix is a query command. Commands are divided into common commands and instrument-specific commands that are different in syntactic structure. SCPI has the following features:

- 1) The SCPI is established for the test functions rather than instrument operation description.
- 2) The SCPI reduces the repetition of the realization process of similar test functions, thus ensuring the programming compatibility;
- 3) Program message is defined in a layer that is independent of the communication physical layer hardware.
- 4) The SCPI is unrelated with the programming methods and languages, and the SCPI test program is easy to be transplanted;
- 5) The SCPI is scalable so that it is applicable to measurement control on different scales.
- 6) Scalability makes SCPI a “Live” standard.

If you are interested in learning more about SCPI, please refer to:

- IEEE Standard 488.1-1987, IEEE Standard Digital Interface for Programmable Instrumentation. New York, NY, 1998.
- IEEE Standard 488.2-1987, IEEE Standard Codes, Formats, Protocols and Comment Commands for Use with ANSI/IEEE Std488.1-1987. New York, NY, 1998.
- Standard Commands for Programmable Instruments(SCPI) VERSION 1999.0.

For details about the SCPI set, classification and description of the 2438 series microwave power meter , please refer to:

- 1) Appendix B Lookup Table of SCPI in this manual.
- 2) “3 Remote control command” in the Programming Manual.
- 3) 6.1 Appendix A SCPI Tree in the Programming Manual.
- 4) 6.2 Appendix B Lookup Table of SCPI by Subsystem in the Programming Manual.
- 5) 6.3 Appendix C Lookup Table of SCPI by Menu in the Programming Manual.

6.1.3.2 SCPI description

● General terms	85
● Command type	86
● Instrument-specific command syntax	86
● Command tree	87
● Command parameter and response	88
● Systems of values in command	90
● Command line structure	91

1) General terms

For the purpose of this section, the following terms should apply. It is necessary to know about the exact definitions of these terms for a better understanding of the content in various chapters.

a) Controller

The controller is any computer used to communicate with the SCPI device. The controller may be a personal computer, a small computer or a card inserted onto a cage. Some artificial intelligence device can also be used as a controller.

b) Device

The device is any component that supports SCPI. Most devices are electronic measuring or excitation device and use the GPIB interface for communication.

6.1 Remote control basis

c) Program message

The program message is a combination of one or more correctly formatted SCPIs. It guides the device to measure and output the signal.

d) Response message

The response message is a data set that specifies the SCPI format. It is always sent from the device to the controller or listener to remind the controller of the internal condition or measured value of the device.

e) Command

A command is an instruction in compliance with the SCPI standard. The combination of controller commands forms a message. In general, a command includes the keyword, parameter and punctuation.

f) Event command

An event-type SCPI can't be queried. An event command generally has no corresponding key settings on front panel. Its function is to trigger an event at a particular moment.

g) Query

Query is a special command. When the controller is queried, it is necessary to return to the response message in conformity with syntax requirement of the controller. The query statement is always ended with a question mark.

2) Command type

There are two types of SCPIs: common commands and instrument-specific commands. Common commands are defined in IEEE 488.2 to manage macros, status registers, synchronization, and data storage. Common commands are easy to recognize as they all begin with an asterisk. For example *IDN? , *OPC and *RST are common commands. Common commands don't belong to any instrument-specific command. The instrument uses the same method to interpret them without consideration to the current path setting.

It is very easy to identify instrument-specific commands because they contain a colon (:). The colon is used between the beginning of a command expression and a keyword, for example: FREQuency[:CW?]. Instrument-specific commands are divided into command subsets of corresponding subsystem according to the functional block inside the instrument. For example, the power subsystem (:POWer) contains the power-related command while the status subsystem (:STATus) contains the command for the status control register.

3) Instrument-specific command syntax

Table 6.2 Special Characters in Command Syntax

Symbol	Meaning	Example
	The vertical line between the keyword and the parameter represents a variety of options.	[:SENSE]:BANDwidth BWIDth HIGH LOWer BANDwidth and BWIDth are options, and HIGH and LOWer are options.
[]	Square brackets indicate that the included keywords or parameters are optional when they form a command. These implied keywords or parameters are executed even when they are ignored.	[:SENSE]:BANDwidth? SENSE is optional.
< >	The part inside the angle brackets can't be used literally in the command, instead, it represents the part that must be contained.	[:SENSE]:FREQuency[:CW FIXed] <val>[unit] In this command, <val> must be replaced by the actual frequency.

6.1 Remote control basis

		[unit] means a unit that can be omitted. For example: <code>FREQ 3.5GHz</code> <code>FREQ 3.5e+009</code>
{ }	The part inside the braces indicates that the parameter is optional.	<code>MEMory:TABLE:FREQUency</code> <code><val>{,<val>}</code> For example: <code>MEM:TABL:FREQ 5e7</code>

Table 6.3 Command Syntax

Character, Keyword and Syntax	Example
Capitalized characters represent the minimum character set required to execute the command.	<code>[:SENSe]:FREQUency[:CW FIXed]?,</code> FREQ is the short-format part of the command.
The lowercase character part of the command is optional; this flexible format is called “Flexible Listening”. For more information, please refer to the section “Command parameter and response”.	<code>:FREQUency</code> <code>:FREQ, :FREQUency</code> or <code>:FREQUENCY,</code> any of which is correct.
A colon between two command mnemonics moves the current path in the command tree downwards by one layer. For more information, please refer to the command path part in the section “Command tree”.	<code>:TRIGger:MODE?</code> TRIGger is the topmost keyword of this command.
If the command contains multiple parameters, the adjacent parameters will be separated by commas. The parameter isn't a part of the command path, so it doesn't affect the path layer.	<code>MEMory:TABLE:FREQUency</code> <code><val>{,<val>}</code>
The semicolon separates two adjacent commands but doesn't affect the current command path.	<code>:FREQ 2.5GHZ;:POW 10DBM</code>
Blank characters such as <space> or <tab> are usually ignored as long as they don't appear between the keywords or in the keyword. However, the command and parameter must be separated by a blank character, without affecting the current path.	<code>:FREQUency</code> or <code>:POWer :LEVel6.2</code> is not allowed. <code>:LEVel</code> and <code>6.2</code> must be separated by a space. i.e. <code>:POWer:LEVel 6.2</code>

4) Command tree

Most remote control programming tasks involve instrument-specific commands. When such a command is parsed, the SCPI uses a structure similar to a file system. This command structure is called a command tree.

The top command is root command, or simply “root”. In the case of command parsing, the command at the next layer is reached by following a specific route based on the tree structure. For example: `::POWer:ALC:SOURce?`, where, `POWer` stands for `AA`, `:ALC` stands for `BB`, `:SOURce` stands for `GG`, and the whole command path is `(:AA:BB:GG)`.

A software module in the instrument software—the command interpreter—is responsible for parsing each received SCPI. The command interpreter breaks up the command into individual command element using a series of rules for identifying the command tree path. After the current command is parsed, the current command path remains unchanged. In this way, the subsequent commands can be parsed more quickly and efficiently because the same command keyword may appear in different paths. After the power-on*RST (reset) operation of the instrument, the current command path is reset as the root.

6.1 Remote control basis

5) Command parameter and response

Table 6.4 Types of SCPI Parameter and Response

Parameter Type	Response Data Type
Numeric	Real or Integer
Extended Numeric	Integer
Discrete	Discrete
Boolean	Numeric Boolean
String	String
Block	Definite Length Block
	Indefinite Length Block
Non-decimal numeric	Hexadecimal
	Octal
	Binary

The SCPI defines different data formats in the use of the remote control and response messages to conform to the principles of “flexible listening” and “accurate speaking”. For more information, please refer to IEEE 488.2. “Flexible Listening” means that the formats of commands and parameters are flexible.

For example, the frequency offset state command set for the microwave power meter is as follows :FREQUENCY:OFFSet:STATe ON|OFF|1|0,

The following command formats are used to set the frequency offset function as “On”:

:FREQUENCY:OFFSet:STATe ON, :FREQUENCY:OFFSet:STATe 1,

:FREQ:OFFS:STAT ON, :FREQ:OFFS:STAT 1

Each parameter type corresponding to one or more response data types. In the case of query, a numeric parameter will return a data type, and the response data is exact and strict, which is called “Accurate Speaking”.

For example, if you query the power state (:POWER:ALC:STATe?), when it is turned on, the response is always 1, regardless of whether you previously sent :POWER:ALC:STATe 1 or :POWER:ALC:STATe ON.

a) Numeric parameter

Numeric parameters can be used in both instrument-specific commands and common commands. It receives all common decimal systems including signs, decimal point and scientific notation. If a certain piece of device only receives a specified type of numeric parameter such as an integer, it will automatically round off the received numeric parameter.

Examples of numeric parameter:

0	No decimal point
100	Optional decimal point
1.23	With a sign bit
4.56e<space>3	space allowed after exponent marker e
-7.89E-01	exponent marker e may be upper or lower case
+256	leading + allowed
5	Front decimal point allowed

b) Extended numeric parameter

Most measurements related to Instrument-specific commands use extended numeric parameters to specify the physical quantities. Extended numeric parameters receive all numeric parameters and additional special values. All extended numeric parameters receive MAXimum and MINimum as

6.1 Remote control basis

parameter values. Other special values, such as UP and DOWN are received by the instrument parsing capability. SCPI table will list all valid parameters.

Note: extended numeric parameters are not applicable to common commands or STATus subsystem commands.

Examples of extended numeric parameters:

101	Numeric parameter
1.2 GHz	The GHz can be used as an exponent (E009)
200 MHz	The MHz can be used as an exponent (E006)
-100 mV	-100 millivolts
10DEG	10 DEG
MAXimum	Maximum valid setting
MINimum	minimum valid setting
UP	Increase a step
DOWN	Decrease a step

c) Discrete parameter

When there are a finite number of parameter values to be set, discrete parameters are used for identification. A discrete parameter uses mnemonics to represent each valid setting. Like the SCPI mnemonics, the discrete parameter mnemonics can be set in long and short formats, with both capitalized and lowercase characters.

The following example illustrates the combined use of discrete parameter and command.

```
:TRIGger[:SEQuence]:SOURce BUS|IMMediate|EXTernal
```

BUS	GPIB,LAN,RS-232 trigger
IMMediate	Immediate trigger
EXTernal	External trigger

d) Boolean parameter

Boolean parameters represent a single binary condition that is either true or false. There are only four possible representations for a Boolean parameter.

Examples of Boolean parameters:

ON	True
OFF	False
1	True
0	False

e) String parameter

A string parameter allows the ASCII string to be sent as a parameter. Single and double quotes are used as separators.

Examples of string parameter:

```
'This is Valid' "This is also Valid" 'SO IS THIS'
```

f) Real response data

A large portion of measurement data is real. They are formatted as basic decimal notation or scientific notation. Most high-level remote control languages all support these two formats.

Examples of real response data:

```
1.23E+0
-1.0E+2
```

6.1 Remote control basis`+1.0E+2``0.5E+0``0.23``-100.0``+100.0``0.5`**g) Integer response data**

The integer response data are a decimal expression of an integer with the sign bit. When the status register is queried, the integer response data will be mostly returned.

Examples of integer response data:

<code>0</code>	Optional sign bit
<code>+100</code>	Leading + allowed
<code>-100</code>	Leading - allowed
<code>256</code>	No decimal point

h) Discrete response data

The discrete response data and discrete parameters are basically the same. The main difference is that the discrete response data can only be returned in the short format with capitalized characters.

Examples of discrete response data:

<code>INTernal</code>	Internal amplitude stabilization
<code>EXTernal</code>	External amplitude stabilization
<code>MMHead</code>	Amplitude stabilization through MMW source module

i) Numeric Boolean response data

The Boolean response data returns a binary value of 1 or 0.

j) String response data

The string response data and string parameters are the same. The main difference is that the string response data use double quotes rather than single quotes as the separator. The string response data can also be inserted with double quotes inside which there can be no characters. Examples of string response data:

`"This is a string"`

`"one double quote inside brackets: ("")"`

6) Systems of Values in Commands

The value of the command can be entered in binary, decimal, hexadecimal or octal format. In the binary, hexadecimal, or octal format, a suitable identifier should be added in front of the value. In the decimal (default) format, an identifier isn't required. When the value without an indicator is entered, the device will ensure that it is entered in decimal format. The identifiers required in all formats are listed as follows:

- `#B` indicates a binary value;
- `#H` indicates a hexadecimal value;
- `#Q` indicates an octal number.

The representations of the decimal value 45 in the SCPI are given as follows:

`#B101101`

`#H2D`

`#Q55`

The following example shows setting of the RF output power as 10 dBm (or the value equivalent to the

current selected unit including DBUV or DBUVEMF) with the hexadecimal value 000A.

```
:POW #H000A
```

In a non-decimal format, the measurement unit such as DBM or mV isn't used together with the value.

7) Command line structure

A command line may contain multiple SCPIs. To indicate the end of the current command line, the following methods can be used:

- Enter;
- Enter and EOI;
- EOI and the last data byte.

Commands in command line are separated by semicolons, and commands for different subsystems begin with a colon. For example:

```
MMEM:COPY "Test1", "MeasurementXY";:HCOP:ITEM ALL
```

The command line contains two commands of which the first one belongs to the MMEM subsystem and the second one belongs to the HCOP subsystem. If the adjacent commands belong to the same subsystem, the command path will be partially repeated and the command can be abbreviated. For example: For example:

```
HCOP:ITEM ALL;:HCOP:IMM
```

The command line contains two commands both of which belong to the HCOP subsystem of first level. Therefore, the second command can begin with the subordinate to HCOP and may not begin with a colon, which can be abbreviated to the following command line:

```
HCOP:ITEM ALL;:HCOP:IMM
```

6.1.4 Command sequence and synchronization

IEEE488.2 defines the difference between overlapped commands and sequential commands:

- Sequential commands are sequences of commands that are executed continuously. Usually, each command is executed fast.
- Overlapped commands indicate that the previous command is not executed automatically before the next command is executed. Normally overlapped commands take longer to process and allows the program to process other events synchronously.

Even if multiple commands are set in a command line, they are not necessarily executed in the order in which they are received. In order to ensure that the commands are executed in a certain order, each command must be sent as a separate command line.

Example: Command line contains set and query commands

If multiple commands in a command line contain query commands, the query result is unpredictable. The following command returns a fixed value:

```
:FREQ:STAR 1GHZ;SPAN 100;:FREQ:STAR?
```

Returned value: 1000000000 (1GHz)

The following command returns an unfixed value:

```
:FREQ:STAR 1GHZ;STAR?;SPAN 1000000
```

The returned value may be the current start frequency value of the instrument before the command is sent, because the host program executes the commands one by one only after receiving the command message. If the host program executes the command after receiving it, the returned value may also be 1 GHz.

6.1 Remote control basis

NOTE**Setting command and query command are sent separately**

General rule: The setting and query commands should be sent in different program control messages so as to ensure a correct returned value for the query command.

Preventing overlapping execution of the command

In order to prevent the overlapped execution of commands, multiple threads or commands: *OPC, *OPC? or *WAI can be used. These three commands can be executed only after the hardware is set. While programming, the computer can be forced to wait for some time to synchronize certain events. The details are separately described below:

➤ **Controller program uses multiple threads**

Multi threads are used to wait for completion of the command and achieve synchronization of GUI and program control, that is, a single thread waits for completion of *OPC?, without impeding the execution of the GUI or remote control thread.

➤ The usage of the three commands in synchronous execution is shown in the table below:

Table 6.5 Command Syntax

Method	Actions to be Executed	Programming Method
*OPC	Set the operation completion bit is set.	Set ESE BIT0; Set SRE BIT5; Send the overlapped command and *OPC; Wait for service request (SRQ) SRQ represents the completion of execution of the overlapped command
*OPC?	Stop executing the current command until the value 1 is returned. The command is returned only when the operation completion bit in the ESR is set, which indicates that the previous command is processed.	Terminate the processing of the current command before executing other commands. Send this command directly after the current command.
*WAI	Before executing *WAI, wait until all commands are sent and continue processing the uncompleted commands.	Terminate the processing of the current command before executing other commands. Send this command directly after the current command.

6.1.5 Status reporting system

The status reporting system stores all current operation status information and error information of the instrument. Such information is stored in the status register and error queue respectively and can be queried through the remote interface.

- [Structure of status register](#)..... 92
- [Application of status reporting system](#)..... 94

6.1.5.1 Structure of the status register

The register classification is described as follows:

1) STB, SRE

Status Byte (STB) register and its associated mask register, Service Request Enable (SRE) register, constitute the top-level register of the status reporting system. The STB saves the general working

status of the instrument by collecting low-level register information.

2) ESR, SCPI status register

STB receives the information of the following registers:

- The value of Event Status Register (ESR) and Event Status Enable (ESE) mask register.
- SCPI status registers include: STATus:OPERation and STATus:QUEStionable registers (SCPI definition) which contain the specific operating information of the instrument. All SCPI status registers have the same internal structure (please refer to Section 2.1.5.2 “ Structure of SCPI status register” in the Programming Manual).

3) IST, PPE

Similar to the SRQ, an individual bit of the IST mark ("Individual Status") is a combination of all statuses of the instrument. The associated parallel query enable register (PPE) determines which data bits of the STB act on the IST mark.

4) Output buffer

The output buffer stores the message returned by the instrument to the controller. It doesn't belong to the status reporting system but determines the value of the MAV bit of STB.

For detailed description of the above registers, please refer to the section “2.1.6 Status reporting system” in the Programming Manual.

Please refer to Fig. 6.1 Hierarchy Diagram of Status Register.

NOTE

SRE, ESE

The SRE can be used as an enable part of the STB. Similarly, the ESE can be used as an enable part of the ESR.

6.1 Remote control basis

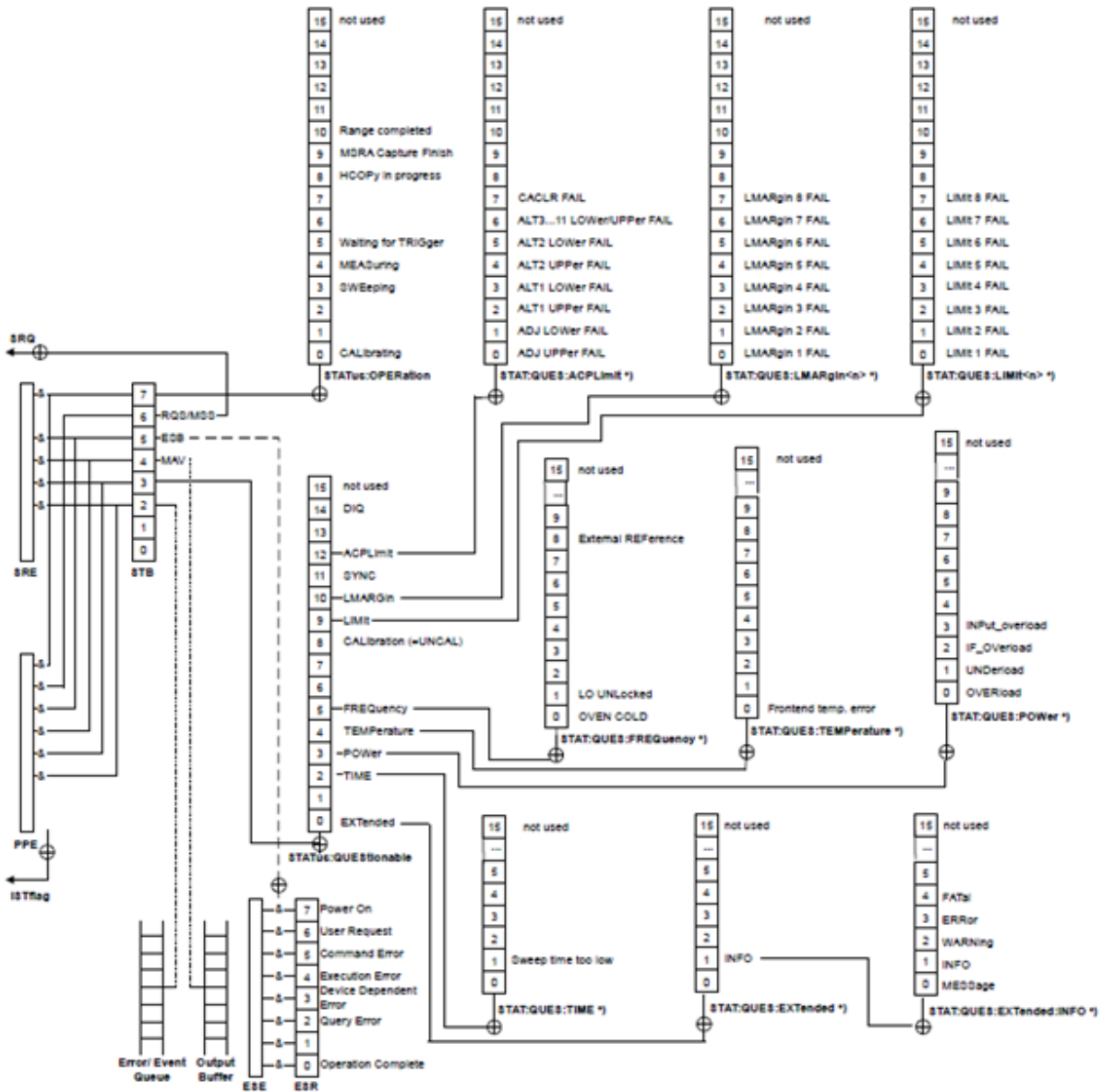

Fig. 6.1 Hierarchy Diagram of Status Register

6.1.5.2 Application of status reporting system

The status reporting system is used to monitor the status of one or more instruments in the test system. To correctly realize the function of the status reporting system, the controller in the test system must receive and evaluate the information of all instruments. The standard methods applied include:

- 1) Query the service request (SRQ) initiated by the instrument;
- 2) Perform serial poll of all instruments in the bus system, which is initiated by the controller in the system in order to find out the initiator and reason of the service request.
- 3) Perform parallel query of all instruments;
- 4) Query of the status of specific instrument by remote control command;

For details about the application methods, please refer to the section “2.1.5 Application of the status reporting system” in the Programming Manual.

6.2 Remote interface and its configuration**6.1.6 Programming considerations****1) Please initialize the instrument status before changing the settings**

When setting the instrument through remote control, it is necessary to initialize the instrument status (e.g. send "*RST") and then set the desired status.

2) Command sequence

In general, the setting and query commands should be sent separately; otherwise the returned value of the query command will change according to the current instrument operation sequence.

3) Failure response

The service request can only be initiated by the instrument itself. The controller program in the test system should instruct the instrument to initiate a service request when an error occurs, and then enter the corresponding interrupt service routine for processing.

4) Error queue

Each time the controller program processes a service request, the error queue rather than the status register of the instrument should be queried to obtain a more accurate error reason. The error queue should be frequently queried to obtain the wrong command sent by the controller to the instrument especially during testing of the controller program.

6.2 Remote interface and its configuration

- [LAN](#)..... 95
- [GPIB](#)..... 96

6.2.1 LAN

- [Connection](#)..... 95
- [Interface configuration](#)..... 95

6.2.1.1 Connection

When the 2438 series microwave power meter and external controller (computer) are connected to the LAN through network cables, special attention should be paid to the fact that the IP address setting may cause an address conflict. Therefore, it is necessary to confirm the address with the network administrator before setting to avoid the conflict.

6.2.1.2 Interface configuration

When remote control of the microwave power meter is achieved through LAN, unblocked physical connection of the network should be guaranteed. When the microwave power meter is subjected to remote control through the LAN, the physical connection of the network should be ensured. As the DHCP, domain name access or WAN connection isn't supported, the remote control setting of the network for the microwave power meter is relatively simple: Press [System] [Interface ▶], and set the "IP address", "Subnet mask" and "Default gateway" to the subnet where the main controller is located using the menu shown in Fig. 6.2.

6.3 Basic programming method of the VISA interface

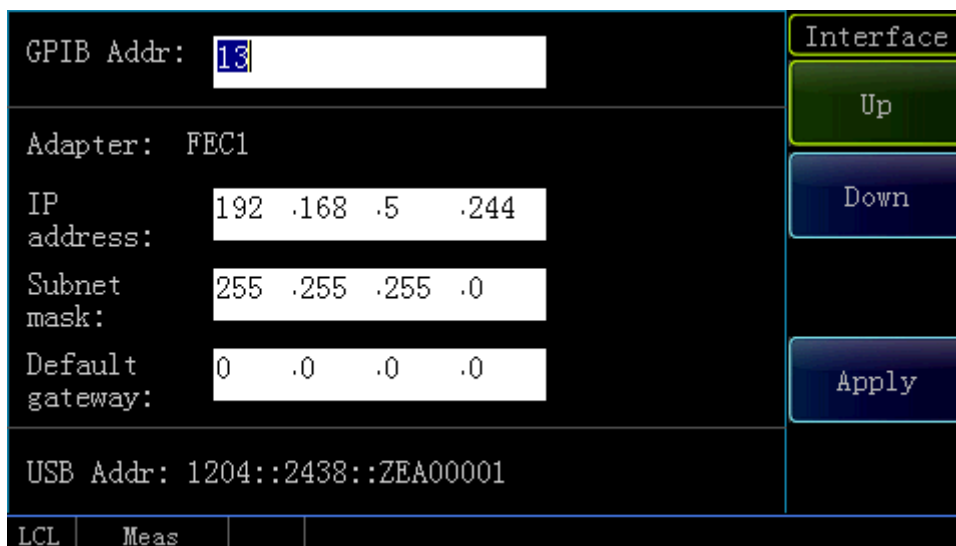

Fig. 6.2 Setting of LAN Interface and GPIB Interface

Attention

Ensure that the microwave power meter is subjected to normal physical connection through a 10Base-T LAN or 100Base-T LAN cable.

Since the microwave power meter only supports the establishment of a single LAN control system and the setting of a static IP address and it doesn't support DHCP or access to the host through the DNS and domain name server, the user isn't required to modify the subnet mask which is set as a fixed value of 255.255.255.0 inside the instrument.

6.2.2 GPIB

- [Connection.....](#) 96
- [Interface configuration.....](#) 96

6.2.2.1 Connection

Use a GPIB cable to connect the 2438 Series microwave power meter to the external controller (computer).

6.2.2.2 Interface configuration

For the setting of the GPIB interface, press [System] [Interface▶] [GPIB Addr] to enter the interface as shown in Fig. 6.2, and then modify the setting in the GPIB address input box through the numeric keys on the front panel of the instrument.

6.3 Basic programming method of the VISA interface

The basic methods for programming of remote control of the instrument through the VISA library are illustrated hereinafter. Take the C++ language as an example.

- [Installation of VISA library.....](#) 97
- [Initialization of controller.....](#) 97

6.3 Basic programming method of the VISA interface

- [Initialization of instrument.....](#) 97
- [Sending of setting command.....](#) 97
- [Reading of instrument status.....](#) 98
- [Synchronization of command.....](#) 98

6.3.1 Installation of VISA library

At first, it is necessary to install the VISA library so as to achieve remote control. The VISA library packages the underlying transfer functions of underlying VXI, GPIB, LAN and USB interfaces so that the user can call them directly. The microwave power meter supports the programming interfaces including GPIB and LAN which are used in combination with the VISA library and programming language for remote control of the microwave power meter.

6.3.2 Initialization of controller

```
/*-----*/
```

The following example shows how to open and establish a communication connection between VISA library and the instrument (specified by instrument descriptor).

```
//Initialize the controller: Open the default resource manager and return the instrument handle analyzer
```

```
/*-----*/
```

void InitController()

```
{
ViStatus iStatus;
iStatus = viOpenDefaultRM(&defaultRM);
iStatus = viOpen(defaultRM, analyzerString, VI_NULL, VI_NULL, &analyzer);
}
```

6.3.3 Initialization of instrument

```
/*-----*/
```

The following example shows how to initialize the instrument default status and clear status registers.

```
/*-----*/
```

void InitDevice()

```
{
ViStatus iStatus;
long retCnt;
iStatus = viWrite(analyzer, "*CLS", 4, &retCnt); //reset the status register
iStatus = viWrite(analyzer, "*RST", 4, &retCnt); //reset the instrument
}
```

6.3.4 Sending of setting command

```
/*-----*/
```

The following example shows how to set the center frequency of the 2438 series microwave power meter.

```
/*-----*/
```

void SimpleSettings()

```
{
```

6.3 Basic programming method of the VISA interface

```

ViStatus iStatus;
long retCnt;
//Set the frequency as 128 MHz
iStatus = viWrite(iDevHandle, "FREQ 1.28e8\n", strlen("FREQ 1.28e8\n"), &uiRetCnt);
}

```

6.3.5 Reading of instrument status

```

/*****/

```

The following example shows how to read the setting status of the instrument.

```

/*****/

```

void ReadSettings()

```

{
ViStatus iStatus;
long uiRetCnt;
char rgcBuf[256];

//Query the frequency
iStatus = viWrite(iDevHandle, "FREQ?\n", strlen("FREQ?\n"), &uiRetCnt);
Sleep(10);
iStatus = viRead(iDevHandle, rgcBuf, sizeof(rgcBuf), &uiRetCnt);
//Print debugging information
printf("frequency %s", rgcBuf);
}

```

6.3.6 Synchronization of command

```

/*****/

```

The methods for command synchronization are illustrated hereinafter by taking sweep as an example.

```

/*****/

```

void SweepSync()

```

{
ViStatus iStatus;
long retCnt;
ViEventType etype;
ViEvent eevent;
int stat;
char OpcOk [2];

/*****/

/*Command INITiate[:IMMEDIATE] initiates a single sweep (INIT:CONT OFF when continuous sweep is OFF)*/

```

```

/* Only when the single sweep is completed can the next command in the command buffer be executed
*/
/*****/
iStatus = viWrite(analyzer, ":INIT:CONT OFF", 13, &retCnt);
//Method 1 of waiting for sweep completion: use *WAI
iStatus = viWrite(analyzer, ":INIT", 18, &retCnt);
iStatus = viWrite(analyzer, "*WAI", 18, &retCnt);

//Method 2 of waiting for sweep completion: use *OPC?
iStatus = viWrite(analyzer, ":INIT", 20, &retCnt);
iStatus = viWrite(analyzer, "*OPC?", 18, &retCnt);
iStatus = viRead(analyzer, OpcOk, 2, &retCnt); //wait*OPC to return "1"

//Method 3 of waiting for sweep completion: use *OPC
//To use the GPIB service request, set "Disable Auto Serial Poll" as "yes"
iStatus = viWrite(analyzer, "*SRE 32", 7, &retCnt);
iStatus = viWrite(analyzer, "*ESE 1", 6, &retCnt); //enable service request ESR
//Set the event enable bit, the operation is completed
iStatus = viEnableEvent(analyzer, VI_EVENT_SERVICE_REQ, VI_QUEUE, VI_NULL);
//Enable SRQ event
iStatus = viWrite(analyzer, ":INIT ", 18, &retCnt);
iStatus = viWrite(analyzer, "*OPC", 18, &retCnt);

//Start sweep synchronously with OPC
iStatus = viWaitOnEvent(analyzer, VI_EVENT_SERVICE_REQ, 10000, &etype, &eevent)
//Wait for service request
iStatus = viReadSTB(analyzer, &stat);
iStatus = viClose(eevent); //close the event handle
//Disable the SRQ event
iStatus = viDisableEvent(analyzer, VI_EVENT_SERVICE_REQ, VI_QUEUE);
//Continue running the main program.....
}

```

6.4 I/O library

- [Overview of I/O library.....](#) 99
- [Installation and configuration of I/O library.....](#) 100

6.4.1 Overview of I/O library

As a library of software programs pre-written for the instrument, the I/O library is called an instrument driver. It is considered as the intermediate layer of the software between the computer and the instrument hardware device, composed of function library, utility program and tool kit, and used as a

6.4 I/O library

software code module set that corresponds to a planned operation, e.g. configuring, reading from, writing to or triggering the instrument. It resides in the computer as the bridge and link between the computer and the instrument and provides an easily programmed high-level modular library so that the user no longer needs to learn complex low-level programming protocols specific to an instrument. The instrument driver is the key to rapid development and test of measurement applications.

From the aspect of function, a general instrument driver usually consists of a functional body, an interactive developer interface, a program developer interface, a subprogram interface and an I/O interface as shown in Fig. 6.3.

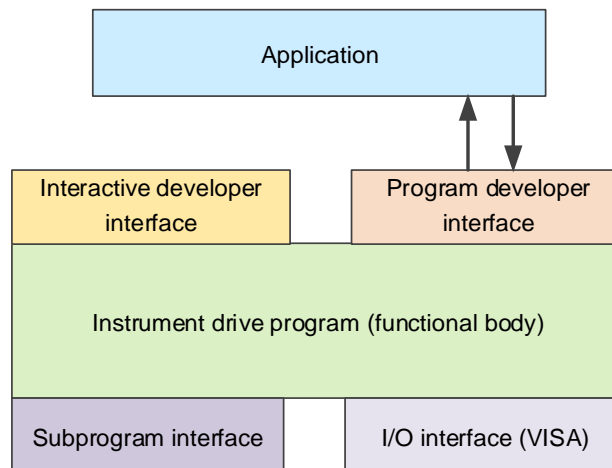

Fig. 6.3 Structural Model of Instrument Driver

The detailed description is given as follows:

- 1) **Functional body.** It is the main functional part of the instrument driver and can be understood as the framework program of the instrument driver.
- 2) **Interactive developer interface.** For user's convenience, a graphical interactive developer interface is generally provided in the application development environment that supports the development of the instrument driver. For example, the function panel in Labwindows/CVI is an interactive developer interface. In the function panel, each parameter of the instrument driver function is represented by a graphical control.
- 3) **Program developer interface.** It is a software interface for calling of the instrument driver function by the application, such as the dynamic link library file .dll of the instrument driver of the Windows system.
- 4) **I/O interface.** It is used to complete the actual communication between the instrument driver and the instrument. The bus-specific I/O software such as GPIB can be used; the common standard I/O software across multiple buses, including: VISA I/O can also be used.
- 5) **Subroutine interface.** It is a software interface for the instrument driver to access other support libraries including database and FFT function. When the instrument driver needs to call other software modules, operating systems, program code libraries and analysis function libraries to complete its task, the subroutine interface will be used.

6.4.2 Installation and configuration of I/O library

With the development of the test field application from the traditional instrument to the virtual instrument, the instrument driver has experienced different development processes in order to solve the instrument interchangeability and test program reusability of the automatic test system. Currently, the IVI (Interchangeable Virtual Instruments) driver is popularly applied. Based on the IVI specification, a new instrument programming interface is defined, the class driver and VPP architecture are inserted onto the VISA so that the test application is completely independent of the instrument hardware, and unique instrument simulation, range detection and status buffer functions are added, which improves the system operation efficiency and truly achieves the instrument interchange.

6.4 I/O library

The IVI driver comes in two types: IVI-C and IVI-COM. IVI-COM is based on Microsoft Component Object Model (COM) technology in the form of COM API; IVI-C is based on ANSI C in the form of C API. Both drivers are designed according to the instrument class defined in the IVI specification, with the same application development environments including Visual Studio, Visual Basic, Agilent VEE, LabVIEW and CVI/LabWindows.

Currently, it is necessary to provide two types of drivers in order to meet the demands of different users in different development environments. The IVI driver of the microwave power meter is developed based on Nimbus Driver Studio so that the IVI-COM and IVI-C drivers and program installation packages are generated directly. For details about installation and configuration, please refer to the accompanied documents of your selected control card and I/O library.

The installed IVI driver is divided into an IVI intrinsic functional group and an instrument class functional group (a basic functional group and an extended functional group). For details about functional classification, functions and attributes, please refer to the accompanied help document of the driver.

NOTE**Configuration of ports and installation of IO library**

Before using a computer to control the microwave power meter, confirm that you have correctly installed and configured the necessary ports and I/O library.

7 Fault Diagnosis and Repair

This chapter will show you how to find out problems and accept after-sales service. and the error message of the microwave power meter will be explained.

If you have purchased 2438 series microwave power meter and encountered some problems during operation, or you need to purchase relevant parts, options or accessories of the power meter, the company will provide perfect after-sales service.

Generally, the problems come from hardware, software or improper use. If there is any problem, please contact us timely. If the microwave power meter you purchased is still within the warranty, we will repair your power meter free of charge according to the commitment in the warranty certificate. If it is beyond the warranty, we will only collect the cost.

- [Working principle.....](#) 103
- [Fault diagnosis and troubleshooting.....](#) 104
- [Error information.....](#) 105
- [Repair methods.....](#) 106

7.1 Working principle

This section introduces the basic working principle and hardware block diagram of the microwave power meter so that the user can know about the functions of the 2438 series microwave power meter and better solve the problems during operation.

The working principle of the 2438 series microwave power meter is shown in Fig. 7.1. The 2438 series microwave power meter includes the main unit, CW power sensor and peak power sensor. The main unit is composed of CPU board, channel board, DSP board, LCD, key/keyboard, power module and rear panel.

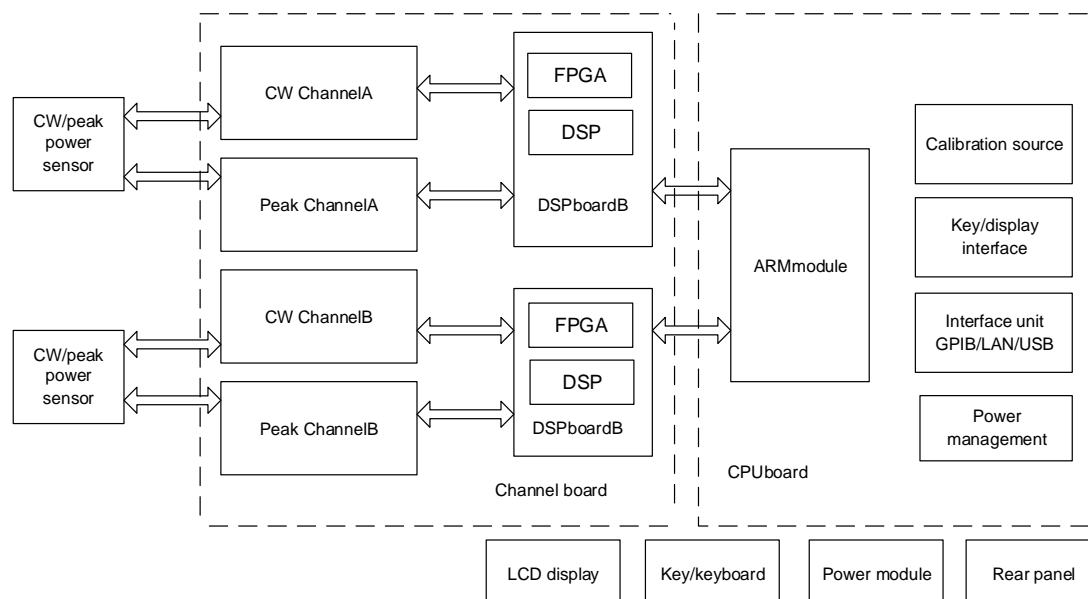

Fig. 7.1 Working Principle of 2348 Series Microwave Power Meter

When the 2438 series microwave power meter is connected to a CW power sensor, it will adopt the same signal processing method as a standard traditional power meter. After being amplified through chopping and weak signals, the sensor detection voltage will be sent to the power meter main unit for further processing. The processed data will be sent to the CPU for display processing after various compensations.

When the 2438 series microwave power meter is connected to a peak power sensor, the internal dual-diode sensor with a balanced configuration will convert the microwave pulse modulation input signals into pulse modulation envelope signals after detection, and the pre-amplification circuit in the

7.2 Fault diagnosis and troubleshooting

sensor will filter and pre-amplify the pulse modulation envelope signals and send them to the power meter channel processing unit for baseband amplification and bandwidth control. The signals will be input to trigger the high-speed comparator circuit to generate the trigger synchronization signal on one way and to the post amplifier for amplification on the other way. The post amplifier will amplify and output the signals to the high-speed analog-to-digital converter (ADC) for analog-to-digital conversion. The converted data will be sent to the DSP for processing and finally sent to the display unit for display.

The power meter calibrator part provides a calibration signal with a power of 1.000 mW. The calibrator provides an absolute power reference for the microwave power meter so that the power can be traced back to a manufacturer' standard or a national standard.

Consisting of microprocessor, system ROM, system RAM and logic control circuit, the CPU mainly completes the communication with the DSP, data transmission, waveform measurement analysis, display processing and interface operation besides control of the keys, LCD display and interface unit.

7.2 Fault diagnosis and troubleshooting

Normally, the problem is caused by the hardware, software, or improper use. Once a problem occurs, first observe the error information, analyze the possible causes, and solve the problem in advance by reference to the methods provided in “7.2.1 Basic fault diagnosis process” and “7.2.2 Common faults and troubleshooting methods”. Alternatively, you can contact our customer service center and provide the collected error information, and we will help you solve the problems as quickly as possible. For more information, please refer to the contact details in this manual or inquire online at www.ceyear.com for contact details of the nearest technical support center.

NOTE

Fault Diagnosis and Guides

This part provides general guidance on how to carry out simple judgment and handling when the 2438 series spectrum analyzer has any fault. If necessary, please feed back the problem to the manufacturer as accurately as possible, so that we can solve it as soon as possible.

7.2.1 Basic fault diagnosis process

Generally, the problems come from hardware, software or improper use. If there is any problem,, it is necessary to check:

- ✧ Whether the power outlet is normal and the power supply complies with the working requirement of the instrument.
- ✧ Whether the microwave power meter is powered on; whether the green LED indicator lamp near the power button lights up;
- ✧ Whether the other instruments, cables and connectors, if used together, are connected with the microwave power meter properly and work normally.

7.2.2 Common faults and troubleshooting methods

The common faults and troubleshooting methods are listed by function.

- [Blank screen.....](#) 105
- [Accidental phenomenon.....](#) 105
- [Hardware fault.....](#) 105

7.2.2.1 Blank screen

If the screen fails to turn on when the power button is pressed after the instrument is connected to the power supply, please do the following checks:

- ✧ check whether the power outlet is normal and the power supply complies with the working requirement of the instrument.
- ✧ check whether the power button is yellow. If the utility power supplies normally but the power button indicator lamp doesn't light up, the instrument power module may be damaged.
- ✧ check whether the power button is pressed effectively. Try pressing the power button for several times.
- ✧ the power button indicator lamp turns green or the fan is in operation. If the power button indicator lamp doesn't turn green and the fan doesn't run, the power supply may be faulty; If the power button indicator lamp turns green and the fan runs as normal, but the screen is blank, the instrument controller may be faulty. If the screen is still blank, the controller or LCD control circuit may be faulty.

7.2.2.2 Accidental phenomenon

Many factors may result in unexpected phenomena during use. The user can determine the causes of instrument problems by reference to the following inspection procedures through which the problems can be solved or the causes of problems can be judged clearly. If a hardware problem is confirmed, please refer to the section "Hardware fault".

If other device, cable or connector is connected to the power meter, check whether they are mechanically connected in a correct way and whether the electrical properties are compatible.

When the problems appear after some settings are made, check the operation and confirm that all settings are correct. If the test is completed, check whether the measurement result matches with the measured signal and meets the performance indicators of the power meter and the connected sensor.

If you are not sure whether the settings are correct when the instrument has unexpected phenomena, press [Menu]>[System]>[Save Recall]>[Default], and then set the instrument according to the measured signal and test requirement.

7.2.2.3 Hardware fault

The 2438 series microwave power meter can test its key circuits. It is necessary to check whether the instrument works normally as per the following steps:

- ✧ Press [Menu]>[System] >[Service] >[Test] >[Self Test], and the system will start to perform self-test.
- ✧ Check whether all self-tests are qualified. If they are unqualified, it indicates the circuit is faulty and should be repaired;

Press [Back] to exit from the self-test window.

7.3 Error information

In case of improper operation or incorrect configuration during actual use, the power meter will display error information at the bottom of its display to indicate that the 2438 series microwave power meter involves software or the hardware fault. The user can roughly judge the type of problem based on the error prompt and take corresponding measures for troubleshooting or get the instrument repaired.

Press [Menu]>[System]>[Error List] to view the recent error information. Press [Clear Error] to clear all error records.

For detailed description of error information, please refer to the 2438 Series Microwave Power Meter Programming Manual.

7.4 Repair Method

7.4 Repair Method

- [Contact us](#).....106
- [Packaging and delivery](#).....106

7.4.1 Contact us

When the 2348 microwave power meter incurs a problem, observe and save error information, analyze the possible causes and eliminate and solve the problems according to the methods provided in the section “7.2. Fault diagnosis and troubleshooting”. Alternatively, you can contact our customer service center and provide the collected error information, and we will help you solve the problems as quickly as possible. Visit our website: www.ceyear.com to find the contact details about the nearest technical support center.

Contact information:

Service hotline: **800-868-7041**

Technical Support: **0532-86889847 86897262**

Fax: **0532-86889056 86897258**

Website: www.ceyear.com

E-mail: ceyearqd@ceyear.com

Postal code: **266555**

Address: **No.98, Xiangjiang Road, Economic and Technological Development Zone, Qingdao City, Shandong Province**

7.4.2 Packaging and delivery

When your microwave power meter incurs a problem that is difficult to solve, please contact us by phone or fax. If it is confirmed that the microwave power meter needs to be repaired, please pack it with the original packaging material and packing box as per the following steps:

- 1) Please include a detailed explanation of the problem that you've encountered when using the microwave meter along with the apparatus in the packaging box.
- 2) Pack the microwave power meter in its original packing material to reduce possible damage.
- 3) Place the pads at the corners of outer packing box and then put the instrument into the packing box.
- 4) Seal the packing box with tapes, and reinforce it with nylon tape;
- 5) Mark “Fragile! No Touch! Handle with Care!” indicated.
- 6) Please arrange the consignment as required for the precise instrument.
- 7) Keep copies of all the shipping documents.

Note

When packaging the microwave power meter, please pay attention to the following items.

Packaging of the microwave power meter with other materials may damage it. It is forbidden to use polystyrene beads as the packaging material because they can't fully protect the instrument and may damage the instrument after being sucked into the instrument fan by the static electricity.

TIP

Packaging and transport of the instrument

The instrument should be transported or handled in strict accordance with the precautions described in section “3.1.1.1 Unpacking” in this manual.

8 Specifications and Test Methods

This chapter introduces the specifications and main test methods of the 2438 series microwave power meter.

- [Statement](#)..... 107
- [Product features](#)..... 107
- [Specifications](#)..... 108

8.1 Statement

Unless otherwise stated, the test conditions of all specifications should be as follows: temperature range: $23^{\circ}\text{C}\pm 5^{\circ}\text{C}$, time: half hour after power-on. The supplementary information about the instrument is provided to help the user know more about the instrument performance and is not within the scope of specifications. The important terms are described as follows:

Specification (spec): Unless otherwise stated, the performance of the calibrated instrument should be guaranteed after being placed at the operating temperature range of $0 \sim 50^{\circ}\text{C}$ for at least 2 h, and warmed up for 30 min; the specifications should include the measurement errors. Unless otherwise stated, all data provided herein should be regarded as specifications.

Typical value (typ): A typical value refers to the typical performance that can be achieved by 80% of instruments; it isn't an assurance data and doesn't include uncertainty in the measurement process. It is valid only at room temperature (about 25°C).

Nominal value (nom): A nominal value refers to the expected average performance or designed performance characteristic, such as 50Ω connector. It isn't an assurance data; it is measured at room temperature (about 25°C).

Measured value (meas): A measured value refers to a performance characteristic measured during design for comparison with the expected performance, e.g. the change of amplitude drift over time. It isn't an assurance data; it is measured at room temperature (about 25°C).

8.2 Product features

Table 8.1 Product Features

General Specifications	
Temperature Range	Operation: $0\sim+50^{\circ}\text{C}$ Storage: $-40\sim+70^{\circ}\text{C}$
Altitude	4,600 m
Electromagnetic Compatibility	The instrument should meet the requirements defined in 3.9.1 of GJB 3947A-2009.
Safety	The instrument should meet the safety certification requirements defined in 3.10 of GJB 3947A-2009. a) The resistance between the device power input end and the instrument enclosure (with the power button set in the ON position) should not be less than $100 \text{ M}\Omega$ under the standard atmospheric pressure for testing or $2 \text{ M}\Omega$ in a wet environment. b) When a $1,500 \text{ V AC}$ voltage is applied between the device power input end and the instrument enclosure, there should be no breakdown, flashover or flashing. c) The leakage current between the instrument enclosure and the ground should not exceed 3.5 mA during device operation.
Power	Voltage and Frequency $100 \text{ V}\sim 240 \text{ V}$, $50 \text{ Hz}\sim 60 \text{ Hz}$; 450 VA MAX

8.3 Specifications

requirement	(Nominal)	
	Power consumption	Max. operating power consumption: 50 W Max. standby power consumption: 5 W
Display screen		4.3" color LCD
Weight		Net weight: below 5 kg; Packed weight: 8 kg (nominal)
Max. overall dimension		W×H×D (mm)=220×100×350
Warranty		Standard warranty period of the 2438 microwave power meter: 18 months
Reliability		MTBF(θ_0) ≥ 5,000 h
Calibration period		The recommended calibration period is one year and the calibration service is provided by a professional calibration agency.

8.3 Specifications

The specifications are listed by function: description/feature value.

- [Main specifications of 2438CA/CB power meter](#) 108
- [Main specifications of the 2438PA/PB power meter](#) 109
- [71710 series CW power sensor](#) 110
- [81702/ 81703 series peak power sensor](#) 111
- [MMW \(THz\) power sensor](#) 112

8.3.1 Main specifications of 2438CA/CB power meter

The 2438CA/CB power meter is compatible with 71710 series CW power sensor and a 71716, 71717, 71718, 87106A, 87106B or 87108B series MMW power sensor, with the following main specifications:

1) Frequency range

9 kHz~500 GHz (sensor dependent)

2) CW power range

-70 dBm~+50 dBm (sensor dependent)

3) Maximum display resolution

“Log” mode: 0.001dB; “Lin” mode: 4 digits

4) Calibrator frequency

50MHz±1MHz

5) Calibrator power (25°C±5°C)

1.000 mW (1±1.0%)

6) Calibrator SWR (typical)

≤1.10:1

8.3.2 Main specifications of the 2438PA/PB power meter

The 2438PA/PB power meter can be connected to a 71710 series CW power sensor, a 81702 or 81703 series peak power sensor and a 71716, 71717, 71718, 87106, 87106B or 87108B series MMW power sensor, with the following main specifications:

1) Frequency range

9 kHz~500 GHz (sensor dependent)

2) CW power range

-70 dBm~+50 dBm (sensor dependent)

3) Pulse power range

-40 dBm~+20 dBm (sensor dependent)

4) Maximum display resolution

“Log” mode: 0.001dB; “Lin” mode: 4 digits

5) Rise time

≤13 ns (for frequencies >500 MHz)

6) Video bandwidth

≥30 MHz

7) Maximum pulse repetition rate

10MHz

8) Minimum pulse width

50ns

9) Timebase range

2 ns/div~3,600 s/div

10) Trigger delay

Trigger delay range: 2 ns/div~2 us/div -4 ms~100 ms

5 us/div~20 us/div -4,000 div~100 ms

50 us/div~5 ms/div -4,000 div~4,000 div

10 ms/div~3,600 s/div -40 s~100 s

8.3 Specifications**11) Internal trigger range**

-20 dBm to + 20 dBm

12) Calibrator frequency

50MHz±1MHz

13) Calibrator power(25°C±5°C)

1.000 mW (1±1.0%)

14) Calibrator SWR (typical)

≤1.10:1

8.3.3 71710 series CW power sensor**1) Frequency range**

71710A: 9kHz to 12GHz

71710D: 10MHz to 18GHz

71710E: 50MHz to 26.5GHz

71710F: 50MHz to 40GHz

71710L: 50MHz to 67GHz

2) Power range

71710A: -60 dBm to + 20 dBm

71710D: -70 dBm to + 20 dBm

71710E: -70 dBm to + 20 dBm

71710F: -70 dBm to + 20 dBm

71710L: -70 dBm to + 20 dBm

3) Maximum SWR

71710A: 1.20 100 kHz~12 GHz

71710D: 1.35 10 MHz~50 MHz

1.15 50 MHz~2 GHz

1.20 2GHz~12.4GHz

1.26 12.4GHz~18GHz

71710E: 1.15 50 MHz~2 GHz

1.20 2GHz~12.4GHz

1.26 12.4GHz~18GHz

1.35 18GHz~26.5GHz

71710F: 1.15 50MHz~2GHz

1.20 2GHz~12.4GHz

1.26 12.4GHz~18GHz

1.35 18GHz~26.5GHz

1.50 26.5GHz~40GHz

71710L:	1.15	50MHz~2GHz
	1.20	2GHz~12.4GHz
	1.26	12.4GHz~18GHz
	1.35	18GHz~26.5GHz
	1.50	26.5GHz~40GHz
	1.78	40GHz~67GHz

4) Calibration factor uncertainty (0 dBm)

71710A: $\pm 4.0\%$

71710D: $\pm 4.5\%$

71710E: $\pm 4.5\%$ 50 MHz~18 GHz
 $\pm 5.9\%$ 18 GHz~26.5 GHz

71710F: $\pm 4.5\%$ 50MHz~18GHz
 $\pm 5.9\%$ 18 GHz~26.5 GHz
 $\pm 6.9\%$ 26.5GHz~40GHz

71710L: $\pm 4.5\%$ 50MHz~18GHz
 $\pm 5.9\%$ 18 GHz~26.5 GHz
 $\pm 6.9\%$ 26.5GHz~40GHz
 $\pm 7.9\%$ 40GHz~67GHz

5) Zero set

≤ 100 pW

8.3.4 81702/81703 series peak power sensor

1) Frequency range

81702D/81703D:	50MHz to 18GHz
81702E/81703E:	500MHz to 26.5GHz
81702F/81703F:	500MHz to 40GHz
81702L/81703L:	500MHz to 67GHz

2) Pulse power range

81702D/E/F/L:	-20 dBm~+20 dBm
81703D/E/F/L:	- 40dBm~+20dBm

8.3 Specifications**3) Maximum SWR**

81702D/81703D:	1.15	50 MHz~2 GHz
	1.26	2GHz~18GHz
81702E/81703E:	1.15	500MHz~2 GHz
	1.26	2GHz~18GHz
	1.35	18GHz~26.5GHz
81702F/81703F:	1.15	500MHz~2 GHz
	1.26	2GHz~18GHz
	1.35	18GHz~26.5GHz
	1.50	26.5GHz~40GHz
81702L/81703L:	1.15	500MHz~2 GHz
	1.26	2GHz~18GHz
	1.35	18GHz~26.5GHz
	1.50	26.5GHz~40GHz
	1.78	40GHz~67GHz

4) Calibration factor uncertainty (0 dBm)

81702D/81703D:	±5.0%	
81702E/81703E:	±5.0%	500MHz~18GHz
	±6.0%	18 GHz~26.5 GHz
81702F/81703F:	±5.0%	500MHz~18GHz
	±6.0%	18 GHz~26.5 GHz
	±7.5%	26.5GHz~40GHz
81702L/81703L:	±5.0%	500MHz~18GHz
	±6.0%	18 GHz~26.5 GHz
	±7.5%	26.5GHz~40GHz
	±8.5%	40GHz~67GHz

5) Rise time (for frequencies >500 MHz, 10 dBm)

81702D/E/F/L: ≤10 ns (NOTE: Rise time ≤ 13 ns when the sensor is connected to the 2438 series microwave power meter)

81703D/E/F/L: ≤100 ns

8.3.5 MMW (THz) power sensor**1) Frequency range**

71716:	50GHz to 75GHz
71717:	75GHz to 110GHz
71718:	110GHz to 170GHz
87106A:	170GHz to 220GHz
87106B:	220GHz to 325GHz

8.4 Test of main performance characteristics

87108B: 325GHz to 500GHz

2) Power range

71716/71717/71718/87106A/87106B/87108B: -30 dBm to + 20 dBm

3) Maximum SWR

71716: 1.35

71717: 1.35

71718: 1.45

87106A: 1.5

87106B: 1.5

87108B: 1.8

8.4 Test of main performance characteristics

- [Recommended test methods](#).....113
- [Record tables of the microwave power meter performance test](#).....122
- [Auxiliary tables of the 2438 series microwave power meter performance test](#).....126
- [Recommended instruments of the performance characteristic test](#).....135

8.4.1 Recommended test methods**Attention**

1. The instrument should be tested after 2 h storage at ambient temperature, warm-up and automatic sensor calibration.
2. Only when the peak power sensor is connected can the peak measurement mode be set. The setting method is as follows: set the “A (or B) TrigMode” as “Continue Trig” below the [Trigger] menu; set the “Disp Type” as “Trace A (or B)” below the [Display] menu. The settings are not explained in detail in the test methods.
3. The MMW power sensors should be independently accepted based on their technical conditions.
4. The test methods of main specifications rather than non-main specifications are provided in this manual.

8.4.1.1 Test of specifications of the microwave power meter**8.4.1.1.1 Frequency range**

The frequency range of the 2438 series microwave power meter depends on the power sensor connected to it.

8.4.1.1.2 CW power range

The CW power range of the 2438 series microwave power meter depends on the CW power sensor connected to it. When the power meter is connected to a 71710X CW sensor, its power measurement range can be up to -70 dBm ~ +20 dBm and extended to +50 dBm when an external 100 W high power attenuator or directional coupler is connected.

8.4 Test of main performance characteristics

8.4.1.1.3 Pulse power range

The CW power range of the 2438PA/PB microwave power meter depends on the peak power sensor connected to it. When the power meter is connected to a 81703X peak power sensor, its power measurement range can be up to -40 dBm ~ +20 dBm. The specific test methods are the same as those of the power measurement range of the 81703X peak power sensor.

8.4.1.1.4 Rising time

a) Description of test items

This indicator describes the Rise time measurement capability that the 2438PA/PB microwave power meter can achieve. The test is carried out with the power meter connected to a peak power sensor. The pulse modulation function of the synthesized signal generator with a narrow pulse modulation option is used to generate a pulse modulation signal. The microwave power meter to be tested measures the rise time of the pulse modulation signal. The minimum Rise time measured at different powers can be considered as the Rise time specification of the power meter.

b) Test Block Diagram

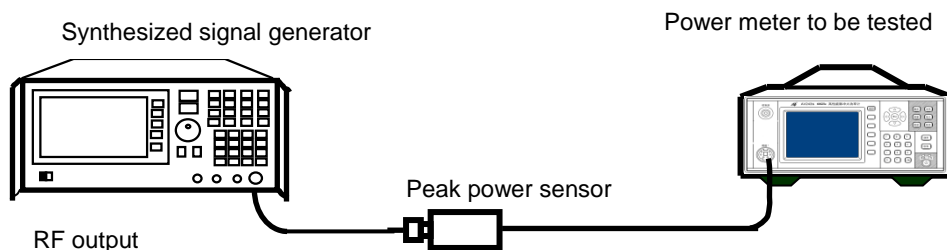

Fig. 8.1 Power Meter Rising Time Test Block Diagram

c) Test steps

- 1) Warm up the instrument for at least 30 min. After automatic calibration of the 2438PA/PB microwave power meter connected to a 81702X peak power sensor, connect the device as shown in Fig. 8.1.
- 2) First, set the synthesized signal generator at a frequency of 10 GHz in the CW dot frequency operation mode, enable the RF output and set the output power to 10 dBm. Then, perform pulse modulation for the synthesized signal generator, select the pulse modulation source as the internal modulation signal generator, and set the pulse period to 10 us and the pulse width to 5 us.
- 3) Set the microwave power meter to be tested in the peak measurement mode. Set the calibration factor frequency to 10 GHz and the X scale to 10 ns/div, select the internal trigger mode and signal's rising edge, set the trigger level to 5 dBm, and record the measured pulse Rise time T1.
- 4) Set the power output of the synthesized signal generator to 0 dBm and - 5 dBm, the trigger level of the microwave power meter to be tested to -5 dBm and -8 dBm, and record the measured pulse Rise time t2 and t3.
- 5) The actual Rise time of the microwave power meter is calculated based on the following formula:

$$t_r^2 = t_R^2 - t_s^2$$

Where: t_r - actual Rise time of the microwave power meter, in ns; t_R - Rise time reading, in ns; t_s - Rise time of the applied fast transition pulse, which is the first transition of pulse modulation of the signal generator, in ns.

- 6) t_1 , t_2 and t_3 are the minimum t_r calculated based on the above formula, i.e. Rise time of the microwave power meter.

8.4 Test of main performance characteristics

8.4.1.1.5 Video Bandwidth

This specification reflects the peak channel bandwidth capability of the microwave power meters. $f_{BW} = \frac{0.35}{t_s}$ The video bandwidth and Rise time are converted according to the formula. The video BW is indirectly measured through measurement of the Rise time. The Rise time corresponding to the 30 MHz video BW is about 11.7 ns when calculated according to the formula. When the Rise time test value is less than 11.7 ns, the video BW meets the requirement.

8.4.1.1.6 Internal trigger range

a) Description of test items

This specification reflects the capability of measurement of the pulse modulation signal in the internal trigger mode of the 2438PA/PB microwave power meter.

b) Test block diagram

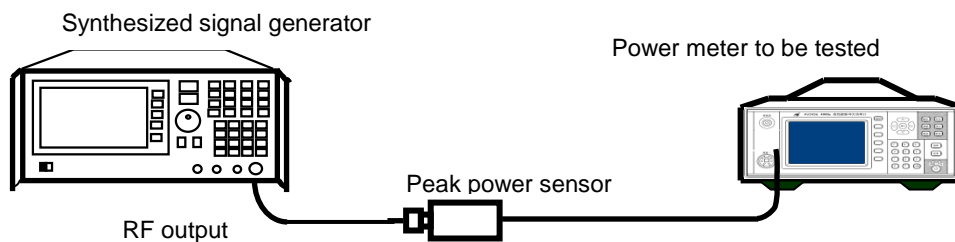

Fig. 8.2 Internal Trigger Test Block Diagram

c) Test steps

- 1) Warm up the instrument for at least 30 min. After automatic calibration of the 2438PA/PB microwave power meter connected to a 81703X peak power sensor, connect the device as shown in Fig. 8.2.
- 2) Set the synthesized signal generator as follows: set the frequency to 10 GHz, enable the pulse modulation mode, and select the internal pulse modulation mode. Set the internal pulse period to 10 us and the pulse width to 5sus.
- 3) Set the microwave power meter in peak measurement mode, the calibration factor frequency to 10 GHz and the X scale to 2 us/div. Select the internal trigger mode and signal's rising edge.
- 4) Set the signal generator output power to +20 dBm and the microwave power meter trigger level to +17 dBm. Ensure the instrument can measure and stably display the pulse waveform.
- 5) Set the signal generator output power to -20 dBm and the microwave power meter trigger level to -23 dBm. Ensure the instrument can measure and stably display the pulse waveform.

8.4.1.1.7 Calibrator frequency

a) Description of test items

In this test, a frequency meter is used to measure whether the output frequency range of the 50 MHz calibrator satisfies the specification requirements.

b) Test Block Diagram

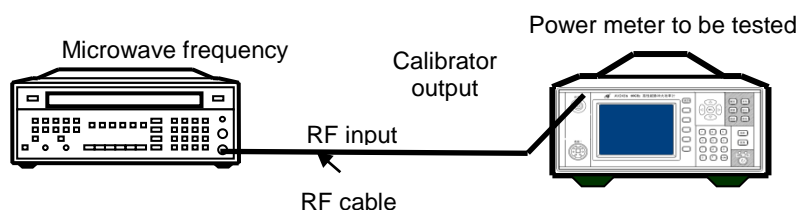

Fig. 8.3 Calibrator Frequency Accuracy Test Block Diagram

8.4 Test of main performance characteristics

c) Test steps

- 1) Connect the device as shown in Fig. 8.3. Warm up the instrument for at least 30 min.
- 2) Press **[Cal]** of the 2438 series microwave power meter to enter the calibrator menu and enable the calibrator output.
- 3) Read the measured value of the microwave frequency meter and record its frequency value which should meet the specification requirement.
- 4) Disable the calibrator output of the 2438 series microwave power meter.

8.4.1.1.8 Calibrator power

a) Description of test items

In this test, a standard power meter is used to test the instrument calibrator output power accuracy.

b) Test block diagram

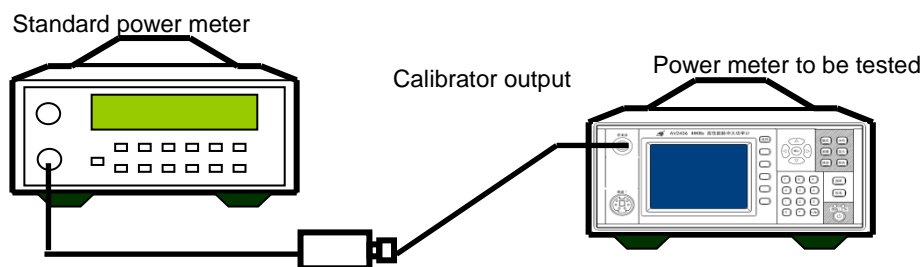

Fig. 8.4 Calibrator Power Accuracy Test Block Diagram

c) Test steps

- 1) Connect the device as shown in Fig. 8.4 and warm up the instrument for at least 30 min.
- 2) Perform automatic calibration of the standard microwave power meter. Set the calibration factor calling frequency of the standard power meter to 50 MHz. Set the display unit as "Lin" and the display resolution to 4 digits.
- 3) Press **[Cal]** of the 2438 series microwave power meter to enter the calibrator menu and enable the calibrator output.
- 4) Write down the reading of the standard power meter which should meet the specification requirement.
- 5) Disable the calibrator output of the 2438 series microwave power meter.

8.4.1.2 Test of specifications of the CW power sensor

8.4.1.2.1 Frequency range

There are five (i.e. 71710A/D/E/F/L) coaxial CW power sensors with a frequency range of 9 kHz ~ 67 GHz in which their calibration factor uncertainties should meet the requirements respectively. The specific test methods are the same as the those of "Calibration factor uncertainty of the CW power sensor".

8.4.1.2.2 Power range

a) Description of test items

In this test, a standard power meter is used to verify whether the power measurement range of the power sensor meets the specification requirement through comparison. For the power range of +20 dBm~+50 dBm, a high power attenuator or directional coupler can be used for the scalability test.

8.4 Test of main performance characteristics

b) Test block diagram

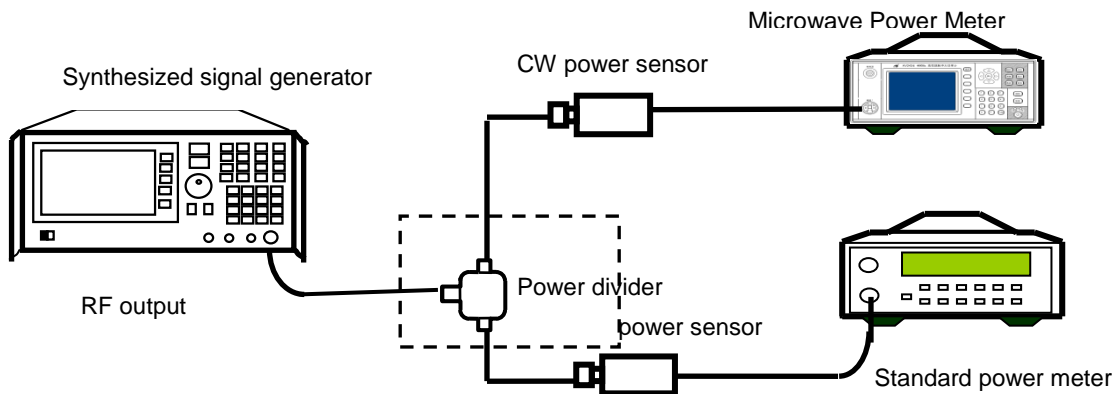

Fig. 8.5 Test of Power Range of CW Power Sensor

c) Test steps

- 1) Connect the standard power meter to a power sensor with a power measurement range of $-70 \sim +20$ dBm and the microwave power meter to be tested to a 71710X power sensor to be tested, warm up the device for at least 30 min, perform automatic calibration, connect the device as shown in Fig. 8.5.
- 2) Set the CW output frequency of the synthesized signal generator to 50 MHz, and set the power in accordance with the requirements in Table B.1 Test of Power Range of CW Power Sensor.
- 3) Use the microwave power meter to be tested and the standard power meter for testing respectively, and record the measured value P_1 of the microwave power meter to be tested and the measured value P_0 of the standard power meter. Measure the error $P_1 - P_0$, and ensure it meets the permissible error requirement in Table B.1.

NOTE: When measuring the power below -40 dBm, set "Step Detect" as "Off", perform the zeroing operation, and ensure the average count is more than 200.

8.4.1.2.3 SWR

a) Description of test items

In this test, a vector network analyzer is used to test whether the SWR of the CW power sensor meets the requirement.

b) Test block diagram

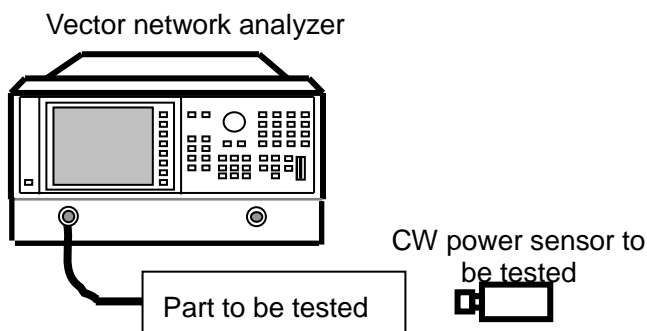

Fig. 8.6 CW Power Sensor SWR Test Block Diagram

8.4 Test of main performance characteristics

c) Test steps

- 1) Connect the test instrument as shown in Fig. 8.6. Power on and reset the instrument, and warm it up for at least 30 min.
- 2) Set the port 1 of the vector network analyzer in S11 mode. Set the corresponding frequency ranges according to different sensors.
- 3) Observe the user manual of vector network analyzer during operation, and use the corresponding calibrator for standing-wave calibration of single port of the vector network analyzer in the S11 mode in the corresponding band.
- 4) At this time, the absolute value of S11 curve displayed on the vector network analyzer is the input SWR of the CW power sensor. The test value should meet the specification requirement.

8.4.1.2.4 Calibration factor uncertainty

a) Description of test items

In this test, a standard power meter is used to verify whether the specification meets the requirement through comparison.

b) Test block diagram

As shown in Fig. 8.5.

c) Test steps

- 1) Power on the instrument, warm it up for at least 30 min, calibrate the microwave power meter connected to a 71710A CW power sensor and the standard power meter respectively, and then connect the device as shown in Fig. 8.5.
- 2) Set the synthesized signal generator in CW mode, with a power of 0 dBm and a frequency of 9 kHz, and set the frequency calibration factors of the microwave power meter and standard power meter accordingly.
- 3) Measure the signal generator output with the standard power meter, and record the measured value P0; measure it with the power meter to be tested, and record the measured value P1; calculate the deviation $\Delta P = P1 - P0$.
- 4) Repeat steps 2) and 3) according to the tested frequency points in Table B.2. Record and calculate the measured value.
- 5) Select the maximum error as the final calibration factor uncertainty of the sensor, and ensure the value meets the specification requirement.
- 6) Repeat steps 1) ~ 5) according to the tested frequency points in Tables B.3 - B.6 to test the 71710D/71710E/71710F/71710L CW power sensor.

NOTE: The logarithm and linear power errors are converted according to the following formula:

$$U = (10^{\frac{\Delta P}{10}} - 1) \times 100\%, \text{ where, } U \text{ is the linear error, and } \Delta P \text{ is the logarithm error.}$$

8.4.1.3 Test of specifications of the peak power sensor**8.4.1.3.1 Frequency range**

There are eight (including 81702X and 81703X) peak power sensors for the 2438PA/PB microwave power sensor, with a frequency range of 50 MHz ~ 67 GHz in which their calibration factor uncertainties should meet the requirements respectively. The specific test methods are the same as the those of "Calibration factor uncertainty of the peak power sensor".

8.4.1.3.2 Pulse power range

a) Description of test items

In this test, a standard power meter is used to verify whether the power measurement range of the peak power sensor meets the specification requirement through comparison.

8.4 Test of main performance characteristics

b) Test block diagram

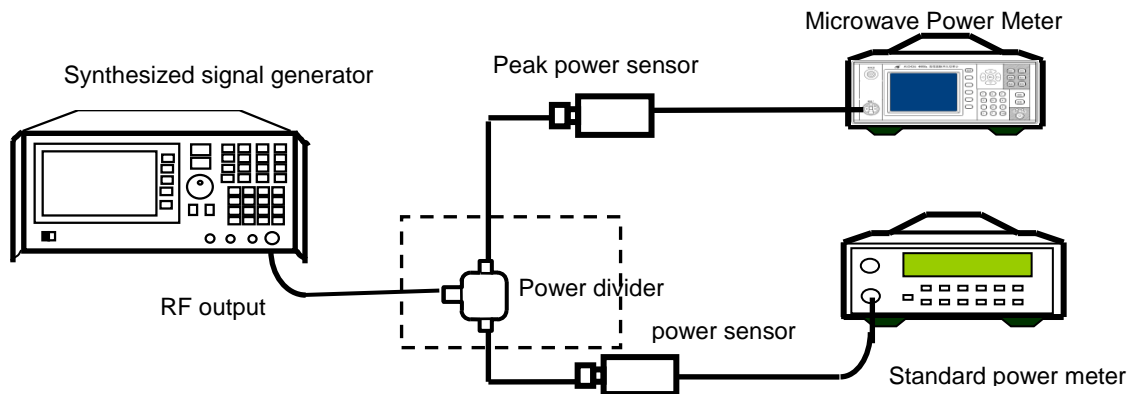

Fig. 8.7 Test of Pulse Power Range of Peak Power Sensor

c) Test steps

- 1) Power on the instrument, warm it up for at least 30 min, calibrate the microwave power meter connected to a 81702X or 81703X peak power sensor and the standard power meter respectively, and then connect the device as shown in Fig. 8.7.
- 2) Set the synthesized signal generator in CW mode, with a frequency of 1 GHz. Set the power output in sequence according to the measurement point requirements in Table B.7 or Table B.8.
- 3) Set the calibration factor frequency of the standard power meter to 1 GHz, and record the measured values P0 in sequence.
- 4) Set the synthesized signal generator in internal (or external) pulse modulation mode, with the pulse period of 100 us and pulse width of 50 us.
- 5) Set the microwave power meter in peak measurement mode, the calibration factor frequency to 1GHz and the X scale to 10 us/div. Select the internal trigger mode and signal's rising edge.
- 6) Move Mark 1 and Mark 2 of the microwave power meter to 5 μ s and 45 μ s respectively. Select the data processing mode of these two marks as "Average".
- 7) Set the power output in sequence according to the measurement point requirements in Table B.7 or Table B.8, set the trigger level value properly based on the measured power, and record the test data P1. For the 81102X series peak power sensor, perform measurement in internal trigger mode within the pulse power range of -5 dBm ~ +20 dBm or in external trigger mode within the pulse power range of -20 dBm ~ -5 dBm, and ensure the average count is more than 100. For the 81703X series peak power sensor, perform measurement in internal trigger mode within the pulse power range of -20 dBm ~ +20 dBm or in external trigger mode within the pulse power range of -40 dBm ~ -20 dBm, and ensure the average count is more than 100.
- 8) Measure the error P1-P0, and ensure it meets the permissible error requirement in the attached table.

8.4.1.3.3 Input SWR

a) Description of test items

In this test, a vector network analyzer is used to test whether the voltage standing-wave ratio of the peak power sensor meets the requirement.

8.4 Test of main performance characteristics

b) Test block diagram

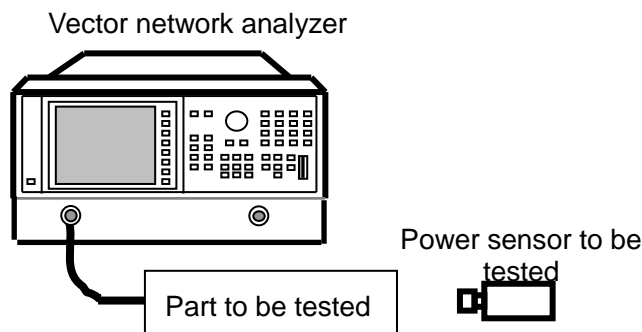

Fig. 8.8 Sensor SWR Test Block Diagram

c) Test steps

- 1) Connect the device as shown in Fig. 8.8, power on and reset the instrument, and warm it up for at least 30 min.
- 2) Set the port 1 of the vector network analyzer in S11 mode. Set the corresponding frequency ranges according to different sensors.
- 3) Observe the user manual of vector network analyzer during operation, and use the corresponding calibrator for standing-wave calibration of single port of the vector network analyzer in the S11 mode in the corresponding band.
- 4) At this time, the absolute value of S11 curve displayed on the vector network analyzer is the input SWR of the peak power sensor. The test value should meet the specification requirement.

8.4.1.3.4 Calibration factor uncertainty

a) Description of test items

In this test, a standard power meter is used to verify whether the specification meets the requirement through comparison.

b) Test block diagram

As shown in Fig. 8.7.

c) Test steps

- 1) Power on the instrument, warm it up for at least 30 min, calibrate the microwave power meter connected to a 81702D peak power sensor and the standard power meter respectively, and then connect the device as shown in Fig. 8.7.
- 2) Set the synthesized signal generator in CW mode, set the frequency at the tested frequency point in the measurement table, and set the frequency calibration factors of the microwave power meter and standard power meter accordingly.
- 3) Measure the signal generator output with the standard power meter, and record the measured value P_0 ; measure it with the power meter to be tested, and record the measured value P_1 ; calculate the deviation $\Delta P = P_1 - P_0$.
- 4) Repeat steps 2) and 3) according to the tested frequency points in Table B.9. Record and calculate the measured value.
- 5) Select the maximum error as the final calibration factor uncertainty of the sensor, and ensure the value meets the specification requirement.
- 6) Repeat steps 1) ~ 5) according to the tested frequency points in Tables B.9 - B.12 to test the 81702X or 81703X power sensor.

8.4.1.3.5 Rise time

a) Description of test items

In this test, a peak power sensor is used to test the pulse modulation signal output from the synthesized signal generator to verify whether the Rise time of the peak power sensor meets the requirement.

8.4 Test of main performance characteristics

b) Test block diagram

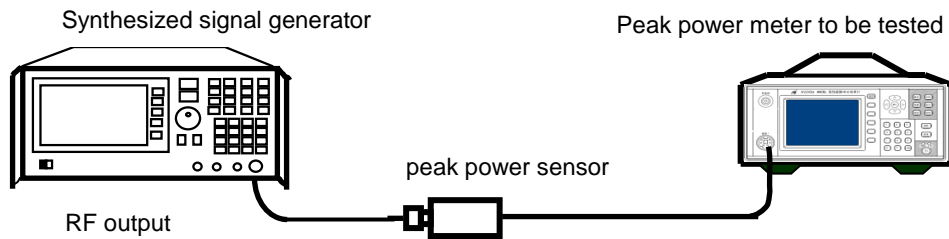

Fig. 8.9 Peak Power Sensor Rising Time Test Block Diagram

c) Test steps

- 1) Power on the instrument, warm it up for at least 30 min, calibrate the microwave power meter connected to a 8170X peak power sensor automatically, and then connect the device as shown in Fig. 8.9.
- 2) Set the synthesized signal generator at a frequency of 10 GHz and an output power of 10 dBm. Then, enable the pulse modulation function of the synthesized signal generator, and set the pulse period and pulse width to 10 us and 5us respectively.
- 3) Set the microwave power meter with a frequency calibration factor of 10 GHz and an X scale of 20 ns/div, and select the internal signal's rising edge.
- 4) Adjust the trigger level and display center position properly, and record the measured first transition t_R of the pulse automatically measured by the instrument.
- 5) The actual Rise time of the peak power sensor is calculated based on the following formula:

$$t_r^2 = t_R^2 - t_s^2$$

Where: t_r - actual Rise time of sensor, in ns;

t_R - Rise time reading, in ns;

t_s - Rise time of pulse modulation signal of signal generator, in ns.

8.4 Test of main performance characteristics

8.4.2 Performance test record of microwave power meter

2348 Series Microwave Power Meter Test Record

Instrument No.: _____ Tested by: _____

Test conditions: _____ Test date: _____

No.	Items	Unit	Standard Requirements	Test Result		
				Channel A	Channel B	
1	Appearance	/	The appearance and structure should meet the requirements in 3.3 of GJB 3947A-2009. The surface should be smooth, without burrs or obvious mechanical damage or coating damage. The structure should be complete. The control parts should be installed correctly and reliably and operated flexibly. The connectors should be connected conveniently in place.			
2	Safety	Insulation resistance	MΩ	The resistance between the device power input end and the instrument enclosure should not be less than 100 MΩ under the standard atmospheric pressure for testing.		
		Dielectric strength	/	The resistance between the device power input end and the instrument enclosure should not be less than 2 MΩ in a wet environment. It should be AC 1.5 kV/10 mA/1 min, without flashover or breakdown.		
		Leakage current	mA	Voltage: 242 V, leakage current ≤ 3.5 mA, 1 min		
3	Functional normality	/	After the microwave peak power meter is powered on and the display interface is entered, there should be no error prompt, and the keys should be operated flexibly.			
4	Main functions	/	a) Accurate measurement of absolute power of the CW signal; b) Measurement of amplitude and time domain parameters of the pulse modulation signal; c) Automatic zeroing and calibration; d) Remote control through the GPIB and LAN interfaces.			
5	Number of channels	/	1 or 2			
6	Frequency range at average power	Hz	9 k ~ 500 G			
7	Frequency range at peak power	GHz	0.05~67			
8	Peak power measurement	dBm	-40~+20			
9	CW power range	dBm	-70~+50			
10	Rise time	ns	≤13			
11	Video Bandwidth	MHz	≥30			
12	Minimum pulse width	ns	50			
13	Maximum measurable pulse repetition frequency	MHz	10			
14	Timebase range	/div	2ns~3600s			
15	Internal trigger range	dBm	-20~+20			
16	Calibrator frequency accuracy	MHz	50±1.0			
17	Calibrator power accuracy	mW	1.000 (1±1.0%)			

8.4 Test of main performance characteristics

71710 Series CW Power Sensor Test Record

No.	Items	Unit	Standard Requirements		Test Result	
1	71710A	Frequency range	Hz	9k~12G		
2		Power range	dBm	-60~+20		
3		Input SWR	/	1.20		
4		Calibration factor uncertainty	%	±4.0		
5		Zero set	pW	≤100		
6	71710D	Frequency range	Hz	10M~18G		
7		Power range	dBm	-70~+20		
8		Maximum SWR	/	10MHz to 50MHz	1.35	
				50MHz to 2GHz	1.15	
				2GHz to 12.4GHz	1.20	
				12.4GHz to 18GHz	1.26	
9		Calibration factor uncertainty	%	±4.5		
10		Zero set	pW	≤100		
11		71710E	Frequency range	Hz	50M~26.5G	
12	Power Range		dBm	-70~+20		
13	Maximum SWR		/	50MHz to 2GHz	1.15	
				2GHz to 12.4GHz	1.20	
				12.4GHz to 18GHz	1.26	
				18GHz to 26.5GHz	1.35	
14	Calibration factor uncertainty		%	10MHz to 18GHz	±4.5	
				18GHz to 26.5GHz	±5.9	
15	Zero set	pW	≤100			
16	71710F	Frequency range	Hz	50M~40G		
17		Power Range	dBm	-70~+20		
18		Maximum SWR	/	50MHz to 2GHz	1.15	
				2GHz to 12.4GHz	1.20	
				12.4GHz to 18GHz	1.26	
				18GHz to 26.5GHz	1.35	
				26.5GHz to 40GHz	1.50	
19		Calibration factor uncertainty	%	10MHz to 18GHz	±4.5	
				18GHz to 26.5GHz	±5.9	
	26.5GHz to 40GHz			±7.9		
20	Zero set	pW	≤100			
21	71710L	Frequency range	Hz	50M~67G		
22		Power Range	dBm	-70~+20		

8.4 Test of main performance characteristics

71710 Series CW Power Sensor Test Record (Continued)

No.	Items	Unit	Standard Requirements		Test Result
23	Maximum SWR	/	50MHz to 2GHz	1.15	
			2GHz to 12.4GHz	1.20	
			12.4GHz to 18GHz	1.26	
			18GHz to 26.5GHz	1.35	
			26.5GHz to 40GHz	1.50	
			40GHz to 67GHz	1.78	
24	Calibration factor uncertainty	%	10MHz to 18GHz	±4.5	
			18GHz to 26.5GHz	±5.9	
			26.5GHz to 40GHz	±6.9	
			40GHz to 67GHz	±7.9	
25	Zero set	pW	≤100		

81702/ 81703 Series Peak Power Sensor Test Record

No.	Items	Unit	Standard Requirements		Test Result	
1	81702D	Frequency range	Hz		50M~18G	
2		Pulse power range	dBm		-20~+20	
3		Maximum SWR	/	50MHz to 2GHz	1.15	
				2GHz to 18GHz	1.26	
4		Calibration factor uncertainty	%	±5.0		
5		Rise time	ns	≤10		
6	81702E	Frequency range	Hz		500M~26.5G	
7		Pulse power range	dBm		-20~+20	
8		Maximum SWR	/	50MHz to 2GHz	1.15	
				2GHz to 18GHz	1.26	
				18GHz to 26.5GHz	1.35	
9		Calibration factor uncertainty	%	50MHz to 18GHz	±5.0	
	18GHz to 26.5GHz			±6.0		
10	Rise time	ns	≤10			
11	81702F	Frequency range	Hz		500M~40G	
12		Pulse power range	dBm		-20~+20	
13		Maximum SWR	/	50MHz to 2GHz	1.15	
				2GHz to 18GHz	1.26	
	18GHz to 26.5GHz			1.35		
			26.5GHz to 40GHz	1.50		

8.4 Test of main performance characteristics

81702/ 81703 Series Peak Power Sensor Test Record (Continued 1)

No.	Items	Unit	Standard Requirements		Test Result
14	Calibration factor uncertainty	%	50MHz to 18GHz	±5.0	
			18GHz to 26.5GHz	±6.0	
			26.5GHz to 40GHz	±7.5	
15	Rise time	ns	≤10		
16	Frequency range	Hz	500M~67G		
17	Pulse power range	dBm	-20~+20		
18	Maximum SWR	/	50MHz to 2GHz	1.15	
			2GHz to 18GHz	1.26	
			18GHz to 26.5GHz	1.35	
			26.5GHz to 40GHz	1.50	
			40GHz to 67GHz	1.78	
19	Calibration factor uncertainty	%	50MHz to 18GHz	±5.0	
			18GHz to 26.5GHz	±6.0	
			26.5GHz to 40GHz	±7.5	
			40GHz to 67GHz	±8.5	
20	Rise time	ns	≤10		
21	Frequency range	Hz	50M~18G		
22	Pulse power range	dBm	-40~+20		
23	Maximum SWR	/	50MHz to 2GHz	1.15	
			2GHz to 18GHz	1.26	
24	Calibration factor uncertainty	%	±5.0		
25	Rise time	ns	≤100		
26	Frequency range	Hz	500M~26.5G		
27	Pulse power range	dBm	-40~+20		
28	Maximum SWR	/	50MHz to 2GHz	1.15	
			2GHz to 18GHz	1.26	
			18GHz to 26.5GHz	1.35	
29	Calibration factor uncertainty	%	50MHz to 18GHz	±5.0	
			18GHz to 26.5GHz	±6.0	
30	Rise time	ns	≤100		
31	Frequency range	Hz	500M~40G		
32	Pulse power range	dBm	-40~+20		
33	Maximum SWR	/	50MHz to 2GHz	1.15	
			2GHz to 18GHz	1.26	
			18GHz to 26.5GHz	1.35	
			26.5GHz to 40GHz	1.50	

8.4 Test of main performance characteristics

81702/ 81703 Series Peak Power Sensor Test Record (Continued 2)

No.	Items	Unit	Standard Requirements		Test Result
34	Calibration factor uncertainty	%	50MHz to 18GHz	±5.0	
			18GHz to 26.5GHz	±6.0	
			26.5GHz to 40GHz	±7.5	
35	Rise time	ns	≤100		
36	Frequency range	Hz	500M~67G		
37	Pulse power range	dBm	-40~+20		
38	Maximum SWR	/	50MHz to 2GHz	1.15	
			2GHz to 18GHz	1.26	
			18GHz to 26.5GHz	1.35	
			26.5GHz to 40GHz	1.50	
			40GHz to 67GHz	1.78	
39	Calibration factor uncertainty	%	50MHz to 18GHz	±5.0	
			18GHz to 26.5GHz	±6.0	
			26.5GHz to 40GHz	±7.5	
			40GHz to 67GHz	±8.5	
40	Rise time	ns	≤100		

8.4.3 Auxiliary tables of the microwave power meter performance test

Auxiliary Tables of the 2438 Series Microwave Power Meter Performance Test

Instrument No.: _____ Tested by: _____

Test conditions: _____ Test date: _____

Table B.1 CW Sensor Power Range Measurement Record

Power Point (dBm)	Measured Value P0 (dBm) of Standard Power Meter	Measured Value P1 (dBm) of Power Meter to be Tested	Error Value Δ P (dB)	Permissible Error Value (dB)
+20				±0.25
0				±0.25
-20				±0.25
-40				±0.47
-70				±1.98

8.4 Test of main performance characteristics

Table B.2 71710A CW Sensor Power Calibration Factor Uncertainty Measurement Record

	Tested Frequency Point	Permissible Error Value (dB)	Measured Value P0 (dBm) of Standard Power Meter	Measured Value P1 (dBm) of Power Meter to be Tested	Permissible Error Value ΔP (dB)
CW power sensor 71710A	9kHz	± 0.17			
	1MHz	± 0.17			
	100MHz	± 0.17			
	1GHz	± 0.17			
	2GHz	± 0.17			
	4GHz	± 0.17			
	6GHz	± 0.17			
	8GHz	± 0.17			
	10GHz	± 0.17			
12GHz	± 0.17				
NOTE: $\pm 4.0\%$ can be converted to ± 0.17 dB in "Log" mode.					

Table B.3 71710D CW Sensor Power Calibration Factor Uncertainty Measurement Record

	Tested Frequency Point	Permissible Error Value (dB)	Measured Value P0 (dBm) of Standard Power Meter	Measured Value P1 (dBm) of Power Meter to be Tested	Permissible Error Value ΔP (dB)
CW power sensor 71710D	10MHz	± 0.19			
	500MHz	± 0.19			
	1GHz	± 0.19			
	2GHz	± 0.19			
	4GHz	± 0.19			
	6GHz	± 0.19			
	8GHz	± 0.19			
	10GHz	± 0.19			
	12GHz	± 0.19			
	14GHz	± 0.19			
	16GHz	± 0.19			
18GHz	± 0.19				
NOTE: $\pm 4.5\%$ can be converted to ± 0.19 dB in "Log" mode.					

8.4 Test of main performance characteristics

Table B.4 71710E CW Sensor Power Calibration Factor Uncertainty Measurement Record

	Tested Frequency Point	Permissible Error Value (dB)	Measured Value P0 (dBm) of Standard Power Meter	Measured Value P1 (dBm) of Power Meter to be Tested	Permissible Error Value Δ P (dB)
CW power sensor 71710E	50MHz	±0.19			
	500MHz	±0.19			
	1GHz	±0.19			
	2GHz	±0.19			
	4GHz	±0.19			
	6GHz	±0.19			
	8GHz	±0.19			
	10GHz	±0.19			
	12GHz	±0.19			
	14GHz	±0.19			
	16GHz	±0.19			
	18GHz	±0.19			
	20GHz	±0.25			
	22GHz	±0.25			
	24GHz	±0.25			
26.5GHz	±0.25				

NOTE: ±4.5% and ±5.9% can be converted to ±0.19 dB and ±0.25 dB in “Log” mode respectively.

Table B.5 71710F CW Sensor Power Calibration Factor Uncertainty Measurement Record

	Tested Frequency Point	Permissible Error Value (dB)	Measured Value P0 (dBm) of Standard Power Meter	Measured Value P1 (dBm) of Power Meter to be Tested	Permissible Error Value Δ P (dB)
CW power sensor 71710F	50MHz	±0.19			
	500MHz	±0.19			
	1GHz	±0.19			
	2GHz	±0.19			
	4GHz	±0.19			
	6GHz	±0.19			
	8GHz	±0.19			
	10GHz	±0.19			
	12GHz	±0.19			
14GHz	±0.19				

8.4 Test of main performance characteristics

Table B.5 71710F CW Sensor Power Calibration Factor Uncertainty Measurement Record
(Continued)

	Tested Frequency Point	Permissible Error Value (dB)	Measured Value P0 (dBm) of Standard Power Meter	Measured Value P1 (dBm) of Power Meter to be Tested	Permissible Error Value ΔP (dB)
CW power sensor 71710F	14GHz	± 0.19			
	16GHz	± 0.19			
	18GHz	± 0.19			
	20GHz	± 0.25			
	22GHz	± 0.25			
	24GHz	± 0.25			
	26GHz	± 0.25			
	28GHz	± 0.29			
	30GHz	± 0.29			
	32GHz	± 0.29			
	34GHz	± 0.29			
	36GHz	± 0.29			
	38GHz	± 0.29			
	40GHz	± 0.29			

NOTE: $\pm 4.5\%$, $\pm 5.9\%$ and $\pm 6.9\%$ can be converted to ± 0.19 dB, ± 0.25 dB and ± 0.29 dB respectively in "Log" mode.

Table B.6 71710L CW Sensor Power Calibration Factor Uncertainty Measurement Record

	Tested Frequency Point	Permissible Error Value (dB)	Measured Value P0 (dBm) of Standard Power Meter	Measured Value P1 (dBm) of Power Meter to be Tested	Permissible Error Value ΔP (dB)
CW power sensor 71710L	50MHz	± 0.19			
	500MHz	± 0.19			
	1GHz	± 0.19			
	2GHz	± 0.19			
	4GHz	± 0.19			
	6GHz	± 0.19			
	8GHz	± 0.19			
	10GHz	± 0.19			
	12GHz	± 0.19			
	14GHz	± 0.19			
	16GHz	± 0.19			
	18GHz	± 0.19			
	20GHz	± 0.25			

8.4 Test of main performance characteristics

Table B.6 71710L CW Sensor Power Calibration Factor Uncertainty Measurement Record (Continued)

	Tested Frequency Point	Permissible Error Value (dB)	Measured Value P0 (dBm) of Standard Power Meter	Measured Value P1 (dBm) of Power Meter to be Tested	Permissible Error Value Δ P (dB)
CW power sensor 71710L	22GHz	±0.25			
	24GHz	±0.25			
	26GHz	±0.25			
	28GHz	±0.29			
	30GHz	±0.29			
	32GHz	±0.29			
	34GHz	±0.29			
	36GHz	±0.29			
	38GHz	±0.29			
	40GHz	±0.29			
	42GHz	±0.33			
	44GHz	±0.33			
	46GHz	±0.33			
	48GHz	±0.33			
	50GHz	±0.33			
	52GHz	±0.33			
	54GHz	±0.33			
	56GHz	±0.33			
	58GHz	±0.33			
	60GHz	±0.33			
62GHz	±0.33				
64GHz	±0.33				
67GHz	±0.33				

NOTE: ±4.5%, ±5.9%, ±6.9% and ±7.9% can be converted to ±0.19 dB, ±0.25 dB, ±0.29 dB and ±0.33dB respectively in “Log” mode.

8.4 Test of main performance characteristics

Table B.7 81702X Peak Power Sensor Pulse Power Range Measurement Record

Power Point (dBm)	Measured Value P0 (dBm) of Standard Power Meter	Measured Value P1 (dBm) of Power Meter to be Tested	Error Value ΔP (dB)	Permissible Error Value (dB)
+20				± 0.29
+10				± 0.29
0				± 0.29
-10				± 0.57
-20				± 1.00

NOTE: The power difference caused by the signal generator pulse modulation should be subtracted from the error.

Table B.8 81703X Peak Power Sensor Pulse Power Range Measurement Record

Power Point (dBm)	Measured Value P0 (dBm) of Standard Power Meter	Measured Value P1 (dBm) of Power Meter to be Tested	Error Value ΔP (dB)	Permissible Error Value (dB)
+20				± 0.29
+10				± 0.29
0				± 0.29
-20				± 0.57
-40				± 1.98

NOTE: The power difference caused by the signal generator pulse modulation should be subtracted from the error.

Table B.9 81702D/81703D Peak Power Sensor Power Calibration Factor Uncertainty Measurement Record

	Tested Frequency Point	Permissible Error Value (dB)	Measured Value P0 (dBm) of Standard Power Meter	Measured Value P1 (dBm) of Power Meter to be Tested	Permissible Error Value ΔP (dB)
Peak power sensor 81702D 81703D	50MHz	± 0.21			
	500MHz	± 0.21			
	1GHz	± 0.21			
	2GHz	± 0.21			
	4GHz	± 0.21			
	6GHz	± 0.21			
	8GHz	± 0.21			
	10GHz	± 0.21			
	12GHz	± 0.21			
	14GHz	± 0.21			
	16GHz	± 0.21			
18GHz	± 0.21				

NOTE: $\pm 5.0\%$ can be converted to ± 0.21 dB in "Log" mode.

8.4 Test of main performance characteristics

Table B.10 81702E/81703E Peak Power Sensor Power Calibration Factor Uncertainty Measurement Record

	Tested Frequency Point	Permissible Error Value (dB)	Measured Value P0 (dBm) of Standard Power Meter	Measured Value P1 (dBm) of Power Meter to be Tested	Permissible Error Value ΔP (dB)
Peak power sensor 81702E 81703E	500MHz	± 0.21			
	1GHz	± 0.21			
	2GHz	± 0.21			
	4GHz	± 0.21			
	6GHz	± 0.21			
	8GHz	± 0.21			
	10GHz	± 0.21			
	12GHz	± 0.21			
	14GHz	± 0.21			
	16GHz	± 0.21			
	18GHz	± 0.21			
	20GHz	± 0.25			
	22GHz	± 0.25			
	24GHz	± 0.25			
26.5GHz	± 0.25				

NOTE: $\pm 5.0\%$ and $\pm 6.0\%$ can be converted to ± 0.21 dB and ± 0.25 dB in "Log" mode respectively.

Table B.11 81702F/81703F Peak Power Sensor Power Calibration Factor Uncertainty Measurement Record

	Tested Frequency Point	Permissible Error Value (dB)	Measured Value P0 (dBm) of Standard Power Meter	Measured Value P1 (dBm) of Power Meter to be Tested	Permissible Error Value ΔP (dB)
Peak power sensor 81702F 81703F	500MHz	± 0.21			
	1GHz	± 0.21			
	2GHz	± 0.21			
	4GHz	± 0.21			
	6GHz	± 0.21			
	8GHz	± 0.21			
	10GHz	± 0.21			
	12GHz	± 0.21			
	14GHz	± 0.21			
	16GHz	± 0.21			
	18GHz	± 0.21			
	20GHz	± 0.25			

8.4 Test of main performance characteristics

Table B.11 81702F/81703F Peak Power Sensor Power Calibration Factor Uncertainty Measurement Record (Continued)

	Tested Frequency Point	Permissible Error Value (dB)	Measured Value P0 (dBm) of Standard Power Meter	Measured Value P1 (dBm) of Power Meter to be Tested	Permissible Error Value ΔP (dB)
Peak power sensor 81702F 81703F	22GHz	± 0.25			
	24GHz	± 0.25			
	26GHz	± 0.25			
	28GHz	± 0.31			
	30GHz	± 0.31			
	32GHz	± 0.31			
	34GHz	± 0.31			
	36GHz	± 0.31			
	38GHz	± 0.31			
	40GHz	± 0.31			

NOTE: $\pm 5.0\%$, $\pm 6.0\%$ and $\pm 7.5\%$ can be converted to ± 0.21 dB, ± 0.25 dB and ± 0.31 dB respectively in "Log" mode.

Table B.12 81702L/81703L Peak Power Sensor Power Calibration Factor Uncertainty Measurement Record

	Tested Frequency Point	Permissible Error Value (dB)	Measured Value P0 (dBm) of Standard Power Meter	Measured Value P1 (dBm) of Power Meter to be Tested	Permissible Error Value ΔP (dB)
Peak power sensor 81702L 81703L	500MHz	± 0.21			
	1GHz	± 0.21			
	2GHz	± 0.21			
	4GHz	± 0.21			
	6GHz	± 0.21			
	8GHz	± 0.21			
	10GHz	± 0.21			
	12GHz	± 0.21			
	14GHz	± 0.21			
	16GHz	± 0.21			
	18GHz	± 0.21			
	20GHz	± 0.25			
	22GHz	± 0.25			
	24GHz	± 0.25			
	26GHz	± 0.25			
	28GHz	± 0.31			
	30GHz	± 0.31			

8.4 Test of main performance characteristics

Table B.12 81702L/81703L Peak Power Sensor Power Calibration Factor Uncertainty Measurement Record (Continued)

	Tested Frequency Point	Permissible Error Value (dB)	Measured Value P0 (dBm) of Standard Power Meter	Measured Value P1 (dBm) of Power Meter to be Tested	Permissible Error Value ΔP (dB)
Peak power sensor 81702L 81703L	32GHz	± 0.31			
	34GHz	± 0.31			
	36GHz	± 0.31			
	38GHz	± 0.31			
	40GHz	± 0.31			
	42GHz	± 0.35			
	44GHz	± 0.35			
	46GHz	± 0.35			
	48GHz	± 0.35			
	50GHz	± 0.35			
	52GHz	± 0.35			
	54GHz	± 0.35			
	56GHz	± 0.35			
	58GHz	± 0.35			
	60GHz	± 0.35			
	62GHz	± 0.35			
64GHz	± 0.35				
67GHz	± 0.35				

NOTE: $\pm 5.0\%$, $\pm 6.0\%$, $\pm 7.5\%$ and $\pm 8.5\%$ can be converted to ± 0.21 dB, ± 0.25 dB, ± 0.31 dB and ± 0.35 dB respectively in "Log" mode.

8.4 Test of main performance characteristics

8.4.4 Recommended instruments of the performance characteristic test

Table B.13 Recommended Instruments of the Performance Characteristic Test

No.	Instrument name	Main technical indicators	Recommended model
1	Frequency meter	Frequency range: 0.01 ~ 20 GHz Frequency resolution: 1 Hz	HP53150A
2	Power meter	Frequency range: 0.01 ~ 67GHz Power range: -70 ~ +20 dBm	N1913A
3	power sensor	Frequency range: 0.01 ~ 50 GHz/67 GHz Power range: -30 ~ +20 dBm	N8487A/N8488A
4	power sensor	Frequency range: 0.01 ~ 18GHz Power range: -70 ~ +20 dBm	E4412A E9300A
5	Microwave synthesized signal generator	Frequency range: 250kHz~67GHz With the fast narrow pulse modulation and high power options	Keysight E8257D
6	Low-frequency synthesized signal generator	Frequency range: 9kHz~6GHz	Keysight N5171B
7	Pulse signal generator	Frequency range: 1mHz~80MHz First transition: <3 ns	Keysight 81104A
8	Integrated vector network analyzer	Frequency range: 100 kHz ~ 67 GHz	3672E
9	Power divider	Frequency range: DC~40GHz	HP11667C

NOTE: Any test device with the same performance characteristics can be used as a substitute.