



MATRIX TECHNOLOGY INC.

**Triple channel programmable DC
power supply**

User Manual

Model: MPS-3063S, MPS-6033S
MPS-3033X, MPS-3063X, MPS-6033X
MPS-3033XP, MPS-3063XP, MPS-6033XP

Version NO.: V1.1



Chapter 1

Inspection and installation	1
1.1 Pack in list	1
1.2 Install power supply	2
1.3 Adjust the handle	3
1.4 Install power cord.....	4

Chapter 2

Quick start	5
2.1 Brief introduction	5
2.2 Front panel introduction.....	6
2.3 Keyboard introduction	7
2.4 VFD indicator light function description	8
2.5 Rear panel introduction.....	8
2.6 Power on self test.....	9
2.7 Output check.....	11

Chapter 3

Fuction and features	10
3.1 Front panel operation introduction.....	10
3.2 Switch local/remote operations.....	11
3.3 Channel switching operation	12
3.4 OUT ON/OFF output setting	13
3.5 Timer operation.....	15
3.6 Voltage setting operation.....	15
3.7 Current setting operation.....	15
3.8 Data save/recall setting.....	16
3.9 Over voltage operation.....	16
3.10 Key board lock function.....	16
3.11 Over heat protection function.....	16
3.12 Menu function.....	17
3.13 Rear panel terminal function.....	23

Chapter 4

Technical specification.....	24
4.1 Main technical specification	24
4.2 Supplementary features.....	27

Chapter 5

Communication between power supply and computer.....	28
5.1 RS-232 interface.....	28
5.2 USB interface	29
appendix	29
FAQ	29

Chapter 1 Inspection and installation

Before installation or operation, please read the safety signs and instructions in this manual.

1.1 Packing List

Open the package and check the contents of the box before operating the instrument. If there are any discrepancies, missing or appearance wear, etc., Please contact the seller as soon as possible.

Accessory name	Quantity	Remark
Three-channel programmable power supply	1pc	MPS-3033S, MPS-3063S, MPS-6033S MPS-3033X, MPS-3063X, MPS-6033X MPS-3033XP, MPS-3063XP, MPS-6033XP
Power cable	1pc	Users can choose the power cord according to power socket specifications in different region
Communication line	1pc	RS232/USB communication line
User manual	1pc	
Warranty card	1pc	

After confirming that the packaging contents are consistent and there is no problem, please keep the packaging box and related contents properly. The instrument must meet the packaging requirements when returning the instrument for service.

1.2 Install the power supply

The instrument needs to be installed in a space with good ventilation and reasonable size. Please introduce according to the following power supply size. Choose a suitable space for installation.

Three-channel programmable power supply size: 215mm(W)*90mm(H)*355mm(D) / 215mm(W)*90mm(H)*452mm(D)(MPS-3033XP/MPS-3063XP/MPS-6033XP)

(W: width; H: height; D: depth)

Please refer to the following dimension drawing for details:

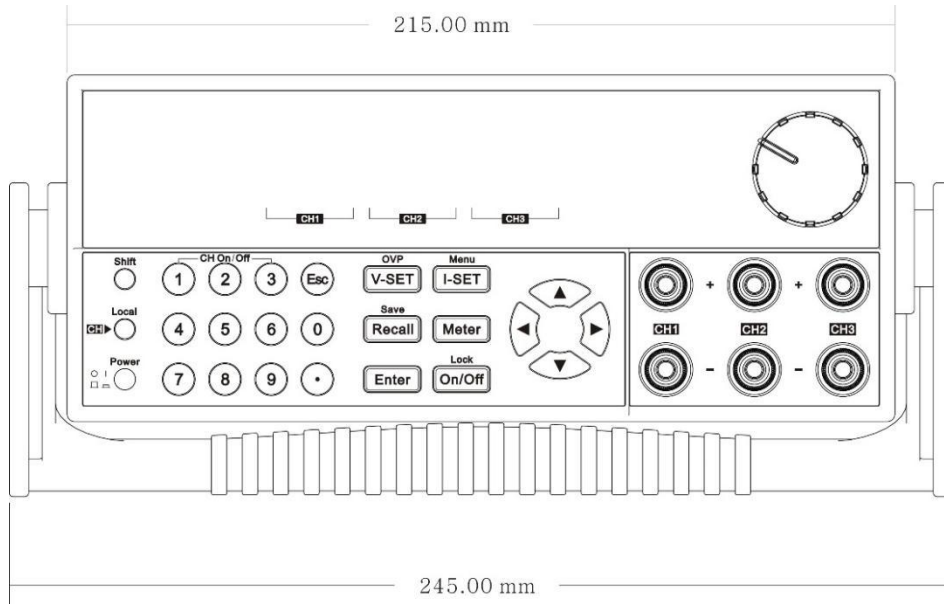

Front view

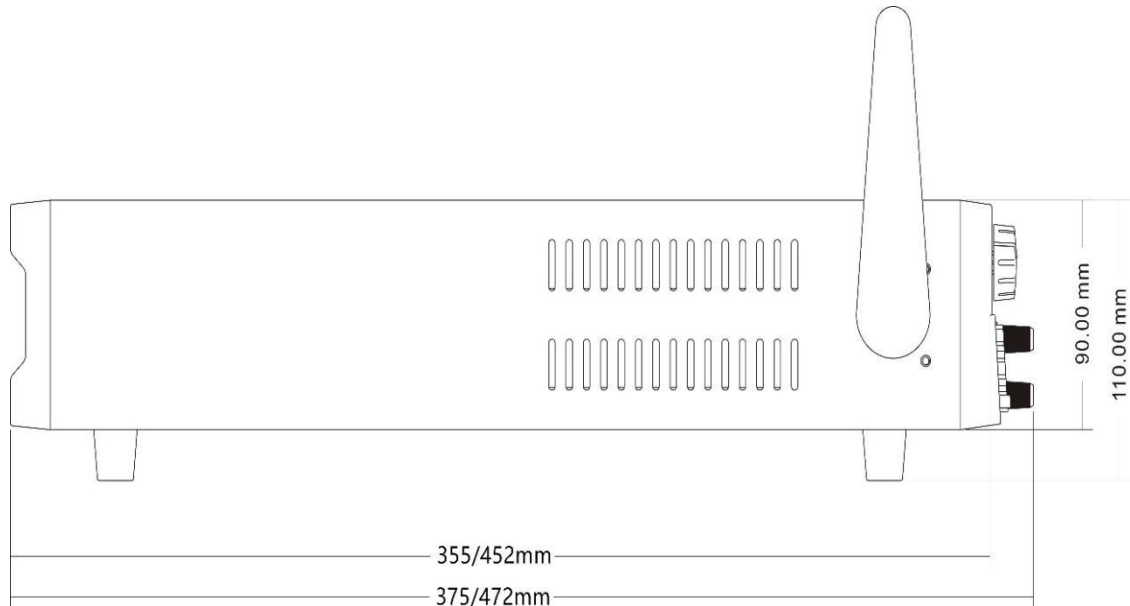

Side view

1.3 Adjust the power handle

Adjust the position of the power supply, grasp the handle with both hands, pull it to the left and right sides, and then turn the handle to the desired position.

There are three options for the placement of the power supply:

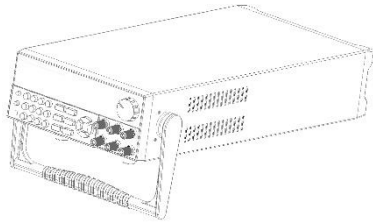
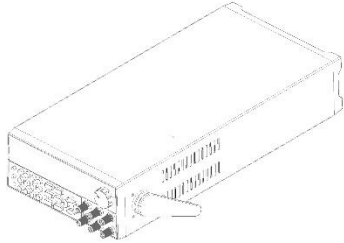
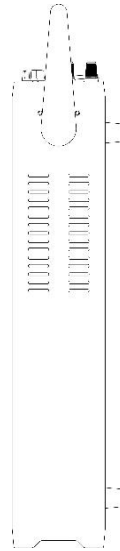

Table placement



Hand position

Tips

Do not use excessive force when loading and unloading the power supply handle, and be careful to pinch your hands.

1.4 Install the power cord

Standard power cord connector fitting, to ensure that the power supply has been normally powered, and grounded.

Power input requirements

The working voltage of the three-channel power supply has two modes: 110V and 220V. Please pay attention to the input voltage of the power supply. There is a power cord that matches your local area in accessories. If you find a mismatch, please contact the company's authorized dealer or after-sales service immediately.

AC power input level (**can be selected by the switch at the bottom of the power supply**)

- Option Opt.1: 220VAC $\pm 10\%$ 47Hz-63Hz
- Option Opt.2: 110VAC $\pm 10\%$ 47Hz-63Hz

Type of power cord

The power cord model provided by the power supply is shown in the figure below. Please select the power cord model suitable for the voltage in your area from the power cord specification table below. If you make a mistake when buying, please contact the dealer or directly to the manufacturer to exchange.

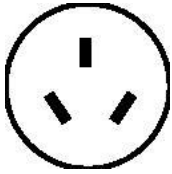

CN PLUG

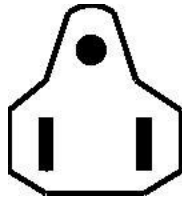

US/CANADA PLUG

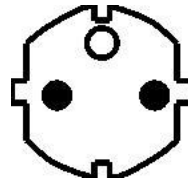

EU PLUG

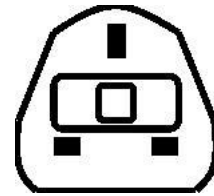

UK PLUG

Chapter 2 Quick Start

This chapter briefly introduces the front panel, rear panel, keyboard key functions and VFD display functions of the three-channel power supply to ensure that you can quickly understand the appearance, structure and key functions of the power supply before operating the power supply, and help you make better use of this series power supply

2.1 Introduction

Three-channel programmable DC power supply, each output voltage and output current can be set from 0 to the maximum rated output value. The three-channel power supply has high resolution, high precision and high stability, and has the functions of over-voltage and overheat protection. In addition, series and parallel operation modes are provided to increase the output capacity of voltage or current. With a resolution of up to 1mV/1mA, it can meet various application requirements. It is an excellent choice for R&D departments, manufacturers, and teaching and research units. The main special functions and advantages are as follows:

- Optional serial, parallel or synchronous
- Three channels can display voltage and current values at the same time
- 1/2 2U ultra small size
- Vacuum fluorescent display (VFD)
- Panel function keys LED display
- Remote measurement function to compensate for line voltage drop
- High resolution and accuracy and high stability
- Output can be controlled independently
- Over-voltage, overheat protection
- Intelligent temperature control fan to reduce noise
- Standard USB/RS232 communication interface
- Low ripple and noise
- Keep memory function when power off
- Software monitoring through computer
- Can save 40 sets of setting data, quickly store and recall
- The knob can be used to adjust the voltage and current
- Timing output time (0.1~99999.9 seconds)

Three-channel power supply series selection table:

Model	CH1		CH2		CH3	
	Voltage	Current	Voltage	Current	Voltage	Current
MPS-3033S	30V	3A	30V	3A	6V	3A
MPS-3063S	30V	6A	30V	6A	6V	3A
MPS-6033S	60V	3A	60V	3A	6V	3A
MPS-3033X	30V	3A	30V	3A	6V	3A
MPS-3063X	30V	6A	30V	6A	6V	3A
MPS-6033X	60V	3A	60V	3A	6V	3A
MPS-3033XP	30V	3A	30V	3A	30V	3A
MPS-3063XP	30V	6A	30V	6A	30V	6A
MPS-6033XP	60V	3A	60V	3A	60V	3A

2.2 Introduction to the front panel

Front panel layout.

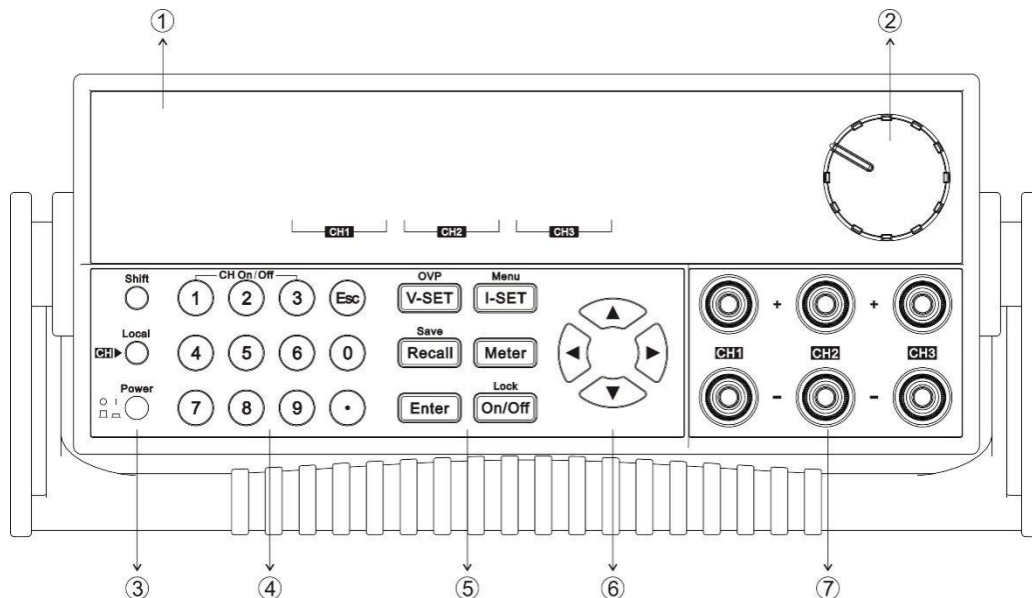

1. VFD display
2. Knob
3. Power switch, Local key and Shift key

4. Number keys and Esc exit key
5. Function keys
6. Move the buttons up, down, left, and right
7. Output terminal

2.3 Introduction to keyboard keys

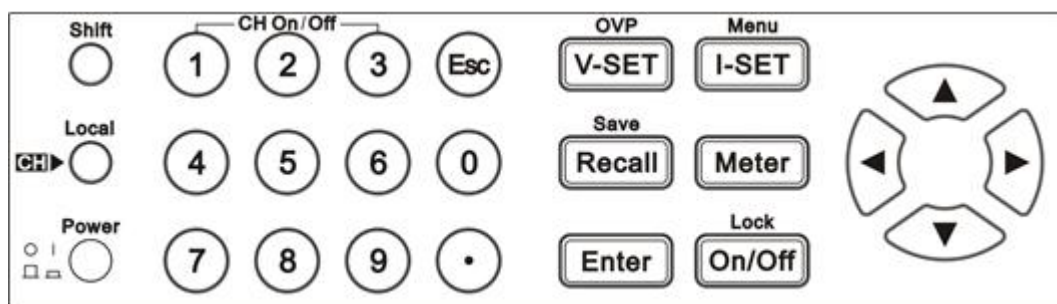

The key description is as follows:

Key	Name and function
0~9	Number keys (1 to 3 are single output switching key, must comply with "Shift" Key to use, except LOCK state).
Esc	Return key
Shift	Compound function key
Local	Local key, switch back to local operation / channel switching key.
Power	Switch button.
V-set/OVP	Set the power supply output voltage value / OVP setting.
I-set/Menu	Set the power protection current value / enter the menu setting.
Recall/Save	Retrieve the power setting value from the designated memory location/store the current power setting value to the designated memory location.
Meter	Switch between measurement and setting status.
Enter	Enter
On/Off, Lock	Control power output status / keyboard lock
◀ ▶	Move left and right keys to move the cursor or select menu items in the menu.

▲▼	The up and down movement keys are used to increase or decrease the set value and change the current parameter.
●(Shift)+1, ●(Shift) +2, ●(Shift) +3	In any state (menu setting or METER state), press this key to immediately turn on/off the corresponding channel output.

2.4 VFD indicator function description

When the power is turned on, if the power appears in any of the signs, the relevant signs will be displayed at the bottom left of the screen.

The function description of the VFD indicator is as follows:

Character	Function description
C	Constant current operation mode
V	Constant voltage operation mode
🔒	Keyboard operation is locked
⏏	Remote operation mode
↑	Shift key down
▶	Channel selection marker
T	Synchronous operation mode

2.5 Introduction to the rear panel

Power supply, rear panel layout.

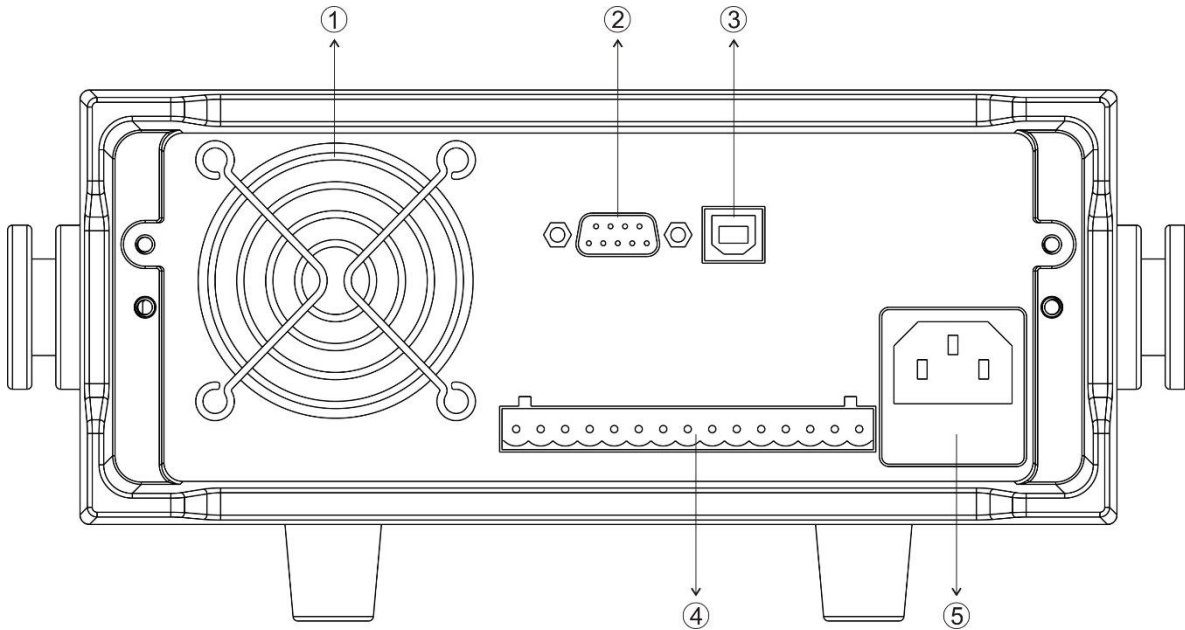

1. Heat dissipation window
2. RS232 communication interface
3. USB communication interface
4. Remote measurement terminal
5. AC power input socket and fuse

Tips

The 110V/220V power switch is at the bottom of the instrument. Please check the position of the switch before plugging in the power source to avoid burning the instrument.

2.6 Power-on self-test

A successful self-inspection process indicates that the power product purchased by the user meets the factory standards and can be used by the user. Before operating the power supply, make sure you have understood the safety instructions.

WARNING

- Please make sure that the power supply voltage is consistent with the power supply voltage before turning on the power, otherwise the power supply will be burned out.
- Be sure to connect the main power plug to a power outlet with a protective ground, and do not use a wiring board without a protective ground. Before operating the power supply, you should first make sure that the power supply is well grounded.
- Please pay attention to the positive and negative signs before wiring the power supply, otherwise the power supply will be burned out.

Self-check steps

The power supply normal self-check process is as follows:

1. Connect the power cord correctly, press the power switch to turn on the power. The power supply performs a self-test.
2. After the power supply self-check is completed, the VFD display shows the following output voltage and current status as follows.

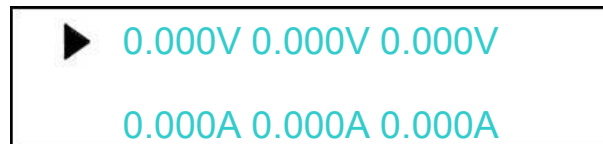

Error message reference

The following error message may appear when an error occurs during the power supply self-test:

- If the EEPROM is damaged, it will prompt "EEPROM Fail".
- If the last saved data in EEPROM is lost, it will prompt "System Lost".
- If the transmit channel data, channel response fails, you are prompted to "Model Fail".
- If the calibration data reading fails, it will prompt "Cal Lost".
- If the factory calibration data is lost, it will prompt "Fact Lost".
- If the channel sending data is lost and the channel initialization fails, it will prompt "Model Lost".

Exception handling

When the power is turned on, the power cannot be started normally, please refer to the following steps to check and deal with it.

1. Check whether the power cord is connected correctly and confirm that the power supply is in a powered state.
 - Good power cord connection => 2
 - Power connection error => Please reconnect the power cord to check whether the abnormality is cleared.
2. Whether the power is on. Press the power switch key to switch on the power.
 - Yes => 3
 - No => Please press the voltage switch to turn on the power and check whether the abnormality is cleared.
3. Check whether the fuse of the power supply is burned out.
 - If the fuse is burned out, replace the fuse. Specific steps are as follows:
 - 1) Unplug the power cord and use a small screwdriver to take out the fuse box. (See the introduction on the rear panel for the location of the fuse)



Fuse specification list:

Model	Fuse specification (220V)	Fuse specification (110V)
MPS-3033S/MPS-3033X	5A	8A
MPS-6033S/MPS-6033X	6.3A	10A
MPS-3063S/MPS-3063X	6.3A	10A
MPS-3033XP	5A	8A
MPS-3063XP/MPS-6033XP	8A	15A

2) Replace the fuse with same specification, put it in the box, and re-install it.

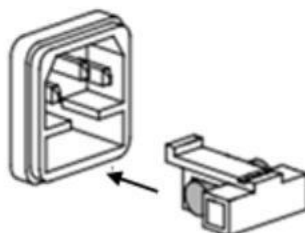

2.7 Output check

The output check can ensure that the power supply reaches its rated output and can perform front panel operations correctly.

Output voltage check

Verify the basic voltage function of the power supply without load.

1. Turn on the power supply.
2. Set the power supply current value ($\geq 0.1A$).
3. Turn on the power output.
Press the ON/OFF function button, and the CV status mark on the VFD display lights up.
4. Set the power supply voltage.
Set different power supply voltages and wait for the power supply to be in METER mode, check whether the voltage value displayed on the VFD is close to the set voltage value, and whether the current value displayed on the VFD is close to 0A.

5. Ensure that the power supply voltage can be adjusted from 0V to the maximum output voltage.
 6. Test the voltage of the other two channels in turn.
- End



Tips

SET mode refers to the setting mode, VFD displays the set value; METER mode refers to the meter measurement mode, and the VFD displays the actual measurement value. It can be switched by pressing the **Meter** button on the panel. When the **Meter** light is off, the power supply is in SET mode, otherwise, the power supply is in METER mode.

Output current check

Verify the basic current function of the power supply when the output is short-circuited.

1. Turn on the power supply.
 2. Turn off the power output, make sure that the power is OFF, and the OFF status sign is displayed on the VFD.
 3. Connect an insulated wire between the output terminals (+) and (-) of one of the channels of the power supply .The wires used should be able to withstand the maximum output current of the power supply.
 4. Set the power supply voltage value to 1V.
 5. The power output is turned on.
 6. Set the power supply current.
 - Set different power supply currents and wait for the current value displayed on the VFD when the power supply is in METER mode.
 - Whether it is close to the set current value.
 7. Ensure that the power supply current can be adjusted from 0A to the rated full output current of the channel.
 8. Turn off the power output and remove the short-circuit wire.
 9. Test the current of the other two channels in turn.
- End



Chapter 3 Functions and features

This chapter will describe in detail how to use keys to complete the basic operations of the three-channel power supply. It will be divided into the following parts:

- Front panel operation introduction
- Switch local/remote operation
- Channel switching operation
- OUT ON/OFF output setting
- Timer operation
- Voltage setting operation
- Current setting operation
- Data save / read settings
- Over-voltage operation
- Keypad lock function
- Overheat protection function
- Menu function
- After the end panel functions

3.1 Introduction to front panel operation

Before operating the power supply, please read the following description of the keys on the front panel.

- After the power is turned on, the power supply automatically enters the panel operation mode. In the panel operation mode, all keys can be used.
- The output switch of the power supply can be controlled by pressing the **On/Off** key on the front panel. When the power is turned on, the status and voltage and current values of each channel will be displayed on the VFD. "C" represents the constant current state, and "V" represents the constant voltage state. When the power is in the OFF state, there is no constant voltage and constant current sign on the VFD.
- VFD can display some operating status or error information of the current power supply. When the power supply is in remote operation mode, the  sign will be displayed. When the power keyboard is locked, the  sign will be displayed, please refer to the "chapter of VFD mark description".
- If it is in the setting state, turn the knob to change the currently set value. If you are in the menu state, turn the knob to change the current menu item.
- When the **V-set** **I-set** **Recall** **Meter** **On/Off** button lights up (displays yellow-green light), it means it is in the corresponding state. If you press  (Shift)+ **Recall** (Save), the **Recall** button LED will be on, and it is in a waiting state, and you need to enter a number for storage.

The following table lists the states represented by the lights of each key:

V-set	This light is on, indicating that it is in the voltage setting state.
I-set	This light is on, indicating that it is in the current setting state.
Recall	This light is on, indicating that it is in the recall state, if it flashes, it indicates that it is in the storage state.
Meter	This light is on, indicating that it is currently in the measurement state, otherwise it is in the setting state.
On/Off	This light is on, indicating that at least one channel of the current power supply is in the on state, otherwise it is in the off state.

Note: **V-set**、**I-set**、**Recall** three lights will not light up at the same time.

3.2 Switch local / remote operation

The power supply provides two operation modes: local operation and remote operation. Communication commands can be used to switch between the two operating modes. The power initialization mode defaults to the local operation mode.

- Local operation mode: In the local operation mode, all keys can be used. Use the buttons on the power supply body to perform related operations.
- Remote operation mode: The power supply is connected to the **PC**, and the related operations of the power supply are performed on the **PC**. When the power supply is in the remote operation mode, except for the **Meter** and **Local** keys, other keys on the panel do not work. You can switch to the **Local** operation mode by pressing the Local button. When the operating mode is changed, it will not affect the output parameters of the power supply.

3.3 Channel switching operation

When the voltage setting **V-set** or current setting **I-set** is on, press the  (Local) operation key to switch between the three channels.

3.4 OUT ON / OFF output setting

You can use the **On/Off** key to change the state of the power supply. This key is in the flip state, that is, when the key is pressed when the output is off, the output will be

changed to **ON**; in the same way, when the key is pressed when the output is on, the output will be changed to the **OFF** state.

In the case of panel operation, you can use the **On/Off** key to control the output switch status of all channels, or press the single-channel switch (shift+**1**, shift+**2**, shift+**3** No. key) to control the output switch status of a channel (number key **1** controls the first channel output status, number key **2** controls the output status of the second channel, number key **3** controls the output status of the third channel). In the case of remote control, you can send SCPI commands (OUTPUT: ON | OFF) to switch the output state.

The output switch operation does not affect the current set value, and the output switch series/parallel setting affects the output switch operation.

Tips

The **On/Off** key will simultaneously control three channels. To control the output status of a single channel, use the single-channel switch key. When the output is turned on, there will be V or C display in the current display position.

3.5 Timer operation

The output time is set in the menu. After the timing is up, the power supply will automatically close the timing channel. For timing setting details, please refer to **Out Timer** in 3.12 Menu Function Description.

3.6 Voltage setting operation

There are three ways to change the current channel voltage value:

- Method 1: Press Local key to switch channels, press **V-set** key + number key, press **Enter** key to confirm, you can directly set the voltage value of the current channel.
- Method 2: Press **V-set** key, press the "▶ ◀" key to adjust the cursor position, turn the knob to change the number on the selected cursor, and then set the voltage value. Press **Enter** to confirm.
- Method 3: Press **V-set** key, press the "▶ ◀" key to adjust the cursor position, press the "▲ ▼" key to change the value of the cursor. Press **Enter** to confirm









Tips

When the output is off and the **Meter** light is on, the knob and the up and down keys cannot adjust the voltage and current parameters; when the knob function is allowed, directly rotate the knob to set the voltage and current values without pressing the **Enter** key to confirm. Press the knob to switch the cursor position.



3.7 Set current

Three Method to change current as below:

- Method 1: Press  Local key to switch channels, press  key+number. Key,  press to confirm, then set the current of the channel directly.
- Method 2: Press , then press “▶ ◀” (or the knob) to move the cursor position adjust the current value by rotating the knob, then set the current. Press  to confirm.
- Method 3: Press , then press “▶ ◀” to move the cursor position and adjust the current value pressing “▲ ▼”. Press  to confirm.





3.8 Save and recall

The power supply can save some used parameters in 40 groups, divided into 4 areas, each zone 9 groups (1~9) for users to take out and use conveniently and quickly. These parameters include voltage upper limit values (MaxVolt), over-voltage value (OVP Set), voltage setting value, current setting value.



Press  Shift +  /save followed by a Number key to save the current and voltage setting to data memory. Press  + Number 1 to 9 to recall voltage/current setting value. You can also use the **SCPI** command (*SAV、*RCL) to save and recall in 40 groups memory.





Tips

No matter it is saving or recalling, a prompt message of success or failure will be displayed after pressing  Shift + Save/  or , and pressing number key to save/recall. After pressing  Shift +  /Save, if the button light is flashing, It is waiting for inputting number to save. In combination mode, data saving/recalling is not supported.

3.9 OVP operation

Press  Shift +  (OVP) to enter into over-voltage setting. After setting OVP successfully, when the actual voltage exceeds the OVP value, then VFD will display “OVER VOLT” in corresponding channel. Three channels can set separately.

3.10 Key lock set

Press  Shift +  (Lock), can lock the front panel, a lock sign  will be displayed at left bottom of VFD.

In key lock mode, all keys are disabled, except **①**, **②**, **③** (On/Off),  key, Meter key,  (Local) key,  (Shift)+  Key.

3.11 Over Temperature Protection

If the internal temperature of the power supply exceeds 80°C, the instrument will protect itself by automatically turning power OFF. When this happens, you will hear a buzzer. And the display will display the following:

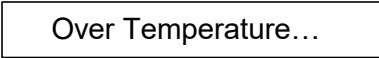

3.12 Menu function

Press Shift + (Menu) to enter into Power Menu. In the menu, right/left arrow keys and rotary knob used for flow around the menu, change the options used to identify the current menu commands or into the next layer menu. Press can exit menu or enter a layer menu.

System	Power Menu		
	System Menu...	System menu	
	Out State	Power Out State Set	Power supply output state Settings
		OFF	Always OFF
		Keep	Keep the last time state before shutdown
	Out Param	Power Out Param Set	Set up the related parameters
		Reset	default
		Keep	Restore the last time's parameters before shutdown
	Knob	Knob Function Set	Knob function setting
		Unlock	Open
		Lock	Close
	Buzzer	Key Beeper Set	Key sound set
		OFF	Key sound closed
		ON	Key sound open
	Communication	Communication Select	Interface choice set
		Port Select	Select communication interface
			RS232
			USB
		Baud	Select baud rate
			4800
			9600
			19200
			38400

				57600 115200
	Memory Group	Select Memory Group	Memory group set	
		Grp1	Group 1	
		Grp2	Group 2	
		Grp3	Group 3	
		Grp4	Group 4	
	Command	Communicatio	Communication version selection	
		Version Select		
		Modbus	Modbus command	
		SCPI	SCPI command	
	Return Meter	Auto Return Meter State	Auto return meter state	
		OFF	Function closed	
		Wait5Sec	Wait for 5 seconds, back to measurement state	
	Reset	Reset Menu Default ?	Back to factory setting	
		NO	NO	
		YES	YES	
	Exit			

Config	System menu			
	Channel Select ...	Channel selection		
	CH1	Config Menu...	Channel 1 menu	
		Max Volt	Max Voltage Set	Max voltage setting
			Max Volt=31.000V	
		Out Timer	Out Timer Set	Output timer time setting

			Out Timer=	
		Timer State	Disable	Timer OFF
			Enable	Timer ON
		Exit	Exit	
	CH2	Config Menu...	Channel 2 menu	
		Max Volt	Max Voltage Set	Max voltage setting
			Max Volt=31.000V	
		Out Timer	Out Timer Set Out Timer=	Output timer time setting
		Timer State	Disable	Timer OFF
			Enable	Timer ON
		Exit	Exit	
	CH3	Config Menu...	Channel 3 menu	
		Max Volt	Max Voltage Set	Max voltage setting
			Max Volt=31.000V	
		Out Timer	Out Timer Set Out Timer=	Output timer time setting
		Timer State	Disable	Timer OFF
			Enable	Timer ON
		Exit	Exit	
Comb	Power Combine Set...	Power combination state selection		
	Inde	Cancel current parallel/serial state		
	Series	Series Choose...	Select serial connection mode	
		CH1+CH2	Connect CH1 and CH2 in serial	
	Para	Parallel Choose...	Select parallel connection mode	
		CH1+CH2	Connect CH1 and CH2 in serial	
	Track	Track Choose...	Enable track function	
		CH1+CH2	Connect CH1 and CH2 in track	
Exit	Exit			

OutState

This parameter sets the output On/Off state at power up. If you select “**Keep**”, the power supply will save the output state when power down and revert to that state at power on. If you select “**Off**”, the output state is always “**OFF**” when the power supply is turned on. The recommend setting is “**OFF**”(default).

OutParam

This menu item is used for set up power whether save the last output parameters. If you select “**Keep**”, the power save the last time’s output parameters before the shutdown. The next time after power on, output parameter is still the last output parameters. If you select “**Reset**”, the power output is for factory default output

parameters.

Knob

This item enables (“**On**”) or disables (“**Off**”) the knob.

Buzzer

This item turns the beep sound for key presses “**On**” or “**Off**”. Set to **On**, the button will have a sound, otherwise it will be silent.

Communication

This item set the communication mode, optional communication interfaces are RS232, USB. Port Select: communication interface selection, Baud Rate: Baud rate selection .

- **RS232 Communication Set**

Baud rate have 4800,9600,19200,38400,57600,115200 for selection.

Before using the power supply to communicate with the computer, you must set this option to ensure that the power baud rate is consistent with the computer's baud rate.

- **USB**

Select communication mode via USB interface.

Memory Group

Here is **SAVE/RECALL** storage areas. All saved parameters are divided into four groups. They are Grp1, Grp2, Grp3 and Grp4. Each group can save 9 different operating states(1~9). Maximum save 40 groups setting.

Command

This option selects SCPI commands and Mod-bus commands.

Return Meter

This option sets the recovery of the measurement state. Select **OFF**. Do not turn on the automatic recovery function of the measurement state. Select "**Wait5Sec**". If you do not operate in the setting state, it will automatically return to the measurement state after waiting for 5S.

Reset

After entering this menu and selecting "**Yes**", all menu settings will be changed to the factory default settings. Select "**No**" to abandon the operation. The default settings of the configuration menu are as follows:

Out State	OFF
Out Param	Keep
Knob	Un Lock
Buzzer	ON
Communication	RS232

Ext Port	None
Memory Group	Grp1
Command	Modbus
Return Meter	Wait 5Sec

System

This option sets the maximum voltage and output timer of each channel.
 The following options are CH1 CH2 CH3.
 Select any channel, the menu options are: **Max Volt/Out Timer/Exit**

Max Volt

The max voltage you set should be within the range of **0V** to the maximum rated voltage. You can edit this value using **▲▼** keys or via numerical key pad followed by **Enter**. The default setting is the maximum rated voltage for each channel.

Out Timer

This item sets the output time for each channel. Select **Enable** to set output timer time. The range is 0.1~99999.9S. When you press **Enter**, it enable this function. If the set channel is open, the timing will start immediately. If you don't need this function, please set it to **Disable**.

This option sets the combined state of CH1 and CH2 channels, options **Inde, Series, Para, Track**. In Series/Para/Track mode, data saving/reading operations are not supported.

Comb

Inde(Remove the serial-parallel and synchronization settings of CH1 and CH2 channels) Press **Enter**, it displays "**Remove success!**"

Series (Series mode)

This function configures the instrument for series operation of CH1 and CH2. Press **Enter** to confirm your set. Press **Esc** to quit your selection.

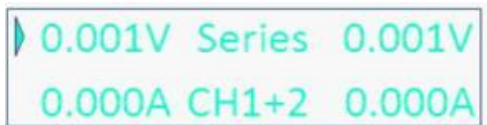

Para(Parallel mode)

This function configures the instrument for parallel operations of CH1 and CH2. Press **Enter** to confirm your set. Press **Esc** to quit your selection.

Track (sync output setting)

This function configures the instrument for tracking operations of CH1 and CH2.

Press **Enter** to confirm your set, and press **Esc** to quit the operation.
 In tracking mode, once the parameters of any one channel are changed, other channels will change proportionally.

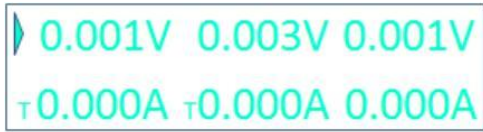

For example: In setting status, if voltage of CH1 is set as 2V, voltage of CH2 will automatically change to 4V proportionally.



Tips

If the set voltage/current value of the synchronized channel is 0 before synchronization, the synchronization operation of the voltage/current of the channel is ignored.

Select the maximum voltage value after series-parallel or synchronization, take MPS-3063X as an example. If you select CH1 and CH2 in series, MaxVolt is the sum of the maximum voltage of each channel 62V. If you select CH1 and CH2 in parallel, the minimum value of the maximum voltage of each channel is 31V.

Select synchronization, the maximum voltage is 62V. Select the output timer after series-parallel or synchronized. After selecting the serial-parallel or synchronous state, the output timer setting will be Disabled.



Tips

After changing serial/parallel, all channels are **OFF** and all voltage values will become **0V**. You need to reset the output parameters. The channel selected as serial-parallel or synchronization will be displayed with **【】** in the menu. After serial or parallel connection or synchronization, the Save and Recall functions will be disabled. Select serial and parallel connection, it needs connect with the hardware.

Power Information

Press (Shift)+  , VFD will display power information as below:

Power Model

Model No.: MPS-3033S, MPS-3063S, MPS-6033S, MPS-3033X, MPS-3063X,
MPS-6033X, MPS-3033XP, MPS-3063XP, MPS-6033XP

Soft Version

Software version: Ver: 1.X-1.X

Power SN

Software Serial No.: SN:XXXXXXXXXXXXXXXXXXXX

Software updated date: 2016-12-26

Temp: temperature inside machine

Error Information

If have error, press (Shift)+  will display errors.

Press any key to display the  next error message. If not, continue to display the above information (model No., software version, serial number, etc.). After the error message is displayed, it will be cleared, but the fault still exists.

3.13 Remote sense function

Remote measurement can adjust the output voltage of the device under test. This function allows to compensate for the voltage drop on the wire between the front panel terminals of the power supply and the device under test.

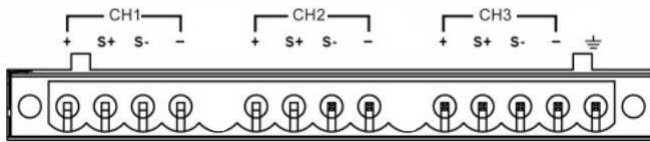

+, **-** : output terminal, the same as front pane output terminals
S+, **S-**: Remote sensing terminal

● Local measurement:

The local measurement does not compensate the voltage drop on the wire, the operation is as follows:

1. Use the short-circuit clip on the back of the instrument, or directly connect the + and S+ and – and S- of the corresponding channel install wires.
2. Connect the output positive and negative terminals of the corresponding channels on the front panel to the device under test with wires.

● Remote measurement:

1. Remove any jumpers or short-circuit clips between the + and S+ & between - and S- connectors on the rear panel terminal board.
2. Connect a pair of sensing wires from S+ and S- to the device under test.
3. Connect a pair of drive wires from + and – to the device under test

 **Tips**

To ensure the system's stability, please use an armored twisted-pair cable between the remote measurement of the three-channel programmable DC power supply and the load. The remote measurement wiring diagram is as follows:

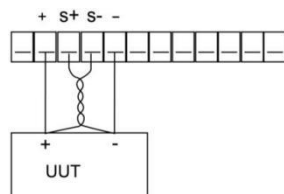

Chapter 4 Specification

This chapter will introduce the main technical parameters such as the rated voltage, rated current, and rated power, as well as the storage environment and temperature of the power supply.

4.1 Main technical parameters

Model		MPS-3033X	MPS-3063X	MPS-6033X
Rated output (0 °C - 40 °C)	Voltage	0~30V*2CH/0~6V*1CH	0~30V*2CH/0~6V*1CH	0~60V*2CH/0~6V*1CH
	Voltage limit protection	33V*2CH/7V*1CH	33V*2CH/7V*1CH	63V*2CH/7V*1CH
	Current	0~3A*2CH/0~3A*1CH	0~6A*2CH/0~3A*1CH	0~3A*2CH/0~3A*1CH
	Power	90W/90W/18W	180W/180W/18W	180W/180W/18W
Load regulation (%of output+offset)	Voltage	≤0.01%+3mV		
	Current	≤0.01%+3mA		
Power regulation (%of output+offset)	Voltage	≤0.01%+3mV		
	Current	≤0.01%+3mA		
Setting resolution	Voltage	1mV		
	Current	1mA		
Readback resolution	Voltage	1mV		
	Current	1mA		
Setting accuracy (in 12 months) (25 °C ± 5 °C) (%of output+offset)	Voltage	≤0.03%+10mV	≤0.03%+10mV	≤0.03%+10mV
	Current	≤0.1%+5mA	≤0.1%+8mA	≤0.1%+5mA
Readback accuracy (25 °C ± 5 °C) (%of output+offset)	Voltage	≤0.03%+10mV	≤0.03%+10mV	≤0.03%+10mV
	Current	≤0.1%+5mA	≤0.1%+8mA	≤0.1%+5mA
Ripple and noise (20Hz-20MHz)	Voltage(Vp-p)	≤5mVp-p	≤6mVp-p	≤5mVp-p
	Voltage(rms)	≤2mVrms	≤2mVrms	≤2mVrms
	Current(rms)	≤4mArms	≤5mArms	≤4mArms
Output temperature coefficient (0 °C ~ 40 °C) (%of output+offset)	Voltage	≤0.03%+10mV		
	Current	≤0.1%+5mA	≤0.1%+8mA	≤0.1%+5mA
Readback temperature coefficient (%of output+offset)	Voltage	≤0.03%+10mV		
	Current	≤0.1%+5mA	≤0.1%+8mA	
Setting accuracy in parallel and series	Voltage	≤0.2%+5mV	≤0.2%+5mV	≤0.2%+5mV
	Current	≤0.1%+30mA		
Memory	Storage /recall	40 groups		
Timer	Function	Output timer		
	Time setting	0.1s~3600s		
	Resolution	0.1s		
Interface		RS232、USB		
Working temperature		0~40°C		

Specification

Equipment size (W*H*D)	mm	255*110*380	255*110*380	255*110*380
Packing size (W*H*D)	mm	325*210*475	325*210*475	325*210*475
N.W	kg	9.1	9.1	9.1
G.W	kg	10	10	10

Model		MPS-3033XP	MPS-3063XP	MPS-6033XP
Rated output (0 °C - 40 °C)	Voltage	0~32V*3CH	0~32V*3CH	0~62V*3CH
	OVP	33V*3CH	33V*3CH	63V*3CH
	Current	0~3.2A*3CH	0~6.2A*3CH	0~3.2A*3CH
	Power	90W*3CH	180W*3CH	180W
Load regulation (%of output+offset)	Voltage	≤0.01%+3mV		
	Current	≤0.01%+3mA		
Power regulation (%of output+offset)	Voltage	≤0.01%+3mV		
	Current	≤0.01%+3mA		
Setting resolution	Voltage	1mV		
	Current	1mA		
Readback resolution	Voltage	1mV		
	Current	1mA		
Setting accuracy (in 12 months) (25 °C ± 5 °C) (%of output+offset)	Voltage	≤0.03%+10mV		
	Current	≤0.1%+5mA	≤0.1%+8mA	≤0.1%+5mA
Readback accuracy (25 °C ± 5 °C) (%of output+offset)	Voltage	≤0.03%+10mV		
	Current	≤0.1%+5mA	≤0.1%+8mA	≤0.1%+5mA
Ripple and noise (20Hz-20MHz)	Voltage(Vp-p)	≤5mVp-p	≤6mVp-p	≤5mVp-p
	Voltage(rms)	≤2mVrms	≤2mVrms	≤2mVrms
	Current(rms)	≤4mA _{rms}	≤5mA _{rms}	≤4mA _{rms}
Output temperature coefficient (0 °C ~ 40 °C) (%of output+offset)	Voltage	≤0.03%+10mV		
	Current	≤0.1%+5mA	≤0.1%+8mA	≤0.1%+5mA
Readback temperature coefficient (%of output+offset)	Voltage	≤0.03%+10mV		
	Current	≤0.1%+5mA	≤0.1%+8mA	≤0.1%+5mA
Setting accuracy in parallel and series	Voltage	≤0.2%+5mV	≤0.2%+5mV	≤0.2%+10mV
	Current	≤0.1%+30mA		
Memory	Storage /recall	40 groups		
Timer	Function	Output timer		
	Time setting	0.1s~3600s		
	Resolution	0.1s		
Interface		RS232、USB		
Working temperature		0~40°C		
Equipment size (W*H*D)	mm	255*110*452	255*110*452	255*110*452
Packing size (W*H*D)	mm	325*210*547	325*210*547	325*210*547
N.W	kg	12	14	14

G.W	Kg	13	15	15
-----	----	----	----	----

Model		MPS-3033S	MPS-3063S	MPS-6033S
Rated output (0 °C - 40 °C)	Voltage	0~32V*2CH/0~6V*1CH	0~32V*2CH/0~6V*1CH	0~62V*2CH/0~6V*1CH
	OVP	33V*2CH/7V*1CH	33V*2CH/7V*1CH	63V*2CH/7V*1CH
	Current	0~3.2A*2CH/0~3A*1CH	0~6.2A*2CH/0~3A*1CH	0~3.2A*2CH/0~3A*1CH
	Power	90W/90W/18W	180W/180W/18W	180W/180W/18W
Load regulation (%of output+offset)	Voltage	≤0.01%+3mV		
	Current	≤0.01%+3mA		
Power regulation (%of output+offset)	Voltage	≤0.01%+3mV		
	Current	≤0.01%+3mA		
Setting resolution	Voltage	10mV		
	Current	1mA		
Readback resolution	Voltage	10mV		
	Current	1mA		
Setting accuracy (in 12 months) (25 °C ± 5 °C) (%of output+offset)	Voltage	≤0.03%+2digits	≤0.03%+2digits	≤0.03%+2digits
	Current	≤0.1%+5mA	≤0.1%+8mA	≤0.1%+5mA
Readback accuracy (25 °C ± 5 °C) (%of output+offset)	Voltage	≤0.03%+2digits	≤0.03%+2digits	≤0.03%+2digits
	Current	≤0.1%+5mA	≤0.1%+8mA	≤0.1%+5mA
Ripple and noise (20Hz-20MHz)	Voltage(Vp-p)	≤5mVp-p	≤6mVp-p	≤5mVp-p
	Voltage(rms)	≤2mVrms	≤2mVrms	≤2mVrms
	Current(rms)	≤4mA _{rms}	≤5mA _{rms}	≤4mA _{rms}
Output temperature coefficient (0 °C ~ 40 °C) (%of output+offset)	Voltage	≤0.03%+2digits		
	Current	≤0.1%+5mA	≤0.1%+8mA	≤0.1%+5mA
Readback temperature coefficient (%of output+offset)	Voltage	≤0.03%+2digits	≤0.03%+2digits	≤0.03%+2digits
	Current	≤0.1%+5mA	≤0.1%+8mA	≤0.1%+5mA
Setting accuracy in parallel and series	Voltage	≤0.2%+2digits	≤0.2%+2digits	≤0.2%+2digits
	Current	≤0.1%+30mA		
Memory	Storage /recall	40 groups		
Timer	Function	Output timer		
	Time setting	0.1s~3600s		
	Resolution	0.1s		
Interface	RS232、USB			
Working temperature	0~40°C			
Equipment size (W*H*D)	mm	255*110*380	255*110*380	255*110*380
Packing size (W*H*D)	mm	325*210*475	325*210*475	325*210*475
N.W	kg	9.1	10	10
G.W	kg	10	11	11

4.2 Supplementary features

Suggested calibration frequency: 1 time/year
 Maximum input power

Model	MPS-3063XP MPS-6033XP	MPS-3063X MPS-3063S MPS-6033X MPS-6033S	MPS-3033XP	MPS-3033X MPS-3033S
Maximum input power	770W	540W	385W	285W

Heat dissipating method: fan

Operating environment temperature: 0-40°C

Storage environment temperature: 20-70°C

Use environment: indoor use design, maximum humidity 80%, no condensation on the instrument.

Factory information:

Company name: MATRIX TECHNOLOGY INC.

Tel: 0086 755 2836 4276

Email: sales@szmatrix.com

Website: www.szmatrix.com

Chapter 5 Communication between power and PC

Standard interface are: RS232, USB, users can choose any one to communicate with computers

5.1 RS-232 Interface

There is a D89 pinhole on rear panel, when connect to computer, use a cable with COM ports at both ends for connection, to activate the connection, you need to keep the setting of composite keys **●** (Shift) + **I-set**(menu) same as the setting in computer.

RS-232 interface accept all programme written by SCPI command.



The RS232 setting in programme must be conform to the setting in front panel system menu, if you want to revise, press composite button **●** (Shift) + **I-set** to enter into system menu to revise.

Baud rate

Front pane **●** (Shift)+ **I-set** (Menu), BaudRate System menu, user can choose one Baudrate saved in nonvolatile memory: 4800 9600 19200 38400 57600 115200.

RS-232 connection

Use on RS-232 cable with DB-9 interface, RS-232 serial port can be connected to controller serial port (such as PC). Do not mediate cable without any data. The table below shows the pins of plug.

If you use a RS-232 port with DB-25 plug, you need a cable and an adaptor (not mediate cable in bare way).

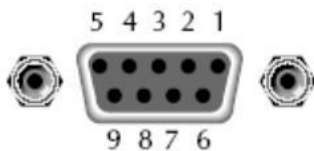

RS232 pin

Pin no.	Description
1	No connection
2	TXD,transmit data
3	RXD,accept data
4	No connection
5	GND,grounding
6	No connection
7	No connection
8	No connection
9	No connection

RS-232 failure solution:

If the connection of RS-232 is wrong, check below points:

Computer and power supply must set same Baudrate, parity check bit, databit and flow control options. Note that the power is configured as a start bit and a stop (these values are fixed).

As described in RS-232 connector. The correct adapter or interface cable must be used. Note that even the cable has a proper plug, the internal wiring may not be correct. Interface cable must be connected to right port on computer(COM1, COM2,etc.).

Communication setting

Before communication, you should make the parameter in computer and power supply matching.
 Baudrate: 9600 (4800、9600、19200、38400、57600、115200) 。 You can enter into system menu on front panel, set communication baudrate.
 Data bits: 8
 Stop bit: 1
 Calibration: (none, even, odd)
 EVEN: all 8 data bits have an even check
 ODD: all 8 data bits have an odd check
 NONE: all 8 data bits have no check
 The machine address: (0 ~ 31, factory set value is 0)

Start Bit	8 Data Bits	Parity=None	Stop Bit
-----------	-------------	-------------	----------

5.2 USB interface

Use a cable with two USB ports, connect power supply and computer. All power supply function can be programmed by USB.

The function description of US848 interface is as below:

- Interface is 488.2 USB488.
- Interface accept REN_CONTROL, GO_TO_LOCAL,and LOCAL_LOCKOUT request.
- Interface accept MsgID = TRIGGER USBTMC command info, and pass the TRIGGER command to the function layer.

The function description of power supply USB488 device is as below:

- The device can read all common SCPI command.
- The device is SR1 enabled.
- The device is RL1 enabled.
- The device is DT1 enabled.

Appendix

FAQ:

1. Specifications of the wire needed

The following table lists the maximum current that AWG copper wire can withstand

AWG	10	12	14	16	18	20	22	24	26	28
Max. current(A)	40	25	20	13	10	7	5	3.5	2.5	1.7

Note: AWG (American Wire Gauge), means X line (there is a mark on the wire). the above table lists the carrying capacity of single wire when working at 30°C, just for reference.

2. Power supply CC mode cannot be setted

The power supply has the function of automatic conversion of constant voltage/current. With this function, the power supply can be maintained in uninterrupted operation during the conversion of CV mode to CC mode, which occurs as the load changes.

For the current load, the power supply works in CV mode and provides a controlled output voltage, as the load resistance decreases, the output voltage drop remains constant until the current increases and is limited to the preset current value, and then the conversion occurs. At this point, the power supply becomes a constant current output, and the output voltage will decrease proportionately according to the further decrease of the load resistance

When the current value is lower than the set value, the power supply returns to the constant voltage mode.

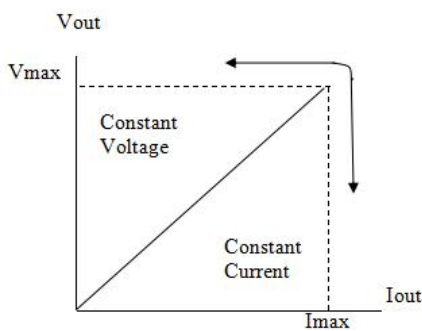

I_{max}

The mode of operation of the power supply can be indicated by the marked area of the VFD. If CV is displayed, the power supply operates in constant voltage mode, and if CC appears, the power supply operates in constant current mode.

3. Test the battery, how to prevent ignition when the battery is connected?

The ignition of the battery is mainly caused by the discharge of the battery (residual voltage) to the positive and negative terminals of the power supply. Method to avoid ignition: connect a switch to the wire and switch a charge current limiting resistor in parallel. Close the switch after all wires are connected, as shown in the diagram below:

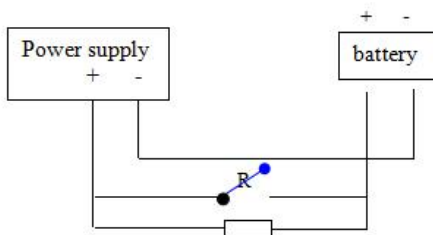

For any questions please contact us at sales@szmatrix.com, or call us at: 0086 755 2836 4276