

Keysight Technologies M9393A PXIe Performance Vector Signal Analyzer

Data Sheet



Table of Contents

Product Overview	3
Technical Specifications and Characteristics	4
Definitions for specifications, recommended best practices in use	4
Standard Configuration - Options F08, F14, F18, F27	5
Block diagram	5
Frequency	6
Amplitude	9
Dynamic range	12
Spectral purity	16
Time and acquisition	18
Measurement speed	19
Format-specific measurement data	20
Extended Frequency Configuration - Option FRX	24
Block diagram	24
Frequency	25
Amplitude	26
Dynamic range	27
Spectral purity	28
Time and acquisition	29
Measurement speed	29
Environmental and Physical Specifications	30
System Requirements	32
Software	33
Setup, Calibration Services, Support and Warranty	34
Configuration and Ordering Information	35

Overview

Acquire the performance edge in PXI

Whether your system supports a leading-edge design or a legacy platform, change is certain. Modular solutions are highly adaptable, and Keysight Technologies, Inc. is taking flexibility farther with the M9393A PXIe performance vector signal analyzer. The M9393A is the realization of our microwave measurement expertise in modular form. It integrates core signal-analysis capabilities with hardware speed and accuracy, enabling you to tailor your solution to fit specific needs – today and tomorrow. Deploy the M9393A and acquire the performance edge in PXI.

Validate the true performance of your device

The M9393A meets stringent system requirements with microwave performance previously unseen in modular. Quickly test to tighter tolerances with best-in-class switching speed and amplitude accuracy.

Get consistent, accurate results faster with optimized software elements

The M9393A leverages Keysight's trusted measurement science, providing proven, familiar software applications that minimize development time and reduce risk.

X-Series measurement applications: Verify signal compliance with standards-based measurements for LTE, WLAN and more, while simplifying software migration through deep programmatic compatibility with Keysight benchtop signal analyzers.

89600 VSA software: Characterize signals across the entire frequency range with new high-speed stepped spectrum capability along with existing software support for > 75 signal formats and multi-channel analysis.

Ensure success at microwave frequencies today and tomorrow

Easily adapt to changing test needs with license key upgradable options and hardware designed for extensibility. Rely on unmatched supportability based on Keysight's N7800A calibration and adjustment software for TME self-maintainers and Keysight's standard 3-year warranty.

Applications

- Aerospace and defense manufacturing and depot test
- Wireless device design validation and manufacturing

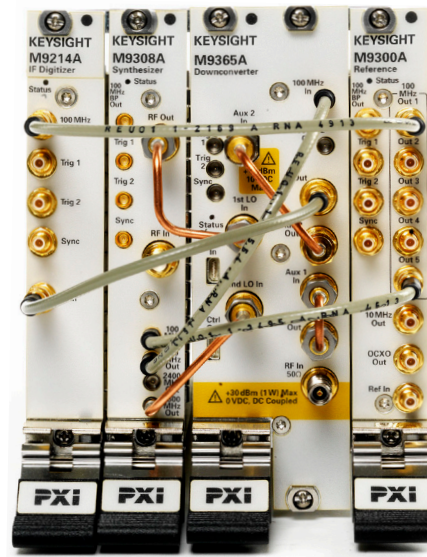

Figure 1. Standard M9393A PXIe performance vector signal analyzer with four modules consisting of M9300A frequency reference, M9308A synthesizer, M9365A downconverter and M9214A digitizer.

Product description

The M9393A PXI performance VSA is a vector signal analyzer with frequency coverage up to 50 GHz. The standard configuration provides frequency coverage from 9 kHz to 8.4, 14, 18 or 27 GHz and includes four individual PXI modules – M9214A digitizer, M9308A synthesizer, M9365A downconverter and M9300A frequency reference. The extended frequency configuration can be used to provide frequency coverage from 3.6 to 50 GHz with the recommended addition of the M9169E switchable attenuator module. For more information on product options and configurations, see the configuration guide, literature number 5991-4580EN.

Reference solutions

Application specific reference solutions, a combination of recommended hardware, software, and measurement expertise, provide the essential components of a test system. The following reference solutions include the M9393A PXI VSA as a hardware component.

- RF PA/FEM characterization and test, Reference Solution for the industry's fastest envelope tracking test, rapid waveform download, tight synchronization, automated calibration and digital pre-distortion. For more information, see www.keysight.com/find/solution-padvt
- LTE/LTE-A multi-channel test, Reference Solution for faster insight into carrier aggregation and spatial multiplexing designs. For more information, see www.keysight.com/find/solution-LTE
- Satellite Signal Monitoring, Reference Solution for monitoring large blocks of spectrum and efficient validation of signal integrity. For more information, see www.keysight.com/find/solution-satsigmon

Technical Specifications and Characteristics

Definitions for specifications

Temperatures referred to in this document are defined as follows:

- Full temperature range = Individual module temperature of 15 to 75 °C, as reported by the module, and environment temperature of 0 to 55 °C.
- Controlled temperature range = Individual module temperature of 36 to 50 °C, as reported by the module, and environment temperature of 20 to 30 °C.

Specifications describe the warranted performance of calibrated instruments. Data represented in this document are specifications under the following conditions unless otherwise noted.

- Calibrated instruments have been stored for a minimum of 2 hours within the full temperature range
- 30 minute warm-up time
- Calibration cycle maintained
- When used with Keysight M9300A frequency reference and Keysight interconnect cables

Characteristics describe product performance that is useful in the application of the product, but that is not covered by the product warranty. Characteristics are often referred to as *Typical* or *Nominal* values and are italicized.

- **Typical** describes characteristic performance, which 80% of instruments will meet when operated within the controlled temperature range.
- **Nominal** describes representative performance that is useful in the application of the product when operated within the controlled temperature range.
- **95th percentile** values indicate the breadth of the population (approx. 2σ of performance tolerances expected to be met in 95 percent of the cases with a 95 percent confidence, for any ambient temperature in the range of 20 to 30 °C. In addition to the statistical observations of a sample of instruments, these values include the effects of the uncertainties of external calibration references. These values are not warranted. These values are updated occasionally if a significant change in the statistically observed behavior of production instruments is observed.

Recommended best practices in use

- Use slot blockers and EMC filler panels in empty module slots to ensure proper operating temperatures. Keysight chassis and slot blockers optimize module temperature performance and reliability of test.
- Set chassis fan to high at environmental temperatures above 45 °C.

Conversion type operating range

Conversion types	Frequency range
Auto	All frequencies
Double conversion	9 kHz to 3.6 GHz
Single high	3.6 GHz to max frequency
Single low	3.6 GHz to max frequency

Additional information

- Mixer level offset modifies the receiver gain prior to the first mixer of the receiver. A negative setting improves distortion (i.e., TOI) at the cost of noise performance (i.e., DANL). A positive setting improves noise performance at the cost of distortion.
- The PeakToAverage property is used with expected RF Power property to optimize level settings in the Downconverter. Set this to the ratio, in dB, of the peak power to the average power. The Downconverter uses this value to optimize mixer level, IF gain, and ADC clip level.
- IF Level Offset (dB) provides additional adjustment of IF power level. Positive values reduce noise. Negative values reduce distortion.
- Digitizer Level Offset (dB) provides additional adjustment of Downconverter IF power to the digitizer. Positive values increase power to the digitizer. Negative values decrease power to the digitizer.
- All graphs contain measured data from one unit and are representative of product performance within the controlled temperature range unless otherwise noted.
- Default conditions apply, unless otherwise noted.
- The specifications contained in this document are subject to change.

Technical Specifications and Characteristics

Standard Configuration - Options F08, F14, F18, F27

Block diagram

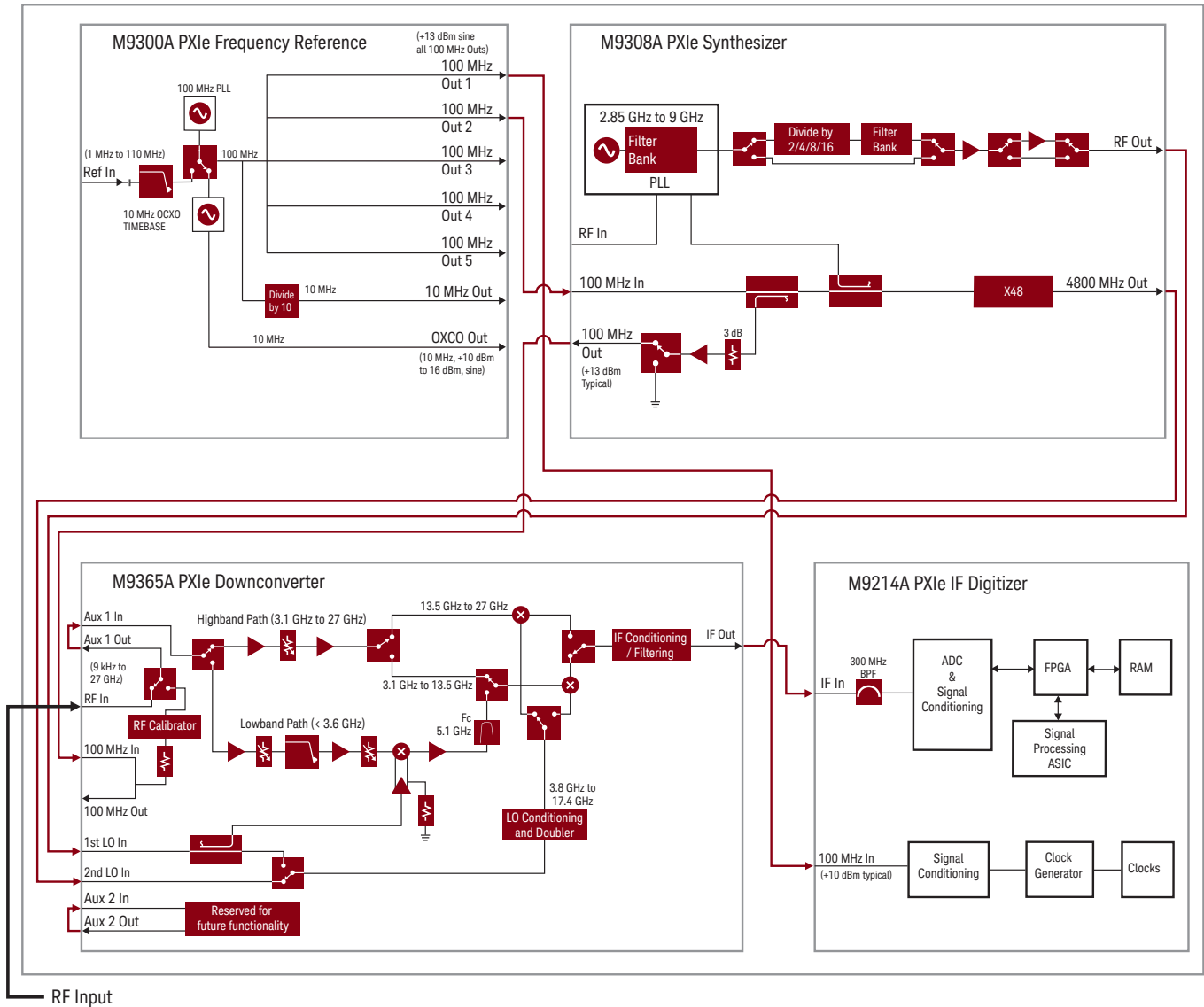

Figure 2. Standard M9393A PXle vector signal analyzer (9 kHz to 27 GHz) block diagram with four modules consisting of the M9308A synthesizer, M9365A downconverter, M9214A digitizer and the optional M9300A frequency reference.

To maximize the M9300A's 100 MHz outputs, especially for multi-channel configurations, an SMB T-type adapter (not shown) can be used to split the signal between the M9214A 100 MHz In and the M9308A 100 MHz In. For more information, please refer to the M9393A startup guide, literature number M9393-90002.

Technical Specifications and Characteristics

Standard Configuration – Options F08, F14, F18, F27

Frequency

Frequency range and resolution			
Option F08	9 kHz to 8.4 GHz		
Option F14	9 kHz to 14 GHz		
Option F18	9 kHz to 18 GHz		
Option F27	9 kHz to 27 GHz		
Tuning resolution	0.01 Hz		
Analysis bandwidth ¹			
Maximum bandwidth	Option B04 (standard)	40 MHz	
	Option B10	100 MHz	
	Option B16	160 MHz	
	Option WB1 ⁵	1 GHz IF output, nominal	
IF frequency ²		Final IF	First IF (< 3.6 GHz)
40 MHz IF path		240 MHz	5040 MHz
100/160 MHz IF path		300 MHz	5100 MHz
40 MHz alternate IF path ³		326 MHz	5126 MHz
Bypass path (Option WB1) ⁶		Adjustable	--
Band	Harmonic mixing mode	LO multiple (N) ⁴	Frequency
Band 0	1	1	9 kHz to 3.6 GHz
Band 1	1	1	3.6 to 8.4 GHz
Band 2	1	2	8.4 to 13.6 GHz
Band 3	2	2	13.6 to 17.1 GHz
Band 4	2	4	17.1 to 27 GHz

1. Instantaneous bandwidth (1 dB bandwidth) available around a center frequency over which the input signal can be digitized for further analysis or processing in the time, frequency or modulation domain.
2. Double conversion below 3.6 GHz, single conversion above 3.6 GHz.
3. Only used for some frequencies below 3.6 GHz for best performance as determined by the instrument software.
4. N is the LO multiplication factor.
5. Enables bypassing of IF filters to provide access to wideband IF output from downconverter for use with an external digitizer. Available > 3.6 GHz. Full 1 GHz not available at band crossings.
6. IF frequency can be tuned from 200 to 800 MHz with a default value of 500 MHz.

Technical Specifications and Characteristics

Standard Configuration – Options F08, F14, F18, F27

Frequency (cont'd)

Frequency switching speed^{7,8}			
List mode switching speed⁹	Band	Standard, nominal	Option UNZ, nominal
Baseband frequency offset change ¹¹	< 40 MHz	5 ms	26 μ s
	\geq 40 MHz to \leq 100 MHz		12 μ s
	> 100 MHz to < 180 MHz		95 μ s
	\geq 180 MHz		11 μ s
Arbitrary frequency change within:	0: < 3.6 GHz	5 ms	175 μ s
	1: 3.6 to 8.4 GHz		135 μ s
	2: 8.4 to 13.6 GHz		135 μ s
	3: 13.6 to 17.1 GHz		155 μ s
	4: 17.1 to 27 GHz		145 μ s
Non-list mode switching speed¹⁰		Standard, nominal	Option UNZ, nominal
Baseband frequency offset change ¹¹		5 ms	250 μ s
Arbitrary frequency change		5 ms	1 ms
Resolution bandwidth (RBW)			
Minimum RBW	1 Hz		
Maximum span:RBW ratio ¹²	135 x 10 ⁶		
Maximum RBW (ENBW)	IF dither OFF	IF dither ON	
Flat top (160 MHz IF)	31.25 MHz	27.3 MHz	
Flat top (40 MHz IF)	7.8 MHz	3.9 MHz	
Gaussian top (160 MHz)	19.4 MHz	16.99 MHz	
Gaussian top (40 MHz)	4.8 MHz	2.4 MHz	
Video bandwidth (VBW)			
Range	1 Hz to maximum RBW and wide open to 50 MHz		
Accuracy	VBW is implemented by averaging to achieve a similar variance reduction effect for the same VBW value.		
Frequency span			
Range	Single FFT: 800 Hz to 160 MHz Stepped: 800 Hz to 27 GHz		
Resolution	2 Hz		

7. When used with the M9018A PXIe chassis (2-link configuration: 1 x 8 [factory default]) and M9037A PXIe embedded controller.
8. Settled to within 2 kHz or 1 ppm, whichever is greater of final value. Does not include data acquisition or processing time. Amplitude settled to within 0.1 dB. Channel filter set to none.
9. Time from trigger input to frequency and amplitude settled. Minimum IQ sample rate \geq 6 MHz. Minimum spectrum acquisition \geq 4.8 MHz. Minimum power acquisition channel filter bandwidth \geq 4.8 MHz. For frequency changes crossing 3.6 GHz with option UNZ, switching time is 2 ms. For frequency changes crossing any other bands with option UNZ, switching time is < 300 μ s.
10. Mean time from IVI command to carrier frequency settled to within 2 kHz or 1 ppm, whichever is greater. Amplitude settled within 0.1 dB. Simultaneous carrier frequency and amplitude switching. For frequency changes crossing 3.6 GHz with option UNZ, switching time is 2 ms.
11. Baseband offset can be adjusted \pm from carrier frequency within limits determined by RF analysis bandwidth and IF filter bandwidth. Synthesizer frequency and amplitude are not changing. Baseband offset settled to within 2 kHz.
12. Indicates minimum RBW which can be set for a given measurement span in 64-bit, stepped spectrum acquisition mode.

Technical Specifications and Characteristics

Standard Configuration – Options F08, F14, F18, F27

Frequency (cont'd)

Frequency reference (M9300A PXIe frequency reference module)		
Reference outputs		
100 MHz Out (Out 1 through Out 5)		
Amplitude	≥ 10 dBm	<i>13 dBm, typical</i>
Connectors	5 SMB snap-on	
Impedance	50 Ω , nominal	
10 MHz Out		
Amplitude	9.5 dBm, nominal	
Connectors	1 SMB snap-on	
Impedance	50 Ω , nominal	
OCXO Out		
Amplitude	11.5 dBm, nominal	
Connectors	1 SMB snap-on	
Impedance	50 Ω , nominal	
Frequency accuracy		
Same as accuracy of internal time base or external reference input		
Internal timebase		
Accuracy	\pm [(time since last adjustment x aging rate) \pm temperature effects \pm calibration accuracy]	
Frequency stability		
Aging rate		
Daily	$< \pm 0.5$ ppb/day, after 72 hours of warm-up	
Yearly	$< \pm 0.1$ ppm/year, after 72 hours of warm-up	
Total 10 years	$< \pm 0.6$ ppm/10 years, after 72 hours of warm-up	
Achievable initial calibration accuracy (at time of shipment)	$\pm 5 \times 10^{-8}$	
Temperature effects		
20 to 30 °C	$< \pm 10$ ppb	
Full temperature range	$< \pm 50$ ppb	
Warm up		
5 minutes over +20 to +30 °C, with respect to 1 hour	$< \pm 0.1$ ppm	
15 minutes over +20 to +30 °C, with respect to 1 hour	$< \pm 0.01$ ppm	
External reference input		
Frequency	1 to 110 MHz, sine wave	
Lock range	± 1 ppm, nominal	
Amplitude	0 to 10 dBm, nominal	
Connector	1 SMB snap-on	
Impedance	50 Ω , nominal	

Technical Specifications and Characteristics

Standard Configuration – Options F08, F14, F18, F27

Amplitude

Input level						
Max safe average total power	+35 dBm					
Max DC voltage	± 10 Vdc					
Max RF input (specified performance)	+30 dBm					
Expected input level setting		Pre-amplifier OFF, peak to average 0 dB				
Range	-170 to +30 dBm					
Resolution	0.01 dB					
Electronic attenuator ¹³						
Frequency range	9 kHz to 27 GHz					
Attenuation range	0 to 42 dB					
Step size	0.25 dB					
Absolute amplitude accuracy ¹⁴						
Frequency ¹⁵	Pre-amp OFF ¹⁶			Pre-amp ON ¹⁷		
	Specification	95 th percentile	Typical	Specification	95 th percentile	Typical
100 kHz to 1 MHz	± 1.53 dB	± 0.97 dB	± 0.71 dB	± 1.76 dB	± 1.01 dB	± 0.71 dB
1 MHz to 20 MHz	± 1.23 dB	± 0.7 dB	± 0.49 dB	± 1.59 dB	± 0.9 dB	± 0.61 dB
20 MHz to 100 MHz	± 0.61 dB	± 0.32 dB	± 0.17 dB	± 0.71 dB	± 0.41 dB	± 0.24 dB
100 MHz to 3.6 GHz	± 0.54 dB	± 0.25 dB	± 0.13 dB	± 0.74 dB	± 0.38 dB	± 0.26 dB
3.6 GHz to 8 GHz	± 0.61 dB	± 0.31 dB	± 0.16 dB	± 0.85 dB	± 0.4 dB	± 0.26 dB
8 GHz to 14 GHz	± 0.71 dB	± 0.36 dB	± 0.23 dB	± 0.95 dB	± 0.45 dB	± 0.32 dB
14 GHz to 18 GHz	± 0.79 dB	± 0.47 dB	± 0.35 dB	± 1.03 dB	± 0.59 dB	± 0.47 dB
18 GHz to 26.5 GHz	± 1.43 dB	± 0.55 dB	± 0.37 dB	± 2.12 dB	± 1.08 dB	± 0.92 dB
26.5 GHz to 27 GHz	± 2.37 dB	± 0.57 dB	± 0.4 dB	± 2.65 dB	± 0.66 dB	± 0.48 dB
Frequency ¹⁵	Pre-amp OFF, expected input level ≤ -5 dBm ¹⁸					
	Specification	95 th percentile	Typical			
100 kHz to 1 MHz	± 1.21 dB	± 0.74 dB	± 0.53 dB			
1 MHz to 20 MHz	± 1.14 dB	± 0.66 dB	± 0.46 dB			
20 MHz to 100 MHz	± 0.69 dB	± 0.36 dB	± 0.21 dB			
100 MHz to 3.6 GHz	± 0.67 dB	± 0.35 dB	± 0.23 dB			

13. Electronic attenuator set by firmware based on expected input level, peak to average, and frequency settings.

14. Measured using an attenuator with VSWR performance equal to or better than the Keysight 8490D-020 coaxial attenuator. Applies after comprehensive alignment and module temperature within ± 3 °C.

15. Frequency is exclusive on the start frequency and inclusive on the stop frequency.

16. Expected input level set to 6 dBm below 3.6 GHz. Expected input level set to -5 dBm above 3.6 GHz. Peak to average 0 dBm.

17. Expected input level set to -3 dBm. Peak to average 0 dBm.

18. Expected input level set to -5 dBm. Peak to average 0 dBm.

Technical Specifications and Characteristics

Standard Configuration – Options F08, F14, F18, F27

Amplitude (cont'd)

Amplitude repeatability and linearity						
	Pre-amp OFF, typical			Pre-amp ON, typical		
Repeatability ¹⁹	± 0.03 dB			± 0.06 dB		
Linearity²⁰						
	ADC dither high			ADC dither Low		
Input signal relative to expected input level setting	Specification	Typical		Specification	Typical	
> -35 dB	0.08 dB	0.03 dB		0.08 dB	0.03 dB	
≤ -35 dB	0.1 dB	0.04 dB		0.21 dB	0.1 dB	
IF flatness, typical^{21, 22}	Across any 20 MHz in 40 MHz path	Across any 20 MHz in 160 MHz path	40 MHz	100 MHz	160 MHz	
≤ 13.6 GHz	± 0.08 dB	± 0.14 dB	± 0.16 dB	± 0.21 dB	± 0.34 dB	
> 13.6 GHz	± 0.12 dB	± 0.14 dB	± 0.17 dB	± 0.31 dB	± 0.47 dB	
IF phase linearity, typical^{21, 22}	Across any 20 MHz in 40 MHz path	Across any 20 MHz in 160 MHz path	40 MHz	100 MHz	160 MHz	
≤ 13.6 GHz	± 0.68 °	± 1.28 °	± 0.81 °	± 1.34 °	± 1.56 °	
> 13.6 GHz	± 1.46 °	± 1.54 °	± 1.69 °	± 2.56 °	± 3.59 °	
IF bandwidth filter switching uncertainty²³						
	Specification	Typical		Nominal		
Preamp On	± 0.3 dB	± 0.14 dB		± 0.1 dB		
Preamp Off	± 0.45 dB	± 0.25 dB		± 0.2 dB		
Expected input level switching uncertainty²⁴						
	Pre-amp OFF²⁵				Pre-amp ON²⁶	
	≤ -5 dBm		> -5 dBm		≤ -3 dBm	
	Specification	Typical	Specification	Typical	Specification	Typical
> 100 kHz to 1 MHz	± 0.14 dB	± 0.03 dB	± 1.53 dB	± 0.6 dB	± 0.48 dB	± 0.18 dB
> 1 to 20 MHz	± 0.18 dB	± 0.04 dB	± 1.56 dB	± 0.64 dB	± 0.48 dB	± 0.18 dB
> 20 to 100 MHz	± 0.15 dB	± 0.04 dB	± 0.56 dB	± 0.24 dB	± 0.39 dB	± 0.15 dB
> 100 MHz to 3.6 GHz	± 0.16 dB	± 0.04 dB	± 0.53 dB	± 0.24 dB	± 0.44 dB	± 0.18 dB
> 3.6 to 8 GHz	± 0.18 dB	± 0.05 dB	± 0.39 dB	± 0.15 dB	± 0.34 dB	± 0.12 dB
> 8 to 17 GHz	± 0.16 dB	± 0.05 dB	± 0.71 dB	± 0.19 dB	± 0.53 dB	± 0.17 dB
> 17 to 24 GHz	± 0.19 dB	± 0.05 dB	± 2.38 dB	± 0.39 dB	± 0.78 dB	± 0.17 dB
> 24 to 27 GHz	± 0.18 dB	± 0.06 dB	± 1.39 dB	± 0.31 dB	± 0.55 dB	± 0.16 dB

19. Input level -11 dBm, LO nulling run at ~1 GHz, 150 ms allowed for amplitude settling, measurement made at 1 kHz from center of IF.

20. Input level 20 dB above the noise floor and ADC dither on, no change in hardware settings, below expected input level.

21. Deviation from the mean error of the entire bandwidth, all conversion types.

22. Expected input level = 0 dBm, Mixer level offset = 0.

23. Amplitude error relative to the reference IF bandwidth filter of 40 MHz. Pre-amplifier mode is set in the on or off position, not Auto.

24. Measured using an attenuator with VSWR performance equal to or better than the Keysight 8490D-020 coaxial attenuator. Peak to average = 0 dB.

25. Measurement referenced to Expected input level setting of -5 dBm.

26. Measurement referenced to Expected input level setting of -3 dBm.

Technical Specifications and Characteristics

Standard Configuration – Options F08, F14, F18, F27

Amplitude (cont'd)

Amplitude switching speed ²⁷			
Option UNZ, nominal			
List mode switching speed	9 kHz to 3.6 GHz	3.6 to 6 GHz	6 to 27 GHz
From lower to higher power ²⁸	90 μ s	180 μ s	50 μ s
From higher to lower power ²⁸	90 μ s	50 μ s	50 μ s
Pre-amp OFF to pre-amp ON	245 μ s	190 μ s	190 μ s
Pre-amp ON to pre-amp OFF	160 μ s	220 μ s	90 μ s
Non-list mode switching speed	1 ms		
Standard, nominal	5 ms		

Input voltage standing wave ratio (VSWR)	Pre-amp OFF, nominal		Pre-amp ON, nominal	
	10 MHz to \leq 50 MHz	< 1.38 : 1		< 2.57 : 1
> 50 MHz to \leq 3 GHz	< 1.21 : 1		< 1.9 : 1	
> 3 GHz to \leq 3.6 GHz	< 1.12 : 1		< 1.61 : 1	
> 3.6 GHz to \leq 12 GHz	< 1.49 : 1		< 1.4 : 1	
> 12 GHz to \leq 20 GHz	< 1.99 : 1		< 1.99 : 1	
> 20 GHz to \leq 23 GHz	< 1.36 : 1		< 1.36 : 1	
> 23 GHz to \leq 27 GHz	< 1.81 : 1		< 1.82 : 1	

Trace detectors	
With IVI driver	Normal
With 89600 VSA software	Normal, Max, Sample, Average, Min

Preamplifier	
Frequency range	
Option F08	9 kHz to 8.4 GHz
Option F14	9 kHz to 14 GHz
Option F18	9 kHz to 18 GHz
Option F27	9 kHz to 27 GHz
Gain ²⁹	Typical
< 3.6 GHz	+15.5 dB
3.6 to < 15 GHz	+25.0 dB
15 to < 25 GHz	+22.0 dB
25 to 27 GHz	+19.0 dB

27. When using M9018A PXIe chassis (2-link configuration: 1 x 8 [factory default]) and M9037A PXIe embedded controller. Amplitude settled to within 0.1 dB. Does not include data acquisition or processing time.

28. No pre-amplifier switching.

29. Gain is normalized to pre-amplifier OFF state.

Technical Specifications and Characteristics

Standard Configuration – Options F08, F14, F18, F27

Dynamic range

Displayed average noise level (DANL) ³⁰					
		Specification		Typical	
		Noise corrections OFF	Noise corrections ON	Noise corrections OFF	Noise corrections ON
Pre-amp OFF	9 to 300 kHz	-120 dBm/Hz	-125 dBm/Hz	-129 dBm/Hz	-135 dBm/Hz
	300 kHz to 51 MHz	-143 dBm/Hz	-147 dBm/Hz	-147 dBm/Hz	-154 dBm/Hz
	51 to 800 MHz	-147 dBm/Hz	-158 dBm/Hz	-150 dBm/Hz	-161 dBm/Hz
	800 MHz to 2.5 GHz	-145 dBm/Hz	-156 dBm/Hz	-148 dBm/Hz	-158 dBm/Hz
	2.5 to 3.6 GHz	-142 dBm/Hz	-153 dBm/Hz	-146 dBm/Hz	-157 dBm/Hz
	3.6 to 7.4 GHz	-146 dBm/Hz	-156 dBm/Hz	-149 dBm/Hz	-160 dBm/Hz
	7.4 to 10 GHz	-144 dBm/Hz	-155 dBm/Hz	-148 dBm/Hz	-158 dBm/Hz
	10 to 13.6 GHz	-142 dBm/Hz	-152 dBm/Hz	-145 dBm/Hz	-156 dBm/Hz
	13.6 to 17 GHz	-136 dBm/Hz	-147 dBm/Hz	-141 dBm/Hz	-151 dBm/Hz
	17 to 20.5 GHz	-133 dBm/Hz	-144 dBm/Hz	-136 dBm/Hz	-147 dBm/Hz
	20.5 to 22 GHz	-131 dBm/Hz	-142 dBm/Hz	-135 dBm/Hz	-145 dBm/Hz
	22 to 25.5 GHz	-123 dBm/Hz	-134 dBm/Hz	-128 dBm/Hz	-138 dBm/Hz
	25.5 to 27 GHz	-117 dBm/Hz	-127 dBm/Hz	-122 dBm/Hz	-133 dBm/Hz
	Pre-amp ON	9 to 300 kHz	-120 dBm/Hz	-126 dBm/Hz	-131 dBm/Hz
300 kHz to 51 MHz		-135 dBm/Hz	-146 dBm/Hz	-142 dBm/Hz	-152 dBm/Hz
51 to 2.3 GHz		-154 dBm/Hz	-165 dBm/Hz	-158 dBm/Hz	-168 dBm/Hz
2.3 to 3.6 GHz		-153 dBm/Hz	-164 dBm/Hz	-157 dBm/Hz	-168 dBm/Hz
3.6 to 9 GHz		-152 dBm/Hz	-162 dBm/Hz	-156 dBm/Hz	-166 dBm/Hz
9 to 16.2 GHz		-149 dBm/Hz	-160 dBm/Hz	-154 dBm/Hz	-164 dBm/Hz
16.2 to 20.5 GHz		-147 dBm/Hz	-157 dBm/Hz	-152 dBm/Hz	-163 dBm/Hz
20.5 to 23.5 GHz		-143 dBm/Hz	-153 dBm/Hz	-149 dBm/Hz	-159 dBm/Hz
23.5 to 25.6 GHz		-139 dBm/Hz	-150 dBm/Hz	-145 dBm/Hz	-155 dBm/Hz
25.6 to 27 GHz		-136 dBm/Hz	-147 dBm/Hz	-141 dBm/Hz	-152 dBm/Hz

For nominal, see figure 4.

Gain compression (0.1 dB two-tone), nominal ³¹		
Frequency	Pre-amp OFF	Pre-amp ON
< 3.6 GHz	0 dBm	-15 dB
3.6 to 5 GHz	-5 dBm	-28 dB
5 to 17 GHz	-3 dBm	-27 dB
17 to 27 GHz	+1 dBm	-21 dB

30. Expected input level = -60 dBm, Mixer level offset = 0 dBm, Noise Correction ON uses 100 averages, Conversion = auto, PeakToAverage = 0 dB.

31. Large signals can cause the analyzer to incorrectly measure on-screen signals because of two-tone gain compression.

This specification tells how large an interfering signal must be in order to cause a 0.1 dB change in a low power signal.

Tone spacing = 100 kHz, measuring a -30 dBm signal for the low power tone. Expected input level = 0 dBm, Mixer level offset = 0 dB.

Technical Specifications and Characteristics

Standard Configuration – Options F08, F14, F18, F27

Dynamic range (cont'd)

Third order intermodulation distortion (TOI)				
	Frequency	Specification ³⁴	Typical	Nominal
Pre-amp OFF ³²	10 to 600 MHz	+26 dBm / -52 dBc	+29 dBm	+31 dBm
	600 MHz to 3.6 GHz	+26 dBm / -52 dBc	+31 dBm	+33.5 dBm
	3.6 to 13.6 GHz	+26 dBm / -52 dBc	+29 dBm	+30 dBm
	13.6 to 16.5 GHz	+24 dBm / -48 dBc	+28.5 dBm	+29.5 dBm
	16.5 to 18 GHz	+21 dBm / -42 dBc	+25 dBm	+28.5 dBm
	18 to 27 GHz	+24 dBm / -48 dBc	+29 dBm	+31 dBm
Pre-amp ON ³³	10 to 600 MHz	+3 dBm / -56 dBc	+8.5 dBm	+12.5 dBm
	600 MHz to 3.6 GHz	+4 dBm / -58 dBc	+10 dBm	+13 dBm
	3.6 to 13.6 GHz	-1.5 dBm / -47 dBc	+3.5 dBm	+4.5 dBm
	13.6 to 16.5 GHz	-4.5 dBm / -41 dBc	+2 dBm	+4 dBm
	16.5 to 18 GHz	-9 dBm / -32 dBc	-3 dBm	+1 dBm
	18 to 24 GHz	-7 dBm / -36 dBc	0 dBm	+3 dBm
	24 to 27 GHz	-1 dBm / -48 dBc	+5 dBm	+7.5 dBm
Second harmonic distortion (SHI)				
	Frequency	Typical ³⁷	Nominal	
Pre-amp OFF ³⁵	10 to 300 MHz	+56 dBm / -56 dBc	+60 dBm	
	300 MHz to 1.8 GHz	+60 dBm / -60 dBc	+62 dBm	
	1.8 to 5.2 GHz	+41 dBm / -41 dBc	+44 dBm	
	5.2 to 10 GHz	+32 dBm / -32 dBc	+36 dBm	
	10 to 13.5 GHz	+21 dBm / -21 dBc	+25 dBm	
	Pre-amp ON ³⁶	10 MHz to 1.8 GHz	+33 dBm / -63 dBc	+35 dBm
1.8 to 4 GHz		+16 dBm / -46 dBc	+22 dBm	
4 to 10 GHz		0 dBm / -30 dBc	+3 dBm	
10 to 13.5 GHz		-10 dBm / -20 dBc	-5 dBm	

32. Tone separation = 100 kHz, Expected input level = 3 dBm, Mixer offset level = 0 dB, PeakToAverage = 6 dB, Conversion type Auto. Signal level of 0 dBm used to calculate distortion in dBc.

33. Tone separation = 100 kHz, Expected input level = -22 dBm, Mixer offset level = 0 dB, PeakToAverage = 6 dB, Conversion type Auto. Signal level of -25 dBm used to calculate distortion in dBc.

34. TOI = third order intercept. The TOI is given by the input tone level (in dBm) minus (distortion/2) where distortion is the relative level of the distortion tones in dBc.

35. Expected input level = 0 dBm . Signal level of 0 dBm used to calculate distortion in dBc.

36. Expected input level = -30 dBm . Signal level of -30 dBm used to calculate distortion in dBc.

37. SHI = second harmonic intercept. The SHI is given by the input power in dBm minus the second harmonic distortion level relative to the input level in dBc.

Technical Specifications and Characteristics

Standard Configuration - Options F08, F14, F18, F27

Dynamic range (cont'd)

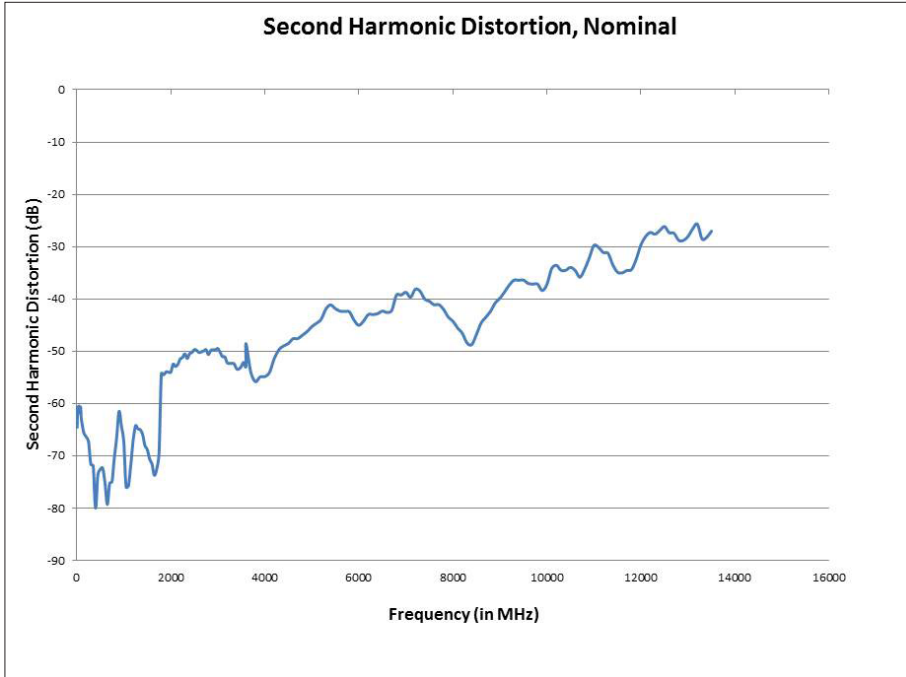

Figure 3. Nominal second harmonic distortion, expected input level = 0 dBm.

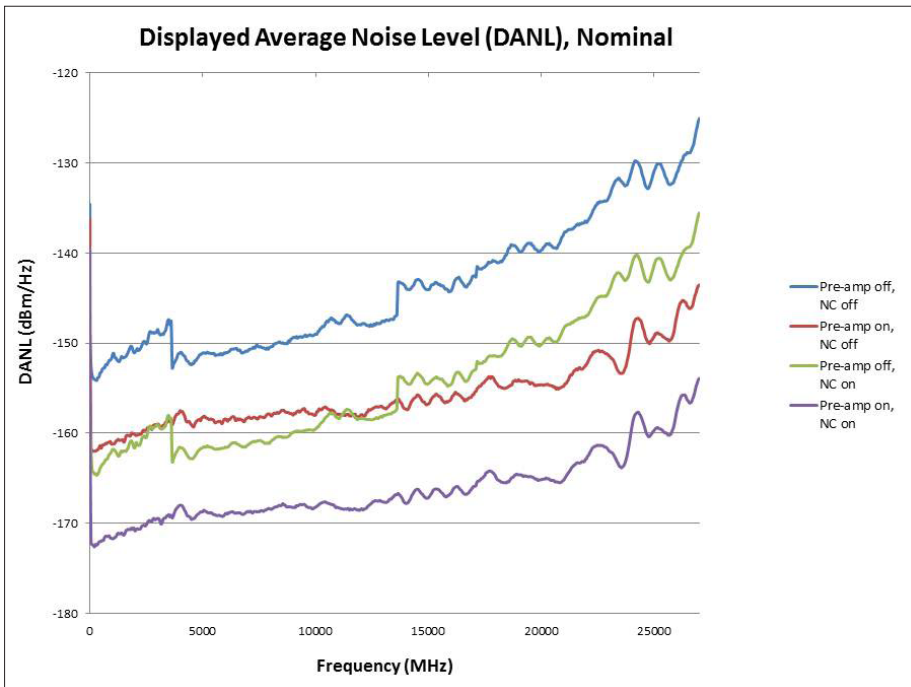

Figure 4. Nominal displayed average noise level. Expected input level = -60 dBm, Mixer level offset = 0 dBm, Noise correction (NC) ON uses 100 averages.

Technical Specifications and Characteristics

Standard Configuration - Options F08, F14, F18, F27

Dynamic range (cont'd)

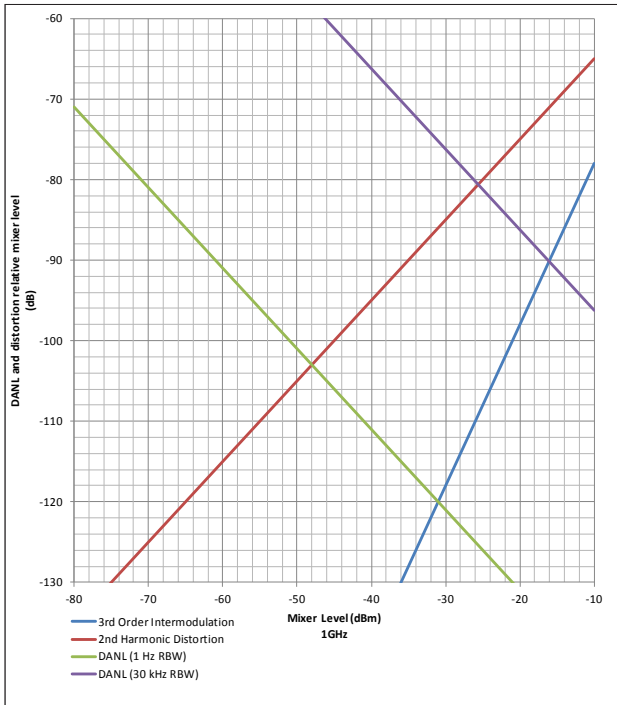

Figure 5. Dynamic range at 1 GHz.

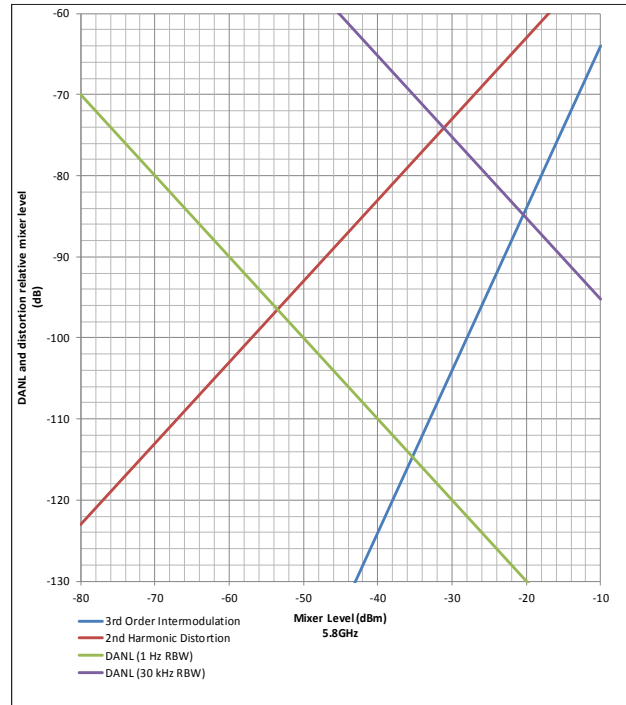

Figure 6. Dynamic range at 5.8 GHz.

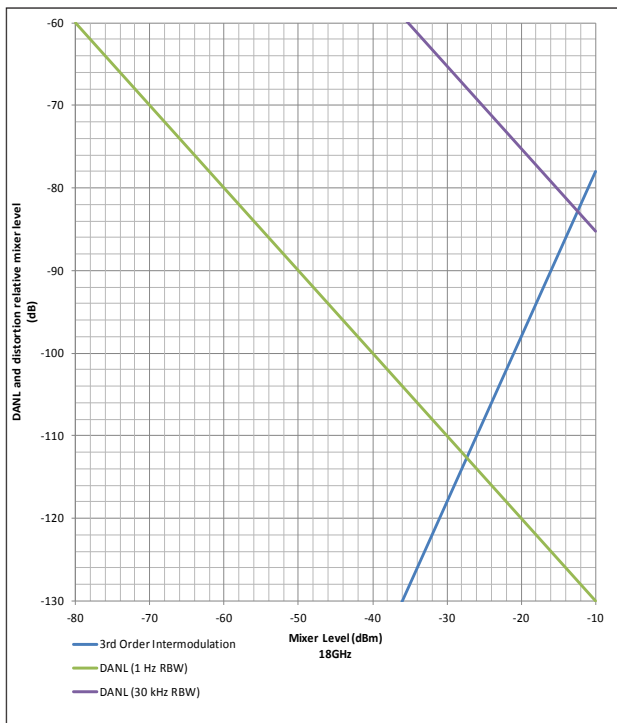

Figure 7. Dynamic range at 18 GHz.

Technical Specifications and Characteristics

Standard Configuration - Options F08, F14, F18, F27

Spectral purity

Phase noise ³⁸				
Center frequency	Offset	Specification, noise corrections OFF	Typical, noise corrections OFF	Typical, noise corrections ON
1 GHz	100 Hz		-88 dBc/Hz	
	1 kHz		-105 dBc/Hz	
	10 kHz	-107 dBc/Hz	-110 dBc/Hz	
	100 kHz		-107 dBc/Hz	
	300 kHz		-118 dBc/Hz	
	1 MHz	-131 dBc/Hz	-134 dBc/Hz	-134 dBc/Hz
	3 MHz		-139 dBc/Hz	-141 dBc/Hz
	10 MHz		-141 dBc/Hz	-144 dBc/Hz

38. Expected input level = 0 dBm, Mixer level offset = 0 dB, Pre-amp = OFF, Noise correction ON results use a counted average of 100, PeakToAverage = 5.

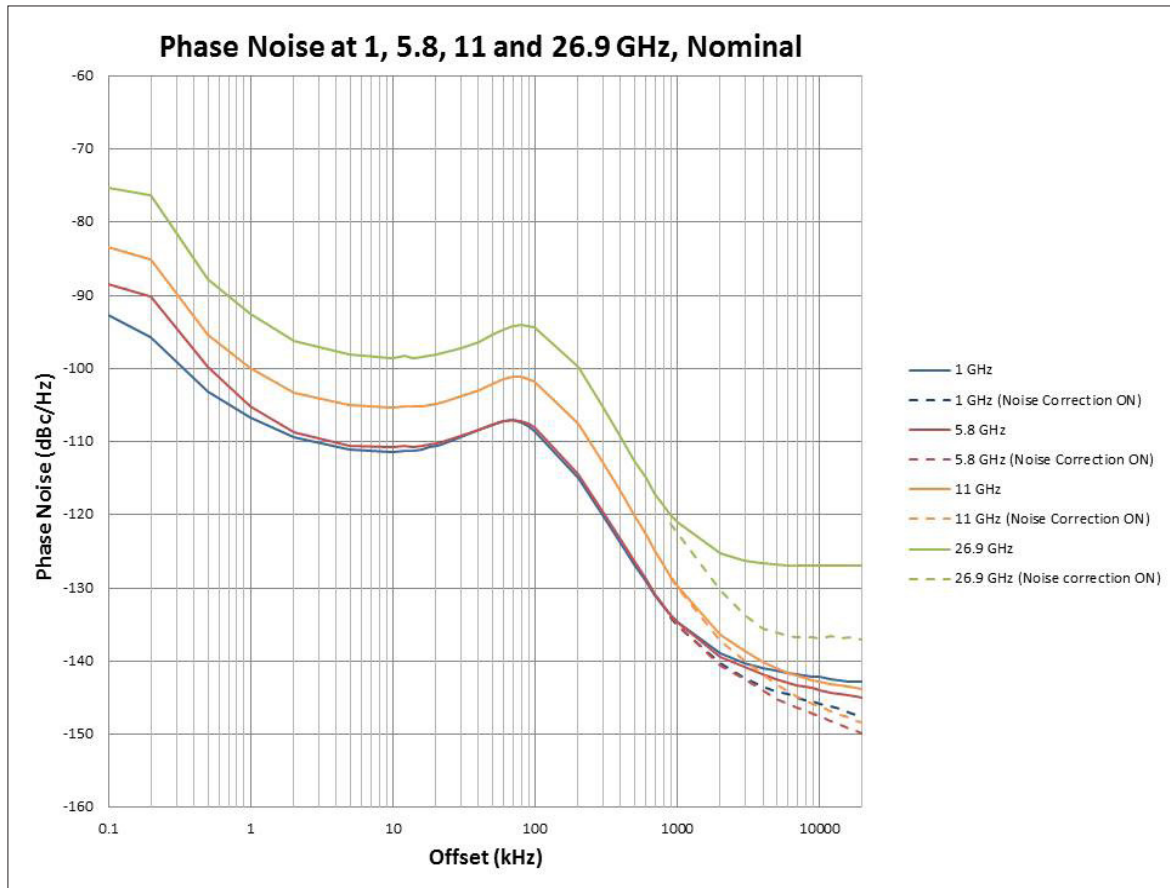

Figure 8. Nominal phase noise 1 to 26.9 GHz. Expected input level = 0 dBm, Mixer level offset = 0 dB, Pre-amp = OFF, Noise correction ON results use a counted average of 100, PeakToAverage = 5.

Technical Specifications and Characteristics

Standard Configuration – Options F08, F14, F18, F27

Spectral purity (cont'd)

Residuals, images & spurious responses									
Non-input related spurs^{39, 40}									
<i>< -100 dBm, nominal</i>									
LO related spurs⁴¹	Offset	Nominal		Nominal		Nominal		Nominal	
	200 Hz - 1 kHz	1 - 10 kHz		10 - 100 kHz		100 kHz - 10 MHz		> 10 MHz	
100 kHz to 3.6 GHz	-67 dBc	-83 dBc	-66 dBc	-83 dBc	-67 dBc	-79 dBc	-65 dBc	-74 dBc	< -65 dBc
3.6 to 8.4 GHz	-62 dBc	-81 dBc	-63 dBc	-81 dBc	-68 dBc	-83 dBc	-64 dBc	-75 dBc	
8.4 to 13.6 GHz	-57 dBc	-76 dBc	-59 dBc	-78 dBc	-64 dBc	-78 dBc	-63 dBc	-72 dBc	
13.6 to 17.1 GHz	-55 dBc	-74 dBc	-57 dBc	-79 dBc	-62 dBc	-75 dBc	-61 dBc	-68 dBc	
17.1 to 27 GHz	-52 dBc	-70 dBc	-52 dBc	-74 dBc	-58 dBc	-71 dBc	-48 dBc	-64 dBc	
Frac-N-Spur ⁴²	<i>< -50 dBc + 20log(N), nominal</i>				<i>IF dither On, < -65 + 20log(N), nominal</i>				
First and higher order spurious responses^{39, 43}									
Below the noise floor by design									
IF rejection, nominal⁴⁴									
Frequency	40 MHz IF path			40 MHz alternate IF path			100/160 MHz IF path		
< 3.6 GHz									
Final IF	-80 dBc			-85 dBc			-82 dBc		
First IF	-64 dBc			-80 dBc			-71 dBc		
3.6 to 13.6 GHz	-78 dBc			-83 dBc			-78 dBc		
13.6 to 20 GHz	-70 dBc			-81 dBc			-70 dBc		
20 to 27 GHz	-53 dBc			-80 dBc			-55 dBc		
Image responses⁴⁵				Specification			Typical		
≤ 3.6 GHz	$f_{\text{IMAGE}} = (f_C \pm 2 * f_{\text{FINAL IF}})$			-63 dBc			-72 dBc		
	$f_{\text{IMAGE}} = (f_C \pm 2 * f_{\text{FIRST IF}})$			-77 dBc			-85 dBc		
> 3.6 GHz (digital image rejection ON)	$f_{\text{IMAGE}} = (f_C \pm 2 * f_{\text{FINAL IF}})$			Images are nominally below the noise floor					
Line related spurious responses									
<i>-60 dBc, nominal</i>									
Spurious free dynamic range (SFDR)									
<i>-72 dBc, nominal</i>									
LO emission⁴⁶		Pre-amp OFF, nominal				Pre-amp ON, nominal			
≤ 100 MHz		-69 dBm				-82 dBm			
> 100 MHz		-80 dBm							

39. Only applies in stepped spectrum mode with digital image rejection and IF dither enabled.

40. Expected input level: -50 dBm, mixer level offset: 0 dBm, pre-amp OFF, noise correction OFF. Enabling pre-amp and/or noise correction will yield a nominal 10 dB improvement. Known non-input related spur at 2.4 GHz nominally < -85 dBm.

41. Input level: -10 dBm, expected input level: 0 dBm, mixer level offset: 0 dBm, averages: 50.

42. N is the LO multiplication factor. See LO multiplier table for the N value versus frequency range.

43. Input level: 0 dBm, expected input level: 0 dBm, mixer level offset: 0 dBm, noise correction ON, averages: 10.

44. Suppression of signal at IF frequencies when turned at least 2x IF filter bandwidth away.

45. Expected input level = -10 dBm, Mixer level offset = 0 dB, Peak to average = 0 dB, f_C = analyzer center frequency, f_{IMAGE} = input frequency that is an image to analyzer center frequency, $f_{\text{FINAL IF}}$ = 240, 300, 326 MHz, $f_{\text{FIRST IF}}$ = 5040, 5100, 5126 MHz. Digital image rejection only available for frequencies > 3.6 GHz in stepped spectrum mode.

46. Expected input level = -50 dBm, RF attenuation = 0 dB. LO emissions refers to the LO power leaking out at the RF input port.

Technical Specifications and Characteristics

Standard Configuration – Options F08, F14, F18, F27

Time and acquisition

Maximum capture memory ⁴⁷	Memory size	Non-list mode acquisition limit	List mode acquisition limit
Option M01	512 MB	128 MSample	64 MSample
Option M05	2 GB	512 MSample	256 MSample
Option M10	4 GB	1 GSample	512 MSample ⁴⁸

Segments	
Minimum length	32 bytes
Maximum length	Full capture memory ⁴⁹

Maximum sample rate	Specification
Option B04 / 40 MHz	50 MS/s complex, 100 MS/s real
Option B10 / 100 MHz	125 MS/s complex, 250 MS/s real
Option B16 / 160 MHz	200 MS/s complex, 400 MS/s real

List mode	
Maximum number of segments	3201
Trigger sources	External, magnitude, wideband magnitude, wideband burst, software, immediate
Trigger modes	Per acquisition

Triggering	
Delay range ⁵⁰	-0.1 to +1 s
Delay resolution	1 sample
Delay accuracy	2 ns
Holdoff range	0 to 1 s
Holdoff resolution	10 ns
Acquisition minimum size	2 samples
Acquisition maximum size	1 GSamples

Timing ⁵¹	
Channel-to-channel synchronization	$\leq \pm 1 \text{ ns, nominal}$
Repeatability across instrument state changes	$< 50 \text{ ps, nominal}$

47. Sample count is based on 32-bit samples. For 64-bit samples, divide by 2.

48. The maximum size for a single list point capture is limited to 512 MSamples (2 GB). However, with option M10, total capture of up to 3.999 GB is available across all list mode captures.

49. The user can allocate memory for one or more acquisitions. Each acquisition takes up the memory that needs to be a power of 2. Minimum is 32 bytes.

50. Negative trigger delay limited to capture size.

51. Configured with a Keysight M9018A PXIe chassis for up to 4 channels. Repeatability across power cycles, IVI sessions, and module slot changes. Chassis FPGA version 1.05 or greater required.

Technical Specifications and Characteristics

Standard Configuration - Options F08, F14, F18, F27

Measurement speed

IQ data capture ⁵²		Nominal	
Large block (50 MSamples)	1.2 s	Transferred in 10 kSa blocks	
Small block (100 captures, 100 ksamples each)	252 ms	Transferred in 10 kSa blocks	
Adjust level, freq (10 ksamples)	1.6 ms	Transferred in 10 kSa blocks	

Power measurements ⁵³			
Channel power settings & filter bandwidth	Acquisition Time	Averages	Nominal
3.84 MHz	400 μ s	None	1.7 ms
		10	8.6 ms
	100 μ s	None	1.2 ms
		10	3.8 ms
	50 μ s	None	1.1 ms
		10	3.3 ms
30 kHz	100 μ s	None	3.9 ms
		10	30.7 ms

52. Capture block, transfer to host memory, 160 MHz BW, excludes frequency band transitions, with M9037A PXIe embedded controller and M9018A PXIe chassis (2-link configuration: 1 x 8 [factory default]).

53. Transfer to host memory, 160 MHz IF bandwidth filter, excludes frequency band transitions, with M9037A PXIe embedded controller and M9018A PXIe chassis (2-link configuration: 1 x 8 [factory default]).

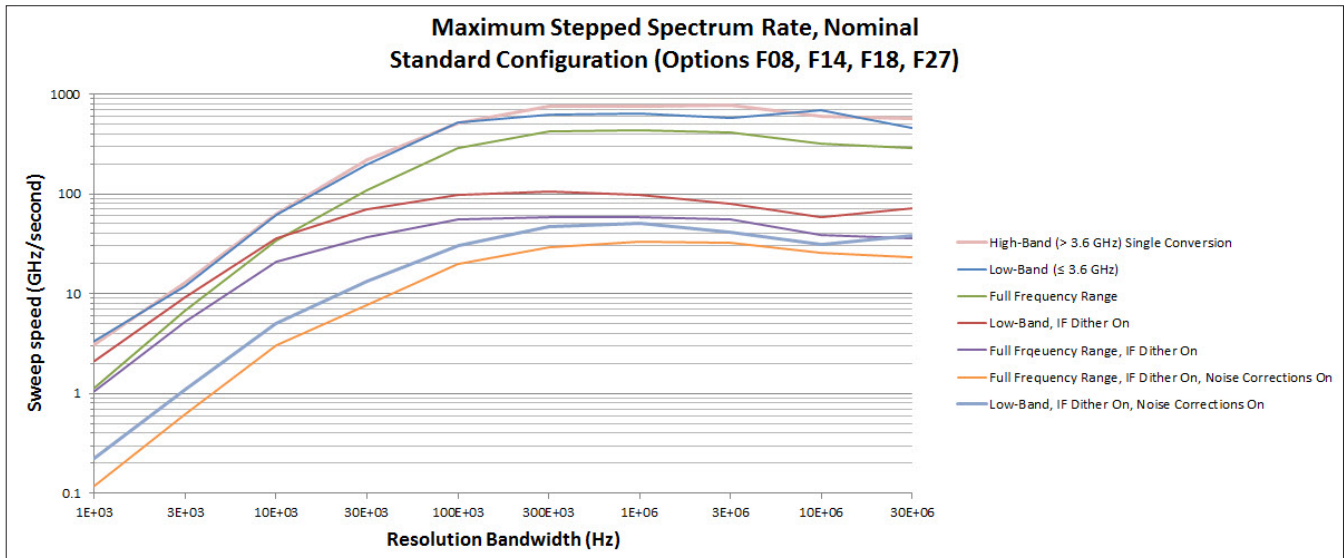

Figure 9. With 89600 VSA software Option SSA version 18.5 power spectrum measurement with M9037A PXIe embedded controller. M9214A IF digitizer in x8 slot and M9393A Option B16 (160 MHz bandwidth) and Option UNZ (fast switching).

Noise Figure Measurement Application

Description	Specifications	Supplemental Information
Noise figure		Uncertainty calculator ⁵⁴
< 10 MHz		See footnote ⁵⁵
10 MHz to 3.6 GHz		Internal and External preamplification recommended ⁵⁶
	Noise source ENR	Measurement range
	4 to 6.5 dB	0 to 20 dB
	12 to 17 dB	0 to 30 dB
	20 to 22 dB	0 to 35 dB
		Instrument Uncertainty⁵⁷
		± 0.02 dB
		± 0.025 dB
		± 0.03 dB

54. The figures given in the table are for the uncertainty added by the X-Series Signal Analyzer instrument only. To compute the total uncertainty for your noise figure measurement, you need to take into account other factors including: DUT NF, Gain and Match, Instrument NF, Gain Uncertainty and Match; Noise source ENR uncertainty and Match. The computations can be performed with the uncertainty calculator included with the Noise Figure Measurement Personality. Go to Mode Setup then select Uncertainty Calculator. Similar calculators are also available on the Keysight web site; go to <http://www.keysight.com/find/nfu>.

55. Uncertainty performance of the instrument is nominally the same in this frequency range as in the higher frequency range. However, performance is not warranted in this range. There is a paucity of available noise sources in this range, and the analyzer has poorer noise figure, leading to higher uncertainties as computed by the uncertainty calculator.

56. The NF uncertainty calculator can be used to compute the uncertainty. For most DUTs of normal gain, the uncertainty will be quite high without preamplification.

57. "Instrument Uncertainty" is defined for noise figure analysis as uncertainty due to relative amplitude uncertainties encountered in the analyzer when making the measurements required for a noise figure computation. The relative amplitude uncertainty depends on, but is not identical to, the relative display scale fidelity, also known as incremental log fidelity. The uncertainty of the analyzer is multiplied within the computation by an amount that depends on the Y factor to give the total uncertainty of the noise figure or gain measurement. See Keysight App Note 57-2, literature number 5952-3706E for details on the use of this specification. Jitter (amplitude variations) will also affect the accuracy of results. The standard deviation of the measured result decreases by a factor of the square root of the Resolution Bandwidth used and by the square root of the number of averages. This application uses the 4 MHz Resolution Bandwidth as default because this is the widest bandwidth with uncompromised accuracy.

Description	Specifications	Supplemental Information
Gain		
Instrument uncertainty ⁵⁸		DUT gain range = -20 to +40 dB. See note ⁵⁹
< 10 MHz		
10 MHz to 3.6 GHz	± 0.10 dB	

58. "Instrument Uncertainty" is defined for gain measurements as uncertainty due to relative amplitude uncertainties encountered in the analyzer when making the measurements required for the gain computation. See Keysight App Note 57-2, literature number 5952-3706E for details on the use of this specification. Jitter (amplitude variations) will also affect the accuracy of results. The standard deviation of the measured result decreases by a factor of the square root of the Resolution Bandwidth used and by the square root of the number of averages. This application uses the 4 MHz Resolution Bandwidth as default since this is the widest bandwidth with uncompromised accuracy. Under difficult conditions (low Y factors), the instrument uncertainty for gain in high band can dominate the NF uncertainty as well as causing errors in the measurement of gain. These effects can be predicted with the uncertainty calculator.

59. Uncertainty performance of the instrument is nominally the same in this frequency range as in the higher frequency range. However, performance is not warranted in this range. There is a paucity of available noise sources in this range, and the analyzer has poorer noise figure, leading to higher uncertainties as computed by the uncertainty calculator.

Description	Specifications	Supplemental Information
Noise figure uncertainty calculator⁶⁰		
Instrument noise figure uncertainty	See the noise figure table earlier in this chapter	
Instrument gain uncertainty	See the gain table earlier in this chapter	
Instrument noise figure		See graphs of “nominal instrument noise figure”; noise figure is DANL + 176.24 dB (nominal) ⁶¹
Instrument input match		See graphs: nominal VSWR

60. The Noise Figure Uncertainty Calculator requires the parameters shown in order to calculate the total uncertainty of a Noise Figure measurement.
 61. Nominally, the noise figure of the spectrum analyzer is given by $NF = D - (K - L + N + B)$ where D is the DANL (displayed average noise level) specification, K is kTB (-173.98 dBm in a 1 Hz bandwidth at 290 K) L is 2.51 dB (the effect of log averaging used in DANL verifications) N is 0.24 dB (the ratio of the noise bandwidth of the RBW filter with which DANL is specified to an ideal noise bandwidth) B is ten times the base-10 logarithm of the RBW (in hertz) in which the DANL is specified. B is 0 dB for the 1 Hz RBW. The actual NF will vary from the nominal due to frequency response errors.

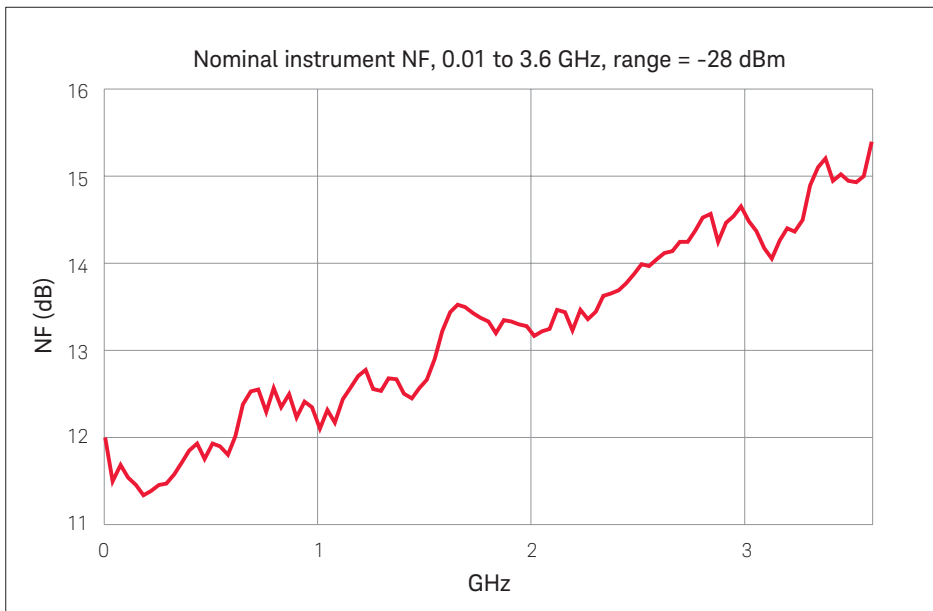

Technical Specifications and Characteristics

Standard Configuration – Options F08, F14, F18, F27

Format specific measurement data

16QAM ⁶²			
EVM	Fc	Unequalized, nominal	Equalized, nominal
RRC Alpha = 0.2, 50 MSymbols/s	1.8 GHz	0.39%	0.21%
	5.95 GHz	0.41%	0.20%
RRC Alpha = 0.35, 50 MSymbols/s	5.95 GHz	0.39%	0.19%
CDMA2000 ⁶³			
	Parameters	Nominal	
Pilot EVM	Fc = 0.9, 1.9 GHz	0.37%	
GSM ⁶³			
	Parameters	Nominal	
Global phase error	Fc = 0.9, 1.8, 1.9 GHz	0.18 °	
ORFS dynamic range (noise corrections OFF)	200 kHz offset	-36 dBc	
	250 kHz offset	-41.5 dBc	
	400 kHz offset	-68 dBc	
	600 kHz offset	-75 dBc	
	800 kHz offset	-77.5 dBc	
	1200 kHz offset	-81.5 dBc	
	1800 kHz offset	-79.5 dBc	
EDGE ⁶³			
	Parameters	Nominal	
Residual EVM	Fc = 0.9, 1.8, 1.9, 2.0, 2.1, 2.2 GHz	0.25%	
ORFS dynamic range (noise corrections OFF)	200 kHz offset	-36.5 dBc	
	250 kHz offset	-42 dBc	
	400 kHz offset	-67 dBc	
	600 kHz offset	-73.5 dBc	
	800 kHz offset	-76.5 dBc	
	1200 kHz offset	-81 dBc	
	1800 kHz offset	-78.5 dBc	
W-CDMA ⁶³			
	Parameters	Nominal	
Residual EVM	Fc = 0.9, 1.8, 1.9, 2.0, 2.1 GHz	0.50%	
ACLR dynamic range (channel bandwidth = 5 MHz, Fc = 2 GHz)		Noise corrections OFF, nominal	Noise corrections ON, nominal
	Adjacent	-73 dB	-75 dB
	Alternate	-75 dB	-79 dB
W-CDMA channel power accuracy		± 0.5 dB	

62. Input signal (total power) 0 dBm, range set to just above overload, conversion mode: Auto, Mixer level offset and IF level offset optimized for EVM performance.

63. Expected input level 0 dBm, input signal (total power) 0 dBm, Mixer level offset 0 dB, conversion mode: Auto, PeakToAverage set per signal peak to average.

Technical Specifications and Characteristics

Standard Configuration - Options F08, F14, F18, F27

Format specific measurement data (cont'd)

802.11g ⁶⁴	Parameters	Nominal 1-channel			
EVM	2.4 GHz, 20 MHz BW	-50.5 dB			
802.11a ⁶⁴	Parameters	Nominal 1-channel			
EVM	5.8 GHz, 20 MHz BW	-50 dB			
802.11n ^{64, 65}	Parameters 64-QAM	Nominal 1-channel	2-channel	3-channel	4-channel
Preamble only					
EVM	2.4 GHz, 40 MHz BW		-48.4 dB	-47 dB	-47.9 dB
	5.8 GHz, 40 MHz BW	-50.5 dB	-49.1 dB	-48 dB	-48.7 dB
Preamble, pilots, and data					
EVM	2.4 GHz, 40 MHz BW		-51.4 dB	-50.7 dB	-50.4 dB
	5.8 GHz, 40 MHz BW		-52.2 dB	-51.8 dB	-51.2 dB
802.11ac ^{64, 65}	Parameters 256-QAM	Nominal 1-channel	2-channel	3-channel	4-channel
Preamble only					
EVM	5.8 GHz, 80 MHz BW	-48.5 dB	-46.9 dB	-45.5 dB	-46.4 dB
	5.8 GHz, 160 MHz BW	-46 dB	-45.7 dB	-44.3 dB	-45.4 dB
Preamble, pilots, and data					
EVM	5.8 GHz, 80 MHz BW	-51.5 dB	-50.9 dB	-49.8 dB	-48.7 dB
	5.8 GHz, 160 MHz BW	-49.5 dB	-49.4 dB	-46.9 dB	-47.1 dB
SEM	5.8 GHz, 80 MHz BW	See Figure 10			
802.11a/g ⁶⁴	Parameters				
SEM	2.4 GHz, 20 MHz BW	See Figure 11			
	5.5 GHz, 20 MHz BW	See Figure 12			
802.16e ⁶⁴	Parameters	Nominal 1-channel			
OFDMA WiMAX™ EVM	Fc = 2.5, 3.5, & 5.8 GHz	-48 dB			

64. Expected input level 0 dBm, input signal (total power) 0 dBm, Mixer level offset 0 dB, conversion mode: Auto, PeakToAverage set per signal peak to average, demod symbol time adjustment -3.125%.

65. Minimum M9393A instrument driver version 1.1 required for multi-channel/MIMO operation.

Technical Specifications and Characteristics

Standard Configuration - Options F08, F14, F18, F27

Format specific measurement (cont'd)

LTE FDD-single channel ⁶⁶		Nominal 1-channel		
E-TM 3.1		5 MHz	10 MHz	20 MHz
EVM	$F_c < 3.6$ GHz	-47.5 dB	-48.5 dB	-48 dB
	$F_c \geq 3.6$ GHz	-49 dB	-51.5 dB	-50.5 dB
Channel BW = 5 MHz, Fc = 2 GHz		Noise corrections OFF	Noise corrections ON	
ACLR	Adjacent	-68.5 dB	-71 dB	
	Alternate	-71 dB	-77.5 dB	

LTE-FDD MIMO ^{66, 67}	Carrier frequency	2-channel, nominal	4-channel, nominal
10 MHz BW EVM, R9 downlink,	900 MHz	-50.7 dB (0.29%)	-50.7 dB (0.29%)
64 QAM, open loop spacial multiplexing	2 GHz	-49.3 dB (0.34%)	-48.9 dB (0.36%)

LTE-TDD MIMO ^{66, 67}	Carrier frequency	2-channel, nominal	4-channel, nominal
10 MHz BW EVM, R9 downlink,	900 MHz	-49.4 dB (0.34%)	-49.4 dB (0.29%)
64 QAM, open loop spacial multiplexing	2 GHz	-47.9 dB (0.4%)	-47.8 dB (0.41%)

66. Expected input level 0 dBm, input signal (total power) 0 dBm, Mixer level offset 0 dB, conversion mode: Auto, PeakToAverage set per signal peak to average, demod symbol time adjustment -3.125%.

67. Minimum M9393A instrument driver version 1.1 required for multi-channel/MIMO operation.

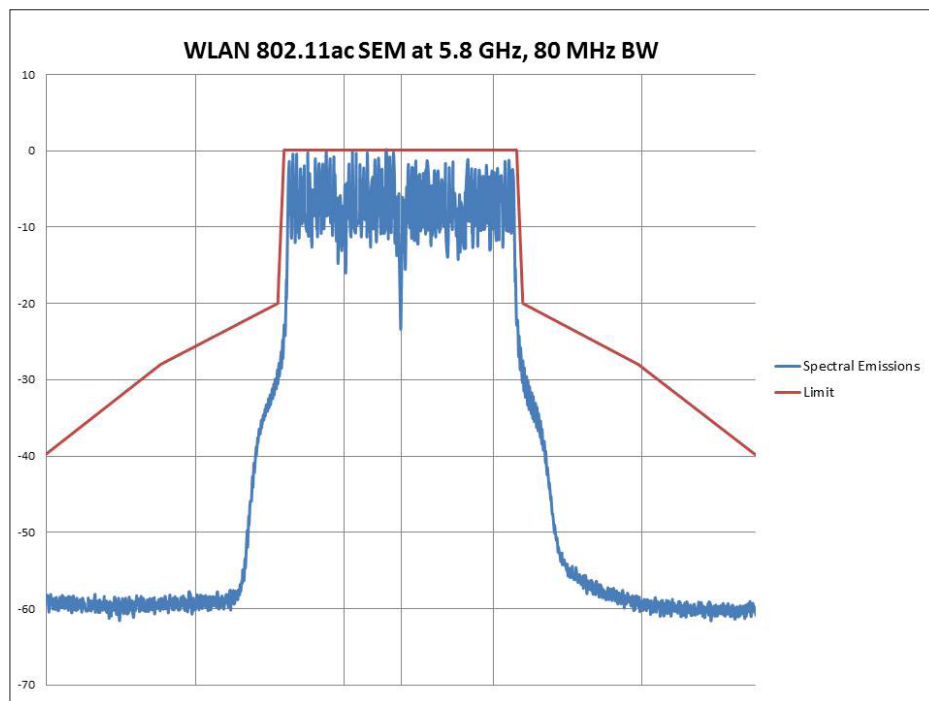

Figure 10. WLAN 802.11ac SEM at 5.8 GHz, 80 MHz bandwidth.

Technical Specifications and Characteristics

Standard Configuration - Options F08, F14, F18, F27

Format specific measurement (cont'd)

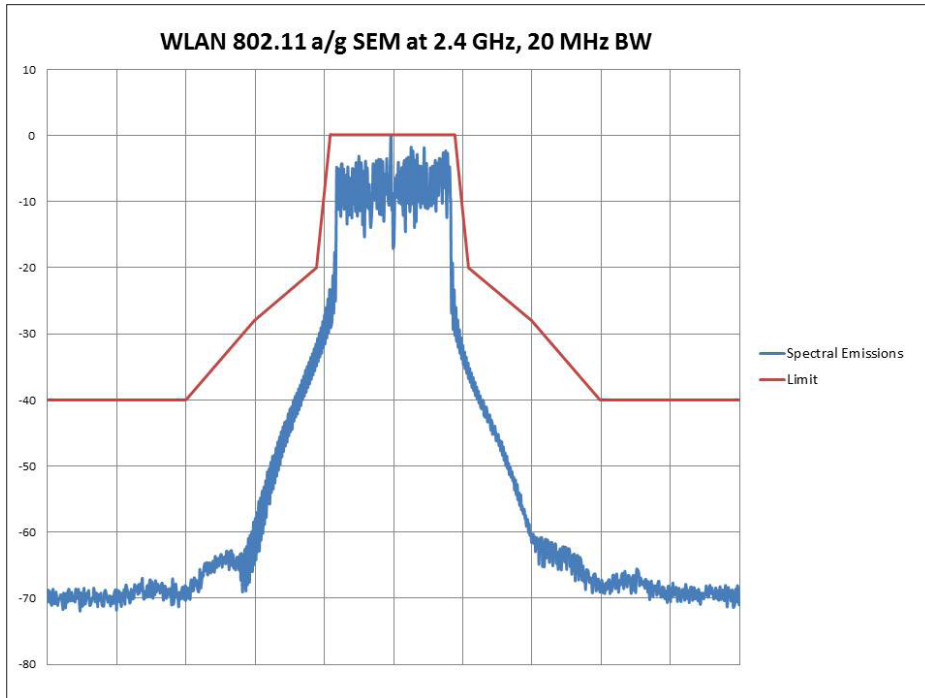

Figure 11. WLAN 802.11 a/g SEM at 2.4 GHz, 20 MHz bandwidth.

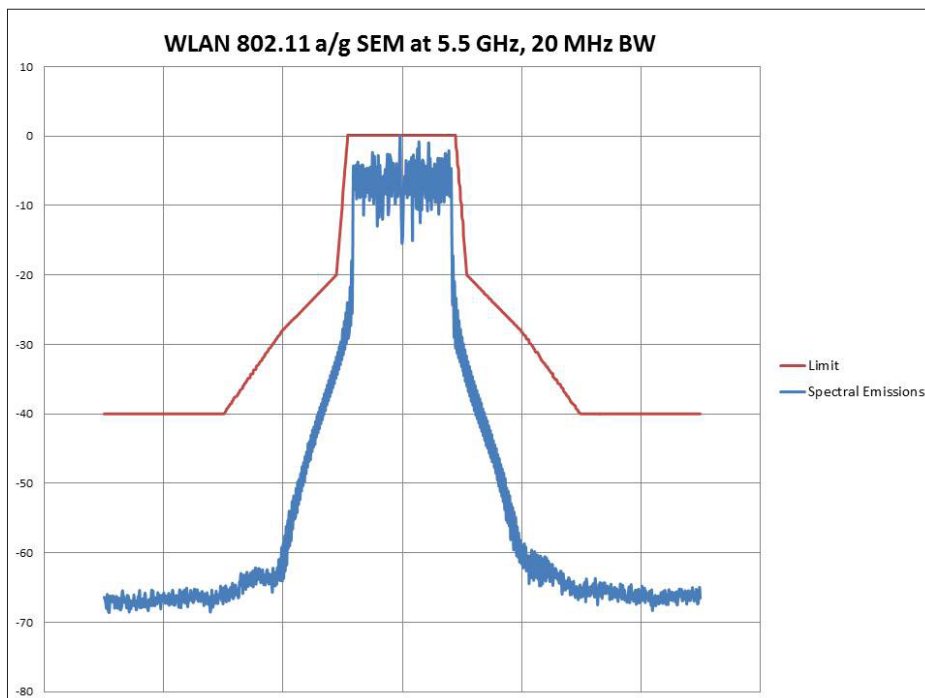

Figure 12. WLAN 802.11 a/g SEM at 5.5 GHz, 20 MHz bandwidth.

Technical Specifications and Characteristics

Extended Frequency Configuration - Option FRX

Block diagram

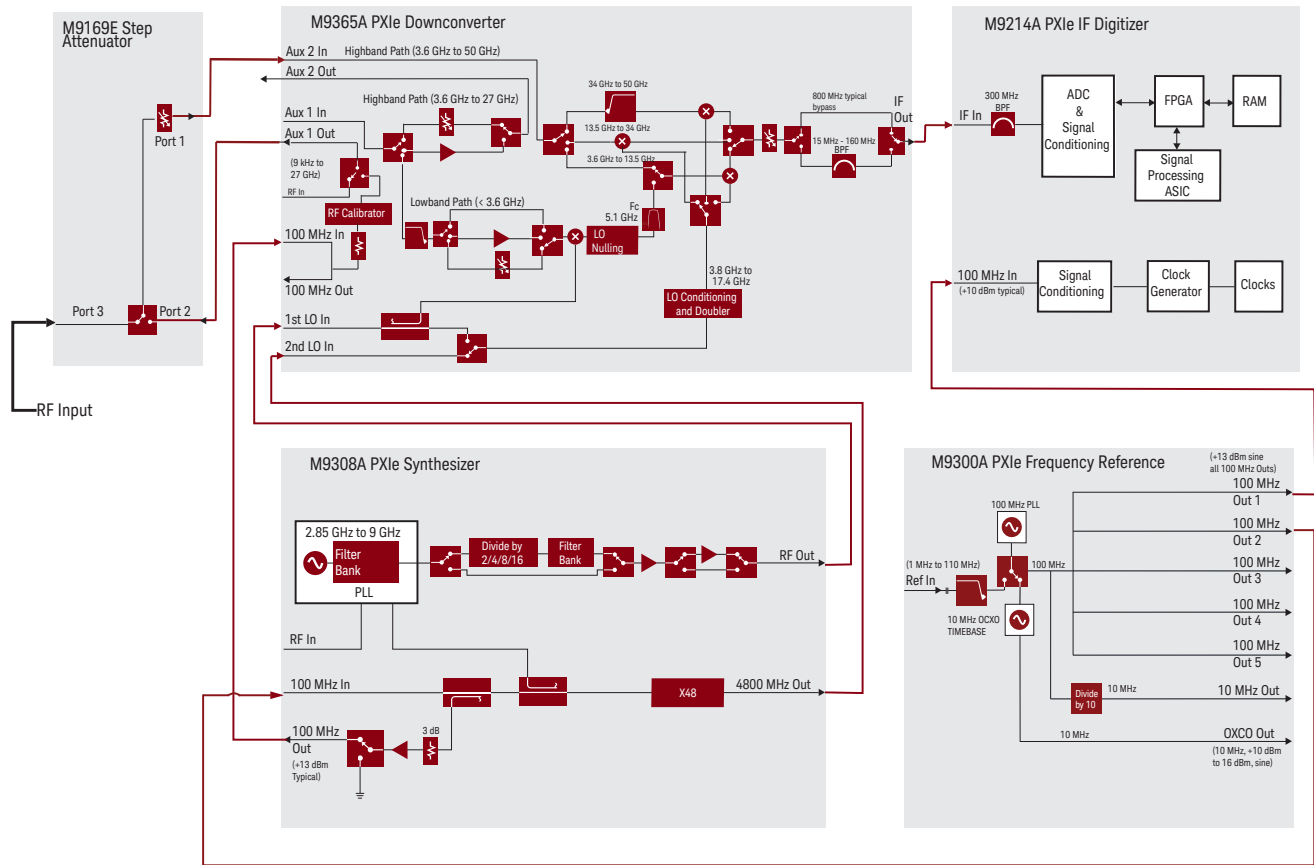

Figure 13. Extended frequency M9393A PXIe vector signal analyzer (3.6 to 50 GHz) block diagram with five modules consisting of the M9308A synthesizer, M9365A downconverter, M9214A digitizer and the optional M9300A frequency reference and M9169E switch input programmable step attenuator.

Technical Specifications and Characteristics

Extended Frequency Configuration - Option FRX

Frequency

Frequency range and resolution			
Option FRX	3.6 to 50 GHz		
Tuning resolution	Same as standard configuration		
Analysis bandwidth			
	Same as standard configuration		
IF frequency			
	Same as standard configuration		
Band	Harmonic mixing mode	LO multiple (N)	Frequency
Band 1	1	1	3.6 to 8.4 GHz
Band 2	1	2	8.4 to 13.6 GHz
Band 3	2	2	13.6 to 17.1 GHz
Band 4	2	4	17.1 to 27 GHz
Band 5	2	4	27 to 34 GHz
Band 6	4	8	34 to 50 GHz
Frequency switching speed ⁶⁸			
List mode switching speed	Band	Standard, nominal	Option UNZ, nominal
Baseband frequency offset change	Same as standard configuration		
Arbitrary frequency change within:	Bands 1 - 4	Same as standard configuration	
	Band 5	5 ms	< 200 μ s
	Band 6	5 ms	< 200 μ s
Non-list mode switching speed			
	Same as standard configuration		
Resolution bandwidth (RBW)			
Minimum RBW	Same as standard configuration		
Maximum span:RBW ratio	Same as standard configuration		
Maximum RBW			
3.6 to 31.8 GHz	Same as standard configuration		
> 31.8 GHz	10 MHz		
Video bandwidth (VBW)			
	Same as standard configuration		
Frequency span			
Range	Single FFT: Same as standard configuration Stepped: 800 Hz to 46.4 GHz		
Resolution	Same as standard configuration		
Frequency reference			
	Same as standard configuration		

68. Frequency changes may result in attenuator state changes when operating with M9169E module. Frequency switching speed does not include attenuator switching time.

Technical Specifications and Characteristics

Extended Frequency Configuration – Option FRX

Amplitude

Input level	Without M9169E		With M9169E	
Max safe average total power	+ 17 dBm		Refer to the M9169E data sheet	
Max DC voltage	± 10 Vdc			
Max RF input (recommended)	– 14 dBm			
Expected input level setting	Without M9169E		With M9169E	
Range	– 170 to – 14 dBm		– 170 to + 30 dBm	
Resolution	Same as standard configuration			
Attenuator	Not available for this configuration		Mechanical attenuator available with M9169E. Refer to M9169E data sheet	
Absolute amplitude accuracy, nominal ⁶⁹	Without M9169E ⁷⁰		With M9169E ⁷¹	
3.6 to 15 GHz	± 0.15 dB		± 0.20 dB	
> 15 to 30 GHz	± 0.39 dB		± 0.38 dB	
> 30 to 50 GHz	± 1.58 dB		± 0.83 dB	
IF flatness, nominal ⁷²	Without M9169E ⁷³		With M9169E	
Frequency	3.6 to 18 GHz	> 18 to 50 GHz	3.6 to 18 GHz	> 18 to 50 GHz
Across any 20 MHz in 40 MHz path	± 0.08 dB	± 0.18 dB	± 0.1 dB	± 0.21 dB
Across any 20 MHz in 160 MHz path	± 0.1 dB	± 0.26 dB	± 0.12 dB	± 0.31 dB
40 MHz	± 0.12 dB	± 0.29 dB	± 0.25 dB	± 0.36 dB
100 MHz	± 0.15 dB	± 0.46 dB	± 0.33 dB	± 0.76 dB
160 MHz	± 0.23 dB	± 0.77 dB	± 0.43 dB	± 1.05 dB
IF phase linearity, nominal ⁷²	Without M9169E ⁷³		With M9169E	
Frequency	3.6 to 17 GHz	> 17 to 50 GHz	3.6 to 17 GHz	> 17 to 50 GHz
Across any 20 MHz in 40 MHz path	± 1.57°	± 2.13°	± 1.8°	± 2.17°
Across any 20 MHz in 160 MHz path	± 1.43°	± 2.51°	± 1.39°	± 2.35°
40 MHz	± 1.58°	± 2.3°	± 1.8°	± 2.62°
100 MHz	± 1.88°	± 3.64°	± 2.38°	± 4.06°
160 MHz	± 2.89°	± 3.8°	± 2.57°	± 4.06°
IF bandwidth filter switching uncertainty	Same as standard configuration with pre-amp off			
Expected input level switching uncertainty, nominal ^{69,70}			With M9169E	
3.6 to 30 GHz			± 0.15 dB	
> 30 to 50 GHz			± 0.3 dB	

69. Measured using an attenuator with VSWR performance equal to or better than the Keysight 8490D-020 coaxial attenuator. Peak to average = 0 dB. Applies after comprehensive alignment. Frequency is exclusive on the start frequency and inclusive on the stop frequency.

70. Referenced to expected input level setting of –14 dBm for configuration without M9169E.

71. Referenced to expected input level setting of –5 dBm for configuration with M9169E.

72. Applies after comprehensive alignment. Deviation from the mean error of the entire bandwidth. Expected input level = 0 dBm, Mixer level offset = 0. Applies for bandwidths where (center frequency ± bandwidth/2) does not exceed the frequency range.

73. Measured using an attenuator with VSWR performance equal to or better than the Keysight 8490D-020 coaxial attenuator.

Technical Specifications and Characteristics

Extended Frequency Configuration – Option FRX

Amplitude (cont'd)

	Without M9169E	With M9169E
Amplitude switching speed	–	Refer to M9169E data sheet
Trace detectors	Same as standard configuration	
Preamplifier	Not available for this configuration	

Dynamic range

Displayed average noise level (DANL), nominal⁶⁶	Without M9169E	With M9169E
3.6 to 13.6 GHz	–161 dBm/Hz	–158 dBm/Hz
> 13.6 to 34 GHz	–158 dBm/Hz	–153 dBm/Hz
> 34 to 45 GHz	–156 dBm/Hz	–151 dBm/Hz
> 45 to 50 GHz	–153 dBm/Hz	–147 dBm/Hz
Third order intermodulation distortion (TOI), nominal⁶⁷	Without M9169E	With M9169E
3.6 to 13.6 GHz	9.5 dBm / –53 dBc	11 dBm / –56 dBc
> 13.6 to 34 GHz	5.5 dBm / –45 dBc	8.5 dBm / –51 dBc
> 34 to 50 GHz	–2 dBm / –30 dBc	2.5 dBm / –39 dBc
Second harmonic distortion (SHI), nominal	Without M9169E	With M9169E
3.6 to 13.6 GHz	33 dBm / –33 dBc	Add loss from M9169E data sheet
13.6 to 34 GHz	25.5 dBm / –25.5 dBc	
34 to 50 GHz	18 dBm / –18 dBc	

74. Mixer level offset = 0, Conversion = auto, PeakToAverage = 0. Expected input level = –60 dBm

75. Tone separation = 100 kHz, Expected input level = –14 dBm, Mixer offset level = 0 dB, PeakToAverage = 6 dB, Conversion type Auto. Signal level of –17 dBm used to calculate distortion in dBc. TOI = third order intercept. The TOI is given by the input tone level (in dBm) minus (distortion/2) where distortion is the relative level of the distortion tones in dBc.

Technical Specifications and Characteristics

Extended Frequency Configuration - Option FRX

Spectral purity

Phase noise

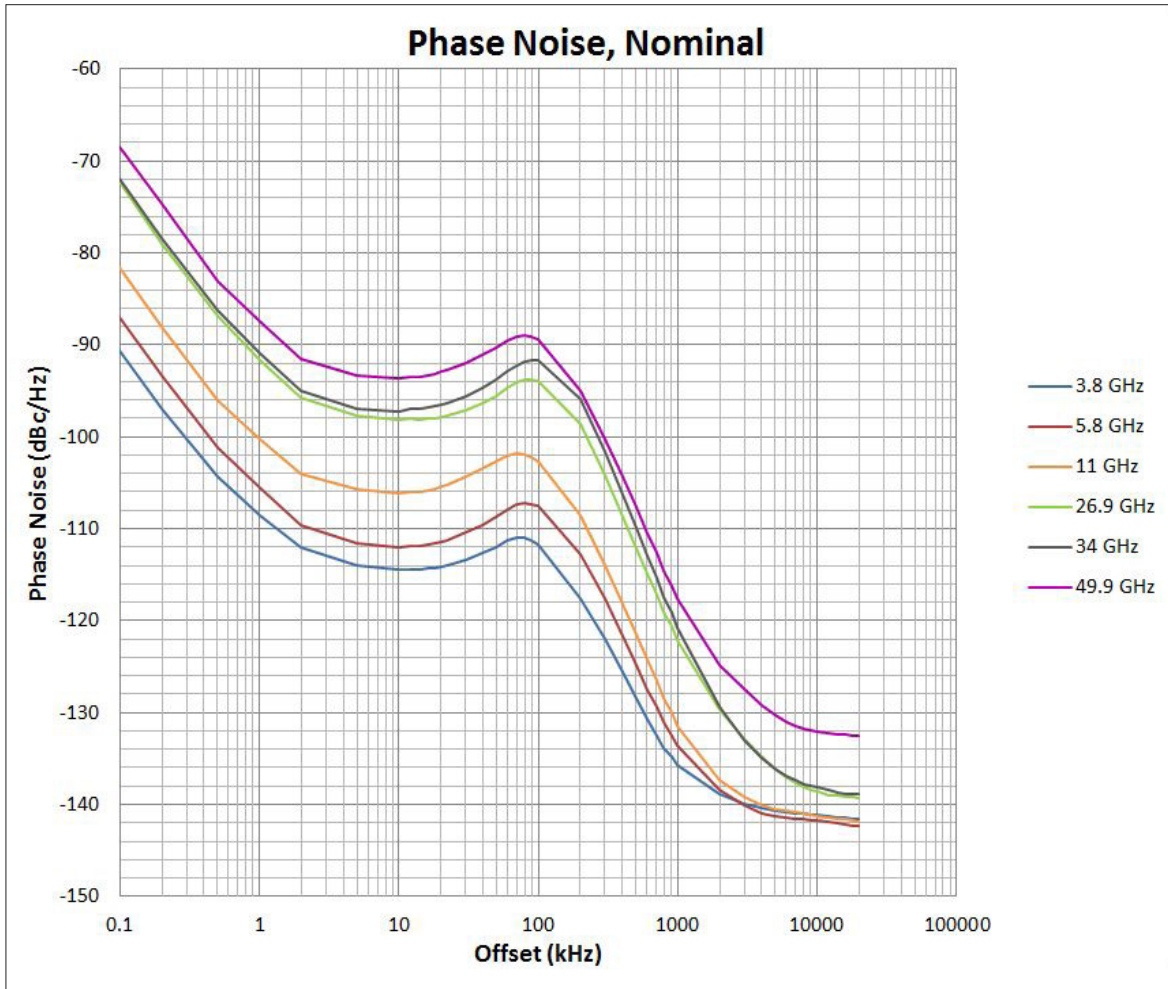

Figure 14. Nominal phase noise 1 to 49.9 GHz. Expected input level = -14 dBm, Mixer level offset = 0 dB, PeakToAverage = 5.

Spurious free dynamic range (SFDR)

Same as standard configuration

Technical Specifications and Characteristics

Extended Frequency Configuration – Option FRX

Time and acquisition

Maximum capture memory	Same as standard configuration
Segments	Same as standard configuration
Maximum sample rate	Same as standard configuration
List mode	Same as standard configuration
Triggering	Same as standard configuration
Timing ⁷⁶	
Channel-to-channel synchronization	$< \pm 1 \text{ ns, nominal}$
Repeatability across instrument state changes	$< \pm 50 \text{ ps, nominal}$

Measurement speed

IQ data capture	Same as standard configuration
Power measurements	Same as standard configuration

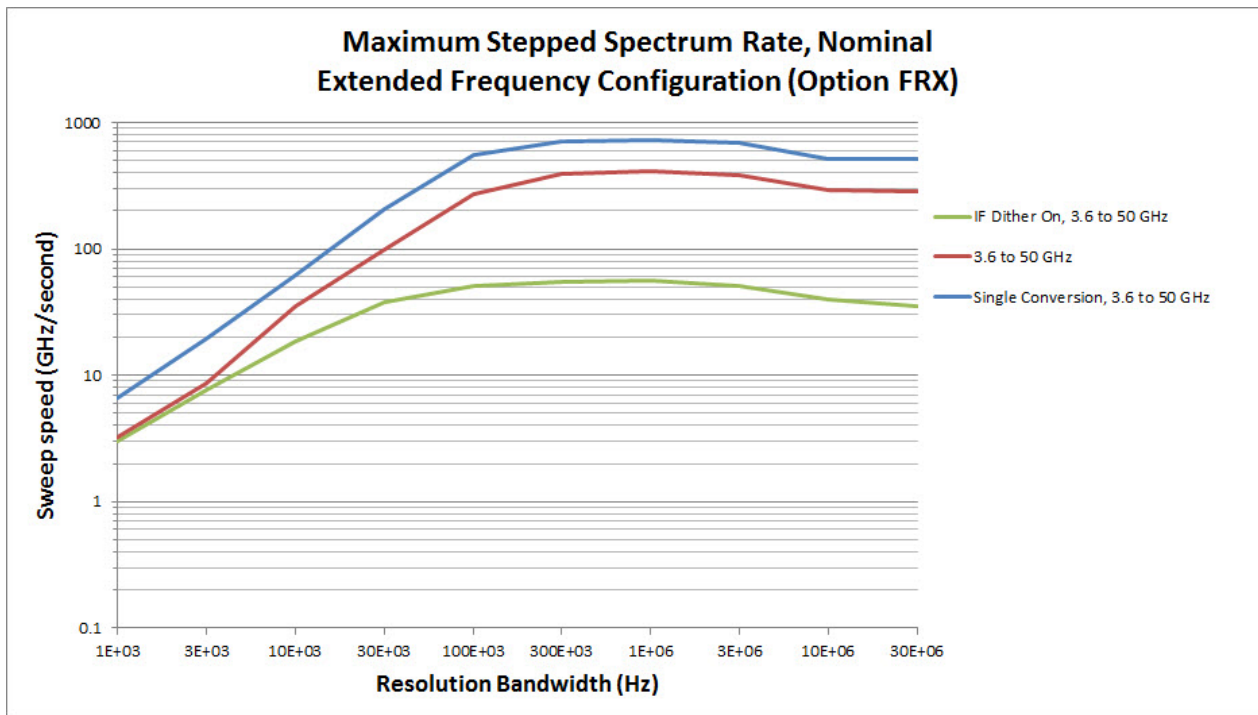

Figure 15. FRX spectrum frequency plot

76. Configured with a Keysight M9018A PXIe chassis. Repeatability across power cycles and IVI sessions. Applies to 2 channels in configurations both with and without M9169E with chassis FPGA version 1.05 or greater required

77. Input signal (total power) 0 dBm, range set to just above overload, conversion mode: Auto, Mixer level offset and IF level offset optimized for EVM performance..

Technical Specifications and Characteristics

Extended Frequency Configuration - Option FRX

16 QAM ⁷⁸ EVM	Without M9169E		With M9169E		
	Fc	Unequalized, nominal	Equalized, nominal	Unequalized, nominal	Equalized, nominal
RRC Alpha = 0.2, 50 MSymbols/s	5.95 GHz	0.43%	0.22%	0.49%	0.22%
RRC Alpha = 0.35, 50 MSymbols/s	5.95 GHz	0.37%	0.21%	0.43%	0.20%
RRC Alpha = 0.2, 62.5 MSymbols/s	5.95 GHz	0.57%	0.22%	0.69%	0.22%
RRC Alpha = 0.35, 62.5 MSymbols/s	5.95 GHz	0.54%	0.21%	0.60%	0.20%
	15 GHz	-	-	0.47%	0.37%
	24 GHz	-	-	1.54%	0.99%
	31 GHz	-	-	1.32%	0.55%
RRC Alpha = 0.35, 104.167 MSymbols/s	40 GHz	-	-	1.21%	0.77%
	15 GHz	-	-	0.50%	0.40%
	24 GHz	-	-	1.87%	1.21%
	31 GHz	-	-	1.76%	0.55%
	40 GHz	-	-	1.32%	0.77%

78. Input signal (total power) 0 dBm, range set to just above overload, conversion mode: Auto, Mixer level offset and IF level offset optimized for EVM performance.

Environmental and Physical Specifications

Temperature	Operating		Individual module temp 15 to 75 °C as reported by the module and environment temp of 0 to 55 °C	
	Non-operating (storage)		Environment temp of -40 to +70 °C	
Humidity ⁷⁹			Type tested at 95%, +40 °C (non-condensing)	
Shock/vibration ⁷⁹	Operating random vibration		Type tested at 5 to 500 Hz, 0.21 g rms	
	Survival random vibration		Type tested at 5 to 500 Hz, 2.09 g rms	
	Functional shock		Type tested at half-sine, 30 g, 11 ms	
	Bench handling		Type tested per MIL-PRF-28800F	
Altitude			Up to 15,000 feet (4,572 meters) ⁸⁰	
Connectors	RF In		APC 3.5 mm (f)	
	Aux 2 In		2.4 mm (f)	
EMC			Complies with European EMC Directive 2004/108/EC <ul style="list-style-type: none"> - IEC/EN 61326-2-1 - CISPR Pub 11 Group 1, class A - AS/NZS CISPR 11 - ICES/NMB-001 This ISM device complies with Canadian ICES-001. Cet appareil ISM est conforme a la norme NMB-001 du Canada.	
Warm-up time			30 minutes	
Size	M9300A		1 PXIe slot	
	M9308A		1 PXIe slot	
	M9365A		2 PXIe slots	
	M9214A		1 PXIe slot	
Dimensions	Module	Length	Width	Height
	M9300A	210 mm	22 mm	130 mm
	M9308A	210 mm	22 mm	130 mm
	M9365A	210 mm	44 mm	130 mm
	M9214A	210 mm	22 mm	130 mm
Weight	M9300A		0.55 kg (1.21 lbs)	
	M9308A		0.59 kg (1.31 lbs)	
	M9365A		1.05 kg (2.31 lbs)	
	M9214A		0.36 kg (0.79 lbs)	
Power drawn from chassis	M9300A		≤ 18 W	
	M9308A		≤ 37 W	
	M9365A		≤ 50 W	
	M9214A		≤ 35 W	

79. Samples of this product have been type tested in accordance with the Keysight Environmental Test Manual and verified to be robust against the environmental stresses of storage, transportation and end-use – those stresses include but are not limited to temperature, humidity, shock, vibration, altitude and power-line conditions. Test methods are aligned with IEC 60068-2 and levels are similar to MIL-PRF-28800F Class 3.

80. At 15,000 feet, the maximum environmental temperature is de-rated to 52 °C.

System Requirements ⁸¹





Operating system ⁸²	Windows 7 (32 & 64 bit)
Processor speed	1.5 GHz dual core (x86 or x64) minimum, 2.4 GHz recommended No support for Itanium64
Available memory	4 GB minimum 8 GB recommended
Available disk space	1.5 GB available hard disk space includes: 1 GB for Microsoft .NET framework 4.0 ⁸³ 100 MB for Keysight IO libraries suite
Video	Support for DirectX 9 graphics with 128 MB graphics recommended (SuperVGA supported)
Browser	Microsoft Internet Explorer 7.0 or greater

81. For a list of computers compatible with Keysight Technologies PXIe M9018A chassis, refer to Tested Computer Technical Note (literature no. 5990-7632EN).

82. Due to Microsoft end of support for Windows XP, M9393A is not supported on Windows XP. At the time of release 1.1 there were no known critical issues running on Windows XP, however if you encounter an issue unique to Windows XP, Keysight may not attempt to address the issue.

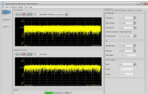
83. .NET framework runtime components are installed by default with Windows 7. Therefore, you may not need this amount of available disk space.

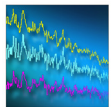
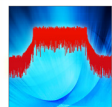
Software

Instrument connection software			
	Keysight IO library	The IO library suite offers a single entry point for connection to the most common instruments including AXIe, PXI, GPIB, USB, Ethernet/LAN, RS-232, and VXI test instruments from Keysight and other vendors. It automatically discovers interfaces, chassis, and instruments. The graphical user interface allows you to search for, verify, and update IVI instrument and soft front panel drivers for modular and traditional instruments. The IO suite safely installs in side-by-side mode with NI I/O software.	Free software download at www.keysight.com/find/iosuite
Module setup and usage			
	Keysight soft front panel	The PXI module includes a soft front panel (SFP), a software-based graphical user interface (GUI) which enables the instrument's capabilities from your PC.	Included on optional CD-ROM shipped with module or online
Module management			
	Keysight connection expert	Connection expert is the graphical user interface included in the IO libraries suite that allows you to search for, verify and update IVI instrument and soft front panel drivers for modular and traditional instruments	Free software download at www.keysight.com/find/iosuite
Programming			
Driver	Development environments		
IVI-COM IVI-C MATLAB	Visual Studio (VB.NET, C#, C/C++), VEE, LabVIEW, LabWindows/CVI, MATLAB		Included on optional CD-ROM shipped with module
Programming assistance			
	Command expert	Assists in finding the right instrument commands and setting correct parameters. A simple interface includes documentation, examples, syntax checking, command execution, and debug tools to build sequences for integration in Excel, MATLAB, Visual Studio, VEE, and SystemVue.	Free software download at www.keysight.com/find/commandexpert
	Programming examples	Each module includes programming examples for Visual Studio.net, MATLAB, and Keysight VEE Pro.	Included on optional CD-ROM shipped with module
Signal analysis software			
	X-Series measurement applications for modular instruments	The X-Series measurement applications transform modular PXI VSAs into standards based RF transmitter testers. Provides conformance measurements for communications standards including: LTE, WLAN 802.11ac and others. Only available for M9393A standard configuration.	Licensed software. For more information, visit www.keysight.com/find/pxi-x-series_apps
	89600 VSA	89600 VSA software sees through the complexity of emerging and existing industry standards, serving as your window into complex signal interactions.	Licensed software. For more information, visit www.keysight.com/find/vsa
	SystemVue	SystemVue is a system-level EDA platform for designing communications and defense systems. Used with the M9393A, SystemVue enables you to create model-based design validation tests to ensure consistency from design to manufacturing.	Licensed software. For more information, visit www.keysight.com/find/systemvue

Setup, Calibration Services, Support and Warranty

Assistance		
One day startup assistance	Gain access to a technical expert who will help you get started quickly with the M9393A PXI Performance VSA and its powerful software tools. The flexible instruction format is designed to get you to your first measurements and familiarize you with ways to adapt the equipment to a specific application.	Included in base configuration
Calibration and traceability		
Factory calibration	The M9393A PXI Performance VSA ships factory calibrated with an ISO-9002, NIST-traceable calibration certificate.	Included in base configuration
Calibration cycle	A one year calibration cycle is recommended.	
Calibration sites	<ul style="list-style-type: none"> – At Keysight worldwide service centers – On-site by Keysight – By self-maintainers 	For more information visit www.keysight.com/find/infoline
N7800A calibration and adjustment software	The M9393A PXI Performance VSA is supported by Keysight's calibration and adjustment software. This is the same software used at Keysight service centers to automate calibration. The software offers compliance tests for ISO 17025:2005, ANSI/NCSL Z540.3-2006, and measurement uncertainty per ISO Guide to Expression of Measurement Uncertainty.	Licensed software. For more information, visit www.keysight.com/find/calibrationsoftware
Keysight calibration status utility	The Keysight calibration status utility helps ensure your M9393A is calibrated by managing the calibration interval and providing messages regarding instrument and module calibration status.	Included in base configuration
Warranty		
Global warranty	Keysight's warranty service provides standard coverage for the country where product is used. <ul style="list-style-type: none"> – All parts and labor necessary to return to full specified performance – Recalibration for products supplied originally with a calibration certificate – Return shipment 	Included
Standard	Return to Keysight warranty – 3 years 15 days typical turnaround repair service	Included
R-51B-001-5Z	Return to Keysight warranty – 5 years 15 days typical turnaround repair service	Optional
R-51B-001-3X Express warranty 3 years	The express warranty upgrades the global warranty to provide, for 3 years, a 5-day typical turnaround repair service in the US, Japan, China and many EU countries.	Optional
R-51B-001-5X Express warranty 5 years	The express warranty upgrades the global warranty to provide, for 5 years, a 5-day typical turnaround repair service in the US, Japan, China and many EU countries.	Optional
Support		
Core exchange program	Keysight's replacement core exchange program allows fast and easy module repairs. A replacement core assembly is a fully functioning pre-calibrated module replacement that is updated with the defective module serial number, allowing the replacement module to retain the original serial number.	For qualified self-maintainers in US only
Self-test utility	A self-test utility runs a set of internal tests which verifies the health of the modules and reports their status.	Included in base configuration

Configuration and Ordering Information

Ordering information

Model	Description
M9393A	PXIe performance vector signal analyzer: 9 kHz to 8.4, 14, 18, or 27 GHz Includes: M9308A PXIe synthesizer M9365A PXIe downconverter M9214A PXIe IF digitizer One day startup assistance Module interconnect cables Software, example programs and product information on CD (optional) Return to Keysight warranty – 3 years
Standard base configuration	
M9393A-F08	Frequency range: 9 kHz to 8.4 GHz
M9393A-B04	Analysis bandwidth, 40 MHz
M9393A-M01	Memory, 128 MSa
M9393A-300	Adds M9300A PXIe frequency reference: Required for 10 and 100 MHz (M9300A module can support warranted multiple M9393A modular instruments) specifications

Configurable options

For a complete list of the M9393A PXI Performance VSA product options, please consult the M9393A configuration guide, literature number **5991-4580EN**.

Frequency	
M9393A-F14	9 kHz to 14 GHz
M9393A-F18	9 kHz to 18 GHz
M9393A-F27	9 kHz to 27 GHz
M9393A-FRX	3.6 to 50 GHz Requires Option F27
Additional capability	
M9393A-UNZ	Fast tuning
M9393A-WB1	Wideband IF output
Analysis bandwidth	
M9393A-B10	100 MHz
M9393A-B16	160 MHz
Memory	
M9393A-M05	512 MSa
M9393A-M10	1024 MSa
Pre-amplifier	
M9393A-P08	8.4 GHz preamplifier
M9393A-P14	14 GHz preamplifier
M9393A-P18	18 GHz preamplifier
M9393A-P27	27 GHz preamplifier
Other	
M9393A-UK6	Commercial calibration certificate with test data for M9393A (M9308A, M9365A, M9214A)
M9300A-UK6	Commercial calibration certificate with test data for M9300A (module only)
Related products in recommended configuration	
M9037A	PXIe embedded controller
M9018A	18-slot PXIe chassis
M9169E	Programmable step attenuator recommended for Option FRX
M9203A	PXIe wideband IF digitizer for Option WB1

Configuration and Ordering Information

Software information

Supported operating systems	Microsoft Windows 7 (32/64-bit)
Standard compliant drivers	IVI-COM, IVI-C, MATLAB
Supported application development environments (ADE)	VisualStudio (VB.NET, C#, C/C++), VEE, LabVIEW, LabWindows/CVI, MATLAB
Keysight IO libraries (version 16.3 or newer)	Includes: VISA libraries, Keysight Connection Expert, IO monitor
Keysight Command Expert	Instrument control for SCPI or IVI-COM drivers
89600 VSA Software (recommended minimum version 20)	89601B-200 89600 VSA software, basic and hardware connectivity 89601B-SSA Spectrum analysis 89601B-AYA Digital demodulation 89601B-BHF Custom OFDM 89601B-B7T cdma2000®/1xEV-DO 89601B-B7U W-CDMA/HSPA+ 89601B-B7R WLAN 802.11a/b/g/j/p 89601B-BHJ WLAN 802.11ac MIMO 89601B-B7X TD-SCDMA 89601B-BHD LTE FDD 89601B-BHG LTE FDD - Advanced 89601B-BHE LTE TDD 89601B-BHH LTE TDD - Advanced 89601B-B7W 1xEV-DO 89601B-B7R 3G bundle 89601B-BHC RFID 89601B-BHK Custom IQ 89601B-BHL Channel quality 89601B-BHM DOCSIS 3.1 89601B-BHP FMCW radar 89601B-BHQ Pulse
X-Series Measurement Applications for Modular Instruments transportable perpetual license (only available for M9393A standard configuration)	M9063A Analog M9064A VXA Vector Signal Analysis M9068A Phase noise M9071A GSM/EDGE/Evo M9072A cdma2000/cdmaOne M9073A W-CDMA/HSPA+ M9076A 1xEV-DO M9077A WLAN 802.11a/b/g/n/ac M9079A TD-SCDMA/HSDPA M9080B LTE/LTE-A FDD M9081A Bluetooth® M9082B LTE/LTE-A TDD

Accessories

Model	Description
Y1212A	Slot blocker kit: 5 modules
Y1213A	PXI EMC filler panel kit: 5 slots
Y1214A	Air inlet kit: M9018A 18-slot chassis
Y1215A	Rack mount kit: M9018A 18-slot chassis

Related products

Model	Description
M9381A	PXIe vector signal generator
M9380A	PXIe CW source
M9300A	PXIe frequency reference
M9021A	PCIe® cable interface
M9045B	PCIe express card adaptor for laptop connectivity
Y1200B	PCIe cable for laptop connectivity
M9048A	PCIe desktop adaptor for desktop connectivity
Y1202A	PCIe cable for desktop connectivity

Advantage services: Calibration and warranty

Keysight Advantage Services is committed to your success throughout your equipment's lifetime

R-51B-001-5Z	Return to Keysight warranty – 5 years
R-51B-001-3X	Express warranty – 3 years
R-51B-001-5X	Express warranty – 5 years
N7800A	Calibration & adjustment software

Evolving

Our unique combination of hardware, software, support, and people can help you reach your next breakthrough. **We are unlocking the future of technology.**

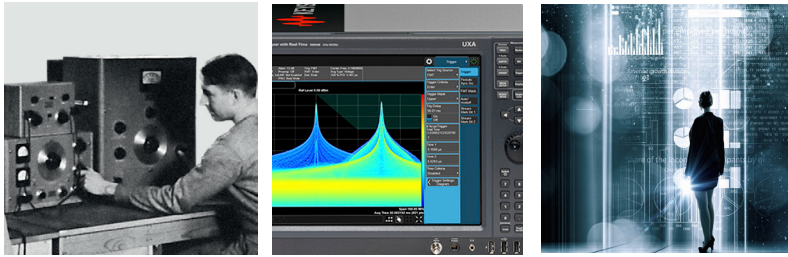

From Hewlett-Packard to Agilent to Keysight

For more information on Keysight Technologies' products, applications or services, please contact your local Keysight office. The complete list is available at: www.keysight.com/find/contactus

Americas

Canada	(877) 894 4414
Brazil	55 11 3351 7010
Mexico	001 800 254 2440
United States	(800) 829 4444

Asia Pacific

Australia	1 800 629 485
China	800 810 0189
Hong Kong	800 938 693
India	1 800 11 2626
Japan	0120 (421) 345
Korea	080 769 0800
Malaysia	1 800 888 848
Singapore	1 800 375 8100
Taiwan	0800 047 866
Other AP Countries	(65) 6375 8100

Europe & Middle East

Austria	0800 001122
Belgium	0800 58580
Finland	0800 523252
France	0805 980333
Germany	0800 6270999
Ireland	1800 832700
Israel	1 809 343051
Italy	800 599100
Luxembourg	+32 800 58580
Netherlands	0800 0233200
Russia	8800 5009286
Spain	800 000154
Sweden	0200 882255
Switzerland	0800 805353
	Opt. 1 (DE)
	Opt. 2 (FR)
	Opt. 3 (IT)
United Kingdom	0800 0260637

For other unlisted countries:
www.keysight.com/find/contactus
 (BP-2-23-17)



www.keysight.com/go/quality
 Keysight Technologies, Inc.
 DEKRA Certified ISO 9001:2015
 Quality Management System

myKeysight

myKeysight

www.keysight.com/find/mykeysight

A personalized view into the information most relevant to you.

KEYSIGHT SERVICES

Accelerate Technology Adoption.
 Lower costs.

Keysight Services

www.keysight.com/find/service

Our deep offering in design, test, and measurement services deploys an industry-leading array of people, processes, and tools. The result? We help you implement new technologies and engineer improved processes that lower costs.

Three-Year Warranty

www.keysight.com/find/ThreeYearWarranty

Keysight's committed to superior product quality and lower total cost of ownership. Keysight is the only test and measurement company with three-year warranty standard on all instruments, worldwide. And, we provide a one-year warranty on many accessories, calibration devices, systems and custom products.



Keysight Assurance Plans

www.keysight.com/find/AssurancePlans

Up to ten years of protection and no budgetary surprises to ensure your instruments are operating to specification, so you can rely on accurate measurements.



Keysight Channel Partners

www.keysight.com/find/channelpartners

Get the best of both worlds: Keysight's measurement expertise and product breadth, combined with channel partner convenience.

PCI-SIG®, PCIe® and the PCI Express® are US registered trademarks and/or service marks of PCI-SIG. cdma2000 is a US registered certification mark of the Telecommunications Industry Association.

Bluetooth and the Bluetooth logos are trademarks owned by Bluetooth SIG, Inc., U.S.A. and licensed to Keysight Technologies, Inc.

WiMAX, Mobile WiMAX, WiMAX Forum, the WiMAX Forum logo, WiMAX Forum Certified, and the WiMAX Forum Certified logo are US trademarks of the WiMAX Forum.

www.keysight.com/find/m9393a

www.keysight.com/find/modular



Unlocking Measurement Insights

This information is subject to change without notice.
 © Keysight Technologies, 2014 - 2017
 Published in USA, April 29, 2017
 5991-4538EN
www.keysight.com