

RIGOL

Quick Guide

DSG800 Series RF Signal Generator

Sept. 2018

RIGOL (SUZHOU) TECHNOLOGIES, INC.

Guaranty and Declaration

Copyright

© 2015 **RIGOL** (SUZHOU) TECHNOLOGIES, INC. All Rights Reserved.

Trademark Information

RIGOL is a registered trademark of **RIGOL** (SUZHOU) TECHNOLOGIES, INC.

Publication Number

QGG02106-1110

Notices

- **RIGOL** products are covered by P.R.C. and foreign patents, issued and pending.
- **RIGOL** reserves the right to modify or change parts of or all the specifications and pricing policies at company's sole decision.
- Information in this publication replaces all previously corresponding material.
- Information in this publication is subject to change without notice.
- **RIGOL** shall not be liable for either incidental or consequential losses in connection with the furnishing, use or performance of this manual as well as any information contained.
- Any part of this document is forbidden to be copied, photocopied or rearranged without prior written approval of **RIGOL**.

Product Certification

RIGOL guarantees this product conforms to the national and industrial standards in China as well as the ISO9001:2015 standard and the ISO14001:2015 standard. Other international standard conformance certification is in progress.

Contact Us

If you have any problem or requirement when using our products or this manual, please contact **RIGOL**.

E-mail: service@rigol.com

Website: www.rigol.com

Safety Requirement

General Safety Summary

Please review the following safety precautions carefully before putting the instrument into operation so as to avoid any personal injury or damage to the instrument and any product connected to it. To prevent potential hazards, please follow the instructions specified in this manual to use the instrument properly.

Use Proper Power Cord.

Only the exclusive power cord designed for the instrument and authorized for use within the local country could be used.

Ground the Instrument.

The instrument is grounded through the Protective Earth lead of the power cord. To avoid electric shock, connect the earth terminal of the power cord to the Protective Earth terminal before connecting any input or output terminals.

Connect the Probe Correctly.

If a probe is used, the probe ground lead must be connected to earth ground. Do not connect the ground lead to high voltage. Improper way of connection could result in dangerous voltages being present on the connectors, controls or other surfaces of the oscilloscope and probes, which will cause potential hazards for operators.

Observe All Terminal Ratings.

To avoid fire or shock hazard, observe all ratings and markers on the instrument and check your manual for more information about ratings before connecting the instrument.

Use Proper Overvoltage Protection.

Ensure that no overvoltage (such as that caused by a bolt of lightning) can reach the product. Otherwise, the operator might be exposed to the danger of an electric shock.

Do Not Operate Without Covers.

Do not operate the instrument with covers or panels removed.

Do Not Insert Objects Into the Air Outlet.

Do not insert objects into the air outlet, as doing so may cause damage to the instrument.

Use Proper Fuse.

Please use the specified fuses.

Avoid Circuit or Wire Exposure.

Do not touch exposed junctions and components when the unit is powered on.

Do Not Operate With Suspected Failures.

If you suspect that any damage may occur to the instrument, have it inspected by **RIGOL** authorized personnel before further operations. Any maintenance, adjustment or replacement especially to circuits or accessories must be performed by **RIGOL** authorized personnel.

Provide Adequate Ventilation.

Inadequate ventilation may cause an increase of temperature in the instrument, which would cause damage to the instrument. So please keep the instrument well ventilated and inspect the air outlet and the fan regularly.

Do Not Operate in Wet Conditions.

To avoid short circuit inside the instrument or electric shock, never operate the instrument in a humid environment.

Do Not Operate in an Explosive Atmosphere.

To avoid personal injuries or damage to the instrument, never operate the instrument in an explosive atmosphere.

Keep Instrument Surfaces Clean and Dry.

To avoid dust or moisture from affecting the performance of the instrument, keep the surfaces of the instrument clean and dry.

Prevent Electrostatic Impact.

Operate the instrument in an electrostatic discharge protective environment to avoid damage induced by static discharges. Always ground both the internal and external conductors of cables to release static before making connections.

Use the Battery Properly.

Do not expose the battery (if available) to high temperature or fire. Keep it out of the reach of children. Improper change of a battery (lithium battery) may cause an explosion. Use the **RIGOL** specified battery only.

Handle with Caution.

Please handle with care during transportation to avoid damage to keys, knobs, interfaces, and other parts on the panels.

Safety Terms and Symbols

Safety Notices in this Manual:



WARNING

Indicates a potentially hazardous situation or practice which, if not avoided, will result in serious injury or death.



CAUTION

Indicates a potentially hazardous situation or practice which, if not avoided, could result in damage to the product or loss of important data.

Safety Terms on the Product:

DANGER It calls attention to an operation, if not correctly performed, could result in injury or hazard immediately.

WARNING It calls attention to an operation, if not correctly performed, could result in potential injury or hazard.

CAUTION It calls attention to an operation, if not correctly performed, could result in damage to the product or other devices connected to the product.

Safety Symbols on the Product:



Hazardous Voltage



Safety Warning



Protective Earth Terminal



Chassis Ground



Test Ground

Allgemeine Sicherheits Informationen

Überprüfen Sie die folgenden Sicherheitshinweise sorgfältig um Personenschäden oder Schäden am Gerät und an damit verbundenen weiteren Geräten zu vermeiden. Zur Vermeidung von Gefahren, nutzen Sie bitte das Gerät nur so, wie in diesem Handbuch angegeben.

Um Feuer oder Verletzungen zu vermeiden, verwenden Sie ein ordnungsgemäßes Netzkabel.

Verwenden Sie für dieses Gerät nur das für ihr Land zugelassene und genehmigte Netzkabel.

Erden des Gerätes.

Das Gerät ist durch den Schutzleiter im Netzkabel geerdet. Um Gefahren durch elektrischen Schlag zu vermeiden, ist es unerlässlich, die Erdung durchzuführen. Erst dann dürfen weitere Ein- oder Ausgänge verbunden werden.

Anschluss eines Tastkopfes.

Die Erdungsklemmen der Sonden sind auf dem gleichen Spannungspegel des Instruments geerdet. Schließen Sie die Erdungsklemmen an keine hohe Spannung an.

Beachten Sie alle Anschlüsse.

Zur Vermeidung von Feuer oder Stromschlag, beachten Sie alle Bemerkungen und Markierungen auf dem Instrument. Befolgen Sie die Bedienungsanleitung für weitere Informationen, bevor Sie weitere Anschlüsse an das Instrument legen.

Verwenden Sie einen geeigneten Überspannungsschutz.

Stellen Sie sicher, daß keinerlei Überspannung (wie z.B. durch Gewitter verursacht) das Gerät erreichen kann. Andernfalls besteht für den Anwender die Gefahr eines Stromschlages.

Nicht ohne Abdeckung einschalten.

Betreiben Sie das Gerät nicht mit entfernten Gehäuse-Abdeckungen.

Betreiben Sie das Gerät nicht geöffnet.

Der Betrieb mit offenen oder entfernten Gehäuseteilen ist nicht zulässig. Nichts in entsprechende Öffnungen stecken (Lüfter z.B.)

Passende Sicherung verwenden.

Setzen Sie nur die spezifikationsgemäßen Sicherungen ein.

Vermeiden Sie ungeschützte Verbindungen.

Berühren Sie keine unisolierten Verbindungen oder Baugruppen, während das Gerät in Betrieb ist.

Betreiben Sie das Gerät nicht im Fehlerfall.

Wenn Sie am Gerät einen Defekt vermuten, sorgen Sie dafür, bevor Sie das Gerät wieder betreiben, dass eine Untersuchung durch **RIGOL** autorisiertem Personal durchgeführt wird. Jedwede Wartung, Einstellarbeiten oder Austausch von Teilen am Gerät, sowie am Zubehör dürfen nur von **RIGOL** autorisiertem Personal durchgeführt werden.

Belüftung sicherstellen.

Unzureichende Belüftung kann zu Temperaturanstiegen und somit zu thermischen Schäden am Gerät führen. Stellen Sie deswegen die Belüftung sicher und kontrollieren regelmäßig Lüfter und Belüftungsöffnungen.

Nicht in feuchter Umgebung betreiben.

Zur Vermeidung von Kurzschluß im Geräteinneren und Stromschlag betreiben Sie das Gerät bitte niemals in feuchter Umgebung.

Nicht in explosiver Atmosphäre betreiben.

Zur Vermeidung von Personen- und Sachschäden ist es unumgänglich, das Gerät ausschließlich fernab jedweder explosiven Atmosphäre zu betreiben.

Geräteoberflächen sauber und trocken halten.

Um den Einfluß von Staub und Feuchtigkeit aus der Luft auszuschließen, halten Sie bitte die Geräteoberflächen sauber und trocken.

Schutz gegen elektrostatische Entladung (ESD).

Sorgen Sie für eine elektrostatisch geschützte Umgebung, um somit Schäden und Funktionsstörungen durch ESD zu vermeiden. Erden Sie vor dem Anschluß immer Innen- und Außenleiter der Verbindungsleitung, um statische Aufladung zu entladen.

Die richtige Verwendung des Akku.

Wenn eine Batterie verwendet wird, vermeiden Sie hohe Temperaturen bzw. Feuer ausgesetzt werden. Bewahren Sie es außerhalb der Reichweite von Kindern auf. Unsachgemäße Änderung der Batterie (Anmerkung: Lithium-Batterie) kann zu einer Explosion führen. Verwenden Sie nur von **RIGOL** angegebene Akkus.

Sicherer Transport.

Transportieren Sie das Gerät sorgfältig (Verpackung!), um Schäden an Bedienelementen, Anschlüssen und anderen Teilen zu vermeiden.

Sicherheits Begriffe und Symbole

Begriffe in diesem Guide:

**WARNING**

Die Kennzeichnung WARNING beschreibt Gefahrenquellen die leibliche Schäden oder den Tod von Personen zur Folge haben können.

**CAUTION**

Die Kennzeichnung Caution (Vorsicht) beschreibt Gefahrenquellen die Schäden am Gerät hervorrufen können.

Begriffe auf dem Produkt:

DANGER weist auf eine Verletzung oder Gefährdung hin, die sofort geschehen kann.

WARNING weist auf eine Verletzung oder Gefährdung hin, die möglicherweise nicht sofort geschehen.

CAUTION weist auf eine Verletzung oder Gefährdung hin und bedeutet, dass eine mögliche Beschädigung des Instruments oder anderer Gegenstände auftreten kann.

Symbole auf dem Produkt:



Gefährliche Spannung



Sicherheits-Hinweis



Schutz-erde



Gehäusemasse



Erde

Care and Cleaning

Care

Do not store or leave the instrument where it may be exposed to direct sunlight for long periods of time.

Cleaning

Clean the instrument regularly according to its operating conditions.

1. Disconnect the instrument from all power sources.
2. Clean the external surfaces of the instrument with a soft cloth dampened with mild detergent or water. Avoid having any water or other objects into the chassis via the heat dissipation hole. When cleaning the LCD, take care to avoid scarifying it.



CAUTION

To avoid damage to the instrument, do not expose it to caustic liquids.



WARNING

To avoid short-circuit resulting from moisture or personal injuries, ensure that the instrument is completely dry before connecting it to the power supply.

Environmental Considerations

The following symbol indicates that this product complies with the WEEE Directive 2002/96/EC.



Product End-of-Life Handling

The equipment may contain substances that could be harmful to the environment or human health. In order to avoid the release of such substances into the environment and harm to human health, we encourage you to recycle this product in an appropriate system that will ensure that most of the materials are reused or recycled appropriately. Please contact your local authorities for disposal or recycling information.

Document Overview

Format Conventions in this Manual

1. Key:

The key at the front panel is denoted by the format of "Text Box + Key Name (Bold)" in the manual. For example, **FREQ** denotes the **FREQ** key.

2. Menu:

The menu is denoted by the format of "Character Shading + Menu Word (Bold)" in the manual. For example, **LF** denotes the low frequency menu item under **FREQ**.

3. Connector:

The connector at the front or rear panel is denoted by the format of "Square Brackets + Connector Name (Bold)" in the manual. For example, **[RF OUTPUT 50Ω]**.

4. Operation Step:

The next step of operation is denoted by an arrow "→" in the manual. For example, **FREQ** → **LF** denotes pressing **FREQ** at the front panel and then pressing **LF**.

Content Conventions in this Manual

DSG800 series RF signal generator includes two models (DSG815 and DSG830). This manual introduces the basic operations of the instrument by taking DSG830 as an example. For the detailed information, refer to *DSG800 User's Guide*.

Manuals of this Product

The manuals of this product include the quick guide, user's guide, programming guide, data sheet and etc. The latest versions of the manuals can be downloaded from www.rigol.com.

Contents

Guaranty and Declaration	I
Safety Requirement	II
General Safety Summary.....	II
Safety Terms and Symbols	IV
Allgemeine Sicherheits Informationen	V
Sicherheits Begriffe und Symbole.....	VII
Care and Cleaning.....	VIII
Environmental Considerations.....	VIII
Document Overview	IX
Quick Start	1
General Inspection	1
Front Panel Overview	2
Rear Panel Overview	8
To Use DSG800 for the First Time	12
To Connect the Power Supply.....	12
Power-on Inspection	12
To Set the System Language.....	12
User Interface.....	13
To Use the Built-in Help System.....	17
Basic Operations	18
To Output a RF Signal.....	18
To Output a RF Sweep Signal	19
To Output a RF Modulated Signal.....	21
Remote Control.....	22
Troubleshooting	24

Quick Start

General Inspection

1. **Inspect the shipping container for damage**

Keep the damaged shipping container or cushioning material until the contents of the shipment have been checked for completeness and the instrument has passed both electrical and mechanical tests.

The consigner or carrier shall be liable for the damage to instrument resulting from shipment. **RIGOL** is not responsible for free maintenance/rework or replacement of the unit in such cases.

2. **Inspect the instrument**

In case of any damage, or defect, or failure, notify your **RIGOL** sales representative immediately.

3. **Check the accessories**

Please check the accessories according to the packing lists. If the accessories are incomplete or damaged, please contact your **RIGOL** sales representative immediately.

Front Panel Overview

The front panel of DSG800 series RF signal generator is as shown in the figure below.

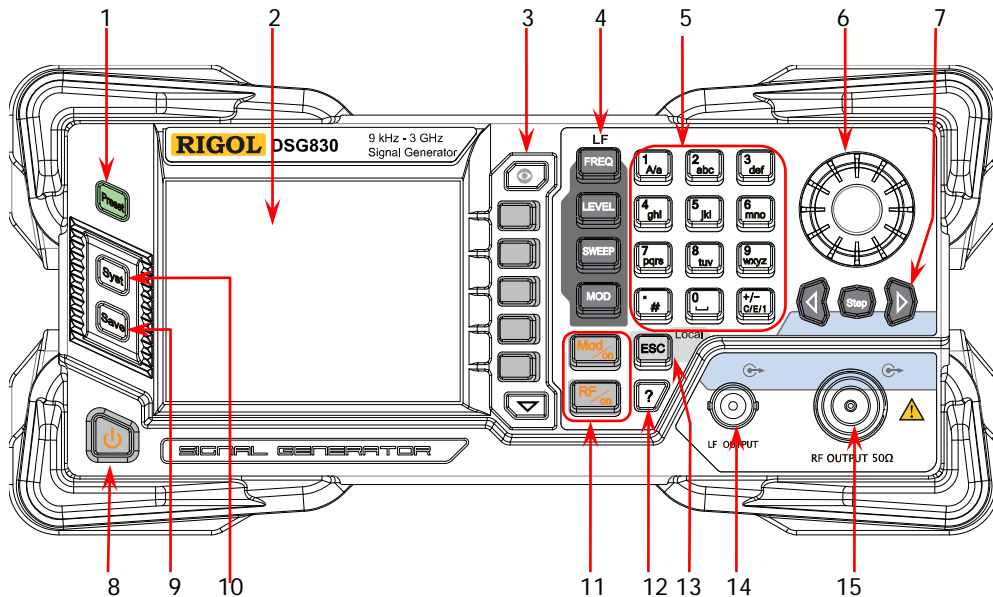

Figure 1 Front Panel

1. Restore to Preset Key



Restore the instrument to the preset state (the factory default state or user-stored state).

2. LCD

3.5 inch TFT high-resolution (320×240) color LCD. The current settings and state of the instrument can be clearly displayed. For the detailed information, refer to "**User Interface**".

3. Menu Control Keys

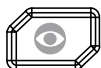

Display switching key. In the menu page of any function, you can press this key to open the parameter information display interface of the current function. At this point, you can use the knob or direction keys to switch the parameter tabs to view the parameter information of different functions. Pressing this key again will switch to the function menu corresponding to the parameter tab currently selected. In addition, you can press any function key to exit the parameter information display interface.



Menu softkeys corresponding to the menus displayed at the left of the softkeys respectively. Pressing the softkey will activate the corresponding menu.



Menu page up/down key.

4. Function Keys



Set the frequency parameters of the RF output signal as well as the related parameters of LF output.



Set the amplitude parameters of the RF output signal and provide the flatness calibration function.



Set the sweep type, sweep manner, sweep mode and etc.



Set the related parameters of amplitude modulation (AM), frequency modulation (FM), phase modulation (ØM), pulse modulation and pulse generator as well as I/Q modulation and I/Q modulation source.

5. Numeric Keyboard

The numeric keyboard supports Chinese characters, English uppercase /lowercase characters, numbers and commonly used symbols (include the decimal point, #, space and positive/negative sign +/-). It is mainly used to edit the file or folder name and set the parameters.

The multiplexing keys of the numbers and letters are used to directly input the desired numbers or letters.



Used to switch among Chinese, English and number input modes.

When setting a parameter, the input mode is fixed at number and this key is used to input the sign ("+" or "-") of the value.



In number input mode, press this key to input 1.

In English input mode, press this key to switch between uppercase and lowercase letter inputs.



The multiplexing key of 0 and space.

In number input mode, press this key to input 0.

In Chinese or English input mode, press this key to input a space.



In number input mode, press this key to insert a decimal point at the current cursor position.

In English input mode, press this key to input "#".

In Chinese input mode, this key is invalid.

6. Knob

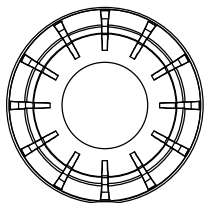

When setting a parameter, the knob is used to modify the value at the cursor or modify the parameter value at the current step.

When editing a filename, it is used to select the desired character.

For the storage function, it is used to select the current directory or file.

In the parameter information display interface, it is used to switch the parameter tabs.

7. Direction Keys/Step Key



When setting a parameter, **Step** is used to set the step of the parameter currently selected; the direction keys are used to enter the parameter editing state and move the cursor to the specified digit.

For the storage function, the direction keys are used to collapse and expand the directory currently selected.

When editing a filename, the direction keys are used to select the desired character.

In the parameter information display interface, the direction keys are used to switch the parameter tabs.

8. Power Key

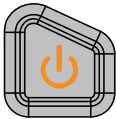

It is used to turn on or off the RF signal generator. You can use the following method to enable or disable this key.

Press **Syst** → **Pwr Status** to select "Default" or "Open".

When "Default" is selected, you need to press this key to start the instrument after the instrument is powered on.

When "Open" is selected, the instrument will start automatically after it is powered on.

Besides, this key provides the delayed switching function (namely, the instrument can be turned on or off only when you press this key and hold it down for a certain period of time) to avoid the shut-down of the instrument due to misoperation.

9. Store and Recall Key



Store and recall various types of files (such as the instrument state).

10. System Setting Key



Set the system-related parameters.

11. Output Control Keys



Used to turn on or off the RF output.

- Press this key; the backlight of the key and the RF label in the function status area in the user interface are illuminated. At this point, the RF output is turned on and the **[RF OUTPUT 50Ω]** connector outputs RF signal according to the current configuration.
- Press this key again; the backlight of the key turns off and the RF label in the function status area in the user interface is grayed out. At this point, the RF output is turned off.



Used to turn on or off the RF modulation output.

- When a modulation function (AM, FM, ØM, Pulse Mod, or I/Q Mod) is turned on, press this key; the backlight of the key and the MOD label in the function status area in the user interface are illuminated. At this point, the RF modulation output is turned on and the **[RF OUTPUT 50Ω]** connector outputs the modulated RF signal according to the current configuration (the backlight of **RF/on** must be illuminated).
- Press this key again and the backlight of the key turns off. At this point, the RF modulation output is turned off.

12. Built-in Help System



To get the help information of any front panel key or menu softkey, press this key and then press the desired key.

13. Exit Key



Local

When setting a parameter, this key is used to clear the number in the editing window and exit the parameter input state.

When editing a filename, this key is used to clear the characters in the input bar.

In the keyboard test state, this key is used to exit the current test state.

When the instrument is working in the remote mode, you can press this key to return to the local mode.

After you select the next level of menu, this key is used to exit the current menu and return to the previous menu.

14. LF Output Connector

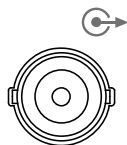

LF OUTPUT

When the LF output is turned on, this connector is used to output the LF signal.

15. RF Output Connector

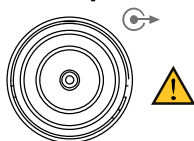

RF OUTPUT 50Ω

When the backlight of **RF/on** is illuminated, this connector is used to output the RF signal and RF sweep signal.

When the backlights of **RF/on** and **Mod/on** are both illuminated, this connector is used to output the RF modulated signal.



CAUTION

To avoid damaging the instrument, the reverse DC voltage on the RF output connector cannot exceed 50 V and the reverse power cannot exceed +30 dBm (1W) in the 1 MHz to 3 GHz frequency segment.

Rear Panel Overview

The rear panel of DSG800 series RF signal generator is as shown in the figure below.

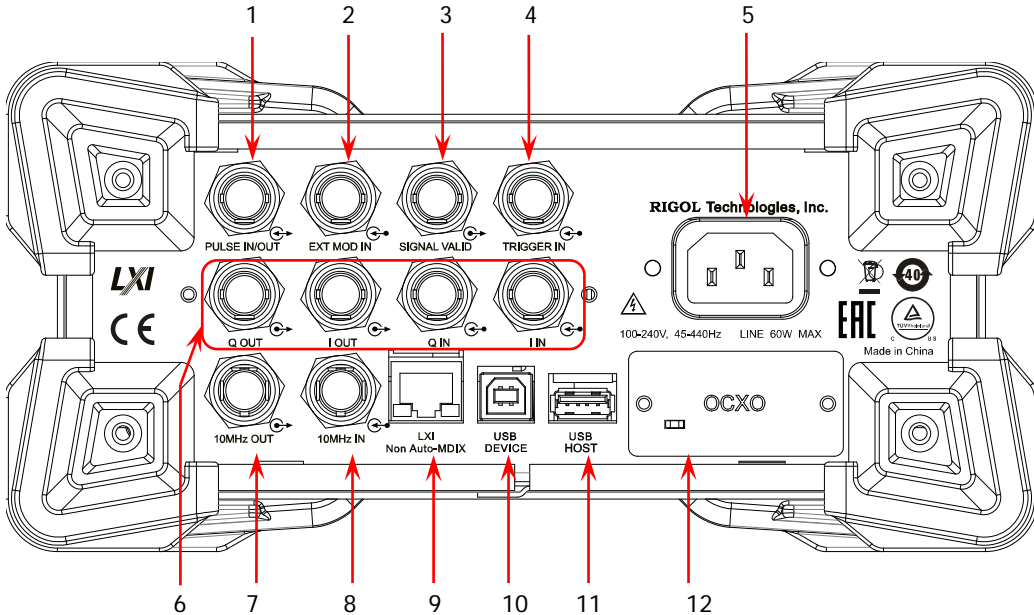
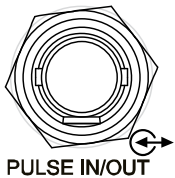

Figure 2 Rear Panel

1. Pulse Signal Input/Output Connector



The function of this connector is determined by the current working mode of pulse modulation.

PULSE IN:

When the pulse modulation source is "Ext", this connector is used to input the external pulse signal.

PULSE OUT:

When the pulse modulation source is "Int" and the pulse output is turned on, this connector is used to output the pulse signal generated by the internal generator. This output signal is related to the pulse "Mode" and can be set to "Single" or "Train".

2. External Modulation Input Connector

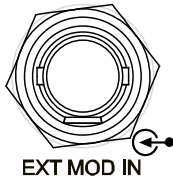

When the modulation source of AM or FM/ØM is set to "Ext", this connector is used to input the external modulating signal.

3. Signal Valid Output Connector

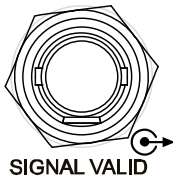

When the RF output frequency or amplitude is modified, after a certain response and processing time of the internal circuit of the instrument, the instrument outputs RF signal with the specified frequency and amplitude via the RF output connector at the front panel. During this process, the **[SIGNAL VALID]** connector outputs a pulse sync signal, indicating that the RF output signal is valid.

- High Level (+3.3 V): indicate that the RF signal is in configuration.
- Low Level (0 V): indicate that the RF signal is stable (namely, the signal is valid).

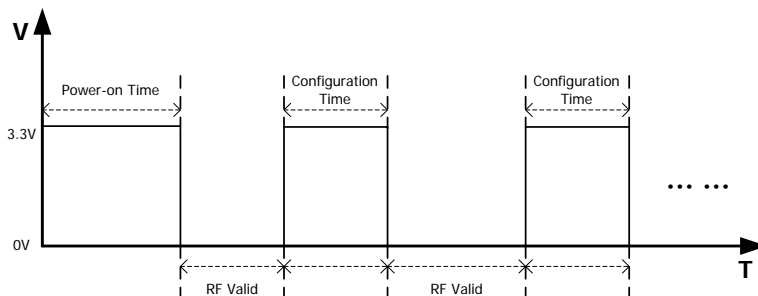

4. External Trigger Input Connector



When the trigger mode of **[SWEEP]** is "Ext", this connector is used to input the external trigger signal. You can press **Trig Slope** to set the polarity of the trigger signal to "Pos" or "Neg".

When the trigger mode of I/Q modulation baseband output is "Ext", this connector is used to input the external trigger signal.

When the pulse modulation source is "Int" and the trigger mode is "Ext Trig", this connector is used to input the external trigger signal.

When the pulse modulation source is "Int" and the trigger mode is "Ext Gate", this connector is used to input the external gated signal.

5. Power Input Connector

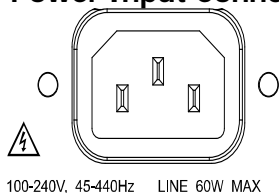

Power input connector.
 This RF signal generator can accept 100 V to 240 V, 45 Hz to 440 Hz AC power supplies. The power consumption of the instrument cannot exceed 60 W.

6. I/Q Modulating Signal Input/Output Connectors (Option DSG800-IQ)

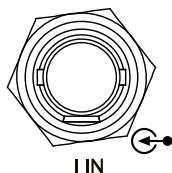

When the I/Q modulation source is "Ext", it is used to input the I (In-Phase) baseband signal of I/Q modulation.

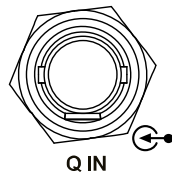

When the I/Q modulation source is "Ext", it is used to input the Q (Quadrature Phase) baseband signal of I/Q modulation.

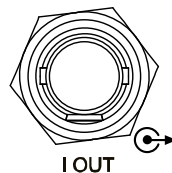

It is used to output the I (In-Phase) components of I/Q modulation of the built-in baseband generator.

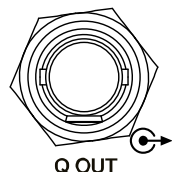

It is used to output the Q (Quadrature Phase) components of I/Q modulation of the built-in baseband generator

7. Reference Signal Output Connector

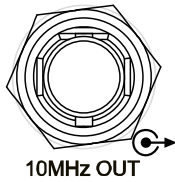

It is used to output the internal 10 MHz reference clock signal which is used to synchronize the generator with other instruments. For more information about the specifications of the clock signal output from this connector, refer to the data sheet of this product.

8. Reference Signal Input Connector

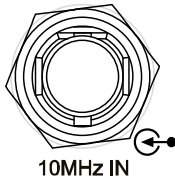

It is used to input the external 10 MHz reference clock signal which is used to synchronize the generator with other instruments. For more information about the specifications of the external clock signal input from this connector, refer to the data sheet of this product.

9. LAN

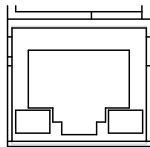

LXI
Non Auto-MDIX

The instrument complies with LXI Core 2011 Device standard. It supports WebServer, Socket and other remote control modes. This interface is used to connect the RF signal generator to the PC or network for remote control.

10. USB DEVICE

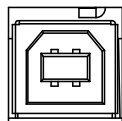

USB
DEVICE

The instrument complies with USBTMC class protocol. This interface is used to connect the PC for remote instrument control.

11. USB HOST

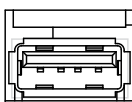

USB
HOST

This interface is used to connect the USB storage device to update the system or store the system states and etc.

12. OCXO (Option OCXO-B08)



OCXO is an oven controlled crystal oscillator. It is a frequency reference source with higher temperature stability.

Note: Sixty minutes of warm-up is required for the OCXO to reach its rated frequency.

For the ordering information of this option, please refer to the data sheet of this product.

To Use DSG800 for the First Time

To Connect the Power Supply

Please connect the RF signal generator to AC power supply using the power cable supplied in the accessories. This RF signal generator can accept 100 V to 240 V, 45 Hz to 440 Hz AC power supplies. The power consumption of the instrument cannot exceed 60 W. When the RF signal generator is connected to AC power supply via this connector, the instrument selects the correct voltage range automatically and users do not need to select the voltage range manually.



CAUTION

To avoid electric shock, use standard plugs.

Power-on Inspection

After the power supply is correctly connected, press the power key  at the front panel to turn on the RF signal generator. During the start-up, the instrument performs initialization and self-test. After that, the instrument enters the default interface.

To Set the System Language

DSG800 series RF signal generator supports multiple system languages. You can press **Syst**→ **Language** to switch the system language.

User Interface

In this manual, DSG830 is taken as an example to illustrate the user interface of DSG800 series RF signal generator, as shown in the figure below.

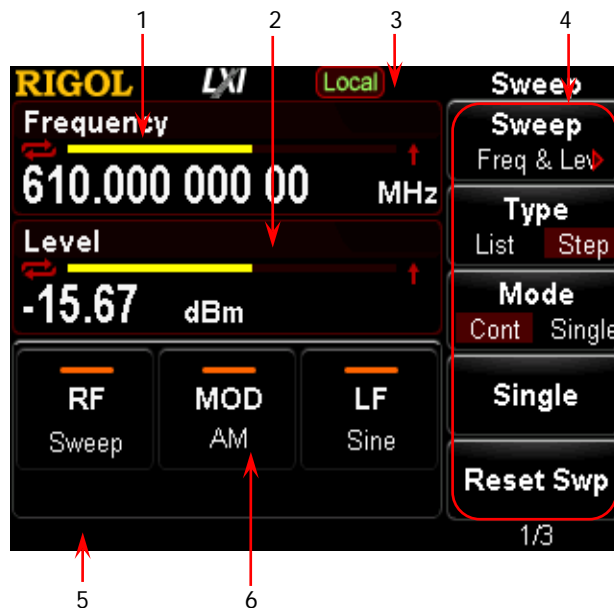



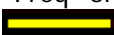

Figure 3 User Interface



1. Frequency Area



Display the current frequency settings of the RF signal generator.

- : continuous sweep label. It is displayed when the sweep manner is "Freq" or "Freq & Lev" and the sweep mode is "Cont".
- : single sweep label. It is displayed when the sweep manner is "Freq" or "Freq & Lev" and the sweep mode is "Single".
- : forward sweep label. It is displayed when the sweep manner is "Freq" or "Freq & Lev" and the sweep direction is "Fwd".
- : downward sweep label. It is displayed when the sweep manner is "Freq" or "Freq & Lev" and the sweep direction is "Down".
- : frequency sweep progress bar. It is displayed when the sweep manner is "Freq" or "Freq & Lev".

2. Amplitude Area





Display the current level settings of the RF signal generator.

- : displayed when the flatness calibration is turned "On".
- : continuous sweep label. It is displayed when the sweep manner is "Level" or "Freq & Lev" and the sweep mode is "Cont".
- : single sweep label. It is displayed when the sweep manner is "Level" or "Freq & Lev" and the sweep mode is "Single".

- : forward sweep label. It is displayed when the sweep manner is "Level" or "Freq & Lev" and the sweep direction is "Fwd".
- : downward sweep label. It is displayed when the sweep manner is "Level" or "Freq & Lev" and the sweep direction is "Down".
- : amplitude sweep progress bar. It is displayed when the sweep manner is "Level" or "Freq & Lev".

3. Status Bar

Indicate the current system states of the RF signal generator.

- : the RF signal generator is working in the remote control mode.
- : the RF signal generator is working in the local operation mode.
- : displayed when a USB storage device is detected.
- : displayed when the instrument parameter information interface is opened.

4. Menu Display Area









The menu items displayed in this area correspond to the softkeys at the right of the screen respectively. Pressing any softkey can enable the corresponding menu function.

5. Message Display Area





Display the operation error messages and prompt messages. You can press **Syst** → **Information** → **System Msg** to view the messages. When multiple messages are generated, you can use the direction keys or knob to select the desired message.

6. Function Status Area

Display the current states of the functions of the RF signal generator. The status icons that might be displayed in the function status area are as shown in the table below.

Icon	Explanation	Icon	Explanation
	The RF output is not turned on and no sweep manner is selected.		The LF output is not turned on and Sine waveform is selected.
	The RF output is not turned on and only a single sweep manner is selected.		The LF output is not turned on and Square waveform is selected.
	The RF output is turned on and no sweep manner is selected.		The LF output is turned on and Sine waveform is selected.
	The RF output is turned on and only a single sweep manner is selected.		The LF output is turned on and Square waveform is selected.

	The RF modulation output is not turned on and only AM is turned on.		The RF modulation output is turned on and AM is turned on.
	The RF modulation output is not turned on and only FM is turned on.		The RF modulation output is turned on and FM is turned on.
	The RF modulation output is not turned on and only ØM is turned on.		The RF modulation output is turned on and ØM is turned on.
	The RF modulation output is not turned on and only Pulse is turned on.		The RF modulation output is turned on and Pulse is turned on.
	The RF modulation output is not turned on and only IQ is turned on.		The RF modulation output is turned on and IQ is turned on.
	The RF modulation output is not turned on; AM and FM are turned on.		The RF modulation output is turned on; AM and FM are turned on.
	The RF modulation output is not turned on; AM and ØM are turned on.		The RF modulation output is turned on; AM and ØM are turned on.
	The RF modulation output is not turned on; AM and Pulse are turned on.		The RF modulation output is turned on; AM and Pulse are turned on.
	The RF modulation output is not turned on; FM and Pulse are turned on.		The RF modulation output is turned on; FM and Pulse are turned on.
	The RF modulation output is not turned on; FM and IQ are turned on.		The RF modulation output is turned on; FM and IQ are turned on.
	The RF modulation output is not turned on; ØM and Pulse are turned on.		The RF modulation output is turned on; ØM and Pulse are turned on.
	The RF modulation output is not turned on; ØM and IQ are turned on.		The RF modulation output is turned on; ØM and IQ are turned on.
	The RF modulation output is not turned on; IQ and Pulse are turned on.		The RF modulation output is turned on; IQ and Pulse are turned on.
	The RF modulation output is not turned on; AM, FM and Pulse are turned on.		The RF modulation output is turned on; AM, FM and Pulse are turned on.
	The RF modulation output is not turned on; AM, ØM and Pulse are turned on.		The RF modulation output is turned on; AM, ØM and Pulse are turned on.

	and Pulse are turned on.		ØM and Pulse are turned on.
	The RF modulation output is not turned on; FM, IQ and Pulse are turned on.		The RF modulation output is turned on; FM, IQ and Pulse are turned on.
	The RF modulation output is not turned on; ØM, IQ and Pulse are turned on.		The RF modulation output is turned on; ØM, IQ and Pulse are turned on.
	The RF modulation output is not turned on and none of the modulation functions is turned on.	--	--

Tip: Press **MOD** and the AM/FM/ØM/PUL/I/Q modulation icons are displayed in the function status area. If a modulation function is turned on (or off), the corresponding icon will be illuminated (or grayed out).

To Use the Built-in Help System

The DSG800 built-in help system provides the help information of all the function keys and menu softkeys at the front panel. Users can view the help information of any key when operating the instrument.

1. Acquire the built-in help information

Press **[?]** and press the desired function key or menu softkey; the help information of the key will be displayed in the instrument interface.

2. Page up/down

When the help information is displayed in multiple pages, you can use the direction keys or knob to switch the help information page.

3. Turn off the current help information

When help information is displayed in the instrument interface, pressing any key (except the direction keys and knob) at the front panel will turn off the help information currently displayed.

4. Acquire the help information of a menu softkey

Press **[?]** and the prompt message about how to acquire the help information is displayed in the instrument interface. Then, press the desired menu softkey and the help information of the menu item corresponding to this menu softkey is displayed in the instrument interface.

5. Acquire the help information of any function key

Press **[?]** and the prompt message about how to acquire the help information is displayed in the instrument interface. Then, press the desired function key and the help information of the function of the key is displayed in the instrument interface.

Basic Operations

To Output a RF Signal

Output a RF signal with 1 GHz frequency and -20 dBm amplitude from the [RF OUTPUT 50Ω] connector.

1. Restore to the factory setting

Press **Syst** → **Reset** → **Preset Type** → "Factory" and then press **Preset** to restore the instrument to the factory setting.

2. Frequency setup

Press **FREQ**, use the numeric keyboard to input the frequency value (1) and select the desired unit (GHz) from the pop-up unit menu.

- The frequency units available are GHz, MHz, kHz and Hz.
- You can press **Backspace** to delete the number at the left of the cursor.
- You can also press the left/right direction key to enter the parameter editing state and move the cursor to the specified digit; then, rotate the knob to modify the value.
- After the frequency is set, you can rotate the knob to modify the frequency at the current step.
- You can press **FREQ** and then press **Step** to set the step.

3. Amplitude setup

Press **LEVEL**, use the numeric keyboard to input the amplitude value (-20) and select the desired unit (dBm) from the pop-up unit menu.

- The amplitude units available are dBm, -dBm, mV, uV and nV.
- You can press **Backspace** to delete the number at the left of the cursor.
- You can also press the left/right direction key to enter the parameter editing state and move the cursor to the specified digit; then, rotate the knob to modify the value.
- You can also rotate the knob to modify the amplitude at the current step.
- You can press **LEVEL** and then press **Step** to set the step.

4. Turn on the RF output

Press **RF/on**; the backlight of the key and the RF label displayed in the function status area in the user interface are illuminated. At this point, the RF output is turned on and the [RF OUTPUT 50Ω] connector outputs RF signal according to the current configuration.

To Output a RF Sweep Signal

This section introduces how to output a RF sweep signal by configuring continuous linear step sweep. Set the frequency range to (1 GHz to 2 GHz), the amplitude range to (-20 dBm to 0 dBm), the number of sweep points to 10 and the dwell time to 500 ms.

1. Restore to the factory setting

Press **Syst** → **Reset** → **Preset Type** → "Factory" and then press **Preset** to restore the instrument to the factory setting (by default, the sweep mode is continuous, the sweep type is step and the sweep space is linear).

2. Step sweep parameter setup

Press **SWEEP** and use the menu page up/down key  to open the 2/3 page of the menu; then, press **Step Swp** to enter the step sweep parameter setting menu.

- Start Frequency
Press **Start Freq**, use the numeric keyboard to input the start frequency value (1) and select the desired unit (GHz) from the pop-up unit menu.
- Stop Frequency
Press **Stop Freq**, use the numeric keyboard to input the stop frequency value (2) and select the desired unit (GHz) from the pop-up unit menu.
- Start Level
Press **Start Lev**, use the numeric keyboard to input the start level value (-20) and select the desired unit (dBm) from the pop-up unit menu.
- Stop Level
Press **Stop Lev**, use the numeric keyboard to input the stop level value (0) and select the desired unit (dBm) from the pop-up unit menu.
- Sweep Points
Press **Points**, use the numeric keyboard to input the number of sweep points (10) and then press **Enter**.
- Dwell Time
The dwell time indicates the duration of a sweep step.
Press **Dwell Time**, use the numeric keyboard to input the time value (500) and select the desired unit (ms) from the pop-up unit menu.

3. Turn on the RF sweep

Press **SWEEP** → **Sweep** and select "Freq & Lev" to turn on the frequency and amplitude sweep functions at the same time.

At this point, the RF signal generator sweeps from the start frequency and level to the stop frequency and level continuously at certain step according to the current settings. The frequency and amplitude sweep progress bars as well as the continuous sweep label are displayed in the frequency and amplitude areas in the user interface respectively; in addition, the Sweep label in the function

status area is illuminated.

4. Turn on the RF output

Press **RF/on**; the backlight of the key and the RF label displayed in the function status area in the user interface are illuminated. At this point, the RF output is turned on and the **[RF OUTPUT 50Ω]** connector outputs RF sweep signal according to the current configuration.

To Output a RF Modulated Signal

This section introduces how to output an AM modulated signal by taking amplitude modulation (AM) as an example. Set the carrier frequency to 800 MHz, the carrier amplitude to -20 dBm, the AM modulation depth to 60% and the modulation frequency to 20 kHz.

1. Restore to the factory setting

Press **Syst** → **Reset** → **Preset Type** → "Factory" and then press **Preset** to restore the instrument to the factory setting (by default, the modulation source is internal and the modulation waveform is sine).

2. Set the carrier frequency and amplitude

(1) Carrier Frequency

Press **FREQ**, use the numeric keyboard to input the frequency value (800) and select the desired unit (MHz) from the pop-up unit menu.

(2) Carrier Amplitude

Press **LEVEL**, use the numeric keyboard to input the amplitude value (-20) and select the desired unit (dBm) from the pop-up unit menu.

3. Set the AM modulation parameters

(1) Press **MOD** → **AM** to enter the amplitude modulation parameter setting menu.

(2) Press **Depth**, use the numeric keyboard to input the value of the modulation depth (60) and select the desired unit (%) from the pop-up unit menu.

(3) Press **Freq**, use the numeric keyboard to input the frequency value (20) and select the desired unit (kHz) from the pop-up unit menu.

(4) Press **Switch** and select "On" to turn on the AM function.

4. Turn on the RF modulation output

Press **Mod/on** and the backlight is illuminated. Then, press **RF/on** and the backlight is illuminated. The MOD, AM and RF labels in the function status area in the user interface are illuminated. At this point, the RF modulation output is turned on and the **[RF OUTPUT 50Ω]** connector outputs RF modulated signal according to the current configuration.

Note: The backlights of **RF/on** and **Mod/on** must be both illuminated.

Remote Control

DSG800 supports to build communication with the PC via the USB or LAN interface to realize remote control. The remote control is realized on the basis of the SCPI (Standard Commands for Programmable Instruments) command set. This section introduces how to control the RF signal generator remotely via the USB interface by sending SCPI commands using the common PC software Ultra Sigma provided by **RIGOL**. For the detailed information of the commands, refer to *DSG800 Programming Guide*.

Note: When the instrument is in remote mode, **Rmt** is displayed in the user interface and all the front panel keys (except **ESC**) are locked. At this point, you can press **ESC** to exit the remote mode.

1. Install Ultra Sigma

Acquire Ultra Sigma as well as install the software and the desired components correctly according to the instructions. You can download the newest version of the software from www.rigol.com.

2. Control via USB

(1) Connect the device

Connect the RF signal generator (USB DEVICE) and PC (USB HOST) using a USB cable.

(2) Install the USB drive

This RF signal generator is a USBTMC device and the **Found New Hardware Wizard** dialog box will be displayed after the RF signal generator is correctly connected to the PC (the RF signal generator will be automatically configured to the USB interface) and both of them are started. Please install the "USB Test and Measurement Device (IVI)" drive program according to the instructions.

(3) Search for the device resource

Start Ultra Sigma and the software will search for the RF signal generator resource currently connected to the PC automatically. You can also click **USB-TMC** to search for the resource.

(4) View the device resource

The resource found will be displayed under the "RIGOL Online Resource" directory and the model number and USB interface information of the instrument will also be displayed.

For example, DSG830

(USB0::0x1AB1::0x6666::DSG8A170200001::INSTR).

(5) **Communication test**

Right-click the resource name "DSG830 (USB0::0x1AB1::0x6666::DSG8A170200001::INSTR)" and select "SCPI Panel Control" to open the remote command control panel through which you can send commands and read data.

Troubleshooting

The chapter lists the commonly encountered failures of DSG800 and their solutions. When you encounter those problems, please solve them following the corresponding steps. If the problem remains still, please contact **RIGOL** and provide your device information (**Syst** → **Information** → **System Info**).

1. The screen of the RF signal generator is still dark (no display) after the power key is pressed:

- (1) Check whether the fan is running;
 - If the fan is running but the screen is dark, the screen connecting wire might be loose.
 - If the fan is not running, the instrument does not start successfully and please go to step (2).
- (2) Check whether the power is correctly connected and whether the power key is really on.
- (3) Check whether the fuse is burned out. If the fuse needs to be replaced, please contact **RIGOL**.
- (4) Restart the instrument after finishing the above inspections.
- (5) If it still does not work correctly, please contact **RIGOL**.

2. The screen is too dark and cannot be seen clearly:

- (1) Check whether the brightness setting value of the LCD is too low.
- (2) Press **Syst** → **Display** → **Brightness** and use the numeric keys or knob to adjust the brightness of the LCD of the RF signal generator to a proper value.

3. The RF signal generator is locked:

- (1) Check whether the RF signal generator is in remote control mode (in remote control, **Rmt** is displayed in the status bar of the user interface). Pressing **ESC** can exit the remote control mode and unlock the front panel.
- (2) Check whether the RF signal generator is in local mode with the screen being locked (when the screen is locked, front panel operations are not available). Pressing **ESC** can unlock the screen and exit the locking state.
- (3) If progress bar is displayed on the screen of the RF signal generator, some operation is in progress. For example, when saving a file, the progress bar will be displayed indicating that the save operation is in progress. During the operation, the front panel is locked.
- (4) Pressing **Preset** or restarting the RF signal generator can also unlock the instrument.

4. The setting is correct but the waveform output is incorrect:

- (1) There is no RF output
 - Check whether the signal connecting cable is tightly connected to the corresponding **[RF OUTPUT 50Ω]** connector.
 - Check whether the connecting cable has internal damage.
 - Check whether the connecting cable is tightly connected to the test instrument.
 - Check whether the backlight of **[RF/on]** is illuminated. If not, press this key to illuminate the backlight. At this point, the RF label in the function status area in the user interface is illuminated and the RF output is correctly turned on.
 - Check whether the output amplitude of the RF signal is too small. Adjust the output amplitude properly.
- (2) The RF output is not modulated
 - Check whether the signal connecting cable is tightly connected to the corresponding **[RF OUTPUT 50Ω]** connector.
 - Check whether the connecting cable has internal damage.
 - Check whether the connecting cable is tightly connected to the test instrument.
 - Check whether the backlights of **[Mod/on]** and **[RF/on]** are both illuminated and check whether the modulation **Switch** is turned on.
 - Check whether the modulation parameter settings are proper and adjust the parameters appropriately.
 - If external modulation source is used, make sure that the external source is correctly connected and outputs signal. At the same time, the external source should work within the specified range of the RF signal generator.

5. The sweep is abnormal:

- (1) The sweep stagnates

The sweep progress bar is displayed in the frequency area/amplitude area in the user interface indicating that the sweep is in progress. If the sweep stagnates, please check:

 - At least one manner of sweep is turned on. Press **[SWEEP]** → **Sweep** to select "Freq", "Level" or "Freq & Lev".
 - If single sweep mode is selected, press **Single** to meet the trigger condition and the instrument performs a sweep.
 - If the sweep trigger mode is not set to auto, press **[SWEEP]** → **Trig Mode** → **Auto** to check whether the sweep stagnates due to the loss of the sweep trigger.
 - If the point trigger mode is not set to auto, press **[SWEEP]** → **Point Trig** → **Auto** to check whether the sweep stagnates due to the loss of the point trigger.
 - Check whether the dwell time is too large or too small that the sweep cannot be seen.

- Make sure that at least two points are set in the step sweep or list sweep.
- (2) The dwell time of list sweep is incorrect
 - Press **SWEEP** → **List Swp** to enter the sweep list menu.
 - Press **Load** to load the desired sweep list and press **View** to check whether the dwell time in the sweep list is correct.
 - If the dwell time is incorrect, re-edit the sweep list and load it to the instrument. If the dwell time is correct, turn to the next step.
 - Press **SWEEP** → **Type** to make sure that "List" sweep is selected. If "Step" sweep is currently selected, the RF signal generator sweeps according to the dwell time of step sweep.
- (3) The list sweep information recalled from the register is lost
 - The list sweep information cannot be stored in the status register of the instrument as a part of the instrument state.
 - The RF signal generator can only use the list currently loaded for sweep.
- (4) In list or step sweep, the amplitude does not change
 - Make sure that the sweep manner is set to "Level" or "Freq & Lev".
 - If the sweep manner is currently set to "Freq", the amplitude will not change.

6. The USB storage device cannot be recognized:

- (1) Check whether the USB storage device can work normally when being connected to other instrument or PC.
- (2) Make sure that the USB storage device used is a Flash type. This instrument does not support hardware USB storage device.
- (3) Restart the instrument and insert the USB storage device to check whether it can work normally.
- (4) If the USB storage device still cannot be used normally, please contact **RIGOL**.

7. No response or incorrect response when a key is pressed:

- (1) After starting the instrument, check whether all the keys are irresponsive.
- (2) Press **Syst** → **Self-Test** → **Key Test** to enter the keyboard test interface. Press the function keys at the front panel sequentially and check whether some key gives no response or incorrect response when it is pressed.
- (3) If the above failures occur, the keyboard connecting wire might be loose or the keyboard is damaged. Please do not disassemble the instrument and contact **RIGOL**.

8. The instrument does not pass the performance specification test:

- (1) Check whether the RF signal generator is within the calibration period (1 year).
- (2) Check whether the RF signal generator is warmed up for at least 40 minutes before the test.

- (3) Check whether the RF signal generator is working under the specified environment temperature.
- (4) Check whether the test is being performed in a highly magnetic environment.
- (5) Check whether the power supplies of the RF signal generator and test system have strong interference.
- (6) Check whether the performance of the test device meets the requirement.
- (7) Check whether the test device is within the calibration period.
- (8) Check whether the test device is working under the required conditions of the corresponding manual.
- (9) Check whether all the connections are tight.
- (10) Check whether the cables have internal damage.
- (11) Make sure that the operations conform to the settings and processes required by the performance verification guide.
- (12) Check whether the error calculation is correct.
- (13) Get a correct understanding of the definitions of "Typical Value" and "Nominal Value".
 - Typical Value: the performance specifications of this product under the specified conditions.
 - Nominal Value: the approximate quantity of the product during application.

RIGOL

快速指南

DSG800 系列射频信号源

2018 年 9 月

RIGOL (SUZHOU) TECHNOLOGIES, INC.

保证和声明

版权

© 2015 苏州普源精电科技有限公司

商标信息

RIGOL 是苏州普源精电科技有限公司的注册商标。

文档编号

QGG02006-1110

声明

- 本公司产品受中国及其它国家和地区的专利（包括已取得的和正在申请的专利）保护。
- 本公司保留改变规格及价格的权利。
- 本手册提供的信息取代以往出版的所有资料。
- 本手册提供的信息如有变更，恕不另行通知。
- 对于本手册可能包含的错误，或因手册所提供的信息及演绎的功能，以及因使用本手册而导致的任何偶然或继发的损失，**RIGOL** 概不负责。
- 未经 **RIGOL** 事先书面许可，不得影印、复制或改编本手册的任何部分。

产品认证

RIGOL 认证本产品符合中国国家产品标准和行业产品标准及 ISO9001:2015 标准和 ISO14001:2015 标准，并进一步认证本产品符合其它国际标准组织成员的相关标准。

联系我们

如您在使用此产品或本手册的过程中有任何问题或需求，可与 **RIGOL** 联系：

电子邮箱：service@rigol.com

网址：www.rigol.com

安全要求

一般安全概要

了解下列安全性预防措施，以避免受伤，并防止损坏本产品或与本产品连接的任何产品。为避免可能的危险，请务必按照规定使用本产品。

使用正确的电源线。

只允许使用所在国家认可的本产品专用电源线。

将产品接地。

本产品通过电源电缆的保护接地线接地。为避免电击，在连接本产品的任何输入或输出端子之前，请确保本产品电源电缆的接地端子与保护接地端可靠连接。

正确连接探头。

如果使用探头，探头地线必须连接到接地端上。请勿将探头地线连接至高电压，否则，可能会在示波器和探头的连接器、控制设备或其它表面上产生危险电压，进而对操作人员造成伤害。

查看所有终端额定值。

为避免起火和过大电流的冲击，请查看产品上所有的额定值和标记说明，请在连接产品前查阅产品手册以了解额定值的详细信息。

使用合适的过压保护。

确保没有过电压（如由雷电造成的电压）到达该产品。否则操作人员可能有遭受电击的危险。

请勿开盖操作。

请勿在仪器机箱打开时运行本产品。

请勿将异物插入排风口。

请勿将异物插入排风口以免损坏仪器。

使用合适的保险丝。

只允许使用本产品指定规格的保险丝。

避免电路外露。

电源接通后，请勿接触外露的接头和元件。

怀疑产品出故障时，请勿进行操作。

如果您怀疑本产品出现故障，请联络**RIGOL**授权的维修人员进行检测。任何维护、调整或零件更换必须由**RIGOL**授权的维修人员执行。

保持适当的通风。

通风不良会引起仪器温度升高，进而引起仪器损坏。使用时应保持良好的通风，定期检查通风口和风扇。

请勿在潮湿环境下操作。

为避免仪器内部电路短路或发生电击的危险，请勿在潮湿环境下操作仪器。

请勿在易燃易爆的环境下操作。

为避免仪器损坏或人身伤害，请勿在易燃易爆的环境下操作仪器。

请保持产品表面的清洁和干燥。

为避免灰尘或空气中的水分影响仪器性能，请保持产品表面的清洁和干燥。

防静电保护。

静电会造成仪器损坏，应尽可能在防静电区进行测试。在连接电缆到仪器前，应将其内外导体短暂接地以释放静电。

正确使用电池。

如果仪器提供电池，严禁将电池暴露于高温或火中。要让儿童远离电池。不正确地更换电池可能造成爆炸（警告：锂离子电池）。必须使用 **RIGOL** 指定的电池。

注意搬运安全。

为避免仪器在搬运过程中滑落，造成仪器面板上的按键、旋钮或接口等部件损坏，请注意搬运安全。

安全术语和符号

本手册中的安全术语:



警告

警告性声明指出可能会造成人身伤害或危及生命安全的情况或操作。



注意

注意性声明指出可能导致本产品损坏或数据丢失的情况或操作。

产品上的安全术语:

DANGER

表示您如果不进行此操作，可能会立即对您造成危害。

WARNING

表示您如果不进行此操作，可能会对您造成潜在的危害。

CAUTION

表示您如果不进行此操作，可能会对本产品或连接到本产品的其他设备造成损坏。

产品上的安全符号:



高电压



安全警告



保护性接地端



壳体接地端



测量接地端

保养与清洁

保养

请勿将仪器放置在长时间受到日照的地方。

清洁

请根据使用情况定期对仪器进行清洁。方法如下：

1. 断开电源。
2. 用柔和的清洁剂或清水浸湿软布擦拭仪器外部，请注意不要将水或其他异物通过散热孔进入机箱内。清洁带有液晶显示屏的仪器时，请注意不要划伤 LCD 显示屏。



注意

请勿使任何腐蚀性的液体沾到仪器上，以免损坏仪器。



警告

重新通电之前，请确认仪器已经干透，避免因水分造成电气短路甚至人身伤害。

环境注意事项

以下符号表明本产品符合 WEEE Directive 2002/96/EC 所制定的要求。



设备回收

本产品中包含的某些物质可能会对环境或人体健康有害，为避免将有害物质释放到环境中或危害人体健康，建议采用适当的方法回收本产品，以确保大部分材料可正确地重复使用或回收。有关处理或回收的信息，请与当地权威机构联系。

文档概述

文档中的格式约定

1. 按键：

本手册中通常用“文本框+文字（加粗）”表示前面板上的一个按键，如 **FREQ** 表示 **FREQ** 键。

2. 菜单：

本手册通常用“字符底纹+文字（加粗）”表示一个菜单，如 **低频** 表示 **FREQ** 功能键的低频菜单项。

3. 连接器：

本手册中通常用“方括号+文字（加粗）”表示前面板或后面板上的一个连接器。例如：**[RF OUTPUT 50Ω]**。

4. 操作步骤：

本手册中通常用一个箭头“→”表示下一步操作。例如：**FREQ** → **低频** 表示按下前面板上的 **FREQ** 功能键后再按 **低频** 菜单软键。

文档中的内容约定

DSG800 系列射频信号源包含 DSG815 和 DSG830 两个型号。本手册以 DSG830 为例，介绍其基本操作。有关更多详细信息，请参考《DSG800 用户手册》。

本产品用户文档

本产品的主要用户文档包括快速指南、用户手册、编程手册、数据手册等。用户可以登录 **RIGOL** 网址下载所需文档的最新版本（www.rigol.com）。

目录

保证和声明	I
安全要求	II
一般安全概要	II
安全术语和符号	IV
保养与清洁	V
环境注意事项	V
文档概述	VI
快速入门	1
一般性检查	1
前面板概述	2
后面板概述	7
首次使用 DSG800	11
连接电源	11
开机检查	11
设置系统语言	11
用户界面	12
使用内置帮助系统	15
基本操作	16
输出 RF 信号	16
输出 RF 扫描信号	17
输出 RF 已调信号	18
远程控制	19
故障处理	20

快速入门

一般性检查

1. 检查运输包装

如运输包装已损坏，请保留被损坏的包装或防震材料，直到货物经过完全检查且仪器通过电性和机械测试。

因运输造成仪器损坏，由发货方和承运方联系赔偿事宜。**RIGOL**公司恕不进行免费维修或更换。

2. 检查整机

若存在机械损坏或缺失，或者仪器未通过电性和机械测试，请联系您的 **RIGOL** 经销商。

3. 检查随机附件

请根据装箱单检查随机附件，如有损坏或缺失，请联系您的**RIGOL**经销商。

前面板概述

DSG800 系列射频信号源前面板如下图所示。



图 1 前面板

1. 恢复预设设置键

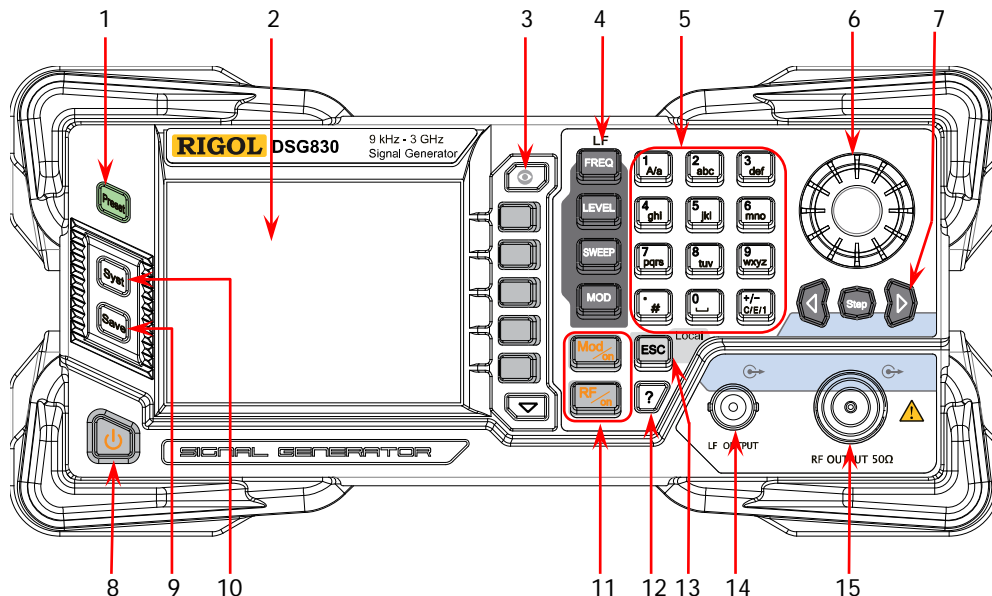

将仪器恢复至预设的状态（出厂默认状态或用户保存的状态）。

2. LCD 显示屏

3.5 英寸 TFT 高清（320×240）彩色液晶显示屏，清晰显示仪器当前的主要设置和状态，详细信息请参考“用户界面”一节。

3. 菜单控制键



显示切换键，在某一功能的菜单页下，按下该键打开当前功能的参数信息显示界面。此时，您可使用旋钮或方向键切换参数标签查看不同功能的参数信息。再次按下该键则可跳转到当前所选参数标签对应的功能菜单。另外，按下任意功能按键可退出参数信息显示界面。



菜单软键，与其左侧显示的菜单一一对应，按下该软键激活相应的菜单。



菜单翻页键。

4. 功能键

LF



设置 RF 输出信号的频率参数以及 LF 输出的相关参数。



设置 RF 输出信号的幅度参数，并提供平坦度校正功能。



设置扫描方式、扫描类型、扫描模式等参数。



设置幅度调制（Amplitude Modulation, AM）、频率调制（Frequency Modulation, FM）、相位调制（Phase Modulation, $\emptyset M$ ）、脉冲调制（Pulse Modulation）及脉冲发生器、I/Q 调制及 I/Q 调制源相关的参数。

5. 数字键盘

数字键盘支持中文字符、英文大/小写字符、数字和常用符号（包括小数点、#、空格和正负号 +/-）的输入。主要用于编辑文件或文件夹的名称、设置参数。

数字与字母复用的按键用于直接输入所需的数字或字母。



用于切换输入模式为中文、英文或数字。
设置参数时，输入模式固定为数字，该键用于输入数值的符号（“+”或“-”）。



数字输入模式下，按下该键输入 1。
英文输入模式下，用于切换字母的大小写状态。



0 与空格的复用:

数字输入模式下, 按下该键输入 0。

中文或英文输入模式下, 按下该键输入空格。



数字输入模式下, 按下该键, 当前光标处插入一个小数点。

英文输入模式下, 该键用于输入“#”。

中文输入模式下, 该键无效。

6. 旋钮

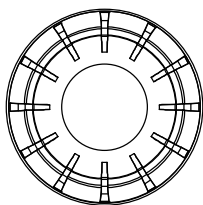

参数设置时, 用于修改光标处的数值或以当前步进修改参数值。

文件名编辑时, 用于选择所需的字符。

存储功能中, 用于选择当前的路径或文件。

参数信息显示界面下, 用于切换参数标签。

7. 方向键/Step 键

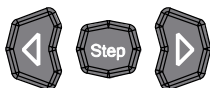

设置参数时, **Step** 键用于设置当前选中参数的步进; 方向键用于进入参数编辑状态并移动光标至指定位。

存储功能中, 方向键用于展开和折叠当前选中目录。

文件名编辑时, 方向键用于选择所需的字符。

参数信息显示界面下, 方向键用于切换参数标签。

8. 电源键

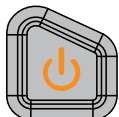

用于打开或关闭射频信号源。您可以通过如下方式启用或禁用该按键的功能。按 **Syst** → **电源状态** 选择“缺省”或“常开”。选择“缺省”时, 仪器上电后, 您需要按下该按键启动仪器。选择“常开”时, 仪器上电后, 仪器自动启动。

另外, 该按键具有延迟开关机的功能 (即按下该键保持一定时间后才可打开或关闭仪器), 避免了因误操作而导致的关机。

9. 存储与调用键



存储和调用仪器状态等类型文件。

10. 系统设置键



设置系统相关的参数。

11. 输出控制键



用于打开或关闭 RF 输出。

- 按下该按键，背灯点亮，用户界面功能状态区 RF 标志点亮，打开 RF 输出。此时，**[RF OUTPUT 50Ω]** 连接器以当前配置输出 RF 信号。
- 再次按下该按键，背灯熄灭，用户界面功能状态区 RF 标志变灰。此时，关闭 RF 输出。



用于打开或关闭 RF 调制输出。

- 打开某一项调制(AM、FM、 \emptyset M、Pulse Mod 或 I/Q Mod) 开关后，按下该按键，背灯点亮，用户界面功能状态区 MOD 标志点亮。打开 RF 调制输出。此时，**[RF OUTPUT 50Ω]** 连接器以当前配置输出已调制的 RF 信号（**[RF/on]** 按键背灯必须点亮）。
- 再次按下该按键，背灯熄灭，此时，关闭 RF 调制输出。

12. 内置帮助系统



要获得任何前面板按键或菜单软键的帮助信息，按下该键，再按下您所需要获得帮助的按键即可。

13. 退出键



设置参数时，用于清除编辑窗口中的数字，同时退出参数输入状态。

编辑文件名时，用于清除输入栏的字符。

在键盘测试状态，用于退出当前测试状态。

仪器工作在远程模式时，用于返回本地模式。

选择下一级菜单后，用于退出当前菜单，并返回上一级菜单。

14. LF 输出连接器

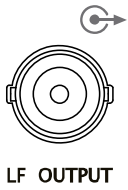

当打开 LF 输出开关时，该连接器用于输出 LF 信号。

15. RF 输出连接器

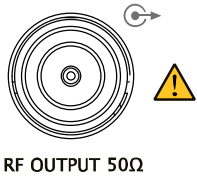

当 **RF/on** 按键背灯点亮时，该连接器用于输出 RF 信号和 RF 扫描信号。

当 **RF/on** 和 **Mod/on** 按键背灯点亮时，该连接器用于输出 RF 已调制信号。



注意

为了避免损坏仪器，RF 输出连接器上的反向直流电压不得超过 50 V；1 MHz 至 3 GHz 频段，反向功率不得超过 +30 dBm (1W)。

后面板概述

DSG800 系列射频信号源后面板如下图所示。



图 2 后面板

1. 脉冲信号输入/输出连接器

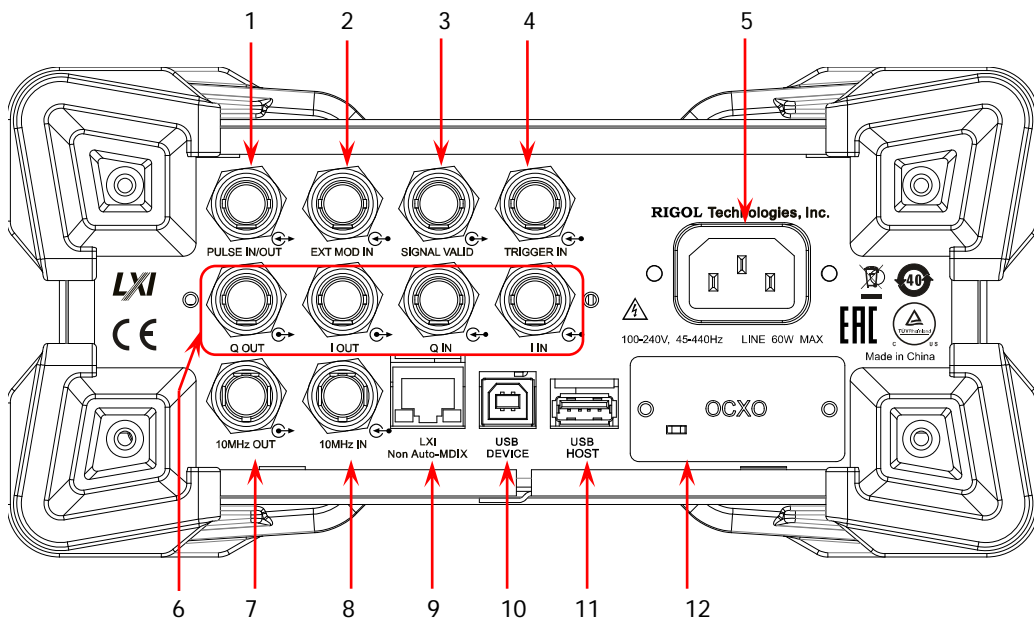
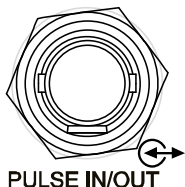

该连接器的功能由脉冲调制当前的工作模式决定。

PULSE IN:

当脉冲调制源为“外部”时，用于输入外部脉冲信号。

PULSE OUT:

当脉冲调制源为“内部”且脉冲输出开关打开时，用于输出内部发生器产生的脉冲信号。该输出信号与“脉冲类型”的选择有关，可设置为“单脉冲”或“多脉冲”。

2. 外部调制输入连接器



当 AM 或 FM/ØM 的调制源为“外部”时，该连接器用于输入外部调制信号。

3. 信号有效输出连接器



修改 RF 输出频率或幅度时，仪器内部电路经过一定的响应和处理时间后，前面板 RF 输出连接器以指定的频率和幅度输出 RF 信号。在此过程中，[**SIGNAL VALID**] 连接器输出一个脉冲同步信号指示 RF 输出信号的有效性：

- 高电平 (+3.3 V)：表示 RF 信号正在配置；
- 低电平 (0 V)：表示 RF 信号已经稳定(即有效)。

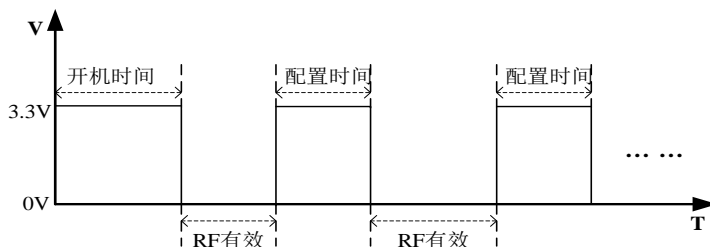

4. 外部触发输入连接器



当 **SWEEP** 的触发方式为“外触发”时，该连接器用于输入外部触发信号。您可按 **触发沿** 软键选择“上升沿”或“下降沿”设置该触发信号的极性。当 I/Q 调制基带输出的触发方式为“外触发”时，用于输入外部触发信号。当脉冲调制源为“内部”且触发方式为“外部触发”时，用于输入外部触发信号。当脉冲调制源为“内部”且触发方式为“外部门控”时，用于输入外部门控信号。

5. 电源输入连接器

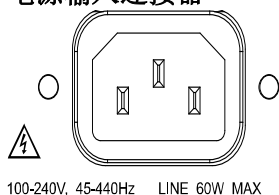

电源输入连接器。

本射频信号源支持 100 V-240 V，45 Hz-440 Hz 规格的交流电源。仪器最大功耗不超过 60 W。

6. I/Q 调制信号输入/输出连接器（选件 DSG800-IQ）

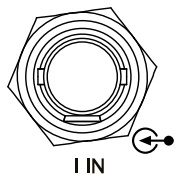

当 I/Q 调制源为“外部”时，用于输入 I/Q 调制的同相（I: In-Phase）基带信号。

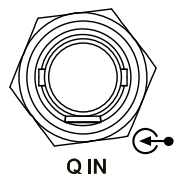

当 I/Q 调制源为“外部”时，用于输入 I/Q 调制的正交相位（Q: Quadrature Phase）基带信号。

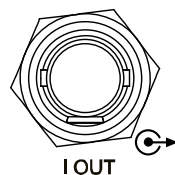

用于输出内置基带发生器 I/Q 调制的同相（I: In-Phase）成分。

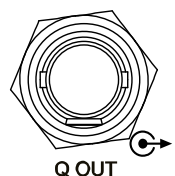

用于输出内置基带发生器 I/Q 调制的正交相位（Q: Quadrature Phase）成分。

7. 参考信号输出连接器

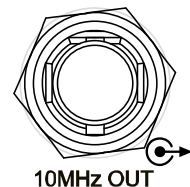

用于输出仪器内部 10 MHz 参考时钟信号，常用于与其它仪器的同步。如需了解该连接器输出时钟信号的规格，请参考本产品的数据手册。

8. 参考信号输入连接器

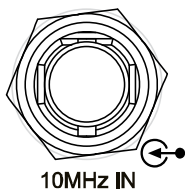

用于输入外部 10 MHz 参考时钟信号，常用于与其它仪器的同步。如需了解该连接器对外部时钟信号的规格要求，请参考本产品的数据手册。

9. LAN

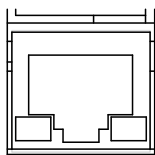

LXI
Non Auto-MDIX

本仪器符合 LXI Core 2011 Device 仪器标准，主要支持 WebServer, Socket 等多种远程控制方式。该接口用于将射频信号源连接至计算机或网络，从而实现远程控制。

10. USB DEVICE

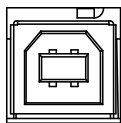

USB
DEVICE

本仪器符合 USBTMC 类协议。该接口用于与计算机相连，从而实现远程控制。

11. USB HOST

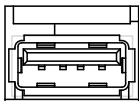

USB
HOST

用于连接 U 盘升级系统或存储系统状态等。

12. OCXO (选件 OCXO-B08)



OCXO 为恒温晶体振荡器(Oven Controlled Crystal Oscillator), 可提供更高温度稳定度的频率参考源。

注意: OCXO 在达到其标称频率前需要 60 分钟的预热时间。

有关该选件的订货信息，请参考本产品的数据手册。

首次使用 DSG800

连接电源

请使用附件提供的电源线将射频信号源连接至 AC 电源中。本射频信号源支持 100 V-240 V，45 Hz-440 Hz 规格的交流电源。仪器最大功耗不超过 60 W。当通过该连接器将射频信号源连接到交流电源时，仪器自动调节至正确的电压范围，无需手动选择。



注意

为避免电击，请务必使用标准配置插头。

开机检查

正确连接电源后，按下前面板的电源键  打开射频信号源。开机过程中仪器执行初始化过程和自检过程。结束后，屏幕进入默认界面。

设置系统语言

DSG800 系列射频信号源支持多种系统语言，您可以按 **Syst** → **Language** 切换系统语言。

用户界面

本手册以 DSG830 型号为例,介绍 DSG800 系列射频信号源的用户界面,如下图所示。









图 3 用户界面

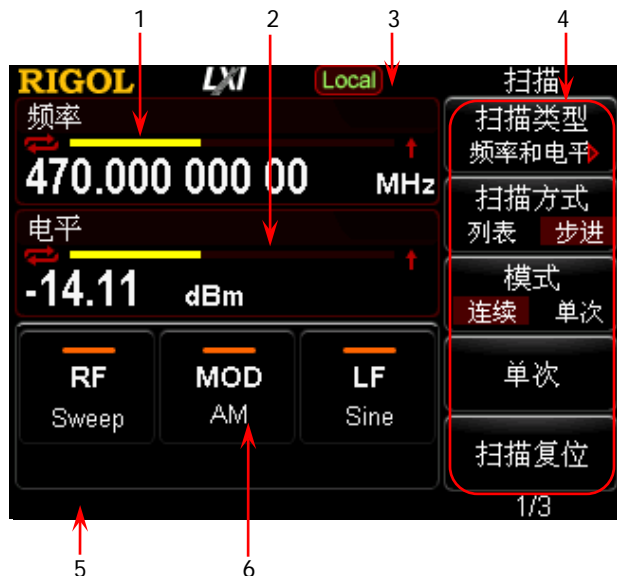



1. 频率区

显示当前射频信号源的频率设置。



- ：连续扫描标志。当扫描类型为“频率”或“频率和电平”且扫描模式为“连续”时显示。
- ：单次扫描标志。当扫描类型为“频率”或“频率和电平”且扫描模式为“单次”时显示。
- ：递增扫描标志。当扫描类型为“频率”或“频率和电平”且扫描方向为“递增”时显示。
- ：递减扫描标志。当扫描类型为“频率”或“频率和电平”且扫描方向为“递减”时显示。
- ：频率扫描进度条。当扫描类型为“频率”或“频率和电平”时显示。

2. 幅度区

显示当前射频信号源的电平设置。





- ：平坦度校正开关为“打开”时显示。
- ：连续扫描标志。当扫描类型为“电平”或“频率和电平”且扫描模式为“连续”时显示。
- ：单次扫描标志。当扫描类型为“电平”或“频率和电平”且扫描模式为“单次”时显示。
- ：递增扫描标志。当扫描类型为“电平”或“频率和电平”且扫描方

向为“递增”时显示。

- ：递减扫描标志。当扫描类型为“电平”或“频率和电平”且扫描方向为“递减”时显示。
- ：幅度扫描进度条。当扫描类型为“电平”或“频率和电平”时显示。

3. 状态栏

指示当前射频信号源的一些系统状态。

- ：射频信号源工作在远程控制模式。
- ：射频信号源工作在本地操作模式。
- ：仪器检测到 U 盘时显示。
- ：打开仪器参数信息界面时显示。

4. 菜单显示区

该区域中的菜单项与显示屏右边的软键一一对应。按下任一软键可激活相应的菜单功能。







5. 消息显示区

显示操作错误消息和操作提示消息。您可通过按 **Syst** → **信息** → **系统消息**，查看出现的消息。如果发生多条消息，您可使用方向键或旋转旋钮选中消息行进行查看。

6. 功能状态区

显示当前射频信号源各功能的工作状态。功能状态区可能出现的状态图标如下表所示。

图标	说明	图标	说明
	未打开 RF 输出，未选择一种扫描类型。		未打开 LF 输出，选择 Sine 波形。
	未打开 RF 输出，仅选择一种扫描类型。		未打开 LF 输出，选择 Square 波形。
	打开 RF 输出，未选择一种扫描类型。		打开 LF 输出，并选择 Sine 波形。
	打开 RF 输出，并选择一种扫描类型。		打开 LF 输出，并选择 Square 波形。
	未打开 RF 调制输出，仅打开 AM。		打开 RF 调制输出，并打开 AM。
	未打开 RF 调制输出，仅打开 FM。		打开 RF 调制输出，并打开 FM。

	未打开 RF 调制输出，仅打开 ØM。		打开 RF 调制输出，并打开 ØM。
	未打开 RF 调制输出，仅打开 Pulse。		打开 RF 调制输出，并打开 Pulse。
	未打开 RF 调制输出，仅打开 IQ。		打开 RF 调制输出，并打开 IQ。
	未打开 RF 调制输出，打开 AM 和 FM。		打开 RF 调制输出，并打开 AM 和 FM。
	未打开 RF 调制输出，打开 AM 和 ØM。		打开 RF 调制输出，并打开 AM 和 ØM。
	未打开 RF 调制输出，打开 AM 和 Pulse。		打开 RF 调制输出，并打开 AM 和 Pulse。
	未打开 RF 调制输出，打开 FM 和 Pulse。		打开 RF 调制输出，并打开 FM 和 Pulse。
	未打开 RF 调制输出，打开 FM 和 IQ。		打开 RF 调制输出，并打开 FM 和 IQ。
	未打开 RF 调制输出，打开 ØM 和 Pulse。		打开 RF 调制输出，并打开 ØM 和 Pulse。
	未打开 RF 调制输出，打开 ØM 和 IQ。		打开 RF 调制输出，并打开 ØM 和 IQ。
	未打开 RF 调制输出，打开 IQ 和 Pulse。		打开 RF 调制输出，并打开 IQ 和 Pulse。
	未打开 RF 调制输出，打开 AM、FM 和 Pulse。		打开 RF 调制输出，并打开 AM、FM 和 Pulse。
	未打开 RF 调制输出，打开 AM、ØM 和 Pulse。		打开 RF 调制输出，并打开 AM、ØM 和 Pulse。
	未打开 RF 调制输出，打开 FM、IQ 和 Pulse。		打开 RF 调制输出，并打开 FM、IQ 和 Pulse。
	未打开 RF 调制输出，打开 ØM、IQ 和 Pulse。		打开 RF 调制输出，并打开 ØM、IQ 和 Pulse。
	未打开 RF 调制输出，并关闭所有调制类型开关。	---	---

提示：按下 **MOD** 键，功能状态区显示 AM/FM/ØM/PUL/IQ 调制类型图标。若打开（或关闭）相应的调制类型开关，则点亮（或置灰）与之对应的图标。

使用内置帮助系统

DSG800 内置帮助系统对于前面板上的每个功能按键以及菜单软键，都提供了相关帮助信息。用户可在操作仪器的过程中随时查看任意键的相关帮助。

1. 获取内置帮助的方法

按下  键，然后按下所需要获得帮助的功能按键或菜单软键，仪器界面显示该键的帮助信息。

2. 帮助的翻页操作

当帮助信息为多页显示时，可通过方向键或旋转旋钮滚动帮助信息页面。

3. 关闭当前的帮助信息

当仪器界面显示帮助信息时，用户按下前面板上的任意按键（方向键和旋钮除外），将关闭当前显示的帮助信息。

4. 获取菜单软键的帮助信息

按下  键，仪器界面将显示获取帮助的提示。按下菜单软键，仪器界面显示菜单键所对应菜单项的帮助信息。

5. 获取任意功能按键的帮助信息

按下  键，仪器界面将显示获取帮助的提示。按下任意功能按键，仪器界面显示按键本身的功能帮助信息。

基本操作

输出 RF 信号

从 [RF OUTPUT 50Ω] 连接器输出一个频率为 1 GHz, 幅度为-20 dBm 的 RF 信号。

1. 恢复出厂设置

按 **Syst** → **复位** → **预置类型** → “出厂设置”，然后按 **Preset** 键恢复出厂设置。

2. 频率设置

按 **FREQ**，使用数字键盘输入频率的数值 1，然后在弹出的单位菜单中选择所需的单位 GHz。

- 可选的频率单位有GHz、MHz、kHz和Hz。
- 按 **退格** 软键，可删除光标左边的数字。
- 您还可以按左右方向键进入参数编辑状态并移动光标至指定的位，旋转旋钮则可修改数值。
- 频率设置完成后，您可以旋转旋钮以当前步进值修改频率。
- 按 **FREQ**，再按 **Step** 键可以设置步进值。

3. 幅度设置

按 **LEVEL**，使用数字键盘输入幅度的数值-20，然后在弹出的单位菜单中选择所需的单位 dBm。

- 可选的幅度单位有dBm、-dBm、mV、uV和nV。
- 按 **退格** 软键，可删除光标左边的数字。
- 您可以按左右方向键进入参数编辑状态并移动光标至指定的位，旋转旋钮则可修改数值。
- 您还可以旋转旋钮以当前步进值修改幅度。
- 按 **LEVEL**，再按 **Step** 键可以设置步进值。

4. 打开 RF 输出

按下 **RF/on** 键，背灯点亮，用户界面功能状态区 RF 标识点亮，打开 RF 输出。此时，[RF OUTPUT 50Ω] 连接器以当前配置输出 RF 信号。

输出 RF 扫描信号

本小节以配置连续的线性步进扫描为例，介绍输出一个 RF 扫描信号：频率范围为 1 GHz 至 2 GHz，幅度范围为 -20 dBm 至 0 dBm，扫描点数为 10，驻留时间为 500 ms。

1. 恢复出厂设置

按 **Syst** → **复位** → **预置类型** → “出厂设置”，然后按 **Preset** 键恢复出厂设置（扫描模式默认为连续，扫描方式默认为步进，扫描间隔默认为线性）。

2. 步进扫描参数设置

按 **SWEEP** 键，使用菜单翻页键  打开第 2/3 页菜单，然后按 **步进扫描** 软键，进入步进扫描参数设置菜单。

- 起始频率
按 **起始频率** 软键，使用数字键盘输入起始频率的数值 1，然后在弹出的单位菜单中选择所需的单位 GHz。
- 终止频率
按 **终止频率** 软键，使用数字键盘输入终止频率的数值 2，然后在弹出的单位菜单中选择所需的单位 GHz。
- 起始电平
按 **起始电平** 软键，使用数字键盘输入起始电平的数值 -20，然后在弹出的单位菜单中选择所需的单位 dBm。
- 终止电平
按 **终止电平** 软键，使用数字键盘输入终止电平的数值 0，然后在弹出的单位菜单中选择所需的单位 dBm。
- 扫描点数
按 **点数** 软键，使用数字键盘输入扫描点的个数 10，然后按 **确认** 软键。
- 驻留时间
驻留时间表示一个扫描步进持续的时间。
按 **驻留时间** 软键，使用数字键盘输入时间数值 500，然后在弹出的单位菜单中选择所需的单位 ms。

3. 启用 RF 扫描

按 **SWEEP** → **扫描类型**，选择“频率和电平”，同时启用频率和幅度扫描功能。

此时，射频信号源以当前设置值从起始频率和电平到终止频率和电平进行连续步进扫描。用户界面频率区和幅度区分别显示频率和幅度扫描进度条以及连续扫描标志，并且功能状态区 Sweep 标志点亮。

4. 打开 RF 输出

按下 **RF/on** 键，背灯点亮，用户界面功能状态区 RF 标识点亮，打开 RF 输出。此时，**[RF OUTPUT 50Ω]** 连接器以当前配置输出 RF 扫描信号。

输出 RF 已调信号

本小节以幅度调制（AM）为例，介绍输出一个 AM 已调信号：载波频率为 800 MHz，载波幅度为-20 dBm，AM 调制深度为 60%，调制频率为 20 kHz。

1. 恢复出厂设置

按 **Syst** → **复位** → **预置类型** → “出厂设置”，然后按 **Presets** 键恢复出厂设置（调制源默认为内部，调制波形默认为正弦）。

2. 设置载波频率和幅度

(1) 载波频率

按 **FREQ**，使用数字键盘输入频率的数值 800，然后在弹出的单位菜单中选择所需的单位 MHz。

(2) 载波幅度

按 **LEVEL**，使用数字键盘输入幅度的数值-20，然后在弹出的单位菜单中选择所需的单位 dBm。

3. 设置 AM 调制参数

(1) 按 **MOD** → **调幅** 软键，进入调幅参数设置菜单。

(2) 按 **调制深度** 软键，使用数字键盘输入调制深度数值 60，然后在弹出的单位菜单中选择所需的单位 %。

(3) 按 **调制频率** 软键，使用数字键盘输入所需的频率值 20，然后在弹出的单位菜单中选择所需的单位 kHz。

(4) 按 **开关** 软键，选择“打开”，开启 AM 功能。

4. 打开 RF 调制输出

按下 **Mod/on** 键，背灯点亮，然后按下 **RF/on** 键，背灯点亮，用户界面功能状态区 MOD、AM 和 RF 标识点亮，打开 RF 调制输出。此时，**[RF OUTPUT 50Ω]** 连接器以当前配置输出已调制的 RF 信号。

注意： **RF/on** 按键和 **Mod/on** 按键背灯必须都处于点亮状态。

远程控制

DSG800 支持通过 USB 或 LAN 接口与计算机进行通信从而实现远程控制。远程控制基于 SCPI 命令集（Standard Commands for Programmable Instruments，用于可编程仪器的标准命令集）实现。本小节将介绍如何使用 **RIGOL** 提供的通用 PC 软件 Ultra Sigma 发送 SCPI 命令并通过 USB 接口对射频信号源进行远程控制。有关命令的详细说明请参考《DSG800 编程手册》。

注意：当仪器工作在远程模式时，用户界面显示  图标，前面板按键被锁定（**ESC** 除外）。此时，您可以按 **ESC** 键退出远程模式。

1. 安装 Ultra Sigma 软件

获取 Ultra Sigma 软件，然后按照指导正确安装软件及所需组件。您可以登录 **RIGOL** 网站下载最新软件版本（www.rigol.com）。

2. 通过 USB 控制

(1) 连接设备

使用 USB 数据线连接射频信号源（USB DEVICE）与计算机（USB HOST）。

(2) 安装 USB 驱动

本射频信号源为 USBTMC 设备，将射频信号源与 PC 正确连接并且开机后（射频信号源将自动配置为 USB 接口），PC 将弹出硬件更新向导对话框，请按照向导的提示安装“USB Test and Measurement Device (IVI)”驱动程序。

(3) 搜索设备资源

打开 Ultra Sigma，软件将自动搜索当前连接到 PC 上的射频信号源资源，您也可以点击  进行搜索。

(4) 查看设备资源

搜索到的资源将出现在“RIGOL Online Resource”目录下，并且显示仪器的型号和 USB 接口信息。

例如：DSG830 (USB0::0x1AB1::0x6666::DSG8A170200001::INSTR)。

(5) 通讯测试

右击资源名“DSG830

(USB0::0x1AB1::0x6666::DSG8A170200001::INSTR)”，选择“SCPI Panel Control”，打开远程命令控制面板，即可通过该面板发送命令和读取数据。

故障处理

本章主要介绍 DSG800 在使用过程中可能出现的故障及排查方法。当您遇到这些故障时，请按照相应的步骤进行处理，如不能处理，请与 **RIGOL** 联系，同时请提供您仪器的设备信息（获取方法：**Syst** → **信息** → **系统信息**）。

1. 如果按下电源键，射频信号源仍然黑屏，没有任何显示：

- (1) 检查风扇是否转动：
 - 如果风扇转动，屏幕不亮，可能是屏幕连接线松动。
 - 如果风扇不转，说明仪器并未成功开机，请参考步骤(2)处理。
- (2) 检查电源接头是否已正确连接，电源开关是否已打开。
- (3) 检查电源保险丝是否已熔断。如需更换保险丝，请与 **RIGOL** 联系。
- (4) 做完上述检查后，重新启动仪器。
- (5) 如果仍然无法正常使用本产品，请与 **RIGOL** 联系。

2. 屏幕显示太暗，看不清：

- (1) 检查液晶屏的亮度设置值是否太小。
- (2) 按 **Syst** → **显示** → **亮度** 软键，使用数字键或旋钮调节射频信号源液晶屏的亮度至合适的状态。

3. 射频信号源被锁定：

- (1) 检查射频信号源是否工作在远程控制模式（远程控制时，用户界面状态栏显示 **Rmt** 标志）。按 **ESC** 键可退出远程控制模式，解锁前面板。
- (2) 确认射频信号源是否工作在本地屏幕锁定状态（屏幕锁定时，前面板操作被禁止）。按 **ESC** 键可解锁屏幕，退出锁定状态。
- (3) 如果射频信号源界面显示进度条，表示正在进行某个操作。例如，保存文件时，显示进度条表示正在进行保存。此操作进行中，前面板被锁定。
- (4) 按 **Preset** 或重新启动射频信号源的电源，也可解除锁定。

4. 设置正确但波形输出不正确：

- (1) 没有 RF 输出
 - 检查信号连接线是否与相应的 **[RF OUTPUT 50Ω]** 端口紧固连接。
 - 检查连接线是否有内部损伤。
 - 检查连接线是否与测试仪器紧固连接。
 - 检查 **RF/on** 键背灯是否点亮。如果未点亮，按下该键使其点亮，并且用户界面功能状态区 RF 标志点亮。此时 RF 输出已正确打开。
 - 检查 RF 信号的输出幅度是否过小，适当调整输出幅度的大小。

- (2) RF 输出上没有调制
- 检查信号连接线是否与相应的 [RF OUTPUT 50Ω] 端口紧固连接。
 - 检查连接线是否有内部损伤。
 - 检查连接线是否与测试仪器紧固连接。
 - 检查 **Mod/on** 和 **RF/on** 按键背灯是否都处于点亮状态，并且需查看调制 **开关** 是否打开。
 - 检查调制参数设置是否合适，适当调整调制参数。
 - 如果使用外部调制源，请确保外部源连接正确并且有输出，同时应在射频信号源指定的范围内工作。

5. 扫描发生异常：

- (1) 扫描出现停滞
- 用户界面频率区/幅度区显示扫描进度条，表示正在进行扫描操作。若出现扫描停滞，应检查以下几点：
- 至少打开一种扫描类型：按 **SWEEP** → **扫描类型**，选择“频率”、“电平”或“频率和电平”。
 - 如果是单次扫描模式，按 **单次** 软键满足触发条件时，则启动一次扫描。
 - 如果扫描触发方式不是自动触发，按 **SWEEP** → **触发方式** → **自动触发**，以确定是否是扫描触发丢失阻塞了扫描。
 - 如果点触发方式不是自动触发，按 **SWEEP** → **点触发方式** → **自动触发**，以确定是否是点触发丢失阻塞了扫描。
 - 确认驻留时间设置值是否太大或太小，导致看不到扫描。
 - 确认在步进扫描或列表扫描中至少已设置两个点。
- (2) 列表扫描驻留时间不正确
- 按 **SWEEP** → **列表扫描** 软键，进入扫描列表菜单页。
 - 按 **装载列表** 软键，加载当前所需扫描列表；按 **查看列表** 软键，确认扫描列表中驻留时间值是否正确。
 - 若驻留时间值不正确，请重新编辑列表并加载至仪器中；若驻留时间值正确，跳转到下一步。
 - 按 **SWEEP** → **扫描方式**，确认选择“列表”扫描方式。
如果此时选择的是“步进”扫描，射频信号源按照步进扫描设置的驻留时间进行扫描。
- (3) 调用的寄存器中列表扫描信息丢失
- 列表扫描信息不能作为仪器状态的一部分被存储在仪器状态寄存器中。
 - 射频信号源只能使用当前装载的列表进行扫描。
- (4) 在列表或步进扫描中，幅度没有变化
- 确认扫描类型设置为电平或频率和电平。
 - 如果当前扫描类型设置为频率，幅度值不会改变。

6. U 盘设备不能被识别：

- (1) 检查 U 盘设备是否连接至其他仪器或计算机上可以正常工作。
- (2) 确认使用的为 Flash 型 U 盘设备，本仪器不支持硬盘型 U 盘设备。

- (3) 重新启动仪器后，再插入 U 盘设备进行检查。
- (4) 如果仍然无法正常使用 U 盘，请与 **RIGOL** 联系。

7. 按键无响应或串键：

- (1) 开机后，确认是否所有按键均无响应。
- (2) 按 **Syst** → **自检** → **键盘测试**，进入键盘测试界面。依次按下前面板上的功能按键，确认是否有按键无响应或者串键现象。
- (3) 如存在上述故障，可能是键盘连接线松动或者键盘损坏，请勿自行拆卸仪器，并及时与**RIGOL**联系。

8. 性能指标测试没有通过：

- (1) 检查射频信号源是否在校准周期内（校准周期为1年）。
- (2) 确认是否在测试之前将射频信号源预热了至少40分钟。
- (3) 检查射频信号源是否处于规定环境温度下。
- (4) 确认测试是否处于强磁环境下进行。
- (5) 检查射频信号源以及测试系统的供电是否有强干扰。
- (6) 检查使用的测试设备的性能是否符合要求。
- (7) 确认使用的测试设备是否在校准周期内。
- (8) 检查使用的测试设备是否在其手册要求的工作条件下。
- (9) 检查所有的连接是否紧固。
- (10) 查看所有的线缆是否有内部损伤。
- (11) 确保操作符合性能校验手册要求的设置和流程。
- (12) 确认误差计算是否有失误。
- (13) 正确理解本产品对“典型值”和“标称值”的定义：
 - 典型值：指产品在特定条件下的性能指标。
 - 标称值：指产品应用过程中的近似量值。