

# Ce/year 思仪 1435 Series Signal Generators User Manual



China Electronics Technology Instruments Co., Ltd.

This manual is applied to the following models of signal generators, based on firmware version 1.0 and above.

- 1435A signal generator (9kHz ~ 3GHz)
- 1435B signal generator (9kHz ~ 6GHz)
- 1435C signal generator (9kHz ~ 12GHz)
- 1435D signal generator (9kHz ~ 20GHz)
- 1435F signal generator (9kHz ~ 40GHz)
- 1435A-V signal generator (9kHz ~ 3GHz)
- 1435B-V signal generator (9kHz ~ 6GHz)

Version: A.1 2019.03, China Electronics Technology Instruments Co., Ltd.

Addr.: No. 98, Xiangjiang Road, Qingdao Economic & Technological Development Zone, Shandong, China

Free customer service number: 800-868-7041

Technical support: (86)0532-86889847

Fax: (86)0532-86889056 86897258

Website: [www.ceyear.com](http://www.ceyear.com)

Email: [eiqd@ceyear.com](mailto:eiqd@ceyear.com)

Postal code: 266555

## Foreword

Thank you for choosing and using 1435 series signal generators developed and produced by China Electronic Technology Instruments Co., Ltd.! Integrating high, sophisticated and cutting-edge technologies, our products offer high cost performance among similar products.

With maximally meeting your requirements as our duty, we will provide you with high-quality measuring instruments as well as first-class after-sales service. With the consistent tenet of "high quality and considerate service" and the promise to provide our users with satisfactory products and services.

### Manual No.

AV2.827.1202SSCN

### Version

A.1 2018.12

China Electronics Technology Instruments Co., Ltd.

## Manual Licensing

The contents of this manual are subject to change without notice. The final right to interpret the contents and terms used in this manual belongs to CETI.

The manual copyright belongs to China Electronics Technology Group Corporation, no modification can be made to the manual contents by any unit or person without approval of the Company, or any copy or propagation of the manual made for profit. China Electronics Technology Group Corporation retains the right of pursuing legal responsibilities from any infringer.

## Product Warranty

The warranty period of this product is 18 months from the shipment date. During the warranty period, the manufacturer will repair or replace damaged parts according to actual conditions. Specific maintenance shall be operated in accordance with the contract.

## Product Quality Certification

This product is guaranteed to meet the specifications in this manual as from the date of shipment. The calibration and measurement are completed by measuring bodies with national qualifications, with relevant data provided for users' reference.

## Quality/Environmental Management

This product complies with the quality and environmental management systems during R&D, manufacturing and testing. The company already has the required qualifications and has passed the certification of ISO 9001 and ISO 14001 management

systems.

## Safety Precautions



The symbol "Warning" indicates a hazard. It reminds the user to pay attention to a certain operation process, operation method or the like. Failure to observe the rules or incorrect operation may cause personal injury. Proceed to the next step only after fully understanding and meeting the warning conditions indicated.

---



The "Note" symbol indicates some important information which will not cause danger. It reminds the user to pay attention to a certain operation process, operation method or the like. Failure to observe the rules or incorrect operation may cause damage to the instrument or loss of important data. Proceed to the next step only after fully understanding and meeting the conditions.

---



# Contents

1. Manual Navigation .....	1
1.1. About the Manual .....	1
1.2 Related Documents .....	2
2 Overview .....	5
2.1 Product Overview .....	5
2.1.1 Product Features .....	5
2.1.2 Typical Applications .....	11
2.2 Safe Operation Guide .....	12
2.2.1 Safety Marks .....	12
2.2.2 Operation Status and Locations .....	14
2.2.3 Electrical Safety .....	14
2.2.4 Operation Precautions .....	15
2.2.5 Maintenance .....	15
2.2.6 Batteries or Power Modules .....	15
2.2.7 Transportation .....	16
2.2.8 Waster Disposal/Environmental Protection .....	16
3 Quick Start .....	17
3.1 Get Prepared .....	17
3.1.1 Preparations before Operation .....	17
3.1.2 Operating System Configuration .....	28
3.1.3 Routine Maintenance .....	33
3.2 Front and Real Panels .....	34
3.2.1 Front Panel .....	34
3.2.2 Real Panel .....	35
3.3 Basic Configurations .....	37
3.3.1 Basic Settings .....	38
3.3.2 Operation Examples .....	43
3.3.3 Main Configuration Scenes .....	53
3.4 Data Management .....	65
3.4.1 Storage/Loading Working Status .....	66
3.4.2 File Management .....	67
3.4.3 Printing/Saving Screenshots .....	70

## Contents

<b>4 Operation Guide</b> .....	<b>73</b>
<b>4.1 Basic Operation Guide</b> .....	<b>73</b>
4.1.1 Digital Modulation .....	73
4.1.2 Analog Modulation and Pulse Modulation .....	74
4.1.3 Sweep .....	78
<b>4.2 Advanced Operation Guide</b> .....	<b>80</b>
4.2.1 Configuring Multi Tone .....	81
4.2.2 Configuring Arbitrary Wave .....	82
4.2.3 Selecting ALC Bandwidth .....	88
4.2.4 External Level Control of the Signal Generator .....	88
4.2.5 Impact of Working in the Mixer Mode/Reverse Power .....	89
4.2.6 Creating and Applying User Pltc Arrays .....	90
4.2.7 Pulse Modulation Input Selection .....	92
4.2.8 Baseband Triggering Function Configuration .....	96
4.2.9 Arbitrary Wave Triggering Function Configuration .....	99
<b>5. Menus</b> .....	<b>105</b>
<b>5.1 Menu Structure and Parameter Settings</b> .....	<b>105</b>
5.1.1 Frequency .....	105
5.1.2 Amplitude .....	106
5.1.3 Sweep .....	109
5.1.4 Modulation .....	110
5.1.5 Baseband .....	116
5.1.6 I/Q .....	119
5.1.7 Arbitrary Wave .....	121
5.1.8 Tone .....	122
5.1.9 AWGN (Optional) .....	124
5.1.10 System .....	126
5.1.11 Storage/Loading .....	129
5.1.12 Calibration .....	130
<b>5.2 Menu Description</b> .....	<b>131</b>
5.2.1 Frequency .....	131
5.2.2 Power .....	135
5.2.3 Sweep .....	140

5.2.4 Modulation .....	146
5.2.5 Baseband.....	152
5.2.6 I/Q.....	156
5.2.7 Arbitrary wave .....	162
5.2.8 Dual/multiple tones .....	168
5.2.10 System.....	171
5.2.11 Storage/loading.....	173
5.2.12 Calibration.....	174
<b>6 Remote control .....</b>	<b>177</b>
6.1 Remote control foundation.....	177
6.1.1 Program control interface.....	177
6.1.2 Message .....	180
6.1.3 SCPI command.....	181
6.1.4 Command sequence and synchronization.....	189
6.1.5 Status report system .....	190
6.1.6 Programming precautions .....	192
6.2 Instrument program control port and configuration .....	193
6.2.1 LAN.....	193
6.2.2 GPIB .....	194
6.3 Basic VISA interface programming .....	194
6.3.1 VISA library .....	194
6.3.2 Initialization and default status setting .....	195
6.3.3 Sending the setting command.....	196
6.3.4 Reading instrument configuration status .....	196
6.3.5 Command synchronization.....	197
6.4 I/O library .....	198
6.4.1 I/O library overview .....	198
6.4.2 I/O library installation and configuration.....	199
<b>7 Troubleshooting and after-sales services.....</b>	<b>201</b>
7.1 Working principles.....	201
7.1.1 Overall working principle and hardware function block diagram .....	201
7.2 Troubleshooting and debugging .....	202
7.2.1 System problem .....	202

## Contents

7.2.2 Hardware losing lock.....	202
7.2.3 Unleveled.....	204
7.2.4 RF output amplitude failure .....	205
7.2.5 No modulation at RF output port .....	205
7.2.6 Sweep failure .....	205
7.2.7 Data storage failure.....	206
7.2.8 No response from front panel keys.....	206
7.2.9 Remote control failure .....	206
<b>7.3 Error message .....</b>	<b>207</b>
7.3.1 Error message file.....	207
7.3.2 Error message description .....	207
<b>7.4 Method to obtain after-sales services .....</b>	<b>208</b>
7.4.1 Contact us.....	208
7.4.2 Package and mailing.....	209
<b>8 Technical indicators and testing methods .....</b>	<b>211</b>
8.1 Statement .....	211
8.2 Product features .....	211
8.3 Technical Indicators.....	212
8.4 Additional information .....	223
8.4.1 General information.....	223
8.5 Performance characteristics test.....	226
8.5.1 Recommended testing method .....	226
8.5.2 Record chart of performance characteristics test .....	239
8.5.3 Recommended instrument for performance characteristics test.....	251
<b>Annex .....</b>	<b>253</b>
<b>Annex A Terminology.....</b>	<b>253</b>
Frequency accuracy.....	253
Frequency stability .....	253
Harmonic distortion and spectrum purity.....	254
I/Q modulation .....	254
Audio coding.....	254
Channel coding.....	255
Digital modulation .....	255



Bandwidth efficiency of digital modulation signal.....	256
Binary frequency shift keying 2FSK .....	256
Binary phase shift keying BPSK.....	256
Quadrature phase shift keying QPSK .....	257
Eight-phase shift keying 8PSK.....	257
Quadrature amplitude modulation QAM.....	258
Differential modulation type $\pi/4$ DQPSK.....	258
QPSK modulation type.....	259
Constant envelope digital modulation MSK (min. frequency shift keying).....	259
$3\pi/8$ rotation 8PSK modulation (EDGE) .....	260
Nyquist filter.....	260
Nyquist filter factor $\alpha$ .....	261
Annex B Zoom table of SCPI commands.....	262
Annex C Zoom table of error information.....	269
Annex D Zoom table of PC keyboard shortcuts in the function configuration window .....	270

## Contents

# 1. Manual Navigation

This chapter introduces the user's manual functions, chapter structure and main contents of the 1435 series signal generators, as well as the instrument-related documents provided to users.

- [About the Manual.....1](#)
- [Related Documents.....2](#)

## 1.1. About the Manual

This manual introduces the basic functions and basic operating methods of the 1435 series signal generators. It describes such contents as product features, basic operations, configuration guide, menu description, remote control, maintenance, technical indicators and testing methods, etc. of the instrument to help users get familiar with and master the operation method and key points of the instrument as soon as possible. To facilitate your skillful use of such instrument, please read carefully and follow this manual in advance for correct operation.

This manual contains the following chapters:

- **Overview**

This part introduces in general the main performance characteristics, typical application examples and safety precautions of operation for 1435 series signal generators. The purpose is to enable users to have a preliminary understanding of the main performance characteristics of the instrument and to guide users to operate the instrument safely.

- **Quick Start**

This chapter introduces the pre-operation inspection, instrument browsing, basic configurations, configuration window description and data storage of 1435 series signal generators so that users can have a preliminary understanding of the instrument itself and its configuration processes as a preparation for the comprehensive introduction of the configuration operations of the instrument hereinafter. This section contains some contents consistent with the relevant sections in the Quick Start.

- **Operation Guide**

This guide introduces the operation methods of various configuration functions of the instrument in detail, including: configuring the instrument, starting the configuration process and obtaining the configuration results, etc. This part mainly includes two parts: basic operation guide and advanced operation guide. For users who are not familiar with 1435 series of signal generators, the basic operation guide introduces and enumerates each function systematically and in detail so that users can understand and master some basic usage of the signal generators, such as setting continuous wave, power, and modulation, etc. The advanced operation guide part introduces relatively complicated testing processes and advanced operation skills for users who have basic knowledge about using signal generators but are not familiar with some special usage, and guides they to implement the operation processes. For example, list configuration for step sweep and list sweep, vector signal generation, etc.

- **Menus**

This part introduce the menu structure and menu items according to the functions to facilitate the users to query for reference.

- **Remote Control**

This part summarizes the remote control operations of the instrument so that users can quickly get started on the remote control operations. It is divided into four parts: program control fundamentals, introducing concepts related to program control, software configuration, program control ports, SCPI commands, etc; port configuration methods, introducing the connection methods and software configuration methods for program-controlled ports of 1435 series signal generators; basic programming methods for VISA interfaces, giving basic programming examples in the form of text description and sample codes to enable users to quickly master the programming methods; I/O function library, introducing the basic concepts of instrument drivers and the basic installation and configuration

### 1.2 Related Documents

instructions of IVI-COM/IVI-C drivers.

- **Troubleshooting and Repair**

This part includes the introduction of the working principles of the instrument, troubleshooting, error information description and repair methods.

- **Technical Indicators and Testing Methods**

This part introduces the product features, main technical indicators and recommended testing methods of 1435 series signal generators.

- **Annexes**

The annexes list necessary reference information for the 1435 series signal generators, including: term description, program control command cheat sheets, error information cheat sheets, etc.

### 1.2 Related Documents

Product documentation of 1435 series signal generators includes:

- Quick Start
- Online Help
- User's Manual
- Program Control Manual

#### **Quick Start**

This part introduces the configuration of the instrument and basic operations for starting configuration with the purpose of: making users quickly understand the characteristics of the instrument, master the basic settings and basic local and program-controlled operations. Main chapters include:

- Get Prepared
- Typical Applications
- Get Help

#### **User's Manual**

This manual introduces the functions and operation methods of the instrument in detail, including configuration, program control, and maintenance, etc.. The purpose is: to guide users to fully understand the functional characteristics of the product and master common testing methods of the instrument. The main chapters include:

- Manual Navigation
- Overview
- Quick Start
- Operation Guide
- Menus
- Remote Control
- Troubleshooting and Repair
- Technical Indicators and Testing Methods
- Annexes

#### **Program Control Manual**

This manual introduces such contents as program control programming fundamentals, SCPI foundation, SCPI commands, programming examples and I/O driver function library in detail. The purpose is to guide users to quickly and comprehensively master the program control commands and methods of the instrument. The main chapters include:

- Remote Control
- Program Control Commands
- Programming Examples
- Error Description
- **Annexes**

### **Online Help**

The Online Help is integrated into the instrument for providing fast text navigation help to facilitate users to operate the instrument locally and remotely. Both the keys on the front panel of the instrument or the user interface tool bar offer corresponding shortcut keys to activate this function. Main chapters are the identical to that of the User's Manual:

1. Manual Navigation

---

**1.2 Related Documents**

## 2 Overview

This chapter introduces the main performance characteristics, main applications and main technical indicators of 1435 series signal generators. It also gives introductions on correct operation of the instrument and precautions such as electrical safety.

- [Product Overview.....5](#)
- [Safe Operation Guide.....12](#)

### 2.1 Product Overview

1435 series signal generators have realized the balanced design of performance, economy, volume and weight based on innovative technologies. With the frequency range covering 9kHz ~ 40GHz, this signal generator has excellent spectral purity, with the SSB noise of 1GHz, the frequency offset of 1GHz carrier @10kHz reaching -136dBc/Hz, the frequency offset of 10GHz carrier @10kHz reaching -116 dBc/Hz; with high power output and large dynamic range, its max. output power can reach 20dBm@20GHz and the dynamic range is greater than 150dB; with extremely short response time and the frequency switching time of only 1ms, it can shorten the test time and improve the test efficiency to meet the test requirements for mass data; and it also has excellent analog modulation and pulse modulation functions. Adopting advanced frequency synthesis and RF channel signal processing technologies, it reduces costs while achieving high performance. The 1435-V series signal generators, with the frequency range of 9 kHz ~ 6 GHz, the internal modulation bandwidth of 200MHz and complete digital modulation types, can meet the analog requirements of various broadband digital modulation signals. Supporting arbitrary wave modulation in 5 download data formats, it allows users to edit and download waveforms as required for configuration, complete various signal simulations, and meet the testing requirements of various complicated signals; Its baseband signal generator, with simple setup and excellent performance, supports real-time generation of general digital modulation signals in more than 20 formats, such as PSK, QAM, FSK and MSK, etc. This series of signal generators offer fully updated operation experience with 7-inch high-sensitivity LED touch screens, support for a variety of operation modes such as touch screen, panel keys, rotary buttons, external mice and keyboards; and with 3U portable chassis structure, small and light, is easy to carry. This series of signal generators can achieve excellent performance in a compact space, and thus can not only meet the demand for high-performance testing during the development, but also meet the demand for high-efficiency testing during the production.

- [Product Features.....5](#)
- [Typical Applications.....11](#)

#### 2.1.1 Product Features

##### 2.1.1.1 Basic Functions

Main features of the 1435 series signal generators developed and produced by China Electronic Technology Instruments Co., Ltd. are as follows:

##### 1) Wide frequency coverage

The frequency coverages of 1435A(A-V)/B(B-V)/C/D/F signal generators are 9kHz ~ 3ghz/6ghz/12ghz/20ghz/40GHz, respectively. The serial lowest frequency is as low as 9kHz and the max. frequency is as high as 40 GHz, which can meet the requirements of broadband testing.

##### 2) High-amplitude output

With the H08 high-amplitude output option, 1435A/B/C/D can achieve the measured values of full-band amplitude of above 20dBm, 1435F can achieve the measured values of full-band amplitude of above 17dBm, and 1435A-V/B-V can achieve the measured values of full-band amplitude of above 20dBm. In testing occasions requiring high-amplitude excitation signals, 1435 allows users to obtain the required testing signals without the use of external amplifiers.

2.1 Product Overview

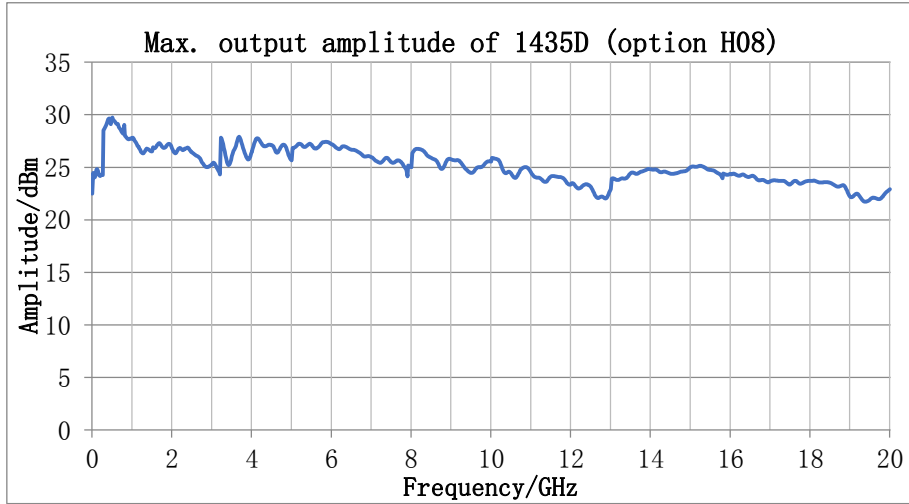

Figure 2.1 Max. output amplitude of 1435D

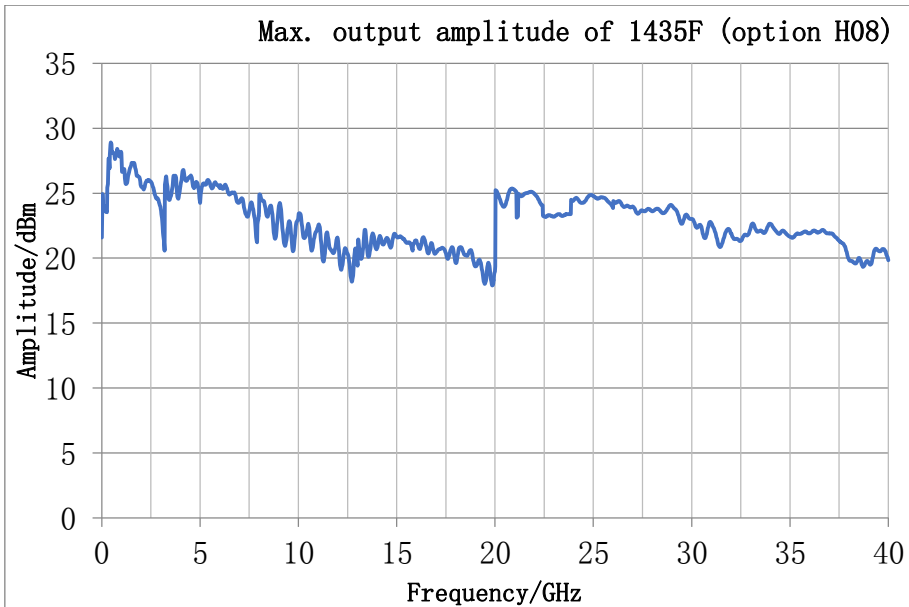

Figure 2.2 Max. output amplitude of 1435F

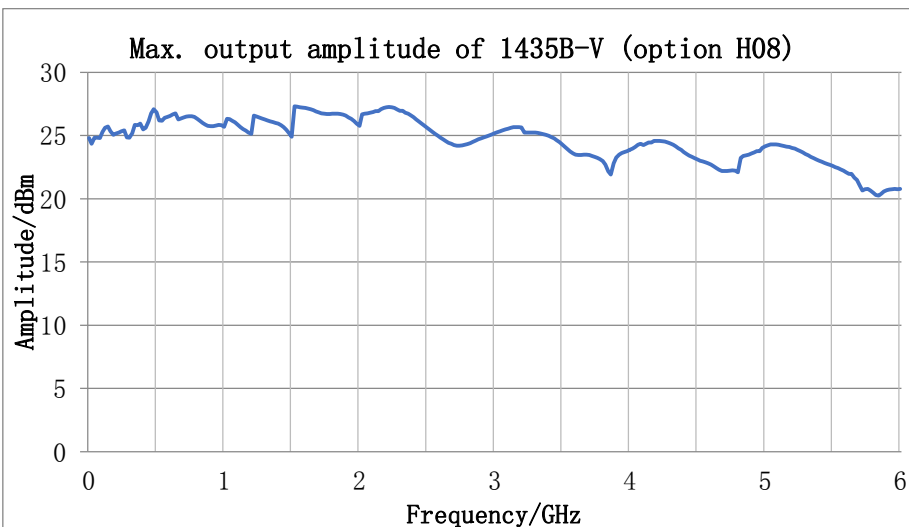

Figure 2.3 Max. output amplitude of 1435B-V



### 3) Excellent SSB phase noise

The 1435 series signal generators offer two phase noise options for users. The measured standard SSB phase noise of analog series signal source is  $-101\text{dBc/Hz}$  ( $10\text{GHz}@10\text{kHz}$ ), and the SSB phase noise is as low as  $-116\text{dBc/Hz}$  ( $10\text{GHz}@10\text{kHz}$ ) when the low phase noise option is adopted; The measured standard SSB phase noise of vector series signal source is  $-101\text{dBc/Hz}$  ( $10\text{GHz}@10\text{kHz}$ ), and the SSB phase noise is as low as  $-116\text{dBc/Hz}$  ( $10\text{GHz}@10\text{kHz}$ ) when the low phase noise option is adopted. The user can select the phase noise according to the actual demand to achieve the best cost performance.

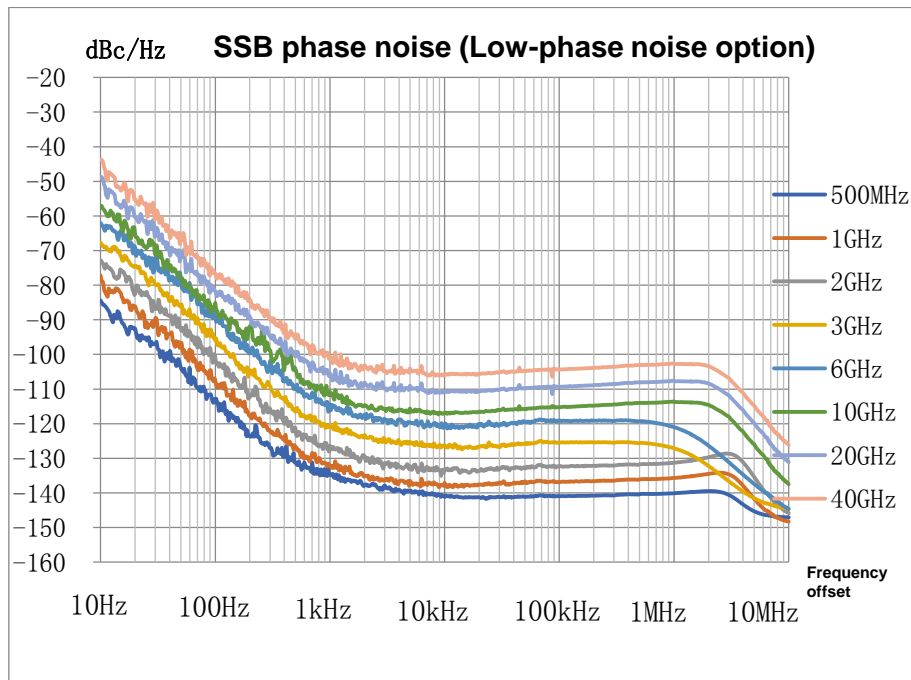

Figure 2.4 SSB phase noise (non-V)

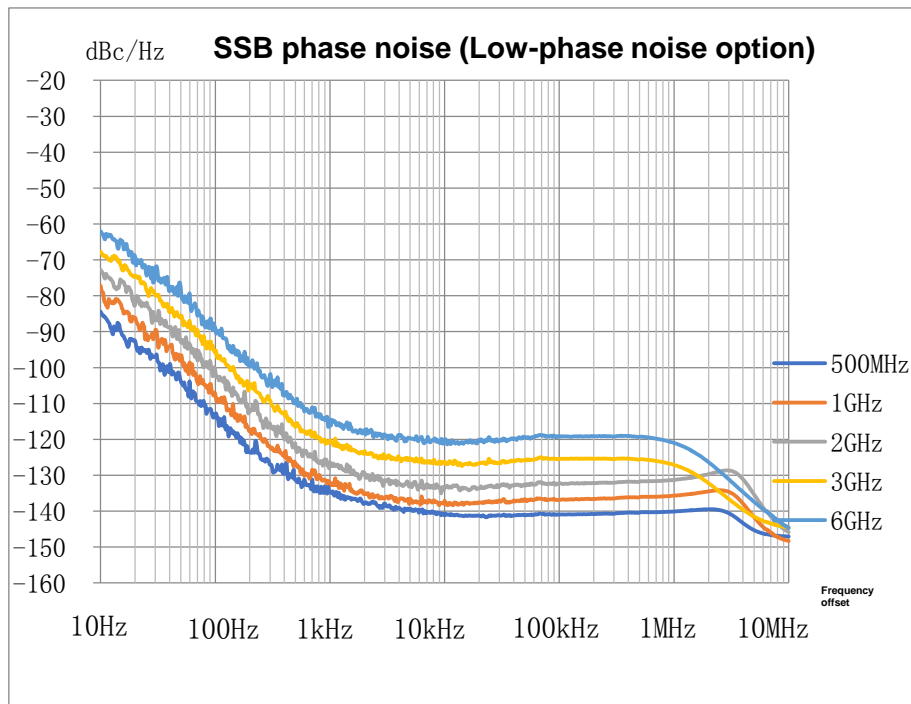

Figure 2.5 SSB phase noise (-V)

2.1 Product Overview

4) **Extremely short frequency switching time**

1435 can realize quick frequency switching in the entire frequency band, and the measured frequency switching time is 0.67ms, which can meet the requirements of high-speed testing.

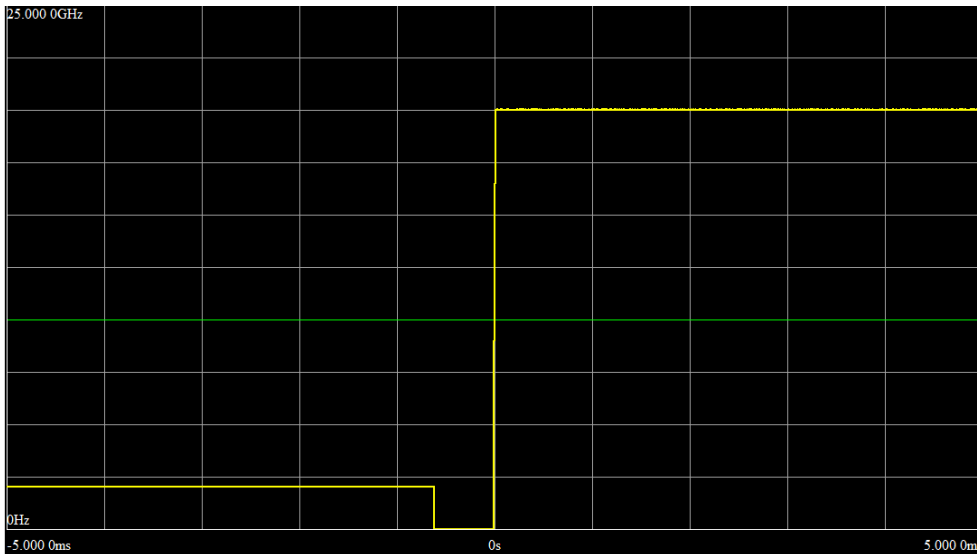

Figure 2.6 Frequency switching time

5) **High-performance pulse modulation**

The pulse on/off ratio is more than 80dB, the rise-fall time is less than 10ns, the narrow pulse option H04 is adopted, the min. pulse width is 20ns, the pulse width range is 20ns ~ 42s-10ns, and the step is 10ns. Various triggering modes, such as gating and external triggering, are supported, and the pulse train function required for radar testing is provided.

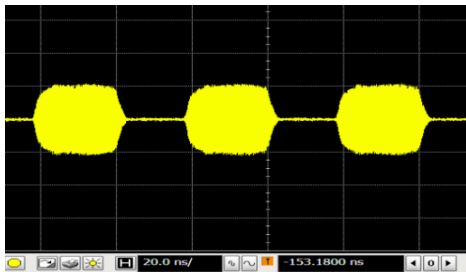

Figure 2.7 Pulse trains (5 pcs)

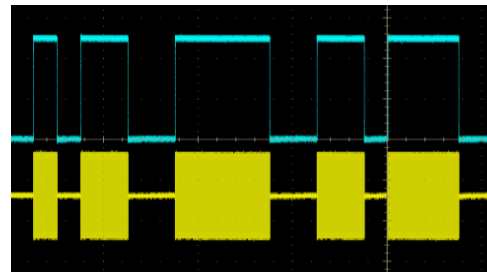

Figure 2.8 Pulse width of 20ns

2.1.1.2 High Performance

1) **Embedded multi-functional function generator**

The multi-functional function generator consists of 7 waveform generators, which are used to generate AM/FM/ΦM modulation signals and low-frequency output signals. Two waveform generators can generate two-tone modulation signals for AM/FM/ΦM through internal addition. These 7 waveform generators include 2 standard function generators, 1 double function generator, 1 sweep function generator, 2 noise generators and 1 DC generator, which generates DC level and can only be used for low-frequency output. The sine wave frequency range of the waveform generator is 0.1 Hz~10 MHz, and the frequency range of triangular wave, square wave, zigzag wave and pulse is 0.1Hz-1MHz with the frequency resolution of 0.1 Hz.

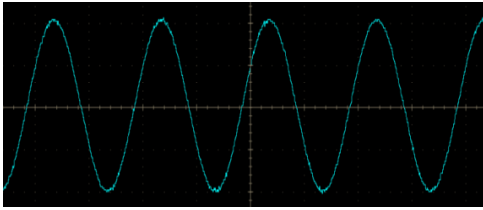

Figure 2.9 Sine wave

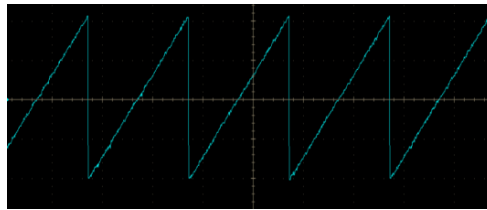

Figure 2.10 Zigzag wave

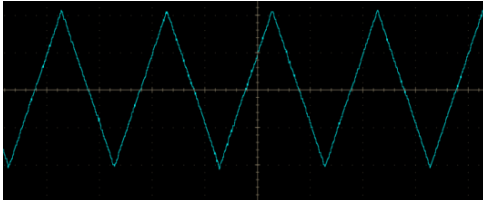

Figure 2.11 Triangular wave

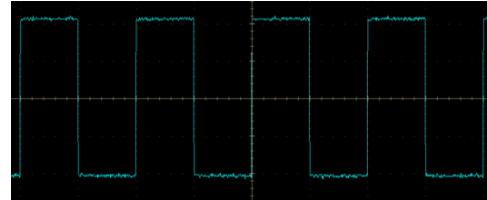

Figure 2.12 Square wave

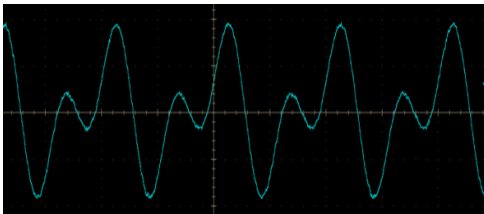

Figure 2.13 Double sinusoidal wave

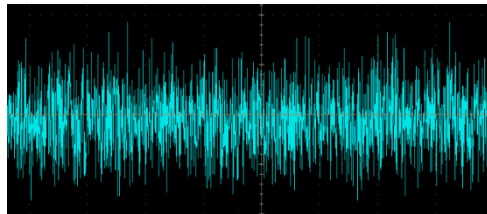

Figure 2.14 Noise

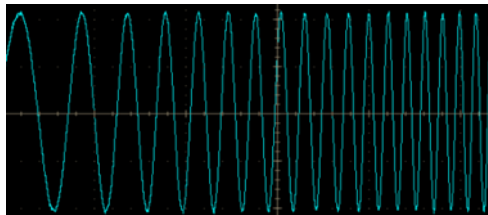

Figure 2.15 Sweep sine

## 2) High-compatibility downloading of arbitrary wave data formats

1435-V series signal generators support direct download and playback of arbitrary wave data in five storage formats, Mat-File 5, ASCII, Binary, cap and csv, with the storage depth of 2G sample points.

## 3) Complete set of general digital modulation styles

1435-V series signal generators can support real-time generation of general digital modulation signals covering over 20 formats, such as PSK, QAM, FSK and MSK, etc.

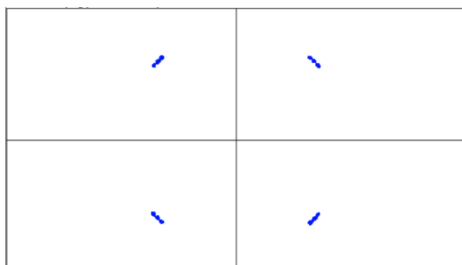

Figure 2.16 2FSK

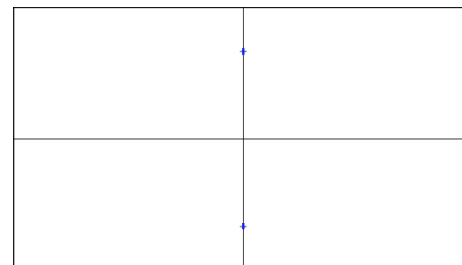

Figure 2.17 MSK

**2.1 Product Overview**

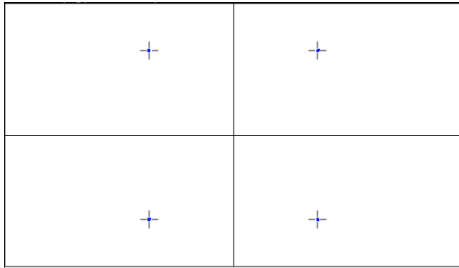

Figure 2.18 QPSK

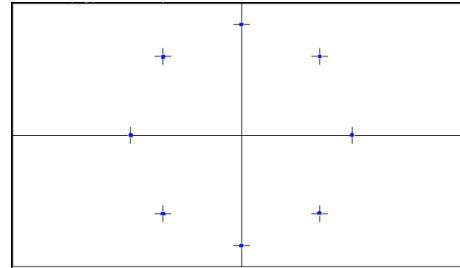

Figure 2.19 8PSK

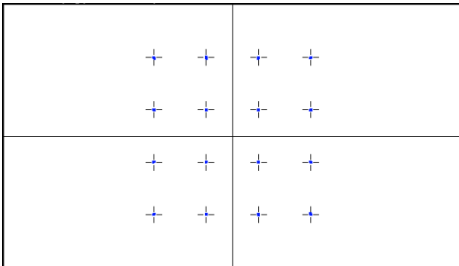

Figure 2.20 16QAM

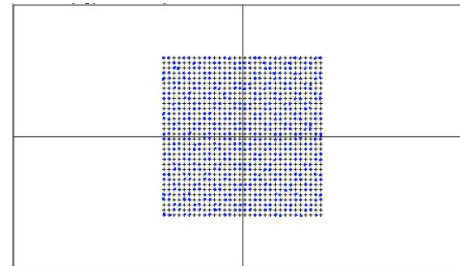

Figure 2.21 1024QAM

**2.1.1.3 Agility**

**1) Small size and light weight**

Adopting highly portable 3U chassis design, the instrument has greatly reduced its weight and volume compared with desktop instruments. The heaviest model in the whole series is 10.9kg, and the lightest model is only 7.4kg.

**2) Sensitive LED touch screen**

The 7-inch-wide LED display with the resolution of 800x480 can clearly display the status information of the instrument. The capacitive touch screen with tailored window interface offer sensitive and accurate touch control. In addition to the touch screen, the instrument can also be operated by means of panel keys, rotary buttons with Enter function, and external keyboard and mouse, etc. for your convenient selection.



Figure 2.22 Screenshot of actual operation interface

**3) Rich program-controlled interfaces**

## 2.1 Product Overview

1435 series signal generators offer program-controlled interfaces such as GPIB interface and network interface, which are freely selectable for convenient realization of remote control and online upgrading.

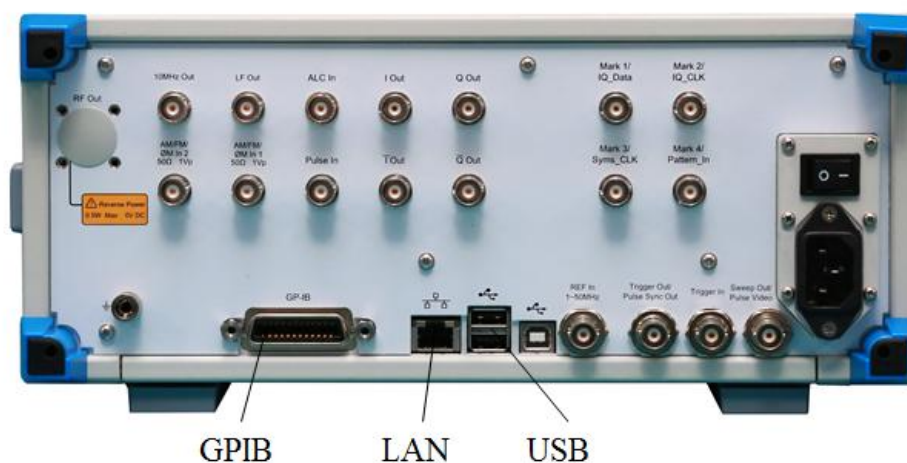

Figure 2.23 Program-controlled interfaces of 1435 series signal generators

## 2.1.2 Typical Applications

### 1) General test

The 1435 series signal generators, offering complete functions and a wide frequency range from 9kHz to 40kHz, support AM, FM,  $\Phi$ M and PM analog modulation functions, support step sweep and list sweep, and offer excellent performance. Through the balanced design of performance, economy, volume and weight, various options are freely configured, making 1435 widely used. They can be used for teaching tests considering the costs and laboratory tests considering the performance.

### 2) National defense test

The 1435 series features high-performance pulse modulation. With the pulse modulation on/off ratio more than 80dB, rise and fall time less than 10ns, min. pulse width of 20ns, as well as multiple pulse patterns, such as Staggered, Jitter and Pulse Train, etc. they are suitable for radar system testing. With excellent phase noise performance, they can be used for receiver testing. Small in size and easy to carry, they are suitable for field testing.

### 3) Production line test

With the frequency switching time of 1ms, 1435 series signal generators can achieve quick testing. Shorten the testing time and improve the testing efficiency, and thus can meet the testing requirements of mass data; with high power output, there's no need of external power amplifier, thus saving space and cost; Supporting multiple control interfaces like USB, LAN and GPIB, they can facilitate the forming of an automatic test system. They are suitable for production line test.

### 4) Communication system test

With excellent digital modulation performance, complete set of digital modulation styles, support for real-time generation of general digital modulation signals and user-defined modulation signals covering more than 20 formats such as PSK, QAM, FSK, MSK, etc. the 1435 series are suitable for testing of indicators such as bit error rate of communication systems.

### 5) Digital demodulation receiver test

With support for high-compatibility arbitrary wave data formats, they can conveniently play user-defined waveform data files. And with the power dynamic range of up to 150dB, they are suitable for testing indicators like sensitivity and SNR of a digital demodulation receivers.

**2.2 Safe Operation Guide**

**2.2 Safe Operation Guide**

Please read carefully and strictly observe the following precautions!

We will spare no effort to ensure that all production processes meet the latest safety standards and provide users with the highest safety guarantee. The design and testing of our products and the auxiliary equipment used meet relevant safety standards, and a quality assurance system has been established to monitor the product quality and ensure the products to always comply with such standards. In order to keep the equipment in good condition and ensure operation safety, please observe the precautions mentioned in this manual. If you have any questions, please feel free to consult us.

In addition, the correct use of this product is also your responsibility. Please read carefully and observe the safety instructions before starting to use this instrument. This product is suitable for use in industrial and laboratory environments or field measurement. Always use the product correctly according to its restrictions to avoid personal injury or property damage. You will be responsible for problems caused by improper use of the product or noncompliance with the requirements, and we will not be held responsible. **Therefore, in order to prevent personal injury or property damage caused by dangerous situations, please always observe the safety instructions.** Please keep the basic safety instructions and the product documentation properly and deliver them to end users.







- [Safety marks.....12](#)
- [Operation Status and Locations.....14](#)
- [Electrical Safety.....14](#)
- [Operation Precautions.....15](#)
- [Maintenance.....15](#)
- [Batteries or Power Modules.....15](#)
- [Transportation.....16](#)
- [Waster Disposal/Environmental Protection.....16](#)

**2.2.1 Safety Marks**











**2.2.1.1 Product-related Marks**

Safety marks on the products are described as follows (Table 2.1):

Table 2.1 Products safety marks

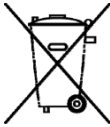
Symbol	Meaning	Symbol	Meaning
	Caution, reminding users of information to be paid special attention to. It reminds users of the operation information or instructions to be paid attention to.		Turn On/Off the power
	Note, handling heavy equipment.		Standby indication
	Danger! Hazard of electric shock.		DC

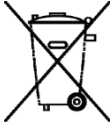
## 2.2 Safe Operation Guide

	Warning! Hot surface.		AC
	Protective conductive end		DC/AC
	Grounding		Reinforced insulation protection of the instrument
	Ground terminal		EU mark for batteries and accumulators. Please refer paragraph 1 of "2.2.8 Waster Disposal/Environmental Protection" in this section for specific instructions.
	Caution, handle classical sensitive devices with care.	 	EU mark for of separate collection of electronic devices. Please refer paragraph 2 of "2.2.8 Waster Disposal/Environmental Protection" in this section for specific instructions.
	Warning! Radiation.		

## 2.2.1.2 Manual-related Marks

In order to remind users to operate the instrument safely and pay attention to relevant information, the following safety warning marks are used in the product manual, which are explained as follows:



Danger mark, personal injury or equipment damage may be caused if not



Warning mark, personal injury or equipment damage may be caused if not avoided.



Caution mark, slight or medium personal injury or equipment damage may be caused if not avoided.



Note mark, indicating some important information which will not cause danger.

**Tip**

Tips on information about the instrument and its operation.

### 2.2.2 Operation Status and Locations

Please note before operating the instrument:

1) Unless otherwise stated, the operating environment of 1435 series signal generators should meet the requirements of Class 3 environment level in GJB3947A-2009. Non-operating temperature: -40°C ~ + 70°C; Operating temperature: 0°C ~ 50°C; Relative Humidity: (5% ~ 95%)+5% RH; Random vibration: frequency 5 ~ 100 Hz, power spectral density 0.015g<sup>2</sup>/Hz; Frequency 100 ~ 137 Hz, gradient -6 dB; Frequency 137 ~ 350 Hz, power spectral density 0.0075g<sup>2</sup>/Hz; Frequency 350 ~ 500 Hz, gradient -6 dB; Frequency 500Hz, power spectral density 0.0039g<sup>2</sup>/Hz; Functional impact: 20g semi-sinusoidal impact; Tilt drop: with one side as the fulcrum, lift the opposite side of the base to the height of 10cm, and allow the base to fall freely onto the test bench.

2) Do not place the instrument on surfaces with water, vehicles, cabinets, tables and other objects that are not fixed and do not meet the load conditions. Please place the instrument securely and fix it on the surface of a solid object (e.g., an ESD workbench).

3) Do not place the instrument on the surface of a heat-dissipating object (e.g., a radiator). The operating environment temperature shall not exceed the value specified in the description of relevant indicators of the product. Overheating of the product will lead to electric shock, fire and other risks.

4) The instrument is required to be pre-heated for 30 min for cold start, and it will reach internal temperature balance after pre-heating for 2 hours at a stable ambient temperature. After the instrument is placed at ambient temperature for 2h, preheated and passes through user calibration, it should meet various performance indicators.

### 2.2.3 Electrical Safety

Precautions for electrical safety of the instrument:

1) Before the instrument is powered on, the actual supply voltage should match the supply voltage marked on the instrument.

2) According to the power requirements of the real panel of the instrument, a three-core power cord should be adopted while ensuring reliable grounding of the ground wire during operation. Either floating ground or poor grounding may cause damage to the instrument and even cause injury to operators.

3) Do not damage the power cord, otherwise electric leakage will be caused, resulting in damage to the instrument and even injury of the operators. If an external power cord or extension socket is used, it should be checked before use to ensure electrical safety.

4) If the power supply socket does not provide an on/off switch, to cut the power of the instrument, you can just directly unplug the instrument, and therefore, it should be ensured that the power plug can be inserted or drawn conveniently.

5) Do not use damaged power cords. Before connecting the instrument to the power cord, check the integrity and safety of the power cord, and properly place the power cord to avoid the impact due to human factors, such as, too long power cord that may trip the operator.

6) Keep the socket clean and tidy, and ensure the plug and the socket in good contact and reliable engagement.

7) Neither the socket nor the power cord can be overloaded, otherwise fire or electric shock will be caused.

8) Unless otherwise allowed, do not open the housing of the instrument, which may expose internal circuits and devices of the instrument and cause unnecessary damage.



## 2.2 Safe Operation Guide

9) If the instrument needs to be fixed at the test site, a qualified electrician is required to install the protective earth wire between the test site and the instrument first.

10) Take appropriate overload protections to prevent overload voltage (caused by lightning, for instance) from damaging the instrument or causing personal injury.

11) When opening the housing of the instrument, do not place objects not belonging to the interior of the instrument, otherwise, short circuit, damage to the instrument and even personal injury may be caused.

12) Unless otherwise stated, the instrument has not received any waterproof treatment, so keep the instrument from contacting with liquid to prevent damage to the instrument or even personal injury.

13) Do not place the instrument in an environment where fog is easily formed, for example, moving the instrument in a environment where cold and heat are in alternation, where water droplets formed on the instrument may cause electric shock and other hazards.

### 2.2.4 Operation Precautions

1) Instrument operators need to have certain professional and technical knowledge, good psychological quality, and certain emergency response capabilities.

2) Before moving or transporting the instrument, please refer to the relevant instructions in "2.2.7 Transportation" of this section.

3) The inevitable use of substances (e.g. nickel) in the production process of the instrument may cause allergy to personnel. If an operator of the instrument has allergic symptoms (e.g. rash, frequent sneezing, ophthalmia or dyspnea) during the operations, please seek medical care in time to find out the reason and solve the symptoms.

4) Please refer to the relevant instructions in "2.2.8 Waster Disposal/Environmental Protection" of this section before disassembling this instrument for disposal.

5) RF instruments will generate high electromagnetic radiation, during which period, pregnant women and operators with cardiac pacemakers need special protection. If the radiation level is high, corresponding measures may be taken to remove the radiation sources to prevent personal injury.

6) In case of fire, the damaged instrument will release toxic substances. Therefore, the operators should wear appropriate protective equipment (e.g. Protective masks and exposure suits) for safety.

7) The EMC grade should meet the requirements specified in 3.9.1 of GJB3947A-2009.

### 2.2.5 Maintenance

1) Only authorized and specially trained operators are allowed to open the casing of the instrument. Before such operations, it is required to disconnect the power cord to prevent damage to the instrument or even personal injury.

2) The repair, replacement and maintenance of the instrument should be performed by dedicated electronic engineers of the manufacturer, and the parts subject to replacement and maintenance should receive safety tests to ensure safe use of the product in the future.

### 2.2.6 Batteries or Power Modules

1) The maximum power consumption of the power supply of the instrument is 300W. The power supply should be adaptive supply with 50 Hz ~ 60 Hz, single-phase 110V or 220V. The steady-state condition of the power supply should meets the requirements of 3.5.1.3 in GJB3947A-2009. The allowable range of steady-state voltage is  $\pm 10\%$  of the rated value and the allowable range of steady-state frequency is  $\pm 5\%$  of the rated value. In this case, the waveform characteristics of the power supply need to meet the following requirements: waveform deviation coefficient not exceeding  $\pm 10\%$ ; total harmonic not exceeding  $\pm 10\%$ ; single harmonic not exceeding  $\pm 5\%$ ; crest factor of 1.27 ~ 1.56.

## 2.2 Safe Operation Guide

### 2.2.7 Transportation

1) If the instrument is heavy, please handle it with care. If necessary, use tools (a crane, for instance) to move the instrument so as to prevent damaging the body.

2) The handle of the instrument is suitable for personal handling of the instrument and cannot be fixed on the transportation equipment when during the transportation of the instrument. In order to prevent property loss and personal injury, please follow the manufacturer's safety regulations on the transportation of the instrument.

3) When operating the instrument on the vehicle, the driver should drive carefully to ensure transportation safety, and the manufacturer is not responsible for any emergencies during the transportation. Therefore, please do not use this instrument during the transportation, and reinforcement and preventive measures should be taken to ensure the transportation safety of the product.

### 2.2.8 Waste Disposal/Environmental Protection

1) Do not dispose of devices marked with batteries or accumulators together with unclassified waste; Instead, such devices should be collected separately and disposed of in a suitable collection location or through the customer service center of the manufacturer.

2) Do not dispose of waste electronic devices together with unclassified waste; Instead, such devices should be collected separately. The manufacturer has the right and responsibility to help end users dispose of waste products. If necessary, please contact the customer service center of the manufacturer for corresponding disposal so as not to damage the environment.

3) During mechanical or thermal processing of the product or its internal components, toxic substances (dust of heavy metals, such as lead, beryllium, and nickel, etc.) may be released. Therefore, specially trained technicians with relevant experience are required to disassemble the product to avoid personal injury.

4) During the reprocessing, please refer to the safety operation rules recommended by the manufacturer to dispose of toxic substances or fuel released from the product with specific methods to avoid causing personal injury.

## 3 Quick Start

This chapter introduces the pre-operation precautions, front/back panel browsing, basic configurations, and data file management of the 1435 series signal generators. so that users can have a preliminary understanding of the instrument itself and its configuration processes. This section contains some contents consistent with the relevant sections in Quick Start.

- [Get Prepared.....17](#)
- [Front and Real Panels.....34](#)
- [Basic Configurations.....37](#)
- [Data Management.....65](#)

### 3.1 Get Prepared

- [Preparations before Operation.....17](#)
- [Operating System Configuration.....28](#)
- [Routine Maintenance .....33](#)

#### 3.1.1 Preparations before Operation

This chapter introduces the precautions before first setup and use of the 1435 series signal generators.



#### Warning

##### Avoid damaging the instrument

To avoid electric shock, fire and personal injury:

- Please do not open the housing without authorization;
- Do not attempt to disassemble or modify any parts not described in this manual. Unauthorized disassembly may lead to the decrease of the electromagnetic shielding efficiency, damage of internal components and other phenomena, which will affect the reliability of the product. If the product is under warranty, we will no longer provide free maintenance.
- Please carefully read the relevant contents in "2.2 Safe Operation Guide" of this manual and the safety precautions therein for operation. Also please pay attention to the requirements for specific operating environment mentioned in the data page.

#### Note

##### Electrostatic protection

Pay attention to the anti-static measures in the workplace to avoid damage to the instrument. For details, please refer to the relevant contents in "2.2 Safe Operation Guide" of the manual.

### 3.1 Get Prepared

#### Note

**Please note when operating the instrument:**

Improper operation location or configuration may damage the instrument or the connected instruments. Please ensure the following before turning on the power:

- The fan blades are unblocked and the heat dissipation holes are unobstructed. The distance between the instrument and the Wall is at least 10cm;
- The instrument is kept dry;
- The instruments is placed horizontally and reasonably;
- The ambient temperature meets the requirements indicated in the data page;
- The input signal power of the port conforms to the marked range;
- The signal output port is properly connected without overloading.

#### Tip

**Impact of EMI:**

Electromagnetic interference will affect the configuration result, therefore, please:

- select appropriate shielded cables. For example, you can use double shielded RF/network connection cables;
- Please close any cable connection port that is enabled but temporarily unused or connect a matching load to the connection port in time;
- Please refer to the EMC level labels in the Data Page.

- [Unpacking.....](#)18
- [Environmental Requirements.....](#)19
- [Turning on/off the Power.....](#)20
- [Correct Use of Connectors.....](#)23
- [User Check.....](#)26

#### 3.1.1.1 Unpacking

##### 1) Visual examination

**Step 1.** Check whether the outer package and the shockproof packing of the instrument are damaged. If there is any damage, keep the outer package for standby and proceed with the following examination steps.

**Step 2.** Unpack the instrument and check the instrument and enclosed items for any damage;

**Step 3.** Carefully check whether the above items for any mistakes according to Table 3.1.

**Step 4.** If the outer package is damaged, or the instrument or the enclosed items are damaged or wrong, it is forbidden to switch on the instrument! Please contact our service consultation center with the service hotline provided on the cover, and we will repair or change it as soon as possible accordingly.

**Note**

**Handling:** Because the instrument and the packing carton are heavy, they should be handled by two people with care.

**2) Model confirmation**

Table 3.1 Packing List of 1435

Name	Qty	Function
<b>Mainframe:</b>		
◇ 1435	1	—
<b>Standard Configuration:</b>		
◇ 3-core power cord	1	
◇ User's Manual	1	—
◇ Program Control Manual	1	—
◇ Packing list	1	—
◇ Product Certificate of Conformity	1	—

**3.1.1.2 Environmental Requirements**

The operation sites of 1435 series signal generators should meet the following environmental requirements:

**1) Operating Environment**

The operating environment should meet the following requirements:

Table 3.2 Environmental requirements of 1435

<b>Temperature</b>	0°C~50°C
<b>Humidity</b>	Hygrometer measurement range at <+29 °C: 20% ~ 80% (non-condensed)
<b>Elevation</b>	0 ~ 2,000 meters (0 ~ 6,561 inches)
<b>Vibration</b>	Max. 0.21 G, 5 Hz ~ 500 Hz

**Note**

The above environmental requirements are only applicable to the operating environment factors of the instrument, and are not with the scope of technical indicators.

**2) Heat dissipation requirements**

In order to ensure that the working environment temperature of the instrument is within the temperature range required by the operating environment, the following heat dissipation space requirements of the instrument shall be met:

### 3.1 Get Prepared

Table 3.3 Heat dissipation requirements of 1435

Instrument part	Heat dissipation distance
Left and right sides	≥180 mm

### 3) Electrostatic protection

Static electricity is extremely destructive to electronic components and equipment. Usually we take two anti-static measures: conductive table mat and wrist strap; Conductive floor mat and ankle strap. Using the above two anti-static measurements at the same time can provide good antistatic protection. If using one of them, only the former can provide antistatic protection. 1MΩ earth isolation resistor must be provided for the antistatic components at least for ensuring user safety.

Correctly take the following antistatic measures to techniques to reduce electrostatic damages:

- Ensure all instruments are grounded properly, so as to avoid any static electricity.
- Let the internal/external conductor of the cable contact the ground shortly before connecting the coaxial cable with the instrument.
- Operators must wear anti-static wrist straps or take other antistatic measures before touching the joints, core or conducting any assembly.



#### Voltage range

The above-mentioned anti-static measures cannot be applied when the voltage exceeds 500V.

#### 3.1.1.3 Turning On/Off the power

##### 1) Precautions before turning on the power

Pay attention to the following when turning on the power of the instrument:

##### a) Confirming power supply parameters

The internal power supply module of the 1435 series signal generator is equipped with 110V/220V adaptive AC power supply module, which can be powered with 110V AC or 220V AC power, when the internal AC power supply module adopts the adaptive working mode to automatically switch the working state according to the voltage of the external AC power supply. Therefore, please carefully check the power supply requirements of on the rear panel of the instrument before using the signal generator. Table 3.4 lists the requirements for external power supply when for normal working of the signal generator.

Table 3.4 Working power parameter requirements of 1435

Power supply parameter	Applications	
Voltage, frequency	220V±10%, 50 ~ 60Hz	110V±10%, 50 ~ 60Hz/360 ~ 440Hz
Rated output current	>3A	>6A
Power consumption (startup)	<300W	<300W
Power consumption (standby)	<20W	<20W

**Tip****Prevent mutual interference of power supplies**

To prevent mutual interference among multiple devices through power supplies, especially spike interference caused by high-power devices which may cause damage to instrument hardware, it is recommended to use a 220 V or 110 V AC stabilized power supply to supply power to the instrument.

**b) Confirm and connect the power cord**

1435 series signal generators adopt three-core power cord interfaces, which conform to national safety standards. Before turning on the power of the signal generator, it is necessary to confirm reliable grounding of the ground wire of the signal generator. Either floating ground or poor grounding may cause damage to the instrument and even cause injury to operators. Using a power cord without protective grounding is strictly prohibited. When the instrument is connected to a suitable power outlet, the power cord connects the housing of the instrument to the ground. The rated voltage value of the power cord should be greater than or equal to 250V, and the rated current should be greater than or equal to 6A.

When connecting the instrument to the power supply:

**Step 1.** Confirm that the working power cord is not damaged;

**Step 2.** Connect the power plug of the rear panel of the instrument to a well-grounded three-core power socket with the power cord.

**Warning****Grounding**

Poor or wrong grounding may cause damage of the instrument or personal injury. Before turning on the power of the signal generator, make sure that the ground wire is in good contact with the ground wire of the power supply.

Please use a power outlet with grounding protection. Do not use external cables, power lines and auto-transformers without grounding protection as institutes of the grounding protection wires. If an auto-transformer is necessary, it is required to connect the common terminal to the protective grounding of the power connector.

**2) Initial power-up**

Precautions for turning on/off the power of the instrument are as follows:

**a) Connecting the Power supply**

Please confirm the power supply parameters and the power cord before power-on for the first time. For details, please refer to the section "3.1.1.3 Precautions before Turning on the Power" in the user manual.

**Step 1. Connect the power cord:** use the power cord matched with the signal generator in the package or a three-core power cord that meets the requirements. Insert one end of the cord to the rear panel power socket of the signal generator (as shown in Figure 3.1), (the voltage parameter indicator required by the signal generator is marked beside the power socket to remind the user that the voltage used should meet the requirements), and the other end to an AC power source meeting the requirements.

**Step 2. Turn on the power switch on the rear panel:** as shown in Figure 3.2, observe whether the standby indicator above the power switch on the front panel (as shown in Figure 3.3) turns on in yellow.

### 3.1 Get Prepared

**Step 3.** Turn on the power of the front panel: As shown in Figure 3.3, please do not connect any equipment to the signal generator before startup. If everything is normal, the instrument can be turned on, and then the indicator above the power switch of the front panel will turn green.



Figure 3.1 Power socket    Figure 3.2 Rear-panel power switch    Figure 3.3 Front-panel power switch

#### b) Turning on/off the power

##### i. Start up

**Step 1.** Turn on the power of the front panel (“I”);

**Step 2.** Turn on the power switch in the lower left corner of the front panel (as shown in Figure 3.3). At this time, the color of the power indicator above the power switch changes from yellow to green.

**Step 3.** The user interface of the front panel of the signal generator will gradually display relevant information of the starting process of the instrument: first, brief information about the manufacturer is displayed, and then enter the operating system menu. There are two options in the menu, in normal use, users need not operate these menus. Windows 7 will start automatically when the timer counts down to 0.

**Step 4.** After Windows 7 is started successfully, the system automatically runs the initialization program of the signal generator and displays the main interface of the signal generator.

**The instrument is in the operable status.**

---

### Tip

#### Time base and preheating

During the cold start of 1435 series signal generators, it is necessary to preheat it for a period of time in order to keep the time base of the signal generator at the operating temperature. When the signal generator starts working from the standby state, preheating is not required. During the indicator test of this machine, the instrument needs to be preheated for 0.5 hour. (Please refer to the relevant instructions in the technical indicators for details).

---

### Tip

#### Attenuator initialization

After entering the host program, the sound of setting the attenuator will be generated when setting the attenuator, which does not indicate any error of the signal generator.

---



**Note****System Startup**

This instrument adopts the control platform of Windows+x86 computers. During BIOS self-check and Windows loading, users do not need to intervene and should not cut off the power midway or modify the BIOS settings.

**ii. Shutdown**

**Step 1.** Turn the power switch in the lower left corner of the front panel (as shown in Figure 3.3). At this time, the instrument enters the shutdown process (the software and hardware need to go through some processing before the power is turned off). After more than ten seconds, the instrument is powered off, when the color of the power indicator above the power switch changes from green to yellow.

**Step 2.** Turn off the power switch on the rear panel ("O") or disconnect the power supply of the instrument.

**The instrument is turned off.**

**Note****Power cut of the instrument**

When the instrument is in normal operation, it can only be shut down by operating the power switch on the front panel. **Do not directly turn off the power switch of the rear panel or directly disconnect the power connection with the instrument.** Otherwise, the instrument cannot enter the normal shutdown state, which may cause damage to instrument or loss of the current instrument status/configuration data. Please shut down the instrument with the correct method.

**c) Power cut**

In case of emergency, in order to avoid personal injury, the signal generator needs to be powered off immediately. Just draw the power cord (from the AC outlet or from the power outlet on the rear panel of the instrument). Therefore, sufficient operating space should be reserved when operating the instrument to facilitate direct shutdown when necessary.

**3.1.1.4 Correct Use of Connectors**

Connectors are often used in various tests of signal generators. Although the connectors of calibration pieces, test cables and analyzer measuring ports are designed and manufactured according to the highest standards, the service life of all these connectors is still limited. Due to the inevitable wear and tear during normal use, the performance indicators of the connectors will decrease or even be unable to meet the measurement requirements. Therefore, correct maintenance and measurement connection of the connectors can not only ensure accurate and repeatable measurement results, but also prolong the service life of the connectors and reduce the measurement costs. In actual use, the following aspects should be paid attention to:

**1) Connector check**

When conducting connector inspection, anti-static wrist band should be worn. It is recommended to use a magnifier to check the following items:

- 1) Whether the electroplated surface is worn or not and whether there are deep scratches;

### 3.1 Get Prepared

- 2) Whether the thread is deformed;
- 3) Whether there are metal particles on the threads and the joint plane of the connector;
- 4) Whether the inner conductor is bent or broken;
- 5) Whether the screw sleeve of the connector rotates improperly.



#### Check the connector to prevent damaging ports of the instrument

Any damaged connector may damage the good connector connected to it even when measuring the connection for the first time. In order to protect each interface of the signal generator itself, the connector must be checked before connector operation.

### 2) Connection method

Before the connection, the connectors should be inspected and cleaned to ensure cleanness and intactness. Anti-static wrist straps should be worn before connection. The correct connection method and steps are as follows:

**Step 1.** As shown in Figure 3.4, align the axes of the two interconnecting devices to ensure that the pin of the male connector slides concentrically into the socket of the female connector.



Figure 3.4 Axes of interconnected devices are in a straight line

**Step 2.** As shown in Figure 3.5, move the two connectors leveled together so that they can be smoothly engaged. Rotate the screw sleeve of the connector (note, not the rotating connector itself) until it is tightened, and there can be no relative rotational movement between the connectors during the connection.

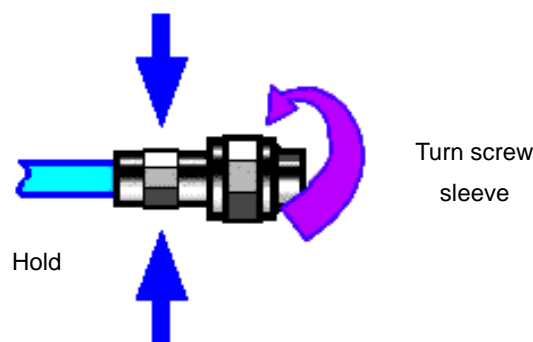

Figure 3.5 Connection method

**Step 3.** As shown in Figure 3.6, tighten the connectors with a torque wrench to complete the connection. Pay attention that the torque wrench should not exceed the initial folding point. Use an auxiliary wrench to prevent the connector from rotating.

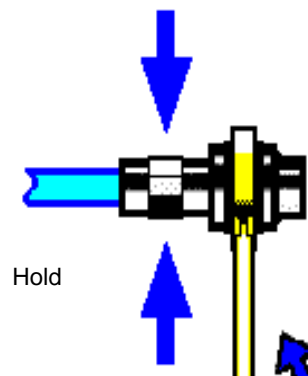

Figure 3.6 Finishing the connection with a torque wrench

### 3) Disconnection

**Step 1.** Support the connectors to prevent any connector from being twisted, shaken or bent;

**Step 2.** An open-ended wrench can be used to prevent the connector body from rotating;

**Step 3.** Loosen the screw sleeve of the connector with another wrench;

**Step 4.** Rotate the screw sleeve of the connector by hand to complete the disconnection;

**Step 5.** Pull the two connectors levelly apart.

### 4) Usage of a torque wrench

The use of a torque wrench is shown in Figure 3.7. The following points should be paid attention to when using it:

- Confirm that the torque of the torque wrench is correct set before use;
- Ensure that the angle between the torque wrench and another wrench (used to support a connector or a cable) is within  $90^\circ$  before applying force;
- Grasp the end of the torque wrench handle gently, and apply force in the direction perpendicular to the handle until reaching the folding point of the wrench.

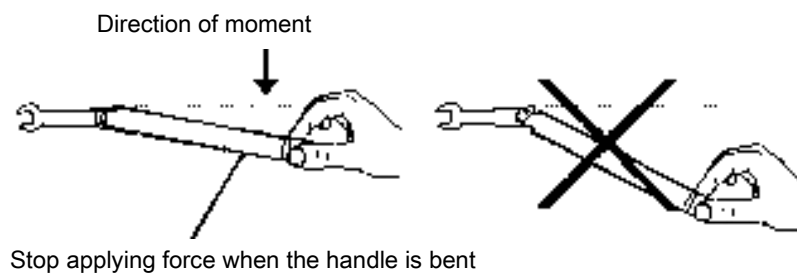

Figure 3.7. Usage of a torque wrench

### 5) Use and storage of connectors

1) The connectors should be covered by protective sleeves when not in use.

2) Do not mix various connectors, air lines and standard calibration pieces in a box because this is one of the most common causes of connector damage.

3) Keep the connectors and the analyzer at the same temperature. Holding a connector by hand or cleaning a connector with compressed air will significantly change its temperature. The connectors should be calibrated after its temperature is stable.

4) Do not touch the joint plane of the connectors because the grease and dust particles on the skin are difficult to be removed from the joint plane;

### 3.1 Get Prepared

5) Do not put the contact surface of a connector downward on a hard table surface. Contact with any hard surface may damage the electroplated layer and the joint surface of the connector.

6) Always wear anti-static wrist straps and work on a grounded conductive workbench pad, which can protect the analyzer and the connectors from electrostatic discharge.

#### 6) Connector cleaning

When cleaning the connectors, always wear antistatic wrist straps and observe the following steps:

1) Remove loose particles on the thread and joint plane of the connectors with clean low-pressure air, and thoroughly inspect the connectors. If further cleaning treatment is required, proceed as follows:

2) Soak (but not thoroughly soak) a lint-free cotton swab with isopropyl alcohol;

3) Remove the dirt and debris from the joint plane and threads of the connectors with cotton swabs. When cleaning the inner surface of a connector, be careful not to apply external force to the central inner conductor and not to leave the fibers of cotton swabs on the central conductor of the connector.

4) Let the alcohol volatilize, then blow the surface clean with compressed air;

5) Check the connector to make sure that it is free of particles and residues.

6) If any defects of the connector is still obvious after cleaning, it indicates that the connector may have been damaged and should not be used again. Make clear the cause of the connector damage before connection.

#### 7) Use of adapters

When the measuring port of the analyzer and the connector type used are different, adapters must be used for the connection before measurement. In addition, even if the measuring port of the analyzer and the connector type of port of the tested piece are the same, it is also advisable to use adapters. Both cases can protect the measuring port, prolong its service life and reduce the maintenance cost. Before connecting an adapter to the measuring port of an analyzer, it is required to carefully check and clean the adapter. And a high-quality adapter should be used to reduce the influence of mismatching on measurement accuracy.

#### 8) Joint plane of connectors

An important concept in microwave measurement is reference plane. And an analyzer, it is the benchmark reference plane for all measurements. During the calibration, the reference plane is defined as the plane where the measuring port and the calibration standard are engaged. Good connection and calibration depend on thorough and level contact between the connectors on the joint plane.

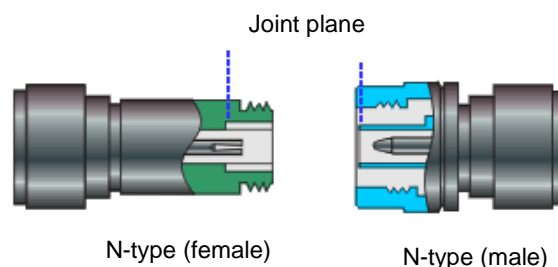

Figure 3.8 Plane calibration

#### 3.1.1.5 User Check

After a 1435 series signal generator is powered on for the first time, it is necessary to check whether the instrument works normally to ensure subsequent configuration operations.

**Tip****Description of front panel hard keys and soft keys on menus**

The description form of the front panel keys is as follows: **【Frequency】** , where frequency is the key name; If the key corresponds to multiple states, an state with the font color of the selected value changed and the background color darkened is valid. For example: [Sweep Time **Man** Auto] indicates that the sweep time manual option is enabled.

**1) Self-test**

Connect 1435 series signal generator to the power supply, and observe that the power indicator above the power switch in the lower left corner of the front panel is yellow, which indicates that the standby power supply is working normally. Touch the front panel power switch gently and observe whether the front panel power indicator turns green and the back light of the display turns on. You need to wait for about 30 seconds for the display startup until the startup status interface is displayed.

After preheating for 10 minutes, set the signal generator as follows:

**Step 1.** Press the **【System】** key on the front panel or tap the [System] function zone on the touch screen to enter the system menu;

**Step 2.** Select [Instrument Self Test] from the "Self Test" option;

**Step 3.** In the pop-up self test configuration window, select the self test item. Select [Start Test] and observe the test results: if successful, "Self Test Passed" will be displayed, indicating that the instrument works normally; If not successful, "Self Test Failed, XX items Failed", indicating that the instrument is not working properly. In this case, please contact our service consulting center according to the contact information provided in the title page or in "7.4 Method to obtain after-sales services" of this manual, and we will repair or replace the instrument as soon as possible accordingly.

**2) Function validation**

Start the 1435 series signal generator and preheat it for at least 30 minutes to add matching load to the RF output. Set the instrument as follows:

**Step 1.** Press the **【Amplitude】** key on the front panel or tap the [Amplitude] function zone on the touch screen to enter the power menu and pop up the power parameter setting dialog box, and set the power to 0dBm;

**Step 2.** Press the **【Frequency】** key on the front panel or tap the [Frequency] function zone on the touch screen to enter the frequency menu and pop up the frequency parameter setting dialog box to set the continuous wave to 100MHz; .

**Step 3.** Press the **【RF On/Off】** key on the front panel or tap the [RF] function zone on the touch screen to turn on the RF output of the signal generator;

**Step 4.** Press the arrow keys on the front panel to set the frequency of the signal generator to step upward at the interval of 100MHz until the max. frequency is reached. Observe the alarm indication zone of the front panel display. If there is no alarm indication, the instrument is working normally. If there is alarm information, the instrument is not working properly. In this case, please contact our service consulting center according to the contact information provided in the title page or in "7.4 Method to obtain after-sales services" of this manual, and we will repair or replace the instrument as soon as possible accordingly.

---

### 3.1 Get Prepared

#### 3.1.2 Operating System Configuration

This section introduces the operating system of the 1435 series signal generators as well as its configuration and maintenance. In order to ensure the normal operation of the software function of the instrument, please refer to the following precautions regarding the signal generator operating system:

- [Instrument Software Description.....28](#)
- [Windows 7 Usage.....28](#)
- [Windows 7 Configuration.....28](#)
- [Security and Maintenance of Windows 7 System.....31](#)
- [System Backup and Recovery.....32](#)

##### 3.1.2.1 Instrument Software Description

The host software of 1435 series signal generator runs on Windows 7, which has been installed and configured according to the characteristic requirements of the signal generator. The host software of the 1435 series signal generator is based on Windows 7 operating system, which has been installed before shipment of the instrument.

##### 3.1.2.2 Windows 7 Usage

The following operations are available with the administrator account:

- Installing third-party software;
- Configuring the network and printers;
- Reading and writing any file on the hard disk;
- Adding and deleting user accounts and passwords;
- Reconfiguring Windows settings;
- Running other applications.

---

### Note

#### Third party software affects instrument performance

The 1435 series signal generator adopts an open Windows environment. Installing third-party software may affect the performance of the signal generator. Only software tested by the manufacturer and compatible with the host software can be run.

---

##### 3.1.2.3 Windows 7 Configuration

Before shipment of the 1435 series signal generator, its operating system has been configured to the best state, and any change in the operating system settings may cause the performance of the instrument to decline. Normally, no changes are required to the settings of the Windows operating system.

---

### Note

#### Altering system configuration may cause problems

Once there is a problem with the use of the instrument or a system crash due to any change of the system configuration, the operating system and application software can be recovered by using the system recovery tool of the instrument, or you may contact our service consultation center with the service hotline provided in the foreword of this manual, and we will help you resolve it as soon as possible.

---

## Note

### BIOS settings cannot be modified

The signal generator has been specifically set in BIOS. Users should not modify the settings in BIOS, otherwise it will cause abnormal startup and operation of the instrument.

However, in order to facilitate the measurement report generation and system integration, users may change the items listed below as required.

- [Configuring USB Devices.....29](#)
- [Configuring GPIB.....30](#)
- [Configuring the Network.....30](#)

### 1) Configuring USB devices

Both the front panel and rear panel of a 1435 series signal generator provide USB interfaces for direct connection with USB devices. If the number of ports is insufficient, USB hubs can be externally connected through the USB interface to meet the demand. USB devices that can be connected to the signal generator include:

- USB storages that are directly connected to or removed from the computer to facilitate data updating;
- CD-ROM drives for easy installation of firmware programs;
- Keyboards and mice to facilitate data edition and instrument operation;
- Printers, to facilitate exporting measurement results.

The Windows 7 operating system supports plug-and-play devices, so it is very convenient to install USB devices. When a device is connected to a USB port, Windows 7 will automatically search for a matching device driver. If it is not found, the system will prompt you to find the driver directory to complete the installation.

If the USB device is removed from the USB port, Windows 7 will automatically detect the hardware configuration change and uninstall the relevant driver. The connection and removal of USB devices does not affect the working state of the signal generator.

The method to connect USB devices is as follows:

#### a) Connecting storages or CD-ROM drives

If the storage or CD-ROM drive is successfully installed, Windows 7 will prompt: "device is successfully installed and can be used" and automatically display the path name and prompt (e.g., "F:").

#### b) Connecting the keyboard

Windows 7 system will automatically detect the USB keyboard connected to the instrument. The default input language is "Chinese (China)-Simplified Chinese-American Keyboard". Keyboard properties can be configured through "Start > Control Panel > Clock, language and region > Region and language > Change keyboards or other input methods".

#### c) Connect the mouse

The Windows 7 system will automatically detect the mouse connected to the instrument, and the mouse properties can be configured through "Start > Control Panel > Hardware and sound > Devices and printers > Mouses".

### 3.1 Get Prepared

#### d) Printers

You can configure the printer using the Windows control panel. Using an external USB mouse and keyboard can make printer configuration easier. If a new printer needs to be installed, only the driver of the printer needs to be installed. The manufacturer of the printer will provide the driver for the printer. The driver can be installed via an external USB CD-ROM device.

#### 2) Configuring GPIB

The user may need to change the GPIB address when using the signal generator to build the system. The default GPIB address of this instrument is 19.

The GPIB address should be changed as follows:

Press the **【System】** key on the front panel or tap the [System] function zone on the touch screen, select [GPIB Port] to enter the interface as shown in Figure 3.9, where you can make changes in the GPIB address bar in the configuration window with the numeric keys on the front panel or by tapping on the touch screen.

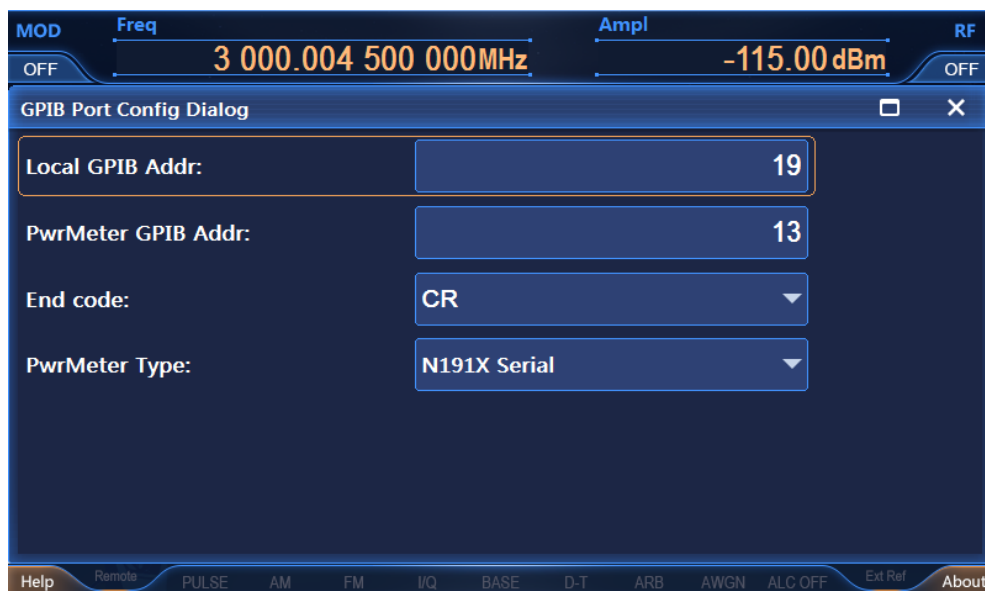

Figure 3.9 GPIB port setting

### 3) Configuring the Network

#### a) Renaming the host

The host name (computer name) of each 1435 series signal generator has been preset as "41-PC" before leaving the factory. In order to avoid duplicate names in the network, the user can change the host name by himself when a network is connected to more than one 1435 generators. The specific steps for changing the host name are as follows: (or you can refer to the Help document of Microsoft Windows 7.)

**Step 1.** Press the **【System】** key or tap the [System] function zone on the touch screen to select [LAN Port] to enter the network attribute settings page as shown in Figure 3.10, where the current LAN "Local Machine Name" is displayed.

**Step 2.** Edit and type in the new name of the host and close the current dialog box.





Figure 3.10 Lan port configuration

### b) Configuring IP address, subnet mask, and default gateway

The IP address and gateway are preset to automatically obtain the IP address before shipment of the instrument. The IP address, subnet mask, and gateway can all be changed manually. The IP address, subnet mask and default gateway can be changed in the window shown in Figure 3.10. Please refer to the steps in "a) Renaming the host" above or refer to the Help Document of Microsoft Windows 7 for details.

### c) Changing system firewall settings

A firewall is used to prevent unauthorized users from operating the instrument remotely. Therefore, the manufacturer suggests you to enable the firewall protection. The 1435 series signal generator has enabled the firewall protection for the system and all port connections related to remote operation at the factory.

The administrator has the sole permission to change the firewall settings.

#### 3.1.2.4 Security and Maintenance of Windows 7 System

##### 1) Anti-virus software

Installing anti-virus software may have some negative effects on the performance of the instrument. It is strongly recommended that users do not use the instrument as a common computer for browsing web pages or transferring files, so as not to be infected with viruses.

Before using various USB mobile storage devices, these mobile devices should first be disinfected with a computer installed with the latest anti-virus software to ensure that they will not become virus carriers.

Once the signal generator system platform is infected with virus, it will bring negative impact on its operation and the use of the instrument. In such case, users are recommended to perform system recovery. Please refer to "2) System Maintenance" in this section for system recovery operations.

##### 2) System maintenance

###### a) Windows 7 backup

Regularly system backup is recommended for users. The "System Recovery Tool" of this instrument can completely backup the data and system of the instrument. Please refer to "System Backup and Recovery" for specific operations.

It is suggested that before the instrument is used for other purposes, such as long-term access to

### 3.1 Get Prepared

the Internet and installation of third-party software, etc., in order to avoid accidental infection with virus and other harmful operation of the instrument system, the instrument needs to be backed up.

The Windows 7 operating system also has a data backup function, which can backup all data on the instrument and create a system disk that can be used to restore Windows in the event of a serious failure. You can refer to the help document and reference of Windows 7 for more information. Third-party backup software can also be used, but it is necessary to ensure that the third-party backup software does not conflict with the system software of the instrument. It is recommended to back up the system data on an external device, such as a network hard disk or a USB hard disk.

#### b) Windows 7 system recovery

Windows 7 has a system recovery function, which can restore the system to its previous state at a certain time. However, the system backup recovery built in Windows does not always succeed, so this backup option is not recommended.

#### 3) Hard disk partition and use

The hard disk is divided into two partitions: "Local Disk C:" and "Local Disk D:".

Disk C is the system disk with Windows 7 operating system installed.

Disk D stores instrument applications and data. Third-party software can also be installed to Disk D. Disk D is the only drive for backup programs and recovery. Disk D can also be used for storage of backup data. These include system data on Disk C, instrument data on Disk D and software backup data stored by users. The backup data on Disk D can be copied to external storage media, so even if the hard disk needs to be replaced, only the backup data needs to be restored to the new hard disk.

#### 3.1.2.5 System Backup and Recovery

##### 1) Hard disk OS or data recovery

The hard disk recovery system of the signal generator is used to fix errors on Disk C (which may be caused by the loss of system files or data) or to recover the original factory data.

Restoring the original factory data will affect the following items:

- User-defined Windows 7 settings. Such as a newly added user account. After the system is restored, these new configurations need to be reset;
- Other third-party software installed by users need to be reinstalled after the system is restored.

The user-defined data generated during the configuration process should be stored on Disk D, and it is recommended that users periodically transfer the data to the computer or other storage media for storage through the LAN connection.

##### 2) How to recovery programs with the instrument

**Step 1.** Confirm that the instrument is turned off.

**Step 2.** Insert a standard keyboard to the USB interface on the rear panel of the instrument.

**Step 3.** Turn on the instrument. After the manufacturer information is displayed, the operating system menu with timer will appear:

Before the timer reaches 0, highlight and select "System Recovery Tool" with the up and down arrow keys on the standard keyboard, and press the OK key after selection.

**Step 4.** After entering the recovery program interface, perform the recovery operation according to the following steps:

- 1) Select to run GHOST 8.2 wizard and wait to enter the next operation prompt interface.
- 2) Select item 5 to start the manual operation of GHOST version 8.2, wait to enter the operation interface of GHOST 8.2, and press Enter when a dialog box with OK button appears.

3) Select Local→Partition→From Image; in the Open File dialog box, press Tab to activate the "File name" input box and enter d: \ system.gho.

**3.1 Get Prepared**

4) In the pop-up dialog box for selecting source partition selection file, use Tab key to switch, tap OK and enter. In the dialog box that pops up after that, use Tab to switch, tap OK and enter. In the dialog box for selecting destination partition that pops up later, select the first partition, use Tab to switch, tap OK and enter.

5) Select Yes and enter in the warning and confirmation dialog box.

6) Wait till the system recovery progress is complete, and select reboot according to the prompt.

**Step 5.** After the recovery is completed and the instrument is restarted, the system enters the system state of the last backup.

**Step 6.** After the system is restored, it is recommended to conduct a self-test of the instrument to check whether there is any error in the stable working state of the instrument 30 minutes after the startup.

**3.1.3 Routine Maintenance**

This section introduces the routine maintenance of the 1435 series signal generators.

- [Cleaning.....33](#)
- [Test Port Maintenance.....33](#)

**3.1.3.1 Cleaning****1) Cleaning instrument surface**

Please follow the steps below when cleaning the surface of the instrument:

**Step 1.** Shut down the instrument and disconnect the power cord connected to it.

**Step 2.** Wipe the surface gently with dry or slightly wet soft cloth, and do not wipe the inside of the instrument.

**Step 3.** Do not use chemical cleaners, such as alcohol, acetone or dilutable cleaners.

**2) Cleaning the display**

After a period of use, the LED display needs to be cleaned. Please follow the steps below:

**Step 1.** Shut down the instrument and disconnect the power cord connected to it.

**Step 2.** Dip a piece of clean and soft cotton cloth into the cleaner and then gently wipe the display panel.

**Step 3.** Dry the display with a piece of clean and soft cotton cloth.

**Step 4.** Connect the power cord only after the cleaner is completely dried.

**Note****Display cleaning**

There is an antistatic coating on the surface of the display. Do not use cleaners containing fluoride, acid and alkaline. Do not spray the cleaner directly onto the display panel, otherwise it may penetrate into the instrument and damage the instrument.

**3.1.3.2 Test Port Maintenance**

The 1435 series signal generator is provided with an N-type (female) or 3.5mm/2.4mm (male) port and multiple BNC ports (female). Damage to the connector or the presence of dust inside the connector will affect the test results. Please maintain such kind of connectors as follows:

### 3.2 Front and Real Panels

- The connectors should be kept away from dust and kept clean.
- To prevent electrostatic discharge (ESD), do not directly contact the joint surface.
- Do not use damaged connectors;
- Please use an air blower to clean the connectors instead of using tools such as sandpaper to grind the surface of the joint.

## Note

#### Port impedance matching

The RF port in front of 1435 series signal generators is a 50Ω N type (female) or 3.5mm/2.4mm (male) connector.

If the connection does not match the impedance connector, the connector will be damaged. If the connection does not match the impedance connector, the connector will be damaged.

### 3.2 Front and Real Panels

This section introduces the composition and functions of the front and rear panels of 1435 series signal generators.

- [Front Panel](#).....34
- [Real Panel](#).....35

#### 3.2.1 Front Panel

This section introduces the composition and functions of the front panels of 1435 series signal generators. The front panel is shown below (Figure 3.11), and the items are described in Table 3.5:

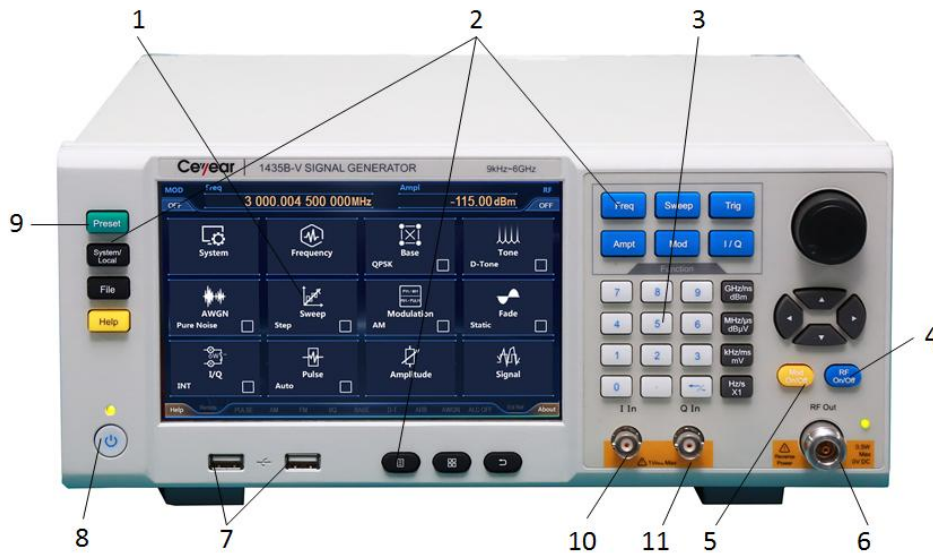

Figure 3.11 Front Panel

- |                  |                      |             |
|------------------|----------------------|-------------|
| 1. Display zone  | 5. Modulation on/off | 9. Reset    |
| 2. Function zone | 6. RF output         | 10. I input |
| 3. Input zone    | 7. USB interface     | 11. Q input |
| 4. RF on/off     | 8. Power switch      |             |

Table 3.5 Front panel description

No.	Name	Description
1	Display zone	The LED display is used to display all measurement results, status and setting information and allows for switching among different measurement tasks. Please refer to section "3.3.1.1 Main Features of the Operation Interface" for detailed description of the operation interface.
2	Function zone	It is composed of functional hard keys on the front panel. Selecting the keys allows you to perform functions of the instrument such as frequency, power, sweep, modulation, baseband mode, IQ, calibration, display, trigger, confirmation, exit, menu, system, storage call, file, printing, reset and local machine.
3	Input zone	Including arrow keys, knob, ←/– (backspace/negative sign), numeric keys. All inputs can be changed through keys and the knob in the input zone.
4	RF on/off	Output impedance of 50Ω, reverse power of 0.5 W, option H92. The connector is on the rear panel. 1435a/b/c: N-type female; 1435D: 3.5mm male (option H91: N-type female); 1435F: 2.4mm male;
5	Modulation on/off	Turns on/off the modulation function, opens the modulation window and sets corresponding modulation parameters as required.
6	RF output	The signal output port of the signal generator. Output impedance of 50Ω, reverse power of 0.5W.
7	USB interfaces	To be used for connection with mouses and keyboards, system software upgrading and data backup.
8	Power switch	When the instrument is in the "standby" state, the yellow indicator light on the left side above the power switch is on; Press the power switch, and the green indicator on the right side of the switch is on, indicating that th instrument is in the "working" state.
9	Reset	Press this key to restart the instrument, and enter the factory or user setup status after self-check and initialization.
10	I input	BNC female, receiving "I" inputs of I/Q modulation. Input impedance of 50Ω.
11	Q input	BNC female, receiving "Q" inputs of I/Q modulation. Input impedance of 50Ω.

### 3.2.2 Real Panel

This section introduces the composition and functions of the rear panels of 1435 series signal generators. The rear panel is shown below (Figure 3.12), and the items are described in Table 3.6:

3.2 Front and Rear Panels

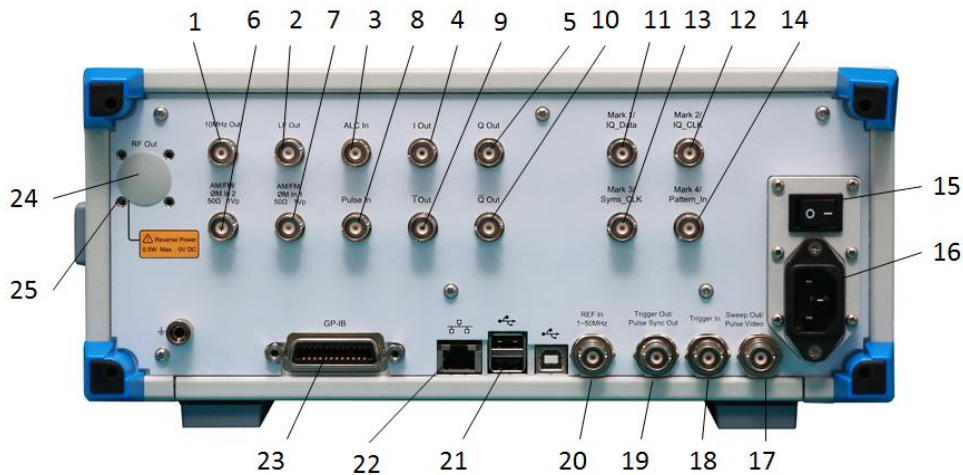

Figure 3.12 Real panel

- |   |  |  |
|---|--|--|
| 1. 10 MHz output                          | 10. $\bar{Q}$ output                       | 19. Trigger output/synchronized pulse output |
| 2. LF output                              | 11. Marker 1/IQ data                       | 20. Reference input 1 ~ 50 MHz.              |
| 3. External detection input               | 12. Marker 2/IQ clock                      | 21. USB                                      |
| 4. I output                               | 13. Marker 3/code element clock            | 22. LAN                                      |
| 5. Q output                               | 14. Marker 4/IQ code pattern trigger input | 23. GPIB                                     |
| 6. AM/FM/phase modulation $\Phi$ M 2      | 15. Power switch                           | 24. RF output                                |
| 7. AM/FM/PM (phase modulation) $\Phi$ M 1 | 16. power interface                        | 25. Ground terminal                          |
| 8. Pulse input                            | 17. Sweep output/pulse monitoring output   |  |
| 9. $\bar{T}$ output                       | 18. Trigger input                          |  |

Table 3.6 Rear panel description

No.	Name	Description
1	10 MHz output	BNC female, signal level $>+4\text{dBm}$ , typical output impedance $50\Omega$ .
2	LF output	BNC female, signal level $>+4\text{dBm}$ , typical output impedance $50\Omega$ .
3	External detection input	BNC female, used for negative level external detection or power meter amplitude stabilization, typical input impedance $1\text{k}\Omega$ , damage level $\geq+15\text{V}$ or $\leq-15\text{V}$ .
4	I output	BNC female, path I output of internal baseband signal generator.
5	Q output	BNC female, path Q output of internal baseband signal generator.
6	AM/FM/ $\Phi$ M 2	BNC female, input fixed at $\pm 1\text{Vp}$ , realizing external AM/FM/PM functions.
7	AM/FM/ $\Phi$ M 1	BNC female, input fixed at $\pm 1\text{Vp}$ , realizing external AM/FM/PM functions.
8	Pulse input	BNC female, output in positive relation to the voltage output of the sweep frequency, 0V corresponding to the start frequency of sweep, 10V corresponding to the stop frequency (0~10V corresponding to the frequency range of the whole instrument in the CW working mode) of sweep.
9	$\bar{T}$ output	BNC female, path $\bar{T}$ output of internal baseband signal generator.

### 3.3 Basic Configurations

10	$\bar{Q}$ output	BNC female, path $\bar{Q}$ output of internal baseband signal generator.
11	Marker 1/IQ data	BNC female, during arbitrary wave modulation, outputting marker 1 set by the arbitrary wave; In the baseband mode, inputting IQ serial data when the data source is external.
12	Marker 2/IQ clock	BNC female, during arbitrary wave modulation, outputting marker 2 set by the arbitrary wave; In the baseband mode, inputting IQ clock when the data source is external.
13	Marker 3/code element clock	BNC female, during arbitrary wave modulation, outputting marker 3 set by the arbitrary wave; In the baseband mode, inputting IQ code element clock when the data source is external.
14	Marker 4/IQ code pattern trigger input	BNC female, during arbitrary wave modulation, outputting marker 4 set by the arbitrary wave; In the baseband mode, input triggered by external code patterns in the baseband and arbitrary wave modes.
15	Power switch	Power switch of mains supply of the instrument.
16	power interface	Instrument power plug, parameter requirements: 220 V ( $\pm 10\%$ ), 50 Hz ( $\pm 5\%$ ), 300W.
17	Sweep output/pulse monitoring output	BNC female, output in positive relation to the voltage output of the sweep frequency, 0V corresponding to the start frequency of sweep, 10V corresponding to the stop frequency (0~10V corresponding to the frequency range of the whole instrument in the CW working mode) of sweep.
18	Trigger input	BNC female, TTL rising edge valid, used for external triggering of Frequency hopping in the step and list sweep modes.
19	Trigger output/synchronized pulse output	Outputting TTL low pulse with the width of 1 $\mu$ s corresponding to each frequency conversion in the sweep mode.
20	Reference input 1 ~ 50 MHz.	BNC female, receiving frequency reference signals with 1~50MHz, stepping of 1Hz and 0 ~ +7dBm from external time base.
21	USB	To be used for connection with mouses and keyboards, system software upgrading and data backup.
22	LAN	used for software upgrading and control, etc.
23	GPIB	Standard IEEE488 interface, supporting SCPI language.
24	RF output	The signal output port of the signal generator.
25	Ground terminal	The ground terminal of the signal generator, used for preventing the generation of static electricity.

### 3.3 Basic Configurations

This part introduces the basic settings and configurations of the 1435 series signal generators, including:

- [Basic Settings.....38](#)
- [Operation Examples.....43](#)
- [Main Configuration Scenes.....53](#)

### 3.3 Basic Configurations

#### 3.3.1 Basic Settings

This section introduces the main features and basic configurations of the user interface of 1435 series signal generators, which will be used in different subsequent configuration tasks. This section includes:

- [Main Features of the Operation Interface.....38](#)
- [Common Configurations and Settings .....39](#)

##### 3.3.1.1 Main Features of the Operation Interface

The LED display on the front panel is used to display the user operation interface. Adopting a novel intuitive graphical user interface, it can clearly display the whole process of signal output. The entire operation interface is divided into different zones according to functional modules, and multiple functional modules can be operated simultaneously to display the status, parameter settings and configuration results of all configuration tasks. This section mainly introduces the partitions and functions of the user operation interface of the signal generator. The operation interface is shown in the following figure (Figure 3.13), and the detailed description is shown in Table 3.7.

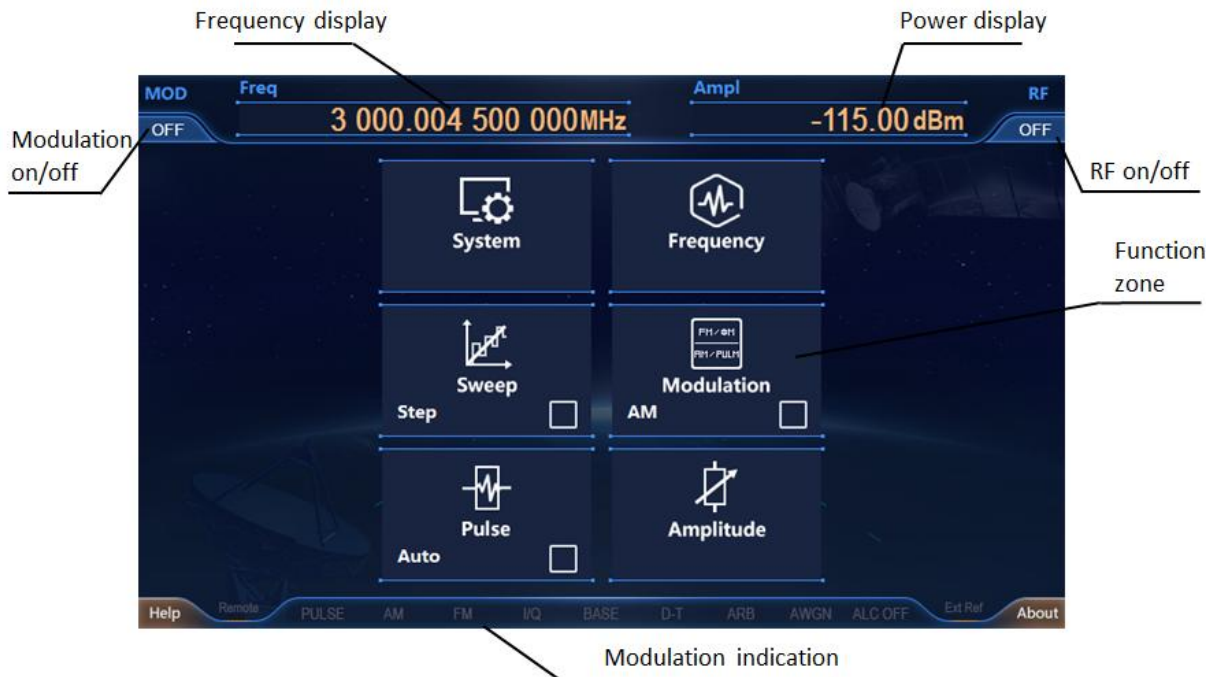

Figure 3.13 Operator interface of 1435

Table 3.7 Operation interface description

No.	Name	Description
1	Main Info Zone	Displays the main parameter values: frequency, power, modulation on/off status, RF on/off status and modulation status, etc. Corresponding to the frequency display, power display, modulation on/off and RF on/off in Figure 3.13.
2	Function zone	When you tap on the corresponding function in the function zone on the touch screen or press a function key on the front panel, the corresponding menu will be displayed in the zone. This zone corresponds to the function zone in Figure 3.13.
3	Status Indication Zone	Used to display the working mode, working status and the latest alarm/error information of the instrument. This zone corresponds to the modulation indication in Figure 3.13.



### 3.3.1.2 Common Configurations and Settings

#### Tip

#### Support for touch screen and front panel operations

The graphical user interface of 1435 series signal generators supports operation on the touch screen and on the front panel of the instrument. The following describes several common settings of this series of signal generators. Among them, method 1 is touch screen operation and method 2 is operation on the front panel of the instrument.

#### 1) [RF On/Off] operation



**Method 1:** Tap the [RF] function zone of the main info zone of the touch screen to turn on RF, and tap this button again to turn RF off.

**Method 2:** Press the **[RF On/Off]** key on the front panel of the instrument to switch the RF on/off status.

#### 2) Setting continuous wave frequency



**Method 1:** Tap the [Frequency] function zone of the configuration info zone of the touch screen to open the Freq Config Dialog window; Tap the [CW] edition box on the touch screen to make the box in the selected status. Enter the value and press the unit key to end the operation.

**Method 2:** Press the [Frequency] key on the front panel of the instrument to open the Freq Config Display window, and rotate the knob (RPG) on the front panel of the instrument to select the input item. When the **[CW]** option is surrounded by a yellow frame, this input item is selected.



Press the knob (RPG) to make the **[CW]** option in the edition status.



Enter the value with the front panel keys and press the unit key to finish the operation.

Note: After inputting all the numerical values of the instrument, you need to press the unit key or the enter key to end the input.

#### 3) Setting progressive increase (decline) of continuous wave frequency

The DW frequency can be output after setting a fixed value, or be increased (decreased) by using the arrow keys (knob). For example, for the CW option, you can move the cursor with the left and right keys to select a digit to be changed, and then change its value with the up and down keys or the knob, thus achieving rapid stepping of frequency switching.



In addition, for the CW option, you can move the cursor to the leftmost side. When the cursor disappears, press the up and down arrow keys or the knob, and the CW input will be increased or

### 3.3 Basic Configurations

decreased at the set step.

#### 4) Selecting configuration window

**Method 1:** Tap the corresponding button in the configuration zone of the instrument to open the corresponding configuration window. For example, tap the [Amplitude] function zone to open the Power Config Dialog window. All operations related to power setting can be done in this window.

**Method 2:** Press the corresponding keys on the front panel of the instrument to open the corresponding configuration window of the instrument. For example, press the **【Amplitude】** key on the front panel of the instrument to open the power configuration window.

#### 5) On/Off button operation

This will be described with “Freq Ref Switch” as an example:

**Method 1:** Tap this button on the touch screen to switch the on and off states of frequency reference.

**Method 2:** Rotate the knob on the front panel of the instrument. When the knob is in the selected state, press the knob to turn the frequency reference on and off.

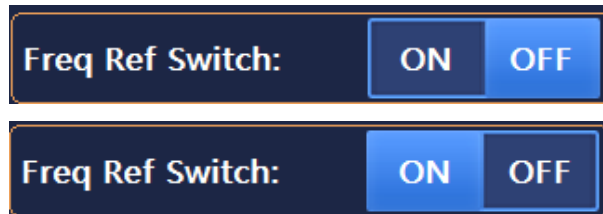

The currently selected status is indicated at the location with the blue block.

#### 6) Drop-down box operation

**Method 1:** Tap the drop-down box control on the touch screen, then the control is in the expanded drop-down box and can be selected by tapping.

**Method 2:** Rotate the RPG on the front panel of the instrument to set the drop-down box control in the selected state:

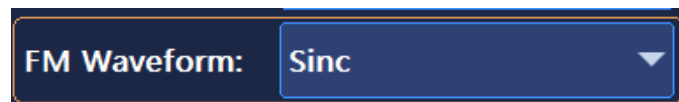

Press the RPG to expand the drop-down box.



Rotate the RPG or use the arrow keys to select the item to be selected.

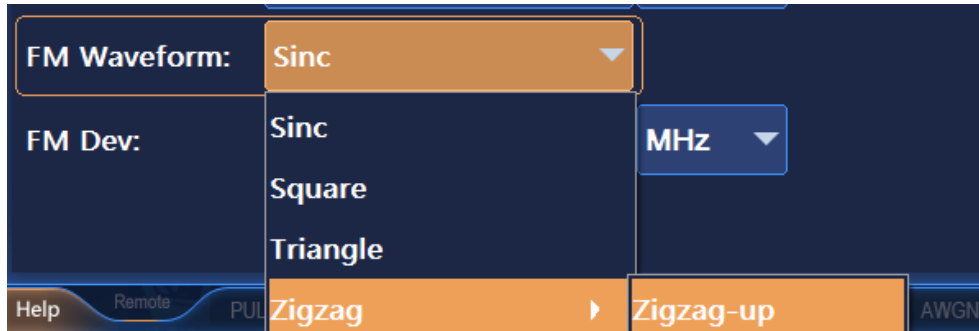

Press RPG key or enter key to finish editing.

## 7) Editing data

Data input consists of two parts: data input and unit selection. If different units are selected, the data will be displayed at different unit precision.



The operation data can be input through the touch screen or the numeric keys on the front panel of the instrument.

**Method 1:** Tap the "Start Frequency" data input box on the touch screen, then the frequency is in the "Edition Status". When you can input data for edition.

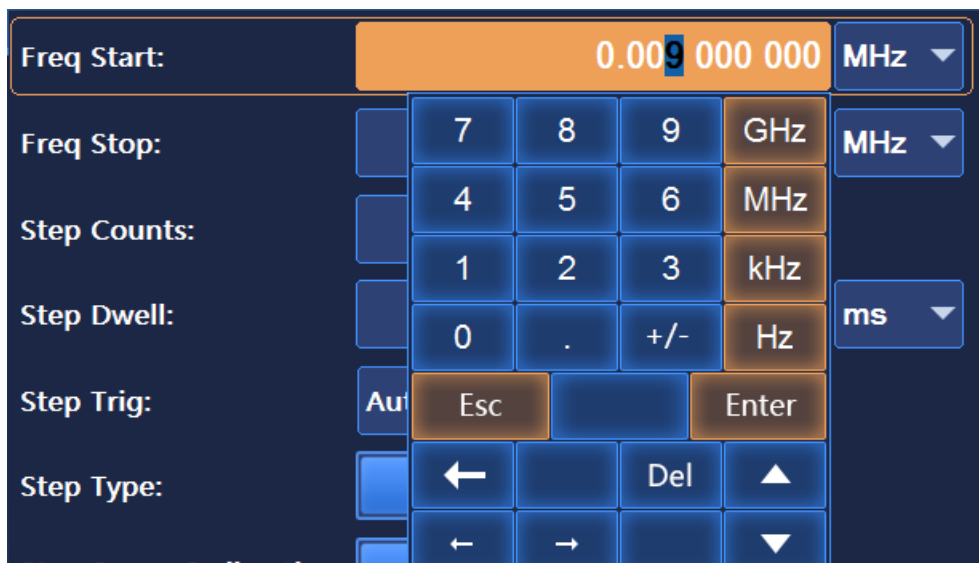

**Method 2:** Rotate the knob on the front panel of the instrument. When the "Start Frequency" data input box is in the selected state, press the knob to set the data input box to the edition status, input data and edit it. After edition, press the knob again to set the data input box to the selected state, and operate other controls by rotating the knob.

## Tip

### Input box focus order

In order to facilitate user input, the focus of the data input box is at the top of the focus order of all controls in the current configuration window, i.e. when a configuration window is opened, you can edit data in the data input box directly.

3.3 Basic Configurations

8) List edition

The 1435 series signal generators offer the list edition function, which requires the user to edit the list information manually. The list is shown in Figure 3.14. Input controls and switch controls are embedded in the list, drop-down box control, and button control.

**Method 1:** Tap a grid in the table on the touch screen to edit, and the grid can be an input box control, a switch control, a drop-down box control or a button control. The editing method of each control is the same as in 1) -7).

**Method 2:** Rotate the RPG on the front panel to select the list.

Index	Freq(MHz)	Offset(dB)	Time(ms)
0	3 000.004 500 000	0.00	10.000 000
1	3 000.004 500 000	0.00	10.000 000
2	3 000.004 500 000	0.00	10.000 000
3	3 000.004 500 000	0.00	10.000 000
4	3 000.004 500 000	0.00	10.000 000
5	3 000.004 500 000	0.00	10.000 000

Press the knob to select a row for editing, rotate the knob or press the arrow key to select a row a time in turn.

Index	Freq(MHz)	Offset(dB)	Time(ms)
0	3 000.004 500 000	0.00	10.000 000
1	3 000.004 500 000	0.00	10.000 000
2	3 000.004 500 000	0.00	10.000 000
3	3 000.004 500 000	0.00	10.000 000
4	3 000.004 500 000	0.00	10.000 000
5	3 000.004 500 000	0.00	10.000 000

Press the left and right arrow keys to select a grid a time in turn. When a cell is an editable control, there will be a yellow frame. Press the knob at this time to edit the control according to 1) -7) above.

Index	Freq(MHz)	Offset(dB)	Time(ms)
0	3 000.004 500 000	0.00	10.000 000
1	3 000.004 500 000	0.00	10.000 000
2	3 000.004 500 000	0.00	10.000 000
3	3 000.004 500 000	0.00	10.000 000
4	3 000.004 500 000	0.00	10.000 000
5	3 000.004 500 000	0.00	10.000 000

Figure 3.14 Table editing of 1435

### 9) Quick operation

The main interface provides quick operations for modulation type switching and working modes. The status of the instrument can be quickly switched through touch operations. On the left side of each function module, there is a prompt of the current status information, as shown in Figure 3.15.

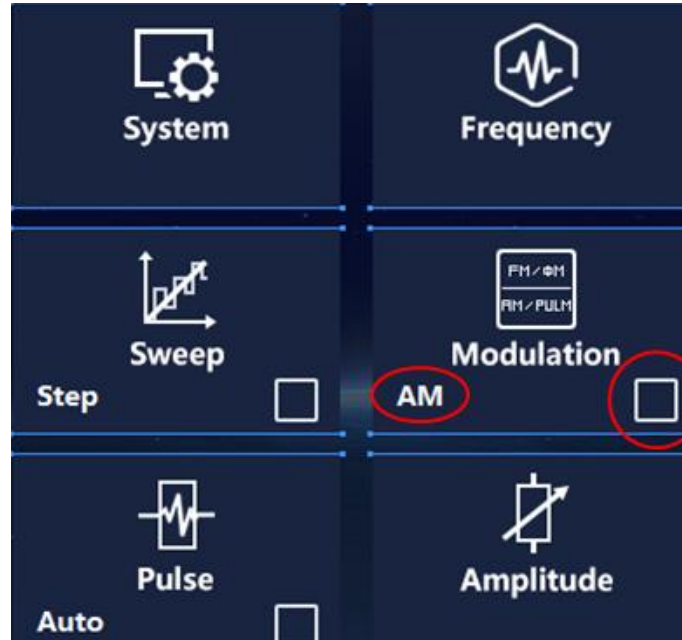

Figure 3.15(a) Quick operation of 1435

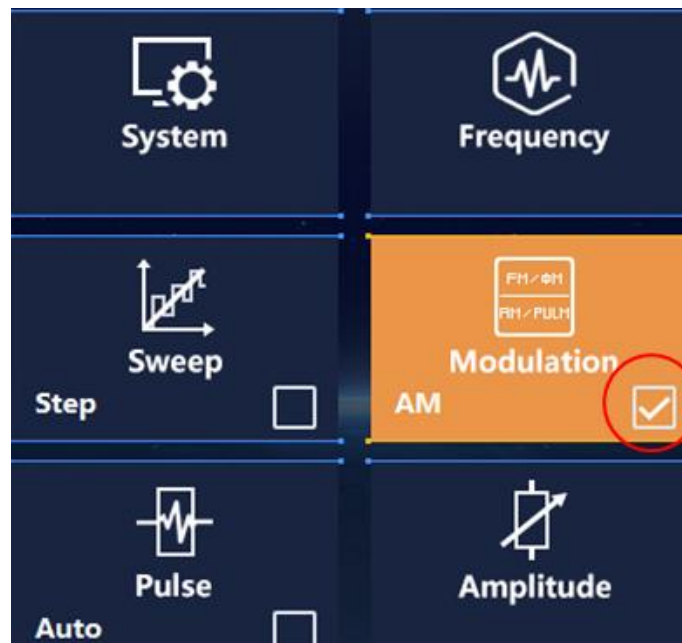

Figure 3.15(b) Quick operation of 1435

### 3.3.2 Operation Examples

This section introduces some common and important basic settings and functions of 1435 series signal generators step by step through examples so as to enable users to quickly understand the characteristics of the instrument and master the basic configurations.

First, the signal generator completes the pre-operation preparations according to the following steps:

### 3.3 Basic Configurations

**Step 1.** Power on and startup;

**Step 2.** Initialization after entering the system;

**Step 3.** preheating for 10 minutes;

**Step 4.** Proceed with the following operations when there are no error messages in the main operation interface.

## Description

The following operations adopt the front panel operation and touch screen operation of the instrument as examples.

### 3.3.2.1 Setting continuous wave RF output

#### 1) Setting RF output frequency

*For example: set the RF output frequency to 500MHz output the frequencies in the ascending or descending order at the step of 1 MHz.*

**Operation Steps:**

#### **Step 1. Reset.**

Press the **【Reset】** key to set the signal generator to factory settings.

## Tip

### **Reset status of the instrument**

The reset condition of the signal generator can be set to a status specified by the user according to user requirements. However, in the following example, factory settings are used as the reset status. Please refer to "3.4.1.1 Resetting Instrument Status" for details.

#### **Step 2. RF On.**

Press **【RF On/Off】** or tap the [RF] function zone on the touch screen, switch to RF On to output RF signals.

At this time, the RF On/Off status in the operation interface of the front panel is displayed as "RF ON".

#### **Step 3. Set continuous wave to 500MHz.**

##### ➤ **Frequency edition:**

Press **【Frequency】** or tap the [Frequency] function zone to pop up the frequency configuration window;

Rotate the RPG of the front panel clockwise (or counterclockwise) to select the frequency input box, and press the knob to make the box in the edition status; Or tap the frequency input box on the touch screen to make the box in the edition status. The frequency value displayed in the box currently being edited is the system default value or the frequency value set during the last continuous wave operation. At this time, type 500MHz to finish the input, and the frequency displayed in the main info zone will be refreshed synchronously.

#### **Step 4. Set the frequency step to 1MHz.**

➤ **Editing frequency stepping.**

Rotate the RPG of the front panel clockwise (or counterclockwise) to select the frequency step edition box of frequency setting, and press the knob to make the box in the edition status; Or tap the frequency step edition box on the touch screen to make the box in the edition status. Then enter 1MHz to end the input.

**Step 5. Progressive increase**

➤ **Press the arrow keys to realize stepping.**

Rotate the front panel RPG clockwise (or counterclockwise) or tap on the touch screen to select the continuous wave input box. Move the cursor to the leftmost end of the edition box, and press the up/down keys or the up/down keys on the virtual keyboard to realize stepping of continuous wave at 1MHz. Alternatively, you can fix the cursor to the location of MHz in the input box, and press the up/down keys or the up/down keys on the virtual keyboard to realize stepping of continuous wave at 1MHz. At this time, the RF output port outputs continuous wave signals at the step of 1MHz.

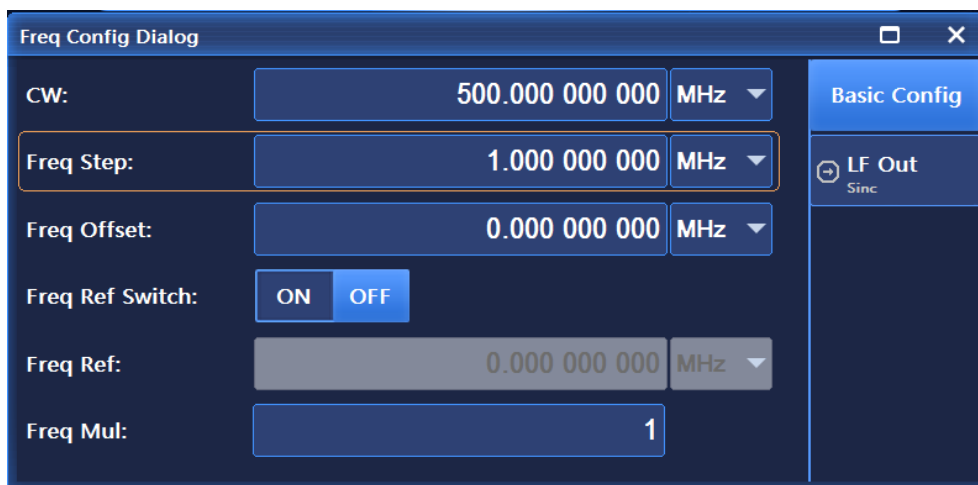

Figure 3.16 Setting the continuous wave to 500MHz, frequency step to 1MHz and a step frequency

**Tip**

**Focus order of continuous wave/power input box**

In order to facilitate user input, when the frequency/power configuration window is opened, the CW/power input box is automatically in the edition status.

**Tip**

**Changing input box parameters by stepping**

When the input box is in the edition status, the input parameter values can also be changed by stepping with the front panel RPG or the arrow keys.

**2) Setting frequency reference and frequency offset**

When the frequency reference is turned on, the frequency related parameters are all based on the relative values of the currently set frequency reference values. For example, the frequency displayed in the main info zone is the difference between the RF output frequency and the frequency reference value.

**For example: set the frequency reference to 500MHz and the frequency offset to 100MHz.**

### 3.3 Basic Configurations

#### Operation Steps:

##### Step 1. Reset.

Press the **【Reset】** key to set the signal generator to factory settings.

##### Step 2. Set continuous wave to 1.5GHz, frequency reference to 500 MHz

###### ➤ Edit the frequency value to 1.5 GHz;

Press the **【Frequency】** key or tap the [Frequency] function zone to pop up the frequency configuration window from the user interface; set the CW to 1.5 GHz.

###### ➤ Edit the frequency reference to 500MHz;

Turn the front panel RPG clockwise (or counterclockwise), select the frequency reference switch, press the knob, and set the frequency reference ON or set the frequency reference ON by tapping on the touch screen. Rotate the front panel RPG clockwise (or counterclockwise) to select the frequency reference input box. Press the knob or tap on the touch screen to make the frequency reference input box in the edition status; The frequency reference value displayed in the current edit box is the system default value or the frequency reference value set by during the last frequency reference operation. Then type in 500MHz to end the input. The frequency displayed in the main info zone is the actual RF output frequency minus the frequency reference value (1GHz = 1.5GHz-500MHz). There is a "Reference" mark before the frequency displayed in the main info zone, when the "Frequency Reference Off On" option is set to "On".

If the frequency reference is turned off, the frequency displayed in the main info zone is the actual RF output frequency value.

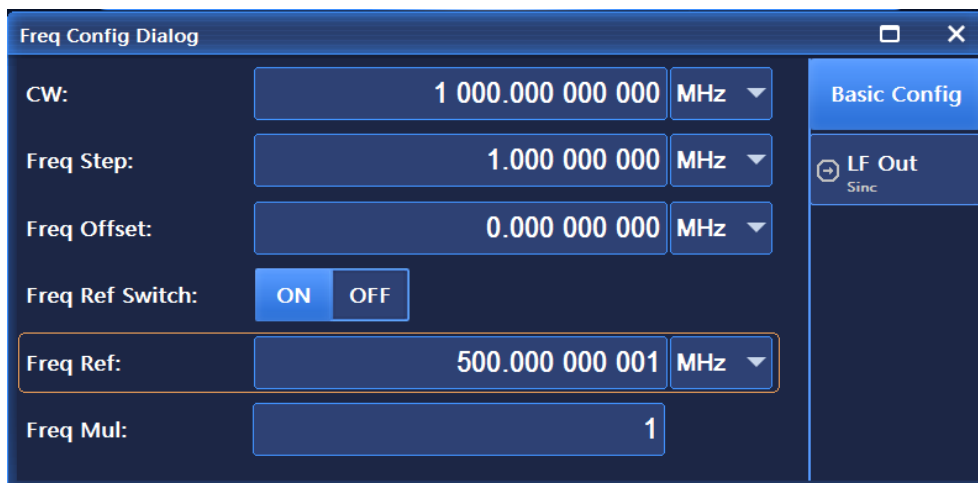

Figure 3.17 Setting frequency reference to 500MHz

##### Step 3. RF On.

Press **【RF On/Off】** or tap the [RF] function zone on the touch screen, switch to RF On to output RF signals.

At this time, the RF On/Off status is displayed as "RF ON".

##### Step 4. Set frequency offset to 100 MHz.

###### ➤ Edit the frequency offset to 100MHz;

Rotate the front panel RPG clockwise (or counterclockwise) to select the frequency offset edition box. Press the knob or tap on the touch screen to make the frequency offset edition box is in the edition status, type in 100MHz to set the frequency offset to 100MHz. At this time, the frequency displayed in the main info zone is 1.1GHz (output frequency (1.5GHz)- frequency reference (500MHz)+ frequency offset (100MHz)). At this time, the RF output frequency is still 1.5GHz.





Figure 3.18 Setting frequency offset to 100 MHz

## Tip

### Marking “Offset” before frequency

If the frequency reference is turned on or the frequency offset is not 0, there will be an "Offset" marked above the frequency value displayed in the main info zone.

If the frequency reference is turned off or the frequency offset is 0, the frequency value displayed in the main information zone is the actual RF output frequency.

### 3) Setting RF output frequency

1435 series signal generators provide stable amplitude power output in CW and frequency sweep modes, and the power setting range can be from -20dBm to +30dBm (-130dBm to +30dBm for signal generators with optional step attenuator output).

**For example: setting the power level to 0dBm.**

#### Operation Steps:

##### Step 1. Reset.

Press the **【Reset】** key to set the signal generator to factory settings.

##### Step 2. RF On.

Press **【RF On/Off】** or tap the [RF] function zone on the touch screen, switch to RF On to output RF signals.

At this time, the RF On/Off status is displayed as “RF ON”.

##### Step 3. Set power to 0dBm.

##### ➤ Edit the power value to 0dBm;

Press the **【Amplitude】** key or tap the [Amplitude] function zone on the touch screen, and the power configuration window will pop up on the operation interface, as shown in Figure 3.19;

Rotate the knob clockwise (or counterclockwise) to select the power input box, and press the knob to make the box in the edition status; Or tap the power input box on the touch screen to make the box in the edition status; the power value displayed in the box currently being edited is the system default value or the power value set during the last power level operation. Input 0dBm in the input box to end the input. The power value displayed in the main info zone is set to the newly input value.

### 3.3 Basic Configurations

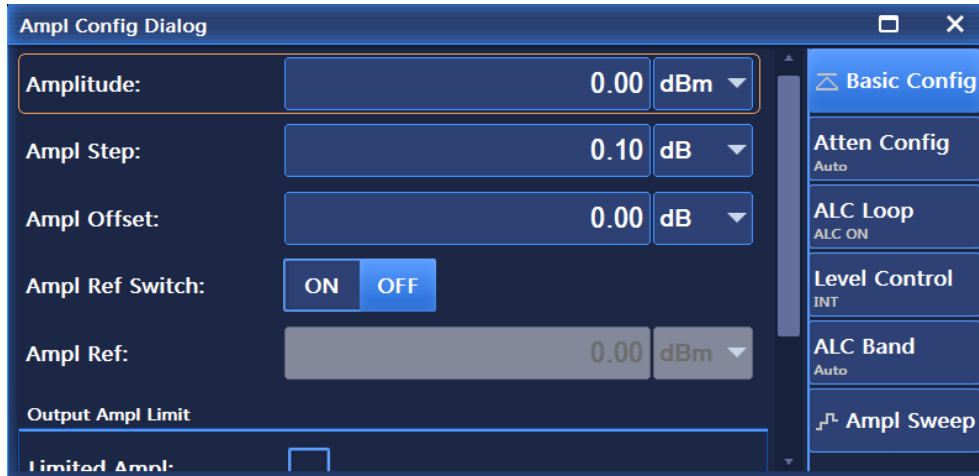

Figure 3.19 Power level set to 0dBm

## Tip

**The input power level value exceeds the power setting range of the signal generator.**

The power input box automatically limits its range and displays the upper and lower limits closest to the input value. If the input power level exceeds the stable amplitude power range that can be generated by the signal generator, the alarm "unstable amplitude" will be displayed in the status indication zone.

#### 4) Setting power reference and power offset

When power reference is turned on, the power-related parameters are all based on the relative values of the currently set power reference values. **For example: the power displayed in the main info zone is the difference between the RF output power and the power reference value.**

**For example: set power reference to 10dBm and power offset to 5dB.**

##### Operation Steps:

##### Step 1. Reset.

Press the **【Reset】** key to set the signal generator to factory settings.

##### Step 2. Set power to 0dBm.

Press the **【Amplitude】** key and rotate the front panel RPG to select the power input box or tap the [Amplitude] function zone on the touch screen to make the power input box in the edition status; the input power is 0dBm;

##### Step 3. Set power reference to 10dBm.

##### ➤ Edit the power reference to 10dBm;

Turn the front panel RPG clockwise (or counterclockwise), select the power reference switch, press the knob, and set the power reference ON or set the power reference ON by tapping on the touch screen.

Rotate the front panel RPG clockwise (or counterclockwise) to select the power reference input box. Press the knob to make the power reference input box in the edition status; The power reference value displayed in the current edit box is the system default value or the power reference value set by during the last power reference operation. Then enter 10dBm and end the input. The main info zone displays the power value which is the actual RF output power minus the power reference value -10dBm (RF output power (0dBm)- power reference (10dBm)), and indicates that the power reference is on, as

## 3.3 Basic Configurations

shown in Figure 3.20.

If the power reference is turned off, the power displayed in the main info zone is the actual RF output power value.

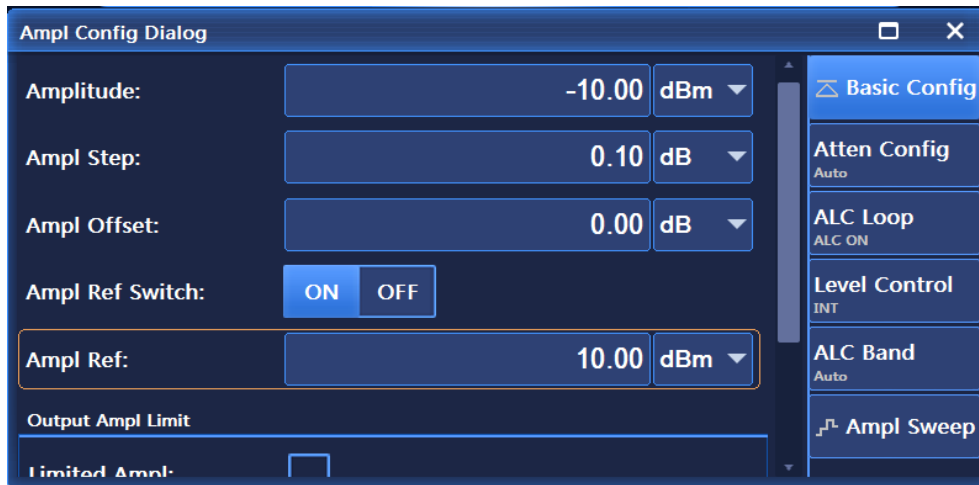

Figure 3.20 Power 0dBm, power reference 10dBm

#### Step 4. RF On.

Press **【RF On/Off】** to switch to RF On to output RF signals.

At this time, the RF On/Off status is displayed as "RF ON".

#### Step 5. Set power offset to 5dB.

##### ➤ Edit power offset to 5dB;

Rotate the knob on the front panel clockwise (or counterclockwise) to select the power offset edition box of power settings, and press the knob to make the box in the edition status; Or tap the power offset edition box on the touch screen to make the box in the edition status. The input 5dB to set the power offset to 5dB.

At this time, the power displayed in the main info zone is -5dBm (RF output power (0dBm)- power reference (10dBm)+ power offset (5dB)). The actual RF output power is still 0dBm; As shown in Figure 3.21.

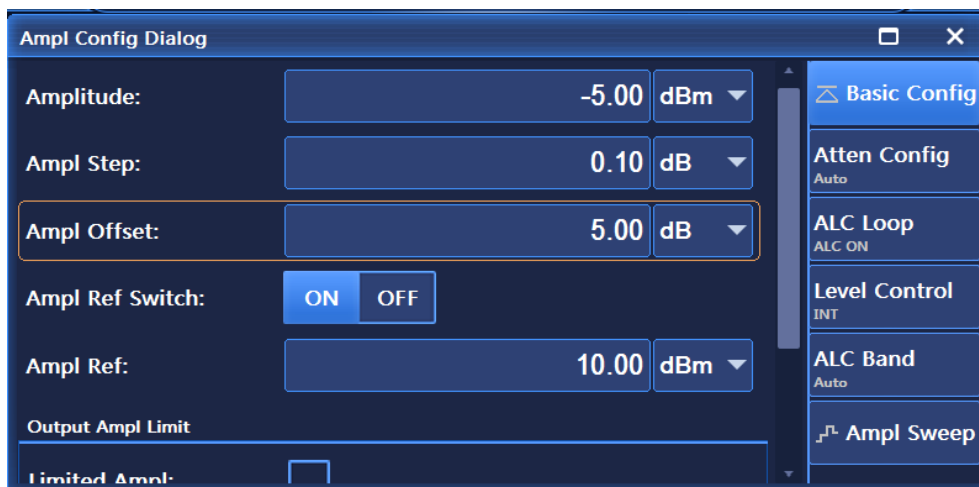

Figure 3.21 Power offset set to 5dB

### 3.3 Basic Configurations

## Tip

#### Marking “Offset” before power

If the power reference is turned on or the power offset is not 0, there will be an "Offset" marked above the power value displayed in the main info zone.

If the power reference is turned off or the power offset is 0, the power value displayed in the main information zone is the actual RF output power.

#### 3.3.2.2 Modulation Signals

The modulation pulses of 1435 series signal generators have four modulation functions: amplitude modulation, frequency modulation /phase modulation and pulse modulation. This section takes amplitude modulation and pulse modulation as examples to introduce how to enable and set modulation signals.

##### 1) Amplitude Modulation

*For example: to generate an AM signal with the local oscillator frequency of 3.5GHz, power of 0dBm, modulation rate of 0.001MHz and AM depth of 30% in Path 1.*

#### Operation Steps:

##### Step 1. Set RF output signals of the signal generator:

Set the continuous wave to 3.5 GHz and the power level to 0 dBm.

##### Step 2. Activate the AM Config Dialog window:

Press the **【Modulation】** key, rotate the knob clockwise (or counterclockwise) to select [Amplitude Modulation] in [Analog Modulation], or tap on [Amplitude Modulation] in [Analog Modulation] on the touch screen, and the AM Config Dialog window will pop up on the operation interface. Or select the **【Modulation On/Off】** button to open the modulation configuration window and switch to the AM Config Dialog window.

##### Step 3. Select path:

Select the [AM Config] option in the AM Config Dialog window, rotate the knob clockwise (or counterclockwise), press the knob to select Path 1; Or tap on the screen to select the "Path 1" for AM type.

##### Step 4. Set AM waveform:

Turn the knob clockwise (or counterclockwise) to select the waveform combo box, press the knob to activate the option, press the up and down keys to select the [Sinc] option; Or tap on the touch screen to select the [Sinc] option from the waveform combo box.

##### Step 5. Set AM type:

Select the [AM Config] option in the AM Config Dialog window, rotate the knob clockwise (or counterclockwise), press the knob to select or tap on the screen to select the "Linear" option for AM type.

##### Step 6. Set AM source:

Select the [AM Source] option in the AM Config Dialog window, rotate the knob clockwise (or counterclockwise) and press the knob to select the [Int] option of FM source; Or tap the [Int] option in [FM Source] on the touch screen.

##### Step 7. Set AM depth:

Select the [AM Depth] option in the AM Config Dialog window, rotate the knob clockwise (or counterclockwise), press the knob or tap on the screen to turn AM Depth "Off".

**Step 8. Set modulation rate:**

Select the [AM Config] option in the AM Config Dialog window, select Path 1, rotate the knob clockwise (or counterclockwise) to select the AM Rate input box, and press the knob to make the AM Rate input box in the edition status; Or tap the AM Rate input box on the touch screen to make the box in the edition status. Enter 0.001 MHz to end the input.

**Step 9. Set AM depth:**

Select the [AM Config] option in the Am Config Dialog window, select Path 1, rotate the knob clockwise (or counterclockwise) to select the AM Depth input box, and press the knob or tap the AM Depth input box on the touch screen to make the AM Depth input box in the edition status. Enter 30% to end the input.

**Step 10. RF On:**

Press **【RF On/Off】** or tap the [Amplitude] function zone on the touch screen, switch to RF On to output RF signals. At this time, the RF On/Off status is displayed as “RF ON”.

**Step 11. Enable AM:**

Select the [AM Config] option in the Am Config Dialog window, rotate the knob clockwise (or counterclockwise) to select the [AM On/Off] option, and press the knob or tap FM On/Off on the touch screen to enable AM. At this time, the modulation indication zone in the main info zone displays the **AM** indication, while the text info zone displays the AM component information in a list. This indicates that amplitude modulation has been enabled and the signal generator is outputting AM signals from the RF output connector.



Figure 3.22 Setting AM signals

**Description**

The amplitude modulation function has two signal output paths, channel 1 and path 2. Users can select channel 1, path 2 or both according to their own needs.

**2) Pulse Modulation**

The modulation pulses of 1435 series signal generators have the functions of Staggered, Jitter and

### 3.3 Basic Configurations

Sliding, and can generate complicated pulse modulated RF signals.

**For example: to generate a pulse modulated signal with the local oscillator frequency of 3.5GHz, the power of 0dBm, the pulse width of 50 $\mu$ s and the period of 1ms is generated.**

#### Operation Steps:

##### Step 1. Set RF output signals of the signal generator:

Set the continuous wave to 3.5 GHz and the power level to 0 dBm, and 【RF On/Off】 to On.

##### Step 2. Activate the Pulse Modu Config Dialog window:

Press the 【Modulation】 key or tap the [Pulse] function zone on the touch screen to pop up the Pulse Modu Config Dialog from the user interface.

##### Step 3. Set pulse source:

Turn the knob clockwise (or counterclockwise) to select the "Auto" option in the pulse source combo box, and press the knob to select the "Auto" option or tap the pulse source combo box on the touch screen to select the "Auto" option.

##### Step 4. Set pulse width:

Rotate the knob clockwise (or counterclockwise) to select the pulse width input box, and press the knob or tap the pulse width input box on the touch screen to make the box in the edition status. Enter 50MHz to end the input.

##### Step 5. Set period:

Rotate the knob clockwise (or counterclockwise) to select the period input box, and press the knob or tap the pulse width input box on the touch screen to make the box in the edition status. Input 1 ms to end the input.

##### Step 6. Enable pulse modulation:

Rotate the knob clockwise (or counterclockwise) to select the Pulse Modulation On/Off option, and press the knob or tap the pulse modulation on/off on the touch screen to turn on pulse modulation. Other options of the pulse configuration window are set by default.

At this time, the modulation indication zone in the main info zone displays the **PULSE** indication, while the text info zone displays the pulse modulation component information in a list.



Figure 3.23 Setting pulse modulation signals

### 3.3.3 Main Configuration Scenes

The function configuration modules of 1435 series signal generators correspond to their respective configuration windows for centralized management of relevant parameter information to facilitate users to set and edit parameters to realize specific functions. The function configuration windows include:

- [Frequency.....53](#)
- [Amplitude.....54](#)
- [Sweep.....55](#)
- [Modulation.....56](#)
- [Base.....58](#)
- [I/Q.....59](#)
- [Arbitrary Wave.....59](#)
- [Tone.....63](#)
- [AWGN.....64](#)
- [System.....65](#)

See “[Appendix D](#)” for shortcut keys of the function configuration window.

#### 3.3.3.1 Frequency

The Frequency window is used to set RF output frequency parameters, mainly including: continuous wave, frequency stepping, frequency offset, frequency reference and other parameters. In order to facilitate input, the CW input box is at the top of all controls in the Freq Config Dialog window, i.e. when the Freq Config Dialog window is opened for the first time, the CW input box is automatically in the edition status. Press the **【Frequency】** key or tap the [Frequency] function zone on the touch screen to pop up the Freq Config Dialog window from the user interface, as shown in Figures 3.24 and 3.25 below.

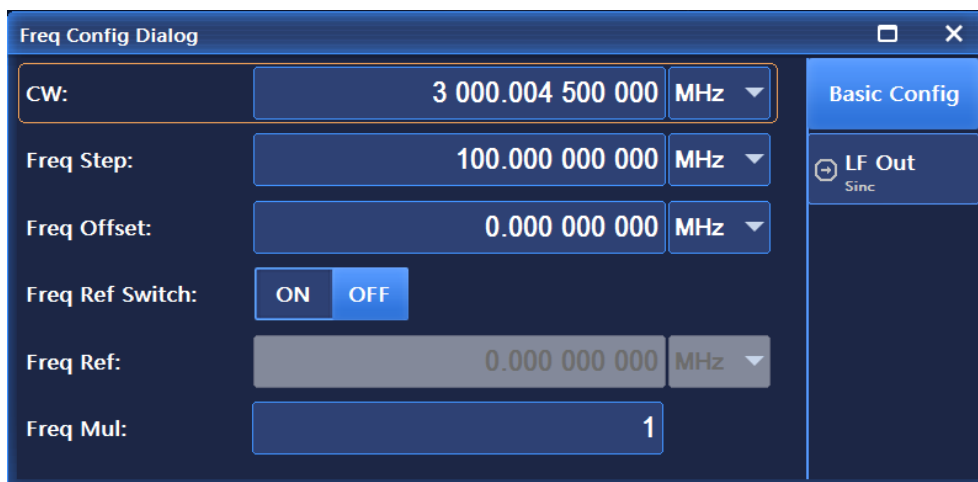

Figure 3.24 Freq Config Dialog window

### 3.3 Basic Configurations



Figure 3.25 Freq Config Dialog window (other settings)

According to the figures above, all frequency functions accept parameters in Hertz (Hz), and adopt the four frequency units (GHz, MHz, kHz or Hz) as the termination key, and the Enter key as the termination key to receive the currently displayed value and unit.

The parameters to be set for the frequency part include: continuous wave, relative frequency mode on/off, relative frequency reference, frequency offset, frequency multiplication coefficient, setting low frequency signal generator, phase reference, phase adjustment and other menus.

#### 3.3.3.2 Amplitude

The power configuration window of the signal generator is used to complete the settings of parameters relevant to the power characteristics of the signal generator. Press the **【Amplitude】** key or tap the [Amplitude] function zone on the touch screen, and the Amplitude Config Dialog window will pop up on the user interface, as shown in Figures 3.26 and 3.27; After the data input is completed, the corresponding unit needs to be confirmed to complete the input confirmation. The setting items in the amplitude window mainly include: power level, relative power type on/off, relative power reference setting, attenuation control, power bias, power stepping, ALC loop state on/off, search type manual/automatic, power search reference, power search execution, normal/minimum output during search, amplitude stabilization mode, ALC bandwidth manual/automatic, external detection coupling coefficient, output blanking on/off, etc.



Figure 3.26 Amplitude Config Dialog window



## 3.3 Basic Configurations

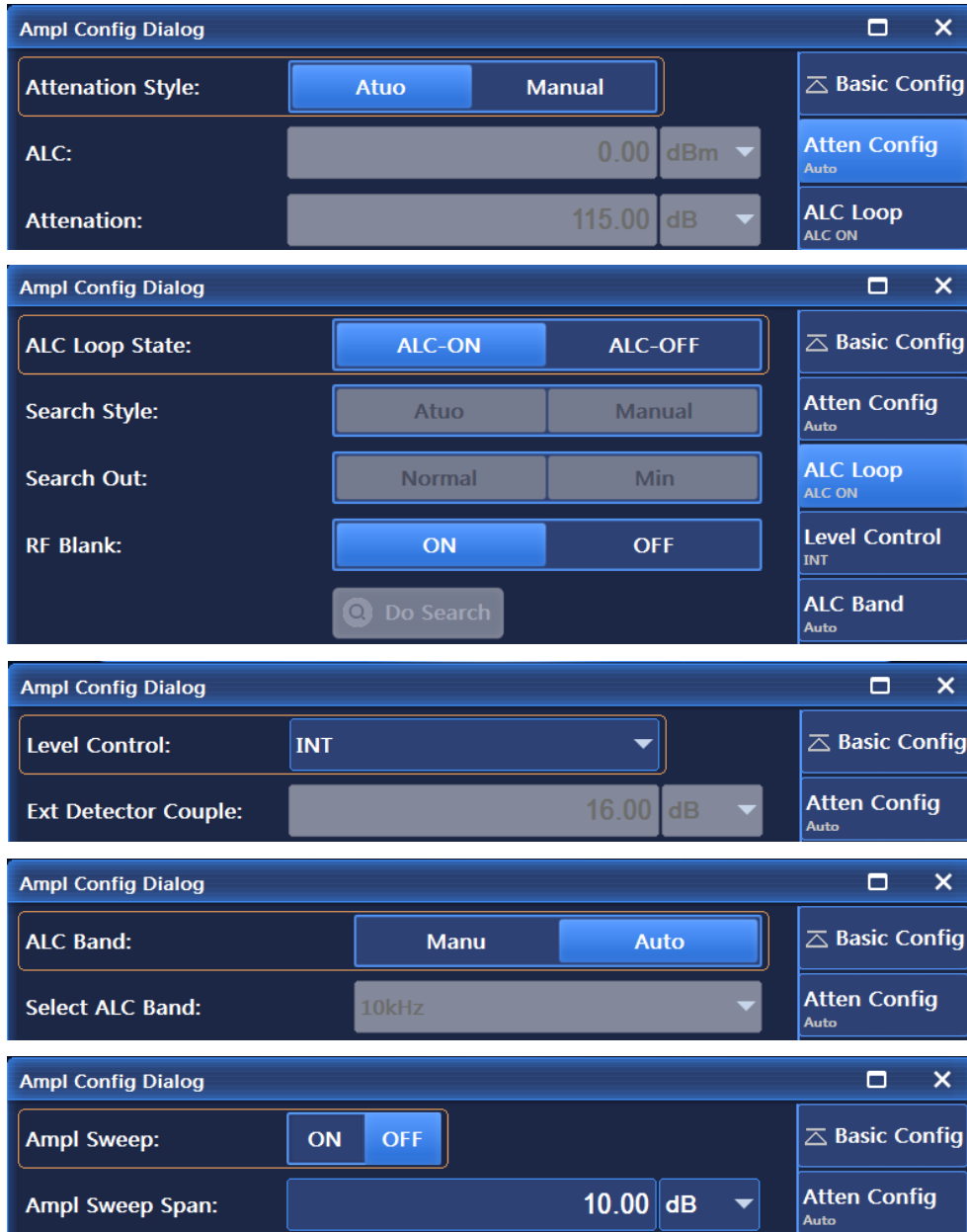

Figure 3.27 Amplitude Config Dialog window (other settings)

## 3.3.3.3 Sweep

This model of signal generator has two sweep modes: step and list. Press the **[Sweep]** key on the front panel or tap the [Sweep] function zone to, and the Sweep Config Dialog window will pop up as shown in Figure 3.28. When "Step Sweep" or "List Sweep" is selected as the frequency generation mode, tap the corresponding option at the top of the window to pop up the Step/List Sweep Config Dialog window as shown in Figures 3.29 and 3.30. Users can edit and set sweep parameters such as start frequency, stop frequency, step counts and step dwell, etc.

The sweep-related configurations include menus such as frequency generation mode, detailed configuration of step sweep, detailed configuration of list sweep, sweep type [Single/Continuous], and Trig Single Sweep, etc.

3.3 Basic Configurations

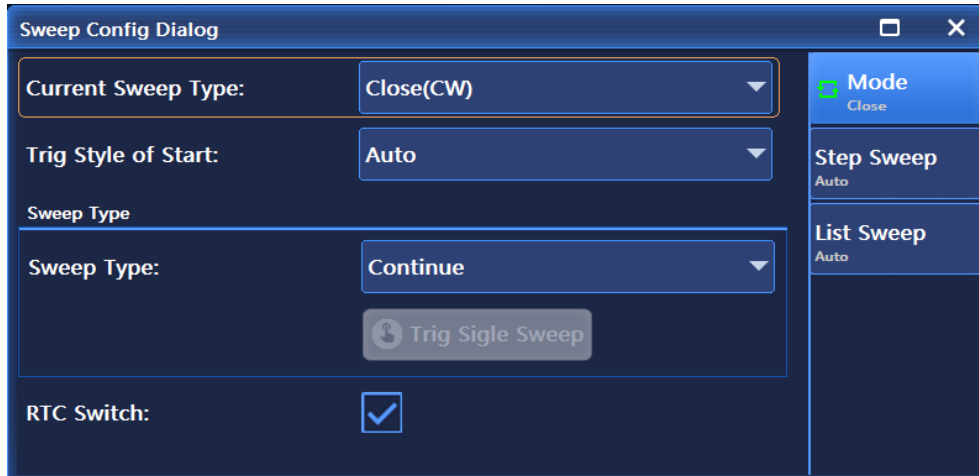

Figure 3.28 Sweep Config Dialog window

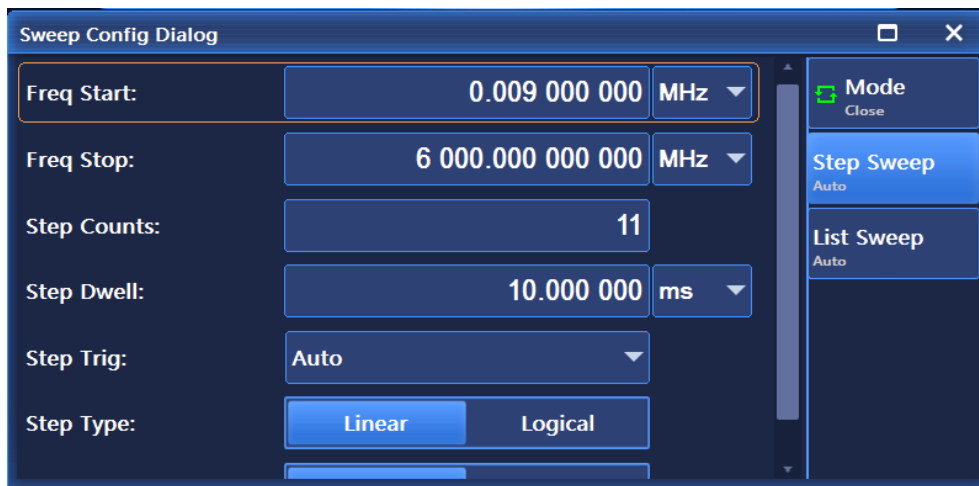

Figure 3.29 Step Sweep Config Dialog window

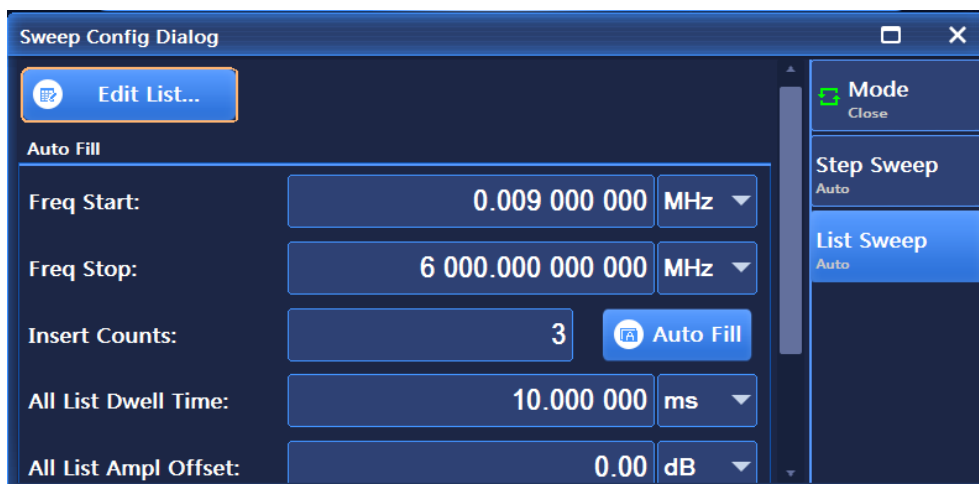

Figure 3.30 List Sweep Config Dialog window

3.3.3.4. Analog Modulation and Pulse Modulation

The signal generator can realize basic analog modulation, including amplitude modulation, frequency modulation and phase modulation. In addition, the signal generator can also realize pulse modulation, and internal or external signals can be selected for modulation through the digital/analog

### 3.3 Basic Configurations

switch on the internal modulation signal generator. Press the **【Modulation】** key on the front panel, rotate the knob clockwise (or counterclockwise) to select [Amplitude Modulation], [Frequency Modulation], [Phase Modulation] options in [Analog Modulation], and [Pulse Modulation] in [Pulse], or tap [Amplitude Modulation], [Frequency Modulation], [Phase Modulation] in the [Analog Modulation] function zone or the [Pulse] function zone on the touch screen to pop up windows for amplitude modulation, frequency modulation, phase modulation, and pulse modulation, respectively, as shown in Figures 3.31, 3.32, 3.33, and 3.34. The standard internal waveforms provided include sine, double sine, sweep sine, triangular, zigzag, square and noise. The Pulse Modu Dialog window mainly include the following configuration items: Pulse Modulation On/Off, Source, Width, Period, PRF, Delay and Input Direction [On/Off], etc.

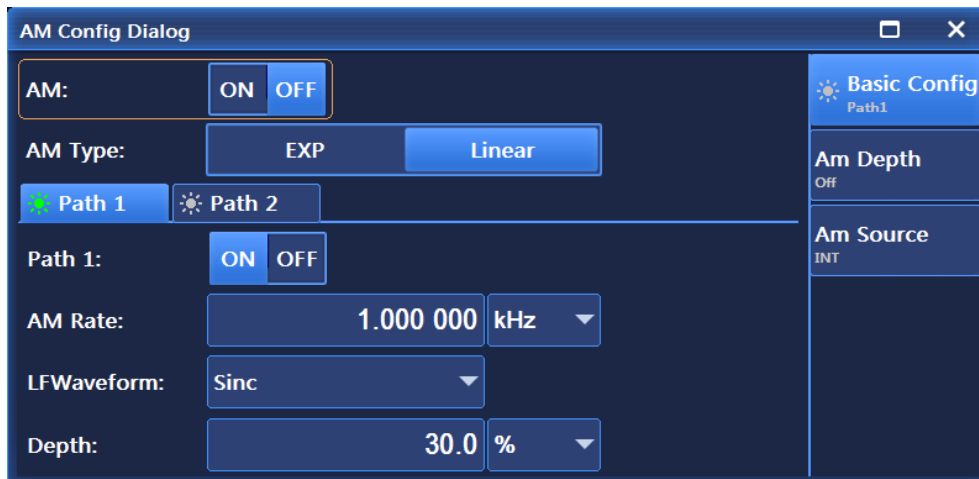

Figure 3.31 Ampl Config Dialog window



Figure 3.32 Freq Config Dialog window

### 3.3 Basic Configurations

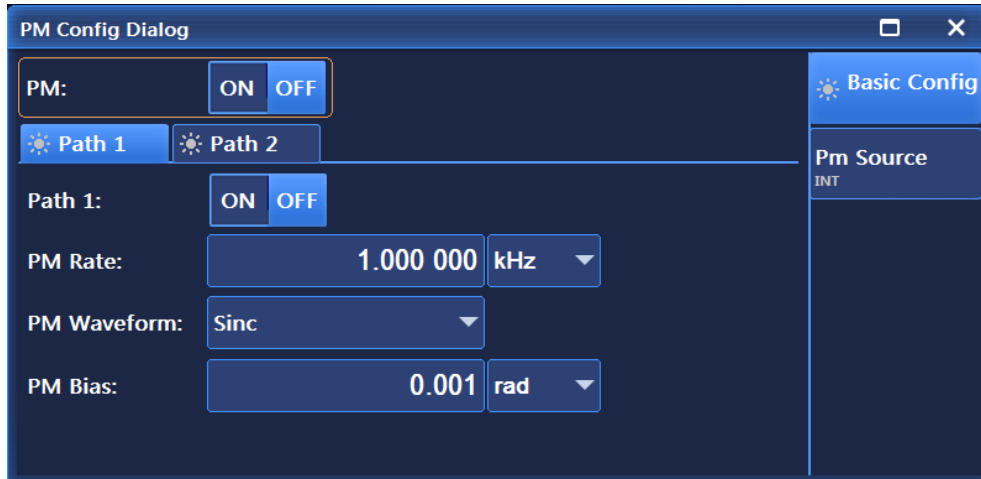

Figure 3.33 PM Config Dialog window



Figure 3.34 Pulse Modu Config Dialog window

#### 3.3.3.5 Baseband

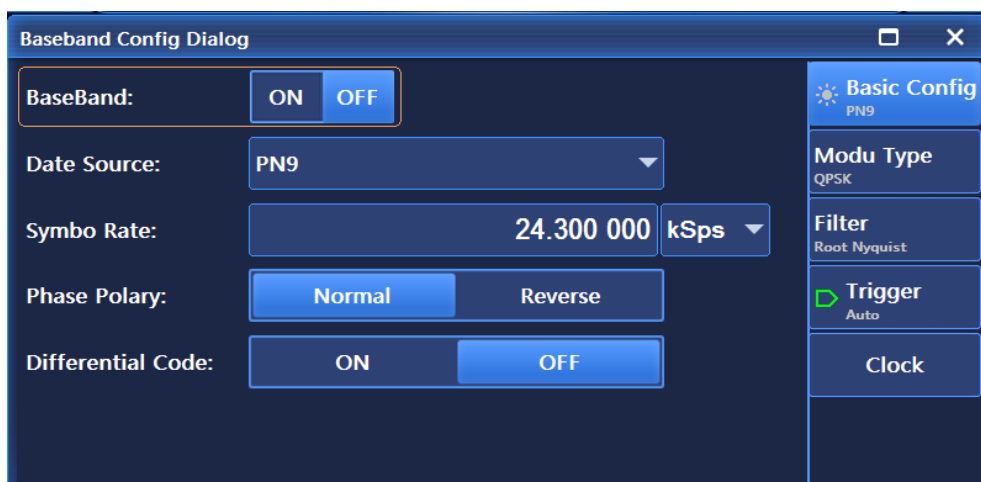

Figure 3.35 Baseband Config Dialog window

The signal generators offer real-time output of baseband signals. Press the **【Modulation】** key to select the "Baseband" function on the front panel or tap the [Base] function area on the touch screen to pop up in the configuration window shown in Figure 3.35). Customized real-time baseband can generate

### 3.3 Basic Configurations

single carriers for modulation of real-time data, and can control all parameters of digital modulated signals in real time. By applying various data patterns, filters, code rates, modulation types and burst shapes, the characteristics of the generated vector modulation signals can be changed. The data sources and modulation types supported by the baseband are shown in Figure 3.36 and Figure 3.37 respectively. The real-time baseband menu (Base) mainly includes the following options: Baseband On/Off, Data Source, Symbol Rate, Module Type, Filter Factor and Filter Selection, etc..

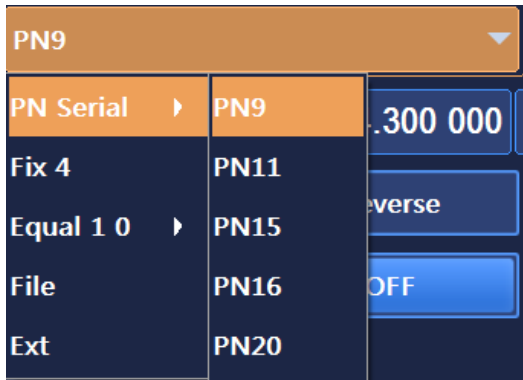

Figure 3.36 Data Source List

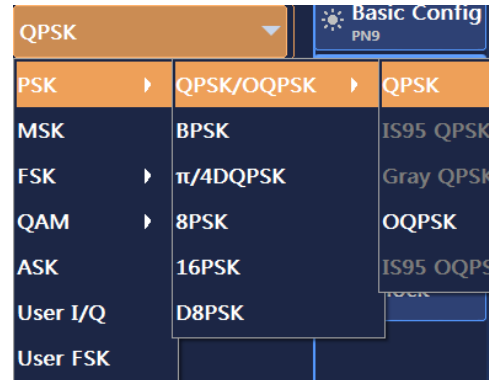

Figure 3.37 Modulation Type List

#### 3.3.3.6 I/Q Modulation

1435 series signal generators can realize I/Q modulation. Press the **[I/Q]** key or tap the [I/Q] function zone on the touch screen to pop up the configuration window as shown in Figure 3.38; Users can select internal and external 50Ω data sources, select external broadband input, and set conditioning channel parameters to meet their requirements. Please refer to "5.2.6 I/Q" in section "5.2 Menu Description" for specific parameter settings.

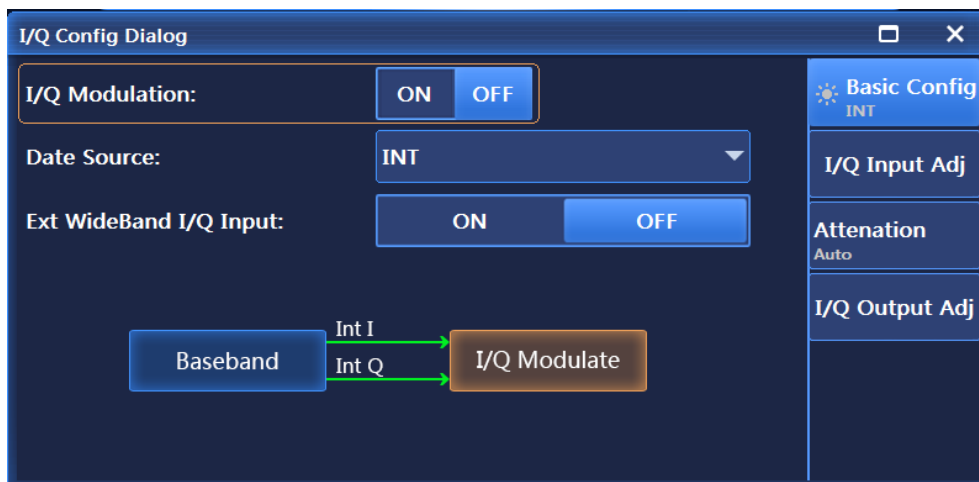

Figure 3.38 I/Q setting interface

#### 3.3.3.7 Arbitrary Wave

1435 series signal generators have such functions as sequence and arbitrary wave playback. Tap [Signal] on the touch screen, and select the "Arb" function, and the configuration window shown in Figure 3.39 will pop up. The arbitrary wave function has two modes of operation, sequence mode and arbitrary wave mode. In the sequence mode, users can generate waveform segment files according to their needs, and can randomly combine waveform segments into sequences for playback; In the arbitrary wave mode, users can load arbitrary wave data files in a custom format for playback. The features like baseband, arbitrary wave, double (multiple) tone and AWGN (white noise function) in the signal generator are mutually exclusive. If any one is turned on, other functions will be automatically turned off. These functions will automatically turn on the IQ Modulation on/off. The main functions are described as follows:

### 3.3 Basic Configurations

- Two modes of operation, sequence mode and arbitrary wave mode, are provided.
- Support for user-defined playback of arbitrary wave data files. Support for custom sample rate playback of the following five arbitrary wave file formats: Mat-File 5, ASCII, Binary, cap and csv.
- Support for user-defined playback of arbitrary wave mark files.
- Flexible sequence edition and playback modes. Waveform segments of any modulation format and different sampling rates can be added to the sequence, List-style edition is adopted to flexibly change the playing order and the number of repetitions.
- The sequence supports three variable sampling rate playback modes, "constant", "highest" and "custom", to meet the testing needs of users Note that the variable sampling rate playback described herein is realized by automatic interpolation of the software, and the hardware adopts fixed sampling rate for playback.
- Support for the storage and calling of edited sequences, achieving quick configuration of parameters.
- Support for the edition and playback of flexible graphical marks.
- Support for waveform segment generation function of user-defined modulation formats.
- Sequence mode providing rich triggering modes and triggering source configurations.
- Providing external sampling clock input for synchronization with the clock of the tested object.

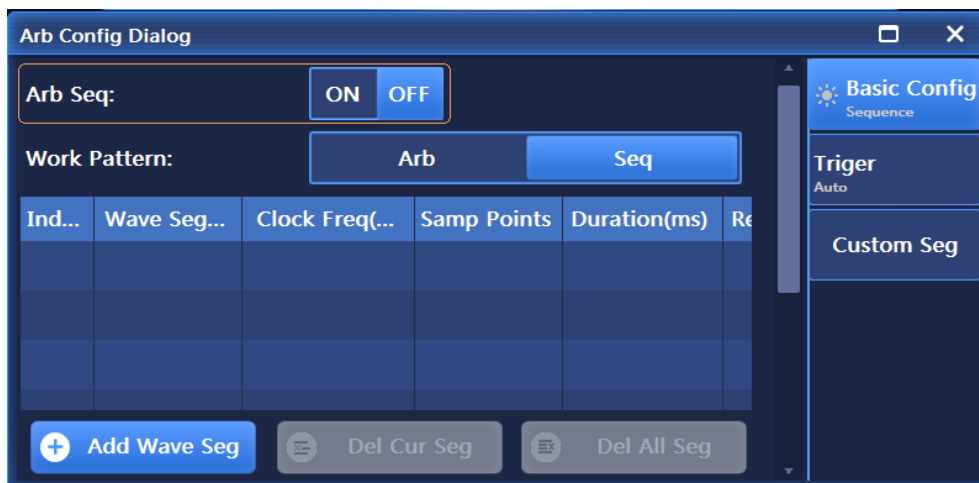

Figure 3.39 Seq Config Dialog window

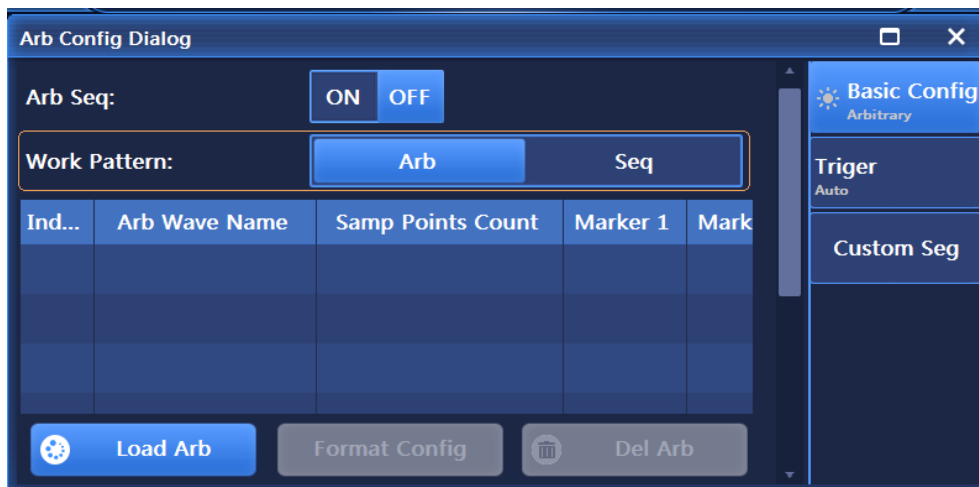

Figure 3.40 Arb Config Dialog window

### 3.3 Basic Configurations

The signal generator supports playback of a sequence of multiple waveform segments. Users can select the option of "Custom Seq" in the Arb Config Dialog window to pop up the custom waveform segment window (as shown in Figure 3.41). After setting the parameters, the waveform segment file (.seq) is generated. After the generation is completed, the waveform segment is added to the sequence list for playback. Users can customize the playback sequence, repetition times, markers, playback clock type, etc.

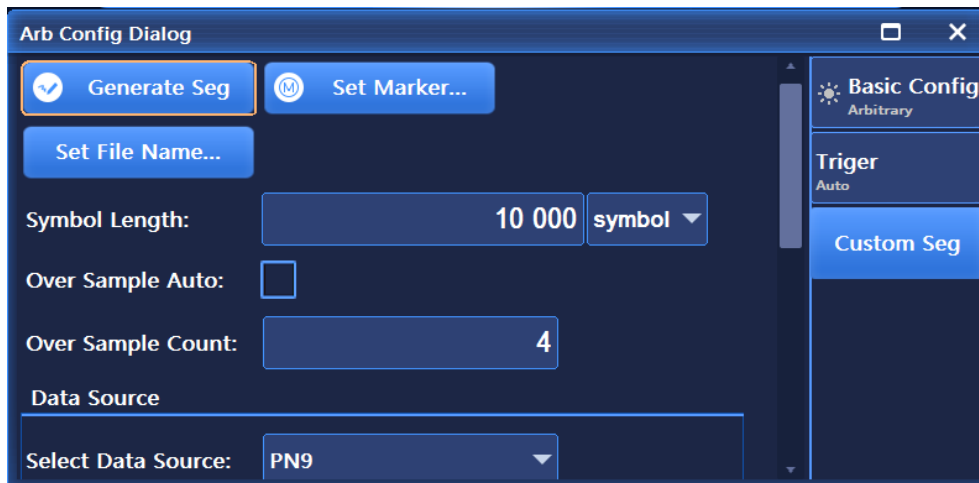

Figure 3.41 Custom Seg window

Users can set markers (markers 1 to 4, as shown in Figure 3.42) for the waveform segments to monitor the playback of the waveform segments. Where, Marker 1, Marker 2, Marker 3 and Marker 4 are output through BNC on the rear panel of the instrument.



Figure 3.42 Schematic diagram of waveform segment marker edition

The signal generator supports user-defined playback of arbitrary wave data files. At present, the signal generator supports the conversion among the following 5 file formats: Mat-File 5, ASCII, Binary, cap and csv. The signal generator can convert data files in the above five formats into waveform data files. seg (16-bit data) and marker files .mrk for playing. The 5 file formats are as follows:

#### ➤ Mat-File 5 file format

Files in the format of Mat-File 5 must be used for storing I/Q data as well as Marker data with the suffix of .mat. The data in mat file is stored in blocks in the form of data matrix.

The format requirements when users generate mat files are as follows:

1) Data content requirements: mat files must store I/Q data (i.e. I data matrix and Q data matrix or I+jQ data matrices (complex matrices, with the real part being I data and imaginary part being Q data)),

### 3.3 Basic Configurations

and can store Marker data matrices.

2) Data type requirements: the data types of I and Q data matrices support double type (8 bytes), int16 type (2 bytes) and int32 type (4 bytes). I data matrix and Q data matrices must be of the same type. The type of marker data matrices is INT8 type (1 byte, four upper bits reserved by system, and four lower bits representing Marker1, Marker2, Marker3 and Marker4 in sequence).

3) Data range requirements: integer int16 and int32 are DA values, with the value range of  $\pm(2^{15}/31)-1$ ; Double is the absolute voltage value and the voltage storage unit is  $\mu\text{V}$ . The value range is related to the unit selection of voltage. When the data unit is V, the value range is  $\pm(2^{63}-1)/1000000$ . When the data unit is mV, the value range is  $\pm(2^{63}-1)/1000$ . And when the data unit is  $\mu\text{V}$ , the value range is  $(2^{63}-1)$ .

4) Size requirements for data matrices: the size of the I data matrix and the Q data matrix must be consistent, and the size of the Markers data matrix must also be consistent.

5) Naming requirements for data matrices: in a mat file, the name of a data matrix must be less than 64 bytes.

#### ➤ ASCII (Text) File Format

Files in ASCII (text) format must be used to store I/Q data and can be used to store Markers data, with the suffix of .txt. The data in a txt file is stored in rows with spaces between the data.

The format requirements for users to generate ASCII (text) files are as follows:

1) Data content requirements: Each row in an ASCII file must be used to store I data, Q data matrices and can be used to store Markers data. Format "I Data Q Data Marker1 Marker2 Marker3 Marker4", with spaces between the data. For example, "1025 502 1 0 0 1", where I data is 1025, Q data is 502, Mark1 is 1, Mark2 is 0, Mark3 is 0, and Mark4 is 1. When the format "I data Q data" is the default Mark data, Mark is automatically set to 0.

2) Data type requirements: the data types of I and Q data matrices in ASCII files support the float type (4 bytes), int16 type (2 bytes), integer int32 type (4 bytes), and double type (8 bytes); the types of I data and Q data must be consistent; The Markers data type is char ('0' means low, '1' means high).

3) Data range requirements: int16 and int32 are DA values, and the value range is set to  $\pm(2^{15}/31)-1$ ; float and double types are absolute voltage values and the voltage storage unit is  $\mu\text{V}$ . The value range is related to the unit selection of voltage. When the data unit is V, the value range is  $(2^{63}-1)/1000000$ . When the data unit is mV, the value range is  $(2^{63}-1)/1000$ . When the data unit is  $\mu\text{V}$ , the value range is  $(2^{63}-1)$ .

#### ➤ Binary file formats

Any wave data file in binary format with the suffix .bin or .dat. Where .dat is a file format in which the spectrum analyzer 4051 of the 41st Research Institute of CETC stores the collected I/Q data. The header information of arbitrary wave data file with the suffix of .dat is the file header information starting with 176 bytes, which stores the statistical information of the corresponding I/Q data.

The format requirements for bin binary files generated by users are as follows:

1) Data content requirements: binary files store I data and Q data, with I/Q data stored alternately (DA value).

2) Data type requirements: the data types of I and Q data in binary files support integer type (2 bytes), with each I and Q data taking up 2 bytes (16 bits), i.e. each sampling point takes up 4 x 4 bytes.

3) Data range requirement:  $\pm(2^{15}-1)$

The format requirements for .dat binary file generated by users are as follows:

1) Data content requirements: .dat binary file store I data and Q data, with I/Q data stored alternately, and the first 176 bytes in the file are header statistics (non-data part).

2) Data type requirements: the data types of I and Q data in .dat binary files support integer type (2 bytes), with each I and Q data taking up 2 bytes (16 bits), i.e. each sampling point takes up 4 x 4



bytes.

3) Data range requirement:  $\pm (2^{15}-1)$ .

➤ **CAP file format**

CAP format is a file format for storing the collected I/Q data in spectrum analyzers of Keysight Company. It stores I/Q data in an alternate manner in the file (DA values), with a suffix of .cap. The first 512 bytes of the CAP file are header information, which stores statistical information of corresponding I/Q data.

➤ **CSV file format**

CSV format is a file format for storing the collected I/Q data in spectrum analyzers of Keysight Company. It stores I/Q data with a suffix of .cap. The data in a csv files is stored in rows. Each row of data is divided into I data column, Q data column, Mark1 data column, Mark2 data column, Mark3 data column and Mark4 data column. The header information is composed of 13 rows of data.

The format requirements for CSV files generated by users are as follows:

1) Data content requirements: the first 13 rows in a CSV file are header information, and the data content starts from the 14th row. Each row of data stores I data and Q data, and can store Mark data. Format: "I data |Q data | Marker1|Marker2|Marker3|Marker4", where, "|" means column division. For example, "1025|502|1|0|0|1", where I data is 1025, Q data is 502, Mark1 is 1, Mark2 is 0, Mark3 is 0, and Mark4 is 1. When the format "I data |Q data" is the default Mark data, Mark is automatically set to 0.

2) Data type requirements: the data types of I and Q data matrices in CSV files support float type (4 bytes), int16 type (2 bytes), integer int32 type (4 bytes), and double type (8 bytes). The types of I and Q data must be consistent. The Markers data type is char('0' means low, '1' means high).

3) Data range requirements: int16 and int32 are DA values, and the value range is set to  $\pm(2^{15}/31)-1$ ; float and double types are absolute voltage values and the voltage storage unit is  $\mu\text{V}$ . The value range is related to the unit selection of voltage. When the data unit is V, the value range is  $(2^{63}-1)/1000000$ . When the data unit is mV, the value range is  $(2^{63}-1)/1000$ . When the data unit is  $\mu\text{V}$ , the value range is  $(2^{63}-1)$ .

Please refer to "5.2.7 Arbitrary Wave" in section "5.2 Menu Description" for specific setting parameters.

### 3.3.3.8 Tone

The 1435 series signal generators offer dual/multi-tone modulation functions. Tap on the [Tone] function zone and select the [Multi tone] or [Dual tone] options respectively to pop up the configuration window shown in Figure 3.43 or Figure 3.44. The features like baseband, arbitrary wave, double (multiple) tone and AWGN (white noise function) in the signal generator are mutually exclusive. If any one is turned on, other functions will be automatically turned off. These functions will automatically turn on the IQ Modulation on/off. Please refer to "5.2.8 Tone" in section "5.2 Menu Description" for specific parameter settings.

### 3.3 Basic Configurations

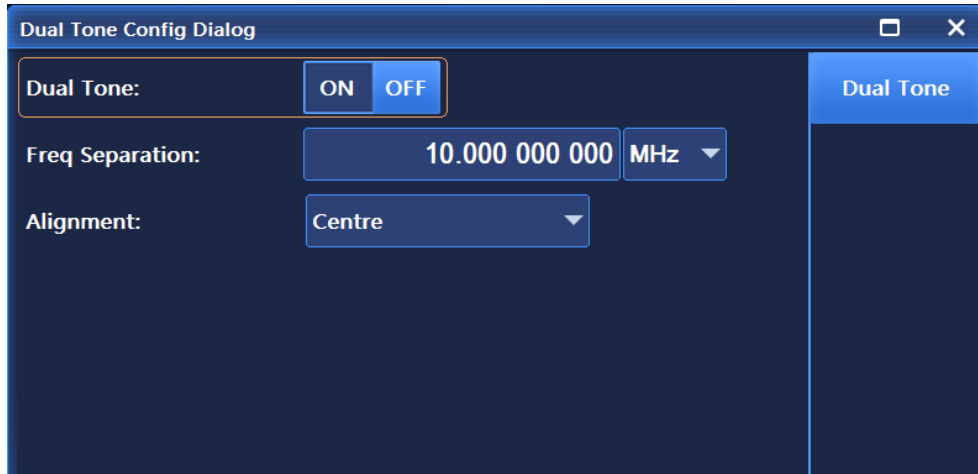

Figure 3.43 Dual Config Dialog window

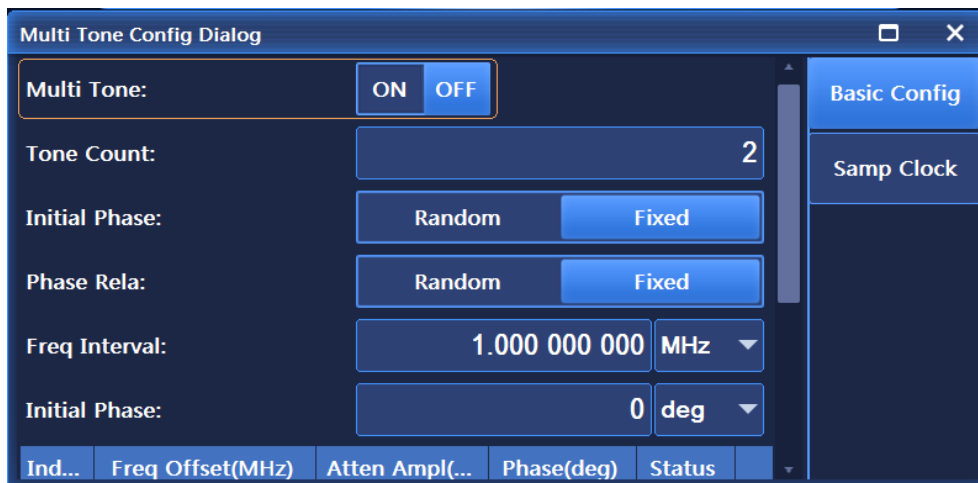

Figure 3.44 Multi Config Dialog window

#### 3.3.3.9 AWGN

The AWGN module is suitable for the arbitrary wave mode and the real-time I/Q baseband mode. As an option of 1435, AWGN module is an independent functional module with three working modes: Add Noise, Pure Noise and CW Interferer.

- Add Noise. This mode is used with the functions of real-time baseband, arbitrary wave, dual/multi-tone, etc. The generated baseband signals, arbitrary wave signals and dual/multi-tone signals are output after controllable noise addition. This addition noise mode is valid only when functions of real-time baseband, arbitrary wave and dual/multi-tone are on.
- CW Interferer This mode can be used with the functions of real-time baseband, arbitrary wave, double/multi-tone, etc. the generated baseband signals, arbitrary wave signals and dual/multi-tone signals are output after continuous wave interference. At this time, the interference signal is a sine signal with certain frequency. This noise mode is valid only when functions of real-time baseband, arbitrary wave and dual/multi-tone are on..
- Pure Noise This mode generates white noise signals and is mutually exclusive with functions like real-time baseband, arbitrary wave, and dual/multi-tone, etc. This operation mode is valid only when real-time baseband, arbitrary wave and dual/multi-tone are off. This mode is the default state for startup. The functions of baseband, arbitrary wave, double (multiple) tone and AWGN (pure noise function) in the signal generator are mutually exclusive. If any one is turned on, other functions will be automatically turned off. These functions will automatically turn on the IQ Modulation on/off.

Please refer to "5.2.9 AWGN" in section "5.2 Menu Description" for specific parameter settings.

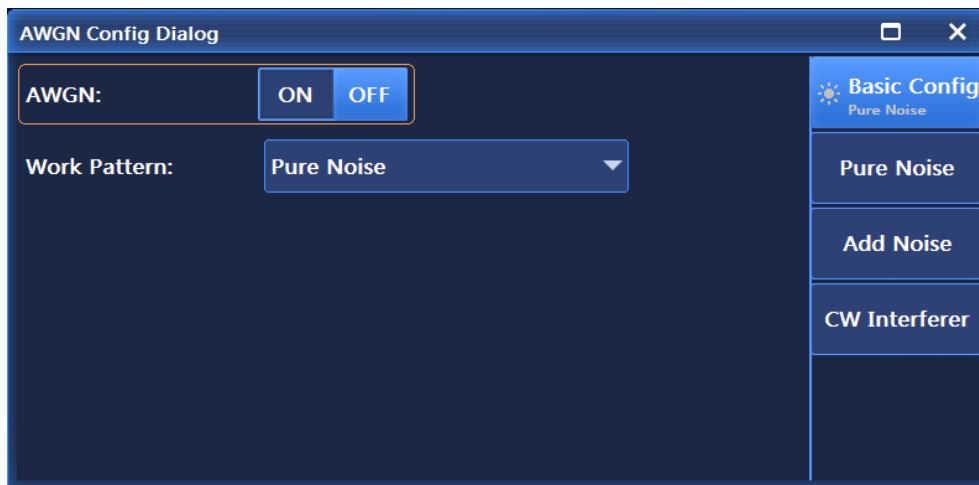

Figure 3.45 AWGN Config Dialog window

### 3.3.3.10 System

The System Config window is used for configuration of the basic functions of the instrument. Press the **【System】** key on the front panel or tap the [System] function zone on the touch screen to pop up the System Config Dialog window (Figure 3.46). The window includes menus of Base Config, GPIB Port, LAN Port, Instrument Self Test and Manual Test, etc.

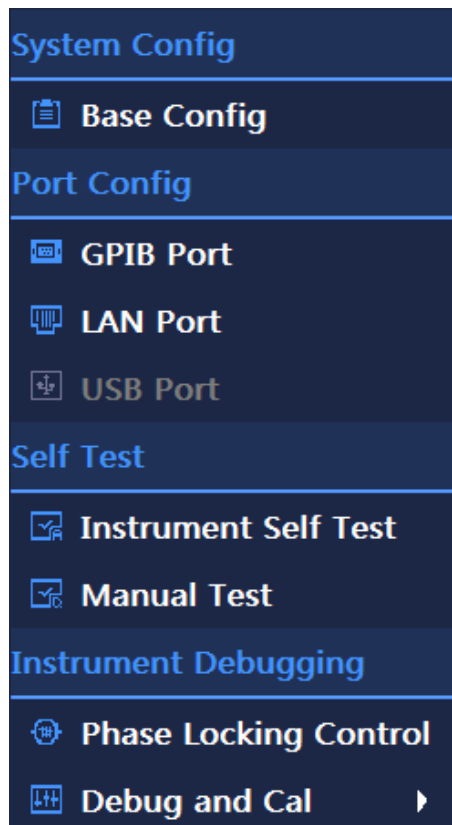

Figure 3.46 System Config Dialog window

## 3.4 Data Management

This section introduces the working state saving/loading, file management, and methods for

**3.4 Data Management**

printing/storing screenshot for 1435 series signal generators.

- [Storage/Loading Working Status.....66](#)
- [File Management.....67](#)
- [Printing/Saving Screenshots.....70](#)

**3.4.1 Storage/Loading Working Status**

- [Resetting Instrument Status.....66](#)
- [Storage/Loading User Status.....66](#)

**3.4.1.1 Resetting Instrument Status**

The 1435 series signal generators provides the user with the option of resetting state upon power-on (manufacturer, user and last state) as the initial state during power-on configuration. Usually, when there is an error in the instrument configuration, the initial state of the instrumentation during normal operation is restored by resetting the instrument state. The reset state of the signal generator is set as follows:

**Step 1. Activate the System Config Dialog window:**

Press the **【System】** key or tap the [System] function zone on the touch screen, and the System Config Dialog window will pop up on the operation interface, where you can select Reset as shown in Figure 3.47;

**Step 2. Resetting reset options.**

Rotate the RPG clockwise (or counterclockwise), select the Reset combo box, press the knob to activate the option, press the up and down keys or tap on the touch screen to switch among "Factory" | "User" | "Last state" to select the status when the signal generator is reset.

- Select "Factory": press the **【Reset】** key or restart the instrument, and the instrument will enter the default state of the manufacturer upon startup;
- Select "User" and tap the "Save User State" button: The instrument automatically saves the current configuration, press the **【Reset】** key or restart the instrument, the instrument will be initialized to the state saved by the user last time upon startup;
- Select "Last State": press the **【Reset】** key, or restart the instrument, the instrument will enter the state automatically stored upon last shutdown upon startup.

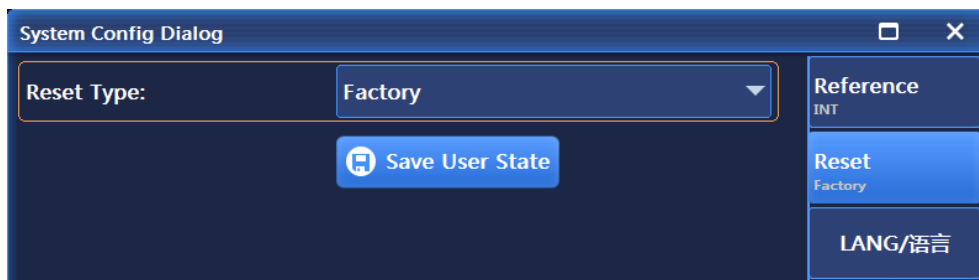

Figure 3.47 Setting reset state

**3.4.1.2 Storage/Loading User Status**

1435 series signal generators provide the function of storing and calling the instrument setting state, which is convenient for users to restore the saved setting state, reduce the complexity of operation, and observe, evaluate and store the required measurement data again. Please refer to "5.2.6 Storage/Loading" in section "5.2 Menu Description" for specific parameter settings.

**Step 1. Open the Save/Call configuration window:**

Press the **【File】** key to pop up the file operation in the user interface, as shown in Figure 3.48.

**Step 2. Set number of file to be saved/loaded:**

Rotate the RPG clockwise (or counterclockwise), or tap on the touch screen to select the input box of "Select No. of File to be Saved/Loaded" and press the knob to make the input box in the edition state. Enter a number within the range of 0-99, and press Enter on the front panel to end the input. After storage, wait for several seconds till it is completed; after calling, wait for more than ten seconds so that the signal generator can complete the software and hardware settings again according to the selected instrument state.

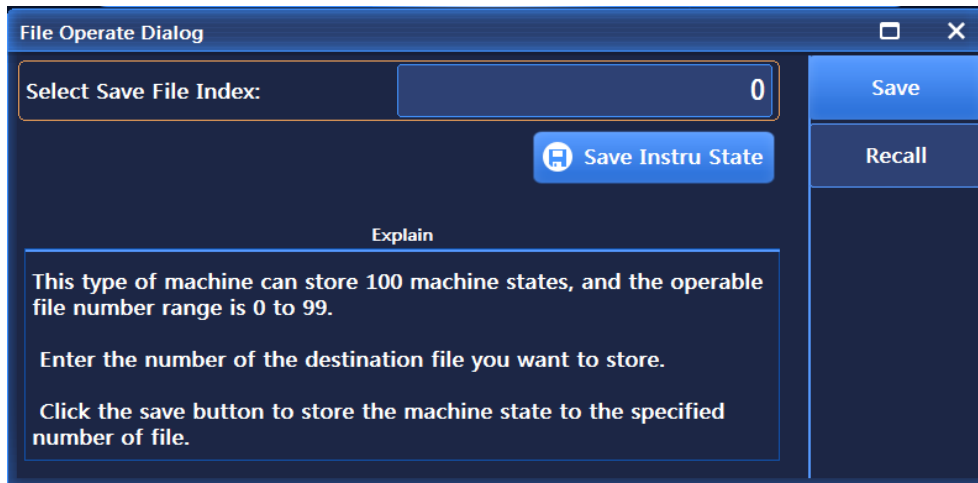

Figure 3.48(a) File operation window

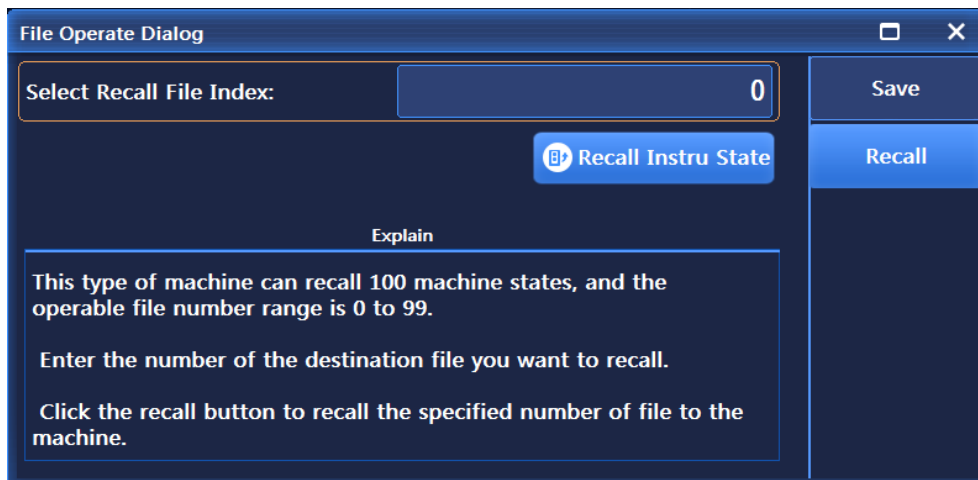

Figure 3.48(b) File operation window

**Tip****Max. number of statuses of instruments stored / loaded**

The max. number for 1435 series signal generator to save/call instrument states is 100, and the state file number range is from 0 ~ 99.

**3.4.2 File Management**

The 1435 series signal generator has the file management function, providing such operations as file input/output, file browsing, and copying, cutting, pasting and deletion of directory (file). Data files can

### 3.4 Data Management

be accessed through front panel keys, touch screen, mouse or remote control (refer to the Program Control Manual of 1435 Series Signal Generators for details).

- [User Data File Types.....68](#)
- [File Input/Output Methods.....69](#)
- [File Format Description.....69](#)

#### 3.4.2.1 User Data File Types

The types of user data files related to file management are shown in Table 3.8.

Table 3.8 Data file type list

Data file type	Data description	Default directory and suffix of file
User instrument status	Stores the instrument state data saved by the user (instrument operation state parameters such as frequency, amplitude, sweep and modulation, etc.). It is automatically stored in a fixed directory upon user reset, last state reset, and storing instrument state.	D:\1435data\user\urset.dat
User list sweep	Stores user-configured list sweep data (e.g. frequency, power, dwell time, etc. of list points). It is automatically stored in a fixed directory upon user reset, last state reset, and storing instrument state.	D:\1435data\user\ulist.dat
User pulse train	Stores pulse train data set by the user, including pulse number, pulse width, and period, etc. It is automatically stored in a fixed directory upon user reset, last state reset, and storing instrument state.	D:\1435data\user\pulsetrain.dat
User-defined data source	User-defined data source when storing real-time baseband. The instrument provides a window for editing this data. Users can customize the file name and directory for storage.	D:\1435data\user\DataSrc*.src
User FSK data	Stores user-defined FSK modulation mapping data. Users can customize the file name and directory for storage.	D:\1435data\user\Fsk*.fsk
User FIR data	Stores user-defined FIR filter coefficients. Users can customize the file name and directory for storage.	D:\1435data\user\Fir*.fir
User waveform segment data	Stores user-defined waveform segment data. Users can customize the file name and directory for storage.	D:\1435data\user\Wav*.seg
User sequence configuration data	Stores the currently edited sequence list data. Number of waveform segments in the sequence, number of repetitions, marking switch, etc. Users can customize the file name and directory for storage.	D:\1435data\user\Sequence*.config_seg
User marker data	Stores the marker data of the waveform segments edited by users. Markers 1 to 4 are stored in one file. Users can customize the file name and directory for storage.	D:\1435data\user\Mark*.mrk

**Warning****Do not move/delete/rename factory data files**

No factory data files in the directory D:\1435data\sys\ can be moved, deleted or renamed. Otherwise, the manufacturer will not be responsible for the serious consequences caused by wrong output of the instrument. If the user deletes any such data by mistake, it can only be fixed through system recovery or returned to the manufacturer for recalibration.

All user data files in the directory D:\1435data\user\ can be operated by users, but please be careful because the data saved by users will not be recovered once being deleted by mistake.

**3.4.2.2 File Input/Output Methods**

The 1435 series of signal generator provide data file input/output functions. File input refers to opening the selected data file, refreshing the display information of control (list, etc.) parameters, and facilitating user observation and evaluation. File output refers to storing the configuration data into the file according to the agreed format (e.g. ASCII, \*.dat). The signal generator provides input/output of debugging information file. Users only need to enter the corresponding menu to pop up the dialog box, and select the corresponding keys or menu items realize file operations.

The 1435 series signal generator has the function of debugging the whole instrument. This part is not open to users and is just to facilitate the manufacturer to maintain the functionality of the instrument. Important debugging data includes: power flatness data, IQ modulation calibration data and reference frequency response calibration data. In order to facilitate observation, relevant information files can be loaded to display parameter component information in the form of lists, and these debugging information data can also be stored in default files.

**3.4.2.3 File Format Description**

The following describes the file formats stored by the signal generator to facilitate users to analyze the configuration data. The file formats stored in the signal generator are divided into two types: direct storage and additional file header information storage.

**1) Direct storage**

When such files are stored, the configuration result data structure is directly stored in the files (\*.dat), such as whole instrument debugging information, etc. Such files are not readable after being opened directly and are not used as a reference analysis method for users. They are generally recovered to controls for viewing through the file input/output function.

**2) Additional file header information storage**

According to the design requirements, some files need additional file headers. A file header occupies 256Byte and stores the associated parameter information. For example, for arbitrary waveform segment data files, relevant parameter information including symbol length, sampling clock, manufacturer identification, etc. is stored according to the agreed format, and the waveform data is stored subsequently. The user files related to the additional header information are as follows (Table 3.9):

Table 3.9 Storage Formats of Additional File Header Files

Waveform segment files (.seg)	
File header composition	Description
Company name (Byte0 ~ Byte3)	EI41.
Reserved (Byte4~ Byte7)	

**3.4 Data Management**

Sampling rate (Byte8 ~ Byte15)	INT64 type. Sampling rate = symbol rate x number of oversampling points.
Symbol length (Byte16 ~ Byte23)	INT64 type. Number of symbols saving the current waveform segments.
number of oversampling points (Byte24 ~ Byte31).	INT64 type. Interpolation points in variable sampling rate playback
Period (Byte32 ~ Byte40)	INT64 type. Playback period of the waveform segment. Period = symbol length x symbol rate.
Waveform length (Byte41 ~ Byte47)	INT64 type. Namely the number of sampling points. Waveform length = symbol length x number of oversampling points.
Reserved for extension (Byte48 ~ Byte255)	
Waveform segment data (Byte256~...)	I and Q data are stored in alternation, each taking 16 Bit.
<b>Marker files (.mkr)</b>	
<b>File header composition</b>	<b>Description</b>
Company name (Byte0 ~ Byte3)	EI41.
Reserved (Byte4~ Byte7)	
Number of sampling points (Byte8 ~ Byte15)	INT64 type. Number of sampling points.
Period (Byte16 ~ Byte23).	Reserved.
Reserved for extension (Byte48 ~ Byte255)	
Marker data (Byte256~ ...)	Stores data corresponding to four markers (mark1, mark2, mark3, mark4) to indicate the high and low levels of the markers at the corresponding sampling points (0 means low level, and 1 means high level). Each sampling point contains four marker data, with each sampling point occupying one byte.
<b>User Data Source Files (.src)</b>	
<b>File header composition</b>	<b>Description</b>
Company name (Byte0 ~ Byte3)	EI41.
Reserved (Byte4~ Byte7)	
Data length (Byte8 ~ Byte15)	INT64 type.
Reserved for extension (Byte48 ~ Byte255)	
Data source data (Byte256~...)	Stores sequences of 0 and 1, wherein each 0 or 1 occupies one data bit and one byte contains eight data.

**3.4.3 Printing/Saving Screenshots**

The 1435 series signal generators provide such functions as storing snapshots to graphics files (bmp or jpg) and printing screenshots.

- [Save Screen \(to File\).....71](#)
- [Print Screen.....71](#)



**3.4.3.1 Saving Screen (to File)****Operation Steps:**

Step 1: If the signal generator is not connected to a printer, press the **【Print】** button on the front panel to pop up the "Save As" dialog box, enter the name of the snapshot image file (\*.bmp), and click Save to complete saving the screenshot to file.

**3.4.3.2 Print screen**

---

**Tip****Installing Printer Driver**

Supporting printer driver needs to be installed for 1435 series signal generator before it can print.

---

**Tip****Saving screenshots to clipboard**

Press the Save Screenshot button on the front panel to save the screenshot to the clipboard, which will be emptied after the printing/storage is completed.

---



## 4 Operation Guide

This chapter introduces the operation methods of different configuration functions and details the configuration steps of the 1435 series signal generators.

- [Basic Operation Guide.....73](#)
- [Advanced Operation Guide.....80](#)

### 4.1 Basic Operation Guide

This part introduces the operation methods of basic configuration functions of the 1435 series signal generators, including modulation, sweep, etc. The configuration steps are detailed as follows with examples.

- [Digital Modulation.....73](#)
- [Analog modulation.....74](#)
- [Sweep.....78](#)

#### 4.1 1 Digital Modulation

The 1435 series signal generators allow for real-time output of digital modulation signals.

**Example: TO generate real-time baseband signals with PN9 as the data source, QPSK as the modulation format and 4Msps as the symbol rate.**

##### Operation Steps:

##### Step 1. Activate the baseband configuration window:

Press the **【Modulation】** key to select the "baseband" function or tap the [Base] function zone on the touch screen, and the baseband configuration window will pop up in the operation interface (Figure 4.1).

##### Step 2. Select data source:

Select the [Base Config] option in the Baseband Config Dialog window, rotate the RPG clockwise (or counterclockwise) to move the focus to the data source selection combo box, and click the knob to display the data source options; Or select the data source from the data source combo box on the touch screen to be selected. The data source options include: [PN Serial], [Fix 4], [Equal 1 0] and [File]. Select [PN9] in [PN Serial].

##### Step 3. Select modulation type:

Select the [Modulation Type] option in the baseband configuration window to display the currently selected modulation type, select the modulation type of "QPSK", or tap on the screen to select the [PSK] option of [Modulation Type Selection]-> then select the [QPSK/OQPSK] option in [PSK], and finally select the [QPSK] option in [QPSK/OQPSK].

##### Step 4. Set symbol rate:

Select the [Base Config] option in the Baseband Config Dialog window, rotate the RPG clockwise (or counterclockwise) to select the symbol rate input box, press the knob, or select the [Symbol Rate] on the touch screen to make the symbol rate input box in the edition status; Or touch the screen to select the symbol rate input box to make it in the edition state. Input 4 Msps to end the input.

##### Step 5. Select the filter type:

Select the [Filter] option in the Baseband Config Dialog window, rotate the RPG clockwise (or counterclockwise) to move the focus to the filter selection combo box, press the knob to select "Root Nyquist"; Or touch the screen to select [Filter Select] in the [Filter] option to display the filter options, and select [Root Nyquist].

##### Step 6. Enable baseband:

**4.1 Basic Operation Guide**

After configuring the baseband parameters, select the [Baseband] option in the Baseband Config Dialog window, rotate the RPG on the front panel clockwise (or counterclockwise), select the Base switch and press the knob to enable the baseband; Or touch the screen to select [Base On/Off] to enable baseband output. At this time, corresponding indication will be shown in the modulation indication zone of the main information display zone **IQ** **BASE**.

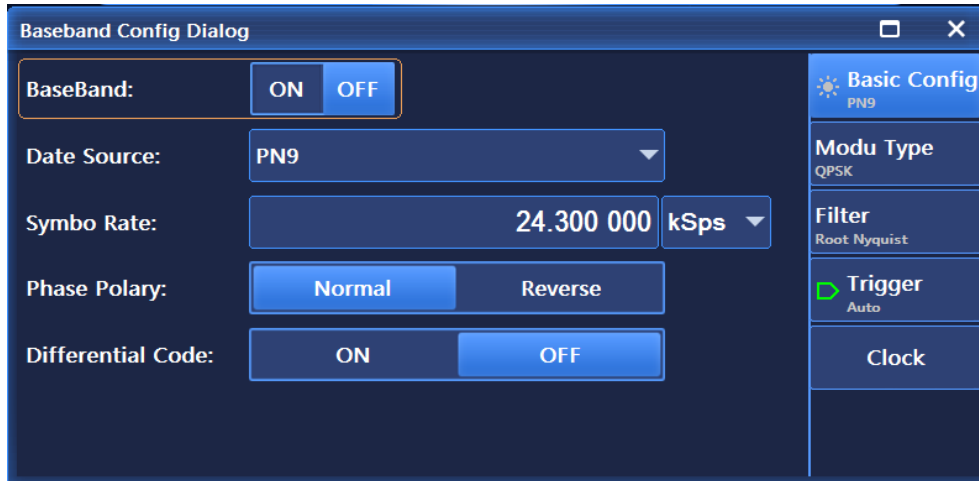

Figure 4.1 Baseband Config Dialog window

**Tip**

**Fix 4 and Filters**

If the data source is selected as “Fix 4”, it is required to input the code pattern data, ranging from 0000 (binary) to 1111 (binary), which is displayed and inputted in decimal in the configuration window, ranging from 0 to 15.

When the modulation type is selected as FSK (2FSK, 4FSK, 8FSK, 16FSK) or MSK, to get better output, the filter type should be selected as “Gauss”.

**4.1.2 Analog Modulation and Pulse Modulation**

- [Amplitude Modulation.....74](#)
- [Frequency Modulation.....74](#)
- [Phase Modulation.....76](#)
- [Pulse Modulation.....77](#)

**4.1.2.1 Amplitude Modulation**

For details, please refer to section "3.3.2.2 Modulation Signals" chapter in part "3 Quick Start".

**4.1.2.2 Frequency Modulation**

*For example, to generate an FM signal with the local oscillator frequency of 3.5GHz, power of 0dBm, modulation rate of 0.001MHz and FM frequency offset of 1MHz at path 1.*

**Operation Steps:**

**Step 1. Set RF output signals of the signal generator:**

Set the continuous wave to 3.5 GHz and the power level to 0 dBm, and **【RF On/Off】** to On.

**Step 2. Activate the FM Config Dialog window:**

#### 4.1 Basic Operation Guide

Press the **【Modulation】** key, rotate the knob clockwise (or counterclockwise) to select [Frequency Modulation] in [Analog Modulation], or tap on the [FM ] function zone in the [Analog Modulation] function zone, and the FM Config Dialog window will pop up on the operation interface (Figure 4.2). Or select the [MOD On/Off] button to open the modulation configuration window and switch to the FM Config Dialog window.

##### Step 3. Select path:

Select the [Base Config] option in the Frequency Modulation window, rotate the knob clockwise (or counterclockwise), press the knob to select Path 1; Or tap on the screen to select the "Path 1" for FM type.

##### Step 4. Set FM waveform:

Turn the knob clockwise (or counterclockwise) to select the FM Waveform combo box, press the knob to activate the option, press the up and down buttons to select the [Sinc] option; Or select the FM Waveform combo box on the touch screen and select the [Sinc] option.

##### Step 5. Set FM source:

Select the [FM Source] option in the FM Config Dialog window, rotate the knob clockwise (or counterclockwise) and press the knob to select the [Int] option of FM source; Or tap the [Int] option in [FM Source] on the touch screen.

##### Step 6. Set modulation rate:

Select the [Base Config] option in the FM Config Dialog window, select Path 1, rotate the knob clockwise (or counterclockwise) to select the FM Rate input box, and press the knob to make the FM Rate input box in the edition status; Or tap the FM Rate input box on the touch screen to make the box in the edition status. Enter 0.001MHz to end the input.

##### Step 7. Set FM frequency offset:

Select the [[Base Config] option in the FM Config Dialog window, select Path 1, rotate the knob clockwise (or counterclockwise) to select the FM Offset input box, and press the knob to make the box in the edition status. Enter 1MHz to end the input.

##### Step 8. RF On:

Press **【RF On/Off】** . At this time, the RF On/Off status is displayed as "RF ON".

##### Step 9. Enable FM:

Select the [Base Config] option in the FM Config Dialog window, rotate the knob clockwise (or counterclockwise) to select the [FM On/Off] option, and press the knob to enable FM; or tap FM On/Off on the touch screen to enable FM.

At this time, there is an indication **FM** in the modulation indication zone of the main information display zone, indicating that frequency modulation has been enabled and the signal generator is outputting FM signals from the RF output connector.

## 4.1 Basic Operation Guide



Figure 4.2 Setting FM signals

### Description

The frequency modulation function has two signal output paths, path 1 and path 2. Users can select path 1, path 2 or both according to their own needs.

#### 4.1.2.3 Phase Modulation

**For example: to generate an FM signal with the local oscillator frequency of 3.5GHz, power of 0dBm, modulation rate of 0.001MHz and PM frequency offset of 1MHz at path 1.**

##### Operation Steps:

##### Step 1. Set RF output signals of the signal generator:

Set the continuous wave to 3.5 GHz and the power level to 0 dBm, and 【RF On/Off】 to On.

##### Step 2. Activate the PM Config Dialog window:

Press the 【Modulation】 key, rotate the knob clockwise (or counterclockwise) to select [Phase Modulation] in [Analog Modulation], or tap on [Phase Modulation] in the [Analog Modulation] function zone, and the PM Config Dialog window will pop up on the operation interface (Figure 4.3). Or select the [MOD On/Off] button to open the modulation configuration window and switch to the PM Config Dialog window.

##### Step 3. Select path:

Select the [Base Config] option in the PM Config Dialog window, rotate the knob clockwise (or counterclockwise), press the knob to select Path 1; Or tap on the screen to select the "Path 1" option for PM type.

##### Step 4. Set PM waveform:

Turn the knob clockwise (or counterclockwise) to select the PM Waveform combo box, press the knob to activate the option, press the up and down buttons to select the [Sinc] option; Or select the PM Waveform combo box on the touch screen and select the [Sinc] option.

##### Step 5. Set PM source:

## 4.1 Basic Operation Guide

Select the [PM Source] option in the PM Config Dialog window, rotate the knob clockwise (or counterclockwise) and press the knob to select the [Int] option of PM source; Or tap the [Int] option in [PM Source] on the touch screen.

**Step 6. Set modulation rate:**

Select the [Base Config] option in the PM Config Dialog window, select Path 1, rotate the knob clockwise (or counterclockwise) to select the PM Rate input box, and press the knob to make the PM Rate input box in the edition status; Or tap the PM Rate input box on the touch screen to make the box in the edition status. Enter 0.001MHz to end the input.

**Step 7. Set PM frequency offset:**

Select the [Base Config] option in the PM Config Dialog window, select Path 1, rotate the knob clockwise (or counterclockwise) to select the PM Rate input box, and press the knob to make the PM Rate input box in the edition status; Or tap the PM Rate input box on the touch screen to make the box in the edition status. Enter 1, with the default unit rad, and press Enter on the front panel to end the input.

**Step 8. RF On.**

Press **[RF On/Off]** or tap the [RF On/Off] function zone on the touch screen to turn on the RF. At this time, the RF On/Off status is displayed as "RF ON".

**Step 9. Enable PM:**

Select the [Base Config] option in the PM Config Dialog window, rotate the knob clockwise (or counterclockwise) to select the [PM On/Off] option, and press the knob to enable FM; or tap PM On/Off on the touch screen to enable PM.



Figure 4.3 Setting PM signals

## Description

The phase modulation function has two signal output paths, path 1 and path 2. Users can select path 1, path 2 or both according to their own needs.

### 4.1.2.4 Pulse Modulation

For details, please refer to section "3.3.2.2 Modulation Signals" chapter in part "3 Quick Start".

4.1 Basic Operation Guide

**Tip**

**Mutually exclusion of modulations**

Amplitude modulation, frequency modulation, phase modulation and low frequency output are mutually exclusive, and only one signal can be output at a time.

FM and PM repel each other and only one signal can be output at a time.

When analog modulation is enabled, in addition to displaying the associated modulation type indication in the main info zone, the signal flow chart indication description is synchronously displayed in the instrument status configuration area.

**4.1.3 Sweep**

The sweep function is one of many important functions of signal generators. 1435 series signal generators mainly provide two sweep modes: step and list. the configuration and implementation methods of step sweep and list sweep modes are described in detail below.

- [Step Sweep.....78](#)
- [List Sweep.....79](#)

**4.1.3.1 Step Sweep**

*For example: to output a step sweep signal, with the start frequency of 1GHz, stop frequency of 10GHz, number of step points of 10, step dwell time of 10ms, step trigger mode of "Auto" and step type of "linear".*

**Operation Steps:**

**Step 1. Activate the sweep configuration window:**

Press the **[Sweep]** key or tap the [Sweep] function zone on the touch screen, and the Sweep Config Dialog window will pop up on the operation interface (Figure 4.4).

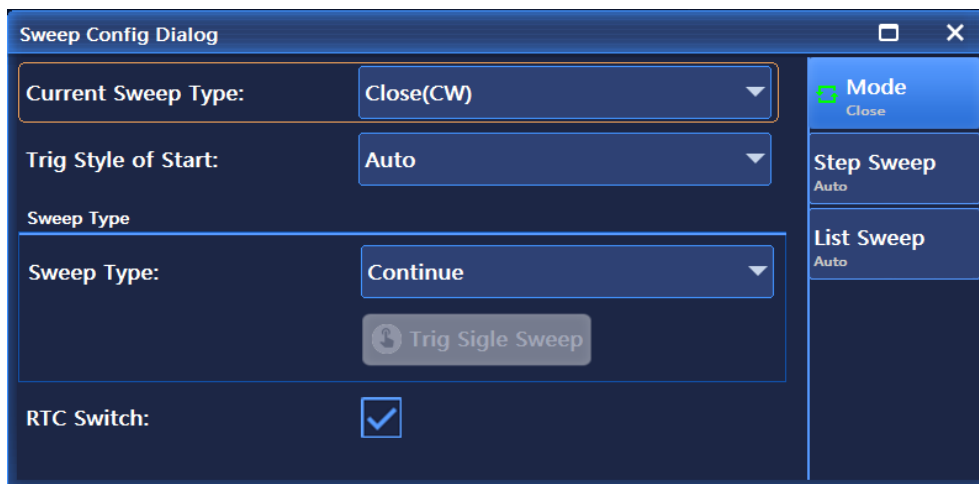

Figure 4.4 Sweep Config Dialog window

**Figure 2 Activate the step sweep configuration window:**

- **Select [Step Sweep].**

Select the [Mode] option in the Sweep Config Dialog window, rotate the knob clockwise (or counterclockwise) to select the [Current Sweep Type] option, press the knob, and rotate the knob clockwise (or counterclockwise) to select the [Step Sweep] option to enable the step sweep mode; or tap [Step Sweep] in the [Current Sweep Type] option on to touch screen to enable the Step Sweep mode. At



## 4.1 Basic Operation Guide

this time, the instrument will automatically perform step sweep with the current configuration parameters.

### Step 3. Configure step sweep parameters

Select [Step Sweep] in the Sweep Config Dialog window, as shown in Figure 4.5. In the step sweep configuration window, set Freq Start to 1GHz, Freq Stop to 10GHz, Step Counts to 10, Step Dwell to 10ms, Step Trig to "Auto" and Step Type to "Linear".

Upon completion, press the **X** key or press the key or press the [Return] key continuously to close the current window.



Figure 4.5 Step sweep configuration window

### Step 4. Instrument state display:

After step sweep is activated, parameters like Freq Start, Freq Stop will be displayed in the main info zone of the operation interface.

#### 4.1.3.2 List Sweep

**For example: to output a list sweep signal, with 10 list sweep points, 1GHz for the first list point and 2GHz for the second list point, and so on, the power offset of 0.00dBm for each list point, the Dwell time of 10ms, the list trigger mode of "Auto" and the sweep direction of "Forward".**

#### Operation Steps:

##### Step 1. Activate the sweep configuration window:

Press the **[Sweep]** key or tap the [Sweep] function zone on the touch screen, and the power configuration window will pop up on the operation interface, as shown in Figure 4.4;

##### Step 2. Activate the list sweep configuration window:

###### ➤ Select [List Sweep].

Select the [Mode] option in the Sweep Config Dialog window, rotate the knob clockwise (or counterclockwise) to select the [Current Sweep Type] option, press the knob, and rotate the knob clockwise (or counterclockwise) to select the [List Sweep] option to enable the list sweep mode; or tap [List Sweep] in the [Current Sweep Type] option on to touch screen to enable the List Sweep mode. At this time, the instrument will automatically perform list sweep with the current configuration parameters.

##### Step 3. Configure list sweep parameters:

Select the [List Sweep] option in the Sweep Config Dialog window, as shown in Figure 4.6. There are two options in the list sweep configuration window.

##### Method 1: Manually inserting list points.

**4.2 Advanced Operation Guide**

Rotate the knob clockwise (or counterclockwise) to select the [Edit List...] option, press the knob and select “Insert”, then rotate the knob clockwise (or counterclockwise) to select the parameter to be set, making it in the edition status; or tap the parameter to be set in the [Edit List...] option on the touch screen to make it in the edition status. List sweep parameters include: current frequency CW rate, offset and dwell time. Continuously insert frequency points till the sweep list edition is completed.

**Method 2: Auto filling.**

Turn the knob clockwise (or counterclockwise) to select the Freq Start input box, press the knob to make it in the edition status, and input 1 GHz; similarly, set the Freq Stop to 10GHz and the Insert Counts to 10, rotate the knob clockwise (or counterclockwise) to select the [Auto Fill] option, and press the knob to apply automatic filling of the sweep list; or tap on the touch screen to select the Freq Start input box and make it in the edition status, then set the Freq Stop to 10GHz and the Insert Counts to 10 in the same manner, and tap [Auto Fill] on the touch screen.

Set All List Ampl Offset to 0dBm, All List Dwell Time to 10 ms, List Trig to Auto and Sweep Direction to Forward.

After auto filling, it is also allowed to manually edit the parameters in the edition list.

Upon completion, press the  key or press the key or press the **【Return】** key continuously to close the current window.



Figure 4.6 List sweep configuration window

**Step 4. Instrument state display:**

After list sweep is activated, parameters of List Sweep like Min. Freq, Max. Freq will be displayed in the main info zone of the operation interface.

**4.2 Advanced Operation Guide**

This section introduces the configuration processes of the 1435 series signal generators which are relatively complicated.

- [Configuring Multi Tone.....81](#)
- [Configuring Arbitrary Wave.....82](#)
- [Selecting ALC Bandwidth.....88](#)
- [External Amplitude Stabilization of the Signal Generator.....88](#)
- [Impact of Working in the Mixer Mode/Reverse Power.....89](#)
- [Creating and Applying User Flatness Calibration Arrays.....90](#)
- [Pulse Modulation Input Selection.....92](#)

- [Baseband Triggering Function Configuration.....96](#)
- [Arbitrary Wave Triggering Function Configuration..... 99](#)

### 4.2.1 Configuring Multi Tone

The signal generators has such functions as dual-tone and multi-tone signal output.

**For example: to generate a multi-tone signal with 6 tones, frequency interval of 10MHz and 0dB attenuation for each tone**

#### Operation Steps:

##### Step 1. Activate the Dual/Multi Tone Config Dialog window:

Tap the [Multi Tone] option in the [Tone] function zone, and the multi-tone configuration window will pop up in the operation interface (Figure 4.7).

##### Step 2. Set tone count:

Select the [Base Config] option in the Multi Config Dialog window, rotate the knob clockwise (or counterclockwise) to select the “Tone Count” input box, and press the knob or tap the “Tone Count” input box on the touch screen to make the box in the edition status. Input 6, press the Enter key on the front panel to end the input, thus 6 tones are automatically added to the multi tone list.

##### Step 3. Set Freq Interval

Select the [Base Config] option in the Multi Config Dialog window, rotate the knob clockwise (or counterclockwise) to select the “Freq Interval” input box, and press the knob or tap the “Freq Interval” input box on the touch screen to make the box in the edition status. Enter 10, and press Enter on the front panel to end the input. Then the frequency offset is automatically changed in the multi tone list. At present, the multi-tone setting range is (2 ~ 64) and the frequency interval cannot exceed 80MHz.

##### Step 4. Enable Multi Tone:

After configuring multi tone parameters, rotate the RPG of the front panel clockwise (or counterclockwise) to select the Multi Tone On/Off option, and press the knob or tap the Multi Tone On/Off option on the touch screen to enable multi tone. At this time, corresponding indication **IQ** **M-T** will be shown in the modulation indication zone of the main information display zone.

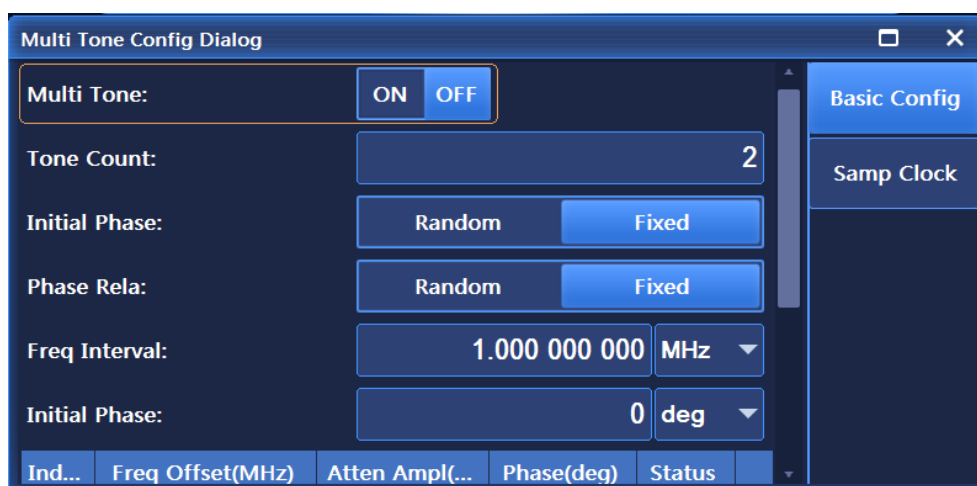

Figure 4.7 Dual/Multi Tone configuration window

## 4.2 Advanced Operation Guide

### Tip

#### Attenuation powers and phases in multi tone list

An attenuation power in the multi tone list refers to the attenuation value of a tone power. Different attenuation values can be set for each tone, ranging from -100 dB to 0 dB. At present, the measurable attenuation value measured of the hardware system is -40dB.

A phase refers to the initial phase value of each tone, which can be to be random or fixed.

### Tip

#### Mutual exclusion of dual tone and multi tone

Multi tone modulation and dual tone modulation are mutually exclusive. When the user turns on one modulation, the other is automatically turned off.

### 4.2.2 Configuring Arbitrary Wave

The arbitrary wave function has two modes of operation, sequence mode and arbitrary wave mode. 1435 series signal generators can realize such functions as sequence and arbitrary wave playback.

In the sequence mode, users can generate waveform segment files according to their needs, and can randomly combine waveform segments into sequences for playback; In the arbitrary wave mode, users can load arbitrary wave data files in a custom format for playback.

**Example 1: to generate a waveform segment file example.seg, with the data source of PN9, modulation format of QPSK, sample counts of 40000, and sample clock of 4MHz, and markers set for the beginning and end of the waveform segment file.**

#### Operation Steps:

##### Step 1. Activate the arbitrary wave configuration window:

Tap [Signal] on the touch screen, and select the "Arb" function, and the arbitrary wave sequence configuration window will pop up on the operation interface (Figure 4.8).

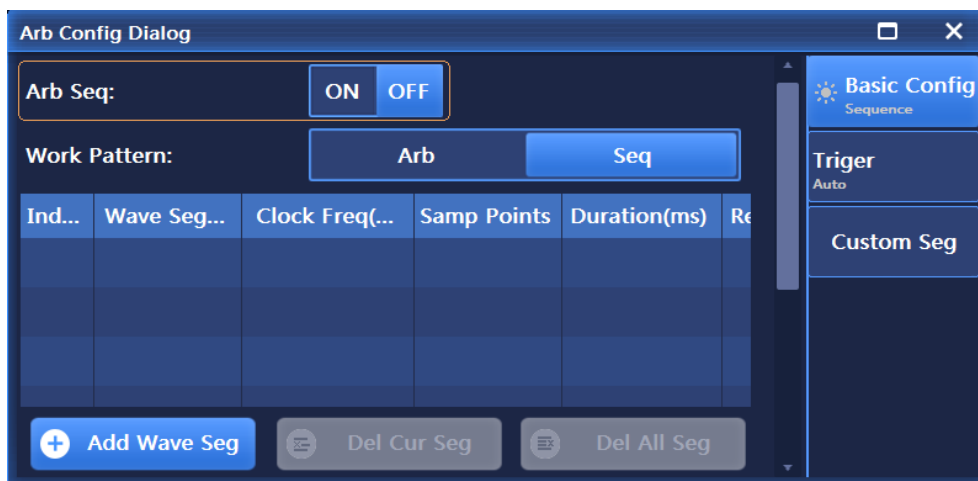

Figure 4.8 Arbitrary wave sequence configuration window

##### Step 2. Work pattern selection:

## 4.2 Advanced Operation Guide

Rotate the RPG clockwise (or counterclockwise) to move the focus to the "Work Pattern" combo box, and press the knob to select "Seq"; Or tap the "Work Pattern" option on the touch screen to set the work pattern to sequence.

**Step 3 Customize waveform segment:**

Select the "Custom Seq" button to pop up the "Custom Seg" window (Figure 4.9).

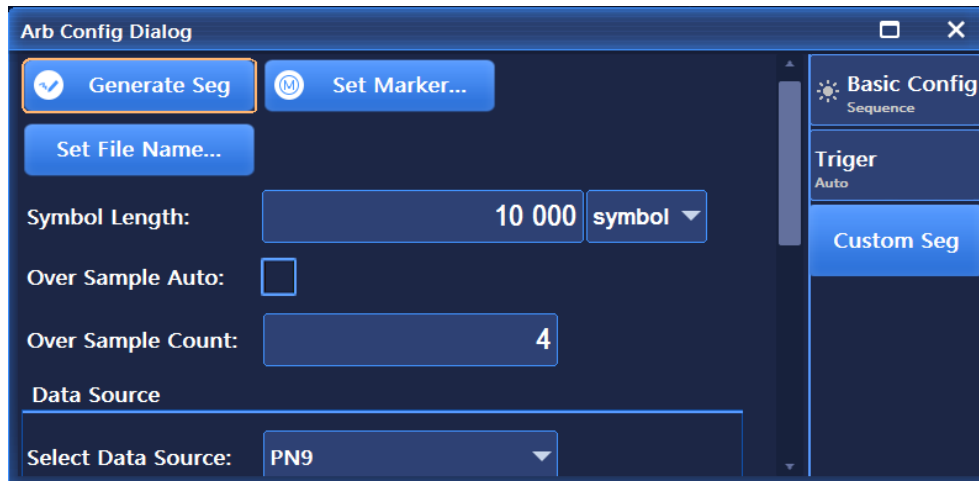

Figure 4.9 Custom Seg window

**Step 4. Set waveform segment name:**

Before generating a waveform segment, specify the name of the waveform segment to be generated. Select the "Set File Name ..." button to pop up the "Save As" dialog box (Figure 4.10), in which you can enter example, name of the waveform segment to be generated, with seg as the extension. This waveform segment file is automatically stored in folder wav. Close the dialog box, return to the Custom Seg waveform segment window, and continue to set the waveform segment parameters according to the following steps.

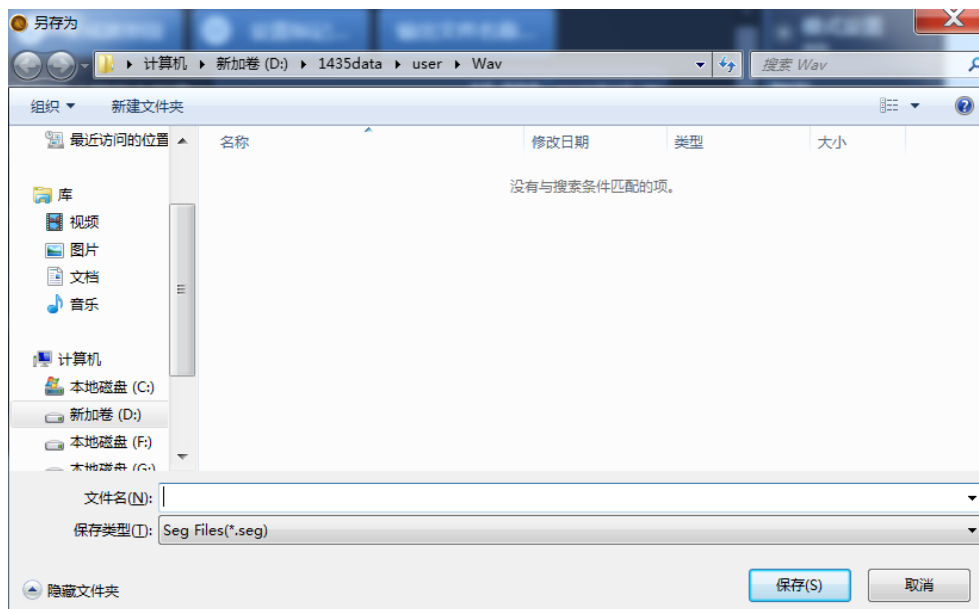

Figure 4.10 "Save As" window for outputting waveform segment file

**Step 5. Set waveform segment filtering parameters:**

To generate a waveform segment file with 40,000 sample points, according to the formula: Sample Count = Wave Seg (symbol) Length × Over Sampling Count where Over Sampling Count refers to the

## 4.2 Advanced Operation Guide

interpolation number of each symbol during shaping filtering. The default Over Sampling Count in the software is calculated automatically, with the max. count of 32; In the current model of 1435 series signal generator, each sample point occupies 4 bytes (16 bits for Path I data and 16 bits for Path Q data), and the max. storage capacity of the baseband board is 4GByte (8GByte option), so the max. Sample Count is 1GSample (2GSample option).

The software automatically limits the lengths of the input symbols and the number of over sampling points according to the current baseband storage capacity. The larger the number of over sampling points, the longer it takes to generate waveform segments. It is recommended to turn off automatic calculation of over sampling points and set the over sampling points to 4.

In this example, the number of sampling points to be generated is 40,000, the number of over sampling points is set to 4, and the length of the waveform segment (symbol) is set to 10,000. It is required that the sampling clock of the generated waveform segment is 4MHz, and the sampling clock = over sampling points × symbol rate; Set symbol rate to 4Msps.

### Step 6. Select data source:

Rotate the RPG clockwise (or counterclockwise) to move the focus to the "Data Source" combo box, and press the knob to select SPN9. Or you can tap the "Data Source" option on the touch screen and select PN9.

### Step 7. Set waveform segment modulation parameters:

The Modulation Type combo box displays the currently selected modulation type. Select the modulation type "QPSK"; Or tap the "Select Modulation Type" combo box on the touch screen and select [PSK] → [QPSK/OQPSK] → [QPSK] in order. Selects the default filter.

### Step 8. Set waveform segment marker:

Select the "Set Marker ..." button to open the marker edition dialog box (Figure 4.11). In this dialog box, the user can edit 4 independent markers.

The coordinate system length of the marker edition dialog box is 40000, just the sample count edited previously. Select the marker with the mouse, double-click the left mouse button at the specified index, and set the marker to be output when the marker line is at high level and not output when the marker line is at low level.

The example requires to set markers at the beginning and end of the waveform segment. Click at the beginning of marker 1, the current index is displayed as 0. Double-click the left mouse button to set the marker line to high level, the mouse is positioned at the location of index 100. Double-click the left mouse button to set the marker line to low level. At this time, index 0 to index 100 are high level, index 100 to index 40000 are low level. Similarly, set the marker line to high level between index 39900 and index 40000.

**In order to facilitate users to select the marker indexes by mouse, user can modify the value of "Zoom Range" and then select the "Zoom in" option. After the modification, the coordinate system displayed with the current index as the center according to the value of the zoom-in range.** In this way, during the playback of waveform segment, when the 0 to 100th sample points and the 39900th to the 40000th sample points are being played, marker 1 port outputs a high level. After edition, click the "Generate Mrk" button to generate a marker file named example.mrk in the same directory of the wav folder and the waveform segment.

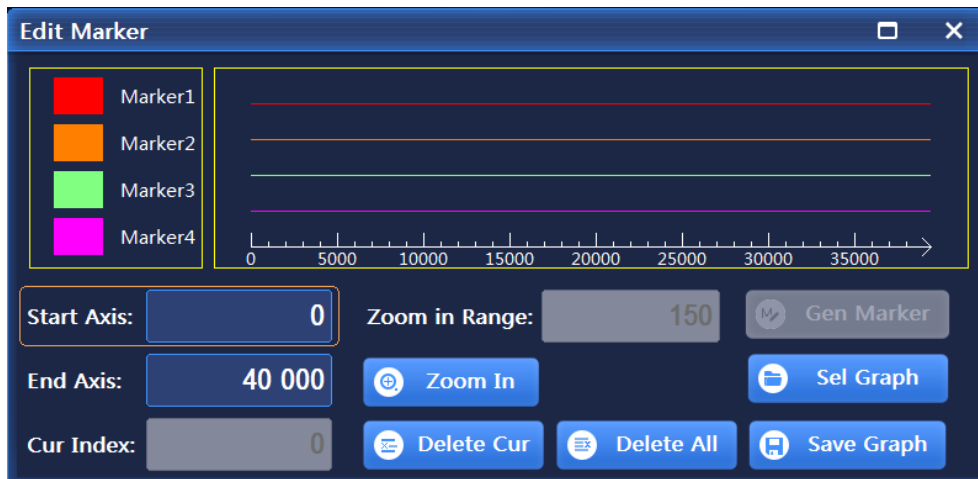

Figure 4.11 Setting waveform segment marker

## Tip

### Use of Markers:

- When the user has not selected the name of the waveform segment output file, the "Generate Mrk..." button in the Edit Mrk dialog box is invalid. Only when the name of the waveform segment file is set can a marker file with the same name as the waveform segment be generated.
- The output ends of marker 1, marker 2, marker 3 and marker 4 are SMA plugs of the rear panel.
- In the Edit Mrk dialog box, users can save the edited marker with the file name specified by the user through the "SaveMarker Pic ..." button, and call the marker file edited last time with the "SelMarker Pic..." button. The default storage directory is fold Mark.
- To make the edited markers valid, set the marker switch of the waveform segment to ON in the sequence list.

### Step 9 Generating waveform segment:

Close the Edit Mrk dialog box, return to the "Custom Seg" dialog box, and select the "Generate Segment" button to complete the generation of the waveform segment.

**Example 2: Sequence playback function, demonstrating flexible sequence edition and playback functions.**

#### Operation Steps:

##### Step 1. Set frequency

- **Edit frequency and power, enable RF.**

Set the frequency to 10GHz, the power to 0dBm, and set RF on.

##### Step 2. Activate the arbitrary wave configuration window:

- **Open the Arb Config Dialog window**

Tap the [Arb] option in the [Signal] function zone on the touch screen, and the Arb Config Dialog window will pop up on the operation interface (Figure 4.8).

##### Step 3. Set parameter

- **Set work pattern: Seq.**

Rotate the RPG clockwise (or counterclockwise) to select the "Work Pattern" option, and press the

## 4.2 Advanced Operation Guide

knob to select "Seq" as the work pattern; Or tap the "Work Pattern" option on the touch screen to set the work pattern to sequence.

➤ **Set clock type: invariant.**

Turn the front panel RPG clockwise (or counterclockwise) to select the "Clock Type" option box, and press the knob to set the clock type as invariant; Or tap the "Clock Type" option box on the touch screen to set the clock type as unchanged.

This clock type indicates that the baseband plays each waveform segment with variable sampling rate, and the two waveform segments in the sequence are played according to their default clock frequency.

### Step 4. Add waveform segments

➤ **Add waveform segments as required.**

Rotate the front panel RPG clockwise (or counterclockwise) or select "Add Wave Seg" on the touch screen, and select the waveform segment sample file 400KSin\_16MClk.seg from the pop-up window to be added to the sequence table; and then select "Add Wave Seg" again to add the waveform segment sample file 400KTri\_16MClk.seg to the sequence table.

## Tip

### Description of waveform segment sample file

- The baseband output of the waveform segment sample file 400KSin\_16MClk is a sine wave (clock frequency 16MHz, playback duration 25ms). The sine wave output can be seen by connecting the Path I output (or Path Q output) on rear panel of the instrument to the oscilloscope.
- The baseband output of 400KTri\_16MClk is 16M triangular wave (clock frequency 16MHz, playback duration 25ms). The triangular wave output can be seen by connecting the Path I output (or Path Q output) on rear panel of the instrument to the oscilloscope.

### Step 5. Enable arbitrary wave

➤ **Set "Arb Seg" on.**

After configuring arbitrary wave parameters, rotate the RPG of the front panel clockwise (or counterclockwise) to select the Arb On/Off option, press the knob to enable arbitrary wave sequence; or tap the "Arb On/Off" option on the touch screen to enable arbitrary wave sequence. At this time, the instrument will automatically download the playback sequence.

An example of association sequence playback is shown in the following table (Table 4.1):

Table 4.1 Examples of sequence playback extensions

No.	Description
1	Set Repetition of 400KSin_16MClk to 2, and check Arb Seq On to download again. With the oscilloscope, you can see two sine waves and one triangular wave being played circularly.
2	Change Clock Type to "Highest", and check Arb Seq On, then the two waveform segments will be played at the highest clock frequency of them, which is 32MHz in the current example. The output waveform can be seen with the oscilloscope.
3	Change Clock Type to "User Defined", set Clock Freq to 32MHz, check Arb Seq On, and the two waveform segments will be played with the customized clock.
4	Delete all waveform segments, add waveform segment 2MSin_8MClk.seg, add waveform segment 2MQPSK_8MClk, check Arb Seq On, set Clock Type to "Invariant", set carrier to 10GHz, connect the RF output port to the signal analyzer, set the signal analyzer as follows: set



	center frequency to 10GHz and sweep width to 5MHz. QPSK and sine wave spectrum can be observed.
--	---

**Note that the variable sampling rate playback described herein is realized by automatic interpolation of the software, and the hardware adopts fixed sampling rate for playback.**

### **Example 3: Arbitrary wave playback**

#### **Operation Steps:**

##### **Step 1. Set frequency**

- **Edit frequency and power, enable RF.**

Set the frequency to 10GHz, the power to 0dBm, and set RF on.

##### **Step 2. Activate the arbitrary wave configuration window:**

- **Open the Arb Config Dialog window**

Tap the [Arb] option in the [Signal] function zone on the touch screen, and the Arb Config Dialog window will pop up on the operation interface (Figure 4.8).

##### **Step 3. Set parameter**

- **Set work pattern: Arb.**

Rotate the RPG of the front panel clockwise (or counterclockwise) to select the arbitrary wave sequence; or tap the "Arb Seq" option on the touch screen to enable Arbitrary wave sequence.

- **Set clock frequency: 100MHz.**

Rotate the RPG of the front panel clockwise (or counterclockwise) to select the "Clock Freq" input box, and press the knob to make the box in the edition status; Or tap the "Clock Freq" option on the touch screen to make the box in the edition status.

##### **Step 4. Add arbitrary wave file**

- **Load arbitrary wave as required.**

Select "Load Arb", and select the file type Mat-File from the pop-up window, then select the sample file 1MSin.mat, and add it to the list.

##### **Step 5. Set file format**

- **Press "File Format Config ..." to set the matrix list data type.**

Rotate the front panel RPG clockwise (or counterclockwise) or tap the "File Format Config ..." option box on the touch screen to automatically read the matrix list in the current mat file. Select Qdata\_Int16 from the drop-down list of I-matrix, select Qdata\_Int16 from the drop-down list of Q-matrix, and select MarkerData\_int8 from the drop-down list of marker matrix. Select the default data type. Close the File Format Config ... dialog box and return to the Arb Config Dialog window.

##### **Step 6. Set marker on/off**

- **Set markers 1~4 in the list to on.**

##### **Step 7. Enable arbitrary wave**

- **Set "Arb Seg" on.**

The instrument will start automatic downloading and playback. The triangular wave output can be seen by connecting the Path I output (or Path Q output) on rear panel of the instrument to the oscilloscope. The edited marker output can be seen by connecting markers 1~2 on the rear panel of the instrument to the oscilloscope.

**Tip****Supporting for user-defined formats of arbitrary wave data files.**

The signal generator supports user-defined playback of arbitrary wave data files.

At present, the signal generator supports the conversion among the following 5 file formats: Mat-File 5, ASCII, Binary, cap and csv. The signal generator can convert data files in the above five formats into waveform data files. seg (16-bit data) and marker files .mrk for playing.

### 4.2.3 Selecting ALC Bandwidth

In the internal amplitude stabilization mode, the signal generator adopts an automatic level control (ALC) circuit before RF output.

ALC bandwidth has five options: Auto, 100Hz, 1kHz, 10kHz, and 100kHz.

In auto mode (reset option), the signal generator automatically selects ALC bandwidth according to the configuration and settings; When the frequency is less than 1MHz or when vector modulation is on, the bandwidth is 100Hz, when the frequency is greater than 1MHz but less than 10MHz, the bandwidth is 1 kHz; when the frequency is greater than 10MHz, if AM is on and pulse modulation is off, the bandwidth is 100kHz; in other cases, the bandwidth is set to 10kHz. In non-automatic mode of ALC bandwidth, the bandwidth is set according to user selection.

**Operation Steps:****Step 1. Enable ALC bandwidth**

Press the **【Amplitude】** key or tap the [Amplitude] function zone on the touch screen to select the [ALC Band] option in the power configuration window, and set "ALC Band Auto" to ON;

**Step 2. Select bandwidth value**

Bandwidth options: 100Hz, 1kHz, 10kHz, 100kHz, which should be selected as required;

Limited bandwidth or narrow bandwidth will lengthen the ALC sampling time and result in more accurate representation of the RMS value of the signal.

### 4.2.4 External Level Control of the Signal Generator

#### 4.2.4.1 Description of External Level Control

In the external level control mode, the output power of the signal generator is detected by an external probe, the detection voltage is sent back to the level control circuit of the signal generator, and the output power is automatically corrected to keep the power constant at the detection point.

#### 4.2.4.2 Level Control with Detector/Coupler/Power Divider

##### 1) Measuring diagram

Figure 4.12 describes a typical setting for external level control. During external level control, the power level is fed back from an external negative voltage output detector instead of from the internal detector. The feedback voltage controls the ALC system to control the output power.

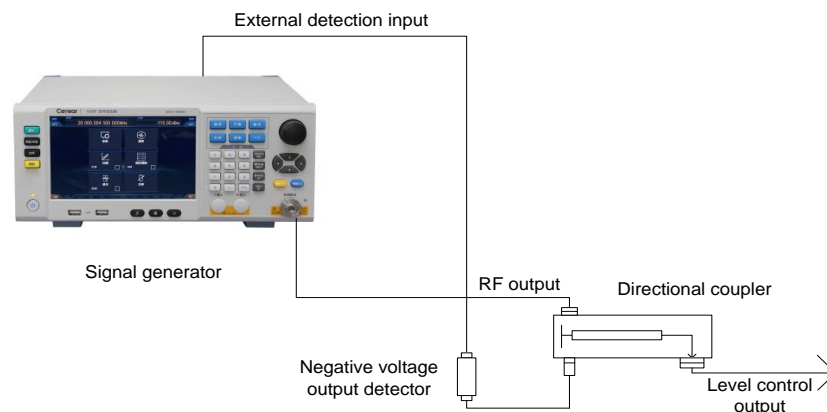

Figure 4.12 Connection block diagram of external level control measurements of ALC circuit

## 2) Measurement steps

### Step 1. Set external level control:

- 1) Connect the instrument as per Figure 4.12;
- 2) Press the [Amplitude] key or tap the [Level Control] option in the [Amplitude] function zone;
- 3) Select "Level Control": Ext.

### Step 2. Set coupling parameters:

Edit "Ext Detector Coupler" to 20dB (the coupling factor of the directional coupler is 20dB).

## Tip

The coupling factor of the power divider is 0dB.

### 4.2.5 Impact of Working in the Mixer Mode/Reverse Power

Attenuators are manually used for mixer testing. In the example shown in Figure 4.13, the output power of the signal generator is -8dBm. In the internal level control mode, the attenuator attenuation is set to 0dB. Set the ALC power level to -8 dBm. The local oscillator (LO) drive of the mixer is +10dBm. The isolation between the local oscillator (LO) and the RF output of the signal generator is 15dB. The power fed by LO to the output end of the signal generator is -5dBm, which passes through the attenuator without loss to the internal detector.

For some frequencies, most of this energy can enter the detector. However, the input response of the detector has nothing to do with frequency. This energy causes the amplitude stabilizing circuit of the signal generator to reduce the power output. In this example, the reverse power is actually greater than the ALC power level, so the power output of the signal generator is actually turned off.

In the example given in Figure 4.14, a power output of -8dBm is generated manually with an attenuator. In the example, the attenuation is 10dB, the ALC power level is +2dBm, and the local oscillator power of the mixer is 10dBm. The attenuator attenuates the reverse power of the local oscillator by 10dB, while the reverse power of the local oscillator is -5dBm, so only the reverse power of -15dBm passes through the detector, which just passes the required ALC level of +2dBm and the unnecessary reverse power of -15dBm. A difference of 17dB results in a drift of 0.1dB in the output level of the signal generator. Set the signal generator manually with the attenuator:

### Operation Steps:

#### Step 1. Open the power configuration window

**4.2 Advanced Operation Guide**

Press the **【Amplitude】** key or tap the [Amplitude] function zone on the touch screen to open the power configuration window.

**Step 2. Set the work pattern of the attenuator in the ALC system to manual and set the value of the attenuator**

Select the [Atten Config] option in the Power Config Dialog window, rotate the front panel RPG clockwise (or counterclockwise) to select the "Attenuation Style" option box, press the knob to select Manual, then rotate the front panel RPG to select the "Attenuation" input box, and then press the knob to make the box in the edition state; Or tap the "Attenuation Style" option box on the touch screen to select the manual mode. Then tap the "Attenuation" input box to make it in the edition status. Then set the attenuation to 10 dB.

**Step 3. Set ALC power**

Select the [Atten Config] option in the Power Config Dialog window, rotate the front panel RPG clockwise (or counterclockwise) to select the "ALC" input box, press the knob or tap the "ALC" input box to make it in the edition status. At this point, the input ALC power is 2dBm.

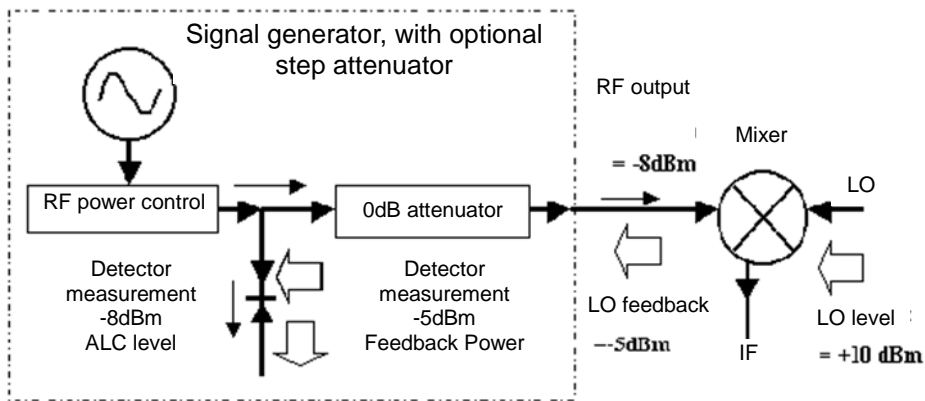

Figure 4.13 Reverse power effect, -8dBm coupling output

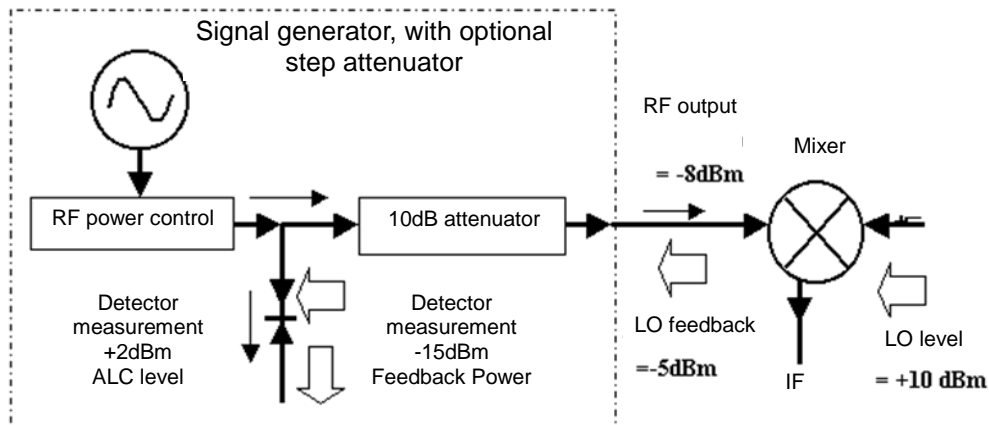

Figure 4.14 Reverse power effect, -8dBm non-coupling output

**4.2.6 Creating and Applying User Pltc Arrays**

The basic operation method for creating Pltc arrays is to connect a power meter via the GPIB interface to realize calibration. The user Pltc function is described with the following example.

**For example: to realize auto Pltc from 4GHz to 7GHz sweep signals with a 2432 power meter. In this example, Pltc is performed for 4 GHz to 7 GHz sweep signals, at the interval of 1GHz, and the signal generator controls the 2432 power meter through the interface bus to generate a calibration data array.**

**Operation Steps:**

**Step 1.** Connect the instrument as per Figure 4.15.

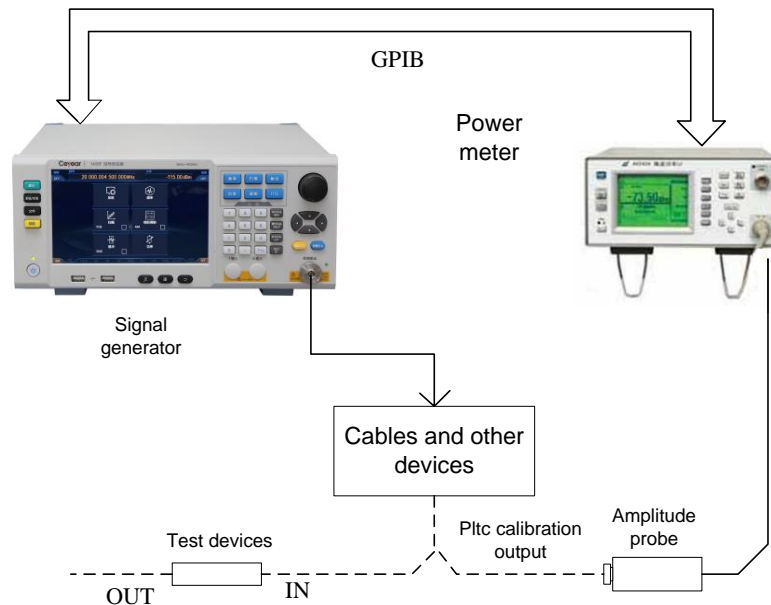

Figure 4.15 User Pt1c

**Step 2.** Set the power meter and zero power meter/probe.

**Step 3.** Set appropriate calibration parameters of power probe for the power meter.

**Step 4.** Enable meter/probe calibration parameter series.

Please refer to the instrument manual for the specific usage of the 2432 power meter.

**Step 5.** Connect the power probe to the power output connector to be calibrated.

**Step 6.** Set the signal generator and press the **【Reset】** key. Set the power level to 0dBm and set [User Pt1c **On/Off**].

**Step 7.** Press the **【Calibration】** key and select the [Power Pt1c] option to open the "User Pt1c" window.

**Step 8.** In the "User Pt1c" window, select [Delete All Points], which ensures the calibration data to be cleared.

**Step 9.** Enter the frequency point to be calibrated: manually enter the frequency point at the step of 1GHz or automatically generate the frequency point.

In the example, the automatic filling method is adopted:

- 1) Select [Start Fill Freq] in [Auto Fill] option and enter 4 GHz;
- 2) Select [Stop Fill Freq] and enter 7 GHz;
- 3) Select [Fill Freq Interval] option and enter 1 GHz;
- 4) Select the [Confirm Fill] option.

The frequency list is automatically filled: the start frequency is 4GHz, the stop frequency is 7GHz, increased by 1GHz gradually. Input the calibration data, as shown in Figure 4.16 below.

## 4.2 Advanced Operation Guide

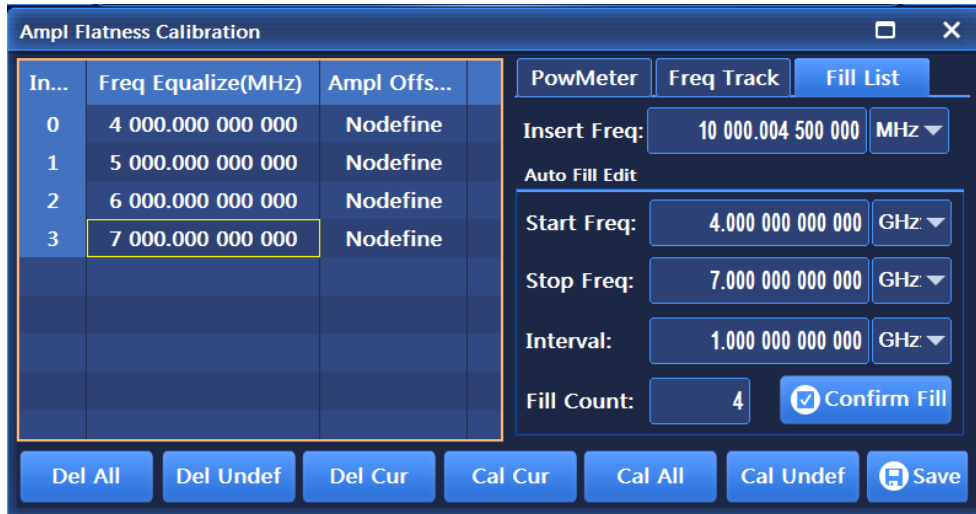

Figure 4.16 User Pltc Calibration List

**Step 10.** Start calibration after the parameters are set.

Confirm that the signal generator is connected to the power meter via the GPIB cable, select the [GPIB Port] option under in [System], and set the GPIB address, program-controlled language and power meter options.

Select the [Calibrate All Points] option to start calibration. The power meter is controlled by the signal generator and the frequency point calibration is continuously performed according to the calibration list. After calibration is completed, calibration data is automatically stored.

### 4.2.7 Pulse Modulation Input Selection

#### 4.2.7.1 Selection of ALC Working State when Pulse Modulation is On

Due to the tracking speed of the ALC loop of the signal generator itself, when the pulse modulation is on and the pulse width is less than  $1\mu\text{s}$ , the ALC loop should be set in the open loop or search mode.

#### 4.2.7.2 Pulse Input Selection

##### 1) Pulse input "Scalar"

Press the **[Pulse]** key or tap the [Pulse] function zone on the touch screen, and the pulse modulation configuration window will pop up on the operation interface. Turn the knob clockwise (or counterclockwise) to select the "Source" option box, press the knob and select the [Scalar] option; or tap the "Source" option box on the touch screen to select the [Scalar] option.

Activate pulse modulation and make the pulse generator inside the instrument generate a square wave of 27.8kHz (18 ms pulse width, 36 ms period, as shown in Figure 4.17). The rise and fall times of the RF envelope are about 0.2 ms. This kind of pulse is used for AC detection of scalar network analyzers.

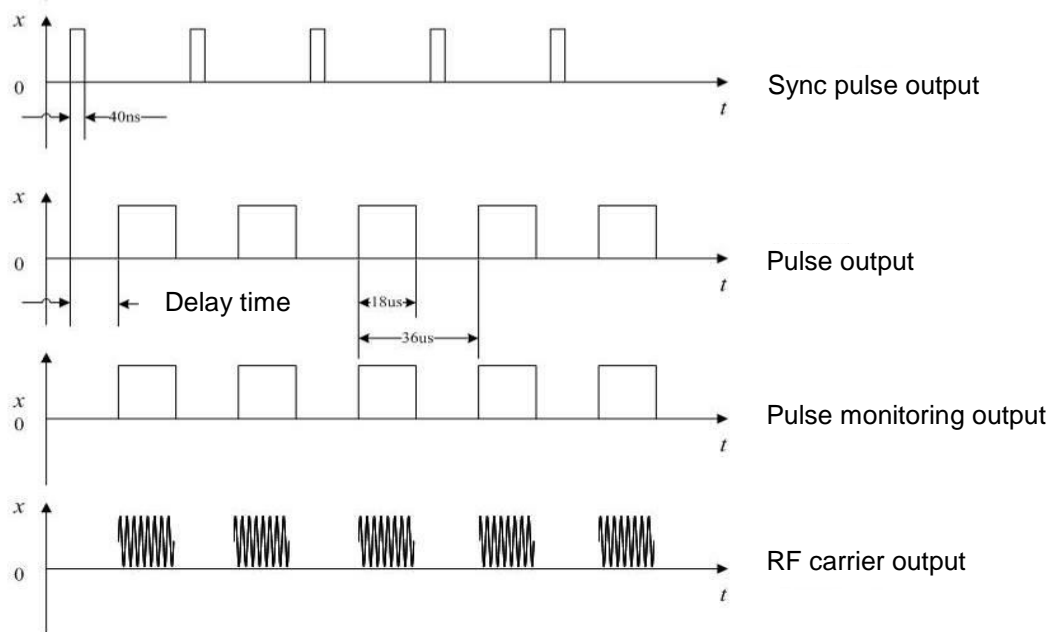

Figure 4.17 Internal Scalar Pulse

## 2) Pulse input "Auto"

Press the [Pulse] key or tap the [Pulse] function zone on the touch screen, and the pulse modulation configuration window will pop up on the operation interface. Turn the knob clockwise (or counterclockwise) to select the "Source" option box, press the knob and select the [Auto] option or tap the "Source" option box on the touch screen to select the [Auto] option.

Activate pulse modulation and set the pulse generator inside the instrument as the pulse modulation source (Figure 4.18). No external pulse signals are required. At the same time, activate the automatic trigger mode of internal pulse, which is not synchronized with other trigger signals. The parameters of the pulse signals can be set by the user through the modulation configuration window (Figure 3.22).

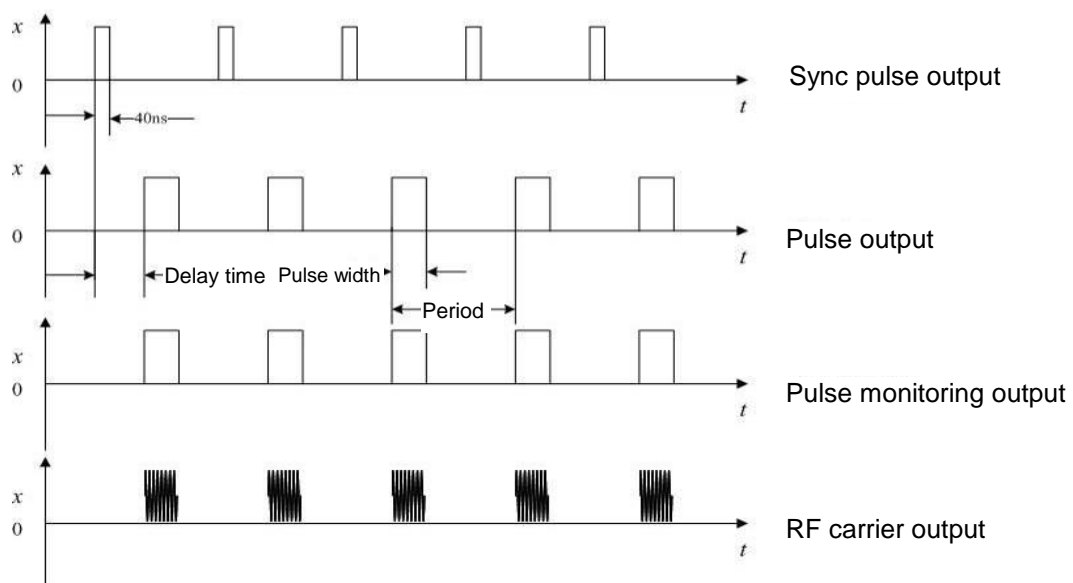

Figure 4.18 Internal Auto mode

## 3) Pulse input "Trig"

Press the **[Pulse]** key or tap the [Pulse] function zone on the touch screen, and the pulse

**4.2 Advanced Operation Guide**

modulation configuration window will pop up on the operation interface. Turn the knob clockwise (or counterclockwise) to select the "Source" option box, press the knob and select the [Trig] option or tap the "Source" option box on the touch screen to select the [Trig] option.

In the pulse configuration window, select the "Delay" input box to set the pulse delay value of the internal pulse generator. The pulse output of the internal pulse generator is achieved with the leading delay of the external pulse input signals (Figure 4.19).

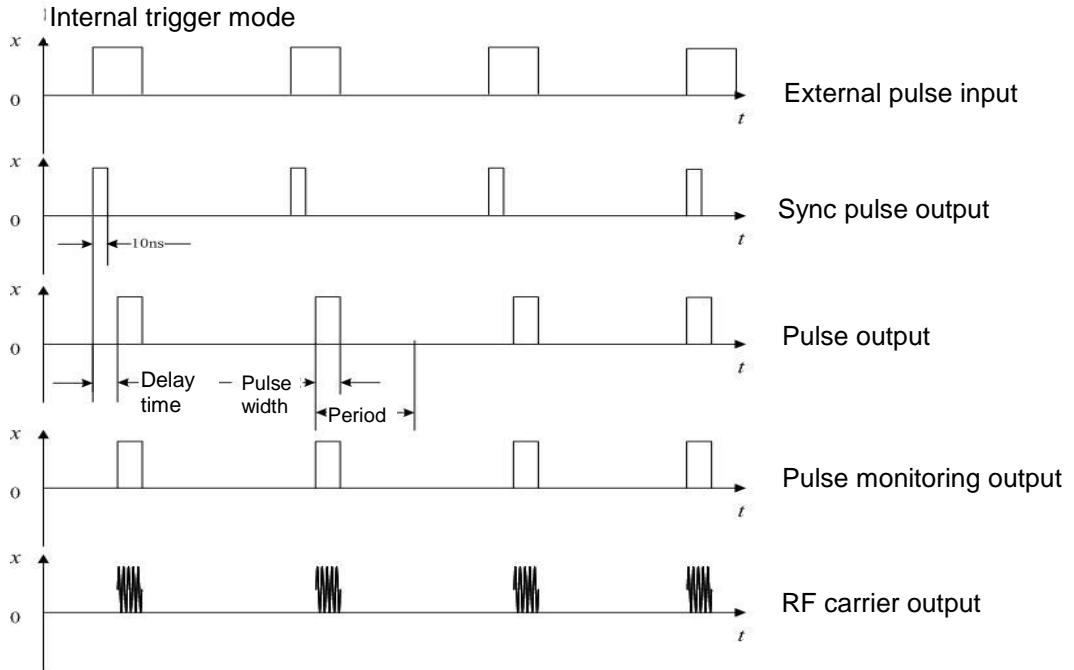

Figure 4.19 Internal trigger mode

**4) Pulse input "Gate"**

Press the **[Pulse]** key or tap the [Pulse] function zone on the touch screen, and the pulse modulation configuration window will pop up on the operation interface. Turn the knob clockwise (or counterclockwise) to select the "Source" option box, press the knob and select the [Gate] option or tap the "Source" option box on the touch screen to select the [Gate] option.

Activate the gate trigger mode of internal pulse type to obtain logical sum of the internal pulse generator and the external pulse signals (Figure 4.20).



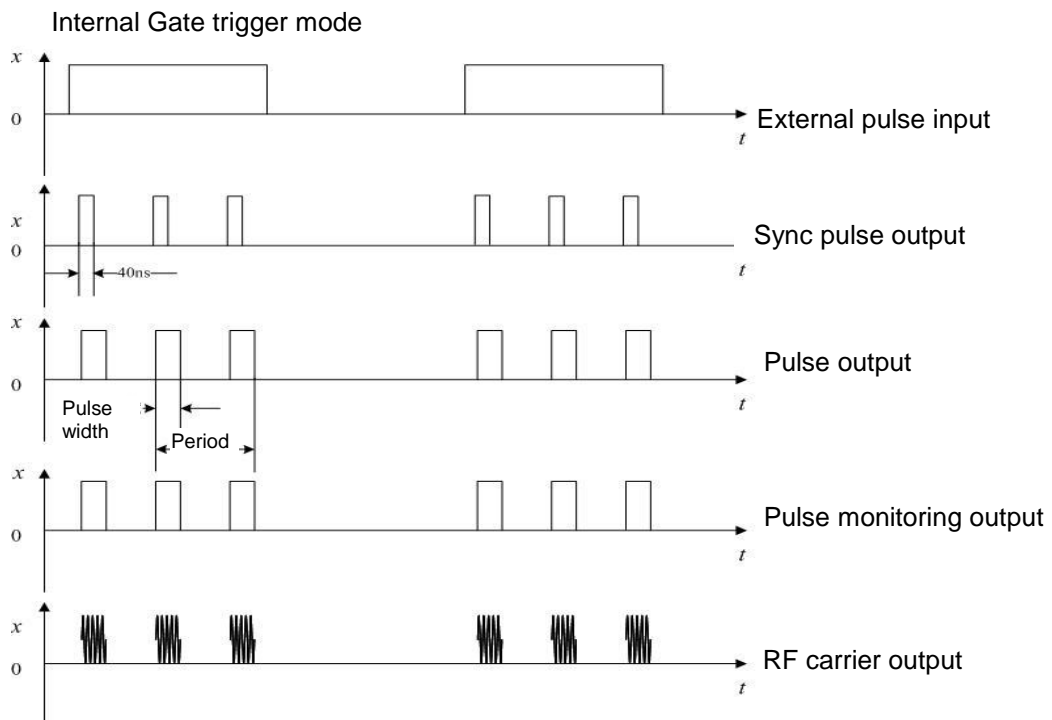

Figure 4.20 Internal Gate trigger mode

### 5) Pulse input “D-Pulse”

Press the **[Pulse]** key or tap the [Pulse] function zone on the touch screen, and the pulse modulation configuration window will pop up on the operation interface. Turn the knob clockwise (or counterclockwise) to select the "Source" option box, press the knob and select the [D-Pulse] in the [M-Pulse] option or tap the "Source" option box on the touch screen to select [D-Pulse] in the [M-Pulse] option.

Activate the D-Pulse trigger mode (Figure 4.21).

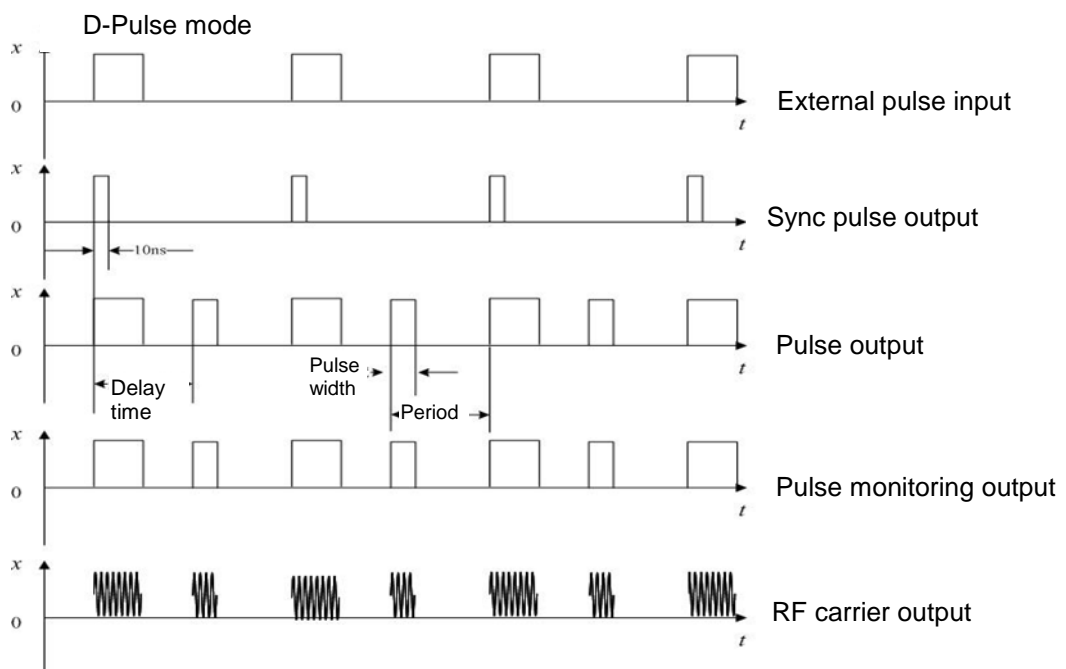

Figure 4.21 D-Pulse mode

## 4.2 Advanced Operation Guide

### 4.2.8 Baseband Triggering Function Configuration

The real-time baseband trigger modes of 1435 series signal generators include: Continuous, Single and Gate. Baseband trigger sources: Key, Ext and Bus. Please refer to "5.1.5 Baseband" in "5.1 Menu Description" for specific parameter settings.

**Example 1: Real-time baseband mode. Data Source: PN9, Symbol Rate: 4Mbps, Modulation Type: QPSK, Trigger Mode: Single, Trigger Source: External, Polarity: Positive, Delay: Off.**

#### Operation Steps:

**Step 1.** Connect the instrument as per Figure 4.22.

Connect the I and Q output signals of the rear panel of the instrument to the two input ports of the oscilloscope via BNC cables, and another signal generator is set to pulse modulation output as the external trigger source with the pulse width set to 50us and the Period set to 200us. The "Monitor Output" of the signal generator is connected to the "Code pattern trigger input" of the rear panel of the 1435 series signal generator under test through the BNC, and the other end is connected to the third input port of the oscilloscope.

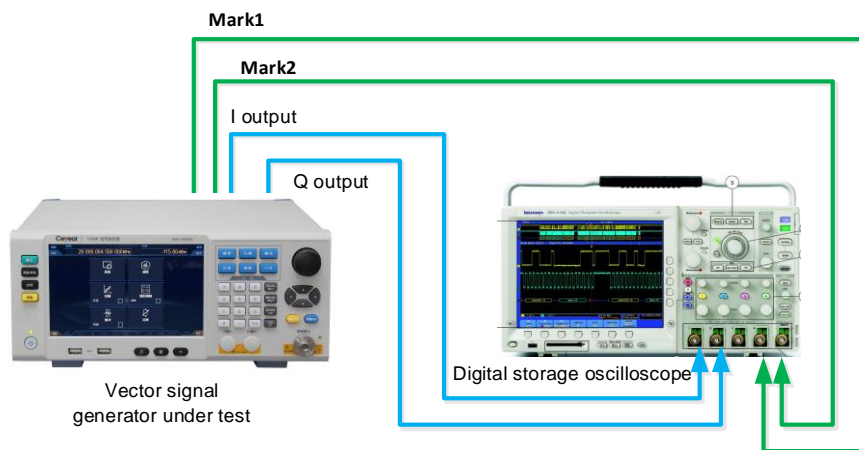

Figure 4.22 Triggering test

**Step 2.** Press the **[Modulation]** key or tap the [Base] option on the touch to open the baseband configuration window (Figure 4.1).

**Step 3.** Set parameters:

- 1) Set data source: PN9, symbol rate: 4Mbps, modulation type: QPSK;
- 2) Select the [Trigger] option to set the trigger mode: continuous (single), Trig Source: Ext, external trigger polarity: positive, delay: off;

**Step 4.** Set "Baseband On/Off" to On.

**Step 5.** Observe the oscilloscope measurement track.

As shown in Figure 4.23: signal 1: external trigger signal, signal 2: Path I output, signal 3: Path Q output. After the rising edge of each pulse arrives, the baseband signal is triggered to be played once. When the data source is PN9, it takes 60us to play it once according to 4Mbps baseband signal. The correctness of this function can be verified by observing the oscilloscope test results.

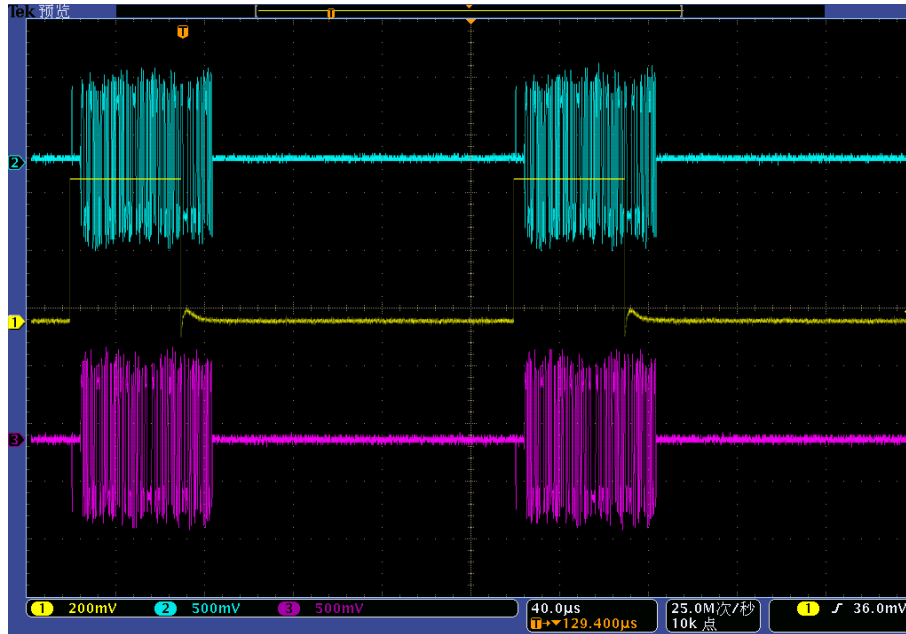

Figure 4.23 Baseband triggering (Continuous/Single)

**Example 2: Trigger Mode: Gate (Height), Data Source: PN9, Symbol Rate: 4Mbps, Modulation Type: QPSK.**

#### Operation Steps:

**Step 1.** Connect the instrument as per Figure 4.22.

Connect the I and Q output signals of the rear panel of the instrument to the two input ports of the oscilloscope via BNC cables, and another signal generator is set to pulse modulation output as the external trigger source with the pulse width set to 50ms and the Period set to 200ms. The "Monitor Output" of the signal generator is connected to the "Code pattern trigger input" of the rear panel of the 1435 series signal generator under test through the BNC, and the other end is connected to the third input port of the oscilloscope.

**Step 2.** Press the **【Modulation】** key or tap the [Base] option on the touch to open the baseband configuration window (Figure 4.1).

**Step 3.** Set parameters:

- 1) Set data source: PN9, symbol rate: 4Mbps, modulation type: QPSK;
- 2) Select the [Trigger] option to set the trigger mode: Gate (Height), Trig Source: Ext, Polarity: positive, Delay: off;

**Step 4.** Set "Baseband On/Off" to on.

**Step 5.** Observe the oscilloscope measurement track.

As shown in Figure 4.24: signal 1: external trigger signal, signal 2: Path I output, signal 3: Path Q output. During the input with external pulse signals as the gate control signals, at high level, the baseband signal has output; and at low level, and baseband signal has no output.

4.2 Advanced Operation Guide

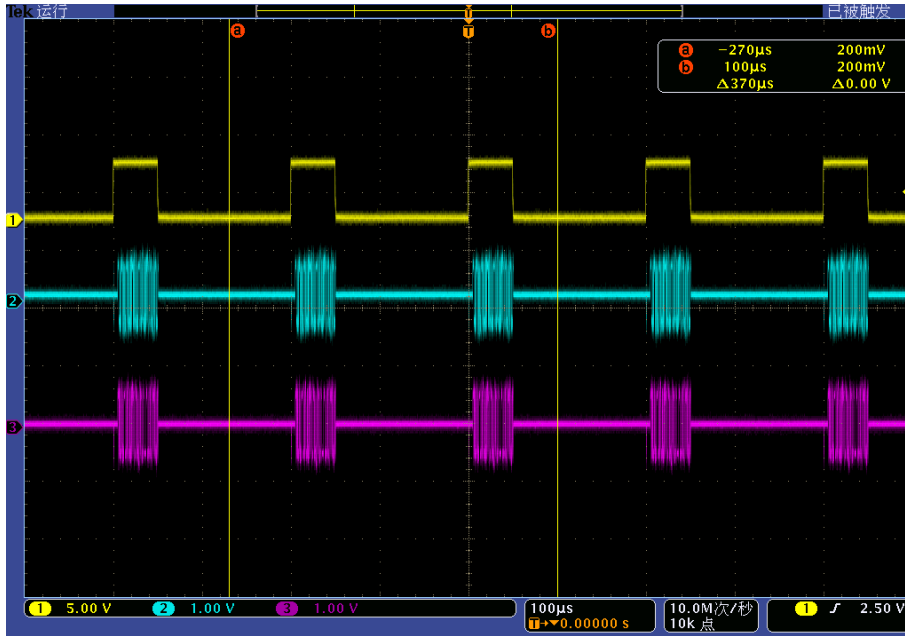

Figure 4.24 Baseband triggering (Gate Height)

**Example 3: Trigger Mode: Gate (Low), Data Source: PN9, Symbol Rate: 4Mbps, Modulation Type: QPSK. External trigger source: pulse width: 50ms, Period: 200ms.**

The operation steps are the same as in "Example 2". The trigger mode is changed to gate (low), and the measurement results of the oscilloscope are shown in Figure 4.25.



Figure 4.25 Baseband triggering (Gate Low)

**Tip****Working status of the signal generator when the baseband trigger mode is “Gate”**

The trigger source is automatically set to external and the polarity changes according to the Gate state. The baseband signals are continuously played in the Gate state.

### 4.2.9 Arbitrary Wave Triggering Function Configuration

Trigger sources of arbitrary wave trigger include: Key, Ext, Bus and Int. Please refer to “5.2.7 Arbitrary Wave” in “5.2 Menu Description” for specific parameter settings.

**Example 1: Work Pattern: Seq, Add Wave Seg sample: 4KTri\_2MClk (sinc), Clock: custom 200MHz, Trig Mode: Configuring (Realtime), Trig Source: Ext, external detailed configuration window; Polarity: Positive.**

**Operation Steps:**

**Step 1.** Connect the instrument as per Figure 4.22.

Connect the I and Q output signals of the rear panel of the instrument to the two input ports of the oscilloscope via BNC cables, and another signal generator is set to pulse modulation output as the external trigger source with the pulse width set to 200ns and the Period set to 4us. The "Monitor Output" of the signal generator is connected to the "Code pattern trigger input" of the rear panel of the signal generator under test through the BNC, and the other end is connected to the third input port of the oscilloscope.

Step 2 Select the [Arb] option in the [Signal] function zone to open the arbitrary wave sequence configuring window (Figure 4.8).

**Step 3.** Set parameters:

- 1) Work Pattern: Seq, adding example waveform segment: 4KTri\_2MClk (sinc), Clock: custom 200MHz;
- 2) Select the [Trigger] option to set the trigger mode: Continuous (Realtime), Trig Source: Ext, detailed external configuration window, Trigger Polarity: Positive, Delay: off;

**Step 4.** Set "Arb Seq On/Off" to On.

**Step 5.** Observe the oscilloscope measurement track.

As shown in Figure 4.26: signal 1: external trigger signal, signal 2: Path I output, signal 3: Path Q output. Every time an external trigger comes, the waveform segment starts playing, and when the next trigger comes, the waveform segment responds to replay in real time.

4.2 Advanced Operation Guide

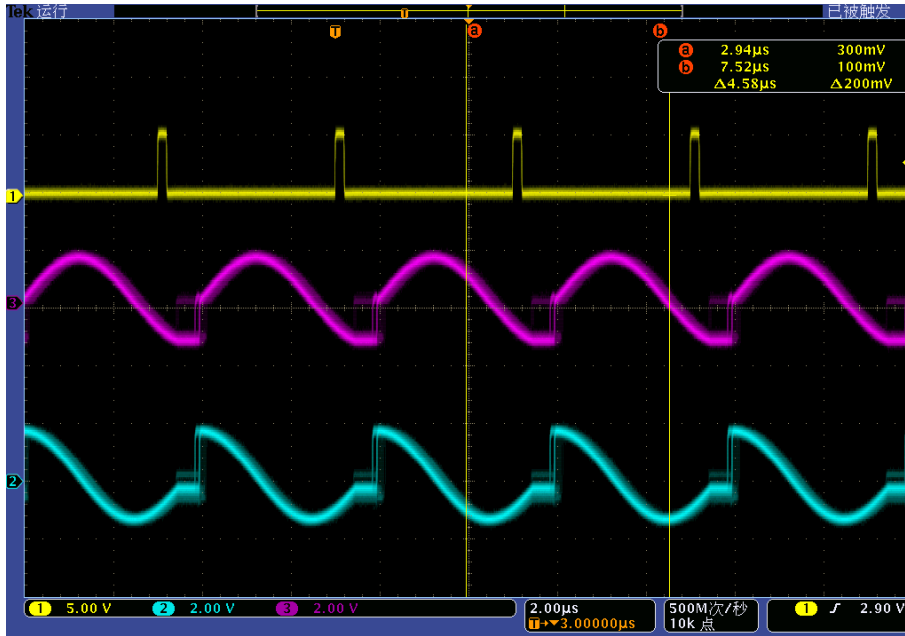

Figure 4.26 Arbitrary wave triggering (Continuous Realtime)

**Example 2: Work Pattern: Seq, Add Wave Seg sample: 4KTri\_2MClk (sinc), Clock: custom 200MHz, Trig Mode: Single (Ignore repeated trig), Trig Source: Ext; Polarity: Positive.**

The operation steps are the same as above. The trigger mode is changed to Single (Ignore repeated trig), and the measurement results of the oscilloscope are shown in Figure 4.27. As shown in the figure: when the second pulse arrives, it triggers a play. During the playback, when the next trigger arrives, the trigger is ignored.

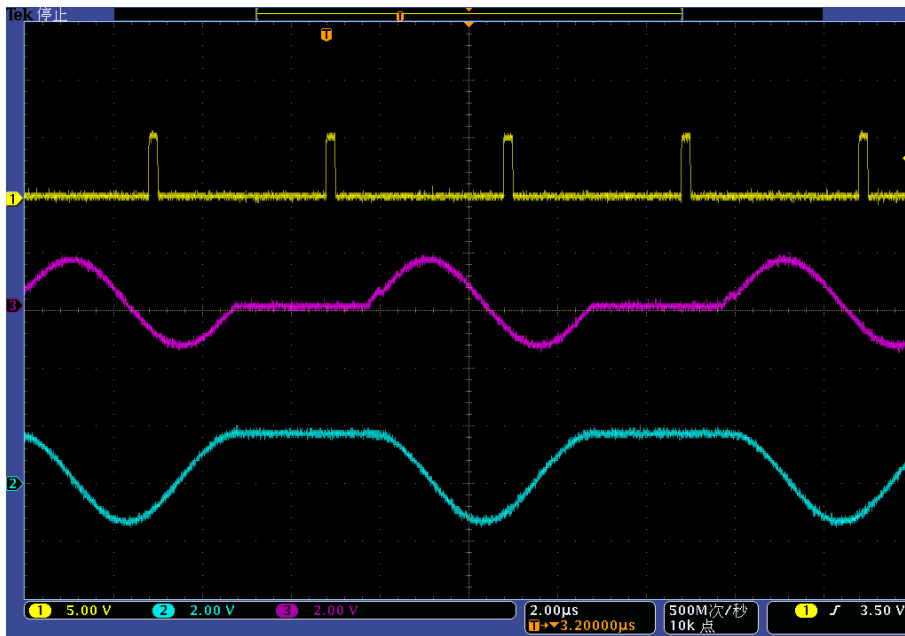

Figure 4.27 Arbitrary wave triggering (Single Ignore repeated trig)

**Example 3: Work Pattern: Seq, Add Wave Seg sample: 4KTri\_2MClk (sine wave), Clock: custom 200MHz, Trig Mode: single (Buffer repeated trig), Trig Source: Ext; Polarity: Positive.**

**Operation Steps:**

**Step 1.** Connect the instrument as per Figure 4.22.

## 4.2 Advanced Operation Guide

Connect the I and Q output signals of the rear panel of the instrument to the two input ports of the oscilloscope via BNC cables, and another signal generator is set to pulse modulation output as the external trigger source with the pulse source set to pulse train, and three pulses are generated, with the pulse width of 0.2 $\mu$ s, and the periods of 4 $\mu$ s, 10 $\mu$ s and 20 $\mu$ s respectively. The "Monitor Output" of the signal generator is connected to the "Code pattern trigger input" of the rear panel of the signal generator under test through the BNC, and the other end is connected to the third input port of the oscilloscope.

**Step 2** Select the [Arb] option in the [Signal] function zone to open the arbitrary wave sequence configuring window (Figure 4.8).

**Step 3.** Set parameters:

- 1) Work Pattern: Seq, adding example waveform segment: 4KTri\_2MClk (sinc), Clock: custom 200MHz;
- 2) Select the [Trigger] option to set the trigger mode: Continuous (Realtime), Trig Source: Ext, Polarity: positive, Delay: off;

**Step 4.** Change trigger mode to Single (Buffer repeated trigger)

**Step 5.** Set "Arb Seq On/Off" to On.

**Step 6.** Observe the oscilloscope measurement track.

As shown in Figure 4.28: signal 1: external trigger signal, signal 2: Path I output, signal 3: Path Q output. When the first pulse arrives, it triggers a playback of the waveform segment. When then next pulse arrives, this trigger is recorded and the playback is triggered after the previous waveform segment playback is completed.

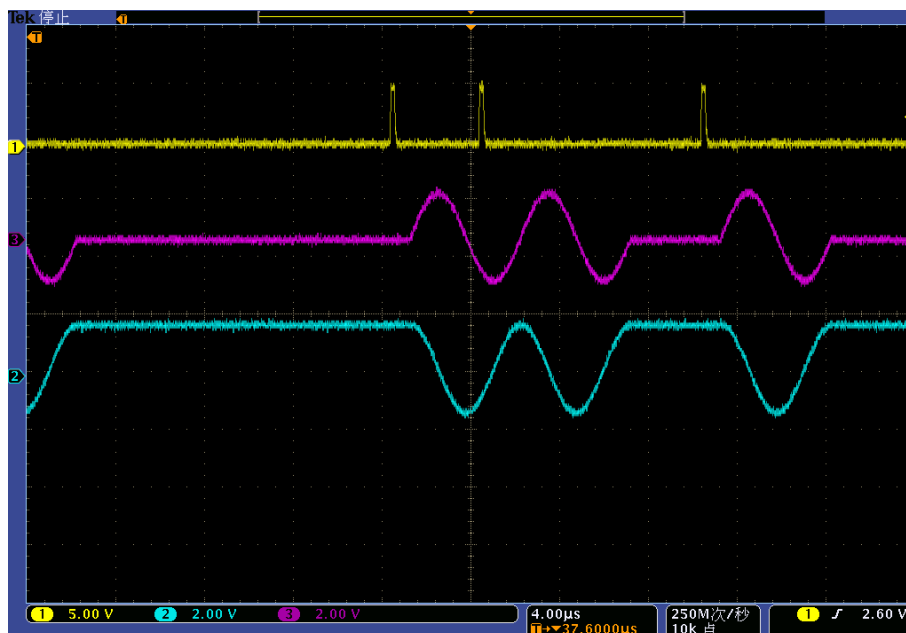

Figure 4.28 Arbitrary wave triggering (Single Buffer repeated trig)

**Example 4: Work Pattern: Seq, Add Wav Seg sample: 4KTri\_2MClk (sinc), Clock: custom 200MHz, Trig Mode: Single (Real-time repeated trigger), Trig Source: Ext: Polarity: positive.**

The operation steps are the same as above. The trigger mode is changed to Single (Real-time repeated trig), and the output results of the oscilloscope are shown in Figure 4.29.

As shown in the figure: signal 1: external trigger signal, signal 2: Path I output, signal 3: Path Q output.

When the first pulse arrives, Stop a playback of the waveform segment. When then next pulse arrives, the playback of the current waveform segment is terminated and the trigger is replayed.

## 4.2 Advanced Operation Guide

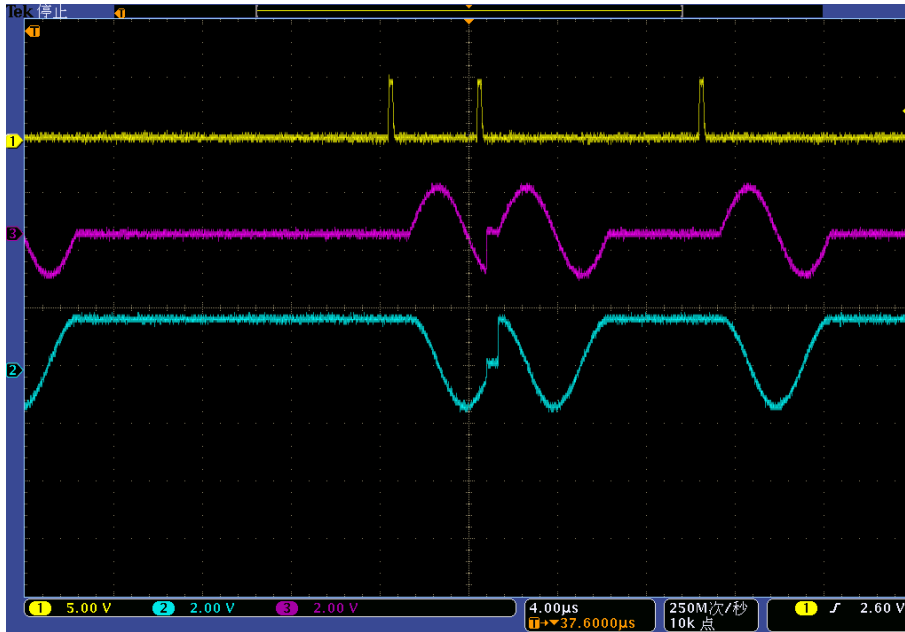

Figure 4.29 Arbitrary wave triggering (Single Real-time repeated trig)

**Example 5: Work Pattern: Seq, Add Wav Seg sample: 4KSin\_2MClk, 4kTir\_2MClk, Clock: custom 200MHz, Trig Mode: Wave Segment (Single), Trig Source: Ext: Polarity: positive.**

**Operation Steps:**

**Step 1.** Connect the instrument as per Figure 4.22.

Connect the I and Q output signals of the rear panel of the instrument to the two input ports of the oscilloscope via BNC cables, and another signal generator is set to pulse modulation output as the external trigger source with the pulse width set to 200ns and the Period set to 8us. The "Monitor Output" of the signal generator is connected to the "Code pattern trigger input" of the rear panel of the signal generator under test through the BNC, and the other end is connected to the third input port of the oscilloscope.

**Step 2** Select the [Arb] option in the [Signal] function zone to open the arbitrary wave sequence configuring window (Figure 4.8).

**Step 3.** Set parameters:

1) Work Pattern: Seq, Add Wav Seg sample: 4kTri\_2MClk, 4KSin\_2MClk, Clock: custom 200MHz;

2) Select the [Trigger] option to set the trigger mode: Wave Seg (Single), Trig Source: Ext, Polarity: Positive, Delay: off;

**Step 4.** Set "Arb Seq On/Off" to On.

**Step 5.** Observe the oscilloscope measurement track.

As shown in Figure 4.30: signal 1: external trigger signal, signal 2: Path I output, signal 3: Path Q output. Every time a pulse arrives, a waveform segment is triggered to be played. Different waveform segment is played each time.



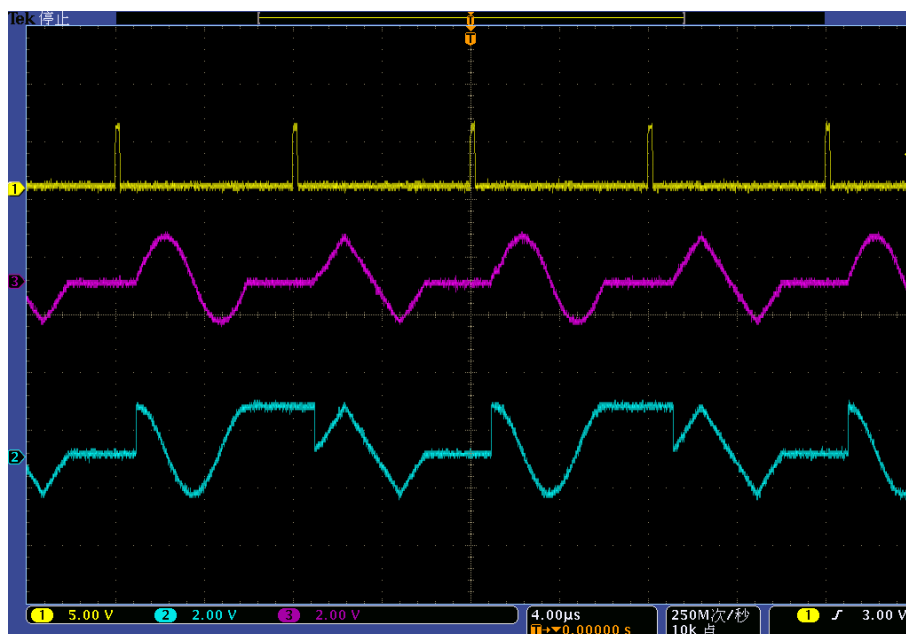

Figure 4.30 Arbitrary wave triggering (Wave Seg Single)

**Example 6: Work Pattern: Seq, Add Wav Seg sample: 4kTir\_2MClk, Clock: custom 200MHz, Trig Mode: Gate (Height), Trig Source: Ext: Polarity: positive. External trigger source: Pulse width: 10ms, Period: 15ms.**

The operation steps are the same as above. The trigger mode is changed to Gate (Height), and the output of the oscilloscope is shown in Figure 4.31.

As shown in the figure: signal 1: external trigger signal, signal 2: Path I output, signal 3: Path Q output.

Waveform segments are successively played at high level of input and the playback is stopped at low level of input.

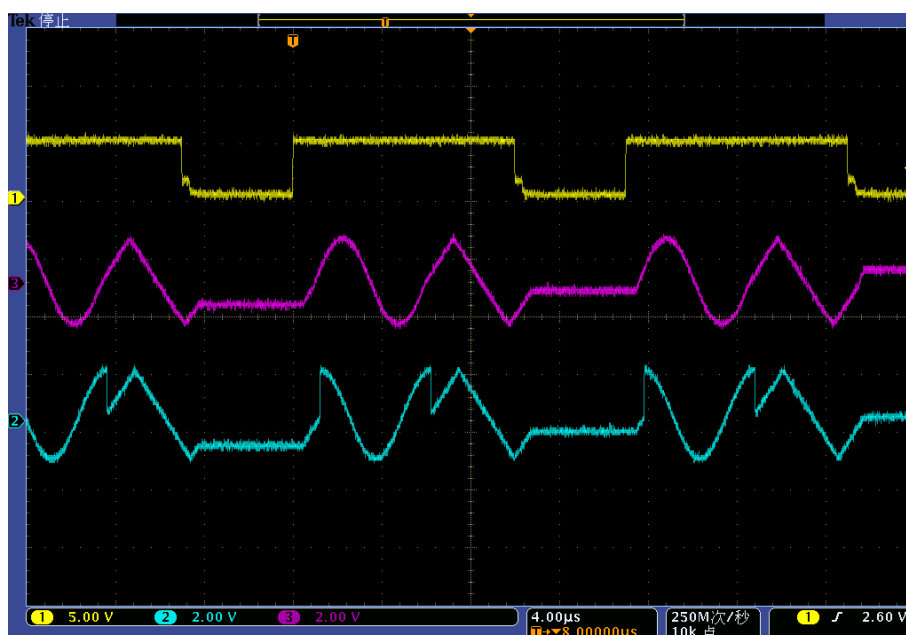

Figure 4.31 Arbitrary wave triggering (Gate Height)



## 5. Menus

The main menus of 1435 series signal generators include: frequency, power, sweep, modulation, baseband, AWGN, I/Q, arbitrary wave, system, save/call and calibration, etc.. Due to the limited number of soft keys in the front panel menu of the instrument, the boot menu displays only commonly used function menus according to factory settings, mainly including: frequency, power, sweep, modulation, baseband, I/Q, RF On/Off, etc. This chapter mainly introduces the main function menus of 1435 series signal generators, and detailed menu description of signal generators is listed in turn below.

### 5.1 Menu Structure and Parameter Settings

- [Frequency.....105](#)
- [Amplitude.....106](#)
- [Sweep.....109](#)
- [Modulation.....110](#)
- [Base.....116](#)
- [I/Q.....119](#)
- [Arbitrary Wave.....121](#)
- [Tone.....122](#)
- [AWGN.....124](#)
- [System.....126](#)
- [Storage/Loading.....129](#)
- [Calibration.....130](#)

#### 5.1.1 Frequency

Press the front panel key **【Frequency】** or tap the [Frequency] menu in the user interface to pop up a menu related to frequency for setting specific parameters related to frequency. The main operation interfaces are as follows:

##### 5.1.1.1 Frequency Settings

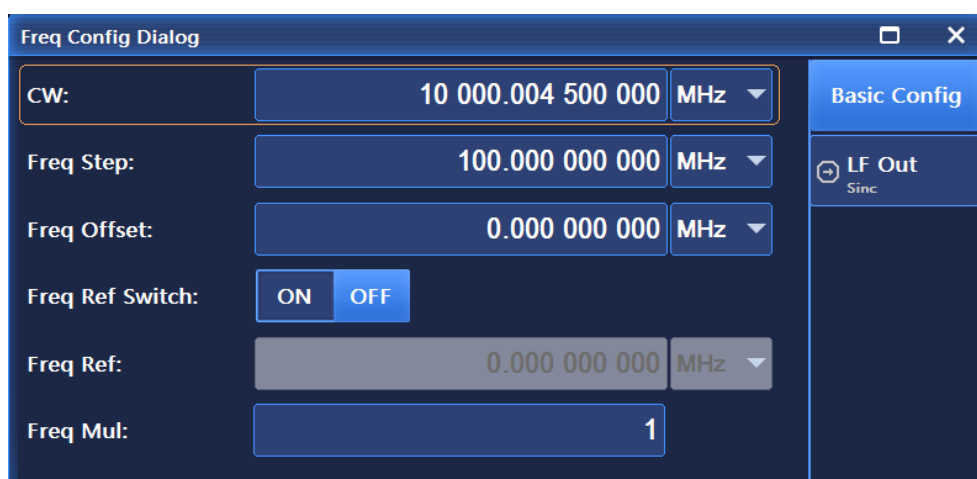

Figure 5.1 Figure settings interface

As shown in Figure 5.1, the frequency settings interface is mainly used for setting parameters such as continuous wave, frequency stepping, frequency offset, frequency reference switch, frequency multiplication and frequency reference value when the frequency reference is turned on.

5.1 Menu Structure and Parameter Settings

5.1.1.2 LF output

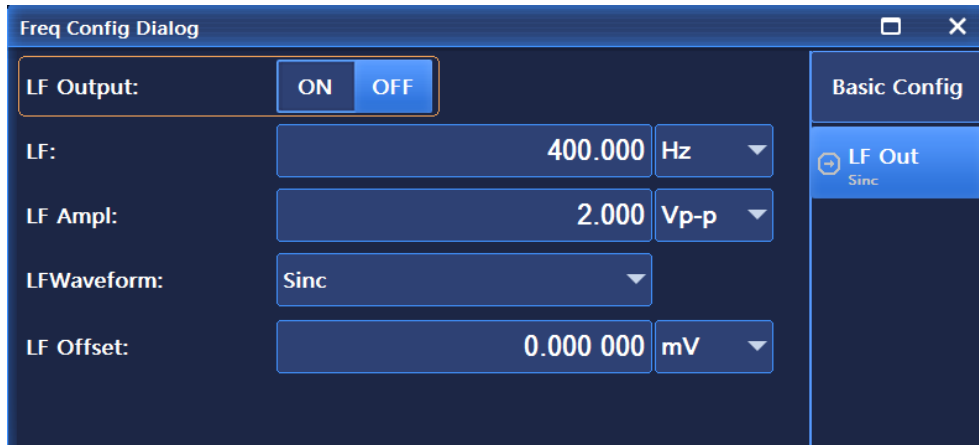

Figure 5.2 LF output interface

As shown in fig. 5.2, this interface is mainly used to set parameters including low-frequency On/Off, low-frequency frequency, low-frequency amplitude, low-frequency waveform type, and low-frequency DC offset. Among them, the low-frequency waveforms mainly include Sinc, Square, Triangle, Zigzag (including Zigzag-Up and Zigzag-Down), Function Generator (including Function Generator 1, Function Generator 2, Dual-Function Generator, Sweep Signal Generator, Noise Generator 1, Noise Generator 2 and DC).

**Tip**

**Frequency unit**

All frequency parameters accept parameters in hertz (Hz). Therefore, the digital input must take four frequency units (GHz, MHz, kHz or Hz) as the termination key.

5.1.2 Amplitude

Press the front panel key **【Amplitude】** or tap the [Amplitude] menu in the user interface to pop up a menu related to power for setting parameters related to power. The main operation interfaces are as follows:

5.1.2.1 Basic Config

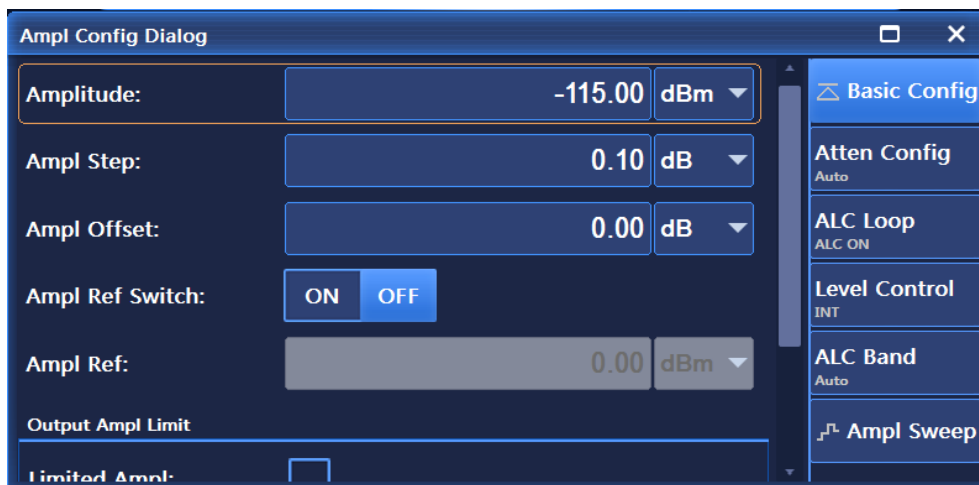

Figure 5.3 Amplitude settings interface

### 5.1 Menu Structure and Parameter Settings

As shown in Figure 5.3, the Basic Config interface is mainly used to set parameters such as amplitude, amplitude step, amplitude offset, amplitude reference and output amplitude limit, etc.

#### 5.1.2.2 Atten Config



Figure 5.4 Atten Config interface

The Atten Config interface, as shown in Figure 5.4, is mainly used to set parameters like attenuation coupling, ALC power and attenuation value, etc..

#### 5.1.2.3 ALC Loop

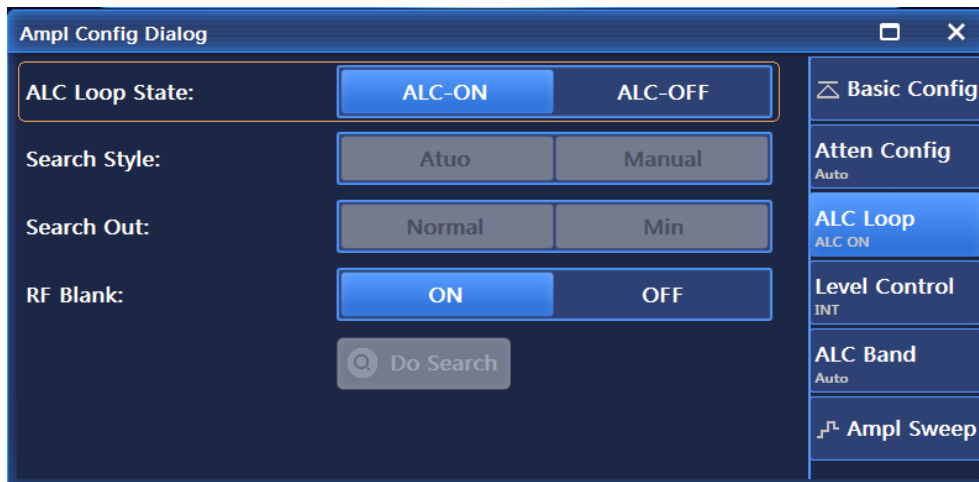

Figure 5.5 ALC Loop interface

As shown in Figure 5.5, the ALC Loop interface is mainly used to set parameters like ALC loop state, search style, search out, RF blank and Do Search, etc.

### 5.1 Menu Structure and Parameter Settings

#### 5.1.2.4 Level Control

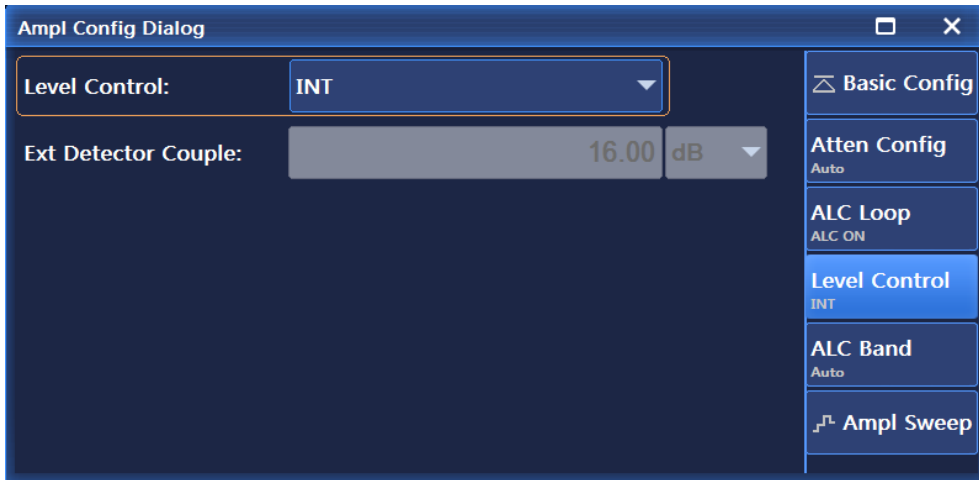

Figure 5.6. Level control Interface

As shown in Figure 5.6, the Level Control interface is mainly used to set the level control modes, including Int and Ext, when set to Ext, Ext Detector Coupler can be set.

#### 5.1.2.5 ALC Band

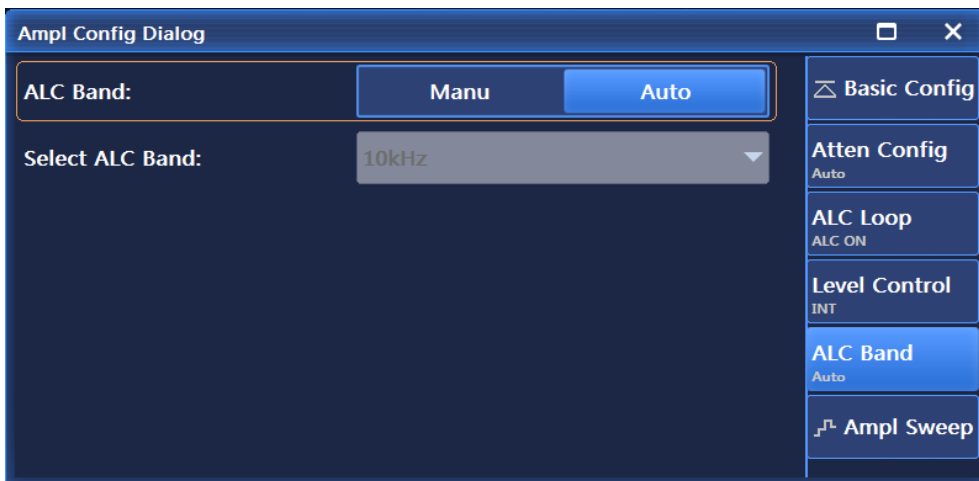

Figure 5.7 ALC Band interface

As shown in Figure 5.7, the ALC Band interface is mainly used to set ALC bandwidth, including Manu and Auto, and when set to Manu, the ALC bandwidth can be set.

### 5.1.2.6 Ampl Sweep

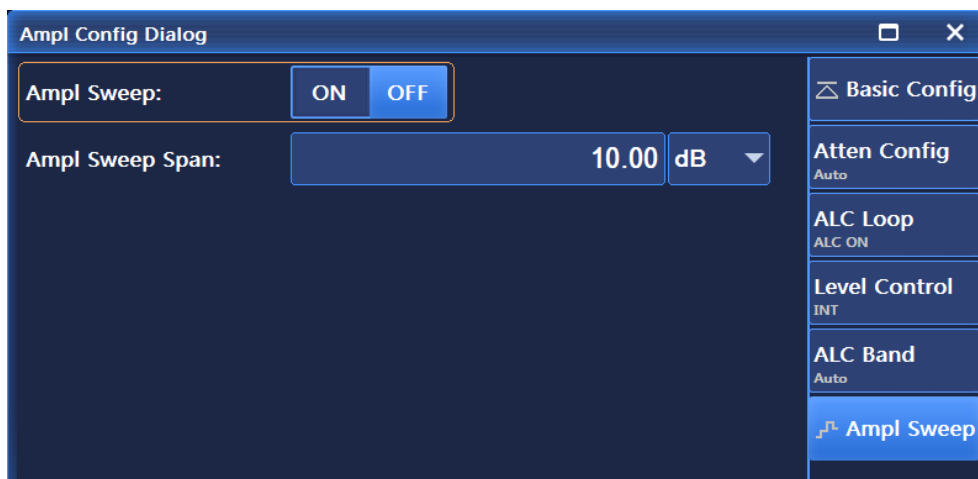

Fig. 5.8 Ampl Sweep interface

As shown in Figure 5.8, the Amplitude Sweep interface is mainly used to set parameters related to amplitude sweep, including Ampl Sweep On/Off and Ampl Sweep Span.

### 5.1.3 Sweep

Press the front panel key **【Sweep】** or tap the user [Sweep] menu in the interface menu to pop up a menu related to sweep for setting parameters related to sweep. The main operation interfaces are as follows:

#### 5.1.3.1 Sweep mode

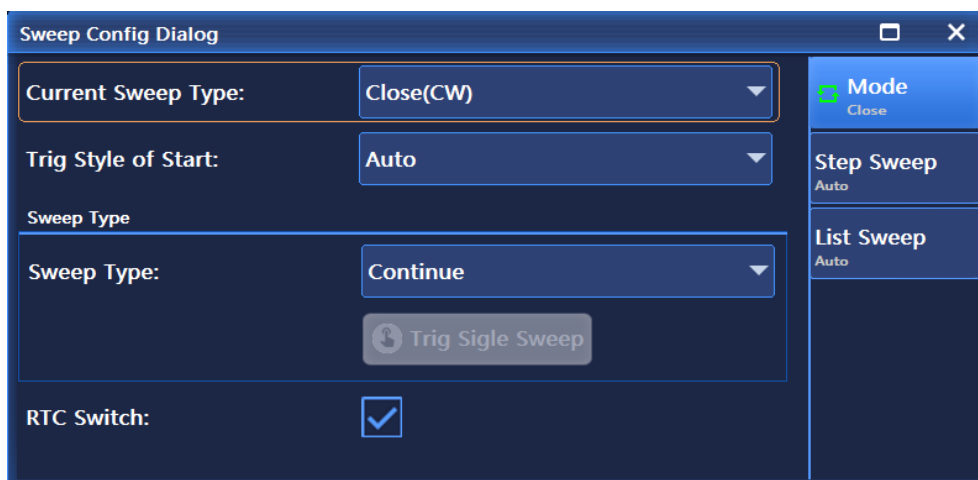

Figure 5.9 Sweep mode interface

As shown in Figure 5.9, the Mode interface is mainly used to set parameters including Current Sweep Type, Trig Style of Start, Sweep Type and RTC Switch, etc. Where, the Current Sweep Type options mainly includes Close (CW), Step Sweep and List Sweep. The Trig Style of Start options mainly include Auto, Bus, Ext and Key, and the Sweep Type options mainly include Continuous and Single.

5.1 Menu Structure and Parameter Settings

5.1.3.2 Step Sweep

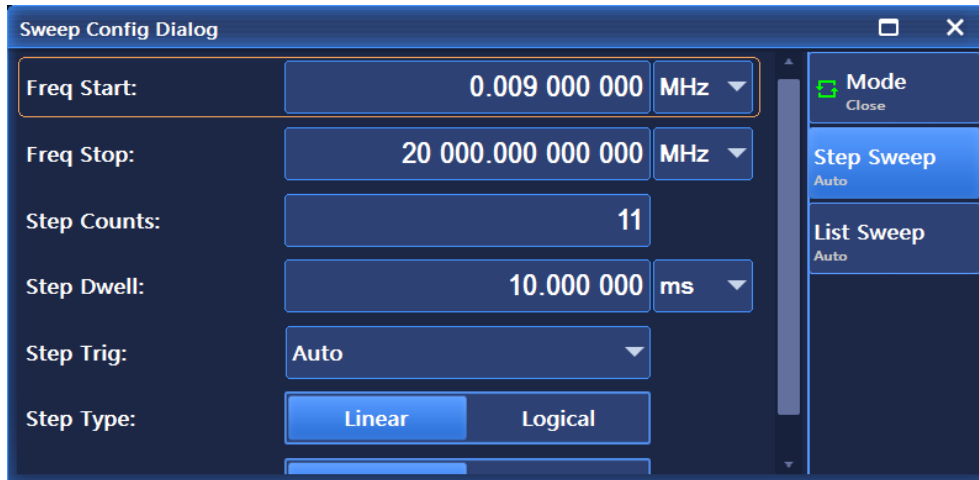

Figure 5.10 Step Sweep interface

As shown in Figure 5.10, the Step Sweep interface is mainly used to set step sweep parameters, including Freq Start, Freq Stop, Step Counts, Step Trig, Step Type and Step Sweep Direction, etc. Where, Step Type options include Linear and logarithm, and the Step Sweep Direction options include Forward and Backward.

5.1.3.3 List Sweep



Figure 5.11 List Sweep interface

As shown in Figure 5.11, the List Sweep interface is mainly used to set list sweep parameters including Freq Start, Freq Stop, Insert Counts, All List Dwell Time, All List Power Offset, Trig List, Sweep Direction, etc.

5.1.4 Modulation

5.1.4.1 Amplitude Modulation

Press the front panel key **【Modulation】** and rotate the knob clockwise (or counterclockwise) to select [Amplitude Modulation] under [Analog Modulation]; Or click [Amplitude Modulation] in the [Analog Modulation] menu on the user interface to pop up a menu related to amplitude modulation for setting AM-related parameters. The main operation interfaces are as follows:



## 1) AM Config



Figure 5.12 AM Config interface

As shown in Figure 5.12, the Base Config interface is mainly used to set such options as AM On/Off, AM Type and Path. Where, the path options including Path 1 and Path 2, each path has such settings including Path On/Off, AM rate, LFWaveform and Depth. The waveform options include Sinc, Square, Triangle, Zigzag (including Zigzag-Up and Zigzag-Down), Function Generator (including Function Generator 1, Function Generator 2, Dual-Function Generator, Sweep Signal Generator, Noise Generator 1 and Noise Generator 2).

## 2) Am Depth

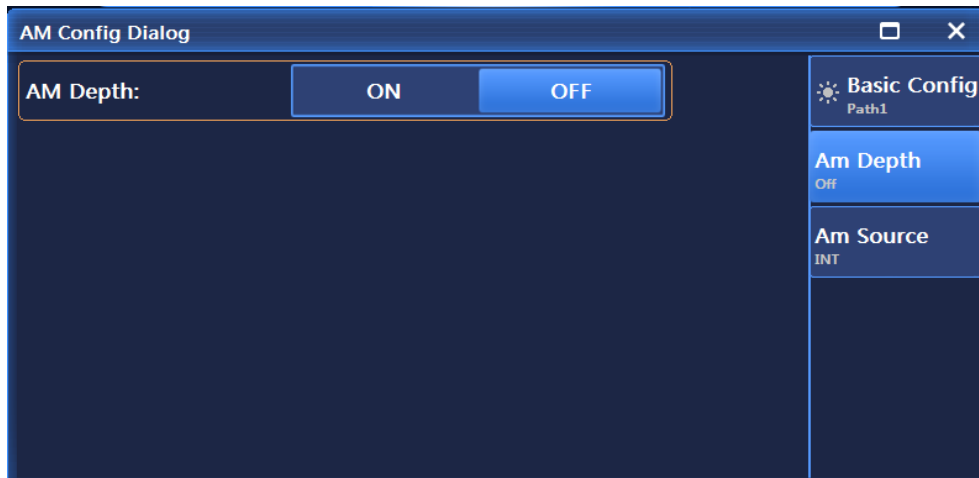

Figure 5.13 Am Depth interface

As shown in Figure 5.13, the Am Depth interface is mainly used to set such options as Am Depth On/Off.

5.1 Menu Structure and Parameter Settings

3) Am Source

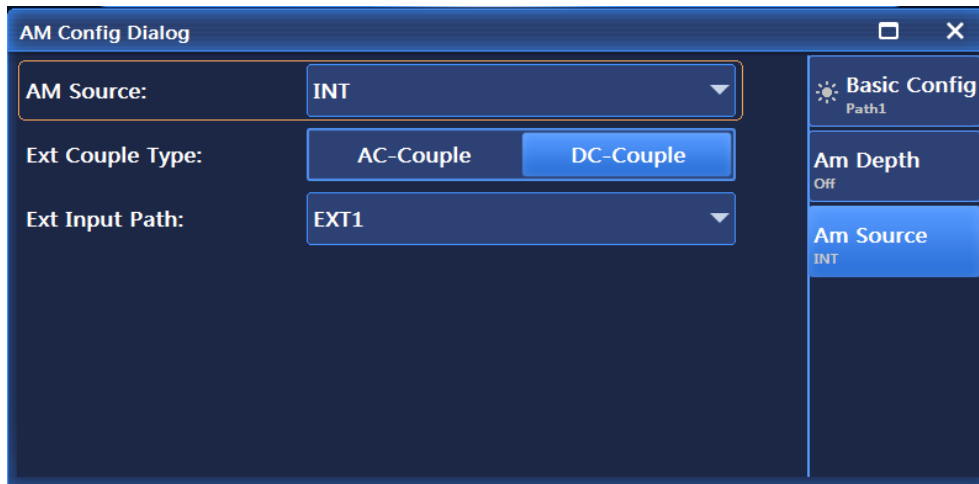

Figure 5.14 Am Source interface

As shown in Figure 5.14, the Am Source interface is mainly used to Related set such options as Am Source, Ext Couple Type and Ext Input Path. Where, Am Source options include Int and Ext (Input 50Ω), Ext (Input 600Ω) and Ext (Input 1MΩ) Ext Couple Type options include AC-Couple and DC-Couple. Ext Input Path options include Ext1 and Ext2.

5.1.4.2 Frequency Modulation

Press the front panel key **【Modulation】** and rotate the knob clockwise (or counterclockwise) to select [Frequency Modulation] under [Analog Modulation]; Or click [Frequency Modulation] in the [Analog Modulation] menu on the user interface to pop up a menu related to frequency modulation for setting FM-related parameters. The main operation interfaces are as follows:

1) FM Config



Figure 5.15 FM Config interface

As shown in Figure 5.15, the FM Config interface is mainly used to set such options as Fm On/Off, FM Type and Path. Where, the path options including Path 1 and Path 2, each path has such settings including Path On/Off, AM rate, FM Waveform and FM Offset. The waveform options include Sinc, Square, Triangle, Zigzag (including Zigzag-Up and Zigzag-Down), Function Generator (including Function Generator 1, Function Generator 2, Dual-Function Generator, Sweep Signal Generator, Noise Generator 1 and Noise Generator 2).

## 2) FM Source

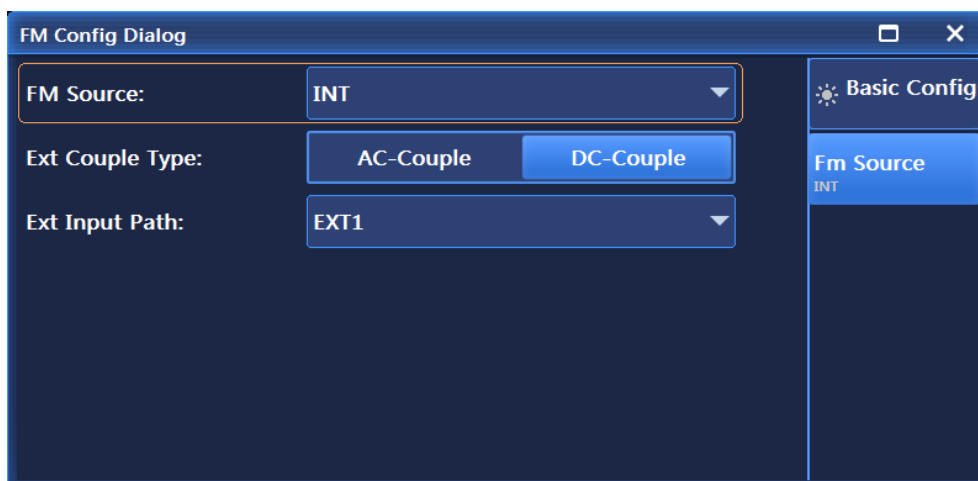

Figure 5.16 Fm Source interface

As shown in Figure 5.16, the Fm Source interface is mainly used to Related set such options as FM Source, Ext Couple Type and Ext Input Path. Where, Fm Source options include Int and Ext (Input 50Ω), Ext (Input 600Ω) and Ext (Input 1MΩ) Ext Couple Type options include AC-Couple and DC-Couple. Ext Input Path options include Ext1 and Ext2.

## 5.1.4.3 Phase Modulation

Press the front panel key **【Modulation】** and rotate the knob clockwise (or counterclockwise) to select [Phase Modulation] under [Analog Modulation]; Or click [Phase Modulation] in the [Analog Modulation] menu on the user interface to pop up a menu related to Phase modulation for setting PM-related parameters. The main operation interfaces are as follows:

## 1) PM Config

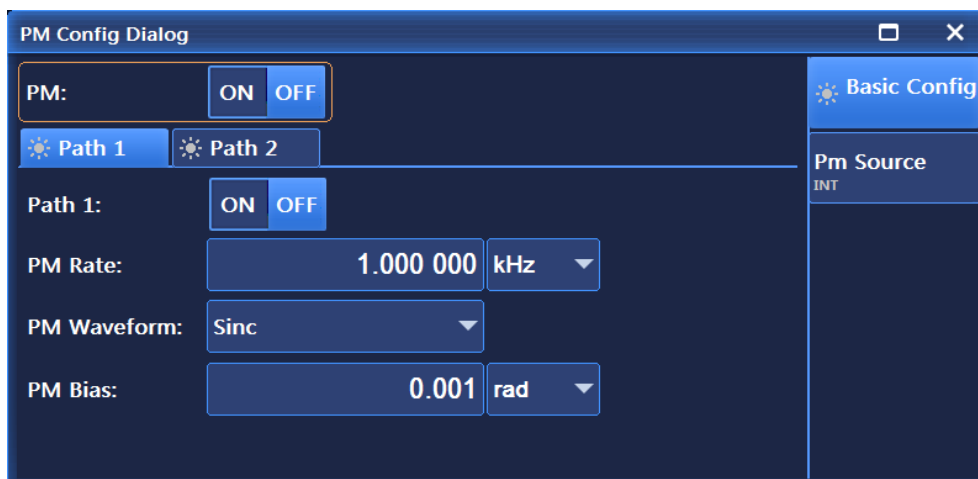

Figure 5.17 PM Config interface

As shown in Figure 5.17, the PM Config interface is mainly used to set such options as Pm On/Off, PM Type and Path. Where, the path options including Path 1 and Path 2, each path has such settings including Path On/Off, AM rate, PM Waveform and PM Offset. The PM Waveform options include Sinc, Square, Triangle, Zigzag (including Zigzag-Up and Zigzag-Down), Function Generator (including Function Generator 1, Function Generator 2, Dual-Function Generator, Sweep Signal Generator, Noise Generator 1 and Noise Generator 2).

5.1 Menu Structure and Parameter Settings

2) PM Source

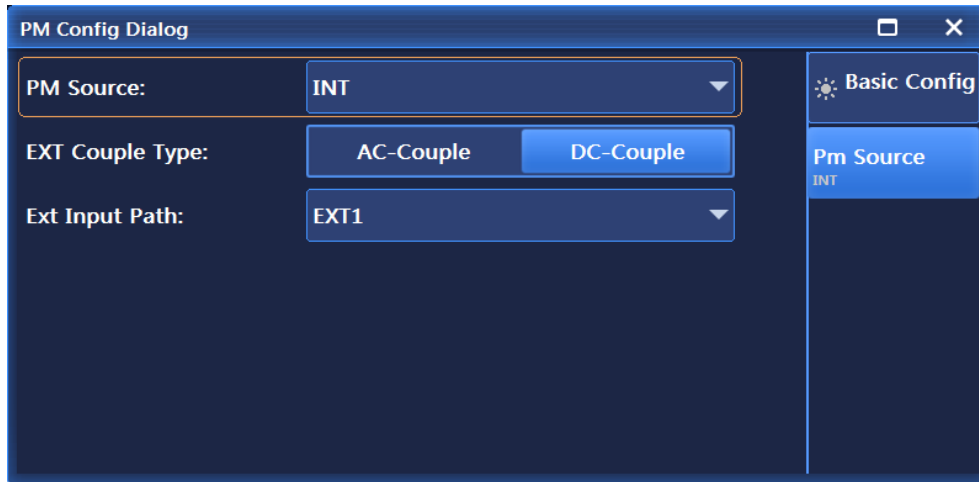

Figure 5.18 Pm Source interface

As shown in Figure 5.18, the Pm Source interface is mainly used to Related set such options as Pm Source, Ext Couple Type and Ext Input Path. Where, Pm Source options include Int and Ext (Input 50Ω), Ext (Input 600Ω) and Ext (Input 1MΩ) Ext Couple Type options include AC-Couple and DC-Couple. Ext Input Path options include Ext1 and Ext2.

5.1.4.4 Pulse Modulation

Press the front panel key **【Modulation】** or tap the [Pulse] menu in the interface menu to pop up a menu related to pulse modulation for setting parameters related to pulse modulation. The main operation interfaces are as follows:

1) Pulse Modu Config



Figure 5.19 Pulse Modu Config interface

As shown in Figure 5.19, the Pulse Modu Config interface is mainly used to set parameters such as pulse modulation On/Off, Source, Width, Delay, Period, PRF and Input Direction, etc.

## 2) Pulse Train



Figure 5.20 Pulse Train interface

As shown in Figure 5.20, the Pulse Train interface is mainly used to set such parameters as Width, Period and Fill Point Counts of the Auto Fill function in the Edit Pulse Train menus.

## 3) Staggered

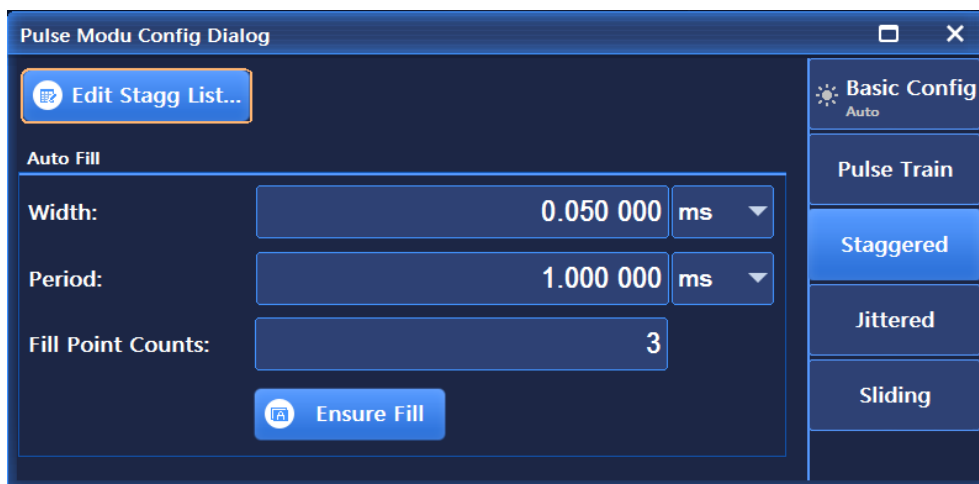

Figure 5.21 Staggered interface

As shown in Figure 5.21, the Staggered interface is mainly used to set such parameters as Width, Period and Fill Point Counts of the Auto Fill function in the Edit Stagg List menu.

5.1 Menu Structure and Parameter Settings

4) Jittered



Figure 5.22 Jittered interface

As shown in Figure 5.22, the Jittered interface is mainly used to set such parameters as Dither Style, Dither Percent, Width and Period of pulse. The Dither Style options include Random and Gaussian.

5) Sliding



Figure 5.23 Sliding interface

As shown in Figure 5.23, the Sliding interface is mainly used to set such parameters as Sliding Step, Width, Period and Sliding Counts of pulse.

5.1.5 Baseband

Press **【Modulation】** on the front panel or click the [Base] menu in the interface menu to pop up a menu related to baseband for setting parameters related to baseband. The main operation interfaces are as follows:

## 5.1 Menu Structure and Parameter Settings

## 5.1.5.1 Basic Config

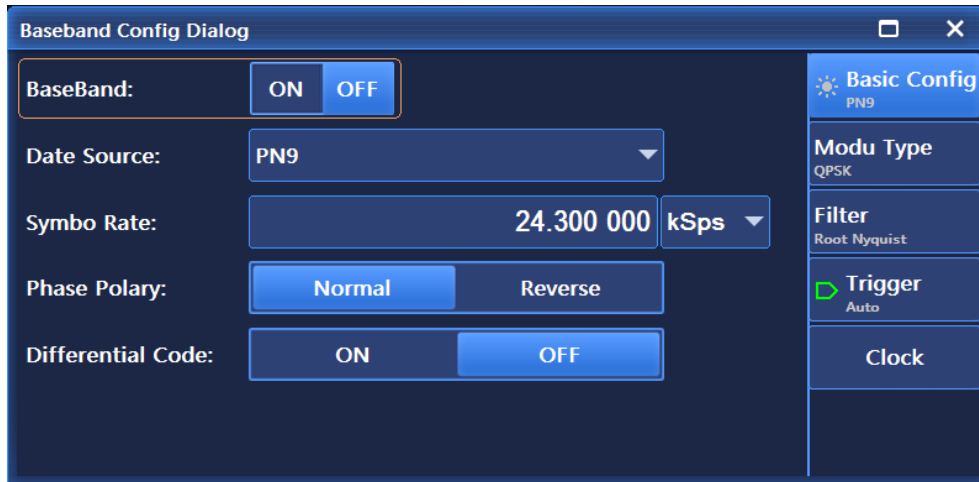

Figure 5.24 Base Config interface

As shown in Figure 5.24, the Basic Config interface is mainly used to set parameters like BaseBand On/Off, Data Source, Symbol Rate, Phase Polarity and Differential Code, etc. Data Source options including PN Serial, Fix 4, Equal 1 0, File and Ext, and the Phase Polarity options include Normal and Reverse.

## 5.1.5.2 Module Type

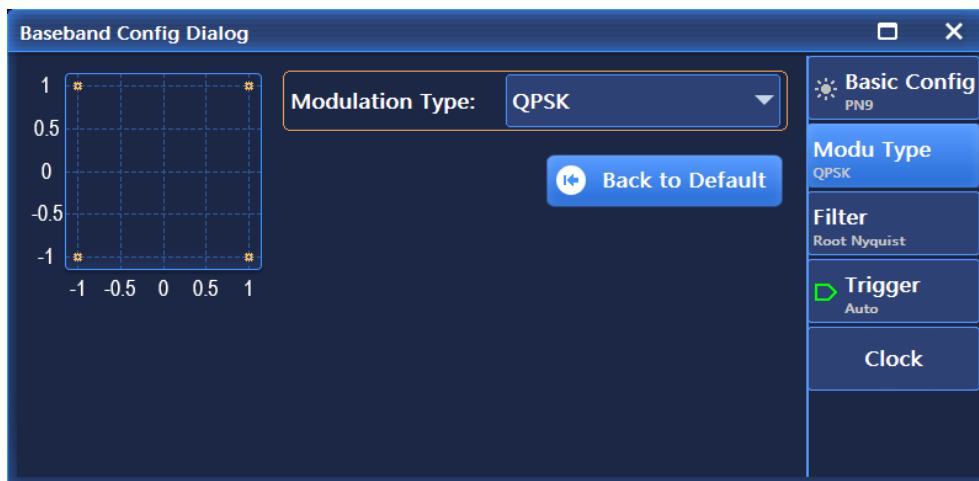

Figure 5.25 Module Type interface

As shown in Figure 5.25, the Module Type interface is mainly used to set modulation type parameters, including Modulation Type and Back to Default Module Type. Where, the modulation types mainly include PSK, MSK, FSK, QAM, ASK, user I/Q and user FSK.

5.1 Menu Structure and Parameter Settings

5.1.5.3 Filter

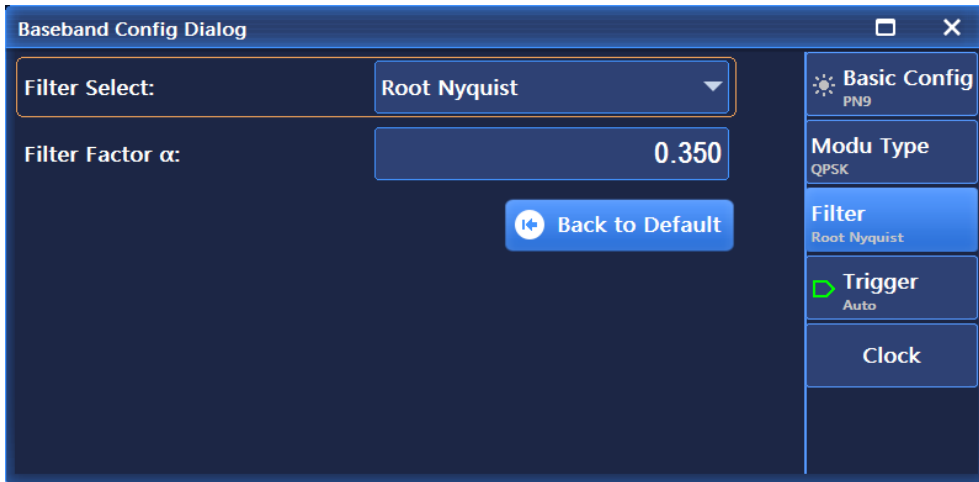

Figure 5.26 Filter interface

The Filter interface, as shown in Figure 5.26, is mainly used to set parameters like Filter Select and Filter Factor  $\alpha$ , etc.. Where, the filter types include Root Nyquist, Nyquist, Gauss and Rectangle.

5.1.5.4 Trigger

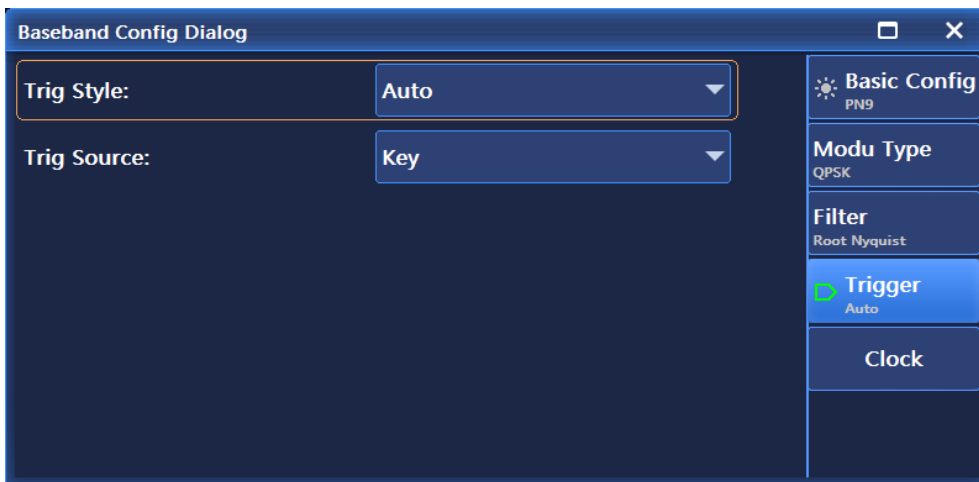

Figure 5.27 Trigger interface

The Trigger interface, as shown in Figure 5.27, is mainly used to set parameters like Trig Style and Trig Source, etc.. Where, the Trig Style options mainly include Continue (Auto, Trigger, Realtime), Single and Gate (High and Low). The Trigger Source options include Key, Bus and Ext.



### 5.1.5.5 Clock

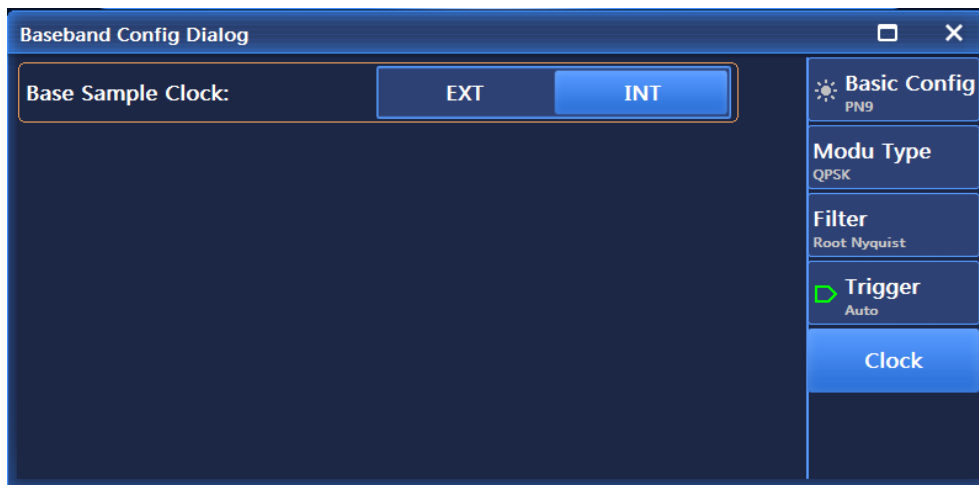

Figure 5.28 Clock interface

The Clock interface, as shown in Figure 5.28, is mainly used to set parameters like Base Sample Clock, etc.. Base Sample Clock options include Ext and Int.

### 5.1.6 I/Q

Press the **【I/Q】** key on the front panel or click [I/Q] in the user interface to pop up a menu related to I/Q for setting parameters related to I/Q. The main operation interfaces are as follows:

#### 5.1.6.1 I/Q Config

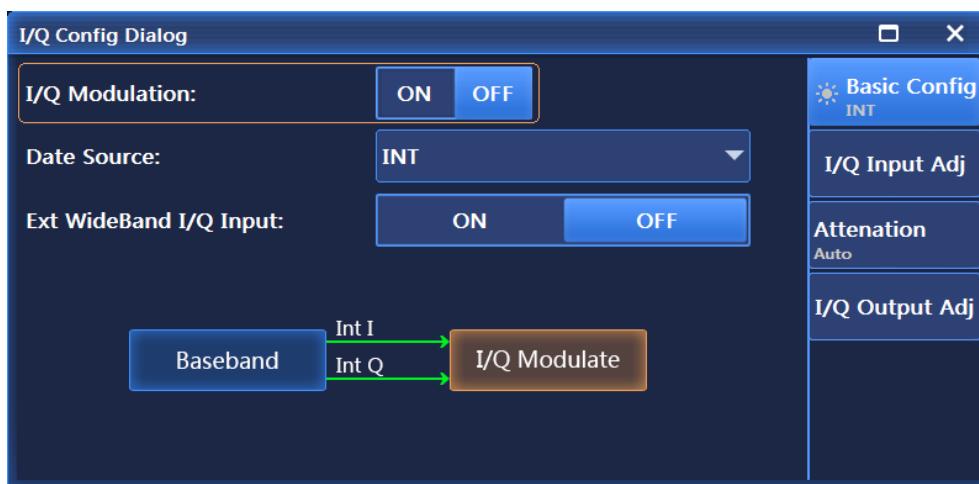

Figure 5.29 Base Config interface

As shown in Figure 5.29, the I/Q Config interface is mainly used to set parameters such as I/Q Modulate On/Off, Data Source and Ext WideBand I/Q Input On/Off. Where, the Data Source options include Ext 50Ω and Int.

### 5.1 Menu Structure and Parameter Settings

#### 5.1.6.2 I/Q Input Adj

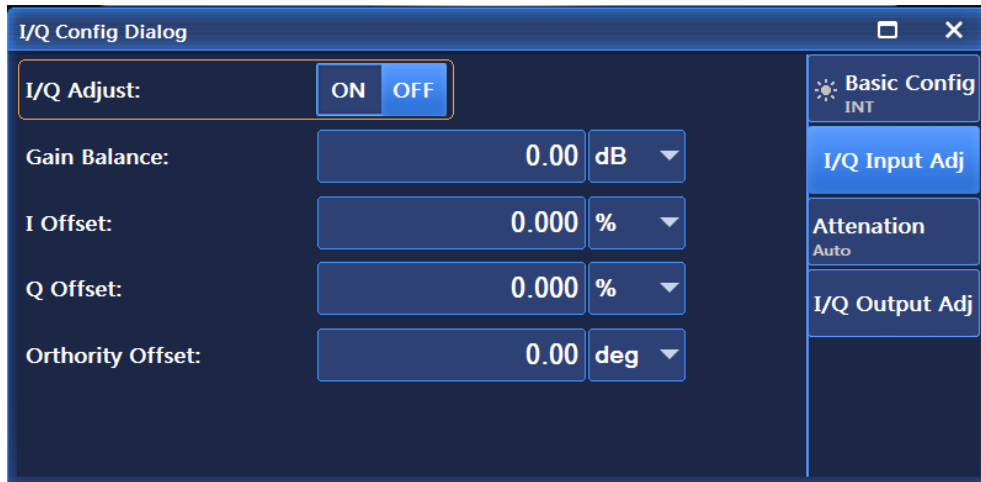

Figure 5.30 I/Q Input Adj

The I/Q Input Adj interface, as shown in Figure 5.30, is mainly used to set parameters like I/Q Adjust On/Off, Gain Balance, I Offset, Q Offset and Orthority Offset, etc.

#### 5.1.6.3 Attenuation

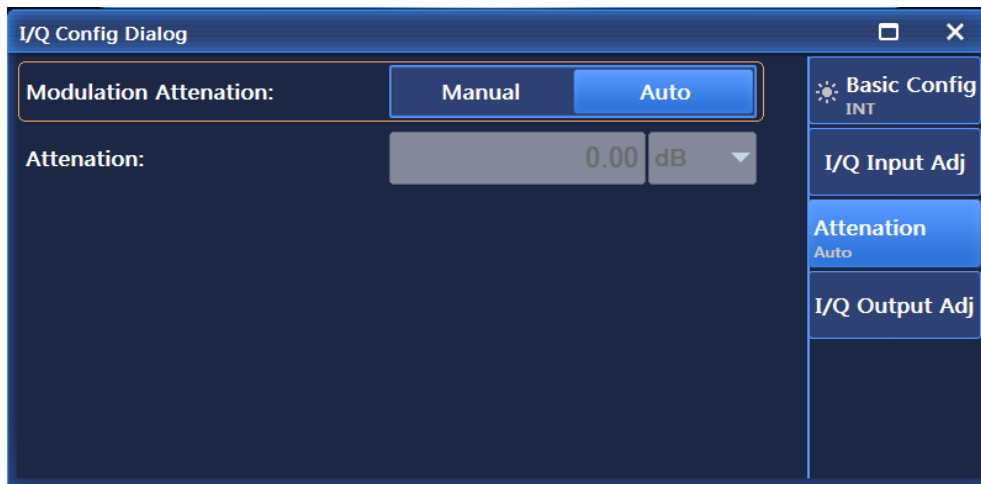

Figure 5.31 Attenuation interface

The Attenuation interface, as shown in Figure 5.31, mainly includes Modulation Attenuation option, when set to Manual, you can set attenuation value here.

### 5.1.6.4 I/Q Output Adj

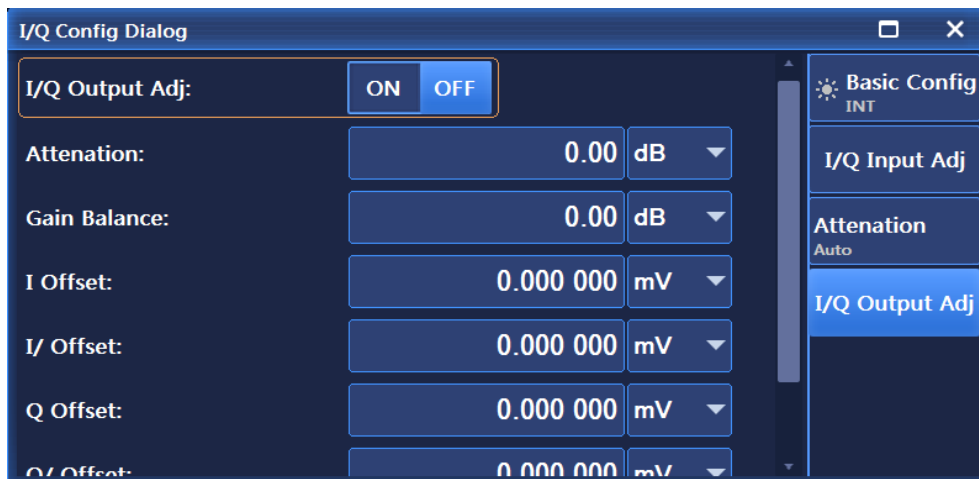

Figure 5.32 I/Q Output Adj interface

The I/Q Output Adj interface, as shown in Figure 5.32, is mainly used to set parameters like I/Q Adjust On/Off, Attenuation, Gain Balance, I Offset, I/Offset, Q Offset, Q Offset and Orthority Offset, etc.

### 5.1.7 Arbitrary Wave

Click the [Arb] option in [Signal] to pop up a menu related to arbitrary wave for setting parameters related to arbitrary wave. The main operation interfaces are as follows:

#### 5.1.7.1 Basic Config

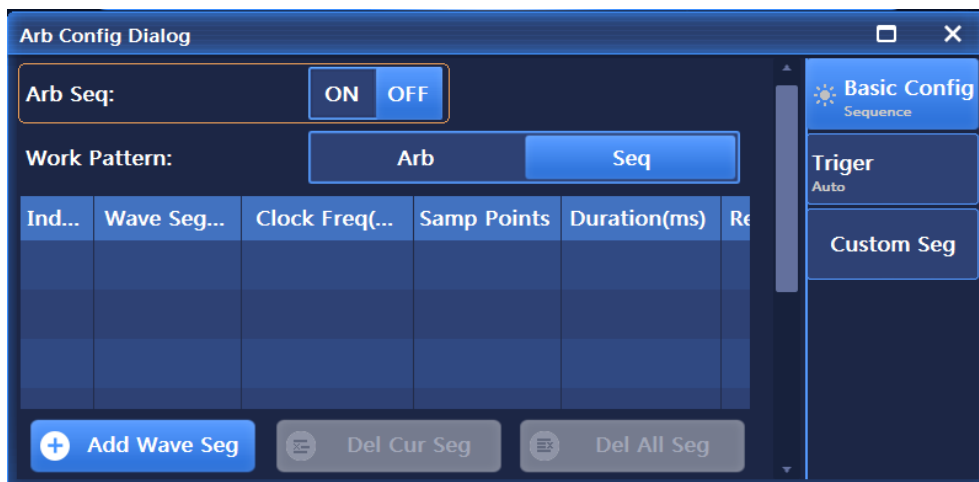

Figure 5.33 Base Config interface

The Basic Config interface, as shown in Figure 5.33, is mainly used to for such operations as Arb Seq On/Off, Work Patter and Add/Del Wave Seg, etc.

5.1 Menu Structure and Parameter Settings

5.1.7.2 Trigger

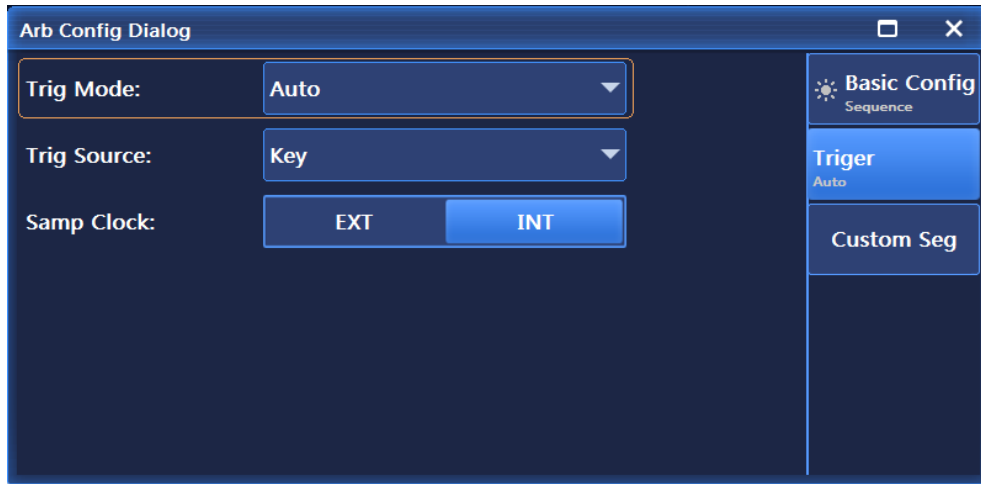

Figure 5.34 Trigger interface

The Trigger interface, as shown in Figure 5.34, is mainly used to set parameters like Trig Mode, Trig Source and Samp Clock, etc. Where, the Trigger Mode options mainly include Continuous (Auto, Trig, and Realtime), single (Ignore repeated trig, Buffer Repeated Trig and Real-time Repeated Trig), Waveform Segment (Single and Continuous), Gate (Low and High). The trigger sources are mainly Key, Bus, Ext and Int, and Sample Clock options are Ext and Int.

5.1.7.3 Customize Seg

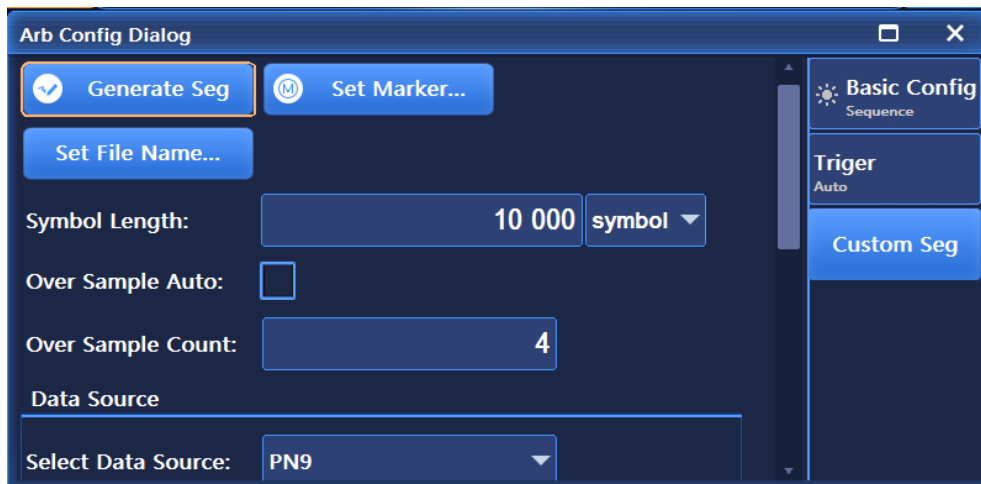

Figure 5.35 Customize Seg interface

As shown in Figure 5.35, the Customize Seg interface is mainly used to generate user-customized waveform segments. The main setting options include Symbol (code element) Length, Over Sample Auto, Over Sample Count, Data Source, Symbol Rate, Modulation Type and Filter, etc. Where, Data Source options include PN Serial, Fix 4, Equal 1 0, the Modulation Type options include PSK, MSK, FSK, QAM and ASK, and the Filter options include Root Nyquist, Nyquist, Gaussian and Rectangle, etc.

5.1.8 Tone

5.1.8.1 D-Tone

Click [D-Tone] in the [Tone] menu of the user interface to pop up a menu related to dual tone for setting parameters related to dual tone. The main operation interfaces are as follows:

## 1) Dual Config

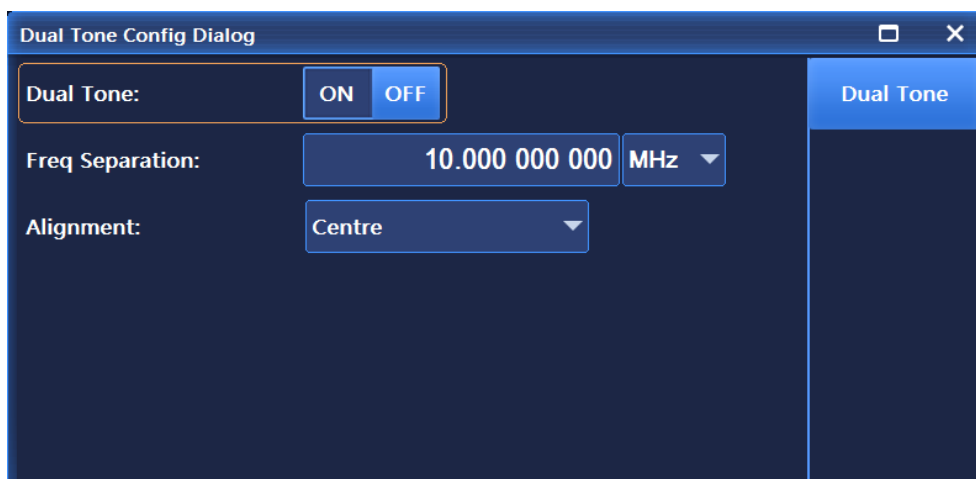

Figure 5.36 Dual Config Dialog window

The Dual Config Dialog window, as shown in Figure 5.36, is mainly used to set the dual tone mode, including such parameters as Dual Tone On/Off, Freq Separation and D-Tone Offset. Where, D-Tone Offset options include Left, Center and Right.

## 5.1.8.2 M-Tone

Click [M-Tone] in the [Tone] menu of the user interface to pop up a menu related to multi tone for setting parameters related to multi tone. The main operation interfaces are as follows:

## 1) Basic Config

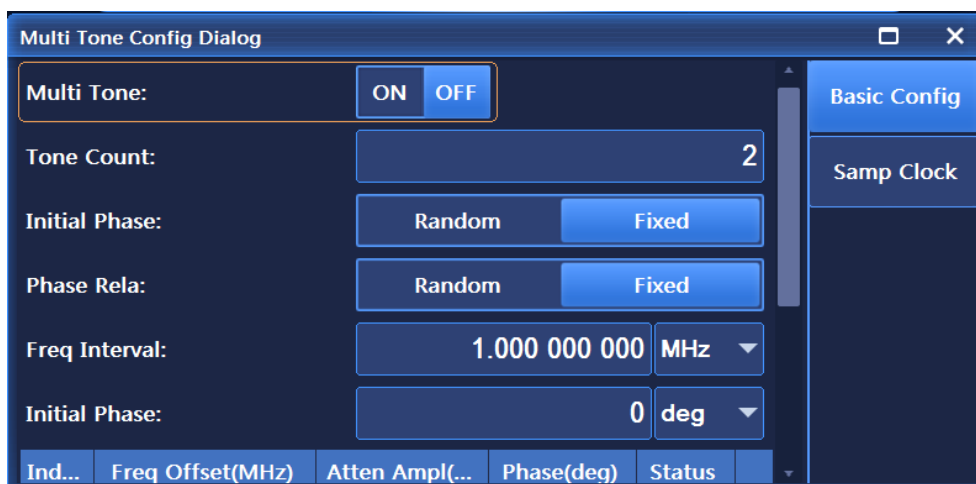

Figure 5.37 Base Config interface

The Basic Config Dialog window, as shown in Figure 5.37, is mainly used to set the multi tone mode, including such parameters as Multi Tone On/Off, Initial Phase, Tone Count, Phase Rela, Freq Interval and Initial Phase, etc. Where, the Initial Phase options include Random and Fixed, and the Phase Rela options include Random and Fixed

5.1 Menu Structure and Parameter Settings

2) Samp Clock

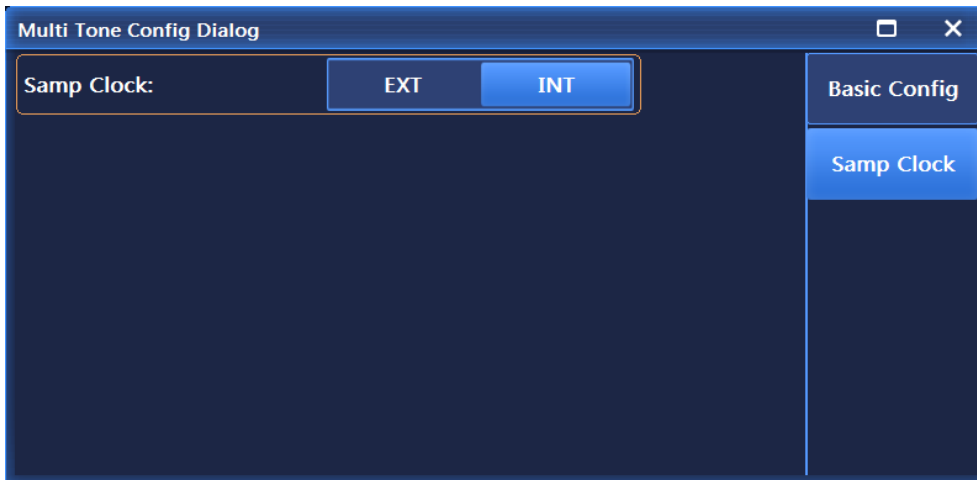

Figure 5.38 Samp Clock interface

The Samp Clock interface, as shown in Figure 5.38, is mainly used to set the sample clock type and external clock frequency when in the Ext mode.

5.1.9 AWGN (Optional)

Click the [AWGN] menu of the user interface to pop up a menu related to noise for setting parameters related to noise. The main operation interfaces are as follows:

5.1.9.1 Basic Config

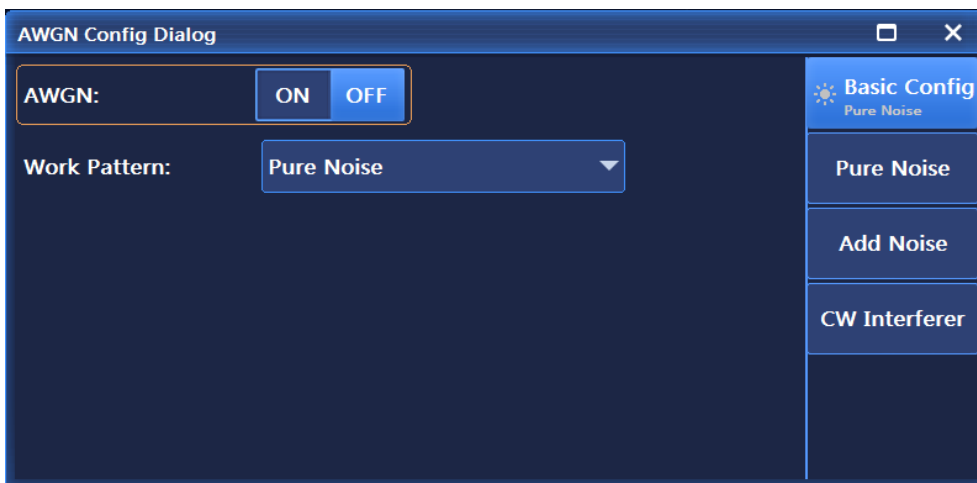

Figure 5.39 Base Config interface

The Basic Config interface, as shown in Figure 5.39, is mainly used to set the noise switch and the work pattern, etc. Where, the Work Pattern options include Pure Noise, Add Noise, and CW Interferer.

### 5.1.9.2 Pure Noise

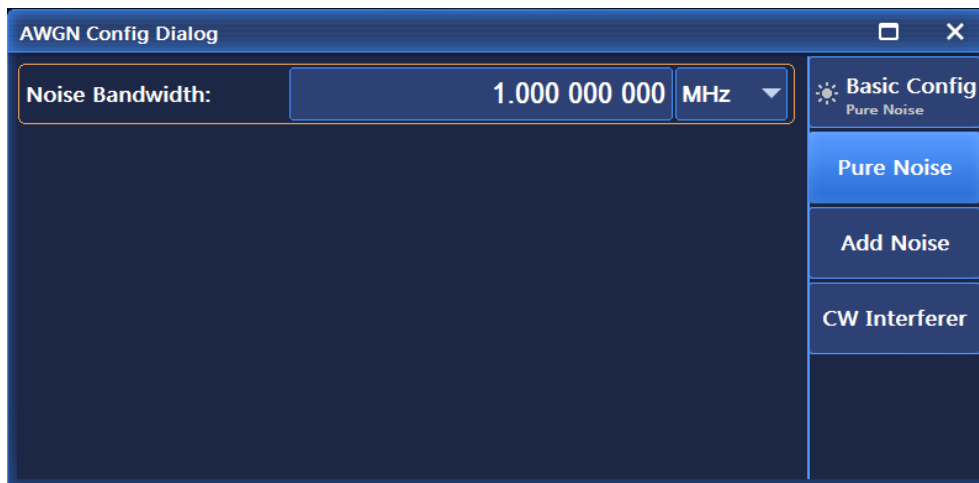

Figure 5.40 Pure Noise interface

As shown in Figure 5.40, the Pure Noise interface is mainly used to set the specific value of noise bandwidth when the work pattern is Pure Noise.

### 5.1.9.3 Add Noise

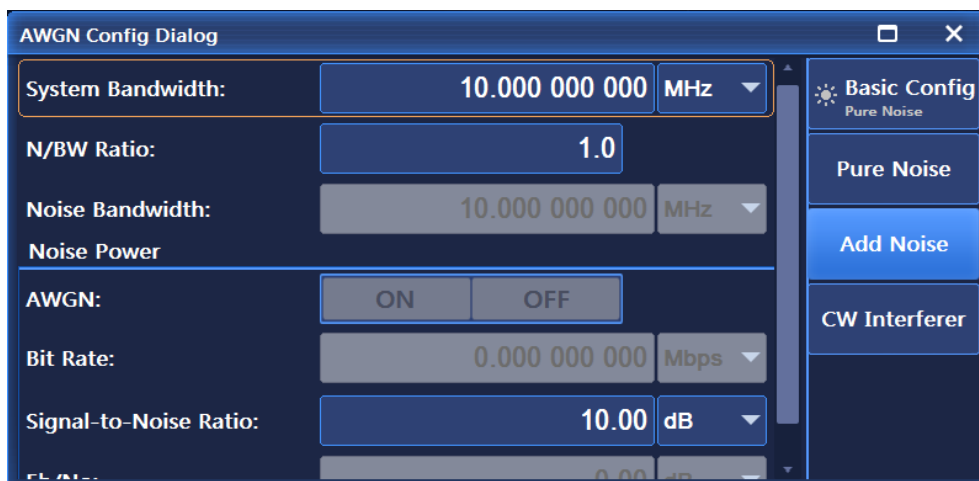

Figure 5.41 Add Noise interface

As shown in Figure 5.41, the Add Noise interface is mainly used to set the such parameters as System Bandwidth, Noise/System Bandwidth Ratio, Noise Bandwidth and Noise Power when the work pattern is Add Noise.

5.1 Menu Structure and Parameter Settings

5.1.9.4 CW Interferer

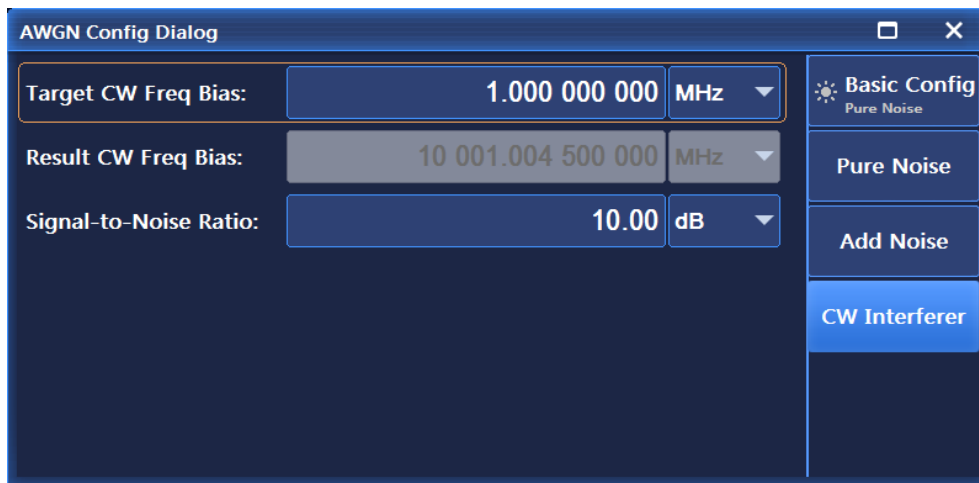

Figure 5.42 CW Interferer interface

As shown in Figure 5.42, the CW Interferer interface is mainly used to set the such parameters as Target CW Freq Bias, Result CW Freq Bias and Signal-to-Noise Ratio when the work patten is CW Interferer.

5.1.10 System

Press the **【System】** key on the front panel or click the [System] menu in the user interface to pop up a menu related to the system for setting system-related parameters. The main operation interfaces are as follows:

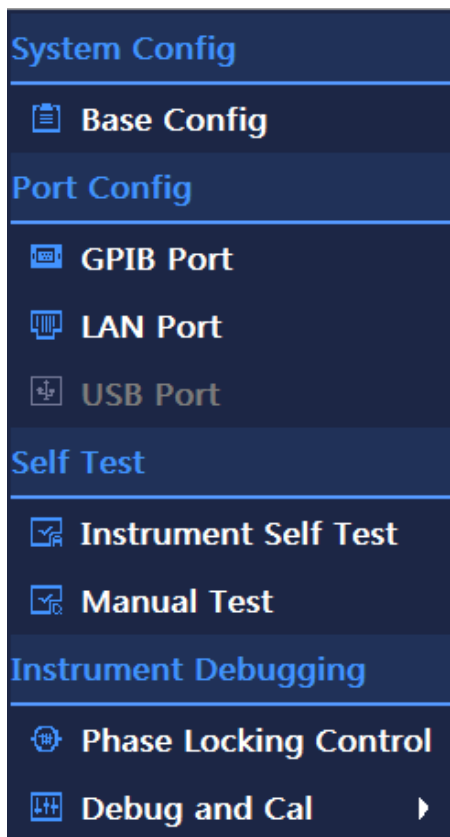

Figure 5.43 System interface

As shown in Figure 5.43, the System interface includes such main setup modules as System Config,



Port Config, Self Test and Instrument Debugging, etc.

### 5.1.10.1 System Config

#### 1) Reference

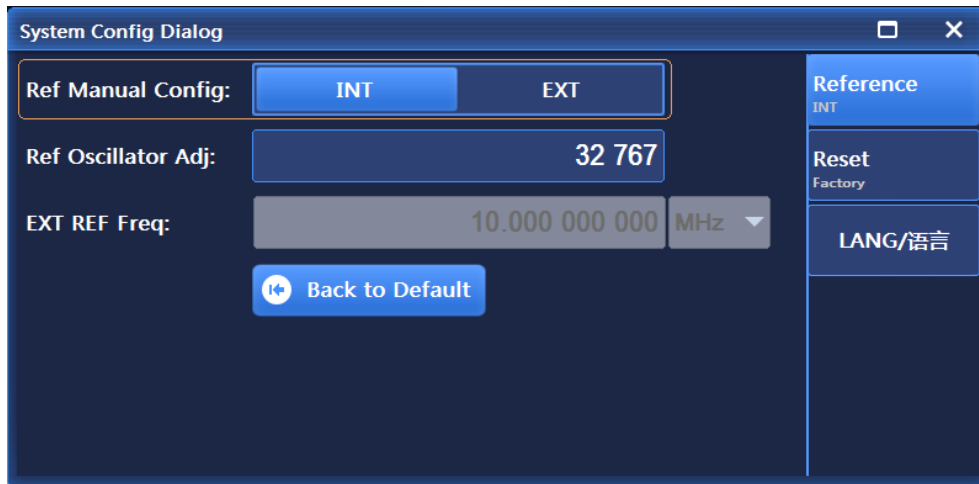

Figure 5.44 Reference interface

As shown in Figure 5.44, the Reference interface mainly include such parameters as Ref Manual Config, Ref Manual Config when set to Manual Reference, Ext Ref Freq when set to Ext Reference, and Back to Default.

#### 2) Reset

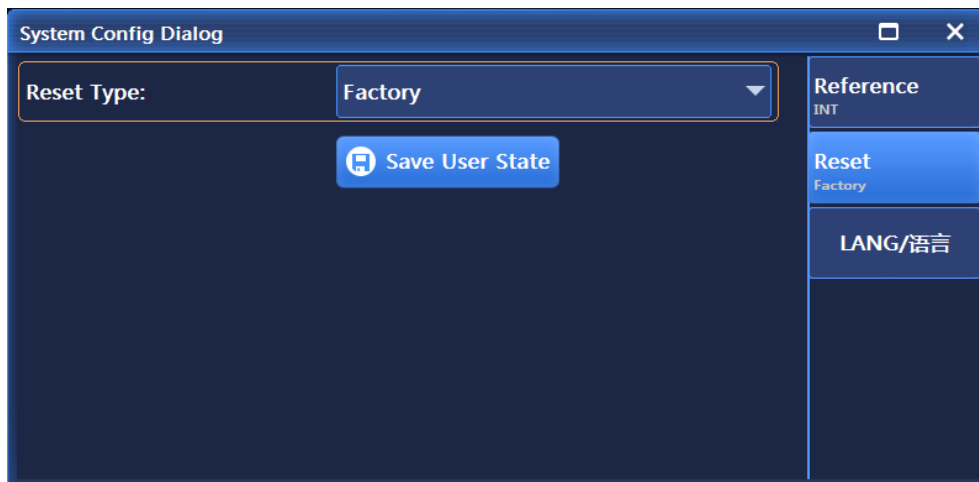

Figure 5.45 Reset interface

As shown in Figure 5.45, the Reset interface mainly includes such options as Reset Type and Save User State after the user saves the settings. Where, the Reset Type options include Factory, User and Last State.

5.1 Menu Structure and Parameter Settings

3) LANG

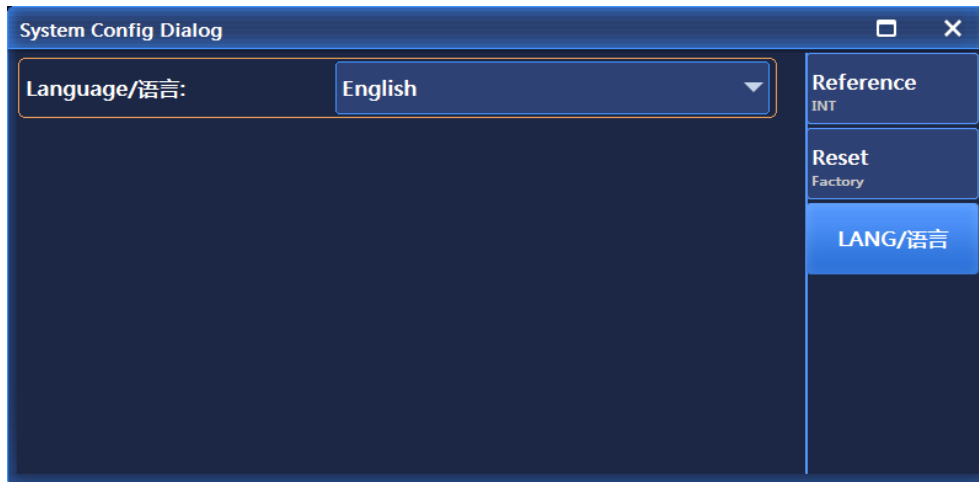

Figure 5.46 LANG interface

As shown in Figure 5.46, the LANG interface is mainly used to set the language of the system. This system supports Chinese and English, which are switchable as required.

5.1.10.2 Port Config

1) GPIB

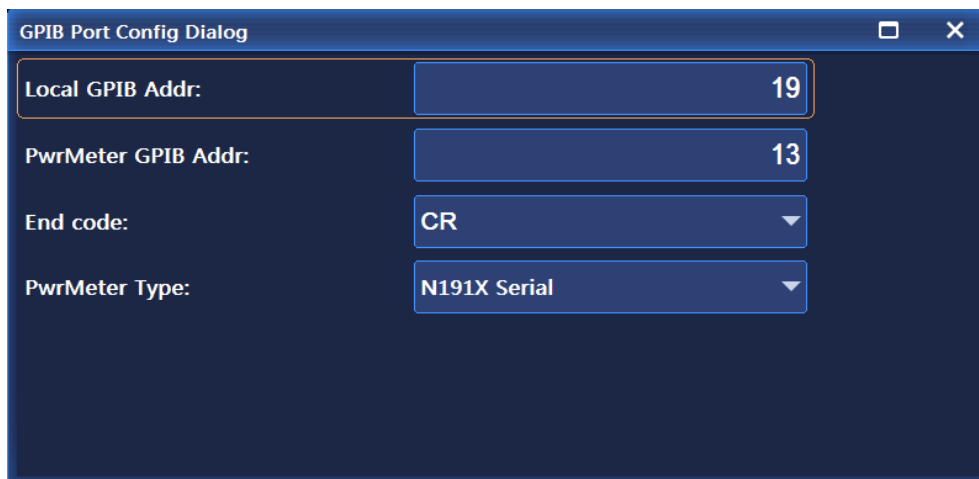

Figure 5.47 GPIB Port Config interface

As shown in Figure 5.47, the GPIB Port Config interface is mainly used to set such options as Local GPIB Addr, PwrMeter GPIB Addr, END Code and PwrMeter Type. Where, the END Code options include CR, LF and EOL, PwrMeter Type options include N191X Series, 2434/36/38 Series and 2432 Series.

## 2) LAN

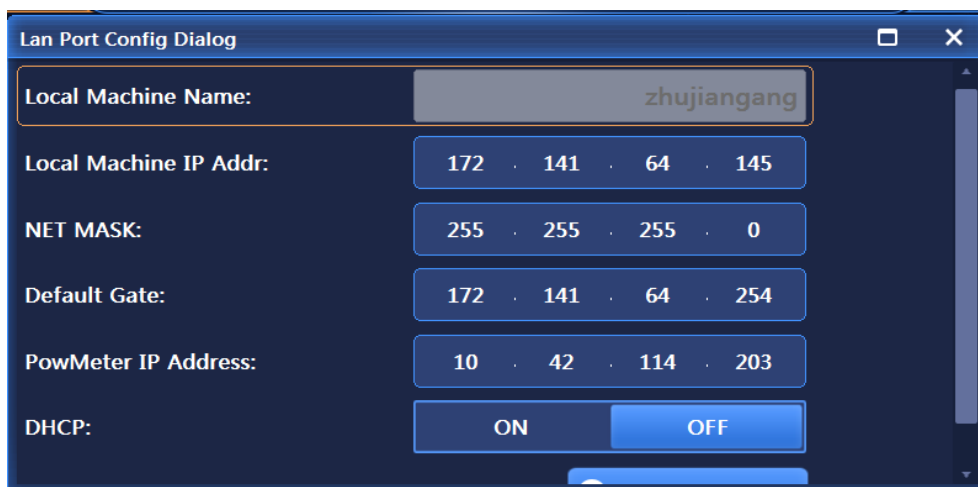

Figure 5.48 LAN interface

The Lan Port Config interface, as shown in Figure 5.48, is mainly used to set such options as Local Machine Name, Local Machine IP Addr, NET MASK, Default Gate, PowMeter IP Address, DHCP On/Off and Apply Net Config, etc.

## 5.1.10.3 Self Test

## Instrument Self Test/Manual Test

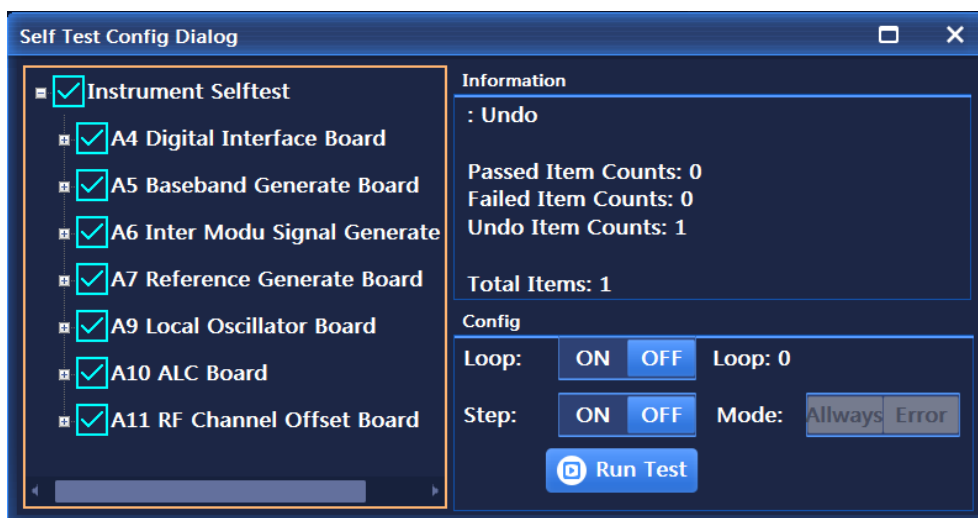

Figure 5.49 Self-test interface

The self-test interface, as shown in Figure 5.49, is mainly used for self-test of the instrument, mainly including two modes, Instrument Self-test and Manual Test. Instrument Self-test will perform self-test on all modules of the instrument, and Manual Test allows users to select corresponding modules for self-test. The interface also includes such buttons as Loop, Step and Run Test.

## 5.1.10.4 Instrument Debugging

## 1) Debug and Cal

This part mainly includes setup interfaces required for factory debugging.

## 5.1.11 Storage/Loading

Press the **【File】** key on the front panel to pop up a menu related to storage/loading for setting related parameters. The main operation interfaces are as follows:

## 5.1 Menu Structure and Parameter Settings

### 5.1.11.1 Store

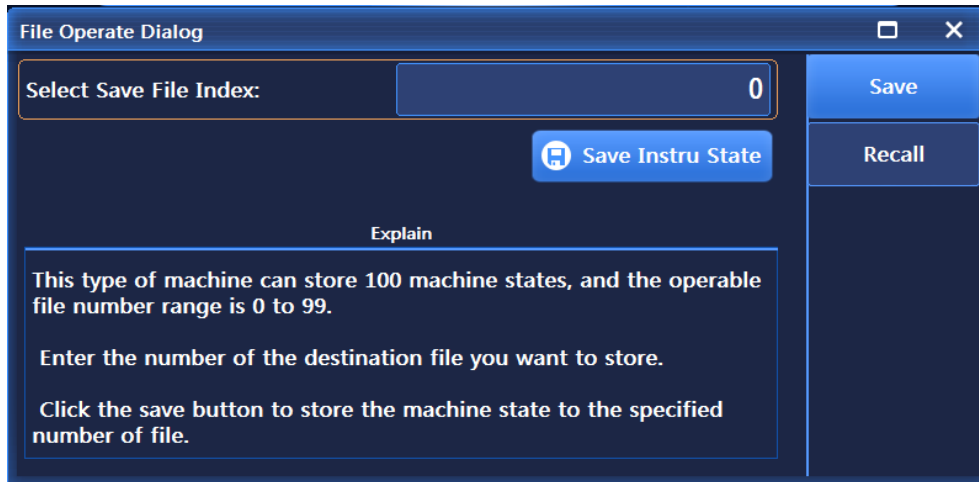

Figure 5.50 Store interface

As shown in Figure 5.50, the Store interface mainly stores the instrument state of the signal generator, including options like Select File No. and Save Instrument State. This signal generator can store 0-99 instrument states.

### 5.1.11.2 Recall

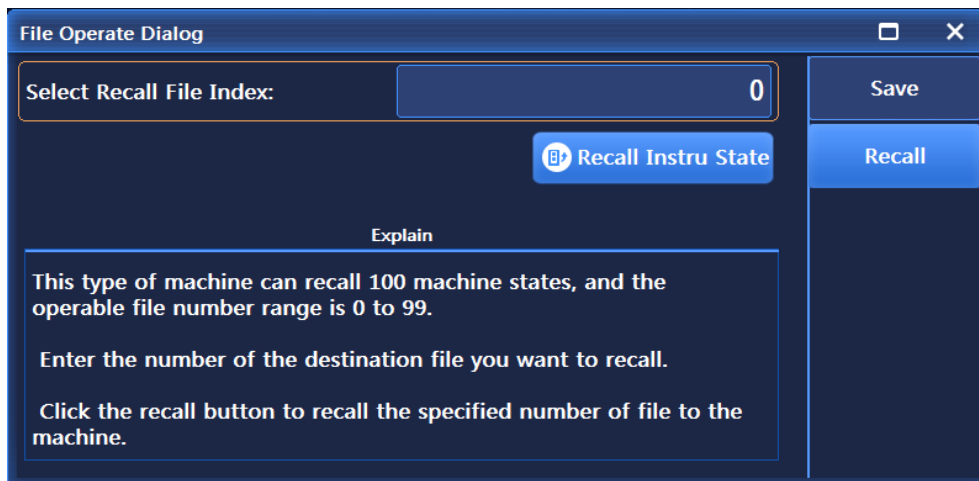

Figure 5.51 Recall interface

As shown in Figure 5.51, the Recall interface mainly calls the instrument states of the signal generator, including options like Select File No. and Call Instrument State. This signal generator allows for calling 0-99 instrument states freely.

## 5.1.12 Calibration

This instrument only supports power Pltc calibration for the time being. Press the **【Calibration】** key on the front panel to pop up a menu related to calibration for setting related parameters. The main operation interfaces are as follows:

## 5.2 Menu Description

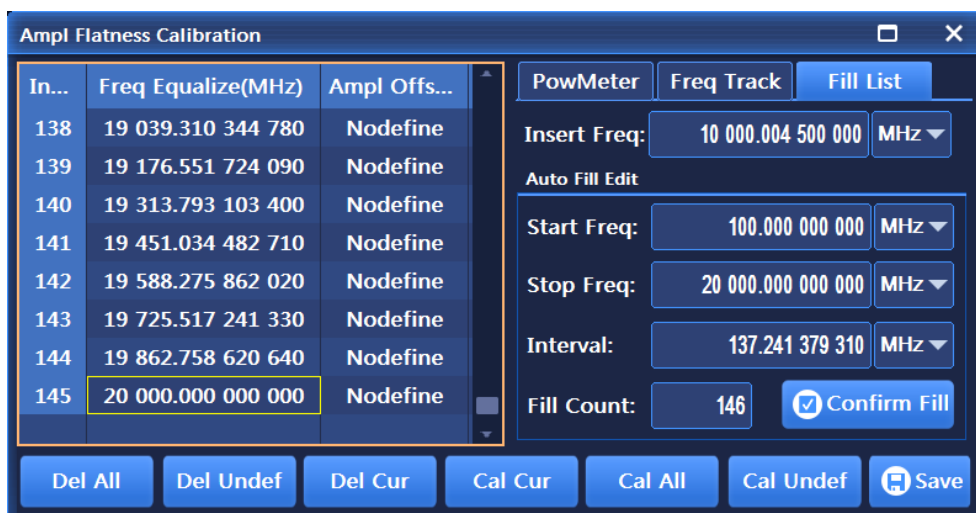

Fig. 5.52 Power and Pltc interface

As shown in Figure 5.52, the Power Pltc interface is mainly used to set such options as Power Pltc Cal, including Freq Follow-up Switch, PwrMeter Connection Mode, Insert Freq Point and Auto Fill Edit, etc. Where, Auto Fill Edit options include Start Fill Freq, Stop Fill Freq, Fill Freq Interval, Fill Count and Confirm Fill. After filling is completed, operations such as deletion, calibration and storage can also be performed on each filled point.

## 5.2 Menu Description

This section mainly introduces program-controlled commands for menu functions, and mainly introduces program-controlled commands for some common functions. For detailed program-controlled commands for 1435 series signal generators, please refer to the relevant programmer's command manuals.

- [Frequency.....131](#)
- [Amplitude.....135](#)
- [Sweep.....140](#)
- [Modulation.....146](#)
- [Base.....152](#)
- [I/Q.....156](#)
- [Arbitrary Wave.....162](#)
- [Tone.....168](#)
- [AWGN.....170](#)
- [System.....171](#)
- [Storage/Loading.....173](#)
- [Calibration.....174](#)

### 5.2.1 Frequency

#### 5.2.1.1 CW

**Function description:** This command sets the output frequency of the signal generator in continuous wave mode.

**Setting format:** [:SOURce]:FREQUENCY[:CW] <val>

**Query format:** [:SOURce]:FREQUENCY[:CW]?

## 5.2 Menu Description

### Parameter Description:

<Frequency> Output frequency in the CW mode.

Model	Range
1435A	[9kHz~3GHz]
1435A-V	[9kHz~3GHz]
1435B	[9kHz~6GHz]
1435B-V	[9kHz~6GHz]
1435C	[9kHz~12GHz]
1435D	[9kHz~20GHz]
1435F	[9kHz~40GHz]

**Example:** [:SOURce]:FREQUENCY 10GHz sets the dot frequency of the signal generator to 10GHz.

### 5.2.1.2 Frequency Generation Mode

**Function description:** Setting the frequency generation mode of the signal generator

**Setting format:** [:SOURce]:FREQUENCY:MODE FIXed|CW|STEP|LIST

**Query format:** [:SOURce]:FREQUENCY:MODE?

### Parameter Description:

<Mode> Discrete data, frequency generation mode to be configured. Values are taken as follows:

FIXed|CW The setting of these two discrete parameters has the same meaning in this signal generator, that is, the control signal generator outputs continuous wave (dot frequency) signals, and this mode will terminate the frequency sweep signal currently output by the instrument.

STEP This parameter sets the current frequency generation mode to step sweep mode.

LIST Setting the frequency generation mode to List. If the current list is empty, the signal generator will prompt that the list is empty. At least one sweep point is stored in the list before the signal generator can start the sweep.

**Example:** FREQUENCY:MODE LIST sets the signal generator to list sweep mode.

### 5.2.1.3 Frequency Offset

**Function description:** When the set frequency offset is not zero, the offset indicator "Offset" is displayed above the frequency display area, and the display value changes to the frequency value after the offset is added. At this time, the display frequency value = RF output frequency value x multiple factor+frequency offset, but the real frequency output is still the frequency before the double factor and frequency offset. When the frequency offset is set to zero, the indicator disappears.

**Setting format:** [:SOURce]:FREQUENCY:OFFSet <val>

**Query format:** [:SOURce]:FREQUENCY:OFFSet?

### Parameter Description:

<FreqOffs> Frequency offset.

Range: 0Hz[-325GHz, +325GHz].

**Example:** :FREQUENCY:OFFSetr 10GHz sets the frequency offset of the signal generator to 10GHz.

#### 5.2.1.4 Frequency Reference On/Off

**Function description:** This command sets whether the frequency reference switch is on. When the frequency reference is turned on and the continuous wave frequency of the signal generator is changed, the frequency reference indicator "reference" is displayed above the frequency display area. The frequency value displayed in the frequency display area is based on the frequency reference. When the switch is not turned on, the frequency value displayed in the frequency display area is the actual continuous wave frequency of the signal generator.

**Setting format:** [:SOURce]:FREQUency:REFerence:STATe ON|OFF|1|0

**Query format:** [:SOURce]:FREQUency:REFerence:STATe?

**Parameter Description:**

<State> Boolean data, with the following values:

ON | 1: Frequency reference on,

OFF | 0: Frequency reference off.

**Example:** :FREQUency:REFerence:STATe 1 Frequency Reference of the signal generator on.

#### 5.2.1.5 Frequency Reference

**Function description:** This command sets the frequency reference function, which can be used normally when the frequency reference switch is turned on. Any continuous wave output signal set at this time will be subtracted from the frequency reference value. For example: the current continuous wave output frequency is 1GHz. If the frequency reference is set to 1GHz, the continuous wave output frequency displayed at this time will be based on the frequency reference of 0Hz, so the display in the frequency display area will be 0Hz and the actual signal generator output frequency will be 1GHz. If the continuous wave frequency is set to 1MHz, the frequency display area will be 1MHz and the actual output frequency will be 1.001GHz.

**Setting format:** [:SOURce]:FREQUency:REFerence <val>

**Query format:** [:SOURce]:FREQUency:REFerence?

**Parameter Description:**

<FreqRef> Frequency reference.

Model	Range
1435A	[9kHz~3GHz]
1435A-V	[9kHz~3GHz]
1435B	[9kHz~6GHz]
1435B-V	[9kHz~6GHz]
1435C	[9kHz~12GHz]
1435D	[9kHz~20GHz]
1435F	[9kHz~40GHz]

**Example:** :FREQUency:REFerence 10GHz This example shows setting the relative frequency of the signal generator to 10GHz

#### 5.2.1.6 Frequency Multiplication Coefficient

**Function description:** This command sets the multiplication factor for the signal source frequency. When the frequency multiplier is set to a value greater than 1, the multiplier indicator "multiplier" is displayed above the frequency display area. At this time, the display frequency value = RF output frequency value x multiplier factor, but the actual frequency output is still the frequency before the multiplier factor is not doubled. When the frequency multiplier is set to 1, the indicator disappears.

## 5.2 Menu Description

**Setting format:** [:SOURce]:FREQUENCY:MULTIPLIER <val>

**Query format:** [:SOURce]:FREQUENCY:MULTIPLIER?

**Parameter Description:**

<FreqMult> Multiplier factor.

Range: 1 [1,36].

**Example:** :FREQUENCY: MULTIPLIER 8 The frequency multiplication coefficient of the signal generator is 8.

### 5.2.1.7 Setting LF Generators

This menu is used to set low-frequency generators of signal generators. Click the menu to enter the submenu

#### 1) LF output switch

**Function description:** This command sets the low-frequency output switch of the signal generator.

**Setting format:** [:SOURce]:LFOutput:STATE ON|OFF|1|0

**Query format:** [:SOURce]:LFOutput:STATE?

**Parameter Description:**

<State> Boolean data, with the following values:

ON | 1: Low frequency output on, low frequency signal output is on.

OFF | 0: Low frequency output is off, low frequency signal output is off.

**Example:** :LFOutput:STATE OFF turns off low-frequency signal output.

#### 2) Low frequency

**Function description:** This command sets low-frequency output frequency.

**Setting format:** [:SOURce]:LFOutput:FREQUENCY <val>

**Query format:** [:SOURce]:LFOutput:FREQUENCY?

**Parameter Description:**

<Frequency> Outputs signal frequency at low frequency.

Range: 400Hz[0.01Hz , 10MHz].

**Example:** :LFOutput:FREQUENCY 1MHz sets low-frequency output frequency to 1MHz.

#### 3) LF Amplitude

**Function description:** This command sets the signal amplitude output from the low frequency output BNC connector of the signal generator

**Setting format:** [:SOURce]:LFOutput:AMPLITUDE <val> ( unit:Vpp|Mvpp|VRMS )

**Query format:** [:SOURce]:LFOutput:AMPLITUDE?

**Parameter Description:**

<Ampl> Outputs signal frequency at low frequency.

Range: 2.000Vpp[0.002Vpp, 5.000Vpp].

**Example:** :LFOutput:AMPLITUDE 1VPP Sets the low frequency output signal amplitude to 1VPP.



#### 4) Waveform selection

**Function description:** This command sets the output waveforms of low-frequency signals. The user can select from Sinc, Square, Triangle and Zigzag.

**Setting format:** [:SOURce]:LFOutput:SHAPE SINE|SQUare|TRIangle|RAMP|FUNCTion[1]|FUNCTion2|DUAL|SWEep|NOISe[1]|NOISe2| DC

**Query format:** [:SOURce]:LFOutput:SHAPE?

**Parameter Description:**

<Mode> discrete data. The output waveform types of low-frequency signal are as follows:

Sine sine wave,

Square square wave,

Triangle triangular wave,

Ramp zigzag wave,

FUNCTion[1] function generator 1

FUNCTion2 function generator 2

DUAL dual-function generator

SWEep sweep function generator

NOISe[1] noise generator 1

NOISe2 noise generator 2

DC Direct current

**Example:** :LFOutput:SHAPE TRIangle The waveform of low frequency signal generator is triangular wave.

### 5.2.2 Power

#### 5.2.2.1 Power

**Function description:** This command sets the output frequency of the signal generator.

**Setting format:** [:SOURce]:POWER[:LEVel][:IMMEDIATE][:AMPLitude] <value>

**Query format:** [:SOURce]:POWER[:LEVel][:IMMEDIATE][:AMPLitude]?

**Parameter Description:**

<Ampl> Power level value.

Range: -135dBm [-135dBm, +30dBm].

**Example:** :POWER 0dBm Power output level set to 0dBm.

#### 5.2.2.2 Power Offset

**Function description:** The command is the actual output power offset value of the signal generator. The word "offset" will be displayed above the non-zero power display area. The power display value is the actual output power plus the power offset. The power offset value does not change the actual output power of the signal generator, but only changes the displayed power value.

**Setting format:** [:SOURce]:POWER[:LEVel][:IMMEDIATE]:OFFSet <value>

**Query format:** [:SOURce]:POWER[:LEVel][:IMMEDIATE]:OFFSet?

**Parameter Description:**

<PowOffset> Power offset value.

## 5.2 Menu Description

Range: 0dB [-100dB, +100dB].

**Example:** :POWer:OFFS -10dB Power offset value set to -10dB.

### 5.2.2.3 Power Reference Switch

**Function description:** This command sets the power reference switch state. When the power reference is on and the power reference value is not zero, the power value displayed in the power display area is based on the power reference when the power level of the signal generator is changed. When the power reference is off, the power value displayed in the power display area is the actual continuous wave output power of the signal generator.

**Setting format:** [:SOURce]:POWer:REFerence:STATe ON|OFF|1|0

**Query format:** [:SOURce]:POWer:REFerence:STATe?

**Parameter Description:**

<State> Boolean data, with the following values:

ON | 1: Power Reference on,

OFF | 0: Power Reference off.

**Example:** :POWer:REFerence:STATe 1 Power Reference on.

### 5.2.2.4 Power Reference

**Function description:** When the power reference is on, the power reference value can be set. When the power reference is on, the power display area displays the indicator "\*\*\*", and the power display value = actual output power - power reference value.

For example, the current continuous wave output power is 1dBm. If the power reference is set to 1dBm, the continuous wave output power displayed at this time will be based on the power reference, so the power display area will be displayed at 0dBm and the actual signal generator output frequency will still be 1dBm.

**Setting format:** [:SOURce]:POWer:REFerence <value>

**Query format:** [:SOURce]:POWer:REFerence?

**Parameter Description:**

<PowRef> Power reference value.

Range: 0dBm [-135dBm, +30dBm].

**Example:** :POWer:REFerence -10dBm Power reference set to -10dBm.

### 5.2.2.5 Atten Config

#### 1) ALC power

**Function description:** This command sets the ALC level value when the attenuator is set to manual.

**Setting format:** [:SOURce]:POWer:ALC:LEVel <value>

**Query format:** [:SOURce]:POWer:ALC:LEVel?

**Parameter Description:**

<AlcLevel> ALC level.

Range: 0dBm[-20dBm, +30dBm].

**Example:** :POWer:ALC:LEVel 5dBm ALC level set to 5dBm.

#### 2) Attenuation Coupling Manual

**Function description:** This command sets the control state of the internal programmable

---

**5.2 Menu Description**

stepping attenuator: Auto or Manual mode. In the Auto mode, the signal generator will automatically set the value of the power attenuator according to the current output power. In the Manual mode, the power attenuation value of the current attenuator will not change during the process of changing the power output level.

**Setting format:** [:SOURce]:POWer:ATTenuation:AUTO ON|OFF|1|0

**Query format:** [:SOURce]:POWer:ATTenuation:AUTO?

**Parameter Description:**

<State> Boolean data, with the following values:

ON | 1: Attenuation Auto,

OFF | 0: Attenuation Manual.

**Example:** :POWer:ATTenuation:AUTO 0 Attenuator set to manual.

### 3) Set Attenuation

**Function description:** This command is used to set the power attenuation value of the mechanical attenuator of the signal generator. The command setting value can only work when the attenuator is kept in the manual state.

The minimum attenuation step set by this command is 5dB, that is, the user can only set the attenuation values to 0dB, 5dB, 10dB, 15dB, with 5dB as the step. After setting the attenuation value, the output power of the signal generator is the current ALC power minus the currently set attenuation value.

**Setting format:** [:SOURce]:POWer:ATTenuation <value>

**Query format:** [:SOURce]:POWer:ATTenuation?

**Parameter Description:**

<Atten> Power attenuation value.

Range: 115dB[0dB , 115dB].

**Example:** :POWer:ATTenuation 15dB Attenuation value set to 15dB.

### 4) Attenuation pass-through [On/Off]

**Function description:**

Set attenuation pass-through On/Off, off by default.

#### 5.2.2.6 Power Step

**Function description:** Set the stepping value of power each time.

**Setting format:** [:SOURce]:POWer:STEP <value>

**Query format:** [:SOURce]:POWer:STEP?

**Parameter Description:**

<PowStep> Power reference value.

Range: 0.10dB [0.01dB, 20dB].

**Example:** :POWer:STEP 1dB Power step set to 1dB.

#### 5.2.2.7 ALC Loop

##### 1) ALC loop open

**Function description:** It is used to open or close the ALC loop. The ALC loop is mainly used to correct the power drift, and guarantee the output power level of the signal generator does not vary with the time and temperature.

## 5.2 Menu Description

**Setting format:** [:SOURce]:POWer:ALC[:STATe] ON|OFF|1|0

**Query format:** [:SOURce]:POWer:ALC[:STATe]?

**Parameter Description:**

<State> Boolean data, with the following values:

ON | 1: ALC loop closed,

OFF | 0: ALC loop opened.

**Example:** :POWer:ALC 1 To set the ALC loop to Close.

### 2) Search Style [Manual/Auto]

**Function description:** When the ALC loop of the signal generator is opened, the command is used to activate or close the auto internal power search function of the signal generator, and power search can keep the signal generator stay at the output power selected by the user when the ALC loop is closed, and keep the internal modulator in the driving status.

**Setting format:** [:SOURce]:POWer:ALC:SEARch ON|OFF|1|0|ONCE

**Query format:** [:SOURce]:POWer:ALC:SEARch?

**Parameter Description:**

<Mode> discrete data. It is the auto power search status, with values being taken as follows:

OFF | 0: This command terminates automatic power search, and the search style is Manual.

On | 1: The power will be searched automatically with the change of RF output power or frequency. The search style is Auto

To conduct power search once with current RF output frequency.

**Example:** :POWer:ALC:SEARch 1 power search state is Auto.

### 3) Run Power Search

**Function description:**

Run Power Search

### 4) Output on Search [Normal/Minimum]

**Function description:**

Set the output type for search to normal or minimum.

#### 5.2.2.8 Level Control

**Function description:** This command allows the user to select the ALC power level Control type adopted by the signal generator according to the appropriate situation, including internal and external methods

**Setting format:** [:SOURce]:POWer:ALC:SOURce INTernal|EXTernal

**Query format:** [:SOURce]:POWer:ALC:SOURce?

**Parameter Description:**

<State > discrete data. Values are as follows in the Power Level Control mode:

INTernal: the Power level control type is internal,

EXTernal: the Power level control type is external.

**Example:** :POWER:ALC:SOURce INT the level control type of the signal generator is Internal.

### 5.2.2.9 ALC Band

#### 1) ALC Bandwidth Mode

**Function description:** This command sets the ALC(automatic leveling control) loop bandwidth selection mode. When automatic, the signal generator automatically selects the appropriate ALC loop bandwidth. In manual operation, ALC loop bandwidth is set by the user.

**Setting format:** [:SOURce]:POWER:ALC:BANDwidth|BWIDth:AUTO ON|OFF|1|0

**Query format:** [:SOURce]:POWER:ALC:BANDwidth|BWIDth:AUTO?

**Parameter Description:**

<State> Boolean data, with the following values:

ON | 1: ALC loop bandwidth set to auto,

OFF | 0: ALC loop bandwidth set to manual.

**Example:** [:SOURce]:POWER:ALC:BANDwidth|BWIDth:AUTO 1 ALC bandwidth state set to manual.

#### 2) ALC Bandwidth Selection

**Function description:** This command sets the bandwidth of ALC (automatic leveling control) loop, which is applicable to different bandwidth settings of the automatic level control loop in different states of different frequency bands output by the signal generator. The user can select four states of 100Hz, 1kHz, 10kHz and 100kHz.

Rules to Note:

1. When the ALC bandwidth is selected automatically, if the ALC bandwidth is not selected properly, the setting is invalid;

2. When the internal baseband of the instrument is turned on, the bandwidth selection is invalid, and the baseband shall select the appropriate bandwidth.

**Setting format:** [:SOURce]:POWER:ALC:BANDwidth|BWIDth 100Hz|1kHz|10kHz|100kHz

**Query format:** [:SOURce]:POWER:ALC:BANDwidth|BWIDth?

**Parameter Description:**

<AlcBandWidth > discrete data. ALC loop bandwidth, values are as follows:

100Hz | 0: Loop bandwidth at 100Hz,

1kHz | 1: Loop bandwidth at 1kHz,

10kHz | 2: Loop bandwidth at 10kHz,

100kHz | 3: Loop bandwidth at 100kHz.

**Example:** [:SOURce]:POWER:ALC:BANDwidth|BWIDth 100Hz.

ALC loop bandwidth set to 100Hz;

### 5.2.2.10 External Detection Coupling Coefficient

**Function description:** This command sets the external detection coupling factor. When the power level control type is external diode detection, this command is used to set the coupling factor needed for external level control.

**Setting format:** [:SOURce]:POWER:ALC:SOURce:EXternal:COUPling <value>

**Query format:** [:SOURce]:POWER:ALC:SOURce:EXternal:COUPling?

**Parameter Description:**

## 5.2 Menu Description

<CouplingValue> external detection coupling factor.

Range: 16dB[-90dB, +90dB].

**Example:** :POWER:ALC:SOURce:EXternal:COUPling 16dBm external detection coupling factor set to 16dBm.

### 5.2.2.11 Output Blanking [On/Off]

**Function description:** This command sets the state of RF blanking. When blanking is on, if the signal generator is in a point frequency state, the RF output signal will be turned off during frequency switching. If the signal generator is in sweep state, the RF output signal will be turned off during frequency band switching and retrace.

**Setting format:** [:SOURce]:OUTPut:BLANKing[:STATe] ON|OFF|1|0

**Query format:** [:SOURce]:OUTPut:BLANKing[:STATe]?

**Parameter Description:**

<State> Boolean data, with the following values:

ON | 1: Blanking on,

OFF | 0: Blanking off.

**Example:** :OUTPut:BLANKing 1 enables signal generator blanking function.

## 5.2.3 Sweep

### 5.2.3.1 Frequency Generation Mode

**Function description:** Setting the frequency generation mode of the signal generator

**Setting format:** [:SOURce]:FREQuency:MODE FIXed|CW|STEP|LIST

**Query format:** [:SOURce]:FREQuency:MODE?

**Parameter Description:**

<Mode> Discrete data, frequency generation mode to be configured. Values are taken as follows:

FIXed|CW The setting of these two discrete parameters has the same meaning in this signal generator, that is, the control signal generator outputs continuous wave (dot frequency) signals, and this mode will terminate the frequency sweep signal currently output by the instrument.

STEP This parameter sets the current frequency generation mode to step sweep mode.

LIST Setting the frequency generation mode to List. If the current list is empty, the signal generator will prompt that the list is empty. At least one sweep point is stored in the list before the signal generator can start the sweep.

**Example:** :FREQuency:MODE LIST sets the signal generator to list sweep mode.

### 5.2.3.2 Detailed Step Sweep Configuration

#### 1) Start Freq

**Function description:** This command sets the start frequency of the instrument step sweep.

**Setting format:** [:SOURce]:FREQuency:STARt <val>

**Query format:** [:SOURce]:FREQuency:STARt?

**Parameter Description:**

<StartFreq> Start frequency of the sweep.

Model

Range

## 5.2 Menu Description

1435A	[9kHz~3GHz]
1435A-V	[9kHz~3GHz]
1435B	[9kHz~6GHz]
1435B-V	[9kHz~6GHz]
1435C	[9kHz~12GHz]
1435D	[9kHz~20GHz]
1435F	[9kHz~40GHz]

**Example:** :FREQUENCY:START 1MHz The start frequency of the step sweep of the signal generator set to 1MHz.

## 2) Stop Freq

**Function description:** This command sets the stop frequency of the instrument step sweep.

**Setting format:** [:SOURce]:FREQUENCY:STOP <val>

**Query format:** [:SOURce]:FREQUENCY:STOP?

### Parameter Description:

<StopFreq> stop frequency of sweep.

Model	Range
1435A	[9kHz~3GHz]
1435A-V	[9kHz~3GHz]
1435B	[9kHz~6GHz]
1435B-V	[9kHz~6GHz]
1435C	[9kHz~12GHz]
1435D	[9kHz~20GHz]
1435F	[9kHz~40GHz]

**Example:** FREQUENCY:STOP 100MHz The STOP frequency of the step sweep of the signal generator set to 100MHz.

## 3) Step Count

**Function description:** This command sets the current number of sweep points.

**Setting format:** [:SOURce]:SWEep:POINts <val>

**Query format:** [:SOURce]:SWEep:POINts?

### Parameter Description:

<Num> Number of step sweep points.

Range: 11[2, 801].

**Example:** :SWEep:POINts 101 Sets the number of step sweep points to 101.

## 4) Step Dwell Time

**Function description:** This command sets the dwell time of the stepping sweep, which refers to the pause time in the sweep process of the current stepping frequency point. The dwell time set by the user works in the mode where the stepping sweep trigger source is selected as automatic.

**Setting format:** [:SOURce]:SWEep:DWELI <value>

**Query format:** [:SOURce]:SWEep:DWELI?

## 5.2 Menu Description

### Parameter Description:

<Val> Step Sweep dwell time

Range: 10.000ms[100us, 100s].

**Example:** :SWEep:DWELI 1s Sets the dwell time for all step sweep points to 1 s.

## 5) Step Trig

**Function description:** This command sets the trigger source to start stepping sweep. The trigger source has four modes: Auto, Bus, Ext and Key.

**Setting format:** [:SOURce]:SWEep:TRIGger:SOURce IMMEDIATE|BUS|EXTernal|KEY

**Query format:** [:SOURce]:SWEep:TRIGger:SOURce?

### Parameter Description:

<Mode> discrete data. The trigger source types of step sweep are as follows:

IMMEDIATE automatic, trigger signal is always true, when a sweep is completed, the system automatically triggers the next sweep.

BUS bus, trigger source is triggered by GPIB group or by the \*TRG command.

EXTernal Externally, the trigger signal source comes from the trigger input connector of the rear panel.

KEY | Trigger key, trigger signal source is from trigger key of front panel.

**Example:** :SWEep:TRIGger:SOURce BUS Sets the stepping sweep trigger mode as bus trigger.

### 5.2.3.3 Step Type [Linear/Logarithm]

**Function description:** This command sets the step sweep type.

**Setting format:** [:SOURce]:SWEep:TYPE LINEar|LOGarithm

**Query format:** [:SOURce]:SWEep:TYPE?

### Parameter Description:

<Mode> Discrete data, with values taken as follows:

LINEar: Linear.

LOGarithm: logarithm.

**Example:** :LIST:SWEep:TYPE LINEar Sets the stepping sweep type to Linear.

### 5.2.3.4 Sweep Direction [Forward/Backward]

**Function description:** This command sets the step sweep direction, including: forward and Backward. The forward direction indicates that the step sweep is from the start frequency to the end frequency, and the Backward direction indicates that the step sweep is from the end frequency to the start frequency.

**Setting format:** [:SOURce]:SWEep:DIRection UP|DOWN

**Query format:** [:SOURce]:SWEep:DIRection?

### Parameter Description:

<Direction> discrete data. Step sweep direction, the values are as follows:

UP | Forward,

DOWN | Backward.



**Example:** :SWEep:DIRection DOWN Step Sweep starts backward sweep.

### 5.2.3.5 Detailed List Sweep Configuration

#### 1) Start Freq

**Function description:** This command sets the start frequency of list sweep, and is used in combination with the stop frequency in the list and the number of points in the list to generate list sweep points.

**Setting format:** [:SOURce]:LIST:FILL:STARt <val>

**Query format:** [:SOURce]:LIST:FILL:STARt?

**Parameter Description:**

<FreqStart> Start frequency of the List Sweep.

Model	Range
1435A	[9kHz~3GHz]
1435A-V	[9kHz~3GHz]
1435B	[9kHz~6GHz]
1435B-V	[9kHz~6GHz]
1435C	[9kHz~12GHz]
1435D	[9kHz~20GHz]
1435F	[9kHz~40GHz]

**Example:** :LIST:FILL:STARt 300MHz Sets the start frequency of List Sweep to 300MHz.

#### 2) Stop Freq

**Function description:** This command sets the Stop frequency of list sweep, and is used in combination with the Stop frequency in the list and the number of points in the list to generate list sweep points and set the start frequency and sweep points of the list.

**Setting format:** [:SOURce]:LIST:FILL:STOP <val>

**Query format:** [:SOURce]:LIST:FILL:STOP?

**Parameter Description:**

<FreqSto stop frequency of List Sweep.

Model	Range
1435A	[9kHz~3GHz]
1435A-V	[9kHz~3GHz]
1435B	[9kHz~6GHz]
1435B-V	[9kHz~6GHz]
1435C	[9kHz~12GHz]
1435D	[9kHz~20GHz]
1435F	[9kHz~40GHz]

**Example:** :LIST:FILL:STOP 1GHz Sets the STOP frequency of List Sweep to 1GHz.

#### 3) List Count

**Function description:** This command sets the number of list points to be generated.

**Setting format:** [:SOURce]:LIST:FILL:POINts <num>

## 5.2 Menu Description

**Query format:** [:SOURce]:LIST:FILL:POINts?

**Parameter Description:**

<Num> Number of list sweep points.

Range: 3[2, 801].

**Example:** :LIST:FILL:POINts 100 Sets 100 frequency points of the list.

### 4) All List Dwell Time

**Function description:** This command sets the dwell time of each sweep point in the current list. If users need to set different dwell times, they must enter the corresponding dwell time for each point in the list. They only need to enter the dwell time parameter values of the sweep points in the list in turn, separated by commas. If the number of points entered by users is less than the number of points in the current list, the current default value will be used for the number of points that have not entered dwell time. Note that the list needs to be filled in before setting, to ensure that the list is not empty. If it is empty, the query program will not respond.

**Setting format:** [:SOURce]:LIST:DWELI <val>{,{val}}

**Query format:** [:SOURce]:LIST:DWELI?

**Parameter Description:**

<Val> Dwell time of list sweep points.

Range: 10ms [100us, 100s].

**Example:** :LIST:DWELI 30ms, 20ms sets the dwell time of the first point in the list to 30ms, and the dwell time of the second point to 20 ms.

### 5) All List Power Offset

**Function description:** This command sets the power of each sweep point in the current list. If the user needs to set a different offset for each sweep point in the list, he must enter a corresponding offset value for each point in the list. Only the power offset values of the sweep points in the list need to be entered in turn, separated by commas. If the number of points entered by the user is less than the number of points in the current list, the number of points for which no list bias power has been entered will use the current default value. Note that the list needs to be filled in before setting, to ensure that the list is not empty. If it is empty, the query program will not respond.

**Setting format:** [:SOURce]:LIST:POWER <val>{,{val}}

**Query format:** [:SOURce]:LIST:POWER?

**Parameter Description:**

<Val> Power offset of list sweep points.

Range: 0dBm [-100dB, +100dB].

**Example:** :LIST:POWER 1dB, 0.2dB, 1.3dB, 2.5dB, -3.6dB

Sets the power offsets in the list at 1dB, 0.2dB, 1.3dB, 2.5dB, -3.6dB in order.

### 6) List Trig [Auto/Bus/ Ext/Key]

**Function description:** This command sets the trigger source to List Sweep. The trigger source has four modes: Auto, Bus, Ext and Key.

**Setting format:** [:SOURce]:LIST:TRIGger:SOURce IMMEDIATE|BUS|EXTernal|KEY

**Query format:** [:SOURce]:LIST:TRIGger:SOURce?

**Parameter Description:**

< Source > discrete data. The list sweep trigger source, with the values as follows:

**5.2 Menu Description**

**IMMediate** Automatic, trigger signal is always true, when a sweep is completed, the system automatically triggers the next sweep.

**Bus** Bus, trigger source is triggered by GPIB group or by The \*TRG command.

**EXTernal** Externally, the trigger signal comes from the trigger input connector of the rear panel.

**KEY** Trigger key, trigger signal is from trigger key of front panel.

**Example:** :LIST:TRIGger:SOURce BUS Sets bus as the List Sweep trigger source.

**7) Sweep Direction [backward/ forward]**

**Function description:** This command sets the sweep direction of the list. The user can select two ways: forward means sweep from the first point in the list to the last point in the list, and backward means sweep from the last point in the list to the first point in the current list.

**Setting format:** [:SOURce]:LIST:DIRection UP|DOWN

**Query format:** [:SOURce]:LIST:DIRection?

**Parameter Description:**

< Direc > discrete data. Sweep direction, the values are as follows:

UP Starts the forward sweep from the first point in the list,

DOWN Starts the backward sweep from the last point in the list,

**Example:** :LIST:DIRection UP Sets List Sweep direction to forward.

**5.2.3.6 Single Sweep****Function description:**

Run single sweep.

**5.2.3.7 Trig Style of Start****1) Auto****Function description:**

When selecting frequency sweep Ext trigger mode is Auto trigger. Select menu [Sweep Type Single | Continuous], when switching (Single) or (Continuous), the instrument starts frequency sweep automatically. The default setting is (Auto).

**2) Bus****Function description:**

When selecting frequency sweep, the trigger mode is bus trigger. Select menu [Sweep Type Single | Continuous], when switching (Single) or (Continuous), when the instrument starts frequency sweep when receiving trigger signals from GPIB, LAN and RS232.

**3) Ext****Function description:**

When selecting frequency sweep Ext trigger mode is Ext trigger. Select menu [Sweep Type Single | Continuous], when switching (Single) or (Continuous), when the instrument starts frequency sweep when receiving the rising edge trigger signals from external sources.

**4) Trigger key****Function description:**

When selecting frequency sweep Ext trigger mode is Manual trigger. Select menu [Sweep Type

## 5.2 Menu Description

Single | Continuous], when switching (Single) or (Continuous), when the instrument starts frequency sweep when receiving the rising edge trigger signals from external sources.

### 5.2.4 Modulation

#### 5.2.4.1 Pulse Modulation On/Off

**Function description:** This command sets whether to output the pulse modulation signals of the signal generator.

**Setting format:** [:SOURce]:PULM:STATe ON|OFF|1|0

**Query format:** [:SOURce]:PULM:STATe?

**Parameter Description:**

<State> Boolean data, with the following values:

ON | 1: Pulse Modulation on,

OFF | 0: Pulse Modulation off.

**Example:** :PULM:STATe 1 Pulse Modulation on.

#### 5.2.4.2 Pulse Source

**Function description:** This command sets the pulse source modes of pulse modulation, including Ext, Scalar, Internal Auto, Square, D-Pulse, Pulse Train, Gate, Trigger, Jittered, Staggered and Sliding. In the scalar mode, the relevant pulse parameters are not allowed to be changed, and the signal generator will automatically output pulse signals with the pulse width of 18 ms and the period of 36 ms.

**Setting format:** [:SOURce]:PULM:SOURce EXTernal|SCALAR|INTERNAL|SQUare|DOUBLEt  
|PTRain|GATED|TRIGGERed|JITTERed|STAGger|SLIDing

**Query format:** [:SOURce]:PULM:SOURce?

**Parameter Description:**

<Mode> discrete data. Pulse source mode, the values are as follows:

EXTernal The pulse source is external.

SCALAR The pulse source is scalar, with the output of 27.8kHz square wave.

INTERNAL The pulse source is internal automatic.

SQUare The pulse source is square wave.

DOUBLEt The pulse source is doublet pulse.

PTRain The pulse source is pulse train.

GATED The pulse source is gated control.

TRIGGERed activates the internal pulse automatic trigger mode, in which the period is the one of external synchronization pulse and the pulse width is the one set by this machine.

JITTERed The pulse source is jittered.

STAGger The pulse source is staggered.

SLIDing The pulse source is sliding.

**Example:** :PULM:SOURce SQUare The pulse source is set to square wave.

**Reset:** INT

**Button Path:** **【Analog Modulation】** -> [Pulse Modulation]-> [Pulse Modulation Config]-> [Pulse Source]

### 5.2.4.3 Pulse width

**Function description:** This command sets the pulse width of the pulse signal generated inside the signal generator. If the set pulse width value is greater than or equal to the current pulse Period, the pulse Period will be automatically adjusted to be greater than the current pulse Period value. In addition, if the set pulse width is less than 1us, it is recommended to perform the power search function. When the pulse source is in the Stagger mode, the pulse width in the stagger list is a uniform value, and the pulse width in the stagger list needs to be changed through this command.

**Setting format:** [:SOURce]:PULM:INTernal:PWIDth <val>

**Query format:** [:SOURce]:PULM:INTernal:PWIDth?

**Parameter Description:**

<PWidth> Pulse signal width.

Range: 50.000us [20ns, 41.999999990s].

**Example:** :PULM:INTernal:PWIDth 10us sets pulse signal width to 10us.

### 5.2.4.4 Period

**Function description:** This command sets the Period of the pulse signal generated inside the signal generator. If the set Period is less than or equal to the current pulse width, the pulse width will be automatically adjusted to be less than the pulse Period.

**Setting format:** [:SOURce]:PULM:INTernal:PERiod <value>

**Query format:** [:SOURce]:PULM:INTernal:PERiod?

**Parameter Description:**

<Percent> Pulse period.

Range: 1.000000ms[40ns,42.000000000s].

**Example:** :PULM:INTernal:PERiod 10ms sets pulse signal period to 10ms.

### 5.2.4.5 Delay

**Function description:** This command sets the pulse delay of pulse modulation. The actual maximum value that can be set depends on the pulse Period currently set by the user. In addition, it should be noted that the setting of pulse delay can only work when the pulse source is selected as Auto, Square, D-pulse and Trig modes, and the pulse delay has an inherent delay of 100ns when the trigger mode is selected.

**Setting format:** [:SOURce]:PULM:INTernal:DELay <val>

**Query format:** [:SOURce]:PULM:INTernal:DELay?

**Parameter Description:**

<DelayTime> Pulse delay time of pulse modulation.

Range: Non-trig mode: 0s[0ns, 42.000000000s],

Trigger mode: 0s[100ns, 42.000000000s].

**Example:** :PULM:INTernal:DELay 1ms Sets pulse delay to 1ms

### 5.2.4.6 Repetition Frequency

**Function description:** This command sets the pulse modulation repetition frequency. When the pulse source set to Square, the pulse signal outputs a signal with a duty ratio of 50%, and this command can change the frequency of the Square signal.

**Setting format:** [:SOURce]:PULM:INTernal:FREQuency <val>

**Query format:** [:SOURce]:PULM:INTernal:FREQuency?

## 5.2 Menu Description

### Parameter Description:

<Frequency> Pulse modulation repetition frequency.

Range: 1kHz [0.023Hz, 25MHz]

**Example:** :PULM:INTernal:FREQuency 1MHz Sets pulse repetition frequency to 1 MHz.

### 5.2.4.7 Input Reverse [On/Off]

**Function description:** This command logically reverses external input pulse signals, that is, when the pulse source is set to the external mode, the pulse signals input from the pulse input port of the front panel of the signal generator is TTL high level signals or reversed to TTL low level signals.

**Setting format:** [:SOURce]:PULM:EXTernal:POLarity INVerted|NORMal

**Query format:** [:SOURce]:PULM:EXTernal:POLarity?

### Parameter Description:

<Mode> discrete data. Pulse input inversion On/Off state, with the values as follows:

NORMal Pulse input inversion is turned off, and the input pulse signals are at TTL high level.

INVerted Pulse input inversion is turned On, and the input pulse signals are at TTL low level.

**Example:** :PULM:ENTernal:POLarity INV External input pulse signals inverted to TTL low level.

### 5.2.4.8 Sweep Delay

**Function description:** not implemented for the time being

### 5.2.4.9 Amplitude Modulation [On/Off]

**Function description:** This command sets the On/Off status of the AM Path 1 or 2 of the signal generator. Only when the path switch, the AM switch and the Modulation on/off are all on can the AM signals be output.

**Setting format:** [:SOURce]:AM[1]|2:STATe ON|OFF|1|0

**Query format:** [:SOURce]:AM[1]|2:STATe?

### Parameter Description:

<State> Boolean data, with the following values:

ON | 1: Path output on,

OFF | 0: Path output off.

**Example:** :AM:STATe 1 Path 1 output on.

### 5.2.4.10 AM (FM, PM) Waveforms

**Function description:** This command sets the output waveforms of AM (FM, PM) signals, including: Sinc, Square, Triangle and Zigzag.

**Setting format:** [:SOURce]:AM(FM、PM):INTernal:SHAPE SINE|SQUare|TRIangle|RAMP  
NOISe|SWEPTsine|DUALsine

**Query format:** [:SOURce]:AM(FM、PM):INTernal:SHAPE?

### Parameter Description:

<Mode> discrete data. The output waveform types of AM (FM, PM) signals, with the values as follows:

Sine sine wave,

Square square wave,

Triangle triangular wave,

Ramp zigzag wave,

**Example:** :AM(FM、PM):INTernal:SHAP RAMP Sets the waveform of AM (FM, PM) signals in Path 1 to Zigzag.

#### 5.2.4.11 AM [Exponential /Linear]

**Function description:** This command selects whether the amplitude modulation type of the signal generator is Exponential or Linear amplitude modulation. When the user selects Exponential amplitude modulation, the amplitude modulation depth value will be in dB. When the user selects Linear amplitude modulation, the amplitude modulation depth value will be expressed as a percentage.

**Setting format:** [:SOURce]:AM:TYPE EXPonential|LINear

**Query format:** [:SOURce]:AM:TYPE?

**Parameter Description:**

<Mode> discrete data. AM mode, with the values are as follows:

EXPonential Exponential AM,

LINear Linear AM.

**Example:** :AM:TYPE EXP Exponential AM,

#### 5.2.4.12 AM (FM, PM) Source

**Function description:** This command selects amplitude (frequency, phase) modulation source selection, including: Int and Ext 50Ω, Ext 600Ω and Ext 1MΩ. When selecting the Ext mode, external amplitude modulation (frequency, phase) signals need to be connected to the amplitude modulation input interface on the rear panel of the signal generator.

**Setting format:** [:SOURce]:AM(FM、PM):SOURce INTernal

**Query format:** [:SOURce]:AM(FM、PM):SOURce?

**Parameter Description:**

<Mode> discrete data. Amplitude (frequency, phase) modulation source, with the values are as follows:

INTernal Internal AM.

EXT50 External 50Ω

EXT600 External 600Ω

EXT1M External 1MΩ

**Example:** :AM(FM、PM):SOURce INT AM (FM, PM) source set to Int.

#### 5.2.4.13 Am Depth[On/Off]

**Function description:** This command sets the AM mode.. When the DEEP type is selected, the AM depth of the signal generator has a larger dynamic range than the modulation depth when ALC is closed-loop, and the amplitude modulation index is better than that of the data sheet index. When NORMAL type is selected, the amplitude modulation index is the same as that in the data sheet. please refer to indicators of 1435 series signal generators.

**Setting format:** [:SOURce]:AM:MODE DEEP|NORMAl

**Query format:** [:SOURce]:AM:MODE?

**Parameter Description:**

## 5.2 Menu Description

<Mode> discrete data. AM mode, with the values are as follows:

DEEP AM Depth on,

NORMal AM Depth off.

**Example:** :AM:MODE NORM AM Depth off.

### 5.2.4.14 Modulation Rate (AM, FM, PM)

**Function description:** This command sets the internal modulation rate of the AM (FM, PM) path of the signal generator.

**Setting format:** [:SOURce]:AM(FM, PM) [1]|2:INTernal:FREQuency <val>

**Query format:** [:SOURce]:AM(FM, PM) [1]|2:INTernal:FREQuency?

**Parameter Description:**

<Frequency> AM ( FM, PM) modulation rate.

Range: 1kHz[1mHz, 1MHz].

**Example:** :AM(FM, PM):INTernal:FREQuency 100kHz Set the internal modulation rate of AM (FM, PM) in path 1 to 100kHz.

### 5.2.4.15 AM Depth

**Function description:** When AM type is exponential, set amplitude modulation depth of AM Path 1 or Path 2, in dB.

**Setting format:** [:SOURce]:AM[1]|2:DEPTTh:EXPonential <.val>

**Query format:** [:SOURce]:AM[1]|2:DEPTTh:EXPonential?

**Parameter Description:**

<AmDepthExp> AM Depth (Exponential).

Range: 0.00dB[0.00dB, 40.00dB].

**Example:** :AM2:DEPTTh:EXPonential 10dB sets the AM depth of AM Path 2 to 10dB.

### 5.2.4.16 Modulation Mode (FM/PM)

**Function description:**

It sets the modulation type to AM or PM. The both are mutually exclusive.

### 5.2.4.17 FM [On/Off]

**Function description:** This command sets the switching state of signal generator FM path 1 or 2. Only when the path on/off, the frequency Modulation on/off and the Modulation on/off are all on can the FM signal be output.

**Setting format:** [:SOURce]:FM[1]|2:STATe ON|OFF|1|0

**Query format:** [:SOURce]:FM[1]|2:STATe?

**Parameter Description:**

<State> Boolean data, with the following values:

ON | 1: Path output on,

OFF | 0: Path output off.

**Example:** :FM:STATe 1 Path 1 output on.



### 5.2.4.18 FM Offset

**Function description:** This command sets the frequency modulation frequency offset of frequency modulation Path 1 or Path 2 of the signal generator. It should be noted that when frequency modulation frequency offset is set in different frequency bands, it corresponds to different frequency offset ranges.

**Setting format:** [:SOURce]:FM[1]|2:DEVIation <val>

**Query format:** [:SOURce]:FM[1]|2:DEVIation?

**Parameter Description:**

<Deviation> The relationship between the current frequency and the FM frequency offset is as follows:

1435	Current Frequency	FM Offset
	9kHz – 250MHz	0 – 4MHz
	250MHz – 375MHz	0 – 1MHz
	375MHz – 750GHz	0 – 2MHz
	750MHz – 1.5GHz	0 – 4MHz
	1.5GHz – 3GHz	0 – 8MHz
	3GHz – 6GHz	0 – 16MHz
	6GHz – 12GHz	0 – 32MHz
	12GHz – 24GHz	0 – 64MHz
	24GHz – 40GHz	0 – 128MHz

**Example:** :FM:DEVIation 500kHz Sets the frequency offset of FM signals in Path 1 to 500kHz.

### 5.2.4.19 PM [On/Off]

**Function description:** This command sets the switching state of signal generator PM path 1 or 2. Only when the path on/off, the PM on/off and the Modulation on/off are all on can the PM signals be output.

**Setting format:** [:SOURce]:PM[1]|2:STATe ON|OFF|1|0

**Query format:** [:SOURce]:PM[1]|2:STATe?

**Parameter Description:**

<State> Boolean data, with the following values:

ON | 1: Path output on,

OFF | 0: Path output off.

**Example:** :PM:STATe 1 Path 1 output on.

### 5.2.4.20 PM Offset

**Function description:** This command sets the phase modulation frequency offset of phase modulation Path 1 or Path 2 of the signal generator. It should be noted that when phase modulation offset is set in different frequency bands, it corresponds to different phase offset ranges.

**Setting format:** [:SOURce]:PM[1]|2:DEVIation <val>

**Query format:** [:SOURce]:PM[1]|2:DEVIation?

**Parameter Description:**

## 5.2 Menu Description

<Deviation> The relationship between the PM phase offset range and PM bandwidth is as follows:

1435	Current Frequency	PM Offset
	9kHz – 250MHz	0 – 4.000rad
	250MHz – 375MHz	0 – 1.000rad
	375MHz – 750GHz	0 – 2.000rad
	750MHz – 1.5GHz	0 – 4.000rad
	1.5GHz – 3GHz	0 – 8.000rad
	3GHz – 6GHz	0 – 16.000rad
	6GHz – 12GHz	0 – 32.000rad
	12GHz – 24GHz	0 – 64.000rad
	24GHz – 40GHz	0 – 128.000rad

**Example:** :PM2:DEVIation 3rad sets PM Path 2 offset to 3rad.

### 5.2.5 Baseband

#### 5.2.5.1 Baseband [On/Off]

**Function description:** The command enables the on/off function of the real-time baseband of the signal generator. After such function is enabled, the modulation instruction between the baseband and IQ is displayed on the main information display area of the UI of the signal generator.

**Setting format:** [:SOURce]:RADio:CUSTom:STATe ON|OFF|1|0

**Query format:** [:SOURce]:RADio:CUSTom:STATe?

**Parameter description:**

<State> Boolean data, which is taken as follows:

ON | 1: Baseband is on,

OFF | 0: Baseband is off.

**Example:** :RADio:CUSTom:STATe 1 Enable real-time baseband.

#### 5.2.5.2 Data source

**Function description:** It is used to set the data source for the baseband modulation signal of the signal generator, which can be selected from 15 data sources, including PN9, PN11, PN15, PN16, PN20, PN21, PN23, FIX4, P4, P8, P16, P32, P64, PRAM and EXT (which is not supported at present).

**Setting format:** [:SOURce]:RADio:CUSTom:DATA PN9|PN11|PN15

|PN16|PN20|PN21|PN23|FIX4|P4|P8|P16|P32|P64PRAM

**Query format:** [:SOURce]:RADio:CUSTom:DATA?

**Parameter description:**

<Mode> Discrete data. It is the data source type of the baseband modulation signal. For details, see the setting command format.

**Example:** :RADio:CUSTom:DATA FIX4

Select Fix 4 for the baseband data source.

#### 5.2.5.3 Code element rate

**Function description:** It is used to set the code element rate of the baseband signal of the signal generator, and the units of the code element are sps, ksps, Msps and Gsps.

**Setting format:** [:SOURce]:RADio:CUSTom:SRATe <val>

**Query format:** [:SOURce]:RADio:CUSTom:SRATe?

**Parameter description:**

<Val> Code element rate of the baseband signal.

The relationship between the baseband modulation type, number of code element digit(s) and code element rate are as follows:

Modulation format	number of code element digit(s)	code element rate scope
BPSK	1	0.00005Msps – 50Msps
MSK	1	0.00005Msps – 50Msps
2FSK	1	0.00005Msps – 50Msps
OQPSK	2	0.00005Msps – 50Msps
QPSK	2	0.00005Msps – 50Msps
8FSK	3	0.00005Msps – 50Msps
QAM16	4	0.00005Msps – 50Msps

**Example:** :RADio:CUSTom:SRATe 3Msps The code element rate is 3Msps.

#### 5.2.5.4 Modulation type

**Function description:** It is used to set the modulation format of the baseband.

**Setting format:** [:SOURce]:RADio:CUSTom:MODulation[:TYPE] BPSK|QPSK  
|IS95QPSK|GRAYQPSK|OQPSK|IS95OQPSK|P4DQPSK|8PSK  
|16PSK|D8PSK|MSK|2FSK|4FSK|8FSK|16FSK|C4FM|4QAM  
|16QAM|32QAM|64QAM|128QAM|256QAM|512QAM|1024Q AM|ASK

**Query format:** [:SOURce]:RADio:CUSTom:MODulation[:TYPE]?

**Parameter description:**

<Mode> Discrete data. It is the baseband modulation type. For details, see the setting command format:

**Example:** :RADio:CUSTom:MODulation 8PSK

The baseband modulation type is 8PSK.

#### 5.2.5.5 Filter selection

**Function description:** It is used to select the baseband premodulation filter type for the signal generator, including four types, namely, RNYQuist, NYQuist, GAUSsian and RECTangle, whereas RECTangle applies to the digital FM signals, such as FSK and MSK.

**Setting format:** [:SOURce]:RADio:CUSTom:FILTer RNYQuist|NYQuist|GAUSsian|RECTangle

**Query format:** [:SOURce]:RADio:CUSTom:FILTer?

**Parameter description:**

<Mode> Discrete data. It is the baseband premodulation filter type, with values being set as follows:

RNYQuist Root-Nyquist filter,  
NYQuist Nyquist filter,  
GAUSsian Gaussian filter,

## 5.2 Menu Description

RECTangle Rectangular filter.

**Example:** [:RADio:CUSTom:FILTer RNYQuist

The baseband premodulation filter type is the root-Nyquist filter.

### 5.2.5.6 Filter optimization

Function description: It is not supported at present.

### 5.2.5.7 Trigger mode

**Function description:** It is used to set the trigger mode of the baseband signal that is used for data transmission control, including three modes, namely, continuous, single and gate.

**Setting format:** [:SOURce]:RADio:CUSTom:TRIGger:TYPE CONTInuous|SINGle|GATE

**Query format:** [:SOURce]:RADio:CUSTom:TRIGger:TYPE?

**Parameter description:**

<Mode> Discrete data. It is the baseband trigger mode, with values being taken as follows:

CONTInuous | 0: Set the baseband trigger mode to be continuous,

SINGle | 1: Set the baseband trigger mode to be single,

GATE | 2: Set the baseband trigger mode to be gate,

**Example:** [:SOURce]:RADio:CUSTom:TRIGger:TYPE SING

The baseband trigger mode is single.

### 5.2.5.8 Trigger source

**Function description:** It is used to set the baseband signal trigger source of the signal generator, including three modes, namely, KEY, BUS and EXT.

**Setting format:** [:SOURce]:RADio:CUSTom:TRIGger:SOURce KEY|BUS|EXT

**Query format:** [:SOURce]:RADio:CUSTom:TRIGger:SOURce?

**Parameter description:**

<Mode> Discrete data. It is the baseband trigger source, with values being taken as follows:

KEY | 0: The trigger source comes from the trigger key on the front panel of the instrument;

BUS | 1: The trigger source comes from GPIB trigger in batch, or trigger occurs only when the “\*TRG” command is received;

EXT | 2: The trigger source comes from the trigger input from the rear panel interface of the instrument.

**Example:** [:SOURce]:RADio:CUSTom:TRIGger:SOURce BUS

The baseband signal trigger source is the bus.

### 5.2.5.9 Sync output

It is not supported at present.

### 5.2.5.10 Sudden shape configuration

It is not supported at present.

### 5.2.5.11 I/Q wave absorbing factor

It is not supported at present.

### 5.2.5.12 Phase polarity

**Function description:** It is used to set the rotation direction of the baseband signal phase, including two modes, namely, normal and invert: Select the normal type to modulate the signal normally, and select the invert type to invert the Q-path signal for carrier signal reversal.

**Setting format:** [:SOURce]:RADio:CUSTom:POLarity[:ALL] NORMal|INVert

**Query format:** [:SOURce]:RADio:CUSTom:POLarity[:ALL]?

**Parameter description:**

<Mode> Discrete data. It is the baseband phase rotation mode, with values being taken as follows:

NORMal | 0: Normal;

INVert | 1: Invert.

**Example:** [:SOURce]:RADio:CUSTom:POLarity[:ALL] INV

It is the baseband signal inversion mode.

### 5.2.5.13 Differential encoding

**Function description:** It enables the on/off function of differential encoding. When it is on, the modulation bit is set to 1 if the data bit is different from the previous one, and set to 0 if they are the same. For example, when the data bits are 1010 and differential encoding is on, the modulation bits are 1111.

**Setting format:** [:SOURce]:RADio:CUSTom:DENCode ON|OFF|1|0

**Query format:** [:SOURce]:RADio:CUSTom:DENCode?

**Parameter description:**

<State> Boolean data, which is taken as follows:

ON | 1: Start differential encoding;

OFF | 0: Close differential encoding.

**Example:** [:SOURce]:RADio:CUSTom:DENCode 1: Differential encoding is on.

### 5.2.5.14 Hardware Setup

#### 1) Baseband sampling clock [internal/external]

**Function description:** It is used to set the baseband sampling clock type.

**Setting format:** [:SOURce]:RADio:CUSTom:VCO:CLOCK INTernal|EXTernal

**Query format:** [:SOURce]:RADio:CUSTom:VCO:CLOCK?

**Parameter description:**

<Mode> Discrete data, with values taken as follows:

INTernal: Internal sampling clock;

EXTernal; External sampling clock.

**Example:** [:SOURce]:RADio:CUSTom:VCO:CLOCK INT : The baseband sampling clock type is internal.

#### 2) External sampling clock frequency

**Function description:**

It is valid when the baseband sampling clock type is external. It is used to set the external sampling clock frequency.

**Parameter description:**

## 5.2 Menu Description

NONE

### Program Control Commands:

It is not supported at present.

### 3) Baseband data clock [internal/external]

#### Function description:

It is used to set the baseband data clock type to be internal or external. It is in the internal type by default.

#### Parameter description:

INTernal [INTernal | EXTernal]

Parameter list:

INTernal                      Internal

EXTernal                      External

### Program Control Commands:

It is not supported at present.

### 4) External data clock frequency

#### Function description:

It is valid when the baseband data clock type is external. When the data source type is external, calculate the data clock frequency automatically via the code element rate, or set the data clock frequency here.

#### Parameter description:

NONE

### Program Control Commands:

It is not supported at present.

## 5.2.6 I/Q

### 5.2.6.1 I/Q modulation [on/off]

**Function description:** It enables the on/off function of the internal I/Q modulator.

**Setting format:** [:SOURce]:DM:STATe ON|OFF|1|0

**Query format:** [:SOURce]:DM:STATe?

#### Parameter description:

<State>            Boolean data, which is taken as follows:

ON | 1:            I/Q modulation output is on;

OFF | 0:           I/Q modulation output is off.

**Example:**        :DM:STATe 1 Start the I/Q modulator.

### 5.2.6.2 I/Q modulation source

**Function description:** It is used to select the signal generator to enter the I/Q modulation source of the I/Q modulator, with two modes available for user selection, namely, EXTernal and INTernal.

**Setting format:** [:SOURce]:DM:SOURce EXTernal| INTernal

**Query format:** [:SOURce]:DM:SOURce?

#### Parameter description:

**5.2 Menu Description**

<Mode> Discrete data. It is used to select the filter with the I/Q filter in the manual mode, with values being taken as follows:

EXternal | 0: I/Q signal input corresponding to external 50 Ohm resistance;

INTernal | 1: I/Q modulator for internal I/Q signal input.

**Example:** [:SOURce]:DM:SOURce EXT Select the I/Q modulation source to be external.

**5.2.6.3 External broadband I/Q input**

**Function description:** It is used to set the on/off status of the external broadband I/Q input.

**Setting format:** [:SOURce]:DM:EXTernal:BWIDth[:STATe] ON|OFF|1|0

**Query format:** [:SOURce]:DM:EXTernal:BWIDth[:STATe]?

**Parameter description:**

<State> Boolean data, which is taken as follows:

ON | 1: External broadband I/Q input is on;

OFF | 0: External broadband I/Q input is off.

**Example:** :DM:EXT:BWID:STATe 1 External broadband I/Q input is on.

**5.2.6.4 Manual modulator attenuation**

**Function description:** It is used to set the manual status of the I/Q path attenuator of the signal generator. When the manual status is on, current decrement is maintained; when it is off, users cannot change the decrement, and the signal generator will select the optimal attenuation value for its current status automatically.

**Setting format:** [:SOURce]:DM:MODulation:ATTenuation:AUTO ON|OFF|1|0

**Query format:** [:SOURce]:DM:MODulation:ATTenuation:AUTO?

**Parameter description:**

<State> Boolean data, which is taken as follows:

ON | 1: The modulator attenuation mode is manual;

ON | 0: The modulator attenuation mode is auto;

**Example:** :DM:MODulation:ATTenuation:AUTO 1

The modulator attenuation mode is manual.

**5.2.6.5 Modulator attenuation**

**Function description:** It is used to set the decrement of the I/Q signal that is modulated when passing the RF path of the signal generator, and the decrement output can be set when the attenuator is in the manual status. The attenuation value is valid even if the I/Q modulation function is closed.

**Setting format:** [:SOURce]:DM:MODulation:ATTenuation <val>

**Query format:** [:SOURce]:DM:MODulation:ATTenuation?

**Parameter description:**

<Atten> I/Q modulator attenuation.

Range: 12.00dB[0.00dB , 40.00dB].

**Example:** :DM:MODulation:ATTenuation 10dB I/Q modulator attenuation is 10dB.

## 5.2 Menu Description

### 5.2.6.6 I/Q modulation

#### 1) I/Q modulation On

**Function description:** It is used to set the on/off status of I/Q modulation. When it is on, such I/Q modulation parameters as the gain balance, I offset, Q offset and orthogonal deviation will be superimposed to the modulation circuit; when it is off, such values will not be used, but the modulator attenuation will not be affected by the on/off status of the I/Q modulation.

**Setting format:** [:SOURce]:DM:IQADjustment[:STATe] ON|OFF|1|0

**Query format:** [:SOURce]:DM:IQADjustment[:STATe] ?

**Parameter description:**

<State> Boolean data, which is taken as follows:

ON | 1: I/Q modulation is on;

OFF | 0: I/Q modulation is off.

**Example:** :DM:IQADjustment 1 Start I/Q modulation.

#### 2) Gain balance

**Function description:** Select I/Q modulation to on to set the gain of the I signal of the signal generator relative to the Q signal.

**Setting format:** [:SOURce]:DM:IQADjustment:GAIN <val>

**Query format:** [:SOURce]:DM:IQADjustment:GAIN?

**Parameter description:**

<Gain> I/Q signal gain balance.

Range: 0dB[-4.00dB , +4.00dB].

**Example:** :DM:IQADjustment:GAIN 0dB

Set I and Q signal gain balance to 0 dB.

#### 3) I offset

**Function description:** Select I/Q modulation to on to set the offset value of the signal generator I path in percentage, with the max. value corresponding to the DC of 1.5V and min. resolution ratio of 0.025%. This parameter is used to restrain the carrier leakage signal. Since carrier leakage will increase after completing other modulations (such as perpendicularity and modulator attenuation modulations), users still need to modulate the DC offset.

**Setting format:** [:SOURce]:DM:IQADjustment:IOfFset <val>

**Query format:** [:SOURce]:DM:IQADjustment:IOfFset?

**Parameter description:**

<Offset> I/Q signal I offset.

Value range: 0 [-50 , +50].

**Example:** :DM:IQADjustment:IOFfset 30

Set I offset to 30%.

#### 4) Q offset

**Function description:** It is used to set the offset value of the signal generator Q path in percentage, with the max. value corresponding to the DC of 1.5V and min. resolution ratio of 0.025%. This parameter is used to restrain the carrier leakage signal. Since carrier leakage will increase after completing other modulations (such as perpendicularity and modulator attenuation modulations), users



still need to modulate the DC offset.

**Setting format:** [:SOURce]:DM:IQADjustment:QOFFset <val>

**Query format:** [:SOURce]:DM:IQADjustment:QOFFset?

**Parameter description:**

<Offset> I/Q signal Q offset.

Value range: 0 [-50 , +50].

**Example:** :DM:IQADjustment:QOFFset 30

Set Q offset to 30%.

## 5) Orthogonality offset

**Function description:** When I/Q modulation is on, it is used to adjust the phase angle between the I and Q vector quantity by increasing or decreasing the I or Q phase angle; if current carrier frequency exceeds 3.2GHz, the error of the orthogonality offset can exceed the value specified in the sample indicator of the 1435 series signal generator.

**Setting format:** [:SOURce]:DM:IQADjustment:QSKew <val>

**Query format:** [:SOURce]:DM:IQADjustment:QSKew?

**Parameter description:**

<Offset> I/Q modulation orthogonality offset.

Range: 0deg [-10.00deg , +10.00deg].

**Example:** :DM:IQADjustment:QSKew 30deg

Set the I/Q modulation orthogonality offset to 30deg.

### 5.2.6.7 ALC open loop

**Function description:** It is used to open or close the ALC loop. The ALC loop is mainly used to correct the power drift, and guarantee the output power level of the signal generator does not vary with the time and temperature.

**Setting format:** [:SOURce]:POWER:ALC[:STATe] ON|OFF|1|0

**Query format:** [:SOURce]:POWER:ALC[:STATe]?

**Parameter description:**

<State> Boolean data, which is taken as follows:

ON | 1: ALC loop closed;

OFF | 0: ALC loop opened.

**Example:** :POWER:ALC 1: To set the ALC loop to Close.

### 5.2.6.8 Search type [Manual/Auto]

**Function description:** When the ALC loop of the signal generator is opened, the command is used to activate or close the auto internal power search function of the signal generator, and power search can keep the signal generator stay at the output power selected by the user when the ALC loop is closed, and keep the internal modulator in the driving status.

**Setting format:** [:SOURce]:POWER:ALC:SEARch ON|OFF|1|0|ONCE

**Query format:** [:SOURce]:POWER:ALC:SEARch?

**Parameter description:**

## 5.2 Menu Description

<Mode> Discrete data. It is the auto power search status, with values being taken as follows:  
 OFF | 0: This command terminates automatic power search, and the search style is Manual.  
 On | 1: The power will be searched automatically with the change of RF output power or frequency.  
 The search style is Auto  
 ONCE To conduct power search once with current RF output frequency.  
**Example:** :POWER:ALC:SEARCh 1 Power search is in the auto status.

### 5.2.6.9 Power search

**Function description:** When the ALC loop of the signal generator is opened, the command is used to activate or close the auto internal power search function of the signal generator, and power search can keep the signal generator stay at the output power selected by the user when the ALC loop is closed, and keep the internal modulator in the driving status.

**Setting format:** [:SOURce]:POWER:ALC:SEARCh ON|OFF|1|0|ONCE

**Query format:** [:SOURce]:POWER:ALC:SEARCh?

**Parameter description:**

<Mode> Discrete data. It is the auto power search status, with values being taken as follows:  
 OFF | 0: This command terminates automatic power search, and the search style is Manual.  
 On | 1: The power will be searched automatically with the change of RF output power or frequency.  
 The search style is Auto  
 ONCE To conduct power search once with current RF output frequency.  
**Example:** :POWER:ALC:SEARCh 1 Power search is in the auto status.

### 5.2.6.10 Search output [Normal/Min.]

**Function description:**

To select the search output to be normal or min..

### 5.2.6.11 External output source

**Function description:** It is used to select the signal generator to enter the I/Q modulation source of the I/Q modulator, with two modes available for user selection, namely, EXTERNAL and INTERNAL.

**Setting format:** [:SOURce]:DM:SOURce EXTERNAL|INTERNAL

**Query format:** [:SOURce]:DM:SOURce?

**Parameter description:**

<Mode> Discrete data. It is used to select the filter with the I/Q filter in the manual mode, with values being taken as follows:  
 EXTERNAL | 0: I/Q signal input corresponding to external 50 Ohm resistance;  
 INTERNAL | 1: I/Q modulator for internal I/Q signal input.  
**Example:** [:SOURce]:DM:SOURce EXT Select the I/Q modulation source to be external.

### 5.2.6.12 Output modulation

#### 1) Output modulation on/off

**Function description:** It is used to set the on/off status of I/Q output modulation.

**Setting format:** [:SOURce]:DM:IQADjustment:OUTPut[:STATE] ON|OFF|1|0

**Query format:** [:SOURce]:DM:IQADjustment:OUTPut[:STATE]?

**Parameter description:**

<State> Boolean data, which is taken as follows:

ON | 1: I/Q output modulation is on;

OFF | 0: I/Q output modulation is off.

**Example:** DM:IQADjustment:OUTPut 1 I/Q output modulation is on.

## 2) Output attenuation

**Function description:** To set the I/Q output modulation attenuation, which is valid when I/Q output modulation is on.

**Setting format:** [:SOURce]:DM:IQADjustment:OUTPut:ATTen <val>.

**Query format:** [:SOURce] :DM:IQADjustment:OUTPut:ATTen?

**Parameter description:**

<Atten> I/Q output modulation attenuation.

Range: 0dB [0dB , 94.5dB].

**Example:** :DM:IQADjustment:OUTPut:ATTen 10dB To set I/Q output attenuation to 10dB.

## 3) Gain balance

**Function description:** To set the gain balance of I/Q output modulation, which is valid when I/Q output modulation is on.

**Setting format:** [:SOURce]:DM:IQADjustment:OUTPut:GAIN <val>.

**Query format:** [:SOURce] :DM:IQADjustment:OUTPut:GAIN?

**Parameter description:**

<Gain> I/Q output modulation gain balance value.

Range: 0dB [-4dB , 4dB].

**Example:** :DM:IQADjustment:OUTPut:GAIN 2dB To set I/Q output gain balance to 2dB.

## 4) I offset

**Function description:** To set the I offset of the I/Q output modulation, which is valid when I/Q output modulation is on.

**Setting format:** [:SOURce]:DM:IQADjustment:OUTPut:IOFFset <val>.

**Query format:** [:SOURce] :DM:IQADjustment:OUTPut: IOFFset?

**Parameter description:**

<Offset> I offset of I/Q output modulation.

Range: 0V [-1V , 1V].

**Example:** :DM:IQADjustment:OUTPut:IOFFset 1V To set I offset of I/Q output to 1V.

## 5) I/ offset

**Function description:** To set the I/ offset of the I/Q output modulation, which is valid when I/Q output modulation is on.

**Setting format:** [:SOURce]:DM:IQADjustment:OUTPut:UIOFFset <val>.

**Query format:** [:SOURce] :DM:IQADjustment:OUTPut:UIOFFset?

**Parameter description:**

<Offset> I/ offset of I/Q output modulation.

## 5.2 Menu Description

Range: 0V [-1V , 1V].

**Example:** :DM:IQADjustment:OUTPut:UIOffset 1V To set I/ offset of I/Q output to 1V.

### 6) Q offset

**Function description:** To set the Q offset of the I/Q output modulation, which is valid when I/Q output modulation is on.

**Setting format:** [:SOURce]:DM:IQADjustment:OUTPut:QOFFset <val>.

**Query format:** [:SOURce] :DM:IQADjustment:OUTPut:QOFFset?

**Parameter description:**

<Offset> Q offset of I/Q output modulation.

Range: 0V [-1V , 1V].

**Example:** :DM:IQADjustment:OUTPut:QOFFset 1V To set Q offset of I/Q output to 1V.

### 7) Q/ offset

**Function description:** To set the Q/ offset of the I/Q output modulation, which is valid when I/Q output modulation is on.

**Setting format:** [:SOURce]:DM:IQADjustment:OUTPut:UQOFFset <val>.

**Query format:** [:SOURce] :DM:IQADjustment:OUTPut:UQOFFset?

**Parameter description:**

<Offset> Q/ offset of I/Q output modulation.

Range: 0V [-1V , 1V].

**Example:** :DM:IQADjustment:OUTPut:UQOFFset 1V To set I/ offset of I/Q output to 1V.

### 8) Orthogonality offset

**Function description:** To set the Orthogonality offset of the I/Q output modulation, which is valid when I/Q output modulation is on.

**Setting format:** [:SOURce]:DM:IQADjustment:OUTPut:SKEW <val>.

**Query format:** [:SOURce] :DM:IQADjustment:OUTPut:SKEW?

**Parameter description:**

<Skew> I/Q output modulation orthogonality offset.

Range: 0V [-10deg , 10deg].

**Example:** :DM:IQADjustment:OUTPut:SKEW 1deg To set I/Q output orthogonality offset to 1deg.

## 5.2.7 Arbitrary wave

### 5.2.7.1 Arbitrary wave sequence on

**Function description:** To enable the status of the random waveform generator of the signal generator. When it is on, the main information display area on the UI of the signal generator will display instructions.

**Setting format:** [:SOURce]:RADio:ARB:STATe ON|OFF|1|0

**Query format:** [:SOURce]:RADio:ARB:STATe?

**Parameter description:**

<State> Boolean data, which is taken as follows:

ON | 1: Arbitrary wave is on;

OFF | 0: Arbitrary wave is off.

**Example:** [:SOURce]:RADio:ARB:STATe 1 to start random wave.

### 5.2.7.2 Operation mode

**Function description:** To set the random wave type to be ARB or sequence. In the ARB mode, the user can load the random wave data file in the customized format for playing; in the SEQUENCE mode, the user can generate the waveform segment file as required, and combine such waveform segments for playing in sequence.

**Setting format:** [:SOURce]:RADio:ARB:MODE ARB|SEQUence

**Query format:** [:SOURce]:RADio:ARB:MODE?

**Parameter description:**

<Mode> Discrete data. It is the random wave mode, with values being taken as follows:

ARB | 0: In the ARB mode.

SEQUence | 1: In the sequence mode.

**Example:** [:SOURce]:RADio:ARB:MODE SEQ The random wave is in the sequence mode.

### 5.2.7.3 Clock type

**Function description:** It is used to set the sampling clock type when the signal generator is in the ARB mode. In the ARB mode, the user can use the CUSTom mode only rather than setting other modes; in the sequence mode, the user can select from three modes, namely, CURREnt, HIGH and CUSTom.

**Setting format:** [:SOURce]:RADio:ARB:SEQUence:CLOCK CURREnt|HIGH|CUSTom

**Query format:** [:SOURce]:RADio:ARB:SEQUence:CLOCK?

**Parameter description:**

<Mode> Discrete data. It is the sampling clock type in the ARB mode, with values being taken as follows:

CURREnt | 0: To play the waveform segment file in sequence as per the sampling rate of each segment;

HIGH | 1: To play the waveform segment file in sequence as per the highest sampling rate of the segments;

CUSTom | 2: To play the waveform segment file in sequence as per the clock rate set by the signal generator.

**Example:** [:SOURce]:RADio:ARB:SEQUence:CLOCK HIGH

It is used to set the sampling clock type to high.

### 5.2.7.4 Clock frequency

**Function description:** To set the ARB signal sampling rate, which is valid only when the clock type is in the custom mode.

**Setting format:** [:SOURce]:RADio:ARB:SClock:RATE <val><freq unit>

**Query format:** [:SOURce]:RADio:ARB:SClock:RATE?

**Parameter description:**

## 5.2 Menu Description

<ClockRate> I/Q signal Q offset.

Range: 100MHz[0.01MHz , 250MHz].

**Example:** [:SOURce]:RADio:ARB:SCLock:RATE 50MHz The ARB clock frequency is 50MHz.

### 5.2.7.5 Creating sequence

#### Function description:

To clean current sequence list and create an empty one in the sequence mode. It is valid in the sequence mode.

### 5.2.7.6 Loading sequence

**Function description:** To add a waveform sequence consisting of multiple waveform segments, with parameters consisting of file\_name, waveform, reps and M1M2M3M4, whereas file\_name is the folder specified for storing the waveform segment files (the user-specified folder can only be that under relevant path rather than absolute one. For example, if the user name the file\_name as "D:\USER\SEQ", such folders cannot be created in Disk D, which will be deemed to be incorrect file names), waveform is the specific waveform segment file, with the number of waveform segment files of up to 64, reps is the times of each waveform segment subjected to loop playback, with each waveform segment to be subjected to loop playback by up to 65535 times, and M1M2M3M4 is the mark on/off status of each waveform segment file, for example, the user can select ALL or NONE to show or not to show all mark outputs in the waveform segment.

**Setting format:** [:SOURce]:RADio:ARB

:SEquence <file\_name>,<waveform>,<reps>,NONE

|M1|M2|M3|M4|M1M2|M1M3|M1M4|M2M3|M2M4

|M3M4|M1M2M3|M1M2M4|M1M3M4|M2M3M4|ALL,{

<waveform2>,<reps>,NONE|M1|M2|M3|M4

|M1M2|M1M3|M1M4|M2M3|M2M4|M3M4|M1M2M3

|M1M2M4|M1M3M4|M2M3M4|ALL

#### Parameter description:

<FileName> Character string type.

It is the folder to store the waveform segment files, whereas the user-specified folder can only be under the relative path.

<WaveForm> Character string type.

It is the waveform file name, and the number of waveform segment files supported by the command is up to 64.

<Reps> Integer. It is the times for loop playback of each waveform segment.

Range: 1[1 , 65535].

<Marks> Discrete data type, which is the mark status (on/off) of each waveform segment file, with specific options shown in the command format.

**Example:** [:SOURce]:RADio:ARB:SEquence Seq1 , waveform1 , 12 , NONE , vaveform2 , 300 , M1M2

To load a waveform sequence in the Seq1 folder, which includes two waveform segment files, namely, waveform1 and waveform2, whereas waveform1 is subjected to loop playback for 12 times without mark output, and waveform2 is subjected to loop playback for 300 times with mark1 and mark2 output for each code element.

### 5.2.7.7 Saving sequence

#### Function description:

To save the configured sequence (ARB) file that is saved in the hard disk by the user, with file suffix of .config\_seg and default sequence configuration file directory of d:\\1435data\\user\\sequence. The user shall save the sequence (ARB) file for convenient and quick configuration loading.

### 5.2.7.8 Trigger mode

**Function description:** To set the trigger mode for waveform playback control, including such four modes as CONTInuous, SINGle, GATE and SADVance. For signal trigger, the system cannot receive valid trigger events until current code pattern sequence is played. In addition, each of the CONTInuous, SINGle, GATE and SADVance modes has multiple statuses. For details, see “:RADio:ARB:TRIGger:TYPE:CONTInuous”,

“:RADio:ARB:TRIGger:TYPE:SINGle”,

“:RADio:ARB:TRIGger:TYPE:SADVance:TYPE”, and “:RADio:ARB:TRIGger:TYPE:GATE:ACTIve”.

**Setting format:** [:SOURce]:RADio:ARB:TRIGger:TYPE CONTInuous

|SINGle|SADVance|GATE

**Query format:** [:SOURce]:RADio:ARB:TRIGger:TYPE?

#### Parameter description:

<Mode> Discrete data. The trigger mode for controlling waveform playback in the arbitrary wave mode, with values taken as follows:

CONTInuous | 0: Set the trigger mode to continuous, and the instrument will play the waveform sequence repeatedly after receiving valid trigger events;

SINGle | 1: Set the trigger mode to single, and the instrument will play the waveform sequence for once only;

SADVance | 2: Set the trigger mode to waveform segment, and the instrument will play one waveform segment repeatedly every time when receiving a valid trigger event;

GATE | 3: Set the trigger mode to gate, and the instrument will play the waveform sequence continuously during the valid time of the gate signal.

**Example:** [:SOURce]:RADio:ARB:TRIGger:TYPE SING The trigger mode is single.

### 1) Cont

**Function description:** To set the mode of the sequence file to respond to the trigger signal under the ARB continuous/single trigger mode, including three modes, namely, FREE, TRIGger and RESet.

**Setting format:** [:SOURce]:RADio:ARB:TRIGger:TYPE:CONTInuous

FREE|TRIGger|RESet

**Query format:** [:SOURce]:RADio:ARB:TRIGger:TYPE:CONTInuous?

#### Parameter description:

<Mode> Discrete data. To set the mode of the sequence file to respond to the trigger signal in the ARB continuous mode,

with values taken as follows:

FREE | 0: Select the auto mode to automatically trigger the sequence for playing after the sequence waveform data is downloaded, and ignore all trigger events during playback.

TRIGger | 1: Select the trigger mode, and the system will not play current waveform sequence in the trigger mode until the system receives valid trigger events. The system will play

## 5.2 Menu Description

current waveform sequence after receiving valid trigger events. After sequence playback, it waits for valid trigger events for playing current waveform sequence again.

**RESet** | 2: Select the real time mode, and the system will not generate any modulation source data until it receives valid trigger events, thus generating no code pattern signals; the system starts to generate selected modulation source data after receiving valid trigger events, thus generating corresponding code pattern data and signal. After generating current source data, the system starts to automatically generate the modulation source data set currently again. When generating the modulation source data, the system will stop such operation immediately after receiving valid trigger events, and starts over again to generate the modulation source data set.

**Example:** [:SOURce]:RADio:ARB:TRIGger:TYPE:CONTInuous TRIG

To set the mode of the sequence file to respond to the trigger signal in the ARB continuous trigger mode to trigger.

### 2) Single

**Function description:** To set the mode of the sequence file to respond to the trigger signal under the ARB single trigger mode, including three modes, namely, FREE, TRIGger and RESet.

**Setting format:** [:SOURce]:RADio:ARB:TRIGger:TYPE:SINGle

FREE|TRIGger|RESet

**Query format:** [:SOURce]:RADio:ARB:TRIGger:TYPE:SINGle?

**Parameter description:**

<Mode> Discrete data. To set the mode of the sequence file to respond to the trigger signal in the ARB single trigger mode,

with values taken as follows:

**FREE** | 0: Select the auto mode to automatically trigger the sequence for playing after the sequence waveform data is downloaded, and ignore all trigger events during playback.

**TRIGger** | 1: Select the trigger mode, and the system will not play current waveform sequence in the trigger mode until the system receives valid trigger events. The system will play current waveform sequence after receiving valid trigger events. After sequence playback, it waits for valid trigger events for playing current waveform sequence again.

**RESet** | 2: Select the real time mode, and the system will not generate any modulation source data until it receives valid trigger events, thus generating no code pattern signals; the system starts to generate selected modulation source data after receiving valid trigger events, thus generating corresponding code pattern data and signal. After generating current source data, the system starts to automatically generate the modulation source data set currently again. When generating the modulation source data, the system will stop such operation immediately after receiving valid trigger events, and starts over again to generate the modulation source data set.

**Example:** [:SOURce]:RADio:ARB:TRIGger:TYPE:SINGle TRIG

To set the mode of the sequence file to respond to the trigger signal in the ARB trigger mode to trigger.

### 3) Waveform segment

**Function description:** To set the mode of the sequence file to respond to the trigger signal under the ARB waveform segment trigger mode, including two modes, namely, SINGle and CONTInuous. The waveform segment playback trigger function is for single waveform segment in the sequence rather than the whole waveform sequence.

**Setting format:** [:SOURce]:RADio:ARB:TRIGger:TYPE:SADVance:TYPE

SINGle|CONTInuous

**Query format:** [:SOURce]:RADio:ARB:TRIGger:TYPE:SADVance:TYPE?



**Parameter description:**

<Mode> Discrete data. To set the mode of the sequence file to respond to the trigger signal in the ARB waveform segment trigger mode,

with values taken as follows:

SINGle | 0: Single waveform segment trigger;

CONTInuous | 1: Continuous waveform segment trigger.

**Example:** [:SOURce]:RADio:ARB:TRIGger:TYPE:SADVance:TYPE SING

To set the mode of the sequence file to respond to the trigger signal in the ARB waveform segment trigger mode to single.

**4) Gate**

**Function description:** To set the mode of the sequence file to respond to the trigger signal under the gate trigger mode, including two modes, namely, low and high.

**Setting format:** [:SOURce]:RADio:ARB:TRIGger:TYPE:GATE:ACTive

LOW|HIGH

**Query format:** [:SOURce]:RADio:ARB:TRIGger:TYPE:GATE:ACTive?

**Parameter description:**

<Mode> Discrete data. To set the mode of the sequence file to respond to the trigger signal in the ARB gate trigger mode,

with values taken as follows:

LOW | 0: Low;

HIGH | 1: High.

**Example:** [:SOURce]:RADio:ARB:TRIGger:TYPE:GATE:ACTive LOW

To set the mode of the sequence file to respond to the trigger signal in the ARB gate trigger mode to low.

**5.2.7.9 Trigger source**

**Function description:** To set the ARB trigger source.

**Setting format:** [:SOURce]:RADio:ARB:TRIGger:SOURce KEY|BUS|EXT|INT

**Query format:** [:SOURce]:RADio:ARB:TRIGger:SOURc e?

**Parameter description:**

<Mode> Discrete data. It is the ARB trigger source,

with values taken as follows:

KEY: The trigger key;

BUS: The bus;

EXT: External;

INT: Internal.

**Example:** [:SOURce]:RADio:ARB:TRIGger:SOURce BUS

To set the trigger source to bus.

**5.2.7.10 Sampling clock [internal/external]**

**Function description:** To set the ARB sampling clock, and the clock frequency is 200MHz

## 5.2 Menu Description

when the clock is set to internal, which cannot be changed. If the clock is set to external, the clock frequency can be set via the external clock frequency command.

**Setting format:** [:SOURce]:RADio:ARB:VCO:CLCOk INTernal|EXTernal

**Query format:** [:SOURce]:RADio:ARB:VCO:CLOCK?

**Parameter description:**

<Mode> Discrete data. It is the ARB sampling clock, with values being taken as follows:

INTernal : Internal;

EXTernal: External.

**Example:** [:SOURce]:RADio:ARB:VCO:CLOCK EXTernal

To set the trigger source to bus.

### 5.2.7.11 External clock frequency

**Function description:** To set the external clock frequency, which is valid when the sampling clock is set to external.

**Setting format:** [:SOURce]:RADio:ARB:EXTernal:CLCOk:RATE <val><freq unit>

**Query format:** [:SOURce]:RADio:ARB:EXTernal:CLOCK:RATE?

**Parameter description:**

<Mode> It is the ARB sampling clock, with values being taken as follows:

Range: [100Hz,250MHz]

**Example:** [:SOURce]:RADio:ARB:EXTernal:CLOCK:RATE 100MHz

To set the trigger source to bus.

### 5.2.7.12 Waveform calibration

**Function description:**

It is not supported at present.

### 5.2.7.13 Real-time waveform calibration

**Function description:**

It is not supported at present.

### 5.2.7.14 Wave absorption

**Function description:**

It is not supported at present.

### 5.2.7.15 Frequency marker polarity

**Function description:**

It is not supported at present.

### 5.2.7.16 Frequency marker function

**Function description:**

It is not supported at present.

## 5.2.8 Dual/multiple tones

### 5.2.8.1 Multiple (dual) tones on

**Function description:** To set the on/off status of the signal generator. When it is on, the main

---

**5.2 Menu Description**

information display zone on the UI of the signal generator will display the IQ modulation and multiple-tone instructions.

**Setting format:** [:SOURce]:RADio:MTONe:ARB:STATe ON|OFF|1|0

**Query format:** [:SOURce]:RADio:MTONe:ARB:STATe?

**Parameter description:**

<State> Boolean data. The on/off status of the multiple-tone modulation, with value taken as follows:

ON | 1: Multiple-tone modulation is on;

OFF | 0: Multiple-tone modulation is off.

**Example:** [:SOURce]:RADio:MTONe:ARB:STATe 1 To start multiple-tone modulation.

### 5.2.8.2 Initial phase position ([Fixed]/[Random])

**Function description:** To initialize the initial phase mode in the multiple-tone modulation list, including two modes, namely, random and fixed. When it is set to fixed, all tone phase positions in the multiple-tone list will be set to the fixed value of 0 degrees; when it is set to random, such phase positions will be set with different random values based on the random seed settings.

**Setting format:** [:SOURce]:RADio:MTONe:ARB:SETUp:TABLE:PHASe:INITialize RANDom|FIXed

**Query format:** [:SOURce]:RADio:MTONe:ARB:SETUp:TABLE:PHASe:INITialize?

**Parameter description:**

<Mode> Discrete data. It is the initial phase mode in the multiple-tone modulation list, with values being taken as follows:

RANDom : To set all tones to random values;

FIXed : To set all tones to fixed values.

**Example:** [:SOURce]:RADio:MTONe:ARB:SETUp:TABLE:PHASe:INITialize FIX

To set the tone phase position in the multiple-tone list to fixed value.

### 5.2.8.3 Phase position relationship between tones ( [Fixed]/[Random] )

**Function description:** To set the phase position relationship between multiple modulation tones, including two modes, namely, random and fixed.

**Setting format:** [:SOURce]:RADio:MTONe:ARB:SETUp:TABLE:PHASe:INITialize:SEED RANDom|FIXed

**Query format:** [:SOURce]:RADio:MTONe:ARB:SETUp:TABLE:PHASe:INITialize:SEED?

**Parameter description:**

<Mode> Discrete data. It is the mode of the phase relationship between multiple modulation tones, with values being taken as follows:

RANDom: Phase position relationship between tones is random;

FIXed :Phase position relationship between tones is fixed.

**Example:** [:SOURce]:RADio:MTONe:ARB:SETUp:TABLE:PHASe:INITialize:SEED FIX

To set phase position relationship between tones to fixed.

### 5.2.8.4 Frequency spacing

**Function description:** To set the frequency spacing between multiple tones, which is valid only when the multiple-tone modulation is on.

## 5.2 Menu Description

**Setting format:** [:SOURce]:RADio:MTONe:ARB:SETUp:TABLE:FSPacing <val><freq unit>

**Query format:** [:SOURce]:RADio:MTONe:ARB:SETUp:TABLE:FSPacing?

**Parameter description:**

<FreqSpacing> Frequency spacing between multiple tones.

Range: 1MHz[100Hz , 200MHz].

**Example:** [:SOURce]:RADio:MTONe:ARB:SETUp:TABLE:FSPacing 200kHz

To set the frequency spacing in the multiple-tone list to 200kHz.

### 5.2.8.5 Dual tone alignment ( [Left]/[Middle]/[Right] )

**Function description:** To set the alignment between dual tones, including three modes, namely, left, middle and right, which is valid only when the dual-tone modulation is on.

**Setting format:** [:SOURce]:RADio:TTONe:ARB:ALIGNment LEFT|CENTer|RIGHT

**Query format:** [:SOURce]:RADio:TTONe:ARB:ALIGNment?

**Parameter description:**

<Mode> Discrete data. It is the dual-signal alignment position, with values taken as follows:

LEFT | 0: Left;

CENTer | 1: Middle;

RIGHt | 2: Right.

**Example:** [:SOURce]:RADio:TTONe:ARB:ALIGNment RIGHT

To set to show the dual-tone signal alignment in the right of the carrier.

### 5.2.8.6 File loading

**Function description:** To select the multiple-tone file and load it to the signal generator memory for playback. The command parameter requires only the multiple-tone file name rather than absolute path.

**Setting format:** [:SOURce]:RADio:MTONe:ARB:SETUp <file\_name>

**Parameter description:**

<FileName> Character string type, namely, the multiple-tone file name.

**Example:** [:SOURce]:RADio:MTONe:ARB:SETUp "mtone1.mtn"

To load the mtone1.mtn file to the signal generator memory.

### 5.2.8.7 File storage

**Function description:** To store current waveform data in the multiple-tone list to the multiple-tone file of the signal generator. The command parameter requires only the multiple-tone file name rather than absolute path.

**Setting format:** [:SOURce]:RADio:MTONe:ARB:STORe <file\_name>

**Parameter description:**

<FileName> Character string type, namely, the multiple-tone file name.

**Example:** [:SOURce]:RADio:MTONe:ARB:STORe "mtone1.mtn"

To save the multiple-tone list to the multiple-tone file mtone1.mtn of the signal generator.

### 5.2.8.8 Multiple-tone list setup

**Function description:** To create and configure a multiple-tone waveform, including such

## 5.2 Menu Description

parameters as <freq\_offset>, <num\_tones>, <pow>, <phase> and <state>. <Freq\_offset> is subject to the 200M bandwidth of the baseband and the number of tones in the multiple-tone list, which is the same between tones and frequency spacing.

**Setting format:** [:SOURce]:RADio:MTONE:ARB:SETup:TABLE <freq\_spacing>,<num\_tones>,{<pow>,<phase>,<state>...}

**Parameter description:** String parameters

<FreqSpacing> Frequency spacing between multiple tones.

Range: 1MHz[100Hz , 200MHz].

<NumTones>Number of tones.

Range: 2[2 , 64].

<Pow> Power attenuation.

Range: 0dB[-100dB , 0dB].

<Phase> Initial phase position.

Range: 0deg[0deg , 359deg].

<State> Status. Boolean data, which is taken as follows:

1: On;

0: Off.

**Example:** [:SOURce]:RADio:MTONE:ARB:SETup:TABLE "1000000 , 3 , -10 , 90 , 0 , -20 , 0 , 1 , -30 , 45 , 1"

To set the multiple-tone modulation spacing to 1MHz, and there are 3 tones, with the power attenuation value, phase position and status of the first one are 10dB, 90 degrees and on respectively, those of the second one are 20dB, 0 degrees and on respectively, and those of the third one are 30dB, 45 degrees and on respectively.

### 5.2.10 System

#### 5.2.10.1 Reference selection Auto [On/Off]

**Function description:**

To check or not to check the box in the left of option is to set to manual or auto respectively.

In the auto mode, the instrument selects the frequency reference automatically if there is any external frequency reference or internal one, with the former being the priority. The default setting is [Auto].

#### 5.2.10.2 Internal reference accuracy

**Function description:** To set the internal alignment parameter to adjust the internal reference of the signal generator, ensuring higher accuracy of the frequency output. Note: The instrument need some warm-up time in 2h after the signal generator is started. Do not change internal parameters at will. For details, see the user manual of 1435 series signal generators.

**Setting format:** [:SOURce]:ROSCillator:REFerence <val>

**Query format:** [:SOURce]:ROSCillator: REFerence?

**Parameter description:**

<Val> Internal alignment parameter data.

## 5.2 Menu Description

Range: [0 , 65535].

**Example:** :ROSCillator: REFerence 30000

Adjust the internal reference accuracy to 30000.

### 5.2.10.3 Reset setting

#### 1) Factory

**Function description:**

After factory setting, press **【Reset】** to restore to the factory settings.

**Program Control Commands:**

\*RST

**·Program control example:**

\*RST

#### 2) User

**Function description:**

After user setting, click to save the user status, and press **【Reset】** to restore to the user settings.

#### 3) Previous status

**Function description:**

After setting the previous status, the instrument, after being started again, will restore to the status when it is shut down last time.

**Program Control Commands:**

It is not supported at present.

**·Program control example:**

NONE

#### 4) Save user status

**Function description:**

To save the user status in the user resetting status.

**Program Control Commands:**

It is not supported at present.

**Program control example:**

NONE

### 5.2.10.4 Remote control port configuration

#### 1) GPIB port configuration

**Function description:**

To configure the GPIB port. For specific operations, see Section [“6.2.2 GPIB”](#).

#### 2) LAN port configuration

**Function description:**

To configure the LAN port. For specific operations, see Section [“6.2.1 LAN”](#).

### 5.2.10.5 Complete machine self test

#### 1) Self test [Start self test]

**Function description:**

To start self test on the self test item selected by the user.

#### 2) Loop test [on/off]

**Function description:**

To set the on/off status for the self test items selected by the user for loop test. When it is on, the loop test will continue till the user stop it. The default setting is (off).

#### 3) Display test results [All/ Error]

**Function description:**

To display all or incorrect test data during self test. The default setting is (off).

### 5.2.10.6 Debugging code

**Function description:**

To set or change the command entering the debugging window. The instrument is provided with a default debugging code upon delivery. In case of any special demand, please contact the factory.

## 5.2.11 Storage/loading

### 5.2.11.1 Selecting file storage number

**Function description:**

The instrument can store files in 100 statuses with storage numbers of 0 ~ 99. Select the number of the status for the file to be stored in the instrument, and press Enter for storage.

**Function description:**

0 [ 0 , 99 ]

**Program control commands :**

\*SAV

**Program control example:**

\*SAV 8

### 5.2.11.2 Selecting file loading number

**Function description:**

The instrument can load files in 100 statuses with storage numbers of 0 ~ 99. Select the number of the status for the instrument to be loaded, and press Enter for loading.

**Function description:**

0 [ 0 , 99 ]

**Program Control Commands:**

\*RCL

**Program control example:**

\*RCL 8

---

## 5.2 Menu Description

### 5.2.12 Calibration

Only user power flatness calibration is available at present.

#### 5.2.12.1 Index

**Function description:**

To position certain item in the list as per current index value for editing.

#### 5.2.12.2 Inserting frequency point

**Function description:**

To insert the frequency point into current user calibration list.

#### 5.2.12.3 Following frequency [on/off]

**Function description:**

It is not supported at present.

#### 5.2.12.4 Auto filling-in

**1) Initial filling-in frequency.**

**Function description:**

To set the initial filling-in frequency for auto filling-in.

**2) Final filling-in frequency.**

**Function description:**

To set the final filling-in frequency for auto filling-in.

**3) Filling-in frequency spacing**

**Function description:**

To set the frequency spacing for auto filling-in.

**4) Number of filling-in points**

**Function description:**

To set the number of filling-in points for auto filling-in.

**5) Confirming filling-in**

**Function description:**

To confirm the filling-in after editing.

#### 5.2.12.5 Editing list

**1) Modifying frequency compensation**

**Function description:**

To modify the frequency of the number of frequency points in current user calibration list.

**2) Modifying power offset**

**Function description:**

To modify the frequency offset of the number of frequency points in current user calibration list.

**3) Storage**

**Function description:**

To store the calibration value after auto calibration or manual user modification.



**4) Loading****Function description:**

To call the stored calibration value and display it in the calibration list.

**5) Delete****Function description:**

To delete the calibration value from calibration list.

**5.2.12.6 Calibrating all points****Function description:**

To calibrate all frequency points in the calibration list.

**5.2.12.7 Calibrating undefined points****Function description:**

To calibrate all undefined power offset points in the calibration list.

**5.2.12.8 Calibrating current points****Function description:**

To calibrate currently-selected points in the calibration list.

---

**5.2 Menu Description**

## 6 Remote control

This section introduces briefly the program control foundation, program control interface and configuration method and basic VISA interface programming method of the 1435 series signal generator, as well as the concept and classification of the I/O instrument driver library, so as to facilitate users' remote control. Specific contents are as follows:

- [Remote control foundation.....177](#)
- [Instrument program control port and configuration .....193](#)
- [basic VISA interface programming method .....194](#)
- [I/O library.....198](#)

### 6.1 Remote control foundation

- [Program control interface.....177](#)
- [Message.....180](#)
- [SCPI command.....181](#)
- [Command sequence and synchronization.....189](#)
- [Status report system.....190](#)
- [Programming precautions.....192](#)

#### 6.1.1 Program control interface

1435 series signal generators support two types of remote control interfaces, namely, LAN and GPIB.

It is shown in the table below:

Table 6.1 Remote control interface type and VISA addressing character string

Program control interface	VISA addressing character string	Description
LAN (Local Area Network)	<b>VXI-11 protocol:</b> TCPIP::host_address[::LAN_device_name][::INSTR] <b>Original socket protocol:</b> TCPIP::host_address::port::SOCKET	The operator realizes remote control by connecting the instrument via the network port on the rear panel of the instrument. For specific protocols, see the following: <a href="#">“6.1.1.1 LAN interface”</a>
GPIB (IEC/IEEE Bus Interface)	GPIB::primary address[::INSTR]	The operator

**6.1 Remote control foundation**

		realizes remote control by connecting the instrument via the port on the rear panel of the instrument. It follows the IEC 625.1/IEEE 418 bus interface standard. For details, see the following: <a href="#">“6.1.1.2 GPIB interface”</a>
--	--	---

- [LAN interface.....178](#)
- [GPIB interface.....180](#)

**6.1.1.1 LAN interface**

The signal generator can realize remote control via the computer in the 10Base-T and 100Base-T LANs, and various instruments form a system in the LAN, which is controlled by the computer in the LAN. The signal generator needs to be provided with port connectors, network cards, associated network protocols and relevant network services first before realizing remote control in the LAN, and the master computer in the LAN needs also to be provided with instrument control software and VISA library in advance. Three working modes of the network card are as follows:

- 10Mbit/s Ethernet IEEE802.3;
- 100Mbit/s Ethernet IEEE802.3u;
- 1Gbit/s Ethernet IEEE802.3ab.

Both the master computer and signal generator need to be connected to the shared TCP/IP protocol network via the Internet access. The commercial RJ45 cable (type-5 twisted-pair cable with or without shield) is used to connect the computer with the signal generator. Data packet transmission is adopted for quick LAN transmission. The cable length between the computer and the signal generator shall not exceed 100 meters (100Base-T and 10Base-T). For more information about LAN communication, please refer to: <http://www.ieee.org>. Knowledges about the LAN interface are introduced below:

**1) IP address**

Physical connection of the network should be guaranteed for remote control on the signal generator via the LAN. To do this, just set the address to the subnet of the master computer via the menu “Local IP” of the signal generator. For example, if the IP address of the master computer is 192.168.12.0, the IP of the signal generator shall be set to 192.168.12.XXX, whereas XXX is the figure between 1 ~ 255.

Only the IP address is required for network connection, and the VISA addressing character string format is as follows:

TCPIP::host address[::LAN device name][::INSTR] or

TCPIP::host address::port::SOCKET

Whereas:

- TCPIP is the network protocol used;
- host address is the instrument IP address or host name for identifying and controlling the instrument under control;
- LAN device name defines the handle number of the protocol and subset (optional);
  - Equipment 0: Select VXI-11;
  - High-speed LAN instrument 0: Select the new high-speed LAN instrument protocol;
- INSTR is the instrument resource type (optional);
- port marks the socket port number;
- SOCKET is the socket resource type of the original network.

Example:

- If the instrument IP is 192.1.2.3, the valid resource character string of the VXI-11 protocol is as follows:

TCPIP::192.1.2.3::INSTR

- The following can be used for establishing original socket connection:

TCPIP::192.1.2.3::5025::SOCKET

## Tip

### Method of recognizing multiple instruments in the program control system

In case of multiple instruments connected in the network, independent instrument IP and associated resource character string are used for recognition. The master computer adopts respect VISA resource character strings to recognize the instrument.

## 2) VXI-11 protocol

The VXI-11 standard is based on the ONC RPC (Open Network Computing Remote Procedure Call) protocol, which is the network/transport layer of the TCP/IP protocol. Since the TCP/IP network protocol and relevant network services are configured in advance, such connection-oriented communication can follow the principle of exchanging in sequence and recognize connection interruption during communication, ensuring no information missing.

## 3) Socket communication

The TCP/IP protocol connects the signal generator to the network via LAN sockets. Socket is a basic method used in computer network programming that enables applications using different hardware and operating systems to communicate in the network. This method allows for two-way communication between the signal generator and the computers via ports.

A sockets is a specially-written software class that defines the information necessary for network communication (such as the IP addresses and device port numbers) and integrates some basic operations in network programming. Sockets can be used after installing packaged libraries in the operating system. Two commonly used socket libraries are the Berkeley socket library for UNIX the Winsock library for Windows.

## 6.1 Remote control foundation

Sockets in signal generators are compatible with Berkeley socket and Winsock through application programming interfaces (APIs). They are also compatible with other standard socket APIs. When the SCPI command is used to control the signal generator, such command is sent by the socket program established in the program. The socket port numbers of the signal generators must be set first before using LAN sockets. The socket port number of the signal generator is 5025.

### 6.1.1.2 GPIB interface

The GPIB interface is a type of remote control interface still widely used for instrument connection at present, which is connected with various instruments via the GPIB cable, and forms test systems with the master computer. The master computer needs to be provided with the GPIB bus card, driver and VISA library for remote control. During communication, the master computer addresses the instrument to be controlled via the GPIB bus. Users can set the GPIB address and ID query character string, and the GPIB communication language can be in the SCPI command by default.

GPIB and its related associated interface operations are defined and described in detail in ANSI/IEEE Standard 488.1-1987 and ANSI/IEEE Standard 488.2-1992. For details on the standard, please refer to the IEEE website at <http://www.ieee.org>.

GPIB processes information in bytes at the data transmission speed of up to 8MBps, which is fast. Since the data transmission speed is limited by the distance between the equipment/system and computer, pay attention to the following during GPIB connection:

- Up to 15 instruments can be set up via the GPIB interface;
- The total length of the transmission cable cannot exceed 15m nor double the number of instruments in the system. In general, the maximum length of the transmission cable between the devices cannot exceed 2 meters.
- In case of multiple instruments connected in parallel, the “alternative” connecting line must be used.
- The end of the IEC bus cable shall be connected to the instrument or master computer.

## 6.1.2 Message

Messages transmitted on the data cable can be classified into two types as follows:

### 1) Interface message

During communication between the instrument and master computer, the attention line must be pulled down so that the interface message can be transmitted to the instrument via the data cable. Only instruments with the GPIB bus function can transmit the interface message.

### 2) Instrument message

For the detailed structure and syntax of the instrument message, see Section “6.1.3 SCPI command”. The instrument message can be divided into two types as per the transmission direction, namely, command and instrument response. Methods of using the instrument message by all program control interfaces are the same, unless otherwise specified.

#### a) Command:

The command (programming message) is transmitted from the master computer to the instrument) for remote instrument control and status information query. The command is divided into the following two types:

- Based on the effect on the instrument:
  - Setting command: to change the instrument setting status, for example, to reset or set frequencies.
  - Query command: to query and return data, for example, to recognize instruments or query parameter values. The query command is ended with a suffix question mark.
- Based on the definition in the standard:

**6.1 Remote control foundation**

— General command: to define the function and syntax by IEEE488.2, applicable to all types of instruments (if realized) for such functions as register management in standard status, reset and self test.

— Instrument control command: to be the instrument feature command for realizing instrument functions. For example, to set frequencies.

The syntax also follows the SCPI standard.

**b) Instrument response:**

Instrument response (response message and service request) is the query result information sent from the instrument to the computer. The information contains the measurement result and instrument status.

**6.1.3 SCPI command**

- [SCPI command brief.....181](#)
- [SCPI command description.....182](#)

**6.1.3.1 SCPI command brief**

SCPI (Standard Commands for Programmable Instruments) is the command set that is established based on the standard IEEE488.2 and applicable to all instruments. The purpose is to provide the same function with same program control command, realizing universality of program control commands.

The SCPI command consists of the command header and one or multiple parameters, which are separated by blank. The command header contains one or multiple key fields. The command acts as a query command if it is suffixed with a question mark. The command can be divided into the common command and instrument-specific command, with different syntactic structure for each other. The SCPI command has the following features:

- 1) The program control commands target test functions instead of describing instrument operations;
- 2) The program control command reduces the realization process repetition of similar test functions, ensuring programming compatibility;
- 3) Program messages are defined at a sub-layer independent of the hardware of the communication physical layer.
- 4) The program control command is irrelevant to programming means and programming languages, and the SCPI test procedure can be easily transplanted.
- 5) The program control command features scalability, thus applicable to measurement control of different scales.

SCPI is a “living” standard for their scalability.

For SCPI details, see the following:

IEEE Standard 488.1-1987, IEEE Standard Digital Interface for Programmable Instrumentation. New York, NY, 1998.

IEEE Standard 488.2-1987, IEEE Standard Codes, Formats, Protocols and Comment Commands for Use with ANSI/IEEE Std488.1-1987. New York, NY, 1998

Standard Commands for Programmable Instruments(SCPI) VERSION 1999.0.

For details on the program control command set, classification and description of the 1435 series signal generators, see the following:

- 1) “Annex B Zoom table of SCPI commands” of the Manual;

## 6.1 Remote control foundation

- 2) “3 Program control commands” of the Program Control Manual;
- 3) “Annex A Zoom table of SCPI commands classified as per subsystems” of the Program Control Manual;
- 4) “Annex B Zoom table of SCPI commands classified as per menus” of the Program Control Manual.

### 6.1.3.2 SCPI command description

- [General terms.....182](#)
- [Command type.....183](#)
- [Special instrument command syntax .....183](#)
- [Command tree.....184](#)
- [Command parameters and response.....185](#)
- [Numeral systems in commands.....188](#)
- [Command line structure.....188](#)

#### 1) General terms

The following terms apply to this section. In order to better understand the content hereinafter, you need to understand the exact definitions of these terms.

##### **Controller**

A controller is any computer used to communicate with the SCPI device. A controller may be a PC, a small computer, or a card on the card cage. Some AI devices can also be used as controllers.

##### **Device**

A device is any device that supports SCPI. Most of the devices are electronic measurement or excitation devices that use GPIB interfaces for communication.

##### **Program message**

A program message is the combination of one or more SCPI commands that have been correctly formatted. Program messages tell the devices how to measure and output the signals.

##### **Response message**

A response message is a set of data of specified SCPI formats. Response messages always come from the devices or listening devices. Response messages tell the controllers about the internal state or measured values of the devices.

##### **Command**

A command is an instruction that satisfies the SCPI standard. The combination of commands controlling the devices forms a message. In general, a command includes keywords, parameters, and punctuation.

##### **Event command**

The event program control command cannot be queried. An event command has no corresponding front panel key settings and it triggers an event at a specific moment.

##### **Query**

A query is a special type of command. When querying the control equipment, it returns response messages meeting the syntax requirements of the controllers. A query statement always ends with a question mark.



## 2) Command type

SCPI commands can be divided into two types: common commands and subsystem commands. Figure 5.2 shows the differences between the two types. Common commands, defined by IEEE 488.2, are used to manage macros and status registers and for synchronization and data storage. Since all common commands are started with an asterisk, they can be recognized easily. For example, \*IDN? , \*OPC, \*RST are all common commands. Common commands do not belong to any instrument-specific command, and the instrument interprets them in the same way, regardless of current command path settings.

Since the instrument-specific command contains the colon (:), it can be recognized easily. A colon is used in the beginning of an expression or between two keywords, for example: FREQUency[:CW? ]. The instrument-specific command is divided into corresponding subsystem command subset as per the internal instrument function module. For example, the power subsystem (:POWer) contains power-related command, whereas the state subsystem (:STATus) contains commands of the status control registers.

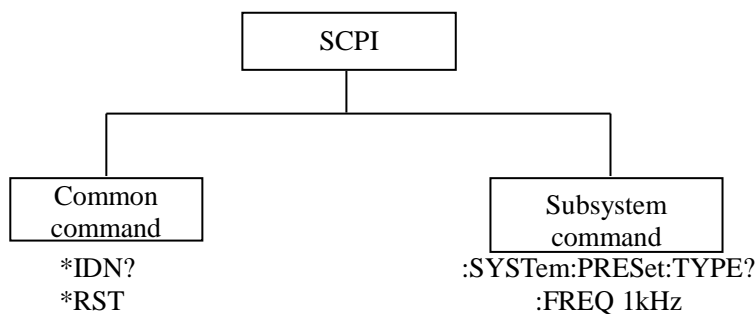

Figure 6.1 Types of SCPI Commands

## 3) Special instrument command syntax

A typical command consists of a keyword prefixed with a colon. The keyword is followed by parameters. The following is an example of a syntax declaration:

```
[ :SOURce]:POWer[:LEVel] MAXimum|MINimum
```

In the example above, the [:LEVel] in the command follow : POWer closely without any space. Following the [:LEVel]: MINimum|MAXimum is the parameter. There is a space between the command and its parameter. Conventions of other parts of the syntax expression are shown in Tables 6.2 and 6.3.

Table 6.2 Special characters in the command syntax

Symbol	Meaning	Example
	The vertical between the keyword and the parameter means multiple options.	[ :SOURce]:AM: SOURce EXTernal INTernal EXTernal and INTernal are options.
[]	Square brackets indicate that the keyword or parameter contained is optional when constructing the command. The command will also be executed even if these implied keywords or parameters are ignored.	[ :SOURce]:AM[:DEPTh]:E7ponential? SOURce and DEPTh are optional.
<>	The contents in the angle brackets indicate that the command is not used literally. They indicate the contents that are required.	[ :SOURce]:FREQ:STOP <val><unit> In this command, <val> and <unit> must be replaced with actual frequency and unit. For example::FREQ:STOP 3.5GHz

### 6.1 Remote control foundation

{ }	Contents in the brace indicate the parameter herein is optional.	[:SOURce]:LIST:POWer <val>{,<val>} For example: LIST:POWer 5
-----	--	--

Table 6.3 Command syntax

Characters, keywords and syntax	Example
Uppercase characters represent the minimum set of characters required to execute a command.	[:SOURce]:FREQUency[:CW]?, FREQ is the short format part of the command.
The lower case part of the command is optional; such flexible format is loaded “flexible listening”. For more information, please refer to Section “Command parameter and response”.	:FREQUency :FREQ,:FREQUency or :FREQUENCY; either of them is correct.
When a colon is between the two command mnemonics, it moves the current path in the command tree down by one level. For more information, please refer to the command path part in section “Command tree”.	:TRIGger:OUTPut:POLarity? TRIGger is the topmost keyword of this command.
If the command contains multiple parameters, the comma is used for spacing between parameters. The parameter is not part of the command path, so it does not affect the levels of the path.	[:SOURce]:LIST:DWELI <val>{,<val>}
The semicolon is used to separate 2 adjacent commands, without affecting current command path.	:FREQ 2.5GHZ; :POW 10DBM
Blank characters, such as <space> or <tab>, are usually ignored as long as they do not appear between keywords or in keywords. However, you must separate the commands and parameters with blank characters, which does not affect the current path.	:FREQ uency or :POWer :LEVel6.2 is not allowed. There must be a blank between LEVel and 6.2, namely, POWer:LEVel 6.2.

#### 4) Command tree

Most remote control programming will adopt the instrument-specific command. SCPI adopts a structure similar with the file system for analyzing such command, and this command structure is called a command tree, as shown in Figure 6.2:

## 6.1 Remote control foundation

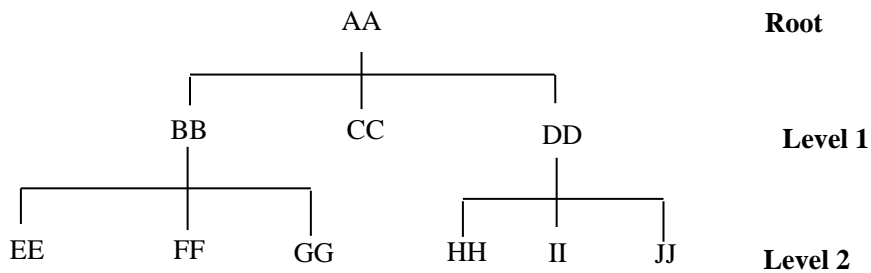

Figure 6.2 Diagram of the simplified command tree

The command on the top is the root command, which is called the "root" for short. You must go to the next level of commands based on a specific path during command analysis. For example: :POWER:ALC:SOURce? Whereas, : POWER stands for AA, :ALC stands for BB, :SOURce stands for GG, and the whole command path is (:AA:BB:GG) .

The software module (**command interpreter**) in the instrument software is used specially for analyzing each SCPI command received. The interpreter uses a series of rules that identify the paths of the command tree to divide the command into separate command elements. Since the same command keyword can exist in different paths, current command path will be kept after current command is analyzed, so as to make analysis on follow-up commands quicker and more efficient. After booting or \*RST (resetting) the instrument, current command path is reset to root.

### 5) Command parameters and response

SCPI define different data formats in the use of program and response messages to comply with the principles of "**flexible listening**" and "**precise speaking**". For more information, please refer to IEEE488.2. "**Flexible listening**" means that the formats of the commands and parameters are flexible.

For example, to set the frequency offset status command for the signal generator :FREQuency:OFFSet:STATe ON|OFF|1|0,

The following command formats are all used to set the frequency offset function to on:

:FREQuency:OFFSet:STATe ON, :FREQuency:OFFSet:STATe 1,

:FREQ:OFFS:STAT ON, :FREQ:OFFS:STAT 1

Different parameter type corresponds to one or more response data types. The value type parameter returns a data type when querying, and the response data are accurate and rigorous, which is called "**precise speaking**."

For example, if you query the power state (:POWER:ALC:STATe?), when it is on, the response data returned is always 1 whether the setting command sent previously is POWER:ALC:STATe 1 or :POWER:ALC:STATe ON.

Table 6.4 SCPI command parameters and response types

Parameter type	Response data type
Numerical	Real number or integer
Extended numerical	Integer
Discrete	Discrete
Boolean	Digital boolean

### 6.1 Remote control foundation

String	String
Blocks	Finite-length blocks
	Infinite-length blocks
Non-decimal numeric types	Hexadecimal
	Octal
	Binary

#### Numerical parameters

Numeric parameters can be used in both instrument-specific commands and common commands. Numeric parameters receive all common decimal notations, including positive/negative signs, decimal point, and scientific notation. If a device only accepts a specified numeric type, such as an integer, it will automatically round up the received numeric parameters.

The following are examples of numeric parameters:

- 0 No decimal point
- 100 Optional decimal point
- 1.23 Signed bit
- 4.56e<space>3 Index mark e can be followed by a space
- 7.89E-01 Index marker e can be uppercase or lowercase
- +256 Positive lookahead allowed
- 5 Decimal points can be used first

#### Extended numerical parameters

Most measurements related to instrument-specific commands use extended numeric parameters to specify physical quantities. Extended numerical parameters receive all numeric parameters and additional special values. All extended numeric parameters receive MAXimum and MINimum as parameter values. Other special values, For example: whether to receive the UP and DOWN values depends on the instrument analysis capacity, and all valid parameters are listed in the SCPI command table.

Note: Extended numeric parameters do not apply to common commands or subsystem command STATus.

Examples of extended numeric parameters:

- 101 Numeric parameter
- 1.2GHz GHz can be used as an index (E009)
- 200MHz MHz can be used as an index (E006)
- 100mV -100 millivolts
- 10DEG 10 degrees
- MAXimum's Maximum effective setting
- MINimum Minimum effective setting
- UP Increase by a step
- DOWN Reduce by a step

#### Discrete parameters

When the number of parameter values to be set are finite, they are identified by discrete parameters. Discrete parameters use mnemonics to represent each valid setting. Like program command

---

**6.1 Remote control foundation**

mnemonics, discrete parameter mnemonics have two formats, long and short, and allows for mixture of upper and lower cases.

In the following example, discrete parameters are used with commands:

:TRIGger[:SEQuence]:SOURce BUS|IMMediate|EXTernal

BUS GPIB, LAN, RS-232 trigger

IMMediate Trigger immediately

EXTernal Trigger externally

### Boolean parameters

A Boolean parameter represents a true or false binary condition, which can only have four possible values.

Boolean parameter examples:

ON	Logically true
OFF	Logically false
1	Logically true
0	Logically false

### String parameters

String parameters allow ASCII strings to be sent as parameters. Single quotes and double quotes are used as separators.

The following are example of string parameters:

'This is Valid' "This is also Valid" 'SO IS THIS'

### Real response data

Most of the test data are of real number type, and their formats can be basic decimal notation or scientific notation, which are supported by most advanced programming languages.

Examples of real number response data:

1.23E+0  
 -1.0E+2  
 +1.0E+2  
 0.5E+0  
 0.23  
 -100.0  
 +100.0  
 0.5

### Integer response data

An integer response data is a decimal expression of an integer value containing signed bit. When querying the status register, most of the response data returned are of integer type.

Examples of integer response data:

0 Sign bit optional  
 +100 Positive lookahead allowed  
 -100 Negative lookahead allowed

## 6.1 Remote control foundation

256 No decimal point

### Discrete response data

Discrete response data are basically the same as discrete parameters, only that the return format of discrete response data is only a short form in uppercase.

Samples of discrete response data:

INTernal Stabilization type is internal

EXTernal Stabilization type is external

MMHead Stabilization type is millimeter wave source module

### Digital Boolean response data

A Boolean response data returns a binary value of 1 or 0.

### String response data

String response data and string parameters are alike. The main difference is that the separators of string response data are double quotes instead of single quotes. Double quotes can also be embedded in string response data, and there may be no characters between the double quotes. Here are some examples of string response data:

“This is a string”

“one double quote inside brackets: (“”)”

## 6) Numeral systems in commands

The value of command can be entered in binary, decimal, hexadecimal or as long as they do not appear between keywords or in keywords octal format. When using binary, hexadecimal or octal format, a proper identifier is required before the value. The decimal format (the default format) does not require an identifier. When a value is entered without an identifier in front of it, the device will ensure it to be in decimal format. The following list shows the identifiers required for different formats:

- #B indicates that this number is a binary value.
- #H indicates that this number is a hexadecimal value.
- #Q indicates that this number is an octal value.

The following are various representations of the decimal number 45 in SCPI commands:

#B101101

#H2D

#Q55

The following example sets the RF output power to 10 dBm (or a value of the equivalent value of the currently selected unit, such as DBUV or DBUVEMF) with a hexadecimal value of 000A.

:POW #H000A

When using a non-decimal format, a measurement unit, such as DBM or mV, is not used with the value.

## 7) Command line structure

Since one command line can contain multiple SCPI commands, the following methods can be used to indicate the end of current command line:

- Enter;
- Enter and EOI;
- EOI and the last data byte.

## 6.1 Remote control foundation

The command in the command line is separated with a semicolon, whereas the commands belonging to different subsystems are started with a colon. For example:

```
MMEM:COPY "Test1", "MeasurementXY";:HCOP:ITEM ALL
```

The command line contains two commands: the first one belongs to the MMEM subsystem, and the second belongs to the HCOP subsystem. If adjacent commands belong to the same subsystem with repeated command path, they can be expressed in abbreviation. For example:

```
HCOP:ITEM ALL;:HCOP:IMM
```

The command line contains two commands: both of them belong to the HCOP subsystem, with the same first level. Therefore, the second command can start from the next level of HCOP, and the colon for starting the command can be omitted. It can be abbreviated as follows:

```
HCOP:ITEM ALL;IMM
```

### 6.1.4 Command sequence and synchronization

IEEE488.2 defines the difference between the overlapping and sequential commands as follows:

- The sequential commands refer to the command sequences to be executed continuously. Each of such commands is usually executed quickly.
- The overlapping commands indicate that the previous command is not executed automatically when current command is to be executed. Generally, the time taken for handling overlapping commands is long, and other events can be handled by the program synchronously at this time.

In case of multiple commands set in one command line, such commands may not be executed as per the receiving sequence. To ensure commands are executed as per certain sequence, each command must be sent in separate command line.

#### Example: a command line containing setting and query commands

If multiple commands of a command line contain query commands, the query results are unpredictable. The following command returns a fixed value:

```
:FREQ:STAR 1GHZ;SPAN 100;:FREQ:STAR?
```

Returned value: 1000000000 ( 1GHz )

The following command returns an unfixed value:

```
:FREQ:STAR 1GHZ;STAR?;SPAN 1000000
```

The returned result can be current initial frequency value of the instrument before such command is sent, since the host program will not execute the commands one by one until all command messages are received. If the host program executes the command after being received, the return result can also be 1GHz.

### Tip

#### The setting command and query command are sent separately.

General rules: The setting command and query command shall be sent in different program control messages, so as to ensure the returned result of the query command is correct.

#### 6.1.4.1 Preventing commands from being subject to overlapping execution

Multi-threading or commands \*OPC, \*OPC? or \*WAI can be adopted to prevent commands from being subject to overlapping execution. Such three commands cannot be executed until relevant hardware are set. The computer can wait for a while forcibly during programming, so as to synchronize some events. They are described in details as follows:

## 6.1 Remote control foundation

### ➤ Master program using multi-threading

Multi-threading is used to wait for command completion and synchronization between the UI and program control, that is, to wait for \*OPC? Completion in separate threading without interfering GUI or program threading execution.

- Applications of such three commands in synchronous execution are shown in the table below:

Table 6.5 Command syntax

Method	Execution action	Programming method
*OPC	After command execution, set the operation completion position of the ESR register.	Set ESE BIT0; Set SRE BIT5; Send the overlapping command and *OPC; Wait for the service request signal (SRQ). The service request signal indicates completion of overlapping command execution.
*OPC?	Stop current command till value 1 is returned. Such command returns values only when the setting operation in the ESR register is completed, indicating current command is completed.	Current command is stopped first before other command is executed, and other command is sent directly after current one.
*WAI	All commands shall be sent first before *WAI is to be executed, and then other commands can be handled accordingly.	Current command is stopped first before other command is executed, and other command is sent directly after current one.

### 6.1.5 Status report system

The status report system stores all operation status information and error information of current instrument. Such information is stored in the status register and error list respectively, which can be queried via the program control interface.

- [Status register structure.....190](#)
- [Application of status report system.....192](#)

#### 6.1.5.1 Status register structure

Please refer to the hierarchical chart of the status register:





## 6.1 Remote control foundation

Similar with SRQ, IST (“Individual Status”) marks a separate bit consisting of all statuses of the instrument. The associated parallel poll enable register (PPE) determines the STB data bits for IST marking.

### 4) Output buffer zone

It stores the messages returned by the instrument to the master. It does not belong to the status report system, but determines the MAV position value of the STB.

For details on the registers mentioned above, see [“2.1.5 Status report system” of the program control manual](#).

## Tip

### SRE, ESE

The service request enabling register (SRE) can be used for STB enabling. Similarly, the ESE can be used for ESR enabling.

### 6.1.5.2 Application of the status report system

The status report system is used to monitor the status of one or more instruments in the test system. The master computer in the test system must receive and assess all instrument information with the following standard methods, so as to realize functions of the status report system properly:

- 1) Service requests (SRQ) initiated by the instrument;
- 2) All instruments in the serial query bus system initiated by the master computer in the system, aiming to find the service request originator and reasons.
- 3) Query all instruments concurrently;
- 4) Use the program control command to query specific instrument status;

For specific operation methods, see [“2.1.5.4 Status report system application” of the program control manual](#).

### 6.1.6 Programming precautions

#### 1) Please initialize the instrument status first before changing the setting.

During remote instrument setting, initialize the instrument status (for instance, to send “\*RST”) first before realizing required status setting.

#### 2) Command sequence

Generally, the setting command and query command must be sent separately. Otherwise, the returned value of the query command will vary with current operation sequence of the instrument.

#### 3) Failure response

The service request can only be initiated by the instrument itself. The master program in the test system shall instruct the instrument to initiate the service request actively in case of any failure, and then enter corresponding service termination program for handling.

#### 4) Error Queue

When handling the service request each time, the master program shall query the instrument error queue rather than the status register, so as to obtain the error cause with higher accuracy. Especially during the test phase of the master program, it shall often query the error queue, so as to obtain the error command sent by the master program to the instrument.

## 6.2 Instrument program control port and configuration

- LAN.....193
- GPIB.....194

### 6.2.1 LAN

#### Note

#### Operation of the USB master port connector on the front panel

The Type-A connector is used as the USB master port connector on the front panel, and the port is used to connect with the flash disk of the USB port in the 1435 series signal generators for upgrading the built-in software of the instrument, which can also be connected to the USB keyboard and mouse for controlling the signal generator. This port cannot be used for remote control of the instrument.

- Connection establishment.....193
- Interface configuration.....193

#### 6.2.1.1 Connection establishment

Connect the 1435 signal generator and the external master program (the computer) to the LAN via a network cable, as shown in Fig. 6.4:

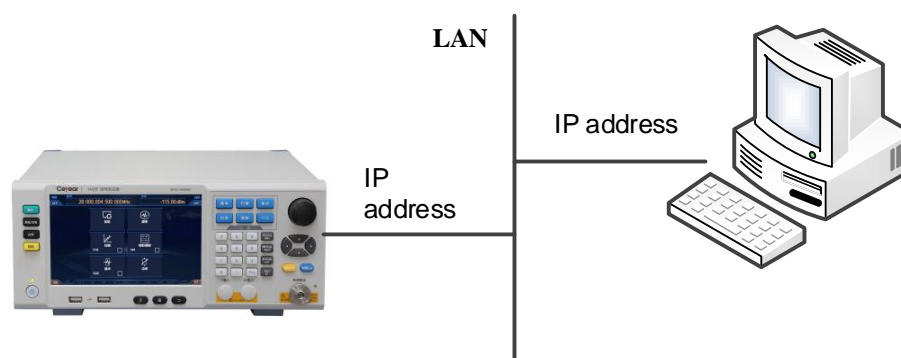

Fig. 6.4 LAN interface connection diagram

#### 6.2.1.2 Interface configuration

Physical connection of the network should be guaranteed for remote control on the signal generator via the LAN. Since the signal generator does not support DHCP, domain access, and wide area network connection, its network program control setting is relatively simple, that is, to just set the “IP address”, “subnet mask” and “default gateway” in the system menu to the subnet of the master controller.

#### Note

**Make sure the signal generator are in normal physical connection via 10Base-T LAN or 100Base-T LAN cables.**

Since the signal generator supports only the setup of single LAN control system and setting of static IP address rather than DHCP or host access via DNS or domain name server, the user does not need to modify the subnet mask, which will be set to 255.255.255.0 by default in the instrument.

### 6.3 Basic VISA interface programming

#### 6.2.2 GPIB

- [Connection establishment](#).....194
- [Interface configuration](#).....194

##### 6.2.2.1 Connection establishment

Connect the 1435 signal generator to the external master program (the computer) via the GPIB cable, as shown in Fig. 6.5:

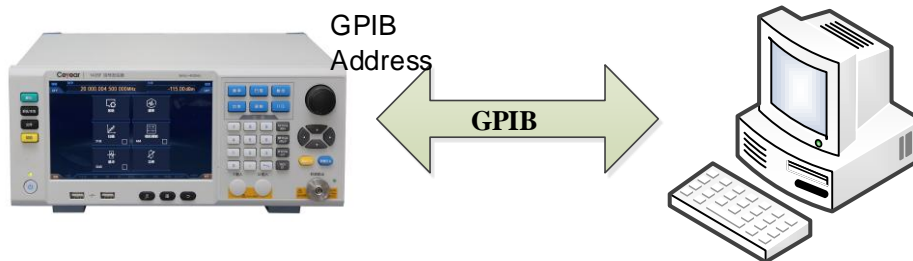

Fig. 6.5 GPIB interface connection diagram

##### 6.2.2.2 Interface configuration

GPIB interface setting consists of two parts, namely, GPIB address setting and program control language setting. GPIB address setting is realized via the “GPIB address setting” menu, which contains two items, namely, “Local” and “Power meter”, whereas “Local” is the address setting soft key of the signal generator that is set to 19 normally. The local GPIB address setting can be realized via number keys, arrow keys, and knobs (For operation method on editing figures of the signal generator, see “7) Editing data” in “3.3.1.2 Common configuration setting method” of the manual).

Program control language setting is realized via the “Program control language setting” menu, which contains two items, namely, “SCPI” and “Analyzer”, whereas the language of the “Analyzer” is used for factory debugging. The program control language shall be set to “SCPI” when establishing the auto test system.

### 6.3 Basic VISA interface programming

Take the following as an example to describe the basic method for realizing instrument program control programming via the VISA library. Take the C++ language as an example.

- [VISA library](#).....194
- [Initialization and default status setting](#).....195
- [Sending the setting command](#).....196
- [Reading instrument configuration status](#).....196
- [Command synchronization](#).....197

#### 6.3.1 VISA library

VISA is the generic term of the standard I/O function library and relevant specifications. Whereas, the VISA library functions are a set of functions convenient for loading, and the core function can control various instruments, regardless of the instrument interface type and operation method of various I/O interface software. Such library functions are used to compile the instrument drive program, and complete the command and data transmission between the computer and instrument, realizing remote instrument control. The addressing strings (“VISA resource strings”) can be initialized to establish instrument connection with program control ports (LAN, USB and GPIB).

To realize remote control, the VISA library must be installed first. The VISA library is encapsulated with the transmission function at the bottom layer with VXI, GPIB, LAN and USB interfaces, so as to

### 6.3 Basic VISA interface programming

facilitate users' direct loading. Programming interfaces supported by the signal generator is GPIB and LAN. **These interfaces can be used with VISA libraries and programming languages for remote control of signal generators.** The Agilent I/O Library provided by Agilent Company is widely used as the bottom-layer I/O library.

Figure 6.6 shows the relationship between program control interfaces, VISA libraries, programming languages and signal generators with the GPIB interface as an example.

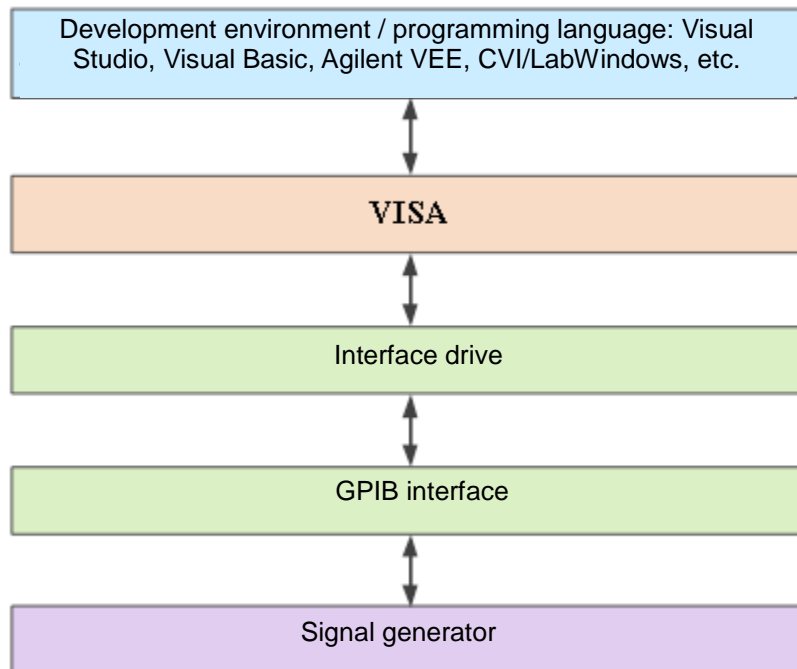

Figure 6.6 Program control software/hardware layers

#### 6.3.2 Initialization and default status setting

To start the program, the VISA resource manager must be initialized, so as to open and establish the communication connection between the VISA library and instrument. Specific steps are shown below:

##### 6.3.2.1 Generating global variables

First, generate the global variables to be loaded by other program modules, for example, the instrument handle variable. The programs shown below must contain the following global variables:

```
Global ViSession analyzer;
```

```
Global ViSession defaultRM;
```

```
Const char analyzerString [VI_FIND_BUFLen] = "GPIB0::20::INSTR";
```

```
Const analyzerTimeout = 10000;
```

Whereas, the constant analyzerString indicates the instrument descriptor, "GPIB0" indicates the master, and "20" indicates the instrument connected with the master. If the instrument is connected with the LAN with IP of "192.168.1.1", such variable is as follows:

```
Const char analyzerString [VI_FIND_BUFLen] = "TCPIP::192.168.1.1::INSTR";
```

##### 6.3.2.2 Master initialization

The following example shows the way to open and establish the communication connection between the VISA library and instrument (with instrument descriptor specified).

```
//Initialize the master: Open the default resource manager and return the instrument handle analyzer
```

### 6.3 Basic VISA interface programming

#### **void InitController()**

```
{
ViStatus status;
status = viOpenDefaultRM(&defaultRM);
status = viOpen(defaultRM, analyzerString, VI_NULL, VI_NULL, &analyzer);
}
```

#### 6.3.2.3 Instrument initialization

The example below is to initialize the default instrument status and empty the status register.

#### **void InitDevice()**

```
{
ViStatus status;
long retCn;
status = viWrite(analyzer, "**CLS", 4, &retCn); //reset status register
status = viWrite(analyzer, "**RST", 4, &retCn); //reset instrument
}
```

### 6.3.3 Sending the setting command

The example below shows the way to set the continuous wave and amplitude of the 1435 series signal generators.

#### **void SimpleSettings()**

```
{
ViStatus status;
long retCn;
//Set continuous wave 128MHz
status = viWrite(analyzer, "FREQUENCY:CW 128MHz", 22, &retCn);
//Set amplitude -10dBm
status = viWrite(analyzer, "POW -10dBm", 23, &retCn);
}
```

### 6.3.4 Reading instrument configuration status

The example below shows the way to read the instrument setting status.

#### **void ReadSettings()**

```
{
ViStatus status;
long retCn;
char rd_Buf_CW[VI_READ_BUFLEN]; // #define VI_READ_BUFLEN 20
char rd_Buf_LVL[VI_READ_BUFLEN];

//Query continuous wave
status = viWrite(analyzer, "FREQ:CW?", 10, &retCn);
```

**6.3 Basic VISA interface programming**

```

Sleep(10);
status = viRead(analyzer, rd_Buf_CW, 20, &retCnt);
//Query amplitude
status = viWrite(analyzer, "POW?", 12, &retCnt);
Sleep(10);
status = viRead(analyzer, rd_Buf_LVL, 20, &retCnt);
//Print debugging information
sprintf("Cw is %s", rd_Buf_CW);
sprintf("POW is %s", rd_Buf_LVL);
    }

```

**6.3.5 Command synchronization**

The following example of sweeping process is taken to show the command synchronization method:

**void SweepSync()**

```

{
ViStatus status;
long retCn;
ViEventType etype;
ViEvent eeent;
int stat;
char OpcOk [2];
/*****/

/* command INITiate[:IMMEDIATE] to start single sweeping ( when continuous sweeping is closed:
INIT:CONT OFF ) */

/* After single sweeping, execute the next command in the command buffer zone
*/
/*****/

status = viWrite(analyzer, "INIT:CONT OFF", 13, &retCnt);
//Method 1 to wait for sweeping completion: use *WAI
status = viWrite(analyzer, "ABOR;INIT:IMM;*WAI", 18, &retCnt);

//Method 2 to wait for sweeping completion: use *OPC ?
status = viWrite(analyzer, "ABOR;INIT:IMM; *OPC?", 20, &retCnt);
status = viRead(analyzer, OpcOk, 2, &retCnt); //wait for *OPC to return "1"

//Method 3 to wait for sweeping completion: use *OPC
//To use the GPIB service request, set "Disable Auto Serial Poll" to "yes"
status = viWrite(analyzer, "*SRE 32", 7, &retCnt);

```

**6.4 I/O library**

```

status = viWrite(analyzer, "*ESE 1", 6, &retCnt); //enable service request ESR
//Set the event enabling position, and end the operation.
status = viEnableEvent(analyzer, VI_EVENT_SERVICE_REQ, VI_QUEUE, VI_NULL);
//Enable the SRQ event
status = viWrite(analyzer, "ABOR;INIT:IMM;*OPC", 18, &retCnt);
//Start sweeping together with OPC
status = viWaitOnEvent(analyzer, VI_EVENT_SERVICE_REQ, 10000, &etype, &event)
//Wait for service request
status = viReadSTB(analyzer, &stat);
status = viClose(event); //close event handle
// disable SRQ event
status = viDisableEvent(analyzer, VI_EVENT_SERVICE_REQ, VI_QUEUE);
//Main program continues.....
}

```

**6.4 I/O library**

- [I/O library overview.....](#)198
- [I/O library installation and configuration.....](#)199

**6.4.1 I/O library overview**

I/O library is the software program library programmed for the instrument in advance, namely, the instrument driver, which is the software interlayer between the computer and the instrument hardware. It consists of the function library, utility program, tool suite and is the set of series software code modules, which is corresponding to a planned operation, such as instrument configuration, reading from the instrument, writing into the instrument and triggering the instrument. It remains in the computer, acting as the bridge and link between the computer and instrument. With high-level modular libraries facilitating programming, users do not need to learn complex lower-level programming protocol for specific instrument any more. Instrument driver is the key for rapid test and measurement application development.

In respect of function, a common instrument driver consists of five parts generally, namely, the function body, interactive developer interface, programming developer interface, subroutine interface and I/O interface, as shown in Fig. 6.7.



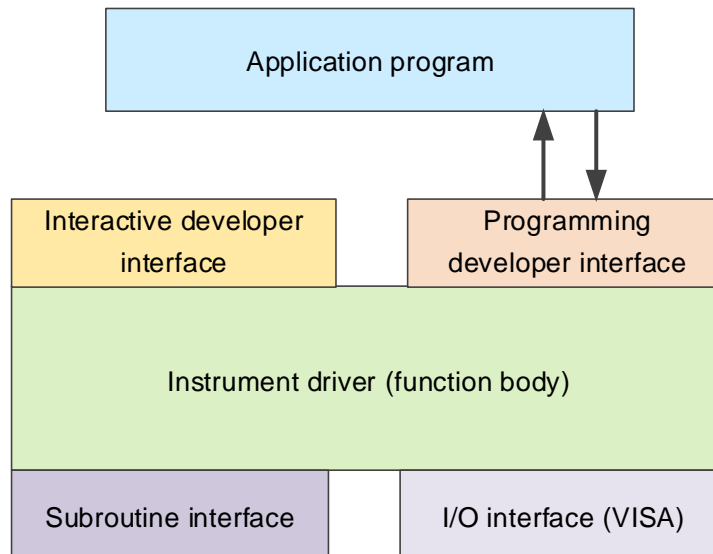

Fig. 6.7 Instrument driver structure model

Specific descriptions are shown below:

- 1) Function body. It is the main function part of the instrument driver, which can be interpreted as the framework program of the instrument driver.
- 2) Interactive developer interface. The application development environment supporting instrument driver development always provides graphical interactive developer interface for user convenience. For example, the function panel in Labwindows/CVI is a type of interactive developer interface. In the function panel, each parameter of the instrument driver functions is expressed in the form of graphical control.
- 3) Programming developer interface. It is the software interface used by the application program for loading the instrument driver function, for example, the dynamic link library file .dll of the instrument driver in the Windows system.
- 4) I/O interface. It is used to realize actual communication between the instrument driver and instrument. The bus-specific I/O software (such as GPIB) or the generally-standardized I/O software applied cross multiple buses (VISA I/O) can be used.
- 5) Subroutine interface. It is the software interface used by the instrument driver to access other supporting libraries, such as the database and FFT function. The instrument driver will use the subroutine interface to call other software module, operating system, program control code library and analysis function library, so as to complete relevant functions.

### 6.4.2 I/O library installation and configuration

Applications in the test field has underwent various development phases from traditional instruments to virtual ones, so does the instrument drive program for the purpose of realizing instrument interchangeability and test program reusability in the auto test system. The common instrument driver used widely at present is the interchangeable virtual instruments (IVI), which is based on the IVI specification, defines new instrument programming interface, adds class driver and VPP framework to VISA to realize complete independence of the test application from the instrument hardware, and adds such functions as unique instrument simulation, range detection and state caching, improving system operation efficiency and realizing real instrument interchange.

IVI driver consists of two types, namely, IVI-C and IVI-COM. IVI-COM is based on the Microsoft component object model (COM) technology and adopts the COM API mode; IVI-C is based on ANSI C and adopts the C API mode. Such two drive types are designed by following the instrument type specified in the IVI specification with the same application development environment, including Visual Studio, Visual Basic, Agilent VEE, LabVIEW and CVI/ LabWindows.

#### 6.4 I/O library

Two drive types must be provided to meet the needs of different users in different development environment. The IVI driver of the signal generator is developed via Nimbus Driver Studio to generate IVI-COM and IVI-C drivers and program installation package. For specific installation configuration, see the selected control card and documentation provided together with the I/O library.

The installed IVI driver is divided into the inherent IVI function group and instrument function group (namely, the basic function group and extended function group). For specific function classification, function and property description, see the built-in file of the driver.

---

### Tip

#### Configuration port and I/O library installation

Before using a computer-controlled signal generator, please verify that you have properly installed and configured necessary ports and I/O libraries.

---

## 7 Troubleshooting and after-sales services

The section introduces how to find problems and ask for after-sales services. It also describes the error information of the signal generator.

If you encounter any problem when operating the 1435 series signal generator or want to buy relevant components or accessories, we can provide you with complete after-sales services.

Generally, causes of problems are due to hardware, software or user maloperation. In case of any problem, please contact us in time. If the signal generator is within the warranty period, we will repair it for free as per the provisions specified in the warranty bill. Otherwise, we will charge maintenance costs as per the contract requirement.

- [Working Principles.....201](#)
- [Troubleshooting and debugging.....202](#)
- [Error message.....207](#)
- [Method to obtain after-sales services.....208](#)

### 7.1 Working principles

The section introduces the basic working principle and hardware function block diagram of the signal generator, so as to facilitate users' understanding on functions of the 1435 series signal generators and solving problems encountered during operation.

#### 7.1.1 Overall working principle and hardware function block diagram

The 1435 series signal generators adopt the intelligent instrument hardware platform based on modern computer technologies and the multiple task operating system of Windows 7, and follow the design philosophy of modularization and option oriented, dividing the hardware and software of the whole instrument into multiple modules with relatively independent functions. The system consists mainly of such modules as the overall main control platform, frequency synthesis, vector signal generation, RF signal conditioning, and baseband signal generation and conditioning. The detailed overall hardware planning block diagram is shown in Fig. 7.1.

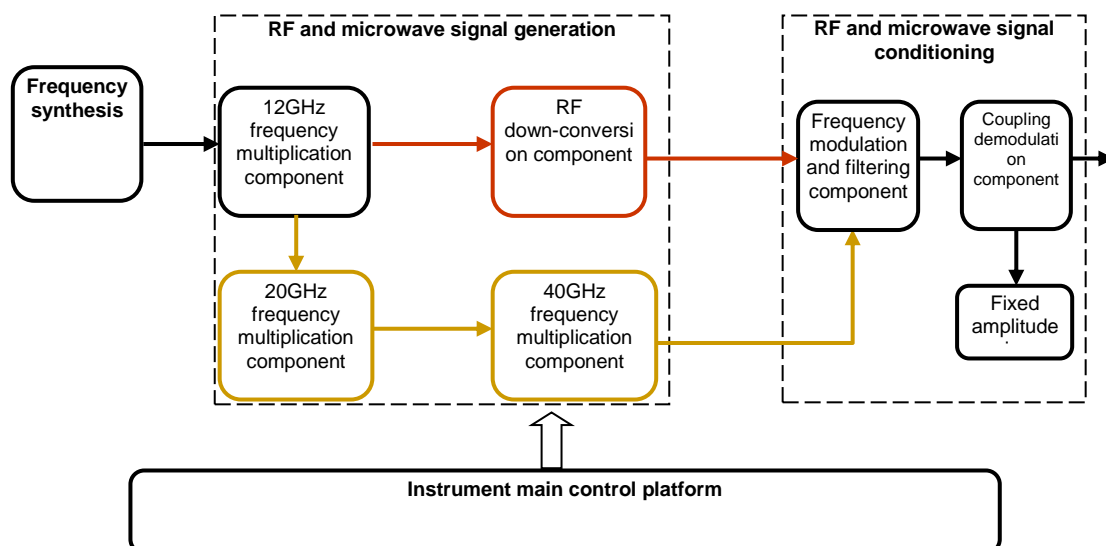

Fig. 7.1 Instrument hardware planning block diagram

The overall main control platform provides working environment support for all overall function units.

The frequency synthesis unit adopts the multi-loop frequency synthesis technology to generate high-purity continuous wave RF signal.

## 7.2 Troubleshooting and debugging

The vector signal generation unit divides and mixes the RF signal generated by the frequency synthesis unit, and then sends it to the RF vector modulation module for vector modulation, so as to obtain the RF vector modulation signal.

The radio frequency signal conditioning unit conducts such operations on the signal as filtering, amplitude stabilization, pulse modulation, and programmed attenuation, and then outputs the signal to the RF output port.

## 7.2 Troubleshooting and debugging

---

### Tip

#### Troubleshooting and instructions

This section introduces the way on how to judge and handle failures (if any) of the 1435 series signal generators, and feed them back to the manufacturer as accurately as possible if necessary for quick solution.

---

The following failures and debugging methods are listed as per function types.

- [System problems.....202](#)
- [Hardware losing lock.....202](#)
- [Unleveled.....204](#)
- [RF output power failure.....205](#)
- [No modulation at RF output port.....205](#)
- [Sweeping failure.....205](#)
- [Data storage failure.....206](#)
- [No response from front panel keys.....206](#)
- [Remote control failure.....206](#)

### 7.2.1 System problem

- [Standby lamp not on.....202](#)
- [No fan rotation after startup.....202](#)

#### 7.2.1.1 Standby lamp not on

Check whether the 220V AC input (with max. allowable deviation of  $220V \pm 10\%$ ) of the signal generator is normal, which cannot be too high or too low. Otherwise, the instrument will run abnormally. If it is abnormal, check the external lines for any failure. After troubleshooting, power on the instrument again and start it. If the failure is caused by the power supply of the instrument itself, send the product back to the manufacturer for repairing or power supply replacement.

#### 7.2.1.2 No fan rotation after startup

In case of no fan rotation after startup, check the fan for any obstacle or too much dust. In this case, shut down the instrument, and remove the obstacle or clean the fan. After that, power it on. If the fan still does not rotate, send it back to the manufacturer for repairing or fan replacement.

### 7.2.2 Hardware losing lock

- [Reference loop losing lock.....203](#)
- [LO loop losing lock.....203](#)

**7.2 Troubleshooting and debugging**

- [VCO loop losing lock.....203](#)
- [Decimal loop losing lock.....204](#)

**7.2.2.1 Reference loop losing lock**

The warning message “Reference loop losing lock” appears in the UI status indication area. If the signal generator is subject to cold start in the non-standby status, temporary reference loop losing lock may occur. If is ignored at this time, such message will disappear automatically 10 min. after startup. Otherwise, it deems to be a failure. In case of any failure, follow the steps below for troubleshooting:

**Operation steps:**

**Step 1. Click **【System】** on the front panel to activate the system configuration window.**

Step 2. Click [Instrument Self Test] to open the self test window for starting the instrument self test process automatically.

Step 3 Search and check the failed self test via the up/down direction key, and continue to perform the following operations:

**Step 4. Set **【Step On/Off】** to On;**

**Step 5. Set **【Mode Always/Error】** to Error;**

**Step 6 . Click **【Run Test】**;**

**Step 7 It a self test contains multiple steps, click **【Continue】** till the self test is completed.**

**Step 8 Record the configuration value in each step and return it to the manufacturer.**

**7.2.2.2 LO losing clock**

If “LO losing clock” appears in the UI status indication area, follow the operations below:

**Operation steps:**

**Step 1. Click **【System】** on the front panel to activate the system configuration window.**

Step 2. Click [Instrument Self Test] to open the self test window for starting the instrument self test process automatically.

Step 3 Search and check the A8 low noise frequency synthesizer via the up/down direction key, and continue to perform the following operations:

**Step 4. Set **【Step On/Off】** to On;**

**Step 5. Set **【Mode Always/Error】** to Error;**

**Step 6 . Click **【Run Test】**;**

**Step 7 It a self test contains multiple key steps, click **【Continue】** till the self test is completed.**

**Step 8 Record the configuration value in each step and return it to the manufacturer.**

**7.2.2.3 VCO loop losing lock**

If “VCO losing clock” appears in the UI status indication area, follow the operations below:

**Operation steps:**

**Step 1. Click **【System】** on the front panel to activate the system configuration window.**

Step 2. Click [Instrument Self Test] to open the self test window for starting the instrument self test process automatically.

Step 3 Search and check the A7 reference and decimal frequency synthesizer and A8 Low noise frequency synthesizer via the up/down direction key, and continue to perform the following operations:

## 7.2 Troubleshooting and debugging

**Step 4. Set [Step On/Off] to On;**

**Step 5. Set [Mode Always/Error] to Error;**

**Step 6 . Click [Run Test];**

**Step 7 It a self test contains multiple key steps, click [Continue] till the self test is completed.**

**Step 8 Record the configuration value in each step and return it to the manufacturer.**

### Note

#### Sequence for handling loop losing lock

LO losing lock can cause VCO loop losing lock. In case of both warning messages appearing at the same time, handle the LO losing lock first and then the VCO loop losing lock.

#### 7.2.2.4 Decimal loop losing lock

If “Decimal loop losing clock” appears in the UI status indication area, follow the operations below:

##### Operation steps:

**Step 1. Click **【System】** on the front panel to activate the system configuration window.**

Step 2. Click [Instrument Self Test] to open the self test window for starting the instrument self test process automatically.

Step 3 Search and check the failed self test via the up/down direction key, and continue to perform the following operations:

**Step 4. Set [Step On/Off] to On;**

**Step 5. Set [Mode Always/Error] to Error;**

**Step 6 . Click [Run Test];**

**Step 7 It a self test contains multiple steps, click [Continue] till the self test is completed.**

**Step 8 Record the configuration value in each step and return it to the manufacturer.**

## 7.2.3 Unleveled

### Note

#### Unleveled indication

If the amplitude level setting of the signal generator exceeds the index range, an “Unleveled” indication may appear, which is normal, reminding the user of output amplitude uncertainty of the signal generator.

If “Unleveled” appears in the UI status indication area, follow the operations below:

##### Operation steps:

**Step 1. Click **【System】** on the front panel to activate the system configuration window.**

Step 2. Click [Instrument Self Test] to open the self test window for starting the instrument self test

**7.2 Troubleshooting and debugging**

process automatically.

Step 3 Search and check the failed self test via the up/down direction key, and continue to perform the following operations:

**Step 4. Set [Step On/Off] to On;**

**Step 5. Set [Mode Always/Error] to Error;**

**Step 6 . Click [Run Test];**

**Step 7 It a self test contains multiple key steps, click [Continue] till the self test is completed.**

**Step 8 Record the configuration value in each step and return it to the manufacturer.**

**7.2.4 RF output amplitude failure**

- [Low RF output amplitude.....205](#)
- [RF output signal loss due to mixer.....205](#)

**7.2.4.1 Low RF output amplitude**

Check the amplitude display area on the front panel UI for any amplitude offset indication. If yes, it indicates the amplitude offset has been set. The amplitude offset can change the value displayed in the amplitude area of the display, but will not affect the output amplitude. The amplitude displayed is the actual output amplitude of the signal generator plus the offset value.

Conduct the follow operation to cancel the amplitude offset:

Press **[Amplitude]** or click [Amplitude] on the touchscreen to set [Ampl Offset] to 0dB, and then the amplitude offset indication in the amplitude display area disappears, indicating the amplitude offset function is canceled.

**7.2.4.2 RF output signal loss due to mixer**

If the signal generator is used together with the spectrum analyzer without the preselection function, the reverse amplitude effect can cause inaccurate output at the RF port of the signal generator. Some spectrum analyzers can cause LO feedthrough of up to +5dBm at the RF input port at some frequency points. If the frequency difference between the LO feed-through and RF carrier is lower than the ALC bandwidth of the signal generator, the reverse LO amplitude may conduct amplitude modulation on the RF output of the signal generator. Any of the following two ALC working modes can be used to eliminate the reverse amplitude effect, that it, to set the ALC loop status to open, or set the ALC working mode to manual amplitude search.

**7.2.5 No modulation at RF output port**

Check the RF output indication on the front panel UI. If it is off, press **[RF On/Off]** to set it to on. If there still is no RF output, check whether there is output in the continuous wave status. After that, test the analog and digital modulation outputs in sequence. If the problem cannot be solved, please contact the manufacturer for solution.

**7.2.6 Sweep failure**

- [Sweep stopped.....205](#)
- [Sweep cannot be stopped.....206](#)
- [Incorrect dwell time during list sweep.....206](#)

**7.2.6.1 Sweep stopped**

Current sweep status is shown in the status bar at the bottom of the instrument. Sweep status can be observed via the progress bar. If sweep is stopped, check as follows:

## 7.2 Troubleshooting and debugging

- 1) Check whether sweep is started, or sweep is in the continuous mode. If it is in the single mode, check whether the single sweep soft key in the sweep control has been clicked at least for once after previous sweep is completed.
- 2) Check whether the signal generator receives proper sweep trigger signal. Set the sweep trigger mode to auto, and check whether the missing sweep trigger signal stops the sweep.
- 3) Check whether the Dwell time is correct. Set the Dwell time to 1s. Check whether the Dwell time is set too long or too short, resulting in failure of observing the Dwell time.
- 4) Check whether the step sweep or list sweep involves at least 2 points.

### 7.2.6.2 Sweep cannot be stopped

To stop the sweep status at the step or list status, select [Close ( CW )] from [Current Sweep Type] in the Sweep Config Dialog.

### 7.2.6.3 Incorrect Dwell time during list sweep

Currently, the instrument sets the Dwell time via timing interruption by software, resulting in deviation. Please contact the manufacturer for solution.

## 7.2.7 Data storage failure

- [The status of the instrument stored is empty.....206](#)

### Tip

#### Max. number of statuses of instruments stored / loaded

The 1435 series signal generator can store/load up to 100 instrument statuses, with register number range of 0~99. If the number entered is bigger than 99, the status is stored in register 99 automatically.

### 7.2.7.1 The status of the instrument stored is empty

The file for storing / calling the instrument status is stored at “D:\1435data\user” by default, and the system does not provide backup or recover function for user files in the user folder. In case of any file loss due to power failure or illegal operation, please contact the service and consultation center of the Company via the contact information provided in title page or “7.4 Method to obtain after-sales services” for coordination and solution.

## 7.2.8 No response from front panel keys

If the signal generator has no response to the front panel keys, check whether the signal generator is in the remote control mode (The display will show a remote control mark in such mode). To exit the remote control mode, press **【Local】** to switch the status of the signal generator from remote control to local control.

## 7.2.9 Remote control failure

- [Command channel blocked.....206](#)

### 7.2.9.1 Command channel blocked

In the remote control mode, when the signal generator receives a series SCPI program control commands and execution failure is overtime (for example, in the trigger sweep mode, the signal generator never receives any trigger signal, resulting in master waiting overtime and blockage of the remote control channel (GPIB, LAN or other interfaces) between the master and signal generator, failing



**7.3 Error message**

to receive other commands), current remote configuration process must be interrupted, so that the master can control the remote control channel again, with specific steps shown below:

Step 1 The master sends the “Clear Instrument” command to let the signal generator clean all commands running in the remote control channel currently

and receive new program control commands. Send the command as per the interface and protocol types:

- Visa: viClear();
- GPIB: ibclr();
- RSIB: RSDLLibclr().

Step 2 Send the SCPI command “ABORT” during program control configuration to cancel current configuration and reset the trigger system.

**7.3 Error message**

The signal generator records errors occurred during configuration in two ways, namely, front-panel-displayed error message list and SCPI (remote control mode) error message list, which are stored and managed separately.

- [Error message file.....207](#)
- [Error message description.....207](#)

**7.3.1 Error message file**

The error message file cannot be viewed in current version of the 1435 series signal generator.

**7.3.2 Error message description**

- [Local error message.....207](#)
- [Program control error message.....207](#)

**Table 7.3.2.1 Local error message****1) Error message view**

View via interface:

In case of any error prompt at the lower right of the signal generator, it indicates that there is something wrong with the software or hardware of the signal generator. You can basically judge the error type as per the error code, and take corresponding measures for troubleshooting.

The error display area of the signal generator can only display one error prompt. Since multiple errors can occur to the instrument, it displays all errors one by one.

**7.3.2.2 Program control error information**

- [Error message format and description.....207](#)
- [Error message type.....208](#)

**1) Error message format and description**

In the remote control mode, the error message is recorded in the error/event queue of the status report system, which can be queried via the command “SYSTem:ERRor[:NEXT]?”, with the format as follows:

“<Error code>, “<Error message in the error queue>; <Detailed error message description>”

**Example:**

“-135,” data exceeds limit ; parameters entered exceed the lower limit. ”

**7.4 Method to obtain after-sales services**

The program control error message includes two types:

- The negative error code defined in the SCPI standard, which is not described here in details. For details, see “[Appendix C Zoom table of error messages](#)”.
- The positive error code of the instrument features, with details shown below:

Table 7.1 List of descriptions on instrument feature error messages

Failure code	Error Description
1052	Data error. Only for digital baseband interfaces: Digital IQ input data error.
1053	FIFO overload. Only for digital baseband interfaces: External input sampling rate is too high.
1054	Input overload. Signal amplitude at the RF input port exceeds the limit.

**2) Error message type**

The error event corresponds only to one type of error message, and the error message types are introduced in details below:

- Query error (–499 to –400): indicates the output queue control of the instrument detects the message exchange protocol error specified in Chapter 6 of IEEE 488.2. At this time, the event status register of the error query bit (bit2) is set (for details, see 6.5 of IEEE 488.2). Data cannot be read from the output queue currently.
- Instrument feature error (399 to –300, 201 to 703, and 800 to 810); indicates the instrument operation is failed due possibly to abnormal hardware or firmware status, which is used for instrument self-test generally. At this time, the instrument feature error bit (bit3) of the event status register is set.
- Execution error (-299 to –200): Indicates error is detected during instrument configuration. At this time, the execution error bit (bit4) of the event status register is set.
- Command error (-199 to –100): Indicates syntax error is detected during instrument command analysis, which is caused by incorrect command format usually. At this time, the command error bit (bit5) of the event status register is set.

**7.4 Method to obtain after-sales services**

- [Contact us.....208](#)
- [Package and mailing .....209](#)

**7.4.1 Contact us**

In case of any failure to the 1435 series signal generators, check and save the error message, analyze possible causes, and refer to the methods provided in “[7.2 Troubleshooting and debugging](#)” for preliminary troubleshooting. If the problem cannot be solved, contact the service and consultation center of the Company as per the contact information provided below and provide us with the error message collected. We will coordinate with you to solve the problem as soon as possible.

Contact information:

Free customer service: **800-868-7041**

Technical support: **0532-86889847 86897262**

Fax: **0532-86889056 86897258**

Website: [www.ceyear.com](http://www.ceyear.com)

Email: [ceyearqd@ceyear.com](mailto:ceyearqd@ceyear.com)

Postal code: **266555**

**7.4 Method to obtain after-sales services**

Address: **No. 98, Xiangjiang Road, Qingdao Economic & Technological Development Zone, Shandong, China**

**7.4.2 Package and mailing**

In case of any failure to the signal generator that is difficult to be eliminated, contact us by phone or fax. If it is confirmed by both parties that the signal generator has to be returned for repairing, pack the instrument with the original packing materials and case by following the steps below:

- 1) Prepare a detailed description of the failure of the signal generator and put it into the package along with the instrument.
- 2) Pack it with the original packing materials, so as to minimize possible damage.
- 3) Place cushions at the four corners of the outer packing carton, and place the instrument in the outer packing carton.
- 4) Seal the opening of the packing carton with adhesive tape and reinforce the packing carton with nylon tape.
- 5) Specify text like “Fragile! Do not touch! Handle with care!” and so on.
- 6) Please check by precision instrument.
- 7) Keep a copy of all shipping documents.

**Note****Precautions on packing the signal generator**

Using other materials instead of the original ones to pack the signal generator can damage the instrument. Never use polystyrene beads to pack the instrument due to two reasons, that is, they cannot provide sufficient protection on the instrument, and they can be sucked in to the instrument fan by the static electricity generated, resulting in instrument damage.

**Tip****Instrument package and transportation**

Please follow carefully the precautions described in [“3.1.1.1 Unpacking”](#) when transporting or handling the instrument (for example, damage occurred during delivery).

**7.4 Method to obtain after-sales services**

## 8 Technical indicators and testing methods

The section introduces the technical indicators and testing methods of the 1435 series signal generators.

- [Statement.....211](#)
- [Product features.....211](#)
- [Technical indicators.....212](#)
- [Additional information.....223](#)
- [Performance characteristics test .....226](#)

### 8.1 Statement

The test conditions for all indicators are under the temperature of  $23^{\circ}\text{C}\pm 5^{\circ}\text{C}$  (half hours after startup), unless otherwise specified. The additional instrument information is to facilitate users to understand more clearly the instrument performance that is not contained in the technical indicator range. Key word descriptions are shown below:

**Technical specification (spec):** Place the calibrated instrument in the working environment of  $0^{\circ}\text{C}$  -  $50^{\circ}\text{C}$  for at least 2h, and then warm it up for 30 min., so as to ensure its performance (including the measurement uncertainty), unless otherwise specified. All data in the document are technical specifications, unless otherwise specified.

**Typical value (Typ):** It indicates 80% of the instruments can reach typical performance, which is not a guarantee, and excludes uncertainty factors during the measurement. It is valid only at the room temperature (about  $25^{\circ}\text{C}$ ).

**Nominal value (nom):** It indicates such performances as the expected average performance, designed performance features or those that cannot be tested by limited test means, for example, the  $50\ \Omega$  connector. Products marked with nominal values are not included in the warranty, and such values are taken at the room temperature (about  $25^{\circ}\text{C}$ ).

**Measured value (meas):** It indicates the performance feature measured during the design phase for comparing with the expected performance, for example, amplitude drifting change with time. Note: Such data is not a guarantee, which is also taken at the room temperature (about  $25^{\circ}\text{C}$ ).

### 8.2 Product features

Table 8.1 Product features

General characteristics		
Remote Control	Interface	GPIB IEEE-488.2, 1987 listening and writing
		LAN 1000BaseT LAN interface
	Program control language	SCPI Version: 1997.0
Display screen	LED display screen	
Operation interface language	Chinese/English	
Power supply requirement	The max. power consumption of the power supply is less than 300W, with 50Hz ~ 60Hz, single-phase 110V or 220V self-adaption, the rated range of steady-state voltage is $\pm 10\%$ , and the rated range of the steady-state frequency is $\pm 5\%$ .	
Working temperature range	$0^{\circ}\text{C}$ ~ $+50^{\circ}\text{C}$	
Storage temperature range	$-40^{\circ}\text{C}$ ~ $+70^{\circ}\text{C}$	

## 8.3 Technical Indicators

<b>Relative humidity</b>	( 5% ~ 95% ) $\pm 5\%$ RH
<b>Elevation</b>	0 ~ 4600 m
<b>Storage</b>	To store the instrument status, user data file, sweep list file, waveform sequence and other files.
	Memory space of 32GB
	RAM memory space of 4GB
	Number of instrument statuses to be stored of up to 100
<b>Self test</b>	When resetting, the signal generator will test most of the modules automatically. Such test is not needed if the voltage at the test point of the module is normal.
<b>Weight</b>	< 12kg
<b>Boundary dimension ( Width×Height×Depth )</b>	420Mm×147mm×445mm ( including handle and protective base angle )
	330mm×147mm×397mm ( excluding handle and protective base angle )
<b>Vibration</b>	Random vibration: Frequency of 5 ~ 100Hz, power spectrum density of 0.015g <sup>2</sup> /Hz ; frequency of 100 ~ 137Hz , slope of -6dB ; frequency of 137 ~ 350Hz ,power spectrum density of 0.0075g <sup>2</sup> /Hz ;frequency of 350 ~ 500Hz , slope of -6dB ; frequency of 500Hz, power spectrum density of 0.0039g <sup>2</sup> /Hz.
<b>Safety requirement</b>	The instrument should comply with the requirements of 3.10.2 of GJB 3947A-2009, with the specific requirements as follows: a) The insulation resistance should not be less than 100 M $\Omega$ under standard atmospheric conditions for testing and not be less than 2M $\Omega$ under humid environment. b) The dielectric strength test voltage of the instrument shall be 1500V, without any breakdown, flashover and flicker during the test. During qualification test, the test voltage applied to the test point shall be kept for more than 1 min; during quality consistence test, such voltage shall be kept for ( 2 ~ 5 ) s. c) During instrument operation, the leakage current shall not be more than 3.5mA.
<b>Reliability requirement</b>	The instrument should comply with Article 3.12 of GJB3947A-2009, with the MTBF ( $\theta_0$ ) $\geq$ : 5000h.
<b>Electromagnetic compatibility requirement</b>	The instrument should comply with the requirements of 3.9.1 of GJB 3947A-2009.
<b>Maintenance requirement</b>	The instrument should comply with Article 3.13 of GJB3947A-2009.

## 8.3 Technical Indicators

Table 8.2 Technical indicators of 1435 (non-V) series

## Frequency characteristics

## 8.3 Technical Indicators

Frequency Span	1435A:9kHz~3GHz 1435B:9kHz~6GHz 1435C:9kHz~12GHz 1435D:9kHz~20GHz 1435F:9kHz~40GHz	Frequency	N ( Number of times of internal harmonic wave )
		9kHz≤f < 250MHz	1/8
		250MHz≤f≤375MHz	1/16
		375MHz < f≤750MHz	1/8
		750MHz < f≤1.5GHz	1/4
		1.5GHz < f≤3GHz	1/2
		3GHz < f≤6GHz	1
		6GHz < f≤12GHz	2
		12GHz < f≤24GHz	4
24GHz < f≤40GHz	8		
Frequency resolution	0.001Hz		
Frequency switching time	≤1Ms ( Typical value <sup>2</sup> )		
Time base aging rate (typical value)	Standard configuration: ±5×10 <sup>-7</sup> /year (after 30 days of continuous turn-on) High-stability time base option H10: ±5×10 <sup>-8</sup> /year (after 30 days of continuous turn-on) ±5×10 <sup>-10</sup> /day (after 30 days of continuous turn-on)		
Reference output	Frequency	10MHz	
	Amplitude	>+4dBm, up to a load of 50Ω	
Reference input	Frequency	1MHz ~ 50MHz, stepping of 1Hz	
	Amplitude	0dBm ~ +7dBm, impedance of 50Ω	
<b>Sweep feature</b>			
Sweep mode	Step sweep List sweep		
Sweep Dwell time	100μs ~ 100s		
<b>Amplitude characteristics</b>			
Min. amplitude	Standard configuration		Option H01
	-15dBm ( which can be set to -20dBm )		-110dBm ( which can be set to -135dBm )
Max. amplitude ( 25±10°C )	Frequency span	Standard configuration	High-amplitude output option H08
	1435A/B		
	9kHz≤f≤3GHz	18dBm	22dBm

**8.3 Technical Indicators**

	3GHz < f≤5GHz	16dBm	20dBm			
	5GHz < f≤6GHz	15dBm	18dBm			
	1435C/D					
	9kHz≤f≤3GHz	16dBm	21dBm			
	3GHz < f≤20GHz	15dBm	20dBm			
	1435F					
	9kHz≤f≤3GHz	14dBm	20dBm			
	3GHz < f≤17GHz	13dBm	17dBm			
	17GHz < f≤40GHz	11dBm	15dBm			
<b>Amplitude accuracy ( 25±10°C )</b>	Standard configuration					
	Amplitude (dBm ) Frequency	10 ~ max. amplitude	-10~10	-15~-10		
	9kHz≤f≤2GHz	±0.8dB	±0.6dB	±1.5dB		
	2GHz < f≤20GHz	±0.9dB	±0.7dB	±1.5dB		
	20GHz < f≤40GHz	±0.9dB	±0.8dB	±1.8dB		
	H01A/B program control stepping attenuator option					
	Amplitude (dBm ) Frequency	10 ~ max. amplitude	-10~10	-70~-10	-90~-70	
	9kHz≤f≤2GHz	±0.8dB	±0.6dB	±0.7dB	±1.4dB	
	2GHz < f≤20GHz	±0.9dB	±0.7dB	±0.7dB	±1.6dB	
	20GHz < f≤40GHz	±0.9dB	±0.8dB	±1.1dB	±2.0dB	
	<b>Amplitude resolution</b>	0.01dB				
	<b>Output impedance</b>	50Ω ( rated value <sup>3</sup> )				
<b>Source standing wave rate VSWR (internal fixed amplitude) (typical value)</b>	9kHz≤f≤3GHz	< 1.7				
	3GHz < f≤13GHz	< 1.6				
	13GHz < f≤20GHz	< 1.8				
	20GHz < f≤40GHz	< 1.6				
<b>Max. reverse amplitude</b>	0.5W ( 0V DC ) ( rated value )					
<b>Spectrum purity<sup>4</sup></b>						
<b>Harmonic wave (at +10dBm)</b>	9kHz≤f≤10MHz	< -23dBc				
	10MHz < f≤2GHz	< -30dBc				



## 8.3 Technical Indicators

	2GHz < f≤6GHz ( 1435B )	< -30dBc			
	2GHz < f≤20GHz	< -55dBc			
	20GHz < f≤40GHz	< -50dBc ( typical value )			
<b>Subharmonic wave (at +10dBm)</b>	9kHz≤f≤6GHz	NONE			
	6GHz < f≤12GHz	< -60dBc			
	12GHz < f≤24GHz	< -55dBc			
	24GHz < f≤40GHz	< -50dBc			
<b>Anharmonic wave (at 0dBm, beyond 10kHz frequency offset)</b>	Frequency	Standard configuration	Low phase noise option		
	9kHz≤f≤250MHz	< -54dBc	< -60dBc		
	250MHz < f≤3GHz	< -62dBc	< -77dBc		
	3GHz < f≤6GHz	< -56dBc	< -71dBc		
	6GHz < f≤12GHz	< -50dBc	< -65dBc		
	12GHz < f≤24GHz	< -44dBc	< -59dBc		
	24GHz < f≤40GHz	< -38dBc	< -53dBc		
<b>Single sideband phase noise ( dBc/Hz, at +10dBm )</b>	Standard configuration				
	Frequency	100Hz	10kHz		
	100MHz	-83	-115		
	250 MHz	-93	-127		
	500MHz	-89	-121		
	1 GHz	-83	-115		
	2 GHz	-77	-109		
	3GHz	-74	-105		
	4 GHz	-71	-103		
	6 GHz	-68	-99		
	10 GHz	-63	-95		
	20 GHz	-57	-89		
	40 GHz	-51	-83		
	Low phase noise option				
	Frequency	100Hz	1kHz	10kHz	100kHz
	100MHz	-83	-112	-131	-131
250 MHz	-93	-123	-139	-139	
500MHz	-89	-119	-135	-135	

## 8.3 Technical Indicators

	1 GHz	-83	-113	-132	-132
	2 GHz	-77	-107	-126	-126
	3GHz	-74	-104	-121	-121
	4 GHz	-71	-101	-120	-120
	6 GHz	-68	-98	-115	-115
	10 GHz	-63	-93	-113	-113
	20 GHz	-57	-87	-107	-107
	40 GHz	-51	-81	-101	-101
<b>Modulation characteristic</b>					
<b>Frequency modulation ( Option H02 )</b>	<p>Max. frequency offset: <math>N \times 16\text{MHz}</math> (N is the number of times of the harmonic wave of the fundamental wave)</p> <p>Accuracy (modulation rate of 1kHz and frequency offset of <math>N \times 500\text{kHz}</math>): <math>\pm (2\% \times \text{frequency offset set} + 20\text{Hz})</math></p> <p>Modulation rate ( bandwidth of 3dB and frequency offset of <math>N \times 500\text{kHz}</math> ) : DC-7MHz</p> <p>Distortion ( rate of 1kHz and frequency offset of <math>N \times 500\text{kHz}</math> ) : <math>&lt; 0.4\%</math></p>				
<b>Phase modulation ( Option H02 )</b>	<p>Max. phase offset: <math>N \times 16\text{rad}</math> (N is the number of times of the harmonic wave of the fundamental wave)</p> <p>Accuracy (modulation rate of 1kHz and frequency offset of <math>N \times 500\text{kHz}</math>): <math>\pm (2\% \times \text{phase offset set} + 0.01\text{rad})</math></p> <p>Modulation rate ( bandwidth of 3dB and phase offset of <math>N \times 8\text{rad}</math> ) : DC-1MHz</p> <p>Distortion ( modulation rate of 1kHz and phase offset of <math>N \times 8\text{rad}</math> ) : <math>&lt; 0.4\%</math></p>				
<b>Amplitude modulation ( Option H02 )</b>	<p>Max. depth: <math>&gt; 90\%</math></p> <p>Accuracy (modulation rate of 1kHz and modulation depth of 30%): <math>\pm (4\% \times \text{depth set} + 1\%)</math></p> <p>Modulation rate ( bandwidth of 3dB , modulation depth of 30% , frequency test points: 1GHz、5GHz、20GHz、40GHz ) : DC ~ 100kHz</p> <p>Distortion ( modulation rate of 1kHz , linear mode, total harmonic distortion, and modulation depth of 30% ) : <math>&lt; 2\%</math> ;</p>				
<b>Pulse modulation<sup>5</sup> ( Option H03 )</b>	On/off ratio	$> 80\text{dB}$			
	Rise/fall time	$< 10\text{ns}$			
	Min. pulse width of the internal fixed amplitude	$1\mu\text{s}$			
	Min. pulse width of the non-fixed amplitude	$100\text{ns}$			
<b>Narrow modulation<sup>5</sup> ( Option H04 )</b>	On/off ratio	$> 80\text{dB}$			
	Rise/fall time	$< 10\text{ns}$			
	Min. pulse width of the	$1\mu\text{s}$			

## 8.3 Technical Indicators

	internal fixed amplitude	
	Min. pulse width of the non-fixed amplitude	20ns
<b>Internal analog modulation signal generator (option H02)</b>	<p>Three separate signals are provided for frequency/phase modulation, amplitude modulation and low frequency output respectively.</p> <p>Waveform: sine wave, square wave, triangle wave, and zigzag wave</p> <p>Frequency range: 0.1Hz~10MHz for fine wave 0.1Hz~1MHz for the square wave, triangle wave and zigzag wave</p> <p>Frequency resolution: 0.1Hz</p> <p>Low frequency output: amplitude 0 ~ 5Vpeak (rated value), up to 50Ω load</p>	
<b>Internal pulse generator (Option H03)</b>	<p>Pulse width: 20ns ~ ( 42s-10ns )( rated value )</p> <p>Pulse period: 40ns ~ 42s ( rated value )</p> <p>Resolution: 10ns</p>	
<b>Multifunction generator (option H05)</b>	<p>The multifunction generator consists of 7 waveform generators, and all of them can be set separately or 5 of them set at the same time via the complex Modulation characteristic of the AM, FM/ΦM and low frequency output.</p> <p>Waveform:</p> <p>Function generator 1: Sine wave, triangle wave, square wave, saw tooth wave and pulse</p> <p>Function generator 2: Sine wave, triangle wave, square wave, saw tooth wave and pulse</p> <p>Dual-function generator: Sine wave, triangle wave, square wave, saw tooth wave, and pulse phase offset and amplitude rate of frequency 2 (relative to frequency 1)</p> <p>Sweep function generator: Sine wave, triangle wave, square wave and saw tooth wave</p> <p>Noise generator 1: balance, gauss</p> <p>Noise generator 2: balance, gauss</p> <p>DC: Only for LF output</p> <p>Frequency parameter:</p> <p>Fine wave: 0.1Hz-10MHz</p> <p>Triangle wave, square wave, saw tooth wave and pulse: 0.1Hz-1MHz</p> <p>Resolution: 0.1Hz</p>	
<b>General characteristics</b>		
<b>RF output port</b>	<p>1435A/B/C: N type ( negative ), impedance of 50Ω</p> <p>1435D: 3.5mm ( positive ), N type ( negative )( option H91 ), impedance of 50Ω</p> <p>1435F: 2.4mm ( positive ), impedance of 50Ω</p>	
<b>Max. boundary dimension</b> ( Width×Height×Depth )	<p>330mm×147mm×397mm ( excluding handle )</p> <p>420Mm×147mm×445mm ( including handle )</p>	
<b>weight</b>	< 12 kg ( which varies with the type and option configuration )	

## 8.3 Technical Indicators

<b>Power supply</b>	100 ~ 120VAC , 50 ~ 60Hz,; or 200 ~ 240VAC , 50 ~ 60Hz ( self-adaption )
<b>Power consumption</b>	Less than 300W
<b>Temperature range</b>	Working temperature: 0°C ~ +50°C ; storage temperature: -40°C ~ +70°C

Table 8.3 Technical indicators of 1435-V series

Frequency characteristics			
Frequency Span	1435A-V:9kHz~3GHz 1435B-V:9kHz~6GHz	Frequency	N( Number of times of harmonic wave of the fundamental wave )
		9kHz≤f < 250MHz	1/8
		250MHz≤f≤375MHz	1/16
		375MHz < f≤750MHz	1/8
		750MHz < f≤1.5GHz	1/4
		1.5GHz < f≤3GHz	1/2
		3GHz < f≤6GHz	1
Frequency resolution	0.001Hz		
Frequency switching time	≤1Ms ( Typical value <sup>2</sup> )		
Time base aging rate (typical value)	Standard configuration: ±5×10 <sup>-7</sup> /year (after 30 days of continuous turn-on) High-stability time base option H10: ±5×10 <sup>-8</sup> /year (after 30 days of continuous turn-on) ±5×10 <sup>-10</sup> /day (after 30 days of continuous turn-on)		
Reference output	Frequency	10MHz	
	Amplitude	>+4dBm, up to a load of 50Ω	
Reference input	Frequency	1MHz ~ 50MHz, stepping of 1Hz	
	Amplitude	0dBm ~ +7dBm, impedance of 50Ω	
Sweep feature			
Sweep mode	Step sweep List sweep		
Sweep Dwell time	100μs ~ 100s		
Amplitude characteristics			
Min. amplitude	Standard configuration	Option H01	
	-15dBm ( which can be set to -20dBm )	-110dBm ( which can be set to -135dBm )	
Max. amplitude	Frequency Span	Standard	High-amplitude output option

## 8.3 Technical Indicators

( 25±10°C )		configuration	H08		
	9kHz≤f≤3GHz		18dBm	22dBm	
	3GHz < f≤5GHz		16dBm	20dBm	
	5GHz < f≤6GHz		15dBm	18dBm	
Amplitude accuracy ( 25±10°C )	Standard configuration				
	Frequency Amplitude (dBm)	10 ~ max. amplitude	-10~10	-15~-10	
	9kHz≤f≤2GHz	±0.8dB	±0.6dB	±1.5dB	
	2GHz < f≤6GHz	±0.9dB	±0.7dB	±1.5dB	
	H01 program control stepping attenuator option				
	Frequency Amplitude (dBm)	10 ~ max. amplitude	-10~10	-70~-10	-90~-70
	9kHz≤f≤2GHz	±0.8dB	±0.6dB	±0.7dB	±1.4dB
	2GHz < f≤6GHz	±0.9dB	±0.7dB	±0.7dB	±1.6dB
Amplitude resolution	0.01dB				
Output impedance	50Ω ( rated value <sup>3</sup> )				
Source standing wave rate VSWR (internal fixed amplitude) (typical value)	9kHz≤f≤3GHz	< 1.7			
	3GHz < f≤6GHz	< 1.6			
Max. reverse amplitude	0.5W ( 0V DC ) ( rated value )				
Spectrum purity <sup>4</sup>					
Harmonic wave (at +10dBm)	Frequency	Standard configuration			
	9kHz≤f≤10MHz	< -23dBc			
	10MHz < f≤2GHz	< -30dBc			
	2GHz < f≤3GHz ( 1435A-V )	< -55dBc			
	2GHz < f≤6GHz ( 1435B-V )	< -30dBc			
Subharmonic wave (at +10dBm)	9kHz≤f≤6GHz		NONE		
Anharmonic wave (at 0dBm, beyond 10kHz frequency)	Frequency	Standard configuration	Low phase noise option		
	9kHz≤f≤250MHz	< -54dBc	< -60dBc		

**8.3 Technical Indicators**

<b>offset)</b>	250MHz < f≤3GHz	< -62dBc	< -77dBc		
	3GHz < f≤6GHz	< -56dBc	< -71dBc		
<b>Single sideband phase noise ( dBc/Hz, at +10dBm )</b>	Standard configuration				
	Frequency	100Hz	10kHz		
	100MHz	-83	-115		
	250 MHz	-93	-127		
	500MHz	-89	-121		
	1 GHz	-83	-115		
	2 GHz	-77	-109		
	3GHz	-74	-105		
	4 GHz	-71	-103		
	6 GHz	-68	-99		
	Low phase noise option H06				
	Frequency	100Hz	1kHz	10kHz	100kHz
	100MHz	-83	-112	-131	-131
	250 MHz	-93	-123	-139	-139
	500MHz	-89	-119	-135	-135
	1 GHz	-83	-113	-132	-132
	2 GHz	-77	-107	-126	-126
	3GHz	-74	-104	-121	-121
4 GHz	-71	-101	-120	-120	
6 GHz	-68	-98	-115	-115	
<b>Modulation characteristic</b>					
<b>Frequency modulation ( Option H02 )</b>	<p>Max. frequency offset: N×16MHz (N is the number of times of the harmonic wave of the fundamental wave)</p> <p>Accuracy (modulation rate of 1kHz and frequency offset of N×500kHz): ± ( 2% ×frequency offset set+20Hz )</p> <p>Modulation rate ( bandwidth of 3dB and frequency offset of N×500kHz ) : DC-7MHz</p> <p>Distortion ( rate of 1kHz and frequency offset of N×500kHz ) : &lt;0.4%</p>				
<b>Phase modulation ( Option H02 )</b>	<p>Max. phase offset: N× 16rad (N is the number of times of the harmonic wave of the fundamental wave)</p> <p>Accuracy (modulation rate of 1kHz and frequency offset of N×500kHz): ± ( 2% ×phase offset set+0.01rad )</p> <p>Modulation rate ( bandwidth of 3dB and phase offset of N× 8rad ) : DC-1MHz</p> <p>Distortion ( modulation rate of 1kHz and phase offset of N× 8rad ) : &lt; 0.4%</p>				
<b>Amplitude modulation</b>	<p>Max. depth: &gt; 90%</p> <p>Amplitude modulation accuracy: (modulation rate of 1kHz and modulation</p>				

## 8.3 Technical Indicators

<b>( Option H02 )</b>	<p>depth of 30%): <math>\pm</math>: ( 4%<math>\times</math>depth set+1% )</p> <p>Amplitude modulation distortion : ( modulation rate of 1kHz , linear mode, total harmonic distortion, and modulation depth of 30% ) : &lt; 2% ;</p> <p>Amplitude modulation bandwidth ( bandwidth of 3dB , modulation depth of 30% , frequency test points: 1GHz、 5GHz ) : DC ~ 100kHz</p>	
<b>Pulse modulation<sup>5</sup></b> <b>( Option H03 )</b>	On/off ratio	> 80dB
	Rise/fall time	< 10ns
	Min. pulse width of the internal fixed amplitude	1 $\mu$ s
	Min. pulse width of the non-fixed amplitude	100ns
<b>Narrow pulse modulation<sup>5</sup></b> <b>( Option H04 )</b>	On/off ratio	> 80dB
	Rise/fall time	< 10ns
	Min. pulse width of the internal fixed amplitude	1 $\mu$ s
	Min. pulse width of the non-fixed amplitude	20ns
<b>Internal modulation signal generator (option H02)</b>	<p>Three separate signals are provided for frequency/phase modulation, amplitude modulation and low frequency output respectively.</p> <p>Waveform: sine wave, square wave, triangle wave, and zigzag wave</p> <p>Frequency range: 0.1Hz~10MHz for fine wave</p> <p>0.1Hz~1MHz for the square wave, triangle wave and zigzag wave</p> <p>Frequency resolution: 0.1Hz</p> <p>Low frequency output: amplitude 0 ~ 5Vpeak (rated value), up to 50<math>\Omega</math> load</p>	
<b>Internal pulse generator (Option H03)</b>	<p>Pulse width: 20ns ~ ( 42s-10ns )( rated value )</p> <p>Pulse period: 40ns ~ 42s ( rated value )</p> <p>Resolution: 10ns</p>	
<b>Multifunction generator (option H05)</b>	<p>The multifunction generator consists of 7 waveform generators, and all of them can be set separately or 5 of them set at the same time via the complex modulation characteristic of the AM, FM/<math>\Phi</math>M and low frequency output.</p> <p>Waveform:</p> <p>Function generator 1: Sine wave, triangle wave, square wave, saw tooth wave and pulse</p> <p>Function generator 2: Sine wave, triangle wave, square wave, saw tooth wave and pulse</p> <p>Dual-function generator: Sine wave, triangle wave, square wave, saw tooth wave, and pulse phase offset and amplitude rate of frequency 2 (relative to frequency 1);</p> <p>Sweep function generator: Sine wave, triangle wave, square wave and saw tooth wave ;</p>	

**8.3 Technical Indicators**

	Noise generator 1: balance, gauss ; Noise generator 2: balance, gauss ; DC: Only for LF output ; Frequency parameter: Fine wave: 0.1Hz-10MHz ; Triangle wave, square wave, saw tooth wave and pulse: 0.1Hz-1MHz ; Resolution: 0.1Hz ;			
<b>Vector modulation accuracy (25°C±10°C after calibration)</b> ( Code element rate of 4Msps , root-Nyquist filter , α=0.3 ,QPSK format , 0dBm )	1435A/B -V	50MHz~3GHz	EVM ( RMS% ) <1.4%	
		3GHz~6GHz	Standard configuration	EVM ( RMS% ) <1.8%
			Low phase noise option	EVM ( RMS% ) <1.4%
<b>Internal modulation bandwidth</b>	( Carrier 900MHz, 1.8GHz, 2.4GHz and 6GHz ) Standard configuration: 120MHz ( multitone, number of tones of 51, frequency interval of 2.4MHz , bandwidth of ±3dB ) ; H09 high-modulation bandwidth option: 200MHz ( multitone, number of tones of 51, frequency interval of 4MHz , bandwidth of ±3dB ) .			
<b>External modulation bandwidth</b>	( Carrier 900MHz, 1.8GHz, 2.4GHz and 6GHz ) 200MHz (fixed amplitude with open loop, path I input with 100mVrms sine wave, bandwidth of ±4dB)			
<b>Internal baseband signal generator</b>	Number of paths: 2 ( I and Q ) Maximum code element rate: Standard configuration: 75Msps Option 09: 125Msps Base bank waveform memory: Standard configuration: 1G sample points Option H32: 2G sample points Real-time baseband mode: Modulation format: PSK: BPSK, QPSK, OQPSK, π/4DQPSK, D8PSK and 16PSK QAM: 4, 16, 32, 64, 128, 256, 512 and 1024 FSK: 2, 4, 8 and 16 ASK, MSK , random wave modulation EVM: <1.0% typical value , RMS% , code element rate of 4Msps ,root-Nyquist			



## 8.4 Additional information

	filter , $\alpha=0.3$ , QPSK format ) Max. frequency interval in dual-tone mode: 200MHz Arbitrary wave mode: Data format: Mat-File 5, ASCII, Binary, cap and csv. Trigger: Trigger type: Continuous, single, gate and advanced waveform segment; Trigger source: key trigger, external trigger and bus trigger (GPIB and LAN); Trigger mode: Auto playback, trigger playback, trigger reset, single auto, single trigger buffering, single reset, gate (high/low), single waveform segment, and continuous waveform segment;
<b>General characteristics</b>	
<b>RF output port</b>	N type ( negative ) , impedance of 50 $\Omega$
<b>Max. boundary dimension</b>	WidthxHeightxDepth: 330mmx147mmx397mm ( excluding handle ) 420Mm $\times$ 147mm $\times$ 445mm ( including handle )
<b>weight</b>	< 12 kg ( which varies with the type and option configuration )
<b>Power supply</b>	100 ~ 120VAC , 50 ~ 60Hz,; or 200 ~ 240VAC , 50 ~ 60Hz ( self-adaption )
<b>Power consumption</b>	Less than 300W
<b>Temperature range</b>	Working temperature: 0 $^{\circ}$ C ~ +50 $^{\circ}$ C ; storage temperature: -40 $^{\circ}$ C ~ +70 $^{\circ}$ C

Note: 1 After the 1435 series signal generators are placed at the environment temperature for 2h and warmed up for 30 min., the attenuator will be coupled automatically (or the ALC amplitude is bigger than -5dBm). It can meet various indicator performances in given working ranges.

2 The typical value is the supplementary feature given in the form of set value, which is for users reference only rather than evaluation.

3 The rated value refers to the expected performance, or describes the product performance that is useful for the product but not included in the product warranty.

4 Spectrum purity indicator is the dot frequency non-modulation type.

5 The technical indicators of pulse modulation and narrow pulse modulation apply to frequencies of higher than 50MHz.

## 8.4 Additional information

- [General information.....223](#)

### 8.4.1 General information

- [Front panel port.....223](#)
- [Rear panel port.....224](#)
- [EMC and safety.....225](#)

#### 8.4.1.1 Front panel port

Table 8.4 Front panel port

<b>Front panel port</b>			
<b>RF output port</b>	1435A/B/C	1435D	1435F

## 8.4 Additional information

	N type ( negative )	3.5mm ( positive ) Option H91: N type ( negative )	2.4mm ( positive )
<b>I input</b>	I input: To receive the “I” input of the I/Q modulation, with input impedance of 50Ω.		
<b>Q input</b>	Q input: To receive the “Q” input of the I/Q modulation, with input impedance of 50Ω.		
<b>USB interface</b>	To be used for connection with mouses and keyboards, system software upgrading and data backup.		

## 8.4.1.2 Rear panel port

Table 8.5 Rear panel port

Rear panel port	
<b>AM/FM/ΦM input 1</b>	To input fixed $\pm 1V_p$ for realizing external amplitude/frequency/phase modulation.
<b>AM/FM/ΦM input 2</b>	To input fixed $\pm 1V_p$ for realizing external amplitude/frequency/phase modulation.
<b>LF output</b>	To set to output the LF signal with frequency of 0.01Hz ~ 10MHz, amplitude of 40mV <sub>p</sub> ~ 4V <sub>p</sub> and output impedance of 50Ω.
<b>Pulse input</b>	The input signal of the pulse signal compatible with TTL level, with input impedance of 2kΩ.
<b>Sync pulse output</b>	To multiplex with trigger output (which is the sync pulse output by default) to output a sync pulse signal compatible with TTL, with rated value width of 20ns during internal and trigger pulse modulation and rated source impedance of 50Ω.
<b>Pulse monitoring output</b>	To output the pulse signal consistent with the modulation envelope together with the pulse signal compatible with TTL level in all pulse modes, with rated source impedance of 50Ω.
<b>Sweep output</b>	To output the voltage output in direct proportion to the sweep frequency, whereas, 0V is corresponding to the start sweep frequency, and 10V to the end one (in the CW working mode, 0 ~ 10V is corresponding to the instrument frequency range).
<b>External detection input</b>	To realize fixed amplitude of external detection.
<b>Network port</b>	To be used for software upgrading and control.
<b>Reference input 1 ~ 50MHz</b>	To receive the frequency reference signal of 1-50MHz, 1Hz stepping and 0 ~ +7dBm from the external time base.
<b>10 MHz output</b>	Signal level >+4dBm, and typical output impedance of 50Ω.
<b>Trigger output</b>	To multiplex with sync pulse output. Trigger output can be realized by setting in the sweep mode. The signal is of high level at the start of residence or when being triggered at the waiting point in the manual sweep mode, and of low level at the end of residence or when the point trigger is received.
<b>Trigger input</b>	It is used for external trigger stepping and frequency hopping in the list sweep mode.

## 8.4 Additional information





<b> GPIB interface </b>	Standard IEEE488 interface, supporting SCPI language.
<b> USB interface </b>	To be used for connection with mouses and keyboards, system software upgrading and data backup.
<b> 1435A/B -V </b>	
<b> I output </b>	Path-I output of the internal baseband signal generator.
<b> I output </b>	Path-I output of the internal baseband signal generator.
<b> Q output </b>	Path-Q output of the internal baseband signal generator.
<b> Q output </b>	Path-Q output of the internal baseband signal generator.
<b> Marker 1/IQ data </b>	During random wave modulation, to output mark 1 set with the random wave; in the baseband mode, when the data source is from external, to input the IQ serial data.
<b> Marker 2/IQ clock </b>	During random wave modulation, to output mark 2 set with the random wave; in the baseband mode, when the data source is from external, to input the IQ serial clock.
<b> Marker 3/code element clock </b>	During random wave modulation, to output mark 3 set with the random wave; in the baseband mode, when the data source is from external, to input the code element clock.
<b> Marker 4/IQ code pattern trigger input </b>	During random wave modulation, to output mark 4 set with the random wave; in the baseband and random wave modes, to input the external code pattern trigger.

## 8.4.1.3 EMC and safety

Table 8.6 EMC and safety

<b> Name </b>	<b> Description information </b>
<b> EMC </b>	
 <b> ISM 1-A </b>	Regulations from European Commission: 89/336/EEC, 92/31/EEC, 93/68/EEC IEC 61326-1:1997 +A1:1998 +A2:2000/EN 61326-1:1997 +A1:1998 +A2:2001 CISPR 11:1997 +A1:1999/EN 55011:1998 +A1:1999 Group 1, Class A IEC 61000-4-2:1995 +A1:1998/EN 61000-4-2:1995 +A1:1998 4 kV CD / 8 kV AD IEC 61000-4-3:1995 +A1:1998/EN 61000-4-3:1996 +A1:1998 3 V/m, 80-1000 MHz, 80% AM IEC 61000-4-4:1995/EN 61000-4-4:1995 1 kV power / 0.5 kV Signal IEC 61000-4-5:1995/EN 61000-4-5:1995 0.5 kV Normal / 1 kV Common IEC 61000-4-6:1996/EN 61000-4-6:1996 3 V, 0.15-80 MHz, 80% AM IEC 61000-4-11:1994/EN 61000-4-11:1994 100% 1cycle European Council Directive
<b> ICES/NMB-001 </b>	The instrument complies with the Canadian ICES-001:1998.

**8.5 Performance characteristics test**

 <b>N10149</b>	AS/NZS 2064.1/2 Group 1, Class A
<b>Safety</b>	
	Regulations from European Commission: 73/23/EEC, 93/68/EEC IEC 61010-1:2001/EN 61010-1:2001 Measurement level: I; pollution level: 2 For indoor: IEC60825-1:1994 Class 1 LED
 LR95111C	CAN/CSA C22.2 No. 1010.1-92
<b>Environment</b>	
	<p>The product complies with provisions specified in WEEE ( 2002/96/EC ) .</p> <p>Note information indicates that the electronic products cannot be discarded as indoor garbage.</p> <p>Product category: The product belongs to the “monitoring and control instruments” as per the instrument category specified in Appendix I of WEEE.</p> <p>Please do not discard the product as indoor garbage. Please contact local Agilent office, or visit <a href="http://www.agilent.com/environment/product/">www.agilent.com/environment/product/</a> for relevant contact information and specific disposal solutions.</p>

**8.5 Performance characteristics test**

- Recommended test method.....226
- Record chart of performance characteristics test table.....239
- Recommended instrument for performance characteristics test .....251

**8.5.1 Recommended testing method**

- Frequency characteristic.....226
- Amplitude characteristic.....231
- Modulation characteristic.....233
- Source voltage standing-wave ratio test.....238

**8.5.1.1 Frequency characteristics**

**1) Frequency span**

a) Item description

The frequency span is also called the frequency coverage, namely, the frequency span of the signal generator capable of providing qualified signals, which is described in the upper and lower frequency limit. The test is to check whether the frequency span of the signal generator is qualified.

b) Test equipment and test block diagram

Test equipment recommended:

- |                                 |         |
|---------------------------------|---------|
| Microwave frequency meter 3212D | 1 set   |
| RF coaxial cable                | 1 piece |

## 8.5 Performance characteristics test

Test block diagram:

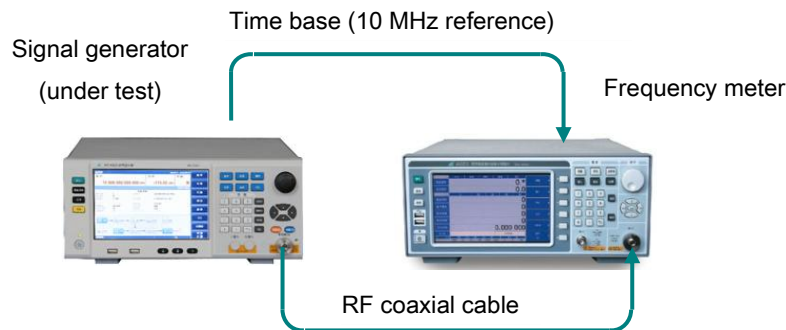

Fig. 8.1 Frequency span test

c) Test steps

- 1) Connect equipment as shown in Figure 8.1.
- 2) Start up and reset, and then warm it up for at least 30 min.
- 3) Set the signal generator under test to the dot frequency mode.
- 4) Set the output frequency of the signal generator to the lower frequency limit of 9kHz and amplitude of +10dBm; use the microwave frequency meter to test, and record the measurement result. If the test result is within  $9\text{kHz}\pm 1\text{Hz}$ , it deems that the lower output frequency limit is qualified, and vice versa.
- 5) Set the output frequency of the signal generator to the upper frequency limit of and amplitude of +10dBm; use the microwave frequency meter to test, and record the measurement result. If the test results of the 1435A, 1435B, 1435C, 1435D and 1435F are within  $3\text{GHz}\pm 1.5\text{kHz}$ ,  $6\text{GHz}\pm 3\text{kHz}$ ,  $12\text{GHz}\pm 6\text{kHz}$ ,  $20\text{GHz}\pm 10\text{kHz}$  and  $40\text{GHz}\pm 20\text{kHz}$  respectively, the upper output frequency limit is qualified, and vice versa.

d) Test record and data management

Record the test result in the record chart.

**2) Frequency resolution**

a) Item description

The frequency resolution is the output frequency interval controlled accurately by the broadband signal generator. Change the dot frequency change of the signal generator for 0.001Hz, and use the frequency meter (frequency comparator) to check whether the signal frequency change is 0.001Hz. If yes, the frequency resolution of the broadband signal generator is 0.001Hz.

b) Test equipment and test block diagram

Test equipment recommended:

Frequency meter Agilent53230A	1 set
RF coaxial cable	1 piece
BNC cable	1 piece

Test block diagram:

## 8.5 Performance characteristics test

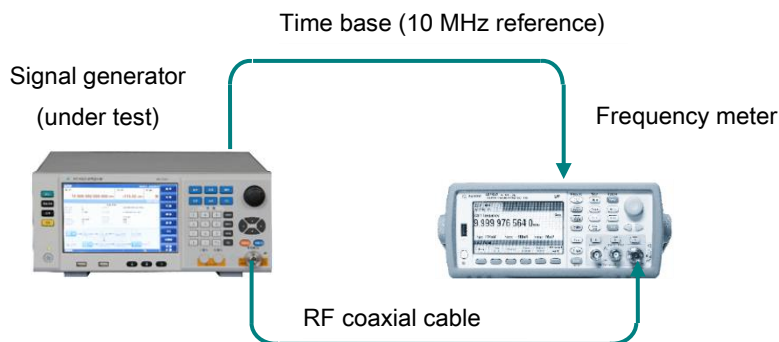

Fig. 8.2 Frequency resolution test

## c) Test steps

1) Connect equipment as shown in Figure 8.2, start up the instrument, and warm it up for at least 30 min.

2) Set the signal generator under test as follows:

【Frequency】 1.000 000 001MHz

【Amplitude】 0dBm

3) Set the frequency meter to being work in the channel 1 mode and resolution to 1mHz.

4) Change the output frequency of the signal generator under test for 1mHz, and check whether the test value of the frequency meter is changed for 1mHz accordingly.

## d) Test record and data management

Record the test result in the record chart.

## 3) Internal time base aging rate

## a) Item description

The test is to check the daily aging rate indicator of the internal time base. Under the specified warm-up time and environment conditions, measure the frequency variations inside the instrument with the standard time base and frequency comparator once every 12h for 7 days in sequence, with 3 values being taken continuously each time. The arithmetic mean value of such three values is taken as the measurement result at  $t_i$ , and the mean frequency variation is the aging rate of the internal time base.

The aging rate indicator of the internal time base is tested by the time base manufacturer, aiming to represent the standard long-term variation of the frequency. The standard provides the following common verification methods rather than specific tests.

The internal time base of the instrument must be warmed up sufficiently first before test since it cannot reach the specified indicator of the time base aging rate until it has been warmed up for 30 days after being disconnected from the power supply for 2h. If the frequency difference between the internal time base and frequency standard is big, the “10MHz standard modulation” shall be conducted first, so as to adjust the frequency accuracy of the internal time base to be the same with that of the standard time base.

Since the test environment has big impact on the internal time base accuracy, the following shall be assured during the test:

- 1) The environment temperature change shall be kept within  $\pm 2^{\circ}\text{C}$ .
- 2) Keep the direction of the instrument consistent with that of the earth magnetic field.
- 3) Keep the instrument at the same height.
- 4) Keep the instrument away from any mechanical impact.

**8.5 Performance characteristics test**

## b) Test equipment and test block diagram

Test equipment recommended:

Frequency standard HP5061/CH-47	1 set
Frequency comparator CH7-45	1 set
BNC cable	2 pieces

Test block diagram:

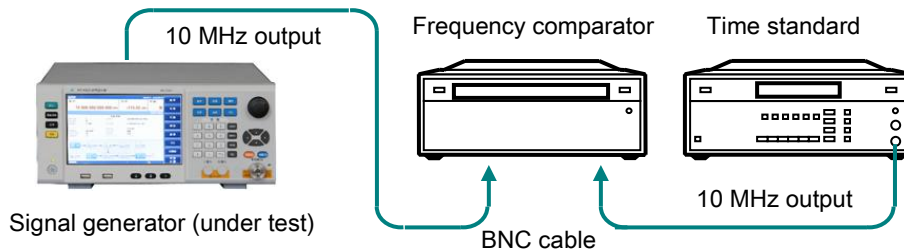

Fig. 8.3 Test on internal time base aging rate

## c) Test steps

- 1) Connect equipment as shown in Figure 8.3.
- 2) Warm up the instrument after startup and reset as per the requirement.
- 3) Set the signal generator under test to dot frequency of 10 GHz, with amplitude of 0 dBm.
- 4) Measure a group of data every 12 h with sampling for three times for each group and sampling time of not less than 10s, and then calculate the arithmetic mean value as a measurement data (number of daily measurement  $n=2$ ). Conduct the measurement for 7 days in sequence, and obtain a total of 15 measurement data.
- 5) Calculate the aging rate  $A$  as per the formula below:

$$A = \frac{2 \sum_{i=1}^N (Y_i - Y_p)(t_i - t_p)}{\sum_{i=1}^N (t_i - t_p)^2}$$

Whereas:

 $Y_i$  —Frequency value measured at the  $i$  time, with unit of Hz ; $Y_p$  —Mean frequency value measured for  $N$  times, with unit of Hz ; $t_i$ —Time for measurement at the  $i$  time, with unit of h; $t_p$ —Time for measurement at the  $N$  time, with unit of h; $N$ —Number of times of measurement.**4) Harmonic wave parasitism**

## a) Item description

The test is to verify whether the harmonic wave indicator of the signal generator is qualified. Harmonic wave is integral multiple of the output frequency of the signal generator. In this test, set the output amplitude of the signal generator to +10dBm or the max. output amplitude, whichever is smaller. Adjust manually the output frequency in the indicator frequency range, and use the spectrum analyzer to

**8.5 Performance characteristics test**

test and find the poorest point of the harmonic wave.

b) Test equipment and test block diagram

Test equipment recommended:

- Spectrum analyzer 4051 1 set
- RF coaxial cable 1 piece

Testing diagram

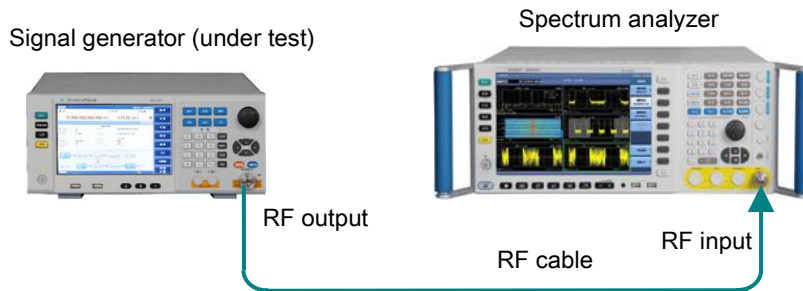

Fig. 8.4 Diagram of connection via spectrum analyzer

c) Test steps

- 1) Connect the equipment as per Fig. 8.4, start it up and warm it up for at least 30 min.
- 2) Set the signal generator to the dot frequency mode, and set the amplitude level to +10dBm or the max. output amplitude, whichever is smaller.
- 3) Adjust the output frequency in the indicator range of the signal generator till it reaches 33.5GHz, and then test and find the poorest point of the harmonic wave via the spectrum analyzer. Test the signal generator phase by phase (with phased point of 3.2GHz), and adjust the sweep width of the spectrum analyzer according to the output frequency of the signal generator. During the test, keep the frequency stepping of the signal generator before and after the phased point at 10MHz and 100MHz respectively.

d) Test record and data management

Record the test result in the record chart.

**5) Anharmonic wave parasitism**

a) Item description

The test is to check whether the anharmonic wave indicator in the whole frequency range of the signal generator is qualified. A anharmonic wave refers to a parasitic or residual signal generated from frequency synthesis, which is expressed as a fixed signal output or a signal output with a certain frequency deviation. Set the signal generator to a series of CW output frequencies likely generating anharmonic wave, and modulate the spectrum analyzer to corresponding parasitic signal, and then conduct measurement and find the poorest point of the anharmonic wave.

b) Test equipment and test block diagram

The test equipment and test block diagram are the same with those of the harmonic wave test.

c) Test steps

- 1) Connect equipment as shown in Figure 8.4, start up the instrument, and warm it up for at least 30 min.
- 2) In the dot frequency working mode, set the output frequency of the signal generator to 100MHz, and amplitude level to 0dBm.
- 3) Set the reference level of the spectrum analyzer to +10dBm, sweep width to 50kHz, resolution



**8.5 Performance characteristics test**

bandwidth and video bandwidth to auto, and center frequency to the output frequency of the signal generator.

4) Measure the level dBc of the parasitic offset carrier of the anharmonic wave 10kHz beyond the offset carrier with the spectrum analyzer, and record it to the test record chart (do not record if no anharmonic wave parasitism is found).

5) Set the sweep width of the spectrum analyzer to 500kHz and 5MHz respectively, and repeat step 4).

6) Set the output frequency of the signal generator to 3GHz, 6GHz, 12GHz, 20GHz and 40GHz respectively, and repeat steps 4) and 5).

7) Test record and data management

d) Test record and data management

Record the test result in the record chart.

**8.5.1.2 Amplitude characteristics****1) Test on the max. output of the fixed amplitude**

a) Item description

The test is to check whether the max. output of the fixed amplitude meet the indicator requirement.

b) Test equipment and test block diagram

Test equipment recommended:

Power meter N1914A	1 set
Power meter probe N8488A	1 pc
Power meter probe E9304A	1 pc
Attenuator AV71515A	1 pc

Test block diagram:

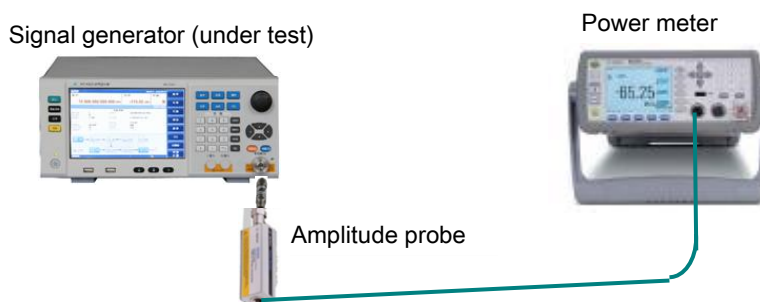

Fig. 8.5 Amplitude test

c) Test steps

1) Connect the equipment as shown in Fig. 8.5, select E9304A for the power meter probe, start up the instrument and warm it up for at least 30 min.

2) Set the signal generator to the dot frequency mode, output frequency to 9kHz, output amplitude to 3dB higher than the max. indicator amplitude, and RF to on.

3) When the signal generator shows no "unfixed amplitude", measure the current amplitude value with the power meter, and record it to the test record chart. When the signal generator shows "unfixed amplitude", reduce the output amplitude of the signal generator gradually at a stepping of 0.1dB, record the reading of the power meter soon after the "unfixed amplitude" indication

**8.5 Performance characteristics test**

disappears, and fill in it to the test record chart.

4) Set the output frequency of the signal generator to 10MHz, 250MHz, 3GHz, 6GHz, 9GHz, 12GHz, 20GHz, 30GHz and 40GHz respectively till reaching the highest frequency, change the power meter probe to N8488A when the frequency exceeds 6GHz, and repeat step 3).

d) Data record and test conclusion

Record the test data and conclusion in the record chart.

**2) Test on the min. output of the fixed amplitude**

a) Item description

The test is to check whether the min. output of the fixed amplitude of the signal generator meet the indicator requirement.

b) Test equipment and test block diagram

Test equipment recommended:

Power meter N1914A	1 set
Power meter probe N8488A	1 pc
Spectrum analyzer FSW67	1 set

Test block diagram:

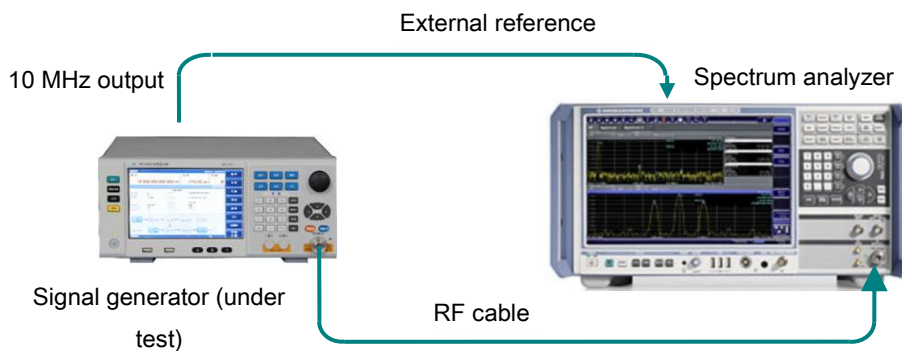

Fig. 8.6 Small amplitude test

c) Test steps

1) Connect the instrument as per Fig. 8.5, set the frequency of the signal generator to 9kHz, amplitude to 0dBm, and record the reading P1 of the power meter.

2) Connect the spectrum analyzer to the signal generator as shown in Fig. 8.6, set the amplitude of the signal generator to 0dBm, set the level to the reference one; set the amplitude value of the signal generator to the min. fixed amplitude via the relative fixed amplitude mode of the spectrum analyzer, and test the difference P2 relative to its min. fixed amplitude at 0dBm with the spectrum analyzer (P1+P2 is the measured min. output of the fixed amplitude), and record the measured value to the record chart.

3) In the absence of the attenuator, if the min. fixed amplitude output is within the amplitude accuracy indicator, it deems that the min. fixed amplitude is qualified; in the presence of the attenuator, if the measured min. fixed amplitude error of 1435A/B/C/D/F is within ±3.5dB, it deems the min. fixed amplitude is qualified.

4) Set the output frequency of the signal generator to 10MHz, 1GHz, 3/6/12GHz, 20GHz and 40GHz respectively, and repeat steps 1) - 3).

d) Test record and data management

**8.5 Performance characteristics test**

Record the test data and conclusion in the record chart.

**3) Amplitude accuracy****a) Item description**

This test checks whether the amplitude accuracy indicator of the signal generator meets the requirement with the measuring receiver. Set the frequency of the signal generator to 9kHz, 10MHz, 1GHz, 3/6/12GHz, 20GHz and 40GHz respectively, reduce gradually the max. indicator output amplitude to the min. indicator one (which is -20dBm in the absence of the attenuator and selects corresponding indicator as per the attenuator if any), and then check whether the output amplitude accuracy is qualified via the measuring receiver.

This test checks whether the amplitude accuracy indicator of the signal generator meets the requirement at several frequency points with the power meter and spectrum analyzer. Set the frequency of the signal generator to 9kHz, 10MHz, 500MHz, 3/6/12GHz, 20GHz and 40GHz respectively, reduce gradually the max. indicator output amplitude to the min. indicator one (which is -20dBm in the absence of the attenuator and selects corresponding indicator as per the attenuator if any), and then check whether the output amplitude accuracy is qualified via the power meter and spectrum analyzer.

**b) Test equipment and test block diagram**

The test equipment and block diagram is the same with those of the test on fixed amplitude output range.

**c) Test steps**

- 1) Connect the equipment as per Fig. 8.5, start it up and warm it up for at least 30 min.
- 2) Set the output frequency of the signal generator to 9kHz, level to the max. indicator output amplitude level, and RF to on.
- 3) Connect the power meter, and set its frequency to 9kHz. After that, reduce the output amplitude of the signal generator to -10dBm at a stepping of 1dB. Record the measured value to the test record chart.
- 4) Set the amplitude of the signal generator to 0dBm, and record the reading P1 of the power meter.
- 5) Connect the spectrum analyzer to the signal generator as shown in Fig. 8.6, set the amplitude of the signal generator to 0dBm, reduce the amplitude to the min. indicator amplitude P2 at a stepping of 10dB, test the amplitude difference P3 at each frequency point relative to 0dBm with the spectrum analyzer,
- 6) calculate the amplitude accuracy error  $\Delta = P3 - P1 - P2$ , and fill it in to the test record chart.
- 7) Set the output frequency of the signal generator to 10MHz, 1GHz, 3/6/12GHz, 20GHz and 40GHz respectively, and repeat steps 3) and 4).

**d) Data record and test conclusion**

Record the test data and conclusion in the record chart.

**8.5.1.3 Modulation characteristics****1) Test on rise/fall time for pulse modulation****a) Item description**

The test is to check whether the rise/fall time for pulse modulation of the signal generator meet the indicator requirement. The oscilloscope is used to test whether the rise/fall time for pulse modulation meets the indicator requirement.

**b) Test equipment and test block diagram**

Testing equipment:

**8.5 Performance characteristics test**

Digital oscilloscope TDS4054 1 set

Coaxial detector 1 set

Test block diagram:

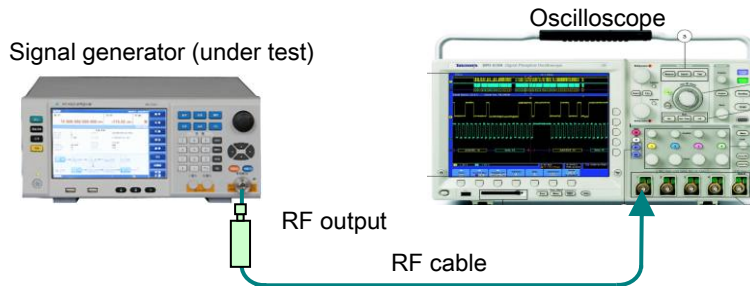

Fig. 8.7 Test on rise/fall time for pulse modulation

c) Test steps

- 1) Connect equipment as shown in Figure 8.7, start up the instrument, and warm it up for at least 30 min.
- 2) Set the signal generator under test as follows:  
Dot frequency: 3GHz, and amplitude: 0 dBm
- 3) Set the signal generator as follows for pulse modulation: Set it to pulse modulation, pulse source to auto, pulse width to 5 $\mu$ s, pulse period to 10 $\mu$ s, and pulse modulation to on.
- 4) Adjust the time base delay of the digital storage oscilloscope to let it show signals of at least one period, and then measure the rise/fall time for pulse modulation.
- 5) Select the rise/fall time for auto pulse measurement of the oscilloscope with the rise/fall time measurement options in **【MEASURE】** of the oscilloscope, and fill them in to Appendix A.
- 6) Follow the steps above to test the rise/fall time for pulse modulation of the 1435C/D/F signal generators at 10GHz.

d) Test record and data management

Record the test result in the record chart.

**2) Test on on/off ratio of pulse modulation**

a) Item description

The on/off ratio of pulse modulation reflects mainly the signal leakage when pulse modulation is off. Set pulse modulation to on/off, and check the amplitude difference in such two statuses (which is the on/off ratio of pulse modulation).

b) Test equipment and test block diagram

Test equipment recommended:

Spectrum analyzer 4051 1 set

RF coaxial cable 1 piece

The test block diagram is the same with that of the harmonic wave test.

c) Test steps

- 1) Connect equipment as shown in Figure 8.4, start up the instrument, and warm it up for at least 30 min.
- 2) Set the signal generator to dot frequency of 50MHz, with amplitude level of 0 dBm.

**8.5 Performance characteristics test**

- 3) Set the spectrum analyzer as follows:

Center frequency: 50MHz

Sweep width 200kHz

Reference level: 5dBm

- 4) Measure the on/off ratio of pulse modulation with the frequency marker and frequency marker difference value functions on the spectrum analyzer:

Frequency marker Frequency marker Peak value Frequency marker difference value on

- 5) Set the signal generator as follows for pulse modulation:

Modulation Pulse modulation Pulse source External Pulse modulation on Modulation on/off on

- 6) Observe current on/off ratio on the spectrum analyzer and record it.

- 7) Set the signal generator as follows for canceling pulse modulation:

Modulation Pulse modulation Pulse modulation off

- 8) Test the pulse modulation on/off ratio of the signal generator at 500MHz, 1GHz, 3GHz, 6/12GHz, 15GHz, 20GHz, 25GHz, 35GHz and 40GHz respectively, and record the poorest test result to the performance test record.

- d) Test record and data management

Record the test result in the record chart.

### 3) Test on EVM and original offset

- a) Item description

The test is to check whether the EVM and original offset of the vector signal generator meets the requirement.

- b) Test equipment and test block diagram

Test equipment recommended:

Vector signal analyzer FSQ40

1 set

Test block diagram:

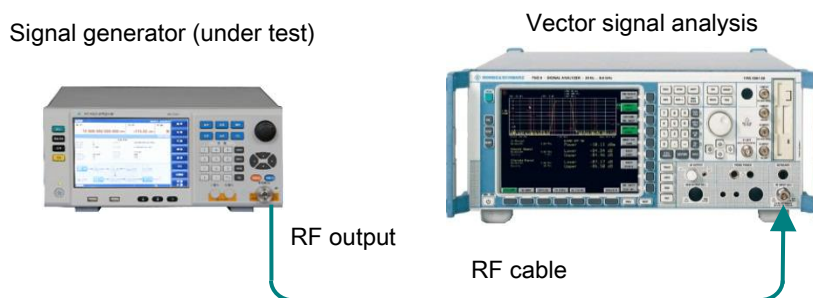

Fig. 8.8 Test on EVM and original offset

- c) Test steps

- 1) Connect equipment as shown in Figure 8.8, start up the instrument, and warm it up for at least 30 min.

- 2) Set the signal generator under test as follows:

Dot frequency: 900MHz, and amplitude: 0 dBm

### 8.5 Performance characteristics test

- 3) Set the signal generator under test as follows:  
baseband baseband on  
Modulation format: QPSK  
Code element rate: 4Msym/s  
Filter root-Nyquist  $\alpha=0.3$   
I/Q I/Q modulation source Internal  
I/Q modulation on
- 4) Set the signal analyzer as follows to measure the EVM and original offset:  
Frequency: 900MHz  
Code element rate: 4MHz  
Modulation format: QPSK  
Modulation filter Transmitter filter RRC Receiver filter RRC  
Measuring filter RRC ALFA/BT 0.3

The EVM and Original OFFSET shown in the signal analyzer are the measured EVM and original offset.

- 5) Follow the steps above to test the EVM and original offset of the signal generator at 1.8GHz, 2.4GHz and 6GHz.
- d) Test record and data management  
Record the test result in the record chart.

#### 4) Internal modulation bandwidth test

- a) Item description  
The test is to check whether the internal modulation bandwidth of the vector signal generator meets the requirement.
- b) Test equipment and test block diagram  
The test equipment and test block diagram are the same with those of the test on EVM and original offset.
- c) Test steps
  - 1) Connect equipment as shown in Figure 8.8, start up the instrument, and warm it up for at least 30 min.
  - 2) Set the vector signal generator under test as follows:  
Dot frequency: 900MHz, and amplitude: 0 dBm
  - 3) Set the vector signal generator under test as follows:  
M-tone M-tone on  
Number of tones: 51 Frequency interval: 2.4MHz (option: H31: 4MHz)  
I/Q I/Q modulation on
  - 4) Set the signal analyzer as follows:  
Center frequency: 900MHz  
Sweep width 300MHz  
Amplitude 0dBm

**8.5 Performance characteristics test**

Amplitude per pattern: 1dB

Trace held open maximally

Get the modulation frequency response by using the amplitude difference at the highest and lowest points divided by 2 via the delta frequency marker function of the signal generator.

Follow the steps above to test the frequency response of the vector signal generator at 1.8GHz, 2.4GHz and 6GHz.

d) Test record and data management

Record the test result in the record chart.

**5) External modulation bandwidth test**

a) Item description

The test is to check whether the external modulation bandwidth of the signal generator meets the requirement. Input a sweep signal in path I of the vector signal generator to generate a double-sideband modulation signal via I/Q modulation, and observe the double-sideband signal frequency response via the signal analyzer. Set the signal generator to ALC open loop during the test. Set the sweep time of the signal generator to 50s.

b) Test equipment and test block diagram

Test equipment recommended:

Vector signal analyzer FSQ40 1 set

1435D signal generator 1 set

Test block diagram:

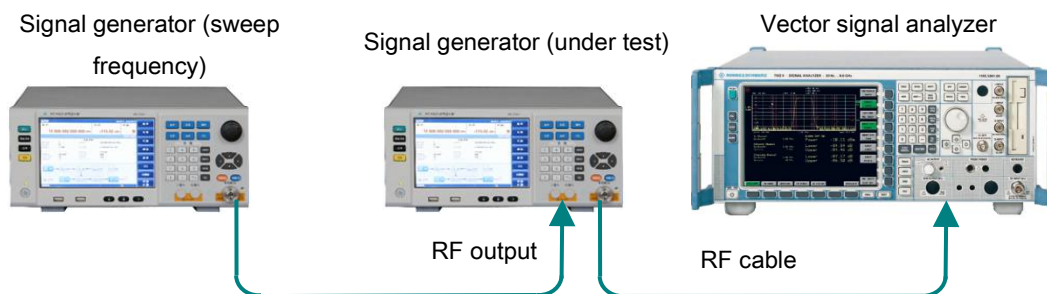

Fig. 8.9 Test on external modulation frequency response

c) Test steps

1) Connect equipment as shown in Figure 8.9, start up the instrument, and warm it up for at least 30 min.

2) Set the vector signal generator under test as follows:

Dot frequency: 900MHz, and amplitude: 0 dBm

Amplitude ALC loop status Open loop Amplitude search

I/Q I/Q modulation source External 50  $\Omega$  I/Q modulation on

3) Set the sweep frequency signal generator as follows:

Stepping sweep Start frequency 1MHz End frequency 100MHz Number of stepping points 100  
Stepping Dwell time 50ms

Amplitude level 0dBm

4) Set the signal analyzer as follows:

**8.5 Performance characteristics test**

Center frequency: 900MHz

Sweep width: 300MHz Amplitude per pattern: 1dB

Trace held maximally

Observe the amplitude difference at the highest and lowest amplitude points of the trace of the signal analyzer, and get the frequency response by using such difference divided by 2.

5) Follow the steps above to test the external modulation bandwidth frequency response of the vector signal generator at 1.8GHz, 2.4GHz and 6GHz.

d) Test record and data management

Record the test result in the record chart.

**8.5.1.4 Test on source voltage standing wave ratio**

a) Item description

The output port standing wave ratio is the ratio of the max. and min. standing wave voltages at the RF output port due to external load characteristics change, which reflects the offset degree of the output impedance of the signal generator against the standard one. For the signal generator with auto level control function, such ratio is determined mainly by the directivity of the internal directional coupler. The test provides a general test method to test the output port standing wave ratio via the spectrum analyzer, another signal generator, directional coupler and attenuator.

b) Test equipment and test block diagram

Testing equipment:

Signal generator	1 set
Spectrum analyzer	1 set
Directional coupler (directivity>30 )	1 pc
6dB attenuator	1 pc

Test block diagram:

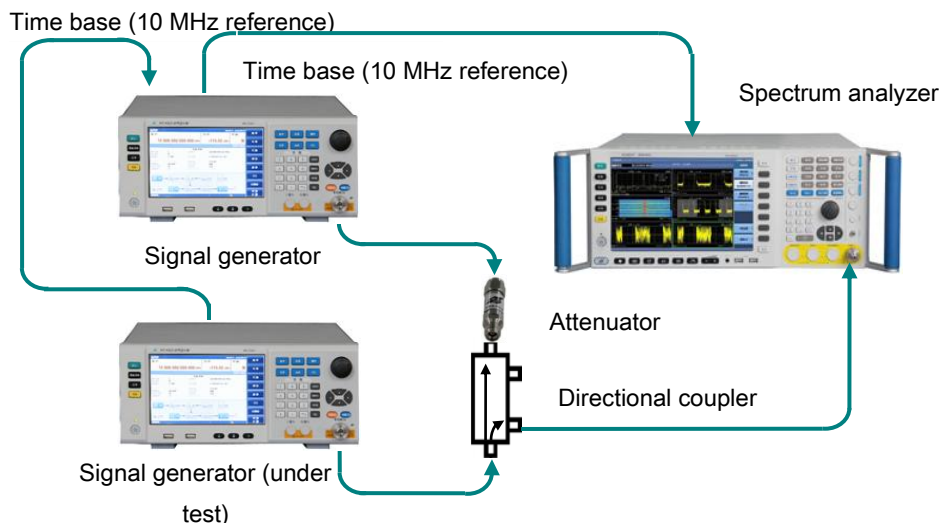

Fig. 8.10 Connection diagram for test on output port source standing-wave ratio

c) Test steps

1) Connect the test equipment as shown in Figure 8.10. Set the signal generator under test to the status of internal fixed-amplitude continuous wave output, with frequency of 2GHz and output amplitude of 0dBm.



**8.5 Performance characteristics test**

- 2) Set the spectrum analyzer as follows: external reference to 10MHz, center frequency to the test frequency, sweep width to 0Hz, amplitude to the test amplitude value, resolution and video bandwidth to 10Hz, and sweep time to 20ms, with linear level scale adopted.
  - 3) Set the secondary (not under test) signal generator as follows: external reference to 10MHz, continuous output frequency to the test frequency -100Hz, and amplitude to the min. output amplitude.
  - 4) Adjust the reference level of the spectrum analyzer to let the test signal displayed in the middle of the screen, and measure the voltage of the signal  $V_{ref}$ .
  - 5) Disconnect the connecting cable of the signal generator under test, and set the test port to open loop. Adjust the amplitude of the secondary (not under test) signal generator till the signal voltage value  $V_{ref}$  displayed on the spectrum analyzer is  $\pm 0.5\%$ .
  - 6) Reconnect the signal generator under test.
  - 7) At this time, the signal voltage of the spectrum analyzer is a sine curve. Measure the crest voltage  $V_{max}$  and trough voltage  $V_{min}$ , and calculate the standing wave ratio:  $VSWR = V_{max}/V_{min}$ .
  - 8) Set the output frequency of the signal generator under test to 3GHz, 6GHz, 12GHz, 15GHz, 20GHz, 31GHz and 40GHz respectively, and repeat steps 2) and 6).
- d) Test record and data management  
Record the test result in the record chart.

**8.5.2 Record chart of performance characteristics test**

Test site: \_\_\_\_\_ Test environment: \_\_\_\_\_ Test time: \_\_\_\_\_

Equipment number under test: \_\_\_\_\_ Test personnel: \_\_\_\_\_

Table 8.6 Record chart of the appearance, structure, and function abnormality

Item	Requirement	Results
Appearance and structure	The appearance shall be clean and tidy, and surface shall be free of rust, mildew, stains, peeling of plating coating and obvious scratches and burrs; plastic parts shall be free of bubble, crack or deformation; characters, symbols and marks and various signs shall be clean and firm. The structure member and control parts shall be integrate and free of any mechanical damage; all control parts must be installed properly, firm and reliable, with operation flexibility.	
Functional normality	Local function test: After startup, the modulation domain analyzer shall show the measuring interface normally, free of any error prompt; the keys on the keyboard of the operational front panel shall respond normally.	
	Program control function check: Connect the external master computer with the GPIB cable and LAN cable, and let it send the "IDN?;" command via the GPIB and intersect access respectively. It shall return the "CETC41,1435,XXXXXXXX,Y.Y.Y" message normally, whereas , "XXXXXXXX" is the product lot number, and "Y.Y.Y" if the product software version.	

**8.5 Performance characteristics test**

Test site: \_\_\_\_\_ Test environment: \_\_\_\_\_ Test time: \_\_\_\_\_

Equipment number under test: \_\_\_\_\_ Test personnel: \_\_\_\_\_

Table 8.7 Record chart of indicator test

No.	Test contents		Technical indicators		Measured value
1	Structure and appearance	/	The surface shall be smooth and clean, free of burr, obvious mechanical damage, deposition or damage, the structure shall be complete, and control parts shall be installed properly and reliably, with operation flexibility.		
2	Safety	MΩ	The insulation resistance of the instrument should not be less than 100 MΩ under standard atmospheric conditions for testing.		
		MΩ	The insulation resistance of the instrument should not be less than 2 MΩ under humid environment.		
		/	AC1.5kV/15mA/1min ,free of flashover or breakdown;		
		mA	Voltage 242 V, 1 min, leakage current ≤3.5 mA.		
3	Functional normality	/	After power-on, the indicator light near the instrument power switch shall change from yellow in the standby status to green, the display shall show contents, keys shall operate flexibly, and the front panel display shall be free of losing lock or unfixed amplitude prompt.		
4	Frequency Span		1435A/A-V	9kHz~3GHz	
			1435B/B-V	9kHz~6GHz	
			1435C	9kHz~12GHz	
			1435D	9kHz~20GHz	
			1435F	9kHz~40GHz	
5	Frequency resolution		0.001Hz		
6	Frequency accuracy		±5×10 <sup>-8</sup>		
7	Frequency switching time		≤1ms		
8	Sweep Dwell time		100μs ~ 100s		
9	Max. output of the fixed amplitude	1435A/B	Standard configuration	9kHz≤f≤3GHz	+18dBm
				3GHz<f≤5GHz	+16dBm
				5GHz<f≤6GHz	+15dBm
			High-power option H08	9kHz≤f≤3GHz	+22dBm
				3GHz<f≤5GHz	+20dBm
				5GHz<f≤6GHz	+18dBm

## 8.5 Performance characteristics test

Table 8.7 ( Cont. 1 )

No.	Test contents		Technical indicators			Measured value		
9	Max. output of the fixed amplitude	1435C/D	Standard configuration	9kHz≤f≤3GHz	+16dBm			
				3GHz<f≤20GHz	+15dBm			
			High-power option H08	9kHz≤f≤3GHz	+21dBm			
				3GHz≤f≤20GHz	+20dBm			
		1435F	Standard configuration	9kHz≤f≤3GHz	+14dBm			
				3GHz<f≤17GHz	+13dBm			
			High-power option H08	17GHz<f≤40GHz	+11dBm			
				9kHz≤f≤3GHz	+20dBm			
3GHz<f≤17GHz	+17dBm							
	17GHz<f≤40GHz	+15dBm						
10	Min. output of the fixed amplitude	Standard configuration			-15dBm			
		Program control step attenuator option H01			-110dBm			
11	Amplitude resolution		0.01dB					
12	Amplitude accuracy	Standard configuration						
		9kHz ≤ f ≤ 2GHz	+10dBm<P≤ Max. Fixed amplitude		±0.8dB			
			- 10dBm<P≤+10dBm		±0.6dB			
			- 15dBm≤P≤ - 10dBm		±1.5dB			
		2GHz < f ≤ 20GHz	+10dBm<P≤ Max. Fixed amplitude		±0.9dB			
			- 10dBm<P≤+10dBm		±0.7dB			
			- 15dBm≤P≤ - 10dBm		±1.5dB			
		20GHz < f ≤ 40GHz	+10dBm<P≤ Max. Fixed amplitude		±0.9dB			
			- 10dBm<P≤+10dBm		±0.8dB			
			- 15dBm≤P≤ - 10dBm		±1.8dB			
		13	Amplitude accuracy	With program control step attenuator option H01				
				9kHz ≤ f ≤ 2GHz	+10dBm<P≤ Max. Fixed amplitude		±0.8dB	
- 10dBm<P≤+10dBm					±0.6dB			
- 70dBm<P≤-10dBm					±0.7dB			
- 90dBm<P≤-70dBm					±1.4dB			

8.5 Performance characteristics test

Table 8.7 ( Cont. 2 )

No.	Test contents	Technical indicators	Measured value	
13	Amplitude accuracy	With program control step attenuator option H01		
		2GHz < f ≤ 20GHz	+10dBm < P ≤ Max. Fixed amplitude	±0.9dB
			- 10dBm < P ≤ +10dBm	±0.7dB
			- 70dBm < P ≤ -10dBm	±0.7dB
			- 90dBm < P ≤ -70dBm	±1.6dB
		20GHz < f ≤ 40GHz	+10dBm < P ≤ Max. Fixed amplitude	±0.9dB
			- 10dBm < P ≤ +10dBm	±0.8dB
			- 70dBm < P ≤ -10dBm	±1.1dB
- 90dBm < P ≤ -70dBm	±2.0dB			
14	Harmonic wave parasitism	9kHz ≤ f ≤ 10MHz	< -23dBc	
		10MHz < f ≤ 2GHz	< -30dBc	
		2GHz < f ≤ 6GHz (1435B and 1435B-V)	< -30dBc	
		2GHz < f ≤ 20GHz	< -55dBc	
		20GHz < f ≤ 40GHz	< -50dBc	
15	Anharmonic wave parasitism	Standard configuration	9kHz ≤ f < 250MHz	< -54dBc
			250MHz ≤ f ≤ 3GHz	< -62dBc
			3GHz < f ≤ 6GHz	< -56dBc
			6GHz < f ≤ 12GHz	< -50dBc
			12GHz < f ≤ 24GHz	< -44dBc
			24GHz < f ≤ 40GHz	< -38dBc
		Low noise option	9kHz ≤ f < 250MHz	< -60dBc
			250MHz ≤ f ≤ 3GHz	< -77dBc
			3GHz < f ≤ 6GHz	< -71dBc
			6GHz < f ≤ 12GHz	< -65dBc
			12GHz < f ≤ 24GHz	< -59dBc
			24GHz < f ≤ 40GHz	< -53dBc

## 8.5 Performance characteristics test

Table 8.7 ( Cont. 3 )

No.	Test contents	Technical indicators		Measured value	
16	Subharmonic wave parasitism	9kHz≤f≤6GHz		NONE	
		6GHz<f≤12GHz		< -60dBc	
		12GHz<f≤24GHz		< -55dBc	
		24GHz<f≤40GHz		< -50dBc	
17	Single sideband phase noise	Standard configuration			
		100MHz	100Hz frequency offset	< -83dBc/Hz	
			10kHz frequency offset	< -115dBc/Hz	
		250MHz	100Hz frequency offset	< -93dBc/Hz	
			10kHz frequency offset	< -127dBc/Hz	
		500MHz	100Hz frequency offset	< -89dBc/Hz	
			10kHz frequency offset	< -121dBc/Hz	
		1GHz	100Hz frequency offset	< -83dBc/Hz	
			10kHz frequency offset	< -115dBc/Hz	
		2GHz	100Hz frequency offset	< -77dBc/Hz	
			10kHz frequency offset	< -109dBc/Hz	
		3GHz	100Hz frequency offset	< -74dBc/Hz	
			10kHz frequency offset	< -105dBc/Hz	
		4GHz	100Hz frequency offset	< -71dBc/Hz	
			10kHz frequency offset	< -103dBc/Hz	
		6GHz	100Hz frequency offset	< -68dBc/Hz	
			10kHz frequency offset	< -99dBc/Hz	

## 8.5 Performance characteristics test

Table 8.7 ( Cont. 4 )

No.	Test contents	Technical indicators		Measured value	
17	Single sideband phase noise	Standard configuration			
		10GHz	100Hz frequency offset	< -63dBc/Hz	
			10kHz frequency offset	< -95dBc/Hz	
		20GHz	100Hz frequency offset	< -57dBc/Hz	
			10kHz frequency offset	< -89dBc/Hz	
		40GHz	100Hz frequency offset	< -51dBc/Hz	
			10kHz frequency offset	< -83dBc/Hz	
		Low noise option			
		100MHz	100Hz frequency offset	< -83dBc/Hz	
			1kHz frequency offset	< -112dBc/Hz	
			10kHz frequency offset	< -131dBc/Hz	
			100kHz frequency offset	< -131dBc/Hz	
		250MHz	100Hz frequency offset	< -93dBc/Hz	
			1kHz frequency offset	< -123dBc/Hz	
			10kHz frequency offset	< -139dBc/Hz	
			100kHz frequency offset	< -139dBc/Hz	
		500MHz	100Hz frequency offset	< -89dBc/Hz	
			1kHz frequency offset	< -119dBc/Hz	
			10kHz frequency offset	< -135dBc/Hz	
			100kHz frequency offset	< -135dBc/Hz	

## 8.5 Performance characteristics test

Table 8.7 ( Cont. 5 )

No.	Test contents	Technical indicators		Measured value	
17	Single sideband phase noise	Low noise option			
		1GHz	100Hz frequency offset	< -83dBc/Hz	
			1kHz frequency offset	< -113dBc/Hz	
			10kHz frequency offset	< -132dBc/Hz	
			100kHz frequency offset	< -132dBc/Hz	
		2GHz	100Hz frequency offset	< -77dBc/Hz	
			1kHz frequency offset	< -107dBc/Hz	
			10kHz frequency offset	< -126dBc/Hz	
			100kHz frequency offset	< -126dBc/Hz	
		3GHz	100Hz frequency offset	< -74dBc/Hz	
			1kHz frequency offset	< -104dBc/Hz	
			10kHz frequency offset	< -121dBc/Hz	
			100kHz frequency offset	< -121dBc/Hz	
		4GHz	100Hz frequency offset	< -71dBc/Hz	
			1kHz frequency offset	< -101dBc/Hz	
			10kHz frequency offset	< -120dBc/Hz	
			100kHz frequency offset	< -120dBc/Hz	
		6GHz	100Hz frequency offset	< -68dBc/Hz	
			1kHz frequency offset	< -98dBc/Hz	
			10kHz frequency offset	< -115dBc/Hz	
			100kHz frequency offset	< -115dBc/Hz	

## 8.5 Performance characteristics test

Table 8.7 ( Cont. 6 )

No.	Test contents	Technical indicators			Measured value	
17	Single sideband phase noise	Low noise option				
		10GHz	100Hz frequency offset		< -63dBc/Hz	
			1kHz frequency offset		< -93dBc/Hz	
			10kHz frequency offset		< -113dBc/Hz	
			100kHz frequency offset		< -113dBc/Hz	
		20GHz	100Hz frequency offset		< -57dBc/Hz	
			1kHz frequency offset		< -87dBc/Hz	
			10kHz frequency offset		< -107dBc/Hz	
			100kHz frequency offset		< -107dBc/Hz	
		40GHz	100Hz frequency offset		< -51dBc/Hz	
			1kHz frequency offset		< -81dBc/Hz	
			10kHz frequency offset		< -101dBc/Hz	
			100kHz frequency offset		< -101dBc/Hz	
18	Pulse modulation	On/off ratio	50MHz≤f≤40GHz		>80dB	
		Rise/fall time	50MHz≤f≤40GHz		<10ns	
		Min. pulse width	50MHz≤f≤40 GHz	Fixed amplitude	1μs	
			50MHz≤f≤40 GHz	Unfixed amplitude	20ns	
18	Narrow pulse modulation	On/off ratio	50MHz≤f≤40GHz		>80dB	
		Rise/fall time	50MHz≤f≤40GHz		<10ns	
		Min. pulse width	50MHz≤f≤40 GHz	Fixed amplitude	1μs	
			50MHz≤f≤40 GHz	Unfixed amplitude	20ns	



## 8.5 Performance characteristics test

Table 8.7 ( Cont. 7 )

No.	Test contents		Technical indicators		Measured value
19	Frequency modulation	Max. frequency offset	16MHz×N ( N is the times of the harmonic wave )		
		FM bandwidth	DC - 7MHz		
		FM accuracy	± ( 2%× Frequency offset set+20Hz) ( 1kHz modulation rate , frequency offset N×500kHz )		
		FM distortion	<0.4% ( 1kHz modulation rate , frequency offset N×500kHz )		
20	Phase modulation	Max. phase offset	16rad×N ( N is the times of the harmonic wave )		
		Phase modulation bandwidth	DC ~ 1MHz		
		Phase modulation accuracy	±(2%×Phase offset set+0.01rad) ( 1kHz modulation rate , phase offset N×8rad )		
		Phase modulation distortion	<0.4% ( 1kHz modulation rate , phase offset N×8rad )		
21	Amplitude modulation	Modulation depth	Linear mode	>90%	
		AM bandwidth	DC ~ 100kHz , up to 1MHz , ( 3dB bandwidth ,30% modulation depth ,1GHz , 5GHz, 20GHz and 40GHz )		
21	Amplitude modulation	AM accuracy	Linear mode	±( 4%×Depth set+1% ) 1kHz modulation rate , 30% modulation depth )	
		AM distortion	<2% ( 1kHz modulation rate, linear mode, 30% modulation depth )		

8.5 Performance characteristics test

Table 8.7 ( Cont. 8 )

No.	Test contents		Technical indicators		Measured value
22	Frequency span of the multifunction generator	Sine wave	0.1Hz~10MHz		
		Square wave	0.1Hz~1MHz		
23	Source standing-wave ratio VSWR		9kHz≤f≤3GHz		< 1.7
			3GHz < f≤13GHz		< 1.6
			13GHz < f≤20GHz		< 1.8
			20GHz < f≤40GHz		< 1.6
24	Vector modulation	EVM	9kHz≤f≤3GHz		<1.4% ( RMS% , code element rate 4Msps , root-Nyquist filter , α=0.3 , QPSK format )
			3GHz < f≤6GHz		<1.8% ( RMS% , code element rate 4Msps , root-Nyquist filter , α=0.3 , QPSK format )
			Options H06	3GHz < f≤6GHz	<1.4% ( RMS% , code element rate 4Msps , root-Nyquist filter , α=0.3 , QPSK format )
		Original offset	<-40dBc ( Code element rate 4Msps , root-Nyquist filter , α=0.3 , QPSK format )		
		Internal modulation bandwidth	Standard configuration: 120MHz ( ±3dB bandwidth )		
			Option H31: 200MHz ( ±3dB bandwidth )		
		External modulation bandwidth	200MHz ( ±4dB bandwidth )		

## 8.5 Performance characteristics test

Table 8.7 ( Cont. 9 )

No.	Test contents		Technical indicators		Measured value	
25	I/O interface of the front/rear panel	Front panel	USB interface		To connect with the mouse and keyboard for system software upgrading and data backup;	
			-V Series	I input	Receive the "I" input of I/Q modulation, with input impedance of 50Ω.	
				Q input	Receive the "Q" input of I/Q modulation, with input impedance of 50Ω.	
		Rear panel	AM/FM/phase modulation input 1		Input fixed $\pm 1V_p$ to realize external AM/FM/ phase modulation function.	
			AM/FM/phase modulation input 2		Input fixed $\pm 1V_p$ to realize external AM/FM/ phase modulation function.	
			LF output		To set for outputting LF signal with output frequency of 0.01Hz ~ 10MHz, amplitude of 40mVp ~ 4Vp and output impedance of 50Ω.	
			Pulse input		Input signal of the pulse signal compatible with the TTL level, with input impedance of 50Ω.	
			Sync pulse output		To be multiplex with the trigger output (which is the sync pulse output by default) to output sync pulse signal with rated width of 20ns and compatible with the TTL level internally and during the trigger pulse modulation, with rated source impedance of 50Ω.	
			Pulse monitoring output		The pulse signal compatible with TTL level, which outputs the pulse signal consistent with the modulation envelope at all pulse modes, with rated source impedance of 50Ω.	
			Sweep output		To output a voltage in direct proportion to the sweep frequency: 0V corresponds to the start sweep frequency, whereas 10V to the end frequency (in the CW working mode, 0-10V corresponds to the instrument frequency span).	

8.5 Performance characteristics test

Table 8.7 ( Cont. 10 )

No.	Test contents		Technical indicators		Measured value	
25	I/O interface of the front/rear panel		Reference input 1-50MHz	Receive 1 ~ 50MHz from external time base , with stepping of 1Hz , and frequency reference signal of 0 ~ +7dBm		
			10 MHz output	Signal level >+4dBm , typical output impedance of 50Ω		
			Trigger output	To multiplex with the sync pulse output, which can realize trigger output by setting and is used in the sweep mode. It is the high level when the signal waits for dot trigger at the start of residence or in the manual sweep mode, and it is the low level when the residence is completed and dot trigger is received.		
			Sweep output	To output a voltage in direct proportion to the sweep frequency: 0V corresponds to the start sweep frequency, whereas 10V to the end frequency (in the CW working mode, 0-10V corresponds to the instrument frequency span).		
			External detection input	To realize fixed amplitude for external detection		
			Network port	For software upgrading and control		
			GPIB interface	Standard IEEE488 interface, supporting SCPI language.		
			USB interface	To connect with the mouse and keyboard for system software upgrading and data backup		
			-V Series	I output	I path output of the internal baseband signal generator;	
				/I output :	/I path output of the internal baseband signal generator;	
Q output	Q path output of the internal baseband signal generator;					
/Q output	/Q path output of the internal baseband signal generator;					

## 8.5 Performance characteristics test

## 8.5.3 Recommended instrument for performance characteristics test

Table 8.8 Recommended instrument for performance characteristics test

No.	Instrument	Main technical indicators	Recommended model
1	Frequency meter	Frequency range: 9kHz~40GHz Frequency resolution: 1Hz/0.001Hz	Agilent53152A Agilent53230A 3212D
2	Frequency comparator	/	CH7-45
3	Time standard	Frequency stability: $<1 \times 10^{-10}$ /day	HP5061 or CH-47
4	Signal generator	Frequency range: 9kHz~40GHz Frequency resolution: 0.001Hz	1435 N5183B
5	Digital storage oscilloscope	For event (counting delay) trigger Bandwidth: DC ~ 500MHz Input impedance: 50Ω 及 1MΩ Direct resolution: $\leq 5$ mV/Div Horizontal resolution: 10ns/Div	TDS4054 DPO4054
6	Spectrum analyzer	Frequency scope: 1kHz~67GHz	4051F N9030A FSW67
7	Vector signal analyzer	Frequency offset range: 1kHz~6GHz	FSW26.5 N9040B
8	Signal source analyzer	Frequency range: 1MHz~50GHz	E5052B FSUP50
9	Measurement receiver	Frequency range: 20 Hz~50GHz	F5MR 50
10	Measuring receiver probe	Frequency range: 20 Hz~50GHz	NRP—Z55
11	Power meter	Frequency scope: 0.01 ~ 40GHz Power scope: 1μW ~ 10W	2438L 2434 N1914A 2436A
12	Amplitude probe	Frequency scope: 9kHz~40GHz	N8488A 81702 E9304A
13	Peak amplitude probe	Frequency range: 500MHz~40GHz	81702
14	Fundamental wave mixer	LO RF: 26-40GHz	80713
15	SMA coaxial detector	Frequency range: 2~40GHz Video bandwidth: >500kHz	2.984.1005
16	Function generator	Frequency range: 1Hz~10MHz	HP3325B HP33250A

**8.5 Performance characteristics test**

17	Directional coupler	Frequency range: 2~40GHz Coupling factor: 10 dB Directivity: >12dB	2.969.504
18	Leakage current puncture tester	Leakage current 0.5 mA ~ 20mA , voltage 242V, 3kV and 5kV	CJ2673
19	Variable-frequency power source	Frequency 47Hz ~ 400Hz , voltage 0 ~ 3000V	AFC-1kW
20	Temperature & humidity chamber	Temperature -70°C ~ +150°C , humidity 25 ~ 98%RH	ESL-10P
21	Temperature & humidity chamber	Temperature -70°C ~ +80°C , humidity (50 ~ 98)%RH	Y751C
22	Impact testbed	Max. load 100kg , accelerated speed ( 50 ~ 400 ) m/s <sup>2</sup>	P-100
23	Electrodynamic vibration generator	Vertical generator: max. displacement 25mm, max. frequency 3000Hz , min. frequency 5Hz , max. load 200Kg ; horizontal generator: max. Displacement 25mm , frequency span 5 Hz ~ 1000Hz , max. load 100kg	D-600-3

## Annex

- [Annex A Terminology.....253](#)
- [Annex B Zoom table of SCPI commands.....262](#)
- [Annex C Zoom table of failure information.....269](#)
- [Annex D Zoom table of PC keyboard shortcuts in the function configuration window.....270](#)

## Annex A Terminology

- [Frequency accuracy.....253](#)
- [Frequency stability.....253](#)
- [Distortion factor and spectrum purity.....254](#)
- [I/Q modulation.....254](#)
- [Audio coding.....254](#)
- [Channel coding.....255](#)
- [Digital modulation.....255](#)
- [Bandwidth efficiency of the digital modulation signal.....256](#)
- [Binary-system frequency-shift keying 2FSK.....256](#)
- [Binary-system phase-shift keying BPSK.....256](#)
- [Quadrature phase shift keying QPSK.....257](#)
- [Eight-phase shift keying 8PSK.....257](#)
- [Quadrature amplitude modulation QAM.....258](#)
- [Differential modulation type  \$\pi/4\$ DQPSK.....258](#)
- [QPSK modulation type.....259](#)
- [Constant envelope digital modulation MSK.....259](#)
- [\$3\pi/8\$  rotation 8PSK modulation.....260](#)
- [Nyquist filter.....260](#)
- [Nyquist filter factor  \$\alpha\$ .....261](#)

### Frequency accuracy

The difference between the frequency value shown on the signal generator and the true value, generally expressed by the relative error:

$$\alpha = \frac{f - f_0}{f_0} = \frac{\Delta f}{f_0} \times 100\%$$

Where,  $f_0$  is the scale value of the signal generator, and  $f$  is the true value.

The frequency accuracy of the low-level signal generator is merely 1%, whereas that of the one with built-in crystal oscillator with high stability can reach  $10^{-8} \sim 10^{-10}$ .

### Frequency stability

It refers to the deviation value of the output frequency of the signal generator relative to the set reading during a specific period with external condition and environment unchanged.

## Annex A Terminology

### Harmonic distortion and spectrum purity

The ideal sine wave shall be of a single frequency. Since the non-linear element in the signal generator causes non-linear distortion and harmonic components of the signal, the signal distortion is generally used to represent the degree of the signal closing to the ideal sine wave, which is expressed with the distortion factor  $\gamma$ :

$$\gamma = \frac{\sqrt{U_2^2 + U_3^2 + \dots + U_n^2}}{U_1} \times 100\%$$

Where,  $U_1$  is the valid fundamental wave value,  $U_2, U_3, \dots$  are valid values of respective harmonic waves, which are also called the total harmonic distortion and measured at given output amplitude and specific signal frequency.

### I/Q modulation

The I/Q modulator is to load the signals of I and Q paths to the carrier. The I/Q modulator consists of the symbol builder, carrier local oscillator, mixer, 90° phase shifter and linear stacker. The symbol builder is used to change the input baseband modulation signal into odd and even signals via series-shunt conversion. Therefore, the modulation type in the digital transmitter is determined by the symbol builder actually. The correspondence between the information and the bearing signals is called “mapping” in some literatures. The receiving end extracts the information sent from the received signal according to the agreed mapping relationship.

There are multiple mapping modes between the information and signal, and the modulation technology varies with the mapping type adopted. Digital modulation is mainly used to control the transmission efficiency. Since digital modulation technologies vary with mapping modes adopted, their performances also vary with the mapping modes. Such mapping relationship is realized via the symbol builder. The in-phase I and sine Q mixers are simulated by the LO signals of two local oscillators respectively. The LO signal of the lower mixer is perpendicular with that of upper one, that is, the LO carriers of the mixer are perpendicular with each other. After that, the outputs of both mixers are mixed.

Note: The I/Q modulator adopts the simulation technique (radio frequency mixer and radio frequency synthesizer), monolithic microwave integrated circuit (MMIC), and even DSP for realization. The I/Q modulator changes the signal phase control into the control on two-path orthogonal component voltage. I/Q indicates the orthogonal mapping of the modulation signal, and Q component signal conducts phase shifting at 90 degrees relative to the carrier. If only I path with output of 0V due to  $\cos(90^\circ) = 0$  is detected, it has no output signal although there is Q input signal. Therefore, vector modulation signal can be generated via linear superimposed signal in-phase orthogonal component without any mutual interference between I and Q components. It shall be subject to cross addition ( $\Sigma$ ) and synthesis first before dispatching for wireless transmission.

### Audio coding

Since audio transmission is the basic service of the wireless communication system, audio coding is the most important source coding in the wireless communication system. Audio coding is to transmit max. audio quality with min. path bandwidth under certain algorithm complexity and communication delay.

Audio coding can be divided into three types:

1) Waveform coding, such as pulse coding modulation (PCM), the source data of which transmitted is the sampling quantization of the audio signal waveform. Audio coding reflects actually the waveform change of the audio signal and keeps all inherent audio features, with sound intelligibility and naturalness. However, since the audio waveform contains a large number of redundant components, it has high code rate and poor bandwidth efficiency.

2) Parameter coding, such as linear predictive coding (LPC), the source data of which transmitted is not a audio waveform, but the audio feature parameter extracted via the linear prediction algorithm. It makes the audio system equivalent to the simulative and linear filtering model, and represents audio change via the model parameters that are updated continuously. Parameter coding can lower



dramatically the transmission code rate, with extremely high bandwidth efficiency. However, it is limited by the feature extraction algorithm, with certain intelligibility but poor naturalness.

3) Hybrid coding, such as integrated waveform coding and parameter coding, which lowers the code rate and improves naturalness of the synthetic audio, being the source coding method widely adopted in the wireless communication field, Such as the RPE-LTP algorithm and CELP algorithm adopted in the GSM and CDMA system respectively. Common audio coding modes used currently include the pulse coding modulation (PCM), differential pulse code modulation (DPCM), adaptive differential pulse code modulation (ADPCM), delta modulation (DM), continuous variable slope delta modulation (CVSDM), adaptive prediction coding (APC), self-bring coding (SBC) and code excitation linear prediction coding.

## Channel coding

During digital signal transmission in actual channels, transmission errors are caused due to noise in the channel and intersymbol interference from poor channel transmission feature. Such measures as eliminating intersymbol interference with equalization technology, selecting effective modulation system and demodulation method and strengthen antenna directivity, so as to improve the digital transmission system reliability, lower the information transmission error rate, and improve the digital transmission system anti-noise performance.

Channel coding consists of the error detecting code and error correcting code. The error detecting code can only detect error codes, for example, the parity check code used commonly in the computer serial port communication. To further improve the digital transmission system reliability, the error correcting code must be adopted, so as to control possible or existing errors.

## Digital modulation

During analog modulation, the carrier parameter changes with continuous analog modulation. During digital modulation, the carrier parameter (amplitude, frequency and phase) change is determined by discrete digital signals.

In this regard, there is no essential difference between the digital modulation and analog one. The digital modulation signal needs only to indicate the discrete modulation status, which is called the symbol point. The combination of such symbol points is called the constellation.

1) **Bit:** It is the unit for the information transmitted in the communication system, which refers to the useful information transmitted in the communication system. Bit Rate: It is the transmission rate of the bit, which is also the information transmission rate within the communication system time, with the unit of bit/s.

2) **Symbol:** It is the discrete state of the modulation carrier, which is also called the vector, a concept with close link with the carrier and modulation method. Analog modulation can also involve symbols, the number of which is infinite and cannot be analyzed and observed directly. Therefore, symbols are discussed only in digital modulation, the number of which is finite. Although symbols are not information, information is transmitted in the carrier status (namely, symbols) which is mapped via digital modulation.

3) **Element code rate or symbol code:** It is the conversion rate of the carrier modulation symbol, which is actually the change rate of the carrier status. The higher the symbol rate, the higher the transmission rate of corresponding information is, resulting in higher spectrum components in the signal and wider band occupied. The unit is Baud.

4) **Constellation:** It is the combination of all symbol points of the modulation signal on the I/Q plane. Constellation defines the mapping relationship between signal distribution and modulation digital bit of the modulation technique. The feature of a modulation technique can be defined completely via signal distribution and mapping, namely, constellation.

5) **Vector diagram:** It is the description of modulation signal change between symbol points. It displays both the constellation points and their conversion process.

6) **Eye Diagram:** It is a visual method to check the digital signal transmission distortion. It is the

## Annex A Terminology

baseband signal output from the low pass filter that is not subject to regeneration after modulation, and bit timing is adopted on the oscilloscope as the waveform for repeated sweep display during external synchronization.

### Bandwidth efficiency of digital modulation signal

It is the information data transmission rate, but independent of the modulation type. Since different communication systems can use different modulation types to transmit data services with same rates, bit rates cannot determine the frequency bandwidth occupied by the modulation signal.

The symbol rate is the change rate of the carrier modulation status, which determines the rate of the modulation symbol change, thus determining the frequency bandwidth of the modulation signal. It is also called the baud rate sometimes. The correspondence between the symbol rate and bit rate is determined by the digital modulation type. The digital modulation type determines the number of discrete states of the carrier, thus determining the number of binary bits represented by each symbol. The symbol rate is the bit rate divided by the number of bits represented by each symbol:

Symbol Rate = Bit Rate / Number of bits represented by each symbol.

Therefore, the digital modulation type determines the modulation rate, namely, the amount of information (bit) transmitted in unit bandwidth (symbol rate). The more complex the modulation is and more modulation symbols there are, the higher the modulation efficiency is.

### Binary frequency shift keying 2FSK

The digital frequency modulation is also called the frequency shift keying, and 2FSK is short for binary frequency shift keying. Digital frequency shift keying transmits the binary symbol by changing the carrier frequency, that is, to control the carrier frequency with the digital information transmitted. The 2FSK signal indicates that symbol "1" is corresponding to carrier frequency  $f_1$ , whereas "0" is corresponding to the modulated waveform of another carrier frequency  $f_2$  different from  $f_1$ . In this case, its frequency spectrum can be regarded as the on/off keying of both the code column against the low frequency carrier and radix-minus-one complement of the code column against the high frequency carrier.

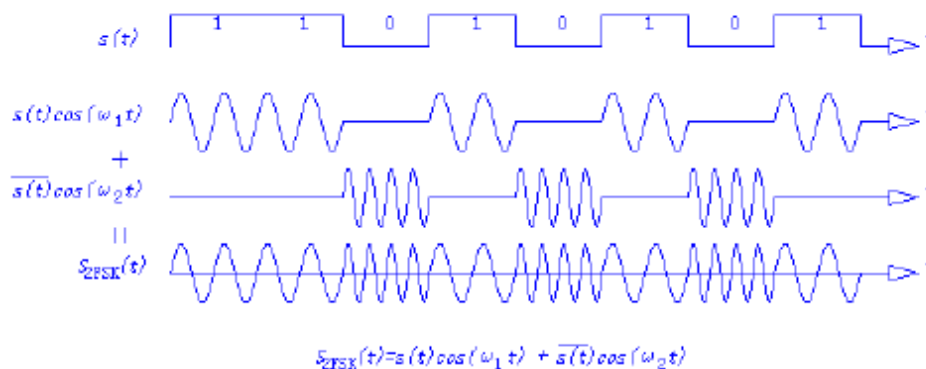

Fig. 1 Schematic diagram of 2FSK

### Binary phase shift keying BPSK

Binary phase shift keying (BPSK) adopts 0 and  $\pi$  to represent "0" and "1" respectively. In this case, phase hopping occurs around the bit cycle. However, the phase information is maintained in the middle of the interval. The receiving end modulation is conducted usually near the center point. Generally, the PSK system performance is better than that of the on-off keying SFK system.

$V(t) = A \cos \sin(2\pi f_c t + \varphi)$   $0 \leq t \leq T$ , whereas, phase  $\varphi = 2(n-1)\pi/n$ ; for BPSK,  $n=1$  and  $2$ , namely,  $\varphi = 0, \pi$ . The BPSK modulation signal can be generated with the traditional analog modulation method (via the double-sideband (DSB) modulation of the NRZ signal) or keying method. It is generated with the I/Q modulator in modern communication equipment.

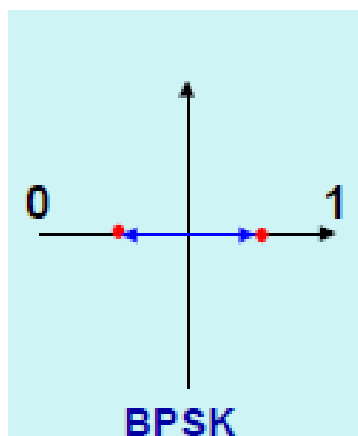

Fig. 2 Schematic diagram of BPSK

### Quadrature phase shift keying QPSK

The most common digital modulation type is the quadrature phase shift keying. Quadrature phase shift modulation is to represent the input digital information via the four different phase differences of the carrier, and the four carrier phases are  $45^\circ$ ,  $135^\circ$ ,  $225^\circ$  and  $275^\circ$  respectively.

The data entered by the modulator is a binary digital sequence. To match with the quaternary carrier phase, the binary data must be converted to the quaternary one, that is, to take every two bits in the binary data sequence as a block, with four blocks in total, namely, 00, 01, 10 and 11, each of which is called the double-bit code element. Each double-bit code element consists of two-digit binary information bits, each of which represents one of the four quadrature symbols.

Modulation in QPSK can transmit 2 information bits once via the four phases of the carrier. The modulator determines the information bit sent from the transmitting end via the constellation and the phase of the carrier signal received.

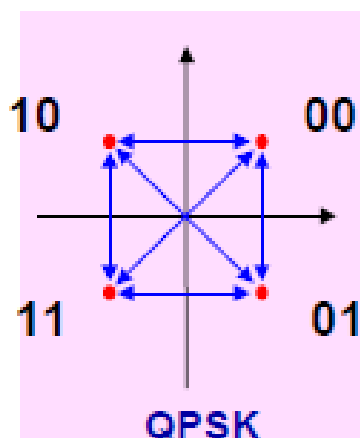

Fig. 3 Schematic diagram of QPSK

### Eight-phase shift keying 8PSK

BPSK and QPSK are commonly used for wireless communication, which can be extended to 8PSK and even 16PSK. However, 16PSK is seldom used due to its small symbol point phase difference and low I/Q plane availability. According to the conversion process of the 8PSK vector diagram, since a 180-degree symbol phase change occurs during modulation, resulting in signal track passing through the original point, its high peak-to-average ratio is not favorable for transmission. In addition, since 8PSK is of absolute phase modulation with phase ambiguity problem, it is seldom used directly.

## Annex A Terminology

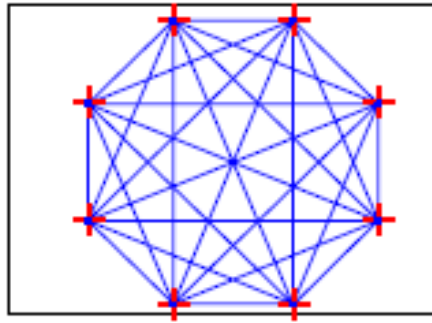

Fig. 4 Schematic diagram of 8PSK

### Quadrature amplitude modulation QAM

QAM is to conduct suppress carrier double - band amplitude modulation on two mutually-orthogonal carriers with the same frequency via two independent baseband signals, so as to realize transmission of two-channel concurrent digital information. Such modulation method includes the 4QAM (namely, QPSK ) , 16QAM, 32QAM and 64QAM, the constellation includes 4, 16, 32 and 64 vector end points respectively.

For 4QAM, if the amplitudes of the two channel signals are the same, its generation, modulation, demodulation, performance and phase vector are the same with those of QPSK. Obviously, when the number of symbol points is not less than 16, the distance between symbol points of the QAM is bigger than that of PSK provided the number of symbols are the same. Since the bandwidth efficiency of the QAM system is higher than that of QPSK, it is a promising modulation type in the systems with limited frequency band, which has been used in the communication system. However, its performance is not as good as that of the QPSK system. Currently, the digital television system has adopts the 128QAM and 256QAM, and the constellations of 16QAM and 32QAM are shown below (Fig. 5 and 6).

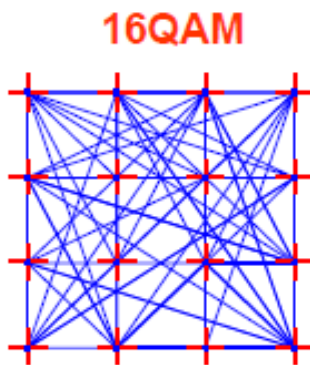

Fig. 5 16QAM constellation

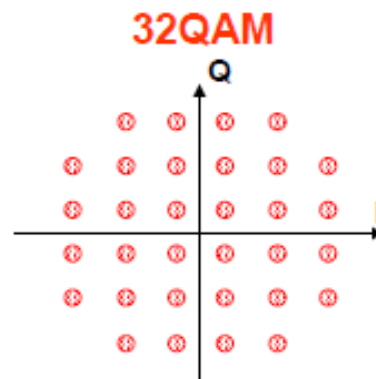

Fig. 6 32QAM constellation

### Differential modulation type $\pi/4$ DQPSK

The QPSK signal mentioned above has high bandwidth efficiency. However, when the block hops from 00 to 11 or from 01 to 10, a  $180^\circ$  carrier phase hopping will occur. Such such hopping will go through the original point, resulting in larger envelope fluctuation. When such hopping goes through nonlinear components, time domain waveform distortion can result in frequency domain distortion. As a result, the out-of-band component filtered will be recovered again, and the expanded frequency spectrum will interfere the adjacent channel. To eliminate the  $180^\circ$  phase hopping, modification must be taken based on the QPSK to realize a modulation type called  $\pi/4$ -DQPSK.  $\pi/4$ -DQPSK belongs to differential modulation, and the combined constellation is shown in Fig. 7. Differential modulation adopts the relative phase change rather than the absolute phase symbol to represent the bit data of "0" or "1". The even symbol point is on the I/Q axle, whereas the odd symbol point (with \*) is on the position  $45^\circ$  away from the I/Q axle. It can be seen that the max. phase hopping is limited to  $135^\circ$ .  $\pi/4$ -DQPSK has four phase changes, namely,  $45^\circ$ ,  $135^\circ$ ,  $-45^\circ$  and  $-135^\circ$  respectively. Since two QPSK constellations

with an offset of  $45^\circ$  are used, each symbol is always subject to phase change, avoiding the  $180^\circ$  phase change and preventing the vector trace from passing through the zero point.

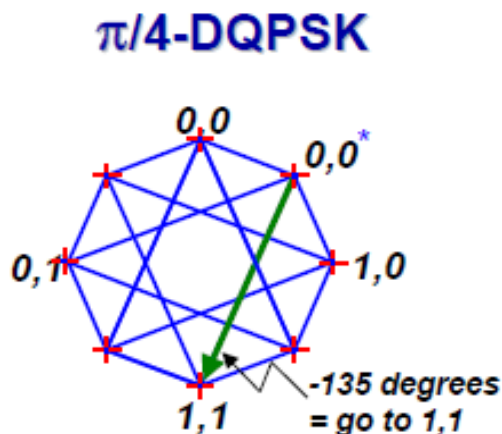

Fig. 7 Combined constellation

### QPSK modulation type

The I and Q bit streams of QPSK modulation are converted at the same time, that is, the symbol clocks of such two paths are provided synchronously. OQPSK modulation is another scheme to prevent the vector from passing through the zero point, which has been adopted in the narrow-band CDMA system. OQPSK is called the staggered quadruple phase shift keying (Offset-QPSK), which is the updated version of QPSK and also called the offset quadruple phase shift keying. It has the same phase relationship with that of QPSK, that is, to divide the code stream into two channels for quadrature modulation. However, it staggers half a code element period  $T_b/2$  for the code streams of the same-frequency channel and quadrature one in respect of time. Due to the half-period offset of the two-channel code elements, only one (instead of both) channel can be subject to polarity reversal each time. In addition, other realization methods are the same with those of the QPSK.

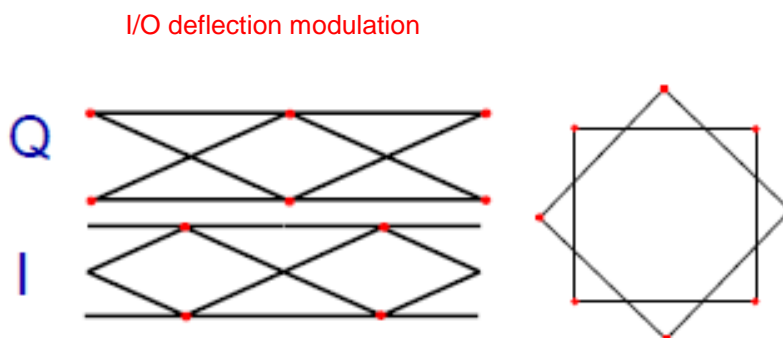

Figure 8 QPSK modulation type

### Constant envelope digital modulation MSK (min. frequency shift keying)

The envelope change of FSK modulation is not as obvious as those of QAM and PSK, but its symbol change is subject to phase hits, resulting in amplitude hits and spectrum regeneration. The MSK is a type of constant envelope digital modulation technique developed according to the FSK. It is a type of continuous phase FSK modulation (CPFSK). The continuous phase guarantees the small signal modulation bandwidth. The frequency offset  $\Delta f$  and frequency difference  $2\Delta f$  of MSK modulation meet the following formula:

$$2\Delta f = \frac{1}{2T_b}$$

Whereas, frequency offset  $\Delta f$  is a quarter of the code element rate  $1/T_b$ , that is, frequency difference

## Annex A Terminology

$2\Delta f$  is a half of the code element rate, which is called the min. frequency shift keying (MSK) .

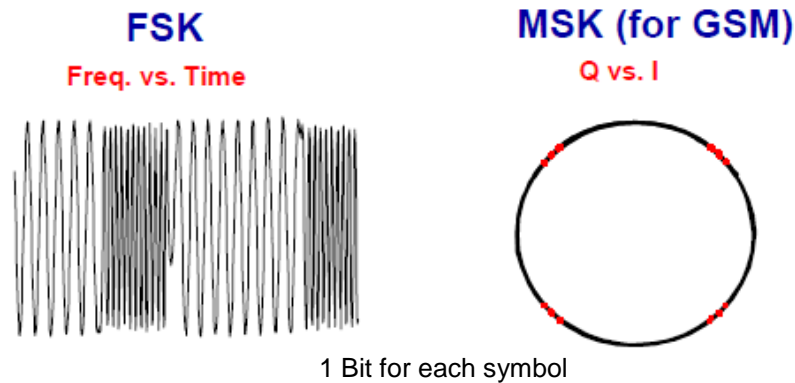

Figure 9 MSK modulation type

### $3\pi/8$ rotation 8PSK modulation (EDGE)

$3\pi/8$  rotation 8PSK modulation is the digital modulation type used in the EDGE system. EDGE system is the upgraded GSM technique developed in Europe, which is mainly used for improving the air interface transmission rate of the GSM system. Since the original GSM system is subject to modulation symbol rate and frequency bandwidth limitation, EDGE system adopts the 8PSK for modulation with a 3-time higher efficiency under the same modulation symbol rate and frequency bandwidth. As we all know, 8PSK has large signal envelope fluctuation and high linear requirement on the system, with poor anti-disturbance performance. Therefore, a type similar with  $\pi/4$ -DQPSK must be adopted to solve the problem.

$3\pi/8$  rotation 8PSK is based on the original 8PSK constellation, that is, to rotate the constellation for  $3\pi/8$ , and then transit the symbol to a new constellation point during symbol change each time. As a result, there are 8 symbol phase changes, namely,  $\pi/8$ ,  $3\pi/8$ ,  $5\pi/8$ ,  $7\pi/8$ ,  $-\pi/8$ ,  $-3\pi/8$ ,  $-5\pi/8$  and  $-7\pi/8$ , which realizes the 8PSK for differential modulation. Since a  $3\pi/8$  offset is used, each symbol is always subject to phase change, avoiding the  $180^\circ$  phase change and preventing the vector trace from passing through the zero point.

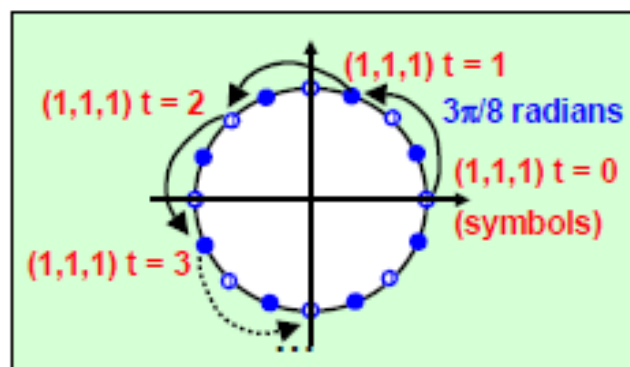

Fig. 10 Diagram of EDGE vectors

### Nyquist filter

Baseband transmission is restricted mainly due to the system frequency features. Widening the transmission band intentionally to lower such interference as expected and result in unnecessary bandwidth waste. Two wide band can introduce big noise in the system. As a result, the signal waveform must be designed properly or ideal transmission filter adopted, so as to reduce or eliminate such interference with min. transmission bandwidth.

The main Nyquist principle solves such problem, and specifies the basic relationship between the channel bandwidth  $f_N$  and symbol rate  $R_S$ . That is, the low pass cutoff bandwidth of ideal channel is  $f_N =$

## Annex A Terminology

RS. In other words, such Nyquist filter can limit the signal bandwidth while eliminating interference between symbols. As shown in the figure, the symbol energy of the time domain impulse response of the raised cosine filter complying with the Nyquist principle at the time of  $t$  of adjacent bits is 0, without any interference between symbols.

Filters with rectangular frequency response do not exist actually, and filters with infinitely steep response require infinite number of poles. However, we can adopt the raised cosine Filter (RCF) to complete the Nyquist criterion for passing through the zero point. If such filters are used, the roll-off between the passband and stopband is a cosine wave function. Method to place the filter is to place “one half” to the transmitter and “another half” to the receiver. After that, the whole raised cosine response can be obtained from the raised root cosine filter (Root RCF) shared by both the transmitter and receiver. In addition to filter noise, the receiver can make judgment at the point with max. SNR via the RCF, that is, to match the feature of the filter.

### Nyquist filter factor $\alpha$

It is difficult to realize the channel with ideal low-pass characteristics, and that used actually is the one with roll-off characteristics. The increase degree of its channel bandwidth against the Nyquist bandwidth: roll-off factor  $\alpha$  (Roll-off factor Alpha). It can be expressed as  $\alpha = (BW - f_N) / f_N$ , whereas,  $BW$  is the channel bandwidth, and  $f_N$  is the Nyquist bandwidth.  $\alpha$  is the numerical value between 0 and 1, and  $1+\alpha$  is the additional bandwidth required by the filter to transmit the non-ISI signal.  $\alpha$  is also called the “excessive bandwidth factor”, which indicates the value of the required bandwidth to be occupied surpassing the ideal bandwidth occupied at the same symbol rate. The occupied signal bandwidth after RCF filtering is approximate to  $(1+\alpha)R_s$ , whereas  $R_s$  is the symbol rate. As shown in Fig. 10, when  $\alpha = 0$ , the occupied bandwidth ( $BW$ ) is  $R_s$  (due to  $F_s = 0.5R_s$ ,  $BW = 2F_s$ ); when  $\alpha = 1$ , the occupied bandwidth is  $2 R_s$ . The typical  $\alpha$  value is  $0.35 \sim 0.5$ . The figure above shows the frequency characteristics for different roll-off factor  $\alpha$ . The smaller the roll-off factor  $\alpha$ , the steeper the filter characteristics are. However, the bigger the sidelobe level generated by the pulse, the higher the requirement on the timing tolerance of sampling is. Such filters are usually realized via the finite impulse response (FIR) filters in some DSP. Since the raised cosine roll-off filtering characteristics can provide the transmission signal with high amplitude featuring fast convergence and reduced interference between symbols, they have been applied widely. Therefore, since the required bandwidth to be occupied by the Nyquist filter is bigger than the symbol rate  $R_s$ , its bandwidth efficiency is no longer the best. The GSM system adopts the Gaussian filter rather than the Nyquist one. The corresponding “excessive bandwidth factor” is the BT (bandwidth time factor), and the BT value is 0.3-0.5 generally. The GSM modulation symbol rate is 270.833KHz, with channel bandwidth of 200KHz, which is smaller than the modulation symbol rate.

$\alpha$ : Reflect the filter frequency response shape  
Compromise between signal-occupied bandwidth  
and amplitude parameter

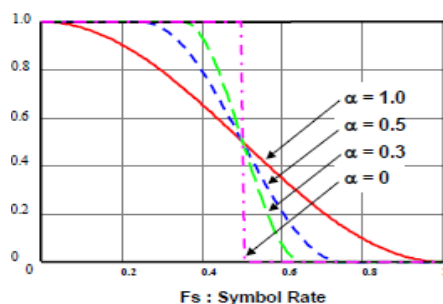

$$\text{Signal-occupied bandwidth} = \text{Symbol rate} \times (1 + \alpha)$$

Fig. 11 Diagram of relationship between channel bandwidth and  $\alpha$

## Annex B Zoom table of SCPI commands

## Annex B Zoom table of SCPI commands

Table 1 Zoom table of 1435 SCPI commands (Zoom table classified as per subsystems)

Index	Command	Function
1	<a href="#">*IDN?</a>	Universal command
2	<a href="#">*RCL</a>	Universal command
3	<a href="#">*RST</a>	Universal command
4	<a href="#">*SAV</a>	Universal command
5	<a href="#">*CLS</a>	Universal command
6	<a href="#">*ESE</a>	Universal command
7	<a href="#">*ESR?</a>	Universal command
8	<a href="#">*STB?</a>	Universal command
9	<a href="#">*TRG</a>	Universal command
10	<a href="#">*TST?</a>	Universal command
11	<a href="#">:OUTPut[:STATe](?)</a>	Set RF output on/off
12	<a href="#">OUTPut:MODulation[:STATe](?)</a>	Set modulation master on/off
13	<a href="#">[:SOURce]:FREQuency[:CW FIXed](?)</a>	Set signal generator output frequency
14	<a href="#">[:SOURce]:FREQuency:MODE(?)</a>	Set frequency generation mode
15	<a href="#">[:SOURce]:FREQuency:MULTIplier(?)</a>	Set frequency multiplier
16	<a href="#">[:SOURce]:FREQuency:OFFSet(?)</a>	Set frequency offset
17	<a href="#">[:SOURce]:FREQuency:REFerence(?)</a>	Set relative frequency
18	<a href="#">[:SOURce]:FREQuency:REFerence:STATe(?)</a>	Set relative frequency on/off
19	<a href="#">[:SOURce]:FREQuency:STEP(?)</a>	Set frequency stepping
20	<a href="#">[:SOURce]:FREQuency:STARt(?)</a>	Set step sweep start frequency
21	<a href="#">[:SOURce]:FREQuency:STOP(?)</a>	Set step sweep end frequency
22	<a href="#">[:SOURce]:POWer:ALC:LEVel(?)</a>	Set ALC level value
23	<a href="#">[:SOURce]:POWer:ALC:SEARch(?)</a>	Set power search mode
24	<a href="#">[:SOURce]:POWer:ALC:SOURce(?)</a>	Set power fixed-amplitude mode
25	<a href="#">[:SOURce]:POWer:ALC:SOURce:EXTernal:COUPling(?)</a>	Set external detection coupling factor
26	<a href="#">[:SOURce]:POWer:REFerence:STATe(?)</a>	Set ALC loop status
27	<a href="#">[:SOURce]:POWer:ATTenuation(?)</a>	Set power attenuation
28	<a href="#">[:SOURce]:POWer:ATTenuation:AUTO(?)</a>	Set power attenuation on/off



## Annex B Zoom table of SCPI commands

29	<a href="#">[:SOURce]:POWer[:LEVel][:IMMediate][:AMPLitude](?)</a>	Set power level
30	<a href="#">[:SOURce]:POWer[:LEVel][:IMMediate]:OFFSet(?)</a>	Set amplitude offset
31	<a href="#">[:SOURce]:POWer:REFerence(?)</a>	Set relative amplitude
32	<a href="#">[:SOURce]:POWer:REFerence:STATe(?)</a>	Set relative amplitude on/off
33	<a href="#">[:SOURce]:POWer:STEP(?)</a>	Set amplitude stepping
34	<a href="#">[:SOURce]:POWer:ALC:BANDwidth BWIDth</a>	Set ALC loop bandwidth
35	<a href="#">[:SOURce]:POWer:ALC:BANDwidth BWIDth:AUTO</a>	Set ALC loop bandwidth selection mode
36	<a href="#">[:SOURce]:POWer:SWEep[:STATe]</a>	Set amplitude sweep on/off
37	<a href="#">[:SOURce]:LIST:DIRection(?)</a>	Set list sweep direction
38	<a href="#">[:SOURce]:LIST:DWELl</a>	Set Dwell time for all points
39	<a href="#">[:SOURce]:LIST:FREQuency</a>	Set list sweep frequency
40	<a href="#">[:SOURce]:LIST:FILL:POINts(?)</a>	Set number of list sweep points
41	<a href="#">[:SOURce]:LIST:FILL:STARt(?)</a>	Set list sweep start frequency
42	<a href="#">[:SOURce]:LIST:FILL:STOP(?)</a>	Set list sweep end frequency
43	<a href="#">[:SOURce]:LIST:FILL:POWer(?)</a>	Set list sweep amplitude
44	<a href="#">[:SOURce]:LIST:TRIGger:SOURce(?)</a>	Set list sweep trigger source
45	<a href="#">[:SOURce]:LIST:FILL:POWer(?)</a>	Set amplitude offset for all list points
46	<a href="#">[:SOURce]:LIST:FILL:DWELl(?)</a>	Set Dwell time for all list points
47	<a href="#">[:SOURce]:LIST:FILL:EXECute</a>	Complete list fill-in
48	<a href="#">[:SOURce]:LIST:DELeTe</a>	Delete list points
49	<a href="#">[:SOURce]:LFOutput:AMPLitude(?)</a>	Set low frequency range
50	<a href="#">[:SOURce]:LFOutput:FREQuency(?)</a>	Set low frequency rate
51	<a href="#">[:SOURce]:LFOutput:RAMP(?)</a>	Set waveform direction of the low-frequency zigzag wave
52	<a href="#">[:SOURce]:LFOutput:SHAPE(?)</a>	Set low frequency waveform
53	<a href="#">[:SOURce]:LFOutput:STATe(?)</a>	Set low frequency on/off
54	<a href="#">[:SOURce]:LFOutput:OFFSet(?)</a>	Set low frequency range offset
55	<a href="#">[:SOURce]:SWEep:DIRection(?)</a>	Set stepping sweep direction
56	<a href="#">[:SOURce]:SWEep:DWELl(?)</a>	Set stepping Dwell time
57	<a href="#">[:SOURce]:SWEep:POINts(?)</a>	Set number of stepping sweep points

**Annex B Zoom table of SCPI commands**

58	<a href="#">[:SOURce]:SWEep:TRIGger:SOURce(?)</a>	Set stepping sweep trigger source
59	<a href="#">[:SOURce]:SWEep:RETRace(?)</a>	Set flyback on/off
60	<a href="#">[:SOURce]:SWEep:STEP:TYPE(?)</a>	Set stepping sweep mode
61	<a href="#">[:SOURce]:SWEep:STARt:TRIGger(?)</a>	Set start stepping sweep trigger mode
62	<a href="#">[:SOURce]:SWEep:MODE(?)</a>	Set sweep mode
63	<a href="#">[:SOURce]:PULM:EXTernal:POLarity(?)</a>	Pulse input inversion on/off
64	<a href="#">[:SOURce]:PULM:INTernal:DELay(?)</a>	Set pulse delay
65	<a href="#">[:SOURce]:PULM:INTernal:FREQuency ( ? )</a>	Set pulse repetition
66	<a href="#">[:SOURce]:PULM:INTernal:PERiod(?)</a>	Set pulse modulation period
67	<a href="#">[:SOURce]:PULM:INTernal:PWIDth(?)</a>	Set pulse modulation width
68	<a href="#">[:SOURce]:PULM:SOURce(?)</a>	Set pulse source
69	<a href="#">[:SOURce]:PULM:STATe(?)</a>	Set pulse modulation on/off
70	<a href="#">[:SOURce]:PULM:INTernal:JITTered:MODE(?)</a>	Set pulse period jittering mode
71	<a href="#">[:SOURce]:PULM:INTernal:JITTered:PERCent (?)</a>	Set jittering percentage of pulse repetition
72	<a href="#">[:SOURce]:PULM:INTernal:PTRain:DATA</a>	Set pulse string points
73	<a href="#">[:SOURce]:PULM:INTernal:PTRain:DELete</a>	Delete any index point in the pulse string list
74	<a href="#">[:SOURce]:PULM:INTernal:PTRain:POINts</a>	Query number of current pulse string points
75	<a href="#">[:SOURce]:AM[1] 2[:DEPTh]:EXPonential(?)</a>	Set signal AM depth for channel 1 or 2
76	<a href="#">[:SOURce]:AM[1] 2[:DEPTh][:LINear](?)</a>	Set signal AM signal depth for channel 1 or 2 in percentage
77	<a href="#">[:SOURce]:AM[1] 2:INTernal:FREQuency(?)</a>	Set internal AM rate for channel 1 or 2
78	<a href="#">[:SOURce]:AM[1] 2:INTernal:RAMP(?)</a>	Set the signal output type for zigzag FM wave for channel 1 or 2
79	<a href="#">[:SOURce]:AM[1] 2:INTernal:SHAPe(?)</a>	This command sets the AM signal output waveform.
80	<a href="#">[:SOURce]:AM[1] 2:STATe(?)</a>	Set the signal generator AM channel 1 or 2 on/off
81	<a href="#">[:SOURce]:AM:MODE(?)</a>	Set depth AM on/off
82	<a href="#">[:SOURce]:AM:SOURce(?)</a>	Set AM input selection
83	<a href="#">[:SOURce]:AM:MODulation:STATe(?)</a>	Set signal generator AM signal output status
84	<a href="#">[:SOURce]:AM:TYPE(?)</a>	Set AM type

## Annex B Zoom table of SCPI commands

85	<a href="#">[:SOURce]:AM:EXternal:COUPling(?)</a>	Set AM external input coupling mode
86	<a href="#">[:SOURce]:AM:EXternal:PATH(?)</a>	Set AM external input channel
87	<a href="#">[:SOURce]:FM[1] 2:DEViation(?)</a>	Set FM offset for signal channel 1 or 2
88	<a href="#">[:SOURce]:FM[1] 2:INTernal:FREQuency(?)</a>	Set internal modulation rate of signal generator FM channel 1 or 2
89	<a href="#">[:SOURce]:FM[1] 2:INTernal:RAMP(?)</a>	Set the zigzag wave type for zigzag FM wave for channel 1 or 2
90	<a href="#">[:SOURce]:FM[1] 2:INTernal:SHAPE(?)</a>	Set FM signal output waveform for channel 1 or 2
91	<a href="#">[:SOURce]:FM[1] 2:STATe(?)</a>	Set signal generator FM channel 1 or 2 on/off
92	<a href="#">[:SOURce]:FM:SOURce(?)</a>	Set FM source
93	<a href="#">[:SOURce]:FM:MODulation:STATe(?)</a>	Set FM on/off
94	<a href="#">[:SOURce]:FM:EXternal:COUPling (?)</a>	Set FM external input coupling mode
95	<a href="#">[:SOURce]:FM:EXternal:PATH (?)</a>	Set AM external input channel
96	<a href="#">[:SOURce]:PM[1] 2:DEViation(?)</a>	Set phase offset for phase modulation channel 1 or 2
97	<a href="#">[:SOURce]:PM[1] 2:INTernal:FREQuency(?)</a>	Set internal modulation rate of signal generator phase modulation channel 1 or 2
98	<a href="#">[:SOURce]:PM[1] 2:INTernal:SHAPE:RAMP(?)</a>	Set the zigzag wave direction for zigzag wave of phase modulation channel 1 or 2
99	<a href="#">[:SOURce]:PM[1] 2:INTernal:SHAPE(?)</a>	Set the output waveform of phase modulation signal channel 1 or 2
100	<a href="#">[:SOURce]:PM[1] 2:STATe(?)</a>	Set signal generator phase modulation channel 1 or 2 on/off
101	<a href="#">[:SOURce]:PM:SOURce(?)</a>	Set phase modulation source
102	<a href="#">[:SOURce]:PM:MODulation:STATe(?)</a>	Set signal generator phase modulation signal output status
103	<a href="#">[:SOURce]:PM:EXternal:COUPling(?)</a>	Set phase modulation external input coupling mode
104	<a href="#">[:SOURce]:PM:EXternal:PATH(?)</a>	Set phase modulation external input channel

**Annex B Zoom table of SCPI commands**

105	<a href="#">[:SOURce]:DM:IQADjustment::GAIN(?)</a>	Set internal IQ gain balance
106	<a href="#">[:SOURce]:DM:IQADjustment:IOFFse(?)</a>	Set I path offset value
107	<a href="#">[:SOURce]:DM:IQADjustment:QOFFse(?)</a>	Set Q path offset value
108	<a href="#">[:SOURce]:DM:IQADjustment:QSKew(?)</a>	Set phase angle between IQ vectors
109	<a href="#">[:SOURce]:DM:IQADjustment[:STATe](?)</a>	Set IQ modulation on/off
110	<a href="#">[:SOURce]:DM:MODulation:ATTenuation(?)</a>	Set IQ signal attenuation
111	<a href="#">[:SOURce]:DM:MODulation:ATTenuation:AUTO(?)</a>	Set IQ signal attenuation on/off
112	<a href="#">[:SOURce]:DM:STATe(?)</a>	Set IQ modulation on/off
113	<a href="#">[:SOURce]:DM:EXTernal:BWIDth[:STATe](?)</a>	Set external broadband I/Q input on/off
114	<a href="#">[:SOURce]:DM:IQADjustment:OUTPut[:STATe](?)</a>	Set I/Q input adjustment on/off
115	<a href="#">[:SOURce]:DM:IQADjustment:OUTPut:ATTen____(?)</a>	Set I/Q output adjustment attenuation
116	<a href="#">[:SOURce]:DM:IQADjustment:OUTPut:GAIN____(?)</a>	Set I/Q output adjustment gain balance
117	<a href="#">[:SOURce]:DM:IQADjustment:OUTPut:IOFFset(?)</a>	Set I/Q output adjustment I offset
118	<a href="#">[:SOURce]:DM:IQADjustment:OUTPut:UIOFFset(?)</a>	Set I/Q output adjustment I/offset
119	<a href="#">[:SOURce]:DM:IQADjustment:OUTPut:QOFFset(?)</a>	Set I/Q output adjustment Q offset
120	<a href="#">[:SOURce]:DM:IQADjustment:OUTPut:UQOFFset(?)</a>	Set I/Q output adjustment Q/offset
121	<a href="#">[:SOURce]:DM:IQADjustment:OUTPut:SKEW____(?)</a>	Set I/Q output adjustment orthogonal deviation
122	<a href="#">[:SOURce]:RADio:CUSTom:ALPHa(?)</a>	Set baseband filter factor
123	<a href="#">[:SOURce]:RADio:CUSTom:DATA(?)</a>	Set baseband modulation signal data source
124	<a href="#">[:SOURce]:RADio:CUSTom:DATA:PRAM_____</a>	Select file code stream file
125	<a href="#">[:SOURce]:RADio:CUSTom:FILTer(?)</a>	Set baseband filter type
126	<a href="#">[:SOURce]:RADio:CUSTom:IQData_____</a>	Transmit IQ data set to the baseband memory
127	<a href="#">[:SOURce]:RADio:CUSTom:MODulation:FSK[:DEViation](?)</a>	Set baseband type to frequency modulation deviation in the FSK mode
128	<a href="#">[:SOURce]:RADio:CUSTom:MODulation:MSK:PHASe(?)</a>	Set baseband type to phase modulation deviation in the MSK mode
129	<a href="#">[:SOURce]:RADio:CUSTom:MODulation[:TYPE](?)</a>	Set the baseband modulation type
130	<a href="#">[:SOURce]:RADio:CUSTom:SRATE(?)</a>	Set baseband code element rate

## Annex B Zoom table of SCPI commands

131	<a href="#">[:SOURce]:RADio:CUSTom:STATe(?)</a>	Set baseband on/off
132	<a href="#">[:SOURce]:RADio:CUSTom:POLarity[:ALL](?)</a>	Set baseband signal phase polarity
133	<a href="#">[:SOURce]:RADio:CUSTom:DENCode(?)</a>	Set command differential encoding on/off
134	<a href="#">[:SOURce]:RADio:CUSTom:VCO:CLOCK(?)</a>	Set baseband sampling clock type
135	<a href="#">[:SOURce]:RADio:CUSTom:TRIGger:EXTernal:SOURce(?)</a>	Set external source of the baseband trigger source
136	<a href="#">[:SOURce]:RADio:CUSTom:TRIGger:EXTernal:SOURce:DELay(?)</a>	Set external delay time of the baseband trigger source
137	<a href="#">[:SOURce]:RADio:CUSTom:TRIGger:EXTernal:SOURce:DELay:STATe(?)</a>	Set external trigger source delay on/off
138	<a href="#">[:SOURce]:RADio:CUSTom:TRIGger:EXTernal:SOURce:SLOPe(?)</a>	Set external trigger source trigger polarity
139	<a href="#">[:SOURce]:RADio:CUSTom:TRIGger:SOURce(?)</a>	Set baseband trigger source type
140	<a href="#">[:SOURce]:RADio:CUSTom:TRIGger:TYPE(?)</a>	Set baseband trigger source trigger mode
141	<a href="#">[:SOURce]:RADio:CUSTom:TRIGger:TYPE:CONTInuous:TYPE____(?)</a>	Set baseband continuous trigger type
142	<a href="#">[:SOURce]:RADio:CUSTom:TRIGger:TYPE:GATE:ACTive(?)</a>	Set baseband trigger mode type
143	<a href="#">[:SOURce]:RADio:MTONE:ARB:SETup</a>	Select multitone file for loading
144	<a href="#">[:SOURce]:RADio:MTONE:ARB:SETup:STORe__</a>	Store multitone file
145	<a href="#">[:SOURce]:RADio:MTONE:ARB: SETup:TABLE__</a>	Configure multitone waveform sequence
146	<a href="#">[:SOURce]:RADio:MTONE:ARB: SETup:TABLE:FSPacing(?)</a>	Set multitone frequency interval
147	<a href="#">[:SOURce]:RADio:MTONE:ARB: SETup:TABLE:NTONes(?)</a>	Set quantity of multitone
148	<a href="#">[:SOURce]:RADio:MTONE:ARB: SETup:TABLE:PHASe:INITialize(?)</a>	Set multitone start phase type
149	<a href="#">[:SOURce]:RADio:MTONE:ARB: SETup:TABLE:PHASeINITialize:SEED(?)</a>	Set phase relationship between multitones
150	<a href="#">[:SOURce]:RADio:MTONE:ARB: SETup:TABLE:ROW(?)</a>	Set multitone parameters for a line in the multitone modulation list
151	<a href="#">[:SOURce]:RADio:MTONE:ARB[:STATe](?)</a>	Set multitone on/off
152	<a href="#">[:SOURce]:RADio:TTONe:ARB:ALIGNment(?)</a>	Set dual-tone signal offset position
153	<a href="#">[:SOURce]:RADio:TTONe:ARB:FSPacing(?)</a>	Set dual-tone frequency interval
154	<a href="#">[:SOURce]:RADio:TTONe:ARB[:STATe](?)</a>	Set dual-tone on/off

**Annex B Zoom table of SCPI commands**

155	<a href="#">[:SOURce]:RADio:ARB:MODE(?)</a>	Set random wave mode
156	<a href="#">[:SOURce]:RADio:ARB[:STATe](?)</a>	Set random wave on/off
157	<a href="#">[:SOURce]:RADio:ARB:SEQuence</a>	Load random wave file
158	<a href="#">[:SOURce]:RADio:ARB:SEQuence:CLOCK (?)</a>	Set random wave clock type
159	<a href="#">[:SOURce]:RADio:ARB:SCLock:RATE(?)</a>	Set random wave clock frequency
160	<a href="#">[:SOURce]:RADio:ARB:TRIGger:TYPE(?)</a>	Set random wave trigger mode
161	<a href="#">[:SOURce]:RADio:ARB:TRIGger:TYPE:CONTInuous[:TYPE](?)</a>	Set random wave continuous trigger mode
162	<a href="#">[:SOURce]:RADio:ARB:TRIGger:TYPE:SINGle(?)</a>	Set random wave single trigger mode
163	<a href="#">[:SOURce]:RADio:ARB:TRIGger:TYPE:SADVance[:TYPE](?)</a>	Set random wave waveform segment trigger mode
164	<a href="#">[:SOURce]:RADio:ARB:TRIGger:TYPE:GATE:ACTive (?)</a>	Set random wave gate trigger mode
165	<a href="#">[:SOURce]:RADio:ARB:TRIGger:SOURce (?)</a>	Set random wave trigger source
166	<a href="#">[:SOURce]:RADio:ARB:VCO:CLOCK(?)</a>	Set random wave trigger sampling clock
167	<a href="#">[:SOURce]:RADio:ARB:EXTernal:CLOCK:RATE(?)</a>	Set random wave trigger external clock frequency
168	<a href="#">:MEMory:COpy:NAME</a>	Copy files from signal generator
169	<a href="#">:MEMory:DLete:NAME</a>	Delete user files
170	<a href="#">:MEMory:MOVE</a>	Rename files from signal generator
171	<a href="#">:MEMory:DATA</a>	Transmit data file
172	<a href="#">:ROSCillator:ADJust:REFerence(?)</a>	Set signal generator internal reference
173	<a href="#">:DIAGnostic:INFormation:CCOunt:PON ?</a>	Query the accumulative startup times of the instrument
174	<a href="#">:DIAGnostic:INFormation:OTIME ?</a>	Query the instrument firmware date and time stamp
175	<a href="#">:DIAGnostic:SNUM?</a>	Read the system serial number of the signal generator
176	<a href="#">:SYSTem:COMMunicate:GPIB:ADDRess(?)</a>	Set signal generator GPIB address
177	<a href="#">:SYSTem:COMMunicate:GTLocal</a>	Set signal generator to local mode

## Annex C Zoom table of error information

Table 3 List of local failure information

Key error field	Error Description
Unleveled	Too high amplitude or no amplitude
Reference loop losing lock	Losing lock of internal reference loop from the signal generator
Decimal loop losing lock	Losing lock of internal decimal loop from the signal generator
LO loop losing lock	Losing lock of LO loop from the signal generator
VCO loop losing lock	Losing lock of internal VCO loop from the signal generator
External reference	The signal generator is using the external reference, which is not an error.

**Annex D Zoom table of PC keyboard shortcuts in the function configuration window****Annex D Zoom table of PC keyboard shortcuts in the function configuration window**

<b>PC keyboard symbols</b>	<b>Corresponding function configuration window name</b>
A	Frequency configuration window
B	Amplitude configuration window
C	Sweep configuration window
E	User calibration window
F	System configuration window
H	Help window
I	Storage/loading window
K	Reset
N	RF on/off
P	Modulation on/off
T	Modulation configuration window