



# 1465 Series Signal Generator User Manual



China Electronics Technology Instruments Co., Ltd

This manual applies to signal generators of models below and based on firmware version 1.0 and above.

- 1465A signal generator (100kHz ~ 3GHz)
- 1465B signal generator (100kHz ~ 6GHz)
- 1465C signal generator (100kHz ~ 10GHz)
- 1465D signal generator (100kHz ~ 20GHz)
- 1465F signal generator (100kHz ~ 40GHz)
- 1465H signal generator (100kHz ~ 50GHz)
- 1465L signal generator (100kHz ~ 67GHz)
- 1465A-V signal generator (100kHz ~ 3GHz)
- 1465B-V signal generator (100kHz ~ 6GHz)
- 1465C-V signal generator (100kHz ~ 10GHz)
- 1465D-V signal generator (100kHz ~ 20GHz)
- 1465F-V signal generator (100kHz ~ 40GHz)
- 1465H-V signal generator (100kHz ~ 50GHz)
- 1465L-V signal generator (100kHz ~ 67GHz)

Version: A.3 September 2018, China Electronics Technology Instruments Co., Ltd

Address: No.98, Xiangjiang Road, Qingdao City, China

Tel: +86-0532-86896691

Website: [www.ceyear.com](http://www.ceyear.com)

E-mail: [sales@ceyear.com](mailto:sales@ceyear.com)

Postal code: 266555

## Foreword

Thank you for choosing the 1465 series signal generator developed and manufactured by China Electronics Technology Instruments Co., Ltd (CETI). Our product is high-end, precise and sophisticated, and embraces a high cost performance among the competitors of the same class.

We are devoted to providing for you high-quality products and first-class after-sales service with your most concerns and demands in mind. Our consistent aim is providing excellent quality and good service, and this is our sincere commitment for all users.

### Manual No.

AV2.827.1202SSEN

### Version

A.3 2018.9

China Electronics Technology Instruments Co., Ltd

### Manual Authorization

This manual may be subject to change without notice. CETI reserves all the rights to the final explanation for all the information and terminologies referred to in this manual.

This manual is the property of CETI. Without CETI's permission, any organizations or individuals shall neither alter nor duplicate/transmit this manual for profits; otherwise, CETI reserves the right to pursue any liabilities therefrom.

### Product Warranty

The warranty period of this product is 18 months from the date of delivery. Instrument manufacturer will repair or replace the damaged parts according to the actual situation in the warranty period. The specific maintenance

matters should be subject to the contract.

### Product Certification

This product is certified to fulfill the standards indicated in this manual from the day of delivery. Calibration measurements have been carried out based on national standards. Related information is available to the user for reference.

### Quality/Environmental Management

The quality and environmental management systems have always been implemented during development, manufacturing and test of this product. China Electronics Technology Instruments Co., Ltd (CETI) has been properly qualified and certified ISO 9001 and ISO 14001 management system standards.

### Safety Precautions



WARNING indicates a danger. It reminds the user to be cautious of a certain operation process, operation method or the similar. Failure to follow the rules or operate correctly may result in the personal injury. The conditions indicated by WARNING should be fully understood and met before the next operation.



ATTENTION indicates an important information rather than a danger. It reminds the user to be cautious of a certain operation process, operation method or the similar. Failure to follow the rules or operate correctly may cause the damage to the instrument or loss of important data. The conditions indicated by

CAUTION should be fully understood and met before the next operation.

---



# Table of Contents

1 About This Manual .....	1
1.1 About This Manual .....	1
1.2 Related Documents .....	2
2 Overview .....	5
2.1 General .....	5
2.1.1 Product features .....	5
2.1.2 Typical Applications .....	11
2.2 Safety guide .....	12
2.2.1 Safety signs .....	13
2.2.2 Operation status and position .....	14
2.2.3 Electrical safety .....	14
2.2.4 Operation precautions .....	15
2.2.5 Maintenance .....	15
2.2.6 Battery or power module .....	15
2.2.7 Transportation .....	16
2.2.8 Disposal/environmental protection .....	16
3 Start Guide .....	17
3.1 Preparation before Use .....	17
3.1.1 Preparations before operation .....	17
3.1.2 Configuration of operating system .....	27
3.1.3 Routine maintenance .....	32
3.2 Description of front and rear panels .....	33
3.2.1 Description of front panel .....	33
3.2.2 Description of rear panel .....	35
3.3 Basic configuration method .....	37
3.3.1 Description of basic settings .....	37
3.3.2 Example of operation .....	42
3.3.3 Description of main configuration scenarios .....	51
3.4 Data management .....	58
3.4.1 Saving/loading of working state .....	59
3.4.2 File management .....	60
3.4.3 Printing/saving of screenshot .....	63

**4 Operation Guides ..... 65**

4.1 Basic operation guides..... 65

    4.1.1 Digital modulation ..... 65

    4.1.2 Simulation modulation and pulse modulation..... 66

    4.1.3 Sweep..... 69

4.2 Advanced operation guides ..... 72

    4.2.1 Configuring multi-tone ..... 72

    4.2.2 ARB configuration ..... 74

    4.2.3 Selecting ALC bandwidth ..... 80

    4.2.4 External level control ..... 81

    4.2.5 Working with a frequency mixer/Effects of reverse power ..... 82

    4.2.6 Creating and applying a user flatness correction array ..... 83

    4.2.7 Selecting pulse modulation input..... 84

    4.2.8 Baseband trigger function configuration..... 87

    4.2.9 Arbitrary waveform triggering function configuration..... 90

**5 Menu ..... 95**

5.1 Menu Structure and Parameter Settings ..... 95

    5.1.1 Frequency ..... 95

    5.1.2 Amplitude ..... 97

    5.1.3 Sweep..... 99

    5.1.4 Modulation..... 101

    5.1.5 Base ..... 107

    5.1.6 I/Q..... 109

    5.1.7 ARB..... 110

    5.1.8 Tone ..... 112

    5.1.9 AWGN (Option) ..... 113

    5.1.10 System..... 114

    5.1.11 File ..... 118

    5.1.12 Save/Recall..... 118

    5.1.13 Calibrate..... 119

5.2 Menu Description..... 120

    5.2.1 Frequency ..... 120

    5.2.2 Ampl..... 125

5.2.3 Sweep.....	131
5.2.4 Modulation.....	137
5.2.5 Base.....	144
5.2.6 I/Q.....	149
5.2.7 ARB.....	156
5.2.8 Tone.....	163
5.2.9 AWGN (Option).....	166
5.2.10 System.....	169
5.2.11 File.....	171
5.2.12 Save/Recall.....	172
5.2.13 Calibrate.....	172
<b>6 Remote Control.....</b>	<b>175</b>
6.1 Remote control basis.....	175
6.1.1 Remote Interface.....	175
6.1.2 Message.....	178
6.1.3 SCPI.....	178
6.1.4 Command Sequence and Synchronization.....	186
6.1.5 Status reporting system.....	187
6.1.6 Programming considerations.....	189
6.2 Remote interface and its configuration.....	189
6.2.1 LAN.....	189
6.2.2 GPIB.....	190
6.3 Basic programming method of the VISA interface.....	191
6.3.1 VISA library.....	191
6.3.2 Initialization and default status setting.....	192
6.3.3 Sending of set command.....	193
6.3.4 Reading of instrument configuration.....	193
6.3.5 Synchronization of command.....	194
6.4 I/O library.....	195
6.4.1 Overview of I/O library.....	195
6.4.2 Installation and configuration of I/O library.....	196
<b>7 Fault Diagnosis &amp; Repair.....</b>	<b>197</b>
7.1 Operating principle.....	197

## Table of Contents

7.1.1 Instrument operating principle & functional block diagram of hardware.....	197
<b>7.2 Fault diagnosis and troubleshooting .....</b>	<b>199</b>
7.2.1 System issue .....	199
7.2.2 Unlocked hardware.....	199
7.2.3 Unfixed amplitude .....	201
7.2.4 Cold timebase.....	201
7.2.5 RF output power issue .....	202
7.2.6 RF output port unmodulated .....	202
7.2.7 Sweeping issue .....	203
7.2.8 Data storage issue.....	203
7.2.9 Unresponsive front panel keys .....	203
7.2.10 Remote control issue .....	203
<b>7.3 Error information .....</b>	<b>204</b>
7.3.1 Error information file .....	204
7.3.2 Error information description .....	204
<b>7.4 Repair methods.....</b>	<b>205</b>
7.4.1 Contact us.....	205
7.4.2 Packaging and transport.....	206
<b>8 Specifications and Test Methods.....</b>	<b>207</b>
8.1 Statement.....	207
8.2 Product Features .....	207
8.3 Specifications .....	208
8.4 Option Information .....	218
8.5 Supplementary Information .....	220
8.5.1 General Information.....	220
8.6 Performance Characteristics Test.....	222
8.6.1 Recommended test method .....	222
8.6.2 Performance characteristics test record table .....	235
8.5.3 Recommended instruments for performance characteristics test.....	246
<b>Appendixes .....</b>	<b>247</b>
<b>Appendix A Explanations of Terms .....</b>	<b>247</b>
Frequency accuracy .....	247
Frequency stability.....	247
Harmonic distortion and spectrum purity.....	247



I/Q modulation .....	248
Speech coding.....	248
Channel coding .....	249
Digital modulation .....	249
Frequency band utilization of digital modulation signals .....	250
Binary frequency shift keying 2FSK.....	250
Binary phase shift keying BPSK.....	250
Quadrature phase shift keying QPSK.....	251
8 phase shift keying 8PSK .....	251
Quadrature amplitude modulation QAM.....	252
Differential modulation method $\pi/4$ DQPSK.....	252
QPSK modulation method.....	253
Constant envelope digital modulation MSK (minimum shift keying).....	253
$3\pi/8$ rotation 8PSK modulation (EDGE) .....	254
Nyquist filter .....	254
Nyquist filter coefficient $\alpha$ .....	255
Appendix B Lookup Table of SCPIs.....	256
Appendix C Lookup Table of Error Information .....	273
Appendix D Lookup Table of PC Keyboard in Function Configuration Windows .....	274



## 1 About This Manual

This chapter introduces the function, compositions and main content of the User Manual of the 1465 series signal generator as well as other related documents provided to the user.

- [About This Manual](#) .....1
- [Related Documents](#) .....2

### 1.1 About This Manual

This manual introduces the basic functions and operation methods of the 1465 series signal generator and describes the features, basic usage, measurement, configuration and operation guides, menus, remote control, maintenance, specifications and test methods of the instrument to help you familiarize yourself with and master the operation methods and essentials as soon as possible. To facilitate your familiarity with the instrument, please read this manual carefully before operating the instrument, and then follow the instructions of manual.

The chapters included in this User Manual are as follows:

- **Overview**

This chapter generally introduces the main performance characteristics, typical application cases and operational safety precautions of the 1465 series signal generator, so that the user can know about the main performance characteristics of the instrument and operate the instrument safely in accordance with the instructions.

- **Start Guide**

This chapter introduces the preoperational check, instrument overview, basic method of configuration, and the method to use the configuration dialog and store data for the 1465 series signal generator. Allow the user to know about the instrument and configuration process and make preliminary preparations for comprehensive introduction of configuration and operation guides of the instrument. The content contained in this chapter is consistent with that in relevant chapters of Quick Start Guide.

- **Operation Guide**

This chapter detailedly introduces the operation methods of various configuration functions of the instrument, including configuration, configuration process start and configuration result acquisition. This chapter falls into two parts: Basic operation guide and advanced operation guide. The basic operation guide is intended for users unfamiliar with the way to use the instrument, and systematically introduces and enumerates each function in detail, to help users understand and master basic usage of the instrument, such as setting of CW, amplitude, modulation, etc. The advanced operation manual is prepared for users who have general knowledge about the use of signal generator but are not familiar with some special usages. It introduces the relatively complicated test process and high-level use techniques and guides the user to implement the operation process, For example: List configuration of step sweep and list sweep, generation of vector signal, etc.

- **Menu**

This chapter introduces the menu structure and items by function for user's query and reference.

- **Remote Control**

This chapter introduces the remote control methods of the instrument so that the user can rapidly master the method to control the instrument in a remote way. It is further divided into the following four sections: remote control basis, which introduces the concepts related to remote control, software configuration, remote interface, SCPI, etc.; instrument interface configuration methods, which introduces the remote interface connection methods and software configuration methods of the 1465 series microwave power meter; basic programming methods of the VISA interface, which gives a basic programming example in the form of text description plus programming examples so that the user can quickly grasp the programming methods; the I/O function library, which introduces the basic concept of the instrument driver and the basic installation and configuration of the IVI-COM/IVI-C driver.

- **Fault Diagnosis and Repair**

## 1.2 Related Documents

This chapter introduces the working principles, fault diagnosis and troubleshooting methods, error message description and repair methods of the unit.

- **Specifications and Test Methods**

This section introduces the product features, main specifications and recommended test method of the 1465 series signal generator.

- **Appendixes**

This section lists the related reference information of the 1465 series signal generator, including: terminology, look-up table of programming command, look-up table of error message.

## 1.2 Related Documents

The product documents related to 1465 series signal generator include:

- Quick Start Guide
- Online support
- User Manual
- Programming Manual

### **Quick Start Guide**

This guide presents the instrument configuration and basic method of initiating configuration, and aims to facilitate a quick understanding of instrument features, a mastery of basic setting, basic operation method of local and remote control. Main chapters included in this manual are as follows:

- Preparation before Use
- Typical Applications
- Getting Help

### **User Manual**

This manual introduces in detail features and operation methods of the instrument, including: configuration, remote control and maintenance. for the purpose of guiding the user to fully understand the features of the product and master the common instrument test methods. The chapters included in this manual are as follows:

- About This Manual
- Overview
- Start Guide
- Operation Guide
- Menu
- Remote Control
- Fault Diagnosis and Repair
- Specifications and Test Methods
- Appendixes

### **Programming Manual**

This manual elaborates the programming fundamentals of remote control, SCPI basics, SCPI, programming examples and I/O driver function library, for the purpose of guiding the user to master the SCPIs and methods of the instrument quickly and comprehensively. The chapters included in this manual are as follows:

- Remote Control
- SCPI

- Programming Examples
- Error Description
- Appendixes

**Online support**

Online help is integrated in the instrument product to provide quick text navigation help for user local and remote control operation. The hard keys on the instrument front panel or the user interface toolbars may be activated with their corresponding shortcut keys. The contents are the same as those in the user manual.

## 1 About This Manual

---

### 1.2 Related Documents

## 2 Overview

This chapter introduces the product features, main scope of application and specifications. Also, it describes how to properly operate the instrument and electrical safety precautions.

- [General](#) .....5
- [Safety guide](#) .....12

### 2.1 General

The 1465 series signal generator has a frequency range of 100kHz ~ 67GHz, excellent spectrum purity and output power, with SSB phase noise of 10GHz carrier @ 10kHz frequency offset of -126dBc/Hz, max. output power up to 1W@20GHz, power dynamic range greater than 150dB which can meet high demands for test signals; it also features high-precision analog sweep function, excellent simulation modulation, pulse modulation and vector modulation; the baseband signal generator is easily set up and flexible, and supports multiple modulation formats, allowing users to edit and download the required waveform for signal simulation based on individual needs; the internal and external vectors have wide modulation bandwidth (internal 200MHz and external 2GHz) which can meet the needs of broadband signal simulation; the internal modulation signal generator has frequency up to 10MHz and multiple signal waveforms, pulse modulation supports minimum PW of 20ns and generates flexible pulse trains that can satisfy the needs for testing various complex signals; the product has a 10.1" large display with resolution of 1280x800 and can be operated by keys, a mouse or screen touch, improving the operating experience while enhancing the testing efficiency. The 1465 series generates high-quality signals in both continuous wave and modulation, making it an ideal local oscillator and clock source, and a high-performance simulation signal source. It is mainly used for comprehensive assessment of radar performance, high-performance receiver testing and component parameter testing, applicable for many fields such as aerospace, radar, communication, navigation equipment, etc.

- [Product features](#) .....5
- [Typical application](#) .....11

#### 2.1.1 Product features

##### 2.1.1.1 Basic function

The 1465 series signal generator developed by CETI embraces the following main features:

- 1) Three basic modes of signal output: Continuous wave (CW) signal, sweep signal and digital modulation signal.
  - **Continuous wave (CW) signal**  
In this mode, the instrument generates a CW sine signal with the frequency and power level defined by the user.
  - **Sweep signal**  
Basic sweep outputs are provided, including step sweep, list sweep and ramp sweep. Multiple sweep triggering inputs and outputs are provided.
  - **High-precision broadband vector modulation signal output**  
If an internal baseband is used in the 1465-V signal generator, vector modulation signals of bandwidth up to 200MHz can be generated; when an external I/Q is used, the modulation bandwidth is 200MHz, supporting broadband I/Q input of external arbitrary waveform generator, with RF modulation bandwidth up to 2GHz.
- 2) Generation of internal broadband and multi-system baseband signals. The vector signal generator can produce digital modulation (real-time) baseband signals, with single-channel bandwidth up to 100MHz.
- 3) External reference clock (ERCLK) input of baseband, and synchronous input of external data source.
- 4) Storage and calling of instrument set state, and one-button self test.

5) Including GPIB, LAN, and other I/O remote interfaces;

### 2.1.2.2 High performance

#### 1) Excellent spectrum purity

The 1465 series signal generator can generate high-purity signal spectrum, of SSB phase noise 10GHz carrier@10kHz frequency offset (typical value) -126dBc/Hz, 1GHz carrier@10kHz frequency offset (typical value) -142dBc/Hz, making it applicable for testing of Doppler radar, high-performance receiver blocking and adjacent channel selectivity, and an ideal alternative of local oscillator and low-jitter clock.

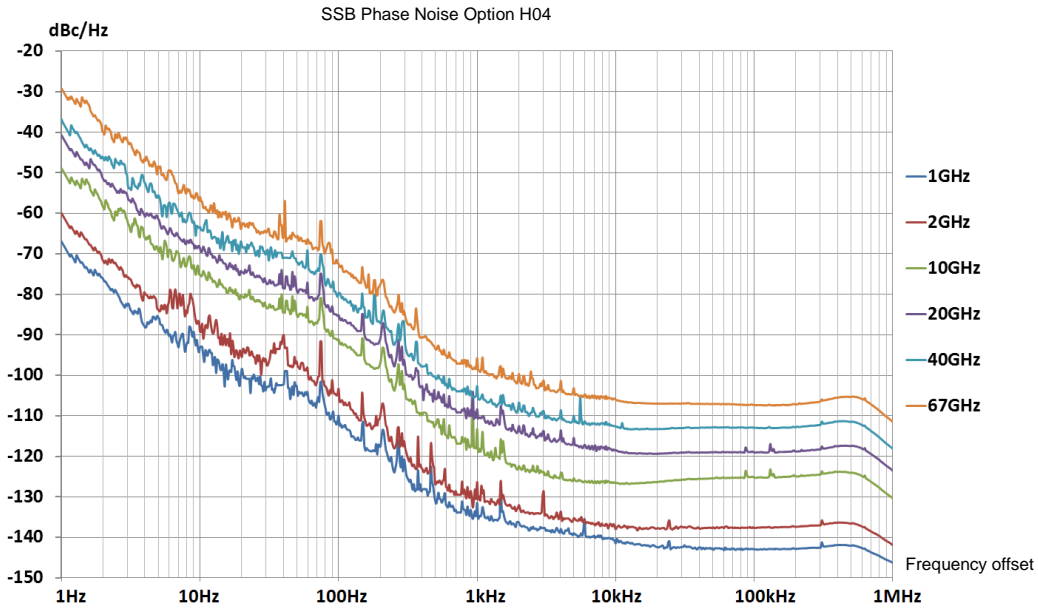

Fig. 2.1 SSB Phase Noise

#### 2) Broadband high power output

Typical value of max. output power of H05 high power option: +22dBm @ 20GHz, +20dBm @ 40GHz (-V series: +16dBm), +10dBm @ 67GHz (-V series: +6dBm). H06 enhanced high power option has output power up to 30dBm (1W). During testing, high power excitation signals, if required, can be obtained without connecting to an external amplifier, and the power has higher accuracy and stability.

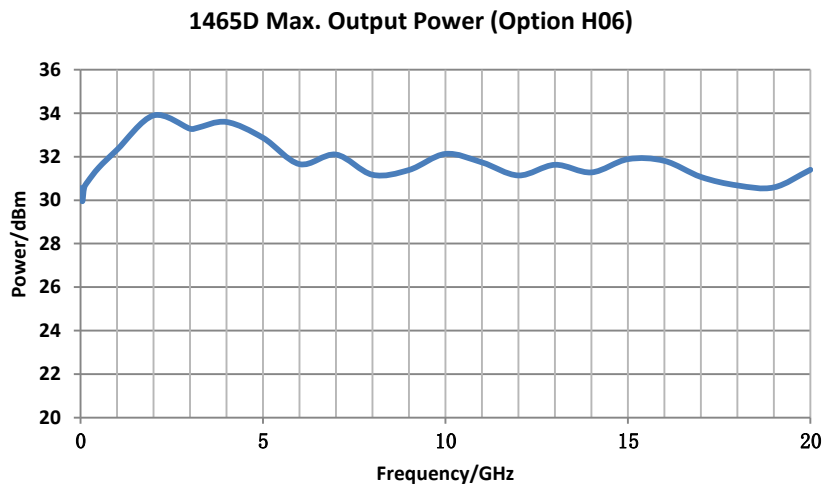

Fig. 2.2 Max. Output Power of 1465D+H06



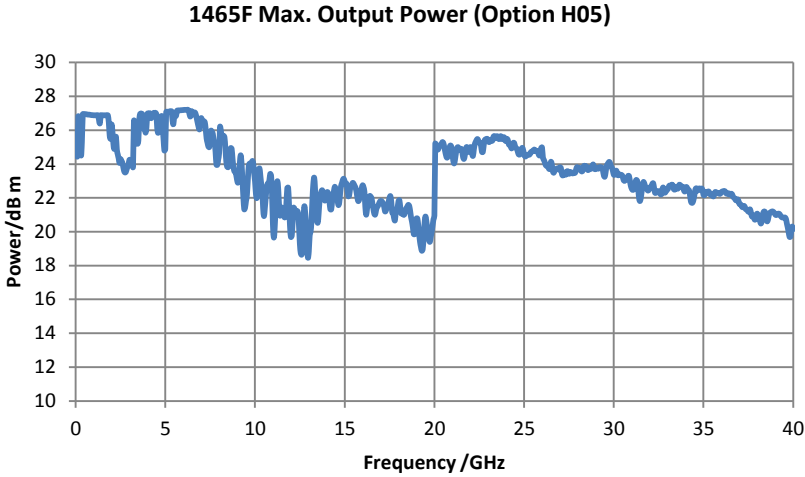

Fig. 2.3 Max. Output Power of 1465F+H05

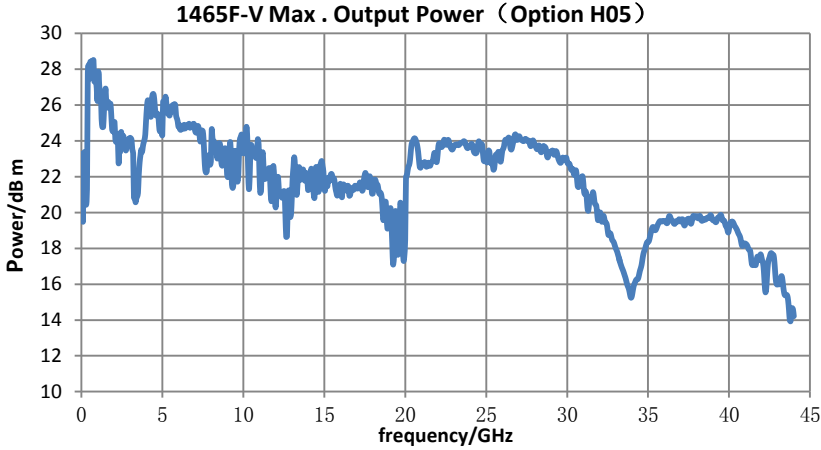

Fig. 2.4 Max. Output Power of 1465F-V+H05

**3) High-vector modulation bandwidth**

The 1465-V series can generate vector signals of modulation bandwidth 200MHz and 2GHz external (> 3.2GHz carrier).

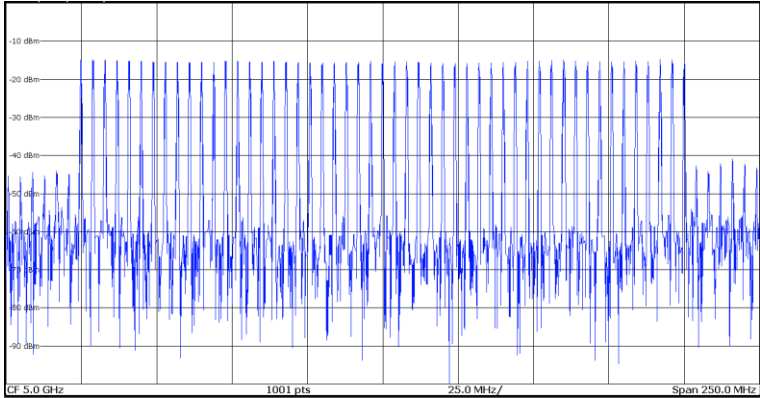

Fig. 2.5 5GHz Carrier 200MHz Modulation Bandwidth Multi-tone Signal

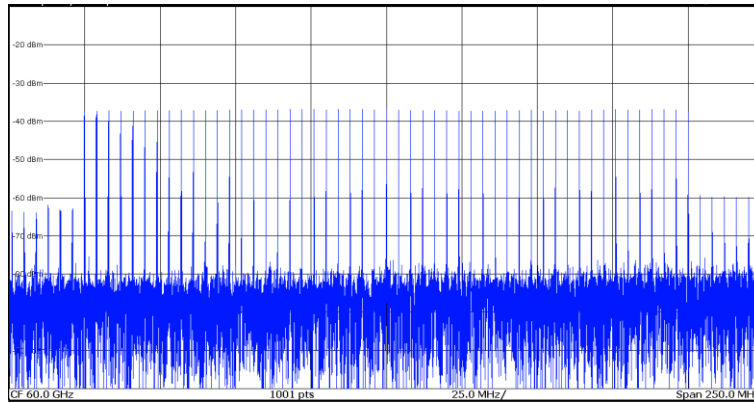

Fig. 2.6 60GHz Carrier 200MHz Modulation Bandwidth Multi-tone Signal

**4) Download of high-compatibility arbitrary waveform data format**

The 1465-V series supports downloading and playing of arbitrary waveform data in storage formats of Mat-File 5, ASCII, Binary, cap, csv and up to the depth of 2G sampling point.

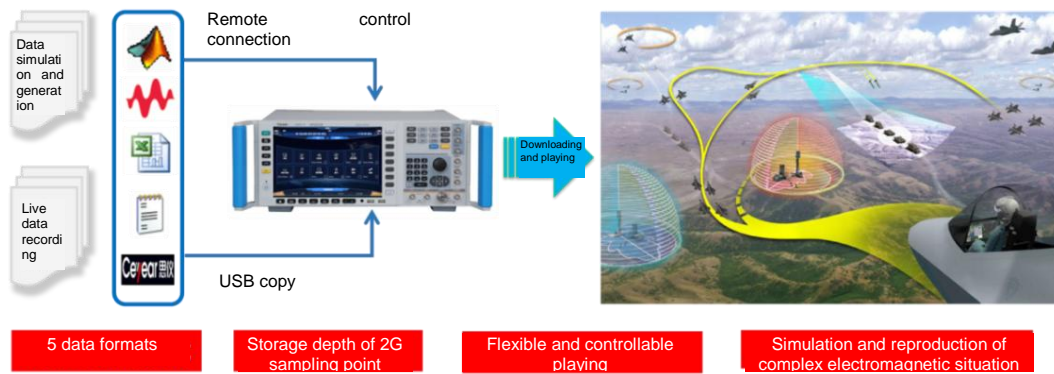

Fig. 2.7 Downloading and Playing of Arbitrary Waveform Data

**5) Vector modulation accuracy**

The 1465-V series has high vector modulation accuracy of  $EVM < 1.4\%$  (test value  $< 1.0\%$  for 100kHz ~ 40GHz) and  $EVM < 2.5\%$  (test value  $< 1.5\%$  for 40GHz ~ 67GHz).

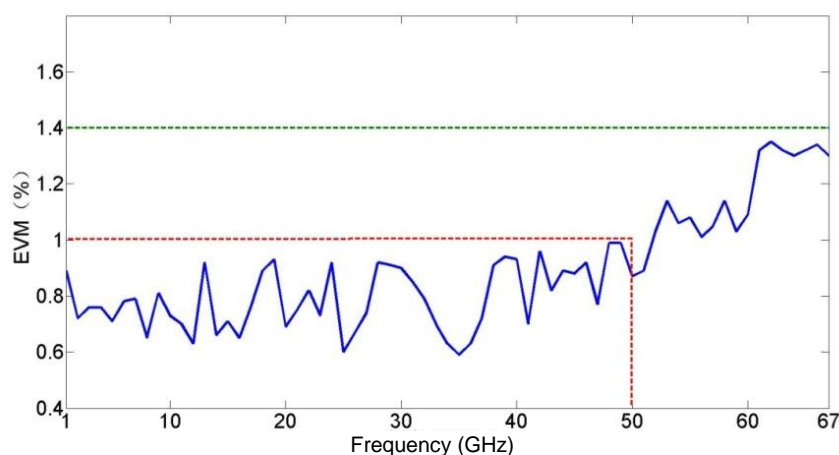

Fig. 2.8 Vector Modulation Accuracy

**6) Universal digital modulation in complete formats**

The 1465-V series supports real-time generation of universal digital modulation signals in more than 20 formats including PSK, QAM, FSK, MSK, etc.

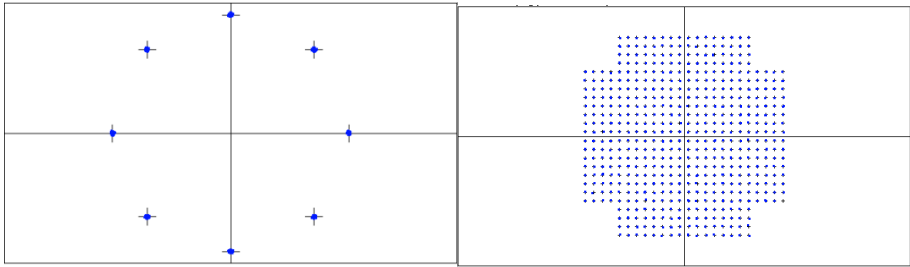

Fig. 2.9 8PSK

Fig. 2.10 512QAM

**7) Complete series of frequency band**

Based on specific demands of different users, the 1465 series signal generator can provide various test plans for upper frequency limits of 3GHz/6GHz/10GHz/20GHz/40GHz/50GHz/67GHz, and there are signal generators of common type and with vector modulation function (-V series) for each frequency band, i.e. totally 14 types of this series. Each type has many options for function and performance extensions. From measuring-level solutions to basic types, whether you only need test signals of RF band or of MMW frequency, we guarantee a suitable one for you.

**2.1.1.3 Flexibility**

**1) Large-screen TFT LED gives graphical display and supports operation by screen touch and front-panel keys.**

The 1465 series signal generator is applied with self-designed software, a large screen and a Chinese/English operation interface to provide a panoramic view of current status information. The interface is of a window-type operation structure, allowing easy operation by keys and screen touch for efficient, flexible and convenient use.



Fig. 2.11(a) Screenshot of Actual Operation Interface

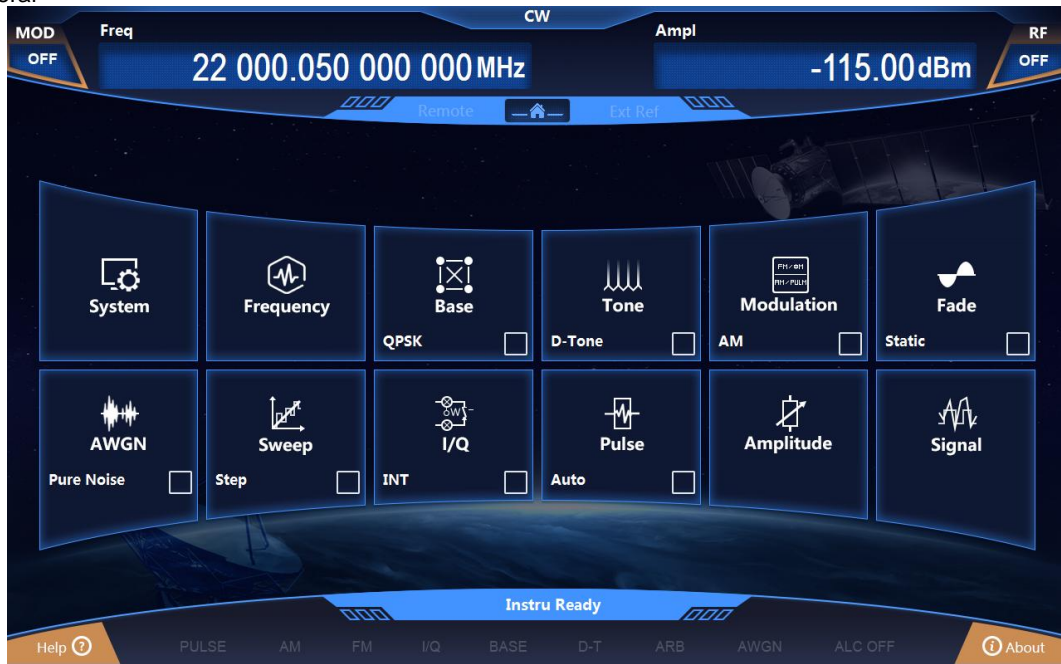

Fig. 2.11(b) Screenshot of Actual Operation Interface

**2) It supports flexible function configurations such as sweep, real-time baseband, etc.**

The 1465 series signal generator supports flexible configurations such as sweep, real-time baseband, and trigger source. The setting of trigger source determines the source of the event triggered, and the setting of trigger mode determines the trigger action after event generation. Through the combination of both, users can generate trigger signals according to actual needs of the test.



Fig. 2.12 Baseband Gating (Low Effective)

**3) Abundant remote interfaces**

There are multiple remote interfaces available for the 1465 series signal generator, including source module port, GPIB port, network port, for easy remote control and network upgrading.

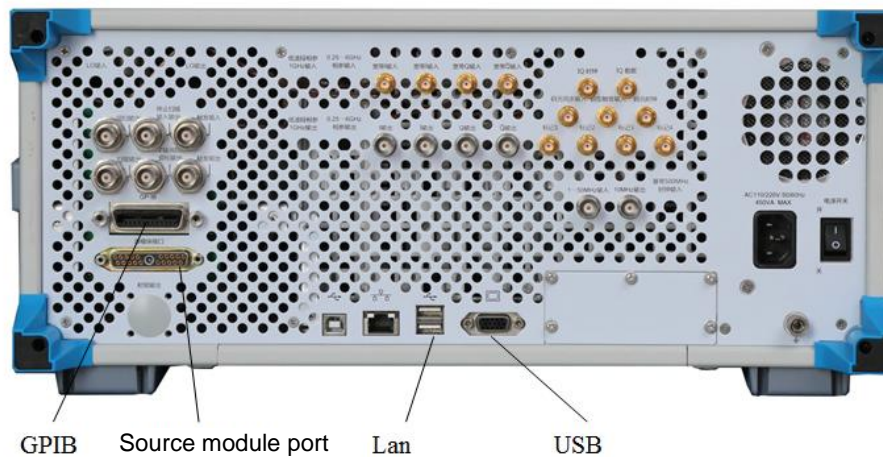

Fig. 2.13 Remote interfaces

### 2.1.2 Typical Applications

#### 1) Building a solid basis for high-reliability satellite communication equipment testing

The 1465-V series can generate high-quality user-defined and basic digital modulation signals within the frequency range of 100kHz ~ 67GHz, and provide repeatable and reliable tests for satellite communication system. The high-bandwidth external vector modulation, self-defined data source and additive noise functions enable users to produce true test signals for product tests.

#### 2) Providing radar equipment and electronic countermeasures system with test signals for different application scenarios.

The 1465-V series has wide frequency range, high resolution (16bit) and excellent signal simulation. In combination with synchronous trigger port with rich functions, it produces complex sequences in various modulation formats by editing waveform segments for different scenarios, in order to simulate complex interference signals in real combat environment to test the radar ECCM performance.

#### 3) Providing accurate arbitrary waveform modulation signals for invisible aircraft systems, high-capacity communication equipment systems and electronic warfare systems (EWS) to meet the current and future market demands.

The 1465-V series has waveform storage up to 2G sampling point to allow designers to obtain long-time test scheme closer to reality. It supports five arbitrary waveform data formats that meet the design requirements of main tool software.

#### 4) High-performance receiver test

With ultra-low SSB phase noise and excellent anharmonic suppression, the 1465 series signal generator can produce ideal pure signals for testing the phase noise, blocking, adjacent channel selectivity of high-performance receivers used in radars, electronic wars and communication equipment.

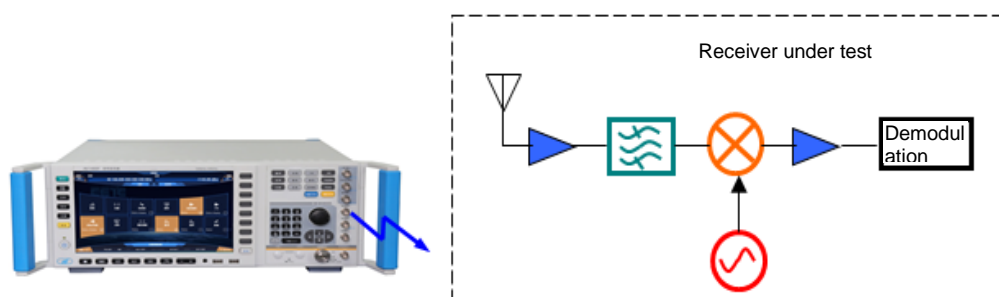

Fig. 2.14 Application of 1465 series signal generator in High-performance Receiver Test

**5) High power device test**

The 1465-D series has output power up to 1W to allow high power devices to be tested without connecting to an external amplifier. Also, it overcomes the test system loss and provides higher signal power accuracy and stability.

**6) Excitation signal and local oscillator substitution**

The 1465 series signal generator has extremely pure signal quality and high output power, making it suitable for signal excitation of various amplifiers and an ideal substitution as a local oscillator for the one in devices under test such as the transmitter, receiver, etc.

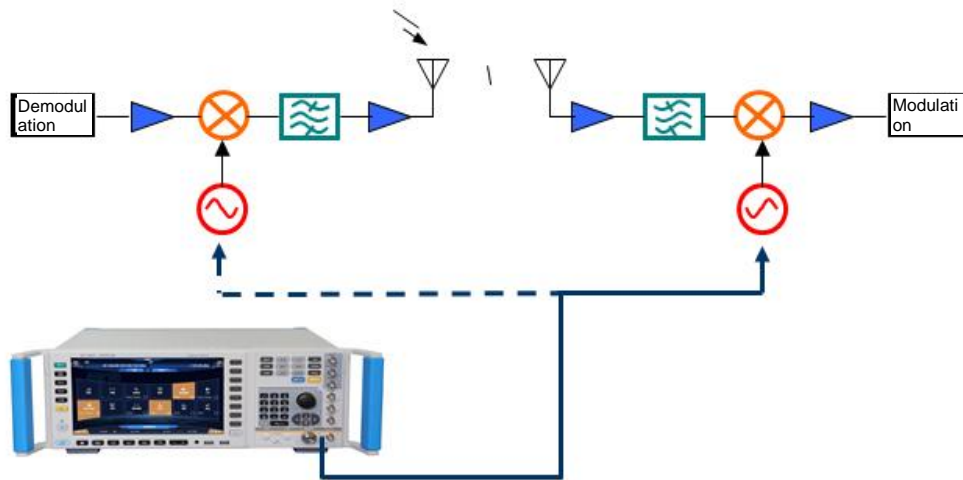

Fig. 2.15 Application of 1465 series signal generator in Local Oscillator Substitution

**2.2 Safety guide**

Please carefully read and strictly follow the precautions below!

We will spare no effort to ensure that all production processes meet the latest safety standards and provide users with the highest security. Our product and its auxiliary equipment have been designed and tested in accordance with relevant safety standards, and a quality assurance system has been established for product quality monitoring to ensure that the product complies with these standards. To keep the equipment in good condition and ensure safe operation, please observe the precautions in this manual. In case of any doubt, please contact us for consultation.

In addition, it is your responsibility to use this product properly. Please carefully read and follow safety instructions prior to use. This product is applicable to measurement in industrial and laboratory environments or on the site. Always remember to use this product within its restricted conditions to avoid personal injury or property damage. Any problems caused by failure to use this product properly or as required are to be accounted by yourself, and we will not bear any responsibility therefrom. **Therefore, please always follow the safety instructions to prevent any risks of personal injury or property damage.** Please keep the basic safety instructions and product document properly and deliver them to the end user.













- [Safety signs .....13](#)
- [Operating status and positions .....14](#)
- [Electrical safety .....14](#)
- [Operation precautions .....15](#)
- [Maintenance .....15](#)
- [Battery or power module .....15](#)
- [Transportation .....16](#)
- [Disposal/environmental protection .....16](#)

## 2.2.1 Safety signs

### 2.2.1.1 Safety signs on the product

The warning signs on the product are given as follows (see Table 2.1):

Table 2.1 Safety Signs on the Product

Symbol	Meaning	Symbol	Meaning
	CAUTION, which indicates information that requires special attention from the user, or operation information or instructions require attention from the user.	○	Power ON/OFF
	ATTENTION, which represents handling of heavy equipment.	⏻	Readiness Indicator
	DANGER! Risk of electric shock.	≡	Direct current (DC)
	WARNING! Risk of scalding.	~	Alternating current (AC)
	Protection of conductive terminal	⎓	Direct/alternating current (DC/AC)
	Ground		Reinforced insulation protection of instrument
	Grounding terminal		EU mark of battery For detailed description, please refer to Paragraph 1 of "2.2.8 Disposal/environmental protection".
	ATTENTION, care should be taken to handle the electrostatic sensitive device.		EU mark of separate collection of electronic device For detailed description, please refer to Paragraph 2 of "2.2.8 Disposal/environmental protection".
	WARNING! Risk of radiation.		

### 2.2.1.2 Safety signs in the manual

For the purpose of this manual, the following safety warning signs are used to remind the user of operating the instrument safely and paying attention to relevant information:

2.2 General



DANGER indicates a situation which, if not being avoided, will lead to personal injury or equipment damage.



WARNING indicates a situation which, if not being avoided, will lead to personal injury or equipment damage.



CAUTION indicates a situation which, if not being avoided, will lead to minor or moderate personal injury or equipment damage.



ATTENTION indicates an important information rather than a danger.



NOTE indicates information about the instrument and its operation.

2.2.2 Operation status and position

Before instrument operation, please pay attention to the followings:

- 1) Unless otherwise indicated, the environment where the instrument is operated shall reach Grade 3 according to GJB3947A-2009. Non-working temperature:  $-40^{\circ}\text{C} \sim +70^{\circ}\text{C}$ ; working temperature:  $0^{\circ}\text{C} \sim 50^{\circ}\text{C}$ ; relative humidity: (5%~95%)  $\pm 5\% \text{RH}$ ; random vibration: Frequency 5 ~ 100 Hz, PSD  $0.015\text{g}^2/\text{Hz}$ ; frequency 100 ~ 137Hz, slope -6dB; frequency 137 ~ 350Hz, PSD  $0.0075\text{g}^2/\text{Hz}$ ; frequency 350 ~ 500Hz, slope -6dB; frequency 500Hz, PSD  $0.0039\text{g}^2/\text{Hz}$ ; function impact: 20g half-sine shock; drop when inclined: Taking one side as the fulcrum, lift the opposite side of the base by 10cm to let it free fall on the test bench.
- 2) Do not place the instrument on a surface with water or an unfixed item such as a car, cabinet, table or others not meeting the weight condition. Please place and fix the instrument reliably on the surface of a solid object (e.g. anti-static workbench).
- 3) Do not place the instrument on the surface of a radiating object (e.g. radiator). The ambient temperature in which the instrument works should not exceed the value given in the section regarding description of relevant indicators of the product. Overheating of the product will result in electric shock, fire and other hazards.
- 4) Warm-up: in the event of cold start, warm up the instrument for 30min; at a stable ambient temperature, warm up for 2h to reach internal temperature equilibrium. Warm up the instrument by keeping it at ambient temperature for 2h, and perform calibration, then all the performance indicators shall be satisfied.

2.2.3 Electrical safety

Electrical safety precautions of the instrument:

- 1) Before turning on the instrument, ensure that the supply voltage matches the indicated supply voltage of the apparatus.
- 2) With reference to the power requirements on the instrument's rear panel, a three-core power cord is used to ensure reliable grounding of the power wire during use. Poor floating or grounding may cause damage to the instrument or harm to the user.
- 3) Do not damage the power cord; otherwise leakage will occur, which may damage the instrument and even cause injury to the operator. If an external power cord or terminal board is used, check it before use to ensure the electrical safety.
- 4) If the power outlet is not equipped with ON/OFF switch, the instrument can be directly unplugged for deenergization. For this purpose, it is necessary to ensure that the instrument can be plugged and unplugged conveniently.
- 5) Do not use a damaged power cord. It is necessary to check the integrity and safety of the power cord before connecting it to the instrument, and place it reasonably to avoid the influence due to human factors, e.g. the operator is tripped by an excessively long power cord.



**2.2 General**

- 6) The outlet should be kept clean and tidy, and the plug and outlet should be contacted properly and firmly.
- 7) The outlet and power cord should not be overloaded; otherwise, fire or electric shock will be caused.
- 8) Unless otherwise permitted, the instrument enclosure should not be opened; otherwise, the internal circuits and components will be exposed, causing unnecessary damage or injury.
- 9) If the instrument needs to be fixed at the test site, a protective ground wire should be installed between the test site and the instrument by a qualified electrician.
- 10) Appropriate overload protection measures should be taken to avoid instrument damage or personal injury caused by overload voltage (in the event of lightning for example).
- 11) When the instrument enclosure is opened, do not place other foreign objects into the case; otherwise a short circuit may be easily caused, resulting in instrument damage or personal injury.
- 12) Unless otherwise stated, the instrument not subject to waterproof treatment should not be exposed to liquid, lest instrument damage or even personal injury should occur.
- 13) Do not place the instrument in an environment that is prone to fogging. For example, if the instrument is moved in an alternate cooling and heating environment, water droplets will be formed on the instrument, causing electric shock and other hazards.

**2.2.4 Operation precautions**

- 1) The instrument operator should have certain professional technical knowledge, good psychological quality and certain ability of emergency response.
- 2) Before moving or transporting the instrument, please refer to the relevant instructions in “2.2.7 Transport” of this section.
- 3) If the instrument operator suffers from allergy (e.g. rash, frequent sneezing, red eyes, or breathing difficulty) during operation due to the inevitable use of substances (such as nickel) that may cause personal allergy in the process of production of the instrument, please seek medical advice promptly to find the cause and resolve the symptom.
- 4) Before disassembling the instrument for disposal, please refer to the relevant instructions of “2.2.8 Disposal/environmental protection” of this section.
- 5) As the radio frequency instrument will produce a high level of electromagnetic radiation, a pregnant woman and an operator with a heart pacemaker need special protection. If the radiation level is high, appropriate measures can be taken to remove the radiation source to avoid personal injury.
- 6) The instrument will release toxic substances once catching fire. For this reason, the operator should wear suitable PPEs (such as protective mask and cloth), just in case.
- 7) EMC grade: instruments with option H90 shall meet the requirements of 3.9.2 in GJB 3947A-2009, and those without H90 meet the requirements of 3.9.1 in GJB 3947A-2009.

**2.2.5 Maintenance**

- 1) Other persons than those authorized technicians who have received professional technical trainings are not allowed to open the instrument case. Before performing such operation, it is necessary to disconnect the power cord to prevent instrument instrument or even personal injury.
- 2) The instrument should be repaired, replaced or maintained by a professional electronic engineer designated by the manufacturer. The replaced and maintained part should be subject to safety test to ensure safe use of the product in the future.

**2.2.6 Battery or power module**

- 1) The instrument has power consumption of 400W maximum, supply of 50Hz ~ 60Hz and single phase of 110V or 220V adaptive. The steady-state power conditions meet the requirements of 3.5.1.3 in GJB3947A-2009, and the permissible range of steady-state voltage and frequency is

2.2 General

$\pm 10\%$  and  $\pm 5\%$  of the rating, respectively.

2.2.7 Transportation

- 1) If the instrument is heavy, please move it carefully, and if necessary, use an aid (such as crane) to move the instrument so as to avoid body damage.
- 2) The instrument handle is suitable for personal handling, and it should not be used to fix the instrument on the carrier for transportation. To prevent property damage or personal injury, please transport the equipment based on the safety regulations specified by the manufacturer.
- 3) When operating the equipment on a transport vehicle, the driver must be cautious to ensure the safety of transport. The manufacturer is not responsible for any unforeseen circumstances during the transport process. Therefore, please do not operate the apparatus when it is being transported. In addition, safety measures should be reinforced in order to ensure that the product is transported safely.

2.2.8 Disposal/environmental protection

- 1) Please do not dispose of equipment marked with batteries or rechargeable batteries with unsorted waste. These wastes should be individually collected and disposed of at an appropriate collection point or through the customer service center of the manufacturer.
- 2) Please do not dispose of electronic equipment with unsorted waste. These wastes should be individually collected. The manufacturer has the right and responsibility to aid the end user in managing waste products. If necessary, please contact the customer service center of the manufacturer for the corresponding procedures in order to avoid environmental harm.
- 3) When the product or the internal components are subjected to mechanical or thermal reprocessing, toxic substances may be released (e.g. lead, niobium, nickel, etc.) To avoid causing harm to the user, the equipment must only be disassembled by technical personnel who have received professional training and have the relevant experience in handling the equipment.
- 4) During reprocessing, the product may release toxic material or fuel. Please refer to the operational safety procedures outlined by the manufacturer and use specific measures for processing in order to avoid causing harm to the user.

## 3 Start Guide

This chapter contains precautions before use, overview of front and rear panels, common basic configuration methods and data file management of 1465 series signal generator, so that the user can have a preliminary knowledge about the instrument and configuration process. The content contained in this chapter is consistent with that in relevant chapters of Quick Start Guide.

- Preparations Before Use .....17
- Description of front and rear panels .....33
- Basic configuration methods .....37
- Data management .....58

### 3.1 Preparation before Use

- Preparations before operation .....17
- Configuration system configuration .....27
- Routine maintenance .....32

#### 3.1.1 Preparations before operation

This chapter introduces the precautions before initial setting and use of the 1465 series signal generator.

#### **WARN**

##### **Damage prevention**

To avoid the electric shock, fire and personal injury:

- Do not open the chassis without authorization;
- Do not attempt to dismantle or modify any part not described in this manual. Improper removal may cause the deterioration of electromagnetic shielding effectiveness, damage of internal parts, etc. and affect the reliability of product. If the product is under warranty, we will no longer provide the unpaid repairs.
- Carefully read the relevant content in “2.2 Safety guide” and the following precautions for operational safety, and pay attention to the specific operating environment requirements involved on the data page.

#### **CAUTION**

##### **ESD protection**

Pay attention to the ESD protection measures in the workplace to avoid the damage to instrument. For details, please refer to the relevant content in “2.2 Safety guide”.

**CAUTION****During instrument operation, please pay attention to the following aspects:**

An improper operating position or configuration setting can damage the instrument or appliances connected to it. Before powering on the instrument, please pay attention to the followings:

- Ensure that the fan blades and vents are unobstructed and keep the instrument at least 10 cm away from the wall.
- Keep the instrument dry;
- Place the instrument horizontally and reasonably;
- Ensure that the surrounding temperature is in accordance with the requirements on the reference data page.
- Ensure that the port input signal power is within the indicated range;
- Ensure that the signal output port is properly connected and isn't overloaded.

**NOTE****Effect of electromagnetic interference (EMI):**

The electromagnetic interference can affect the configuration results, therefore, it is necessary to:

- select appropriate shielded cables, For example, use RF shielded twisted pair/network connection cable.
- Close the opened and temporarily unused cable connection port or connect the matched load to the connection port in time;
- Take note of the electromagnetic compatibility (EMC) grade in the reference data pages.

●	<a href="#">Unpacking .....</a>	<a href="#">18</a>
●	<a href="#">Environmental requirements .....</a>	<a href="#">19</a>
●	<a href="#">Power on/off .....</a>	<a href="#">20</a>
●	<a href="#">Correct use of connectors .....</a>	<a href="#">23</a>
●	<a href="#">User checks .....</a>	<a href="#">26</a>

**3.1.1.1 Unpacking****1) Visual inspection**

**Step 1 Check if there is any damage in the outer packaging and the anti-vibration packaging of the instrument. If no damage is found, keep the packaging in case of future need and continue the inspection**

as per the following steps.

**Step 2 Unpack the instrument and check for any damage to the main unit and attached items.**

**Step 3 Verify the items in the packaging box carefully by cross-checking with Table 3.1;**

**Step 4 If the outer packing box, instrument or any attached item is damaged or incorrect, it is forbidden to power on!** Please contact our service center via the service hotline indicated on the cover, and we will make repairs and replacements rapidly based on individual circumstances.

**CAUTION**

**Handling:** As the instrument and its packing carton are heavy, they should be moved by two persons at the same time and be handled with care.

**2) Model confirmation**

Table 3.1 Packing List of Series 1465

Name	Quantity	Function
<b>Main unit:</b>		
◇ 1465	1	—
<b>Standards:</b>		
◇ 3-core power cord	1	
◇ User Manual	1	—
◇ Programming Manual	1	—
◇ Packing list	1	—
◇ Certificate of Conformity	1	—

**3.1.1.2 Environmental requirements**

The operating place of the 1465 series signal generator should meet the following environmental requirements:

**1) Operating environment**

The operating environment should satisfy the following requirements:

Table 3.2 Requirements for Operating Environment of Series 1465

<b>Temperature</b>	0°C ~ 50°C
<b>Humidity</b>	For <+29°C, range of measured value of hygrometer: 20% ~ 80% (uncondensed)
<b>Altitude</b>	0 ~ 4,600 m (0 ~ 15,000 ft)
<b>Vibration</b>	Max. 0.21 g, 5 Hz ~500 Hz

**CAUTION**

The above environmental requirements are only defined for the operating environment of the instrument and are not within the scope of specifications.

**2) Radiation requirements**

To ensure that the operating environment temperature of the instrument is within the required range, the following radiation requirements should be met:

Table 3.3 Cooling Requirements

Instrument Part	Radiation Distance
Rear part	≥180 mm
Left and right parts	≥60 mm

## 3.2 Description of front and rear panels

**3) ESD protection**

The static electricity is destructive to electronic components and equipment. Generally, we will use two anti-static measures, including combination of conductive table mat and wrist combination as well as combination of conductive floor mat and ankle strap. If these two combinations are used together, a good anti-static protection can be provided. If the combination is used separately, only the former can provide protection. For the safety of users, anti-static components must provide an isolation resistance of at least 1 MΩ to the ground.

Please correctly use the following anti-static measures to reduce electrostatic damage:

- Ensure that all instruments are correctly grounded to prevent electrostatic generation.
- Before connecting the coaxial cable to the instrument, contact its inner and outer conductors with the ground temporarily;
- The staff shall wear anti-static wrist straps or adopt other anti-static measures before contacting joints and core wires or carrying out any assembly operation.

**Operating voltage range**

The above anti-static measures can't be taken in a place where the voltage exceeds 500 V.

**3.1.1.3 Power on/off****1) Precautions before power-on**

It is necessary to check the following items before powering on the instrument:

**a) Confirmation of power supply parameters**

The 1465 series signal generator features an 110V/220V adaptive AC power module which allows either one to be used optionally. In this case, the AC power module is self-adaptive, that is, it automatically switches the operating state according to external AC supply voltage. Therefore, please look through the power requirements of rear panel before using the instrument. Table 3.4 lists the requirements for external power supply when the signal generator is in normal operation.

Table 3.4 Requirements for Working Power Supply Parameters

Power Supply Parameter	Applicable Scope			
Voltage, frequency	220V±10%, 50 ~ 60Hz		110V±10%, 50 ~ 60Hz	
Rated output current	>3A		>6A	
Power consumption (power-on)	Basic configuration	All configuration	Basic configuration	All configuration
	<300W	<400W	<320W	<400W
Power consumption (standby)	<20W		<20W	

**NOTE****Prevention against mutual interference of power supplies**

To avoid instrument hardware damage caused by the interference by the power supply of other equipment, especially the spike pulse interference generated by high-power equipment, it is recommended to use a 220 V or 110 V AC regulated power supply to power the signal generator.

### b) Confirmation and connection of power cord

The 1465 series signal generator uses a 3-core power cord interface that complies with the national safety standard. Before the signal generator is powered on, it must be confirmed that the protective ground wire of the power cord has been reliably grounded. Floating or poor grounding may damage the instrument and even injure the operator. It is prohibited to use a power cord without a protective ground. When connected to a suitable power socket, the power cord realizes grounding of the instrument enclosure. The power cord should have a rated voltage greater than or equal to 250 V and a rated current greater than or equal to 6A.

When connecting the instrument to the power cord:

**Step 1. Confirm that the power cord is undamaged;**

**Step 2. Use the power cord to connect the rear panel power plug and the properly-grounded 3-core power socket.**



#### Grounding

Poor or incorrect grounding may cause instrument damage and even personal injury. Before powering on the signal generator, make sure that the ground wire is in good contact with the power supply ground wire.

Please use the power socket with a protective ground. Do not replace the protective ground wire with an external cable, power cord or autotransformer without grounding protection. If an autotransformer is required, the common terminal must be connected to the protective ground of the power connector.

### 2) First power-on

The methods and precautions for instrument power-on/power-off are as follows:

#### a) Connection of power supply

Before power-on for the first time, please conform the power supply parameters and power cord. For details, please refer to the section "3.3.1.1.3 Precautions before power-on" in this manual.

**Step 1: Connect the power cord.** Use the power line in the packing box that matches with the instrument or an acceptable three-core power line. Connect one end to the power socket of rear panel (see Fig. 3.1) (the required voltage parameter indicators are indicated near the power socket to remind users to use acceptable voltage) and the other end to acceptable AC power.

**Step 2: Turn on the rear panel power button:** As shown in Fig. 3.2, observe that STANDBY indicator lamp above the front panel power button (see Fig. 3.3) turns yellow.

**Step 3: Turn on the front panel power button:** As shown in Fig. 3.3, do not connect any device to the instrument before powering it on. Do not power on the instrument until all goes well. Then, the indicator lamp above the front panel power button will turn green.



Fig. 3.1 Power Socket

Fig. 3.2 Rear Panel Power Button

Fig. 3.3 Front Panel Power Button

3.2 Description of front and rear panels

**b) Power-on/off**

**i. Power-on**

**Step 1: Turn on the rear panel power button (“I”);**

**Step 2: Turn on the power button at the bottom left corner of front panel (see. Fig. 3.3), now the power indicator lamp above the power button will turn from yellow to green.**

**Step 3: The front panel UI will gradually display the information about the startup process:**

First it briefly displays the manufacturer information and then enters the operating system menu. There are two options in this menu. Normally, users do not have to operate the menu. Windows 7 automatically starts up when the timer counts up to 0.

**Step 4: After successful startup, Windows 7 automatically runs the initializer to show the main operating interface.**

**Now the instrument is operational.**

---

**NOTE**

**10MHz time base and warm-up**

In the event of cold start, warm up the instrument for a period of time in order to make 10MHz time base is at the operating temperature. There is no need to warm up the instrument when starting it from the standby state. To perform the indicator test, warm up the instrument for 0.5h in advance. (For details, please refer to the relevant instructions in the specifications).

---

**NOTE**

**Initialization of attenuator**

After entering the host program, a sound of position setting can be heard during initialization of the attenuator, in this case, do not mistake it for instrument malfunction.

---

**CAUTION**

**System startup**

Windows + x86 control platform is adopted to eliminate the need for user intervention, turning off the power and modifying the settings in BIOS during BIOS self test and Windows loading.

**ii. Power-off**

**Step 1: Turn off the power button at the bottom left corner of front panel (see. Fig. 3.3), now the instrument enters the power-off process (power shall not be turned off until software and hardware are processed) and power is turned off after a few seconds. In this case, the power indicator lamp above the power button turns from green to yellow.**

**Step 2: Turn off the rear panel power button (“O”) or disconnect the power connection.**

**The instrument is switched off.**



**CAUTION****Power-off**

When the instrument is in normal working status, it can only be powered off through operation of the front panel power button. **Do not directly turn off the rear panel power button or disconnect the power connection to the instrument, or else, the instrument cannot enter normal shutdown mode and will be damaged, or lose its current status/configuration data. Please correctly power off the instrument.**

**c) Disconnection of power supply**

In an emergency, immediately cut off power in order to avoid personal injury. Just unplug the power line from AC power socket or rear panel power socket. To this end, leave ample working space for operating the instrument to directly cut off power when necessary.

**3.1.1.4 Correct use of connector**

Connectors are frequently used in various tests. Although connectors of calibration kits, testing cables and analyzer measuring ports are designed and manufactured in accordance with the highest standard, yet all of them have limited useful life. Wear is unavoidable in normal use and can make the connector performance degrade or even unable to meet the measurement requirement, therefore, correct maintenance and measurement connections not only provide accurate and repeatable measurement results but also prolong the useful life, reduce the measurement cost. Note the following aspects during actual use:

**1) Check of connectors**

It is necessary to wear an anti-static wrist strap when checking the connectors. It is recommended to use a magnifier to check:

- 1) the electroplated surface for wear and deep scratches;
- 2) the thread for deformation;
- 3) the thread and joint surface for metallic particles;
- 4) the inner conductor for bending and breakage;
- 5) the screw for improper rotation.

 **CAUTION****Check the connectors so as not to damage the instrument ports**

Any damaged connector may damage the good one connected to it even if it is connected for the first time. To protect the ports of the signal generator, it is necessary to check the connectors before operating them.

**2) Connection**

The connectors should be checked and cleaned before measurement and connection to ensure that they are clean and undamaged. It is necessary to wear an anti-static wrist strap during connection. The correct connection methods and procedures are as follows:

**Step 1. As shown in Fig. 3.4, align the axis of both devices to be connected to ensure the pins of male connector can concentrically slide into the holes of female connect;**



Fig. 3.4 Coaxial Alignment of Interconnected Connectors

Step 2. As shown in Fig. 3.5, move both connectors straight together, so that they can be connected smoothly; rotate the threaded sleeve of connector (rather than the connector itself) until it is tightened; during connection, there can be no relative rotary motion both connectors;

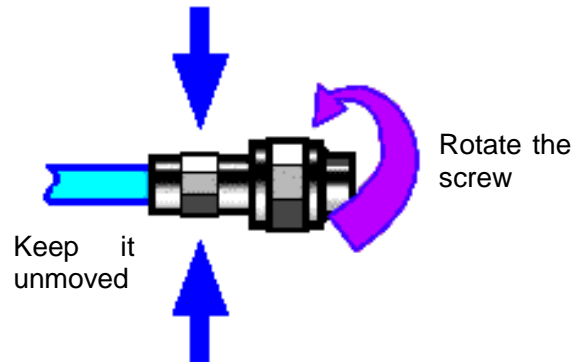

Fig. 3.5 Connection

Step 3. As shown in Figure 3.6, use a torque wrench to complete the final connection. It should be noted that the torque wrench should not exceed the starting kick point. An auxiliary wrench can be used to prevent the connectors from rotation.

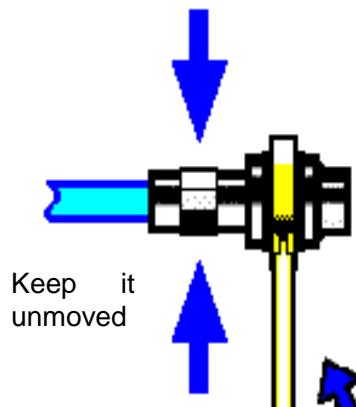

Fig. 3.6 Completion of Final Connection with a Torque Wrench

### 3) Disconnection

**Step 1. Support the connectors to prevent any of the connectors from being twisted, shaken or bent;**

**Step 2. Use one open end wrench to prevent the main body of the connectors from rotating;**

**Step 3. Use another wrench to loosen the screw on the connector.**

**Step 4. Loosen the screw by hand until the connection is completely broken.**

**Step 5. Separate the connectors by pulling them apart in parallel.**

### 4) Use of the torque wrench

The torque wrench should be used as indicated in Figure 3.7. Please pay attention to the following points when using the torque wrench:

- Confirm that the torque of the torque wrench is set correctly before use;
- Ensure that the angle between the torque wrench and the other wrench (used to support the connector or cable) is less than  $90^\circ$  before applying a force;
- Gently grasp the end of the torque wrench handle and apply a force in the direction perpendicular to the handle until the breakout torque of the wrench is reached.

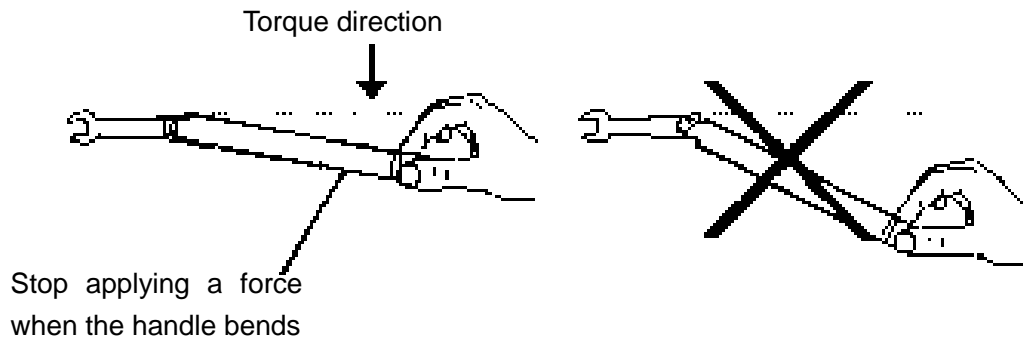

Fig. 3.7 Use of Torque Wrench

### 5) Use and preservation of connectors

- a) Protect the connectors with a protective sheath when not used;
- b) Do not place the various connectors, air lines and calibration standards disorderly in a box; otherwise the connectors will be damaged;
- c) Keep the connector and analyzer at the same temperature. If the connector is held by hand or cleaned with compressed air, the temperature will be significantly changed. The connector can be used for calibration only after its temperature is stabilized;
- d) Do not touch the joint surface of the connector because it is difficult to remove skin oil and dust particles from the joint surface;
- e) Do not place the contact surface of the connector downwards onto a hard surface; otherwise, the electroplated layer and joint surface of the connector may be damaged.
- f) Wear an anti-static wrist strap and work on a grounded conductive workbench mat to protect the analyzer and connector against electrostatic discharge.

### 6) Cleaning of connectors

It is necessary to wear an anti-static wrist strap when cleaning the connectors as per the following steps:

- a) Use clean low-pressure air to remove the loose particles on the thread and joint surface of the connector and check the connectors thoroughly. If further cleaning is required, proceed as follows;
- b) Wet (but not soak) a lint-free cotton swab with isopropyl alcohol;
- c) Use a cotton swab to remove dirt and debris from the joint surface and thread of the connector. When cleaning the inner surface, be careful not to apply an external force to the central inner conductor or leave the cotton swab fibers on the central conductor of the connector;
- d) Evaporate the alcohol and then blow the surface clean with compressed air;
- e) Check the connectors to confirm that they are free of particles and residues;
- f) If the connector still has visible defects after cleaning, it indicates that the connector may be damaged. Never use a damaged connector, and confirm the causes of damage before measurement and connection.

### 7) Use of adapter

When the measuring port of analyzer is different from the type of connector used, an adapter must be adopted for measurement connection. In addition, even if the measurement port of the analyzer is the

## 3.2 Description of front and rear panels

same as the type of connector for the port of tested part, it is also a good idea to use an adapter. Under these two conditions, the measuring port can be protected, thus extending its service life and reducing the maintenance cost. Before connecting the adapter to the measuring port of analyzer, it should be carefully checked and cleaned. A high-quality adapter should be used to reduce the impact of mismatch on the measurement accuracy.

### 8) Joint surface of connector

An important concept in microwave measurement is the reference surface for all measurement. In the case of calibration, the reference surface is defined as the surface on which the measuring port and the calibration standard are jointed. Proper connection and calibration depend on whether the connectors can be completely and straightly contact with each other at each point of the joint surface.

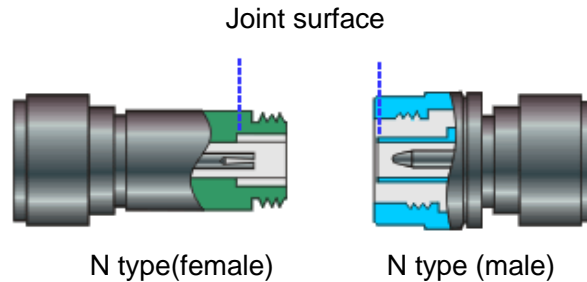

Fig.3.8 Calibration Surface

#### 3.1.1.5 User checks

After the initial power-up of the 1465 series signal generator, it is necessary to check whether the instrument is functioning properly in order to continue measurements.

### NOTE

#### Instructions on using the hard keys on the front panel and the soft menu keys.

- 1) Hard key: **【XXX】** , XXX denotes the name of the hard key.
- 2) Soft key: Soft key: [XXX], XXX denotes the name of the soft key

#### 1) Self-test

Power on the 1465 series signal generator, and check that the power indicator lamp above the power button at the bottom left corner of front panel turns yellow, now the standby power supply is working properly. Press the power button on the front panel, observe that the power indicator lamp on the front panel turns green and the display backlight lights up, and wait for about 30 s to display the power-on status interface.

After warming up the signal generator for 10min, set it by following the steps below:

**Step 1. Press the **【System】** key on the front panel or click the **[System]** function area on the interface to enter the system menu;**

**Step 2. Select **[Instrument Self Test]** in the self test option;**

**Step 3. In the pop-up Self Test Config Dialog, select self test items and click **[Start Test]**, then observe the test result:** If the test is successful, a message “All pass self test” will be displayed, indicating the instrument is working properly; if not, a message “Self test failed in XX” will be displayed, indicating the instrument is not working properly. In this case, contact our service consultation center via the contact provided on front cover II or in “7.4 Repair method” for quick repair or replacement depending on the situation.

#### 2) Functional verification

Start and warm up the instrument for at least 30min, and apply a matched load to RF output. Set the

instrument as below:

**Step 1.** Press the **【Amplitude】** key on the front panel or click the [Amplitude] function area on the interface to enter the Power menu and set the power to 0dBm in the pop-up Power Parameter Setting Dialog.

**Step 2.** Press the **【Frequency】** key on the front panel or click the [Frequency] function area on the interface to enter the Frequency menu and set CW to 100MHz in the pop-up Frequency Parameter Setting Dialog.

**Step 3.** Press the **【RF ON/OFF】** key on the front panel or click the [RF] function area on the interface to turn on the RF output;

**Step 4.** Press the arrow keys on the front panel to set the frequency in increments of 100MHz until the maximum value is reached. Then observe whether there is any alarm indication in the alarm indication zone on the front panel display. If not, it means the instrument is working properly; otherwise, the instrument is not functional normally, in such case, please contact our service consultation center via the contact provided on front cover II or in “7.4 Repair method” for quick repair or replacement depending on the situation.

### 3.1.2 Configuration of operating system

This chapter introduces the operating system and methods of configuration and maintenance of the 1465 series signal generator. To ensure that software is functional properly, please refer to the following notes about the operating system:

- [Description of instrument software](#) .....27
- [Windows 7 usage](#) .....27
- [Windows 7 configuration](#) .....28
- [Windows 7 safety and maintenance](#) .....30
- [System backup and recovery](#) .....31

#### 3.1.2.1 Description of instrument software

The host software of the 1465 series signal generator works with Windows 7 and has been installed and configured according to the requirements for instrument features. The host software is based on Windows 7 and has been installed before delivery.

#### 3.1.2.2 Windows 7 usage

The administrator account has the permissions to:

- install third-party software;
- configure network and printer;
- read and write any files on the hard disk;
- add and delete user accounts and passwords;
- reconfigure Windows settings;
- run other applications.

## CAUTION

### Third-party software may affect the instrument's performance:

1465 series signal generator is equipped with open Windows environment, and installing other third-party software may affect the signal generator's performance. Only software tested by the manufacturer and compatible with the main unit software can be run.

**3.1.2.3 Windows 7 configuration**

Before delivery, the operating system of 1465 series signal generator has been optimized to the best configuration, and any changes in the OS settings may cause a decrease in the performance of the instrument. Generally, no changes need to be made for Windows OS settings.

**CAUTION**

**Change of system settings may cause problems:**

In case that the any problems in use of the instrument or system crash due to changes of system settings, users can use the system recovery tool of the instrument to recover the OS and applications, or contact our service hotline provided in the Foreword of this manual and we will solve the problems as quickly as possible.

**CAUTION**

**The BIOS settings cannot be changed**

As the signal generator has been set in BIOS, the user should not modify the settings in BIOS, otherwise it will cause abnormal startup or operation of the instrument.

In order to facilitate the measurement reporting and system integration, user can change the following items as needed.

- [Configuring USB equipment](#).....28
- [Configuring GPIB](#).....29
- [Configuring network](#).....29

**1) Configuring USB equipment**

The 1465 series signal generator is provided with USB ports on front and rear panels for connecting USB devices directly. If there are no enough USB ports, USB hubs may be used to meet the demands.

USB equipment which can be connected include:

- Hot-plug USB memory for updating data;
- CD-ROM drive for installing firmware and programs;
- Keyboard and mouse for editing data and operating the instrument;
- Printer for outputting measurement results.

The Windows 7 operating system supports plug-and-play devices, so it is convenient to install USB devices, and when a device is connected to USB port, Windows 7 will automatically search for matching device drivers. If no available driver is found, the system will prompt to find the driver directory to complete the installation.

If the USB equipment is removed from the USB port, Windows 7 will automatically detect a change to the hardware configuration and unload the relevant driver. Insertion or extraction of USB equipment does not affect the operating state of the instrument.

The USB equipment shall be connected as follows:

**a) Connecting memory or CD-ROM drive**

If the memory or CD-ROM drive is installed successfully, Windows 7 system will prompt “The device has been installed successfully and is ready to use” and automatically display the path name and prompt (e.g. “F:”).

### b) Connecting keyboard

Windows 7 will automatically detect the USB keyboard connected and set the input language to default “Chinese (China) – Simplified Chinese – American Keyboard”. The keyboard properties can be configured through “Begin > Control Panel > Clock, Language and Region > Region and Language > Change Keyboard or Other Input Method”.

### c) Connecting mouse

Windows 7 will automatically detect the mouse connected to the instrument. The mouse properties can be configured through “Begin > Control Panel > Hardware and Sound > Devices and Printers > Mouse”.

### d) Printer

Use Windows Control Panel to configure printers. Using an external USB mouse and an external USB keyboard makes the printer configuration easier. If you need to install a new printer, you only need to install the printer’s driver. The printer manufacturer will provide the printer installer. You can also install the driver through the external USB optical drive.

## 2) Configuring GPIB

The user may need to modify the GPIB address when building a system with a signal generator. The GPIB address of the machine is 19 by default.

The method to change the GPIB address is as follows:

Press the **【System】** key on the front panel or click the [System] function area on the screen to select [GPIB Port] and enter an interface as shown in Fig. 3.9. Then modify the address in GPIB address bar in the Configuration Dialog by using number keys on the front panel or touching the screen.

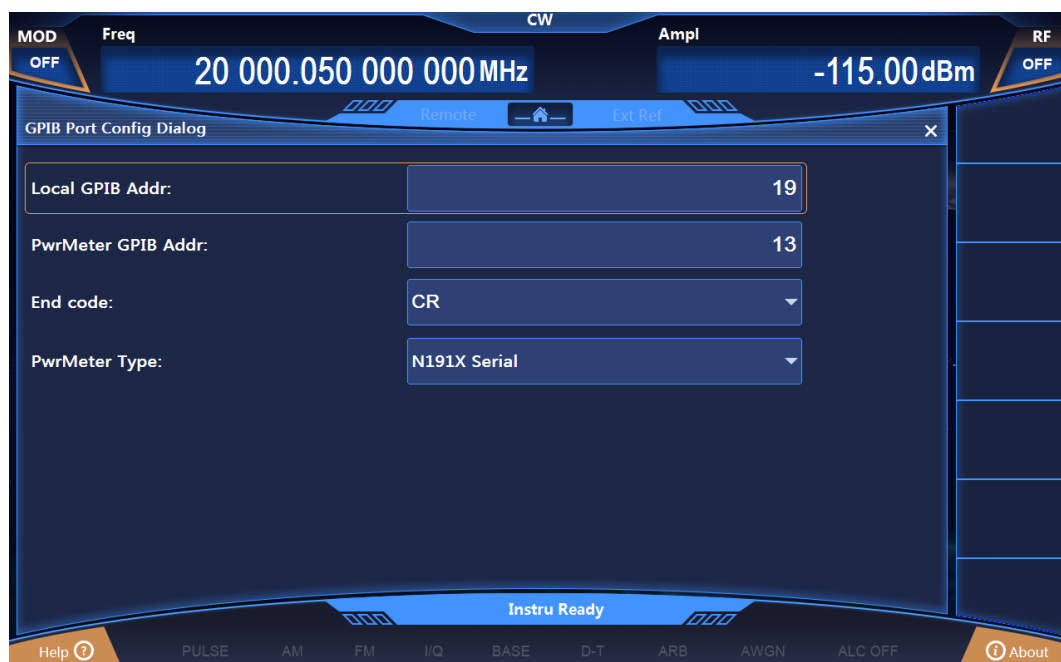

Fig. 3.9 GPIB Port Setting

## 3) Configuring network

### a) Changing host name

The host name (computer name) of 1465 series signal generator is preset as “41-PC” before delivery. To avoid duplication of name in a network, users can change the host name at their own discretion when multiple instruments are connected in a network. The host name shall be changed by following the steps below: (or by reference to Microsoft Windows 7 help document.)

**Step 1: Press the **【System】** key or click the [System] function area on the screen to select**

## 3.2 Description of front and rear panels

[LAN Port] and enter the Network Properties Setting page as shown in Fig. 3.10, where the current LAN “Host Name” is displayed.

**Step 2. Edit and enter a new host name, and close the current dialog.**



Fig. 3.10 LAN Port Configuration

### b) Configuration of IP Address, Subnet Mask and Default Gateway

The IP address and gateway are preset to be automatically obtained as default before delivery. The IP address, subnet mask and default gateway can be changed manually. The IP address, subnet mask and default gateway can be changed in the dialog shown in Fig. 3.10, as detailed in the steps in the above “a) Changing the host name” or by reference to Microsoft Windows 7 help document.

### c) Changing system firewall settings

The firewall is used to prevent unauthorized users from operating the instrument remotely. Therefore, it is recommended by the manufacturer to open the firewall protection. The firewall protection connected to the system and all ports related to remote operation is enabled before delivery.

Only the administrator has the permission to change the firewall settings.

#### 3.1.2.4 Windows 7 system security and maintenance

##### 1) Antivirus software

Installing antivirus software may have some negative effects on the performance of the instrument, and it is strongly advised that users do not to use the instrument as a common computer to browse or transfer documents so as not to get infected with virus.

Before using USB mobile storage devices, a computer with the latest antivirus software should be used to process these mobile devices to kill virus may exist and ensure that they do not become a viral carrier.

Once the system platform of the signal generator is infected with viruses, the viruses will have a negative impact on the operation and use of the instrument. It is recommended that the user should carry out the system recovery in such a case. See “2) System maintenance” for the system recovery operations.

##### 2) System maintenance

###### a) Windows 7 Backup

It is suggested that the user should backup the system regularly, and the instrument data and



system can be completely backed up by using the "System Recovery Tool" of this instrument. For the specific operation, refer to "System Backup and Recovery" .

Before using the instrument for other purposes other than normal use such as long-term Internet connection and installing third-party software, it is recommended to backup the instrument system to avoid accidental infection of virus and other operations harmful to the system.

The Windows 7 operating system has the same data backup function that can backup all data on the instrument and create a system disk that can be used to restore Windows in case of serious failure. For more information, refer to the Help and Reference functions of Windows 7. Additionally, third party backup software can be used, but there is a need to ensure that this software does not conflict with the instrument's system software. It is recommended to backup the system data on external devices such as a network hard drive or USB hard drive.

#### **b) Windows 7 system recovery**

Windows 7 has the system recovery function that can restore the system to the state of a previous moment. However, the built-in system backup recovery function of Window cannot work successfully every time, so it's not recommended to use this backup program.

#### **3) Partitions and use of hard disk**

The hard disk has three partitions: "C:", "D:" and "E:".

Disk C is a system disk containing Windows 7 operating system.

Disk D stores the instrument applications and data. It can also install third-party software to disk D. Disk D is a sole drive for program backup and recovery.

Disk E is mainly used for data backup and storage. It contains system data on disk C, instrument data on disk D and software data backup stored by users. Backup data in Disk E can be copied to external storage media so that even the hard drive needs to be replaced, only the backup data will be recovered to the new hard drive.

#### **3.1.2.5 System backup & recovery**

##### **1) Hard drive OS or data recovery**

The signal generator's hard drive recovery system can used to fix software errors on Disk C (may be caused by loss of system files or data) or recover the original factory data.

Recovery of original factory data will affect on the following entries:

- User-defined Windows 7 settings, such as newly added user accounts, need to be reset after system recovery;
- Other third-party software installed by users needs to be re-installed after system recovery.

The data generated during configuration should be stored in the Disk D; it is recommended to periodically transfer the data to a computer or other storage media through local network connections.

##### **2) How to use the instrument recovery program**

**Step 1. Check if the instrument is shut down.**

**Step 2. Plug a standard keyboard into the USB interface on the rear panel.**

**Step 3. Switch on the instrument and after the display of manufacturer information, an OS menu with timer appears:**

When the timer counts down to 0, use the Up/down arrows on the standard keyboard to highlight the [System Recovery Tool] and press Enter after selecting it.

**Step 4. Perform the recovery in the recovery program screen as below:**

- 1) Select and run GHOST 8.2 wizard tool shelf and wait to enter the prompt interface of next action.
- 2) Select Item 5 to start GHOST 8.2 manual operation and wait to enter GHOST 8.2 operating

3.2 Description of front and rear panels

interface, and press Enter when a dialog with OK button appears.

- 3) Select Local→Partition→From Image; in the OpenFileDialog, activate the “File name” input box by using the Tab key and enter d:\system.gho.
- 4) In the pop-up SelectSourcePartition and SelectFile Dialog, switch to click OK by using the Tab key and press Enter. In the pop-up SelectObjectDeviceDialog, switch to click OK by using the Tab key and press Enter. In the pop-up SelectObjectPartitionDialog, select Partition 1, and switch to click OK by using the Tab key and press Enter.
- 5) In the Alert & Confirmation Dialog, select Yes and press Enter.
- 6) The the system recovery finishes, reboot as prompted.

**Step 5. After the instrument reboots, the system will be restored to the status of last backup.**

**Step 6. After system recovery, we recommend that users do a self test on the instrument after it runs steadily 30 min after startup to check for errors.**

3.1.3 Routine maintenance

This section introduces the routine maintenance method of the 1465 series signal generator.

- [Cleaning method .....32](#)
- [Maintenance of testing port .....32](#)

3.1.3.1 Cleaning method

1) **Cleaning of instrument surface**

Clean the instrument surface as per the following steps:

**Step 1. Power off the instrument, and disconnect the power cord from the instrument;**

**Step 2. Gently wipe the surface with dry or slightly moistened soft cloth. Do not wipe the inside of the instrument.**

**Step 3. Do not use chemical cleaning agents such as alcohol, acetone, or dilutable cleaning agents.**

2) **Cleaning of display**

After the instrument is used for a period of time, it is necessary to clean the LED. Please operate according to the following steps:

**Step 1. Power off the instrument, and disconnect the power cord from the instrument;**

**Step 2. Use clean soft cotton cloth dampened with cleaning agents to gently wipe the display panel;**

**Step 3. Dry the display with clean soft cotton cloth;**

**Step 4. Connect the power cord after the display is dried completely.**

---

**CAUTION**

**Clean the display**

There is a layer of ESD protection coating on the surface of the display, so never use any cleaning agent containing fluoride, acid or alkali. Do not spray the cleaning agent directly onto the display panel, otherwise the cleaning agent may leak into the internal of the instrument, causing damages.

3.1.3.2 Maintenance of testing port

The front panel of 1465 series signal generator has a type N (female) or 3.5mm/2.4mm/1.85mm (male) port and several BNC ports (female). A damaged connector or dust inside will affect RF band test result. Therefore, maintain such connectors in a manner as described below:

- Connectors shall be kept clean and away from dust;
- To prevent ESD, do not directly contact the connector surface;
- Do not use a damaged connector;
- Clean connectors with a dryer, and do not grind the surface with a tool like abrasive paper.

## CAUTION

### Impedance matching of ports

The front RF ports for 1465 series signal generator are 50Ω type-N (female) or 3.5mm/2.4mm/1.85mm (male) connectors. Using a connector with unmatched impedance will cause damage to it.

## 3.2 Description of front and rear panels

This section presents the composition and functions of front and rear panels for the 1465 series signal generator.

- [Description of front panel](#) .....33
- [Description of rear panel](#) .....35

### 3.2.1 Description of front panel

This section introduces the composition and functions of front panel of 1465 series signal generator, which is illustrated below (Fig. 3.11) and itemized in Table 3.5:

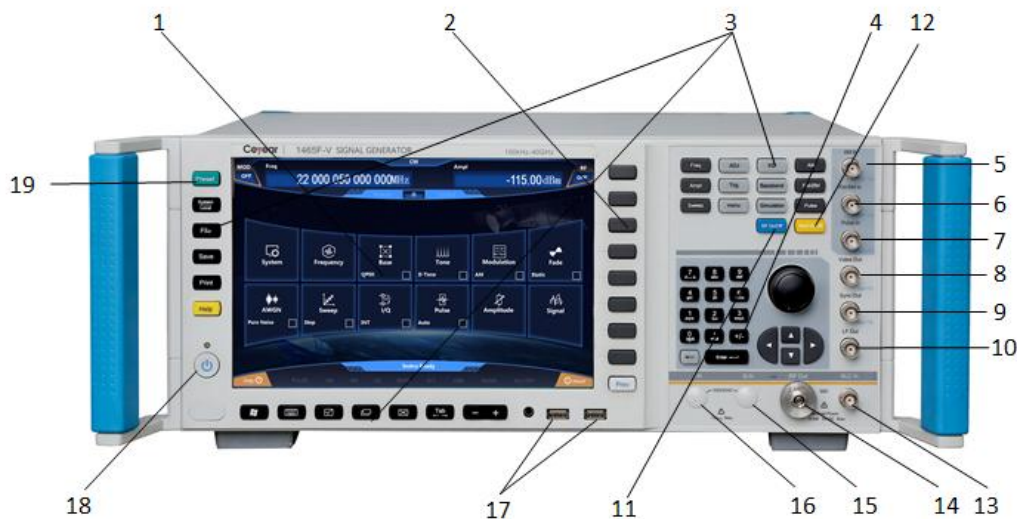

Fig. 3.11 Front Panel

- |                   |                              |                  |
|-------------------|------------------------------|------------------|
| 1. Display screen | 8. Monitor output            | 15. Q input      |
| 2. Soft keys      | 9. Sync output               | 16. I input      |
| 3. Function area  | 10. LF output                | 17. USB port     |
| 4. Input area     | 11. RF switch                | 18. Power button |
| 5. AM input       | 12. Modulation switch        | 19. Reset key    |
| 6. FM/ΦM input    | 13. External detection input |                  |
| 7. Pulse input    | 14. RF output                |                  |

Table 3.5 Description of Front Panel

No.	Name	Description
1	Display screen	LED display, used for showing all the measurement results, states and setup information, allowing switching between different measurement tasks. For more information of the operating interface, please refer to “3.3.1.1 Main features of operating interface”.
2	Soft keys	When a soft key is pressed, the display area will show the menu name corresponding to the left of the key. Pressing a soft key will select the adjacent menu item.
3	Function area	It comprises hard keys on the front panel, pressing any one of them can perform a corresponding function of them such as frequency, power, sweep, modulation, baseband mode, I/Q, arbitrary waveform, calibration, display, trigger, confirmation, exit, menu, system, store/call, file, print, reset and local.
4	Input area	It includes arrow keys, knobs, ←/–(backspace key/minus). All inputs can be changed by using the keys and knobs in this area.
5	AM input	BNC female, inputting fixed $\pm 1V_p$ , for external AM.
6	FM/ $\Phi$ M input	BNC female, inputting fixed $\pm 1V_p$ , for external FM/PM.
7	Pulse input	BNC female, inputting pulse signals compatible with TTL voltage, with input impedance of $2k\Omega$ .
8	Monitor output	BNC female, outputting pulse signals compatible with TTL voltage and consistent with modulation envelope in any pulse mode, with rated source impedance of $50k\Omega$ .
9	Sync output	BNC female, outputting a synchronous TTL-compatible pulse signal with rated value width of 20ns internally and during trigger pulse modulation, with rated source impedance of $50\Omega$ .
10	LF output	BNC female, outputting low frequency signals of frequency 0.01Hz ~ 10MHz, amplitude 40mV <sub>p</sub> ~ 4V <sub>p</sub> and impedance $50\Omega$ through setup.
11	RF switch	RF output on/off, when activated, the green light on the right of the key goes on, indicating RF is turned on, or else, RF is turned off.
12	Modulation switch	Modulation on/off, the Modulation Configuration Dialog can be opened to set corresponding parameters as needed.
13	External detection input	BNC female, providing amplitude control.
14	RF output	The signal output port of the instrument has output impedance of $50\Omega$ and reverse power of 0.5W.
15	Q input	BNC female, receiving “Q” input of I/Q modulation, with input impedance of $50\Omega$ .
16	I input	BNC female, receiving “I” input of I/Q modulation, with input impedance of $50\Omega$ .
17	USB port	It is used to connect mouse and keyboard to upgrade system software and back up data.
18	Power button	When the instrument is in Standby mode, the left yellow indicator lamp above the power button goes on; pressing the power button will turn on the right green indicator lamp above it, indicating that the instrument is “working”.
19	Reset key	Clicking it will restart the instrument for a self test. After initialization, the manufacturer default or user-defined settings will be activated.

## 3.2.2 Description of rear panel

This section introduces the composition and function of rear panel for the 1465 series signal generator, which is illustrated below (Fig. 3.12) and itemized in Table 3.6.

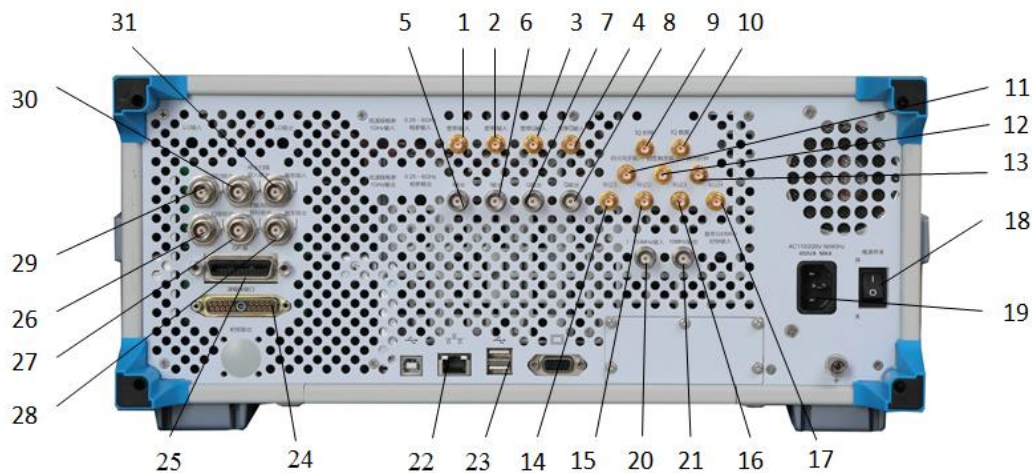

Fig. 3.12 Rear Panel

- |                              |                                |  |
|------------------------------|--------------------------------|--|
| 1. Broadband I input         | 12. Code-pattern trigger input | 23. USB                                    |
| 2. Broadband $\bar{I}$ input | 13. Symbol clock               | 24. Source module port                     |
| 3. Broadband Q input         | 14. Marker 1                   | 25. GPIB                                   |
| 4. Broadband $\bar{Q}$ input | 15. Marker 2                   | 26. Sweep output                           |
| 5. I output                  | 16. Marker 3                   | 27. Z-axis blanking/frequency scale output |
| 6. $\bar{I}$ output          | 17. Marker 4                   | 28. Trigger output                         |
| 7. Q output                  | 18. Power button               | 29. Fly-back output                        |
| 8. $\bar{Q}$ output          | 19. Power input                | 30. Stop sweep input/output                |
| 9. IQ clock                  | 20. 1-50MHz input              | 31. Trigger input                          |
| 10. IQ data                  | 21. 10MHz output               |  |
| 11. Trigger input            | 22. LAN                        |  |

Table 3.6 Description of Rear Panel

No.	Name	Description
1	Broadband I input	BNC female, external baseband signal I input when external broadband is chosen in IQ modulation.
2	Broadband $\bar{I}$ input	BNC female, external baseband signal $\bar{I}$ input when external broadband is chosen in IQ modulation.
3	Broadband Q input	BNC female, external baseband signal Q input when external broadband is chosen in IQ modulation.
4	Broadband $\bar{Q}$ input	BNC female, external baseband signal $\bar{Q}$ input when external broadband is chosen in IQ modulation.
5	I output	BNC female, channel I output of internal baseband signal generator.
6	$\bar{I}$ output	BNC female, channel $\bar{I}$ output of internal baseband signal generator.
7	Q output	BNC female, channel Q output of internal baseband signal generator.
8	$\bar{Q}$ output	BNC female, channel $\bar{Q}$ output of internal baseband signal generator.
9	IQ clock	SMA female, IQ serial clock input in baseband mode and external data source, with level compatibility of 3.3V-LVTTL.

## 3.2 Description of front and rear panels

No.	Name	Description
10	IQ data	SMA female, IQ serial data input in baseband mode and external data source, with level compatibility of 3.3V-LVTTL.
11	Trigger input	SMA female, external trigger signal input in baseband and arbitrary waveform mode, with level compatibility of 3.3V-LVTTL.
12	Code-pattern trigger input	SMA female, external code-patter trigger input in baseband and arbitrary waveform mode, with level compatibility of 3.3V-LVTTL.
13	Symbol clock	SMA female, symbol clock input in baseband mode and external data source, with level compatibility of 3.3V-LVTTL.
14	Marker 1	Output token 1 of arbitrary waveform setting for arbitrary waveform modulation.
15	Marker 2	Output token 2 of arbitrary waveform setting for arbitrary waveform modulation.
16	Marker 3	Output token 3 of arbitrary waveform setting for arbitrary waveform modulation.
17	Marker 4	Output token 4 of arbitrary waveform setting for arbitrary waveform modulation.
18	Power button	Master power switch of the instrument.
19	Power input	Power plug, parameter requirements: 220 V ( $\pm 10\%$ ), 50 Hz ( $\pm 5\%$ ), 200W.
20	1-50MHz input	BNC female, receiving frequency reference signals of 1-50MHz, step 1Hz and -5~+10dBm from external time base.
21	10MHz output	BNC female, signal level > +4dBm, typical output impedance of 50 $\Omega$ .
22	LAN	It is used for software upgrading and control.
23	USB	It is used for connecting a mouse, a keyboard, system software upgrading and data backup.
24	Source module port	It is used for millimeter-wave SPSP, supporting frequency multiplier source module of 82406 series produced by CETC.
25	GPIB	Standard IEEE488 interface, support SCPI language.
26	Sweep output	BNC female, outputting voltage proportional to sweep frequency, 0V and 10V corresponding to frequency start and stop, respectively (0-10V corresponds to overall frequency range in CW working mode).
27	Z-axis blanking/frequency scale output	BNC female, outputting positive pulse (+5V for load of 2k $\Omega$ ) during flyback of RF output or band switching; outputting negative pulse (-5V) for RF output = activated frequency scale frequency.
28	Trigger output	It outputs 1 $\mu$ s TTL low pulse for each frequency conversion in sweep mode.
29	Fly-back output	It outputs TTL high level when sweep starts, and TTL low level when sweep stops.
30	Stop input/output sweep	BNC female, outputting TTL high level when sweep starts, and TTL low level when sweep stops, a forced stop of sweep is allowed when externally grounded.
31	Trigger input	BNC female, TTL rising edge active, used for external trigger step and frequency hopping in list sweep.

### 3.3 Basic configuration method

This section presents basic settings and configuration methods of the 1465 series signal generator, including:

- [Description of basic settings](#) .....37
- [Examples of operation](#) .....42
- [Description of main configuration scenarios](#) .....51

#### 3.3.1 Description of basic settings

This section introduces the main features of UI and basic methods of configuration settings of 1465 series signal generator, which will be used in subsequent different configuration tasks. This section includes:

- [Main features of operating interface](#) .....37
- [Common methods of configuration settings](#) .....38

##### 3.3.1.1 Main features of operating interface

The front panel LED display is used for showing the UI which is a new-type visual GUI clearly displaying the whole process of signal output. The operating interface is divided into different areas according to the function modules and allows concurrent operation of multiple modules, display of states, parameter settings and configuration results of all configuration tasks. This section focuses on the composition and functions of UI. The operating interface is illustrated below (Fig. 3.13) and itemized in Table 3.7:

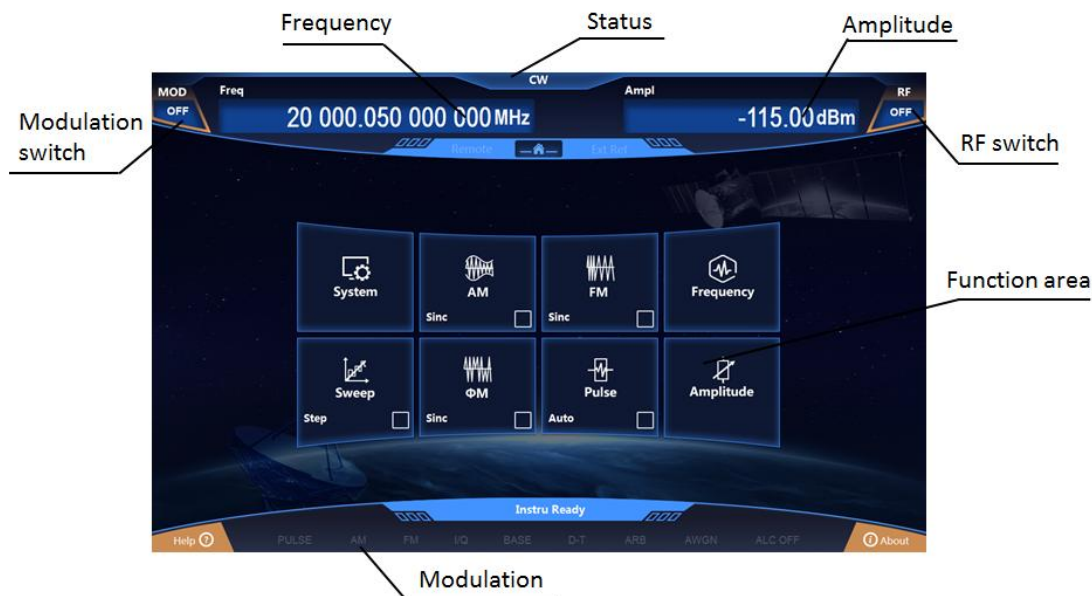

Fig. 3.13 Operating Interface

Table 3.7 Display annotation item description

No.	Name	Description
1	Main information area	It displays main parameter values: Frequency, amplitude, modulation ON/OFF, RF ON/OFF and modulation state. It corresponds to the frequency display, amplitude display, modulation switch and RF switch as shown in Fig. 3.13.
2	Function area	Clicking a function in this area by touching the screen or pressing a function key on the front panel will display the corresponding menu in this area. It corresponds to the function area as shown in Fig. 3.13.

### 3.3 Basic configuration method

3	Status display area	display	It displays the instrument operating mode and state, and the current latest warning/error message. It corresponds to the status display and modulation display as shown in Fig. 3.13.
---	---------------------	---------	---

#### 3.3.1.2 Common methods of configuration settings

## NOTE

**The instrument supports operation by screen touch or front panel.**

The GUI of 1465 series signal generator can be operated by screen touch or front panel, and the following sections describe the operation of common settings. Method 1 is operation by screen touch, and method 2 is by front panel.

#### 1) 【RF ON/OFF】 operation



**Method 1:** Click the [RF] function area in the main information display area on the screen to turn on RF and click this button to turn it off.

**Method 2:** Press the 【RF ON/OFF】 key on the front panel to switch on or off RF.

#### 2) Setting the frequency of CW



**Method 1:** Click the [Frequency] function area in the configuration information display area on the screen to open the Frequency Configuration Dialog; click the [CW] edit box which is selected, enter a value and press the unit key.

**Method 2:** Press the 【Frequency】 on the front panel to open the Frequency Configuration Dialog, turn the knob (RPG) on the front panel to select an entry. An entry is selected when a yellow-lined box appears around 【CW】.



Press the knob (PRG) to make the 【CW】 option editable.



Finally, enter a value by a key on the front panel and press the unit key.

Note: It is a must to press the unit key or Enter to end typing after all numeric values are entered.

#### 3) Increasing (decreasing) the frequency of CW

The frequency of CW can be output after setting a fixed value or increased (decreased) in a digit position by using arrow keys (knob). For example, in the CW option, move the cursor by using left and right arrow keys to select a digit position to be changed, and change the value in the currently selected position so as to switch frequency at fast step.



Additionally, in the CW option, move the cursor to the far left and wait for the cursor to disappear, then press up and down arrow keys or the knob to increase or decrease the CW input at the preset step.



#### 4) Selecting a configuration dialog

**Method 1:** Click a corresponding button in the instrument configuration area on the screen to open the corresponding configuration dialog. For example, clicking the [Power] function area will open the Ampl Config Dialog. Operations related to power setting can be performed in this dialog.

**Method 2:** Press a corresponding key on the front panel to open the corresponding configuration dialog. For example, pressing the 【Amplitude】 key on the front panel will open the Ampl Config Dialog.

#### 5) ON/OFF button control

The operation is described by taking the “Freq Ref Switch” for example:

**Method 1:** Click the button on the screen to switch on or off the frequency reference.

**Method 2:** Turn the front panel knob and press it when it is selected to switch on or off the frequency reference.



The blue block indicates the currently selected status.

#### 6) Drop-down box operation

**Method 1:** Click the drop-down box control on the screen to expand the box and select an entry by touching an input.

**Method 2:** Turn the front panel RPG to make the drop-down box control selected.

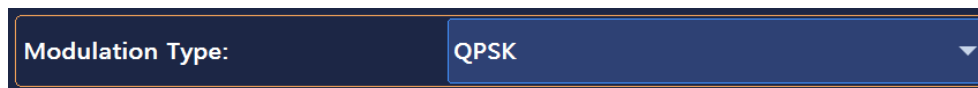

Depress RPG to expand the drop-down box.

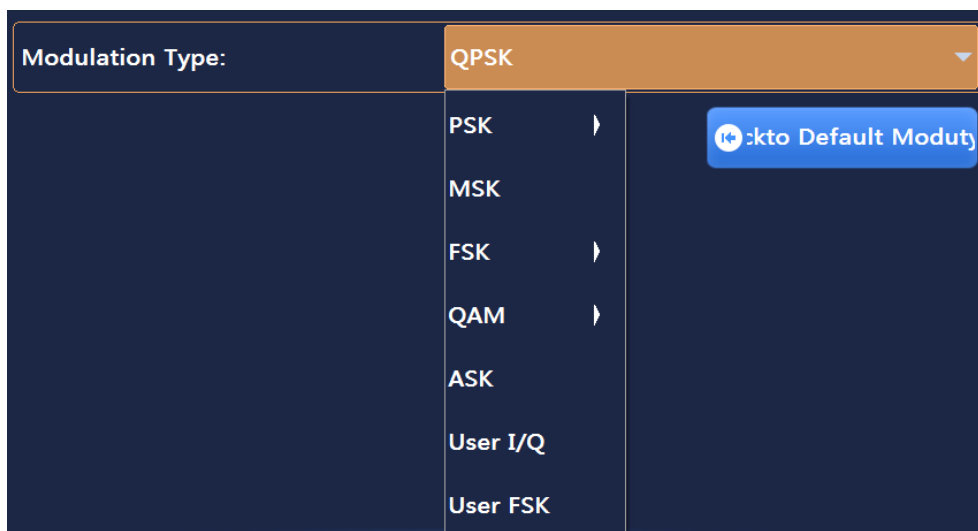

Turn RPG or use arrow keys to select the required item.

3.3 Basic configuration method



Press RPG or Enter to finish editing.

7) Editing data

Data input contains two parts: data input and unit selection. Selecting different units will indicate data in different units of precision.



The operating data can be entered by screen touch or number keys on the front panel.

**Method 1:** Click the “Freq Start” data input box area to make frequency “Editable”, then enter data and edit it.

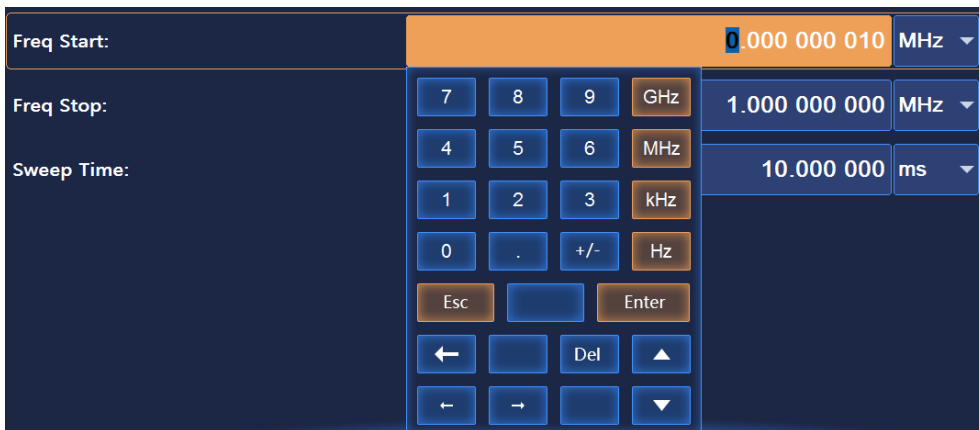

**Method 2:** Turn the front panel knob, when the “Freq Start” data input box is selected, press the knob to make the box “Editable”, then enter data and edit it. After editing, press the knob again to make the data input box selected, and then operate other controls by turning the knob.

**NOTE**

**Focus order of input box**

To facilitate user input, the focus order of data input box is put in the first place among the focus orders of all controls in the current configuration dialog, that is, the data input box is directly editable when a configuration dialog is opened.

8) Editing list

The 1465 series signal generator has a list editing function whereby the list of information needs to be manually edited. The list is illustrated in Fig. 3.14. The list has embedded input and switch controls. Drop-down box control, button control.

**Method 1:** A list cell can be edited by clicking it on the screen, which can be input box control or switch control. Drop-down box control, button control. The editing methods of these controls are the same as those described in 1) - 7).

**Method 2:** Turn the front panel RPG to select a list.

Index	Freq Offset(MHz)	Atten Ampl(dB)	Phase(deg)	Status
0	-31.500 000 000	0.00	0	ON
1	-30.500 000 000	0.00	0	ON
2	-29.500 000 000	0.00	0	ON
3	-28.500 000 000	0.00	0	ON

Pressing the knob will select a line for editing, and turning the knob or pressing arrow keys will select each line in turn.

Index	Freq Offset(MHz)	Atten Ampl(dB)	Phase(deg)	Status
0	-31.500 000 000	0.00	0	ON
1	-30.500 000 000	0.00	0	ON
2	-29.500 000 000	0.00	0	ON
3	-28.500 000 000	0.00	0	ON

Pressing left and right arrow keys will select a cell in turn. A yellow-lined box will appear when a cell is an editable control which can be edited by following the steps in 1) - 7) by pressing the knob.

The screenshot shows the instrument's control interface. On the left is a numeric keypad with buttons for digits 0-9, a decimal point, a sign flip (+/-), and an 'Enter' button. Below the keypad are arrow keys and a 'Del' button. The main display area shows a table with columns: Index, Freq Offset(MHz), Atten Ampl(dB), Phase(deg), and Status. The 'Atten Ampl(dB)' cell for index 1 is highlighted with a yellow border. Above the table, there are controls for 'Freq Inte...', 'MHz', and 'Initial Phase: 0 deg'. At the bottom, there is a status bar with 'Instru Ready' and various mode indicators (I/Q, BASE, D-T, ARB, AWGN, ALC OFF).

Index	Freq Offset(MHz)	Atten Ampl(dB)	Phase(deg)	Status
0	-31.500 000 000	0.00	0	OFF
1	-30.500 000 000	0.00	0	ON
2	-29.500 000 000	0.00	0	ON
3	-28.500 000 000	0.00	0	ON

Fig. 3.14 Table Editing Schematic

9) Shortcut operations

The main interface supports shortcut operations of modulation ON/OFF and working mode. The instrument status can be fast switched by screen touch. There is a prompt display of current status information on the left of each function module, as shown in Fig. 3.15.

3.3 Basic configuration method



Fig. 3.15 Shortcut Operations Schematic

3.3.2 Example of operation

This section gives step-by-step instructions on common but important basic settings and functions of the instrument and aims to enable quicker learning of instrument features and basic configuration methods.

Firstly, make preparations before operation by following the steps below:

- Step 1. Power on the instrument;**
- Step 2. Initialize the system settings;**
- Step 3. Warm it up for 10min;**
- Step 4. Proceed as follows when no error message appears on the main interface.**

**Description**

The following instructions are given by taking the operation of front panel and screen touch for example.

3.3.2.1 Setting RF output of CW

1) Setting RF output frequency

*Example: Set RF output frequency to 500MHz and increase or decrease it by 1MHz each time.*

Operation steps:

**Step 1. Reset.**

Press the **【Reset】** key to set the instrument to the manufacturer-specified state.

**NOTE****Instrument reset state**

The instrument reset condition can be set on request to the user-specified state. But the manufacturer-specified state shall be used in the following example. For details, refer to “3.4.1.1 Instrument reset state”.

**Step 2. RF ON.**

Press **【RF ON/OFF】** or click the [RF] function area on the screen to switch on RF and output RF signals.

Now the RF ON/OFF status area on the front panel operating interface will display “RF ON”.

**Step 3. Set CW to 500MHz.****➤ Edit frequency;**

Press **【Frequency】** or click the [Frequency] function area on the screen to display the pop-up Ampl Config Dialog;

Clockwise or (counterclockwise) turn the front panel RPG to select the Frequency input box and make it editable by pressing the knob or clicking the box on the screen. The frequency value shown in the current edit box is the system default or the value set during the last CW operation. Enter 500MHz and end typing, and then the frequency shown in the main information display area will be refreshed synchronously.

**Step 4. Set the frequency step to 1MHz.****➤ EditFreq Step.**

Clockwise (or counterclockwise) turn the front panel knob to select the Frequency Step edit box in Frequency Setting and make it editable by pressing the knob or clicking the Frequency Step edit box on the screen. Enter 1MHz and end typing.

**Step 5. Increment operation****➤ Press arrow keys to implement step-by-step operation.**

Clockwise (or counterclockwise) turn the front panel RPG or touch the screen to select CW input box. Move the cursor in the edit box cursor to the leftmost end, and press up and down arrow keys or those on the virtual keyboard to increase CW in increments of 1MHz. Alternatively, locate the cursor in the input box to MHz, and press up and down arrow keys or those on the virtual keyboard to implement the above operation. In this case, the RF output port emits CW signals at a step of 1MHz.

## 3.3 Basic configuration method



Fig. 3.16 Setting CW to 500MHz at a Step of 1MHz

**NOTE****Focus order of CW/Power input box**

To facilitate user input, the CW/Power input box automatically becomes editable when the Frequency/Ampl Config Dialog is opened.

**NOTE****Step-by-step change of parameters in input box**

When the input box is editable, step-by-step change of input parameters is possible by front panel RPG or arrow keys.

**2) Set frequency reference and offset**

When the frequency reference is turned on, the frequency-related parameters are relative values based on the currently set frequency reference. For example: The frequency shown in the main information display area is the difference between the RF output frequency and the frequency reference.

**Example: Set the frequency reference to 500MHz and offset to 100MHz.**

**Operation steps:****Step 1. Reset.**

Press the **【Reset】** key to set the instrument to the manufacturer-specified state.

**Step 2. Set CW to 1.5GHz and frequency reference to 500MHz.**➤ **Edit the frequency value as 1.5GHz;**

Press the **【Frequency】** key or click the [Frequency] function area on the screen to display a pop-up Frequency Configuration Dialog on the UI; then set CW to 1.5GHz.

➤ **Edit the frequency reference as 500MHz;**

Clockwise or (counterclockwise) turn the front panel RPG to select Freq Ref Switch, and turn it on by pressing the knob or touching the screen. Clockwise or (counterclockwise) turn the front panel RPG

**3.3 Basic configuration method**

to select the Freq Ref input box. Make the Freq Ref input box editable by pressing the knob or touching the screen; the frequency reference shown in the current edit box is the system default or the value set during the last frequency reference operation. Now enter 500MHz and end typing, then the frequency shown in the main information display area is actual RF output frequency minus the frequency reference (1GHz = 1.5GHz - 500MHz), and the frequency indicated in the main information display area is prefixed by a “reference” mark, now the “Freq Ref OFF/ON” is set to “ON”.

If the frequency reference is turned off, the frequency shown in the main information display area is the actual RF output frequency.



Fig. 3.17 Setting Freq Ref to 500MHz

**Step 3. RF ON.**

Press **【RF ON/OFF】** or click the [RF] function area on the screen to switch on RF and output RF signals.

Now the RF ON/OFF status area on the front panel operating interface shows “RF ON”.

**Step 4. Set the frequency offset to 100MHz.**➤ **Edit frequency offset as 100MHz;**

Clockwise (or counterclockwise) turn the front panel RPG to select the Freq Offset edit box. Make the Freq Offset edit box editable by pressing the knob or touching the screen, and enter 100MHz to set the frequency offset to 100MHz. Now the frequency shown in the main information display area is 1.1GHz (output frequency (1.5GHz) – frequency reference (500MHz) + frequency offset (100MHz)). And the RF output frequency remains 1.5GHz.

## 3.3 Basic configuration method



Fig. 3.18 Setting Freq Offset to 100MHz

**NOTE****“Offset” mark in front of frequency**

If the frequency reference is turned on or the frequency offset is not 0. There will be an “offset” mark above the frequency value shown in the main information display area.

If the frequency reference is turned off or the frequency offset is 0, the frequency value shown in the main information display area is actual RF output frequency.

**3) Setting RF output power**

The 1465 series signal generator provides power output of fixed amplitude in CW and sweep mode, with power ranging from -20dBm to +30dBm (-130dBm ~ +30dBm for signal generators with a step attenuator).

**Example: Set the power level to 0dBm.**

**Operation steps:****Step 1. Reset.**

Press the **【Reset】** key to set the instrument to the manufacturer-specified state.

**Step 2. RF ON.**

Press **【RF ON/OFF】** or click the [RF] function area on the screen to switch on RF and output RF signals.

Now the RF ON/OFF status area on the front panel operating interface shows “RF ON”.

**Step 3. Set the power to 0dBm.**➤ **Edit the power value as 0dBm;**

Press the **【Amplitude】** key or click the [Power] function area on the screen to display a pop-up Ampl Config Dialog, as shown in Fig. 3.19;

Clockwise (or counterclockwise) turn the knob to select the Power input box, and make the box editable by pressing the knob or touching the screen; the currently displayed power is the system default or the value set during the last power operation. Enter 0dBm in the input box and end typing. The power



shown in the main information display area is a new value.

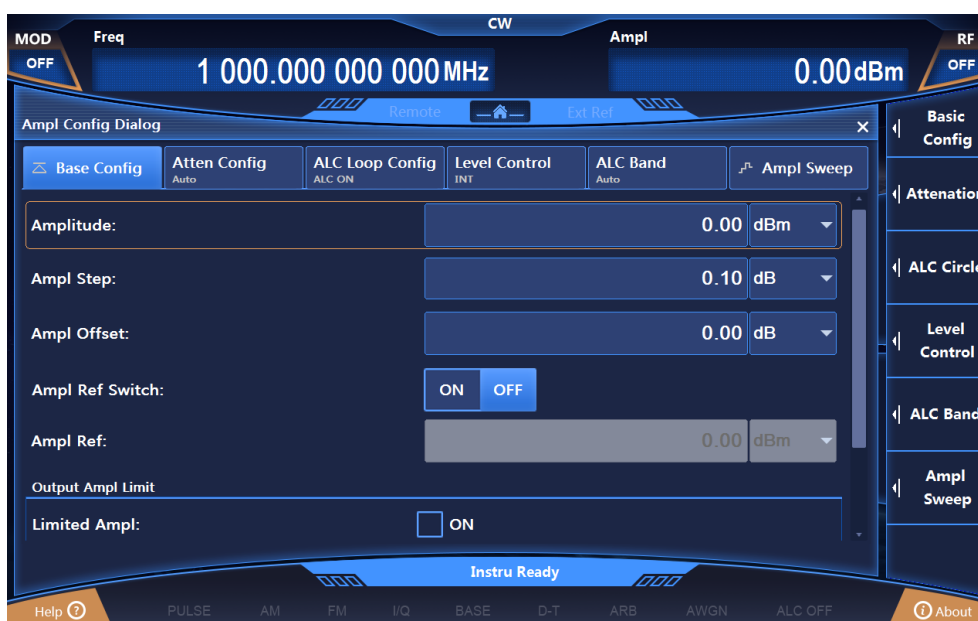

Fig. 3.19 Power Level of 0dBm

## NOTE

### Power level entered out of power setting range of the instrument

The power input box has a preset range of input and displays the upper and lower limits closest to the input value. If a power level out of the range of fixed-amplitude power is entered, the status display area will give a warning message indicating “Amplitude Not Fixed”.

#### 4) Set amplitude reference and offset

When the amplitude reference is turned on, the power-related parameters are relative values based on the currently set amplitude reference. For example: The frequency shown in the main information display area is the difference between the RF output frequency and the frequency reference.

**Example: Set the power frequency to 10dBm and offset to 5dB.**

#### Operation steps:

##### Step 1. Reset.

Press **[Reset]** to set the instrument to the manufacturer-specified state.

##### Step 2. Set the power to 0dBm.

Press the **[Amplitude]** key and turn the front panel RGP to select the Power input box or click the [Power] function box on the screen to make it editable; enter the power value of 0dBm;

##### Step 3. Set the amplitude reference to 10dBm.

#### ➤ Edit the amplitude reference as 10dBm;

Clockwise (or counterclockwise) turn the front panel RPG to select Ampl Ref Switch, and turn on the amplitude reference by pressing the knob or clicking Power Frequency ON on the screen.

Clockwise (or counterclockwise) turn the front panel RPG to select the Ampl Ref input box. Press the knob to make the box editable; the amplitude reference currently shown in the box is the system default or the value set during the last amplitude reference operation. Enter 10dBm and end typing. Then the power shown in the main information display area is actual RF output power minus the frequency

### 3.3 Basic configuration method

reference -10dBm (RF output power (0dBm) – amplitude reference (10dBm)), and Ampl Ref is turned on, as shown in Fig. 3.20.

If the amplitude reference is turned off, the power shown in the main information display area is the actual RF output power.



Fig. 3.20 Power Level of 0dBm with Reference of 10dBm

#### Step 4. RF ON.

Press the **【RF ON/OFF】** key to switch on RF and output RF signals.

Now the RF ON/OFF status area on the front panel operating interface shows “RF ON”.

#### Step 5. Set the amplitude offset to 5dB.

##### ➤ Edit the amplitude offset as 5dB;

Clockwise (or counterclockwise) turn the front panel knob to select the Ampl Offset edit box in Power Setting, and make the box editable by pressing the knob or touching the screen. Set the amplitude offset to 5dB by entering 5dB.

Now the power shown in the main information display area is -5dBm (RF output power (0dBm) – amplitude reference (10dBm) + amplitude offset (5dB)). The RF actual output power remains 0dBm. in Fig. 3.21.



Fig. 3.21 Ampl Offset of 5dB

## NOTE

### “Offset” mark in front of power

If the amplitude reference is turned on or the amplitude offset is not 0. There will be an “offset” mark above the power value shown in the main information display area.

If the amplitude reference is turned off or the amplitude offset is 0, the power value shown in the main information display area is actual RF output power.

### 3.3.2.2 Modulation signal

The modulating pulse of the 1465 series signal generator supports AM, FM/PM and pulse modulation. This section presents how to turn on and set the modulating signal by taking AM and pulse modulation for example.

#### 1) Amplitude modulation (AM)

**Example: Generate an AM signal with local frequency of 3.5GHz, power of 0dBm, modulation rate of 0.001MHz and depth of 30%.**

#### Operation steps:

##### Step 1. Set RF output signal:

Set CW to 3.5GHz and power level to 0dBm.

##### Step 2. Activate the AM Configuration Dialog:

Operate the AM Configuration Dialog that pops up on the interface by pressing the **【AM】** key or clicking [Amplitude Modulation] in [Simulation Modulation] on the screen. Alternatively, select the **【Modulation ON/OFF】** key to open the Modulation Config Dialog and switch to the AM Configuration Dialog.

##### Step 3. Set the AM waveform:

Clockwise (or counterclockwise) turn the knob to select the AM Waveform combo box, and press the knob to activate the option, and select “Sinc” by pressing up and down keys or clicking the AM Waveform combo box on the screen.

##### Step 4. Set AM type:

### 3.3 Basic configuration method

Clockwise (or counterclockwise) turn the knob and select AM type as “Linear” by pressing the knob or clicking the option on the screen.

#### Step 5. Set AM source:

Clockwise (or counterclockwise) turn the knob and select the “INT” option in AM Source by pressing the knob or touching the screen.

#### Step 6. Set deep AM:

Clockwise (or counterclockwise) turn the knob and select the “OFF” option in Deep AM by pressing the knob or touching the screen.

#### Step 7. Set the modulation rate:

Clockwise (or counterclockwise) turn the knob to select the Modulation Rate input box, and make the box editable by pressing the knob or clicking it on the screen. Enter 0.001 MHz and end typing.

#### Step 8. Set AM depth:

Clockwise (or counterclockwise) turn the knob to select the AM Depth input box, and make the box editable by pressing the knob or clicking it on the screen. Enter 30% and end typing.

#### Step 9. Turn on RF.

Press **[RF ON/OFF]** or click the [Power] function area on the screen to switch on RF and output RF signals.

Now the RF ON/OFF status area on the front panel operating interface shows “RF ON”.

#### Step 10. Turn on AM:

Clockwise (or counterclockwise) turn the knob to select the AM Switch option, and turn it on by pressing the knob or clicking the option on the screen. Now the modulation indication area in the main information display area shows **AM** and the text message area tabulates AM component information, indicating that AM is activated and the instrument is emitting amplitude-modulated signals from RF output connector.



Fig. 3.22 Setting of Amplitude-modulated Signals

## 2) Pulse modulation

The 1465 series signal generator produces modulating pulse supporting PRF jittered, staggered and sliding, and can generate complex pulse-modulated RF signals.

**Example: Generate a pulse-modulated signal with local frequency of 3.5GHz, power of 0dBm,**

width of 50 $\mu$ s and period of 1ms.

#### Operation steps:

##### Step 1. Set RF output signal:

Set CW to 3.5GHz, power level to 0dBm and **【RF ON/OFF】** to ON.

##### Step 2. Activate the Pulse Modulation Configuration Dialog:

Display a pop-up Pulse Modulation Configuration Dialog on the UI by pressing the **【Pulse】** key or clicking the [Pulse] function area on the screen.

##### Step 3. Set the pulse source:

Clockwise (or counterclockwise) turn the knob to select the “Auto” option in the Pulse Source combo box, and select the “Auto” option by pressing the knob or clicking the option in the Pulse Source combo box on the screen.

##### Step 4. Set the pulse width:

Clockwise (or counterclockwise) turn the knob to select the Pulse Width input box, and make the box editable by pressing the knob or clicking it on the screen. Enter 50MHz and end typing.

##### Step 5. Set the period:

Clockwise (or counterclockwise) turn the knob to select the Period input box, and make the box editable by pressing the knob or clicking it on the screen. Enter 1ms and end typing.

##### Step 6. Turn on the pulse modulation:

Clockwise (or counterclockwise) turn the knob to select the Pulse Modulation Switch option, and turn it on by pressing the knob or clicking the option on the screen. Other option values in the Pulse Configuration Dialog are defaults.

Now the modulation indication area in the main information display area shows **PULSE** and the text message area tabulates the component information of pulse modulation.



Fig. 3.23 Setting of Pulse-modulated Signals

### 3.3.3 Description of main configuration scenarios

The function configuration modules of 1465 series signal generator correspond to their respective configuration dialogs and centrally manage the relevant parameter information to facilitate parameter setting and editing for specific functions. The function configuration dialogs include:

**3.3 Basic configuration method**

- Frequency .....52
- Amplitude .....53
- Sweep .....54
- Simulation modulation .....56
- Base .....57
- System .....58

See “Appendix D” for keyboard shortcuts of function configuration dialogs.

**3.3.3.1 Frequency**

The Frequency Configuration Dialog is used for setting RF output frequency parameters including: CW, frequency step, frequency offset, frequency reference, etc. To facilitate user input, the selection order of CW input box is put in the first place among the selection orders of all controls in the Frequency Configuration Dialog, that is, the CW input box is directly editable when the Frequency Configuration Dialog is opened for the first time. Pressing the 【Frequency】 key on the front panel or clicking the [Frequency] function area on the screen will display a pop-up Frequency Configuration Dialog on UI, as shown below in Figures 3.24 and 3.25.

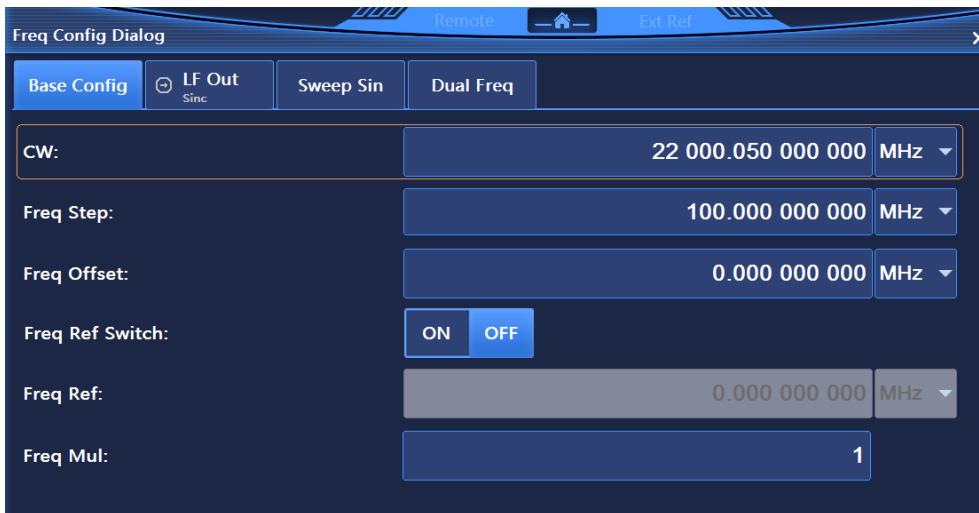
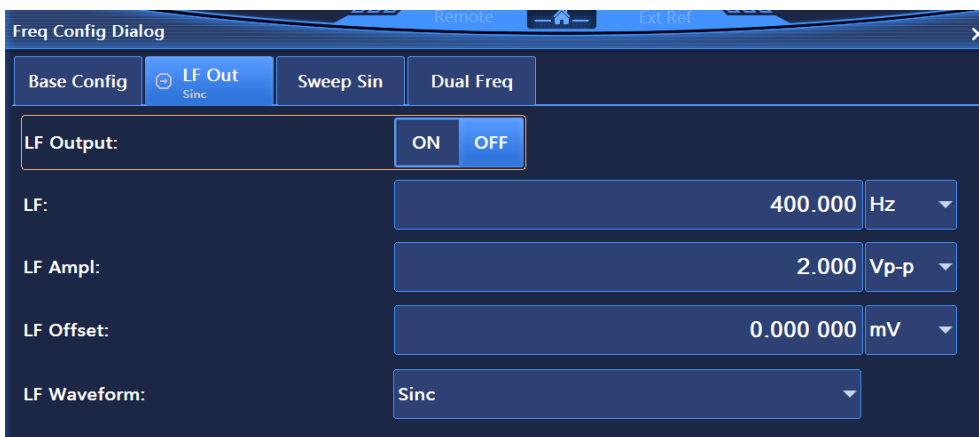

Fig. 3.24 Frequency Configuration Dialog



## 3.3 Basic configuration method



Fig. 3.25 Frequency Configuration Dialog (other settings)

As seen above: In all functions relating to frequency, parameters are in Hz, digital inputs end with a frequency unit like GHz, MHz, kHz or Hz and the currently shown values and units are accepted by pressing Enter (terminator key).

Parameters in Frequency Configuration Dialog include: CW, relative frequency mode (ON/OFF), relative frequency reference, frequency offset, clock multiplier factor, setting of LF signal generator, phase reference, phase adjustment and other menus.

### 3.3.3.2 Amplitude

The Ampl Config Dialog is used for setting parameters relating to the power characteristics. Pressing the **【Amplitude】** key on the front panel or clicking the [Frequency] function area on the screen will display a pop-up Ampl Config Dialog on UI, as shown in Figures 3.26 and 3.27. Confirm an appropriate unit after completion of digital inputs to end typing. Settings in this dialog include: Power level, relative power mode (ON/OFF), relative amplitude reference setting, attenuation control, amplitude offset, amplitude step, ALC loop state ON/OFF, search style (Manu/Auto), amplitude reference, do search, search output (normal/min), amplitude level control mode, ALC band width (Man/Auto), external detector couple coefficient, output blank (ON/OFF).

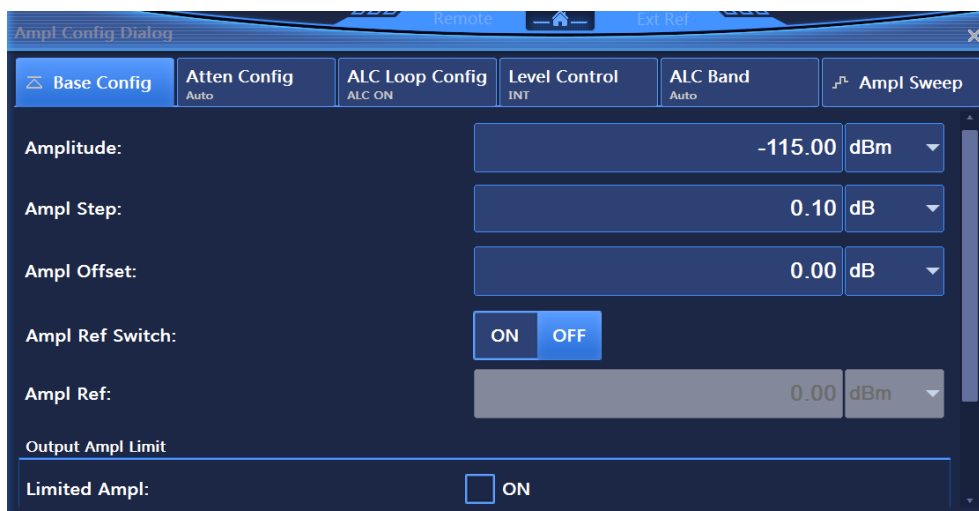

Fig. 3.26 Ampl Config Dialog

3.3 Basic configuration method

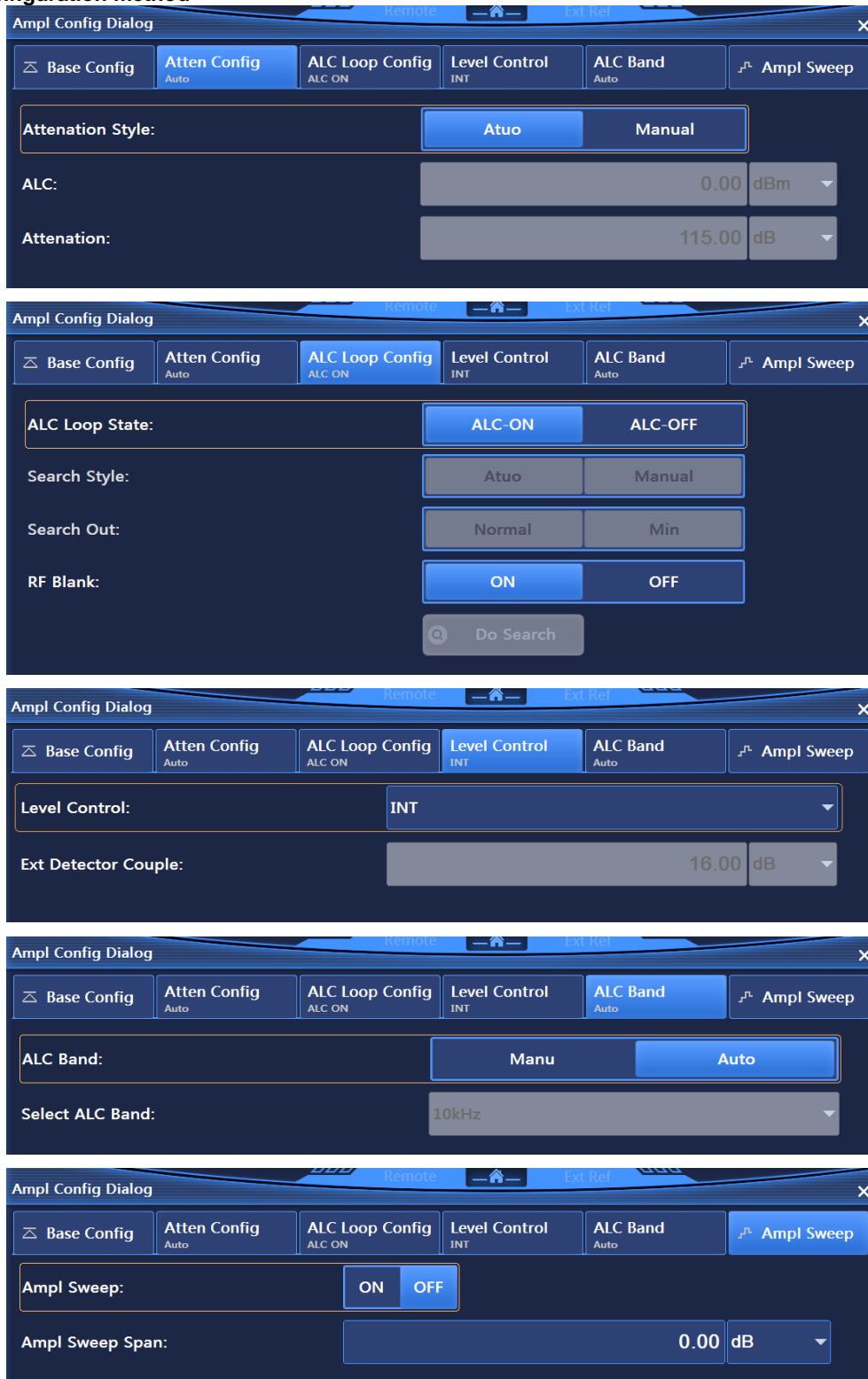

Fig. 3.27 Ampl Config Dialog (other settings)

3.3.3.3 Sweep

The instrument has three sweep modes including step sweep, list sweep and ramp sweep. Pressing the **【Sweep】** key on the front panel or clicking the [Sweep] function area on the screen will display a pop-up Sweep Configuration Dialog as shown in Fig. 3.28. To select the frequency generation mode as “Step”, “List” or “Ramp”, click the corresponding option at the top of the dialog and display a pop-up Step/List/ Ramp Sweep Config Dialog as shown in Figures 3.29, 3.30 and 3.31. Users can edit and set



**3.3 Basic configuration method**

the Freq Start and stop, sweep points, dwell time, etc. Additionally, when manual sweep is activated, the operation is irrelevant to whether the step/list/ramp sweep mode is selected.

Settings in this part include: Frequency generation mode, detailed configuration of step sweep, detailed configuration of list sweep, detailed configuration of ramp sweep, sweep mode [single/continuous], start sweep trigger, manual sweep, etc.

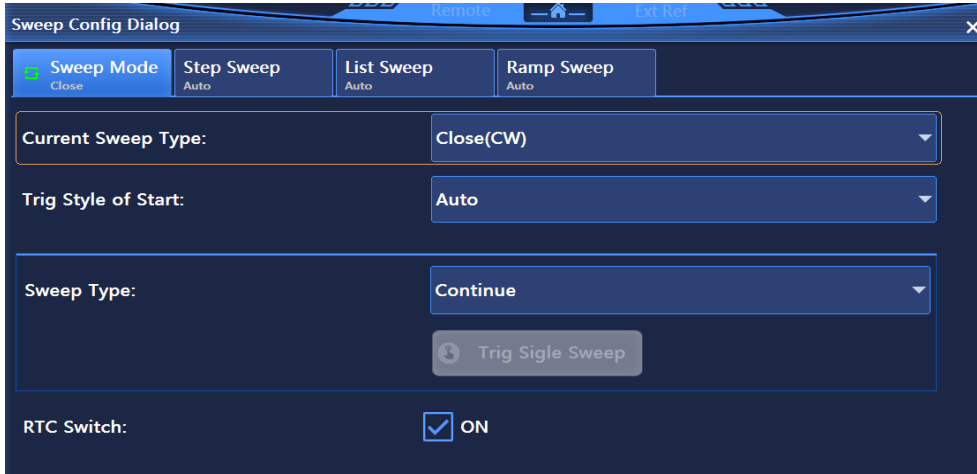

Fig. 3.28 Sweep Configuration Dialog

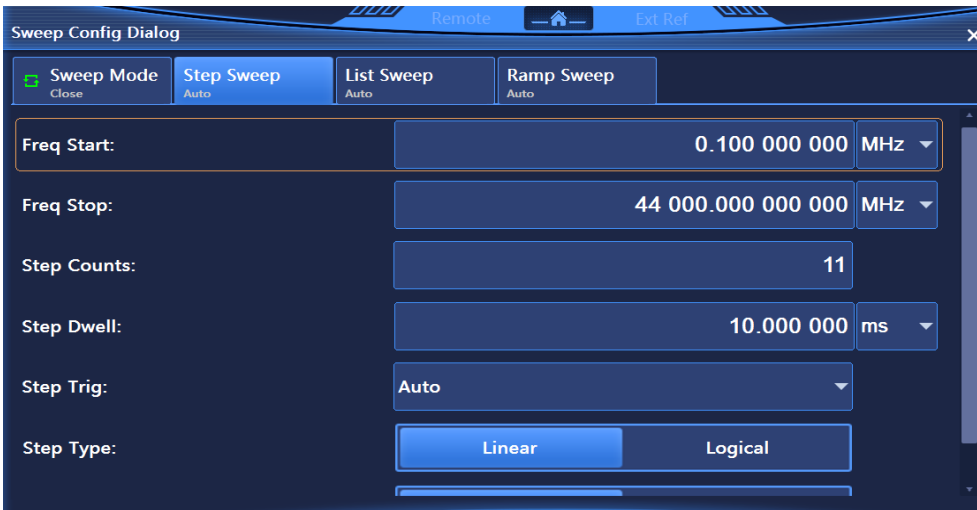

Fig. 3.29 Step Sweep Configuration Dialog



Fig. 3.30 List Sweep Configuration Dialog

3.3 Basic configuration method

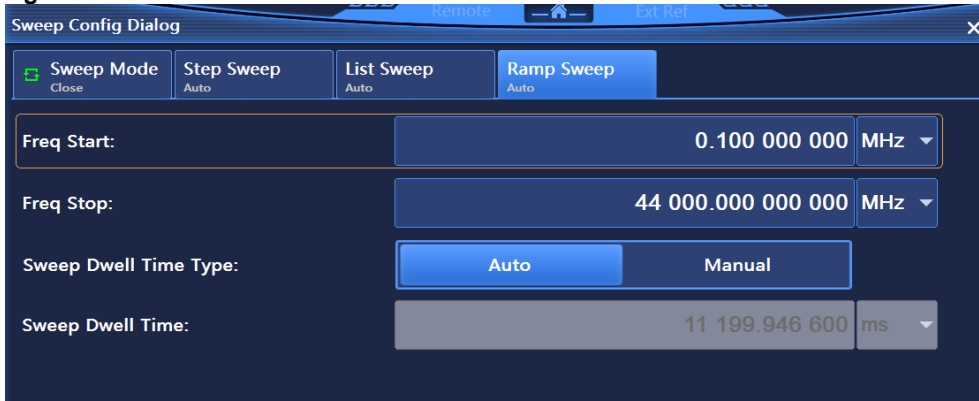

Fig. 3.31 Ramp Sweep Configuration Dialog

3.3.3.4 Simulation modulation

The instrument supports basic simulation modulation including amplitude modulation (AM), frequency modulation (FM) and phase modulation (PM). The instrument also allows pulse modulation to be enabled by using internal or external signal through digital and analog switches. Pressing the **【AM】**, **【FM/ΦM】** and **【Pulse】** keys on the front panel or clicking [Amplitude Modulation], [Frequency Modulation], [Phase Modulation] in the [Simulation Modulation] function area and the [Pulse] function area on the screen will display the pop-up Amplitude Modulation, Frequency Modulation, Phase Modulation and Simulation Modulation dialogs, respectively, as shown in Figures 3.32, 3.33, 3.34 and 3.35. The instrument provides standard internal waveforms including sinc, dualsinc, sweepsinc, triangle, zigzag, square and noise. Settings in Pulse Modulation Configuration Dialog include: Pulse modulation switch, source, width, period, PRF, delay, input reversed phase [ON/OFF], etc.



Fig. 3.32 Amplitude Modulation Configuration Dialog

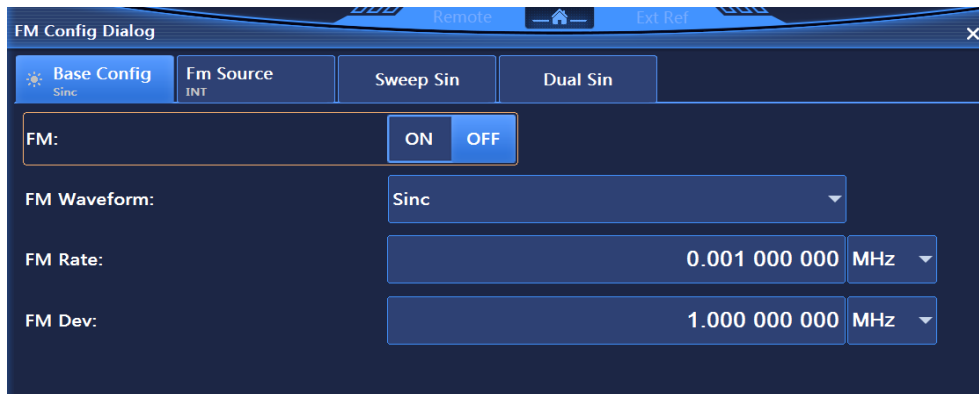

Fig. 3.33 Frequency Modulation Configuration Dialog

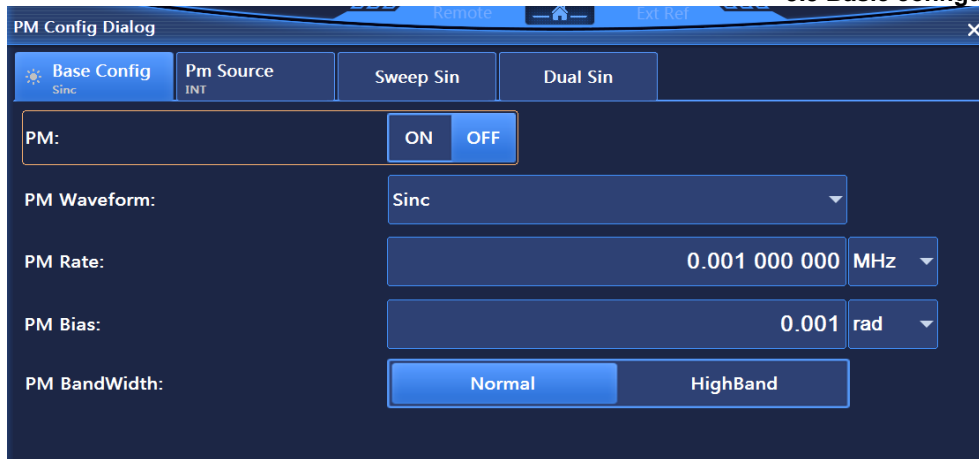

Fig. 3.34 Phase Modulation Configuration Dialog

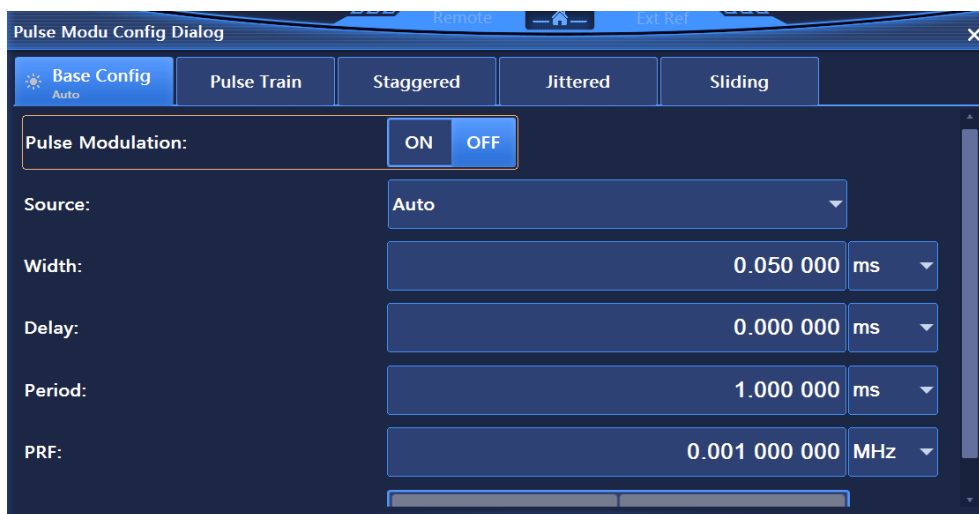

Fig. 3.35 Pulse Modulation Configuration Dialog

### 3.3.3.5 Base

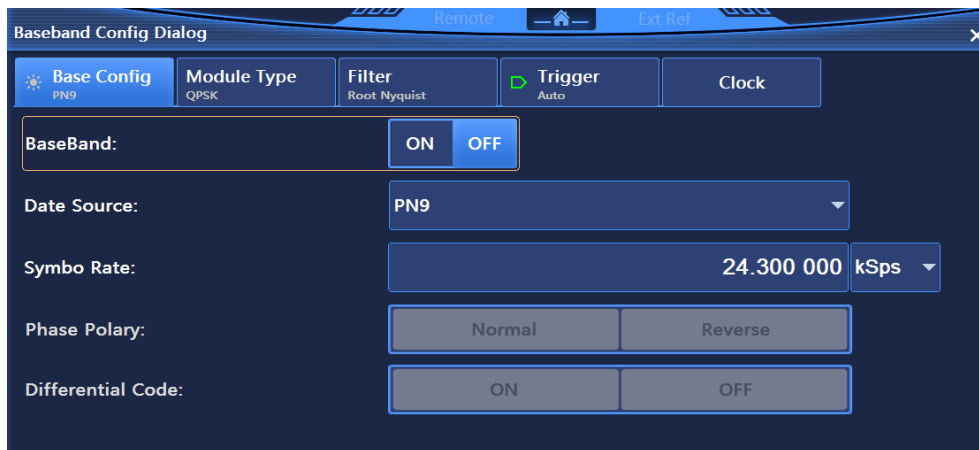

Fig. 3.36 Baseband Configuration Dialog

The instrument can output real-time baseband signals. Pressing the **【Base】** key on the front panel or clicking the [Base] function area on the screen will display a pop-up configuration dialog as shown in Fig. 3.36. Customizing the real-time baseband can generate single carrier, implement real-time data modulation and control all parameters of digital modulation signals in real time. The characteristics of vector-modulated signals can be changed by using various data codes, filter, code rate, modulation type and trigger style. The data source and modulation type supported by baseband are as shown in Figures

**3.4 Data management**

3.37 and 3.38. The settings in real-time baseband menu includes: Baseband ON/OFF, data source, symbol rate, filter factor, filter select, etc.

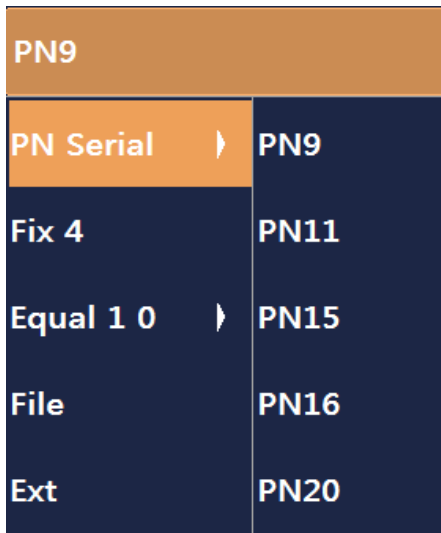

Fig. 3.37 List of Data Source



Fig. 3.38 List of Modulation Type

**3.3.3.6 System**

The System Configuration Dialog is used for setting basic functions of the instrument. Pressing the **【System】** key on the front panel or clicking the [System] function area on the screen will display a pop-up System Configuration Dialog (Fig. 3.39) which includes Base Config, GPIB Port, LAN Port, Instrument Self Test, Manual Test, etc.

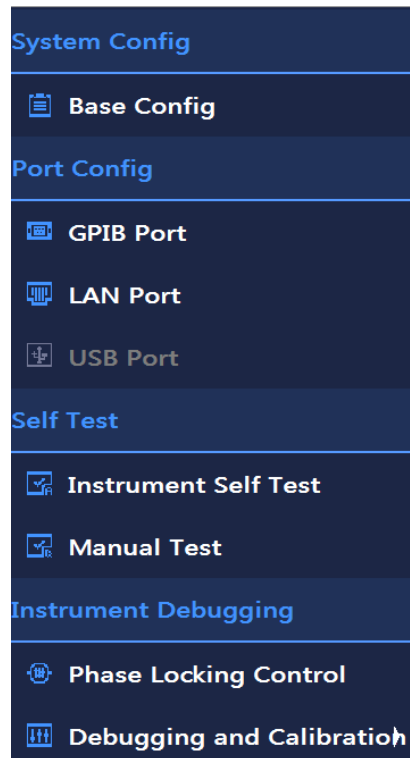

Fig. 3.39 System Configuration Dialog

**3.4 Data management**

This Section introduces the methods for saving/loading of working state, file management, and printing/saving of screenshot of the 1465 series signal generator.

- Saving/loading of working state .....59
- File management .....60
- Printing/saving of screenshot .....63

### 3.4.1 Saving/loading of working state

- Reset state of instrument .....59
- Saving/loading of user state .....59

#### 3.4.1.1 Reset state of instrument

The 1465 series signal generator provides the user with the option of power-on reset state (Factory, User and Last State) as the initial state of start-up configuration. In case of an instrument configuration error, the initial state of instrument during normal operation usually can be recovered by resetting the instrument state. The settings of reset state of the signal generator are as follows:

##### Step 1. Activate the system configuration window:

Press **【System】** key or tap [System] on the touchscreen to pop up the system configuration window on the user interface, and select [Reset] option, as shown in Figure 3.40.

##### Step 2. Set the reset option:

Turn RPG clockwise (or anticlockwise), select [Reset] combo box, press the knob to activate the option, and press the Up and Down keys, or switch among the options of “Factory” | “User” | “Last State” on the touchscreen to select the reset state of the signal generator.

- Select “Factory”: Press **【Reset】** key or restart the instrument, and then the instrument enters the factory default state;
- Select “User” and press the “Save User State” key: The instrument automatically saves the current configuration. Press **【Reset】** key or restart the instrument, and then the instrument is initialized to the setting state previously saved by the user.
- Select “Last State”: Press **【Reset】** key or restart the instrument, and then the instrument enters the state automatically saved before the shutdown last time.

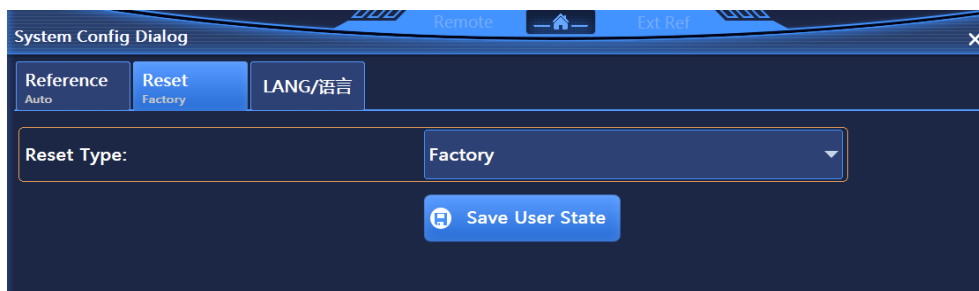

Figure 3.40 Setting of Reset State

#### 3.4.1.2 Saving/loading of user state

The 1465 series signal generator provides the function of saving/loading the instrument setting state, which facilitates the user to recover the saved setting state, reduce the complexity of operation, and observe, evaluate and save the required measurement data again. See “5.2.12 Saving/loading” in “5.2 Menu Description” for specific setting parameters.

##### Step 1.: Open the saving/loading configuration window:

Press **【Save】** key to pop up the saving/loading configuration window on the user interface, as shown in Figure 3.41.

##### Step 2. Set saving/loading file number:

Turn RPG clockwise (or anticlockwise) or select “Saving/Loading File No.” input box on the

**3.4 Data management**

touchscreen, and press the knob to enable the input box in an editing state. Input numbers in the range of 0-99, and complete it by pressing Enter on the front panel. After saving, it's required to wait for a few seconds to complete the saving process; after loading, it's required to wait for more than ten seconds so that the signal generator can reset the hardware and software settings according to the selected instrument state.

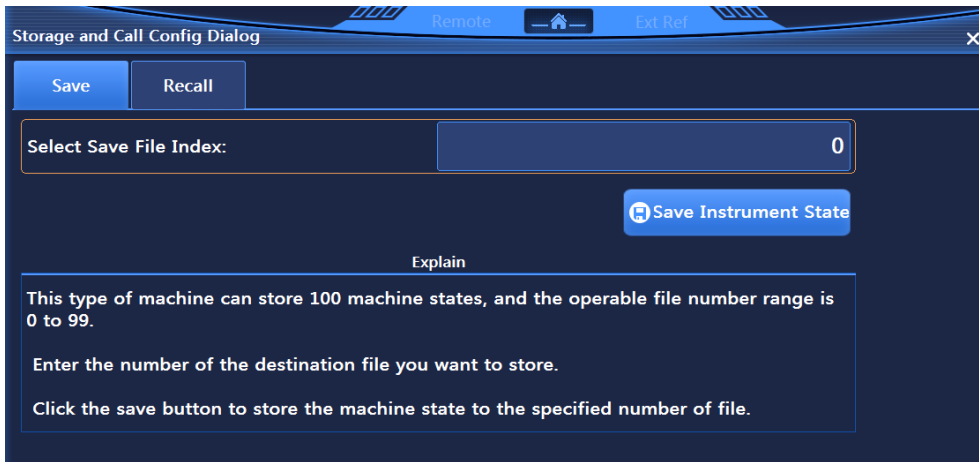

Figure 3.41 (a) Saving/Loading Configuration Window

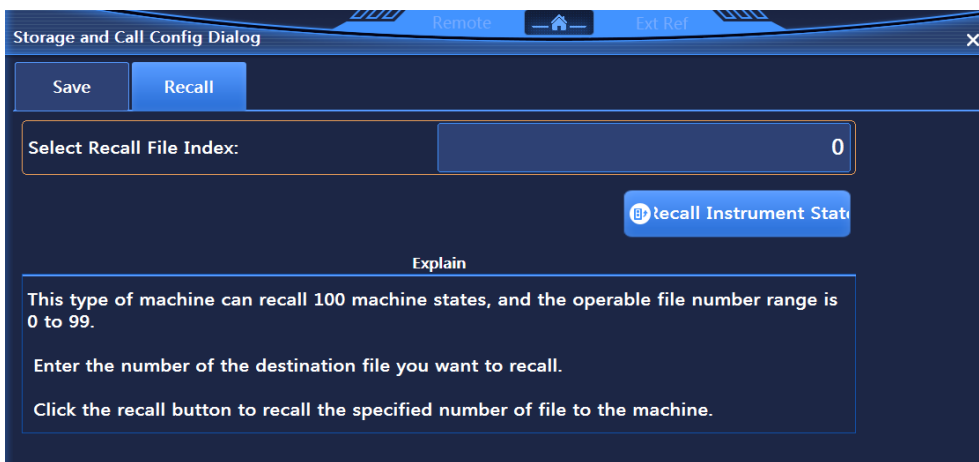

Figure 3.41 (b) Saving/Loading Configuration Window

**NOTE**

**Maximum number of saving/loading instrument state**

The 1465 series signal generator can save/load up to 100 instrument states with file serial numbers of 0~99.

**3.4.2 File management**

The 1465 series signal generator has file management function, providing: File input/output function, file browsing, and copying, cutting, pasting and deleting operations of directory (files). Data files can be accessed through front panel keys, touch screen, mouse or remote control (see Programming Manual of the 1465 series signal generator for details).

- [User data file type .....61](#)
- [File input/output method .....62](#)
- [File format description .....62](#)

### 3.4.2.1 User data file type

User data file types related to file management are shown in Figure 3.8:

Figure 3.8 Data File Type Table

Data file type	Data storage description	Default file storage directory and suffix
User instrument state	Storing the instrument state data saved by the user (instrument operating state parameters such as frequency, amplitude, sweeping and modulation). They are automatically stored in a fixed directory in the case of user reset, last state reset and saving instrument state.	D:\1465data\user\urset.dat
User list sweeping	Storing user-configured list sweeping data (such as frequency, amplitude and dwell time of list points). They are automatically stored in a fixed directory in the case of user reset, last state reset and saving instrument state.	D:\1465data\user\ulist.dat
User pulse train	Storing pulse train data set by the user, including pulse number, pulse width and period, etc. They are automatically stored in a fixed directory in the case of user reset, last state reset and saving instrument state.	D:\1465data\user\pulsetrain.dat
User-defined data source	Storing user-defined data source data in real-time baseband. The instrument provides a window for editing the data. The user can define the file name and directory storage.	D:\1465data\user\DataSrc*.src
User FSK data	Storing user-defined FSK modulation mapping data. The user can define the file name and directory storage.	D:\1465data\user\Fsk*.fsk
User FIR data	Storing user-defined FIR filter coefficients. The user can define the file name and directory storage.	D:\1465data\user\Fir*.fir
User waveform segment data	Storing user-defined waveform segment data. The user can define the file name and directory storage.	D:\1465data\user\Wav*.seg
User sequence configuration data	Storing the currently edited sequence list data. Number of waveform segments, number of repetitions and mark switches, etc. in the sequence. The user can define the file name and directory storage.	D:\1465data\user\Sequence*.config_seg
User mark data	Storing user-edited mark data of waveform segments. Marks 1-4 are stored in the same file. The user can define the file name and directory storage.	D:\1465data\user\Mark*.mrk

### 3.4 Data management



#### Do not move/delete/rename factory data files

All factory data files in D:\1465data\sys\ directory cannot be moved, deleted and renamed by the user. Otherwise, the factory will not be responsible for any serious consequence caused by output errors of the instrument. If the user deletes any one by mistake, either system recovery or recalibration in the factory can be conducted.

All user data files in D:\1465data\user\ directory can be operated by the user with caution, and note that the data saved by the user cannot be recovered anymore after being deleted by mistake.

#### 3.4.2.2 File input/output method

The 1465 series signal generator provides data file input/output function. File input refers to opening the selected data file and refreshing the parameter display of controls (including list, etc.), for ease of observation and evaluation; while file output refers to storing the configuration data in the file in the agreed format (such as ASCII, \*.dat). The signal generator provides input/output of debugging information files. The user only needs to enter the corresponding menu to pop up the dialog box and select the dialog box key or menu item to perform the file operations.

The 1465 series signal generator has the instrument debugging function. This function is only open to the factory for maintenance instead of users. Important debugging data includes: Amplitude flatness data, I/Q modulation calibration data and reference frequency response calibration data. Relevant information files can be loaded to display the parameter component information in a list for ease of observation, and these debugging data can also be stored in default files.

#### 3.4.2.3 File format description

The file formats stored in the signal generator are described here to help users to analyze configuration data. There are two types of these file formats: Direct storage and storage of additional file header information.

##### 1) Direct storage

During storage of such files, the configuration result data structure can be directly stored in the files (\*.dat), such as the instrument debugging information. Such files are poorly readable after being directly opened and are not used as a means for reference analysis by users. They are usually recovered to the controls for viewing through the file input/output function.

##### 2) Storage of additional file header information

According to design requirements, some files need additional file headers, which occupy 256 Bytes and are used for storing associated parameter information. For example: For any random waveform segment data file, the associated parameter information is firstly stored in the agreed format, such as symbol length, sampling clock, factory identification and other information, and then the waveform data is stored. Relevant user files involved with additional file header information are listed in the following table (Table 3.9):

Table 3.9 Storage Format of Files with Additional File Headers

Waveform segment file (.seg)	
File header composition	Description
Reservation (Byte4~Byte7)	
Sampling rate (Byte8~Byte15)	INT64 type Sampling rate = Symbol rate × Number of oversampling points
Symbol length (Byte16~Byte23)	INT64 type Number of waveform segment symbols saved currently.
Number of oversampling points	INT64 type Number of interpolation points for



## 3.4 Data management

(Byte24~Byte31)	displaying variable sampling rate.
Period (Byte32~Byte40)	INT64 type Duration of displaying waveform segment. Period = Symbol length × Symbol rate
Waveform length (Byte41~Byte47)	INT64 type i.e. the number of sampling points. Waveform length = Symbol length × Number of oversampling points
Reserved expansion (Byte48~Byte255)	
Waveform segment data (Byte256~ ...)	I and Q data are alternately stored, each occupying 16Bit.
Mark File (.mrk)	
File header composition	Description
Company name (Byte0~Byte3)	EI41。
Reservation (Byte4~Byte7)	
Number of sampling points (Byte8~Byte15)	INT64 type Number of sampling points.
Period (Byte16~Byte23)	Unused reservation.
Reserved expansion (Byte48~Byte255)	
Mark data (Byte256~ ...)	The data corresponding to four scales (mark 1, mark 2, mark 3 and mark 4) is stored, indicating high and low levels of the scale at the corresponding sampling point (0 refers to low level and 1 refers to high level). Each sampling point contains four mark data, and one sampling point occupies one byte.
User Data Source File (.src)	
File header composition	Description
Company name (Byte0~Byte3)	EI41。
Reservation (Byte4~Byte7)	
Data length (Byte8~Byte15)	INT64 type
Reserved expansion (Byte48~Byte255)	
Data source data (Byte256~ ...)	Storing 0 and 1 sequences, among which, each 0 or 1 occupies one data bit, and one byte contains 8 data.

## 3.4.3 Printing/saving of screenshot

The 1465 series signal generator provides the functions of saving screenshots in graph files (bmp or jpg) and printing screenshots.

- [Saving screenshots \(in file\) .....63](#)
- [Printing screenshots .....63](#)

## 3.4.3.1 Saving screenshots (in file)

Operation steps:

**Step 1.** If the signal generator is not connected to a printer, press [Print] key on the front panel to pop up “Save as” dialog box, enter the name (\*.bmp) of the screenshot graph file, and click “Save” to complete this operation.

## 3.4.3.2 Printing screenshots

## NOTE

### Install printer driver

Before the printing, the 1465 series signal generator needs to be installed with a supporting printer driver.

**NOTE**

**Save screenshot in clipboard**

Pressing “Save Screenshot” key on the front panel can save the screenshot in the clipboard. After printing/saving is completed, the graph in the clipboard will be cleared.

---

## 4 Operation Guides

This chapter describes the operation of different configuration functions of 1465 series signal generator, and introduces the configuration steps in detail.

- [Basic operation guides](#) .....65
- [Advanced operation guides](#) .....72

### 4.1 Basic operation guides

This section describes the operation of different configuration functions of 1465 series vector signal generator, including: modulation, sweep, etc. The configuration steps are detailed by examples.

- [Digital modulation](#) .....65
- [Simulation modulation and pulse modulation](#) .....66
- [Sweep](#).....69

#### 4.1.1 Digital modulation

The signal generator has the function of configuring real-time digital modulation signal output.

**Example: The signal generated is real-time baseband signal with data source of PN9, modulation format of QPSK and symbol rate of 4Msps.**

**Operation steps:**

**Step 1. Open Baseband Config Dialog:**

Press the **【Base】** key or tap [Base] button on the touchscreen to open the Baseband Config Dialog (Fig. 4.1).

**Step 2. Select the data source:**

Select [Base Config] in the Baseband Config Dialog, rotate the RPG clockwise (or counterclockwise) to move to Data Source selection combo box, and click the button to display the available data source options; or tap Data Source on the touchscreen to display the available data source options. The data source options available include: [PN Serial], [Fix 4], [Equal 10] and [File], select [PN 9] option under the [PN Serial].

**Step 3. Select the modulation type:**

Select [Module Type] in the Baseband Config Dialog to display the current type of modulation, select the modulation type “QPSK”, or tap [PSK/OQPSK] under [Modulation Type] on the touchscreen, then tap [QPSK/OQPSK] under [PSK] option, and finally tap [QPSK] under [QPSK/OQPSK] option.

**Step 4. Setting the symbol rate:**

Select [Base Config] in the Baseband Config Dialog, rotate the knob clockwise (or counterclockwise) to select the symbol rate input box and press the knob, or tap [Symbo Rate] on the touchscreen to make the input box editable. Input 4 Msps and finish.

**Step 5. Select the filter type:**

Select [Filter] in the Baseband Config Dialog, rotate the RPG clockwise (or counterclockwise) to move to Filter Select combo box, and press the knob to select “Root Nyquist”; or tap [Filter] on the touchscreen to display the available filter options and tap [Root Nyquist].

**Step 6. Switch on the baseband:**

After configuring baseband parameters, select [Base Config] in the Baseband Config Dialog, rotate the RPG on front panel clockwise (or counterclockwise) to select Base Band switch, press the knob to open the baseband, or tap [Base Band] on the touchscreen to activate the baseband output. The modulation section in the main information screen displays **IQ** **BASE**.

4.1 Basic operation guides



Fig. 4.1 Baseband Config Dialog

**NOTE**

**Instructions for Fix 4 and filters**

If the data source is selected as “Fix4”, Fix4 Data is required, of which the range is 0000 (binary) - 1111 (binary), displayed and input (0-15) by decimal notation in the configuration dialog.

If the modulation type is selected as FSK (2FSK, 4FSK, 8FSK, 16FSK) or MSK, the filter shall be selected as “Gauss” in order to achieve better output.

4.1.2 Simulation modulation and pulse modulation

- Amplitude modulation (AM) .....66
- Frequency modulation (FM) .....66
- Phase modulation (PM) .....67
- Pulse modulation .....69

4.1.2.1 Amplitude modulation(AM)

Please refer to the “3.3.2.2 Modulated signals” of “3 Start Guide”.

4.1.2.2 Frequency modulation(FM)

**Example: To generate FM signals with LO frequency of 3.5GHz, amplitude of 0dBm, modulation rate of 0.001MHz and FM offset of 1MHz.**

**Operation steps:**

**Step 1. Set RF output signal:**

Set CW to 3.5GHz, power level to 0dBm and **【RF ON/OFF】** to ON.

**Step 2. Open FM Config Dialog:**

Press **【FM/ΦM】** key or tap [Frequency Modulation] under [Simulation Modulation] on the touchscreen, and the FM Config Dialog pops up in the operation interface (Fig. 4.2). Or select **【MOD ON/OFF】** key to open the modulation configuration dialog and switch to the FM Config Dialog.

**Step 3. Set FM waveform:**

Select [FM Config] in the frequency modulation dialog, rotate the knob clockwise (or

## 4.1 Basic operation guides

counterclockwise) to select FM Waveform combo box, press the knob to activate the option, and press Up/Down button to select [Sinc]; or tap FM Waveform combo box on the touchscreen to select [Sinc] option.

**Step 4. Set FM source:**

Select [FM Source] in the FM Config Dialog rotate the knob clockwise (or counterclockwise) and press the knob to select [INT], or tap [INT] under the [FM Source] on the touchscreen.

**Step 5. Set modulation rate:**

Select [FM Config] in the frequency modulation dialog, rotate the knob clockwise (or counterclockwise) to select FM Rate input box and press the knob or tap FM Rate input box on the touchscreen to make the input box editable. Input 0.001MHz and end.

**Step 6. Set FM deviation:**

Rotate the knob clockwise (or counterclockwise) to select FM Dev input box and press the knob to make the input box editable. Input 1MHz and end.

**Step 7. RF ON:**

Press **【RF ON/OFF】** to turn on RF output. The RF ON/OFF state displayed on the operation interface is “RF ON”.

**Step 8. Turn on FM output:**

Select [FM Config] in the frequency modulation dialog, rotate the knob clockwise (or counterclockwise) to select [FM ON/OFF] and press the knob to switch on FM or tap [FM ON/OFF] on the touchscreen and turn on FM output. The modulation section in the main information screen displays **FM**, which indicates the FM has been started and the signal generator is outputting FM signals via the RF output connector.



Fig. 4.2 Set FM signal

**4.1.2.3 Phase modulation (PM)**

**Example:** To generate PM signals with LO frequency of 3.5GHz, amplitude of 0dBm, modulation rate of 0.001MHz and phase bias of 1rad.

**Operation steps:**

**Step 1. Set RF output signal:**

3.5GHz CW (continuous wave) with a amplitude level of 0dBm, **【RF ON/OFF】** in ON.

## 4.1 Basic operation guides

**Step 2. Open PM Config Dialog:**

Press **【FM/ΦM】** key or tap [Phase Modulation] under [Simulation Modulation] on the touchscreen, and the PM Config Dialog pop-ups in the operation interface (Fig. 4.3). Or select **【MOD ON/OFF】** key to open the modulation configuration dialog and switch to the PM Config Dialog.

**Step 3. Set the PM waveform:**

Select [PM Config] in the phase modulation dialog, rotate the knob clockwise (or counterclockwise) to select PM Waveform combo box, press the knob to activate the option, and press Up/Down button to select [Sinc], or tap PM Waveform combo box on the touchscreen and select [Sinc] option.

**Step 4. Set the PM source:**

Select [PM Source] in the phase modulation dialog, rotate the knob clockwise (or counterclockwise) and press the knob to select [INT], or tap [INT] under the [PM Source] on the touchscreen.

**Step 5. Set the PM bandwidth:**

Select [PM Config] in the phase modulation dialog, rotate the knob clockwise (or counterclockwise) and press the knob to select [Normal], or tap [Normal] of PM Bandwidth on the touchscreen.

**Step 6. Set the modulation rate:**

Select [PM Config] in the phase modulation dialog, rotate the knob clockwise (or counterclockwise) to select the PM Rate input box and press the knob or tap PM Rate input box on the touchscreen to make the input box editable. Input 0.001MHz and end.

**Step 7. Set the PM bias:**

Select [PM Config] in the phase modulation dialog, rotate the knob clockwise (or counterclockwise) to select PM Bias input box and press the knob or tap PM Bias input box on the touchscreen to make the input box editable. Input 1 (default unit: rad) and press Enter key on the front panel to finish this.

**Step 8. RF ON:**

Press **【RF ON/OFF】** key or tap [RF ON/OFF] on the touchscreen to turn on RF output. The RF ON/OFF state displayed on the operation interface is “RF ON”.

**Step 9. Turn on PM output:**

Select [PM Config] in the phase modulation dialog, rotate the knob clockwise (or counterclockwise) to select [PM ON/OFF] and press the knob to switch on PM or tap [PM ON/OFF] on the touchscreen and turn on PM output.



Fig. 4.3 Set PM signal

#### 4.1.2.4 Pulse modulation

Please refer to the “3.3.2.2 Modulated signals” of “3 Start Guide”.

### NOTE

#### Mutex relationship between modulation modes

AM, FM, PM and LF (low frequency) outputs are incompatible and only one of these signals can be output at a time.

FM and PM are incompatible and either FM or PM signal can be output at a time.

When the simulation modulation is turned on, the signal flow diagram will be display in the instrument status configuration section while the associated modulation mode is shown in the main information display.

#### 4.1.3 Sweep

The sweep function is one of many important functions of a signal generator, and Series 1465 Signal Generator mainly provides step sweep, list sweep and ramp sweep modes, of which the configuration and implementation methods are detailed below.

- [Step sweep](#) .....69
- [List sweep](#) .....70
- [Ramp sweep](#) .....71

##### 4.1.3.1 Step sweep

**Example: Output: step sweep signal; start frequency: 1GHz, stop frequency: 10GHz; step counts: 10; step dwell time: 10ms; step trigger mode: automatic; step type: linear.**

**Operation steps:**

##### Step 1. Open Sweep Config Dialog:

Press **[Sweep]** key or tap [Sweep] on the touchscreen to open the Sweep Config Dialog (Fig. 4.4).

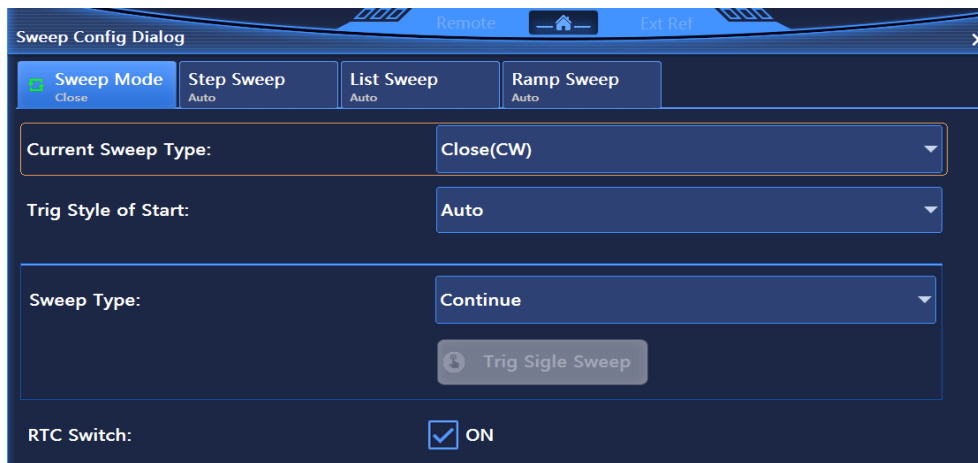

Fig. 4.4 Sweep Config Dialog

##### Step 2. Open Step Sweep configuration dialog:

##### ➤ Select [Step Sweep].

Select [Sweep] mode, rotate the knob clockwise (or counterclockwise) to select [Current Sweep Type], press the knob, rotate the knob clockwise (or counterclockwise) to select [Step Sweep] to turn on the step sweep mode; or tap [Step Sweep] under [Current Sweep Type] on the touchscreen to activate the step sweep mode. Now, the instrument performs step sweep automatically with currently configured parameters.

#### 4.1 Basic operation guides

##### Step 3. Configure step sweep parameters:

Select [Step Sweep] in the Sweep Config Dialog, as shown in Fig. 4.5, and then make the following settings: Freq Start: 1GHz, Freq Stop: 10GHz; Step Counts: 10; Step Dwell: 10ms; Step Trig: Auto; Step Type: Linear.

After all settings are completed, press  key or press **【Back】** key repeatedly to close the current dialog.



Fig. 4.5 Step Sweep configuration dialog

##### Step 4. Display the instrument status:

After the step sweep is activated, the start frequency, stop frequency will be shown in the main information display of the operation interface.

#### 4.1.3.2 List sweep

**Example: Output: list sweep signal; list sweep counts: 10, Count 1 is 1GHz, Count 2 is 2GHz in incrementing order; amplitude offset at each point: 0.00dBm; dwell time: 10ms; list trigger mode: automatic; sweep indirection: forward.**

##### Operation steps:

##### Step 1. Open Sweep Config Dialog:

Press **【Sweep】** key or tap [Sweep] on the touchscreen to open the Sweep Config Dialog (Fig. 4.4).

##### Step 2. Open List Sweep configuration dialog:

##### ➤ Select [List Sweep].

Select [Sweep Mode] in the Sweep Config Dialog, rotate the knob clockwise (or counterclockwise) to select [Current Sweep Type], press the knob, rotate the knob clockwise (or counterclockwise) to select [List Sweep] to turn on the LIST sweep mode; or tap [List Sweep] under [Current Sweep Type] on the touchscreen to activate the list sweep mode. Now, the instrument performs list sweep automatically with currently configured parameters.

##### Step 3. Configure list sweep parameters:

Select [List Sweep] in the Sweep Config Dialog, as shown in Fig. 4.6. In the List Sweep configuration dialog, two methods for configuration are available.

##### Method 1: Manually inserting counts.

Rotate the knob clockwise (or counterclockwise) to select [Edit List], press the knob to select “Insert Counts”, and rotate the knob clockwise (or counterclockwise) to select the parameter to be set and make it editable; or tap the parameter to be set under [Edit List] on the touchscreen make it editable. The list sweep parameters include: CW rate at current frequency, offset and dwell time. Insert counts



continuously until the sweep list is completed.

### Method 2: Auto fill.

Rotate the knob clockwise (or counterclockwise) to select Freq Start input box, press the knob to make the box editable and input 1GHz; set Freq Stop to be 10GHz and Insert Counts to be 10 in the same way; rotate the knob clockwise (or counterclockwise) to select [Auto Fill], press the knob to automatically fill the sweep list; or tap Freq Start input box on the touchscreen to make the box editable and input 1GHz and set Freq Stop to be 10GHz and Insert Counts to be 10 in the same way, and then tap [Auto Fill].

Set All List Ampl Offset as 0dBm, All List Dwell Time as 10ms, List Trig as Auto and Sweep Indirection as Forward.

After automatic filling, parameters can also be edited manually in Edit List.

After all settings are completed, press  key or press **[Back]** key repeatedly to close the current dialog.



Fig. 4.6 List Sweep configuration dialog

### Step 4. Display the instrument status:

After the list sweep is activated, the main information display of the operation interface will show: minimum frequency, maximum frequency, etc.

#### 4.1.3.3 Ramp sweep

**Example: Output: ramp sweep signal; start frequency:1GHz, stop frequency: 10GHz; sweep time setting: automatic.**

#### Operation steps:

##### Step 1. Open Sweep Config Dialog:

Press **[Sweep]** key or tap [Sweep] on the touchscreen to open the Sweep Config Dialog (Fig. 4.4).

##### Step 2. Open Ramp Sweep configuration dialog:

###### ➤ Select [Ramp Sweep].

Select [Sweep Mode] in the Sweep Config Dialog, rotate the knob clockwise (or counterclockwise) to select [Current Sweep Type], press the knob, rotate the knob clockwise (or counterclockwise) to select [Ramp Sweep] to turn on the LIST sweep mode; or tap [Ramp Sweep] under [Current Sweep Type] on the touchscreen to activate the list ramp mode. Now, the instrument performs ramp sweep automatically with currently configured parameters.

##### Step 3. Configure ramp sweep parameters:

Select [Ramp Sweep] in the in the Sweep Config Dialog, as shown in Fig. 4.7, and in the Ramp

**4.2 Advanced operation guides**

Sweep configuration dialog, make the following settings: Freq Start: 1GHz, Freq Stop: 10GHz; Sweep Dwell Time Type: Auto.

After all settings are completed, press  key or press **【Back】** key repeatedly to close the current dialog.

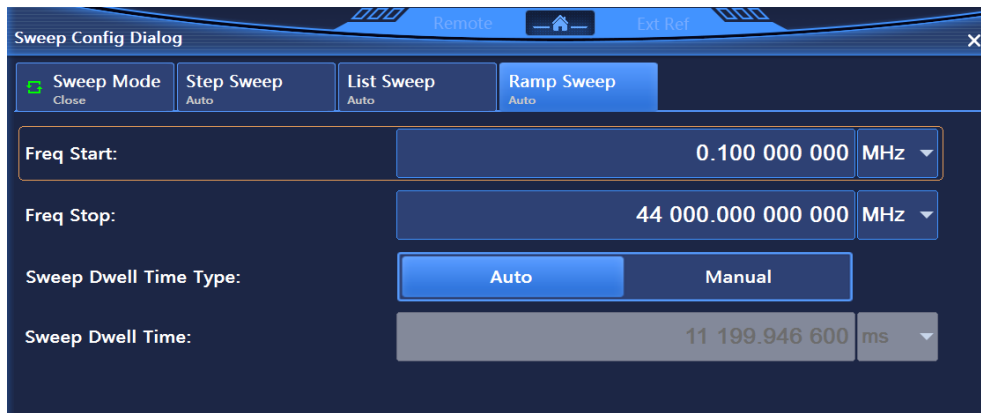

Fig. 4.7 Ramp Sweep configuration dialog

**Step 4. Display the instrument status:**

After the ramp sweep is activated, the main information display of the operation interface will show: minimum frequency, maximum frequency, etc.

**NOTE**

**Return from sweep status to CW state**

To return the instrument from sweep state to CW state, set [Current Sweep Type] in the Sweep Config Dialog to CW.

**4.2 Advanced operation guides**

This section describes the relatively complicated configuration process of series 1465 signal generator.

- [Configuring multi-tone .....72](#)
- [ARB configuration .....74](#)
- [Selecting ALC bandwidth .....74](#)
- [External level control .....81](#)
- [Working with a frequency mixer/Effects of reverse power .....82](#)
- [Creating and applying a user flatness correction array .....83](#)
- [Pulse modulation input selection .....84](#)
- [Baseband triggering function configuration .....87](#)
- [Arbitrary waveform triggering function configuration .....90](#)

**4.2.1 Configuring multi-tone**

The signal generator supports configuration of dual-tone and multi-tone signal outputs.

**Example: The generator can generates multi-tone (6 tones) signals with frequency interval of 10MHz and attenuation of 0dB at each tone.**

**Operation steps:**

**Step 1. Open Dual Tone/Multi Tone configuration dialog:**

**4.2 Advanced operation guides**

Tap [Multi Tone] under [Dual Tone/Multi Tone] on the touchscreen, and the Multi Tone Config Dialog pops up (Fig. 4.8).

**Step 2. Set the number of tones:**

Select [Base Config] in the Multi Tone Config Dialog, rotate the knob clockwise (or counterclockwise) to select Tone Count input box and press the knob or tap Tone Count input box on the touchscreen to make the box editable. Input 6 and press Enter on the front panel to automatically add 6 tones to the multi-tone list.

**Step 3. Set the frequency interval**

Select [Base Config] in the Multi Tone Config Dialog, rotate the knob clockwise (or counterclockwise) to select the Freq Interval input box and press the knob or tap Freq Interval input box on the touchscreen to make the box editable. Input 10 and press Enter key on the front panel to finish this. Freq Offset will be automatically changed in the multi-tone list. Currently, the 2-64 tones can be set and the frequency interval shall not exceed 200MHz.

**Step 4. Turn on multi-tone output**

After configuring multi-tone parameters, rotate RPG on the front panel clockwise (or counterclockwise) to select Multi Tone ON/OFF, and press the knob to turn ON the multi-tone; or tap Multi Tone ON/OFF on the touchscreen to activate the multi-tone. The modulation section in the main information screen displays **IQ** **M-T**.

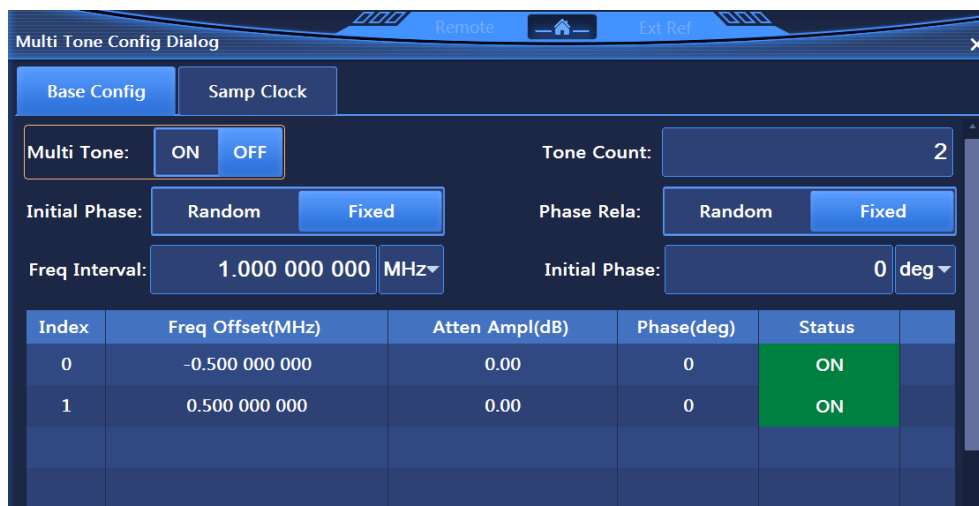

Fig. 4.8 Dual Tone/Multi Tone configuration dialog

**NOTE****Atten Ampl and Phase in multi-tone list**

Atten Ampl in multi-tone list refers to attenuation value of tone amplitude, and each tone can have a different attenuation value ranging from -100 dB to 0 dB. Currently, the hardware system can measure the attenuation up to -40dB.

Phase refers to the initial phase of each tone, and can be set as a random or fixed value.

**NOTE****Multi-tone and dual-tone modulations are incompatible**

Multi-tone and dual-tone modulations are incompatible. When a modulation mode is turned on, the other one will be automatically turned off.

## 4.2 Advanced operation guides

### 4.2.2 ARB configuration

The arbitrary waveform function is available in two modes: sequence and arbitrary waveform. The 1465 Series Signal Generator supports sequence and arbitrary waveform playback functions.

In the sequence mode, you can generate waveform segment files as needed, and play the waveform segments arbitrarily. In arbitrary waveform mode, you can load arbitrary waveform data files in the custom format for playback.

**Example 1: Generate a Wave Segment file example.seg with the Data Source of PN9, the Modulation Type of QPSK, the Sample Counts of 40000 and the Samp Clock of 4 MHz, and set the markers for the start and end of the Wave Segment file.**

#### Operation steps:

##### Step 1. Activate the Arb Seq Config Dialog:

Press **[ARB]** to pop up the Arb Seq Config Dialog on the operation interface (Figure 4.9).



Figure 4.9 Arb Seq Config Dialog

##### Step 2. Select the Work Pattern:

Rotate the RPG clockwise (or counterclockwise), move the focus to the “Work Pattern” combo box, press the knob to select “Seq”; or touch the “Work Pattern” option box on the screen to set the Work Pattern to Seq.

##### Step 3. Custom Wave Segment:

Select the “Custom Wav Seg” button and pop up the “Custom Wav Seg” dialog (Figure 4.10).



Figure 4.10 Custom Wav Seg Dialog

**Step 4. Set the Wave Segment name:**

Before generating a Wave Segment, you shall first set the name of the Wave Segment to be generated. Select the “Output File Name” button, pop up the “Save As” dialog, enter the name (example) of the Wave Segment to be generated in the dialog with the file suffix of seg. The Wave Segment file is automatically saved in the folder wav. Close the dialog and return to the Custom Wav Seg Dialog. Follow the steps below to continue setting the parameters of the Wave Segment.

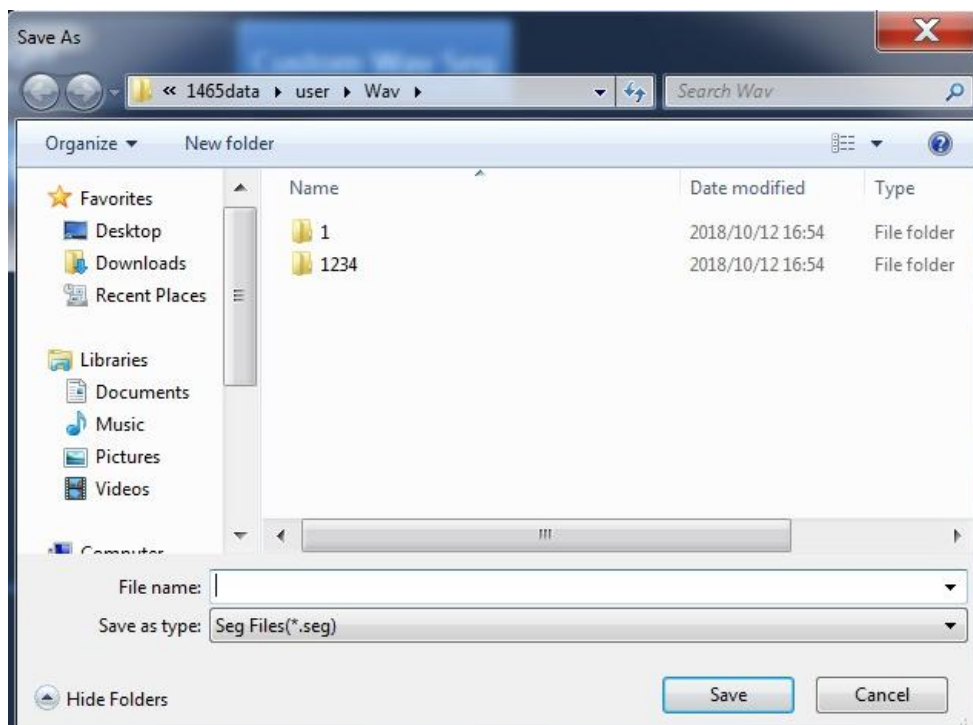

Figure 4.11 Wave Segment Output File “Save As” Dialog

**Step 5. Set the Wave Segment filtering parameters:**

## 4.2 Advanced operation guides

A Wave Segment file with sample counts of 40,000 is to be generated according to the formula:  $\text{Sample Counts} = \text{Length of Wave Segment (Symbol)} \times \text{Over Sample Count}$ , where the Over Sample Count is the number of interpolations of each symbol at the time of shaping filtering. The software automatically calculates the Over Sample Count by default, whose maximum is 32; in the current model 1465, each sampling point occupies 4 bytes (I channel data occupies 16 bits and Q channel data occupies 16 bits), and the maximum storage capacity of the baseband board is 4GByte (8GByte option), so the maximum sample counts is 1GSample (2GSample option).

The software automatically limits the length of the input symbol and the value of the Over Sample Count based on the current baseband storage capacity. It takes a long time to generate a Wave Segment if the Over Sample Count is big. It is recommended to turn off automatic counting of the Over Sample Count and set the Over Sample Count to 4.

In this example, the sample counts to be generated is 40000, the Over Sample Count is set to 4, and the length of the Wave Segment (symbol) is set to 10000. The Samp Clock of the Wave Segment to be generated is 4 MHz and  $\text{Samp Clock} = \text{Over Sample Count} \times \text{Symbol Rate}$ ; the symbol rate is set to 4 Msps.

### Step 6. Select the Data Source:

Rotate the RPG clockwise (or counterclockwise), move the focus to the “Data Source” combo box, and press the knob to select PN9. Or touch the “Data Source” option box on the screen to select PN9.

### Step 7. Set the Wave Segment modulation parameters:

The Modulation Type combo box displays the currently selected modulation type. Select the Modulation Type “QPSK”; or touch the “Modulation Type” combo box on the screen to successively select [PSK]—>[QPSK/OQPSK]—>[QPSK]. Select the default filter.

### Step 8. Set the Wave Segment marker:

Select the “Edit Marker” button to open the Edit Marker dialog (Figure 4.12). In this dialog the user can edit 4 independent markers.

The coordinate system length of the Edit Marker dialog box is 40000, the Sample Counts edited previously. Select the marker with the mouse, double-click the left button at the specified index, and set the output of the marker when the marker line is High or set no output of the marker when the marker line is Low.

The example requires setting the markers at the start and end of the Wave Segment. Put the mouse at the start of the marker 1 and double click the left button to set the marker line to High when the current index is displayed as 0. Put the mouse at the index 100 and double click the left button to set the marker line to Low. At this time, it is High from indexes 0 to 100 and it is Low from indexes 100 to 40000. Similarly, the marker line is set to High between indexes 39900 and 40000.

**For easy selection of the marker index, the user can modify the value of the “Amplification Range” item and then select the “Amplification” option. The coordinate scale is displayed with the current index as a center based on the value of the Amplification Range after modification. Thus, during the playback of the Wave**

## 4.2 Advanced operation guides

Segment, the marker 1 port outputs a high level when the sampling points from 0 to 100 and from 39900 to 40000 are played. After the editing, click the “Generate Marker File” button to generate example.mrk marker file in the wav folder and in the same directory as the Wave Segment.



Figure 4.12 Wave Segment Scale Setting Dialog

### NOTE

#### Instructions for use of markers:

- When the user does not select the output file name of the Wave Segment, the “Generate Marker File” button in the Marker Edit dialog is ineffective. A marker file with the same name as the Wave Segment can be generated only if the name of the Wave Segment file is set.
- The output ends of the Markers 1, 2, 3, and 4 are SMA plugs on the rear panel.
- In the Marker Edit dialog, the user can save the edited marker to the file name specified by the user through the “Save Edited Graphics” button and call the last edited marker file through the “Open Edited Graphics” button. The default saving directory is the Marker folder.
- To make the edited marker valid, set the marker of the Wave Segment to On in the Seq list.

#### Step 9. Generate the Wave Segment:

Close the Marker Edit dialog box, return to the “Custom Wave Segment” dialog box, and select the “Generate Wave Segment” button, to generate the Wave Segment.

**Example 2: Sequence playback function: to demonstrate flexible functions of sequence editing and playbacks.**

#### Operation steps:

##### Step 1. Set the frequency:

- **Edit frequency and amplitude and turn on RF.**

Set the frequency as 10GHz and amplitude as 0dBm, and turn on RF.

## 4.2 Advanced operation guides

### Step 2. Activate the Arb Seq Config Dialog:

➤ **Open the Arb Config Dialog.**

Tap [Arb] under the [Signal] on the touchscreen, and the Arb Config Dialog pops up (Figure 4.9).

### Step 3. Set the parameters

➤ **Set the Work Pattern: Seq.**

Rotate RPG on the front panel clockwise (or counterclockwise) to select “Work Pattern”, press the knob to set Work Pattern as Seq (sequence); or tap “Work Pattern” on the touchscreen and set Work Pattern as Seq.

➤ **Set the Clock Type: Invariant.**

Rotate RPG on the front panel clockwise (or counterclockwise) to select “Clock Type”, press the knob to set Clock Type as Invariant; or tap “Work Pattern” on the touchscreen to set Clock Type as Invariant.

This clock type indicates: The baseband plays each waveform segment at variable sampling rate, and these two waveform segments in the sequence are played according to its default clock frequency.

### Step 4. Add waveform segments

➤ **Add waveform segments as needed.**

Rotate RPG on the front panel clockwise (or counterclockwise) or tap “Add Wave Seg” on the touchscreen and select the sample wave segment file 400KSin\_16MClk.seg in the dialog to add it into the sequence list; select “Add Wave Seg” again to add the sample file 400KTri\_16MClk.seg into the sequence list.

---

## NOTE

### Instructions for sample wave segment file

- The sample wave segment file 400KSin\_16MClk has a baseband output of sine wave (clock frequency: 16MHz, playback duration: 25ms). The sine wave output can be seen by connecting I-channel output (or Q-channel output) on the rear panel of the instrument to an oscilloscope.
- The sample wave segment file 400KTri\_16MClk has a baseband output of triangle wave (clock frequency: 16MHz, playback duration: 25ms). The triangle wave output can be seen by connecting I-channel output (or Q-channel output) on the rear panel of the instrument to an oscilloscope.

---

### Step 5. Turn on the arbitrary waveform function

➤ **Select “Arb Seq ON”.**

After configuring the arbitrary waveform sequence, rotate the knob on the front panel clockwise (or counterclockwise) to select Arb Seq ON/OFF, press the knob to turn ON the Arb Seq; or tap Arb Seq ON/OFF on the touchscreen to activate Arb Seq.



Now, the instrument downloads the playback sequence automatically.

The associated sequence playback sample is shown in Table 4.1:

Table 4.1 Sequence Playback Extension Sample

SN	Description
1	Set the repetitions of 400KSin_16MCIk as 2, check the Arb Seq ON and redownload; through an oscilloscope, it can be seen that two sine waves and a triangle wave are played in loop.
2	Change the clock type to “Highest” and check the Arb Seq ON, then these two waveform segments are played at the maximum frequency of them (32MHz in this sample); the output waveform can be seen on an oscilloscope.
3	Change the clock type to “User Defined”, set the clock frequency as 32MHz and check the Arb Seq ON, then these two waveform segments are played with the user defined clock.
4	Delete all wave segments, add the wave segments 2MSin_8MCIk.seg and 2MQPSK_8MCIk, check the Arb Seq ON, set Clock Type as “Invariant” and the carrier frequency as 10GHz; connect the RF output port to a signal analyzer and set its parameters: center frequency: 10GHz, span: 5MHz; the frequency spectrum of QPSK and sine wave can be observed.

It shall be noted that the playback at variable sampling rate is implemented by software through automatic interpolation, and at the hardware end, the playback will be done at fixed sampling rate.

### Example 3: Arbitrary waveform playback function

#### Operation steps:

#### Step 1. Set the frequency:

- **Edit frequency and amplitude and turn on RF.**

Set the frequency as 10GHz and amplitude as 0dBm, and turn on RF.

#### Step 2. Activate the Arb Seq Config Dialog:

- **Open the Arb Config Dialog.**

Tap [Arb] under the [Signal] on the touchscreen, and the Arb Config Dialog pops up (Figure 4.9).

#### Step 3. Set the parameters

- **Set the Work Pattern: Arb.**

Rotate RPG on the front panel clockwise (or counterclockwise) to select the “Arb Seq” option box, press the knob to turn ON the Arb Seq; or tap “Arb Seq” on the touchscreen to activate Arb Seq.

- **Set the clock frequency: 100MHz.**

Rotate RPG on the front panel clockwise (or counterclockwise) to select “Clock Freq” input box, and press the knob to make it editable; or tap “Clock Freq” on the touchscreen to make it editable.

#### Step 4. Add arbitrary waveform files

## 4.2 Advanced operation guides

- **Load arbitrary waveform as needed.**

Select “Load Arb” and select the file type Mat-File in the popup dialog; select the sample file 1MSin.mat to add it into the list.

### Step 5. Set the file format

- **Press “File Format Config” and set the type as the matrix list data.**

Rotate RPG on the front panel clockwise (or counterclockwise) or tap “File Format Config” on the touchscreen to automatically read the matrix list in the current mat file. Select Idata\_Int16 in the dropdown list of I matrix, Qdata\_Int16 in the dropdown list of Q matrix and MarkerData\_int8 in the dropdown list of Marker matrix. Select the default data type. Close the “File Format Config” dialog box and return to the Arb Seq configuration dialog.

### Step 6. Set the markers

- **Set Markers 1 to 4 in the list as ON.**

### Step 7. Turn on the arbitrary waveform function

- **Select “Arb Seq ON”.**

The instrument will automatically download and play the arbitrary waveform files. The triangle wave output can be seen by connecting I-channel output (or Q-channel output) on the rear panel of the instrument to an oscilloscope. The edited marker output can be observed on an oscilloscope by connecting it to Markers 1-2 outputs on the rear panel.

## NOTE

### Support user-defined arbitrary waveform file formats

The signal generator supports the playback of user-defined arbitrary waveform files.

It currently supports conversion of the following file formats: Mat-File 5, ASCII, Binary, cap, and csv. The generator can convert data files in the above 5 formats to the waveform data file .seg (16-bit data) and marker file .mrk it uses to play.

### 4.2.3 Selecting ALC bandwidth

In the internal level control mode, the signal generator will use the automatic level control (ALC) circuit before the RF output.

There are five ALC bandwidth options: Auto, 100Hz, 1kHz, 10kHz and 100kHz.

In Auto mode (reset option), the signal generator automatically selects ALC bandwidth according to the configuration and settings; when the frequency is less than 1MHz or the vector modulation is turned on, the bandwidth is 100Hz; when the frequency is greater than 1MHz but less than 10MHz, the bandwidth is 1kHz; when the frequency is greater than 10MHz with AM turned on and pulse modulation turned off, the bandwidth is 100kHz; in other cases the bandwidth is 10kHz. In other modes than Auto, the ALC bandwidth will be set according to user’s choice.

#### Operation steps:

##### Step 1. Turn on the ALC bandwidth

Press the **【Amplitude】** key or tap [Amplitude] on the touchscreen to select [ALC Band] in the Ampl Config Dialog and then select “ALC Band Manu”;

### Step 2. Select the bandwidth

Bandwidth options: 100Hz, 1kHz, 10kHz, 100kHz, selected as needed;

Limited bandwidth or narrow bandwidth will extend the time of ALC sampling and thus indicate the RMS value of signal in a more accurate way.

#### 4.2.4 External level control

##### 4.2.4.1 Introduction

In level control regulation mode, the generator's output amplitude will be detected by external probes, the detected voltage will be sent back to the generator's level control circuit and the output amplitude will be automatically corrected to keep the amplitude constant at detection points.

##### 4.2.4.2 Level control using detector/coupler/power divider

###### 1) Block Diagram of Measurement

A typical setup of external level control is shown in Fig. 4.10. In external level control mode, the amplitude level will be fed back by the negative voltage output detector rather than the internal detector. The fed-back voltage controls the ALC system and thus the output amplitude.

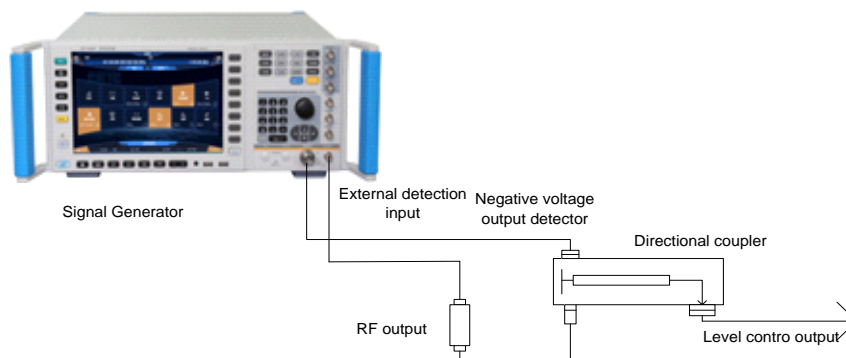

Fig. 4.10 Wiring Diagram of ALC Circuit for External Level Control Measurement

###### 2) Measurement steps

###### Step 1. Set the external level control:

- 1) Connect the instrument as shown in Fig. 4.10;
- 2) Press the **【Amplitude】** key or tap [Level Control] under the [Amplitude] on the touchscreen;
- 3) Select the "Level Control" as: EXT.

###### Step 2. Set the coupling parameters

Edit the option "Ext Detector Couple" and input 20dB (this is the coupling factor of the directional coupler) .

## NOTE

The coupling factor of the power divider is 0dB.

## 4.2 Advanced operation guides

### 4.2.5 Working with a frequency mixer/Effects of reverse power

The attenuator can be manually used for frequency mixer testing. In the example shown in Fig. 4.11, the signal generator has an output amplitude of  $-8\text{dBm}$  and in the internal amplitude modulation mode, the attenuation of attenuator is set to  $0\text{dB}$ . The amplitude level of ALC is set to  $-8\text{dBm}$ . The frequency mixer is driven with an LO of  $+10\text{dBm}$  and has an LO-to-RF (of the generator) isolation of  $15\text{dB}$ . The resulting  $-5\text{dBm}$  LO feedthrough amplitude enters the signal generator's RF output and arrives at the internal detector via the attenuator without loss.

Depending on frequency, it is possible for most of this LO feedthrough energy to enter the detector. Because the detector will respond to its input amplitude regardless of frequency, this energy causes the ALC to reduce the output amplitude. In this example, the reverse power across the detector is actually greater than the ALC level, therefore the amplitude output of the generator is actually shut down.

In the example shown in Fig. 4.12, a  $-8\text{dBm}$  amplitude output is manually generated with the attenuator. In this example, the attenuation is  $10\text{dB}$ , the ALC level is  $+2\text{dBm}$  and the LO frequency of frequency mixer is  $10\text{dBm}$ . With the  $10\text{dB}$  attenuator, the reverse power ( $-5\text{dBm}$ ) of LO is attenuated to  $-15\text{dBm}$ , thus the detector is exposed to a  $+2\text{dBm}$  ALC level and the undesired  $-15\text{dBm}$  reverse power. This  $17\text{dB}$  difference results in a  $0.1\text{dB}$  shift in the signal generator's output level. Set the generator manually with an attenuator:

#### Operation steps:

##### Step 1. Open the Ampl Config Dialog

Press the **【Amplitude】** key or tap [Amplitude] on the touchscreen to open Ampl Config Dialog.

##### Step 2. Set Attenuation Style in ALC system to Manual and set the attenuation value.

Select [Atten Config] in the Ampl Config Dialog, rotate RPG on the front panel clockwise (or counterclockwise) to select Attenuation Style box, and press the knob to select Manual; rotate RPG again to select Attenuation input box, and press the knob to make it editable; or tap Attenuation Style on the touchscreen to select Manual, and then tap Attenuation input box to make it editable. Then, set the Attenuation to  $10\text{dB}$ .

##### Step 3. Set ALC

Select [Atten Config] in the Ampl Config Dialog, rotate RPG on the front panel clockwise (or counterclockwise) to select ALC input box, and press the knob to make it editable; or tap ALC input box on the touchscreen to make it editable. Now, set ALC to  $2\text{dBm}$ .

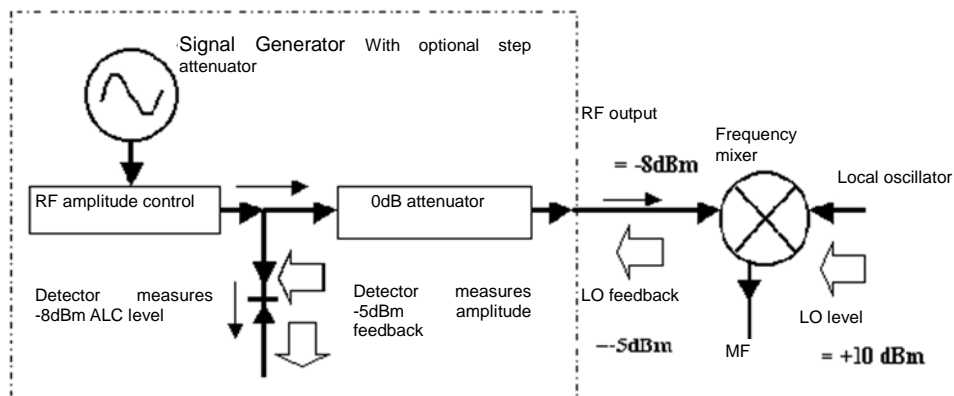

Fig. 4.11 Effects of Reverse Power (  $-8\text{dBm}$  Coupling Output)

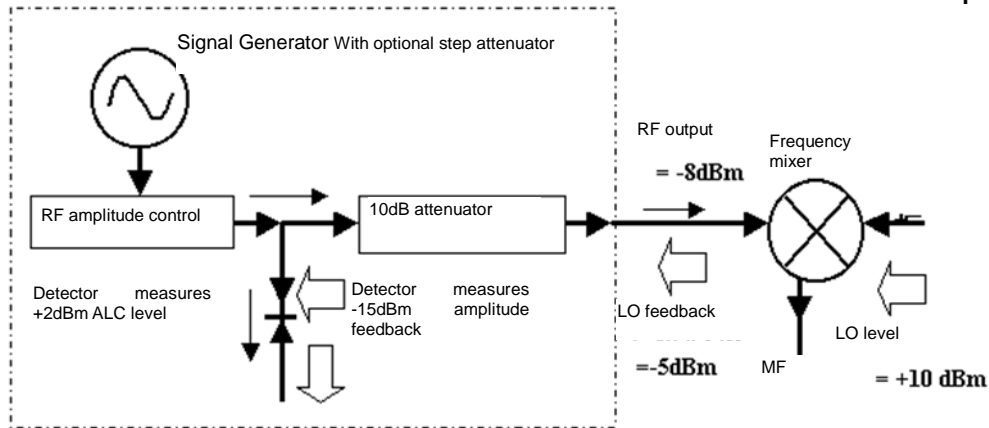

Fig. 4.12 Effects of Reverse Power (-8dBm Non-coupling Output)

#### 4.2.6 Creating and applying a user flatness correction array

The basic operations for creating flatness correction array is to implement correction by connecting the GPIB port to a power meter. The user flatness correction function is explained in the example below.

**Example:** Use a 2432 power meter to perform the automatic flatness correction of sweep signal from 4GHz to 7GHz. In this example, signals from 4GHz to 7GHz are corrected for flatness at interval of 1GHz and the signal generator control the 2432 power meter with an interface bus to generate the correction data array.

Operation steps:

Step 1. Connect the instrument as shown in Fig. 4.13.

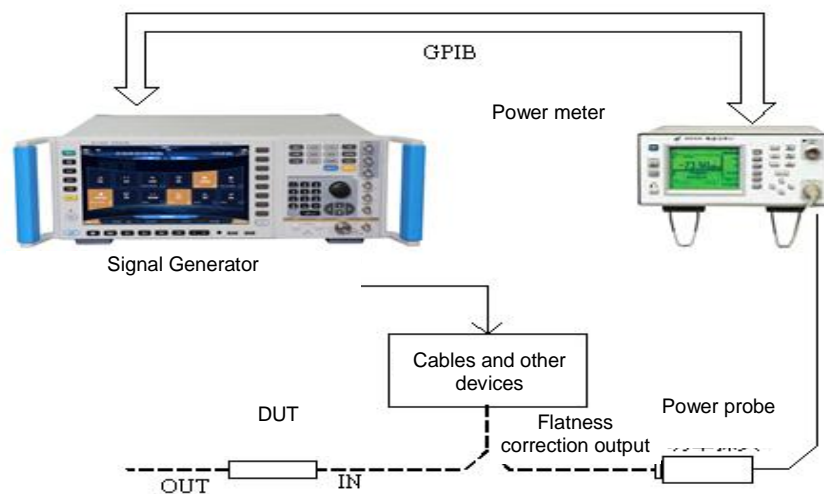

Fig. 4.13 User Flatness Correction

Step 2. Set the power meter and zero it and probe.

Step 3. Set probe calibration parameters properly for the power meter.

Step 4. Enable the power meter/probe calibration parameter series.

See the manual of 2432 power meter for detailed methods of use.

Step 5. Connect the power probe to the amplitude output connector to be calibrated.

Step 6. Set the signal generator and press the **【Reset】** key. Set the amplitude level to 0dBm and turn ON the [User Flatness ON/OFF].

Step 7. Press the **【Calibration】** key and select [User Flatness], the “User Calibration” dialog

## 4.2 Advanced operation guides pops up.

**Step 8.** In the “User Calibration” dialog, select [Delete All Counts] to ensure all calibration data has been cleared.

**Step 9. Input counts to be calibrated:** Input counts at a step of 1GHz manually or generate counts automatically.

In the example, Auto Fill is used.

- 1) Select [Freq Start] under [Auto Fill] and input 4GHz;
- 2) Select [Freq Stop] and input 7GHz;
- 3) Select [Freq Step] and input 1GHz;
- 4) Select [Confirm Fill].

The frequency list will be automatically filled with: 4GHz (Freq Start), 7GHz (Freq Stop) and an increment of 1GHz; input calibration data, as shown in Fig. 4.14.



Fig. 4.14 User Flatness Calibration List

**Step 10.** After all parameters have been set, start the calibration.

Ensure that the signal generator is connected to the power meter with a GPIB cable, select [ GPIB Port] under [System] to set the GPIB address, programming language and power meter selection

Select [Calibrate All Counts] to start the calibration and the power meter is controlled by the signal generator to perform the count calibration continuously according to the calibration list. Calibrated data is automatically stored after calibration.

### 4.2.7 Selecting pulse modulation input

#### 4.2.7.1 Selection of ALC status when pulse modulation is turned on

Limited to the tracking speed of generator’s built-in ALC loop, the ALC loop should be set to open-loop or search mode when the pulse modulation is turned on and the pulse width is smaller than 1  $\mu$ s.

#### 4.2.7.2 Selecting pulse input

##### 1) Pulse input “Scalar”

Press the **【Pulse】** key or tap [Pulse] on the touchscreen, and Pulse Modu Config Dialog pops up; rotate the knob clockwise (or counterclockwise) to select “Source” option, press the knob to select [Scalar]; or tap “Source” on the touchscreen to select [Scalar].

Activate the pulse modulation and enable the internal pulse generator to generate 27.8kHz square wave (pulse width: 18 $\mu$ s, period: 36 $\mu$ s, as shown in Fig. 4.15) with RF envelope rise and fall times of

about  $0.2\mu\text{s}$ . This pulse is used for AC detection of scalar network analyzer.

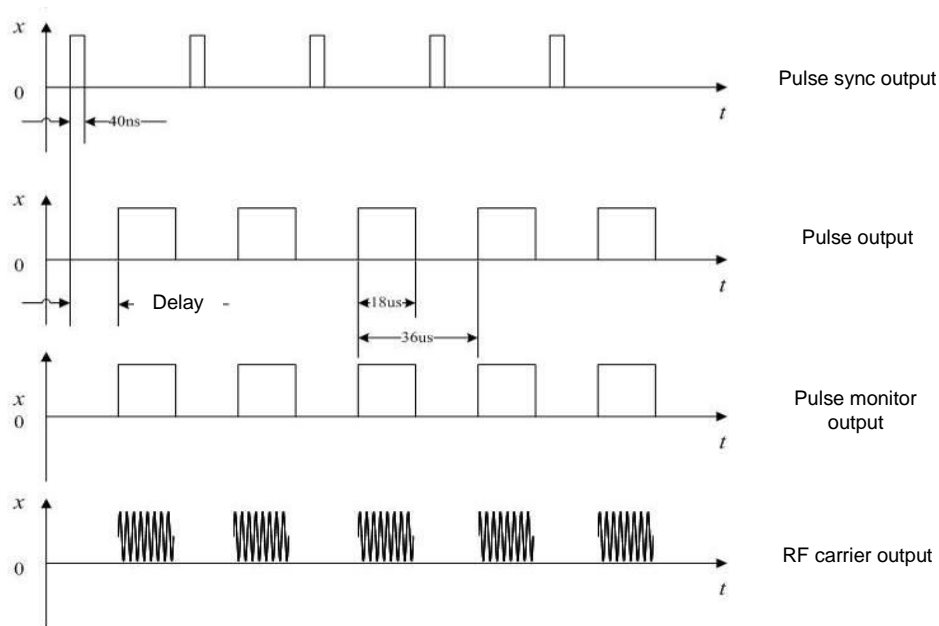

Fig. 4.15 Internal Scalar Pulse

### 2) Pulse input "Auto"

Press the **【Pulse】** key or tap [Pulse] on the touchscreen, and Pulse Modu Config Dialog pops up; rotate the knob clockwise (or counterclockwise) to select "Source" option, press the knob to select [Auto]; or tap "Source" on the touchscreen to select [Auto].

Set Pulse Modulation to ON and set the internal pulse generator as the pulse modulation source (Fig. 4.16), which eliminates the need to connect external pulse signal. Also activate the auto trigger mode of internal pulse and do not sync with other trigger signal. You can set the pulse signal parameters in the Pulse Modu Config Dialog (Fig. 3.22).

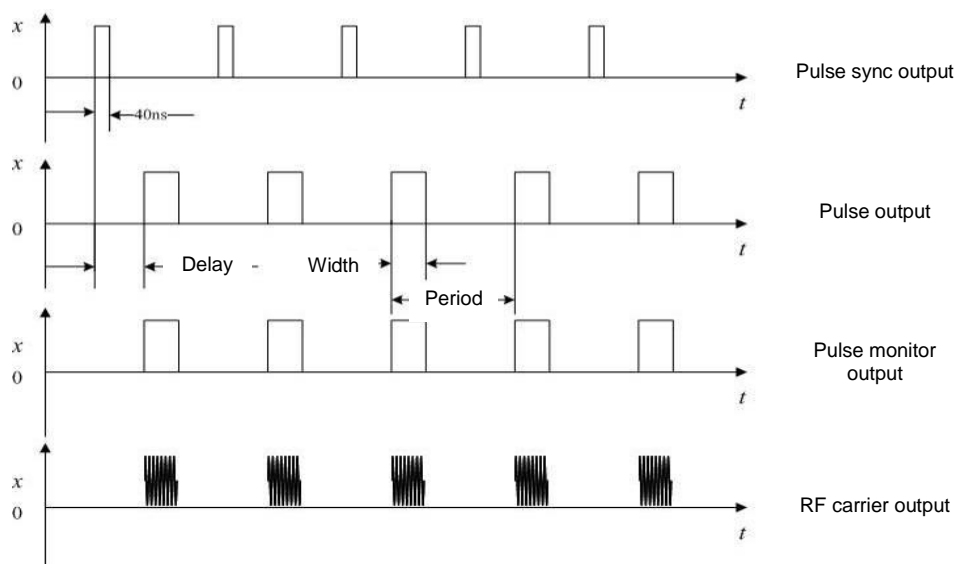

Fig. 4.16 Internal Auto Mode

### 3) Pulse input "Trigger"

Press the **【Pulse】** key or tap [Pulse] on the touchscreen, Pulse Modu Config Dialog pops up; rotate the knob clockwise (or counterclockwise) to select "Source" option, press the knob to select [Trig]; or tap "Source" on the touchscreen to select [Trig].

**4.2 Advanced operation guides**

In the Pulse Modu Config Dialog, select the “Delay” input box to set the pulse delay of internal pulse generator. Use the external pulse input signal leading edge to delay the pulse output of the internal pulse generator (Fig. 4.17).

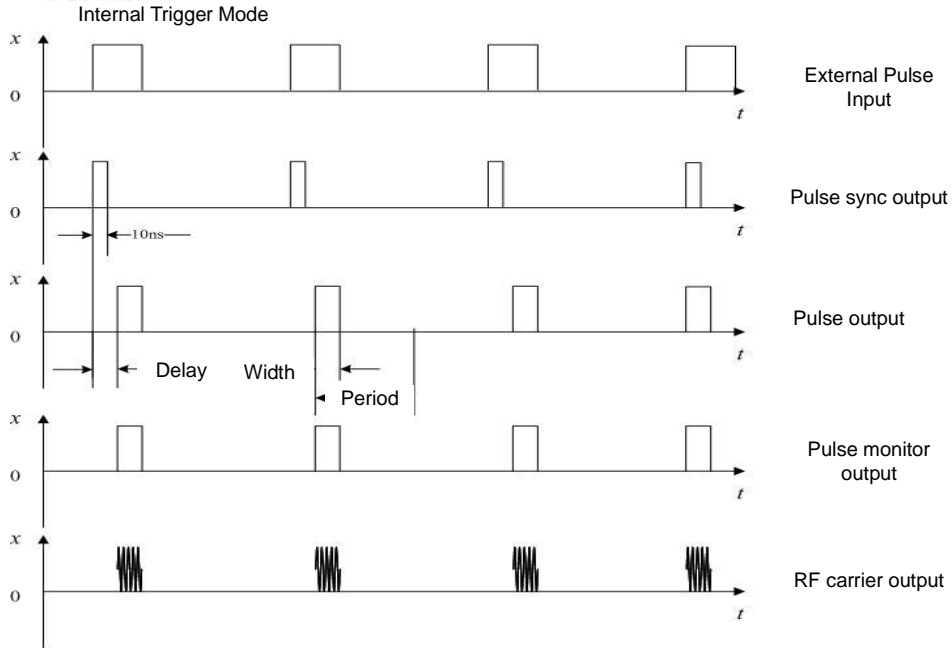

Fig. 4.17 Internal Trigger Mode

**4) Pulse input “Gate”**

Press the **【Pulse】** key or tap [Pulse] on the touchscreen, the Pulse Modu Config Dialog pops up; rotate the knob clockwise (or counterclockwise) to select “Source” option, press the knob to select [Gate]; or tap “Source” on the touchscreen to select [Gate].

Activate the gate trigger mode for internal pulse to enable the internal pulse generator to perform logic AND calculations with external input pulse signals (Fig. 4.18).

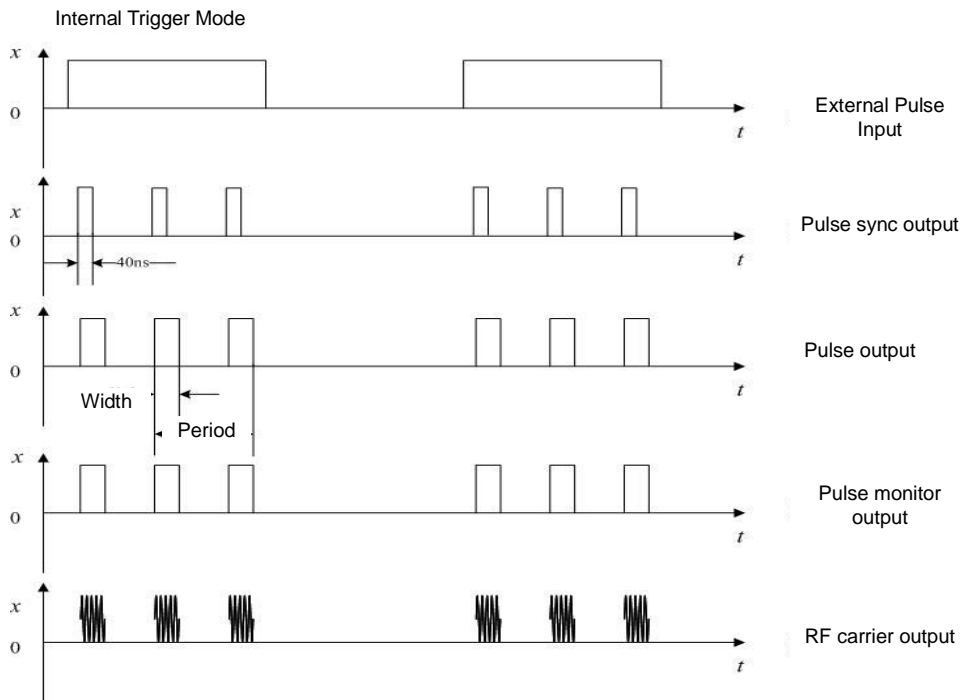

Fig. 4.18 Internal Gate Mode



### 5) Pulse input “Dual Pulse”

Press the **【Pulse】** key or tap [Pulse] on the touchscreen, the Pulse Modu Config Dialog pops up; rotate the knob clockwise (or counterclockwise) to select “Source” option, press the knob to select [D-Pulse] under [M-Pulse]; or tap “Source” on the touchscreen to select [D-Pulse] under [M-Pulse].

Activate the D-Pulse trigger mode (Fig. 4.19).

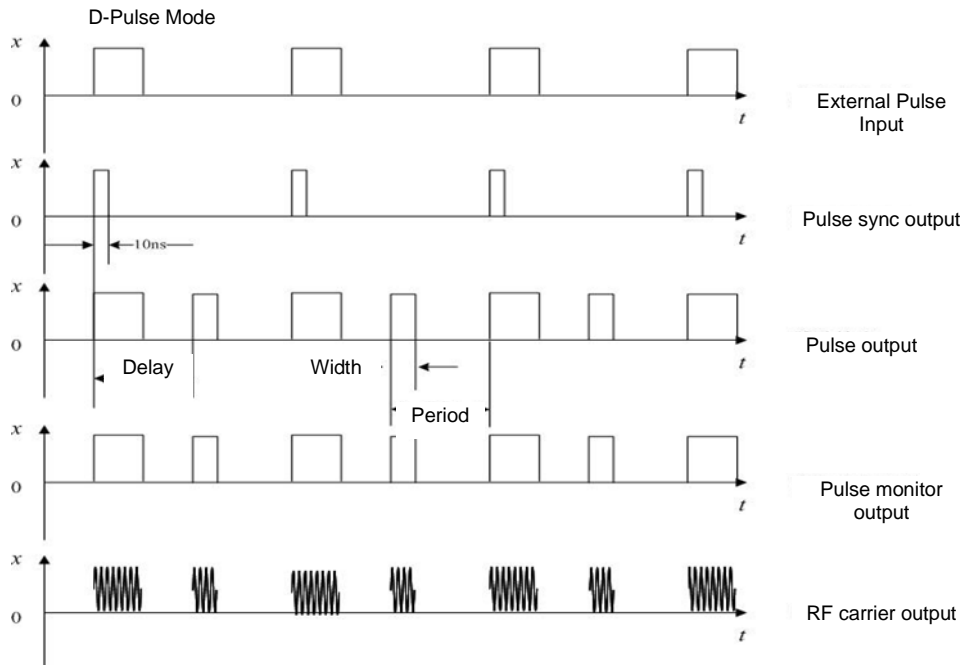

Fig. 4.19 D-Pulse Mode

#### 4.2.8 Baseband trigger function configuration

Series 1465 Signal Generator has three trigger modes for real-time baseband: continuous, single and gate; the trigger sources of baseband include: trigger key (Key), external (Ext) and bus (Bus). See “5.1.5 Baseband” of “5.1 Menu description” for details.

**Example 1: Real-time baseband mode. Data source: PN9, symbol rate: 4Mbps, modulation type: QPSK, trigger mode: single, trigger source: external, polarity: positive, delay: off.**

**Operation steps:**

**Step 1. Connect the instrument as shown in Fig. 4.20.**

Connect I/Q signal output on the rear panel to two input ports of an oscilloscope via the BNC cables, set another signal generator to the pulse modulation output mode and use it as the external trigger source (pulse width: 50 $\mu$ s, period: 200 $\mu$ s). Connect to “Monitor Output” of this signal generator to a BNC tee connector, of which one end is connected to “Code Pattern Trigger Input” of the vector signal generator and the other end is connected to the third input port of the oscilloscope.

4.2 Advanced operation guides

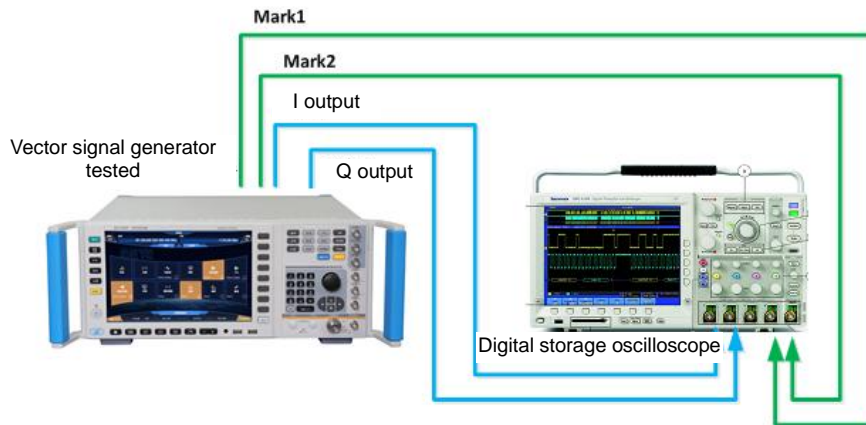

Fig. 4.20 Trigger Test

**Step 2. Press the 【Base】 key or tap [Base] on the touchscreen to open Baseband Config Dialog (Fig. 4.1).**

**Step 3. Set parameters:**

- 1) Set data source: PN9, symbol rate: 4Mbps, modulation type: QPSK;
- 2) Select [Trigger] to set the trigger style: Continue (single), Trigger Source: Ext, Ext Trig Polar: positive, delay: off;

**Step 4. Set “Baseband” to ON.**

**Step 5. Observe those traces on the oscilloscope.**

As shown in Fig. 4.21: Signal 1: external trigger signal, Signal 2: I output, Signal 3: Q output. Each time the rising edge of pulse appears, the baseband signal is trigger for playback once. When the data source is PN9, it needs 60μs to play the 4Mbps baseband signal once; observe the testing results on the oscilloscope to verify if the function works properly.

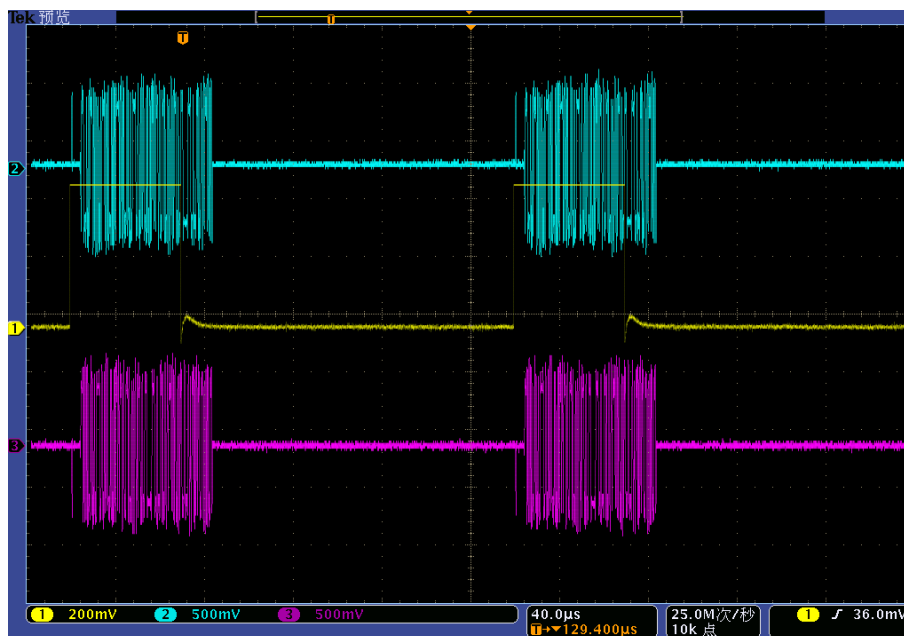

Fig. 4.21 Diagram of Baseband Triggering (Continues/Single)

**Example 2: Trig Style: Gate (High), data source: PN9, symbol rate: 4Mbps, modulation type: QPSK.**

**Operation steps:**

**Step 1. Connect the instrument as shown in Fig. 4.20.**

Connect I/Q signal output on the rear panel to two input ports of a oscilloscope via the BNC cables, set another signal generator to the pulse modulation output mode and use it as the external trigger source (pulse width: 50ms, period: 200ms). Connect to “Monitor Output” of this signal generator to a BNC tee connector, of which one end is connected to “Code Pattern Trigger Input” of the vector signal generator and the other end is connected to the third input port of the oscilloscope.

**Step 2. Press the 【Base】 key or tap [Base] on the touchscreen to open Baseband Config Dialog (Fig. 4.1).**

**Step 3. Set parameters:**

- 1) Set data source: PN9, symbol rate: 4Mbps, modulation type: QPSK;
- 2) Select [Trigger] to set the trigger style: Gate (High), Trig Source: external, polarity: positive, delay: off;

**Step 4. Set “Baseband” to ON.****Step 5. Observe those traces on the oscilloscope.**

As shown in Fig. 4.22: Signal 1: external trigger signal, Signal 2: I output, Signal 3: Q output. With an external pulse signal as the gate signal input, the baseband signal outputs at high level and will not output at low level.

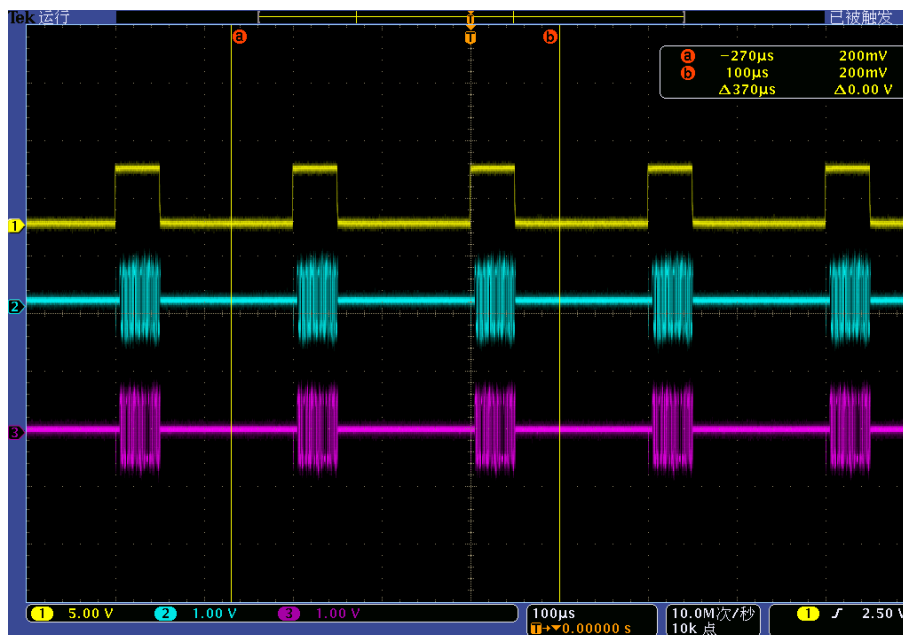

Fig. 4.22 Diagram of Baseband Triggering (Gate/High)

**Example 3: Trig Style: Gate (Low), data source: PN9, symbol rate: 4Mbps, modulation type: QPSK. External trigger source: Pulse width: 50ms, period: 200ms.**

The operations are the same as “Example 2” with the trigger mode changed to Low, and the measurement results of the oscilloscope is shown in Fig. 4.23.

## 4.2 Advanced operation guides



Fig. 4.23 Diagram of Baseband Triggering (Gate/Low)

**NOTE****Status of signal generator when the baseband trigger mode is set as “Gate”**

The trigger source will be set as Ext automatically and the polarity will change with the gate status. In Gate mode, the baseband signal will be played continuously.

## 4.2.9 Arbitrary waveform triggering function configuration

Trigger sources of arbitrary waveform include: trigger key (Key), external (Ext), bus (Bus) and internal (Int). See “5.2.7 Arbitrary waveform” of “5.2 Menu description” for details.

**Example 1: Work pattern: Sequence, Add Wave Seg: 4KTri\_2MClk (sine wave), clock: customized 200MHz, Trig Style: Continue (realtime), Trig Source: Ext, Ext Config Dialog: Polar: Pos.**

**Operation steps:****Step 1. Connect the instrument as shown in Fig. 4.20.**

Connect I/Q signal output on the rear panel to two input ports of a oscilloscope via the BNC cables, set another signal generator to the pulse modulation output mode and use it as the external trigger source (pulse width: 200ns, period: 4µs). Connect to “Monitor Output” of this signal generator to a BNC tee connector, of which one end is connected to “Code Pattern Trigger Input” of the vector signal generator and the other end is connected to the third input port of the oscilloscope.

**Step 2. Select [Arb] under the [Signal Simulation], and Arb Config Dialog pops up (Fig. 4.9).****Step 3. Set parameters:**

- 1) Work pattern: Sequence, Add Wave Seg: 4KTri\_2MClk (sine wave), Clock: customized 200MHz;
- 2) Select [Trigger] to set the trigger style: Continue (realtime), Trig Source: Ext, Ext Config Dialog:: Polar: positive, delay: off;

**Step 4. Set “Arb Seq” to ON.****Step 5. Observe those traces on the oscilloscope.**

As shown in Fig. 4.24: Signal 1: external trigger signal, Signal 2: I output, Signal 3: Q output. Each

## 4.2 Advanced operation guides

time an external trigger signal arrives, the waveform segment starts to play; when next trigger signal arrives, the waveform segment responds in real time and starts to replay.

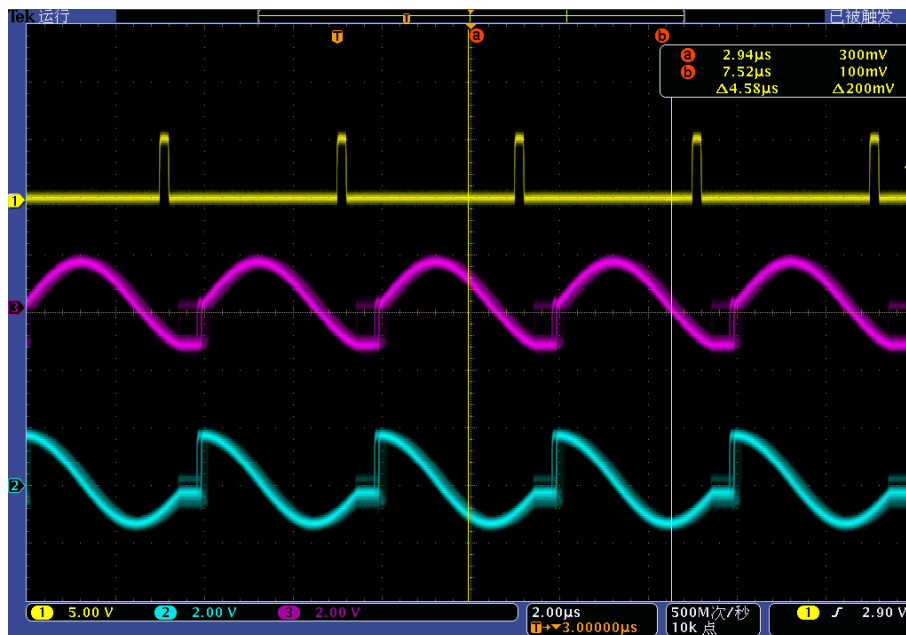

Fig. 4.24 Diagram of Arbitrary Trigger (Continue/Realtime)

**Example 2: Work pattern: Sequence, Add Wave Seg: 4KTri\_2MClk (sine wave), clock: customized 200MHz, Trig Style: Single (Ignore Repeated Trig), Trig Source: Ext; Neg: Pos.**

The operations are the same as above with the trigger mode changed to Single (Ignore Repeated Trig), and the measurement results of the oscilloscope is shown in Fig. 4.25. As shown in the figure: The arrival of the second pulse triggers a playback and if a next trigger signal arrives during the playback, it will be ignored.

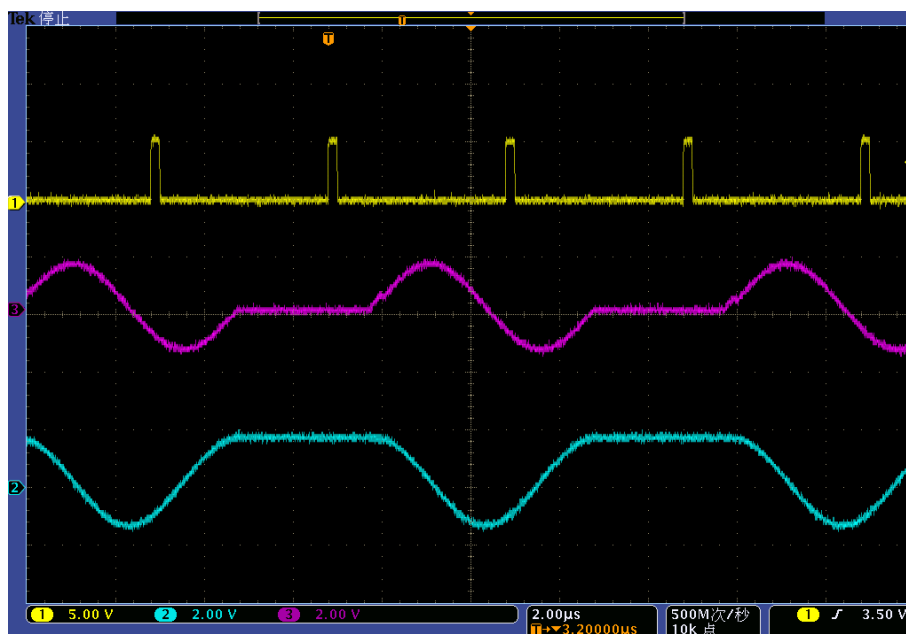

Fig. 4.25 Diagram of Arbitrary Trigger (Single/Ignore Repeated Trig)

**Example 3: Work pattern: Sequence, Add Seg: 4KTri\_2MClk (sine wave), clock: customized 200MHz, Trig Style: Single (Buffer Repeated Trig), Trig Source: Ext; Neg: Pos.**

Operation steps:

## 4.2 Advanced operation guides

**Step 1. Connect the instrument as shown in Fig. 4.20.**

Connect I/Q signal output on the rear panel to two input ports of a oscilloscope via the BNC cables, set another signal generator to the pulse modulation output mode and use it as the external trigger source; set the pulse source as pulse train to generate three pulses: Width: 0.2 $\mu$ s, Period: 4 $\mu$ s, 10 $\mu$ s, 20 $\mu$ s. Connect to “Monitor Output” of this signal generator to a BNC tee connector, of which one end is connected to “Code Pattern Trigger Input” of the vector signal generator and the other end is connected to the third input port of the oscilloscope.

**Step 2. Select [Arb] under the [Signal Simulation], and Arb Config Dialog pops up (Fig. 4.9).****Step 3. Set parameters:**

- 1) Work pattern: Sequence, Add Wave Seg: 4KTri\_2MClk (sine wave), Clock: customized 200MHz;
- 2) Select [Trigger] to set the trigger style: Continue (realtime), Trig Source: external, polarity: positive, delay: off;

**Step 4. Change the trigger style to Single (Buffer Repeated Trig)****Step 5. Set “Arb Seq” to ON.****Step 6. Observe those traces on the oscilloscope.**

As shown in Fig. 4.26: Signal 1: external trigger signal, Signal 2: I output, Signal 3: Q output. The arrival of the first pulse triggers the playback of waveform segment and if a next trigger signal arrives during the playback, it will be recorded and triggers playback at the end of the last waveform segment playback.

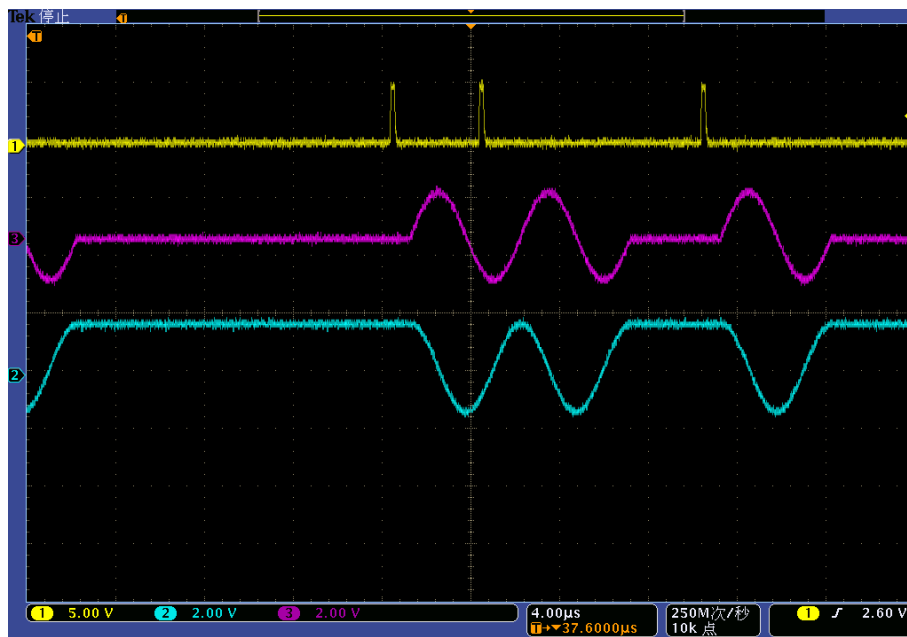

Fig. 4.26 Diagram of Arbitrary Trigger (Single/Buffer Repeated Trig)

**Example 4: Work pattern: Sequence, Add Seg: 4KTri\_2MClk (sine wave), clock: customized 200MHz, Trig Style: Single (Real-time Repeated Trig), trigger source: Ext; Neg: Pos.**

The operations are the same as above with the trigger mode changed to Single (Real-time Repeated Trig), and the oscilloscope output is shown in Fig. 4.27.

As shown in the figure, Signal 1: external trigger signal, Signal 2: I output, Signal 3: Q output.

The arrival of the first pulse triggers the playback of waveform segment and if a next trigger signal arrives during the playback, the current waveform segment stops playing and starts to play from the beginning.

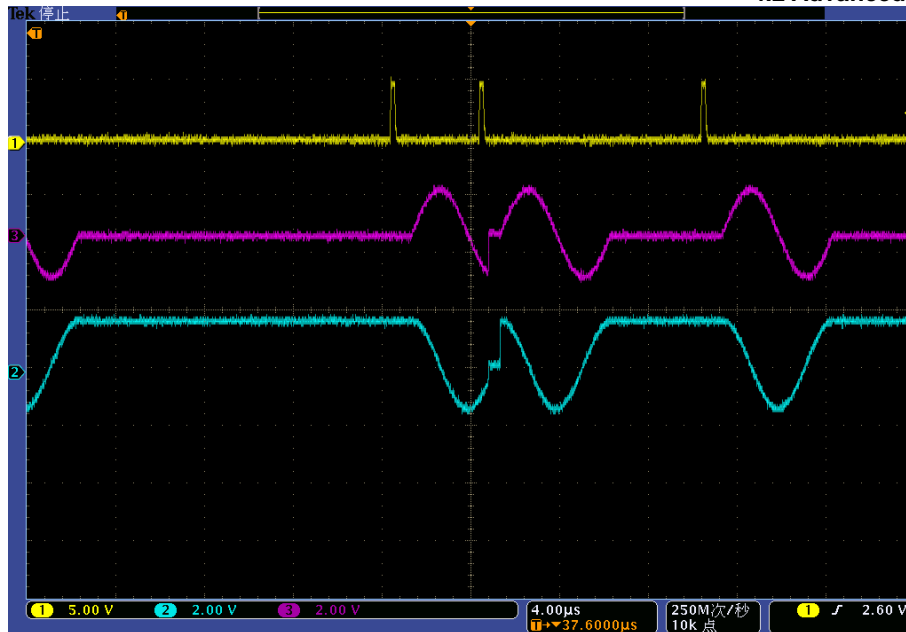

Fig. 4.27 Diagram of Arbitrary Trigger (Single/Real-time Repeated Trig)

**Example 5: Work pattern: Sequence, Add Wave Seg: 4KSin\_2MClk, 4kTir\_2MClk, clock: customized 200MHz, Trig Style: Wave Seg (Single), Trig Source: external, polarity: Pos.**

**Operation steps:**

**Step 1. Connect the instrument as shown in Fig. 4.20.**

Connect I/Q signal output on the rear panel to two input ports of an oscilloscope via the BNC cables, set another signal generator to the pulse modulation output mode and use it as the external trigger source (pulse width: 200ns, period: 8μs). Connect to “Monitor Output” of this signal generator to a BNC tee connector, of which one end is connected to “Code Pattern Trigger Input” of the vector signal generator and the other end is connected to the third input port of the oscilloscope.

**Step 2. Select [Arb] under the [Signal Simulation], and Arb Config Dialog pops up (Fig. 4.9).**

**Step 3. Set parameters:**

- 1) Work pattern: Sequence, Add Wave Seg: 4KTri\_2MClk, 4KSin\_2MClk, Clock: customized 200MHz;
- 2) Select [Trigger] to set the trigger style: Wave Seg (Single), Trig Source: external, polarity: positive, delay: off;

**Step 4. Set “Arb Seq” to ON.**

**Step 5. Observe those traces on the oscilloscope.**

As shown in Fig. 4.28: Signal 1: external trigger signal, Signal 2: I output, Signal 3: Q output. Each time the pulse arrives, a playback of waveform segment is triggered. Different waveform segment will be played each time.

4.2 Advanced operation guides

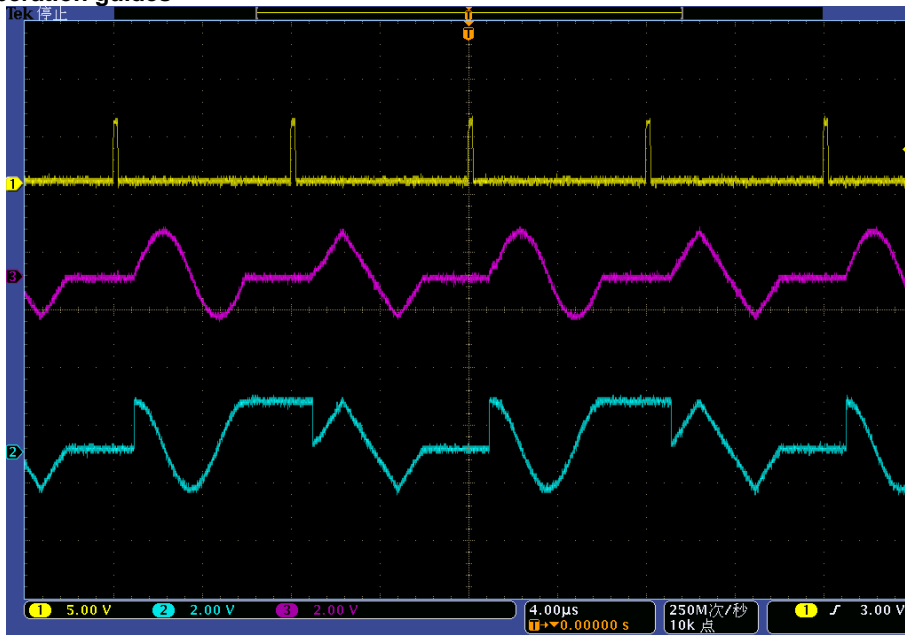

Fig. 4.28 Diagram of Arbitrary Trigger (Wave Seg Single)

**Example 6: Work pattern: Sequence, Add Wave Seg: 4kTir\_2MClk, Clock Type: customized 200MHz, Trig Style: Gate (High), Trig Source: external, polarity: Pos. External trigger source: Pulse width: 10µs, Period: 15µs.**

The operations are the same as above with the trigger mode changed to Gate (High), and the oscilloscope output is shown in Fig. 4.29.

As shown in the figure, Signal 1: external trigger signal, Signal 2: I output, Signal 3: Q output.

For high level inputs, waveform segments are played sequentially and for low level inputs, the playback will be stopped.

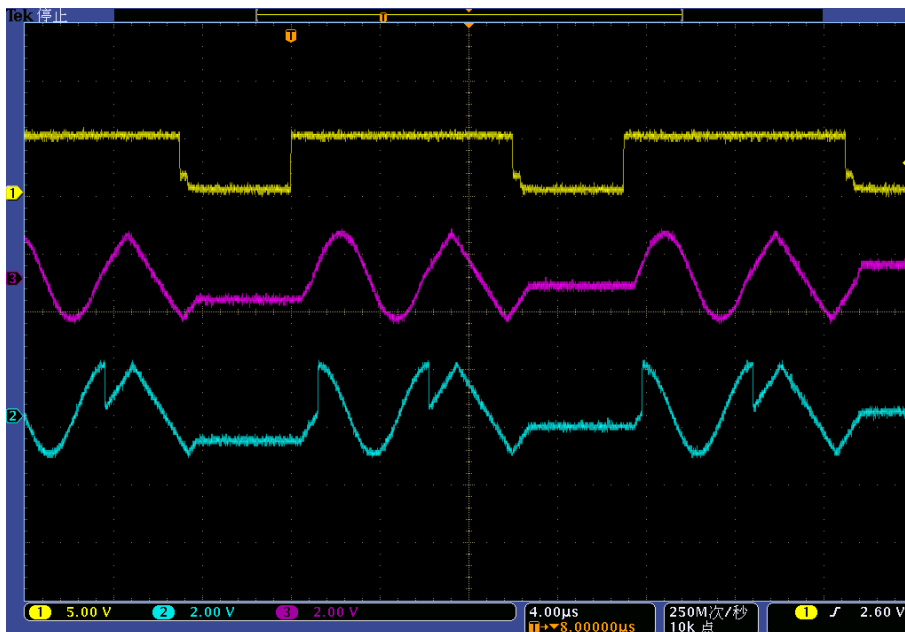

Fig. 4.29 Diagram of Arbitrary Trigger (Gate High)



## 5 Menu

The menu of 1465 series signal generator includes: Frequency, Amplitude, Sweep, Modulation, Base, I/Q, System, File, Save/Recall, Print. As the number of soft keys on the front panel of the instrument is limited, the manufacturer sets the common function menu as boot menu by default, including: Frequency, Amplitude, Sweep, Modulation, Base, I/Q, RF ON/OFF. The menu of the signal generator is described below.

### 5.1 Menu Structure and Parameter Settings

- Frequency.....95
- Amplitude.....97
- Sweep.....99
- Modulation.....101
- Base.....107
- I/Q.....109
- ARB.....110
- Tone.....112
- AWGN (Option).....113
- System.....114
- File.....118
- Save/Recall.....118
- Calibrate.....119

#### 5.1.1 Frequency

Press **【Frequency】** key on the front panel or click [Frequency] menu item in user interface, and a frequency-related menu will pop up to enable you to set frequency-related parameters. The main operation dialogs are as follows:

##### 5.1.1.1 Freq Config

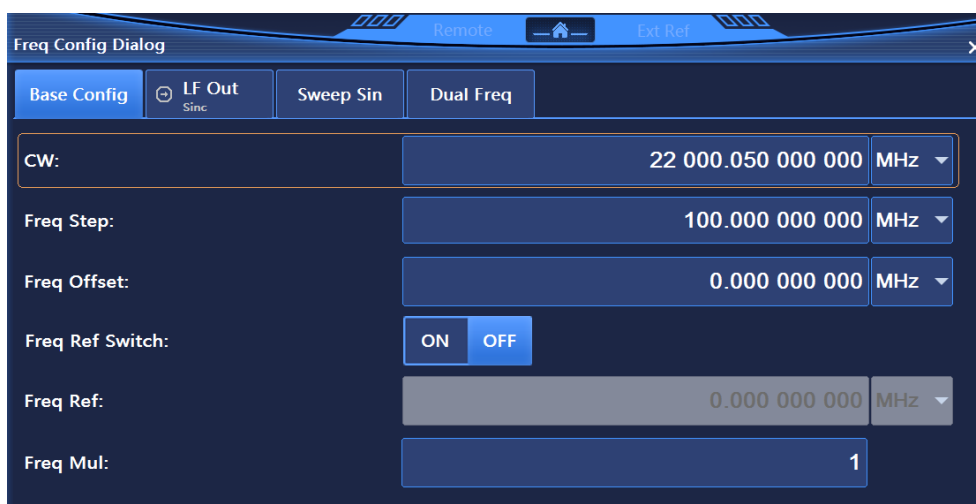

Figure 5.1 Freq Config Dialog

Freq Config Dialog, shown in Figure 5.1, enables you to set parameters such as CW, Freq Step, Freq Offset, Freq Ref Switch, Freq Mul, and Freq Ref when Freq Ref Switch is ON.

5.1 Menu Structure and Parameter Settings

5.1.1.2 LF Out

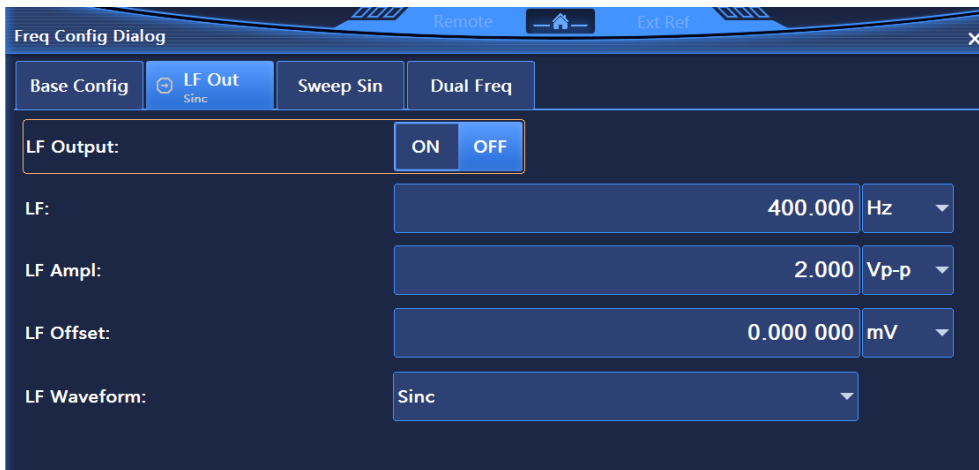

Figure 5.2 LF Out Dialog

LF Out Dialog, shown in Figure 5.2, enables you to set parameters such as LF output ON/OFF, LF, LF Ampl, LF DC Offset and LF Waveform. LF Waveform mainly includes Sinc, Square, Triangle, Zigzag (Zigzag-up and Zigzag-down), White noise (White noise and Gauss), SweepSinc, DualSinc.

5.1.1.3 Sweep Sin

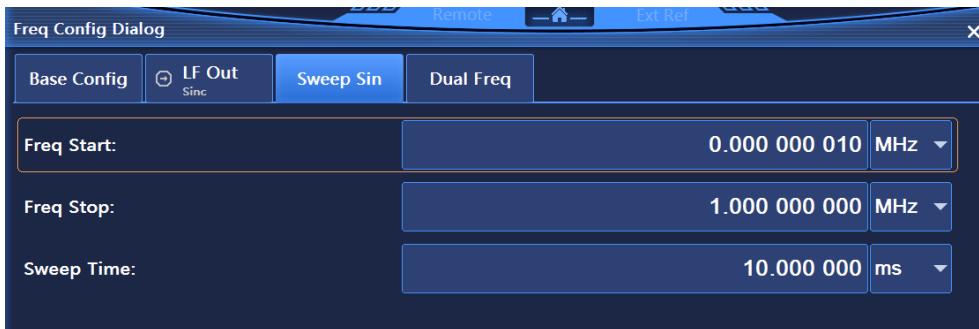

Figure 5.3 Sweep Sin Dialog

Sweep Sin Dialog, shown in Figure 5.3, enables you to set parameters such as Freq Start, Freq Stop and Sweep Time of Sweep Sin.

5.1.1.4 Dual Freq

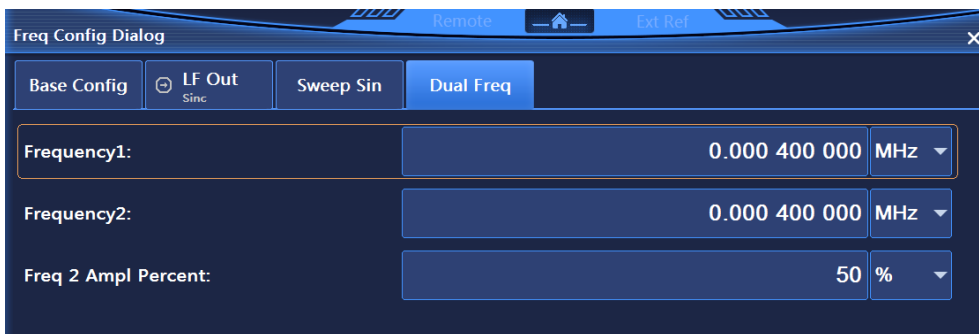

Figure 5.4 Dual Freq Dialog

Dual Freq Dialog, shown in Figure 5.4, enables you to set parameters such as Frequency1, Frequency2 and Freq 2 Ampl Percent of Dual Sin.

**NOTE****Frequency unit**

All frequency parameters in Hertz (Hz) are acceptable. Digital input must be terminated in four frequency units (GHz, MHz, kHz or Hz).

**5.1.2 Amplitude**

Press **【Amplitude】** key on the front panel or click [Amplitude] menu item in user interface, and the amplitude-related menu will pop up to enable you to set frequency-related parameters. The main operation dialogs are as follows:

**5.1.2.1 Ampl Config**

Figure 5.5 Base Config Dialog

Base Config Dialog, shown in Figure 5.5, enables you to set parameters such as Amplitude, Ampl Step, Ampl Offset, Ampl Ref and Output Ampl Limit.

**5.1.2.2 Atten Config**

Figure 5.6 Atten Config Dialog

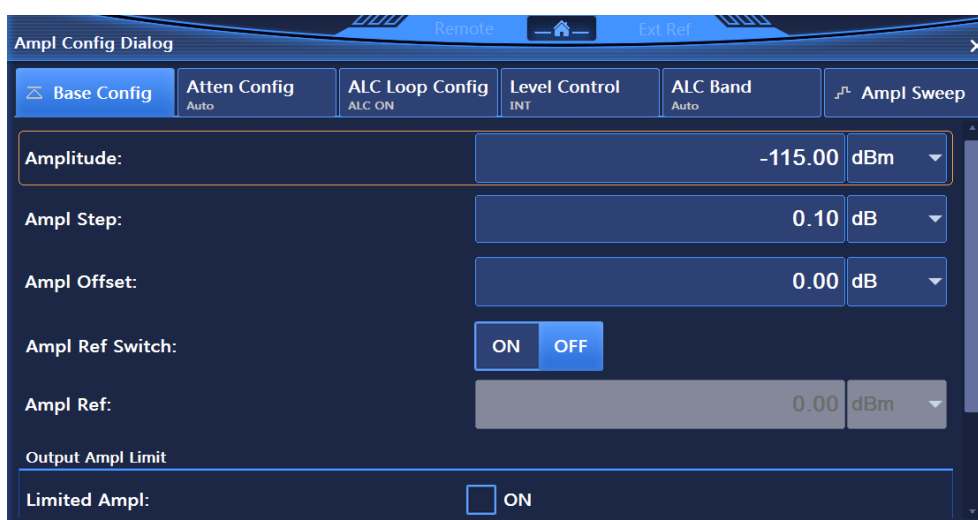
Atten Config Dialog, shown in Figure 5.6, enables you to set parameters such as Attenuation Style, ALC and Attenuation.

## 5.1 Menu Structure and Parameter Settings

### 5.1.2.3 ALC Loop Config

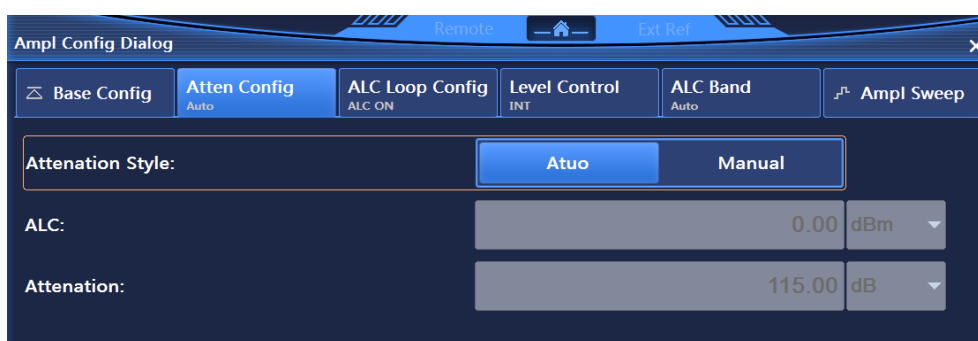
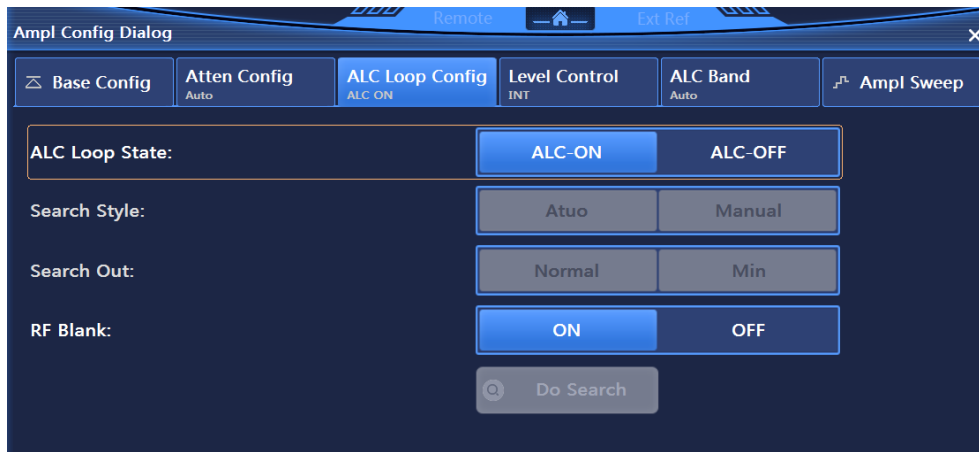

Figure 5.7 ALC Loop Config Dialog

ALC Loop Config Dialog, shown in Figure 5.7, enables you to set parameters such as ALC Loop State, Search Style, Search Out, RF Blank (ON/OFF) and Do Search.

### 5.1.2.4 Level Control



Figure 5.8 Level Control Dialog

Level Control Dialog, shown in Figure 5.8, enables you to set Level Control, including INT and EXT. EXT Detector Couple can be set in EXT mode.

### 5.1.2.5 ALC Band

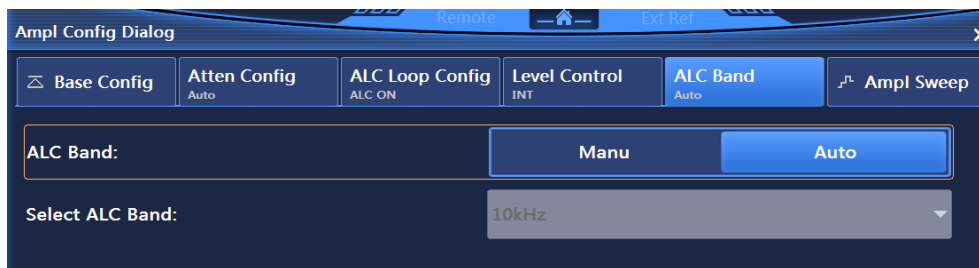

Figure 5.9 ALC Band Dialog

ALC Band Dialog, shown in Figure 5.9, enables you to set ALC Band to Manu and Auto modes. Select ALC Band is available in Manu mode.

### 5.1.2.6 Ampl Sweep

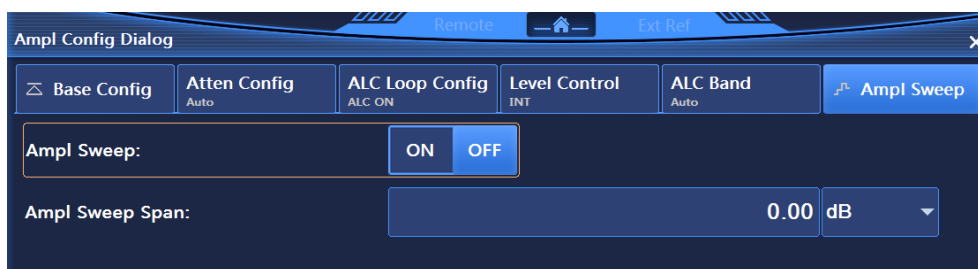

Figure 5.10 Ampl Sweep Dialog

Ampl Sweep Dialog, shown in Figure 5.10, enables you to set Ampl Sweep, including Ampl Sweep ON/OFF and Ampl Sweep Span.

### 5.1.3 Sweep

Press **【Sweep】** key on the front panel or click [Sweep] menu item in user interface, and a sweep-related menu will pop up to enable you to set frequency-related parameters. The main operation dialogs are as follows:

#### 5.1.3.1 Sweep Mode



Figure 5.11 Sweep Mode Dialog

Sweep Mode Dialog, shown in Figure 5.11, enables you to set parameters such as Current Sweep Type, Trig Style of Start, Sweep Type and RTC Switch. Current Sweep Type includes Close (CW), Step Sweep, List Sweep and Ramp Sweep. Trig Style of Start includes Auto, Bus, Ext and Key. Sweep Type includes Continue and Single.

5.1 Menu Structure and Parameter Settings

5.1.3.2 Step Sweep



Figure 5.12 Step Sweep Dialog

Step Sweep Dialog, shown in Figure 5.12, enables you to set step sweep parameters, including Freq Start, Freq Stop, Step Counts, Step Dwell, Step Trig, Step Type and Step Sweep Indirection. Step Type includes Linear and Logical, and Step Sweep Indirection includes Forward and Backward.

5.1.3.3 List Sweep



Figure 5.13 List Sweep Dialog

List Sweep Dialog, shown in Figure 5.13, enables you to set list sweep parameters, including Freq Start, Freq Stop, Insert Counts, All List Dwell Time, All List Ampl Offset, List Trig and Step Sweep Indirection.

### 5.1.3.4 Ramp Sweep

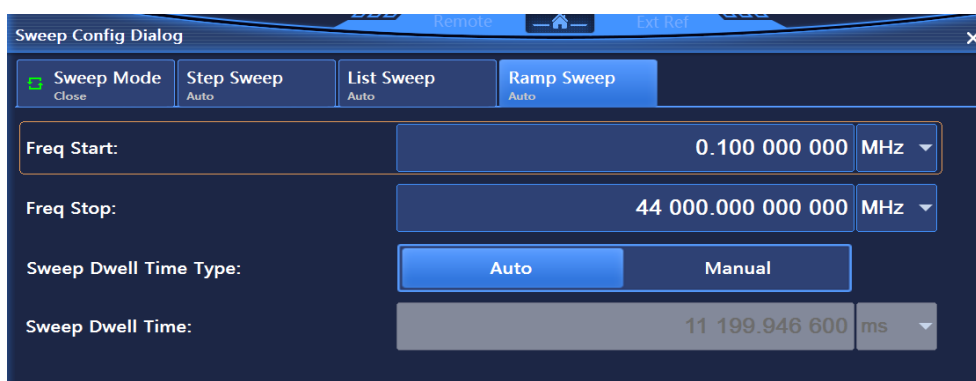

Figure 5.14 Ramp Sweep Dialog

Ramp Sweep Dialog, shown in Figure 5.14, enables you to set list sweep parameters, including Freq Start, Freq Stop and Sweep Dwell Time Type. Sweep Dwell Time Type includes Auto and Manual. You can set sweep time manually in Manual mode.

## 5.1.4 Modulation

### 5.1.4.1 Amplitude Modulation

Press **【AM】** key on the front panel or click [Amplitude Modulation] under menu item [Modulation] in user interface, and an AM-related menu will pop up to enable you to set AM-related parameters. The main operation dialogs are as follows:

#### 1) AM Config



Figure 5.15 Base Config Dialog

Base Config Dialog, shown in Figure 5.15, enables you to set parameters such as AM Waveform, AM Rate, Depth, AM Type and AM Depth ON/OFF. AM Type includes EXP and Linear.

#### 2) Am Source

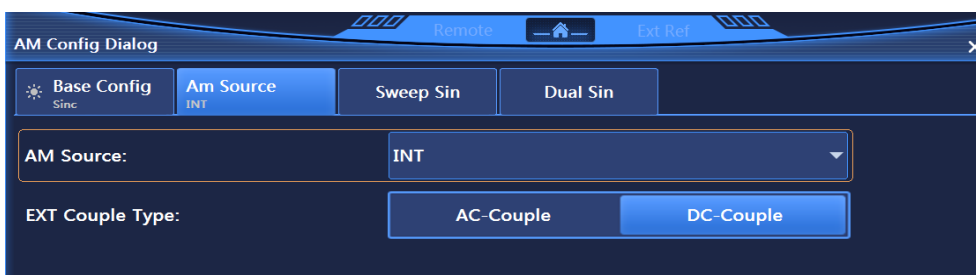

Figure 5.16 Am Source Dialog

**5.1 Menu Structure and Parameter Settings**

Am Source Dialog, shown in Figure 5.16, enables you to set AM Source and EXT Couple Type. AM Source includes INT, EXT (Input 50 Ω), EXT (Input 600 Ω) and EXT (Input 1 MΩ). EXT Couple Type includes AC-Couple and DC-Couple.

**3) Sweep Sin**

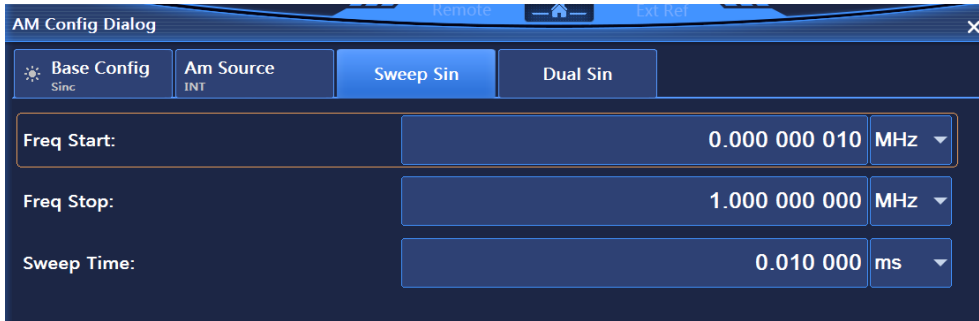

Figure 5.17 Sweep Sin Dialog

Sweep Sin Dialog, shown in Figure 5.17, enables you to set Freq Start, Freq Stop and Sweep Time.

**4) Dual Sin**

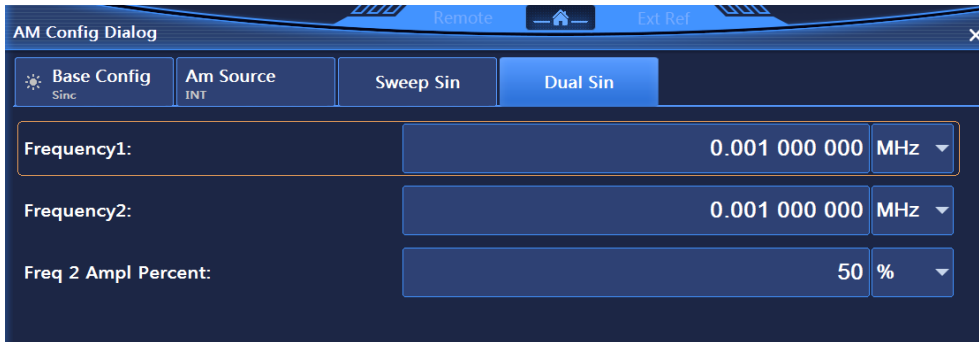

Figure 5.18 Dual Sin Dialog

Dual Sin Dialog, shown in Figure 5.18, enables you to set Frequency1, Frequency2 and Freq 2 Ampl Percent of Dual Sin.

**5.1.4.2 Frequency Modulation**

Press **【FM/ΦM】** key on the front panel or click [Frequency Modulation] under [Modulation] menu item in user interface, and an FM-related menu will pop up to enable you to set FM-related parameters. The main operation dialogs are as follows:

**1) FM Config**

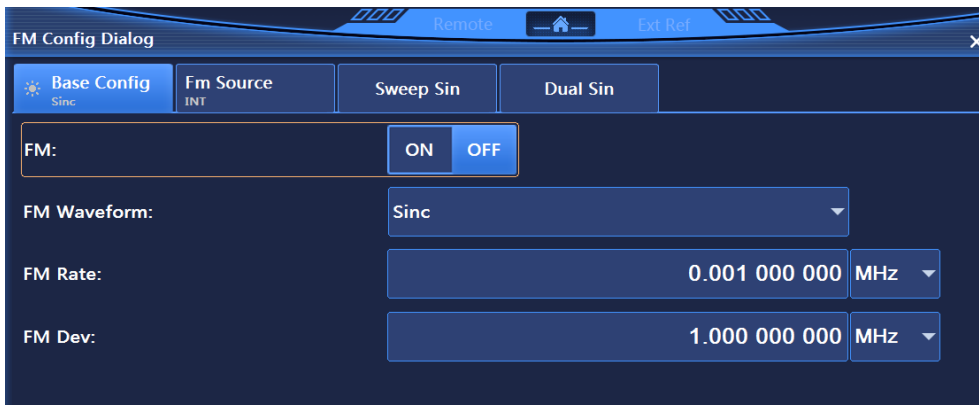

Figure 5.19 Base Config Dialog

Base Config Dialog, shown in Figure 5.19, enables you to set parameters such as FM Waveform,



### 5.1 Menu Structure and Parameter Settings

FM Rate and Frequency Dev. AM Waveform mainly includes Sinc, Square, Triangle and Zigzag (Zigzag-up and Zigzag-down), White noise (White noise and Gauss), SweepSinc and DualSinc.

#### 2) Fm Source

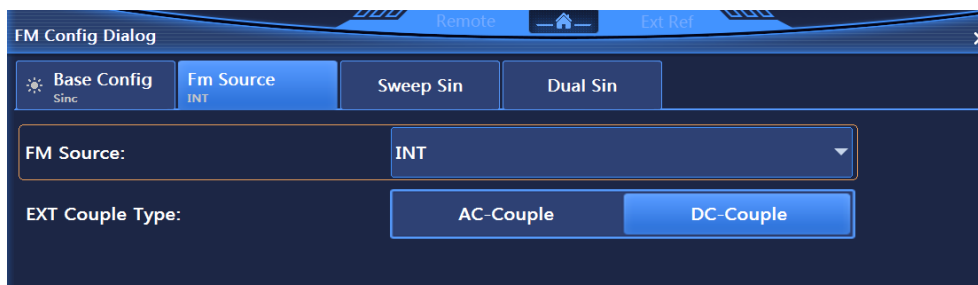

Figure 5.20 Fm Source Dialog

Fm Source Dialog, shown in Figure 5.20, enables you to set FM Source and EXT Couple Type. FM Source includes INT, EXT (Input 50  $\Omega$ ), EXT (Input 600  $\Omega$ ) and EXT (Input 1 M $\Omega$ ). EXT Couple Type includes AC-Couple and DC-Couple.

#### 3) Sweep Sin

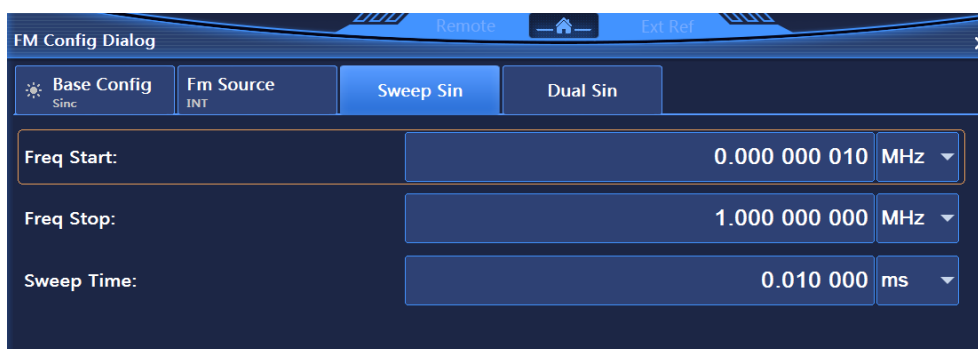

Figure 5.21 Sweep Sin Dialog

Sweep Sin Dialog, shown in Figure 5.21, enables you to set Freq Start, Freq Stop and Sweep Time.

#### 4) Dual Sin

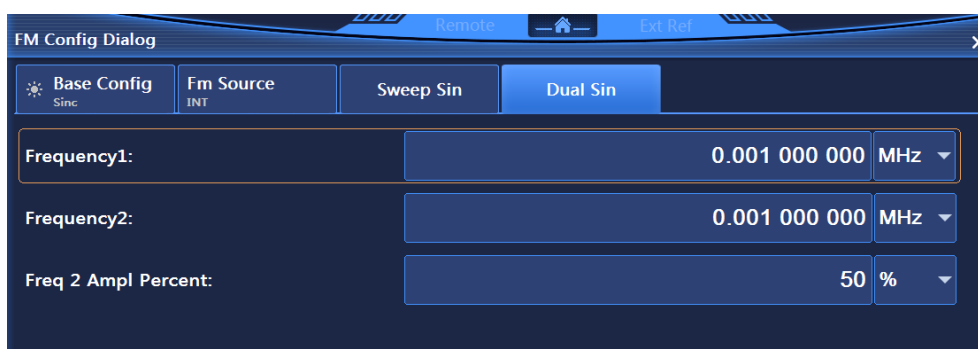

Figure 5.22 Dual Sin Dialog

Dual Sin Dialog, shown in Figure 5.22, enables you to set Frequency1, Frequency2 and Freq 2 Ampl Percent of Dual Sin.

#### 5.1.4.3 Phase Modulation

Press **【FM/ $\Phi$ M】** key on the front panel or click [Phase Modulation] under [Modulation] menu item in user interface, and a PM-related menu will pop up to enable you to set PM-related parameters. The main operation dialogs are as follows:

5.1 Menu Structure and Parameter Settings

1) PM Config

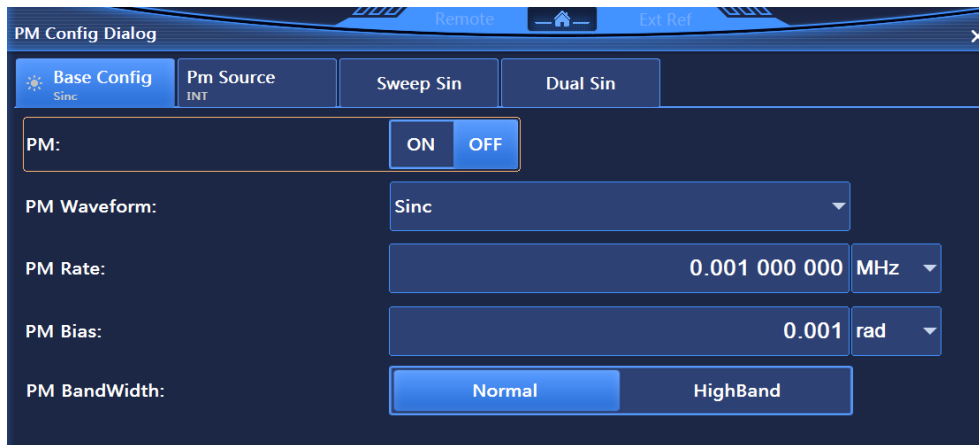

Figure 5.23 Base Config Dialog

Base Config Dialog, shown in Figure 5.23, enables you to set PM Waveform, PM Rate, PM Bias and PM BandWidth. AM Waveform mainly includes Sinc, Square, Triangle and Zigzag (Zigzag-up and Zigzag-down), White noise (White noise and Gauss), SweepSinc and DualSinc.

2) PM Source

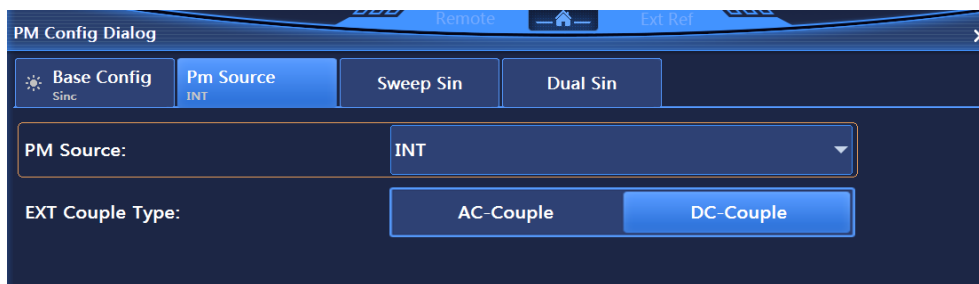

Figure 5.24 Pm Source Dialog

Pm Source Dialog, shown in Figure 5.24, enables you to set PM source and EXT Couple Type. PM Source includes INT, EXT (Input 50 Ω), EXT (Input 600 Ω) and EXT (Input 1 MΩ). EXT Couple Type includes AC-Couple and DC-Couple.

3) Sweep Sin

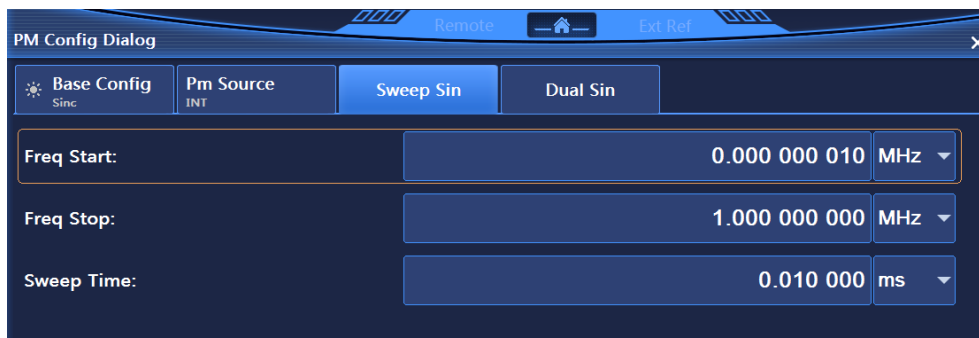

Figure 5.25 Sweep Sin Dialog

Sweep Sin Dialog, shown in Figure 5.25, enables you to set Freq Start, Freq Stop and Sweep Time.

#### 4) Dual Sin

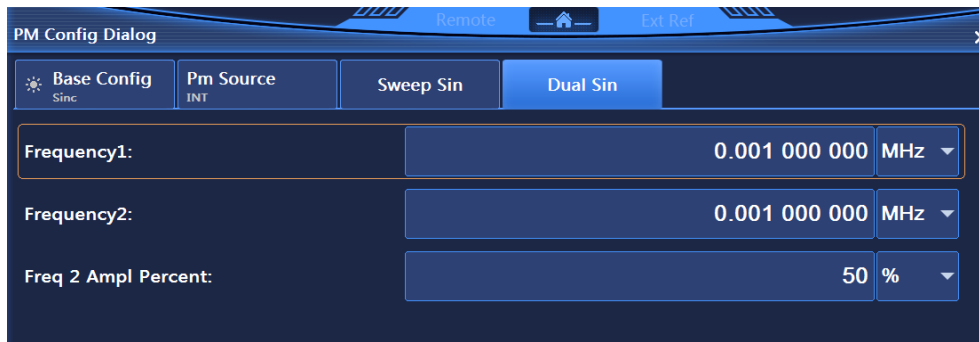

Figure 5.26 Dual Sin Dialog

Dual Sin Dialog, shown in Figure 5.26, enables you to set Frequency1, Frequency2 and Freq 2 Ampl Percent of Dual Sin.

#### 5.1.4.4 Pulse Modulation

Press **【Pulse】** key on the front panel or [Pulse] menu item in user interface, and a menu related to pulse modulation will pop up to enable you to set the parameters related to pulse modulation. The main operation dialogs are as follows:

##### 1) Pulse Modu Config



Figure 5.27 Base Config Dialog

Base Config Dialog, shown in Figure 5.27, enables you to set parameters such as Pulse Modulation ON/OFF, Source, Width, Delay, Period, PRF and Input Direction ON/OFF.

### 5.1 Menu Structure and Parameter Settings

#### 2) Pulse Train

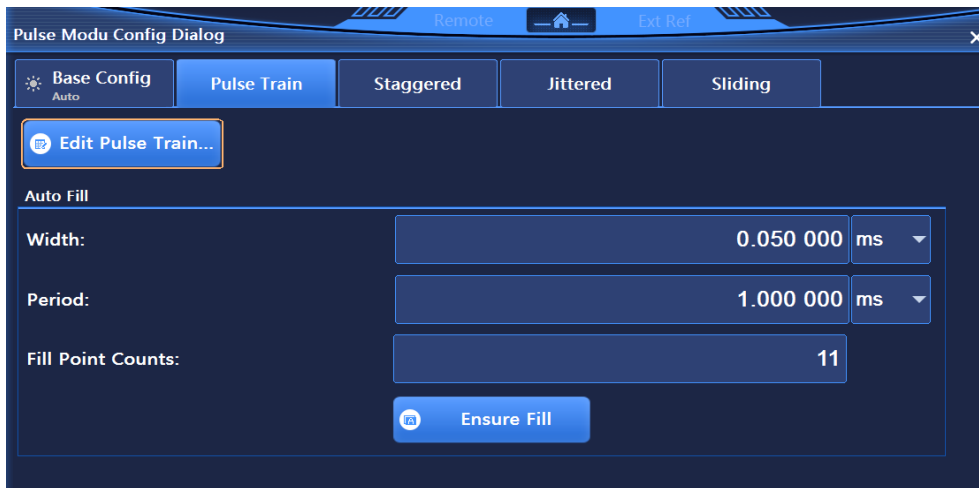

Figure 5.28 Pulse Train Dialog

Pulse Train Dialog, shown in Figure 5.28, enables you to set Width, Period and Fill Point Counts, as well as Auto Fill and Edit Pulse Train.

#### 3) Staggered

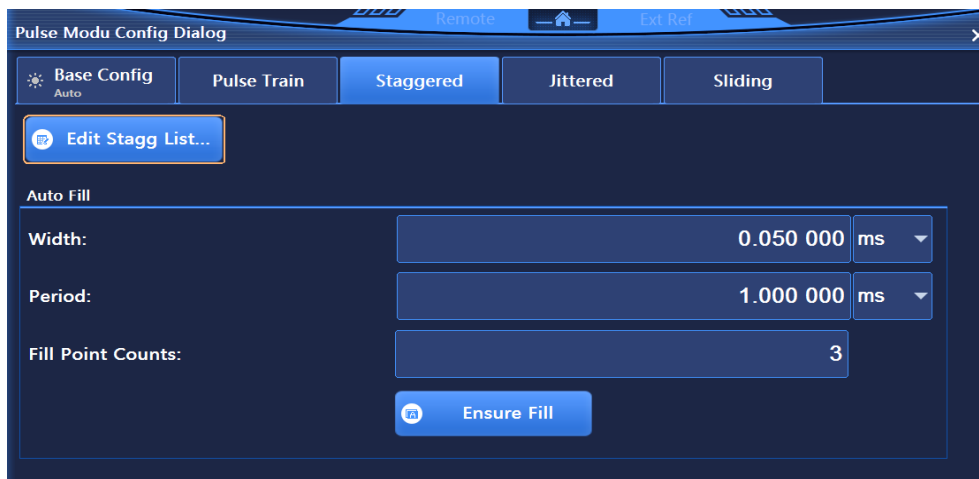

Figure 5.29 Jittered Dialog

Staggered Dialog, shown in Figure 5.29, enables you to set Dither Style and Dither Percent of pulse. Dither Style includes Random and Gaussian.

#### 4) Jittered



Figure 5.30 Staggered Dialog

### 5.1 Menu Structure and Parameter Settings

Jittered Dialog, shown in Figure 5.30, enables you to set Auto Fill and Edit Stag List. Auto Fill includes Period and Fill Point Counts.

#### 5) Sliding



Figure 5.31 Sliding Dialog

Sliding Dialog, shown in Figure 5.31, enables you to set Sliding Step of pulse.

#### 5.1.5 Base

Press **【Base】** key on the front panel or click [Base] menu item in user interface, and a base-related menu will pop up to enable you to set base-related parameters. The main operation dialogs are as follows:

##### 5.1.5.1 Base Config

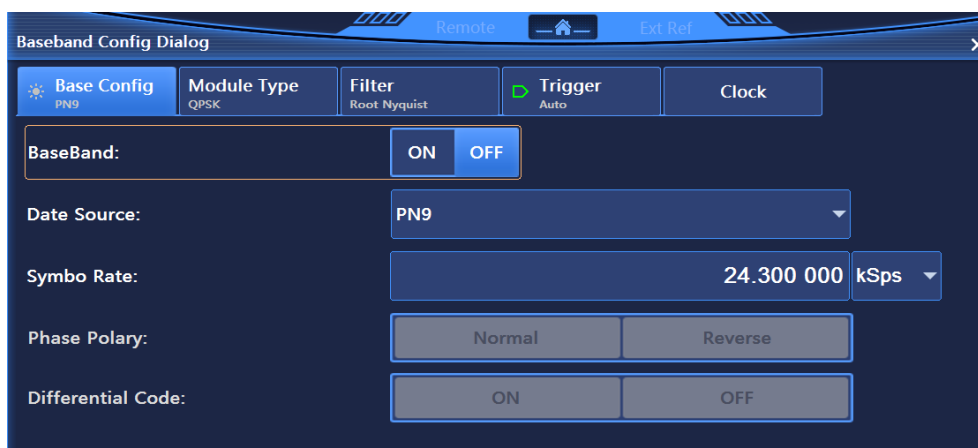

Figure 5.32 Base Config Dialog

Base Config Dialog, shown in Figure 5.32, enables you to set parameters such as BaseBand ON/OFF, Data Source, Symbo Rate, Phase Polary and Differential Encode. Data Source includes PN Serial, Fix 4, Equal 1 0, and File. Phase Polary includes Normal and Reverse.

5.1 Menu Structure and Parameter Settings

5.1.5.2 Module Type

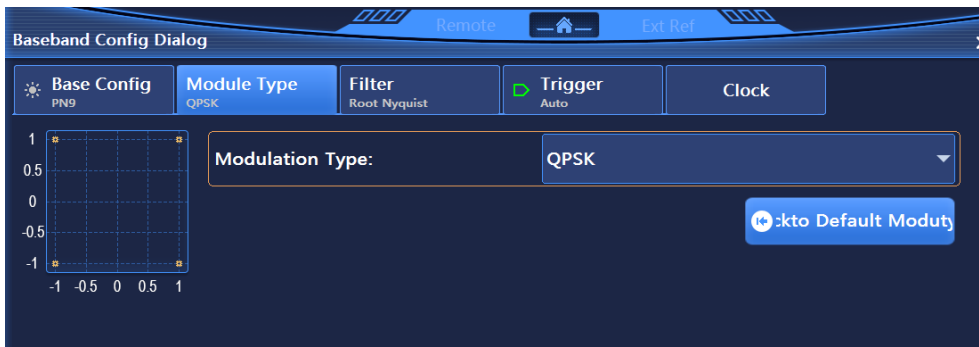

Figure 5.33 Module Type Dialog

Module Type Dialog, shown in Figure 5.33, enables you to set modulation type parameters, including Modulation Type and Gobackto Default Modutype. Modulation Type includes PSK, MSK, FSK, QAM, ASK, user I/Q, User FSK.

5.1.5.3 Filter

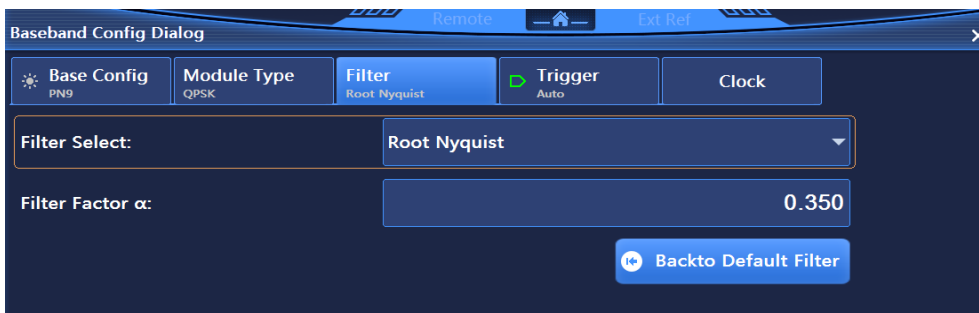

Figure 5.34 Filter Dialog

Filter Dialog, shown in Figure 5.34, enables you to set parameters such as Filter Select and Filtering Factor  $\alpha$ . Filter Select includes Root Nyquist, Nyquist, Gauss and Rectangle.

5.1.5.4 Trigger

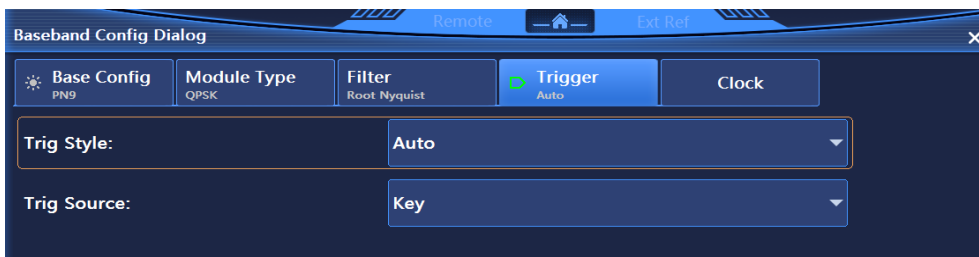

Figure 5.35 Trigger Dialog

Trigger Dialog, shown in Figure 5.35, enables you to set parameters such as Trig Style and Trig Source. Trig Style includes Continue (Auto, Trig, Realtime), Single and Gate (Hight, Low). Trig Source includes Key, Bus and Ext.

5.1.5.5 Clock

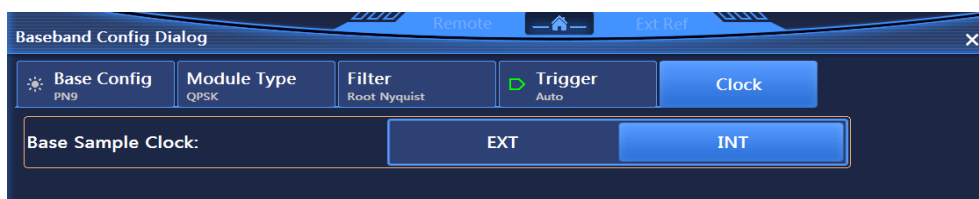

Figure 5.36 Clock Dialog

## 5.1 Menu Structure and Parameter Settings

Clock Dialog, shown in Figure 5.36, enables you to set Base Sample Clock and other parameters. Base Sample Clock includes EXT and INT.

### 5.1.6 I/Q

Press **【I/Q】** key in front panel or click [I/Q] menu item in user interface, and an I/Q-related menu will pop up to enable you to set I/Q-related parameters. The main operation dialogs are as follows:

#### 5.1.6.1 Base Config



Figure 5.37 Base Config Dialog

Base Config Dialog, shown in Figure 5.37, enables you to set parameters such as I/Q Modulate ON/OFF, Data Source and Ext WideBand I/Q Input ON/OFF. Data Source includes EXT50Ω and INT.

#### 5.1.6.2 I/Q Input Adj

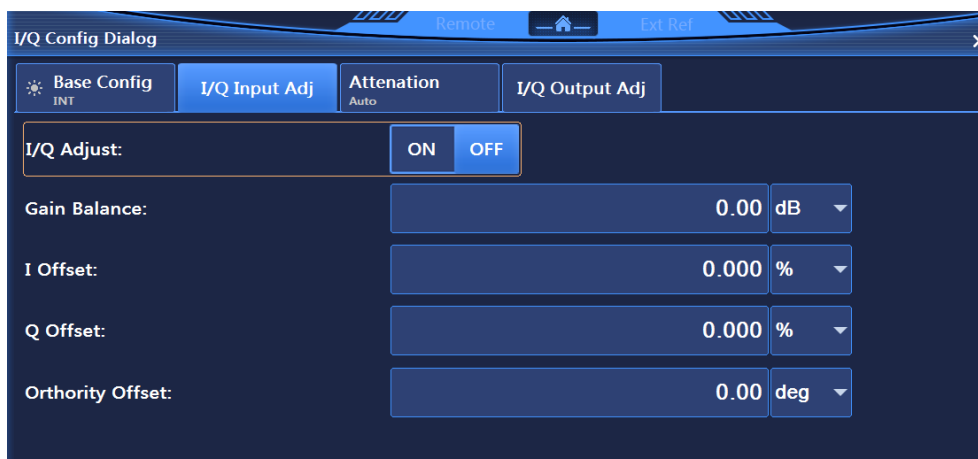

Figure 5.38 I/Q Input Adj Dialog

I/Q Input Adj Dialog, shown in Figure 5.38, enables you to set parameters such as I/Q Adjust ON/OFF, Gain Balance, I Offset, Q Offset and Orthority Offset.

### 5.1 Menu Structure and Parameter Settings

#### 5.1.6.3 Attenuation

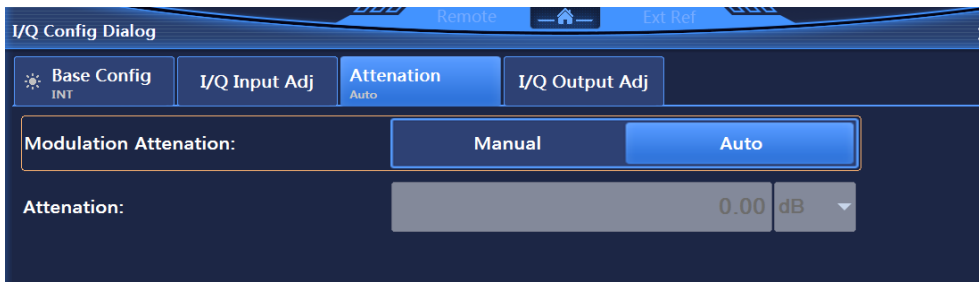

Figure 5.39 Attenuation Dialog

Attenuation Dialog, shown in Figure 5.39, mainly includes Modulation Attenuation. Attenuation can be set in Manual mode.

#### 5.1.6.4 I/Q Output Adj



Figure 5.40 I/Q Output Adj Dialog

I/Q Output Adj Dialog, shown in Figure 5.40, enables you to set parameters such as I/Q Output Adj ON/OFF, Attenuation, Gain Balance, I Offset, I/ Offset, Q Offset, Q/ Offset.

#### 5.1.7 ARB

Click [Arb] under [Signal] menu item in user interface, and an Arb-related menu will pop up to enable you to set Arb-related parameters. The main operation dialogs are as follows:



### 5.1.7.1 Base Config



Figure 5.41 Base Config Dialog

Base Config Dialog, shown in Figure 5.41, enables you to set Arb Seq ON/OFF, Work Pattern, Clock Type, Clock Freq, and Add Wave Seg, Del Cur Seg and Del All Seg.

### 5.1.7.2 Trigger

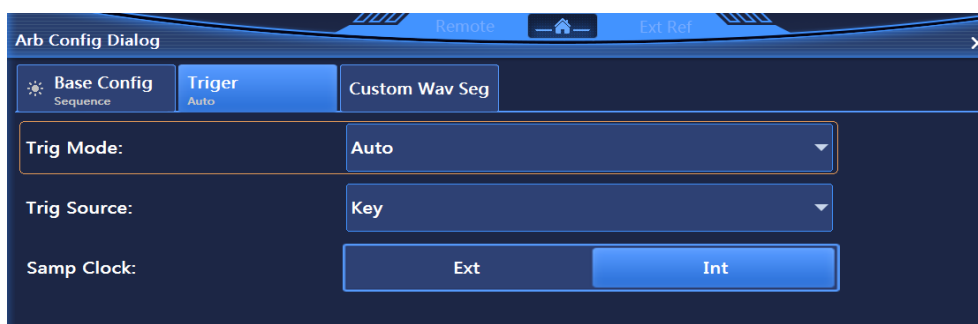

Figure 5.42 Trigger Dialog

Trigger Dialog, shown in Figure 5.42, enables you to set Trig Mode, Trig Source, Sample Clock and EXT Clock Freq when Sample Clock is EXT. Trig Mode includes Continue (Auto, Trig, Realtime), Single (Ignore Repeated Trig, Buffer Repeated Trig, Real-time Repeated Trig), Wave Segment (Single, Continue), Gate (Low, High). Trig Source includes Key, Bus, Ext and Int. Sample Clock includes Ext and Int.

**5.1 Menu Structure and Parameter Settings**  
**5.1.7.3 Custom Wave Segment**



Figure 5.43 Custom Wav Seg Dialog

The Custom Wav Seg Dialog is shown in Figure 5.43. The dialog is mainly used to generate user-customized wave segments. The main setting options include wave segment (symbol) length, over sample counts auto on/off, data source, symbol rate, modulation type, and filter selection. The data source options include PN Serial, Fix 4, and Equal 1 0. The modulation types include PSK, MSK, FSK, QAM, and ASK. The filter options include Root Nyquist, Nyquist, Gauss and Rectangle.

**5.1.8 Tone**

**5.1.8.1 D-Tone**

Click [Dual Tone] under [Tone] menu item in user interface, and a menu related to dual tone will pop up to enable you to set the parameters related to dual tone. The main operation dialogs are as follows:

**1) Dual Tone Config**

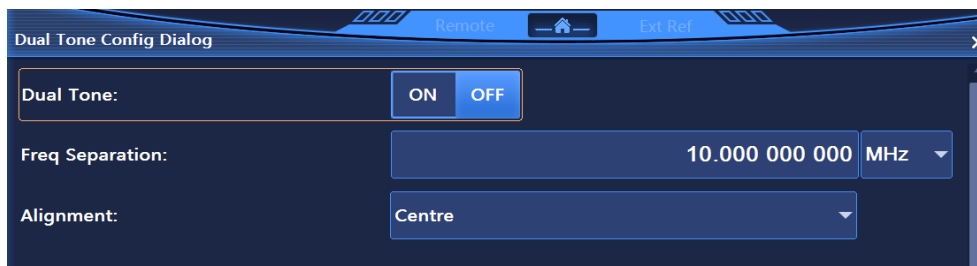

Figure 5.43 Dual Tone Config Dialog

Dual Tone Config Dialog, shown in Figure 5.43, enables you to set Dual Tone, including parameters such as Dual Tone ON/OFF, Freq Separation and Alignment. Alignment includes Left, Centre and Right.

**5.1.8.2 Multi Tone**

Click [Multi Tone] under [Tone] menu item in user interface, and a menu related to multi tone will pop up to enable you to set the parameters related to multi tone. The main operation dialogs are as follows:

## 1) Base Config



Figure 5.44 Base Config Dialog

Base Config Dialog, shown in Figure 5.44, enables you to set Multi Tone, including parameters such as Multi Tone ON/OFF, Initial Phase, Tone Count, Phase Rela, Freq Interval and Initial Phase. Initial Phase includes Random and Fixed. Phase Rela includes Random and Fixed.

## 2) Samp Clock

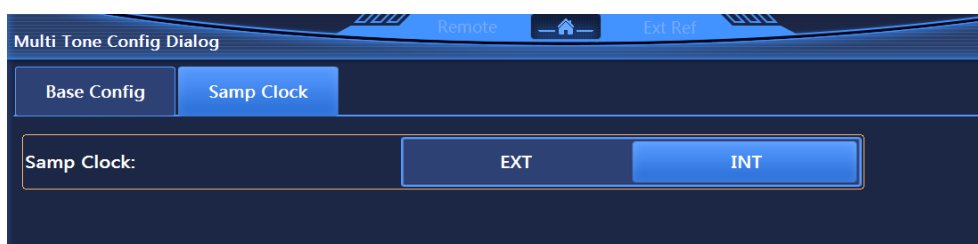

Figure 5.45 Samp Clock Dialog

Samp Clock Dialog, shown in Figure 5.45, enables you to set Samp Clock and EXT Clock Freq when Samp Clock is EXT.

### 5.1.9 AWGN (Option)

Click menu item [AWGN] in user interface, and an AWGN-related menu will pop up to enable you to set AWGN-related parameters. The main operation dialogs are as follows:

#### 5.1.9.1 Base Config

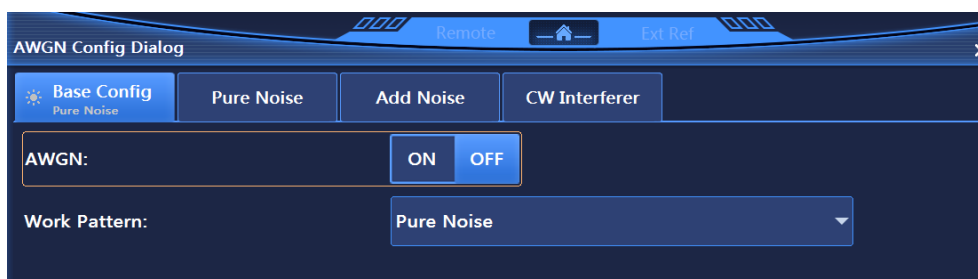

Figure 5.46 Base Config Dialog

Base Config Dialog, shown in Figure 5.46, enables you to set AWGN ON/OFF and Work Pattern. Work Pattern includes Pure Noise, Add Noise and CW Interferer.

## 5.1 Menu Structure and Parameter Settings

### 5.1.9.2 Pure Noise

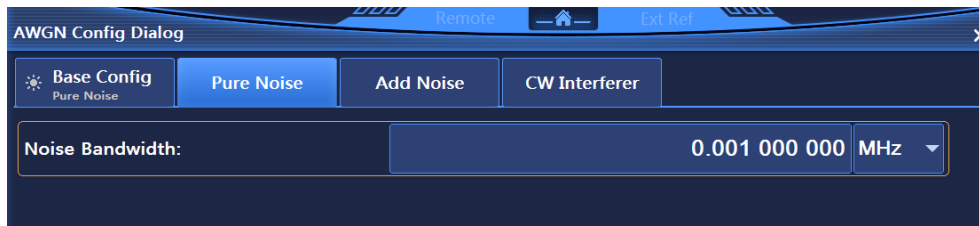

Figure 5.47 Pure Noise Dialog

Pure Noise Dialog, shown in Figure 5.47, enables you to set Noise Bandwidth in Pure Noise mode.

### 5.1.9.3 Add Noise



Figure 5.48 Add Noise Dialog

Add Noise Dialog, shown in Figure 5.48, enables you to set parameters such as System Bandwidth, Noise/System Bandwidth Ratio, Noise Bandwidth and Noise Power in Add Noise mode.

### 5.1.9.4 CW Interferer

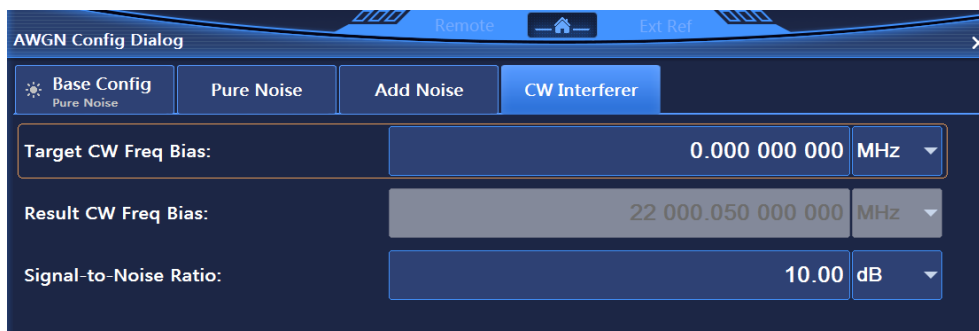

Figure 5.49 CW Interferer Dialog

CW Interferer Dialog, shown in Figure 5.49, enables you to set parameters such as Target CW Freq Bias, Result CW Freq Bias, and Signal-to-Noise Ratio in CW Interferer mode.

### 5.1.10 System

Press **【System】** key on the front panel or click [System] menu item in user interface, and a system-related menu will pop up to enable you to set system-related parameters. The main operation dialogs are as follows:

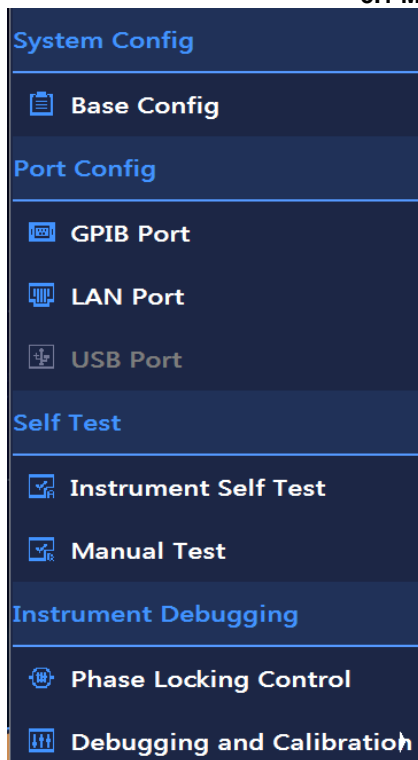

Figure 5.50 System Dialog

System Dialog, shown in Figure 5.50, enables you to set four main modules: System Config, Port Config, Self Test and Instrument Self Test.

### 5.1.10.1 System Config

#### 1) Ref Config

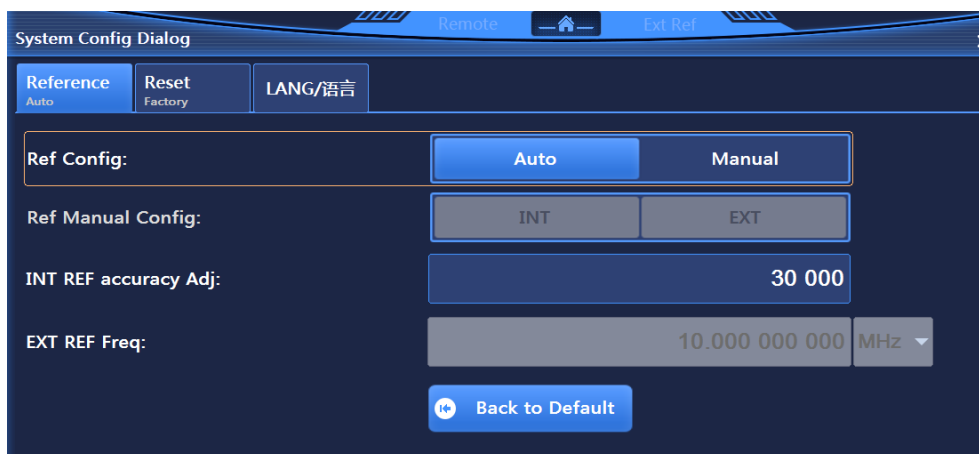

Figure 5.51 Ref Config Dialog

Ref Config Dialog, shown in Figure 5.51, mainly includes Ref Config, INT REF accuracy Adj, Ref Manual Config when Ref Config is Manual, EXT Ref Freq when Ref Manual Config is EXT and Back to Default.

### 5.1 Menu Structure and Parameter Settings

#### 2) Reset

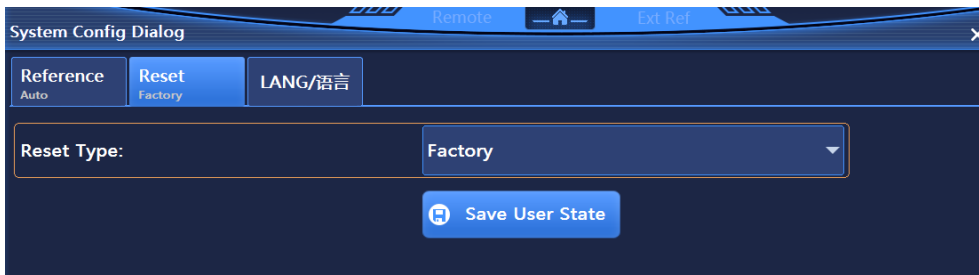

Figure 5.52 Reset Dialog

Reset Dialog, shown in Figure 5.52, mainly includes Reset Type and Save User State after user setting. Reset Type includes Factory, User and Last State.

#### 3) Lang

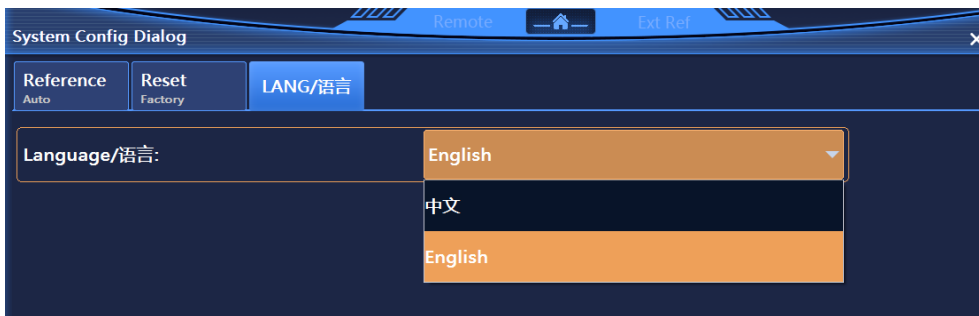

Figure 5.53 Lang Dialog

Lang Dialog, shown in Figure 5.53, enables you to set Lang. The system mainly supports Chinese and English.

### 5.1.10.2 Port Config

#### 1) GPIB

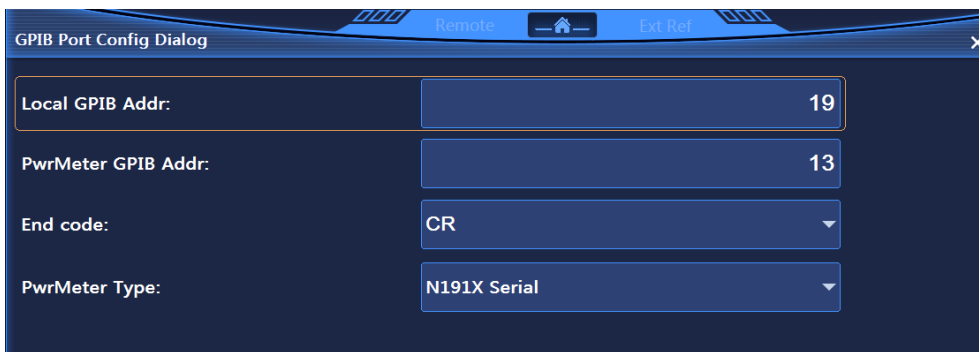

Figure 5.54 GPIB Port Config Dialog

GPIB Port Config Dialog, shown in Figure 5.54, mainly includes options such as Local GPIB Addr, PwrMeter GPIB Addr, End code, PwrMeter Type. End code includes CR, LF and EOL. PwrMeter Type includes N191X Serial, 2434/36/38 Serial and 2432 Serial.

## 2) LAN

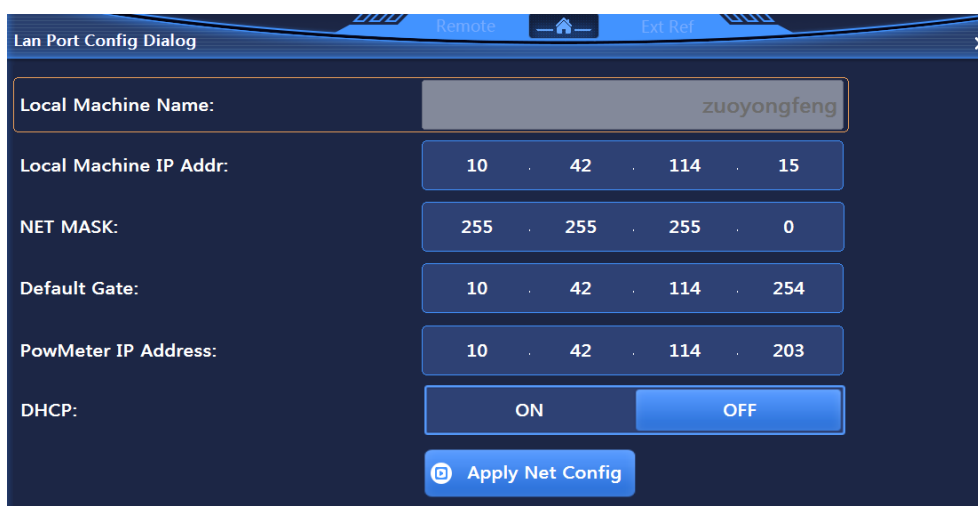

Figure 5.55 LAN Port Config Dialog

LAN Port Config Dialog, shown in Figure 5.55, mainly includes options such as Local Machine Name, Local Machine IP Addr, NET MASK, Default Gate, PowMeter IP Address, DHCP ON/OFF and Apply Net Config.

## 5.1.10.3 Self Test

## Instrument Self Test/Manual Test

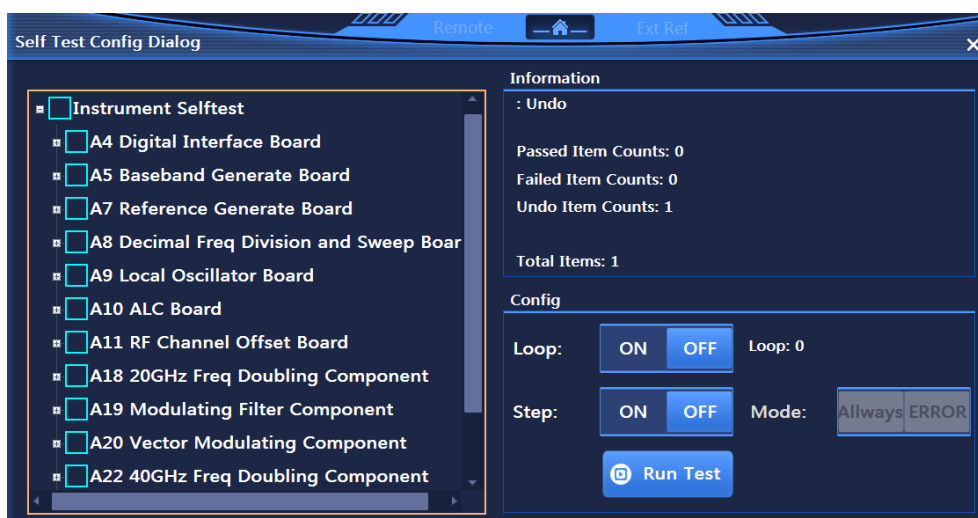

Figure 5.56 Self Test Dialog

Self Test Dialog, shown in Figure 5.56, enables you to carry out self-test on the instrument. There are two test modes, Instrument Self Test and Manual Test. All modules of the instrument are tested in Instrument Self Test. Self-test modules are selected freely for testing in Manual Test. It also includes Loop ON/OFF, Step ON/OFF and Run Test.

5.1 Menu Structure and Parameter Settings

5.1.10.4 Instrument Self Test

1) Phase Locking Control

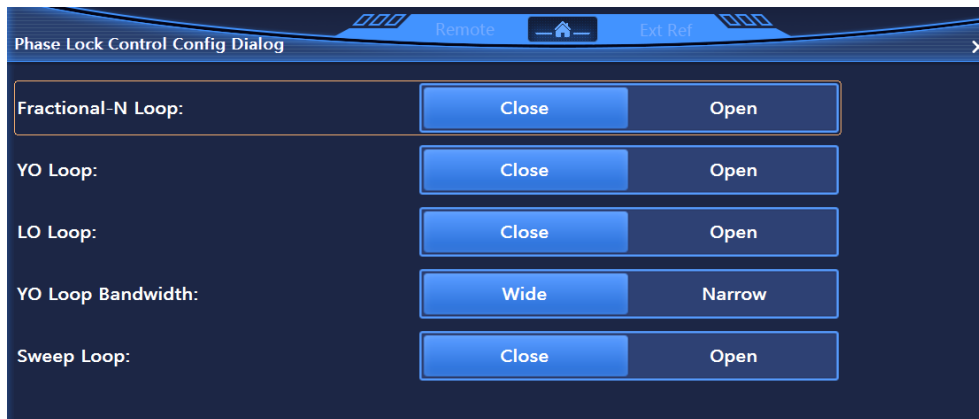

Figure 5.57 Phase Locking Control Dialog

Phase Locking Control Dialog, shown in Figure 5.57, enables you to control phase locking configuration, including control switches of Fractional Loop, YO Loop, LO Loop, YO Loop Bandwidth and Sweep Loop.

2) Debugging and Calibration

This part mainly includes configuration dialogues required for factory debugging.

5.1.11 File

Press **【File】** key on the front panel, and a file-related menu will pop up to enable to set file-related parameters. The main operation dialogs are as follows:

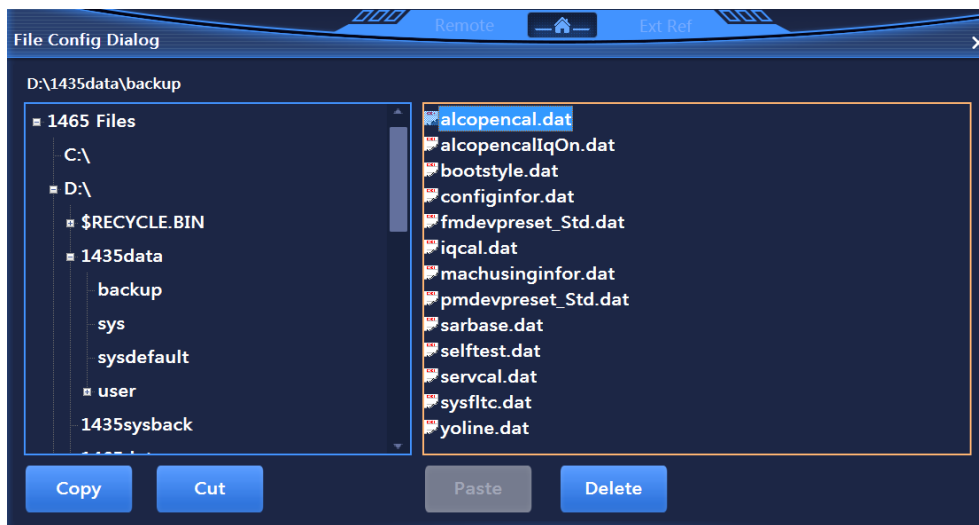

Figure 5.58 File Dialog

File Dialog, shown in Figure 5.58, enables you to copy, cut, paste and delete the system files related to 1465 series signal generator.

5.1.12 Save/Recall

Press **【Save】** on the front panel, and a menu related to Save/Recall will pop up to enable you to set parameters related to Save/Recall. The main operation dialogs are as follows:



### 5.1.12.1 Save

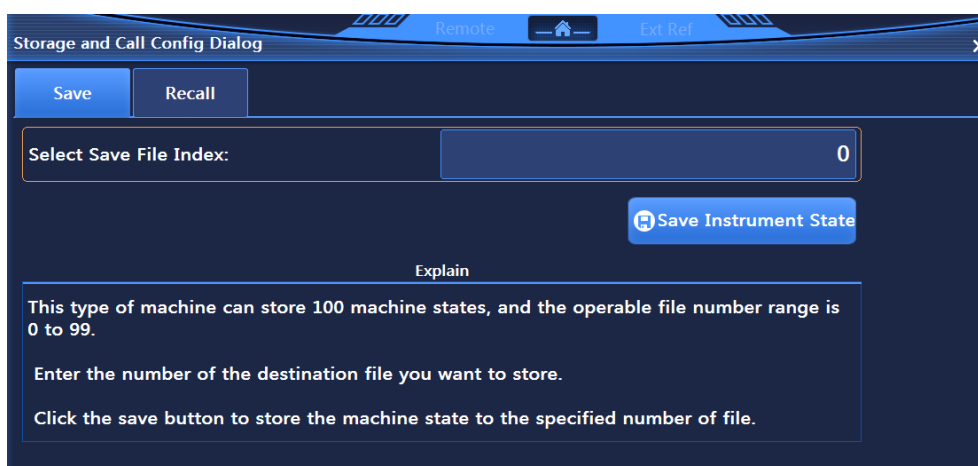

Figure 5.59 Save Dialog

Save Dialog, shown in Figure 5.59, enables you to set parameters such as CW, Freq Step, Freq Offset, Freq Ref and Freq Mul.

### 5.1.12.2 Recall

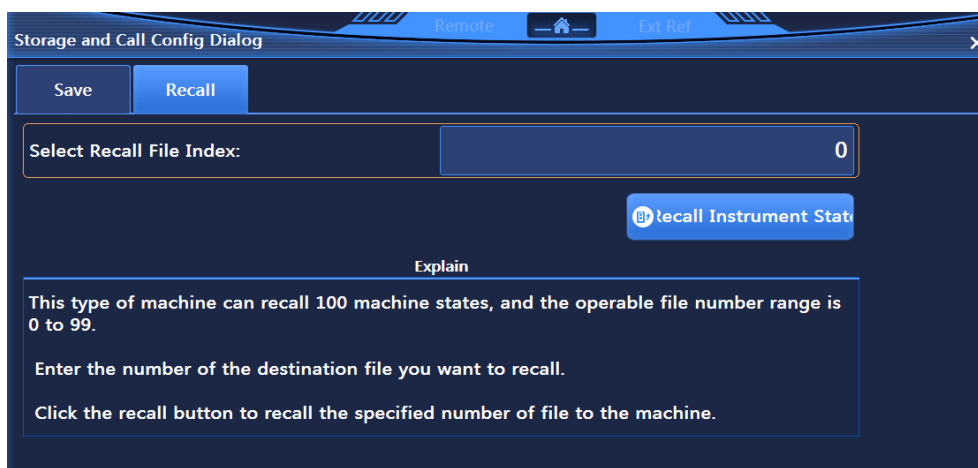

Figure 5.60 Recall Dialog

Recall Dialog, shown in Figure 5.60, enables you to set parameters such as LF Out, LF, LF Ampl, LF DC Offset and LF Waveform.

### 5.1.13 Calibrate

This instrument only supports the calibration of power flatness for the time being. Press **【Calibrate】** key on the front panel, and a menu related to system calibration will pop up to enable you to set calibration-related parameters. The main operation dialogs are as follows:

5.2 Menu Description

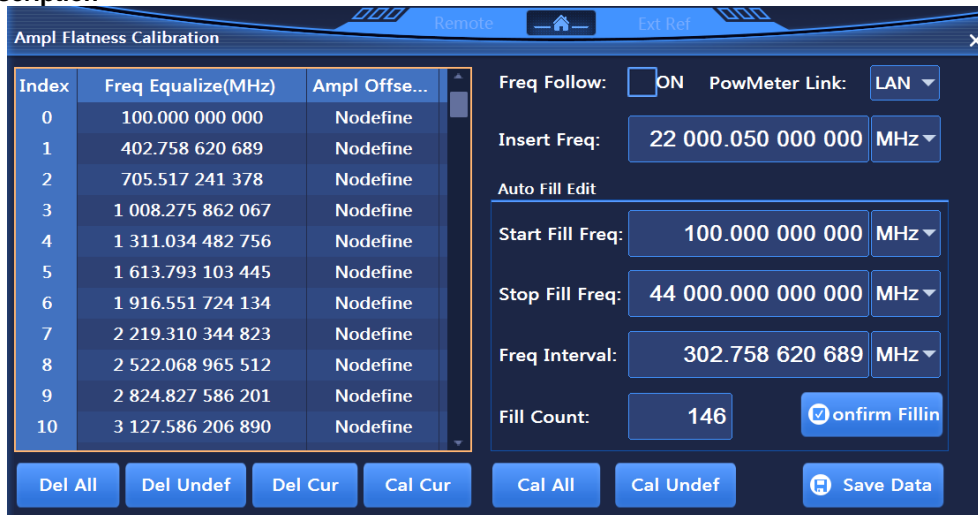

Figure 5.61 Ampl Flatness Dialog

Ampl Flatness Dialog, shown in Figure 5.61, enables you to set parameters such as LF Out, LF, LF Ampl, LF DC Offset and LF Waveform.

5.2 Menu Description

This section introduces menu item functions, parameters and other information.

- [Frequency.....120](#)
- [Amplitude.....125](#)
- [Sweep.....131](#)
- [Modulation.....137](#)
- [Base.....144](#)
- [I/Q.....149](#)
- [ARB.....156](#)
- [Tone.....163](#)
- [AWGN \(Option\).....166](#)
- [System.....169](#)
- [File.....171](#)
- [Save/Recall.....172](#)
- [Calibrate .....172](#)

5.2.1 Frequency

5.2.1.1 CW

**Functional Description:**

This command sets the signal generator output frequency in CW mode.

Parameter values can be set and adjusted via touch screen, mouse/keyboard, and spinning wheel, numeric and step keys on the front panel.

**Parameter specification:**

<Frequency> Output frequency in CW mode.

Model	Range
1465A	[100kHz~3GHz]
1465B	[100kHz~6GHz]

1465C	[100kHz~10GHz]
1465D	[100kHz~20GHz]
1465E	[100kHz~40GHz]
1465H	[100kHz~50GHz]
1465L	[100kHz~67GHz]

**Programmable command:**

```
[[:SOURce]:FREQuency[:CW|FIXed] <val>
```

```
[[:SOURce]:FREQuency[:CW|FIXed]?
```

**Example:**

```
[[:SOURce]:FREQuency[:CW|FIXed] 10GHz Set the spot frequency of the signal generator to 10 GHz.
```

**5.2.1.2 Freq Step****Functional Description:**

Set each frequency step. When the signal generator CW frequency is set after the above value is set, each frequency variation will vary with the current step quantity setting when frequency is changed using UP|DOWN.

**Parameter specification:**

```
<FreqStep> Freq Step.
```

Model	Range
1465A	[0Hz~2.9999GHz]
1465B	[0Hz~5.9999GHz]
1465C	[0Hz~9.9999GHz]
1465D	[0Hz~19.9999GHz]
1465E	[0Hz~39.9999GHz]
1465H	[0Hz~49.9999GHz]
1465L	[0Hz~66.9999GHz]

**Programmable command:**

```
[[:SOURce]:FREQuency:STEP <val>
```

```
[[:SOURce]:FREQuency:STEP?
```

**Example:**

```
:FREQuency: STEP 1MHz Freq Step of the signal generator is 1 MHz.
```

**5.2.1.3 Freq Offset****Functional Description:**

When Frequency Offset is not set to zero, an offset indicator “\*” is displayed in frequency display area, and the display value becomes the frequency value plus offset. At this time, the displayed frequency value= RF output frequency ×multiplier+ frequency offset. However, the actual frequency output is still the frequency with no multiplier and frequency offset added. When Freq Offset is set to zero, the indicator disappears.

**Parameter specification:**

```
<FreqOffs> Freq Offset
```

**5.2 Menu Description**

Range: 0Hz[-325GHz, +325GHz].

**Programmable command:**

[:SOURce]:FREQuency:OFFSet &lt;val&gt;

[:SOURce]:FREQuency:OFFSet?

**Example:**

:FREQuency:OFFSetr 10GHz Freq Offset of the signal generator is 10 MHz.

**5.2.1.4 Freq Ref Switch****Functional Description:**

This command sets Freq Ref Switch to ON or OFF state. When the CW frequency of the signal generator is changed after Freq Ref is turned on, the frequency value displayed in frequency display area is based on the frequency reference. When it is not turned on, the frequency value displayed in frequency display area is the actual CW frequency of the signal generator.

**Parameter specification:**

&lt;State&gt; Boolean data is as follows:

ON | 1: Freq Ref Switch is turned on,

OFF | 0: Freq Ref Switch is turned off.

**Programmable command:**

[:SOURce]:FREQuency:REFerence:STATe ON|OFF|1|0

[:SOURce]:FREQuency:REFerence:STATe?

**Example:**

:FREQuency:REFerence:STATe 1 Freq Ref of the signal generator is turned on.

**5.2.1.5 Freq Ref****Functional Description:**

This command sets Freq Ref. Such set value is available when Freq Ref is turned on and a frequency reference indicator "\*" is displayed in frequency display area. Any CW output signal set at this time will subtract frequency reference value. For example: The current CW output frequency is 1 GHz. If Freq Ref is set to 1 GHz, the CW output frequency displayed at this time will be based on 0 Hz frequency reference, so frequency display area will display 1 MHz; if CW frequency is set to 1 MHz, frequency display area will display 1 MHz and the actual output frequency is 1.001 GHz.

**Parameter specification:**

&lt;FreqRef&gt; Freq Ref.

Model	Range
1465A	[0Hz~3GHz]
1465B	[0Hz~6GHz]
1465C	[0Hz~10GHz]
1465D	[0Hz~20GHz]
1465E	[0Hz~40GHz]
1465H	[0Hz~50GHz]
1465L	[0Hz~67GHz]

**Programmable command:**

[:SOURce]:FREQuency:REFerence &lt;val&gt;

[:SOURce]:FREQuency:REFErency?

**Example:**

:FREQuency:REFErency 10GHz Set the relative frequency of the signal generator to 10 GHz.

### 5.2.1.6 Freq Mul

**Functional Description:**

This command sets Freq Mul for signal source. When set Freq Mul is greater than 1, a multiplier indicator "\*" is displayed in frequency display area. At this time, displayed frequency value= RF output frequency value x multiplier. However, the actual frequency output is still the frequency with no multiplier added. When Freq Mul is set to 1, the indicator disappears.

**Parameter specification:**

<FreqMult> Freq Mul.

Range: 1[1, 36].

**Programmable command:**

[:SOURce]:FREQuency:MULTIplier <val>

[:SOURce]:FREQuency:MULTIplier?

**Example:**

:FREQuency: MULTIplier 8 Freq Mul of the signal generator is 8.

### 5.2.1.7 Set LF Generator

This menu enables you to set LF generator of the signal generator. Click the menu to enter the lower menu

#### 1) LF Output ON/OFF

**Functional Description:**

This command sets LF Output ON/OFF of the signal generator

**Parameter specification:**

<State> Boolean data is as follows:

ON | 1: LF Output is turned on, and LF signal output is turned on accordingly.

OFF | 0: LF Output is turned off, and LF signal output is turned off accordingly.

**Programmable command:**

[:SOURce]:LFOutput:STATe ON|OFF|1|0

[:SOURce]:LFOutput:STATe?

**Example:**

:LFOutput:STATe OFF Turn off LF signal output.

#### 2) LF

**Functional Description:**

This command sets LF output frequency. It should be noted that when LF Waveform is SweepSinc or DualSinc, this command sets Freq Start of Sweep Sin or DualSinc Frequency1.

**Parameter specification:**

<Frequency> LF output signal frequency.

Range: 400Hz[0.01Hz, 10MHz].

Freq Start of Sweep Sin

**5.2 Menu Description**

Range: 400Hz[0.01Hz,9.99999999MHz]. When 10 MHz is input, the software shows no error prompt and Freq Start of Sweep Sin is automatically set to 9.99999999 MHz.

DualSinc Frequency1

Range: 400Hz[0.01Hz,10MHz].

Programmable command:

[:SOURce]:LFOuTput:FREQuency <val>

[:SOURce]:LFOuTput:FREQuency?

**Example:**

:LFOuTput:FREQuency 1MHz Set LF output signal frequency to 1 MHz.

**3) LF Ampl****Functional Description:**

This command sets the output signal amplitude of LF output BNC connector of the signal generator.

**Parameter specification:**

<Ampl> LF output signal amplitude.

Range: 2.000VPP[0.002VPP, 4.000VPP].

Programmable command:

[:SOURce]:LFOuTput:AMPLitude <val>(unit:VPP|Mvpp|VRMS)

[:SOURce]:LFOuTput:AMPLitude?

Example:

:LFOuTput:AMPLitude 1VPP LF output signal amplitude is set to 1 VPP.

**4) LF DC Offset**

**Functional Description:** Not supported

**5) LF Waveform**

This command sets LF signal output waveform. There are seven waveforms for selection: Sinc, Square, Triangle, Zigzag, White noise, SweepSinc and DualSinc.

**Functional Description:**

Select this menu, and the menu item will be lighted, and the waveform of LF output signal is Sinc.

**Parameter specification:**

<Mode> Discrete data. LF Waveform is as follows:

SINE	Sine,
SQUare	Square,
TRIangle	Triangle,
RAMP	Zigzag,
NOISe	Noise,
SWEPTsine	SweepSinc,
DUALsine	DualSinc.

**Programmable command:**

[:SOURce]:LFOuTput:SHAPE SINE|SQUare|TRIangle|RAMP

|NOISe|SWEPTsine|DUALsine

[[:SOURce]:LFOutput:SHAPE?

**Example:**

:LFOutput:SHAPE TRIangle      LF Waveform of the signal generator is Triangle.

### 5.2.1.8 Phase Ref Config

**Functional Description:** Not supported

### 5.2.1.9 Phase Adj

**Functional Description:** Not supported

## 5.2.2 Ampl

### 5.2.2.1 Ampl

**Functional Description:**

This command sets the output amplitude level of the signal generator.

**Parameter specification:**

<Ampl> Amplitude level value.

Range: -135dBm [-135dBm, +30dBm].

**Programmable command:**

[[:SOURce]:POWER[:LEVel][:IMMediate][:AMPLitude] <value>

[[:SOURce]:POWER[:LEVel][:IMMediate][:AMPLitude]?

**Example:**

:POWER 0dBm      The output amplitude level is 0 dBm.

### 5.2.2.2 Ampl Offset

**Functional Description:**

The command is the actual output amplitude offset of the signal generator. When the value is non-zero, an offset indicator “\*” is displayed in amplitude display area and the displayed amplitude value is the actual amplitude power plus the amplitude offset. Such amplitude offset does not change the actual output amplitude of the signal generator. Only the displayed amplitude value is changed.

**Parameter specification:**

<PowOffset>      Ampl Offset.

Range: 0dB [-100dB, +100dB].

**Programmable command:**

[[:SOURce]:POWER[:LEVel][:IMMediate]:OFFSet <value>

[[:SOURce]:POWER[:LEVel][:IMMediate]:OFFSet?

**Example:**

:POWER:OFFS -10dB      Ampl Offset is -10 dB.

### 5.2.2.3 Ampl Ref Switch

**Functional Description:**

This command sets the state of Ampl Ref Switch. When Ampl Ref is turned on and amplitude reference value is non-zero, the amplitude value displayed in amplitude display area is based on the amplitude reference when the amplitude level of the signal generator is changed; when Ampl Ref is turned off, the amplitude value displayed in amplitude display area is the actual CW output amplitude of

## 5.2 Menu Description

the signal generator.

### Parameter specification:

<State> Boolean data is as follows:

ON | 1: Ampl Ref is turned on,

OFF | 0: Ampl Ref is turned off.

### Programmable command:

[[:SOURce]:POWer:REFerence:STATe ON|OFF|1|0

[[:SOURce]:POWer:REFerence:STATe?

### Example:

:POWer:REFerence:STATe 1    Ampl Ref is turned on.

### 5.2.2.4 Ampl Ref

#### Functional Description:

Ampl Ref can be set when Ampl Ref Switch is turned on. When Ampl Ref Switch is turned on, an indicator “\*” is displayed in amplitude display area and the displayed amplitude value = actual output amplitude - amplitude reference value.

For example, current CW output amplitude is 1 dBm. If amplitude reference is set to 1 dBm, displayed CW output amplitude is based on the amplitude reference, so amplitude display area will display 0 dBm, and the actual output frequency of the signal generator is still 1 dBm.

#### Parameter specification:

<PowRef>    Ampl Ref.

Range: 0dBm [-135dBm, +30dBm].

#### Programmable command:

[[:SOURce]:POWer:REFerence <value>

[[:SOURce]:POWer:REFerence?

#### Example:

:POWer:REFerence -10dBm    Ampl Ref is -10 dBm.

### 5.2.2.5 Attenuation

#### 1) ALC

#### Functional Description:

This command sets ALC level when Attenuation Style is set to Manual mode.

#### Parameter specification:

<AlcLevel>    ALC level.

Range: 0dBm[-20dBm, +30dBm].

#### Programmable command:

[[:SOURce]:POWer:ALC:LEVel <value>

[[:SOURce]:POWer:ALC:LEVel?

#### Example:

:POWer:ALC:LEVel 5dBm    ALC level is 5 dBm.



## 2) Attenuation Style Manual

### Functional Description:

This command sets the control state of internal programmable step attenuator: Auto or Manual. In Auto mode, the signal generator automatically sets the value of amplitude attenuator based on the current output amplitude; in Manual mode, the current amplitude attenuation of attenuator does not change during the process of changing amplitude output level.

### Parameter specification:

<State> Boolean data is as follows:

ON | 1: Attenuation is AUTO,  
OFF | 0: Attenuation is Manual.

### Programmable command:

```
[[:SOURce]:POWer:ATTenuation:AUTO ON|OFF|1|0
```

```
[[:SOURce]:POWer:ATTenuation:AUTO?
```

### Example:

```
:POWer:ATTenuation:AUTO 0 Attenuation Style is Manual.
```

## 3) Set Attenuation

### Functional Description:

This command sets the amplitude attenuation of mechanical attenuator of the signal generator. The value set by this command only works when Attenuation Style is Manual.

The minimum attenuation step set by this command is 5 dB, that is, users can only set attenuation to 0 dB, 5 dB, 10 dB, 15 dB by step of 5 dB. After Attenuation is set, the signal generator output amplitude is the current ALC minus the currently set attenuation.

### Parameter specification:

<Atten> Amplitude attenuation.  
Range: 115dB[0dB, 115dB].

### Programmable command:

```
[[:SOURce]:POWer:ATTenuation <value>
```

```
[[:SOURce]:POWer:ATTenuation?
```

### Example:

```
:POWer:ATTenuation 15dB Attenuation is 15 dB.
```

## 4) Attenuation Through [ON/OFF]

### Functional Description:

Set Attenuation Through to OFF by default.

### 5.2.2.6 Ampl Step

#### Functional Description:

Set each Ampl Step. When the signal generator CW amplitude is set after the above value is set, each amplitude variation will vary with the currently set step quantity when amplitude is changed using UP|DOWN.

#### Parameter specification:

<PowStep> Ampl Ref.  
Range: 0.10dB [0.01dB, 20dB].

**5.2 Menu Description****Programmable command:**

[:SOURce]:POWer:STEP &lt;value&gt;

[:SOURce]:POWer:STEP?

**Example:**

:POWer:STEP 1dB      Ampl Step is 1 dB.

**5.2.2.7 ALC Loop Config****1) ALC ON****Functional Description:**

This command enables you to turn ALC loop ON or OFF. ALC Loop is mainly to correct amplitude drift and to make the signal generator output amplitude level not change with time and temperature.

**Parameter specification:**

&lt;State&gt; Boolean data is as follows:

ON | 1: ALC Loop is turned off,

OFF | 0: ACL Loop is turned on.

**Programmable command:**

[:SOURce]:POWer:ALC[:STATe] ON|OFF|1|0

[:SOURce]:POWer:ALC[:STATe]?

**Example:**

:POWer:ALC 1      Set ACL Loop to OFF state

**2) Search Style [Manual/Auto]****Functional Description:**

This command activates or deactivates the internal amplitude auto search of the signal generator when ALC loop is turned on. Amplitude search will enable amplitude to stabilize the signal generator on the output amplitude selected by users and keep the internal modulator in drive state when ALC Loop is turned off.

**Parameter specification:**

&lt;Mode&gt; Discrete data. Auto amplitude search state is as follows:

OFF | 0: This command terminates Auto mode, and Search Style is Manual.

ON | 1: Amplitude is automatically searched with the change of RF output amplitude or frequency. Search Style is then in Auto mode

ONCE Do Search once at current RF output frequency.

**Programmable command:**

[:SOURce]:POWer:ALC:SEARch ON|OFF|1|0|ONCE

[:SOURce]:POWer:ALC:SEARch?

**Example:**

:POWer:ALC:SEARch 1      Search Style is Auto.

**3) Do Search****Functional Description:**

Select Do Search.

**4) Search Out [Normal/Min]****Functional Description:**

Set Search Out to Normal or Min.

**5.2.2.8 Level Control****Functional Description:**

This command allows users to select ALC Level Control for the signal generator as appropriate, including INT, EXT and Source Module.

**Parameter specification:**

<State > Discrete data. Level Control is as follows:

INTernal : Level Control is INT,

DIODe Level Control is EXT diode detector.

**Programmable command:**

[[:SOURce]:POWer:ALC:SOURce INTernal|DIODe

[[:SOURce]:POWer:ALC:SOURce?

**Example:**

:POWer:ALC:SEARch:REFerence INT Level Control is INT.

**5.2.2.9 ALC Band****1) ALC Band****Functional Description:**

This command sets ALC (automatic leveling control) Band. The signal generator automatically selects appropriate ALC Band in Auto mode; ALC Band is user setting in Manu mode.

**Parameter specification:**

<State> Boolean data is as follows:

ON | 1: ALC Band is in Auto mode,

OFF | 0: ALC Band is in Manu mode.

**Programmable command:**

[[:SOURce]:POWer:ALC:BANDwidth|BWIDth:AUTO ON|OFF|1|0

[[:SOURce]:POWer:ALC:BANDwidth|BWIDth:AUTO?

**Example:**

[[:SOURce]:POWer:ALC:BANDwidth|BWIDth:AUTO 1 ACL Band is in Auto mode.

**2) Select ALC Band****Functional Description:**

This command sets ALC (automatic leveling control) Band which enables the signal generator to output different frequency bands. There are four ALC loop bandwidth settings in different states, 100 Hz, 1 kHz, 10 kHz and 100 kHz.

Notes:

1. When ALC Band is in Auto mode, if ALC Band is not selected properly, the setting is invalid;
2. When the internal baseband of the instrument is turned on, ACL Band is invalid, and the appropriate bandwidth should to be selected by baseband.

**Parameter specification:**

**5.2 Menu Description**

<AlcBandWidth > Discrete data. ALC Band is as follows:

100Hz		0: ALC Band is 100 Hz,
1kHz		1: ALC Band is 1 kHz,
10kHz		2: ALC Band is 10 kHz,
100kHz		3: ALC Band is 100 kHz.

**Programmable command:**

```
[ :SOURce]:POWer:ALC: BANDwidth|BWIDth 100Hz|1kHz|10kHz|100kHz
[:SOURce]:POWer:ALC: BANDwidth|BWIDth?
```

**Example:**

```
[ :SOURce]:POWer:ALC: BANDwidth|BWIDth 100Hz      ALC Band is 100 Hz.
```

**5.2.2.10 EXT Detector Couple****Functional Description:**

This command sets EXT Detector Couple. When Level Control is EXT diode detector, this command enables you to set the coupling value for external level control.

**Parameter specification:**

<CouplingValue> EXT Detector Couple  
Range: 16dBm[-90dBm, +90dBm].

**Programmable command:**

```
[ :SOURce]:POWer:ALC: SOURce:EXTernal:COUPling <value>
[:SOURce]:POWer:ALC: SOURce:EXTernal:COUPling?
```

**Example:**

```
:POWer:ALC: SOURce:EXTernal:COUPling 16dBm      EXT Level Control Couple is 16 dBm.
```

**5.2.2.11 RF Blank [ON/OFF]****Functional Description:**

This command sets the state of RF Blank. When RF Blank is turned on, if the signal generator is in spot frequency state, RF output signal will be turned off during frequency switching; if the signal generator is in sweep state, RF output signal will be turned off during frequency band switching and RTC.

**Parameter specification:**

<State> Boolean data is as follows:

ON   1:	Blank is turned on,
OFF   0:	Blank is turned off.

**Programmable command:**

```
:OUTPut:BLANking[:STATe] ON|OFF|1|0
:OUTPut:BLANking[:STATe]?
```

**Example:**

```
:OUTPut:BLANking 1 Set the signal generator Blank to ON state.
```

### 5.2.3 Sweep

#### 5.2.3.1 Current Sweep Type

##### Functional Description:

Set Current Sweep Type of the signal generator.

##### Parameter specification:

<Mode> Discrete data, Current Sweep Type to be configured. The values are as follows:

**FIXed|CW** The setting of these two discrete parameters is the same in the signal generator in meaning, that is, the controlled signal generator outputs CW (spot frequency) signal, which will terminate the frequency sweep signal currently output by the instrument.

**SWEep** Current Sweep Type is set to Sweep mode. It is divided into Step Sweep and Ramp Sweep in the software, Step Sweep by default.

**LIST** Current Sweep Type is set to List mode. If the current list is empty, the signal generator will prompt the list is empty. The signal generator can start sweep only when there is at least one sweep point in the list.

##### Programmable command:

```
[ :SOURce]:FREQuency:MODE CW|SWEep|LIST
```

```
[ :SOURce]:FREQuency:MODE?
```

##### Example:

```
:FREQuency:MODE LIST Set the signal generator to List Sweep mode.
```

#### 5.2.3.2 Step Sweep Config

##### 1) Freq Start

##### Functional Description:

This command sets Freq Start of Step Sweep.

##### Parameter specification:

<StartFreq> Freq Start of sweep.

Model	Range
1465A	[100kHz~3GHz]
1465B	[100kHz~6GHz]
1465C	[100kHz~10GHz]
1465D	[100kHz~20GHz]
1465E	[100kHz~40GHz]
1465H	[100kHz~50GHz]
1465L	[100kHz~67GHz]

##### Programmable command:

```
[ :SOURce]:FREQuency:STARt <val>
```

```
[ :SOURce]:FREQuency:STARt?
```

##### Example:

```
:FREQuency:STARt 1MHz Freq Start of Step/Analog Sweep of the signal generator is 1 MHz.
```

##### 2) Freq Stop

##### Functional Description:

**5.2 Menu Description**

This command sets Freq Stop of Step Sweep.

**Parameter specification:**

<StopFreq> Freq Stop of sweep.

Model	Range
1465A	[100kHz~3GHz]
1465B	[100kHz~6GHz]
1465C	[100kHz~10GHz]
1465D	[100kHz~20GHz]
1465E	[100kHz~40GHz]
1465H	[100kHz~50GHz]
1465L	[100kHz~67GHz]

**Programmable command:**

[[:SOURce]:FREQuency:STOP <val>

[[:SOURce]:FREQuency:STOP?

**Example:**

:FREQuency:STOP 100MHz Freq Stop of Step/Analog Sweep of the signal generator is 100 MHz.

**3) Step Counts****Functional Description:**

This command sets the current step counts.

**Parameter specification:**

<Num> Step Counts

Range: 11[2, 801].

**Programmable command:**

[[:SOURce]:SWEep:POINts <val>

[[:SOURce]:SWEep:POINts?

**Example:**

:SWEep:POINts 101 Set Step Counts to 101.

**4) Step Dwell****Functional Description:**

This command sets Step Dwell. It refers to the pause time when the current step frequency point is swept. Step Dwell set by users works when Step Trig is in Auto mode.

**Parameter specification:**

<Val> Step dwell.

Range: 10.000ms[1ms, 60s].

**Programmable command:**

[[:SOURce]:SWEep:DWELl <value>

[[:SOURce]:SWEep:DWELl?

**Example:**

:SWEep:DWELI 1s Set All Step Dwell Time to 1 s.

## 5) Step Trig

### Functional Description:

This command sets Step Trig. It includes Auto, Bus, Ext and Key.

### Parameter specification:

<Mode>	Discrete data. Step Trig is as follows:
IMMediate	Auto, the trigger signal is always true, when a sweep is completed, the system automatically triggers the next sweep.
BUS	Bus, the trigger source is from GPIB group execute trigger, or triggered by *TRG command.
EXTernal	Ext, the trigger signal is from the trigger input connector on the rear panel.
KEY	Key, the trigger signal is from the trigger key on the front panel.

### Programmable command:

```
[ :SOURce ]:SWEep:TRIGger:SOURce IMMEDIATE|BUS|EXTernal|KEY
```

```
[ :SOURce ]:SWEep:TRIGger:SOURce?
```

### Example:

```
:SWEep:TRIGger:SOURce BUS Set Step Trig to Bus mode.
```

### 5.2.3.3 Step Type [Linear/Logical]

#### Functional Description:

Select Step Type, the default setting is (Linear).

### 5.2.3.4 Step Sweep Indirection [Forward/Backward]

#### Functional Description:

This command sets Step Sweep Indirection, including: Forward and Backward. Forward indicates Step Sweep from Freq Start to Freq Stop, and Backward indicates sweep from Freq Stop to Freq Start.

#### Parameter specification:

<Direction> Discrete data. Step Sweep Indirection is as follows:

UP		Forward,
DOWN		Backward.

#### Programmable command:

```
[ :SOURce ]:SWEep:DIRrection UP|DOWN
```

```
[ :SOURce ]:SWEep:DIRrection?
```

#### Example:

```
:SWEep:DIRrection DOWN Start Step Sweep in Backward direction.
```

### 5.2.3.5 List Sweep Config

#### 1) Freq Start

#### Functional Description:

This command sets Freq Start of List Sweep, which is used with Freq Stop and Insert Counts to automatically generate list sweep points.

#### Parameter specification:

**5.2 Menu Description**

<FreqStart> Freq Start of List Sweep.

Model	Range
1465A	[100kHz~3GHz]
1465B	[100kHz~6GHz]
1465C	[100kHz~10GHz]
1465D	[100kHz~20GHz]
1465E	[100kHz~40GHz]
1465H	[100kHz~50GHz]
1465L	[100kHz~67GHz]

**Programmable command:**

[[:SOURce]:LIST:FILL:START <val>

[[:SOURce]:LIST:FILL:START?

**Example:**

:LIST:FILL:START 300MHz Set Freq Start of List Sweep to 300 MHz.

**2) Freq Stop****Functional Description:**

This command sets Freq Stop of List Sweep, which is used with Freq Start and Insert Counts in list to automatically generate list sweep points and set Freq Start and Insert Counts.

**Parameter specification:**

<FreqStop> Freq Stop of List Sweep.

Model	Range
1465A	[100kHz~3GHz]
1465B	[100kHz~6GHz]
1465C	[100kHz~10GHz]
1465D	[100kHz~20GHz]
1465E	[100kHz~40GHz]
1465H	[100kHz~50GHz]
1465L	[100kHz~67GHz]

**Programmable command:**

[[:SOURce]:LIST:FILL:STOP <val>

[[:SOURce]:LIST:FILL:STOP?

**Example:**

:LIST:FILL:STOP 1GHz Set Freq Stop of List Sweep to 1 GHz.

**3) Insert Counts****Functional Description:**

After this command is set, frequency point will be inserted according to Freq Start, Freq Stop and Equal Freq Interval. It should be noted that if users do not want the frequency points in list to increase or decrease sequentially, do not use this command

**Parameter specification:**



<Num> Insert Counts

Range: 3[2, 801].

**Programmable command:**

[[:SOURce]:LIST:FILL:POINts <num>

[[:SOURce]:LIST:FILL:POINts?

**Example:**

:LIST:FILL:POINts 100 Set frequency points to 100 in list.

#### 4) All List Dwell Time

**Functional Description:**

This command sets the dwell time of each sweep point in current list. If users need to set different dwell time, it is necessary to enter the corresponding dwell time for each point in list, i.e. the dwell time parameter value of list sweep points in turn, separated by commas. If the number of points input by users are less than that of the current list points, the number of points where the dwell time is not entered uses the current default.

**Parameter specification:**

<Val> Dwell Time of List Sweep Points.

Range: 1ms [1ms, 60s].

**Programmable command:**

[[:SOURce]:LIST:DWELI <val>{,{val}}

[[:SOURce]:LIST:DWELI?

**Example:**

:LIST:DWELI 30ms, 20ms Set the dwell time of the first point in list to 30 ms, and the second point to 20 ms.

#### 5) All List Ampl Offset

**Functional Description:**

This command sets the amplitude of each sweep point in current list. If users need to set different offset for each list point, it is necessary to enter the corresponding offset value for each point in list, i.e. the amplitude offset of list sweep points in turn, separated by commas. If the number of points input by users are less than that of the current list points, the number of points where the list power offset is not entered uses the current default.

**Parameter specification:**

<Val> Ampl Offset of List Sweep Points.

Range: 0dBm [-100dB, +100dB].

**Programmable command:**

[[:SOURce]:LIST:POWer <val>{,{val}}

[[:SOURce]:LIST:POWer?

**Example:**

:LIST:POWer 1dB, 0.2dB, 1.3dB, 2.5dB, -3.6dB Set List Ampl Offset to 1 dB, 0.2 dB, 1.3 dB, 2.5 dB, -3.6 dB in turn.

#### 6) List Trig [Auto/Bus/Ext/Key]

**Functional Description:**

**5.2 Menu Description**

This command sets List Trig. It includes Auto, Bus, Ext and Key.

**Parameter specification:**

<Source>	Discrete data. List Trig is as follows:
IMMediate	Auto, the trigger signal is always true, when a sweep is completed, the system automatically triggers the next sweep.
BUS	Bus, the trigger source is from GPIB group execute trigger, or triggered by “*TRG” command.
EXTernal	Ext, the trigger signal is from the trigger input connector on the rear panel.
KEY	Key, the trigger signal is from the trigger key on the front panel.

**Programmable command:**

```
[ :SOURce ]:LIST:TRIGger:SOURce IMMEDIATE|BUS|EXTernal|KEY
```

```
[ :SOURce ]:LIST:TRIGger:SOURce?
```

**Example:**

```
:LIST:TRIGger:SOURce BUS Set List Trig to Bus mode.
```

**7) Step Sweep Indirection [Backward/Forward]****Functional Description:**

This command sets Step Sweep Indirection. Users can select both Forward and Backward modes: Forward indicates sweep from the first point to the last point in list, and Backward indicates sweep from the last point to the first point in current list.

**Parameter specification:**

<Direc>	Discrete data. Step Sweep Indirection is as follows:
UP	Start Forward sweep from the first point in list.
DOWN	Start Backward sweep from the last point in list.

**Programmable command:**

```
[ :SOURce ]:LIST:DIRrection UP|DOWN
```

```
[ :SOURce ]:LIST:DIRrection?
```

**Example:**

```
:LIST:DIRrection UP Set Step Sweep Indirection to Forward.
```

**5.2.3.6 Single Sweep****Functional Description:**

Trig Single Sweep.

**5.2.3.7 Trig Style of Start****1) Auto****Functional Description:**

When sweep frequency is selected, the trigger mode is Auto. When the menu [Sweep Mode Single | Continue] is selected to switch (Single) or (Continue), the instrument automatically triggers sweep frequency. The default setting is (Auto).

**2) Bus****Functional Description:**

When sweep frequency is selected, the trigger mode is Bus. When the menu [Sweep Mode Single |

**5.2 Menu Description**

Continue] is selected to switch (Single) or (Continue), and the instrument receives trigger signal of GPIB, LAN, RS232, sweep frequency is started.

**3) External****Functional Description:**

When sweep frequency is selected, the trigger mode is Ext. When the menu [Sweep Mode Single | Continue] is selected to switch (Single) or (Continue), and the instrument receives rising edge triggered signal input from external trigger, sweep frequency is started.

**4) Key****Functional Description:**

When sweep frequency is selected, the trigger mode is Manual. When the menu [Sweep Mode Single | Continue] is selected to switch (Single) or (Continue), and the instrument receives rising edge triggered signal input from external trigger, sweep frequency is started.

**5.2.3.8 RTC Switch****Functional Description:**

Not supported.

**5.2.3.9 Amplitude Sweep****Functional Description:**

Not supported.

**5.2.4 Modulation****5.2.4.1 Pulse Modulation ON/OFF****Functional Description:**

This command sets whether to output the pulse modulation signal of the signal generator.

**Parameter specification:**

<State> Boolean data is as follows:  
 ON | 1: Pulse Modulation is turned on,  
 OFF | 0: Pulse Modulation is turned off.

**Programmable command:**

[[:SOURce]:PULM:STATe ON|OFF|1|0

[[:SOURce]:PULM:STATe?

**Example:**

:PULM:STATe 1 Pulse Modulation is turned on.

**5.2.4.2 Source****Functional Description:**

This command sets Source of Pulse Modulation, including: EXT, Scalar, Auto, Square, D-Pulse, Pulse Train, Gate, Trig, Jittered, Staggered and Sliding. In Scalar mode, it is not allowed to change associated pulse parameters, and the signal generator will automatically output pulse signal of 18-microsecond pulse width and 36-microsecond period.

**Parameter specification:**

<Mode> Discrete data. Source is as follows:  
 EXTernal Source is EXT,  
 SCALar Source is Scalar and outputs 27.8 kHz square wave,

**5.2 Menu Description**

INTernal	Pulse Source is Auto,
SQUare	Source is Square.
DOUBler	Source is D-Pulse.
PTRain	Source is Pulse Train.
GATEd	Source is Gate.
TRIGgered	Auto mode is activated. In this mode, the period is the external sync pulse period, and the pulse width is the local pulse width setting.
JITTered	Source is Jittered.
STAGger	Source is Staggered.
SLIDing	Source is Sliding.

**Programmable command:**

```
[[:SOURce]:PULM:SOURceEXTernal|SCALar|INTernal|SQUare|DOUBlet|PTRain|GATEd|TRIGgered|JITTered|STAGger|SLIDing
```

```
[[:SOURce]:PULM:SOURce?
```

**Example:**

```
:PULM:SOURce SQUare Set Source to Square.
```

**5.2.4.3 Width****Functional Description:**

This command sets Width of pulse signal generated inside the signal generator. If the set pulse width is greater than or equal to the current pulse period, the pulse width will be automatically adjusted to be smaller than the current pulse period. Besides, if the set pulse width is less than 1 us, it is recommended to execute power search function. When Source is Staggered, the pulse width in stagger list is uniform. You also need to change the pulse width in parameter list by this command.

**Parameter specification:**

<PWidth> Pulse signal width.

Range: 50.000us [20ns, 41.999999990s].

**Programmable command:**

```
[[:SOURce]:PULM:INTernal:PWIDth <val>
```

```
[[:SOURce]:PULM:INTernal:PWIDth?
```

**Example:**

```
:PULM:INTernal:PWIDth 10us Set the pulse signal width to 10 us.
```

**5.2.4.4 Period****Functional Description:**

This command sets the period of pulse signal generated inside the signal generator. If the set period is smaller than or equal to the current pulse width, the pulse width will be automatically adjusted to be smaller than pulse period.

**Parameter specification:**

<Percent> Pulse period.

Range: 1.000000ms[40ns, 42.000000000s].

**Programmable command:**

```
[[:SOURce]:PULM:INTernal:PERiod <value>
```

[[:SOURce]:PULM:INTernal:PERiod?

**Example:**

:PULM:INTernal:PERiod 10ms Pulse signal period is 10 ms.

#### 5.2.4.5 Delay

**Functional Description:**

This command sets the pulse delay of pulse modulation. The actual maximum pulse delay that can be set depends on the pulse period currently set by users. Besides, it should be noted that pulse delay setting works only when Source is Auto, Square, D-Pulse or Trig, and pulse delay has an inherent delay of 100 ns in Trig mode.

**Parameter specification:**

<DelayTime> Pulse delay time of pulse modulation.

Range: Non-Trig Mode: 0s[0ns, 42.000000000s],

Trig Style: 0s[100ns, 42.000000000s].

**Programmable command:**

[[:SOURce]:PULM:INTernal:DELay <val>

[[:SOURce]:PULM:INTernal:DELay?

**Example:**

:PULM:INTernal:DELay 1ms Set pulse delay to 1 ms

#### 5.2.4.6 PRF

**Functional Description:**

This command sets PRF of pulse modulation. When Source is Square, the pulse signal outputs a signal with duty cycle of 50%, and the command can change the frequency of square signal.

**Parameter specification:**

<Frequency> PRF of pulse modulation.

Range: 1kHz [0.023Hz, 25MHz]

**Programmable command:**

[[:SOURce]:PULM:INTernal:FREQuency <val>

[[:SOURce]:PULM:INTernal:FREQuency?

**Example:**

:PULM:INTernal:FREQuency 1MHz Set PRF to 1 MHz.

#### 5.2.4.7 Input Direction [ON/OFF]

**Functional Description:**

The command logically inverts the external input pulse signal, i.e. when Pulse Source is EXT, the pulse signal input from pulse input port on the front panel of the signal generator is TTL high level signal or is inverted to TTL low level signal.

**Parameter specification:**

<Mode> Discrete data. Input Direction is as follows:

NORMal Input Direction is turned off and the input pulse signal is TTL high level.

INVerted Input Direction is turned on and the input pulse signal is TTL low level.

**Programmable command:**

**5.2 Menu Description**

```
[ :SOURce]:PULM:EXTernal:POLarity INVerted|NORMal
```

```
[ :SOURce]:PULM:EXTernal:POLarity?
```

**Example:**

PULM:ENTernal:POLarity INV External input pulse signal is inverted to TTL low level.

**5.2.4.8 Delayed Sweep**

**Functional Description: Not implemented**

**5.2.4.9 AM [ON/OFF]****Functional Description:**

This command sets the AM signal output state of the signal generator.

**Parameter specification:**

<State> Boolean data is as follows:

ON | 1: AM output is turned on,

OFF | 0: AM output is turned off.

**Programmable command:**

```
[ :SOURce]:AM:STATe ON|OFF|1|0
```

```
[ :SOURce]:AM:STATe?
```

**Example:**

```
:AM:STATe 1 AM is turned on.
```

**5.2.4.10 AM (FM, PM) Waveform****Functional Description:**

This command sets AM (FM, PM) signal output waveform, including: Sinc, Square, Triangle, Zigzag, White noise, SweepSinc, and DualSinc.

**Parameter specification:**

<Mode> Discrete data. AM Waveform is as follows:

SINE	Sine,
SQUare	Square,
TRlangle	Triangle,
RAMP	Zigzag,
NOISe	Noise,
SWEPTsine	SweepSinc,
DUALsine	DualSinc.

**Programmable command:**

```
[ :SOURce]:AM(FM、PM):INTernal:SHAPeSINE|SQUare|TRlangle|RAMP|NOISe
```

```
|SWEPTsine|DUALsine
```

```
[ :SOURce]:AM(FM、PM):INTernal:SHAPe?
```

**Example:**

```
[ :SOURce]:AM(FM、PM):INTernal:SHAP RAM AM (FM, PM) Waveform is Zigzag.
```

#### 5.2.4.11 AM [EXP/Linear]

##### Functional Description:

This command sets AM Type of the signal generator to EXP or Linear . AM Depth will be in dB in EXP mode; AM Depth will be in percent in Linear mode.

##### Parameter specification:

<Mode> Discrete data. AM Type is as follows:

EXPonential EXP AM,  
LINear Linear AM.

##### Programmable command:

[[:SOURce]:AM:TYPE EXPonential|LINear

[[:SOURce]:AM:TYPE?

##### Example:

:AM:TYPE EXP EXP AM.

#### 5.2.4.12 AM (FM, PM) Source

##### Functional Description:

This command selects AM (FM, PM) Source, including: INT and EXT, you need to connect the external AM (FM, PM) signal to the AM (FM, PM) input ports on the front panel of the signal generator in EXT mode.

##### Parameter specification:

<Mode> Discrete data. AM (FM, PM) Source is as follows:

EXTernal EXT AM (FM, PM),  
INTernal INT AM (FM, PM).

##### Programmable command:

[[:SOURce]:AM(FM、PM):SOURce EXTernal|INTernal

[[:SOURce]:AM(FM、PM):SOURce?

##### Example:

:AM(FM、PM):SOURce INT AM (FM, PM) Source is in INT mode.

#### 5.2.4.13 AM Depth [ON/OFF]

##### Functional Description:

This command sets AM mode. In DEEP mode, AM Depth of the signal generator is dynamically greater than that when ALC Loop is turned off, and AM index is superior to the index in data manual; in NORMAl mode, AM index is the same as that in data manual. Please refer to data index of 1465 series signal generator.

##### Parameter specification:

<Mode> Discrete data. AM Mode is as follows:

DEEP AM Depth is turned on,  
NORMAl AM Depth in turned off.

##### Programmable command:

[[:SOURce]:AM:MODE DEEP|NORMAl

[[:SOURce]:AM:MODE?

**5.2 Menu Description****Example:**

:AM:MODE NORM      AM Depth is turned off.

**5.2.4.14 AM (FM, PM) Rate****Functional Description:**

This command sets the internal AM (FM, PM) rate of the signal generator. It can also set the first tone when AM (FM, PM) Waveform is DualSinc, and Freq Start when AM (FM, PM) Waveform is SweepSinc.

**Parameter specification:**

<Frequency>      AM (FM, PM) Rate.  
 Range: 1kHz[5mHz, 1MHz].  
 Freq Start of SweepSinc.  
 Range: 10mHz[10mHz,0.99999999MHz]  
 DualSinc frequency1.  
 Range: 1kHz[10mHz,1MHz].

**Programmable command:**

[[:SOURce]:AM(FM、PM):INTernal:FREQuency <val>

[[:SOURce]:AM(FM、PM):INTernal:FREQuency?

**Example:**

:AM(FM、PM):INTernal:FREQuency 100kHz      Internal AM (FM, PM) Rate is 100 kHz.

**5.2.4.15 AM Depth****Functional Description:**

When AM Type is EXP, set AM Depth of AM signal in dB.

**Parameter specification:**

<AmDepthExp>    AM Depth (EXP).  
 Range: 0.00dB[0.00dB, 40.00dB].

**Programmable command:**

[[:SOURce]:AM:DEPTTh:EXPonential <.val>

[[:SOURce]:AM: DEPTTh:EXPonential?

**Example:**

:AM: DEPTTh:EXPonential 10dB    AM Depth is 10 dB.

**5.2.4.16 Modulation Mode [FM/PM]****Functional Description:**

Set Modulation Mode to FM or PM. Both are mutually exclusive.

**5.2.4.17 FM [ON/OFF]****Functional Description:**

This command sets the FM signal output state of the signal generator.

**Parameter specification:**

<State>      Boolean data is as follows:



ON | 1: FM output in turned on,

OFF | 0: FM output in turned off.

**Programmable command:**

[[:SOURce]:FM:STATe ON|OFF|1|0

[[:SOURce]:FM:STATe?

**Example:**

:FM:STATe 0      FM is in turned off.

#### 5.2.4.18 FM Dev

**Functional Description:**

This command sets FM Dev of the signal generator. It should be noted that FM Dev varies in different frequency band.

**Parameter specification:**

**<Deviation> The relationship between current frequency and FM Dev is as follows:**

1465	Current frequency	FM Dev
	9kHz - 250MHz	0 - 2MHz
	250MHz -500MHz	0 - 1MHz
	500MHz - 1GHz	0 - 2MHz
	1GHz - 2GHz	0 - 4MHz
	2GHz-3.2GHz	0 - 8MHz
	3.2GHz - 10GHz	0 - 16MHz
	10GHz-20GHz	0 - 32MHz
	20GHz-40GHz	0 - 64MHz
	40GHz-67GHz	0 - 128MHz

**Programmable command:**

[[:SOURce]:FM:DEViation <val>

[[:SOURce]:FM:DEViation?

**Example:**

:FM:DEViation 500kHz      FM Dev of FM signal is 500 kHz.

#### 5.2.4.19 PM [ON/OFF]

**Functional Description:**

This command sets the PM signal output state of the signal generator.

**Parameter specification:**

<State>            Boolean data is as follows:

ON | 1: PM output is turned on,

OFF | 0: PM output is turned off.

**Programmable command:**

[[:SOURce]:PM:STATe ON|OFF|1|0

[[:SOURce]:PM:STATE?

**Example:**

**5.2 Menu Description**

:PM:STATe 0      PM is turned off.

**5.2.4.20 PM Bias****Functional Description:**

This command sets PM Bias of the signal generator. It should be noted that PM Bias varies in different frequency band.

**Parameter specification:**

<Deviation> The relationship between PM Bias and PM BandWidth is as follow:

1465	Current frequency	PM BandWidth Normal	PM BandWidth HighBand
	100kHz - 250MHz	0 - 2.000rad	0 – 0.200rad
	250MHz-500MHz	0 - 1.000rad	0 – 0.100rad
	500MHz - 1GHz	0 - 2.000rad	0 – 0.200rad
	1GHz - 2GHz	0 - 4.000rad	0 – 0.400rad
	2GHz-3.2GHz	0 - 8.000rad	0 – 0.400rad
	3.2GHz - 10GHz	0 - 16.000rad	0 – 1.600rad
	10GHz-20GHz	0 - 32.000rad	0 – 3.200rad
	20GHz-40GHz	0 – 64.000rad	0 – 6.400rad
	40GHz-67GHz	0 - 128.000rad	0 – 12.800rad

**Programmable command:**

[[:SOURce]:PM:DEViation <val>

[[:SOURce]:PM:DEViation?

**Example:**

:PM:DEViation 3rad      PM Bias of PM signal is 3 rad.

**5.2.5 Base****5.2.5.1 Base [ON/OFF]****Functional Description:**

This command enables BaseBand of the signal generator to ON/OFF state. When BaseBand is turned on, the main information display area in user interface of the signal generator will display the indication of BaseBand and IQ Modulate.

**Parameter specification:**

<State> Boolean data is as follows:

ON | 1: BaseBand in turned on,

OFF | 0: BaseBand in turned off.

**Programmable command:**

[[:SOURce]:RADio:CUSTom:STATe ON|OFF|1|0

[[:SOURce]:RADio:CUSTom:STATe?

**Example:**

:RADio:CUSTom:STATe 1      Turn on BaseBand.

**5.2.5.2 Data Source****Functional Description:**

**5.2 Menu Description**

This command sets the data source of baseband modulation signal of the signal generator. There are 14 data sources for selection, PN9, PN11, PN15, PN16, PN20, PN21, PN23, FIX4, P4, P8, P16, P32, P64 and EXT.

**Parameter specification:**

<Mode> Discrete data. For data source of baseband modulation signal, please refer to the format of set command.

**Programmable command:**

```
[ :SOURce]:RADio:CUSTom:DATAPN9|PN11|PN15|PN16|PN20|PN21|PN23|FIX4|P4|P8|P16|P32|P64|EXT
```

```
[ :SOURce]:RADio:CUSTom:DATA?
```

**Example:**

```
:RADio:CUSTom:DATA FIX4      Baseband Data Source is Fix 4.
```

**5.2.5.3 Symbo Rate****Functional Description:**

This command sets the baseband signal symbol rate of the signal generator in sps, ksps, Msps and Gsps.

**Parameter specification:**

<Val> Baseband signal symbol rate.

The relationship between Modulation Type, Symbo Bits and Symbo Rate is as follows:

Modulation Type	Symbo Bits	Symbo Rate
BPSK	1	0.00005Msps – 50Msps
MSK	1	0.00005Msps – 50Msps
2FSK	1	0.00005Msps – 50Msps
OQPSK	2	0.00005Msps – 50Msps
QPSK	2	0.00005Msps – 50Msps
8FSK	3	0.00005Msps – 50Msps
QAM16	4	0.00005Msps – 50Msps

**Programmable command:**

```
[ :SOURce]:RADio:CUSTom:SRATe <val>
```

```
[ :SOURce]:RADio:CUSTom:SRATe?
```

**Example:**

```
:RADio:CUSTom:SRATe 3Msps Symbo rate is 3 Msps.
```

**5.2.5.4 Modulation Type****Functional Description:**

This command sets Modulation Type.

**Parameter specification:**

<Mode> Discrete data. For Modulation Type, please refer to the format of set command:

**Programmable command:**

```
[ :SOURce]:RADio:CUSTom:MODulation[:TYPE]
```

```
BPSK|QPSK|IS95QPSK|GRAYQPSK|OQPSK|IS95OQPSK|P4DQPSK|8PSK|16PSK|D8PSK|MSK|
```

**5.2 Menu Description**

2FSK|4FSK|8FSK|16FSK|C4FM|4QAM|16QAM|32QAM|64QAM|128QAM|256QAM|512QAM|1024 QAM|ASK

[:SOURce]:RADio:CUSTom:MODulation[:TYPE]?

**Example:**

:RADio:CUSTom:MODulation 8PSK      Modulation Type is 8 PSK.

**5.2.5.5 Filter Select****Functional Description:**

This command selects the baseband pre-modulation filter types of the signal generator, including: RNYQuist, NYQuist, GAUSSian, RECTangle.

**Parameter specification:**

<Mode>	Discrete data. Baseband pre-modulation filter types are as follows:	
	RNYQuist	Root Nyquist filter,
	NYQuist	Nyquist filter,
	GAUSSian	Gauss filter,
	RECTangle	Rectangle filter.

**Programmable command:**

[:SOURce]:RADio:CUSTom:FILTer RNYQuist|NYQuist |GAUSSian| RECTangle

[:SOURce]:RADio:CUSTom:FILTer?

**Example:**

:RADio:CUSTom:FILTer RNYQuist      Baseband pre-modulation filter type is Root Nyquist.

**5.2.5.6 Optimize Filter**

**Functional Description:** Not supported.

**5.2.5.7 Trig Style**

Series 1465 Signal Generator has three trigger modes for real-time baseband: Continue, Single and Gate. The function of each style is described as follows:

Continue: After a valid trigger event is received, the currently selected code pattern is repeatedly generated.

Single: After a valid trigger event is received, the currently selected code pattern is generated once.

Gate: The current code pattern is generated continuously and repeatedly during the effective period of gate signal.

**Functional Description:**

This command sets the baseband signal trigger mode that controls data transmission, including: CONTinuous, SINGle and GATE.

**Parameter specification:**

<Mode>	Discrete data. Baseband signal trigger style is as follows:	
	CONTinuous	0: Trig Style is set to Continue,
	SINGle	1: Trig Style is set to Single,
	GATE	2: Trig Style is set to Gate.

**Programmable command:**

[:SOURce]:RADio:CUSTom:TRIGger:TYPE CONTinuous|SINGle|GATE

```
[:SOURce]:RADio:CUSTom:TRIGger:TYPE?
```

**Example:**

```
[:SOURce]:RADio:CUSTom:TRIGger:TYPE SING    Trig Style is Single.
```

**5.2.5.8 Trig Source**

Trig Source of real-time baseband of 1465 series signal generator includes: Key, Ext and Bus. Each trigger source is described as follows.

**Functional Description:**

This command sets the baseband signal trigger source of the signal generator, including: KEY, BUS and EXT.

**Parameter specification:**

```
<Mode>    Discrete data. Baseband signal trigger source is as follows:
           KEY          | 0: The trigger source is from the trigger key on the front panel of the
           instrument,
           BUS          | 1: The trigger source is from GPIB group execute trigger, or triggered
           when “*TRG” command is received;
           EXT          | 2: The trigger source is from the trigger input of ports on the rear
           panel of the instrument.
```

**Programmable command:**

```
[:SOURce]:RADio:CUSTom:TRIGger:SOURce KEY|BUS|EXT
```

```
[:SOURce]:RADio:CUSTom:TRIGger:SOURce?
```

**Example:**

```
[:SOURce]:RADio:CUSTom:TRIGger:SOURce BUS    Baseband signal trigger source is Bus.
```

**5.2.5.9 Sync Output**

Not supported

**5.2.5.10 Burst Shape Config**

Not supported

**5.2.5.11 I/Q Wave Attenuation Coefficient**

Not supported

**5.2.5.12 Phase Polary****Functional Description:**

This command sets the phase rotation direction of baseband signal, including: Normal and Reverse, signal is normally modulated in Normal mode; Q channel signal is reversed to complete the reverse of carrier signal in Reverse mode.

**Parameter specification:**

```
<Mode>    Discrete data. Phase rotation mode of baseband signal is as follows:
           NORMal| 0: Normal,
           INVert | 1: Reverse.
```

**Programmable command:**

```
[:SOURce]:RADio:CUSTom:POLarity[:ALL] NORMal|INVert
```

```
[:SOURce]:RADio:CUSTom:POLarity[:ALL] ?
```

**Example:**

**5.2 Menu Description**

[[:SOURce]:RADio:CUSTom:POLarity[:ALL] INV      Baseband signal phase is in Reverse mode.

**5.2.5.13 Differential Encode****Functional Description:**

This command enables Differential Encode ON/OFF. When Differential Encode is turned on, modulated bit is set to 1 if data bit is different from its previous bit; if data bits are the same, modulated bit will be set to 0. For example, when data bit is 1010 and Differential Encode is turned on, modulated bit is 1111.

**Parameter specification:**

<State>      Boolean data is as follows:  
 ON | 1:      Turn on Differential Encode,  
 OFF | 0:      Turn off Differential Encode.

**Programmable command:**

[[:SOURce]:RADio:CUSTom:DENCode ON|OFF|1|0

[[:SOURce]:RADio:CUSTom:DENCode?

**Example:**

[[:SOURce]:RADio:CUSTom:DENCode 1      Differential Encode is turned on.

**5.2.5.14 Hardware Config****1) Base Sample Clock [INT/EXT]****Functional Description:**

Set Base Sample Clock to INT or EXT, INT by default.

**Parameter specification:**

INTernal [INTernal | EXTernal]

Parameter list:

INTernal              Internal

EXTernal              External

**Programmable command:**

Not supported

**2) Frequency of EXT Sample Clock****Functional Description:**

It is valid when Base Sample Clock is EXT. Set the frequency of EXT Sample Clock.

**Parameter specification:**

None

**Programmable command:**

Not supported

**3) Base Data Clock [INT/EXT]****Functional Description:**

Set Base Data Clock to INT or EXT. The default is INT.

**Parameter specification:**

INTernal [INTernal | EXTernal]

Parameter list:

INTernal Internal

EXTernal External

**Programmable command:**

Not supported

#### 4) Frequency of EXT Data Clock

**Functional Description:**

It is valid when Base Data Clock is EXT. When Data Source is EXT, data clock frequency is automatically calculated by Symbo Rate or data clock frequency is set here.

**Parameter specification:**

None

**Programmable command:**

Not supported

#### 5.2.6 I/Q

##### 5.2.6.1 I/Q Modulate [ON/OFF]

**Functional Description:**

This command enables the internal I/Q modulator to ON/OFF state.

**Parameter specification:**

<State> Boolean data is as follows:  
 ON | 1: I/Q Modulate is turned on,  
 OFF | 0: I/Q Modulate is turned off.

**Programmable command:**

[:SOURce]:DM:STATe ON|OFF|1|0

[:SOURce]:DM:STATe?

**Example:**

:DM:STATe 1 Turn on I/Q modulator.

##### 5.2.6.2 I/Q Data Source

**Functional Description:**

This command selects I/Q Data Source entering IQ modulator of the signal generator. There are two modes for selection, EXTernal and INTernal.

**Parameter specification:**

<Mode> Discrete data. I/Q filter is selected as follows in Manual mode:  
 EXTernal | 0: I/Q signal input matching EXT50Ω,  
 INTernal | 1: Internal I/Q signal input to I/Q modulator,

**Programmable command:**

[:SOURce]:DM:SOURce EXTernal| INTernal

[:SOURce]:DM:SOURce?

**Example:**

[:SOURce]:DM:SOURce EXT Set I/Q Data Source as EXT.

**5.2 Menu Description****5.2.6.3 Ext WideBand I/Q Input****Functional Description:**

This command sets the ON/OFF state of Ext WideBand I/Q Input.

**Parameter specification:**

<State> Boolean data is as follows:  
 ON | 1: Ext WideBand I/Q Input is turned on,  
 OFF | 0: Ext WideBand I/Q Input is turned off.

**Programmable command:**

```
[ :SOURce]:DM:EXTernal:BWIDth[:STATe] ON|OFF|1|0
[:SOURce]:DM:EXTernal:BWIDth[:STATe]?
```

**Example:**

```
:DM:EXT:BWID:STATe 1 Ext WideBand I/Q Input is turned on.
```

**5.2.6.4 Modulation Attenuation Manual****Functional Description:**

This command sets the Manual state of the signal generator I/Q channel attenuator. The current attenuation is maintained in Manual mode. Users cannot change attenuation when Manual state is turned off, and the signal generator automatically optimizes the optimum attenuation in the current state of the signal generator.

**Parameter specification:**

<State> Boolean data is as follows:  
 ON | 1: Modulation Attenuation is in Manual state,  
 OFF | 0: Modulation Attenuation is in Auto state.

**Programmable command:**

```
[ :SOURce]:DM:MODulation:ATTenuation:AUTO ON|OFF|1|0
[:SOURce]:DM:MODulation:ATTenuation:AUTO?
```

**Example:**

```
:DM:MODulation:ATTenuation:AUTO 1 Modulation Attenuation is in Manual mode.
```

**5.2.6.5 Modulation Attenuation****Functional Description:**

This command sets the attenuation of I/Q signal modulated by the signal generator RF channel. The output of the output attenuation can be set when Attenuation is in Manual state. Attenuation is valid even if I/Q Adjust is turned off.

**Parameter specification:**

<Atten> I/Q Modulation Attenuation.  
 Range: 12.00dB[0.00dB, 40.00dB].

**Programmable command:**

```
[ :SOURce]:DM:MODulation:ATTenuation <val>
[:SOURce]:DM:MODulation:ATTenuation?
```

**Example:**

```
:DM:MODulation:ATTenuation 10dB I/Q Modulation Attenuation is 10 dB.
```



### 5.2.6.6 I/Q Adjust

#### 1) I/Q Adjust ON

##### Functional Description:

This command enables I/Q Adjust ON/OFF. After this function is turned on, the parameters adjusted: Gain Balance, I Offset, Q Offset and Orthority Offset are superimposed on adjustment circuit; after this function is turned off, the above parameter values are not used, but the modulation attenuation is not affected by the ON/OFF state of I/Q Adjust.

##### Parameter specification:

<State> Boolean data is as follows:  
 ON | 1: I/Q Adjust is turned on,  
 OFF | 0: I/Q Adjust is turned off.

##### Programmable command:

```
[ :SOURce]:DM:IQADjustment[:STATe] ON|OFF|1|0
[:SOURce]:DM:IQADjustment[:STATe]?
```

##### Example:

```
:DM:IQADjustment 1 Turn on I/Q Adjust.
```

#### 2) Gain Balance

##### Functional Description:

When I/Q Adjust is turned on, set the gain of the signal generator I signal relative to Q signal.

##### Parameter specification:

<Gain> I/Q Signal Gain Balance.  
 Range: 0dB[-4.00dB, +4.00dB].

##### Programmable command:

```
[ :SOURce]:DM:IQADjustment:GAIN <val>
[:SOURce]:DM:IQADjustment:GAIN?
```

##### Example:

```
:DM:IQADjustment:GAIN 0dB Set I/Q Signal Gain Balance to 0 dB.
```

#### 3) I Offset

##### Functional Description:

When I/Q Adjust is turned on, set the offset of the signal generator I channel. The set parameters are in percent. The maximum corresponds to 1.5 V DC and the minimum resolution is 0.025%. The parameter completes the suppression of carrier leakage signal. Carrier leakage increases after users completes other adjustments, such as orthority and modulation attenuation. It is necessary to adjust DC offset after other adjustments are completed.

##### Parameter specification:

<Offset> I/Q signal I offset.  
 Range: 0 [-50, +50].

##### Programmable command:

```
[ :SOURce]:DM:IQADjustment:IOFFset <val>
[:SOURce]:DM:IQADjustment:IOFFset?
```

**5.2 Menu Description****Example:**

:DM:IQADjustment:IOffset 30      Set I Offset to 30%.

**4) Q Offset****Functional Description:**

This command sets the offset of the signal generator Q channel. The set parameters are in percent. The maximum corresponds to 1.5 V DC and the minimum resolution is 0.025%. The parameter completes the suppression of carrier leakage signal. Carrier leakage increases after users completes other adjustments, such as orthority and modulation attenuation. It is necessary to adjust DC offset after other adjustments are completed.

**Parameter specification:**

<Offset>      I/Q signal Q offset.

Range: 0 [-50, +50].

**Programmable command:**

[:SOURce]:DM:IQADjustment:QOFFSET <val>

[:SOURce]:DM:IQADjustment:QOFFSET?

**Example:**

:DM:IQADjustment:QOFFSET 30      Set Q Offset to 30%.

**5) Orthority Offset****Functional Description:**

When I/Q Adjust is turned on, this command adjusts the phase angle between I and Q vectors by increasing or decreasing the phase angle of I or Q. If the current carrier frequency exceeds 3.2 GHz, the error of orthority offset may exceed that specified in the sample specification of 1465 series signal generator.

**Parameter specification:**

<Offset>      I/Q adjustment orthority offset.

Range: 0deg [-10.00deg, +10.00deg].

**Programmable command:**

[:SOURce]:DM:IQADjustment:QSKew <val>

[:SOURce]:DM:IQADjustment:QSKew?

**Example:**

:DM:IQADjustment:QSKew 30deg      Set I/Q adjustment orthority offset to 30 deg.

**5.2.6.7 ALC ON****Functional Description:**

This command enables you to turn ALC loop ON or OFF. ALC Loop is mainly to correct amplitude drift and to make the signal generator output amplitude level not change with time and temperature.

**Parameter specification:**

<State>      Boolean data is as follows:

ON | 1: ALC Loop is turned off,

OFF | 0: ACL Loop is turned on.

**Programmable command:**

[:SOURce]:POWER:ALC[:STATe] ON|OFF|1|0

```
[:SOURce]:POWer:ALC[:STATe]?
```

**Example:**

```
:POWer:ALC 1 Set ALC Loop to OFF state.
```

**5.2.6.8 Search Style [Manual/Auto]****Functional Description:**

This command activates or deactivates the internal amplitude auto search of the signal generator when ALC loop is turned on. Amplitude search will enable amplitude to stabilize the signal generator on the output amplitude selected by users and keep the internal modulator in drive state when ALC Loop is turned off.

**Parameter specification:**

<Mode> Discrete data. Auto amplitude search state is as follows:

OFF | 0: This command terminates Auto mode, and Search Style is Manual.

ON | 1: Amplitude is automatically searched with the change of RF output amplitude or frequency. Search Style is then in Auto mode

ONCE Do Search once at current RF output frequency.

**Programmable command:**

```
[:SOURce]:POWer:ALC:SEARch ON|OFF|1|0|ONCE
```

```
[:SOURce]:POWer:ALC:SEARch?
```

**Example:**

```
:POWer:ALC:SEARch 1 Search Style is Auto.
```

**5.2.6.9 Amplitude Search****Functional Description:**

This command activates or deactivates the internal amplitude auto search of the signal generator when ALC loop is turned on. Amplitude search will enable amplitude to stabilize the signal generator on the output amplitude selected by users and keep the internal modulator in drive state when ALC Loop is turned off.

**Parameter specification:**

<Mode> Discrete data. Auto amplitude search state is as follows:

OFF | 0: This command terminates Auto mode, and Search Style is Manual.

ON | 1: Amplitude is automatically searched with the change of RF output amplitude or frequency. Search Style is then in Auto mode

ONCE Do Search once at current RF output frequency.

**Programmable command:**

```
[:SOURce]:POWer:ALC:SEARch ON|OFF|1|0|ONCE
```

```
[:SOURce]:POWer:ALC:SEARch?
```

**Example:**

```
POWer:ALC:SEARch 1 Search Style is Auto.
```

**5.2.6.10 Search Out [Normal/Min]****Functional Description:**

Set Search Out to Normal or Min.

**5.2 Menu Description****5.2.6.11 EXT Output Source****Functional Description:**

This command selects I/Q Data Source entering IQ modulator of the signal generator. There are two modes for selection, EXTernal and INTernal.

**Parameter specification:**

<Mode> Discrete data. I/Q filter is selected as follows in Manual mode:

EXTernal | 0: I/Q signal input matching EXT50Ω,

INTernal | 1: INT I/Q signal is input to I/Q modulator.

**Programmable command:**

[ :SOURce ] : DM : SOURce EXTernal | INTernal

[ :SOURce ] : DM : SOURce ?

**Example:**

[ :SOURce ] : DM : SOURce EXT Set I/Q Data Source as EXT.

**5.2.6.12 Output Adj****1) Output Adj ON/OFF****Functional Description:**

This command sets I/Q Output Adj to ON/OFF state.

**Parameter specification:**

<State> Boolean data is as follows:

ON | 1: I/Q Output Adj is turned on,

OFF | 0: I/Q Output Adj is turned off.

**Programmable command:**

[ :SOURce ] : DM : IQADjustment : OUTPut [ :STATe ] ON | OFF | 1 | 0

[ :SOURce ] : DM : IQADjustment : OUTPut [ :STATe ] ?

**Example:**

DM : IQADjustment : OUTPut 1 I/Q Output Adj is turned on.

**2) Output Attenuation****Functional Description:**

This command sets the attenuation of I/Q output adjustment. This command works when I/Q Output Adj is turned on.

**Parameter specification:**

<Atten> Attenuation of I/Q Output Adj.

Range: 0dB [0dB, 94.5dB].

**Programmable command:**

[ :SOURce ] : DM : IQADjustment : OUTPut : ATTen <val>

[ :SOURce ] : DM : IQADjustment : OUTPut : ATTen ?

**Example:**

:DM : IQADjustment : OUTPut : ATTen 10dB Set Attenuation of I/Q Output Adj to 10 dB.

### 3) Gain Balance

**Functional Description:**

This command sets Gain Balance of I/Q Output Adj. This command works when I/Q Output Adj is turned on

**Parameter specification:**

<Gain> Gain Balance of I/Q Output Adj.

Range: 0dB [-4dB, 4dB].

**Programmable command:**

[[:SOURce]:DM:IQADjustment:OUTPut:GAIN <val>

[[:SOURce] :DM:IQADjustment:OUTPut:GAIN?

**Example:**

:DM:IQADjustment:OUTPut:GAIN 2dB Set Gain Balance of I/Q Output Adj to 2 dB.

### 4) I Offset

**Functional Description:**

This command sets I Offset of I/Q Output Adj. This command works when I/Q Output Adj is turned on.

**Parameter specification:**

<offset> I Offset of I/Q Output Adj.

Range: 0V [-1V, 1V].

**Programmable command:**

[[:SOURce]:DM:IQADjustment:OUTPut:IOFFset <val>

[[:SOURce] :DM:IQADjustment:OUTPut: IOFFset?

**Example:**

:DM:IQADjustment:OUTPut:IOFFset 1V Set I Offset of I/Q Output Adj to 1 V.

### 5) I/ Offset

**Functional Description:**

This command sets I/ Offset of I/Q Output Adj. This command works when I/Q Output Adj is turned on.

**Parameter specification:**

<offset> I/ Offset of I/Q Output Adj.

Range: 0V [-1V, 1V].

**Programmable command:**

[[:SOURce]:DM:IQADjustment:OUTPut:UIOFFset <val>

[[:SOURce] :DM:IQADjustment:OUTPut:UIOFFset?

**Example:**

:DM:IQADjustment:OUTPut:UIOFFset 1V Set I/ Offset of I/Q Output Adj to 1 V.

### 6) Q Offset

**Functional Description:**

This command sets Q Offset of I/Q Output Adj. This command works when I/Q Output Adj is turned

**5.2 Menu Description**

on.

**Parameter specification:**

<offset> Q Offset of I/Q Output Adj.

Range: 0V [-1V, 1V].

**Programmable command:**

[[:SOURce]:DM:IQADjustment:OUTPut:QOFFset <val>

[[:SOURce] :DM:IQADjustment:OUTPut:QOFFset?

**Example:**

:DM:IQADjustment:OUTPut:IOFFset 1V Set I Offset of I/Q Output Adj to 1 V.

**7) Q/ Offset****Functional Description:**

This command sets Q/ Offset of I/Q Output Adj. This command works when I/Q Output Adj is turned on.

**Parameter specification:**

<offset> Q/ Offset of I/Q Output Adj.

Range: 0V [-1V, 1V].

**Programmable command:**

[[:SOURce]:DM:IQADjustment:OUTPut:UQOFFset <val>

[[:SOURce] :DM:IQADjustment:OUTPut:UQOFFset?

**Example:**

:DM:IQADjustment:OUTPut:UQOFFset 1V Set I/ Offset of I/Q Output Adj to 1 V.

**8) Orthority Offset****Functional Description:**

This command sets Orthority Offset of I/Q Output Adj. This command works when I/Q Output Adj is turned on.

**Parameter specification:**

<skew> Orthority Offset of I/Q Output Adj.

Range: 0V [-10deg, 10deg].

**Programmable command:**

[[:SOURce]:DM:IQADjustment:OUTPut:SKEW <val>

[[:SOURce] :DM:IQADjustment:OUTPut:SKEW?

**Example:**

:DM:IQADjustment:OUTPut:SKEW 1deg Set Orthority Offset of I/Q Output Adj to 1 deg.

**5.2.7 ARB****5.2.7.1 Arb Seq ON****Functional Description:**

This command enables ARB generator state of the signal generator. When ARB is turned on, the main information display area in user interface of the signal generator will display an indication.

**Parameter specification:**

<State> Boolean data is as follows:  
 ON | 1: ARB is turned on,  
 OFF | 0: ARB is turned off.

**Programmable command:**

```
[:SOURce]:RADio:ARB:STATe ON|OFF|1|0
```

```
[:SOURce]:RADio:ARB:STATe?
```

**Example:**

```
[:SOURce]:RADio:ARB:STATe 1      Turn on ARB.
```

**5.2.7.2 Work Pattern****Functional Description:**

This command sets Arb modes. There are two modes for selection, Arb and Seq. Arb mode enables users to load Arb data file in custom format for playback; Seq mode enables users to generate waveform segment files as needed and combine waveform segments into a sequence.

**Parameter specification:**

<Mode> Discrete data. Arb mode is as follows:  
 ARB | 0: Arb mode,  
 SEQUENCE | 1: Seq mode.

**Programmable command:**

```
[:SOURce]:RADio:ARB:MODE ARB|SEQUENCE
```

```
[:SOURce]:RADio:ARB:MODE?
```

**Example:**

```
[:SOURce]:RADio:ARB:MODE SEQ      Set Arb mode to Seq.
```

**5.2.7.3 Clock Type**

In Seq mode, the software provides three types of clock: CURRENT, HIGH, CUSTOM. Only CUSTOM is valid in Arb mode.

**Functional Description:**

This command sets Clock Type when the signal generator is in Arb mode. Arb mode allows users to use CUSTOM mode only. Other modes cannot be set; Seq mode enables users to select CURRENT, HIGH or CUSTOM.

**Parameter specification:**

<Mode> Discrete data. Clock Type in Arb mode is as follows:  
 CURRENT | 0: Play waveform segment files in Seq mode at sampling rate of each waveform segment;  
 HIGH | 1: Play waveform segment files in Seq mode at maximum sampling rate of waveform segments each waveform segment;  
 CUSTOM | 2: Play waveform segment files in Seq mode at the current clock frequency setting of the signal generator.

**Programmable command:**

```
[:SOURce]:RADio:ARB:SEQUENCE:CLOCK CURRENT|HIGH|CUSTOM
```

```
[:SOURce]:RADio:ARB:SEQUENCE:CLOCK?
```

**Example:**

**5.2 Menu Description**

[ :SOURce]:RADio:ARB:SEQUence:CLOCK HIGH      Set Clock Type to HIGH mode.

**5.2.7.4 Clock Freq****Functional Description:**

This command sets the sampling rate of ARB signal. The value set by this command is valid only when Clock Type is CUSTom.

**Parameter specification:**

<ClockRate>    I/Q signal Q offset.

Range: 100MHz[0.01MHz, 250MHz].

**Programmable command:**

[ :SOURce]:RADio:ARB:SClock:RATE <val><freq unit>

[ :SOURce]:RADio:ARB:SClock:RATE?

**Example:**

[ :SOURce]:RADio:ARB:SClock:RATE 50MHz ARB Clock Freq is 50 MHz.

**5.2.7.5 New Seq****Functional Description:**

Clear the current sequence list and create an empty list in Seq mode. This function is valid in Seq mode.

**5.2.7.6 Load Seq****Functional Description:**

The command indicates that a waveform sequence is loaded. A waveform sequence can be composed of multiple waveform segments. Parameters are composed of file\_name, waveform, reps and M1M2M3M4. File\_name refers to the folder where waveform segment file is stored. The user-specified folder can only be that under relative path. In this parameter, the user has no right to specify an absolute path. For example, if the user names "D:\\USER\\SEQ" for file\_name, these folders cannot be created under D drive, and the file name is considered wrong; waveform refers to the specific waveform segment file. The maximum number of waveform segment files supported by this command is 64; Reps refers to the number of times each waveform segment is played cyclically, and one waveform segment file can be played back up to 65,535 times; M1M2M3M4 is a mark switch of each waveform segment files, for example: If users do not want to output any mark of waveform segment, they can select NONE, or ALL if they want to output all marks of waveform segment.

**Parameter specification:**

<FileName>      String type.

The folder where waveform segment file is stored, the folder specified by users can only be that under relative path.

<WaveForm>      String type.

Name of waveform segment file, the maximum number of waveform segment file supported by this command is 64.

<Reps>            Integer. Times of looped playback of each waveform segment.

Range: 1[1, 65535].

<Marks>           Discrete data type, mark switch of each waveform segment file, specific option is in command format.

**Programmable command:**

[ :SOURce]:RADio:ARB:SEQUence <file\_name>,<waveform>,<reps>,NONE



```
|M1|M2|M3|M4|M1M2|M1M3|M1M4|M2M3|M2M4
|M3M4|M1M2M3|M1M2M4|M1M3M4|M2M3M4|ALL,{
<waveform2>,<reps>,NONE|M1|M2|M3|M4
|M1M2|M1M3|M1M4|M2M3|M2M4|M3M4|M1M2M3
|M1M2M4|M1M3M4|M2M3M4|ALL
```

**Example:**

```
[:SOURce]:RADio:ARB:SEquence Seq1, waveform1, 12, NONE, vaveform2, 300M1M2
```

Load a waveform sequence, which is located in Seq1 folder which contains waveform1 and waveform2. The former is played 12 times with no mark output; the latter is played 300 times, with mark 1 and mark 2 of each symbol output.

**5.2.7.7 Save Seq****Functional Description:**

Save the configured sequence (ARB) file stored by users on the hard disk. The file suffix is .config\_seg, and the default sequence configuration file directory is d:\1465data\user\sequence. Users saves sequence (ARB) file for quick loading configuration.

**5.2.7.8 Trig Mode**

Trig Mode for playing ARB of 1465 series signal generator includes: Continue, Single, Wave Segment and Gate. The function of each mode is described as follows.

Continue: After a valid trigger event is received, waveform sequence is played repeatedly.

Single: After a valid trigger event is received, waveform sequence is played once.

Wave Segment: Each time a valid trigger event is received, a wave segment is played.

Gate: Waveform sequence is continuously played during the effective period of gate signal.

**1) Continue**

Continue function of 1465 series signal generator is for the entire waveform sequence, i.e. auto start or each time a valid trigger event is received, the waveform sequence in memory is completely played once. For the case where the trigger event generation period is less than the play time of the entire waveform sequence, the continuous trigger function menu of vector signal generator provides more advanced settings:

**Functional Description:**

This command sets the mode in which sequence file responds to trigger signal when ARB is in Continue or Single mode. There are three modes for selection, FREE, TRIGger and RESet.

**Parameter specification:**

<Mode>	Discrete data. The mode in which sequence file responds to trigger signal when ARB is in Continue mode,
	The values are as follows:
FREE	0: When Auto mode is selected, sequence is triggered automatically to start playing after sequence waveform data is downloaded. All trigger events are ignored during playback
TRIGger	1: When Trig mode is selected, no current waveform sequence will be played until a valid trigger event is received. After a valid trigger event is received, the system starts to play the current waveform sequence. After the sequence is played, no current waveform sequence is replayed until a valid trigger event occurs
RESet	2: When Realtime mode is selected, no modulation source data will

## 5.2 Menu Description

be generated until a valid trigger event is received, with no code pattern signal generated; after a valid trigger event is received, the system starts to generate the selected modulation source data, thereby generating corresponding code pattern data and signals. After the current source data is generated, the system will automatically restart to generate the currently set modulation source data. During the generation process of modulation source data, if a valid trigger event is received, the system will immediately abort the modulation source data currently being generated and restart to generate the set modulation source data

### Programmable command:

```
[:SOURce]:RADio:ARB:TRIGger:TYPE:CONTInuous
```

```
FREE|TRIGger|RESet
```

```
[:SOURce]:RADio:ARB:TRIGger:TYPE:CONTInuous?
```

### Example:

```
[:SOURce]:RADio:ARB:TRIGger:TYPE:CONTInuous TRIG
```

When ARB is in Continue mode, set the mode in which sequence file responds to trigger signal to Trig.

## 2) Single

Single function of 1465 series signal generator is for the entire waveform sequence, i.e. each time a valid trigger event is received, the waveform sequence in memory is completely played once. For the case where the trigger event generation period is less than the play time of the entire waveform sequence, the single trigger function menu of vector signal generator provides more advanced settings:

### Functional Description:

This command sets the mode in which sequence file responds to trigger signal when ARB is in Single mode. There are three modes for selection, FREE, TRIGger and RESet.

### Parameter specification:

<Mode> Discrete data. The mode in which sequence file responds to trigger signal when ARB is in Single mode,

The values are as follows:

FREE | 0: When Auto mode is selected, sequence is triggered automatically to start playing after sequence waveform data is downloaded. All trigger events are ignored during playback

TRIGger | 1: When Trig mode is selected, no current waveform sequence will be played until a valid trigger event is received. After a valid trigger event is received, the system starts to play the current waveform sequence. After the sequence is played, no current waveform sequence is replayed until a valid trigger event occurs

RESet | 2: When Realtime mode is selected, no modulation source data will be generated until a valid trigger event is received, with no code pattern signal generated; after a valid trigger event is received, the system starts to generate the selected modulation source data, thereby generating corresponding code pattern data and signals. After the current source data is generated, the system will automatically restart to generate the currently set modulation source data. During the generation process of modulation source data, if a valid trigger event is received, the system will immediately abort the modulation source data currently being generated and restart to generate the set modulation source data

### Programmable command:

```
[:SOURce]:RADio:ARB:TRIGger:TYPE:SINGle
```

```
FREE|TRIGger|RESet
```

```
[:SOURce]:RADio:ARB:TRIGger:TYPE:SINGle?
```

**Example:**

```
[:SOURce]:RADio:ARB:TRIGger:TYPE:SINGle TRIG
```

When ARB is in Single mode, set the mode in which sequence file responds to trigger signal to Trig.

### 3) Wave Segment

Unlike Continue and Single modes, Wave Segment advanced play trigger function of 1465 series signal generator is not for the entire waveform sequence, but for a single wave segment in the wave segment, i.e. when a valid trigger event is received, the current wave segment in the waveform sequence being played is played. When Wave Segment is in advanced play trigger mode, the times of play of each wave segment is independent of the number of cycles of wave segment edited in sequence, but the detailed setting for triggering wave segment, trigger event generation period, etc. The detailed configuration of wave segment advanced play trigger is as follows:

**Functional Description:**

This command sets the mode in which sequence file responses to trigger signal when ARB is in Wave Segment mode. There are two modes for selection, Single and Continue. Wave segment play trigger function is not for the entire waveform sequence, but a single wave segment in the sequence.

**Parameter specification:**

<Mode> Discrete data. The mode in which sequence file responses to trigger signal when ARB is in Wave Segment mode,

The values are as follows:

SINGle | 0: Single waveform segment trigger,

CONTinuous | 1: Continue waveform segment, trigger.

**Programmable command:**

```
[:SOURce]:RADio:ARB:TRIGger:TYPE:SADVance:TYPE
```

```
SINGle|CONTinuous
```

```
[:SOURce]:RADio:ARB:TRIGger:TYPE:SADVance:TYPE?
```

**Example:**

```
[:SOURce]:RADio:ARB:TRIGger:TYPE:SADVance:TYPE SING
```

When ARB is in Wave Segment mode, set the mode in which sequence file responds to trigger signal to Single.

### 4) Gate

**Functional Description:**

This command sets the mode in which sequence file responds to trigger signal when ARB is in Gate mode. There are two modes for selection, Low/Hight.

**Parameter specification:**

<Mode> Discrete data. The mode in which sequence file responds to trigger signal when ARB is in Gate mode,

The values are as follows:

LOW | 0: Low,

HIGH | 1: Hight.

**5.2 Menu Description****Programmable command:**

```
[:SOURce]:RADio:ARB:TRIGger:TYPE:GATE:ACTive
LOW|HIGH
```

```
[:SOURce]:RADio:ARB:TRIGger:TYPE:GATE:ACTive?
```

**Example:**

```
:SOURce]:RADio:ARB:TRIGger:TYPE:GATE:ACTive LOW
```

When ARB is in Gate mode, set the mode in which sequence file responds to trigger signal to Low.

**5.2.7.9 Trig Source****Functional Description:**

This command sets ARB Trig Source.

**Parameter specification:**

<Mode> Discrete data. ARB Trig Source,  
The values are as follows:

KEY	: Trigger key,
BUS	: Bus,
EXT	: External,
INT	: Internal.

**Programmable command:**

```
[:SOURce]:RADio:ARB:TRIGger:SOURce KEY|BUS|EXT|INT
[:SOURce]:RADio:ARB:TRIGger:SOURce?
```

**Example:**

```
[:SOURce]:RADio:ARB:TRIGger:SOURce BUS
```

Set Trig Source to Bus.

**5.2.7.10 Samp Clock [Int/Ext]****Functional Description:**

This command sets ARB Samp Clock. When Samp Clock is Int, the clock frequency is 200 MHz. It cannot be changed. When Int is Ext, the clock frequency can be set by the external clock frequency command.

**Parameter specification:**

<Mode> Discrete data. ARB Samp Clock is as follows:

INTernal	: Internal,
EXTernal	: EXT.

**Programmable command:**

```
[:SOURce]:RADio:ARB:VCO:CLCOK INTernal|EXTernal
[:SOURce]:RADio:ARB:VCO:CLOCK?
```

**Example:**

```
[:SOURce]:RADio:ARB:VCO:CLOCK EXTernal
```

Set Trig Source to Bus.

### 5.2.7.11 Ext Clock Frequency

**Functional Description:**

This command sets Ext Clock Frequency. This command is valid when Samp Clock is Ext.

**Parameter specification:**

<Mode> ARB Sampl Clock is as follows:  
Range [100Hz,250MHz]

**Programmable command:**

```
[:SOURce]:RADio:ARB:EXTernal:CLCOK:RATE <val><freq unit>
[:SOURce]:RADio:ARB:EXTernal:CLOCK:RATE?
```

**Example:**

```
[:SOURce]:RADio:ARB:EXTernal:CLOCK:RATE 100MHz
Set Trig Source to Bus.
```

### 5.2.7.12 Wave Scale

**Functional Description:**

Not supported

### 5.2.7.13 Wave Realtime Scale

**Functional Description:**

Not supported

### 5.2.7.14 Wave Attenuation

**Functional Description:**

Not supported

### 5.2.7.15 Marker Polary

**Functional Description:**

Not supported

### 5.2.7.16 Marker Function

**Functional Description:**

Not supported

## 5.2.8 Tone

### 5.2.8.1 Dual Tone/Multi Tone Modulation ON

**Functional Description:**

This command sets Multi Tone ON/OFF state of the signal generator. When Multi Tone is turned on, the main information display area in user interface of the signal generator will display the indication of IQ Modulate and Multi Tone.

**Parameter specification:**

<State> Boolean data. Multi Tone ON/OFF state is as follows:  
ON | 1: Multi Tone is turned on,  
OFF | 0: Multi Tone is turned off.

**Programmable command:**

```
[:SOURce]:RADio:MTONE:ARB:STATe ON|OFF|1|0
```

**5.2 Menu Description**

[:SOURce]:RADio:MTONe(TTONe):ARB:STATe?

**Example:**

[:SOURce]:RADio:MTONe:ARB:STATe 1      Turn on Multi Tone.

**5.2.8.2 Initial Phase ([Fixed]/[Random])****Functional Description:**

This command initializes initial phase mode in multi tone modulation table, including: Random and Fixed. In Fixed mode, the phase of all tones in multi tone table will be set to a Fixed value (0 degree); in Random mode, the phase of all tones in multi tone table will be set to different random values based on random seed.

**Parameter specification:**

<Mode>            Discrete data. Initial phase mode in multi tone modulation table is as follows:  
                     RANDOM        : Set all tones to random value,  
                     FIXed         : Set all tones to fixed value.

**Programmable command:**

[:SOURce]:RADio:MTONe:ARB:SETup:TABLE:PHASe:INITialize RANDOM|FIXed

[:SOURce]:RADio:MTONe:ARB:SETup:TABLE:PHASe:INITialize?

**Example:**

[:SOURce]:RADio:MTONe:ARB:SETup:TABLE:PHASe:INITialize FIX

Set the tone phase in multi tone table to a fixed value.

**5.2.8.3 Phase Rela ([Fixed]/[Random])****Functional Description:**

This command sets Phase Rela, including: Random and Fixed.

**Parameter specification:**

<Mode>            Discrete data. Phase Rela is as follows:  
                     RANDOM        : Phase Rela is Random,  
                     FIXed        : Phase Rela is Fixed.

**Programmable command:**

[:SOURce]:RADio:MTONe:ARB:SETup:TABLE:PHASe:INITialize:SEED RANDOM|FIXed

[:SOURce]:RADio:MTONe:ARB:SETup:TABLE:PHASe:INITialize:SEED?

**Example:**

[:SOURce]:RADio:MTONe:ARB:SETup:TABLE:PHASe:INITialize:SEED FIX

Set Phase Rela to Fixed.

**5.2.8.4 Freq Interval****Functional Description:**

This command sets Freq Interval, which takes effect only after Multi Tone is turned on.

**Parameter specification:**

&lt;FreqSpacing&gt; Freq Interval.

Range: 1MHz[100Hz, 200MHz].

**Programmable command:**

```
[[:SOURce]:RADio:MTONE:ARB:SETup:TABLE:FSPacing <val><freq unit>
```

```
[[:SOURce]:RADio:MTONE:ARB:SETup:TABLE:FSPacing?
```

**Example:**

```
[[:SOURce]:RADio:MTONE:ARB:SETup:TABLE:FSPacing 200kHz
```

Set frequency interval in multi tone table to 200 kHz.

**5.2.8.5 Dual Tone Alignment ([LEFT]/[CENTER]/[RIGHT])****Functional Description:**

This command sets Dual Tone Alignment, including: Left, Centre and Right, which takes effect only after Dual Tone is turned on.

**Parameter specification:**

<Mode> Discrete data. Dual Tone Alignment is as follows:

```
LEFT | 0: Left,
CENTer | 1: Center,
RIGHt | 2: Right.
```

**Programmable command:**

```
[[:SOURce]:RADio:TTONE:ARB:ALIGNment LEFT|CENTer|RIGHt
```

```
[[:SOURce]:RADio:TTONE:ARB:ALIGNment?
```

**Example:**

```
[[:SOURce]:RADio:TTONE:ARB:ALIGNment RIGHt
```

Display Dual Tone Alignment to be displayed to the right of carrier.

**5.2.8.6 Load File****Functional Description:**

This command selects multi tone file and loads it into the signal generator memory to play. For command parameters, it is only necessary to set multi tone file name without specifying an absolute path.

**Parameter specification:**

<FileName> String type, multi tone file name.

**Programmable command:**

```
[[:SOURce]:RADio:MTONE:ARB:SETup <file_name>
```

**Example:**

```
[[:SOURce]:RADio:MTONE:ARB:SETup "mtone1.mtn"
```

Load mtone1.mtn file to the signal generator memory.

**5.2.8.7 Save File****Functional Description:**

This command stores the waveform data in the current multi tone table to the multi tone file of the signal generator. For command parameters, it is only necessary to set multi tone file name without specifying an absolute path.

**Parameter specification:**

<FileName> String type, multi tone file name.

**Programmable command:**

**5.2 Menu Description**

```
[ :SOURce]:RADio:MTONE:ARB:STORE <file_name>
```

**Example:**

```
[ :SOURce]:RADio:MTONE:ARB:STORE "mtone1.mtn"
```

Save multi tone table to the signal generator multi tone file mtone1.mtn.

**5.2.8.8 Edit Multi Tone Table****Functional Description:**

This command creates and configures a multi tone waveform. The command parameters include: <freq\_offset>, <num\_tones>, <pow>, <phase> and <state>. <Freq\_offset>, this parameter is limited by 200 M baseband bandwidth and tone count in multi tone table. Such value between tones is the same as frequency interval.

**Parameter specification:**

String Type Parameter

<FreqSpacing>	Freq Interval. Range: 1MHz[100Hz, 200MHz].
<NumTones>	Tone Count Range: 2[2, 64].
<Pow>	Atten Ampl Range: 0dB[-100dB, 0dB].
<Phase>	Initial Phase. Range: 0deg[0deg, 359deg].
<State>	Status. Boolean data is as follows: 1: ON, 0: off.

**Programmable command:**

```
[ :SOURce]:RADio:MTONE:ARB:SETup:TABLE  
<freq_spacing>,<num_tones>,{<pow>,<phase>,<state>...}
```

**Example:**

```
[ :SOURce]:RADio:MTONE:ARB:SETup:TABLE "1000000, 3, -10, 90, 0, -20, 0, 1, -30, 45,  
1"
```

This example shows that the multi tone frequency interval is set to 1 MHz. There are three tones. The first has an Atten Ampl of 10 dB and Phase of 90 degrees, in OFF status; the second has an Atten Ampl of 20 dB and Phase of 0 degrees, in ON status; the third has an Atten Ampl of 30 dB and Phase of 45 degrees, in ON status.

**5.2.9 AWGN (Option)****5.2.9.1 AWGN [ON/OFF]****Functional Description:**

As an option of 1465 series signal generator, AWGN (Additional Gaussian White Noise) module is a stand-alone functional module that performs AWGN output functions. Base, ARB, Dual Tone (Multi Tone) and AWGN (White noise) in the signal generator are mutually exclusive. Others will be turned off automatically when any one is turned on. These functions will automatically turn on I/Q Modulate Switch.

**Parameter specification:**



Switch [ OFF | ON ]

Turn off |OFF0

Turn on |ON 1

**Programmable command:**

[ :SOURce]:RADio:AWGN:ARB[:STATe] ON|OFF|1|0

[ :SOURce]:RADio:AWGN:ARB[:STATe]?

**Example:**

RAD:AWGN:ARB:STAT ON

### 5.2.9.2 Work Pattern

#### 1) Add Noise

**Functional Description:**

It is used with Band, ARB and Tone, and the generated base, ARB and dual tone/multi tone signals are output after noise is added. This work pattern is valid only when Base, ARB and Tone are turned on.

**Parameter specification:**

ADDNoise [ADDNoise | PUREnoise | CWDisturb]

Parameter list:

ADDNoise Add Noise

PUREnoise Pure Noise

CWDisturb CW disturbance

**Programmable command:**

[ :SOURce]:RADio:AWGN:ARB:MODE ADDNoise|PUREnoise|CWDisturb

[ :SOURce]:RADio:AWGN:ARB:MODE?

**Example:**

RAD:AWGN:ARB:MODE ADDN

#### 2) Pure Noise

**Functional Description:**

This pattern produces pure noise signal that is mutually exclusive with Band, ARB and Tone. This work pattern is valid only when Band, ARB and Tone are turned off. The software is initialized to this mode after start-up.

**Parameter specification:**

PUREnoise [ADDNoise | PUREnoise | CWDisturb]

Parameter list:

ADDNoise Add Noise

PUREnoise Pure Noise

CWDisturb CW disturbance

**Programmable command:**

[ :SOURce]:RADio:AWGN:ARB:MODE ADDNoise|PUREnoise|CWDisturb

[ :SOURce]:RADio:AWGN:ARB:MODE?

**Example:**

**5.2 Menu Description**

RAD:AWGN:ARB:MODE PURE

**3) CW disturbance****Functional Description:**

The noise mode is used with Band, ARB and Tone. After the generated base, ARB and dual tone/multi tone signals are added with interference, the interference signal which is sine signal with a certain frequency at this time is output. This work pattern is valid only when Band, ARB and Tone are turned on.

**Parameter specification:**

CWDisturb [ADDNoise | PUREnoise | CWDisturb]

Parameter list:

ADDNoise Add Noise

PUREnoise Pure Noise

CWDisturb CW disturbance

**Programmable command:**

[:SOURce]:RADio:AWGN:ARB:MODE ADDNoise|PUREnoise|CWDisturb

[:SOURce]:RADio:AWGN:ARB:MODE?

**Example:**

RAD:AWGN:ARB:MODE CWD

**5.2.9.3 System Bandwidth****Functional Description:**

For the bandwidth taken up by signal transmission, the minimum is 1 kHz and the maximum is the maximum sample clock of the instrument \*0.4\*2. In Base and Tone modes, the configuration item is not editable, and the software automatically calculates the system bandwidth under the current configuration. The specific calculation formula is:

In Base mode: System Bandwidth= Symbol Rate \* (1+ $\alpha$ ); where  $\alpha$  is the current filtering factor.

In Dual Tone mode: System Bandwidth= Dual Tone Freq Separation;

In Multi Tone mode: System Bandwidth= Tone Count \* Multi Tone Freq Interval;

In ARB mode, the configuration item is editable and is used to determine noise bandwidth value with "noise/system bandwidth ratio".

**5.2.9.4 Noise/System Bandwidth Ratio****Functional Description:**

The ratio of noise bandwidth to system bandwidth, minimum= 1.0, maximum= maximum sample clock of the instrument \*0.4\*2/system bandwidth.

This value is used to determine noise bandwidth with System Bandwidth according to the following formula: Noise Bandwidth= System Bandwidth \* Noise/System Bandwidth Ratio.

**5.2.9.5 Noise Power**

The software provides C/N and Eb/No modes to calculate and display noise power. In C/N mode, SNR configuration item is valid; in Eb/No mode, Eb/No configuration item is valid. In ARB and Tone modes, this configuration item only provides Noise Power Calculation Mode of C/N mode.

**1) Signal-to-noise Ratio****Functional Description:**

The ratio of noise power to signal power, ranging from -50 dB to 40 dB. This value is editable in C/N

**5.2 Menu Description**

mode. This value is not editable in Eb/No mode. After the parameter value is set, the software automatically calculates and displays Eb/No value. The formula is:  $E_b/N_o = \text{Signal-to-noise Ratio} / (\text{Bit Rate}/\text{System Bandwidth})$ .

**2) Eb/No****Functional Description:**

This value can be edited in Eb/No mode. After this value is set, the software automatically calculates SNR according to the following formula:

$SNR = (E_b/N_o) * (\text{Bit Rate}/\text{System Bandwidth})$ . In ARB and Tone modes, this value is invalid.

**5.2.9.6 Noise Bandwidth****Functional Description:**

Set the bandwidth of pure noise. Parameter range: The minimum is 1 kHz and the maximum is the maximum sample clock of the instrument  $*0.4*2$ .

**Parameter specification:**

10MHz [ 1kHz ~ the maximum sample clock  $*0.4*2$  ].

**Programmable command:**

[ :SOURce ] :RADio:AWGN:ARB:BWIDth <freq><freq unit>

[ :SOURce ] :RADio:AWGN:ARB:BWIDth?

**Example:**

RAD:AWGN:ARB:BWID 10MHz

**5.2.9.7 Target CW Freq Bias****Functional Description:**

Set the relative frequency of disturbing CW relative to modulated carrier. Parameter range: Baseband bandwidth/2 ~ + baseband bandwidth/2.

**5.2.9.8 Result CW Freq Bias****Functional Description:**

The actual output frequency of disturbing CW (currently modulated carrier frequency + relative frequency). This value is a displayed value that cannot be set. After users set Target CW Freq Bias, the value is automatically calculated and displayed.

**5.2.9.9 CIR****Functional Description:**

The ratio of noise power to signal power ratio.

**Parameter specification:**

0dB [-50dB, 40dB]

**5.2.10 System****5.2.10.1 Reference Auto [ON/OFF]****Functional Description:**

The selection in the box to the left of this option indicates Manual reference, otherwise Auto reference.

In Auto mode, the instrument automatically selects frequency reference. If there is external frequency reference, it is selected as the frequency reference of the instrument; if there is no external frequency reference, the internal reference is selected as the frequency reference of the instrument. The default is set to [Auto].

## 5.2 Menu Description

### 5.2.10.2 INT REF Accuracy Adj

#### Functional Description:

This command adjusts the internal reference of the signal generator by setting internal calibration parameters to make the frequency output accuracy more accurate. It should be noted that the instrument needs to be warmed up within 2 hours after the signal generator is started. Do not change the internal reference value. For more detailed information, please refer to user manual of 1465 signal generator.

#### Parameter specification:

<Val> Internal calibration parameter data.

Range: [0, 32767].

#### Programmable command:

[[:SOURce]:ROSCillator:ADJust:REFerence <val>

[[:SOURce]:ROSCillator:ADJust:REFerence?

#### Example:

:ROSCillator:ADJust:REFerence 30000 Adjust the internal reference accuracy value to 30,000.

### 5.2.10.3 Reset

#### 1) Factory

##### Functional Description:

After Factory Reset setting, press **【Reset】** key to restore the instrument to factory settings.

##### Programmable command:

\*RST

##### Example:

\*RST

#### 2) User

##### Functional Description:

After User Reset setting, click to save user state and press **【Reset】** key to restore the instrument to user saved settings.

#### 3) Last State

##### Functional Description:

After Last State setting, the instrument will be restored to the last shutdown state after restarted.

##### Programmable command:

Not supported

##### Example:

None

#### 4) Save User State

##### Functional Description:

Save User State in User Reset mode.

##### Programmable command:

Not supported

##### Example:

None

#### 5.2.10.4 Remote Control Port Config

##### 1) GPIB Port Config

**Functional Description:**

For GPIB Port Config, please refer to "6.2.2 GPIB".

##### 2) LAN Port Config

**Functional Description:**

For LAN Port Config, please refer to "6.2.1 LAN".

#### 5.2.10.5 Instrument Self Test

##### 1) Self Test [Run Test]

**Functional Description:**

Start self test on the user-selected self-test item.

##### 2) Loop Test [ON/OFF]

**Functional Description:**

Loop Test is carried out on user-selected self-test items in ON/OFF state. Self test made in ON state is cyclic until it is interrupted by the user. The default setting is (OFF).

##### 3) Display test results [All/Error]

**Functional Description:**

Allways or ERROR is displayed during self test. The default setting is (OFF).

#### 5.2.10.6 Debug Password

**Functional Description:**

Set or change the password to enter debug window. The default debug password will be set before the instrument leaves the factory. If you have special requirements, please contact the manufacturer.

#### 5.2.11 File

##### 5.2.11.1 Select Folder

**Functional Description:**

Select the folder tree on the left side of the window to select folder.

##### 5.2.11.2 Select File

**Functional Description:**

Select the file on the right side of the window to select file.

##### 5.2.11.3 Copy

**Functional Description:**

Copy the selected file on the right side of the window.

##### 5.2.11.4 Cut

**Functional Description:**

Cut the selected file on the right of the window.

##### 5.2.11.5 Paste

**Functional Description:**

Paste the file in the currently specified directory.

## 5.2 Menu Description

### 5.2.11.6 Delete

**Functional Description:**

Delete the selected file on the right side of the window.

### 5.2.11.7 Refresh File Directory

**Functional Description:**

When the hardware (disk) structure is changed, press this button to refresh file directory.

### 5.2.12 Save/Recall

#### 5.2.12.1 Select the number of files to be saved

**Functional Description:**

The instrument can save one hundred states numbered from 0 to 99. Select the number of instrument state files to be saved, and press Enter.

**Parameter specification:**

0 [ 0, 99 ]

**Programmable command:**

\*SAV

**Example:**

\*SAV 8

#### 5.2.12.2 Select the number of files to be recalled

**Functional Description:**

The instrument can save one hundred states numbered from 0 to 99. Select the number of instrument state files to be recalled, and press Enter.

**Parameter specification:**

0 [ 0, 99 ]

**Programmable command:**

\*RCL

**Example:**

\*RCL 8

### 5.2.13 Calibrate

Only user power flatness calibration is available Currently.

#### 5.2.13.1 Index

**Functional Description:**

Locate to an item in the list for editing based on the current index value.

#### 5.2.13.2 Insert Freq Point

**Functional Description:**

Insert Freq Point in the current user calibration list.

#### 5.2.13.3 Frequency Following [ON/OFF]

**Functional Description:**

The function is not implemented.

#### 5.2.13.4 Auto Fill

1) **Fill Freq Start**

**Functional Description:**

Set Freq Start for Auto Fill.

2) **Fill Freq Stop**

**Functional Description:**

Set Freq Stop for Auto Fill.

3) **Freq Interval**

**Functional Description:**

Set Freq Interval for Auto Fill.

4) **Fill Points**

**Functional Description:**

Set Fill Points for Auto Fill.

5) **Confirm Fill**

**Functional Description:**

Confirm Fill after editing is completed.

#### 5.2.13.5 Edit List

1) **Modify Freq Compensation**

**Functional Description:**

Modify the frequency of frequency points in the current user calibration list.

2) **Modify Ampl Offset**

**Functional Description:**

Modify the amplitude offset of frequency points in the current user calibration list.

3) **Save**

**Functional Description:**

Save calibration value after automatic calibration or manual modification by users.

4) **Recall**

**Functional Description:**

Recall and display the saved calibration value in calibration list.

5) **Delete**

**Functional Description:**

Delete the calibration value from calibration list.

#### 5.2.13.6 Calibrate all points

**Functional Description:**

Calibrate all frequency points in list.

#### 5.2.13.7 Calibrate Undefined Points

**Functional Description:**

Calibrate all undefined points of power offset in calibration list.

**5.2 Menu Description**

**5.2.13.8 Calibrate Current Points**

**Functional Description:**

Calibrate the currently selected points in calibration list.



## 6 Remote Control

This chapter briefly introduces the remote control basis, remote interface and its configuration method and the basic VISA interface programming method of 1465 series signal generator, and also briefly describes the concept and classification of the I/O driver library, so that the user can have a preliminary knowledge about the remote control of this instrument. The specific content includes:

- Remote Control Basis.....175
- Remote Interface and its Configuration.....189
- Basic Programming Method of VISA Interface.....191
- I/O Library.....195

### 6.1 Remote control basis

- Remote Interface.....175
- Message.....178
- SCPI.....178
- Command Sequence and Synchronization.....186
- Status Reporting System.....187
- Programming Considerations.....189

#### 6.1.1 Remote Interface

1465 series signal generator supports four kinds of remote interfaces: LAN and GPIB,

It is shown in the table below:

Table 6.1 Types and VISA Addressing Strings of Remote Control Interfaces

Remote Interface	VISA Addressing String	Description
LAN (Local Area Network)	<b>VXI-11 protocol:</b> TCPIP::host_address[:LAN_device_name][:INSTR] <b>Raw socket protocol:</b> TCPIP::host_address::port::SOCKET	Controller realizes remote control by connecting the instrument via the network port on the rear panel of the instrument.  For the specific protocol, please refer to: <a href="#">“6.1.1.1 LAN Interface”</a>
GPIB (IEC/IEEE Bus Interface)	GPIB::primary address[:INSTR]	Controller realizes remote control by connecting the instrument via the port on the rear panel of the instrument.  Compliance with the bus interface standard of

**6.1 Remote control basis**

		IEC 625.1/IEEE 418. For details, please refer to: <a href="#">“6.1.1.2 GPIB Interface”</a>
--	--	---

- [LAN Interface.....176](#)
- [GPIB Interface.....177](#)

**6.1.1.1 LAN interface**

The signal generator is available for remote control via computer in 10Base-T and 100Base-T LAN, in which various instruments are integrated into a system and controlled by network computer. In order to realize the remote control within the LAN, the signal generator shall be preinstalled with the port connector, network card and relevant network protocol, and configured with relevant network service. And, the controller computer within the LAN shall also be preinstalled with the instrument control software and VISA library. The three working modes of the network card include:

- 10 Mbit/s Ethernet IEEE802.3;
- 100 Mbit/s Ethernet IEEE802.3u;
- 1 Gbit/s Ethernet IEEE802.3ab.

Control computer and signal generator need to be connected to a common TCP/IP protocol network via network interface. The cable between the computer and the signal generator is a commercial RJ45 cable (shielded or unshielded Category 5 twisted pair). During data transmission, data packet transmission will be adopted, and LAN transmission is faster. The cable length between the computer and the signal generator shall generally not exceed 100 m (100Base-T and 10Base-T). For more information about LAN communication, refer to: <http://www.ieee.org>. The knowledge of LAN interface is introduced hereinafter.

**1) IP address**

When the signal generator is remotely controlled via LAN, the physical network connection shall be guaranteed to be smooth. The address of the signal generator is set to the subnet where the main control computer is located via menu “local IP”. For example: If the IP address of main control computer is 192.168.12.0, the IP address of the signal generator shall be set to 192.168.12.XXX, where XXX is a value between 1 and 255.

Only the IP address is required to establish a network connection. The VISA addressing string is as follows:

TCPIP::host address[::LAN device name][::INSTR] or

TCPIP::host address::port::SOCKET

Where,

- TCPIP - network protocol used;
- host address - IP address or host name of the instrument, for identification and control of the controlled instrument;
- The LAN device name defines the handle number of the protocol and sub-device (optional);
  - The VXI-11 protocol is adopted for the 0# equipment;
  - The newer high speed LAN instrument protocol is adopted for the 0# high speed LAN instrument;
- The INSTR represents the instrument resource type (optional);
- The port represents the socket port number;
- SOCKET is resource class of original network socket.

Example:

- The IP address of the instrument is 192.1.2.3, and the valid resource string of the VXI-11 protocol is:

TCPIP::192.1.2.3::INSTR

- When the raw socket connection is created, the following addressing string can be used:

TCPIP::192.1.2.3::5025::SOCKET

## NOTE

### Method for identification of multiple instruments in the remote control system

If multiple instruments are connected to the network, they can be identified by their individual IP address and associated resource string. The main control computer uses the respective VISA resource string for instrument identification.

### 2) VXI-11 protocol

The VXI-11 standard is based on the ONC RPC (Open Network Computing Remote Procedure Call) protocol, which is the network/transport layer of the TCP/IP protocol. TCP/IP network protocol and related network services are pre-configured. In communication, such connection-oriented communication follows sequential exchange and can identify the interruption of connection to ensure no information is lost.

### 3) Socket communication

TCP/IP protocol connects signal generator in the network through LAN socket. As a basic computer network programming method, the socket enables applications with different hardware and operating systems to communicate in the network, This method enables two-way communication between the signal generator and the computer via port.

The socket is a special software class that defines the necessary information for network communication such as IP address and device port number and integrates some basic network programming operations. Sockets can be used in the operating system installed with a packaged library. UNIX Berkeley socket and Winsock are commonly used.

The socket in the signal generator is compatible with Berkeley socket and Winsock through Application Program Interface (API). In addition, other standard sockets are also compatible through the API. When the signal generator is controlled using SCPI, the socket program created in the program issues command. The socket port number of the signal generator must be set before LAN socket is used. For the signal generator, the socket port number is set to 5,000.

#### 6.1.1.2 GPIB interface

The GPIB interface is a widely-used instrument remote interface currently, which can be connected with different kinds of instruments through the GPIB cable and can establish the test system with the main control computer. To realize remote control, the main control computer shall be preinstalled with the GPIB bus card, driver and VISA library. During communication, the main control computer will address the controlled instrument through the GPIB bus address firstly. The user can set the GPIB address and ID for querying strings, and the GPIB communication language can be set to the SCPI form by default.

The operation of the GPIB and its relevant interface is defined and described in details in the ANSI/IEEE standard 488.1-1987 and the ANSI/IEEE standard 488.2-1992. For details, refer to IEEE website: <http://www.ieee.org>.

As the GPIB processes information in bytes and the data transmission rate can reach 8 MBps, the GPIB data transmission is faster. The data transmission rate is limited by the distance between the device/system and the computer. When GPIB is connected, the following points shall be noted:

- Up to 15 instruments may be set up through the GPIB interface;

**6.1 Remote control basis**

- The total length of the transmission cable shall not exceed 15 m, or shall not exceed twice of number of instruments in the system. The maximum length of transmission cable between equipment generally does not exceed 2 m.
- If you connect multiple instruments in parallel, you need to use “OR” connectors.
- The terminal of the IEC bus cable shall be connected with the instrument or the controller computer.

**6.1.2 Message**

Messages transmitted by data cable fall into the following two categories:

**1) Interface message**

During communication between the instrument and the main control computer, it is necessary to pull down the attention line and then the interface message can be transmitted to the instrument through the data line. Only the instrument with the GPIB bus functions can send the interface message.

**2) Instrument message**

For the structure and syntax of instrument message, refer to Section "6.1.3 SCPI". Instrument message can be divided into command and instrument response according to the different transmission directions. All remote interfaces use instrument message in the same method unless otherwise stated.

**a) Commands:**

A command (programming message) is a message transmitted from the main control computer to the instrument for remote control of instrument functions and query of status information. It falls into the following two categories:

- Based on the impact on the instrument:
  - Set command: change the instrument setup status, for example: reset or set the frequency.
  - Query command: query and return data, for example: identify instrument or query parameter values. The query command is always ended with a question mark.
- Based on the definition in the standard:
  - Common command: with functions and syntax defined in IEEE488.2, applicable to all types of instrument (if implemented)  
for management of standard status register, reset, self-test, etc.
  - Instrument control command: Instrument characteristic command for instrument functions. For example: set the frequency.

The syntax also follows SCPI specification.

**b) Instrument response:**

The instrument response (response message and service request) is the query result information sent by the instrument to the computer. This information includes measurement result and instrument status.

**6.1.3 SCPI**

- [Brief Introduction of SCPI.....178](#)
- [Description of SCPI.....179](#)

**6.1.3.1 Brief introduction to SCPI**

SCPI (Standard Commands for Programmable Instruments) is a set of commands established for all instruments based on IEEE488.2 mainly to achieve the universality of SCPI, i.e.the same SCPI is generated and issued for the same function.

The SCPI consists of a command header and one or more parameters which are separated by a space. The command header contains one or more key fields. The command with question mark as

**6.1 Remote control basis**

postfix is a query command. Commands are divided into common commands and instrument-specific commands that are different in syntactic structure. SCPI has the following features:

- 1) The SCPI is established for the test functions rather than instrument operation description.
- 2) The SCPI reduces the repetition of the realization process of similar test functions, thus ensuring the programming compatibility;
- 3) Remote control message is defined in a layer that is independent of the communication physical layer hardware.
- 4) The SCPI is unrelated with the programming methods and languages, and the SCPI test program is easy to be transplanted;
- 5) The SCPI is scalable so that it is applicable to measurement control on different scales.

Scalability makes SCPI a “Live” standard.

If you are interested in learning more about SCPI, please refer to:

IEEE Standard 488.1-1987, IEEE Standard Digital Interface for Programmable Instrumentation. New York, NY, 1998.

IEEE Standard 488.2-1987, IEEE Standard Codes, Formats, Protocols and Comment Commands for Use with ANSI/IEEE Std488.1-1987. New York, NY, 1998

Standard Commands for Programmable Instruments (SCPI) VERSION 1999.0.

For the collection of SCPIs, classification and description of 1465 series signal generator, please refer to:

- 1) “Appendix B SCPI Lookup Table” in the manual;
- 2) "3 SCPI" in Programming Manual;
- 3) “Appendix A Lookup Table of the SCPI by Subsystem” in Programming Manual;
- 4) “Appendix B Lookup Table of the SCPI by Menu” in Programming Manual.

**6.1.3.2 Description of SCPI**

● <a href="#">General terms</a> .....	179
● <a href="#">Command Types</a> .....	180
● <a href="#">Instrument-specific Command Syntax</a> .....	180
● <a href="#">Command Tree</a> .....	182
● <a href="#">Command Parameters and Responses</a> .....	182
● <a href="#">System of Values in Command</a> .....	185
● <a href="#">Command Line Structure</a> .....	185

**1) General terms**

For the purpose of this section, the following terms should apply. It is necessary to know about the exact definitions of these terms for a better understanding of the content in various chapters.

**Controller**

The controller is any computer used to communicate with the SCPI equipment. The controller may be a personal computer, a small computer or a card inserted onto a cage. Some artificial intelligence equipment can also be used as a controller.

**Equipment**

The equipment is any device that supports SCPI. Most equipment is electronic measuring or excitation equipment and use the GPIB interface for communication.

**Remote control message**

### 6.1 Remote control basis

The remote control message is a combination of one or more correctly formatted SCPIs. It guides the equipment to measure and output the signal.

#### Response message

The response message is a data set that specifies the SCPI format. It is always sent from the equipment to the controller or listener to remind the controller of the internal condition or measured value of the equipment.

#### Command

A command is an instruction in compliance with the SCPI standard. The combination of controller commands forms a message. In general, a command includes the keyword, parameter and punctuation.

#### Event command

An event-type SCPI can't be queried. An event command generally has no corresponding key settings on front panel. Its function is to trigger an event at a particular moment.

#### Query

Query is a special command. When the controller is queried, it is necessary to return to the response message in conformity with syntax requirement of the controller. The query statement is always ended with a question mark.

## 2) Command type

There are two types of SCPIs: common commands and instrument-specific commands. Figure 5.2 shows the difference between two commands. Common commands are defined in IEEE 488.2 to manage macros, status registers, synchronization, and data storage. Common commands are easy to recognize as they all begin with an asterisk. For example \*IDN? , \*OPC and \*RST are common commands. Common commands don't belong to any instrument-specific command. The instrument uses the same method to interpret them without consideration to the current path setting.

It is very easy to identify instrument-specific commands because they contain a colon (:). Colons are used between the beginning of command expression and keywords, e.g.: FREQuency[:CW ? ]. Instrument-specific commands are divided into command subsets of corresponding subsystem according to the functional block inside the instrument. For example, the power subsystem (:POWEr) contains the power-related command while the status subsystem (:STATus) contains the command for the status control register.

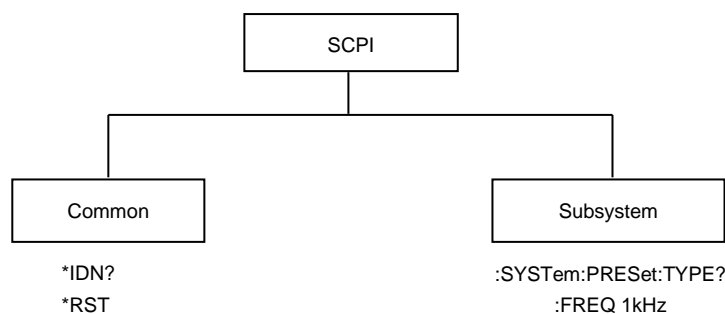

Figure 6.1 SCPI Types

## 3) Instrument-specific command syntax

A typical command consists of keywords with colon as prefix.. These keywords are followed by parameters.. An example of syntax statement is shown below.

[[:SOURce]:POWEr[:LEVEl] MAXimum|MINimum

In the above example, the [:LEVEl] portion of the command immediately follows :POWEr with no separating space. The portion following [:LEVEl] is MINimum|MAXimum that is a parameter. There is a space between the command and the parameter. The description of other parts of the syntax expression is as shown in Table 6.2 and Table 6.3.

Table 6.2 Special Characters in Command Syntax

Symbol	Meaning	Example
	The vertical line between the keyword and the parameter represents a variety of options.	[[:SOURce]:AM: SOURce EXTernal INTernal EXTernal and INTernal alternative choices
[]	Keywords or parameters in square brackets are optional when composing the command. These implied keywords or parameters also will be executed even if they are ignored.	[[:SOURce]:AM[:DEPTH]:E7onential? SOURce and DEPTH are dispensable.
<>	The part inside the angle brackets can't be used literally; instead, it represents the part that must be contained.	[[:SOURce]:FREQ:STOP <val><unit> In this command, <val> and <unit> must be replaced by an actual frequency and unit. For example: :FREQ:STOP 3.5GHz
{ }	The part inside the braces indicates that the parameter is optional.	[[:SOURce]:LIST:POWER <val>{,<val>} For example: LIST:POWER 5

Table 6.3 Command Syntax

Character, Keyword and Syntax	Example
Upper-case characters represent the minimum character set required by command execution.	[[:SOURce]:FREQuency[:CW]?, FREQ is the short-format part of the command.
The lower-case characters portion of command is optional; Such flexible format is called "flexible listening". For more information, please refer to "Command Parameter and Response".	:FREQuency :FREQ, :FREQuency or :FREQUENCY, any of which is correct.
When a colon is placed between two command mnemonics, it moves the current path down one level in the command tree. For more information, please refer to the command path part of "Command Trees".	:TRIGger:OUTPut:POLarity? TRIGger is the topmost keyword of this command.
If a command requires more than one parameter, you must separate adjacent parameters using a comma. Parameters do not affect path layers as they are not the portion of the command path.	[[:SOURce]:LIST:DWELI <val>{,<val>}
A semicolon separates 2 adjacent commands without affecting the current path.	:FREQ 2.5GHZ; :POW 10DBM
White space characters, such as <space> or <tab>, are generally ignored so long as they don't appear between or among . However, the command and parameter must be	:FREQ uency or :POWER :LEVel6.2 is not allowed. :LEVel and 6.2 must be separated by a space.

**6.1 Remote control basis**

separated by a blank character, without affecting the current path.

i.e. :POWER:LEVel 6.2

**4) Command tree**

Most remote control programming tasks involve instrument-specific commands. When such a command is parsed, the SCPI will use a structure similar to the file structure, and it is called as a command tree, as shown in Figure 6.2:

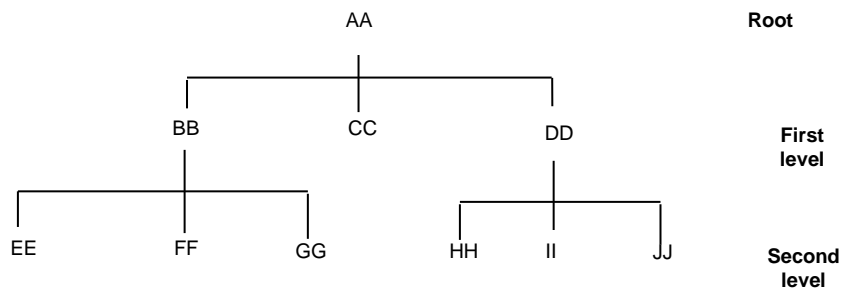

Figure 6.2 Simplified Command Tree

The top command is root command, or simply “root”. In the case of command parsing, the command at the next layer is reached by following a specific route based on the tree structure. For example: :POWER:ALC:SOURce? where, POWER stands for AA, : ALC stands for BB, :SOURce stands for GG, and the whole command path is (:AA:BB:GG).

A software module in the instrument software—the command interpreter—is responsible for parsing each received SCPI. The command interpreter breaks up the command into individual command element using a series of rules for identifying the command tree path. After the current command is parsed, the current command path remains unchanged. In this way, the subsequent commands can be parsed more quickly and efficiently because the same command keyword may appear in different paths. After the power-on or \*RST (reset) operation of the instrument, the current command path is reset as the root.

**5) Command parameter and response**

The SCPI defines different data formats in the use of the remote control and response messages to conform to the principles of “flexible listening” and “accurate speaking”. For more information, please refer to IEEE 488.2. “Flexible Listening” means that the formats of commands and parameters are flexible.

For example, for the signal generator, the frequency offset state command is set as: FREQUency:OFFSet:STATe ON|OFF|1|0,

The following command formats are used to set the frequency offset function as “On”:

:FREQUency:OFFSet:STATe ON, :FREQUency:OFFSet:STATe 1,

:FREQ:OFFS:STAT ON, :FREQ:OFFS:STAT 1

Each parameter type corresponding to one or more response data types. In the case of query, a numeric parameter will return a data type, and the response data is exact and strict, which is called “Accurate Speaking”.

For example, if you query the power state (:POWER:ALC:STATe?), when it is turned on, the response is always 1, regardless of whether you previously sent :POWER:ALC:STATe 1 or :POWER:ALC:STATe ON.



Table 6.4 Types of SCPI Parameter and Response

Parameter Type	Response Data Type
Numeric	Real or Integer
Extended Numeric	Integer
Discrete	Discrete
Boolean	Numeric Boolean
String	String
Block	Definite Length Block
	Indefinite Length Block
Non-decimal numeric	Hexadecimal
	Octal
	Binary

### Numeric parameter

Numeric parameters can be used in both instrument-specific commands and common commands. It receives all common decimal systems including signs, decimal point and scientific notation. If a certain piece of equipment only receives a specified type of numeric parameter such as an integer, it will automatically round off the received numeric parameter.

Examples of numeric parameter:

0	no decimal point
100	decimal point optional
1.23	with sign digit
4.56e<space>3	space allowed after exponent marker e
-7.89E-01	exponent marker e may be upper or lower case
+256	leading + allowed
5	decimal point may be leading

### Extended numeric parameter

Most measurements related to Instrument-specific commands use extended numeric parameters to specify the physical quantities. Extended numeric parameters receive all numeric parameters and additional special values. All extended numeric parameters receive MAXimum and MINimum as parameter values. Other special values, such as: UP and DOWN are received by the instrument parsing capability. SCPI table will list all valid parameters.

Note: Extended numeric parameters are not applicable to common commands or STATus subsystem commands.

Examples of extended numeric parameters:

101	Numeric parameter
1.2GHz	GHz may be used an exponent (E009)
200MHz	MHz may be used an exponent (E006)
-100mV	-100 millivolt
10DEG	10 degrees
MAXimum	maximum valid setting
MINimum	minimum valid setting

**6.1 Remote control basis**

UPincrease a step

DOWN decrease a step

**Discrete parameter**

When there are a finite number of parameter values to be set, discrete parameters are used for identification. A discrete parameter uses mnemonics to represent each valid setting. Like the SCPI mnemonics, the discrete parameter mnemonics can be set in long and short formats, with both capitalized and lowercase characters.

The following example illustrates the combined use of discrete parameter and command.

```
:TRIGger[:SEQuence]:SOURce BUS|IMMEdiate|EXTernal
```

BUS GPIB,LAN,RS-232 triggered

IMMEdiate Immediate trigger

EXTernal External trigger

**Boolean parameter**

Boolean parameters represent a single binary condition that is either true or false. There are only four possible representations for a Boolean parameter.

Examples of Boolean parameters:

ON Logical true

OFF Logical false

1 Logical true

0 Logical false

**String parameter**

A string parameter allows the ASCII string to be sent as a parameter. Single and double quotes are used as separators.

Examples of string parameter:

'This is Valid' "This is also Valid" 'SO IS THIS'

**Real response data**

A large portion of measurement data are real. They are formatted as basic decimal notation or scientific notation. Most advanced programming languages all support these two formats.

Examples of real response data:

1.23E+0

-1.0E+2

+1.0E+2

0.5E+0

0.23

-100.0

+100.0

0.5

**Integer response data**

The integer response data are a decimal expression of an integer with the sign bit. When the status register is queried, the integer response data will be mostly returned.

Examples of integer response data:

0	Sign digit optional
+100	Leading + allowed
-100	Leading – allowed
256	No decimal point

### Discrete response data

The discrete response data and discrete parameters are basically the same. The main difference is that the discrete response data can only be returned in the short format with capitalized characters.

Examples of discrete response data:

INTernal	Amplitude level control mode is internal
EXTernal	Amplitude level control mode is external
MMHead	Amplitude level control mode is millimeter wave source module

### Numeric Boolean response data

The Boolean response data returns a binary value of 1 or 0.

### String response data

The string response data and string parameters are the same. The main difference is that the string response data use double quotes rather than single quotes as the separator. The string response data can also be inserted with double quotes inside which there can be no characters. Examples of string response data:

“This is a string”

“one double quote inside brackets: (“”)”

## 6) Systems of Values in Commands

The value of the command can be entered in binary, decimal, hexadecimal or octal format. In the binary, hexadecimal, or octal format, a suitable identifier should be added in front of the value. In the decimal (default) format, an identifier isn't required. When the value without an indicator is entered, the equipment will ensure that it is entered in decimal format. The identifiers required in all formats are listed as follows:

- #B indicates that this digit is a binary value.
- #H indicates that this digit is a hexadecimal value.
- #Q indicates an octal number.

The representations of the decimal value 45 in the SCPI are given as follows:

#B101101

#H2D

#Q55

The following example shows setting of the RF output power as 10 dBm (or the value equivalent to the current selected unit including DBUV or DBUVEMF) with the hexadecimal value 000A.

:POW #H000A

In a non-decimal format, the measurement unit such as DBM or mV isn't used together with the value.

## 7) Command line structure

A command line may contain multiple SCPIs. To indicate the end of the current command line, the following methods can be used:

- Enter;

**6.1 Remote control basis**

- Enter and EOI;
- EOI and the last data byte.

Commands in command line are separated by semicolons, and commands for different subsystems begin with a colon. For example:

```
MMEM:COPY "Test1", "MeasurementXY";:HCOP:ITEM ALL
```

The command line contains two commands of which the first one belongs to the MMEM subsystem and the second one belongs to the HCOP subsystem. If the adjacent commands belong to the same subsystem, the command path will be partially repeated and the command can be abbreviated. For example: For example:

```
HCOP:ITEM ALL;:HCOP:IMM
```

The command line contains two commands both of which belong to the HCOP subsystem of first level. Therefore, the second command can begin with the subordinate to HCOP and may not begin with a colon, which can be abbreviated to the following command line:

```
HCOP:ITEM ALL;:HCOP:IMM
```

**6.1.4 Command Sequence and Synchronization**

IEEE488.2 defines the difference between overlapped commands and sequential commands:

- Sequential commands are sequences of commands that are executed continuously. Usually, each command is executed fast.
- Overlapped commands indicate that the previous command is not executed automatically before the next command is executed. Normally overlapped commands take longer to process and allows the program to process other events synchronously.

Even if multiple commands are set in a command line, they are not necessarily executed in the order in which they are received. In order to ensure that the commands are executed in a certain order, each command must be sent as a separate command line.

**Example: Command line contains set and query commands**

If multiple commands in a command line contain query commands, the query result is unpredictable. The following command returns a fixed value:

```
:FREQ:STAR 1GHZ;SPAN 100;:FREQ:STAR?
```

Return value: 1000000000 (1GHz)

The following command returns an unfixed value:

```
:FREQ:STAR 1GHz;STAR?;SPAN 1000000
```

The returned value may be the current start frequency value of the instrument before the command is sent, because the host program executes the commands one by one only after receiving the command message. If the host program executes the command after receiving it, the returned value may also be 1 GHz.

**NOTE****Set command and query command are sent separately**

General rules: in order to ensure the correct return of query command, set commands and query commands shall be sent in different remote control messages.

**6.1.4.1 Preventing overlapped execution of the command**

In order to prevent the overlapped execution of commands, multiple threads or commands: \*OPC, \*OPC? or \*WAI can be used. These three commands can be executed only after the hardware is set.

**6.1 Remote control basis**

During programming, the computer can be forced to wait for some time to synchronize certain events. The details are separately described below:

➤ **Controller program uses multiple threads**

Multi threads are used to wait for completion of the command and achieve synchronization of GUI and program control, that is, a single thread waits for completion of \*OPC?, without impeding the execution of the GUI or remote control thread.

➤ **The usage of the three commands in synchronous execution is shown in the table below:**

Table 6.5 Command Syntax

Method	Actions to be Executed	Programming Method
*OPC	Set the operation completion bit is set.	Set ESE BIT0; Set SRE BIT5; Send the overlapped command and *OPC; Wait for service request (SRQ) SRQ represents the completion of execution of the overlapped command
*OPC?	Stop executing the current command 1. The command is returned only when the operation completion bit in the ESR is set, which indicates that the previous command is processed.	Terminate the processing of the current command before executing other commands. Send this command directly after the current command.
*WAI	Before executing *WAI, wait until all commands are sent and continue processing the uncompleted commands.	Terminate the processing of the current command before executing other commands. Send this command directly after the current command.

### 6.1.5 Status reporting system

Status reporting system stores all current operating status information and error information of the instrument. Such information is stored in the status register and error queue respectively and can be queried through the remote interface.

- [Structure of the status register.....187](#)
- [Application of Status Reporting System.....189](#)

#### 6.1.5.1 Structure of the status register

Please refer to the hierarchical structure of status register below:

6.1 Remote control basis

As shown in the following figure, the status information is of hierarchical structure.

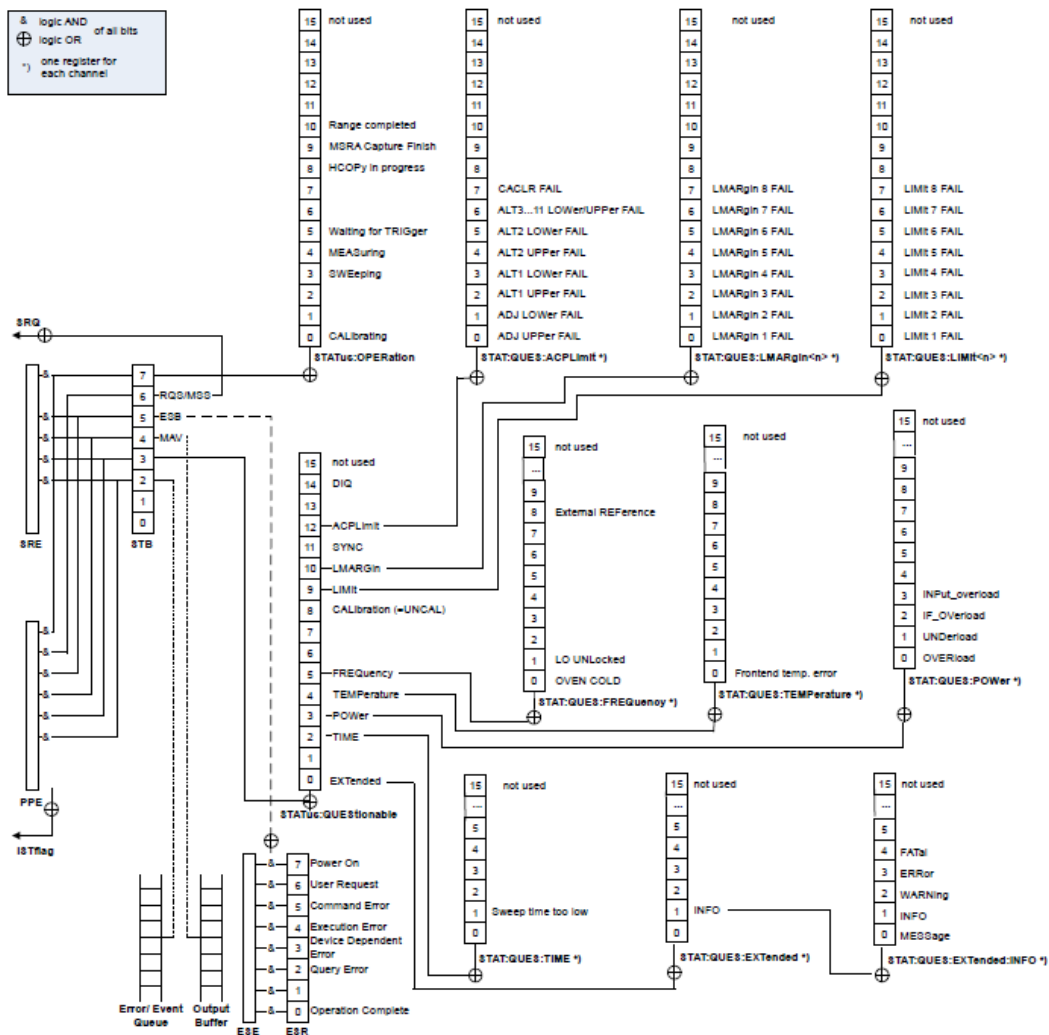

Figure 6.3 Hierarchy Diagram of Status Registers

The register classification is described as follows:

1) STB, SRE

Status Byte (STB) register and its associated mask register, Service Request Enable (SRE) register, constitute the top-level register of the status reporting system. The STB saves the general working status of the instrument by collecting low-level register information.

2) ESR, SCPI status register

STB receives the information of the following registers:

- The value of Event Status Register (ESR) and Event Status Enable (ESE) mask register.
- SCPI status registers include: STATUS:OPERation and STATUS:QUESTionable registers

(SCPI definition), they contain the specific operating information of the instrument. All SCPI status registers have

the same internal structure (please refer to Section 2.1.5.2 “ Structure of SCPI status register” in the Programming Manual).

3) IST, PPE

Similar to the SRQ, an individual bit of the IST mark ("Individual STatus") is a combination of all statuses of the instrument. The associated parallel query enable register (PPE) determines which data

bits of the STB act on the IST mark.

#### 4) Output buffer

The output buffer stores the message returned by the instrument to the controller. It doesn't belong to the status reporting system but determines the value of the MAV bit of STB.

For details of above register descriptions, please refer to "2.1.5 Status reporting system".

## NOTE

### SRE, ESE

The SRE can be used as an enable part of the STB. Similarly, the ESE can be used as an enable part of the ESR.

### 6.1.5.2 Application of status reporting system

The status reporting system is used to monitor the status of one or more instruments in the test system. To correctly realize the function of the status reporting system, the controller in the test system must receive and evaluate the information of all instruments. The standard methods applied include:

- 1) Query the service request (SRQ) initiated by the instrument;
- 2) Perform serial poll of all instruments in the bus system, which is initiated by the controller in the system in order to find out the initiator and reason of the service request.
- 3) Perform parallel query of all instruments;
- 4) Query of the status of specific instrument by remote control command;

For the details, please refer to "2.1.5.4 Application of Status Reporting System" in Programming Manual.

### 6.1.6 Programming considerations

#### 1) Please initialize the instrument status before changing the settings

When setting the instrument through remote control, it is necessary to initialize the instrument status (e.g. send "\*RST") and then set the desired status.

#### 2) Command sequence

In general, the set and query commands should be sent separately; otherwise the returned value of the query command will change according to the current instrument operation sequence.

#### 3) Failure response

The service request can only be initiated by the instrument itself. The controller program in the test system should instruct the instrument to initiate a service request when an error occurs, and then enter the corresponding interrupt service routine for processing.

#### 4) Error queue

Each time the controller program processes a service request, the error queue rather than the status register of the instrument should be queried to obtain a more accurate error reason. The error queue should be frequently queried to obtain the wrong command sent by the controller to the instrument especially during testing of the controller program.

## 6.2 Remote interface and its configuration

- LAN.....189
- GPIB.....190

### 6.2.1 LAN

6.2 Remote interface and its configuration

**CAUTION**

**Use of USB main control port connector on front panel**

Type-A connector on the front panel is the connector of USB master control port. In 1465 series signal generator, this port is used to connect the flash disk of USB interface to upgrade the instrument TSR software. The signal generator can also be controlled by connecting USB keyboard and mouse. It is not possible to remotely control the instrument via this port.

- [Connection.....190](#)
- [Interface Configuration.....190](#)

**6.2.1.1 Connection**

1465 signal generator and external controller (computer) are connected to LAN using network cable, as shown in Figure 6.4:

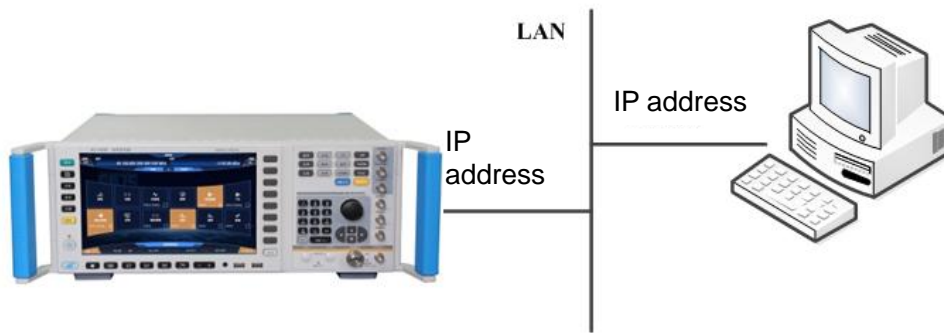

Figure 6.4 LAN Interface Connection

**6.2.1.2 Interface configuration**

When the signal generator is remotely controlled via LAN, the physical network connection shall be guaranteed to be smooth. As the signal generator does not support DHCP, domain name access and wide-area network connection, the network programmable setting is relatively simple. In system menu, “IP address”, “subnet mask” and “default gateway” are set to the subnet where the master controller is located.

**CAUTION**

**Ensure that the signal generator is physically connected properly by 10Base-T LAN or 100Base-T LAN cable**

As the signal generator only supports the construction of a single LAN control system and the setting of static IP address, rather than DHCP and the access to the host via DNS and domain name server, users do not need to modify the subnet mask. In the instrument, it is fixedly set to: 255.255.255.0.

**6.2.2 GPIB**

- [Connection.....191](#)
- [Interface Configuration.....191](#)



### 6.3 Basic programming method of the VISA interface

#### 6.2.2.1 Connection

1465 signal generator and external control (computer) are connected using network cable, as shown in Figure 6.5:

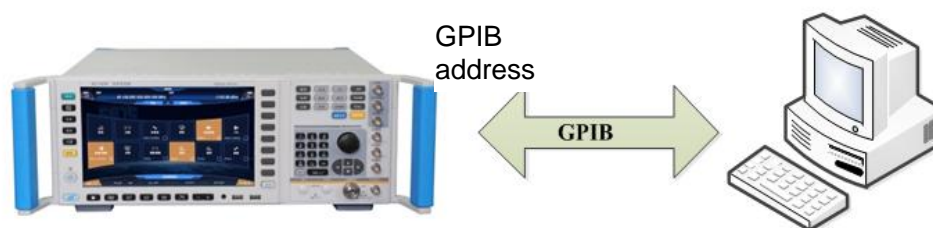

Figure 6.5 GPIB Interface Connection

#### 6.2.2.2 Interface configuration

The GPIB interface settings consist of two parts: GPIB address and programming language. GPIB address is set by the menu “GPIB Address Setting”, which contains two menu items “Local” and “Power Meter”. “Local” is the address setting soft key of the signal generator, usually set to 19. The local GPIB address can be set by numeric keys, arrow keys and knobs (For the value editing method of the signal generator, refer to "7) Edit Data in “3.3.1.2 Common Configuration Setting Method” in this method.)

Programming language is set by the menu “Programming Language Setting”, which contains two menu items “SCPI” and “Analyzer”. The latter is used for factory debugging. When building an automatic test system, the programming language of the signal generator shall be "SCPI".

### 6.3 Basic programming method of the VISA interface

The basic methods for programming of remote control of the instrument through the VISA library are illustrated hereinafter. Take the C++ language as an example.

- [VISA Library](#).....191
- [Initialization and default status setting](#).....192
- [Sending of set command](#).....193
- [Reading of instrument configuration](#).....193
- [Synchronization of command](#).....194

#### 6.3.1 VISA library

VISA is a general term of standard I/O function libraries and their related specifications. VISA library function is a set of functions that can be easily recalled. Its core function enables you to control various devices, regardless of their interface types and the usage of different I/O interface software. These library functions are used to write the driver of the instrument as well as complete the command and data transmission between the computer and the instrument, so as to realize the remote control of the instrument. By initializing addressing string ("VISA Resource String"), you can establish a connection to an instrument with a programmable port (LAN, USB, GPIB, etc.).

At first, it is necessary to install the VISA library so as to achieve remote control. The VISA library packages the underlying transfer functions of underlying VXI, GPIB, LAN and USB interfaces so that the user can recall them directly. Programming interfaces supported by the signal generator: GPIB, LAN, and RS-232. The use of these interfaces in conjunction with VISA library and programming languages allows remote control of the signal generator. Agilent I/O Library provided by Agilent for users is often used as the underlying I/O library.

Figure 6.6 shows the relationship between Remote Interface, VISA library, programming language and the signal generator taking GPIB interface as an example.

### 6.3 Basic programming method of the VISA interface

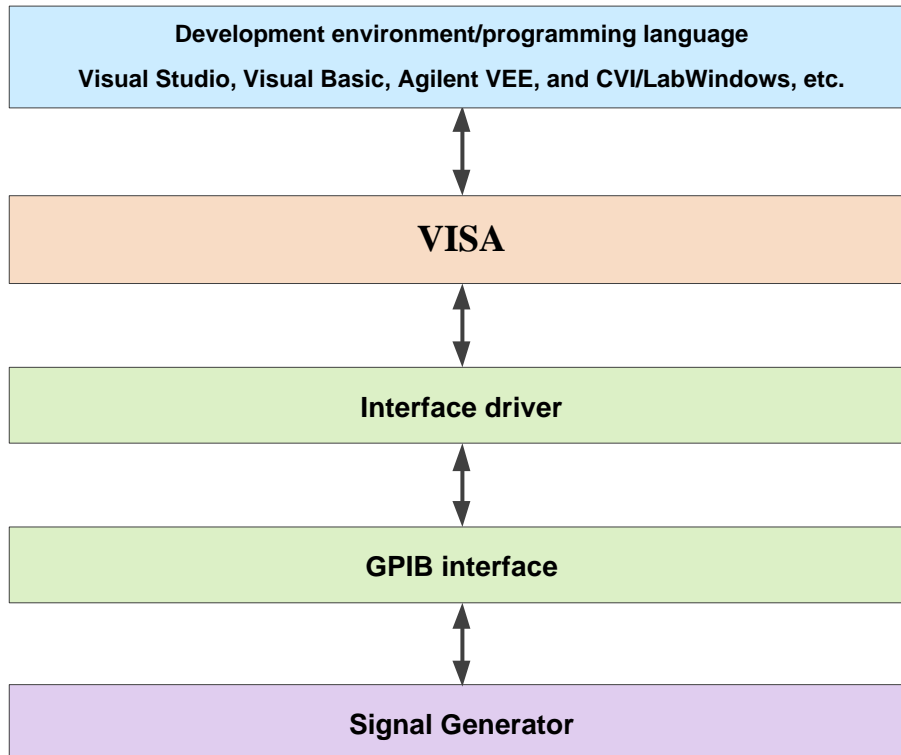

Figure 6.6 Programmable Software and Hardware Layers

#### 6.3.2 Initialization and default status setting

When the program starts, firstly initialize VISA resource manager, and then enable and establish the communication connection between VISA library and the instrument. The specific steps are as follows:

##### 6.3.2.1 Generation of global variable

First generate global variables to be recalled by other program modules, for example: Instrument handle variable. The following example program shall contain the following global variables:

```

Global ViSession analyzer;
Global ViSession defaultRM;
Const char analyzerString [VI_FIND_BUFLLEN] = "GPIB0::20::INSTR";
Const analyzerTimeout = 10000;
  
```

Wherein, the constant analyzerString is instrument descriptor, "GPIB0" is controller, and "20" is the instrument connected to the controller. If supposing that the instrument is connected with LAN and IP address is "192.168.1.1", the variable will be:

```

Const char analyzerString [VI_FIND_BUFLLEN] = "TCPIP::192.168.1.1::INSTR ";
  
```

##### 6.3.2.2 Controller initialization

The following example shows how to open and establish a communication connection between VISA library and the instrument (specified by instrument descriptor).

```

//Initialize controller: Open the default resource manager and return the instrument handle analyzer
  
```

```

void InitController()
  
```

```

{
  
```

```

ViStatus status;
  
```

**6.3 Basic programming method of the VISA interface**

```

status = viOpenDefaultRM(&defaultRM);
status = viOpen(defaultRM, analyzerString, VI_NULL, VI_NULL, &analyzer);
}

```

**6.3.2.3 Instrument initialization**

The following example shows how to initialize the instrument default status and clear status registers.

```

void InitDevice()
{
ViStatus status;
long retCn;
status = viWrite(analyzer, "**CLS", 4, &retCnt); //reset status registers
status = viWrite(analyzer, "**RST", 4, &retCnt); //reset the instrument
}

```

**6.3.3 Sending of set command**

The following example shows how to set the continuous wave and amplitude of 1465 series signal generator.

```

void SimpleSettings()
{
ViStatus status;
long retCn;
//Set the continuous wave to 128 MHz
status = viWrite(analyzer, "FREQUENCY:CW 128MHz", 22, &retCnt);
//Set the amplitude to -10 dBm
status = viWrite(analyzer, "POW -10dBm", 23, &retCnt);
}

```

**6.3.4 Reading of instrument configuration**

The following example shows how to read the setting status of the instrument.

```

void ReadSettings()
{
ViStatus status;
long retCn;
char rd_Buf_CW[VI_READ_BUFLEN]; // #define VI_READ_BUFLEN 20
char rd_Buf_LVL[VI_READ_BUFLEN];
//Query continuous wave
status = viWrite(analyzer, "FREQ:CW?", 10, &retCnt);
Sleep(10);
status = viRead(analyzer, rd_Buf_CW, 20, &retCnt);
//Query amplitude
status = viWrite(analyzer, "POW?", 12, &retCnt);
}

```

**6.3 Basic programming method of the VISA interface**

```

Sleep(10);

status = viRead(analyzer, rd_Buf_LVL, 20, &retCnt);
//Print debugging information
sprintf("Cw is %s", rd_Buf_CW);
sprintf("POW is %s", rd_Buf_LVL);
}

```

**6.3.5 Synchronization of command**

The methods for command synchronization are illustrated hereinafter by taking sweep as an example.

**void SweepSync()**

```

{
ViStatus status;
long retCn;
ViEventType etype;
ViEvent eevent;
int stat;
char OpcOk [2];
/*****/

/*Command INITiate[:IMMEDIATE] initiates a single sweep (INIT:CONT OFF when continuous sweep
is OFF)*/

/* Only when the single sweep is completed can the next command in the command buffer be
executed */

/*****/

status = viWrite(analyzer, "INIT:CONT OFF", 13, &retCnt);
//The method to wait for the end of the sweep 1: Use *WAI
status = viWrite(analyzer, "ABOR;INIT:IMM;*WAI", 18, &retCnt);
//The method to wait for the end of the sweep 2: Use *OPC?
status = viWrite(analyzer, "ABOR;INIT:IMM;*OPC?", 20, &retCnt);
status = viRead(analyzer, OpcOk, 2, &retCnt); //wait for *OPC to return "1"
//The method to wait for the end of the sweep 3: Use *OPC
//To use the GPIB service request, set "Disable Auto Serial Poll" as "yes"
status = viWrite(analyzer, "**SRE 32", 7, &retCnt);
status = viWrite(analyzer, "**ESE 1", 6, &retCnt); //Enable Service Request ESR
//Set the event enable bit, the operation is completed
status = viEnableEvent(analyzer, VI_EVENT_SERVICE_REQ, VI_QUEUE, VI_NULL);
//Enable SRQ event
status = viWrite(analyzer, "ABOR;INIT:IMM;*OPC", 18, &retCnt);
//Start sweep synchronously with OPC
status = viWaitOnEvent(analyzer, VI_EVENT_SERVICE_REQ, 10000, &etype, &eevent)

```

```

//Wait for service request
status = viReadSTB(analyzer, &stat);
status = viClose(eevent); //Close event handle
//Disable the SRQ event
status = viDisableEvent(analyzer, VI_EVENT_SERVICE_REQ, VI_QUEUE);
//Continue running the main program.....
}

```

## 6.4 I/O library

- [I/O Libraries Overview](#).....195
- [Installation and configuration of I/O library](#).....196

### 6.4.1 Overview of I/O library

As a library of software programs pre-written for the instrument, the I/O library is called an instrument driver. It is considered as the intermediate layer of the software between the computer and the instrument hardware equipment, composed of function library, utility program and tool kit, and used as a software code module set that corresponds to a planned operation, e.g. configuring, reading from, writing to or triggering the instrument. It resides in the computer as the bridge and link between the computer and the instrument, and provides an easily programmed high-level modular library so that the user no longer needs to learn complex low-level programming protocols specific to an instrument. The instrument driver is the key to rapid development and test of measurement applications.

From the aspect of function, a general instrument driver usually consists of a functional body, an interactive developer interface, a program developer interface, a subprogram interface and an I/O interface as shown in Fig. 6.7.

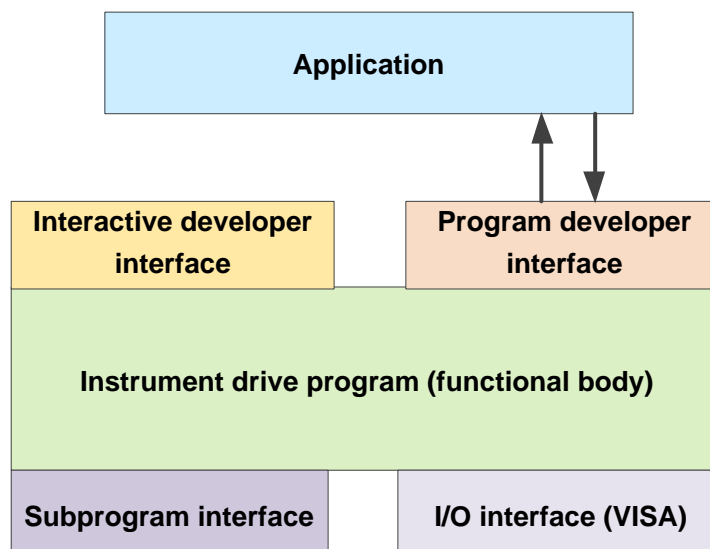

Figure 6.7 Instrument Driver Structure Model

The detailed description is given as follows:

- 1) Functional body. It is the main functional part of the instrument driver and can be understood as the framework program of the instrument driver. .
- 2) Interactive developer interface. For user's convenience, a graphical interactive developer interface is generally provided in the application development environment that supports the development of the instrument driver. For example, the function panel in Labwindows/CVI is an interactive developer interface. In the function panel, each parameter of the instrument driver function is represented by a graphical control.

#### 6.4 I/O library

- 3) Program developer interface. It is a software interface for recalling of the instrument driver function by the application, such as the dynamic link library file .dll of the instrument driver of the Windows system.
- 4) I/O interface. It is used to complete the actual communication between the instrument driver and the instrument. The bus-specific I/O software such as GPIB can be used; the common standard I/O software across multiple buses, including: VISA I/O can also be used. VISA I/O.
- 5) Subroutine interface. It is a software interface for the instrument driver to access other support libraries including database and FFT function. When the instrument driver needs to recall other software modules, operating systems, program code libraries and analysis function libraries to complete its task, the subprogram interface will be used.

##### 6.4.2 Installation and configuration of I/O library

With the development of the test field application from the traditional instrument to the virtual instrument, the instrument driver has experienced different development processes in order to solve the instrument interchangeability and test program reusability of the automatic test system. Currently, the IVI (Interchangeable Virtual Instruments) driver is popularly applied. Based on the IVI specification, a new instrument programming interface is defined, the class driver and VPP architecture are inserted onto the VISA so that the test application is completely independent of the instrument hardware, and unique instrument simulation, range detection and status buffer functions are added, which improves the system operation efficiency and truly achieves the instrument interchange.

IVI driver is divided into two types: IVI-C and IVI-COM. IVI-COM is based on Microsoft Component Object Model (COM) and adopts COM API; IVI-C is based on ANSI C and adopts C API. Both drivers are designed according to the instrument class defined in the IVI specification, with the same application development environments including Visual Studio, Visual Basic, Agilent VEE, LabVIEW and CVI/LabWindows.

Currently, it is necessary to provide two types of drivers in order to meet the demands of different users in different development environments. The IVI driver of the signal generator uses Nimbus Driver Studio to produce IVI-COM and IVI-C drivers as well as program installation package. For specific installation and configuration, please refer to documents accompanied with the control card and I/O Library of your choice.

The IVI drivers installed are divided into: IVI intrinsic function group and instrument class function group (basic function group and extended function group). For details about functional classification, functions and attributes, please refer to the accompanied help document of the driver.

---

## NOTE

### Configuration of ports and installation of IO library

When a computer is to be used to control the signal generator, please confirm that the necessary ports and I/O library have been properly installed and configured.

---

## 7 Fault Diagnosis & Repair

This chapter aims to help you to identify a problem and receive after-sales service. Error information of the signal generator is also introduced.

If you have any doubt about operating the 1465 series signal generator, or if you need to purchase any parts or accessories related, refer to this chapter for perfect after-sales service.

A problem is usually caused by the hardware, software or improper operation. Please contact us immediately if there is any problem. In the event where your signal generator is within warranty period, free service will be provided as promised in the warranty certificate; in the event where your signal generator is out of warranty, the service will be charged as required in the agreement.

- [Operating principle.....197](#)
- [Fault diagnosis and troubleshooting.....199](#)
- [Error information.....204](#)
- [Repair method.....205](#)

### 7.1 Operating principle

To help the user to know the functions of 1465 series signal generator and to solve an operation problem easily, this section introduces basic operating principle of signal generator and functional block diagram of hardware.

#### 7.1.1 Instrument operating principle & functional block diagram of hardware

The 1465 series signal generator adopts artificial intelligence instrument hardware platform based on modern computer technology, and Windows 7 MTOS. The design concept of modulization and option is observed in design, and both the instrument hardware and software can be divided into relatively independent modules. The system mainly consists of instrument main console, frequency synthesis, vector signal generating, RF signal conditioning, baseband signal generating and conditioning modules. A detailed block diagram of instrument hardware overall plan is shown in Fig.7.1.

## 7.1 Operating principle

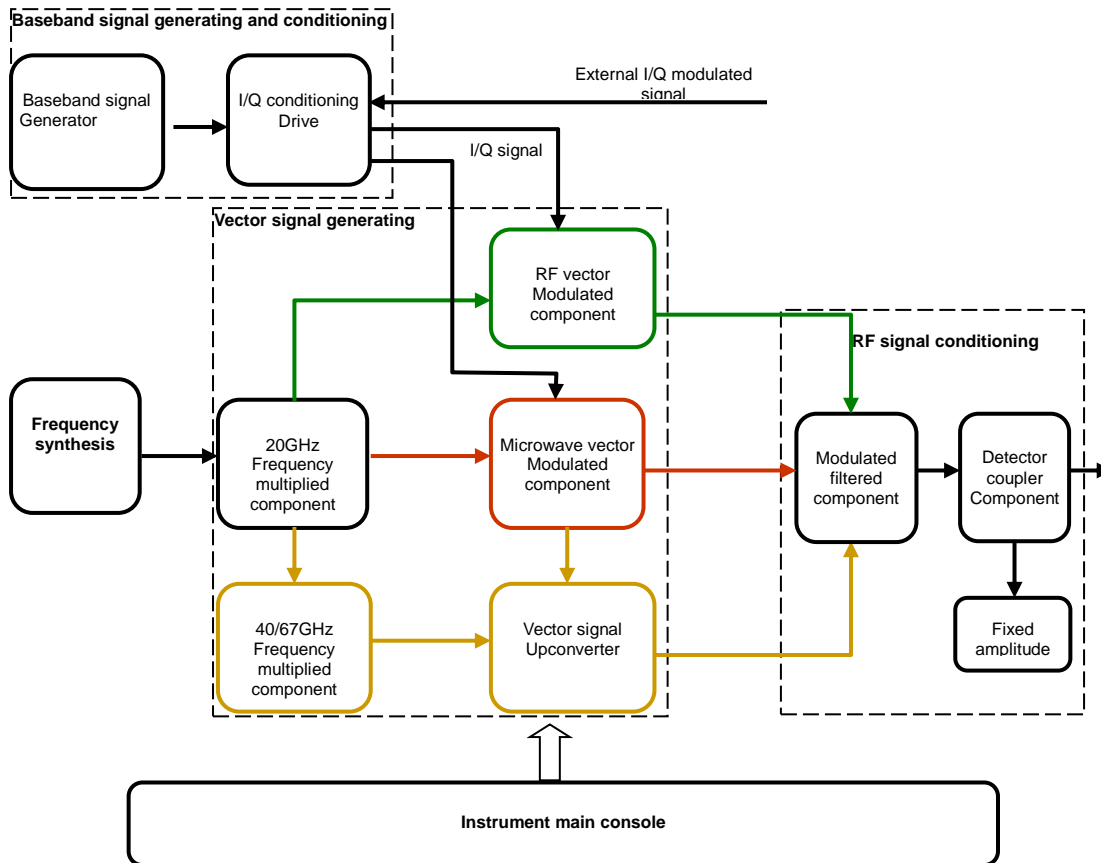

Fig.7.1 Block diagram of instrument hardware overall plan

The instrument main console provides work environment support for all instrument functional units.

The frequency synthesizer produces high-purity continuous wave RF signal through multiloop frequency synthesis technique.

Vector signal generation unit divides and mixes the RF signal from frequency synthesizer, which then enters in RF vector modulated component for vector modulation so that a RF vector modulated signal can be obtained; after frequency multiplication, RF signal enters in microwave vector modulated component for vector modulation so that a microwave vector modulated signal can be obtained; both the microwave vector modulated signal and MMW signal which is frequency multiplied by 40/67GHz frequency multiplied component are converted to a MMW vector modulated signal, thus generating full range vector signal.

RF signal conditioning unit filters the signal, completes the fixed amplitude, pulse modulation, programmable attenuation and other amplitude control functions, and outputs the signal to RF output port.

Baseband signal generating and conditioning drive unit has such functions as internal baseband signal generation, baseband signal input selection, baseband signal conditioning, and vector modulator drive. Baseband signal generator produces baseband modulated signals and common standard communication modulated signals, required by digital modulation. The signal through I/Q conditioning drive is input to the RF vector modulated component and microwave vector modulated component, to drive I/Q modulator.

The I/Q conditioning drive receives I/Q signal, external input I/Q signal and other calibrated signals produced by baseband signal generator, then regulates circuits through gain adjustment, offset voltage correction and differential signal conversion etc., and finally outputs to drive both low-range I/Q modulator and high-range I/Q modulator, generating the required vector modulated signal. Wide-band I/Q input signal is received directly to microwave vector modulated component.



## 7.2 Fault diagnosis and troubleshooting

**NOTE****Fault diagnosis and guide**

This section provides a simple method to determine and handle with a faulty 1465 series signal generator (if any). Please feed back the problem accurately to the factory when necessary, so that we can provide service for you as soon as possible.

Fault symptom and troubleshooting methods are listed as below based on the type of function.

● System issue	199
● Unlocked hardware	199
● Unfixed amplitude	201
● Cold timebase	201
● RF output power issue	202
● RF output port unmodulated	202
● Sweeping issue	203
● Data storage issue	203
● Unresponsive front panel keys	203
● Remote control issue	203

## 7.2.1 System issue

● Ready lamp fails	199
● Fan fails after power on	199

## 7.2.1.1 Ready lamp fails

Check if signal generator 220V AC input is normal. Any deviation from the maximum allowable deviation of  $220V \pm 10\%$  may stop the instrument working normally. In the case of any abnormality, check external circuits, locate the fault, troubleshoot the instrument, and then turn it on again. If the battery of instrument itself is the cause, send the instrument back to the factory for battery repair or replacement

## 7.2.1.2 Fan fails after power on

In the event that the fan fails after power on, check if it gets blocked or dusty. If any, turn off the instrument to remove the obstacles or clean the fan. Turn on the instrument again, and check that the fan works. Otherwise it should be repaired or replaced by the factory.

## 7.2.2 Unlocked hardware

● Unlocked reference loop	199
● Unlocked local oscillator loop	200
● Unlocked YO loop	200
● Unlocked PLL	201

## 7.2.2.1 Unlocked reference loop

The user interface state indicator displays the alarm information: "Unlocked reference loop". If the signal generator is started in non-ready mode (i.e. cold start), transient unlocked reference loop may occur. The alarm information should disappear 10 minutes after power on, if this is disregarded, otherwise there must be a fault. When a fault occurs, carry out the following steps for troubleshooting:

**Operation steps:**

## 7.2 Fault diagnosis and troubleshooting

- Step 1.** Press the front panel key **【System】** , to activate the system configuration dialog.
- Step 2.** Select [Instrument Self Test] and activate the self test dialog to start the instrument self test automatically.
- Step 3.** Operate the up and down arrow keys to find and check the failed self test, and then continue the following operations:
- Step 4.** Select [Step ] switch to ON;
- Step 5.** Select [Step Mode Always Error] switch to Error;
- Step 6.** Select [Run test];
- Step 7.** When some self test contains multi steps, press the button [Continue] till the self test is completed.
- Step 8.** Record the configuration value of each step and send it back to the factory

### 7.2.2.2 Unlocked local oscillator

when user interface state indicator displays “Unlocked local oscillator”, carry out the following steps:

#### Operation steps:

- Step 1.** Press the front panel key **【System】** , to activate the system configuration dialog.
- Step 2.** Select [Instrument Self Test] and activate the self test dialog to start the instrument self test automatically.
- Step 3.** Operate the up and down arrow keys to find and check the A9 local oscillator board, and then continue the following operations:
- Step 4.** Select [Step ] switch to ON;
- Step 5.** Select [Step Mode Always Error] switch to Error;
- Step 6.** Select [Run test];
- Step 7.** When some self test contains multi steps, press the button [Continue] till the self test is completed.
- Step 8.** Record the configuration value of each step and send it back to the factory

### 7.2.2.3 Unlocked YO loop

When user interface state indicator displays “Unlocked YO loop”, carry out the following steps:

#### Operation steps:

- Step 1.** Press the front panel key **【System】** , to activate the system configuration dialog.
- Step 2.** Select [Instrument Self Test] and activate the self test dialog to start the instrument self test automatically.
- Step 3.** Operate the up and down arrow keys to find and check A8 fractional-N, sweep board, and A9 local oscillator board, and then continue the following operation:
- Step 4.** Select [Step ] switch to ON;
- Step 5.** Select [Step Mode Always Error] switch to Error;
- Step 6.** Select [Run test];
- Step 7.** When some self test contains multi steps, press the button [Continue] till the self test is completed.
- Step 8.** Record the configuration value of each step and send it back to the factory

**CAUTION****Processing sequence of unlocked loop**

Unlocked local oscillator can cause unlocked YO loop. So when two alarm indications are shown, troubleshoot the unlocked local oscillator, and then the unlocked YO loop.

**7.2.2.4 Unlocked PLL**

When user interface state indicator displays “Unlocked PLL”, carry out the following steps:

**Operation steps:**

- Step 1. Press the front panel key **【System】** , to activate the system configuration dialog.**
- Step 2. Select [Instrument Self Test] and activate the self test dialog to start the instrument self test automatically.**
- Step 3. Operate the up and down arrow keys to find and check the failed self test, and then continue the following operations:**
- Step 4. Select [Step ] switch to ON;**
- Step 5. Select [Step Mode Always Error] switch to Error;**
- Step 6. Select [Run test];**
- Step 7. When some self test contains multi steps, press the button [Continue] till the self test is completed.**
- Step 8. Record the configuration value of each step and send it back to the factory**

**7.2.3 Unfixed amplitude****CAUTION****Unfixed amplitude is indicated.**

When the power level setting of the signal generator is out of the indicated range, “Unfixed amplitude” may be displayed, which is normal and reminds the user of uncertainty of signal generator output power.

Carry out the following steps, when user interface state indicator displays “Unfixed amplitude”:

**Operation steps:**

- Step 1. Press the front panel key **【System】** , to activate the system configuration dialog.**
- Step 2. Select [Instrument Self Test] and activate the self test dialog to start the instrument self test automatically.**
- Step 3. Operate the up and down arrow keys to find and check the failed self test, and then continue the following operations:**
- Step 4. Select [Step ] switch to ON;**
- Step 5. Select [Step Mode Always Error] switch to Error;**
- Step 6. Select [Run test];**
- Step 7. When some self test contains multi steps, press the button [Continue] till the self test is completed.**
- Step 8. Record the configuration value of each step and send it back to the factory**

**7.2.4 Cold timebase**

**CAUTION**

**Cold timebase indication**

When the signal generator’s 10M crystal oscillator is unstable, the “Cold timebase” indication may occur immediately after the instrument is turned on. Otherwise, the 10M crystal oscillator may be damaged. Contact the factory for repair.

When user interface state indicator displays “Cold timebase”, carry out the following steps:

**Operation steps:**

- Step 1. Press the front panel key **【System】** , to activate the system configuration dialog.**
- Step 2. Select [Instrument Self Test] and activate the self test dialog to start the instrument self test automatically.**
- Step 3. Operate the up and down arrow keys to find and check the failed self test, and then continue the following operations:**
- Step 4. Select [Step ] switch to ON;**
- Step 5. Select [Step Mode Always Error] switch to Error;**
- Step 6. Select [Run test];**
- Step 7. When some self test contains multi steps, press the button [Continue] till the self test is completed.**
- Step 8. Record the configuration value of each step and send it back to the factory**

7.2.5 RF output power issue

- [Low RF output power.....202](#)
- [Loss of RF output signal due to use of mixer .....202](#)

**7.2.5.1 Low RF output power**

Check if amplitude offset is shown in the amplitude display area of front panel user interface, and if any, it indicates that the amplitude offset has been set. Amplitude offset can change the value displayed in the amplitude area of the display, but not affect the output power, and the displayed power is equal to the actual output power of signal generator plus the offset.

Cancel the amplitude offset as follows:

Press the key **【Amplitude】** or click [Amplitude] area, set the [Amplitude offset] to 0dB, then the amplitude offset indication disappears, and now amplitude offset function is cancelled.

**7.2.5.2 Loss of RF output signal due to use of mixer**

When the signal generator is used along with spectrum analyzer with no pre-selection function, reverse power effect may cause an incorrect RF port output from the signal generator. Some spectrum analyzers at certain frequency points can cause the RF input port to produce +5dBm local oscillator feedthrough. If frequency difference between local oscillator feedthrough and RF carrier is lower than the ALC bandwidth of the signal generator, then the reverse power of the local oscillator may modulate amplitude for the RF output of signal generator. The effect of reverse power can be solved by using one of such two ALC working modes as setting ALC loop to open, and setting ALC to work in manual power search mode.

7.2.6 RF output port unmodulated

Check front panel user interface for RF output indication. If the RF output is off, press the key **【RF ON/OFF】** to enable RF output. Check if there is output in continuous wave state when no output is found yet. Test the analog modulation and digital modulation outputs in sequence, and contact the factory if the problem remains unsolved.

### 7.2.7 Sweeping issue

- [Stop sweeping.....203](#)
- [Failure to stop sweeping.....203](#)
- [Failure to stop sweeping.....203](#)

#### 7.2.7.1 Stop sweeping

The current sweeping state is displayed in status bar at the bottom of the instrument. Observe the progress bar and check if the sweeping is in the process. If the sweeping has stopped, inspect:

- 1) if sweep is started and if it is continuous sweep mode. If it is single sweep mode, make sure that, after the previous sweep is finished, the single sweep soft key of sweep control has been clicked at least once.
- 2) if the signal generator receives proper sweep trigger signal, set the sweep trigger to automatic mode, and check if missing sweep trigger signal stops sweep.
- 3) if dwell time is proper, set the dwell time to 1s, and check if invisible dwell time is actually caused by improper setting of dwell time.
- 4) if there are at least two points in step sweep or list sweep.

#### 7.2.7.2 Failure to stop sweeping

To stop sweeping when the instrument is in step sweep or list sweep state, select [Close (CW)] in the option of [Current Sweep Type] below the sweep configuration dialog.

#### 7.2.7.3 Incorrect dwell time in the case of list sweep

Currently the dwell time is set by software interrupt timing, which causes deviations. Please contact the factory for solution.

### 7.2.8 Data storage issue

- [The saved instrument state is null.....203](#)

## NOTE

### Maximum number of saving/loading instrument state

For the 1465 series signal generator, up to 100 instrument states can be saved/loaded, with the register serial numbers of 0~99. When a serial number of more than 99 is input, the state will be saved to 99# register automatically.

#### 7.2.8.1 Saved instrument state is null

Saving/loading instrument state file is saved under the "D:\1465data\user" folder as default, and for user files under the user folder, backups and recovery function are not provided. If some file is missing due to power failure or improper operation, please contact our service center according to the contact information on the second page of this manual or in the section "7.4 Repair methods".

### 7.2.9 Unresponsive front panel keys

If the signal generator does not respond to front panel keys, check if it is set to remote control mode (in which mode, remote control indication will be shown on the display screen). To exit from this mode, press down the front panel key **【Local】** to switch the signal generator from the remote control to local control.

### 7.2.10 Remote control issue

- [Command channel blocked.....204](#)

**7.3 Error information****7.2.10.1 Command channel blocked**

In remote control mode, if the signal generator receives a series of SCPI remote control commands, carry out failure timeout as follows: In trigger sweep mode, failure to receive trigger signal leads to control waiting timeout, and the remote control channel (GPIB, LAN and other interfaces) between the control and the signal generator is blocked, so other commands can not be received. In this case, the current remote control configuration should be suspended to allow the control to regain the right of control of remote channel as follows:

**Step 1. The control sends the command “Clear instrument”, and then the signal generator clears all the current commands in working status on remote channel,**

to receive new remote control commands. Send command according to the interface and protocol type:

- Visa: viClear();
- GPIB: ibclr();
- RSIB: RSDLLibclr().

**Step 2. During remote control configuration, send SCPI “ABORT”, cancel the current configuration and reset the trigger system.**

**7.3 Error information**

The signal generator records the error in configuration in two ways: The front panel displays both error information queue and SCPI (in remote control mode) error information queue, which are stored and managed separately.

- [Error information file](#).....204
- [Error information description](#).....204

**7.3.1 Error information file**

In the current version of 1465 series signal generator, error information file can not be viewed.

**7.3.2 Error information description**

- [Local error information](#).....204
- [Remote control error information](#).....204

**7.3.2.1 Local error information****1) Error information view****Operation method through interface:**

When an error message is displayed at the lower right corner of signal generator during operation, the signal generator software must be running or the hardware must be faulty. You can determine the type of the fault according to the error code and then take appropriate measures for troubleshooting.

There is only one error message shown in the error display area of the signal generator. However several issues may occur in the instrument, and the signal generator displays them in sequence.

**7.3.2.2 Remote control error information**

- [Format and description of error information](#).....204
- [Type of error information](#).....205

**1) Format and description of error information**

In remote control mode, error information is recorded in the error/event queue of status reporting system, inquire the error information through the command “SYSTem:ERRor[:NEXT]?” in the format of:

“<Error code>, “<Error information in error queue>; <Detailed description of error information>”

**E.g.:**

“-135,” data is out of bound; input parameter is out of lower bound.”

There are two types of remote control error information:

- For negative value error code defined by SCPI, detailed description of error information is not provided. Refer to “Appendix C Error information zoom table”.
- See table below for instrument feature positive value error codes

Table 7.1 List of instrument feature error information

Error code	Error Description
1052	Data error Only for digital-based band interface: Digital I/Q input data error.
1053	FIFO overload Only for digital-based band interface: High external input sampling rate.
1054	Input overload Signal power of RF input port is out of specified range.
1055	No reference. The signal generator does not detect any required external reference single input.
1056	OVEN OCXO is below working temperature, and a few minutes later after power on, OCXO enters normal working state, and the error information disappears.

## 2) Type of error information

Error event is only provided with an error information, and types of error information are as follows:

- Query error (–499 to –400): Instrument output queue control detects the message exchange protocol error described in IEEE 488.2, Chapter 6. Now the event state register’s query error bit (bit2) is set (refer to IEEE 488.2, 6.5 for details). Now data can not be read successfully from output queue.
- Instrument feature error (399 to –300, 201 to 703, and 800 to 810): Instrument operation fails, which may be caused by abnormal hardware/firmware state, and this error code is often used in instrument self test. Now the event state register’s instrument feature error bit (bit3) is set.
- Execution error (-299 to –200): Fault is detected during configuration of the instrument. Now the event state register’s execution error bit (bit4) is set.
- Command error (-199 to –100): The instrument detects syntactic error during command parsing, which is caused by incorrect command format. Now the event state register’s command error bit (bit5) is set.

## 7.4 Repair methods

- [Contact us](#).....205
- [Packaging and express](#).....206

### 7.4.1 Contact us

When the 1465 series signal generator is faulty, first view the error information and store it, find possible causes and refer to the methods provided in the section “7.2 Fault diagnosis and troubleshooting”, so as to troubleshoot the signal generator in advance. Please contact our service center according to the contact information below in the case of fault unsolved, and provide collected error information, so that we can help you to solve your problem as early as possible.

#### Contact information:

Tel: **+86-0532-86896691**  
 Website: [www.ceyear.com](http://www.ceyear.com)  
 E-mail: [sales@ceyear.com](mailto:sales@ceyear.com)

#### 7.4 Repair methods

Postal code: **266555**

Address: **No.98, Xiangjiang Road, Qingdao City, China**

##### 7.4.2 Packaging and transport

If you have any intricate problem with your signal generator, contact us by phone or fax. After necessary repair is confirmed, pack the signal generator with original packaging materials and put it in a box before the following steps.

- 1) A detailed description of fault symptom should be provided and attached to the signal generator.
- 2) The signal generator should be packed by the original packaging materials, so as to minimize damages.
- 3) Four corners of external packaging box should be cushioned before the instrument is put in the box.
- 4) The packaging box should be sealed up by adhesive tape, and then fastened by nylon tape.
- 5) Words "Fragile! Do not touch! Handle with care!" should be marked on the box.
- 6) The instrument should be consigned as a precise instrument.
- 7) The copies of all transport documents should be retained.

---

### CAUTION

#### Precautions for packaging

Packaging the signal generator with other materials may damage the instrument. Packaging materials of polystyrene spheres must not be used. They can not protect the instrument fully, but produce static electricity which in turn will draw them to the instrument fan, thus damaging the instrument.

---

### NOTE

#### Packaging and transport of instrument

Please observe the precautions in the section "3.1.1.1 Unpacking" strictly during the transport or handling of the instrument (for example, damage during shipment).

---



## 8 Specifications and Test Methods

This chapter introduces the specifications and main test methods of the 1465 series signal generator.

- [Statement](#).....207
- [Product Features](#).....207
- [Specifications](#).....208
- [Option Information](#) .....218
- [Supplementary Information](#).....220
- [Performance Characteristics Test](#).....222

### 8.1 Statement

Unless specifically stated, all specifications shall be tested at the temperature of  $23\text{ }^{\circ}\text{C}\pm 5\text{ }^{\circ}\text{C}$  (half an hour after startup). The supplementary information of the instrument is to help users understand the instrument performance but not specifications. The important terms are explained as follows:

**Specifications (spec):** unless otherwise stated, the performance of the calibrated instrument should be guaranteed after being placed at the operating temperature range of  $0\text{ }^{\circ}\text{C}\sim 50\text{ }^{\circ}\text{C}$  for at least 2 h, and warmed up for 30 min; (the measured uncertainty is included). Unless otherwise stated, all data provided herein should be regarded as specifications.

**Typical value (typ):** the typical performance that can be achieved by 80% of instruments; it is not an assurance data and does not include uncertainty in the measurement process. It is valid only at room temperature (about  $25\text{ }^{\circ}\text{C}$ ).

**Nominal (nom):** expected average performance, designed performance characteristics or performance that cannot be tested by limited test methods, such as  $50\text{ }\Omega$  connector. Product performance marked as rating is not included within the product warranty and is measured at room temperature (approximately  $25\text{ }^{\circ}\text{C}$ ).

**Measured value (meas):** the performance characteristics measured at design stage for comparison with expected performance, e.g. the change of amplitude drift over time. It should be noted that it is not an assurance data, and is measured at room temperature (about  $25\text{ }^{\circ}\text{C}$ ).

### 8.2 Product Features

Table 8.1 Product Features

General characteristics		
Remote Control	Interface	GPIB IEEE-488.2, 1987 listening and writing LAN 1000BaseT LAN interface
	Programmable language	SCPI version 1997.0
Display		LED display
Operation interface language		Chinese/English
Power requirements		The maximum power consumption is less than 400W, the power supply is 50 Hz ~ 60 Hz, single-phase 110 V or 220 V self-adaptive, the allowable range of steady-state voltage is $\pm 10\%$ of the nominal value, and the allowable range of steady-state frequency is $\pm 5\%$ of the nominal value
Operating temperature range		$0\text{ }^{\circ}\text{C}$ to $+50\text{ }^{\circ}\text{C}$
Storage temperature range		$-40\text{ }^{\circ}\text{C}$ to $+70\text{ }^{\circ}\text{C}$
Operating humidity (nominal)		0 to 80% at $40\text{ }^{\circ}\text{C}$

**8.3 Specifications**

<b>Altitude</b>	0 to 4600 m
<b>Save</b>	Save instrument state, user data files, sweep list files, waveform sequences, and other files.
	4GB (32GB) storage
	4GB (8GB) RAM base storage
	Save up to 100 instrument states
<b>Self-test</b>	When the signal generator is reset, it will automatically test most of the modules. If the voltage at the test point of the module is normal, no test is required.
<b>Maximum weight</b>	About 28 kg
<b>Overall dimensions (width × height × depth)</b>	517 mm × 192 mm × 550 mm (including handles and protective bottom corners)
	435 mm × 178 mm × 498 mm (excluding handles and protective bottom corners)
<b>Vibration</b>	Random vibration: Frequency 5 to 100 Hz, power spectral density 0.015 g <sup>2</sup> /Hz; frequency 100 to 137 Hz, slope -6dB; frequency 137 to 350 Hz, power spectral density 0.0075 g <sup>2</sup> /Hz; frequency 350 to 500 Hz, slope -6dB; frequency 500 Hz, power spectral density 0.0039 g <sup>2</sup> /Hz.
<b>Safety requirements</b>	<p>The requirements of 3.10.2 in GJB 3947A-2009 are met and the specific requirements are as follows:</p> <p>a) The insulation resistance of the instrument should not be less than 100 MΩ under standard atmospheric conditions for testing and should also not be less than 2 MΩ under humid ambient conditions.</p> <p>b) At a dielectric strength test voltage of 1500 V, the instrument should be free of breakdown, flashover and flickering during the test. During the qualification test, the test voltage applied on the test point shall be maintained for more than 1 min. When the quality conformity test is performed, the test voltage applied on the test point shall be maintained for more than (2 to 5) s.</p> <p>c) Leakage current should not exceed 3.5 mA during operation of the instrument.</p>
<b>Reliability requirements</b>	The instrument shall meet the requirements of 3.12 in GJB3947A-2009 with MTBF (θ <sub>0</sub> ) ≥ 5000 h
<b>Electromagnetic compatibility requirements</b>	If the option H90 is used, it shall meet the requirements of 3.9.2 in GJB 3947A-2009.
	If the option H90 is not used, it shall meet the requirements of 3.9.1 in GJB3947A-2009.
<b>Maintainability requirements</b>	The instrument shall meet the requirements specified in 3.13 of GJB3947A-2009.

**8.3 Specifications**

Table 8.2 1465 (non-V) Series Specifications

Frequency characteristics					
Frequency range	1465A:100kHz ~ 3GHz (Minimum frequency to 9kHz)	Frequency	N (number of internal YO harmonics)		
		100kHz≤f≤250MHz	1/8		
	1465B:100kHz ~ 6GHz (Minimum frequency to 9kHz)	250MHz<f≤500MHz	1/16		
		500MHz<f≤1GHz	1/8		
	1465C:100kHz ~ 10GHz	1GHz<f≤2GHz	1/4		
	1465D:100kHz ~ 20GHz	2GHz<f≤3.2GHz	1/2		
	1465D+H06: 10MHz ~ 20GHz	3.2GHz<f≤10GHz	1		
	1465F:100kHz ~ 40GHz	10GHz<f≤20GHz	2		
	1465H:100kHz ~ 50GHz	20GHz<f≤40GHz	4		
1465L:100kHz ~ 67GHz (Maximum frequency to 70GHz)	40GHz<f≤67GHz	8			
Frequency resolution	0.001Hz				
Frequency switching time	<20ms				
Time base aging rate (typical <sup>2</sup> )	5×10 <sup>-10</sup> /day (after continuous power-on for 30 days)				
Reference output	Frequency	10MHz			
	Power	>+4 dBm, to 50 Ω load			
Reference input	Frequency	1 to 50MHz with the step of 1Hz			
	Power	-5dBm to +10dBm, impedance 50Ω			
Sweep characteristics					
Sweep mode	Step sweep List sweep Analog sweep Power sweep				
Analog sweep (Option H03)	Maximum sweep speed	100kHz≤f≤500MHz	25MHz/ms		
		500MHz<f≤1GHz	50MHz/ms		
		1GHz<f≤2GHz	100MHz/ms		
		2GHz<f≤3.2GHz	200MHz/ms		
		3.2GHz<f	400MHz/ms		
	Sweep accuracy	0.05% span (sweep time is 100ms within the specified 100ms maximum span)			
Power characteristics					
Minimum power	Model	Standard	Option H01A/B		
	1465A/B/C/D/F	-20dBm	-110dBm (can be set to -135dBm)		
	1465D + option H06	-10dBm	-90dBm (can be set to -125dBm)		
	1465H/L	-20dBm	-90dBm (can be set to -110dBm)		
Maximum power	Frequency range	Standard	Programmable step	High power	Option

8.3 Specifications

<b>(25±10°C)</b>			attenuator option H01A/B	output option H05	H01A/B+H05	
	1465A/B/C/D					
	100kHz≤f≤20GHz	15dBm	15dBm	20dBm*3	20dBm*3	
	1465D + option H06					
	10MHz≤f≤20GHz	28dBm	27dBm	---	---	
	1465F					
	100kHz≤f≤9GHz	12dBm	12dBm	20dBm	20dBm	
	9GHz<f≤40GHz	12dBm	12dBm	17dBm	17dBm	
	1465H/L					
	100kHz≤f≤15GHz	5dBm	5dBm	17dBm	17dBm	
	15GHz<f≤30GHz	5dBm	5dBm	13dBm	13dBm	
	30GHz<f≤67GHz	5dBm	4dBm	8dBm	8dBm	
<b>Power accuracy (25±10°C)</b>	Standard					
	Power (dBm) \ Frequency	>20	>10 to 20	>-10 to 10	-20~-10	
	100kHz≤f≤2GHz	---	±0.8dB	±0.6dB	±1.5dB	
	2GHz<f≤20GHz	---	±0.8dB	±0.8dB	±1.5dB	
	20GHz<f≤40GHz	---	±1.0dB	±0.9dB	±1.8dB	
	40GHz<f≤50GHz	---	---	±1.3dB	±1.8dB	
	50GHz<f≤67GHz	---	---	±1.5dB	±2.0dB	
	1465D + enhanced high power output option H06					
	500MHz < f≤20GHz	±1.2dB	±0.8dB	±0.9dB	---	
	H01A/B programmable step attenuator option					
	Power (dBm) \ Frequency	>20	>10 to 20	>-10 to 10	>-70 to -10	-90~-70
	100kHz≤f≤2GHz	---	±0.8dB	±0.6dB	±0.7dB	±1.5dB
	2GHz<f≤20GHz	---	±0.8dB	±0.8dB	±0.9dB	±1.8dB
	20GHz<f≤40GHz	---	±1.0dB	±0.9dB	±1.0dB	±2.0dB
	40GHz<f≤50GHz	---	---	±1.3dB	±1.5dB	±2.5dB
	50GHz<f≤67GHz	---	---	±1.5dB	±1.8dB	±3.0dB
	1465D + enhanced high power output option H06					
	10MHz≤f≤500GHz	---	±1.3dB	±0.9dB	±1.0dB	±1.8dB
500MHz < f≤20GHz	±1.2dB	±0.8dB	±0.8dB	±1.1dB	±2.0dB	
<b>Power resolution</b>	0.01dB					
<b>Power temperature stability</b>	0.02 dB/°C (typical)					

## 8.3 Specifications

<b>Output impedance</b>	50 $\Omega$ (nominal <sup>4</sup> )						
<b>Source standing wave ratio VSWR (Internal amplitude level control) (typical)</b>	100kHz $\leq$ f $\leq$ 20GHz	< 1.6					
	20GHz < f $\leq$ 40GHz	< 1.8					
	40GHz < f $\leq$ 67GHz	< 2.0					
<b>Maximum reverse power</b>	0.5W (0V DC) (nominal)						
<b>Spectrum purity<sup>5</sup></b>							
<b>Harmonics (+10 dBm or the maximum output power, which is the lesser)</b>	Frequency	Standard				Enhanced high power option H06	
	100kHz $\leq$ f $\leq$ 10MHz	< -25dBc				---	
	10MHz < f $\leq$ 2GHz	< -30dBc				< -25dBc	
	2GHz < f $\leq$ 6GHz (1465B)	< -30dBc				---	
	2GHz < f $\leq$ 9GHz	< -55dBc				< -35dBc	
	9GHz < f $\leq$ 14GHz	< -55dBc				< -27dBc	
	14GHz < f $\leq$ 20GHz	< -55dBc				< -30dBc	
	20GHz < f $\leq$ 67GHz	< -50 dBc (typical)				---	
<b>Subharmonic (+10 dBm or the maximum output power, which is the lesser)</b>	100kHz $\leq$ f $\leq$ 10GHz	None					
	10GHz < f $\leq$ 20GHz	< -60dBc					
	20GHz < f $\leq$ 67GHz	< -50dBc					
<b>Non-harmonic (at 0 dBm, beyond 3kHz frequency offset)</b>	Frequency	Standard				Option H04	
	100kHz $\leq$ f $\leq$ 250MHz	< -58dBc				< -58dBc	
	250MHz < f $\leq$ 3.2GHz	< -74dBc				< -80dBc	
	3.2GHz < f $\leq$ 10GHz	< -62dBc				< -70dBc	
	10GHz < f $\leq$ 20GHz	< -56dBc				< -64dBc	
	20GHz < f $\leq$ 40GHz	< -50dBc				< -58dBc	
	40GHz < f $\leq$ 67GHz	< -44dBc				< -52dBc	
<b>Single sideband phase noise (dBc/Hz, +10 dBm or the maximum output power, which is the lesser)</b>	Frequency	1Hz	10Hz	100Hz	1kHz	10kHz	100kHz
	100kHz $\leq$ f $\leq$ 250MHz	---	---	-104	-121	-128	-130
	250 MHz < f $\leq$ 500MHz	---	---	-108	-126	-132	-136
	0.5 GHz < f $\leq$ 1GHz	---	---	-101	-121	-130	-130
	1 GHz < f $\leq$ 2GHz	---	---	-96	-115	-124	-124
	2 GHz < f $\leq$ 3.2GHz	---	---	-92	-111	-120	-120
	3.2 GHz < f $\leq$ 10GHz	---	---	-81	-101	-110	-110
	10 GHz < f $\leq$ 20GHz	---	---	-75	-95	-104	-104
	20 GHz < f $\leq$ 40GHz	---	---	-69	-89	-98	-98

## 8.3 Specifications

	40 GHz < f ≤ 67GHz	---	---	-64	-84	-92	-92
	H04 ultra-low phase noise option						
	100kHz ≤ f ≤ 250MHz <sup>6</sup>	-64	-92	-105	-123	-138	-141
	250 MHz < f ≤ 500MHz	-67	-93	-111	-126	-138	-142
	0.5 GHz < f ≤ 1GHz	-62	-91	-105	-123	-138	-138
	1 GHz < f ≤ 2GHz	-57	-86	-100	-117	-133	-133
	2 GHz < f ≤ 3.2GHz	-52	-81	-96	-113	-128	-128
	3.2 GHz < f ≤ 10GHz	-43	-72	-85	-105	-120	-120
	10 GHz < f ≤ 20GHz	-37	-66	-79	-98	-114	-114
	20 GHz < f ≤ 40GHz	-31	-60	-73	-91	-108	-108
	40 GHz < f ≤ 67GHz	-26	-54	-68	-85	-102	-102
<b>Modulation characteristics</b>							
<b>Frequency modulation (Option H02A)</b>	Maximum frequency offset: N×16 MHz (N is the number of YO harmonics) Accuracy (1kHz rate, N×20kHz ≤ frequency offset < N×800kHz): <± (3.5% × set frequency offset + 20Hz) Modulation rate (3dB bandwidth, N×500kHz frequency offset): DC-10MHz Distortion (1kHz rate, N×20kHz ≤ frequency offset < N×800kHz): <1%						
<b>Phase modulation (Option H02A)</b>	Maximum PM deviation: Normal mode: N×16rad (N is the number of YO harmonics) Broadband mode: N×1.6rad (N is the number of YO harmonics) Accuracy (1kHz rate, N × 0.2rad ≤ PM deviation < N × 8rad, normal mode): <± (5% × set PM deviation + 0.01 rad) Modulation rate (3dB bandwidth): Narrowband mode DC to 1MHz (typical) Broadband mode DC to 10MHz (typical) Distortion (1 kHz rate, N × 0.8 rad ≤ PM deviation < N × 8 rad PM deviation, total harmonic distortion): <1%						
<b>Amplitude modulation (Option H02A)</b>	Maximum AM depth: >90% Modulation rate (3 dB bandwidth, 30% modulation depth): DC to 100kHz Accuracy (1 kHz modulation rate, 30% modulation depth): ± (6%×set depth + 1%) Distortion (1kHz modulation rate, linear mode, total harmonic distortion, 30% modulation depth): <1.5%						
<b>Pulse modulation (Option H02B)</b>		500MHz ~ 3.2GHz		Greater than 3.2 GHz			
	On-off ratio <sup>7</sup>	> 80dB		> 80dB			
	Rise and fall time	< 20ns		< 20ns			
	Internal amplitude level control minimum pulse width	1μs		1μs			
	Non-amplitude level control minimum pulse width	0.1μs		0.1μs			
<b>Narrow pulse</b>		50MHz ~ 3.2GHz		Greater than 3.2 GHz			

## 8.3 Specifications

<b>modulation (Option H02C)</b>	On-off ratio <sup>7</sup>	> 80dB	> 80dB
	Rise and fall time	< 15ns	< 10ns
	Internal amplitude level control minimum pulse width	1 $\mu$ s	1 $\mu$ s
	Non-amplitude level control minimum pulse width	30ns	20ns
<b>Internal modulation signal generator (Option H02A/B/C)</b>	Provide 3 independent signals for frequency/phase modulation, amplitude modulation, and low frequency output signals Waveform: Sinc, Square, Triangle, Zigzag, Noise, DualSinc, SweepSinc Frequency range: Sinc DualSinc, SweepSinc DC ~ 10MHz; Square, Triangle, Zigzag 0.1Hz ~ 100kHz Frequency resolution: 0.1Hz LF output: Amplitude 0 to 5 V <sub>peak</sub> (nominal), to 50 $\Omega$ load PM signal: Width: 20Ns to (42s-10ns) Period: 100ns to 42s resolution: 10ns		
<b>General characteristics</b>			
<b>RF output port</b>	1465A/B/C: N type (female), impedance 50 $\Omega$ 1465D: 3.5 mm (male), N type (female) (option H91), impedance 50 $\Omega$ 1465F: 2.4 mm (male), impedance 50 $\Omega$ 1465H/L: 1.85 mm (male), impedance 50 $\Omega$		
<b>Maximum overall dimensions</b>	Width x height x depth: 517mmx192mmx550mm		
<b>Weight</b>	<28 kg (different model, option configuration or weight)		
<b>Power supply</b>	100 to 120VAC, 50 to 60Hz, or 200 to 240VAC, 50 to 60Hz (self-adaptive)		
<b>Power consumption</b>	Less than 350W		
<b>Temperature range</b>	Operating temperature: 0°C to +50°C; storage temperature: -40°C to +70°C		

Table 8.3 1465-V Series Specifications

<b>Frequency characteristics</b>			
<b>Frequency range</b>	1465A-V:100kHz ~ 3GHz (Minimum frequency to 9kHz)	Frequency	N (number of internal YO harmonics)
		100kHz $\leq$ f $\leq$ 250MHz	1/8
	1465B-V:100kHz ~ 6GHz (Minimum frequency to 9kHz)	250MHz < f $\leq$ 500MHz	1/16
		500Hz < f $\leq$ 1GHz	1/8
	1465C-V:100kHz ~ 10GHz	1GHz < f $\leq$ 2GHz	1/4
	1465D-V:100kHz ~ 20GHz	2GHz < f $\leq$ 3.2GHz	1/2
	1465F-V:100kHz ~ 40GHz (Maximum frequency to 44GHz)	3.2GHz < f $\leq$ 10GHz	1
		10GHz < f $\leq$ 20GHz	2
	1465H-V:100kHz ~ 50GHz	20GHz < f $\leq$ 28.5GHz	3
1465L-V:100kHz ~ 67GHz	28.5GHz < f $\leq$ 50GHz	5	

## 8.3 Specifications

		50GHz < f ≤ 67GHz	10		
<b>Frequency resolution</b>	0.001Hz				
<b>Frequency switching time</b>	< 20ms				
<b>Time base aging rate (typical<sup>2</sup>)</b>	5×10 <sup>-10</sup> /day (after continuous power-on for 30 days)				
<b>Reference output</b>	Frequency	10MHz			
	Power	>+4 dBm, to 50 Ω load			
<b>Reference input</b>	Frequency	1 to 50MHz with the step of 1Hz			
	Power	-5dBm to +10dBm, impedance 50Ω			
<b>Sweep characteristics</b>					
<b>Sweep mode</b>	Step sweep List sweep Analog sweep Power sweep				
<b>Analog sweep (Option H03)</b>	Maximum sweep speed	100kHz ≤ f ≤ 500MHz	25MHz/ms		
		500Hz < f ≤ 1GHz	50MHz/ms		
		1GHz < f ≤ 2GHz	100MHz/ms		
		2GHz < f ≤ 3.2GHz	200MHz/ms		
		3.2GHz < f	400MHz/ms		
	Sweep accuracy	0.05% span (sweep time is 100ms within the specified 100ms maximum span)			
<b>Power characteristics</b>					
<b>Minimum power</b>	Model	Standard	Option H01A/B		
	1465A/B/C/D/F-V	-20dBm	-110dBm (can be set to -135dBm)		
	1465H/L-V	-20dBm	-90dBm (can be set to -110dBm)		
<b>Maximum power (25±10°C)</b>	Frequency range	Standard	Programmable step attenuator option H01A/B	High power output option H05	Option H01A/B+H05
	1465A/B/C/D-V				
	100kHz ≤ f ≤ 20GHz	15dBm	15dBm	20 <sup>3</sup> dBm	20 <sup>3</sup> dBm
	1465F-V				
	100kHz ≤ f ≤ 9GHz	10dBm	10dBm	18dBm	18dBm
	9GHz < f ≤ 30GHz	10dBm	10dBm	15dBm	15dBm
	30GHz < f ≤ 40GHz	10dBm	10dBm	12dBm	12dBm
	1465H/L-V				
	100kHz ≤ f ≤ 15GHz	5dBm	5dBm	15dBm	15dBm
	15GHz < f ≤ 30GHz	5dBm	5dBm	12dBm	12dBm
	30GHz < f ≤ 60GHz	5dBm	4dBm	8dBm	6dBm
60GHz < f ≤ 67GHz	4dBm	3dBm	6dBm	4dBm	
<b>Power accuracy</b>	Standard				



## 8.3 Specifications

<b>(25±10°C)</b>	Power (dBm) Frequency	>10 to 20	>-10 to 10	-20~-10		
	100kHz≤f≤2GHz	±0.8dB	±0.6dB	±1.5dB		
	2GHz<f≤20GHz	±0.8dB	±0.8dB	±1.5dB		
	20GHz<f≤40GHz	±1.0dB	±0.9dB	±1.8dB		
	40GHz<f≤50GHz	---	±1.3dB	±1.8dB		
	50GHz<f≤67GHz	---	±1.5dB	±2.0dB		
	H01A/B programmable step attenuator option					
	Power (dBm) Frequency	>10 to 20	>-10 to 10	>-70 to -10	-90~-70	
	100kHz≤f≤2GHz	±0.8dB	±0.6dB	±0.7dB	±1.5dB	
	2GHz<f≤20GHz	±0.8dB	±0.8dB	±0.9dB	±1.8dB	
	20GHz<f≤40GHz	±1.0dB	±0.9dB	±1.0dB	±2.0dB	
40GHz<f≤50GHz	---	±1.3dB	±1.5dB	±2.5dB		
50GHz<f≤67GHz	---	±1.5dB	±1.8dB	±3.0dB		
<b>Power resolution</b>	0.01dB					
<b>Power temperature stability</b>	0.02 dB/°C (typical)					
<b>Output impedance</b>	50 Ω (nominal <sup>4</sup> )					
<b>Source standing wave ratio VSWR (Internal amplitude level control) (typical)</b>	100kHz≤f≤20GHz	< 1.6				
	20GHz<f≤40GHz	< 1.8				
	40GHz<f≤67GHz	< 2.0				
<b>Maximum reverse power</b>	0.5W (0V DC) (nominal)					
<b>Spectrum purity<sup>5</sup></b>						
<b>Harmonics (+10 dBm or the maximum output power, which is the lesser)</b>	Frequency	Standard				
	100kHz≤f≤10MHz	< -25dBc				
	10MHz<f≤2GHz	< -30dBc				
	2GHz < f≤6GHz (1465B)	< -30dBc				
	2GHz<f≤20GHz	< -55dBc				
	20GHz<f≤67GHz	< -45dBc (typical)				
<b>Subharmonic (+10 dBm or the maximum output power, which is the lesser)</b>	100kHz≤f≤10GHz	None				
	10GHz<f≤20GHz	< -60dBc				
	20GHz<f≤67GHz	< -45dBc				
<b>Non-harmonic (at 0 dBm, beyond 3kHz)</b>	Frequency	Standard		Option H04		
	100kHz≤f≤250MHz	< -58dBc		< -58dBc		

8.3 Specifications

<b>frequency offset)</b>	250MHz < f ≤ 3.2GHz	< -74dBc				< -80dBc		
	3.2GHz < f ≤ 10GHz	< -62dBc				< -70dBc		
	10GHz < f ≤ 20GHz	< -56dBc				< -64dBc		
	20GHz < f ≤ 28.5GHz	< -52dBc				< -52dBc		
	28.5GHz < f ≤ 40GHz	< -45dBc				< -45dBc		
	40GHz < f ≤ 60GHz	< -42dBc				< -42dBc		
<b>Single sideband phase noise (dBc/Hz, +10 dBm or the maximum output power, which is the lesser)</b>	Frequency	1Hz	10Hz	100Hz	1kHz	10kHz	100kHz	
	100kHz ≤ f ≤ 250MHz	---	---	-104	-121	-128	-130	
	250MHz < f ≤ 500MHz	---	---	-108	-126	-132	-136	
	0.5 GHz < f ≤ 1GHz	---	---	-101	-121	-130	-130	
	1GHz < f ≤ 2GHz	---	---	-96	-115	-124	-124	
	2GHz < f ≤ 3.2GHz	---	---	-92	-111	-120	-120	
	3.2GHz < f ≤ 10GHz	---	---	-81	-101	-110	-110	
	10GHz < f ≤ 20GHz	---	---	-75	-95	-104	-104	
	20GHz < f ≤ 28.5GHz	---	---	-69	-89	-98	-98	
	28.5GHz < f ≤ 50GHz	---	---	-64	-84	-92	-92	
	50GHz < f ≤ 67GHz	---	---	-57	-77	-86	-86	
	H04 ultra-low phase noise option							
	100kHz ≤ f ≤ 250MHz <sup>6</sup>	-64	-92	-105	-123	-138	-141	
	250MHz < f ≤ 500MHz	-67	-93	-111	-126	-138	-142	
	0.5GHz < f ≤ 1GHz	-62	-91	-105	-123	-138	-138	
	1GHz < f ≤ 2GHz	-57	-86	-100	-117	-133	-133	
	2GHz < f ≤ 3.2GHz	-52	-81	-96	-113	-128	-128	
	3.2GHz < f ≤ 10GHz	-43	-72	-85	-105	-120	-120	
	10GHz < f ≤ 20GHz	-37	-66	-79	-98	-114	-114	
	20GHz < f ≤ 28.5GHz	-31	-60	-73	-91	-108	-108	
28.5GHz < f ≤ 50GHz	-26	-54	-68	-85	-102	-102		
50GHz < f ≤ 67GHz	-20	-48	-62	-79	-96	-96		
<b>Modulation characteristics</b>								
<b>Frequency modulation (Option H02A)</b>	Maximum frequency offset: N×16 MHz (N is the number of YO harmonics) Accuracy (1kHz rate, N×20kHz ≤ frequency offset < N×800kHz): <± (3.5% × set frequency offset + 20Hz) Modulation rate (3dB bandwidth, N×500kHz frequency offset): DC-10MHz Distortion (1kHz rate, N×20kHz ≤ frequency offset < N×800kHz): <1%							
<b>Phase modulation (Option H02A)</b>	Maximum PM deviation: Normal mode: N×16rad (N is the number of YO harmonics) Broadband mode: N×1.6rad (N is the number of YO harmonics)							

## 8.3 Specifications

	Accuracy (1kHz rate, $N \times 0.2\text{rad} \leq \text{PM deviation} < N \times 8\text{rad}$ , normal mode): $\pm (5\% \times \text{set PM deviation} + 0.01 \text{ rad})$ Modulation rate (3dB bandwidth, broadband mode): DC to 10MHz (typical) Distortion (1 kHz rate, $N \times 0.8 \text{ rad} \leq \text{PM deviation} < N \times 8 \text{ rad}$ PM deviation, total harmonic distortion): <1%		
<b>Amplitude modulation (Option H02A)</b>	Maximum AM depth: >90% Modulation rate (3 dB bandwidth, 30% modulation depth): DC to 100kHz Accuracy (1 kHz modulation rate, 30% modulation depth): $\pm (6\% \times \text{set depth} + 1\%)$ Distortion (1kHz modulation rate, linear mode, total harmonic distortion, 30% modulation depth): <1.5%		
<b>Pulse modulation (Option H02B)</b>		500MHz ~ 3.2GHz	Greater than 3.2 GHz
	On-off ratio	>80dB	>80dB
	Rise and fall time	<20ns	<20ns
	Internal amplitude level control minimum pulse width	1 $\mu\text{s}$	1 $\mu\text{s}$
	Non-amplitude level control minimum pulse width	0.1 $\mu\text{s}$	0.1 $\mu\text{s}$
<b>Narrow frequency modulation (Option H02C)</b>		50MHz ~ 3.2GHz	Greater than 3.2 GHz
	On-off ratio	>80dB	>80dB
	Rise and fall time	<15ns	<10ns
	Internal amplitude level control minimum pulse width	1 $\mu\text{s}$	1 $\mu\text{s}$
	Non-amplitude level control minimum pulse width	30ns	20ns
<b>Internal modulation signal generator (Option H02A/B/C)</b>	Provide 3 independent signals for frequency/phase modulation, amplitude modulation, and low frequency output signals Waveform: Sinc, Square, Triangle, Zigzag, Noise, DualSinc, SweepSinc Frequency range: Sinc, SweepSinc, DualSinc DC to 10MHz; Square, Triangle, Zigzag 0.1Hz ~ 100kHz Frequency resolution: 0.1Hz LF output: Amplitude 0 to 5 V <sub>peak</sub> (nominal), to 50 $\Omega$ load PM signal: Width: 20ns to (42s-10ns) Period: 100ns to 42s resolution: 10ns		
<b>Vector modulation accuracy (after calibration, 25°C <math>\pm</math> 10°C) (Symbol rate 4Msps, root Nyquist filter, <math>\alpha=0.3</math>, QPSK format, 0 dBm)</b>	1465A/B/C/D/F-V	50MHz ~ 40GHz (or maximum frequency)	EVM (RMS%) < 1.4%
		50MHz ~ 40GHz	EVM (RMS%) < 1.4%
	1465H/L-V	40GHz ~ 67GHz (or maximum frequency)	EVM (RMS%) < 2.5%

## 8.4 Option Information

<b>Internal modulation bandwidth</b>	(Carriers 900MHz, 1.8GHz, 2.4GHz, 6GHz, 18GHz, 35GHz, 50GHz) Standards: 120MHz (multi-tone, number of tones 51, frequency interval 2.4MHz, $\pm 3$ dB bandwidth); H31 large modulation bandwidth option: 200MHz (multi-tone, number of tone 51, frequency interval 4MHz, $\pm 3$ dB bandwidth).
<b>External modulation bandwidth</b>	(Carriers 900MHz, 1.8GHz, 2.4GHz, 6GHz, 18GHz, 35GHz, 50GHz) 200MHz (ALC open loop, input 100mVrms sinc in channel I, $\pm 4$ dB bandwidth)
<b>External broadband modulation bandwidth (Option H33)</b>	(7GHz, 18GHz, 35GHz, 50GHz) 2GHz (ALC open loop, input 100mVrms sinc in channel I, $\pm 6$ dB bandwidth)

## 8.4 Option Information

Table 8.4 1465 (Non-V) Series Options

Option Number	Name	Function	Applicability
1465-H01A	115dB programmable step attenuator	Used to extend the output power dynamic range	A/B/C/D/F only
1465-H01B	90dB programmable step attenuator	Used to extend the output power dynamic range	H and L only
1465-H02A	Analog modulation	Add analog modulation function, including AM, FM, $\Phi$ M and low frequency output	All models
1465-H02B	Pulse modulation	Add pulse modulation function with minimum pulse width of 100 ns	All models
1465-H02C	Narrow pulse modulation	Add pulse modulation function with minimum pulse width of 20 ns	All models, including H02B
1465-H03	Analog sweep frequency	Add analog sweep frequency function (Ramp Sweep)	All models
1465-H04	Ultra low phase noise	Optimize phase noise, 10GHz@10kHz: -120dBc/Hz	All models
1465-H05	High power output	Increase maximum output power	All models
1465-H06	Enhanced high power output	Greatly increase maximum output power from 10MHz to 20GHz	1465D only
1465-H80	87230 USB power probe	For power measurement and calibration (50 MHz-6 GHz)	All models
1465-H81	87231 USB power probe	For power measurement and calibration (50 MHz-18 GHz)	All models
1465-H82	87232 USB power probe	For power measurement and calibration (50 MHz-26.5 GHz)	All models
1465-H83	87233 USB power probe	For power measurement and calibration (50 MHz-40 GHz)	All models

## 8.4 Option Information

Option Number	Name	Function	Applicability
1465-H90	National military standard electromagnetic compatibility	Comply with GJB-151A electromagnetic compatibility regulations (without touch screen function)	All models
1465-H91	N type RF output port	Change the RF output port to N type (female)	1465D only
1465-H92	Rear panel RF output	Move the RF output port to the rear panel	All models
1465-H94	Rack mounting kit	Mounting kit for upper cabinet	All models
1465-H95	Commercial calibration certificate	Entrust a metrology agency for instrument measurement	All models
1465-H96	5-year extended warranty	Extend the warranty period to 5 years	All models
1465-H97	Color printed user manual	Color printed user and programming manuals	All models
1465-H98	English kit	Panel, software interface, and user and programming manuals in English	All models
1465-H99	Aluminum alloy transport case	A high-strength lightweight aluminum alloy transport case with a handle and universal wheels for easy transportation	All models

Table 8.5 1465-V Series Options

Option Number	Name	Function	Applicability
1465-H01A	115dB programmable step attenuator	Used to extend the output power dynamic range	A/B/C/D/F-V only
1465-H01B	90dB programmable step attenuator	Used to extend the output power dynamic range	H/L-V only
1465-H02A	Analog modulation	Add analog modulation function	All models
1465-H02B	Pulse modulation	Add pulse modulation function with minimum pulse width of 100 ns	All models
1465-H02C	Narrow pulse modulation	Add pulse modulation function with minimum pulse width of 20 ns	All models, including H02B
1465-H03	Analog sweep frequency	Add analog sweep frequency function (Ramp Sweep)	All models
1465-H04	Ultra low phase noise	Optimize phase noise, 10GHz@10kHz: -120dBc/Hz	All models
1465-H05	High power output	Increase maximum output power	All models
1465-H31	Large modulation bandwidth	Extend internal modulation bandwidth to 200 MHz	All models
1465-H32	High-capacity built-in baseband memory	Extend built-in baseband memory to 8 GB	All models
1465-H33	Broadband external IQ input	Add broadband external IQ input function	1465C/D/F-V only

8.5 Supplementary Information

Option Number	Name	Function	Applicability
1465-H80	87230 USB power probe	For power measurement and calibration (50 MHz-6 GHz)	All models
1465-H81	87231 USB power probe	For power measurement and calibration (50 MHz-18 GHz)	All models
1465-H82	87232 USB power probe	For power measurement and calibration (50 MHz-26.5 GHz)	All models
1465-H83	87233 USB power probe	For power measurement and calibration (50 MHz-40 GHz)	All models
1465-H90	National military standard electromagnetic compatibility	Comply with GJB-151A electromagnetic compatibility regulations (without touch screen function)	All models
1465-H91	N type RF output port	Change the RF output port to N type (female), for 1465D-V only	1465D-V only
1465-H92	Rear panel RF output	Move the RF output port to the rear panel	All models
1465-H94	Rack mounting kit	Mounting kit for upper cabinet	All models
1465-H95	Commercial calibration certificate	Entrust a metrology agency for instrument measurement	All models
1465-H96	5-year extended warranty	Extend the warranty period to 5 years	All models
1465-H97	Color printed user manual	Color printed user and programming manuals	All models
1465-H98	English kit	Panel, software interface, and user and programming manuals in English	All models
1465-H99	Aluminum alloy transport case	A high-strength lightweight aluminum alloy transport case with a handle and universal wheels for easy transportation	All models

8.5 Supplementary Information

- General Information.....220

8.5.1 General Information

- Front Panel Port.....220
- Rear Panel Port.....221
- EMC and Safety.....错

误 ! 未 定 义 书 签 。

8.5.1.1 Front panel port

Table 8.4 Front Panel Port

Front panel port				
	1465A/B/C	1465D	1465F	1465H/L
RF output port	N type (female)	3.5 mm (male) Option H91: N type (female)	2.4mm (male)	1.85mm (male)

## 8.5 Supplementary Information

<b>I/Q input</b>	BNC female for inputting I and Q signals. Input impedance 50 Ω, damage level 1 V <sub>rms</sub> , 5 V <sub>peak</sub>
<b>AM input</b>	BNC female, external AM input.
<b>FM/ΦM input</b>	BNC female, external FM/ΦM input.
<b>Pulse input</b>	BNC female, TTL low level off RF output, typical input impedance 2 kΩ. Damage level ≥ +5.5V or ≤ -0.5V.
<b>Monitor output</b>	BNC female, which outputs pulse modulation wave generated by the drive modulator. Internal or external pulse modulation.
<b>Sync output</b>	BNC female, which outputs a 100 ns wide TTL sync pulse that is synchronized with the rising edge of the pulse generated by the internal pulse generator.
<b>LF output</b>	BNC female, which outputs low-frequency signals with the frequency of 1Hz ~ 10MHz, the amplitude of 40mVP to 4VP, and the impedance of 50Ω.
<b>External detection input</b>	BNC female, which provides the user with amplitude level control function.
<b>USB port</b>	It is used to connect mouse and keyboard to upgrade system software and back up data.

## 8.5.1.2 Rear panel port

Table 8.5 Rear Panel Port

Rear panel port	
<b>Broadband I/I input</b>	BNC female, used when selecting the external broadband baseband signal I/I input by I/Q modulation.
<b>Broadband Q/Q input</b>	BNC female, used when selecting the external broadband baseband signal Q/Q input by I/Q modulation.
<b>I/I output</b>	BNC female, used to output baseband I/I signals.
<b>Q/Q output</b>	BNC female, used to output baseband Q/Q signals.
<b>IQ clock</b>	SMA female, IQ serial clock input in baseband mode and external data source, with level compatibility of 3.3V-LVTTL.
<b>IQ data</b>	SMA female, IQ serial data input in baseband mode and external data source, with level compatibility of 3.3V-LVTTL.
<b>Trigger input</b>	SMA female, external trigger signal input in baseband and arbitrary waveform mode, with level compatibility of 3.3V-LVTTL.
<b>Code-pattern input</b>	<b>trigger</b> SMA female, external code-pattern trigger input in baseband and arbitrary waveform mode, with level compatibility of 3.3V-LVTTL.
<b>Symbol clock</b>	SMA female, symbol clock input in baseband mode and external data source, with level compatibility of 3.3V-LVTTL.
<b>Marker 1</b>	Output the marker 1 of the arbitrary wave setting.
<b>Marker 2</b>	Output the marker 2 of the arbitrary wave setting.
<b>Marker 3</b>	Output the marker 3 of the arbitrary wave setting.
<b>Marker 4</b>	Output the marker 4 of the arbitrary wave setting.
<b>Power button</b>	Master power switch of the instrument.
<b>Power input</b>	Power plug, parameter requirements: 220 V (±10%), 50 Hz (±5%), 200W.
<b>1-50MHz input</b>	BNC female, used to receive frequency reference signals with the frequency of 1-50 MHz, the step of 1 Hz and -5 to +10 dBm from the external time base. Typical input impedance 50 Ω, damage level ≥ +10V,

**8.6 Performance Characteristics Test**

	$\leq -5V$ .
<b>10MHz output</b>	BNC female, signal level 0dBm, typical output impedance 50 $\Omega$ .
<b>LAN</b>	It is used for software upgrading and control.
<b>USB</b>	It is used for connecting a mouse, a keyboard, system software upgrading and data backup.
<b>GPIB</b>	Standard IEEE488 interface, support SCPI language.
<b>Sweep output</b>	BNC female, outputting voltage proportional to sweep frequency, 0V and 10V corresponding to frequency start and stop, respectively (0-10V corresponds to overall frequency range in CW working mode).
<b>Trigger output</b>	1601 1 $\mu$ s wide TTL low pulses are evenly output during the analog sweep frequency.
<b>Z-axis blanking/frequency scale output</b>	BNC female, used to output positive pulse (about +5V under 2 k $\Omega$ load) when RF output retraces or the waveband changes, or output negative pulse (-5V) when RF output frequency is active frequency.
<b>Fly-back output</b>	It outputs TTL high level when sweep starts, and TTL low level when sweep stops.
<b>Stop sweep input/output</b>	BNC female, outputting TTL high level when sweep starts, and TTL low level when sweep stops, a forced stop of sweep is allowed when externally grounded.
<b>Trigger input</b>	BNC female, TTL rising edge active, used for external trigger step and frequency hopping in list sweep.

**8.6 Performance Characteristics Test**

- [Recommended Test Method](#) .....222
- [Performance Characteristics Test Record](#).....235
- [Recommended Instruments for Performance Characteristics Test](#).....246

**8.6.1 Recommended test method**

- [Frequency Characteristics](#).....222
- [Power Characteristics](#).....227
- [Modulation Characteristics](#).....229
- [Source Voltage Standing Wave Ratio Test](#).....233

**8.6.1.1 Frequency characteristics****1) Frequency range****a) Test description**

The frequency range, also known as frequency coverage, is the frequency range over which the signal generator can provide acceptable signals. It is usually specified by its upper and lower frequency limits. This test is to verify whether the frequency range of the signal generator is acceptable. When the output frequency of the signal generator under test is set to more than 40 GHz, the fundamental wave frequency mixer is used for down-conversion, and then the microwave frequency meter is used for testing.



## b) Test block diagram

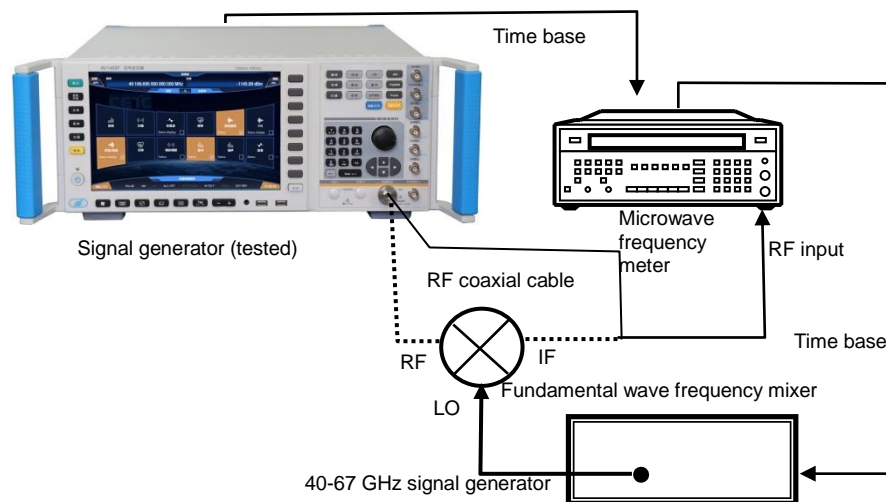

Figure 8.1 Frequency Range Test Block Diagram

## c) Test equipment

Microwave frequency meter 3212D	1 set
Signal generator 1465	1 set
RF coaxial cable	1 piece
Fundamental wave frequency mixer	1 set

## d) Test procedures

**Step 1. Power on and reset it, and warm it up for at least 30 minutes.**

**Step 2. Connect the device as shown in Figure 8.1.**

**Step 3. Set the signal generator under test to continuous wave mode.**

**Step 4. Set the output frequency of the signal generator to the lower limit frequency of 100 kHz and the power of +10 dBm. Test directly with the microwave frequency meter and record the measurement results.** If the test result is within  $100 \text{ kHz} \pm 1 \text{ Hz}$ , the test at this frequency point is successful. Otherwise, the test fails.

**Step 5. Set the output frequency of the signal generator to the upper limit frequency.** When the frequency is 40 GHz and below, the output frequency value of the signal generator under test is directly measured with a frequency meter. When the frequency is between 50 GHz and 67 GHz, the frequency mixer and the local oscillator source are connected as shown in the figure. The local oscillator source and the frequency meter shall have the same time base. The frequency of the local oscillator is set to 45 GHz and 60 GHz respectively, and the power is 10 dBm. The test results are the results measured by the frequency meter plus 45 GHz and 60 GHz. Test results should be as follows: 1465A : within  $3 \text{ GHz} \pm 1.5 \text{ kHz}$ , 1465B: within  $6 \text{ GHz} \pm 3 \text{ kHz}$ , 1465C: within  $10 \text{ GHz} \pm 5 \text{ kHz}$ , 1465D: within  $20 \text{ GHz} \pm 10 \text{ kHz}$ , 1465F: within  $40 \text{ GHz} \pm 20 \text{ kHz}$ , 1465H: Within  $50 \text{ GHz} \pm 25 \text{ kHz}$ , and 1465L: within  $67 \text{ GHz} \pm 33 \text{ kHz}$ .

**Step 6. Record the tests and process the data.**

## 2) Frequency resolution

## a) Test description

The frequency resolution is the output frequency interval that the broadband signal generator can precisely control. Change the continuous wave frequency of the broadband signal generator by 0.001 Hz and observe whether the change of the signal frequency is 0.001 Hz by using a frequency counter (frequency comparator). If yes, the frequency resolution of the broadband signal generator is 0.001 Hz.

8.6 Performance Characteristics Test

b) Test block diagram

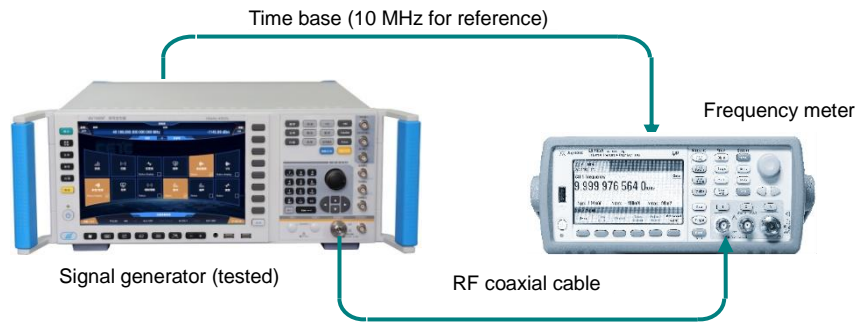

Figure 8.2 Frequency Resolution Test

c) Test equipment

Frequency meter keysight53520A	1 set
RF coaxial cable	2 pieces
2.4 mm(f) to 3.5mm (f) connector	1 piece
BNC cable	1 piece

d) Test procedures

**Step 1. Power on and reset it, and warm it up for at least 30 minutes.**

**Step 2. Connect the device as shown in Figure 8.2.**

**Step 3. Set the signal generator frequency to 1.000 000 001 MHz, the power to 0 dBm, and RF on.**

**Step 4. Set the frequency meter to work in channel 1 mode with a resolution of 0.001 Hz.**

**Step 5. Change the output frequency of the signal generator under test to 0.001 Hz and observe if the test value of the frequency meter changes by 0.001 Hz.**

**Step 6. If the test meets the requirements, record the test results in the performance test records.**

3) Internal time base aging rate

a) Test description

This test is used to check the daily aging rate index of the internal time base. Under the preheating time and environmental conditions meeting the requirements, measure the frequency drift of the internal time base of the instrument with the standard time base and the frequency comparator once every 12 h, continuously measure 3 numbers, and take the arithmetic mean as the test result at the time of  $t_i$ . The measurement is continuously made for more than 7 days, and the average frequency drift is the internal time base aging rate.

The internal time base aging rate index is tested by the time base manufacturer and is mainly used to indicate the long-term drift of the frequency standard. There is no specific test in this manual, but general verification method is given below.

Before the test, the internal time base should be fully preheated. After the instrument is disconnected from the AC power for 2 h, it needs to be warmed up for 30 days to reach the specified time base aging rate. If the internal time base and the frequency standard differ greatly in frequency, "10 MHz Standard Debugging" should be performed to keep the same frequency accuracy of the internal time base as that of the standard time base.

Due to the impact of the test environment on the accuracy of the internal time base, the test shall be carried out with the followings ensured:

The ambient temperature changes within  $\pm 2$  °C.

The instrument maintains the same direction as the earth's magnetic field.

The instrument is at the same height.

- 4) The instrument shall not be subjected to any mechanical shock.

**b) Test block diagram**

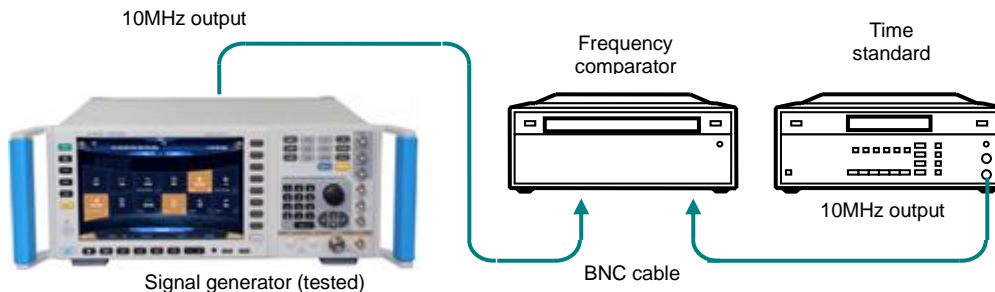

Figure 8.3 Internal Time Base Aging Rate Test

**c) Test equipment**

Frequency standard	HP5061/CH-47	1 set
Frequency comparator (CH7-45 recommended)		1 set
BNC cable		2 pieces

**d) Test procedures**

**Step 1. Power on and reset it, and warm it up for at least 30 minutes.**

**Step 2. Connect the device as shown in Figure 8.3.**

**Step 3. Set the signal generator under test:** Continuous wave 10 GHz, power 0 dBm, and RF on.

**Step 4. The reading of the frequency comparator is relative average frequency offset. Read a set of relative average frequency offset data every 12 hours, measure three numbers in each group and take the arithmetic average as the time measurement data (n=2 measurements per day).** Continuously measure it for 7 days and get a total of 15 measurement data.

**Step 5. Calculate the daily aging rate K by the following formula:**

$$A = \frac{2 \sum_{i=1}^N (Y_i - Y_p)(t_i - t_p)}{\sum_{i=1}^N (t_i - t_p)^2}$$

Where,

$Y_i$  --- the frequency value measured for the  $i^{\text{th}}$  measurement in Hz;

$Y_p$  --- the average frequency measured for N measurements in Hz;

$t_i$  --- the time for the  $i^{\text{th}}$  measurement in h;

$t_p$  --- the time of the  $N^{\text{th}}$  measurement in h;

N --- the number of measurements.

Notes: Refer to 5.15.5 in GB/T 12114-2013 for test methods.

8.6 Performance Characteristics Test

4) Harmonic parasitism

a) Test description

This test is used to verify whether the harmonic index of the signal generator is acceptable. The harmonic is an integer multiple of the output frequency of the signal generator. During this test, set the output power of the signal generator to a power level of +10 dBm or the maximum indicated output power, manually adjust the output frequency within the index frequency range, and test and find the worst point of the harmonics with the spectrum analyzer.

b) Test block diagram

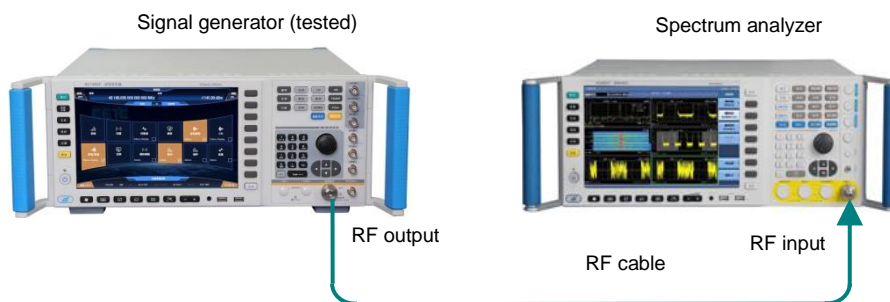

Figure 8.4 Harmonic Test

c) Test equipment

Spectrum analyzer 4051	1 set
RF coaxial cable	1 piece

d) Test procedures

**Step 1. Power on and reset it, and warm it up for at least 30 minutes.**

**Step 2. Connect the device as shown in Figure 8.4.**

**Step 3. Set the signal generator under test to continuous wave mode, the power level to +10 dBm or the maximum indicated power and RF on.**

**Step 4. Adjust the output frequency up to 33.5 GHz within the signal generator specifications, test and find the worst point of the harmonics with the spectrum analyzer.** During the test, the signal generator shall be tested in segments (segment point at 3.2 GHz), and the span of the spectrum analyzer shall be appropriately adjusted according to the change of the output frequency of the signal generator. During the test, the frequency step of the signal generator before the segment point is 10 MHz, and the frequency step after the segment point is 100 MHz.

**Step 5. Record the test results.**

5) Non-harmonic parasitism

a) Test description

This test is used to verify whether the non-harmonic indexes are acceptable within the entire frequency range of the signal generator. Non-harmonics are undesired parasitic or residual signals generated by the frequency synthesis section and appear as fixed signal outputs or signal outputs with some frequency offset. Set the signal generator to a series of CW output frequencies that are most likely to produce non-harmonics, and then tune the spectrum analyzer to the corresponding parasitic signals to measure and find the worst point of the non-harmonics.

b) Test block diagram

The test block diagram is the same as 8.4.

c) Test equipment

Spectrum analyzer 4051	1 set
------------------------	-------

## d) Test procedures

**Step 1. Power on and reset it, and warm it up for at least 30 minutes.**

**Step 2. Connect the device as shown in Figure 8.4.**

**Step 3. Set the signal generator under test:** Continuous wave 100MHz, power 0 dBm, and RF on.

**Step 4. Use the spectrum analyzer to measure the level dBc of non-harmonic parasitic deviation carrier beyond 3 kHz from the carrier and record it in the test record. If non-harmonic parasitism is not visible, no record is taken.**

**Step 5. Set the span of the spectrum analyzer to 500 kHz and 5 MHz respectively, and repeat the step 4.**

**Step 6. Set the output frequency of the signal generator to 3 GHz, 6/10 GHz, 20 GHz, 28.5 GHz (1465F/H/L-V), 40 GHz, and 50/67 GHz respectively and repeat the steps 4 and 5.**

**Step 7. Record the test results in the performance test records.**

## 8.6.1.2 Power characteristics

## 1) Maximum ALC output power test

## a) Test description

This test is used to verify whether the ALC output power range of the signal generator is acceptable. Set the output power of the signal generator under test to 3 dB above the maximum indicated output power and use the power meter to directly test the ALC output power range.

## b) Test block diagram

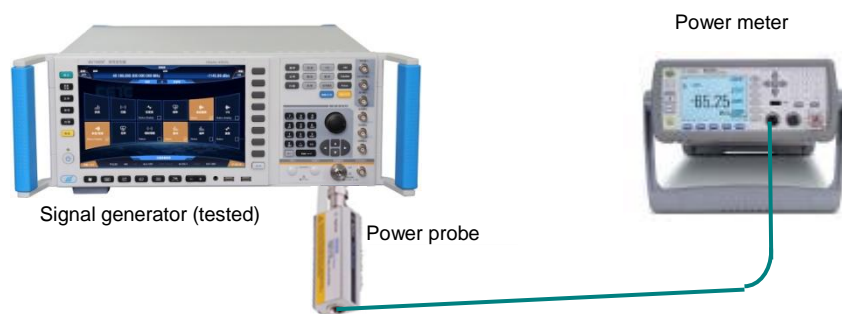

Figure 8.5 Maximum ALC Output Power Test

## c) Test equipment

Power meter 2438/N1914A	1 set
Power meter probe 81702/N8488A	1 piece

## d) Test procedures

**Step 1. Power on and reset it, and warm it up for at least 30 minutes.**

**Step 2. Connect the device as shown in Figure 8.5.**

**Step 3. Set the signal generator to the fixed frequency mode, the output frequency to 100 kHz (10 MHz for the H06 option), the output power to 3 dB above the maximum indicated power, and the RF on.**

**Step 4. When there is no “No ALC” indication on the signal generator, use the power meter to measure the power value at this time and fill it in the test record table. When the “No ALC” indication appears on the signal generator, gradually reduce the output power of the signal generator by 0.1 dB. When the “No ALC” indication just disappears, record the power meter reading at this time and fill it in the test record table.**

**Step 5. Set the output frequency of the signal generator to 10 MHz, 250 MHz, 3/6 GHz, 9 GHz,**

**8.6 Performance Characteristics Test**

10 GHz, 15 GHz, 20 GHz, 30 GHz, 40 GHz, 50 GHz, and 67 GHz respectively until the highest frequency is reached, and then repeat the step 4.

**Step 6. Record the tests and process the data.**

**2) Minimum ALC output power test**

**e) Test description**

This test is used to verify whether the minimum ALC output power range of the signal generator is acceptable.

**f) Test block diagram**

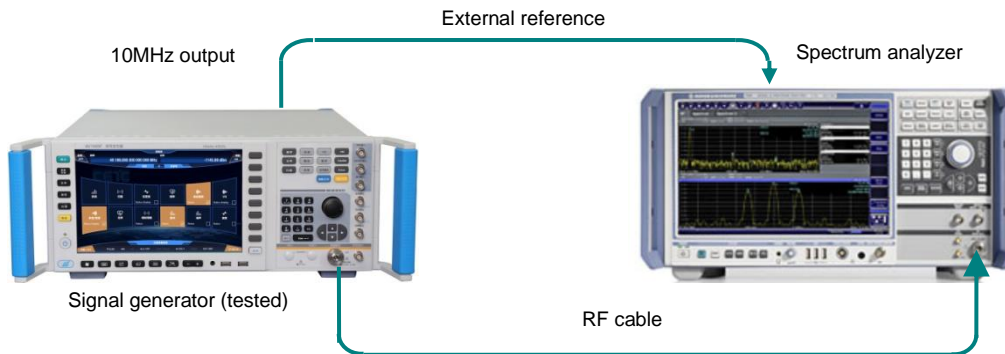

Figure 8.6 Low Power Test

**g) Test equipment**

Power meter 2438/N1914	1 set
Power meter probe 81702/N8488A	1 piece
Spectrum analyzer 4051/FSW	1 set

**h) Test procedures**

**Step 1. Power on and reset it, and warm it up for at least 30 minutes.**

**Step 2. Connect the device as shown in Figure 8.5, set the signal generator frequency to 100 kHz and the power to 0 dBm, and record the reading P1 of the power meter.**

**Step 3. Connect the spectrum analyzer to the signal generator as shown in Figure 8.6. Set the power of the signal generator to 0 dBm. Set this level to the reference level and use the spectrum analyzer relative measurement mode to set the signal generator power to the minimum ALC power. Use the spectrum analyzer to test relative difference P2 of its minimum ALC power relative to 0 dBm (P1 + P2 is the measured value of the minimum ALC output power) and record the measured value on the test record table.**

**Step 4. When the attenuator is not used, the minimum ALC range is acceptable if the measured value of the minimum ALC output power is within the power accuracy index. When the attenuator is used, the minimum ALC range is acceptable if the error of the minimum ALC output power measured for 1465A/B/C/D/F or for 1465H and 1465L is within  $\pm 3.5$  dB or  $\pm 4$  dB.**

**Step 5. Set the output frequency of the signal generator to 10 MHz, 1 GHz, 3/6/10 GHz, 20 GHz, 40 GHz, 50 GHz, and 67 GHz respectively and repeat the steps 1) to 3).**

**Step 6. Record the tests and process the data.**

**3) Power accuracy**

**a) Test description**

This test is used to check whether the power accuracy index of the signal generator satisfies requirements at several frequency points with the power meter and the spectrum analyzer. Set the

**8.6 Performance Characteristics Test**

frequency of the signal generator to 100 kHz, 10 MHz, 500 MHz, 3/6/10 GHz, 20 GHz, 40 GHz, 50 GHz, and 67 GHz respectively, and gradually decrease the power output from the maximum indicated output power to the minimum indicated power (-20dBm when the attenuator is not used and select the appropriate index according to different attenuators when they are used), and measure whether the output power accuracy is acceptable with the power meter and the spectrum analyzer.

**b) Test block diagram**

The same as the Figures 8.5 and 8.6.

**c) Test equipment**

Power meter 2438/N1914A	1 set
Power meter probe 81702/N8488A	1 piece
Spectrum analyzer 4051/FSW	1 set

**d) Test procedures**

**Step 1. Connect the device as shown in Figure 8.5 and start and warm up for at least 30 minutes.**

**Step 2. Set the signal generator output frequency to 100 kHz, maximum indicated output power level, and RF on.**

**Step 3. Connect the power meter and set the power meter frequency to 100 kHz. Then set the signal generator output power up to -10 dBm with the step of 1 dB. Record the measured value on the test record table.**

**Step 4. Set the signal generator power to 0 dBm and record the reading P1 of the power meter.**

**Step 5. Connect the spectrum analyzer to the signal generator as shown in Figure 8.6. Set the signal generator power to 0 dBm, attenuate to the minimum indicated power P2 with the step of 10 dB, and test the relative difference P3 between the power at each frequency point and 0 dBm.**

The power accuracy error is:  $\Delta = P3 - P1 - P2$ , fill in the test record table.

**Step 6. Set the output frequency of the signal generator to 10 MHz, 500 MHz, 3/6/10 GHz, 20 GHz, 40 GHz, 50 GHz, and 67 GHz respectively and repeat the steps 3 and 4.**

**Step 7. Record the tests and process the data.**

**8.5.1.3 Modulation characteristics****1) Pulse modulation rise and fall time test****a) Test description**

This test is used to verify whether the pulse modulation rise and fall time of the signal generator is acceptable. Detect the pulse modulation signal with the detector and use the oscilloscope to observe whether the rise and fall time of the detected pulse signal meets the requirement of the specifications.

**b) Test block diagram**

Figure 8.7 Pulse Modulation On-off Ratio Test

**8.6 Performance Characteristics Test**

**c) Test equipment**

Digital storage oscilloscope TDS220/TDS4054 1 set  
 Coaxial detector 1 set

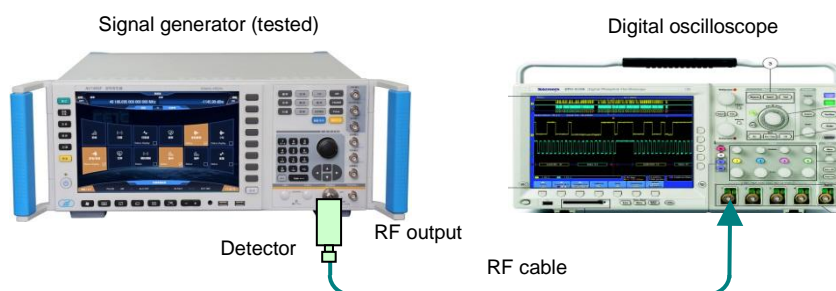
**d) Test procedures**

**Step 1. Power on and reset it, and warm it up for at least 30 minutes.**

**Step 2. Connect the device as shown in Figure 8.7.**

**Step 3. Set the signal generator under test to 2 GHz continuous wave with the power level of 0 dBm.**

**Step 4. Set the pulse modulation form of the signal generator under test as follows:**

PM Source Auto

Width 5 $\mu$ s

Period 10 $\mu$ s

Modulation ON

**Step 5. Set the digital storage oscilloscope to measure the pulse modulation rise and fall time as follows:**

Chan1 On DC Couple 10 mV/div Invert ON Probe 1X Impedance 50  $\Omega$

Trigger Trig Source Chan1 Trigger Couple DC Trigger Mode Auto Edge

Trig Level 10 mV Trig Edge Rise

Time Base 1  $\mu$ s/Div

Adjust the time base delay to allow the oscilloscope to display at least one cycle of the signal

Select the rise or fall time measurement in **【MEASURE】** function of the oscilloscope so that the oscilloscope automatically measures the pulse rise or fall time.

**Step 6. Follow the above steps for 1465C/D/F/H/L.** Test the pulse modulation rise and fall time at 10 GHz of the signal generator under test.

**Step 7. Record the tests and process the data.**

**2) Pulse modulation on-off ratio test**

**a) Test description**

The pulse modulation on-off ratio mainly reflects the signal leakage when the pulse modulation is off. Turn on or off the pulse modulation and measure the difference between the signal powers in the two cases as the pulse modulation on-off ratio.

**b) Test block diagram**

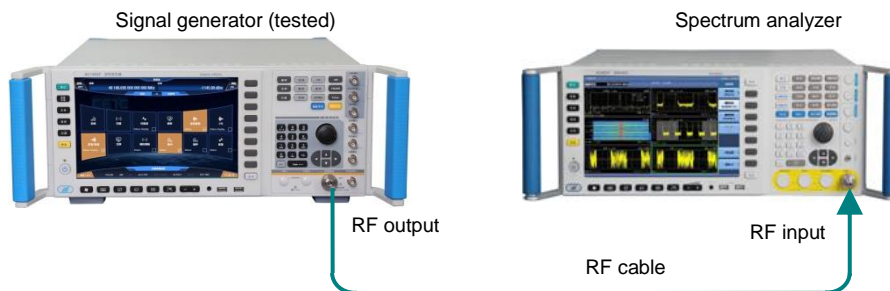

Figure 8.8 Pulse Modulation Rise/Fall Test

**c) Test equipment**

Spectrum analyzer 4051 1 set



## 8.6 Performance Characteristics Test

RF coaxial cable

1 piece

## d) Test procedures

**Step 1. Power on and reset it, and warm it up for at least 30 minutes.**

**Step 2. Connect the device as shown in Figure 8.8.**

**Step 3. Set the signal generator to 250 kHz continuous wave with the power level of 0 dBm.**

**Step 4. Set up the spectrum analyzer as follows:** The center frequency is 250 kHz, the span is 200 kHz, and the reference level is 5 dBm.

**Step 5. Measure the pulse modulation on-off ratio on the spectrum analyzer by using the frequency marker and frequency marker difference functions:** Freq Marker Freq Marker Peak Freq Marker Delta ON.

Set the signal generator for pulse modulation as follows: Modulation Pulse Modulation Pulse Input Selection Ext Pulse Modulation ON, observe and record the on-off ratio at this time on the spectrum analyzer.

Set the signal generator to cancel the pulse modulation as follows: Modulation Pulse Modulation Pulse Modulation OFF.

**Step 6. Test the pulse modulation on-off ratio of the signal generator at 1 GHz, 3 GHz, 10 GHz, 15 GHz, 20 GHz, 25 GHz, 30 GHz, 35 GHz, 40 GHz, and 67 GHz respectively and record the worst test result in the performance test record.**

## 3) EVM and original offset test

## a) Test description

This test is used to verify whether the EVM and the original offset of the vector signal generator meet the requirements of the specifications.

## b) Test block diagram

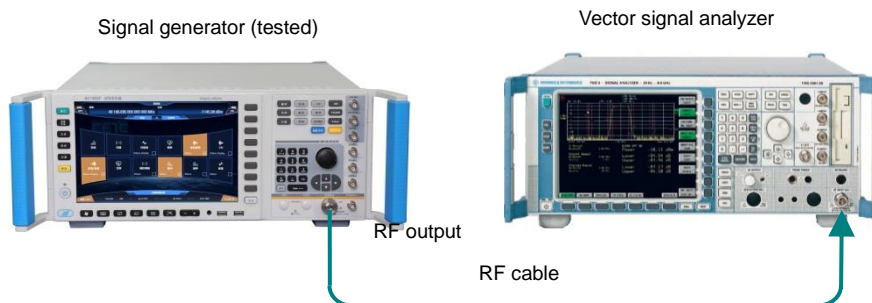

Figure 8.9 EVM and Original Offset Test

## c) Test equipment

Spectrum analyzer FSQ40

1 set

## d) Test procedures

**Step 1. Power on and reset it, and warm it up for at least 30 minutes.**

**Step 2. Connect the device as shown in Figure 8.9.**

**Step 3. Set the vector signal generator:** Continuous wave 900 MHz and power level 0 dBm.

**Step 4. Set the tested vector signal generator as follows:** Base Base ON; Modulation Type QPSK; Symbol Rate 4M; filter root Nyquist  $\alpha=0.3$ ; I/Q I/Q Modulation Source INT

**Step 5. Set the vector signal analyzer to measure EVM and original offset as follows:**

Frequency 900 MHz

### 8.6 Performance Characteristics Test

Symbol Rate 4 MHz

Modulation Type QPSK

Modulation filter Transmitter filter RRC Receiver filter RRC

Measurement filter RRC ALFA/BT 0.3

EVM and Original OFFSET displayed by the vector signal analyzer are the tested EVM and original offset.

**Step 6. Test the EVM and original offset of the tested vector signal generator at 1.8 GHz, 2.4 GHz, 6 GHz, 12 GHz, 18 GHz, 24 GHz, and 35 GHz according to the above steps.**

#### 4) Internal modulation bandwidth test

##### a) Test description

This test is used to verify whether the internal modulation bandwidth of the vector signal generator is acceptable.

##### b) Test block diagram

The same as the Figure 8.9

##### c) Test equipment

Spectrum analyzer FSQ40 1 set

##### d) Test procedures

**Step 1. Power on and reset it, and warm it up for at least 30 minutes.**

**Step 2. Connect the device as shown in Figure 8.9.**

**Step 3. Set the vector signal generator:** Continuous wave 900 MHz, power level 0 dBm, and RF on.

**Step 4. Set the tested vector signal generator as follows:**

Multi Tone Multi Tone ON

Tone Count 51

Freq Interval 2.4 MHz (option H31: 4 MHz).

**Step 5. Set up the signal analyzer as follows:**

Center Freq 900 MHz

Ampl 0 dBm

Span 300 MHz

Ampl 1 dB/Div

Trace Max. Hold

With the delta frequency marker function of the signal analyzer, the power difference between the maximum and minimum power points is divided by 2 to get the modulation frequency response.

**Step 6. Test the frequency responses of the tested vector signal generator at 1.8 GHz, 2.4 GHz, 6 GHz, 18 GHz, and 35 GHz respectively according to the above steps.**

#### 5) External modulation bandwidth test

##### a) Test description

This test is used to verify whether the external modulation bandwidth of the vector signal generator is acceptable. A sweep frequency signal is input in the I channel of the vector signal generator. The I/Q modulation generates a double-sideband modulation signal, and the signal analyzer is used to observe the frequency response of the double-sideband signal. When testing, the vector signal generator is set to ALC open loop. The sweep time of the sweep signal generator is set to 50 s.

## b) Test block diagram

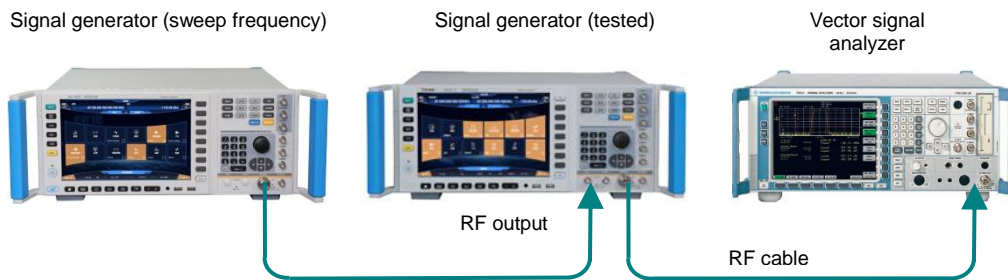

Figure 8.10 External FM Frequency Response Test

## c) Test equipment

Spectrum analyzer FSQ40	1 set
1465D	1 set

## d) Test procedures

**Step 1. Power on and reset it, and warm it up for at least 30 minutes.**

**Step 2. Connect the device as shown in Figure 8.10.**

**Step 3. Set the vector signal generator:**

CW 900 MHz, Power Level 0 dBm

Amplitude ALC Loop State ALC-ON Search

I/Q I/Q Data Source EXT 50Ω I/Q Modulate ON.

**Step 4. Set the sweep signal generator:**

Freq Start 1 MHz Freq Stop 200 MHz Sweep Time 50 s

Power Level 0 dBm

**Step 5. Set up the signal analyzer as follows:**

Center Freq 900 MHz

Span 300 MHz Amplitude 1 dB/Div

Trace Max. Hold

Observe the power difference between the maximum and minimum power points of the trace on the signal analyzer and divide the power difference by 2 to be the frequency response.

**Step 6. Test the external modulation bandwidth frequency responses of the tested vector signal generator at 1.8 GHz, 2.4 GHz, 6 GHz, 18 GHz, and 35 GHz respectively according to the above steps.**

## 8.6.1.4 Source voltage standing wave ratio test

## 1) Test description

This test is used to determine whether the source voltage standing wave ratio index of the signal generator meets the requirements by using the power meter, directional coupler, and sliding load. The source voltage standing wave ratio reflects the degree of influence of the reflected signal on the output power of the final signal generator when the signal generator mismatches during output. Refer to 5.15.14 in GB 12114-2013 for test methods.

8.6 Performance Characteristics Test

2) Test block diagram

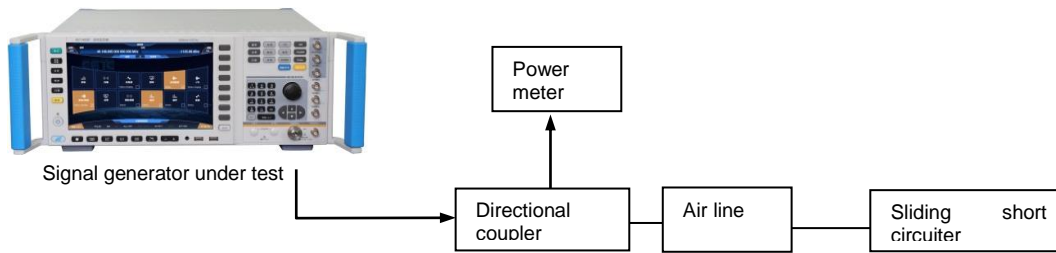

Figure 8.11 Source Standing Wave Test

3) Test equipment

Power meter 2434/N1911	1 set
Power meter probe 23212/N8488A	1 piece
Directional coupler HP778D	1 set
Directional coupler 2.969.504MX	1 set

4) Test procedures

**Step 1. Power on and reset it, and warm it up for at least 30 minutes.**

**Step 2. Connect the device as shown in Figure 8.11.** The HP778D directional coupler is used and it is powered on and reset and warmed up for at least 30 minutes.

**Step 3. Set the signal generator to 100 MHz continuous wave, and set it to the state of internal amplitude level control continuous wave output and the output power to the maximum indicated power**

**Step 4. Adjust the sliding short circuiter knob to change the short-circuit length back and forth in a wavelength range of the measured frequency and test the power value of the coupled port with the power meter. .**

**Step 5. Find the maximum peak power  $P_{max}$  (mW) and the minimum valley power  $P_{min}$  (mW) that change with the variable length of the short circuiter and then obtain the source voltage standing wave ratio  $S$  by using the following formula:**

$$S = \sqrt{\frac{P_{max}}{P_{min}}}$$

Where,

$S$  --- source voltage standing wave ratio;

$P_{max}$  --- maximum peak power;

$P_{min}$  --- minimum valley power

**Step 6. Repeat the steps 2, 3 and 4, set the frequency of the signal generator to 1 GHz, 3 GHz, 5 GHz, 10 GHz, 30 GHz, and 67 GHz for test respectively and replace the corresponding directional coupler according to the frequency band.**

**8.6 Performance Characteristics Test****8.6.2 Performance characteristics test record table**

Test location: \_\_\_\_\_ Test environment: \_\_\_\_\_ Test time: \_\_\_\_\_

DUT number: \_\_\_\_\_ Testers: \_\_\_\_\_

Table 8.6 Appearance and Structure, Functional Normality Test Record

Test Item	Requirements	Test Result
Appearance and structure	The surface should be clean and free of rust, mildew, stains, peeling of plating or coating and obvious scratches or burrs; plastic parts should be free of blistering, cracking and deformation; texts, symbols, signs and various displays should be clear and secure. The structural and control parts should be complete without mechanical damage; all control parts must be installed correctly, firmly and reliably and operated flexibly.	
Functional normality	Local function check: After being powered on, the modulation domain analyzer shall normally display the measurement interface without any error prompt; the keyboard keys on the front panel, if pressed, shall be able to respond normally.	
	Programmable function check: The external main control computer is connected to the GPIB and the LAN cables. The main control computer sends the “*IDN?;” command via the GPIB and the network port respectively. If the function is normal, the message “CETC41, 1465, XXXXXXXX,Y.Y.Y” shall be returned. “XXXXXXX” represents the product batch number and “Y.Y.Y” represents the product software version number.	

**8.6 Performance Characteristics Test**

Test location: \_\_\_\_\_ Test environment: \_\_\_\_\_ Test time: \_\_\_\_\_

DUT number: \_\_\_\_\_ Testers: \_\_\_\_\_

Table 8.7 Specification Test Record

No.	Test Content		Specification		Measured Value
1	Structure and appearance	/	The surface should be smooth and free of burrs, obvious mechanical damage and coating damage. The structure should be complete. The control parts should be installed correctly and reliably and operated flexibly.		
2	Safety	MΩ	The insulation resistance of the instrument shall not be less than 100 MΩ under the standard atmospheric conditions for test;		
		/	AC1.5kV/10mA/1min, no flashover or breakdown;		
		mA	Voltage 242V, 1min, leakage current ≤ 3.5.		
3	Functional normality	/	After the instrument is powered on, the rear panel fan rotates, the green indicator near the power switch of the instrument lights up, there is a picture on the display, and the keys are operated flexibly. The front panel shows no indication of Lock Loss and No ALC within the index range.		
4	Frequency range	1465A/A-V	100 kHz ~ 3 GHz		
		1465B/B-V	100 kHz ~ 6 GHz		
		1465C/C-V	100 kHz ~ 10 GHz		
		1465D/D-V	100 kHz ~ 20 GHz		
		1465D/D-V +H06	10 MHz ~ 20 GHz		
		1465F/F-V	100 kHz ~ 44 GHz		
		1465H/H-V	100 kHz ~ 50 GHz		
		1465L/L-V	100 kHz ~ 67 GHz		
5	Frequency resolution	0.001Hz			
6	Frequency accuracy	±5×10 <sup>-8</sup>			
7	Minimum amplitude level control output power	1465A/B/C/D/F	Without the attenuator option H01A	-20dBm	
			With the attenuator option H01A	-110dBm	
		1465D + H06 option	Without the attenuator option H01A	-10dBm	
			With the attenuator option H01A	-90dBm	
		1465H/L	Without the attenuator option H01B	-20dBm	
			With the attenuator option H01B	-90dBm	

Table 8.7 (Continued 1)

No.	Test Content		Specification			Measured Value	
8	Maximum amplitude level control output power	1465A/B/C/D	10MHz≤f≤250MHz (H08 low noise mode, H07 filter on)		+12dBm		
			Standard	100kHz<f≤20GHz	+15dBm		
			Option H05	100kHz<f≤20GHz	+20dBm		
		1465D + enhanced high power option H06	Standard	10MHz≤f≤20GHz		+28dBm	
			Attenuator H01A	10MHz≤f≤20GHz		+27dBm	
		1465F	10MHz≤f≤250MHz (H08 low noise mode, H07 filter on)		+10dBm		
			Standard	100kHz<f≤40GHz		+12dBm	
			High power option H05	100kHz≤f≤9GHz		+20dBm	
				9GHz<f≤40GHz		+17dBm	
		1465H/L	Standard	100kHz<f≤67GHz		+5dBm	
			Attenuator H01B	100kHz≤f≤30GHz		+5dBm	
				30GHz<f≤67GHz		+4dBm	
			High power option H05	10MHz≤f≤250MHz (H08 low noise mode, H07 filter on)		+9dBm	
				100kHz≤f≤15GHz		+17dBm	
				Option H01B		+17dBm	
				15GHz<f≤30GHz		+13dBm	
				Option H01B		+13dBm	
				30GHz<f≤67GHz		+10dBm	
			-V series + H05	30GHz<f≤60GHz		+8dBm	
		Option H01B		+6dBm			
		9	Power accuracy	Without the programmable step attenuator option H01A/B			
100kHz ≤ f ≤ 2GHz	+10dBm < P ≤ +20dBm			±0.8dB			
	-10dBm < P ≤ +10dBm			±0.6dB			
	-20dBm ≤ P ≤ -10dBm			±1.5dB			
2GHz ≤ f ≤ 20GHz	+10dBm < P ≤ +20dBm			±0.8dB			
	-10dBm < P ≤ +10dBm			±0.8dB			
	-20dBm ≤ P ≤ -10dBm			±1.5dB			
20GHz ≤ f ≤ 40GHz	+10dBm < P ≤ +20dBm			±1.0dB			
	-10dBm < P ≤ +10dBm			±0.9dB			
	-20dBm ≤ P ≤ -10dBm		±1.8dB				

8.6 Performance Characteristics Test

Table 8.7 (Continued 2)

No.	Test Content		Specification		Measured Value		
9	Power accuracy	40GHz ≤ f ≤ 50GHz	-10dBm < P ≤ +10dBm	±1.3dB			
			-20dBm ≤ P ≤ -10dBm	±1.8dB			
		50GHz ≤ f ≤ 67GHz	-10dBm < P ≤ +10dBm	±1.5dB			
			-20dBm ≤ P ≤ -10dBm	±2.0dB			
		1465D + option H06 without the attenuator option H01A					
		500MHz ≤ f ≤ 20GHz	> +20dBm	±1.2dB			
			+10dBm < P ≤ +20dBm	±0.8dB			
			-10dBm < P ≤ +10dBm	±0.9dB			
		With the programmable step attenuator option H01A/B					
		100kHz ≤ f ≤ 2GHz	+10dBm < P ≤ +20dBm	±0.8dB			
			-10dBm < P ≤ +10dBm	±0.6dB			
			-70dBm < P ≤ -10dBm	±0.7dB			
			-90dBm < P ≤ -70dBm	±1.5dB			
		2GHz < f ≤ 20GHz	+10dBm < P ≤ +20dBm	±0.8dB			
			-10dBm < P ≤ +10dBm	±0.8dB			
			-70dBm < P ≤ -10dBm	±0.9dB			
			-90dBm < P ≤ -70dBm	±1.8dB			
		20GHz < f ≤ 40GHz	+10dBm < P ≤ +20dBm	±1.0dB			
			-10dBm < P ≤ +10dBm	±0.9dB			
			-70dBm < P ≤ -10dBm	±1.0dB			
			-90dBm < P ≤ -70dBm	±2.0dB			
		40GHz < f ≤ 50GHz	-10dBm < P ≤ +10dBm	±1.3dB			
			-70dBm < P ≤ -10dBm	±1.5dB			
			-90dBm < P ≤ -70dBm	±2.5dB			
		50GHz < f ≤ 67GHz	-10dBm < P ≤ +10dBm	±1.5dB			
			-70dBm < P ≤ -10dBm	±1.8dB			
			-90dBm < P ≤ -70dBm	±3.0dB			
		1465D + option H06 with the attenuator option H01A					
10MHz ≤ f ≤ 500MHz	+10dBm < P ≤ +20dBm	±1.3dB					
	-10dBm < P ≤ +10dBm	±0.9dB					
	-70dBm < P ≤ -10dBm	±1.0dB					
	-90dBm < P ≤ -70dBm	±1.8dB					



Table 8.7 (Continued 3)

No.	Test Content		Specification		Measured Value
9	Power accuracy	500MHz < f ≤ 20GHz	>+20dBm	±1.2dB	
			+10dBm < P ≤ +20dBm	±0.8dB	
			-10dBm < P ≤ +10dBm	±0.8dB	
			-70dBm < P ≤ -10dBm	±1.1dB	
			-90dBm < P ≤ -70dBm	±2.0dB	
10	Harmonic parasitism	Standard	100kHz ≤ f ≤ 1MHz	< -25dBc	
			10MHz < f ≤ 60MHz	< -30dBc	
			10MHz < f ≤ 60MHz Option H07 RF filtering on	< -45dBc	
			60MHz < f ≤ 2GHz	< -30dBc	
			60MHz < f ≤ 2GHz Option H07 RF filtering on	< -55dBc	
			2GHz < f ≤ 6GHz(1465B)	< -35dBc	
			2GHz < f ≤ 6GHz(1465B) Option H07 RF filtering on	< -55dBc	
			2GHz < f ≤ 20GHz	< -55dBc	
			20GHz < f ≤ 67GHz	< -50dBc	
			20GHz < f ≤ 67GHz (1465F/H/L-V)	< -45dBc	
		Enhanced high power option H06	10MHz < f ≤ 60MHz	< -25dBc	
			10MHz < f ≤ 60MHz Option H07 RF filtering on	< -35dBc	
			60MHz < f ≤ 2GHz	< -25dBc	
			60MHz < f ≤ 2GHz Option H07 RF filtering on	< -35dBc	
2GHz < f ≤ 9GHz	< -35dBc				
9GHz < f ≤ 14GHz	< -27dBc				
14GHz < f ≤ 20GHz	< -30dBc				
11	Subharmonic parasitism	100kHz ≤ f ≤ 10GHz	None		
		10GHz ≤ f ≤ 20GHz	< -60dBc		
		20GHz ≤ f ≤ 67GHz	< -50dBc		
		20GHz ≤ f ≤ 67GHz (1465F/H/L-V)	< -45dBc		

8.6 Performance Characteristics Test

Table 8.7 (Continued 4)

No.	Test Content		Specification		Measured Value
12	Non-harmonic parasitism	Standard	100kHz≤f≤250MHz	< -58dBc	
			250MHz≤f≤3.2GHz	< -74dBc	
			3.2GHz≤f≤10GHz	< -62dBc	
			10GHz≤f≤20GHz	< -56dBc	
			20GHz≤f≤40GHz	< -50dBc	
			40GHz≤f≤67GHz	< -44dBc	
			1465F/H/L-V		
			20GHz≤f≤28.5GHz	< -52dBc	
			28.5GHz≤f≤47.5GHz	< -45dBc	
		47.5GHz≤f≤67GHz	< -42dBc		
		Option H04	100kHz≤f≤250MHz	< -58dBc	
			250MHz<f≤3.2GHz	< -80dBc	
			3.2GHz<f≤10GHz	< -70dBc	
			10GHz<f≤20GHz	< -64dBc	
			20GHz<f≤40GHz	< -58dBc	
			40GHz<f≤67GHz	< -52dBc	
			1465F/H/L-V		
			20GHz<f≤28.5GHz	< -52dBc	
28.5GHz<f≤47.5GHz	< -45dBc				
47.5GHz<f≤67GHz	< -42dBc				
13	Single sideband phase noise	Without the H04 ultra-low phase noise option			
		100kHz≤f≤250MHz	100 Hz frequency offset	<-104 dBc/Hz	
			1 kHz frequency offset	<-121 dBc/Hz	
			10 kHz frequency offset	<-128 dBc/Hz	
			100 kHz frequency offset	<-130 dBc/Hz	
		250MHz<f≤500MHz	100 Hz frequency offset	<-108 dBc/Hz	
			1 kHz frequency offset	<-126 dBc/Hz	
			10 kHz frequency offset	<-132 dBc/Hz	
			100 kHz frequency offset	<-136 dBc/Hz	
		500MHz<f≤1GHz	100 Hz frequency offset	<-101 dBc/Hz	
			1 kHz frequency offset	<-121 dBc/Hz	
			10 kHz frequency offset	<-130 dBc/Hz	
			100 kHz frequency offset	<-130 dBc/Hz	

Table 8.7 (Continued 5)

No.	Test Content	Specification	Measured Value		
13	Single sideband phase noise	500MHz < f ≤ 1GHz	100 Hz frequency offset	<-101 dBc/Hz	
			1 kHz frequency offset	<-121 dBc/Hz	
			10 kHz frequency offset	<-130 dBc/Hz	
			100 kHz frequency offset	<-130 dBc/Hz	
		1GHz < f ≤ 2GHz	100 Hz frequency offset	<-96 dBc/Hz	
			1 kHz frequency offset	<-115 dBc/Hz	
			10 kHz frequency offset	<-124 dBc/Hz	
			100 kHz frequency offset	<-124 dBc/Hz	
		2GHz < f ≤ 3.2GHz	100 Hz frequency offset	<-92dBc/Hz	
			1 kHz frequency offset	<-111dBc/Hz	
			10 kHz frequency offset	<-120dBc/Hz	
			100 kHz frequency offset	<-120dBc/Hz	
		3.2GHz < f ≤ 10GHz	100 Hz frequency offset	<-81dBc/Hz	
			1 kHz frequency offset	<-101dBc/Hz	
			10 kHz frequency offset	<-110dBc/Hz	
			100 kHz frequency offset	<-110dBc/Hz	
		10GHz < f ≤ 20GHz	100 Hz frequency offset	<-75dBc/Hz	
			1 kHz frequency offset	<-95dBc/Hz	
			10 kHz frequency offset	<-104dBc/Hz	
			100 kHz frequency offset	<-104dBc/Hz	
		20GHz < f ≤ 40GHz	100 Hz frequency offset	<-69dBc/Hz	
			1 kHz frequency offset	<-89dBc/Hz	
			10 kHz frequency offset	<-98dBc/Hz	
			100 kHz frequency offset	<-98dBc/Hz	
		40GHz < f ≤ 67GHz	100 Hz frequency offset	<-64dBc/Hz	
			1 kHz frequency offset	<-84dBc/Hz	
			10 kHz frequency offset	<-92dBc/Hz	
			100 kHz frequency offset	<-92dBc/Hz	
		1465F/H/L-V without the H04 ultra-low phase noise option			
		20GHz < f ≤ 28.5GHz	100 Hz frequency offset	<-69dBc/Hz	
			1 kHz frequency offset	<-89dBc/Hz	
			10 kHz frequency offset	<-98dBc/Hz	
100 kHz frequency offset	<-98dBc/Hz				

## 8.6 Performance Characteristics Test

Table 8.7 (Continued 6)

No.	Test Content	Specification		Measured Value		
13	Single sideband phase noise	28.5GHz < f ≤ 50GHz	100 Hz frequency offset	< -63dBc/Hz		
			1 kHz frequency offset	< -83dBc/Hz		
			10 kHz frequency offset	< -92dBc/Hz		
			100 kHz frequency offset	< -92dBc/Hz		
		50GHz < f ≤ 67GHz	100 Hz frequency offset	< -57dBc/Hz		
			1 kHz frequency offset	< -77dBc/Hz		
			10 kHz frequency offset	< -86dBc/Hz		
			100 kHz frequency offset	< -86dBc/Hz		
		H04 ultra-low phase noise option				
		100MHz (Option H08)	1 Hz frequency offset	< -70 dBc/Hz		
			10 Hz frequency offset	< -97 dBc/Hz		
			100 Hz frequency offset	< -119 dBc/Hz		
			1 kHz frequency offset	< -130 dBc/Hz		
			10 kHz frequency offset	< -140 dBc/Hz		
			100 kHz frequency offset	< -140 dBc/Hz		
		100kHz < f ≤ 250MHz	1 Hz frequency offset	< -64 dBc/Hz		
			10 Hz frequency offset	< -92 dBc/Hz		
			100 Hz frequency offset	< -105 dBc/Hz		
			1 kHz frequency offset	< -123 dBc/Hz		
			10 kHz frequency offset	< -138 dBc/Hz		
			100 kHz frequency offset	< -141 dBc/Hz		
		250MHz < f ≤ 500MHz	1 Hz frequency offset	< -67 dBc/Hz		
			10 Hz frequency offset	< -93 dBc/Hz		
			100 Hz frequency offset	< -111 dBc/Hz		
			1 kHz frequency offset	< -126 dBc/Hz		
			10 kHz frequency offset	< -138 dBc/Hz		
			100 kHz frequency offset	< -142 dBc/Hz		
		500MHz < f ≤ 1GHz	1 Hz frequency offset	< -62 dBc/Hz		
			10 Hz frequency offset	< -91 dBc/Hz		
			100 Hz frequency offset	< -105 dBc/Hz		
1 kHz frequency offset	< -123 dBc/Hz					
10 kHz frequency offset	< -138 dBc/Hz					
100 kHz frequency offset	< -138 dBc/Hz					

Table 8.7 (Continued 7)

No.	Test Content	Specification	Measured Value	
13	Single sideband phase noise			
		1GHz < f ≤ 2GHz	1 Hz frequency offset	<-57 dBc/Hz
			10 Hz frequency offset	<-86 dBc/Hz
			100 Hz frequency offset	<-100 dBc/Hz
			1 kHz frequency offset	<-117 dBc/Hz
			10 kHz frequency offset	<-133 dBc/Hz
			100 kHz frequency offset	<-133 dBc/Hz
		2GHz < f ≤ 3.2GHz	1 Hz frequency offset	<-52 dBc/Hz
			10 Hz frequency offset	<-81 dBc/Hz
			100 Hz frequency offset	<-96 dBc/Hz
			1 kHz frequency offset	<-113 dBc/Hz
			10 kHz frequency offset	<-128 dBc/Hz
			100 kHz frequency offset	<-128 dBc/Hz
		3.2GHz < f ≤ 10GHz	1 Hz frequency offset	<-43 dBc/Hz
			10 Hz frequency offset	<-72 dBc/Hz
			100 Hz frequency offset	<-85 dBc/Hz
			1 kHz frequency offset	<-105 dBc/Hz
			10 kHz frequency offset	<-120 dBc/Hz
			100 kHz frequency offset	<-120 dBc/Hz
		10GHz < f ≤ 20GHz	1 Hz frequency offset	<-37 dBc/Hz
			10 Hz frequency offset	<-66 dBc/Hz
			100 Hz frequency offset	<-79 dBc/Hz
			1 kHz frequency offset	<-98 dBc/Hz
			10 kHz frequency offset	<-114 dBc/Hz
			100 kHz frequency offset	<-114 dBc/Hz
		20GHz < f ≤ 40GHz	1 Hz frequency offset	<-31 dBc/Hz
			10 Hz frequency offset	<-60 dBc/Hz
			100 Hz frequency offset	<-73 dBc/Hz
			1 kHz frequency offset	<-91 dBc/Hz
			10 kHz frequency offset	<-108 dBc/Hz
			100 kHz frequency offset	<-108 dBc/Hz
		40GHz < f ≤ 67GHz	1 Hz frequency offset	<-26 dBc/Hz
			10 Hz frequency offset	<-54 dBc/Hz
			100 Hz frequency offset	<-68 dBc/Hz
			1 kHz frequency offset	<-85 dBc/Hz
			10 kHz frequency offset	<-102 dBc/Hz
100 kHz frequency offset	<-102 dBc/Hz			

## 8.6 Performance Characteristics Test

Table 8.7 (Continued 7)

No.	Test Content	Specification	Measured Value			
13	Single sideband phase noise	1465F/H/L-V + H04 ultra-low phase noise option				
		20GHz $f \leq 28.5\text{GHz}$	<	1 Hz frequency offset	<-31 dBc/Hz	
				10 Hz frequency offset	<-60 dBc/Hz	
				100 Hz frequency offset	<-73 dBc/Hz	
				1 kHz frequency offset	<-91 dBc/Hz	
				10 kHz frequency offset	<-108 dBc/Hz	
				100 kHz frequency offset	<-108 dBc/Hz	
		28.5GHz $f \leq 50\text{GHz}$	<	1 Hz frequency offset	<-26 dBc/Hz	
				10 Hz frequency offset	<-54 dBc/Hz	
				100 Hz frequency offset	<-68 dBc/Hz	
				1 kHz frequency offset	<-85 dBc/Hz	
				10 kHz frequency offset	<-102 dBc/Hz	
				100 kHz frequency offset	<-102 dBc/Hz	
		50GHz < $f \leq 67\text{GHz}$	<	1 Hz frequency offset	<-20 dBc/Hz	
				10 Hz frequency offset	<-48 dBc/Hz	
				100 Hz frequency offset	<-62 dBc/Hz	
				1 kHz frequency offset	<-79 dBc/Hz	
				10 kHz frequency offset	<-96 dBc/Hz	
100 kHz frequency offset	<-96 dBc/Hz					
14	Frequency modulation (Option H01A)	Maximum frequency offset	16 MHzxN (N is the number of YO harmonics)			
		FM bandwidth	DC coupling	DC-10 MHz		
		FM accuracy	$\pm (3.5\% \times \text{set FM deviation} + 20 \text{ Hz})$			
		FM distortion	< 1% (1 kHz modulation rate, $N \times 20\text{kHz} \leq \text{FM deviation} < N \times 800 \text{ kHz}$ )			
15	Phase modulation (Option H01A)	Maximum PM deviation	16 radxN (N is the number of YO harmonics, normal mode)			
		PM bandwidth	DC to 10 MHz			
		PM accuracy	$\pm (5\% \times \text{set PM deviation} + 0.01 \text{ rad})$			
		PM distortion	< 1% (1 kHz modulation rate, $N \times 0.8\text{rad} \leq \text{PM deviation} < N \times 8\text{rad}$ )			
16	Amplitude modulation (Option H01A)	Modulation depth	Linear mode	>90%		
		AM bandwidth	DC to 100 kHz, up to 1 MHz, (3 dB, 30% modulation depth, 1 GHz, 5 GHz, 20 GHz, 40 GHz and 50 GHz)			
		AM accuracy	Linear mode	$\pm (6\% \times \text{set depth} + 1\%)$		
		AM distortion	30% depth	<1.5%		

Table 8.7 (Continued 8)

No.	Test Content	Specification	Measured Value	
No.	Test Content	Specification	Measured Value	
17	Pulse modulation (option H01B/C)	On-off ratio	500MHz≤f≤67GHz >80dB	
		Rise and fall time	500MHz<f≤67GHz <20ns	
		ALC minimum width	500MHz≤f≤67GHz 1μs	
		Non-amplitude level control minimum pulse width	500MHz≤f≤67GHz 0.1μs	
		Narrow pulse option H02C		
		On-off ratio	50MHz≤f≤67GHz >80dB	
		Rise and fall time	50MHz<f≤3.2GHz	15ns
			3.2GHz<f≤67GHz	10ns
		ALC minimum width	50MHz≤f≤67GHz 1μs	
		Non-amplitude level control minimum pulse width	50MHz≤f≤67GHz 20ns	
18	Vector modulation (-V series)	EVM	< 1.5% (RMS%, symbol rate 4 Msps, root Nyquist filter, α=0.3, QPSK format)	
		Original offset	<-40 dBc (symbol rate 4 Msps, root Nyquist filter, α=0.3, QPSK format)	
		Internal modulation bandwidth	Standards: 120MHz (±3 dB bandwidth)	
			Option H31: 200MHz (±3 dB bandwidth)	
		External modulation bandwidth	200MHz (±3 dB bandwidth)	
External broadband modulation bandwidth (H33)	2GHz (±6 dB bandwidth)			

**8.6 Performance Characteristics Test****8.5.3 Recommended instruments for performance characteristics test**

Table 8.8 Recommended Instruments for Performance Characteristics Test

No.	Instrument Name	Main Specifications	Recommended Model
1	Frequency meter	Frequency range: 250 kHz ~ 67 GHz Frequency resolution: 1Hz/0.001Hz	Agilent53150A Agilent53520A 3212D
2	Time standard	Frequency stability: $<1 \times 10^{-10}$ /day	HP5061 or CH-47
3	Signal Generator	Frequency range: 250 kHz ~ 67 GHz Frequency resolution: 0.001Hz	1464 E8257D
4	Digital storage oscilloscope	Event (count delay) trigger supported Bandwidth: DC to 500 MHz Input resistance: 50 $\Omega$ and 1 M $\Omega$ Vertical resolution: $\leq 5$ mV/Div Horizontal resolution: 10 ns/Div	TDS4054 DPO4054
5	Spectrum analyzer	Frequency range: 0.01 to 67 GHz	4051G N9030A FSW67
6	Vector signal analyzer	Frequency offset range 0.01 GHz ~ 67 GHz	FSW67 N9040B
7	Signal source analyzer	Frequency range: 1 MHz ~ 50 GHz	E5052B FSUP50
8	Measuring receiver	Frequency range: 20 Hz ~ 50 GHz	FSMR 50
9	Measuring receiver probe	Frequency range: 20 Hz ~ 50 GHz	NRP-Z55
10	Power meter	Frequency range: 0.01 to 67 GHz Power range: 1 $\mu$ W to 10 W	2438L 2434 N1914A 2436A
11	Power probe	Frequency range: 0.01 GHz ~ 67 GHz	N8488A 81702 E9300B
12	Fundamental wave frequency mixer	Local oscillator RF: 50-75 GHz Local oscillator input power: $>+12$ dBm	82707
13	Function generator	Frequency range: 1Hz-10MHz	HP3325B HP33250A



## Appendixes

- [Appendix A Explanations of Terms](#).....247
- [Appendix B Lookup Table of SCPIs](#).....256
- [Appendix C Lookup Table of Error Information](#).....273
- [Appendix D Lookup Table of PC Keyboard in Function Configuration Windows](#) .....274

### Appendix A Explanations of Terms

- [Frequency Accuracy](#).....247
- [Frequency Stability](#).....247
- [Harmonic Distortion and Spectrum Purity](#).....247
- [I/Q Modulation](#).....248
- [Speech Coding](#).....248
- [Channel Coding](#).....249
- [Digital Modulation](#).....249
- [Frequency Band Utilization of Digital Modulation Signals](#).....250
- [Binary Frequency Shift Keying 2FSK](#).....250
- [Binary Phase Shift Keying BPSK](#).....250
- [Quadrature Phase Shift Keying QPSK](#).....251
- [8 Phase Shift Keying 8PSK](#).....251
- [Quadrature Amplitude Modulation QAM](#).....252
- [Differential Modulation Method  \$\pi/4\$ DQPSK](#).....252
- [QPSK Modulation Method](#).....253
- [Constant Envelope Digital Modulation MSK](#).....253
- [\$3\pi/8\$  Rotation 8PSK Modulation](#).....254
- [Nyquist Filter](#).....254
- [Nyquist Filter Coefficient  \$\alpha\$](#) .....255

#### Frequency accuracy

The deviation between the frequency value displayed by the signal generator and the true value, which is usually expressed as a relative error:

$$\alpha = \frac{f - f_0}{f_0} = \frac{\Delta f}{f_0} \times 100\%$$

Where  $f_0$  is the signal generator scale value and  $f$  is the true value.

The frequency accuracy of the low-range signal generator is only 1%, while the frequency accuracy of the internal high-steady crystal oscillator can reach  $10^{-8}$  to  $10^{-10}$ .

#### Frequency stability

The frequency stability means the magnitude of the deviation of the signal generator output frequency relative to the set reading within a specified time when the external conditions and the environment are constant.

#### Harmonic distortion and spectrum purity

The ideal sine wave should be a single frequency. Because the non-linear elements inside the signal generator cause the signal to generate non-linear distortion and harmonic components, the signal distortion is usually used to indicate the degree of the signal close to the ideal sine wave, and is expressed by the distortion coefficient  $\gamma$ :

**Appendix A Explanations of Terms**

$$\gamma = \frac{\sqrt{U_2^2 + U_3^2 + \dots + U_n^2}}{U_1} \times 100\%$$

Where,  $U_1$  is the valid value of the fundamental wave, and  $U_2, U_3, \dots$  are the valid values of harmonics. They are also called the total harmonic distortion (THD) and are usually measured at a given output power and a specific signal frequency.

**I/Q modulation**

The function of the I/Q modulator is to load I and Q signals onto the carriers. The I/Q modulator consists of a symbol builder, a carrier local oscillator, a frequency mixer, a  $90^\circ$  phase shifter, and a linear superimposer. The symbol builder is responsible for converting the input modulation baseband signal into odd-even two-way signals through serial-to-parallel conversion. Therefore, the modulation method in the digital transmitter is actually determined by its symbol builder. Some literatures refer to the correspondence between information and carrying signals as “mapping”. The receiving end extracts the transmitted information from the received signal according to the mapping relationship previously agreed.

There are many ways to map information and signals. Different modulation techniques use different mapping methods. The main purpose of digital modulation is to control the transmission efficiency. Different digital modulation techniques are distinguished by their mapping methods and their performances are also determined by their mapping methods. This mapping relation is implemented by the symbol builder. The two frequency mixers, in-phase I and quadrature Q, are excited by the LO signals of the two local oscillators. The local oscillator signal of the lower frequency mixer is orthogonal to that of the upper frequency mixer, namely, the frequency mixers' local oscillator carriers are orthogonal to each other. Then the outputs of the two frequency mixers are mixed.

Note that the I/Q modulator uses analog technique (RF frequency mixer and RF synthesizer) and monolithic microwave integrated circuit MMIC, and even it is implemented in the DSP. The I/Q modulator changes the control problem from signal phases to two-way orthogonal component voltages. The I/Q indicates the orthogonal transformation of the modulated signal. The Q component signal is phase-shifted by  $90$  degrees with respect to the carrier. If only the I channel is used for detection, the I output is  $0$  V although the Q input signal exists because of  $\text{Cos}(90^\circ) = 0$  and there is no output signal in the I channel. Therefore, a vector-modulated signal can be generated by linearly superimposing the signal in-phase and quadrature components, without worrying that the I and Q components interfere with each other. For wireless transmission, it shall be sent out after being added ( $\Sigma$ ) and synthesized.

**Speech coding**

Speech coding is the most important source coding in wireless communication systems because speech transmission is the basic service of such systems. The purpose of speech coding should be to use as few channel bandwidths as possible to deliver the highest possible speech quality while maintaining certain algorithm complexity and communication delay.

Speech coding can be classified into three categories:

- 1) Waveform coding (such as pulse code modulation PCM), whose transmitted source data is the sampling quantized value of the speech signal waveform. Waveform coding truly reflects the waveform changes of the speech signals and retains all intrinsic features of the speech, so its intelligibility and naturalness are good. However, the code rate of the waveform coding is high and the band utilization is poor since the speech waveform contains a large number of redundant components.
- 2) Parameter coding (such as linear predictive coding LPC), whose transmitted source data is not a speech waveform, but characteristic parameters of speech extracted by a linear prediction algorithm. Parameter coding equates the human sound system to an excitation and linear filtering model and represents the change in speech through model parameters updated constantly. Parameter coding can greatly reduce the transmission code rate and extremely improve the utilization rate of the frequency bands. However, simple parameter coding is limited by the feature extraction algorithm and can achieve certain intelligibility, but the naturalness of speech is poor.

**Appendix A Explanations of Terms**

3) Hybrid coding, namely an algorithm that synthesizes waveform coding and parameter coding. This not only reduces the code rate, but also improves the naturalness of synthesized speech. It is a source coding method commonly used in wireless communications. For example, the RPE-LTP algorithm used in the GSM system and the CELP algorithm used in CDMA. The most commonly used speech coding forms include: Pulse Code Modulation (PCM), Differential Pulse Code Modulation (DPCM), Adaptive Differential Pulse Code Modulation (ADPCM), Delta Modulation (DM), Continuous Variable Slope Delta Modulation (CVSDM), Adaptive Predictive Coding (APC), Sub Band Coding (SBC), and Code-excited Linear Predictive Coding.

**Channel coding**

During the transmission of the digital signals in the actual channel, the transmission error is caused by the noise existing in the channel and the inter-symbol interference due to the unsatisfactory transmission characteristics of such channel. In order to improve the reliability of the digital transmission system and reduce the error rate of information transmission, measures can be taken to improve the anti-noise performance of the digital transmission system, for example, using equalization techniques to eliminate inter-symbol interference, selecting a good modulation system and demodulation method, and enhancing the directionality of the antenna.

Channel coding is classified into error detecting codes and error correcting codes. Error detecting codes can only detect errors, such as parity check codes commonly used in computer serial communications. To further improve the reliability of digital transmission systems, it is necessary to use error control coding to control possible or already existing errors.

**Digital modulation**

In analog modulation, the changes of carrier parameters are based on continuous analog information. In digital modulation, the changes in these carrier parameters (amplitude, frequency, and phase) are determined by discrete digital signals.

In this sense, there is no essential difference between digital and analog modulation. Digital modulation signals only have to represent discrete modulation states, which are called symbol points on the vector diagrams. The combination of such symbol points is called constellation.

**1) Bit:** It is a unit for transmitting information in a communication system and generally refers to useful information transmitted in a communication system. Bit rate: It is the bit transmission rate, that is, the information transmission rate in the communication system time, and the unit is bit/s.

**2) Symbol:** It is the discrete state of the information-modulated carrier, that is, the vector, a concept that is closely related to the carrier and modulation method. There are also symbols in analog modulation and the number of symbols is infinite, so they cannot be directly analyzed and observed. Therefore, symbols are only discussed in digital modulation and the number of its symbols is limited. A symbol is not information, but information is transmitted by mapping to a carrier state (namely a symbol) through digital modulation.

**3) Symbol Rate:** It is the conversion rate of the carrier modulation symbol and is actually the rate of change of the carrier state. The higher the symbol rate, the higher the corresponding information transmission rate. The higher the spectral components contained in the signals, the wider the frequency band occupied. The unit is Baud.

**4) Constellation:** It is the combination of all symbol points of the modulation signal on the I/Q plane. The constellation defines the mapping relation between the signal distribution of the modulation technique and the modulated digital bits. The characteristics of a modulation technique can be fully defined by signal distribution and mapping, that is, they can be fully defined by the constellation.

**5) Vector Diagram:** It is the process description of changes of the modulation signals among symbol points. The vector diagram shows not only the constellation points, but also the conversion process between such constellation points.

**6) Eye Diagram:** It is an intuitive way to check the transmission distortion of digital signals. It is a baseband signal that the low-pass filter output is not regenerated after being demodulated, and it is a waveform repeatedly swept and displayed on the oscilloscope with bit timing as the external

**Appendix A Explanations of Terms**  
synchronization.

**Frequency band utilization of digital modulation signals**

It is the rate of transmission of information data, but it is unrelated with the modulation method. Different communication systems can use different modulation methods to transmit data services with the same rate, so the bit rate cannot determine the frequency bandwidth occupied by the modulation signals.

The symbol rate is the rate of change of the carrier modulation state, which determines the speed of change of the modulation symbols and also determines the frequency bandwidth of the modulation signals. It is sometimes called the baud rate. The correspondence between symbol rate and bit rate is determined by the form of digital modulation. The form of digital modulation determines the number of carriers in discrete states and also determines the number of binary bits that each symbol can represent. The symbol rate is equal to the bit rate divided by the number of bits represented by per symbol:

$$\text{Symbol Rate} = \text{Bit Rate} / \text{the number of bits represented by per symbol.}$$

It can be seen that the form of digital modulation determines the efficiency of the modulation, namely the amount of information (bits) transmitted under a unit bandwidth (symbol rate). If the modulation is more complex, the modulation symbols are more and the modulation efficiency is higher.

**Binary frequency shift keying 2FSK**

Digital frequency modulation is also called frequency shift keying (FSK) and binary frequency shift keying is written as 2FSK. Digital frequency shift keying is used to transfer binary symbols by changing the frequency of the carrier, that is, the frequency of the carrier is controlled by the transmitted digital messages. The 2FSK signal is the modulated waveform that the symbol “1” corresponds to the carrier frequency  $f_1$  and the symbol “0” corresponds to another carrier frequency  $f_2$ , which is different from  $f_1$ . At this time, its spectrum can be regarded as the on-off keying of the code column on the low frequency carrier and the on-off keying of the inverse code of the code column on the high frequency carrier.

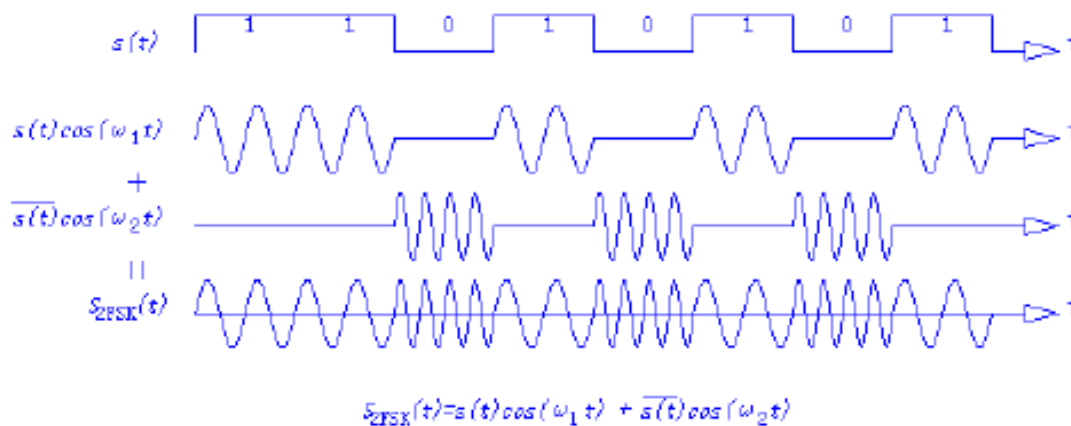

Attached Figure 1 2FSK Diagram

**Binary phase shift keying BPSK**

Binary phase shift keying (BPSK) uses phases 0 and  $\pi$  to represent “0” or “1” respectively. At this time, the phase jump occurs at the edge of the bit cycle. However, the phase information is retained in the middle of the interval. The receiving end demodulation is usually done near its center point. In general, the performance of the PSK system is better than that of the on-off keying FSK system.

$V(t) = A \cos(2\pi f_c t + \varphi)$   $0 \leq t \leq T$  where the phase  $\varphi = 2(n-1)\pi/n$ . For BPSK,  $n = 1$  and  $2$ , namely  $\varphi = 0, \pi$ . The BPSK modulation signals can be generated by using the conventional analog modulation method (using the NRZ signal double-sideband DSB amplitude modulation) or by using the keying method. In modern communication devices, they are generally generated by using I/Q modulators.

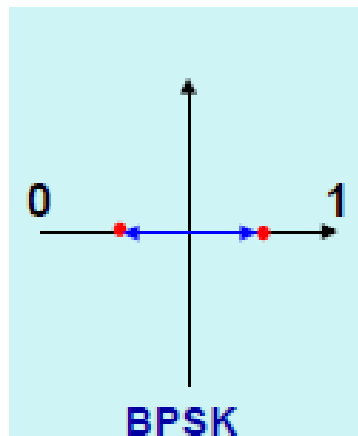

Attached Figure 2 BPSK Diagram

### Quadrature phase shift keying QPSK

The most common digital modulation is quadrature phase shift keying (QPSK). Quadrature phase shift modulation uses four different phase differences of the carriers to characterize the input digital information. The four carrier phases are  $45^\circ$ ,  $135^\circ$ ,  $225^\circ$  and  $275^\circ$  respectively.

The data input by the modulator is a binary digital sequence. To match the quaternary carrier phases, the binary data needs to be converted into quaternary data, that is to say, every two bits in the binary digital sequence need to be grouped together and there are four combinations 00, 01, 10 and 11, each of which is called a double-bit symbol. Each double-bit symbol consists of two binary information bits, which represent one of the four quaternary symbols respectively.

Each modulation in QPSK can transmit 2 information bits, which are transmitted through the four phases of the carrier. The demodulator determines the information bits transmitted by the transmitting end according to the constellation and the phases of the received carrier signals.

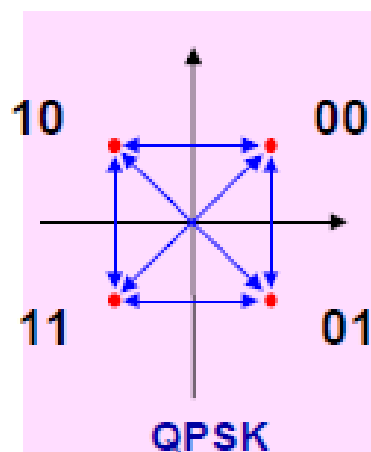

Attached Figure 3 QPSK Diagram

### 8 phase shift keying 8PSK

What are commonly used in wireless communications is BPSK and QPSK and can also be extended to 8PSK or even 16PSK. However, 16PSK is rarely used since the utilization of its I/Q plane is very low and the phase difference at the symbol points is small. From the conversion process of the 8PSK vector diagram, it can be seen that a 180-degree symbol phase change causes the signal trace to cross the original point during the modulation and its high peak-to-average ratio is not conducive to transmission. Moreover, 8PSK is an absolute phase modulation and there is a phase ambiguity problem, so it is less directly applied.

**Appendix A Explanations of Terms**

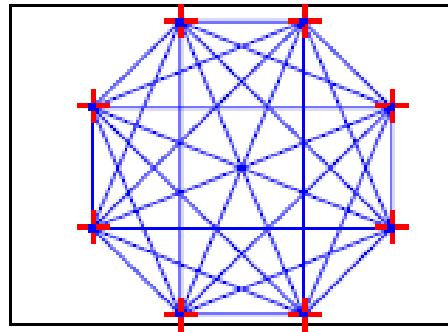

Attached Figure 4 8PSK Diagram

**Quadrature amplitude modulation QAM**

QAM performs suppressed carrier double-sideband amplitude modulation for two quadrature carriers with the same frequency by using two independent baseband signals and realizes transmission of two parallel digital information by using the orthogonality of the frequency spectrum of such modulated signals in the same bandwidth. The modulation methods include 4QAM (namely QPSK), 16QAM, 32QAM and 64QAM... and the constellations have 4, 16, 32 and 64... vector endpoints.

For 4QAM, its generation, demodulation, performance, and phase vector are the same as QPSK when the amplitudes of the two signals are equal. Obviously, when the symbol point is greater than or equal to 16, the distance between QAM symbol points is greater than that of PSK if the number of symbols is the same. Since the bandwidth utilization of the QAM system is higher than that of the QPSK, it is a very promising modulation method in a frequency band-limited system and has already been used in communication systems, but its performance is not as good as that of the QPSK system. Now, 128QAM and 256QAM are used in digital television systems. The 16QAM and 32QAM constellations are shown in the figures below (Attached Figures 5 and 6).

**16QAM**

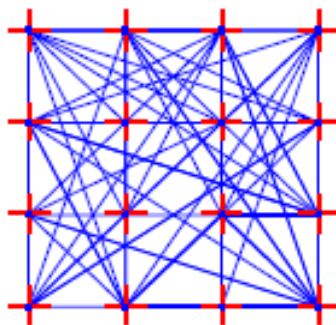

Attached Figure 5 16QAM Constellation

**32QAM**

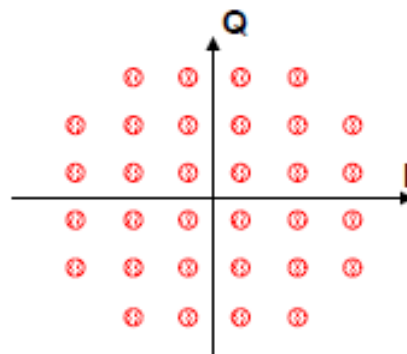

Attached Figure 6 32QAM Constellation

**Differential modulation method  $\pi/4$ DQPSK**

The QPSK signal discussed earlier has a high frequency band utilization. However, a  $180^\circ$  carrier phase jump occurs when the code group jumps from 00 to 11 or from 01 to 10. This phase jump will cross the original point, causing large envelope fluctuations. When passing through non-linear components, the distortion of the time-domain waveform will cause distortion in the frequency domain so that the out-of-band components that have been filtered out will be recovered again, and the extended spectrum will cause interference with adjacent channels. In order to eliminate such  $180^\circ$  phase jump, a modulation method called  $\pi/4$ -DQPSK is obtained after the correction is made on the basis of QPSK.  $\pi/4$ -DQPSK is a differential modulation and it is a synthesized constellation in the Attached Figure 7. Differential modulation uses relative changes of phases, not absolute phase symbols, to represent "0" or "1" bit data. The even symbol point here is on the I/Q axis and the odd symbol point (with \*) is at the position  $45^\circ$  away from the I/Q axis. It can be seen that the maximum phase jump is limited to  $135^\circ$  degrees. There are four phase changes in  $\pi/4$ -DQPSK, including  $45^\circ$ ,  $135^\circ$ ,  $-45^\circ$  and  $-135^\circ$  respectively.

## Appendix A Explanations of Terms

There is always a phase change for each symbol due to the use of two QPSK constellations with 45° offsets. This avoids a 180° phase change and the trace of its vector diagram does not pass zero point.

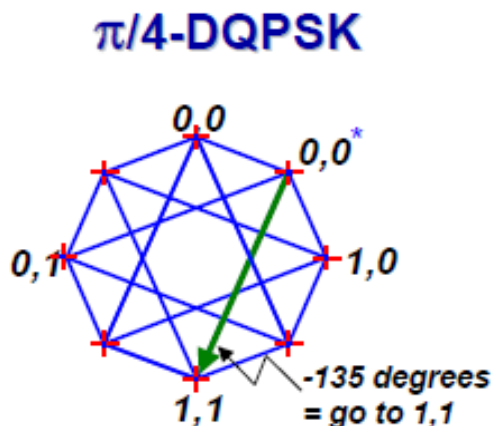

Attached Figure 7 Synthesized Constellation

### QPSK modulation method

QPSK modulation I and Q bit streams are transformed at the same time, namely the two symbol clocks are provided synchronously. OQPSK modulation is another solution to solve the problem of the vector crossing zero point and has been adopted in narrowband CDMA systems. OQPSK is called Offset-QPSK and is the improved QPSK. It is also called offset quadrature phase shift keying. It has the same phase relation as QPSK. It also divides the input code stream into two channels and then performs quadrature modulation. The difference is that it shifts the code streams of the in-phase and quadrature branches by a half symbol period  $T_b/2$  in time. Due to the offset of half symbol period of the two branches, only the polarity of one branch may be inverted at a time and the polarity invert of the symbols in the two branches will not occur at the same time. In addition, other implementation methods have the same effect as QPSK.

### I/Q offset modulation

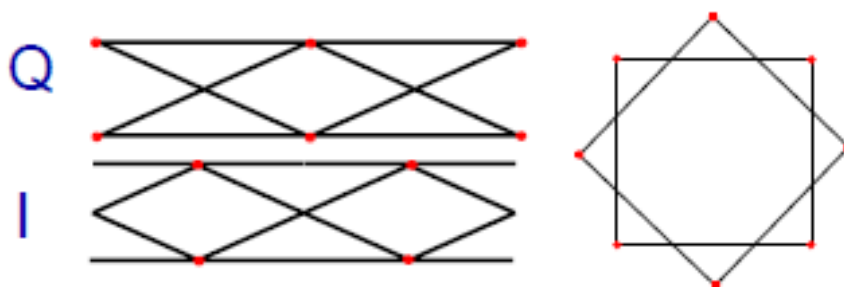

Attached Figure 8 QPSK Modulation Method

### Constant envelope digital modulation MSK (minimum shift keying)

FSK modulation does not have as great envelope change as QAM and PSK, but FSK has an abrupt phase change when the sign changes, which can also cause amplitude abrupt and spectrum regeneration. The minimum shift keying (MSK) is a constant envelope digital modulation technique developed on the basis of FSK. The minimum shift keying (MSK) is a continuous phase FSK modulation CPFSK. The continuous phase ensures that the signals have small modulation bandwidths. The frequency offset  $\Delta f$  of the MSK modulation and its frequency difference  $2\Delta f$  satisfy the following equation:

$$2\Delta f = \frac{1}{2T_b}$$

**Appendix A Explanations of Terms**

It can be seen from the equation that the frequency offset  $\Delta f$  is equal to one quarter of the symbol rate  $1/T_b$ , namely the frequency difference  $2\Delta f$  is equal to half the symbol rate. This special selection is called minimum shift keying (MSK).

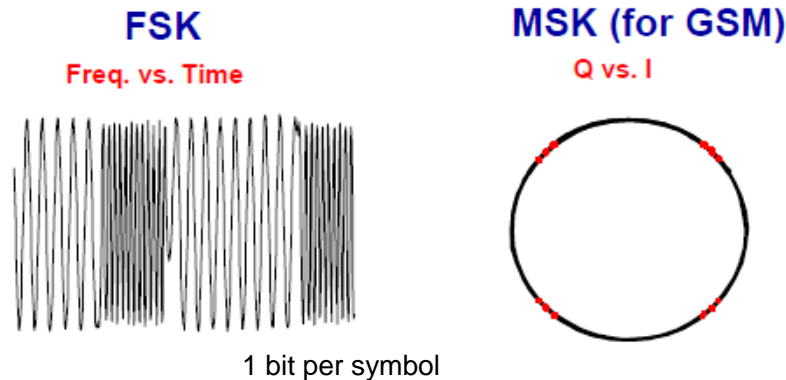

Attached Figure 9 MSK Modulation Method

**3π/8 rotation 8PSK modulation (EDGE)**

3π/8 rotation 8PSK is a digital modulation method used in EDGE systems. The EDGE system is a technology for upgrading GSM developed in Europe and is mainly used to improve the air interface transmission rate of the GSM system. Since the original GSM system limited the modulation symbol rate and frequency bandwidth, the EDGE system uses 8PSK to achieve modulation with a higher efficiency, reaching 3 times transmission data rate with the same modulation symbol rate and frequency bandwidth. We already know that 8PSK has such disadvantages as large signal envelope fluctuations, high linearity requirements on systems, and poor anti-interference performance. Therefore, it is necessary to use the method similar to π/4-DQPSK to solve this problem.

3π/8 rotation 8PSK is based on the original 8PSK constellation. Each time the symbol changes, the constellation rotates 3π/8 and then the symbol points transfer to new constellation points. This corresponds to 8 symbol phase changes, including π/8, 3π/8, 5π/8, 7π/8, -π/8, -3π/8, -5π/8 and -7π/8 respectively, for realizing differential modulation 8PSK. There is always a phase change for each symbol due to the use of 3π/8 offset. This avoids a 180° phase change and the trace of its vector diagram does not pass zero point.

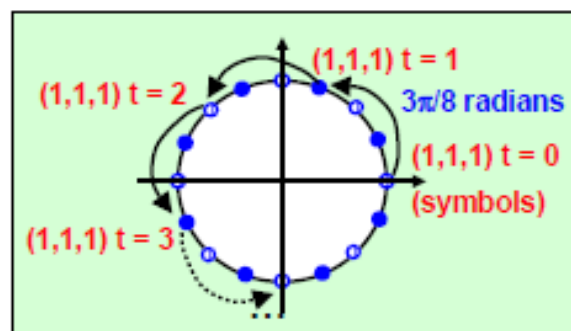

Attached Figure 10 EDGE Vector Diagram

**Nyquist filter**

The main factor constraining transmission baseband signals is the frequency characteristics of the system. If the transmission band is intentionally broadened to reduce this interference to any degree, it will result in unnecessary waste of the bandwidth. If the frequency band is broadened excessively, excessive noise will be introduced into the system. Therefore, it is necessary to design the signal waveform appropriately or to use an ideal transmission filter to reduce or eliminate such interference under the condition of minimum transmission bandwidth.

The Nyquist first criterion solves this problem and points out the fundamental relationship between the channel bandwidth  $f_N$  and the symbol rate  $RS$ . Namely: The low-pass cut-off bandwidth  $f_N = RS$  in



### Appendix A Explanations of Terms

an ideal communication channel. That is to say, this Nyquist filter can limit the signal bandwidth and eliminate interference among the symbols. It can be seen from the above figure that this raised cosine filter complying with the Nyquist criterion has zero symbol energy at the time of the adjacent bit  $t$  in the time domain impulse response, therefore it will not cause any interference among symbols.

Filters with rectangular frequency responses are not possible in reality and filters with infinitely steep responses require infinite number of poles. However, we can use the raised cosine filter (RCF) to complete the zero-crossing Nyquist criterion. When these filters are used, the roll-off between the passband and the stopband is a cosinc function. For such filters, “half” are placed in the transmitters and the other “half” are put in the receivers. In this way, the entire raised cosine response can be obtained from the Root RCF used simultaneously by the transmitter and the receiver. In addition to noise filtering, the receiver can also use RCF to make decisions at the maximum signal-to-noise ratio, which is the characteristic of matched filter pairs.

#### Nyquist filter coefficient $\alpha$

Channels with ideal low-pass characteristics are difficult to be implemented and channels with roll-off characteristics are practically used. The increase of its channel bandwidth over Nyquist bandwidth is: Roll-off factor  $\alpha$ . It can be expressed as  $\alpha = (BW - f_N) / f_N$ , where  $BW$  is the channel bandwidth and  $f_N$  is the Nyquist bandwidth.  $\alpha$  is a value between 0 and 1.  $1+\alpha$  indicates the extra bandwidth required for the filter to send signals without ISI.  $\alpha$  is also called “excessive bandwidth factor”, which means that the required occupied bandwidth exceeds the ideal occupied bandwidth at the same symbol rate. The bandwidth occupied by RCF-filtered signals is approximately  $(1+\alpha)R_s$ , where  $R_s$  is the symbol rate. As shown in the Attached Figure 10, the occupied bandwidth  $BW$  is  $R_s$  (because  $F_s = 0.5R_s$ ,  $BW = 2F_s$ ) when  $\alpha=0$ ; the occupied bandwidth is  $2R_s$  when  $\alpha=1$ . The typical value of  $\alpha$  is usually between 0.35 and 0.5. The above figure shows the frequency characteristics of the RCF with different roll-off factors  $\alpha$ . If the roll-off factor  $\alpha$  is smaller, the filter characteristics are steeper, but the sidelobe level generated by the pulse is higher, causing the higher requirements for the sampling timing tolerance. These filters are generally implemented with finite impulse response (FIR) filters in some DSPs. The raised cosine roll-off filters have been widely used due to their abilities to transmit signals with great power and fast convergence to reduce inter-symbol interference. It can be seen that the Nyquist filter requires the occupied bandwidth greater than the symbol rate  $R_s$  and that its band utilization is no longer optimal. A Gaussian filter, not a Nyquist filter, is used in the GSM system. The corresponding “excessive bandwidth factor” is  $BT$  (bandwidth time factor), whose value is usually between 0.3 and 0.5. The modulation symbol rate of GSM is 270.833 KHz and the channel bandwidth is 200 KHz, so the channel bandwidth is smaller than the modulation symbol rate.

$\alpha$  reflects the compromise between the signal occupied bandwidth and the power parameter in the frequency response shape of the filter

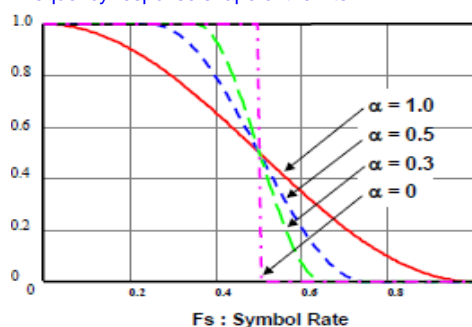

Signal occupied bandwidth = symbol rate  $\times$   $(1+\alpha)$

Attached Figure 11 Diagram of Relation between Channel Bandwidth and  $\alpha$

**Appendix B Lookup Table of SCPIs**

## Appendix B Lookup Table of SCPIs

Attached Table 1 Lookup Table of 1465 SCPIs (Classified by Subsystem)

Index	Command	Function
1	<a href="#">*IDN?</a>	General instruction
2	<a href="#">*RCL</a>	General instruction
3	<a href="#">*RST</a>	General instruction
4	<a href="#">*SAV</a>	General instruction
5	<a href="#">:OUTPut:BLANking[:STATe](?)</a>	Set the output blanking
6	<a href="#">:OUTPut[:STATe](?)</a>	Set the RF output on-off
7	<a href="#">[:SOURce]:FREQuency[:CW FIXed](?)</a>	Set the signal generator output frequency
8	<a href="#">[:SOURce]:FREQuency:MODE(?)</a>	Set the frequency generation mode
9	<a href="#">[:SOURce]:FREQuency:MULTiplier (?)</a>	Set the frequency multiplication
10	<a href="#">[:SOURce]:FREQuency:OFFSet (?)</a>	Set the frequency offset
11	<a href="#">[:SOURce]:FREQuency:REFerence (?)</a>	Set the relative frequency
12	<a href="#">[:SOURce]:FREQuency:REFerence:STATe (?)</a>	Set the relative frequency on-off
13	<a href="#">[:SOURce]:FREQuency:STEP(?)</a>	Set the frequency step
14	<a href="#">[:SOURce]:FREQuency:STARt(?)</a>	Set the step sweep start frequency
15	<a href="#">[:SOURce]:FREQuency:STOP(?)</a>	Set the step sweep stop frequency
16	<a href="#">[:SOURce]:POWer:ALC:LEVel(?)</a>	Set the ALC level
17	<a href="#">[:SOURce]:POWer:ALC:SEARch(?)</a>	Set the power search mode
18	<a href="#">[:SOURce]:POWer:ALC:SEARch:REFerence?</a>	Set the power search reference
19	<a href="#">[:SOURce]:POWer:ALC:SOURce(?)</a>	Set the power amplitude level control mode
20	<a href="#">[:SOURce]:POWer:ALC:SOURce:EXTernal:COUPling(?)</a>	Set the external detection coupling coefficient
21	<a href="#">[:SOURce]:POWer:ALC[:STATe](?)</a>	Set the ALC loop state
22	<a href="#">[:SOURce]:POWer:ATTenuation(?)</a>	Set the power attenuation
23	<a href="#">[:SOURce]:POWer:ATTenuation:AUTO(?)</a>	Set the power attenuation on-off
24	<a href="#">[:SOURce]:POWer[:LEVel][:IMMediate][:AMPLitude](?)</a>	Set the power level
25	<a href="#">[:SOURce]:POWer[:LEVel][:IMMediate]:OFFSet(?)</a>	Set the power offset
26	<a href="#">[:SOURce]:POWer:REFerence(?)</a>	Set the relative power
27	<a href="#">[:SOURce]:POWer:REFerence:STATe(?)</a>	Set the relative power on-off
28	<a href="#">[:SOURce]:POWer:STEP(?)</a>	Set the power step

## Appendix B Lookup Table of SCPIs

29	<a href="#">[:SOURce]:LIST:DELeTe</a>	Delete the list point
30	<a href="#">[:SOURce]:LIST:DIRection(?)</a>	Set the list sweep direction
31	<a href="#">[:SOURce]:LIST:DWELl</a>	Set dwell times of all points
32	<a href="#">[:SOURce]:LIST:FREQuency</a>	Set the list sweep frequency
33	<a href="#">[:SOURce]:LIST:FILL:POINts(?)</a>	Set the list sweep points
34	<a href="#">[:SOURce]:LIST:FILL:STARt(?)</a>	Set the list sweep start frequency
35	<a href="#">[:SOURce]:LIST:FILL:STOP(?)</a>	Set the list sweep stop frequency
36	<a href="#">[:SOURce]:LIST:POWer</a>	Set the list sweep power
37	<a href="#">[:SOURce]:LIST:RETRace(?)</a>	Set the list sweep retrace on-off
38	<a href="#">[:SOURce]:LIST:TRIGger:SOURce(?)</a>	Set the list sweep trigger source
39	<a href="#">[:SOURce]:LIST:FILL:POWer(?)</a>	Set the power offsets of all points in the list
40	<a href="#">[:SOURce]:LIST:FILL:DWELl(?)</a>	Set the dwell times of all points in the list
41	<a href="#">[:SOURce]:LIST:FILL:EXECute</a>	Complete the list fill
42	<a href="#">[:SOURce]:LFOutput:AMPLitude(?)</a>	Set the low frequency amplitude
43	<a href="#">[:SOURce]:LFOutput:FREQuency(?)</a>	Set the low frequency
44	<a href="#">[:SOURce]:LFOutput:FREQuency:ALTeRnate(?)</a>	Set the sweep frequency sine stop frequency and double-sine frequency 2
45	<a href="#">[:SOURce]:LFOutput:FREQuency:ALTeRnate:AMPLitude:PRECent(?)</a>	Set the percent of amplitude occupied by frequency 2 in the case of double-sine
46	<a href="#">[:SOURce]:LFOutput:SHAPE:NOISe(?)</a>	Set the low frequency output noise type
47	<a href="#">[:SOURce]:LFOutput:SHAPE:RAMP(?)</a>	Set the direction of the low frequency zigzagform
48	<a href="#">[:SOURce]:LFOutput:SHAPE(?)</a>	Set the low frequency waveform
49	<a href="#">[:SOURce]:LFOutput:STATe(?)</a>	Set the low frequency on-off
50	<a href="#">[:SOURce]:LFOutput:SWEEp:TIME(?)</a>	Set the sweep frequency sine sweep time
51	<a href="#">[:SOURce]:SWEEp:DIRection(?)</a>	Set the step sweep direction
52	<a href="#">[:SOURce]:SWEEp:DWELl(?)</a>	Set the step dwell time
53	<a href="#">[:SOURce]:SWEEp:MODE(?)</a>	Set the manual sweep on-off
54	<a href="#">[:SOURce]:SWEEp:POINts(?)</a>	Set the step sweep points

**Appendix B Lookup Table of SCPIs**

55	<a href="#">[:SOURce]:SWEep:STEP(?)</a>	Set the step amount of the step sweep frequency
56	<a href="#">[:SOURce]:SWEep:TIME:AUTO(?)</a>	Set the ramp sweep time auto manual
57	<a href="#">[:SOURce]:SWEep:TIME (?)</a>	Set the ramp sweep time
58	<a href="#">[:SOURce]:SWEep:GENeration(?)</a>	Set the sweep type
59	<a href="#">[:SOURce]:SWEep:TRIGger:SOURce(?)</a>	Set the step sweep trigger source
60	<a href="#">[:SOURce]:PULM:INTernal:DELAy(?)</a>	Set the pulse delay
61	<a href="#">[:SOURce]:PULM:INTernal:FREQuency ( ? )</a>	Set the pulse repetition frequency
62	<a href="#">[:SOURce]:PULM:INTernal:PERiod(?)</a>	Set the pulse modulation period
63	<a href="#">[:SOURce]:PULM:INTernal:POLarity(?)</a>	Set the pulse modulation input invert on-off
64	<a href="#">[:SOURce]:PULM:INTernal:PWIDth(?)</a>	Set the pulse width of the pulse modulation
65	<a href="#">[:SOURce]:PULM:SOURce(?)</a>	Set the pulse source
66	<a href="#">[:SOURce]:PULM:STATe(?)</a>	Set the pulse modulation on-off
67	<a href="#">[:SOURce]:AM:DEPth:EXPOntial(?)</a>	Set the exponential AM depth
68	<a href="#">[:SOURce]:AM:DEPth:LINear(?)</a>	Set the linear AM depth
69	<a href="#">[:SOURce]:AM:INTernal:FREQuency(?)</a>	Set the AM modulation rate
70	<a href="#">[:SOURce]:AM:INTernal:FREQuency:ALTErnate(?)</a>	Set the sweep frequency sine stop frequency or double-sine frequency 2
71	<a href="#">[:SOURce]:AM:INTernal:FREQuency:ALTErnate:AMPLitude:PERCent(?)</a>	Set the percent of amplitude occupied by double-sine frequency 2
72	<a href="#">[:SOURce]:AM:INTernal:NOISe(?)</a>	Set the AM waveform noise type
73	<a href="#">[:SOURce]:AM:INTernal:RAMP(?)</a>	Set the AM zigzag direction
74	<a href="#">[:SOURce]:AM:INTernal:SHAPE(?)</a>	Set the internal AM source waveform
75	<a href="#">[:SOURce]:AM:INTernal:SWEep:TIME(?)</a>	Set the AM sweep frequency sine sweep time
76	<a href="#">[:SOURce]:AM:MODE(?)</a>	Set the depth modulation on-off
77	<a href="#">[:SOURce]:AM:SOURce(?)</a>	Set the AM input selection
78	<a href="#">[:SOURce]:AM:STATe(?)</a>	Set the amplitude modulation on-off
79	<a href="#">[:SOURce]:AM:TYPE(?)</a>	Set the AM type
80	<a href="#">[:SOURce]:FM[:BANDwidth]BWIDth(?)</a>	Set the FM bandwidth
81	<a href="#">[:SOURce]:FM:DEVIation(?)</a>	Set the internal FM offset

## Appendix B Lookup Table of SCPIs

82	<a href="#">[:SOURce]:FM:INTernal:FREQuency(?)</a>	Set the FM modulation rate or sweep frequency sine start frequency and double-sine frequency 1
83	<a href="#">[:SOURce]:FM:INTernal:FREQuency:ALTErnate(?)</a>	Set the sweep frequency sine stop frequency or double-sine frequency 2
84	<a href="#">[:SOURce]:FM:INTernal:FREQuency:ALTErnate:AMPLitude:PERCent(?)</a>	Set the percent of amplitude occupied by double-sine frequency
85	<a href="#">[:SOURce]:FM:INTernal:NOISe(?)</a>	Set the FM noise type
86	<a href="#">[:SOURce]:FM:INTernal:RAMP(?)</a>	Set the FM zigzag direction
87	<a href="#">[:SOURce]:FM:INTernal:SHAPE(?)</a>	Set the FM waveform
88	<a href="#">[:SOURce]:FM:INTernal:SWEEp:TIME(?)</a>	Set the sweep frequency sine sweep time
89	<a href="#">[:SOURce]:FM:SOURce(?)</a>	Set the FM source
90	<a href="#">[:SOURce]:FM:STATe(?)</a>	Set the FM on-off
91	<a href="#">[:SOURce]:PM[:BANDwidth] BWIDTH(?)</a>	Set the phase modulation bandwidth
92	<a href="#">[:SOURce]:PM:DEVIation(?)</a>	Set the phase modulation offset
93	<a href="#">[:SOURce]:PM:INTernal:FREQuency(?)</a>	Set the phase modulation rate and sweep frequency sine start frequency or double-sine frequency 1
94	<a href="#">[:SOURce]:PM:INTernal:FREQuency:ALTErnate(?)</a>	Set the sweep frequency sine stop frequency or double-sine frequency 2
95	<a href="#">[:SOURce]:PM:INTernal:FREQuency:ALTErnate:AMPLitude:PERCent(?)</a>	Set the percent of amplitude occupied by double-sine frequency 2
96	<a href="#">[:SOURce]:PM:INTernal:NOISe(?)</a>	Set the phase modulation noise type
97	<a href="#">[:SOURce]:PM:INTernal:RAMP(?)</a>	Set the phase modulation zigzag direction
98	<a href="#">[:SOURce]:PM:INTernal:SHAPE(?)</a>	Set the phase modulation waveform
99	<a href="#">[:SOURce]:PM:INTernal:SWEEp:TIME(?)</a>	Set the phase modulation sweep frequency sine sweep time
100	<a href="#">[:SOURce]:PM:SOURce(?)</a>	Set the phase modulation source
101	<a href="#">[:SOURce]:PM:STATe(?)</a>	Set the phase modulation on-off
102	<a href="#">[:SOURce]:DM:IQADjustment::GAIN(?)</a>	Set the internal I/Q gain balance
103	<a href="#">[:SOURce]:DM:IQADjustment:IOFFse(?)</a>	Set the I channel offset

## Appendix B Lookup Table of SCPIs

		value
104	<a href="#">[:SOURce]:DM:IQADjustment:QOFFse(?)</a>	Set the Q channel offset value
105	<a href="#">[:SOURce]:DM:IQADjustment:QSKew(?)</a>	Set the phase angle between I/Q vectors
106	<a href="#">[:SOURce]:DM:IQADjustment[:STATe](?)</a>	Set the I/Q adjustment on-off
107	<a href="#">[:SOURce]:DM:MODulation:ATTenuation(?)</a>	Set the I/Q signal attenuation
108	<a href="#">[:SOURce]:DM:MODulation:ATTenuation:AUTO(?)</a>	Set the I/Q signal attenuation on-off state
109	<a href="#">[:SOURce]:DM:STATe(?)</a>	Set the I/Q modulation on-off
110	<a href="#">[:SOURce]:RADio:CUSTom:ALPHa(?)</a>	Set the baseband filter factor
111	<a href="#">[:SOURce]:RADio:CUSTom:DATA(?)</a>	Set the baseband modulation signal data source
112	<a href="#">[:SOURce]:RADio:CUSTom:FILTer(?)</a>	Set the baseband filter type
113	<a href="#">[:SOURce]:RADio:CUSTom:MODulation:FSK[:DEVIation](?)</a>	Set the FM offset when the baseband modulation type is FSK mode
114	<a href="#">[:SOURce]:RADio:CUSTom:MODulation:MSK:PHASe(?)</a>	Set the phase modulation offset when the baseband modulation type is MSK mode
115	<a href="#">[:SOURce]:RADio:CUSTom:MODulation[:TYPE](?)</a>	Set the baseband modulation format
116	<a href="#">[:SOURce]:RADio:CUSTom:SRATE(?)</a>	Set the baseband symbol rate
117	<a href="#">[:SOURce]:RADio:CUSTom:STATe(?)</a>	Set the baseband on-off
118	<a href="#">:MEMory:COpy:NAME</a>	Copy the files in the signal generator
119	<a href="#">:MEMory:DLete:NAME</a>	Delete the user files
120	<a href="#">:MEMory:MOVE</a>	Rename the signal generator file name
121	<a href="#">:ROSCillator:ADJust:REFerence(?)</a>	Set the signal generator internal reference
122	<a href="#">:DIAGnostic:INFormation:CCOunt:POn?</a>	This command is used to query the cumulative number of times the instrument is powered on
123	<a href="#">:DIAGnostic:INFormation:OTIME?</a>	This command is used to query the instrument firmware date and time stamp
124	<a href="#">:DIAGnostic:SNUM?</a>	Read the signal generator

## Appendix B Lookup Table of SCPIs

		system serial number
125	<a href="#">:SYSTem:COMMunicate:GPIB:ADDRess(?)</a>	Set the signal generator GPIB address
126	<a href="#">:SYSTem:COMMunicate:GTLocal</a>	Set the signal generator to local mode

Attached Table 2 Lookup Table of 1465 SCPIs (Classified by Menu)

Menu	Default Value	Range	SCPI
<b>Frequency Configuration</b>			
CW	1465A 9.999875GHz 1465 22.000125GHz	1465A [100kHz-20GHz] 1465 [100kHz-67GHz]	<a href="#">[:SOURce]:FREQuency[:CW   FIXed]</a>
Freq Step	100MHz	1465A [1mHz – 19.99975GHz] 1465 [1mHz – 43.99975GHz]	<a href="#">[:SOURce]:FREQuency:STEP</a>
Freq Offset	0Hz	[-325GHz-+325GHz]	<a href="#">[:SOURce]:FREQuency:OFFSet</a>
Freq Ref Switch	Off	OFF\ON	<a href="#">[:SOURce]:FREQuency:REFeRence:STATe</a>
Freq Ref	0Hz	1465A [100kHz – 20GHz] 1465 [100kHz – 67GHz]	<a href="#">[:SOURce]:FREQuency:REFeRence</a>
Freq Mul	1	[1-36]	<a href="#">[:SOURce]:FREQuency:MULTIplier</a>
LF Output ON OFF	Off	OFF\ON	<a href="#">[:SOURce]:LFOutput:STATe</a>
LF	400Hz	[0-1MHz]	<a href="#">[:SOURce]:LFOutput:FREquency</a>
LF Ampl	2VPP	[0-4VPP]	<a href="#">[:SOURce]:LFOutput:AMPLitude</a>
LF Waveform	SINE	SINE SQUare TRIangle RAMP NOIS e SWEPTsine DUALsine	<a href="#">[:SOURce]:LFOutput:SHAPE</a>
Zigzag	Zigzag-Up	Zigzag-Up\Zigzag-Down	<a href="#">[:SOURce]:LFOutput:SHAPE:RAMP</a>
White Noise	White noise	White noise\Gauss	<a href="#">[:SOURce]:LFOutput:SHAPE:NOISe</a>
SweepSinc/Freq Start	1MHz	[0.01Hz-1MHz]	<a href="#">[:SOURce]:LFOutput:FREquency</a>
SweepSinc/Freq Stop	1MHz	[0.01Hz-1MHz]	<a href="#">[:SOURce]:LFOutput:FREquency:ALTeRnate</a>
SweepSinc/Swee p Time	10us	[ 1us- 2s ]	<a href="#">[:SOURce]:LFOutput:SWEEP:TIME</a>
Dual Freq/Frequency1	1MHz	[0.01Hz-1MHz]	<a href="#">[:SOURce]:LFOutput:FREquency</a>
Dual Freq/Frequency2	1MHz	[0.01Hz-1MHz]	<a href="#">[:SOURce]:LFOutput:FREquency:ALTeRnate</a>

**Appendix B Lookup Table of SCPIs**

Dual Freq/Frequency 2 Ampl Percent	50%	[ 0% - 100% ]	<a href="#">[:SOURce]:LFOutput:INTERNAL:FREQuency:ALternate:AMPLitude:PERCent</a>
<b>Amplitude Configuration</b>			
Amplitude Level	-115dB	[-135dB--+30dB]	<a href="#">[:SOURce]:POWER[:LEVel][:IMMEDIATE][:AMPLitude]</a>
Ampl Step	0.01dB	[0.01dB-20dB]	<a href="#">[:SOURce]:POWER:STEP</a>
Ampl Offset	0dB	[-100dB--+100dB]	<a href="#">[:SOURce]:POWER[:LEVel][:IMMEDIATE]:OFFSet</a>
POWER Ref ON OFF	Off	OFF\ON	<a href="#">[:SOURce]:POWER:REFerence:STATE</a>
POWER Ref	0dBm	[-135dB--+30dB]	<a href="#">[:SOURce]:POWER:REFerence</a>
Attenuation/ Attenuation Style Auto Manual	Auto	Auto\Manual	<a href="#">[:SOURce]:POWER:ATTe-nuation:AUTO</a>
Attenuation/ ALC	0dBm	[-20dB--+30dB]	<a href="#">[:SOURce]:POWER:ALC:LEVel</a>
Attenuation/ Set Attenuation	115dB	[0dB--+115dB]	<a href="#">[:SOURce]:POWER:ATTe-nuation</a>
ALC Loop Config/ALC Loop State ALC-ON ALC-OFF	ALC-OFF	ALC-OFF/ALC-ON	<a href="#">[:SOURce]:POWER:ALC[:STATE]</a>
ALC Loop Config/Search Style Auto Manual	Manual	Auto/manual	<a href="#">[:SOURce]:POWER:ALC:SEARch</a>
ALC Loop Config/Search Ref Fixed Modulated	Fixed	Fixed/Modulated	<a href="#">[:SOURce]:POWER:ALC:SEARch:REFerence</a>
ALC Loop Config/Do Search			
ALC Band Manu Auto	Auto	Manu/Auto	<a href="#">[:SOURce]:POWER:ALC:Bandwidth BWIDTH:AUTO</a>
Select ACL Band	10kHz	100Hz/1kHz/10kHz/100kHz	<a href="#">[:SOURce]:POWER:ALC:Bandwidth BWIDTH</a>
Level Control	Internal	INT/EXT/Source Module	<a href="#">[:SOURce]:POWER:ALC:SOURCE</a>
EXT Detector Couple	16dB	[-90dB - 90dB]	<a href="#">[:SOURce]:POWER:ALC:SOURCE:EXTERNAL:COUPLI</a>



## Appendix B Lookup Table of SCPIs

			<a href="#">ng</a>
RF Blank	On	ON/OFF	<a href="#">:OUTPut:BLANking[:STA Te]</a>
<b>Sweep Configuration</b>			
Current Sweep Type	Off	Close/Step Sweep/List Sweep	<a href="#">[:SOURce]:FREQuency: MODE</a>
Trig Style of Start	Auto	Auto/Bus/Ext/Key	<a href="#">:TRIGger[:SEQuence]:SO URce</a>
Sweep mode	Continue	Single/Continue	<a href="#">:INITiate:CONTInuous[: ALL]</a>
Manual Sweep	AUTO	AUTO/MANual	<a href="#">[:SOURce]:SWEep:MOD E</a>
Step/Freq Start	100kHz	1465A [100kHz-20GHz] 1465 [100kHz-67GHz]	<a href="#">[:SOURce]:FREQuency:S TARt</a>
Step/Freq Stop	1465A 20GHz 1465 67GHz	1465A [100kHz-20GHz] 1465 [100kHz-67GHz]	<a href="#">[:SOURce]:FREQuency:S TOP</a>
Step Sweep Indirection	Forward	Forward/Backward	<a href="#">[:SOURce]:SWEep:DIRec tion</a>
Step/Step Counts	11	[2-801]	<a href="#">[:SOURce]:SWEep:POIN ts</a>
Step/Step Dwell	10ms	[10ms-100s]	<a href="#">[:SOURce]:SWEep:DWEL l</a>
Step/Step Trig	Auto	Auto/Bus/Ext/Key	<a href="#">[:SOURce]:SWEep:TRIGg er:SOURce</a>
Trig Freq	250MHz	[-200GHz- 200GHz]	
List/All List CW Rates	250kHz	1465A [100kHz-20GHz] 1465 [100kHz-67GHz]	<a href="#">[:SOURce]:LIST:FREQue ncy</a>
List/Delete Frequency Points	Current	Current/Undefined/All Points	<a href="#">[:SOURce]:LIST:DELeTe</a>
List/Sweep Indirection	Forward	Forward/Backward	<a href="#">[:SOURce]:LIST:DIRectio n</a>
List/Dwell Time	1ms	[1ms-60s]	<a href="#">[:SOURce]:LIST:DWELL</a>
List/Insert Frequency Point	3	[2-801]	<a href="#">[:SOURce]:LIST:FILL:POI Nts</a>
List/Freq Start	250kHz	1465A [100kHz-20GHz] 1465 [100kHz-67GHz]	<a href="#">[:SOURce]:LIST:FILL:STA Rt</a>
List/Freq Stop	250kHz	1465A [100kHz-20GHz] 1465 [100kHz-67GHz]	<a href="#">[:SOURce]:LIST:FILL:STO P</a>
List/All List Ampl Offset	0	[-20dBm--+25dBm]	<a href="#">[:SOURce]:LIST:POWer</a>
List/List Trig	Auto	Auto/Bus/Ext/Key	<a href="#">[:SOURce]:LIST:TRIGger: SOURce</a>
<b>Pulse Configuration</b>			

**Appendix B Lookup Table of SCPIs**

Pulse Modulation ON OFF	Off	ON/OFF	<a href="#">[:SOURce]:PULM:STATE</a>
Source	Internal	Auto/EXT/Scalar/Square/D-Pulse/Pulse Train/Gate/Trig/Jittered/Staggered/Sliding	<a href="#">[:SOURce]:PULM:SOURce</a>
Width	50us	[20ns-41.999999990s]	<a href="#">[:SOURce]:PULM:INTERNAL:PWIDth</a>
Delay	0s	Non-Trig Mode [0s-42s] Trig Mode [100ns-42S]	<a href="#">[:SOURce]:PULM:INTERNAL:DELay</a>
Period	1ms	[40ns-42s]	<a href="#">[:SOURce]:PULM:INTERNAL:PERiod</a>
PRF	1kHz	[0.023Hz-25MHz]	<a href="#">[:SOURce]:PULM:INTERNAL:FREQuency</a>
Input Direction ON OFF	Off	ON/OFF	<a href="#">[:SOURce]:PULM:INTERNAL:POLarity</a>
Pulse Source/Pulse Train	0	[0-1023]	<a href="#">[:SOURce]:PULM:INTERNAL:PTRain:DATA</a>
Pulse Source/Pulse Train/Delete Current Point	0	[0-1023]	<a href="#">[:SOURce]:PULM:INTERNAL:PTRain:DELeTe</a>
Pulse Source/Pulse Train/Delete All Points			<a href="#">[:SOURce]:PULM:INTERNAL:PTRain:PRESet</a>
Pulse Source/Pulse Train/Jittered	Gaussion	Random/Gaussion	<a href="#">[:SOURce]:PULM:INTERNAL:JITTered:MODE</a>
Pulse Source/Jittered/Dither Percent	0	[0-10%]	<a href="#">[:SOURce]:PULM:INTERNAL:JITTered:PERCent</a>
Pulse Source/Sliding/Sliding Step	100ns	[0-42ms]	<a href="#">[:SOURce]:PULM:INTERNAL:SLIDing:STEP</a>
Pulse Source/Staggered/Delete Current Point	0	[0-4]	<a href="#">[:SOURce]:PULM:INTERNAL:STAGger:DELeTe</a>
Pulse Source/Staggered/Insert			<a href="#">[:SOURce]:PULM:INTERNAL:STAGger:INSert</a>
Pulse Source/Staggered/Delete All Points			<a href="#">[:SOURce]:PULM:INTERNAL:STAGger:PRESet</a>
Linear Bandwidth FM	4MHz	[0-80MHz]	<a href="#">[:SOURce]:PULM:LFM:BWIDth</a>

## Appendix B Lookup Table of SCPIs

Linear Direction	FM	Forward	Forward/Backward	<a href="#">[:SOURce]:PULM:LFM:DIRECTION</a>
Linear OFF	FM ON	Off	ON/OFF	<a href="#">[:SOURce]:PULM:LFM:STATE</a>
<b>AM Configuration</b>				
AM ON	OFF	Off	ON/OFF	<a href="#">[:SOURce]:AM:STATE</a>
AM Waveform		Sinc	Sinc/Square/Triangle/Zigzag/White noise/SweepSinc and DualSinc	<a href="#">[:SOURce]:AM:INTERNAL:SHAPE</a>
AM Type	EXP Linear	Linear	EXP/Linear	<a href="#">[:SOURce]:AM:TYPE</a>
Am Source		Internal	INT/EXT	<a href="#">[:SOURce]:AM:SOURce</a>
AM Depth	ON OFF	Off	ON/OFF	<a href="#">[:SOURce]:AM:MODE</a>
AM Rate		1kHz	[5mHz-1MHz]	<a href="#">[:SOURce]:AM:INTERNAL:FREQUENCY</a>
Linear AM Depth		30%	[0-100%]	<a href="#">[:SOURce]:AM:DEPTH:LINEAR</a>
EXP AM Depth		0	[0-40dB]	<a href="#">[:SOURce]:AM:DEPTH:EXponential</a>
AM Waveform/Zigzag		Zigzag-Up	Zigzag-up Zigzag-down	<a href="#">[:SOURce]:AM:INTERNAL:RAMP</a>
AM Waveform/White noise/White noise Gauss		White noise	White noise/Gauss	<a href="#">[:SOURce]:AM:INTERNAL:NOISE</a>
AM Waveform/SweepSinc/Freq Start		1kHz	[5mHz-1MHz]	<a href="#">[:SOURce]:AM:INTERNAL:FREQUENCY</a>
AM Waveform/SweepSinc/Freq Stop		1kHz	[5mHz-1MHz]	<a href="#">[:SOURce]:AM:INTERNAL:FREQUENCY:ALternate</a>
AM Waveform/SweepSinc/Sweep Time		10ms	[10us-2s]	<a href="#">[:SOURce]:AM:INTERNAL:SWEep:TIME</a>
AM Waveform/DualSinc/Frequency1		1kHz	[5mHz-1MHz]	<a href="#">[:SOURce]:AM:INTERNAL:FREQUENCY</a>
AM Waveform/DualSinc/Frequency2		1kHz	[5mHz-1MHz]	<a href="#">[:SOURce]:AM:INTERNAL:FREQUENCY:ALternate</a>
AM Waveform/DualSinc/Frequency 2 Amplitude Percent		50%	[0-100%]	<a href="#">[:SOURce]:AM:INTERNAL:FREQUENCY:ALternate:AMPLitude:PERCent</a>

**Appendix B Lookup Table of SCPIs**

<b>FM Configuration</b>				
FM ON OFF	Off	ON/OFF		<a href="#">[:SOURce]:FM:STATe</a>
FM Waveform	Sinc	Sinc/Square/Triangle/Zigzag/White noise/SweepSinc and DualSinc		<a href="#">[:SOURce]:FM:INTErnal:SHAPE</a>
Fm Source	Internal	INT/EXT		<a href="#">[:SOURce]:FM:SOURce</a>
FM Bandwidth 100kHz 1MHz	100kHz	100kHz/1MHz		<a href="#">[:SOURce]:FM[:BANDwi dth] BWIDTh</a>
AM Rate	1kHz	SweepSinc/DualSinc [0.01Hz - 1MHz] Other waveforms [0.005Hz-1MHz]		<a href="#">[:SOURce]:FM:INTErnal:FREQuency</a>
FM Dev	1MHz	1465A 0-32MHz 1465 0-48MHz		<a href="#">[:SOURce]:FM:DEVIatio n</a>
FM Waveform/Zigzag /Zigzag-up Zigzag-down	Zigzag-Up	Zigzag-up Zigzag-down		<a href="#">[:SOURce]:FM:INTErnal:RAMP</a>
FM Waveform/White noise/White noise Gauss	White noise	White noise/Gauss		<a href="#">[:SOURce]:FM:INTErnal:NOISE</a>
FM Waveform/Swee pSinc/Freq Start	1kHz	[5mHz-1MHz]		<a href="#">[:SOURce]:FM:INTErnal:FREQuency</a>
FM Waveform/Swee pSinc/Freq Stop	1kHz	[5mHz-1MHz]		<a href="#">[:SOURce]:FM:INTErnal:FREQuency:ALTErnate</a>
FM Waveform/Swee pSinc/Sweep Time	10ms	[10us-2s]		<a href="#">[:SOURce]:FM:INTErnal:SWEep:TIME</a>
FM Waveform/DualSi nc/Frequency1	1kHz	[5mHz-1MHz]		<a href="#">[:SOURce]:FM:INTErnal:FREQuency</a>
FM Waveform/DualSi nc/Frequency2	1kHz	[5mHz-1MHz]		<a href="#">[:SOURce]:FM:INTErnal:FREQuency:ALTErnate</a>
FM Waveform/DualSi nc/Frequency 2 Ampl Percent	50%	[0-100%]		<a href="#">[:SOURce]:FM:INTErnal:FREQuency:ALTErnate:AMPLitude:PERCent</a>
<b>PM Configuration</b>				
PM ON OFF	Off	ON/OFF		<a href="#">[:SOURce]:PM:STATe</a>
PM Waveform	Sinc	Sinc/Square/Triangle/Zigzag/White noise/SweepSinc and DualSinc		<a href="#">[:SOURce]:PM:INTErnal:SHAPE</a>
PM Source	Internal	INT/EXT		<a href="#">[:SOURce]:PM:SOURce</a>
PM Bandwidth	100kHz	100kHz/1MHz		<a href="#">[:SOURce]:PM[:BANDwi</a>

## Appendix B Lookup Table of SCPIs

100 kHz 1MHz			<a href="#">:BWiDth</a>
AM Rate	1kHz	SweepSinc/DualSinc [0.01Hz - 1MHz] Other waveforms [0.005Hz-1MHz]	<a href="#">[:SOURce]:PM:INTErnal:FREQUency</a>
PM Freq Offset	1MHz	1465A 0-32MHz 1465 0-48MHz	<a href="#">[:SOURce]:PM:DEVIatio<u>n</u></a>
FM Waveform/Zigzag /Zigzag-up Zigzag-down	Zigzag-Up	Zigzag-up Zigzag-down	<a href="#">[:SOURce]:PM:INTErnal:RAMP</a>
FM Waveform/White noise/White noise Gauss	White noise	White noise/Gauss	<a href="#">[:SOURce]:PM:INTErnal:NOISE</a>
FM Waveform/Swee pSinc/Freq Start	1kHz	[5mHz-1MHz]	<a href="#">[:SOURce]:PM:INTErnal:FREQUency</a>
FM Waveform/Swee pSinc/Freq Stop	1kHz	[5mHz-1MHz]	<a href="#">[:SOURce]:PM:INTErnal:FREQUency:ALTErnate</a>
FM Waveform/Swee pSinc/Sweep Time	10ms	[10us-2s]	<a href="#">[:SOURce]:PM:INTErnal:SWEep:TIME</a>
FM Waveform/DualSi nc/Frequency1	1kHz	[5mHz-1MHz]	<a href="#">[:SOURce]:PM:INTErnal:FREQUency</a>
FM Waveform/DualSi nc/Frequency2	1kHz	[5mHz-1MHz]	<a href="#">[:SOURce]:PM:INTErnal:FREQUency:ALTErnate</a>
FM Waveform/DualSi nc/Frequency 2 Ampl Percent	50%	[0-100%]	<a href="#">[:SOURce]:PM:INTErnal:FREQUency:ALTErnate:AMPLitude:PERCent</a>
<b>Baseband Configuration</b>			
Baseband ON OFF	Off	ON/OFF	<a href="#">[:SOURce]:RADio:CUSTom:STATE</a>
Data Source	PN15	PN9/PN11/PN15/PN20/PN21/PN23/ FIX4/P4/P8/P16/P32/P64/EXT	<a href="#">[:SOURce]:RADio:CUSTom:DATA</a>
Data Source/Fix 4	0	[0-15]	<a href="#">[:SOURce]:RADio:CUSTom:DATA:FIX4</a>
Symbo Rate	24.3ksps	[0.0005Msps-50Msps]	<a href="#">[:SOURce]:RADio:CUSTom:SRATE</a>
Modulation Type	QPSK	BPSK QPSK IS95QPSK GRAYQPSK OQPSK IS95OQPSK P4DQPSK 8PSK 16PSK D8PSK MSK 2FSK 4FSK 8FSK 16FSK C4FM 4QAM 16QAM 32QAM 64QAM 128QAM 256QA	<a href="#">[:SOURce]:RADio:CUSTom:MODulation[:TYPE]</a>

**Appendix B Lookup Table of SCPIs**

		M 512QAM ASK	
Filter	NYQuist	NYQuist RNYQuist GAUSSian RECTangle	<a href="#">[:SOURce]:RADio:CUStom:FILTer</a>
Filter Factor a	0.350	[0-1.000]	<a href="#">[:SOURce]:RADio:CUStom:ALPHa</a>
Modulation Type/MSK	90rad	[0rad-100rad]	<a href="#">[:SOURce]:RADio:CUStom:MODulation:MSK:PHASe</a>
Modulation Type/FSK	4kHz	[0.4kHz-20MHz]	<a href="#">[:SOURce]:RADio:CUStom:MODulation:FSK[:DEVIation]</a>
Modulation Type/ASK	100%	[0%-100%]	<a href="#">[:SOURce]:RADio:CUStom:MODulation:ASK:DEPTh:PERCent</a>
Differential Code ON OFF	Off	ON/OFF	<a href="#">[:SOURce]:RADio:CUStom:DENCode</a>
Phase Polary Normal Reverse	Normal	Normal/Reverse	<a href="#">[:SOURce]:RADio:CUStom:POLarity[:ALL]</a>
Trig Source/Ext External Trig Source	EXT1	EXT1/EXT2	<a href="#">[:SOURce]:RADio:CUStom:TRIGger:EXTernal:SOURce</a>
Trig Source/Ext/Delay	0	[0-1048575]	<a href="#">[:SOURce]:RADio:CUStom:TRIGger:EXTernal:SOURce:DELay</a>
Trig Source/Ext/Delay ON OFF	Off	ON/OFF	<a href="#">[:SOURce]:RADio:CUStom:TRIGger:EXTernal:SOURce:DELay:STATe</a>
Trig Source/Ext/External Trig Polary	Hight	Hight/Low	<a href="#">[:SOURce]:RADio:CUStom:TRIGger:EXTernal:SOURce:SLOPe</a>
Trig Source	Key	Key/Bus/Ext	<a href="#">[:SOURce]:RADio:CUStom:TRIGger:SOURce</a>
Trig Style	Continue	Continue/Single/Gate	<a href="#">[:SOURce]:RADio:CUStom:TRIGger:TYPE</a>
Trig Style/Continue	Continue Auto	Continue Auto/Trig/Realtime	<a href="#">[:SOURce]:RADio:CUStom:TRIGger:TYPE:CONTinuous:TYPE</a>
Trig Style/Gate	Low	Low/Hight	<a href="#">[:SOURce]:RADio:CUStom:TRIGger:TYPE:GATE:ACTive</a>
<b>Tone Configuration</b>			
Multi Tone ON	Off	ON/OFF	<a href="#">[:SOURce]:RADio:MTone:ARB:STATe</a>
Multi Tone/Load File			<a href="#">[:SOURce]:RADio:MTone:ARB:SETup</a>

## Appendix B Lookup Table of SCPIs

Multi Tone/Save File			<a href="#">[:SOURce]:RADio:MTONe:ARB:SETIP:STORe</a>
Multi Tone/Freq Interval	1MHz	[1MH-80MHz]	<a href="#">[:SOURce]:RADio:MTONe:ARB:SETup:TABLE:FSPacing</a>
Multi Tone/Tone Count	2	[2-64]	<a href="#">[:SOURce]:RADio:MTONe:ARB:SETup:TABLE:NO TNes</a>
Multi Tone/Initial Phase Random Fixed	Fixed	Random/Fixed	<a href="#">[:SOURce]:RADio:MTONe:ARB:SETup:TABLE:PHASe:INITialize</a>
Multi tone/Phase Rela	Fixed	Random/Fixed	<a href="#">[:SOURce]:RADio:MTONe:ARB:SETup:TABLE:PHASe:INITialize:SEED</a>
Dual Tone ON	Off	ON/OFF	<a href="#">[:SOURce]:RADio:TTONe:ARB:STATe</a>
Dual Tone/Freq Separation	10MHz	[0MHz-40MHz]	<a href="#">[:SOURce]:RADio:TTONe:ARB:FSPacing</a>
Dual Tone Alignment	Centre	Left/Centre/Right	<a href="#">[:SOURce]:RADio:TTONe:ARB:ALIGnment</a>
<b>I/Q Configuration</b>			
I/Q modulation	Off	ON/OFF	<a href="#">[:SOURce]:DM:STATe</a>
I/Q Codulate ON OFF	Off	ON/OFF	<a href="#">[:SOURce]:DM:IQADjustment[:STATe]</a>
I Offset	0%	[-50%-50%]	<a href="#">[:SOURce]:DM:IQADjustment:I OFFset</a>
Q Offset	0%	[-50%-50%]	<a href="#">[:SOURce]:DM:IQADjustment:Q OFFset</a>
Select I/Q Filter	2.1E6/50e6/Throug	Through	<a href="#">[:SOURce]:DM:MODulat ion:FILTer</a>
I/Q Filter Manual Auto	Auto	Manu/Auto	<a href="#">[:SOURce]:DM:MODulat ion:FILTer:AUTO</a>
I/Q Adj/Gain Balance	0dB	[-4dB-4dB]	<a href="#">[:SOURce]:DM:IQADjustment:GAIN</a>
I/Q Adj/Orthority Offset	0rad	[-10rad-10rad]	<a href="#">[:SOURce]:DM:IQADjustment:QSKew</a>
I/Q Adj/EXT600Ω I Offset	0V	[-5V-5V]	<a href="#">[:SOURce]:DM:IQADjustment:EXTernal:I OFFset</a>
I/Q Adj/EXT600Ω Q Offset	0V	[-5V-5V]	<a href="#">[:SOURce]:DM:IQADjustment:EXTernal:Q OFFset</a>
I/Q Data Source	EXT50Ω	EXT50Ω/EXT600Ω/INT/OFF	<a href="#">[:SOURce]:DM:SOURce</a>
Modulation	Auto	Manu/Auto	<a href="#">[:SOURce]:DM:MODulat</a>

**Appendix B Lookup Table of SCPIs**

Attenuation Manual Auto			<a href="#">[:ATTenuation:AUTO]</a>
Modulation attenuation	12dB	[0dB-40dB]	<a href="#">[:SOURce]:DM:MODulat ion:ATTenuation</a>
Phase Polary Normal Reverse	Normal	Normal/Reverse	<a href="#">[:SOURce]:DM:POLarity [:ALL]</a>
Select Output Filter Manual Auto	Auto	Manu/Auto	<a href="#">[:SOURce]:DM:EXTernal :FILTer:AUTO</a>
Output Filtering	Through	Through/50MHz	<a href="#">[:SOURce]:DM:EXTernal :FILTer</a>
External Output Source	EXT50Ω	EXT50Ω/EXT600Ω/INT/OFF	<a href="#">[:SOURce]:DM:EXTernal :SOURce</a>
Output Attenuation	6dB	[0dB-40dB]	<a href="#">[:SOURce]:DM:IQADjust ment:EXTernal:IQATten</a>
Output Adj/Gain Balance	0dB	[-4dB-4dB]	<a href="#">[:SOURce]:DM:IQADjust ment:EXTernal:GAIN</a>
Output Adj/Common Mode I/Q Offset	0V	[-3V-3V]	<a href="#">[:SOURce]:DM:IQADjust ment:EXTernal:COFFset</a>
Output Adj/differential mode I offset	0V	[-3V-3V]	<a href="#">[:SOURce]:DM:IQADjust ment:EXTernal:DIOFFset</a>
Output Adj/differential mode I offset	0V	[-3V-3V]	<a href="#">[:SOURce]:DM:IQADjust ment:EXTernal:DQOFFse t</a>
External Output Source/EXT50Ω I Offset	0V	[-5V-5V]	<a href="#">[:SOURce]:DM:IQADjust ment:EXTernal:IOFFset</a>
External Output Source/ EXT50Ω Q Offset	0V	[-5V-5V]	<a href="#">[:SOURce]:DM:IQADjust ment:EXTernal:QOFFset</a>
<b>Arb Configuration</b>			
Arb Seq ON OFF	Off	ON/OFF	<a href="#">[:SOURce]:RADio:ARB:S TATe</a>
Work Pattern	Seq	Arb/Seq	<a href="#">[:SOURce]:RADio:ARB: MODE</a>
Clock Type	Invariant	Invariant/Highest/User Defined	<a href="#">[:SOURce]:RADio:ARB:S EQuence:CLOCK</a>
Clock Freq	100MHz	[0.01MHz-200MHz]	<a href="#">[:SOURce]:RADio:ARB:S Clock:RATE</a>
Custom Wave Seg/Wave Seg Length	10000	[1-268435456]	<a href="#">[:SOURce]:RADio:ARB:S EGMent:LENGth</a>
Custom Wave Seg/Over	32	[1-32]	<a href="#">[:SOURce]:RADio:ARB:S EGMent:OVERsample</a>



## Appendix B Lookup Table of SCPIs

Sample Count				
Custom Wave Seg/Over Sample Count Auto	Auto	Auto/manual		<a href="#">[:SOURce]:RADio:ARB:SEGMENT:OVERsample:AUTO</a>
New Seq				<a href="#">[:SOURce]:RADio:ARB:SEQUence</a>
Trig Style	Continue	Continue/Single/Gate/Wave Segment		<a href="#">[:SOURce]:RADio:ARB:TRIGger:TYPE</a>
Trig Style/Continue	Auto	Auto/Trig/Realtime		<a href="#">[:SOURce]:RADio:ARB:TRIGger:TYPE:CONTInuous</a>
Trig Style/Gate	Low	Low/Hight		<a href="#">[:SOURce]:RADio:ARB:TRIGger:TYPE:GATE:ACTIve</a>
Trig Mode/Wave Segment	Continue	Single/Continue		<a href="#">[:SOURce]:RADio:ARB:TRIGger:TYPE:SADVance:TYPE</a>
<b>AWGN Configuration</b>				
AWGN ON OFF	Off	ON/OFF		<a href="#">[:SOURce]:RADio:AWGN:ARB[:STATE]</a>
AWGN Noise Bandwidth	10MHz	[1kHz-160MHz]		<a href="#">[:SOURce]:RADio:AWGN:ARB:BWIDth</a>
AWGN Noise Type	Pure Noise	Add noise/Pure noise/CW Inteferer		<a href="#">[:SOURce]:RADio:AWGN:ARB:MODE</a>
<b>File Configuration</b>				
Copy				<a href="#">:MEMory:COpy:NAME</a>
Delete				<a href="#">:MEMory:DELeTe:NAME</a>
<b>Ref Configuration</b>				
INT REF accuracy Adj	30000	[0-65535]		<a href="#">[:SOURce]:ROSCillator:ADJust:REFErence</a>
<b>Save/Recall Configuration</b>				
Save	0	[0-99]		<a href="#">*SAV</a>
Recall	0	[0-99]		<a href="#">*RCL</a>
<b>System Configuration</b>				
Reset	Factory	Factory/User/Last State		<a href="#">:SYSTem:PRESet:TYPE</a>
GPIB Port Config/Local GPIB Addr	19	[0-30]		<a href="#">:SYSTem:COMMunicate:GPIB:ADDRes</a>
LAN Port Config/Local Machine IP Addr				<a href="#">:SYSTem:COMMunicate:LAN:IP</a>
LAN Port				<a href="#">:SYSTem:COMMunicate:</a>

**Appendix B Lookup Table of SCPIs**

Config/NET MASK			<a href="#">LAN:SUBNet</a>
LAN Port Config/Default Gate			<a href="#">:SYSTem:COMMunicate:LAN:GATeway</a>
RS232 Port Config/Baud Rate	9600	300/2400/4800/9600/19200/38400/57600	<a href="#">:SYSTem:COMMunicate:SERial:BAUD</a>
RS232 Port Config/Response ON OFF	Off	ON/OFF	<a href="#">:SYSTem:COMMunicate:SERial:ECHO</a>
RS232 Port Config/Timeout	3s	[1s-25s]	<a href="#">:SYSTem:COMMunicate:SERial:TOUT</a>

## Appendix C Lookup Table of Error Information

Attached Table 3 Table of Local Error Information

Error Key Field	Error Description
No ALC	For excessive or no power
Time base not heated	The internal 10MHz time base of the signal generator is not at the operating temperature
Loss of lock of reference loop	The internal reference loop signal of the signal generator is out of lock
Loss of lock of decimal loop	The internal decimal loop signal of the signal generator is out of lock
Loss of lock of high purity loop	The internal decimal loop signal of the signal generator is out of lock
Loss of lock of YO	The internal YO loop signal of the signal generator is out of lock
External reference	The signal generator is in the external reference state and this is not an error

Attached Table 4 Table of Programming Error Information

Error code	Error Description (Error Information and Error Description)
-101	Command string matching error, this command is not in the library
-102	The command string is too short.
-103	The command string is too long
-104	Command type error
-105	No parameter type with parameters
-106	Query command with incorrect parameters
-107	Set command without parameters
-108	Discrete parameter format error
-120	Command type mismatch
-121	The file to be renamed does not exist
-130	The parameter unit does not match
-131	The value has an illegal value
-132	There is an illegal value in the value of the value block
-133	There is an illegal value in the binary block value
-134	The play file does not exist
-135	The set parameter is out of limit and the limit is the maximum value

**Appendix D Lookup Table of PC Keyboard in Function Configuration Windows**

## Appendix D Lookup Table of PC Keyboard in Function Configuration Windows

<b>PC Keyboard Symbol</b>	<b>Name of Corresponding Function Configuration Window</b>
A	Frequency configuration window
B	Power rate configuration window
C	Sweep configuration window
D	Menu configuration window
E	User calibration window
F	System configuration window
G	Baseband configuration window
H	Help window
I	Save/call window
J	File management window
K	Reset
N	RF switch
P	Modulation switch
Q	I/Q configuration window
R	AM configuration window
S	FM/PM configuration window
T	PM configuration window
U	Trigger
Z	Print