

User Manual

Please read this Manual carefully before operation

Please keep this Manual along with the device



VIEW **770**

Precision Power Analyzer

POWERFUL MEASURING INSTRUMENT

Content

Chapter 1 Components with functions	6
1.1 Panels.....	6
1.2 Functions of Keys.....	7
1.3 Values and Strings.....	8
1.4 Display.....	9
Chapter 2 Ready for Measurement	11
2.1 Instructions in use.....	11
2.2 Connecting with Power Supply.....	11
2.3 Power on/off.....	12
2.4 Connecting the Circuit under Measurement.....	12
2.5 Circuit under Measurement Connected to the EXT Sensor Input Terminal.....	14
Chapter 3 Setting Measurement Conditions	19
3.1 Setting User-Defined Functions.....	19
3.2 Setting User-defined Events.....	23
3.3 Setting the Formula.....	24
3.4 Setting Wiring.....	25
3.5 Selecting Difference Display Format.....	28
3.6 Scaling Setting.....	28
3.7 Phase Calibration Setting for the Sensor.....	30
3.8 Selecting Update Rate.....	30
3.9 Activating Measurement Range.....	31
3.10 Synchronization Measuremen.....	33
3.11 Harmonic Setting.....	33
Chapter 4 Accurate Measurement	34
4.1 Line Filter.....	34
4.2 Frequency Filter.....	35
4.3 Averaging Setting.....	35
4.4 NULL Function Setting.....	36
4.5 Zero-Level Compensation.....	36
Chapter 5 Setting the Source	38
5.1 Setting the Sync Source.....	38
5.2 Setting PLL Source.....	38
Chapter 6 Range Setting	39
6.1 Setting Fixed Ranges of the Voltage and Current.....	39
6.2 Setting Auto Ranges of the voltage and current.....	40

6.3 Setting EXT Current Sensor range.....	40
6.4 Overload protection.....	41
Chapter 7 Numeric Display	42
7.1 Setting the Numeric Display Format.....	42
7.2 Setting the Numeric Display Items.....	43
7.3 User.....	44
7.4 Harmonic Measurement in Normal Measurement Mode.....	45
7.5 Setting the Application Scenarios.....	48
Chapter 8 Waveform Display	50
8.1 Setting the Format of the Waveform Display.....	50
8.2 Setting the Waveform Display Item.....	52
8.3 Setting the Cursors on the Waveforms.....	52
8.4 Waveform Computation (option)	53
Chapter 9 Vector Display	57
9.1 Setting the Format of the Vector.....	57
9.2 Setting the Vector Display Item.....	58
Chapter 10 Bar Display	59
10.1 Setting the Format of the Bar Graph.....	59
10.2 Setting the Bar Graph Display Item.....	60
10.3 Setting the Cursors on the Bar Graphs.....	61
Chapter 11 Trend Display	62
11.1 Setting the Format of the Trend.....	62
11.2 Setting the Trend Display Item.....	63
11.3 Setting the Cursors on the Trends.....	64
Chapter 12 IEC Harmonic Measurement (Option)	65
12.1 IEC Harmonic Measurement Display.....	65
12.2 IEC Harmonic Measurement Format.....	65
12.3 IEC Harmonic Measurement Display Items.....	66
Chapter 13 FFT Function	68
13.1 Setting the FFT Format.....	68
13.2 Setting the Items of FFT Function.....	70
13.3 Setting the FFT Cursor Measurement.....	71

Chapter 14 Flicker Measurement (option)	72
14.1 Setting the Format of the Flicker Measurement.....	72
14.2 Setting the Item of Flicker Measurement.....	76
Chapter 15 Motor Evaluation (Option)	77
15.1 Torque and Speed Signal of Motor Input.....	77
15.2 Setting the Motor Format.....	78
15.3 Setting the Motor Item.....	78
15.4 Setting the Double-Motor Mode.....	83
Chapter 16 Cycle-by-Cycle Measurement	84
16.1 Setting the Format of Cycle-by-Cycle Measurement.....	84
16.2 Cycle-by-Cycle Measurement View.....	85
16.3 Setting the Items of Cycle-by-Cycle Measurement.....	85
Chapter 17 Saving Raw Data	87
Chapter 18 X-Y Graph Display (option)	88
Chaper 19 Integration	90
19.1 Integration Start, Stop or Reset.....	90
19.2 Setting Integration.....	91
19.3 Operation limitations During Integration.....	93
19.4 Restrictions on Instrument Settings by Integration.....	95
Chaper 20 Setting the Data Storage	96
20.1 Setting the File Conversion Modes.....	96
20.2 Setting the Storage.....	96
20.3 Starting, Holding and Stopping Storage.....	97
20.4 Setting the Storage Control.....	98
20.5 Setting Storage Items and Lists.....	99
20.6 Storage File Lists.....	101
Chapter 21 Files	103
21.1 File Manager.....	103
21.2 Saving Image.....	103
21.3 Setting the Printer.....	104
21.4 Configuration (Profile File).....	106
21.5 File saving setting.....	106
21.6 Single saving.....	107

21.7 Item settings.....	108
Chapter 22 System Configuration	110
22.1 System Information.....	110
22.2 Initializing the Setting.....	110
22.3 System Setting.....	111
22.4 Touch Lock/Unlock.....	113
22.5 Remote Control.....	113
22.6 Network Setting.....	115
22.7 Self-Test Operation.....	117
Chapter 23 Other Settings and Operations	119
23.1 Setting the Press Key or Touch Screen.....	119
23.2 Holding the Data.....	119
23.3 Single Shot Measurement.....	120
23.4 Combination Display.....	120
23.5 Setting Home Page.....	121
23.6 Menu Hide.....	121
23.7 Displaying the Setup Parameter List.....	121
23.8 Screenshot.....	122
23.9 Help Function.....	123
23.10 Function of Switching.....	123
23.11 Home Menu.....	124
Appendix	125
Appendix I Symbols and Definitions for Measurement Functions.....	125
Appendix II Formula Used in Power Analyzer Measurement.....	128
Appendix III Initial Settings.....	134

Chapter I Name and Use of Components

1.1 Panels

Front Panel

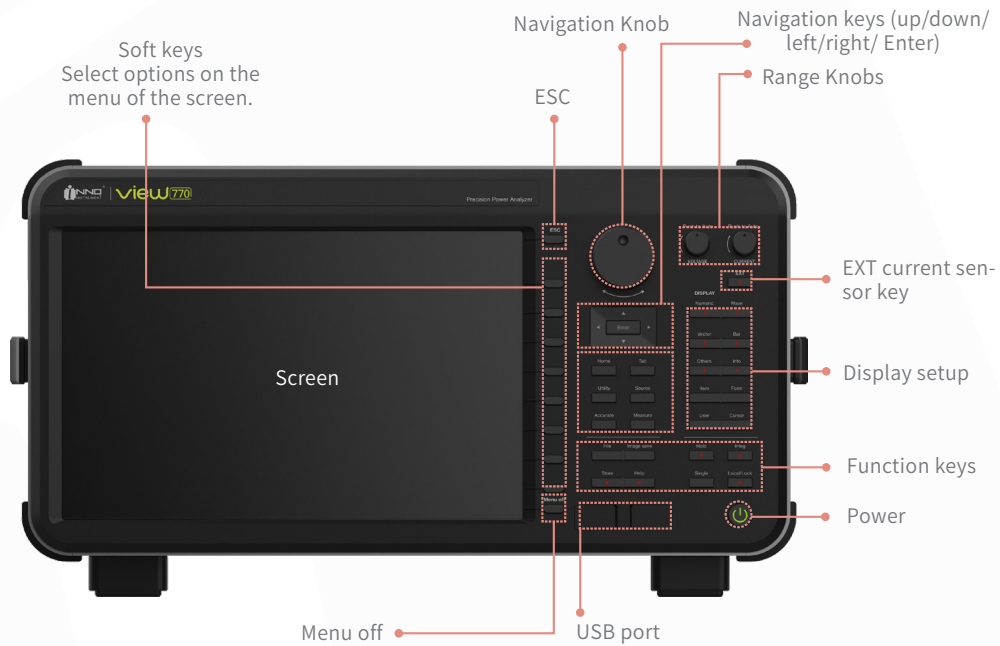

Rear Panel



1.2 Functions of Keys

1.2.1 Illustration

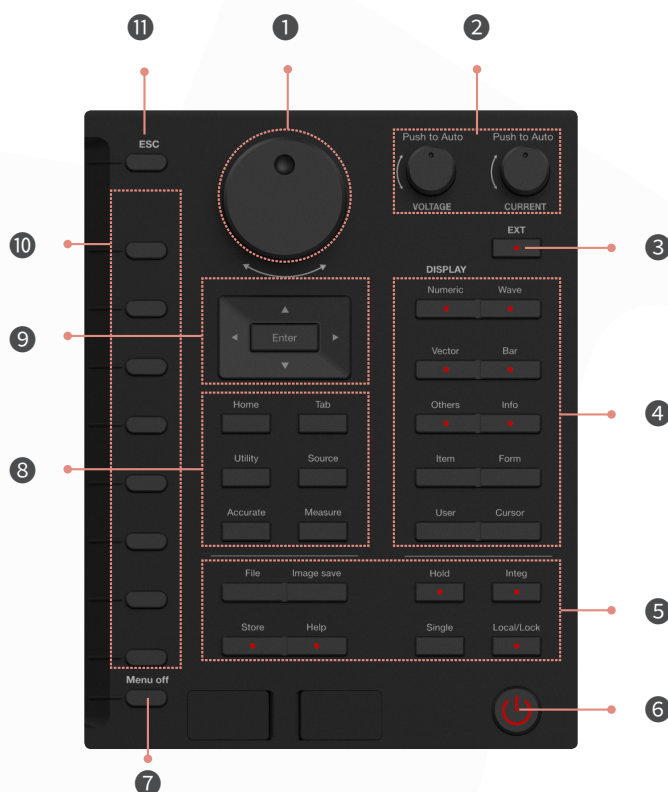

1.2.2 Keys and Functions

No.	Keys/Rotary knobs		Descriptions
1	Navigation knobs		① Rotate this knob for changing the value where the cursor is. ② Outer: anticlockwise(move left) /Clockwise(Move right) Inner: anticlockwise(move up) /Clockwise(Move down) ③ Press: ENTER
2	Range settings	Voltage range control knob (VOLTAGE)	① Rotate this knob for changing voltage measurement range, either range increased (clockwise) or decreased (anticlockwise). ② Press this knob for enabling auto voltage measurement mode.
		Current range control knob (CURRENT)	① Rotate this knob for changing current measurement range, either range increased (clockwise) or decreased (anticlockwise). ② Press this knob for enabling auto voltage measurement mode.
3	EXT key		Press this key to turn on the external current sensor
4	Display settings	Numeric key	Display numeric
		Wave key	Display waveform
		Vector key	Access to the Vector display
		Bar key	Access to the Bar graph display
		Others key	This key is used to switch between other functional menus, such as combination display (Multi-screen), trend display, IEC harmonic measurement, FFT, flicker measurement, motor evaluation, cycle-by-cycle measurement, raw data save, or X-Y graph display.
		Info key	Display basic information of the instrument
		Item key	Display options of ITEM for further setting
		Form key	Display options of FORM for further setting
		User key	The User key is pressed to specify and switch between the measurement functions of the displayed items(4,8,16-values)
		Cursor key	Display options of CURSOR for further setting

5	Functions	File key	Access to file manager menu
		Image Save key	Screenshot
		Hold key	Hold the measurement values
		Single key	Press this key to activate measurement once and update the display data.
		Integ key	Access to Integration menu
		Store key	Access to storage menu
		Help key	Access to HELP menu
		Local/lock key	This key is used to change from remote mode to local mode for this instrument. Besides, this key can be pressed and held to enable the Lock/Unlock functions of this instrument.
6	POWER key	Power on or off	
7	Menu off key	Press this key to conceal the functions displayed currently on the menu.	
8	Condition settings	Home key	Setting on the main menu
		Tab key	Switch between keys
		Utility key	Turn on system setting
		Source key	Setting the source
		Accurate key	Display ACCURATE options and access to setup of following items: Line filter, Frequency filter, NULL setting, AVG setting, Zero level compensation setting.
		Measure key	Display MEASUREMENT options and access to setup of following items: User defined function, User defined event, Formula setting, Wiring system setting, Phase difference setting, Scaling setting, Update rate setting, Range setting, Synchronous measurement, Harmonic setting
9	Arrow keys	UP/Down/Left/Right/Enter	
10	Soft keys (8)	Use these keys to enable the corresponding functions or set the on menus.	
11	ESC key	Quit; Press this key to return to previous menu or switch to range display bar	

1.3 Values and Strings

1.3.1 Numeric Input

All the edit boxes displayed on the screen in this instrument can be input with values via the following two methods:

- 1) Use the arrow keys to select the edit box and then press Enter key to locate the cursor within the edit box with values. Rotate the outer knob to change the location of the cursor, while rotate the inner knob to change the numeric.
- 2) Move the cursor to the edit box, and then touch the screen or use the mouse to input the values when numeric keypad appears on the screen.

Arrow Keys



- Move the cursor with arrow keys to select the values.
- Press ENTER key to confirm

Edit box (to display the edited value)

Numeric keys (0~9)



Backspace (to remove the value from right to left)

Minus "-"

Decimal point key

Shortcut key to set the MAX values for specific setup

Confirm key

1.3.2 Character Strings Input

The keyboard that is shown on the screen can be used to input character strings such as file names, expressions, or comments. There are two methods to input the character strings:

- 1) Use the arrow keys to select the box to edit the character strings and then press Enter key to show the keypad on the screen, as shown in the following picture. Use the arrow keys to select the soft keys with characters and then press Enter to confirm.
- 2) Touch the screen or use the mouse to input the characters when keypad appears on the screen, as shown in the following picture.

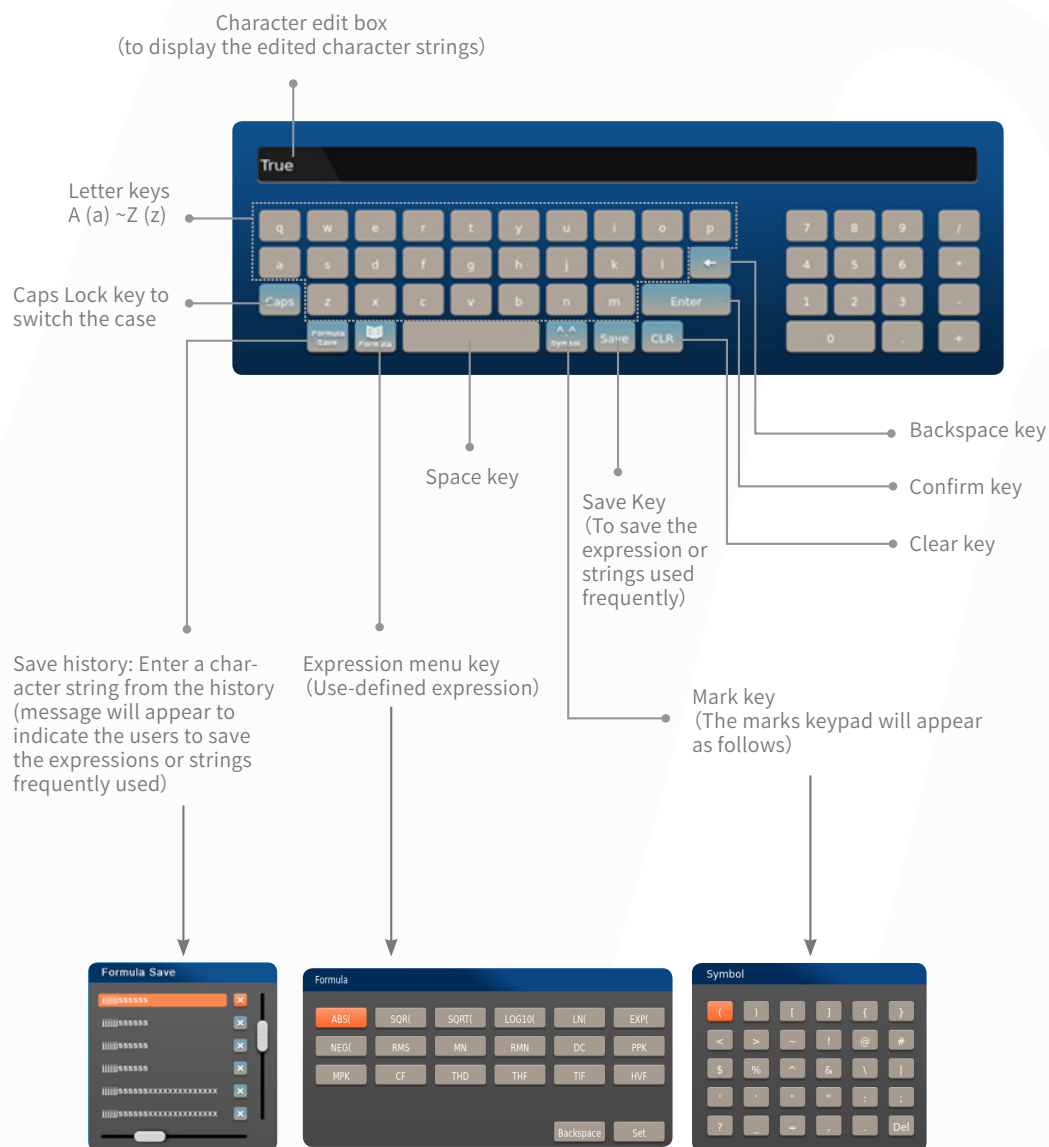

⚠ Note:

Please refer to the chapters afterwards for the limit of the character strings in length.

1.4 Display

1.4.1 Display Descriptions

Normally, the information in current status and real-time measurement information will be displayed on the screen as long as the power analyzer is power-on. Please refer to the following pictures in detail.



Zone A : From left to right on the screen in sequence display the main menu key, output over range indication, scaling, AVG, line filter status, frequency filter status, input elements settings, real-time voltage/current range, and rotary knobs, wherein, the functions of the menu key (Menu icon) are described in Section 23.12 in detailed.

Zone B : menu bar and options when in each mode.

Zone C : From left to right on the screen display will display the data packages (update rate), storage status, integration status, time, current time, date of the system and the company logo.

Zone D : it is operation zone, where the measurement data or the instrument settings are displayed.

1.4.2 Non-Numeric Displays

When the measurement values cannot be displayed normally during measurement, this instrument will display different status depending on different display settings by the symbols as follows:

Display as	Status	Descriptions
OL	Overload	If the RMS value exceeds a percentage of the measurement range, “-OL-” is displayed to indicate an over-load value. Rules: VIEW770-05A12/ VIEW770-40A13/ VIEW770-50A35/ VIEW770-05A35: When CF is 3 or 6, the RMS value of the voltage input measurement item is greater than 200% of the measuring range. The RMS value of the current input measurement item is greater than 140% of the measuring range. The Upk or Ipik value of the input signal exceeds 330% of the currently set range; When CF is 6A, the RMS value of the voltage input measurement item is greater than 400% of the measuring range. The RMS value of the current input measurement item is greater than 280% of the measuring range. The Upk or Ipik value of the input signal exceeds 660% of the currently set range; VIEW770-50A35V/ VIEW770-05A35V: When CF is 3 or 6, the RMS value of the voltage input measurement item is greater than 150% of the measuring range. The RMS value of the current input measurement item is greater than 140% of the measuring range. The Upk or Ipik value of the input signal exceeds 330% of the currently set range; When CF is 6A, the RMS value of the voltage input measurement item is greater than 300% of the measuring range. The RMS value of the current input measurement item is greater than 280% of the measuring range. The Upk or Ipik value of the input signal exceeds 660% of the currently set range;
OF	Overflow	OF will be displayed when Apparent Power, Reactive Power, Phase Difference and Power Factor are over-range.
0	Lower	If the RMS value is less than a percentage of the measurement range, “0” is displayed. Rules: CF3: If the measured value is less than 0.3 percent of the range; CF6 or 6A: If the measured value is less than 0.6 percent of the range;
Err	Error	If the frequency under test is out of the range and Error is selected as an option, fU or fL error will occur, displayed as Error. If λ is more than 2, λ and Φ will be Error.
-----	No data	No measurement items of the input element shown in the computation equations. No measurement functions are chosen.

Chapter 2 Ready for Measurement

2.1 Instructions in use

Safety Precautions :

- The following precautions described herein must be observed to ensure the safety operation of this instrument.
- If the instrument is used in a manner not specified in this manual, the protection provided by the instrument may be impaired.
- Our company assumes no liability for the customer's failure to comply with these requirements.

Using the Correct Power Supply

- To prevent the possibility of electric shock or fire, be sure to use the power cord supplied by our company. The main power plug must be plugged into an outlet with a protective earth terminal.
- Before connecting the power cord, ensure that the source voltage matches the rated supply voltage of the instrument and that it is within the maximum rated voltage of the provided power cord.

Checking Protective Earth

- Do not operate the instrument if the protective earth or fuse might be defective. Also, make sure to check them before operation, to avoid the accident such as electric shock.
- Be sure to connect the protective earth to prevent electric shock before turning ON the power.
- Do not directly touch the circuit by hand. If you have to touch the circuit, make sure that you have turned OFF the circuit and put on safety gloves before that.
- The cover should be removed by our company's qualified personnel only. Opening the cover is dangerous, because some areas inside the instrument have high voltages.

Operating in Safety Environment

- For safety reasons, do not place and operate this instrument in a flammable explosive environment.
- To make sure accurate measurement, this instrument should be operated at a temperature within the range from 5°C to 40°C and humidity within the range from 20%RH to 80%RH.

2.2 Connecting with Power Supply

Checking Before Connection

Before power supply connection, following precautions should be observed.

- 1) Before connecting the power cord, ensure that the instrument is equipped well, without any flaws such as screw loose or lost.
- 2) Ensure that the power cord supplied with this instrument is intact without any defect.
- 3) Ensure that the parts and accessories supplied with this instrument are complete, including the types, models, quantities and so on.

Please contact our sales agency of our company immediately when the above-mentioned cases not to be in accordance with the contract.

Procedures of power cord connection

- 1) Ensure that power is off.

- 2) Ensure that the mains voltage used is within the range of the rated voltage before you can connect the supplied power cord to the power port on this instrument.
- 3) Technical specifications for the power port on this instrument are as follows:

Project	Specification
Rated supply voltage	AC100 ~ 240V
Allowable fluctuation of voltage	AC85 ~ 264V
Rated supply frequency	50/60Hz
Allowable fluctuation of frequency	48Hz~ 63Hz
Maximum power	300W, power supply for 7 current sensors of rated 15W

2.3 Power on/off

Procedures of turning on the power:

Dual power supply design (Bi-switch): Power Switch in the front panel and the Rocker Switch on the rear panel of the instrument, as shown in the illustration in the Section 1.1.

- Both the rocker switch and the power key are not pressed, without power indicator on; The instrument is not connected with the power.
- When the rocker switch is on, the device is powered on and gets into ready mode, with power indicator turning red; If the power key is also pressed at the same time, the device will start operation, with power indicator turning green.
- During operation of the device, press and hold the power key for 4 seconds to stop operation of the device and then the device gets into ready mode, with power indicator turning red.

Notes when accurate measurement is performed:

- Turn on the power and wait for instrument warming up for over 30 minutes.
- After the instrument warns up, perform zero-level compensation.

Procedures of turning off the power:

If you want to turn off the instrument, turn off the power key before turning off the rockery switch. The instrument is power-off normally when it is disconnected with the power completely. The previous setups before power-off will be stored in the instrument.

2.4 Connecting the Circuit under Measurement

Use the cable to connect the circuit under measurement to the voltage or current input terminals.

- Connecting the voltage input terminal.
Connect measurement cables that have safety terminals that cover their conductive parts (ϕ 4mm safety banana plug).
- Connecting the current input terminal
When the voltage of the circuit under measurement is being applied to the current input terminals, do not touch the external current sensor input terminals. It is dangerous because the terminals are electrically connected inside the instrument.

⚠ Note:

- When connection, make sure that no foreign materials exist between the current input terminal and the crimping terminal.
- Periodically make sure that the current input terminal is not loose and that there are no foreign materials existing between the current input terminal and the crimping terminal.

Direct input wiring systems are shown in the following illustration.

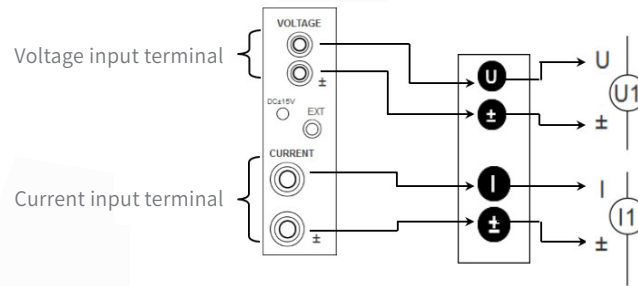

Direct Input Wiring Examples:

- **Single-phase, two-wire system (1P2W)**

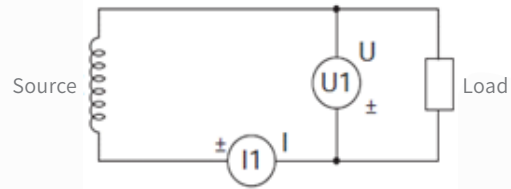
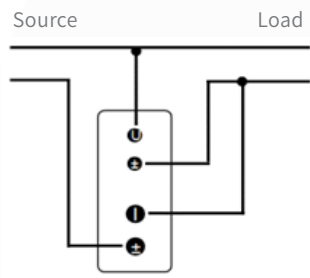

- **Single-phase, three-wire system (1P3W)**

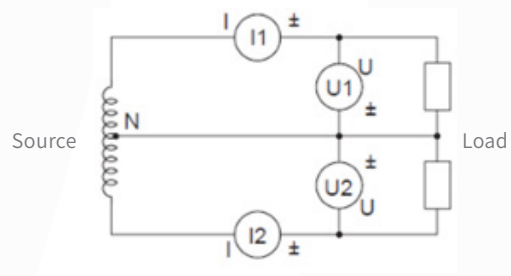
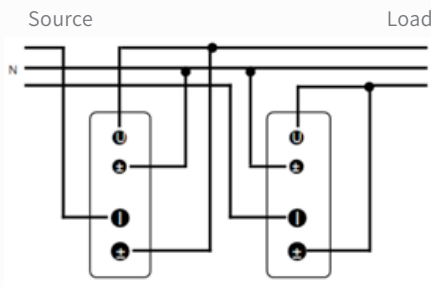

- **Three-phase, three-wire system (3P3W)**

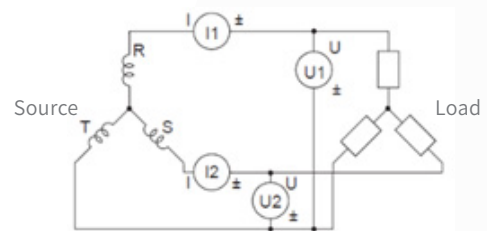
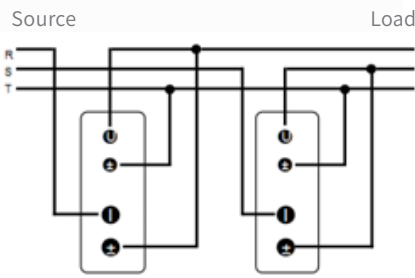

• **Three-phase, three-wire system (Three-voltage, three-current method) 3P3W (3V3A)**

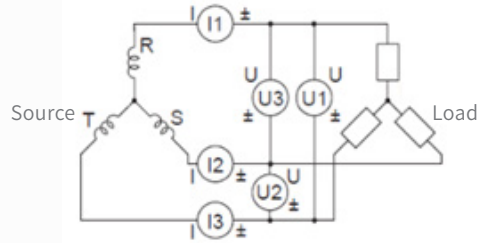
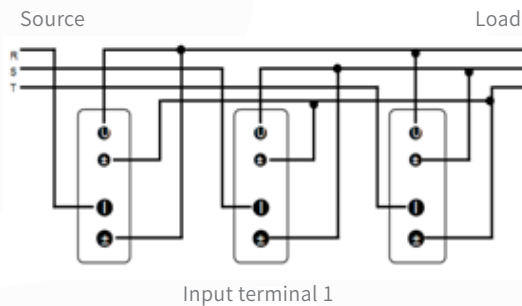

• **Three-phase, four-wire system (3P4W)**

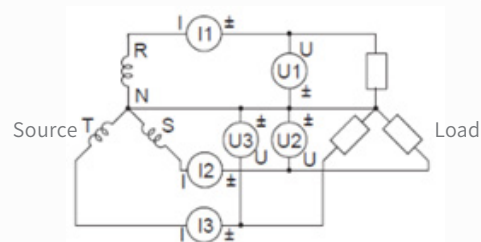
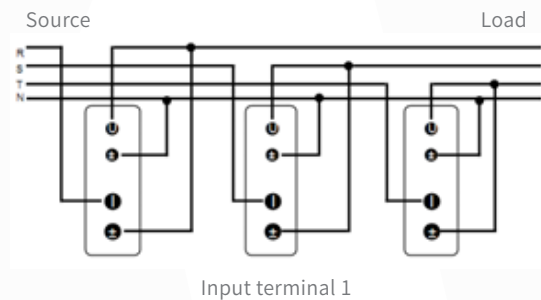

2.5 Circuit under Measurement Connected to the EXT Sensor Input Terminal

When the max current of the circuit under measurement exceeds the max range of the input element (as shown in the following), the EXT current sensor can be connected to the input terminal to test the current.

The power analyzer's input elements, voltage input terminals and external current sensor input terminals are shown in the following illustration.

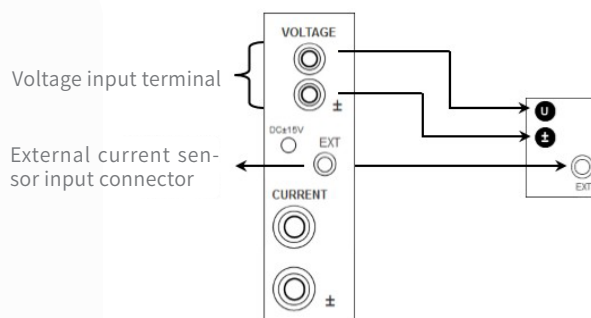

Current sensor output type

The external current sensor can be divided into 2 types: shunt-type current sensor or a clamp-type current sensor that outputs voltage.

2.5.1 Wiring Systems of Connecting Current Sensor

The shunt-type current sensor is connected to the power ground. If the sensor has to be connected to the non-ground end, a wire with a conducting layer is necessary between the sensor and the instrument so that the effects of the common mode voltage can be reduced. Be careful with electrical safety when the cables are connected to the external current sensor.

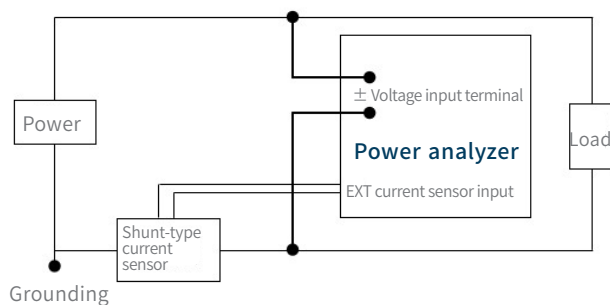

Shunt-type current sensor connection :

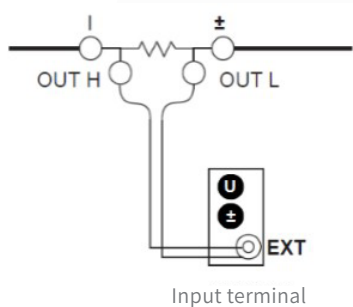

When the circuit under measurement is not grounded and the signal is high in frequency or large in power, the effects of the inductance of the shunt-type current sensor cable will become large. In this case, use an isolation sensor (CT, DC-CT, or clamp) to perform measurements.

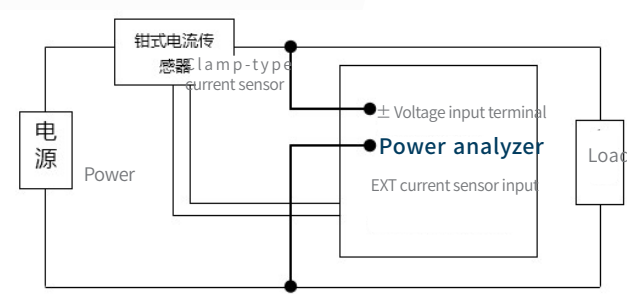

Voltage output and Clamp-type current sensor connection :

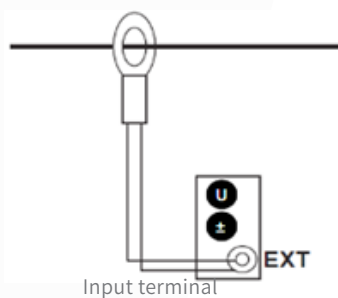

Shunt-type Current Sensor Wiring Examples:

- Single- phase, two-wire system (1P2W)

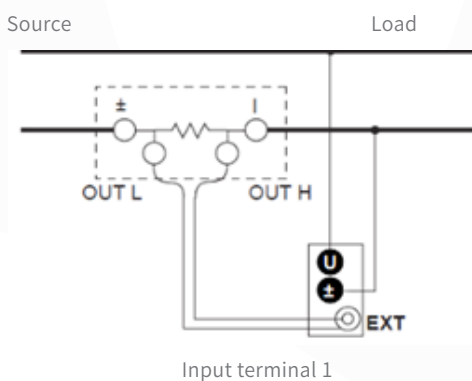

• **Single-phase, three-wire system (1P3W)**

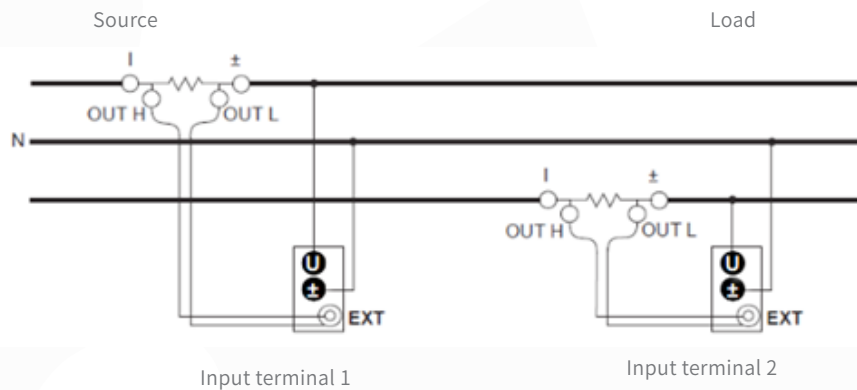

• **Three-phase, three-wire system (3P3W)**

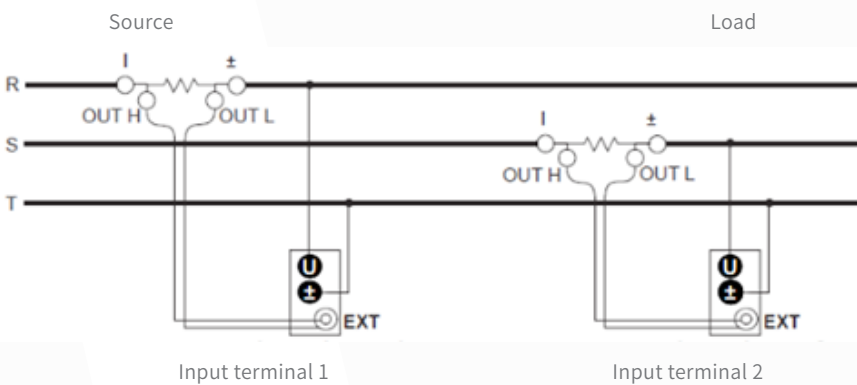

• **Three-phase, three-wire system (Three-voltage, three-current method) 3P3W (3V3A)**

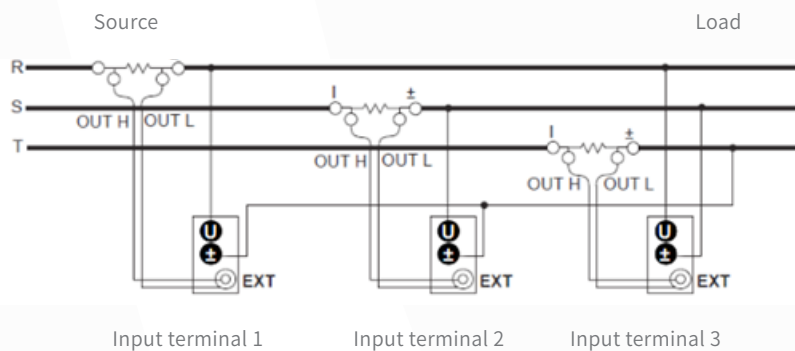

• **Three-phase, four-wire system (3P4W)**

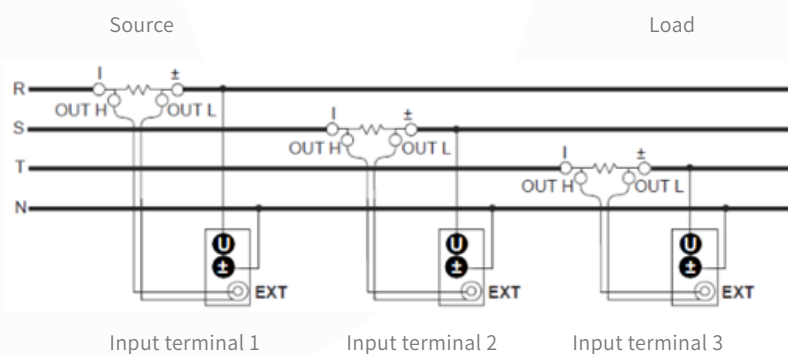

2.5.2 Wiring Systems When VT/CT is Used

If current overrange, the current sensor or current transformer (CT) can be connected to the power analyzer to extend the range. Pay attention that the current sensor should be connected with the current input terminal on the power analyzer. If voltage overrange, voltage sensor or voltage transformer (VT) can be connected to the power analyzer to extend the range. Pay attention that the voltage sensor should be connected with the current input terminal on the power analyzer.

External Voltage Transformer (VT) or Current Transformer (CT) Wiring Examples:

- Single-phase, two-wire system (1P2W)

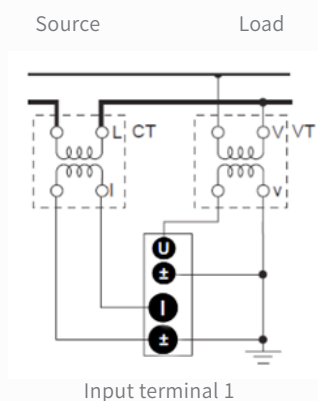

- Single-phase, three-wire system (1P3W)

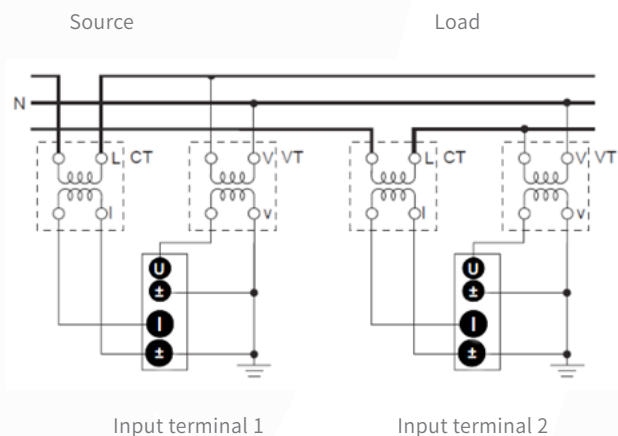

• **Three-phase, three-wire system(3P3W)**

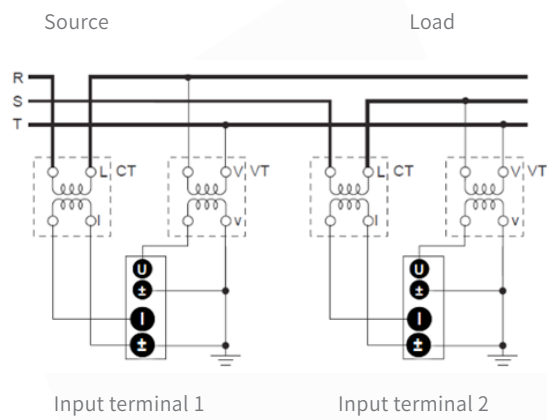

• **Three-phase, three-wire system (Three-voltage, three-current method)3P3W (3V3A)**

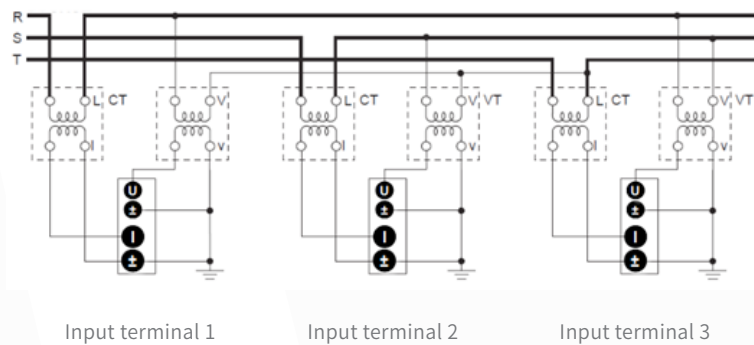

• **Three-phase, four-wire system (3P4W)**

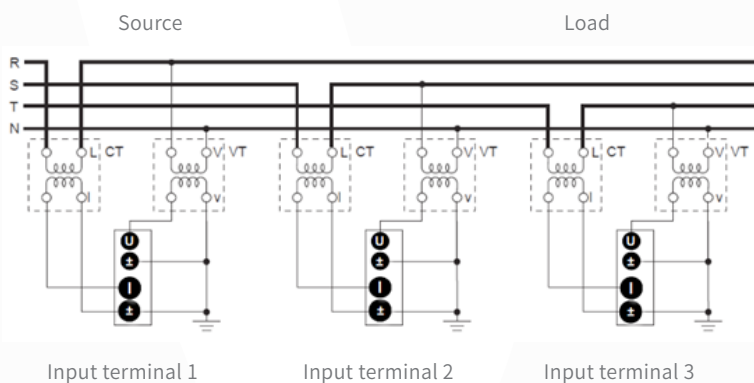

Chapter 3 Setting Measurement Conditions

There are specific measurement setup modules installed in this power analyzer, so users can press <Measure> key on the panel to access to the menus for setting measurement conditions. The items that can be set are as follows:

- User-defined functions
- User-defined events
- Equation settings
- Wiring system settings
- Phase difference display
- Scaling setting
- Sensor phase calibration setting
- Update rate setting
- Range configuration
- Synchronous measurement setting
- Harmonic setting

3.1 Setting User-Defined Functions

The User-defined functions allow the instrument to determine physical values other than those of the measurement functions by combining operands.

- 1) Procedure : Press Measure→User-defined
- 2) Setup menu :

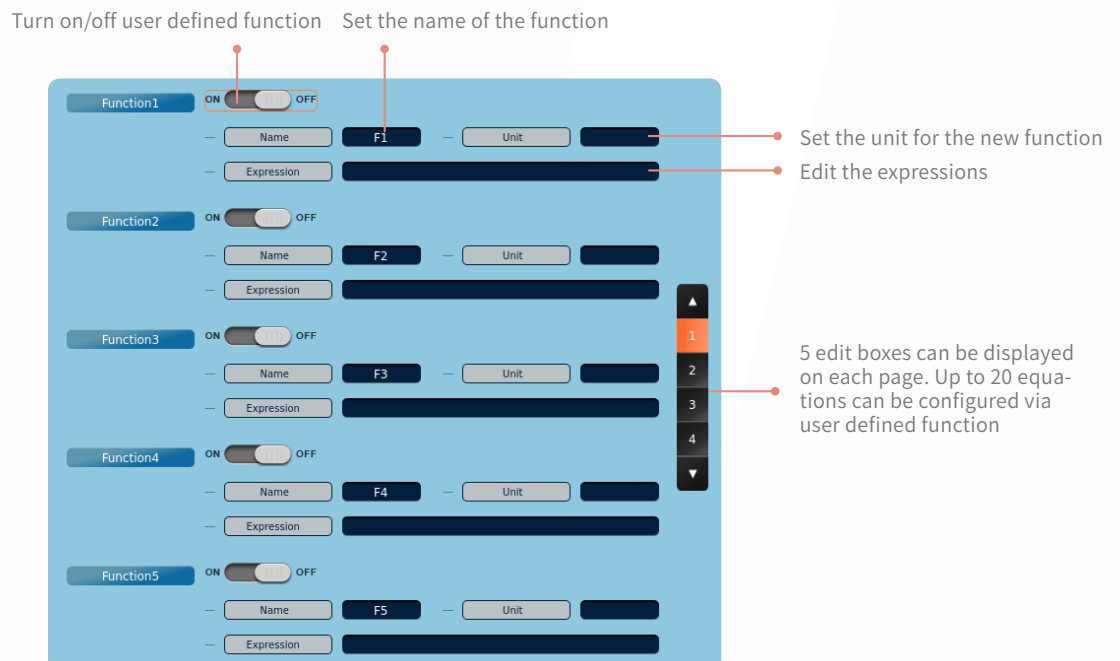

Select the box to edit the expression, wherein, the special symbols can be input via the formula keys on the keypad or cursor key.

Measuring functions of conventional measurement

Measuring item	Formula input format	Examples	* Replaceable parameter	
			Unit *:1~7	Wiring block input format *:SA/SB/SC
Urms	URMS*	URMS1	Yes	Yes
Irms	IRMS*	IRMS1	Yes	Yes
Umn	UMN*	UMN1	Yes	Yes
Imn	IMN*	IMN1	Yes	Yes
Udc	UDC*	UDC1	Yes	Yes
Idc	IDC*	IDC1	Yes	Yes
Uac	UAC*	UAC1	Yes	Yes
Iac	IAC*	IAC1	Yes	Yes
Urmn	URMN*	URMN1	Yes	Yes
Irmn	IRMN*	IRMN1	Yes	Yes
P	P*	P1	Yes	Yes
S	S*	S1	Yes	Yes
Q	Q*	Q1	Yes	Yes
λ	LAMBDA*	LAMBDA1	Yes	Yes
ϕ	PHI*	PHI1	Yes	Yes
CfU	CFU*	CFU1	Yes	No
CfI	CFI*	CFI1	Yes	No
Pc	PC*	PC1	Yes	Yes
FU	FU*	FU1	Yes	No
FI	FI*	FI1	Yes	No
U+pk	UPPK*	UPPK1	Yes	No
I+pk	IPPK*	IPPK1	Yes	No
U-pk	UMPK*	UMPK1	Yes	No
I-pk	IMPK*	IMPK1	Yes	No
P+peak	PPPEAK*	PPPEAK1	Yes	No
P-peak	PMPEAK*	PMPEAK1	Yes	No
Pos U	POSU*	POSUSA	No	Yes
Neg U	NEGU*	NEGUSA	No	Yes
Pos I	POSI*	POSISA	No	Yes
Neg I	NEGI*	NEGISA	No	Yes
Pos P	POSP*	POSPSA	No	Yes

Integral power (Wh)

Measuring item	Formula input format	Examples	* Replaceable parameter	
			Unit *:1~7	Wiring block input format *:SA/SB/SC
Time	TI*	TI7	Yes	Yes
WP	WP*	WP7	Yes	Yes
WP+	WPP*	WPP7	Yes	Yes
WP-	WPM*	WPM7	Yes	Yes
q	AH*	AH7	Yes	Yes
q+	AHP*	AHP7	Yes	Yes
q-	AHM*	AHM7	Yes	Yes
WS	WS*	WS7	Yes	Yes
WQ	WQ*	WQ7	Yes	Yes

Harmonics

Measuring item	Formula input format	Examples	Wiring block input format *:SA/SB/SC	*(n) Replaceable parameter				
				Unit				
				*:1~7	n:0	n:1	n:2-500	n:TOTAL
U	U*(n)	U1(500)	Yes	Yes	Yes	Yes	Yes	Yes
I	I*(n)	I1(500)	Yes	Yes	Yes	Yes	Yes	Yes
P	P*(n)	P1(500)	Yes	Yes	Yes	Yes	Yes	Yes
S	S*(n)	S1(500)	Yes	Yes	Yes	Yes	Yes	Yes
Q	Q*(n)	Q1(500)	Yes	Yes	Yes	Yes	Yes	Yes
λ	LAMBDA*(n)	LAMBDA1(500)	Yes	Yes	Yes	Yes	Yes	Yes
ϕ	PHI*(n)	PHI1(500)	Yes	Yes	No	Yes	Yes	Yes
ϕU	PHIU*(n)	PHIU1(100)	No	Yes	No	No	Yes	No
ϕI	PHII*(n)	PHII(100)	No	Yes	No	No	Yes	No
Z	Z*(n)	Z5(100)	No	Yes	Yes	Yes	Yes	No
Rs	RS*(n)	RS5(100)	No	Yes	Yes	Yes	Yes	No
Xs	XS*(n)	XS5(100)	No	Yes	Yes	Yes	Yes	No
Rp	RP*(n)	RP5(100)	No	Yes	Yes	Yes	Yes	No
Xp	XP*(n)	XP5(100)	No	Yes	Yes	Yes	Yes	No
Uhdf	UHDF*(n)	UHDF5(100)	No	Yes	Yes	Yes	Yes	No
Ihdf	IHDF*(n)	IHDF5(100)	No	Yes	Yes	Yes	Yes	No
Phdf	PHDF*(n)	PHDF5(100)	No	Yes	Yes	Yes	Yes	No
Uthd	UTHD*	UTHD5	No	Yes	No	No	No	No
Ithd	ITHD*	ITHD5	No	Yes	No	No	No	No
Pthd	PTHD*	PTHD5	No	Yes	No	No	No	No
Kfactor	KFACTOR*	KFACTOR5	No	Yes	No	No	No	No
Uthf	UTHF*	UTHF5	No	Yes	No	No	No	No
Ithf	ITHF*	ITHF5	No	Yes	No	No	No	No
Utif	UTIF*	UTIF5	No	Yes	No	No	No	No
Itif	ITIF*	ITIF5	No	Yes	No	No	No	No
hvf	HVF*	HVF5	No	Yes	No	No	No	No
hcf	HCF*	HCF5	No	Yes	No	No	No	No

Δ Delta computation

Measuring item	Formula input format	Examples	* Replaceable parameter	
			Unit *:1~7	Wiring block input format *:SA/SB/SC
$\Delta U1$	DELTAU1*	DELTAU1SA	No	Yes
$\Delta U2$	DELTAU2*	DELTAU2SA	No	Yes
$\Delta U3$	DELTAU3*	DELTAU3SA	No	Yes
$\Delta U\Sigma$	DELTAU4*	DELTAU4SA	No	Yes
$\Delta P1$	DELTAP1*	DELTAP1SA	No	Yes
$\Delta P2$	DELTAP2*	DELTAP2SA	No	Yes
$\Delta P3$	DELTAP3*	DELTAP3SA	No	Yes

Efficiency

Measuring item	Formula input format	Examples	* Replaceable parameter	
			Unit *:1~7	Wiring block input format *:SA/SB/SC
η1	ETA1	ETA1	No	No
η2	ETA2	ETA2	No	No
η3	ETA3	ETA3	No	No
η4	ETA4	ETA4	No	No
η5	ETA5	ETA5	No	No
η6	ETA6	ETA6	No	No
Udef1	UDEF1	UDEF1	No	No
Udef2	UDEF2	UDEF2	No	No

Motor

Measuring item	Formula input format	Examples	* Replaceable parameter	
			Unit *:1~7	Wiring block input format *:SA/SB/SC
Speed1	SPEED1	SPEED1	No	No
Torque1	TORQUE1	TORQUE1	No	No
Theta1	THETA1	THETA1	No	No
SyncSp1	SYNC1	SYNC1	No	No
Slip1	SLIP1	SLIP1	No	No
pm1	pm1	pm1	No	No
Speed2	SPEED2	SPEED2	No	No
Torque2	TORQUE2	TORQUE2	No	No
SyncSp2	SYNC2	SYNC2	No	No
Slip2	SLIP2	SLIP2	No	No
pm2	pm2	pm2	No	No

Operational formula

Operational formula	Description
Add+	Addition
Subtract-	Subtraction
Multiply*	Multiplication
Divide/	Division
ABS(Absolute value
SQR(Square
SQRT(Square root
LOG10(Common logarithm
EXP(Exponent
NEG(Negative value
LN(Natural logarithm

Common shortcut keys

Common shortcut characters	Support or not
PPK	Yes
RMS	Yes
MPK	Yes
MN	Yes
CF	Yes
RMN	Yes
DC	Yes
THD	Yes
THF	Yes
HVF	Yes
TIF	Yes

Note:

- Up to 8 characters can be edited for the name.
- Up to 8 characters can be edited for the unit.
- Up to 60 characters can be used in the expression. Only correct expression can be displayed, otherwise, the edit is invalid.
- The edit is not case sensitive.
- $\eta 1 \sim \eta 6$ are indicated in percentage; e.g. when $\eta 1$ is indicated as 80%, $ETA1=0.8$
- The maximum value length allowed for input: 24;
- For a single motor, it does not support to input measuring items of Speed2, Torque2, SyncSp2, Slip2 and pm2. For dual motors, it does not support to input Theta1; when motor functions are not selected for the equipment, it does not support to input any of these motor measuring items;

3.2 Setting User-defined Events

The user-defined events are set to trigger the storage data, and up to 8 user-defined events can be set on this instrument.

- 1) procedure : Press Measure→User-defined event
- 2) Setup menu :

The screenshot shows the 'User-defined event' setup screen. At the top, there are fields for 'Event No.' (set to 1), a toggle for 'ON/OFF', and 'Event Name' (set to Ev1). Below this are options for 'Expression' (Range or Condition), 'Function' (Urms), 'Element/Z' (Element 1), and 'Order' (Total). Two numerical input fields are set to 0.000. A section for logical conditions includes 'Condition' (radio buttons for Inverse, AND, OR), 'None' dropdowns, and 'AND/OR' buttons. At the bottom, a list of events (Ev1 to Ev8) shows their current status as 'No Expression'. Red callout lines point to these various elements with descriptive text.

Set the event number (1~8)

Turn on/off the event

Set the event name (0 to 8 characters)

Select the judgment condition setup (range or condition)

Set the event condition, function, element/ Σ , harmonic order and reference value within a certain range. Harmonic order: 0~500 Set the reference within the range from -9.9999T to 9.9999T

Use logical AND and OR of events to perform judgment

- Set the judgment condition inversion.
- Set AND, OR or END
- Set the events you can select events with numbers smaller than the number specified by Event No. for the current event

Display the expressions of the user-defined events and their status

Setting judgment conditions:

Range : Set the judgment conditions within the range of the measurement function or the difference of the reference values.

Condition : Set the judgment conditions via user-defined events.

- 1) When the Range is set to be judgment condition, you can set as follows:

Element/ Σ

You can select the all the element/wiring unit configured in this instrument. The available options vary depending on the installed elements.

Function and order

Any kind of measurement functions included in this instrument can be selected. When the function of harmonic measurement is selected, the corresponding harmonic orders can be displayed.

Judgment conditions and reference value

Select the method for comparing the measurement value and the reference value, and the options includes as follows:

OFF, <, >, >=, <=, =, !=. When you select OFF for the above symbols, “no expression” will be displayed.

2) When the Condition is set to be judgment condition, you can set as follows:

Inverting the condition

The judgment results can be reversed. When this function is enabled and the result is True, the result finally will become False.

Setting event boxes

The number of a user-defined event that is smaller than the number of the user-defined event that is currently configured can be selected.

Logical judgment symbols

To use multiple user-defined events to configure a condition, set the method of combining the events to logical AND or logical OR. When you select AND or OR, an event specification box appears to the right of the event edit box. Up to 3 event combination judgments can be set.

End

Select END to end the definition of the condition, when the box on the right side is invalid.

3.3 Setting the Formula

In this section, the setups regarding apparent power, reactive power and corrected power will be introduced.

1) Procedure : Press Measure→Formula

2) Setup Menu :

When IEC76-1(1976) is applied, the coefficient can be set within the range from 0.0000 to 9.9999

Set the apparent power formula: (Urms*Irms, Udc*Idc, Umean*Irms, Umean*Imean, Urmean*Irmean)

Set the types for the Apparent Power, and Reactive Power formula (Type 1, Type 2, Type3)

Set the corrected power formula, 2 standards available to be selected, i.e. IEC76-1(1976)/ IEC76-1(1993)

3.3.1 Types of the Apparent Power and Reactive Power Equation

Three types of powers can be measured by this device: active power, reactive power, and apparent power. Generally, they are defined by the following equations.

- Active power $P = UI\cos\phi$ (Equation 1)
- Reactive power $Q = UI\sin\phi$ (Equation 2)
- Apparent power $S = UI$ (Equation 3)

Wherein, U is the voltage, I is the current, ϕ is the phase difference between voltage and current. Their relations are expressed as follows:

$$(\text{Apparent power } S)^2 = (\text{Active power } P)^2 + (\text{Reactive power})^2 \quad (\text{Equation 4})$$

The above definitions apply for the sine waves only. The measured values for the apparent power and reactive power vary for distorted waveform computation by the above equation. Therefore, this device provides 3 equations for determining the apparent power and reactive power, so that users can select appropriate one from three types of computation methods. Please refer to the attachment II.

3.3.2 Corrected Power Equation

Corrected power (Pc) measurement can be performed under the mode of normal mode. When the load that is connected to the transformer is extremely small, the active power of the transformer that is measured needs to be compensated as per applicable standard. In such cases, it is necessary to set the compensating equation and the coefficient.

Applicable Standards and Equations

IEC76-1(1976): compensating equation is expressed as follows

$$P_c = \frac{P}{P_1 + P_2 \left(\frac{U_{rms}}{U_{mn}} \right)^2}$$

IEC76-1(1993): compensating equation is expressed as follows

$$P_c = p \left(1 + \frac{U_{mn} - U_{rms}}{U_{mn}} \right)$$

3.4 Setting Wiring

In this section, the setups such as wiring systems, efficiency compensation, independent input element and efficiency equation will be described.

- 1) Procedures : Press Measure→Wiring
- 2) Screens :

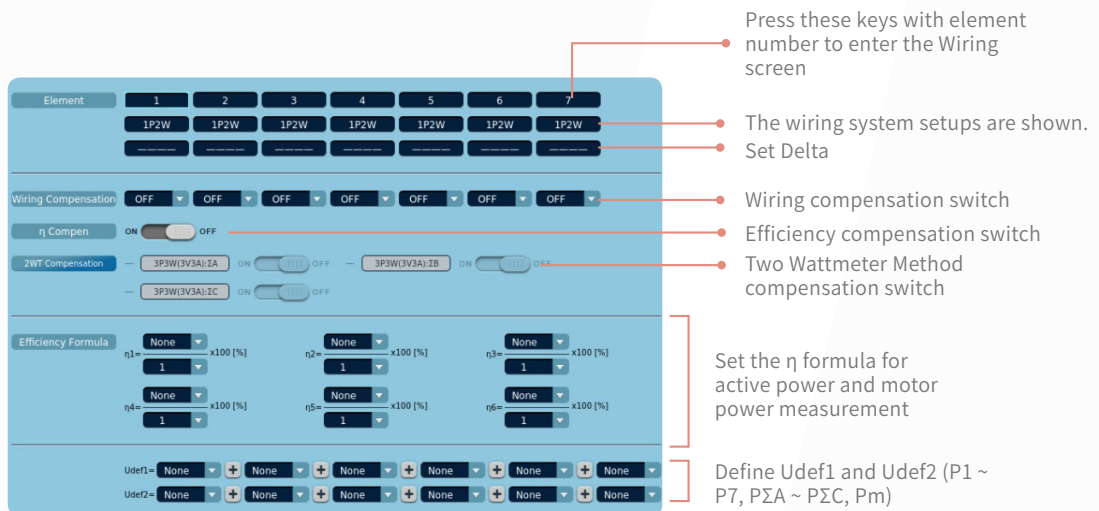

Element

Elements (1 to 7) are displayed on this instrument which can automatically adjust the number of the elements according to the number of the input modules configured.

Please refer to the chapters later for detailed descriptions such as wiring compensation, efficiency compensation, and efficiency equation.

3.4.1 Setting Wiring Systems

Select the number of the input element to enter the wiring system screen where the wiring system selected will be displayed under the number of the corresponding input element. The wiring system that can be set is as follows:

- 1P2W : Single-phase, two-wire system
- 1P3W : Single-phase, three-wire system
- 3P3W : Three-phase, three-wire system
- 3P4W : Three-phase, four-wire system
- 3P3W(3V3A) : Three-voltage, three-current method

Wiring Unit

The wiring units are sets of two or three input elements of the same wiring system that are grouped together. Up to 3 wiring units can be defined, including ΣA , ΣB and ΣC .

⚠ Note:

- When there is one wiring unit, that unit is ΣA . You cannot make ΣB or ΣC the first wiring unit.
- When there are two wiring units, those units are ΣA and ΣB . You cannot make ΣC one of the first two wiring units.
- When there are three wiring units, those units are ΣA , ΣB , and ΣC .
- Wiring units are composed of input elements that are next to each other. Wiring units cannot consist of input elements that are not next to each other.
- A wiring unit must either be composed of only 50 A input elements or only 5 A input elements. Wiring units cannot consist of different types of input elements.

3.4.2 Delta Computation Setting

The sum or difference of the instantaneous voltage or current values (sampled data) between the elements in a wiring unit can be used to determine various types of data such as the differential voltage and phase voltage. This operation is called delta computation. You can select different delta computation types according to the wiring system.

Wiring System	Delta Computation Type
1P3W	Difference, 3P3W>3V3A
3P3W	Difference, 3P3W>3V3A
3P4W	Star>Delta
3P3W(3V3A)	Delta>Star

Computation Notes:

1) Difference (Differential voltage and differential current)

The differential voltage and differential current between two elements can be computed on a single-phase, three-wire system or on a three-phase, three-wire system.

2) 3P3W > 3V3A (Line voltage and phase current)

You can compute unmeasured line voltages and phase currents by converting the data of a three-phase, three-wire system to the data of the three-voltage, three-current method (3V3A).

3) Star>Delta (Star-delta transformation)

You can use the data from a three-phase, four-wire system to compute the data of a delta connection from the data of a star connection.

4) Delta>Star (Delta-star transformation)

By using the data from a three-phase, three-wire system that uses a three-voltage, three-current method, you can compute the data of a star connection from the data of a delta connection. This function is useful when you want to observe the phase voltage of an object that has no neutral line, such as a motor.

⚠ Note:

- The measurement range and scaling (VT/CT ratio and coefficients) of the elements that are undergoing delta computation should be as closely as possible. Using different measurement ranges or scaling causes the measurement resolutions of the sampled data to be different, which will result in error.
- The numbers (1, 2, and 3) that are attached to delta computation measurement function symbols have no relation to the element numbers.
- The computation of all delta measurement functions, from $\Delta U1$ to $\Delta P\Sigma$, varies depending on the wiring system and the delta computation type.
- When only one element is installed in this instrument, this feature cannot be used, and its set up menu will not appear.
- Delta computation cannot be performed on a single-phase, two-wire (1P2W) wiring system.

3.4.3 Wiring Compensation Setting

This instrument contains some types of functions for compensating for the loss caused by the wiring of each element. You can select OFF, U-I, or I-U in the drop-down menu. This instrument can perform the function of compensating the loss caused by the wiring of each element or multiple elements.

Note :

- The wiring compensation defaults to be turned off.
- If current-measuring circuit (I) is configured closely to load, select the U-I wiring compensation method. If voltage-measuring circuit (U) is configured closely to load, select the I-U wiring compensation method.
- If the current input is an external current sensor input (EXT) and the wiring compensation is U-I wiring, wiring compensation is not performed. This is because the instrumental loss of the current measurement is unknown.

3.4.4 Efficiency Compensation Setting

The power measurement on the secondary side of a power transformer such as an inverter includes loss caused by the measurement instrument.

Note :

- The efficiency compensation defaults to be turned off.
- If the current input is an external current sensor input (EXT), efficiency compensation is not performed. This is because the instrumental loss of the current measurement is unknown.

3.4.5 Two Wattmeter Method Compensation

The two-power wattmeter method (2WT Compensation) can be used to compensate the loss caused by the current flowing through the neutral line in a wiring system of three-phase, three wire (3V3A). You can set the compensation function with respect to 3P3W (3V3A): Σ A or 3P3W (3V3A): Σ B.

Note:

- The two wattmeter method compensation defaults to be turned off.
- The available options of 2WT compensation vary depending on the installed elements.
- The options of Two Wattmeter Method Compensation can be selected only when there is wiring system of 3P3W(3V3A) .

3.4.6 Efficiency Equation

The efficiency equation can be created by combining measurement function symbols. This instrument can determine the energy conversion efficiency of the device via the numeric values of the measurement functions. Up to 6 efficiency equations can be created, i.e. from η_1 to η_6 .

The measurement items as operands includes active power of each element (P1 to P7), active power of the Σ function (P Σ A to P Σ C), motor output (Pm1, Pm2), Udef1 and Udef2. For example, in the efficiency equation, the numerator can be set as None, P1, P2, P3, P4, P5, P6, P7, P Σ A, P Σ B, P Σ C, Pm, Udef1, Udef2; the denominator can be set as 1, P1, P2, P3, P4, P5, P6, P7, P Σ A, P Σ B, P Σ C, Pm, Udef1, Udef2.

Defining Udef1 and Udef2

Apply the sum of active power (from P1 to P7), active power of Σ function (from P Σ A to P Σ C) and motor output power (Pm) in the efficiency equations (from η_1 to η_6), when the Udef1 and Udef2 can be used. Up to 6 equations can be set.

Note:

- When the numerator of the equation is set as None, or the numerator or denominator is set as no value, the efficiency value will be displayed as ----.
- If there is None existing among the operators, you can remove the None computation. If Udef1 is defined as P1+None+None-None+P2+None, the formula P1+P2 will be used for computation.
- If invalid value or no numeric is set in the operands, the result will be regarded as 0.

3.5 Selecting Difference Display Format

Phase difference Φ indicates the current phase relative to the voltage of each element.

- 1.Procedures : Press Measure→Degree
2. Setup menu :

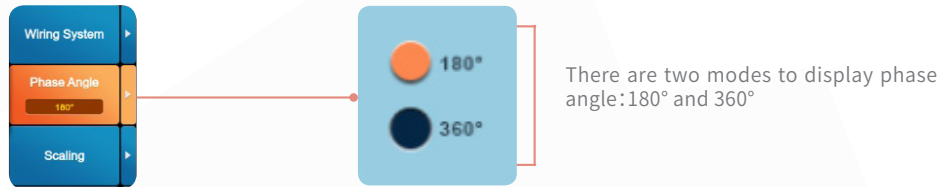

Formats:

- 180°

The phase difference is expressed by an angle between -180° and 180° . The relative voltage of current phase is in the counterclockwise direction, the current leads the voltage, and the value is displayed with D in front; The relative voltage of current phase is in clockwise direction, the current lags behind the voltage, and the value is displayed with G in front.

- 360°

The phase difference is expressed as an angle between 0 and 360° .

3.6 Scaling Setting

You can set the scaling function on or off on this instrument, where the CT ratio, VT ratio and SF (power coefficient) can also be configured for each element. Besides, the external current sensor conversion ratio can be set.

- 1.Procedures : Press Measure→Scaling
2. Operation menu :



3.6.1 Shortcut Keys for all on/All off

In the options of CT/VT/SF/Sensor, you can select from all on/all off, or independently select the channel for each element.

When All On is selected, the measurement data can be displayed via VT ratio/CT ratio /Sensor transformation ratio output for all the input elements.

When All Off is selected, the scaling cannot be used for all the input elements and the displayed data is the measurement data. In fact, you can also specifically select certain or a few input elements to apply the VT, CT or SF to the instrument.

⚠ Note:

- The setups of scaling and sensor ratio default to be All On.
- As long as scaling is applied in an element, the scaling indicator on the top of the screen will illuminate.
- When the scaling is set as ALL ON, the ALL ON status will be displayed.
- If not all the scaling for the elements are turned on, the ALL On status will not be displayed.
- If no scaling for each element is turned on, the ALL OFF status will be displayed.

3.6.2 Scaling Descriptions

- VT Ratio

Set the VT ratio within the range from 0.0001 to 99999.9999 when applying the secondary output of a VT to the voltage input terminal. Then, set the voltage range according to the maximum VT output.

- CT Ratio

Set the CT ratio (or the conversion ratio of the current sensor that produces current) within the range from 0.0001 to 99999.9999 when applying the secondary output of a CT or clamp-type current sensor that produces current to the current input terminal. Then, set the current range according to the maximum CT or current sensor output.

- Power Coefficient(SF Scaling)

On the screen will display the measured active power, apparent power, and reactive power after they have been multiplied by a coefficient when the power coefficient (SF) is set within the range from 0.0001 to 99999.9999.

Measurement Function	Data before Transformation	Result (Measurement)
Voltage U	U2 (secondary output of the VT)	$U2 \times V$
Current I	I2 (secondary output of the CT)	$I2 \times C$
Active power P	P2	$P2 \times V \times C \times SF$
Apparent power S	S2	$S2 \times V \times C \times SF$
Reactive power Q	Q2	$Q2 \times V \times C \times SF$
Max./min. voltage Upk	Upk2 (secondary output of the VT)	$Upk2 \times V$
Max./min. current Ipk	Ipk2 (secondary output of the CT)	$Ipk2 \times C$

Wherein, V stands for VT Ratio, C stands for CT Ratio, SF stands for Power Coefficient.

Note:

- When the VT, CT, SF in channel 1 is set to 10, the current signal in channel 1 will become 10 times of the range is input, the voltage signal will become 10 times, and the power signal will become 1000 times($VT \times CT \times SF$).
- Set the scaling without any changes to the current and the voltage ranges.

3.6.3 External Sensor Conversion Ratio

Set the conversion ratio used to measure the signal received by the external current sensor input connector (EXT) from a current sensor that produces voltage. Set how many millivolts the current sensor transmits when 1 A of current is applied (conversion ratio). Then, the input signal can be made to correspond to the numeric data or waveform display data that is obtained when the current is directly applied to the input terminals. When using a current sensor that produces current, set the conversion ratio as the CT ratio. The element's external current sensor conversion ratio (mv/A) is set to a value within the range from 0.0001 to 99999.9999; And the initial value is 1000.

Formula: Result (measurement reading) =before conversion (actual output value) /conversion ratio

The above formula can be applied in the measurement functions including current I, active power P, apparent power S, Reactive power Q and Max. /Min. current Ipk.

Example of EXT Sensor Range and Transformation Ratio Setup

When you measure a current with a maximum value of 100 A using a current sensor that produces 10 mV/A, the maximum voltage that the current sensor produces is $10 \text{ mV/A} \times 100 \text{ A} = 1 \text{ V}$.

The settings are configured as follows.

External current sensor range: 1V

External current sensor conversion ratio: 10mV/A

Note:

- The setup methods for the ALL ON and ALL OFF function of the sensor transformation ratio and the scaling are the same.
- If the sensor ratio in the element 1 is set as 10, then the amplitude of sensor current will be increased by 100 times (1000/10); if it is set as 10000, the amplitude of sensor current will be reduced by 10 times (1000/10000).
- The CT will affect the current in the sensor.
- When the sensor ratio is set, the fixed range will be increased or reduced simultaneously.

3.7 Phase Compensation

Compensate for the phase deviation caused by the current sensor .

Follows are the setting methods and the precautions in detail.

- 1.Procedure : Press Measure→Scaling→Phase Calibration
2. Setup menu :

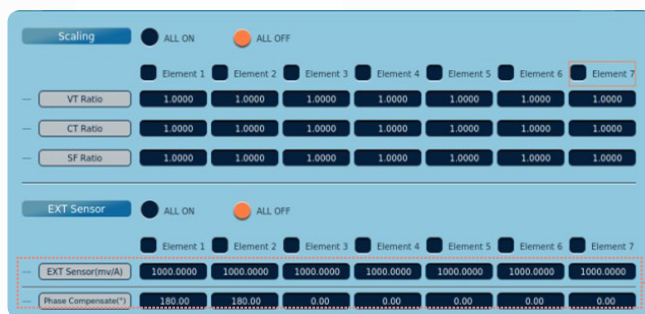

When the angle is displayed as 180°, the values of phase calibration should be set within the range from -180.00 to 180.00; When the angle is displayed as 360°, the values of phase calibration should be set within the range from 0.00 to 360.00

3.8 Data Update Rate

The data update rate is the interval at which the data that is used in measurement functions is sampled. You can select the data update rate from the options including 1ms, 5ms, 10ms, 50ms, 100ms, 200ms, 500ms, 1s, 2s, 5s, 10s, and 20s. The update rate can be set as fixed; besides, the function of auto update rate is available on this instrument.

- 1.Procedure : Press Measure→Update rate
2. Setup menu :

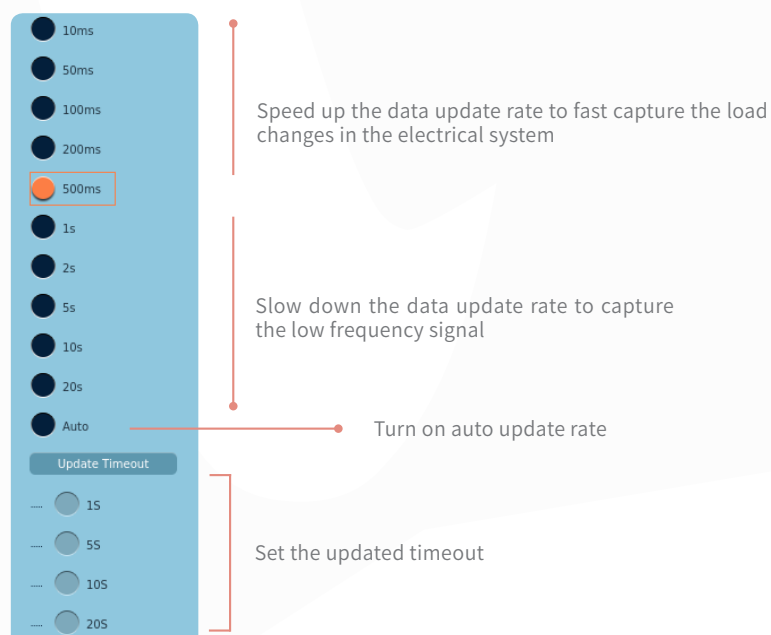

✓ **Explanation:**

Besides fixed update rates that are selectable, this instrument is equipped with the function of automatically adjusting the data update rate, i.e. appropriate data update rates automatically match with the frequencies of the input signals and the timeout configured.

When the function of Auto Update is enabled, the timeout can be set to be 1S, 5S, 10S or 20S. A data package is refreshed after 10-periodic signals are received by the device. If there are not enough signals received within the specified timeout period, this device will automatically update a package of data to display.

⚠ **Note:**

- In the update area displays the update rates automatically matched with the system.
- When Auto Update Rate is turned on, the trends and the waveforms will be displayed at a rate of 50ms, i.e. minimum update rate at 50ms.

3.9 Activating Measurement Range

Some measurement range can be activated if corresponding measurement ranges are selected, so that other range measurement range is disabled, convenient for switching between activated measurement ranges only.

3.9.1 Voltage Range Setup

- 1) Procedure : Press Measure→Range Config→Voltage
- 2) Function : Activate the voltage range and peak over range skip.
- 3) Setup menu :

The screenshot shows the 'Voltage' configuration screen. At the top, there are tabs for 'Voltage', 'Current', and 'EXT'. Below this is a table with 7 columns representing 'Element 1' through 'Element 7', each with its own range specification in brackets (e.g., [1500V-5A]). The first row is labeled 'All' and contains a red checkmark in every cell. Below this are rows of voltage ranges from 3V to 1500V. Each cell contains a red checkmark and the selected voltage value. At the bottom, there is a 'Peak Over Jump' row with seven dropdown menus, all set to 'OFF'.

Annotations on the right side of the image:

- Titles for the ranges of the input elements: showing the voltage/current info for the power modules
- Select all the ranges
- On the configured lists for the voltage range of input element, the users can specify and select the range according to measurement requirement
- Set the peak over range. The setup items: OFF, specified range

The options of voltage range vary depending on different module. For the specific range, please refer to "6.1 Setting fixed range of the voltage and current".

The measurement range when peak over range

When the peak over range occurs on the condition that auto range is turned on, on the instrument will display the specified measurement range, of which the color of the font will change. When the peak over range occurs on the condition that auto range is turned off, the measurement ranges will be switched in order of selected measurement range.

Note :

- The available options of the channels vary depending on the installed elements.
- The options can be set normally in Auto range mode.
- The information of the voltage of the module and the current will be shown on the range title.
- The items selected match with the power module.
- **[All On]** It is used to quickly select or cancel all the measurement range of a single channel.
- **[Peak over range skip]** When the range is selected, the color will change.
- **[Peak over range skip]** The drop-down lists match with the original ranges.
- **[Peak over range skip]** When it is turned on, the corresponding range will also be turned on.

3.9.2 Setting the Current Range

- 1) Procedure : Press Measure→Range Config→Current
- 2) Function: Activate the current range and peak over range skip.
- 3) Setup menu

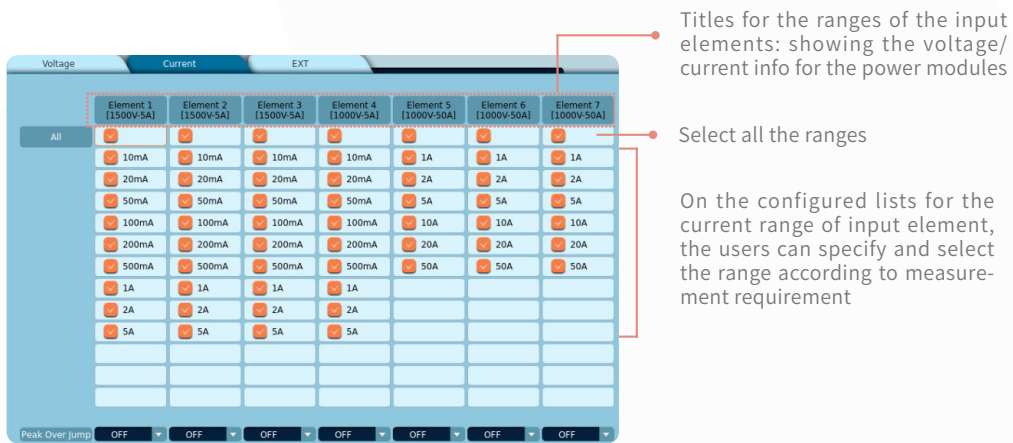

Titles for the ranges of the input elements: showing the voltage/current info for the power modules

Select all the ranges

On the configured lists for the current range of input element, the users can specify and select the range according to measurement requirement

The options of current range vary depending on different module. For the specific range, please refer to "6.1 Setting fixed range of the voltage and current".

3.9.3 Setting the EXT Sensor Range

- 1) Procedure : Press Measure→Range Config→EXT
- 2) Function : Activate the current range and peak over range skip.
- 3) Setup menu :

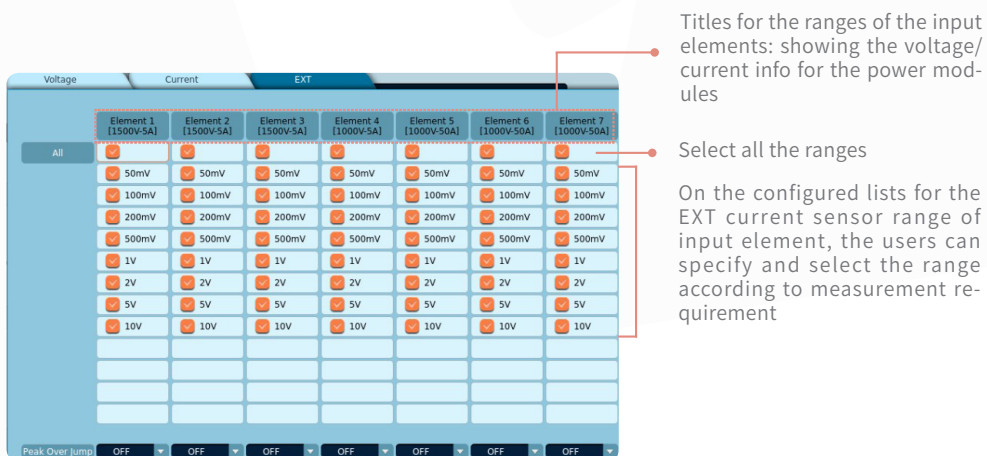

Titles for the ranges of the input elements: showing the voltage/current info for the power modules

Select all the ranges

On the configured lists for the EXT current sensor range of input element, the users can specify and select the range according to measurement requirement

3.10 Synchronization Measurement

- 1) Procedure : Press Measure→Sync Measure
- 2) Function : The master can output the measurement signal, and the slave can receive the signal. The measurement of two devices can be synchronized.
- 3) Setup menu :

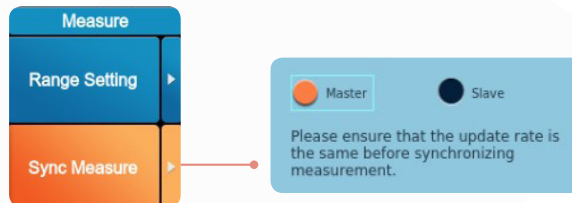

Synchronization Measurement:

- In the Master mode, press **【HOLD】** to stop master updating.
- In the Master mode, press **【HOLD】** to switch to the Slave mode from the Master, and the **【HOLD】** is not affected.
- Switch between the Master and Slave to update the settings.
- In the Slave mode, the functions such as IEC harmonic, FFT, Wave computation, math1 and math2 in wave computation, flicker, info, cycle-by-cycle measurement, Integration, storage cannot be enabled.
- **【Sync Measure】** cannot be set on during the operations such as IEC harmonics, FFT, Wave computation, math1 and math2 in Wave computation, flicker, cycle-by-cycle measurement, integration, view storage.
- The options will not be changed after factory reset.
- In the Slave status, press **【Integ】 【Store】**, but the pop-up message such as <Sync measurement cannot be set> will appear.

3.11 Harmonic Setting

The harmonic measurement range can be specified during measurement. The harmonic orders specified here are used to determine the numeric data of the distortion factor.

- 1) Procedure : Press Measure→Harmonic set
- 2) Setup menu :

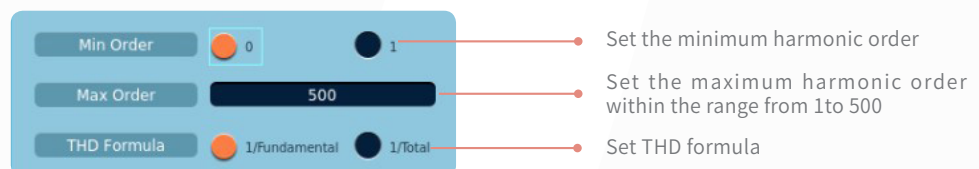

When determining the harmonic measurement functions U_{hdf} , I_{hdf} , Ph_{df} , U_{thd} , I_{thd} , and P_{thd} , you can select to use the data of the fundamental signal component or the measured data of all orders as the denominator for the THD equation.

Chapter 4 Accurate Measurement

Modules for accurate measurement specifically installed in this device improve the accuracy when this device is used for measurement. Users can press Accurate key to access to the Accurate menu, where following items can be set:

- Line filter
- Frequency filter
- Average
- Null
- Zero level compensation
- Auto zero level compensation

4.1 Line Filter

The line filter inserted into the voltage and current measurement input circuits will directly affects voltage, current, and power measurements. When the line filter is turned on, measured values do not contain high frequency components. Thus, the voltage, current, and power of inverter waveforms, strain waveforms, etc., can be measured without their high frequency components interference and noises from transducers or distorted waveforms.

- 1) Procedure: Press Accurate Line filter
- 2) Setup menu:

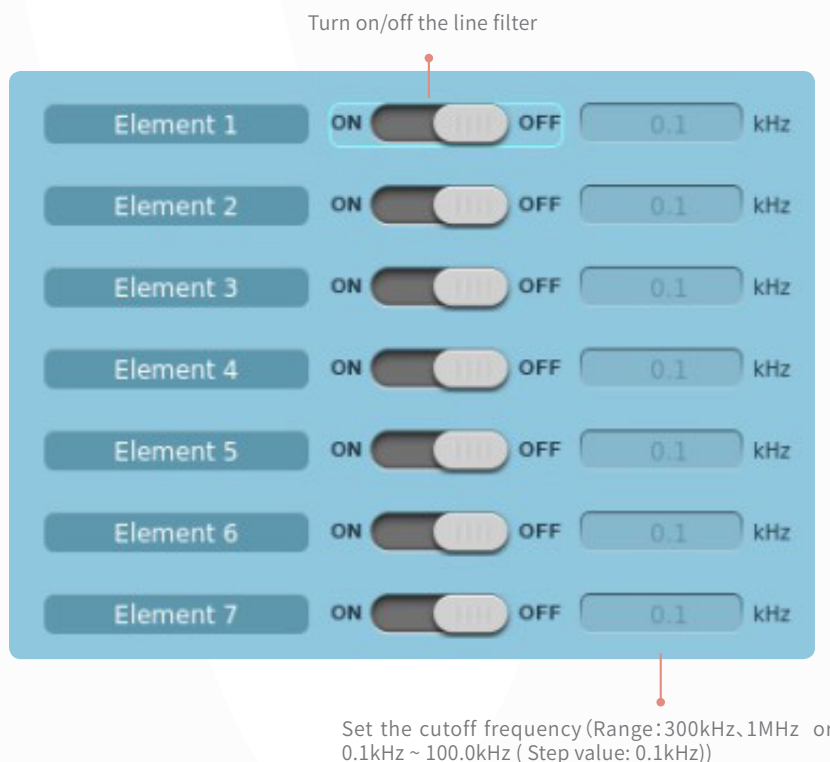

⚠ Note :

- As long as one element is not set as **【OFF】** , the indicator of Line Filter on the top of the screen will illuminate.
- Select all **【OFF】** : With the indicator of the line filter off, the function of line filter is disabled.

4.2 Frequency Filter

The frequency filter inserted into the frequency measurement input circuit will affect frequency measurements and the detection of the measurement period for voltage, current, and power measurements. So the filter also can be used for detecting the zero-crossing of the synchronization source signal more accurately. The frequency filter is not inserted into the voltage and current measurement input circuits. Therefore, the measured values include high frequency components even when the frequency filter is turned on.

- 1) Procedure : Press Accurate→Frequency filter
- 2) Setup menu :

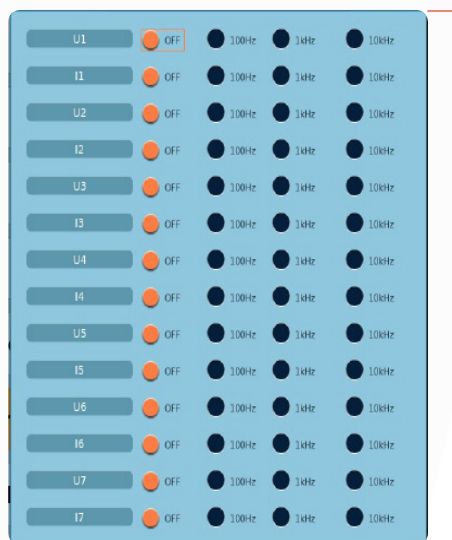

Set the frequency filter (off, 100Hz, 1 kHz, 10kHz)

⚠ Note :

- As long as one element is not set as **[OFF]** , the indicator of Frequency Filter on the top of the screen will illuminate.
- The frequency measurement will be influenced by the line filter turned on even when the frequency filter is off.

4.3 Averaging Setting

This instrument can perform exponential or moving averages of the numeric data. The averaging function is effective when reading of the numeric display is difficult due to fluctuations. This occurs when the fluctuation of the power supply or the load is large or when the input signal frequency is low.

- 1) Procedure : Press Accurate→AVG
- 2) Setup Menu is as follows:



- Enable averaging or not (The AVG indicator will be illuminated if Averaging is on)
- Set the type (Exponential average, Moving average)
- Set attenuation constant or average count (Enter integer value only) :
 - Exponential average: Select the attenuation constant from the values ranging from 2 to 64
 - Moving average: Select the average count from the values ranging from 8 to 64

Note:

- When averaging is turned on, the average value of multiple measurements is determined and displayed. If the input signal changes drastically, it will take longer for the change to be reflected in the measured values when averaging is used.
- A larger attenuation constant (for exponential averaging) or average count (for moving averages) will result in more stable (and less responsive) measured values.

4.4 NULL Function Setting

The NULL function included in the power analyzer can be used to subtract the DC offset or the bias voltage while the external sensor or measurement cable is connected.

- 1) Procedure: Press Accurate→NULL
- 2) Setup Menu

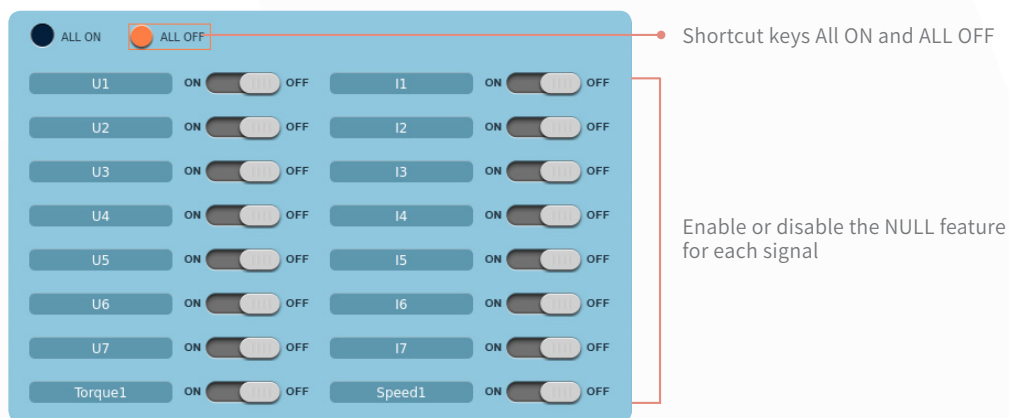
**Note:**

- The measurement items applied in NULL feature include voltage, current signal, motor torque and speed signal for each input element.
- to achieve accurate measurement, it is recommended perform Zero-level compensation prior to enabling NULL feature.

4.5 Zero-Level Compensation

Before measurement, zero-level compensation is required to be performed on this instrument. Zero-level compensation refers to creating a zero input condition in the internal circuit of the instrument to promote measurement accuracy. Zero-level compensation can be performed via manual or auto mode to meet the specifications of this instrument.

Manually

- 1) Procedure: Accurate→Zero
- 2) Setup Menu:

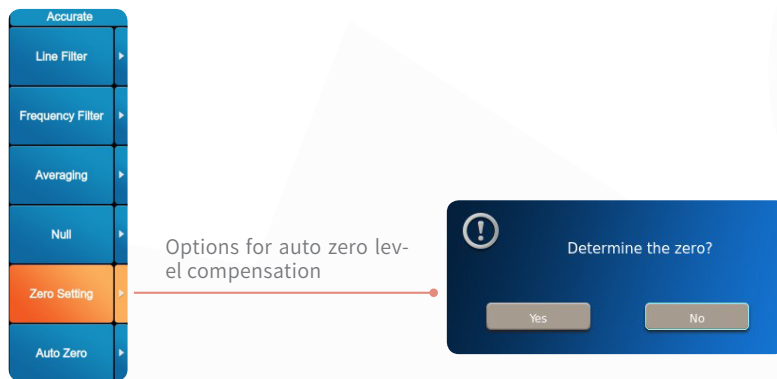

After “Zero” tab is selected, a pop-up message will appear for your confirmation. Select “Enter” to continue.

Auto Zero Setting

- 1) Procedure : Accurate→Auto Zero
- 2) Setup Menu :

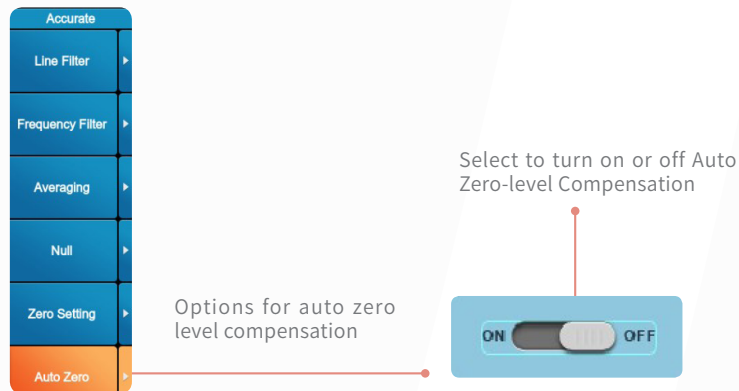

⚠ Note:

- This instrument automatically performs zero-level compensation after device is turned on or initialized, or you change the measurement range by manual.
- This normally running device perform zero-level compensation automatically per hour when the function of auto zero-level compensation is enabled.
- To make accurate measurements, we recommend that you execute zero-level compensation after warming up the instrument for at least half an hour.
- If the measurement range and input filter stay the same for a long time, the zero level may change due to the changes in this instrument’s environment. If this happens, we recommend that you adopt zero-level compensation.

Chapter 5 Setting the Source

The measurement period is determined by the input signal that is used as the reference (synchronization source). The measurement period is set within the data update interval between the first point where the sync source crosses the level-zero point (center of the amplitude) on a rising slope (or falling slope) and the last point where the sync source crosses the level-zero point (center of the amplitude) on a rising slope (or falling slope). This chapter provides operation procedures regarding the synchronization source for normal measurement and PLL source for harmonic measurement

5.1 Setting the Sync Source

The measurement period is determined by the selected input signal that is used as the reference (synchronization source) during normal measurement.

- 1) Procedure: SOURCE→SYNC SOURCE
- 2) Setup menu:



⚠ Note :

- If you specify no sync source by selecting “None,” all of the sampled data within the data update interval is used to determine the numeric data. When you are measuring DC signals, this method can be used to prevent noise from causing errors in the detection of the measurement period.
- If the sync source is set inappropriately, the measured value may fluctuate or be incorrect.

5.2 Setting PLL Source

For harmonics to be measured, the fundamental period (the period of the fundamental signal) that will be used to analyze the harmonics must be determined. The signal for determining the fundamental period is the PLL (phase locked loop) source.

- 1) Procedure: Source→PLL Source
- 2) Setup menu:

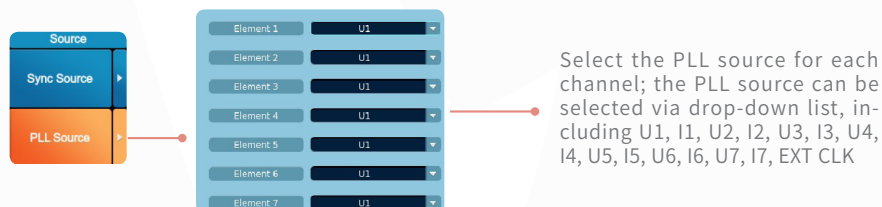

⚠ Note :

- If you select EXT CLK, the frequency of the signal applied to the rear panel’s external clock input connector (EXT) is used as the fundamental frequency for harmonic measurement.
- Select a signal that has the same period as the signal that you want to measure the harmonics. For stable harmonic measurement, choose an input signal for the PLL source that has as little distortion and fluctuation as possible.
- If all of the input signals are distorted or the amplitude is small compared to the measurement range, the specifications may not be met. To achieve stable, accurate measurements on high harmonics, set the PLL source to an external clock signal and apply a signal with the same period as the input signal to the external clock input connector.

Chapter 6 Range Setting

The measured results through the whole measurement process performed by power analyzer are affected by the measurement ranges, which are required to be selected appropriately by the users as per the applications. Two modes that can be selected are fixed range and auto range. This device can automatically apply appropriate ranges according to the signal amplitudes during auto range mode.

6.1 Setting Fixed Ranges of the Voltage and Current

1) Procedure

Pressing the MENU OFF button, you can select the input element whose range is needed to be set, and then rotate the voltage or current adjusting knob to modify the voltage or current range of this element. If you rotate the knob clockwise, the range will rise; if you rotate it counterclockwise, the range will fall; the voltage or current range displayed on the screen will change accordingly. In the upper right corner of the screen display window range you can also press the " \triangle " or " ∇ " keys on the top right corner on the screen to adjust the range.

2) Range

This power analyzer supports multiple types of input modules, according to which the measurement range of the

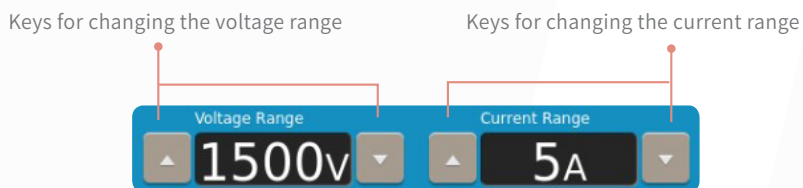

power analyzer changes.

Voltage range

- 1) VIEW770-05A12/ VIEW770-40A13
CF3:15V, 30V, 60V, 100V, 150V, 300V, 600V, 1000V
CF6/CF6A:7.5V, 15V, 30V, 50V, 75V, 150V, 300V, 500V
- 2) VIEW770-05A35/ VIEW770-50A35
CF3:1.5V, 3V, 6V, 10V, 15V, 30V, 60V, 100V, 150V, 300V, 600V, 1000V
CF6/CF6A:750mV, 1.5V, 3V, 5V, 7.5V, 15V, 30V, 50V, 70V, 150V, 300V, 500V
- 3) VIEW770-05A35V/ VIEW770-50A35V
CF3:3V, 6V, 10V, 15V, 30V, 60V, 100V, 150V, 300V, 600V, 1000V, 1500V
CF6/CF6A:1.5V, 3V, 5V, 7.5V, 15V, 30V, 50V, 75V, 150V, 300V, 500V, 750V

Current range

- 1) VIEW770-05A12
CF3:2mA, 5mA, 10mA, 20mA, 50mA, 100mA, 200mA, 500mA, 1A, 2A, 5A
CF6/CF6A: 1mA, 2.5mA, 5mA, 10mA, 25mA, 50mA, 100mA, 250mA, 0.5A, 1A, 2.5A
- 2) VIEW770-40A13
CF3:100mA, 200mA, 500mA, 1A, 2A, 5A, 10A, 20A, 40A
CF6/CF6A: 50mA, 100mA, 250mA, 500mA, 1A, 2.5A, 5A, 10A, 20A
- 3) VIEW770-50A35/ VIEW770-50A35V
CF3:1A, 2A, 5A, 10A, 20A, 50 A

CF6/CF6A:500mA, 1A, 2.5A, 5A, 10A, 25A

4) VIEW770-05A35/ VIEW770-05A35V

CF3:10mA, 20mA, 50mA, 100mA, 200mA, 500mA, 1A, 2A, 5A

CF6/CF6A: 5mA, 10mA, 25mA, 50mA, 100mA, 250mA, 500mA, 1A, 2.5A

6.2 Setting Auto Ranges of the voltage and current

The automatic range is available in this instrument, and its settings will be described in this section.

1) Procedure

Press the MENU OFF key and then select the input elements to set the range; Press the voltage or current range knob to access to the auto range mode, with “Auto” displayed under the voltage or current value, indicating that auto range mode is enabled; Press the voltage or current range knob again, with “Auto” disappearing, the auto range mode is also turned off.

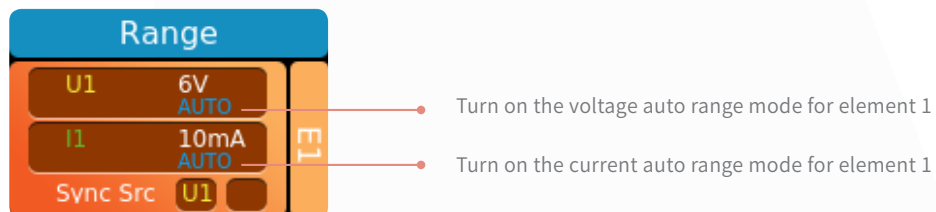

2) Conditions of auto range switching

The options of the auto/current auto ranges vary pending on the selected voltage/current ranges. In the Auto Range mode, the range will rise and fall automatically on the following certain conditions.

Range Up—The measurement range is increased when any of the following conditions is met

- Urms or Irms exceed 110% of the range(220% for CF6A).
- Upk or Ipk of the input signal exceed 330% of the range(660% for CF6/CF6A).

Range Down—The measurement range is decrease when all the following conditions are met.

- Urms or Irms is less or equal to 30% of the measurement range.
- Urms or Irms is less or equal to 105% of the lower range.
- Upk or Ipk of the input signal is less than 300% of the lower range(600% or less for CF6/CF6A).

6.3 Setting EXT Current Sensor range

1) Procedure

Press the MENU OFF key to switch to the element range menu, where you can select the input element of the external current sensor range. Press the EXT key, the EXT indicator will be illuminated and “E” will display in the element range menu, when you can set the current of the EXT sensor by using the current range knob. Press EXT key again to exit from the external sensor measurement mode, with EXT indicator off and “E” disappearing.

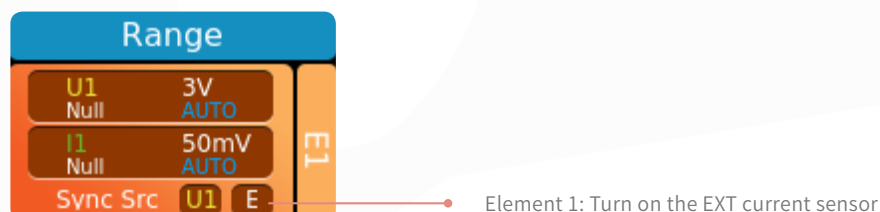

2) Range

- When on the condition of crest factor CF3,

You can select from the ranges of 50mV, 100mV, 200mV, 500mV, 1V, 2V, 5V, 10V.

- When on the condition of crest factor CF6/CF6A,

You can select from the ranges of 25mV, 50mV, 100mV, 250mV, 500mV, 1V, 2.5V, 5V.

3) Auto Mode

Auto range mode is also available in setting the EXT current sensor range, and the methods are the same as those of the current and voltage auto range.

6.4 Overload protection

The current measurement value is detected and displayed as OL for 3min continuously. If the current range is not an automatic range, the current range will be automatically switched to an automatic range.

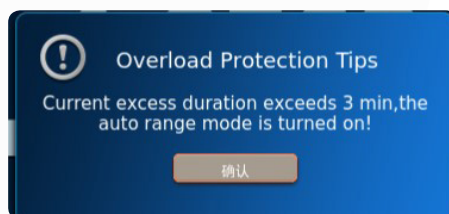

Notes:

Integral non-reset state and store non-reset state. When overload protection occurs, it cannot be automatically switched to automatic range and needs to be set manually.

Flicker view and cycle analysis view cannot trigger overload protection;

16 Items Display

In this mode, a list of measurement data including 16 measurement values can be displayed on one screen. By default, the measurement functions of the Element 1 can be displayed. The displayed measurement functions can be modified in the Item Setting Menu.

All Items Display

In this mode all the measurement values of the all the elements and all the wiring units can be displayed on one screen. And the channels are self-adjustable. The screen is divided into two parts including upper part where the basic measurement functions of each element and wiring units can be displayed and lower part where different measurement values can be displayed along with the page changes.

Single Harmonic Display

In this mode, 3 lists of measurement values can be displayed on one screen. The first list shows the harmonic measurement functions, while the second and the third lists show the measurement values of each order. This instrument can display the total harmonics and the DC components, and measurement values of 40 orders at most can also be displayed. The displayed harmonic measurement functions can be modified in the Item Setting Menu. You can refer to the section 6.1.2.

Dual Harmonic Display

In this mode, 3 lists of measurement values can be displayed on one screen. The first list shows the harmonic measurement functions, while the second and the third lists show the measurement values of dual harmonics of each order. This instrument can display the total harmonics and the DC components, and measurement values of 20 orders at most can also be displayed. The displayed harmonic measurement functions can be modified in the Item Setting Menu. You can refer to the section 6.1.2.

Application scenarios (Custom)

Please refer to the operation instructions in the corresponding section in detail.

7.2 Setting the Numeric Display Items

- 1) Procedure: Press NUMERIC→ITEM
- 2) Setup menu :

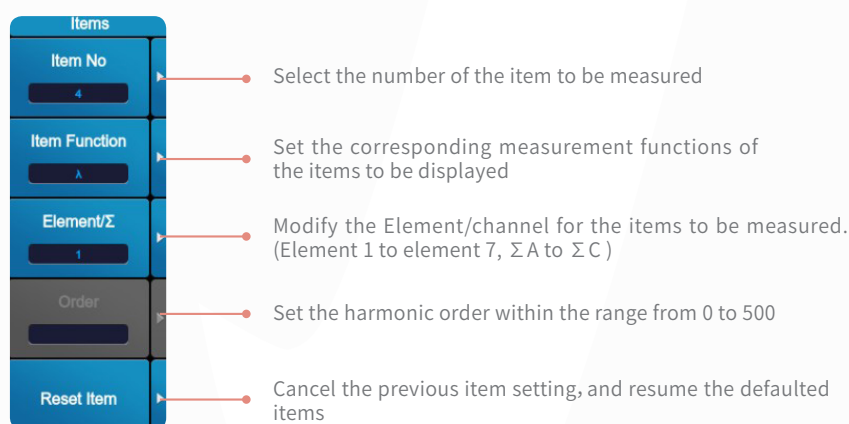

Item No. (Number)

The number of the items refers to the number of the position where the cursor locates; in sequence, the number will increase from the upper to lower, and left to right. If the number is set to 2, the items of the second position where the cursor locates will be displayed, without any influence on the other measurement items.

Function

Specify the measurement functions to be displayed on the corresponding position. All the measurement functions available in this instrument can be selected.

Element Number/ Σ

Users can specify the channel to be displayed by selecting the element numbers, including elements from 1 to 7, and wiring systems from ΣA to ΣC . The available options of the channels vary depending on the installed elements.

Harmonic Order

Users can specify which harmonic measurement data to display by selecting which order only when harmonic measurement function is enabled.

Reset Items

Users can click Reset to revert to the previous items display as needed.

⚠ Note :

- In the all items display mode, only the harmonic order of the harmonic measurement function can be set.
- You can refer to the section 12.2 for the operation procedures regarding the display item settings in the 【Single-harmonic and Dual-harmonic】 menu.

7.3 User

In the 4-, 8-, 16-values display menus and application scenarios menu: you can press the User to view any items to be displayed, as shown in the following picture.

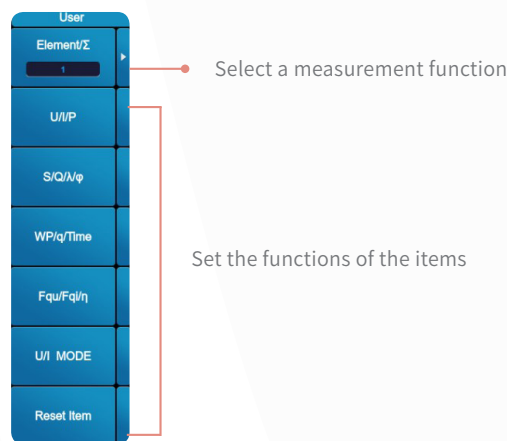

As shown in the above picture, there are the following items which can be selected: U/I/P, S/Q/λ/φ, WP/q/Time, Fqu/Fqi/η and U/I/MODE. The measurement functions can be switched between each other.

U/I/P	U→I→P→U
S/Q/λ/φ	S→Q→λ→φ→S
WP/q/Time	WP→q→Time→WP
Fqu/Fqi/η	FreqU→FreqI→η1→η2→η3→η4→η5→η6→FreqU
U/I MODE	Urms→Umn→Udc→Uac→Urmn or Irms→Imn→Idc→Iac→Irmn

Reset: You can press this key to return to the default initial state.

7.4 Harmonic Measurement in Normal Measurement Mode

The harmonic measurement function enable this device to perform the measurement functions that are based on the voltage, current, and power harmonics and so on (the phase angle of each harmonic relative to the fundamental as well), and to compute the harmonic distortion factors for voltage and current.

7.4.1 Normal Harmonic Measurement Display Format

- 1) Procedure : Press the NUMERIC key > Form key, and then access to the Form menu to select the options to show the numeric display of the 4-,8-,16-, all-item single or dual harmonics.
- 2) Setup menu :

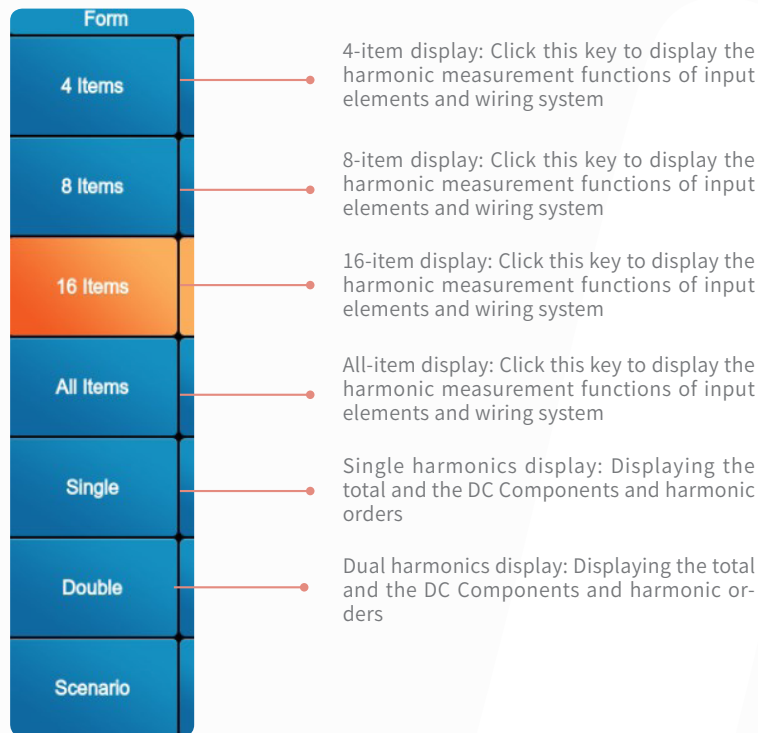

7.4.2 Harmonic Display in Normal Measurement Mode

4-item, 8-item,16-item Harmonic Display

- 1) Procedure : Press Numeric key to access to the 4-, 8-, 16-item display menu, and then press Item key
- 2) Setup menu for Items

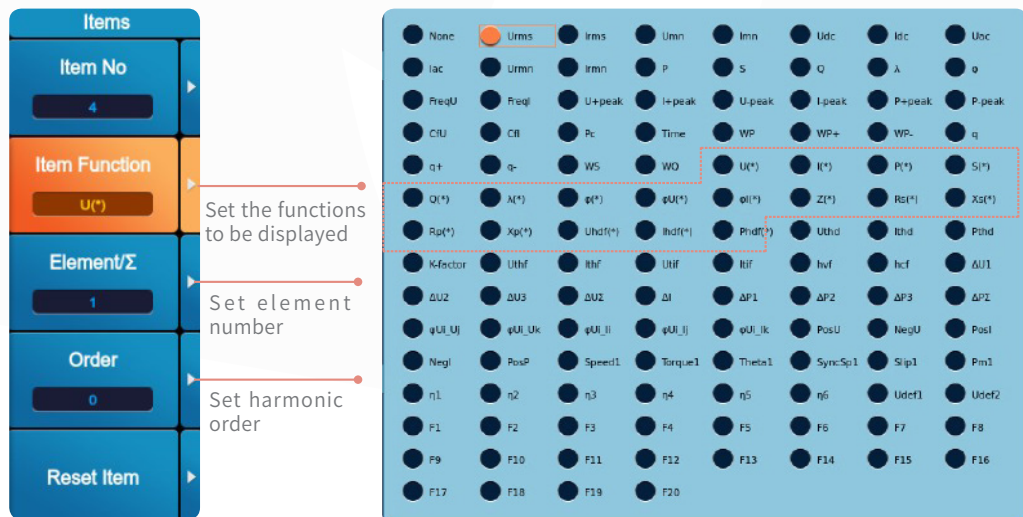

Item No. (Number)

The number of the items refers to the number of the position where the cursor locates; in sequence, the number will increase from the upper to lower, and left to right. If the number is set to 2, the items of the second position where the cursor locates will be displayed, without any influence on the other measurement items.

Function

Specify the measurement functions to be displayed on the corresponding position. All the measurement functions available in this instrument can be selected. In 4-, 8-, 16-value display formats, the functions under harmonic measurement that can be displayed include U(*), I(*), P(*), S(*), Q(*), λ(*), φ(*), φU(*), φI(*), Z(*), Rs(*), Xs(*), Rp(*), Xp(*), Uhdf(*), Phdf(*), lhdf(*). Users can select the functions and harmonic orders.

Element Number/Σ

Users can specify the channel to be displayed by selecting the element numbers, including elements from 1 to 7, and wiring systems from ΣA to ΣC. The available options of the channels vary depending on the installed elements.

Harmonic Order

Users can specify which harmonic measurement data to display by selecting which order only when harmonic measurement function is enabled.

Reset Items

Users can click Reset to revert to the previous items display as needed.

Numeric Display for Harmonics in Normal Mode

The diagram illustrates the relationship between display format options and the number of items displayed for harmonic measurements. A vertical menu on the left lists options: Form, 4 Items, 8 Items, 16 Items, All Items (highlighted in orange), Single, Double, and Scenario. Red lines connect these options to three example display screens on the right:

- 4 Items:** Shows a 2x2 grid of four items: U1(Total) 5.0912 V, I1(Total) 2.21904 A, P1(Total) 9.8074 W, and S1(Total) 9.9512 VA.
- 8 Items:** Shows a 4x2 grid of eight items: U1(Total) 5.0914 V, I1(Total) 2.21904 A, P1(Total) 9.8105 W, S1(Total) 9.9520 VA, Q1(Total) 1.6723 var, λ1(Total) 0.98578, φ1(Total) 9.67°, and φU1(Total) -----.
- 16 Items:** Shows a 4x4 grid of sixteen items: U1(Total) 5.0914 V, I1(Total) 2.21901 A, P1(Total) 9.8028 W, S1(Total) 9.9513 VA, Q1(Total) 1.7127 var, λ1(Total) 0.98508, φ1(Total) 9.91°, φU1(Total) -----, φI1(Total) -----, Z1(Total) -----, Rs1(Total) -----, Xs1(Total) -----, Rp1(Total) -----, Xp1(Total) -----, Uhdf1(Total) -----, and lhdf1(Total) -----.

All Items Display for Harmonic Measurement

The harmonic measurement functions which can be displayed when users select the display format of All Items include U(*), I(*), P(*), S(*), Q(*), λ(*), φ(*), φU(*), φI(*), Z(*), Rs(*), Xs(*), Rp(*), Xp(*), Uhdf(*), lhdf(*), Phdf(*). Users can change harmonic orders. Harmonic orders cannot be changed except when harmonic measurement items are displayed.

16 Items

All Items

Single

All items display for harmonic measurement

	Element1 (low freq)	Element2 (low freq)	Element3 (low freq)	Element4 (low freq)	Element5 (low freq)	Element6 (low freq)	Element7 (low freq)	ΣA E1 E3 ΣA(1+3)	ΣB E4 E5 ΣB(4+5)	ΣC E6 E7 ΣC(6+7)
Urms (V)	5.0914	5.0935	5.0857	5.0916	5.1194	5.08673	7.63378	5.9002	5.1055	6.36026
Irms (A)	2.21906	2.15869	6.4338m	0.0325	2.2483	0.0000	2.2633	1.46139	1.1394	1.1312
P (W)	9.8681	9.5093	2.985m	-0.026	9.975	0.0000	14.6058	19.3114	9.951	14.858
Q (var)	5.6078	5.5158	-32.583m	-0.164	5.722	0.0000	8.8071	11.1276	5.558	8.8071
S (VA)	11.2481	10.9952	32.715m	0.166	11.500	0.0000	17.2702	12.8899	10.102	14.5564
λ	0.86812	0.86686	0.90110	-0.14375	0.88143	Error	0.86020	1.00000	0.99505	0.93327
φ (*)	629.76	630.15	084.77	088.26	629.84	Error	630.46	0.00	9.92	6.65
φU (*)	50.0018	50.0014	50.0010	50.0010	50.0013	50.0015	50.0010	0.00000	0.00000	0.00000
φI (*)	50.0013	50.0013	22.63318	0.00000	50.0013	0.00000	50.0013	0.00000	0.00000	0.00000
φZ (*)	1.5919	1.5932	1.5940	1.5844	1.6145	1.6031	1.6284
φRs (*)	1.3401	1.7259	1.9929	1.8965	1.3433	0.0000	1.3534

Single List and Dual List Display

- 1) Procedure : Press Numeric key, and then press Item in the menu of single list and dual list display.
- 2) Item setup menu :

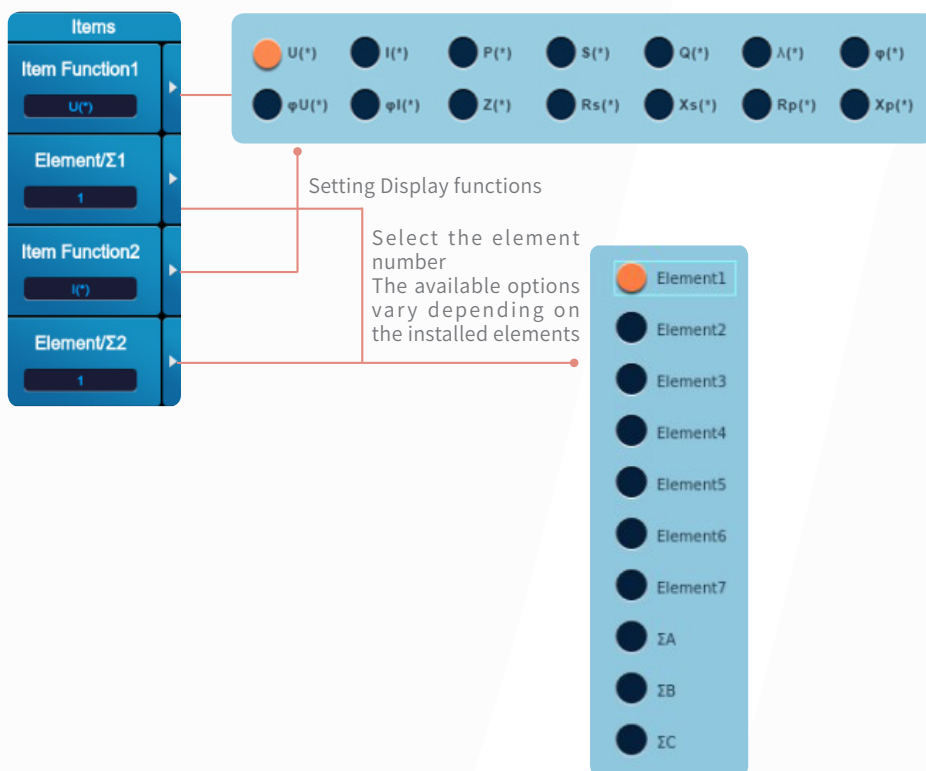

Item Function 1

Users can specify the items to display. Items under harmonic measurement functions that can be set include U(*), I(*), P(*), S(*), Q(*), λ(*), φ(*), φU(*), φI(*), Z(*), Rs(*), Xs(*), Rp(*), Xp(*), as shown in the above picture.

Element/Σ 1

Users can specify the channel to be displayed by selecting the element numbers, including elements from 1 to 7, and wiring systems from ΣA to ΣC. The available options of the channels vary depending on the installed elements.

Item Function 2

Users can specify the items to display. Items under harmonic measurement functions that can be set include U(*), I(*), P(*), S(*), Q(*), λ(*), φ(*), φU(*), φI(*), Z(*), Rs(*), Xs(*), Rp(*), Xp(*), as shown in the above picture. The option of item function 2 is activated only when there is Dual List display.

Element/ Σ 2

Users can specify the channel to be displayed by selecting the element numbers, including elements from 1 to 7, and wiring systems from ΣA to ΣC . The available options of the channels vary depending on the installed elements. The option of Element/ Σ 2 is activated only when there is Dual List display.

Form

- 4 Items
- 8 Items
- 16 Items
- All Items
- Single
- Double
- Scenario

Single List for Harmonic display

Dual List for Harmonic display

Order	Ueff%	hEff%	Order	Ueff%	hEff%
TOTAL	5.9913		DC	1.8483	21.0420
1	4.9620	100.000	2	0.0001	1.8755m
3	0.0000	0.0000m	5	0.0001	1.9664m
5	0.0001	2.62475m	6	0.0001	1.72822m
7	0.0001	1.22022m	8	0.0001	1.84217m
9	0.0002	3.49143m	10	0.0001	2.29372m
11	0.0001	1.64506m	12	0.0001	1.08797m
13	0.0001	2.17996m	14	0.0000	0.43355m
15	0.0002	3.37722m	16	0.0001	3.23356m
17	0.0001	1.50864m	18	0.0002	3.89022m
19	0.0001	1.26274m	20	0.0001	2.93244m
21	0.0002	3.79722m	22	0.0001	3.13336m
23	0.0001	2.85742m	24	0.0001	2.79412m
25	0.0002	4.40722m	26	0.0001	2.94606m
27	0.0001	1.59496m	28	0.0001	2.54572m
29	0.0001	2.50722m	30	0.0001	2.22322m
31	0.0001	2.95772m	32	0.0001	1.80322m
33	0.0001	2.79622m	34	0.0001	1.84322m
35	0.0001	2.14322m	36	0.0001	1.90222m
37	0.0002	3.14022m	38	0.0001	1.94422m
39	0.0000	0.50932m	40	0.0001	2.34822m

Order	Ueff%	hEff%	Order	Ueff%	hEff%
TOTAL	5.1062		96%	2.23887	
DC	1.0482	21.0388	DC	0.97128	54.0755
1	4.9622	100.000	1	1.29618	100.000
2	0.0004	2.21848m	2	0.0004	2.23963m
3	0.0001	1.24378m	3	0.00012	10.3359
4	0.0001	1.86239m	4	0.00005	2.52589m
5	0.0002	3.37848m	5	0.39208	20.0515
6	0.0001	2.48848m	6	0.00002	1.27863m
7	0.0002	4.12388m	7	0.25961	14.2866
8	0.0001	2.53477m	8	0.0004	2.02677m
9	0.0004	7.96388m	9	0.0004	11.1161
10	0.0000	0.041358m	10	0.00002	0.95059m
11	0.0001	1.95488m	11	0.34331	0.80158
12	0.0000	0.00000m	12	0.13171	1.64665
13	0.0000	0.041358m	13	0.13005	1.49481
14	0.0001	2.48374m	14	0.00002	0.85794m
15	0.0001	0.40888m	15	0.00001	1.66665
16	0.0001	2.22088m	16	0.00005	3.06058m
17	0.0001	1.78823m	17	0.30769	1.89792
18	0.0001	3.38158m	18	0.00004	2.40229m
19	0.0000	0.90122m	19	0.00454	3.20311
20	0.0001	2.49908m	20	0.00004	1.98526m

7.5 Setting the Application Scenarios

- 1) Scheduled: Press NUMERIC→Scenario
- 2) Function: Set and customize the numeric display and the pictures.
- 3) Procedures of adding pictures are as follows:

It defaults to be no picture display

Click [Add Picture] icon to access to the File Manager

Access to the menu of picture storage, select pictures as needed, and then you can see the selected pictures will be displayed at the right side of the screen

Urms1	7.183 V
Irms1	4.078 A
P1	-18.83 W
λ 1	-0.6427
S1	29.30 VA
ϕ 1	D130.00°
FreqU1	50.001 Hz
FreqI1	50.001 Hz

- The user-defined pictures will automatically adjust, being displayed in the aligned center as per the scaling.
- Click **【Change】** to see the pop-up menu of File Manager; if you need to add another picture, the current picture shown will be displaced; if you click **【Cancel】** in the File Manager menu, there will be no any change to the current picture.
- If you click **【Remove】** to remove the current user-defined picture shown, there will be no picture shown on this menu.
- When the original picture is removed, the user-defined picture will disappear in the Scenario menu, and there will be no picture shown on the menu.

Chapter 8 Waveform Display

The measured results can be displayed as the waveforms on this power analyzer where users can press Wave key to access to the Waveform menu on which users can set the items such as waveform display formats, measurement items and so on. You can also set the cursor position to trace and view each measurement data.

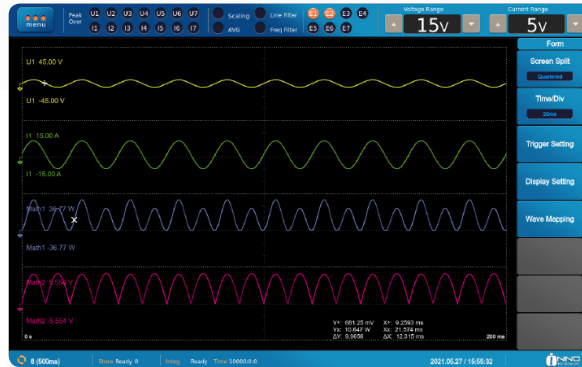

8.1 Setting the Format of the Waveform Display

- 1) Procedure: Press WAVE
- 2) Setup menu:

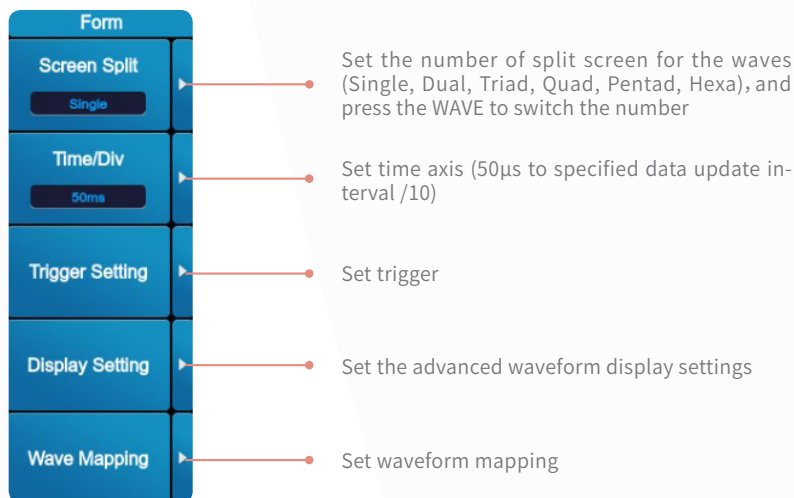

Setting time axis

Press the Time/div ((time per grid division) key to set the time axis. One screen is divided into 10 grids. The time axis can be set up to the point in which the time corresponding to one screen is equal to the data update interval. For example, when the data update interval is 500 ms, if you change the time division in this order: 0.5 ms > 1 ms > 2 ms > 5 ms > 10 ms > 20 ms > 50 ms, the time corresponding to one screen changes in this order: 50 μ s > 1 ms > 2 ms > 5 ms > 10 ms > 20 ms > 50 ms > 100 ms > 200 ms > 500 ms.

Setting the Trigger

The trigger determines when a waveform is displayed. A trigger is said to “occur” when the trigger condition is met and a waveform is displayed. The trigger menu is shown as follow.

Auto Normal OFF

U1

0.0 %

Set the trigger mode (Auto, Normal, OFF)
 Set the trigger slop (rising slop/falling slop/rising and falling slop)
 Set trigger source (U1~U7, I1~I7, EXT CLK)
 Set trigger level (0.0% ~ ±99.9%): it will be failed to set the trigger level when Ext is used as trigger source

Setting Display

Select the Display menu, as shown in the following picture.

ON OFF

ON OFF

ON OFF

Scale Grid None

Turn on/ off the wave label display
 Turn on/off scale value
 Set the interpolation of the waveforms (On or Off)
 Set the graticule

Wave Mapping

The Wave Mapping menu is shown as follows.

Auto Fixed Define

U1	1	I1	1
U2	2	I2	2
U3	3	I3	3
U4	4	I4	4
U5	5	I5	5
U6	6	I6	6
U7	1	I7	1
Torque1	1	Speed1	1
Math1	2	Math2	2

Select the waveform mapping mode (Auto, Fixed, and User)
 Set the mapping destination (the divided screen number: 1 to 6). Map each waveform (U1, I1, etc.) to the part of the divided screen that you want it to appear on. These settings will be displayed when the mode is set to User

Auto: The waveforms whose displays are turned on are assigned in order according to their element numbers, with an element's voltage waveform (U) coming first, followed by its current (I), speed, Speed*1, Torque*1.

Fixed: Regardless of whether their displays are on or off, waveforms are assigned in order according to their element numbers, with an element's voltage waveform (U) coming before its current waveform (I). The Speed1 waveforms appear in the top window. The Torque1 waveforms appear in the second window from the top.

User: You can pick which waveforms to assign to which windows, regardless of whether the waveform's displays are on or off. You can set the display position to a number from 1 to 6. Number 1 corresponds to the window at the top of the screen, and the window number increases for each successively lower window. Speed and torque waveforms are available on models with the motor evaluation option.

8.2 Setting the Waveform Display Item

- 1) Procedure: Press WAVE→ITEM
- 2) Setup menu:

The screenshot shows the 'Items' menu with 'Item Setting' selected. The 'Item Setting' menu is expanded to show 'All ON', 'All OFF', and 'Wave Computation'. The 'Wave Computation' menu is also expanded to show 'U1' through 'U7', 'Torque1', 'Speed1', 'Math1', and 'Math2'. The 'U1' item is selected, and its settings are shown in a table below.

Annotations:

- Select which waveform to be displayed (points to the 'U1' checkbox in the 'Items' menu)
- Set the vertical zoom factor within the range from 0.1 to 100.0 (points to the 'Zoom' column)
- Set the vertical position of a waveform within the range from 0.00 to ± 100.00 (points to the 'Position' column)

Item	Display	Zoom	Position
U1	<input checked="" type="checkbox"/>	1.0	0.00 %
I1	<input checked="" type="checkbox"/>	1.0	0.00 %
U2	<input checked="" type="checkbox"/>	1.0	0.00 %
I2	<input checked="" type="checkbox"/>	1.0	0.00 %
U3	<input checked="" type="checkbox"/>	1.0	0.00 %
I3	<input checked="" type="checkbox"/>	1.0	0.00 %
U4	<input checked="" type="checkbox"/>	1.0	0.00 %
I4	<input checked="" type="checkbox"/>	1.0	0.00 %
U5	<input checked="" type="checkbox"/>	1.0	0.00 %
I5	<input checked="" type="checkbox"/>	1.0	0.00 %
U6	<input checked="" type="checkbox"/>	1.0	0.00 %
I6	<input checked="" type="checkbox"/>	1.0	0.00 %
U7	<input checked="" type="checkbox"/>	1.0	0.00 %
I7	<input checked="" type="checkbox"/>	1.0	0.00 %
Torque1	<input checked="" type="checkbox"/>	1.0	0.00 %
Speed1	<input checked="" type="checkbox"/>	1.0	0.00 %
Math1	<input type="checkbox"/>	1.0	0.00 %
Math2	<input type="checkbox"/>	1.0	0.00 %

Waveform Display

You can select whether to display the waveform of each input signal of each element by selecting or clearing the signal's check box. You can turn on or off the current/voltage signal from the input element, displays of the waveforms of the speed and torque input signals, the displays of the waveforms.

Vertical Zoom

Each displayed waveform can be vertically scaled.

Vertical Position

You can vertically shift the displayed position (vertical position) of a waveform. This is useful when you want to view the relationship between voltage and current waveforms, or when the section of the waveform that you want to view does not fit into the display frame. The upper and lower limit values for the vertical display respectively are 100% and -100%.

Waveform Computation

You can refer to section 8.4 in detail.

8.3 Setting the Cursors on the Waveforms

- 1) Procedure: Press WAVE→CURSOR
- 2) Setup menu:

Cursor	
Cursor OFF	Turn on or off the cursor measurement
C1+Wave U1	Use the cursor C1+Trace to measure the waveform. The input elements that can be displayed are U1~U7, I1~I7, Speed1, Torque1
C2xWave U1	Use the cursor C2xTrace to measure the waveform. The input elements that can be displayed are U1~U7, I1~I7, Speed1, Torque1
C1+Position 0	Set the position of the cursor C1+Position for the input elements (within the range from 0 to 2160)
C2xPosition 0	Set the position of the cursor C2x Position for the input elements (within the range from 0 to 2160)
Linkage OFF	Turn on or off the cursor linkage

You can turn the Linkage on to move cursor 1 (+) and cursor 2 (x) without changing the distance between them.

The Items measured by the cursors on the waveforms

- Y+ The vertical-axis (Y-axis) value of cursor 1 (+)
- Yx The vertical-axis (Y-axis) value of cursor 2 (x)
- ΔY The difference between the vertical-axis (Y-axis) values of cursor 1 (+) and cursor 2(x)
- X+ The horizontal-axis (X-axis) value of cursor 1 (+)
- Xx The horizontal-axis (X-axis) value of cursor 2 (x)
- ΔX The difference between the horizontal-axis (X-axis) values of cursor 1 (+) and cursor 2 (x)

8.4 Waveform Computation (option)

Waveforms obtained by adding/subtracting displayed waveforms or squared or averaged waveforms can be displayed on the models with waveform computation function. The waveform squared or averaged can also be displayed on the screen. Up to 2 computation waveforms can be displayed, including Math 1 and Math 2. For example, this allows the waveform of instantaneous power to be displayed by multiplying the voltage waveform by the current waveform. In addition, a cursor can be placed on the waveform to display various data at that point.

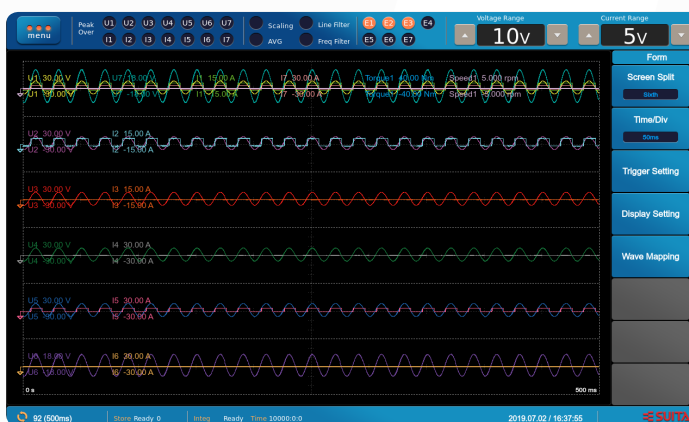

8.4.1 Setting the Waveform Computation Expressions

Follows are the descriptions of the settings of the equations, scales, units and labels for the waveform computation.

- 1) Procedure: Press WAVE→ITEM→Wave Computation
- 2) Setup menu for the equations:

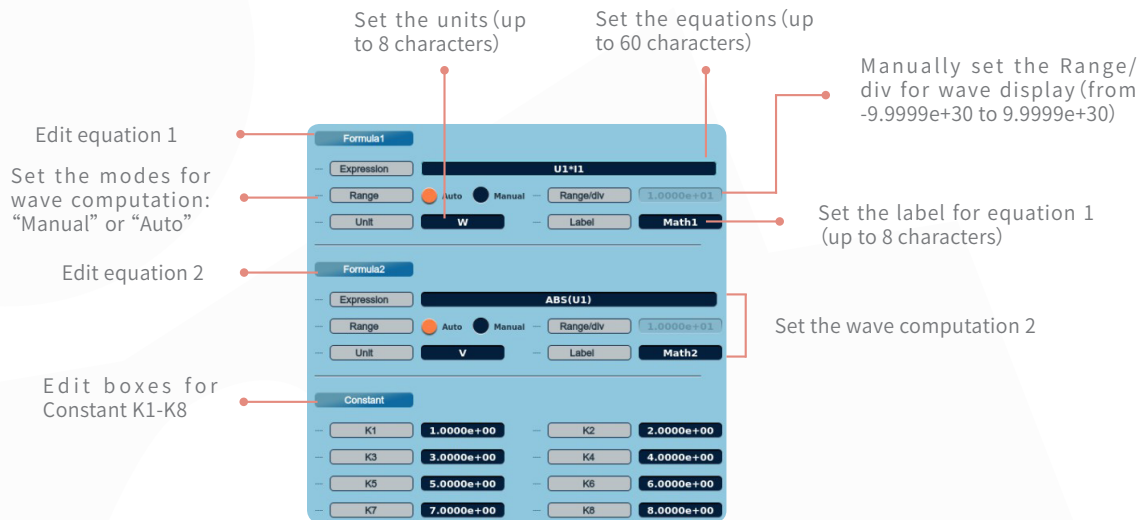

Descriptions to the operands in the waveform computation

Operand	Description
U1~U7	Voltage waveform of each input element
I1~I7	Current waveform of each input element
Speed, Torque	Speed and Torque signal waveform of the motor input
K1~K8	Constant

Descriptions to the operands in the waveform computation

Operator	Example of equation	Description
+, -, *, /	U1+U2	Four arithmetic operation of the specified waveform
ABS	ABS (U1)	Absolute value of the specified waveform
SQR	SQR (U1)	Square of the specified waveform
SQRT	SQRT (U1)	Square root of the specified waveform
LN	LN (U1)	Natural logarithm of the specified waveform
LOG10	LOG10 (U1)	Common logarithm of the specified waveform
EXP	EXP (U1)	Exponent of the specified waveform
NEG	NEG (U1)	Negative of the specified waveform
AVG2	AVG2 (U1*I1)	Average of the specified waveform with an average constant of 2
AVG4	AVG4 (U1*I1)	Average of the specified waveform with an average constant of 4
AVG8	AVG8 (U1*I1)	Average of the specified waveform with an average constant of 8
AVG16	AVG16 (U1*I1)	Average of the specified waveform with an average constant of 16
AVG32	AVG32 (U1*I1)	Average of the specified waveform with an average constant of 32
AVG64	AVG64 (U1*I1)	Average of the specified waveform with an average constant of 64

8.4.2 Setting the Formats of the Waveform Computation

The format settings of the waveform computation contain the corresponding options (for example, Math1 and Math 2) of the waveform computation which is not included in the waveform format setting. The methods of other settings such as split screen, trigger, display, interpolation are the same as those described in the settings of waveform display.

Mapping of the Waveform Computation

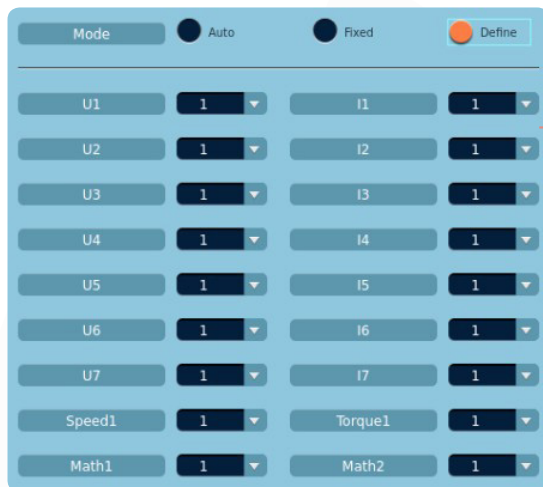

The settings are the same as the waveform mapping setting except Math 1 and Math2

Waveform Computation Cursor



The cursor settings for the wave computation are the same as the settings of the cursor on the Waveforms except Math1 and Math2

8.4.3 Setting the Waveform Computation Item

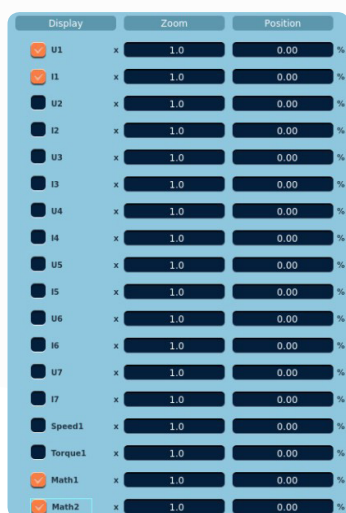

The input elements including Math1 and Math2 can be set for the waveform computation display

- The vertical scale factors for the waveform computation also can be set within the range from 0.1 to 100.0
- The position of the waveform computation can be set within the range from 100.0% to 100.0%

Waveform Computation Error and Expressions

In the following case, the expression is able to be edited, but the results for waveform computation are in error or no waveform is displayed on the screen.

- If an operand of a voltage or current signal of an element that is not installed is used in the equation.

In the following cases, pop-up messages appear to inform the expressions for waveform computation failure.

- If a negative value is substituted in the SQRT parameter
- If a negative value or zero is substituted in the LN or LOG10 parameter
- If a division by zero occurs.
- If any of the operands results in error

Note :

- An equation (Math1 or Math2) cannot be inserted with another equation (Math1 or Math2).
- If the waveform is not displayed, the computed waveform may be turned OFF in the selection of the displayed waveform.

Chapter 9 Vector Display

The results through harmonic measurement by power analyzer can be displayed as vector diagram, where the selected measured items of elements or wiring systems can also be displayed.

Press the Vector key on the panel to access to the Vector menu, where users can set the vector display format, display items and so on. During harmonic measurement, vectors can be displayed to show the relationship between the phase difference of the fundamental harmonic from each selected input element/ Σ and the RMS. In the vector display, the length of the vector reflects the size of the RMS value, while the angle between the vectors reflects the phase difference between each fundamental harmonic.

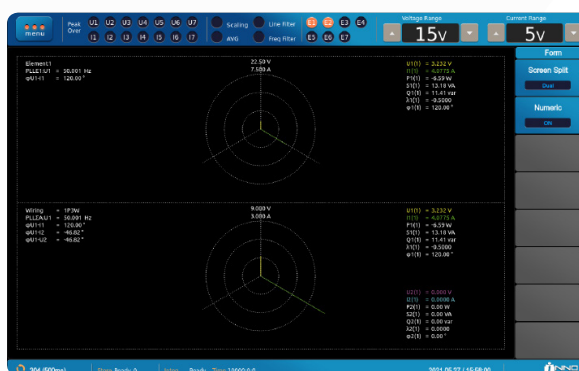

9.1 Setting the Format of the Vector

- 1) Procedure : Press VECTOR
- 2) Setup menu :

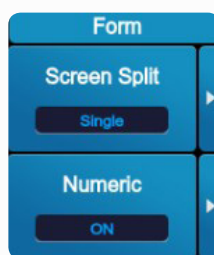

Split screen: Single, Dual

Turn the vector Display of Numeric Data On and Off

Format of the screen split

Single : The data of vector (Item No.) 1 will be displayed

Dual : The data of vectors (Item No.) 1 and 2 will be displayed.

You can press VECTOR key more than once to switch between displays of single and dual.

Turning the Display of Numeric Data On and Off

You can select whether to show (ON) or hide (OFF) numeric data.

9.2 Setting the Vector Display Item

- 1) Procedure : Press VECTOR→ITEM
- 2) Setup menu :

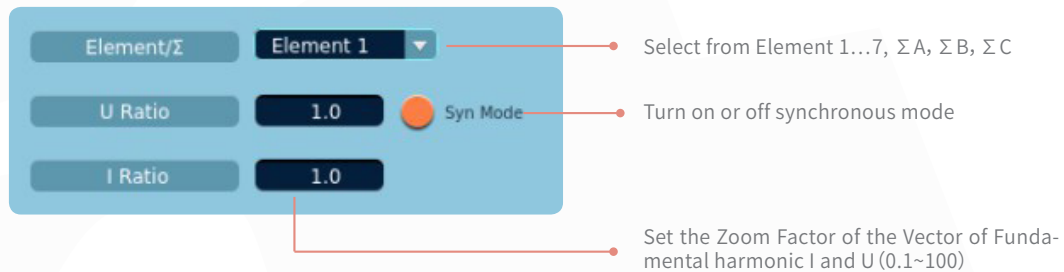

The range of the vector diagram (size of the outermost circle) will be displayed, when the Numeric display is turned on and there exists input element or wiring system.

Voltage : Voltage range of the input element within the wiring system × Crest factor (3 or 6) × voltage zoom factor

Current : Current range of the input element within the wiring system × Crest factor (3 or 6) × current zoom factor

Chapter 10 Bar Display

Bar graph is another way adopted to display the harmonic measurement data. The measured items reflected in the bar match the harmonic measurement items. The data of the harmonics of each order can be displayed in the bar.

Users can press Bar key to access to the Bar menu on which users can set the items such as bar display formats, measurement items and so on. You can also use the cursor to view the measurement data of the harmonic of specified order.



10.1 Setting the Format of the Bar Graph

- 1) Procedures : Press BAR
- 2) Setup menu :

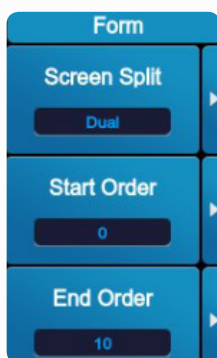

Set the number of split screen for the bar graph (Single, Dual, Triad)

Set the bar display rang

- Display the starting harmonic order (the values are within the range from 0 to 490.)
- Display the ending harmonic order (the values are within the range from 10 to 500)

Format of the screen split

- Single : The data of bar graph (Item No.) 1 are displayed.
- Dual : The data of bar graphs (Item No.) 1 and 2 are displayed
- Triad : The data of bar graphs (Item No.) 1 to 3 are displayed.

Bar Graph Display Range

You can configure the harmonic measurement values of the harmonic order starting and ending to display as a format of bar graph.

⚠ Note :

- You can set the bar graph on such condition that the starting harmonic order cannot be more than 10 orders less than the ending order.
- This instrument cannot display bar graphs containing harmonic orders that are greater than the maximum measurable order.
- When the measurement function of a bar graph is Φ , order 0 has no values, so it cannot be displayed in the bar graph.
- When the measurement function of a bar graph is ΦU or ΦI , orders 0 and 1 have no values, so they cannot be displayed in the bar graph.

10.2 Setting the Bar Graph Display Item

- 1) Procedure : Press BAR→ITEM
- 2) Setup menu :

The screenshot shows the 'Bar Graph Setup' menu with the following settings and annotations:

- Element/ Σ** : Element 1 (Annotation: Set the elements (from 1 to 7, $\Sigma A \sim \Sigma C$))
- Function**: U (Annotation: Set the measurement functions (U, I, P, S, Q, λ , Φ , ΦU , ΦI , Z, Rs, Xs, Rp, Xp))
- Sort**: ON (Annotation: Turn on/off the sorting)
- Scale Mode**: Auto (Annotation: Set the vertical scale modes (Auto or manual))
- Vertical Scale**: Linear (Annotation: Set vertical scale types (Linear or Log). This soft key will appear when the scale mode is set as Manual)
- X position**: Bottom (Annotation: Set the X-axis position (bottom of the screen, center of the screen). When the vertical scale is set as Log, "Center" is not selectable)
- Upper Scale**: 100.000 (Annotation: Linear: 0.01u~9.999T; Log: 1n~10G)

This part of the menu will appear when the scale mode is set as Manual

Element/ Σ

You can specify the bar graphs to be displayed by selecting the measurement element number from 1 to 7 and the wiring system (ΣA , ΣB , ΣC). The available options vary depending on the installed elements.

Function

You can select what kind of measurement functions to be displayed as bar graphs.

Sorting

You can turn on or off the sorting function. There are displays such as Order or Value. The top big 10 harmonic orders (from starting to ending) are selected, being sorted from large to small.

Scale mode

There are 2 kinds of the vertical scale mode, including auto and manual modes.

1) Auto

- When the function is U, I, P, S, or Q, the scaling is logarithmic (Log)
- When the function is λ , Φ , ΦU , ΦI , Z, Rs, Xs, Rp, or Xp, the scaling is linear (Linear).
- The upper and lower limits of the bar graph window are automatically determined based on the maximum and minimum displayed trend data values. The lower and upper limits for λ are -1 and 1 . For Φ , ΦU , and ΦI , the minimum and maximum values are -180 to 180° . Negative values correspond to phase lagging and positive values correspond to phase leading.

2) Manual

You can set the type, upper limit, and X-axis position of the vertical scale in the manual mode.

Vertical scale type : You can set the scale type to linear (Linear) or logarithmic (Log).

Upper Limit : Linear: 0.01u~9.999T ; Log: 1n~10G.

X Axis position : This setting is valid when you set the vertical scale mode to Manual and the vertical scale type to Linear. You can set the point at which the X-axis coordinate is 0 to Bottom (the bottom of the screen) or Center (the center of the screen).

10.3 Setting the Cursors on the Bar Graphs

- 1) Procedure : Press BAR→CURSOR
- 2) Setup menu

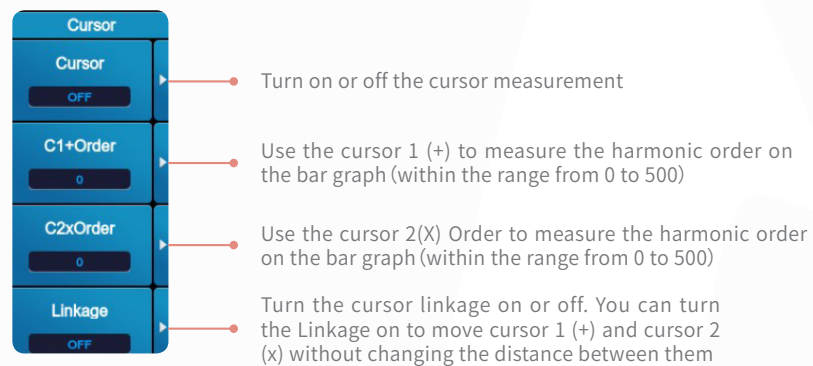

The harmonic orders for the measurement by the cursor on the bar graph can only be set validly between the starting orders and the ending orders.

The Items measured by the cursors on the bar graphs

- Y+ The vertical-axis (Y-axis) value of cursor 1 (+)
- Yx The vertical-axis (Y-axis) value of cursor 2 (x)
- ΔY The difference between the vertical-axis (Y-axis) values of cursor 1 (+) and cursor 2 (x)
- X+ Order Harmonic order measured by Cursor 1(+) currently
- Xx Order Harmonic order measured by Cursor2(x) currently

Chapter 11 Trend Display

The measured results can be displayed as the trends on this power analyzer where users can press Others key to access to the Trend menu on which users can set the items such as trend display formats, measurement items and so on. You can also set the cursor position to view each measurement data.

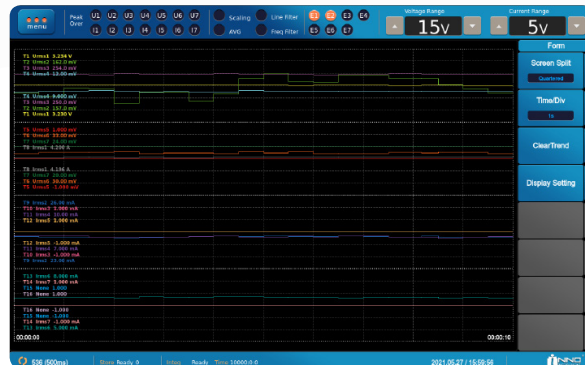

11.1 Setting the Format of the Trend

- 1) Procedure : Press OTHERS→TREND
- 2) Setup menu :

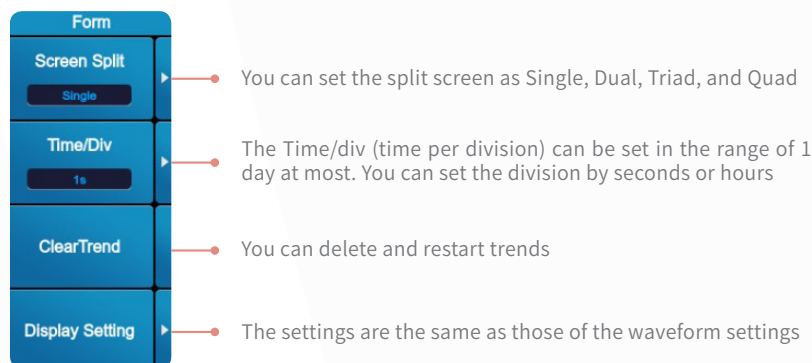

Format of the screen split

The formats of the screen split for the trend display include Single, Dual, Triad, and Quad.

Time Axis

The time axis is set in Time/div (time per grid division). The time per division can be set in the range of 1 s to 1 day. The trend data update interval is determined both by the data update interval and the time axis (Time/div).

Clear Trend

When you restart trends by selecting Clear Trend, the trend display up to that point is cleared, and the trends start over from the right end of the screen. In addition to when you execute Clear Trend Exec, trends will also restart when:

- You change a trend display function, element, or harmonic (option) setting.
- You change the trend time axis (horizontal axis) setting.

Setting the display

Select the Display menu, as shown in the following picture.

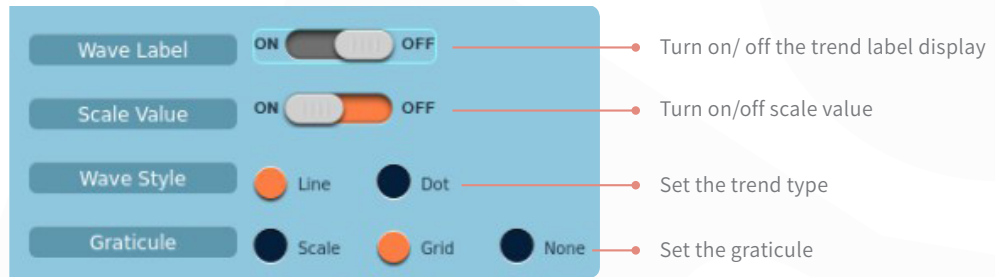

11.2 Setting the Trend Display Item

- 1) Procedure : Press OTHERS→TREND→ITEM
- 2) Setup menu :

Set the functions

Set harmonic order within the range from 0 to 500

Set the limits for the scaling range
Upper limit: -99999.998~99999.999
Lower limit: -99999.999~99999.998

Display	Function	Element/Σ	Order	Scaling	UpperScale	LowerScale
<input checked="" type="checkbox"/> T1	Urms	Element 1	0	Auto		
<input checked="" type="checkbox"/> T2	Urms	Element 2	0	Auto		
<input checked="" type="checkbox"/> T3	Urms	Element 3	0	Auto		
<input checked="" type="checkbox"/> T4	Urms	Element 4	0	Auto		
<input checked="" type="checkbox"/> T5	Irms	Element 1	0	Auto		
<input checked="" type="checkbox"/> T6	Irms	Element 2	0	Auto		
<input checked="" type="checkbox"/> T7	Irms	Element 3	0	Auto		
<input checked="" type="checkbox"/> T8	Irms	Element 4	0	Auto		

You can select which Trend items to be displayed (T1~T16)

Select the elements and wiring units (Element1 to 7, ΣA to ΣC), motor, user-defined function, etc

Set the modes of the vertical scale (Manual or Auto)

Function

You can select any of the measurement functions that this instrument can measure.

Element/Σ

You can select the element/wiring system. The available options vary depending on the installed elements.

Harmonic Order

Only when you have selected the harmonic measurement function can you set the harmonic order.

Setting the scale

You can set one of the scale display modes from the following options.

Auto : The upper and lower limits of the trend window are automatically determined based on the maximum and minimum trend display data values

Manual : You can set the upper and lower limits manually.

Upper and Lower Limits for Manual Scaling

You can set the upper and lower limits as needed after selecting the Manual.

11.3 Setting the Cursors on the Trends

- 1) Procedure : Press OTHERS→TREND→CURSOR
- 2) Setup menu :

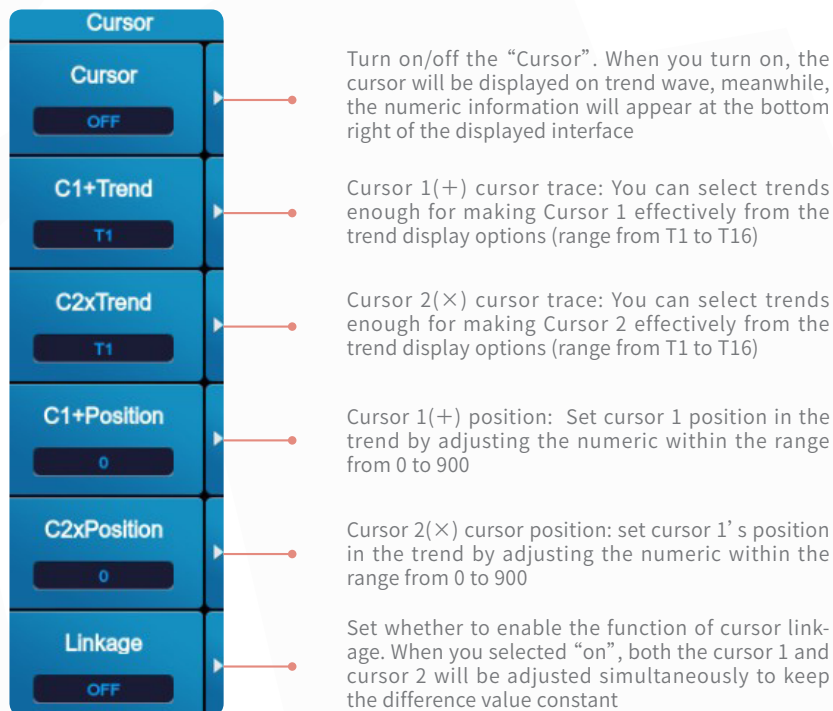

The image shows a vertical menu titled 'Cursor' with six options. Each option has a red arrow pointing to its corresponding text description on the right.

Menu Item	Description
Cursor OFF	Turn on/off the "Cursor". When you turn on, the cursor will be displayed on trend wave, meanwhile, the numeric information will appear at the bottom right of the displayed interface
C1+Trend T1	Cursor 1(+) cursor trace: You can select trends enough for making Cursor 1 effectively from the trend display options (range from T1 to T16)
C2xTrend T1	Cursor 2(x) cursor trace: You can select trends enough for making Cursor 2 effectively from the trend display options (range from T1 to T16)
C1+Position 0	Cursor 1(+) position: Set cursor 1 position in the trend by adjusting the numeric within the range from 0 to 900
C2xPosition 0	Cursor 2(x) cursor position: set cursor 1' s position in the trend by adjusting the numeric within the range from 0 to 900
Linkage OFF	Set whether to enable the function of cursor linkage. When you selected "on", both the cursor 1 and cursor 2 will be adjusted simultaneously to keep the difference value constant

The Items measured by the cursors on the trends

- Y+ The vertical-axis (Y-axis) value of cursor 1 (+)
- Yx The vertical-axis (Y-axis) value of cursor 2 (x)
- ΔY The difference between the vertical-axis (Y-axis) values of cursor 1 (+) and cursor 2 (x)
- X+ The horizontal-axis (X-axis) value of cursor 1 (+)

With the left edge of the screen being 0 seconds, the time from the left edge of the screen is indicated.

- Xx The horizontal-axis (X-axis) value of cursor 2 (x)

With the left edge of the screen being 0 seconds, the time from the left edge of the screen is indicated.

- ΔX The difference between the horizontal-axis (X-axis) values of cursor 1 (+) and cursor 2 (x)

- D+ The date and time at the position of cursor 1 (+)

The date and time of measurement are displayed in this format: Year/ Month/Day Hour:Minute:Second.

- Dx The date and time at the position of cursor 2 (x)

The date and time of measurement are displayed in this format: Year/ Month/Day Hour:Minute:Second.

Chapter 12 IEC Harmonic Measurement (Option)

12.1 IEC Harmonic Measurement Display

- 1) Procedure : Press OTHERS→IEC Harmonic
- 2) Setup menu :

By default, the data information regarding power spectrum, Hrm/InterHar sub Group and Hrm/InterHar State can be displayed simultaneously on the IEC display menu.



12.2 IEC Harmonic Measurement Format

- 1) Procedure : Press OTHERS→IEC Harmonic
- 2) When the harmonic measurement standard is set to be "None", the setup menu of the format is as follows.

The 'Form' setup menu is shown with the following options and annotations:

- Standard**: A dropdown menu with 'None' selected.
- Display Format**: A dropdown menu with 'All View' selected.
- Range**: A dropdown menu.
- Frequency**: A dropdown menu with '50Hz' selected. *Annotation: Switch the frequency between 50Hz and 60Hz*
- Hrm List**: A dropdown menu with 'All' selected. *Annotation: Harmonic list: you can select ALL or harmonics of high order*
- Display Setting**: A dropdown menu. *Annotation: Set the power spectrum display style*

Harmonic Standard

You can select "None" or "IEC 610003-2 standard " to meet the requirement of the instrument measurement.

Display Format

Select the harmonic measurement data format display on the displayed, including All View, Power Spectrum, Hrm/InterHar State and Hrm/InterHar sub Group.

- When All View is selected, the data in the form of the Power Spectrum, Hrm/InterHar State and Hrm/InterHar sub Group will be displayed simultaneously on the screen.

- When Power Spectrum is selected, only the data in the form of the power spectrum of the IEC harmonic measurement can be displayed on the screen.
- When Hrm/InterHar State is selected, only the data in the form of the Hrm/InterHar State can be displayed on the screen.
- When Hrm/InterHar sub Group is selected, only the data in the form of the Hrm/InterHar sub Group can be displayed on the screen.

Setting the Range

The value of difference between the start point and the end point should be great than or equal to 10.

Setting the Display

Select the Display menu, as shown in the following picture.



3) When IEC harmonic measurement standard is selected to be "IEC61000-3-2", you can set the format as the following setup.

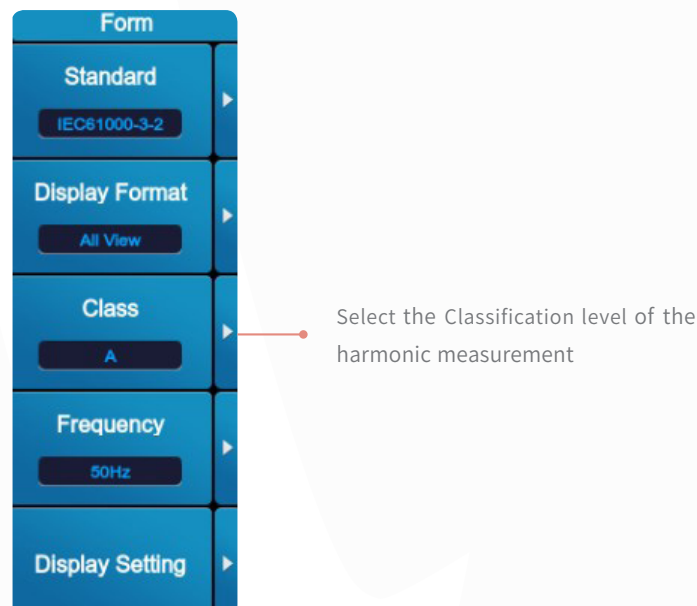

On the condition of "IEC61000-3-2" standard, the setting methods of display format, frequency and display are the same as those of the "None" setting. The difference between them is that in the IEC61000-3-2 standard, the classifications of the harmonic measurement standard can be selected, including five types of classifications of A, B, C1, C2, D, so that the users can decide which kind of the classification is needed during operation.

12.3 IEC Harmonic Measurement Display Items

- 1) Procedure : Press OTHERS→IEC Harmonic→ITEM
- 2) Setup menu :

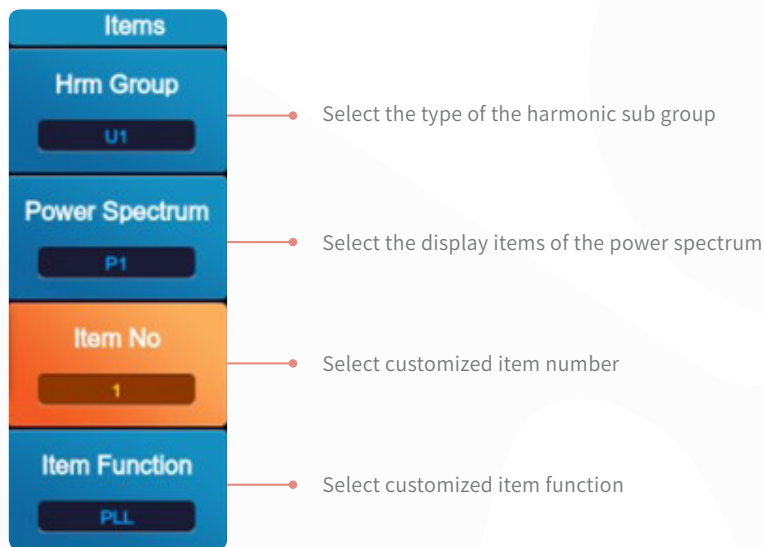

Harmonic group

Press Harmonic Group to view the measurement results of a certain signal. The types of harmonic group that can be set include the ranges from U1 to U7, I1 to I7, and the channels are adjustable. U1 is defaulted to be displayed. If U2 is selected, the harmonic measurement data of each order from U2 signals will be displayed.

Power Spectrum

Press Power Spectrum to view the measurement results of a certain signal. The types of power spectrum that can be set include the ranges from P1 to P7, Q1 to Q7, and the channels are adjustable. Only when IEC harmonic is set as "None" and display format is "ALL View" or "Power Spectrum", this items to be set will be shown.



Item number

To indicate the self-defined harmonic item number. The setttable range is 1-16, increasing from top to bottom, left to right. If the number is set to 2, it means that the following settings are only for the measurement items displayed in the second position, and have no effect on the measurement values displayed in other positions.

Item function

Specify measurement functions to be displayed in corresponding positions of IEC interface, and the optional measurement functions include PLL, Urms, Irms, Umn, Imn, Udc, Idc, Uac, Iac, Urmn, Irmn, P, S, Q, λ, φ, FreqU, FreqI, U+peak, I+peak, U-peak, I-peak, P+peak, P-peak, Cfu, Cfi, Pc, Uthd, Ithd, Pthd, Uthf, Ithf, Uti, Itif, Freq.

Chapter 13 FFT Function

FFT, Fast Fourier Transformation, is useful when you wish to check the frequency distribution, amplitude and phase of the different sinusoidal wave of the input signal measured by this instrument. This power analyzer allows the power spectrum of the input signal to be displayed through FFT.

You can select FFT object from the following measurement functions on this power analyzer:

- Voltage, current, active power and reactive power of each unit
- Torque and rotation speed signal of motor input

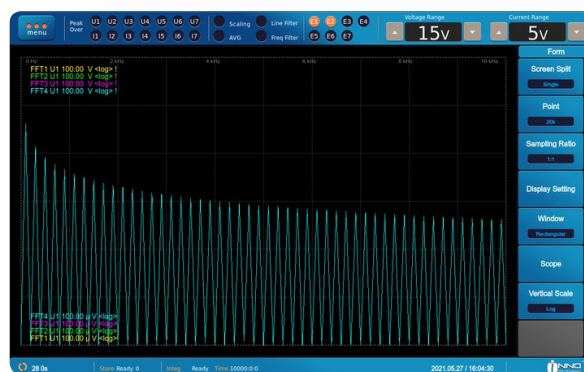

13.1 Setting the FFT Format

- 1) Procedure : Press OTHERS→FFT
- 2) Setup menu :

Form Screen Split Single	→	FFT split screen setting. (Single, dual, quad)
Point 200k	→	FFT points selected: you can select from 20k or 200k
Sampling Ratio 1:1	→	Sampling rate setting (1:1, 1:10, 1:100, 1:200)
Display Setting	→	Set the display FFT style, graticule, scale value, and FFT Type
Window Rectangular	→	Select the window types (rectangular window, Hanning window, Hamming window, Blackman window, Flat-top window)
Scope	→	Setting the display range of the X-axis (frequency): Disp Start and Disp End; it is relative to the settings of the FFT points and sample rate
Vertical Scale Linear	→	Y-axis display format: you can set as linear or logarithm (Linear/ LOG)

FFT window

- Rectangular

The main features of the Rectangular window include narrow main lobe, wide side lobe, more accurate frequency identification, less accurate amplitude identification. Rectangular window function is very useful in measuring the repeated AC signal waveform whose measurement period is integral multiple of FFT measurement interval. FFT measurement interval is 1s or 100ms, which will vary depending on setting FFT points (200K or 20k).

- Hanning and FlatTop

These 2 windows are useful for the waveform which cannot satisfy the requirement of the conditions of the above rectangular window. They can make the signals adjacent to both sides of time window attenuated smoothly to level 0, so as to keep continuous signals. Frequency component non-existent is detectable by applying Hanning window and Flat-top window function. However, compared with rectangular window, the frequency component detectable is much smaller. In aspect of the frequency resolution, Hanning window is higher compared with the flattop window. However, the flattop window has a higher level of accuracy.

- Blackman

The main features of the Blackman window include wide main lobe, narrow side lobe, more accurate amplitude identification, less accurate frequency identification.

Setting the display

Select Display Setting to access to the display setting menu.



FFT type

Line : The data obtained by FFT are displayed in the line graph.

Bar : The data obtained by FFT are displayed in bar graph.

Setting the range

Setting the display range of the X-axis (frequency): Disp Start and Disp End; it is relative to the settings of the FFT points and sample rate.

	1:1		1:10		1:100		1:200	
	Start	End	Start	End	Start	End	Start	End
20k	0-9990	10-10000	0-990	10-1000	0-90	10-100	0-40	10-50
200k	0-99900	10-100000	0-9990	10-10000	0-990	10-1000	0-490	10-500

Vertical scale type

There are two types of vertical scale display for the power spectrum of the FFT data, including Linear and Logarithmic.

If you select Linear mode, the maximum value of the Y-axis is determined automatically from the measurement range. The minimum value is zero.

If you select Logarithmic mode, the maximum value of the Y-axis is one digit above the measurement range, and is a value that is an integer power of 10. The minimum value is equal to 1/1000000 of the maximum value.

13.2 Setting the Items of FFT Function

- 1) Procedure : Press OTHERS→FFT→ITEM
- 2) Setup menu :

The screenshot shows the FFT function setup menu with the following settings and annotations:

- Display:** Hide (unselected), Show (selected). Annotation: Display or conceal FFT item.
- Location:** Graph1 (selected). Annotation: Select the position for FFT item.
- Source:** U1 (selected), I1, P1, Q1, U2, I2, P2, Q2, U3, I3, P3, Q3, U4, I4, P4, Q4, U5, I5, P5, Q5, U6, I6, P6, Q6, U7, I7, P7, Q7, Speed1, Torque1. Annotation: Select the operand for FFT computation. The operands including: the voltage, current, active power, and reactive power of each input element; motor torque and speed.
- Label:** FFT1. Annotation: Modify the label name of the FFT item (up to 8 characters).
- Y Ratio:** 1.00. Annotation: Set the zoom ratio for the FFT graph within the range from 0.1 to 999.9.
- X Position:** Bottom (selected), Center (unselected). Annotation: Select the X-axis position for the FFT graph: Bottom or Center.

Position

You can set the position of the power spectrum in FFT function on the screen. The setting of the position is relative to the number of the screen split.

When the screen split is set as Single, the selectable item is Graph 1.

When the screen split is set as Dual, the selectable items include Graph 1 and Graph2.

When the screen split is set as Quad, the selectable items include Graph 1, Graph 2, Graph 3, and Graph 4.

Y axis ratio

You can set the zoom ratio for the graph display of the FFT function.

⚠ Note :

- You can set the FFT display up to 4 items on the screen of the power analyzer. The setting methods are the same.
- When FFT type is set as line and source are P/Q, the X axis position is fixed to be selectable center, and other condition is not selectable.

13.3 Setting the FFT Cursor Measurement

- 1) Procedure : Press OTHERS→FFT→CURSOR
- 2) Setup menu :

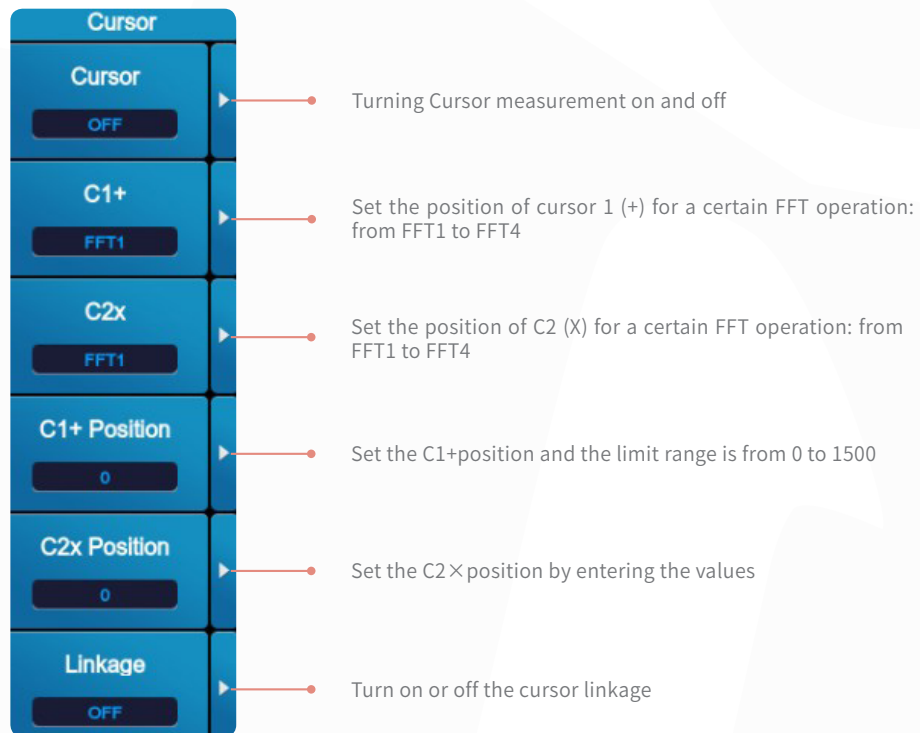

Setting the position of the cursor

The position of the cursor can be set or moved according to the specified points on the FFT graph. The positions of the cursor C1x and C2+ will vary depending on the FFT points.

Items of cursor measurement

- Y+ Vertical value of cursor 1(+) (Y-axis value)
- Yx Vertical value of cursor 2(x) (Y-axis value)
- ΔY The difference between the Y-axis values of cursor1 (+) and cursor2 (x)
- X+ Horizontal value of cursor 1(+) (Frequency)
- Xx Horizontal value of cursor 2(x) (Frequency)
- ΔX The difference between the X-axis values of cursor1 (+) and cursor2 (x)

Chapter 14 Flicker Measurement (option)

Flicker, caught by human eyes, is an unstable effect, caused by fierce fluctuation or spectral distribution, discomfort due to luminance fluctuation. The voltage fluctuation and flicker are mainly caused by greatly changes of active power and reactive power of impact power equipment (such as arc furnace, rolling mill, electric locomotive and arc welding machine) during operation. The voltage fluctuation and flicker will be harmful to the normal electric usage of power consumer' s, becoming an important index for measuring power quality.

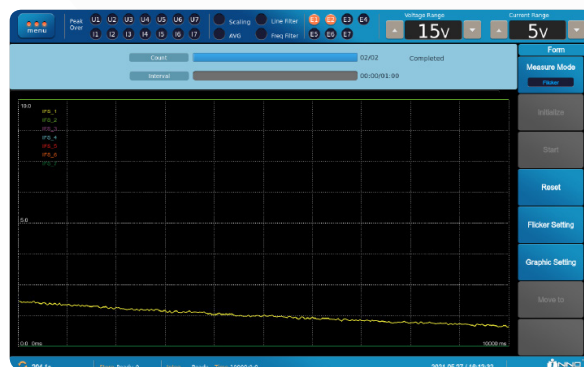

14.1 Setting the Format of the Flicker Measurement

- 1) Procedure : Press OTHERS→FLICKER
- 2) Setup Menu :

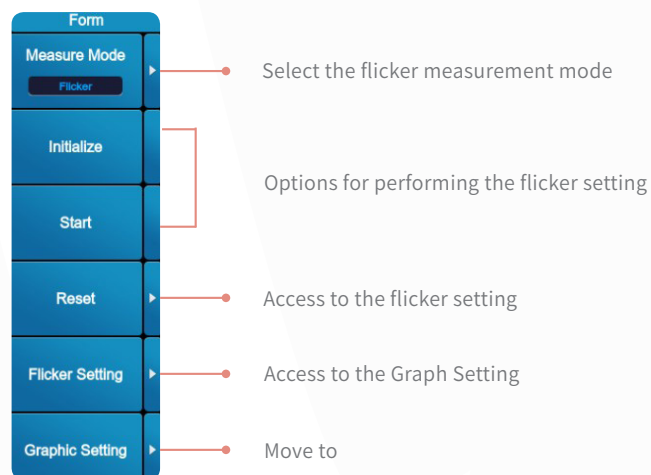

Measurement mode

There are two measurement modes: Flicker and Dmax, described as follows:

In the Flicker mode, i.e. Auto mode, this instrument can automatically judge the parameters during test. The number of the measurement and the time can be set.

In the Dmax mode, i.e. Manual mode, this instrument can perform Dmax test for many times (24 times) after you operation it manually. The time for each test is fixed.

Move to

This function is only available when in Dmax measurement mode and after one measurement by manual completed. This function can be used to reset the number of measurement as needed.

14.1.1 Numeric Display of Flicker Measurement

Numeric display in the Flicker mode

Time and operation duration of single observation period

Input element display

Display Voltage range and target frequency

Rated voltage display

Voltage frequency display

Observation period (Number of flickers)

Number of current measurements/ Total number

Flicker measurement status

Input elements to be judged

Judgment result display

Display the Measured input element

Limit items & specification index of limit

Judgment result of the flicker measurement

	dmax[%]	dmax[%]
1	13	
2	14	
3	15	
4	16	
5	17	
6	18	
7	19	
8	20	
9	21	
10	22	
11	23	
12	24	
Limit :	4.00000	
Result:(Average dmax value)	--	

Judged results of the flicker measurement

Pass

When “Pass” is displayed as measured result, it means that the measured value is in the range of threshold or limit value set by users and accords with judgment criterion.

Fail

When “Fail” is displayed as measured result, it means the measured value is over or equal to the threshold or limit value set by users and it does not meet the requirement of judgment criterion.

Numeric display in the Dmax mode

Time and operation duration of single observation period

Number of current measurements/ Total number

Display the measurement parameters in flicker mode and Judgment results (same as Flicker)

Observation period (Number of flickers)

Judgment result of the flicker measurement

	dmax[%]	dmax[%]
1	13	
2	14	
3	15	
4	16	
5	17	
6	18	
7	19	
8	20	
9	21	
10	22	
11	23	
12	24	
Limit :	1.100	
Result:(Average dmax value)	--	

In the Flicker and Dmax modes, there is difference between the data results of the flicker measurement and the layout which are displayed on the screen. Follows are the differences:

1) Displayed judgment conditions

In the Flicker mode, the limits of the dc, dmax, d(t), Pst, Plt can be displayed.

In the Dmax mode, only the dmax limits can be displayed.

2) The layout display of the flicker measurement values

In the Flicker mode, this instrument can display the values and the judged results up to 12 times of flicker measurement on one page. If the flicker measurement is performed more than 12 times, the values and the judged results are displayed on more pages; the arrow keys “▲” and “▼” are used to change between different pages.

In the Dmax mode, this instrument can display the values and the judged results up to 24 times of flicker measurement on one page.

14.1.2 Setting the Flicker Parameters

1) Procedure : Press OTHERS→Flicker→Flicker Setting

2) Setup menu :

When Un mode is set as AUTO, the parameters will automatically form; when it is SET, the parameters will be changed manually

Select the elements to be measured. You can select more than one at the same time

Modify the rated voltage values within the range from 0.01 to 999.9V only when Un mode is set as SET

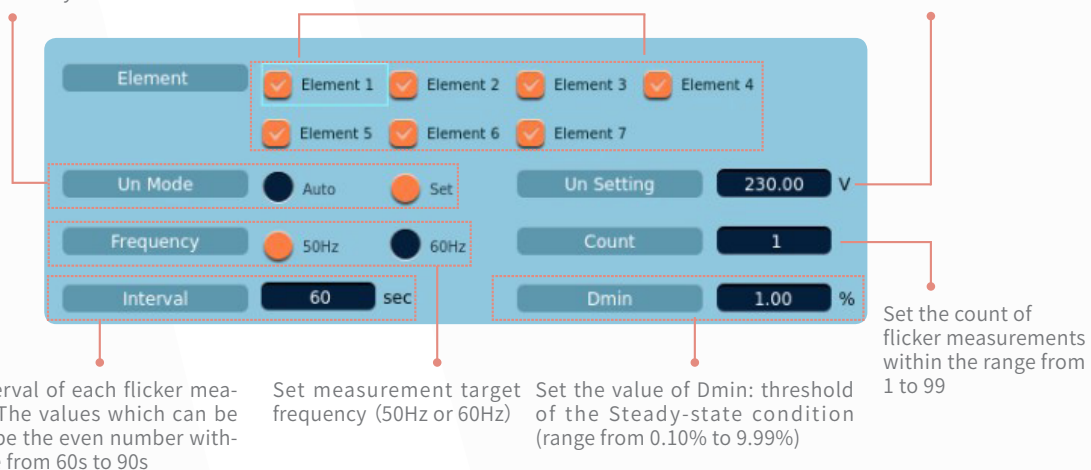

Set the interval of each flicker measurement. The values which can be set should be the even number within the range from 60s to 90s

Set measurement target frequency (50Hz or 60Hz)

Set the value of Dmin: threshold of the Steady-state condition (range from 0.10% to 9.99%)

Set the count of flicker measurements within the range from 1 to 99

Element

Set the element on which to measure the voltage fluctuation and flicker. You can select more than one input element at the same time. The available options vary depending on the installed elements.

Un mode

You can select the assignment method of the rated voltage which acts as a standard of measurement data calculation. There are two methods, respectively are AUTO and SET.

AUTO mode : In this mode, this instrument can automatically retrieve the measured voltage at the start of the voltage fluctuation and flicker measurement as the rated voltage.

SET mode : In this mode, you can set the values of the rated voltages manually.

Measurement target frequency

You should set the measurement source frequency appropriately as the transfer function of the flicker meter and other parameters change accordingly.

Measurement count

You can set the measurement count of short-term flicker value Pst in the range.

Interval

You can specify the single observation period.

Steady-State Range (threshold): dmin

You can set steady-state threshold dmin. The value of the voltage fluctuation voltage which is not within the range of the steady-state range threshold reflects change of the measurement and the ending of the steady state.

14.1.3 Setting the Flicker Measurement Graph

During flicker measurement, this power analyzer can display the graphs of the IFS (Instantaneous Flicker Sensation and CPF (Cumulative probability function) according to the currently measured data. Select Graphic Setting to access to the following menu.

Select the display format for flicker (Numeric, IFS, and CPF)

Select maximum value of the IFS

You can select the input element whose IFS curves should be displayed.

CPF curves of different measured elements in different measurement numbers will be displayed on power analyzer. They can be adjusted by selecting measured elements. After measurement is completed, you can select measurement number.

IFS graphic setting

1) Configuring maximum value for IFS

You can set the maximum range of displaying the IFS graph, and the maximum values that can be selected include 10, 100, 500, 1000, 2000, 5000, 10000.

2) IFS graphic display

During flicker measurement, you can select IFS in the Display Type menu and select the serial number (from IFS_1 to IFS_7) of the IFS graph. You can also select ALL to view all the IFS graphs.

Configuring CPF graph

1) CPF graphic display

During flicker measurement, you can select CPF in the Display Type menu and select the serial number (from CPF_1 to CPF_14) of the CPF graph. You can also select ALL to view all the CPF graphs.

2) Setting the element number

You can specify the flicker measurement values of an input element (from element1 to element 7) for each CPF graph. The available options vary depending on the installed elements. One element may contain multiple CPF graphs. One CPF graph reflects one measurement interval and once flicker measurement.

3) Selecting the count of flicker measurement

You can select the flicker measurement count after flicker measurement starts. One measurement interval equals to once flicker measurement. On the CPF graph reflects the flicker measurement values in a certain measurement interval for a certain element.

14.2 Setting the Item of Flicker Measurement

- 1) Procedure : Press OTHERS→Flicker→ITEM
- 2) Setup menu :

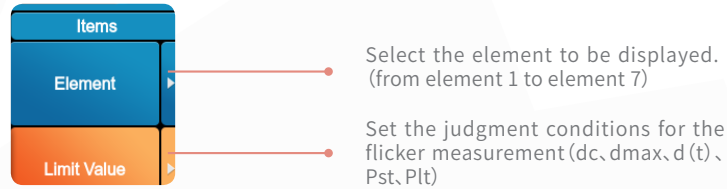

Setting the limits

You can turn on/off the items (dc, dmax, d (t), pst, Plt) and change their ranges and numeric in <Limits> option, which can be operated only in <Reset> option; otherwise popup notice of error will appear.

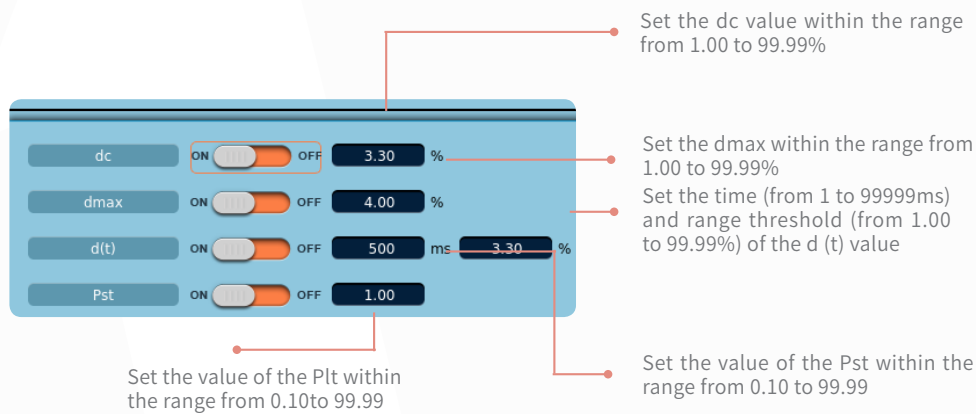

Descriptions to the judgment conditions

Relative steady-state voltage change dc:

A value obtained by dividing the difference between the two steady-state conditions before and after a single voltage fluctuation by the rated voltage expressed as a percentage

Maximum relative voltage change dmax :

A value obtained by dividing the difference between the maximum and minimum values in a single voltage fluctuation (Condition between two steady-state conditions) by the rated voltage expressed as a percentage

Period during which relative voltage change exceeds the threshold level d(t):

A value of the period during which the relative voltage change during a voltage fluctuation period exceeds the threshold level expressed as a percentage

Short-Term Flicker Value Pst :

In the flicker measurement mode, you can select whether to judge the Pst (Short-Term Flicker Value).

Long-Term Flicker Value Plt :

In the flicker measurement mode, you can select whether to judge the Plt (Long-Term Flicker Value).

Chapter 15 Motor Evaluation (Option)

In the model equipped with the function of motor evaluation, by using the motor evaluation function (option), the rotating speed, torque, and output of a motor can be determined from the DC voltage (analog signal) or pulse count signal received from a revolution sensor, which is proportional to the rotating speed of the motor, and the DC voltage (analog signal) or pulse count signal received from a torque meter, which is proportional to the motor’s torque. In addition, the synchronous speed and slip of a motor can be determined by setting the motor’s number of poles. Furthermore, the active power and frequency that are measured by this instrument and the motor output can be used to compute the motor efficiency and the total efficiency. Double-motor is installed on this model.

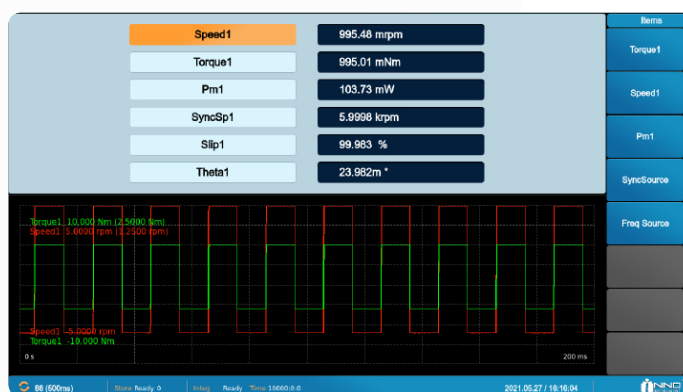

15.1 Torque and Speed Signal of Motor Input

There are 4 connectors regarding motor input installed on the rear panel in this model, marking with “CH A”, “CH B”, “CH C” and “CH D”. The connectors marked with “CH A” and “CH B” are available for analog signal input and pulse signal input; While the “connectors marked with “CH C” and “CH D” are available for pulse signal input only. The definitions for the 4 types of input terminals vary depending on the single motor model or the double-motor model.

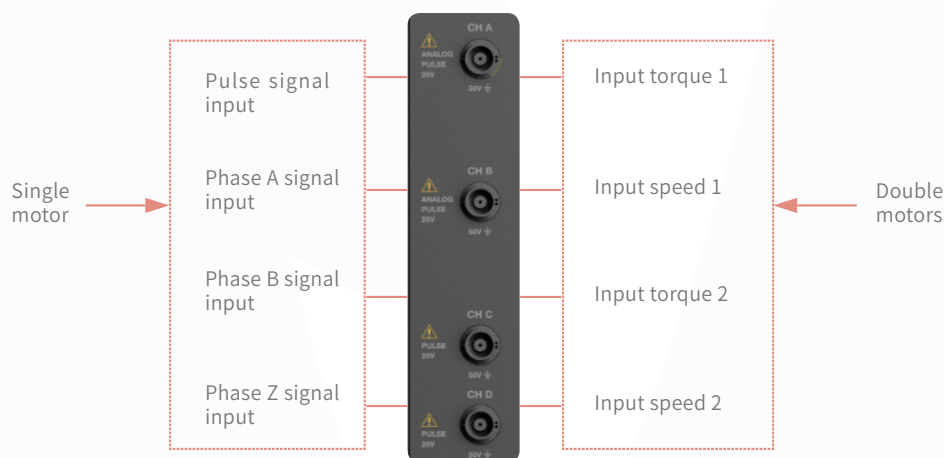

Note :

When in single motor mode, only one motor can be evaluated. The motor functions measured include Speed 1, Torque1, Pm1 (Mechanical Output of the Motor), SyncSp1 (Synchronous Speed), Slip1 and Theta1(Electrical Angle). When in double-motor mode, two motors can be evaluated simultaneously. The motor functions measured include (Speed1/ Speed2), (Torque1/ Torque2), (Pm1/ Pm2), (SyncSp1/ SyncSp2), and (Slip1/ Slip2). There are 4 connectors regarding motor input installed on the rear panel in this model, marking with “CH A”, “CH B”, “CH C”

15.2 Setting the Motor Format

- 1) Procedure : Press OTHERS→Motor→FORM
- 2) Setup menu :

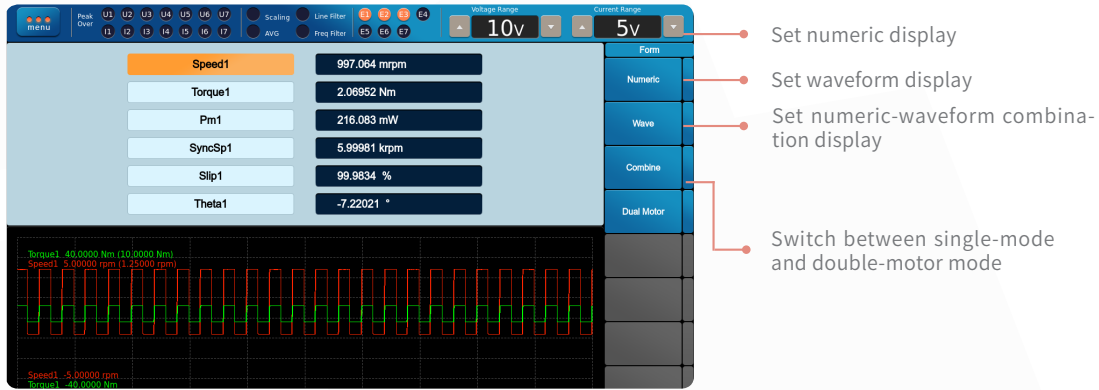

The Single-Motor menu mode is a default mode to access to. Select Double-Motor to access to the Double-Motor menu, as shown in the following picture.

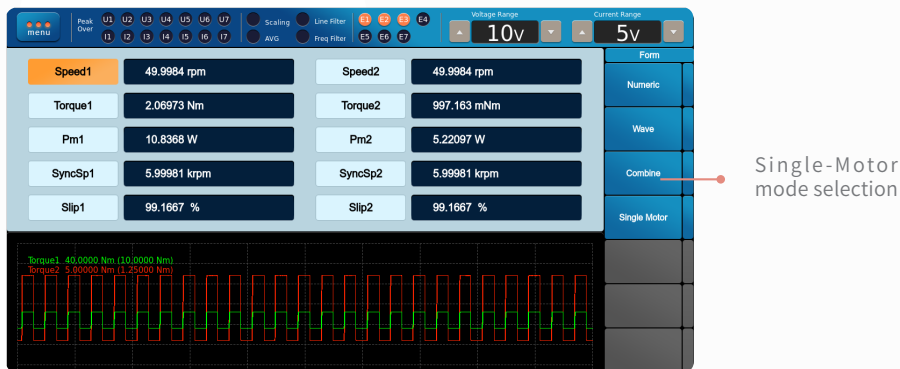

15.3 Setting the Motor Item

15.3.1 Setting the Items of Single-Motor

- 1) Procedure : Press OTHERS→Motor→Single motor mode→ITEM
- 2) Setup menu :

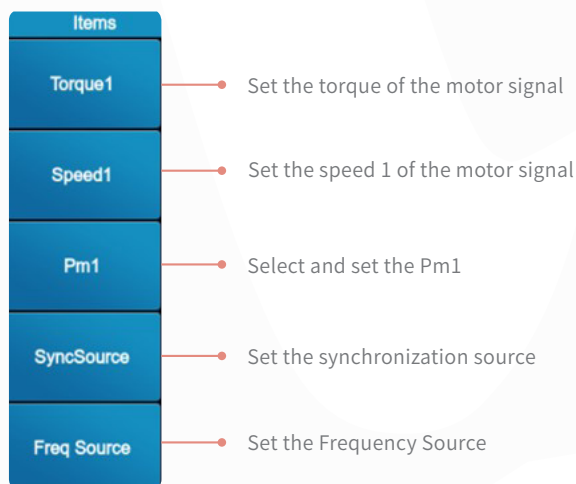

Setting the Speed 1

- 1) Analog signal

Computation

Point X: from -30.000 to 30.000
Point Y: from -10000.0000 to 10000.0000

Set the scaling factor for the analog input within the range from 0.0001 to 99999.9999

Set the unit (up to 8 characters)

Turn on or off the Auto Range

Set the value of the range: 1V, 2V, 5V, 10V, 20V

Set the Slope (A) and Offset (B) of the speed and torque of the motor signal input.

Line A: from 0.001 to 1000000.000;
Line B: From -1000000.000 to 1000000.000

Set the rang for the Line filter: Off, 100HZ, 1000HZ

Note:

You can refer to the section 15.3.3 for the linear scale of the analog signal in detail.

2) Pulse signal

Set the scaling for the pulse signal (within the range from 0.0001 to 99999.9999)

Set the unit (Up to 8 characters)

Range upper limit: from 0.0001 to 99999.9999

Range lower limit: from 0.0001 to 99999.9999

Set the pulse number per cycle (from 1 to 9999)

Setting the Torque 1

1) Analog signal

Computation

Point X: from -30.000 to 30.000
Point Y: from -10000.0000 to 10000.0000

Set the scaling factor for the analog input within the range from 0.0001 to 99999.9999

Set the unit (up to 8 characters)

Turn on or off the Auto Range

Set the value of the range: 1V, 2V, 5V, 10V, 20V

Set the Slope (A) and Offset (B) of the speed and torque of the motor signal input.

Line A: from 0.001 to 1000000.000;
Line B: From -1000000.000 to 1000000.000

Set the rang for the Line filter: Off, 100HZ, 1000HZ

2) Pulse signal

The screenshot shows the 'Pulse' configuration menu with the following fields and their descriptions:

- Sensor Mode:** Pulse (selected)
- Ratio:** 1.0000 (Set the scaling for the pulse signal (within the range from 0.0001 to 99999.9999))
- Unit:** Nm (Set the unit (up to 8 characters))
- Range Upper:** 50.0000 (Range upper limit: From -10000.0000 to 10000.0000)
- Range Lower:** -10000.0000 (Range lower limit: From -10000.0000 to 10000.0000)
- Rated Upper:** 50.0000 (Range upper limit: From -999.9999 to 1999.9999)
- Rated Lower:** - 50.0000 (Rated frequency upper limit: From 1 to 15000)
- Rated Freq Upper:** 50.0000 Hz (Range lower limit: From -999.9999 to 1999.9999)
- Rated Freq Lower:** - 50.0000 Hz (Rated frequency lower limit: From 1 to 15000)

Set the Pm1 (Mechanical Output of the Motor)

The screenshot shows the 'Pm1' configuration menu with the following fields and their descriptions:

- Ratio:** 1.0000 (Set the Scaling: From 0.0001 to 99999.9999)
- Unit:** W (Set the unit (up to 8 characters))
- Motor Pole:** 1 (Set the motor poles (within the range from 1 to 99))

Synchronization Source

Select Sync Source to access to the synchronization source setup menu. You can select the signal to be the synchronization source from the following items, including U1, U2, U3, U4, U5, U6, U7, I1, I2, I3, I4, I5, I6, I7, EXT CLK, None. The selectable items vary depending on the installed elements.

15.3.2 Setting the Items of Double-Motor

- 1) Procedure : Press OTHERS→Motor→Double-Motor→ITEM
- 2) Setup menu

The screenshot shows the 'Double-Motor' setup menu with the following fields and their descriptions:

- Torque1:** (Set the speed 1 of the motor signal)
- Torque2:** (Set the torque 1 of the motor signal)
- Speed1:** (Select and set the Pm1)
- Speed2:** (Set the speed 2 of the motor signal)
- Pm1:** (Set the torque 2 of the motor signal)
- Pm2:** (Select and set the Pm2)
- SyncSource:** (Set the synchronization source)
- Freq Source:** (Set the Frequency Source)

Setting the speed 2

Speed 2 : the sensor mode of the input signal is Pulse

Set the Scaling: From 0.0001 to 99999.9999

Set the unit (up to 8 characters)

Range upper limit: from 0.0001 to 99999.9999

Range lower limit: from 0.0001 to 99999.9999

Set the pulse number per cycle (from 1 to 9999)

Analog mode torque 2 setting

Calculation
 X point: - 30.000-30.000
 Y point: - 10000.0000-10000.0000

Set the scale factor of the analog signal, setting range 0.0001-99999.9999

Set unit (0-8 characters)

On/off auto range

Selected range of range value: 1V, 2V, 5V, 10V, 20V

Set the slope (A) and offset (B) of the revolving speed and torque input signal
 Line A: 0.001-1000000.000;
 Line B: - 1000000.000-1000000.000

Selected range of line filter: off
 100HZ, 1000HZ

Pulse mode torque 2 setting

Torque 2 : the sensor mode of the input signal is Pulse

Set the Scaling: From 0.0001 to 99999.9999

Set the unit (up to 8 characters)

Range upper limit: from -10000.0000 to 10000.0000

Range lower limit: from -10000.0000 to 10000.0000

Range upper limit: From -999.9999 to 1999.9999

Rated frequency upper limit: From 1 to 15000

Range lower limit: From -999.9999 to 1999.9999

Rated frequency lower limit: From 1 to 15000

Set the Pm2 (Mechanical Output of the Motor)



15.3.3 Linear Scale for the Analog Signal

Users can set the slope and offset for the input signal of the speed and torque on the power analyzer either by manual or by two points computation.

Manually Setting

The slope (A) and offset (B) for the input signal of the speed and torque can be set within the following ranges:

Line A : from 0.001 to 1000000.000

Line B : from 1000000.000 to 1000000.000

Formula for the speed and torque : Speed, torque= S(AX + B) – Null (wherein, S : Ratio ; A : Slope for the input signal ; X : Input voltage from speed sensor or torque meter ; B : Offset ; Null : Null value).

Line A is supposed to be 1 and Line B is supposed to be 0, i.e. no offset existing in the input signal for the speed and torque, then the following formula adopted will not affect the results:

Speed (or torque) = SX – Null

Two Points Method

In the speed and torque input diagram, users can specify 2 values for the input voltage (Point1X and Point2X) and 2 corresponding measurement values (Point1Y and Point2Y), in unit of rpm or N•m.

The ranges for setting X and Y values for the 2 specified points have been marked in the diagram.

After X and Y values for the 2 specified points are set, select execution key to activate the power analyzer to calculate the slope (A) and offset (B) for the input signal based on 4 values.

After slope (A) and offset (B) are calculated, the power analyzer can be used to calculate the measurement values for the speed and torque based on the following equation:

Speed, torque= S (AX + B) – Null

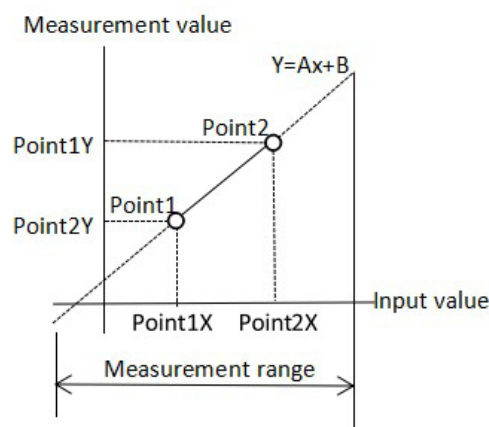

15.3.4 Relationship between torque pulse input range and pulse rating in pulse mode

The torque pulse factor and torque pulse offset are determined by the pulse rating of the torque signal. If a torque sensor is used to measure torque in the range of $-20\text{N}\cdot\text{m}$ to $+20\text{N}\cdot\text{m}$, the pulse input range and pulse rating are set as follows:

- Pulse range upper: 20.0000
- Pulse range lower: - 20.0000
- Rated upper of torque signal: 50.0000
- Rated lower of torque signal: - 50.0000
- Rated freq upper of torque signal: 15000
- Rated freq lower of torque signal: 5000

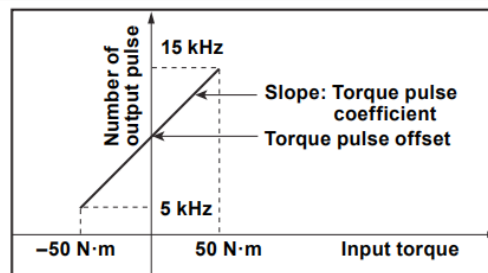

As shown in the figure above, the specification of pulse output torque sensor are :

Pulse rating (positive): Outputs 15 kHz for 50 N·m

Pulse rating (negative): Outputs 5 kHz for -50 N·m

15.4 Setting the Double-Motor Mode

When you switch the instrument to double-motor mode, the settings will be also changed. Follows are a few settings regarding double-motor mode.

- Setting the efficiency equation used in the double-motor mode

Pm2 (Mechanical Output of the Motor 2) is added to the drop-down menus of the efficiency equations.

- Setting the storage items in the double-motor mode

The speed, torque, slip, Synchronization Speed and motor output of the motor 2 are added to the storage setup menu.

- All items display in the double-motor mode

The speed, torque, motor output and the slip of the motor 2 are added to the numeric display menu.

- Setting multiple types of items

The measurement function of Double-motor is added to the setup menus such as numeric, waveform, trend, X-Y graph displays and user-defined items.

Chapter 16 Cycle-by-Cycle Measurement

Cycle-by-cycle measurement is a measurement method by which the voltage, current, power, and other parameters are calculated for each cycle of the AC input signal with respect to the zero crossing of the synchronization source signal. When the measurement of the specified frequency is complete, the measured values are listed in order by period.

16.1 Setting the Format of Cycle-by-Cycle Measurement

- 1) Procedure : Press OTHERS→Cycle by Cycle→FORM
- 2) Setup menu for the format or cycle-by-cycle measurement :

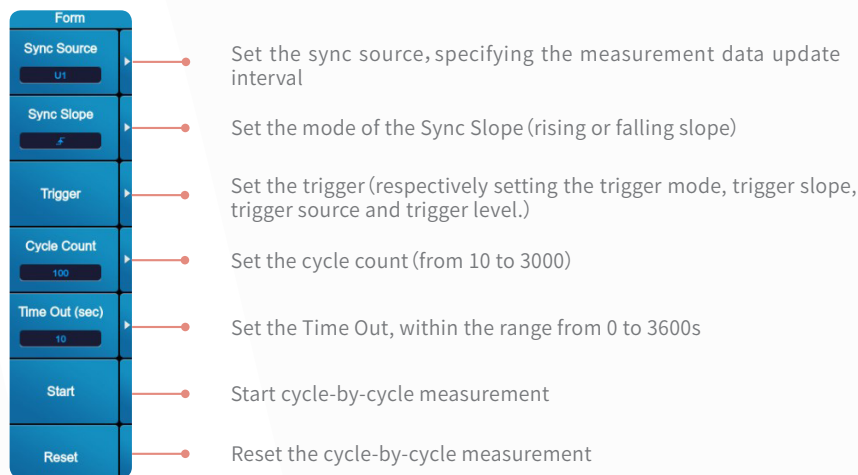

Setting the trigger

Trigger mode : Automatic, Normal, Off

Trigger slope : Rising edge, falling edge, Rising and falling edge

Trigger source : U1、 I1、 U2、 I2、 U3、 I3、 U4、 I4、 U5、 I5、 U6、 I6、 U7、 I7、 EXT CLK

Trigger level : You can set the trigger level within the range from 0.0 to $\pm 99.9\%$

Start and Reset

After the Start key has been selected, the settings of all the parameters cannot be modified. But the parameters can be set only under the Reset function is enabled.

After specified cycle-by-cycle measurement is completed, it will stop automatically. At that point, the status of cycle-by-cycle measurement will display "Complete" and the measured data lists will also be shown on the screen.

Click **[Reset]** , and then the pop-up message will appear, such as "OK", "Cancel".

Click OK, to execute Reset and stop cycle-by-cycle measurement.

Click Cancel, to continue performing cycle-by-cycle measurement, so the Reset is invalid.

⚠ Note:

- You can select the synchronization in the following options : U1、 I1、 U2、 I2、 U3、 I3、 U4、 I4、 U5、 I5、 U6、 I6、 U7、 I7、 EXT CLK. The selectable items vary depending on the installed elements
- When the Sync Source is selected as EXT CLK, you should input the clock signal by applying a clock signal to the external clock input connector (EXT CLK) on the rear panel on this instrument.
- You should select same sync source for all the modules in the cycle-by-cycle measurement mode, apart from the sync source in the non-cycle-by-cycle measurement.
- The time spent in completing cycle-by-cycle measurement : Measurement time = cycle of the sync source signal × measurement cycle count

16.2 Cycle-by-Cycle Measurement View

1) Procedure : OTHERS→Cycle-by-Cycle

No.	Urms1 (V)	Irms1 (A)	P1 (W)	O1 (var)	S1 (VA)	Udcl1 (V)	Idcl1 (A)	Clu1	CR1	Freq (Hz)
1	491.800m	0.57907m	0.09388m	0.26887m	0.28479m	-3.02888m	0.81725μ	1.52105	3.32839	49.8480
2	493.201m	0.57839m	0.09452m	0.26915m	0.28526m	-2.87119m	-0.00119m	1.51862	3.08014	50.1266
3	492.641m	0.58017m	0.09619m	0.26914m	0.28582m	-2.87623m	-0.90747μ	1.51875	3.35701	49.9501
4	492.999m	0.57803m	0.09474m	0.26878m	0.28497m	-2.94498m	-0.00131m	1.52145	3.51359	49.9413
5	493.558m	0.57842m	0.09275m	0.26999m	0.28548m	-2.62790m	-0.02017μ	1.51688	3.00798	50.0438
6	493.870m	0.57905m	0.09454m	0.26990m	0.28598m	-2.45858m	-0.00327m	1.52227	3.04066	50.0438
7	493.324m	0.57752m	0.09265m	0.26942m	0.28491m	-2.74506m	-0.00816m	1.53660	3.04773	49.9276
8	493.760m	0.57881m	0.09021m	0.26947m	0.28579m	-2.74580m	-0.00156m	1.51027	3.14893	49.9863
9	494.111m	0.57821m	0.09403m	0.26978m	0.28570m	-2.59373m	-0.00603m	1.52247	3.26126	50.0325
10	494.290m	0.57896m	0.09432m	0.27018m	0.28617m	-2.78843m	-0.00318m	1.51813	3.29207	50.0463
11	494.628m	0.57921m	0.09533m	0.27017m	0.28649m	-2.47294m	-0.00261m	1.52307	3.12877	50.0463
12	493.795m	0.58079m	0.09585m	0.27030m	0.28679m	-3.24150m	-0.00299m	1.51396	3.17503	49.8442
13	494.865m	0.57812m	0.09405m	0.27020m	0.28610m	-2.75850m	-0.00304m	1.52104	3.00951	50.0839
14	494.981m	0.57735m	0.09410m	0.26984m	0.28578m	-2.81143m	-0.00328m	1.51980	3.33733	50.0739
15	494.865m	0.57800m	0.09420m	0.27008m	0.28603m	-2.63257m	-0.00272m	1.52205	3.17136	49.9713
16	494.769m	0.57778m	0.09519m	0.26955m	0.28587m	-2.82186m	-0.00242m	1.53116	3.19064	49.9713
17	494.660m	0.58020m	0.09616m	0.27041m	0.28700m	-2.64252m	-0.00289m	1.52079	3.17826	49.9239
18	495.904m	0.58051m	0.09724m	0.27095m	0.28788m	-2.88980m	-0.00299m	1.52264	3.01509	50.1165
19	496.096m	0.57982m	0.09593m	0.27118m	0.28764m	-2.92550m	-0.00508m	1.51006	3.18037	50.0952
20	495.637m	0.58127m	0.09765m	0.27104m	0.28810m	-3.08408m	-0.00168m	1.51619	3.97887	49.9451

Peak value display

During cycle-by-cycle measurement, if peak-over-range occurs regarding the voltage(U), Current (I) , Speed, and torque, the peak values over range with marks “↑+” or “↓-” in front will display in red. The items regarding peak measurement include voltage (U), current (I), speed and torque.

Definitions of the marks of the peak value : ↑+ : positive peak over range ; ↓- : negative peak over range.

Power board : IF any voltage or current of a cycle-by-cycle measurement is out of the range limit, the corresponding indicator of the measured input element will turn red.

Motor board : IF any speed or torque of a cycle-by-cycle measurement is out of the range limit, the corresponding indicator of the measured input element will turn red.

Wherein, The indicator of the power board displays on the status bar; while the indicator of the motor board displays on the top main men.

16.3 Setting the Items of Cycle-by-Cycle Measurement

1) Procedure : Press OTHERS→Cycle by Cycle→ITEM

2) Setup menu for cycle-by-cycle measurement items

- List Item No.** : Set the serial numbers for the cycle-by-cycle measurement items
- Function** : Set the items of the functions, which include the measurement functions of power board and the motor board
- Element/Σ/Motor** : Select the Element number; optional items include:Element1~Element7, ΣA~ΣC, Motor; The selectable items vary depending on the installed elements
- Cursor No.** : Modify the position of the cursor within the range of the measurement cycle count
- Storing Item** : Select the items of cycle-by-cycle measurement to be saved, including the measurement functions of the power board and the motor board
- File List** : View the saved file lists
- All** : After “ALL” is selected, all the measurement items in the cycle by cycle measurement will be selected and can be modified

Item lists

The lists reflect the serial numbers of the cycle-by-cycle measurement items, and there are 10 measurement items at one page displaying from left to right. The range of items in the list can be selected from 1 to 10.

Function

The Function setup menu can be used for modifying the function items in the Lists, and following items can be selected:

Urms, Irms (True rms voltage, True rms current)	Urmn, Irmn (Rectified mean voltage or current)
Umn, Imn (Rectified mean voltage or current calibrated to the rms value)	Udc, Idc (Simple voltage or current average)
Uac, Iac (AC current or voltage component)	U+Peak, U-Peak, I+Peak, I-Peak
CfU, Cfl (Crest factor)	P (Active power)
Q (Reactive power)	S (Apparent power)
Phi (Phase difference)	λ (Power factor)
Pc (Corrected power)	Speed1 (Rotary speed)
Torque	Pm1 (Mechanical power)
Freq (Frequency)	

Storage Items

Setup menu for the storage item

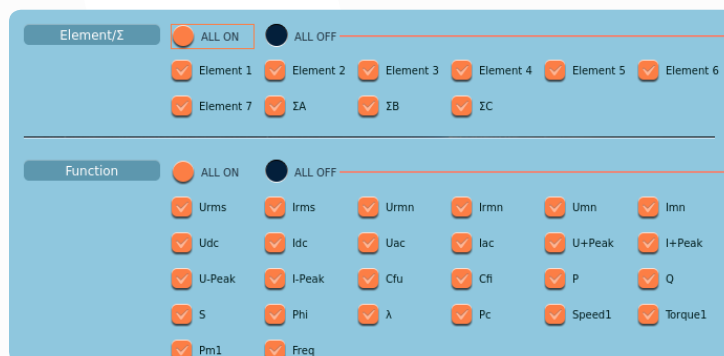

Select the element, including ALL ON and ALL OFF as well. The selectable items vary depending on the installed elements

Select the Function, including ALL ON and ALL OFF as well. The selectable items vary depending on the installed elements

The items that can be stored include as follows:

- Urms、 Irms (True rms voltage, True rms current)
- Urmn、 Irmn (Rectified mean voltage or current)
- Umn、 Imn (Rectified mean voltage or current calibrated to the rms value)
- Udc、 Idc (Simple voltage or current average)
- Uac、 Iac (AC current or voltage component)
- U+Peak、 U-Peak、 I+Peak、 I-Peak (Peak value)
- CfU、 Cfl (Crest factor)
- P (Active power)
- Q (Reactive power)
- S (Apparent power)
- Phi (Phase difference between the signals of input element)
- λ (Power factor)
- Pc (Corrected power)
- Speed1 (Rotary speed 1)
- Torque1 (Torque 1)
- Pm1 (Mechanical power 1)
- Freq (Frequency)

Chapter 17 Saving Raw Data

The power analyzer can acquire high frequency components of the raw data input at high speeds. And there is spacious free space for storing a great number of raw data.

- 1) Procedure : Press OTHERS→Save Raw Data
- 2) Setup menu :

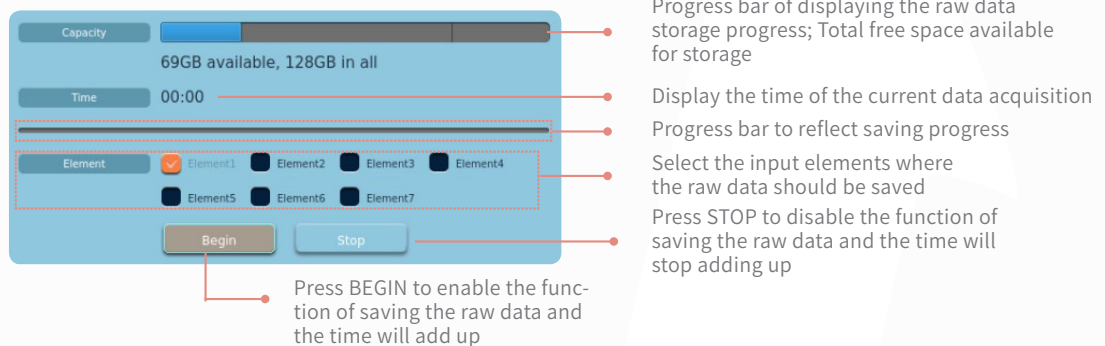

⚠ Note :

- The raw data can be exported in MAT file via USB or FTP.
- After the raw data save stops, the new raw data will form new file.

Limitations on Execution

- Once raw data save function is enabled, the Hold function is disabled.
- IEC Harmonic, FFT, Flicker, Motor Evaluation, Cycle-by-Cycle Measurement, Integration and upgrade are not available after the raw data starts.

Chapter 18 X-Y Graph Display (option)

The measured results and their relations can be displayed as the X-Y Coordinate Graph on this power analyzer where users can press Other key to access to the X-Y Graph menu on which users can set the items such as measurement items to be analyzed.

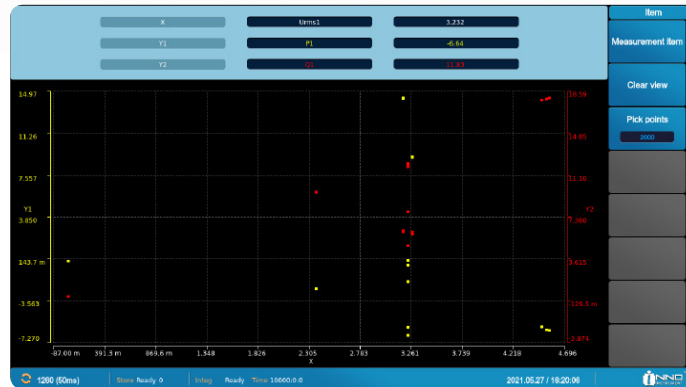

The measured results and their relations can be displayed as the X-Y Coordinate Graph on this power analyzer where users can press Other key to access to the X-Y Graph menu on which users can set the items such as measurement items to be analyzed.

- 1) Procedure : Press OTHERS→X-Y Graph
- 2) Setup menu :

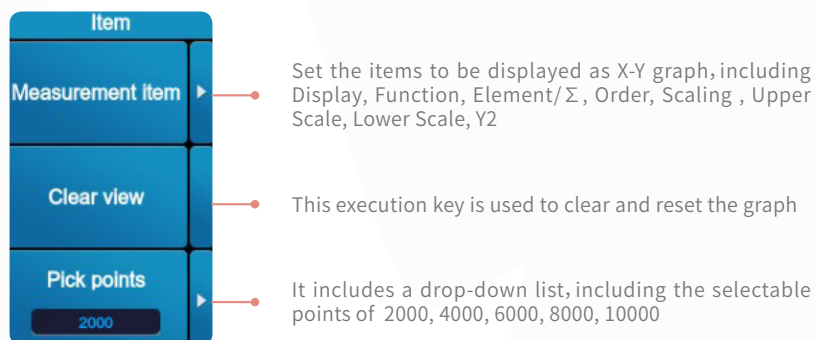

3) Select Measurement Item to access to the following setup menu:

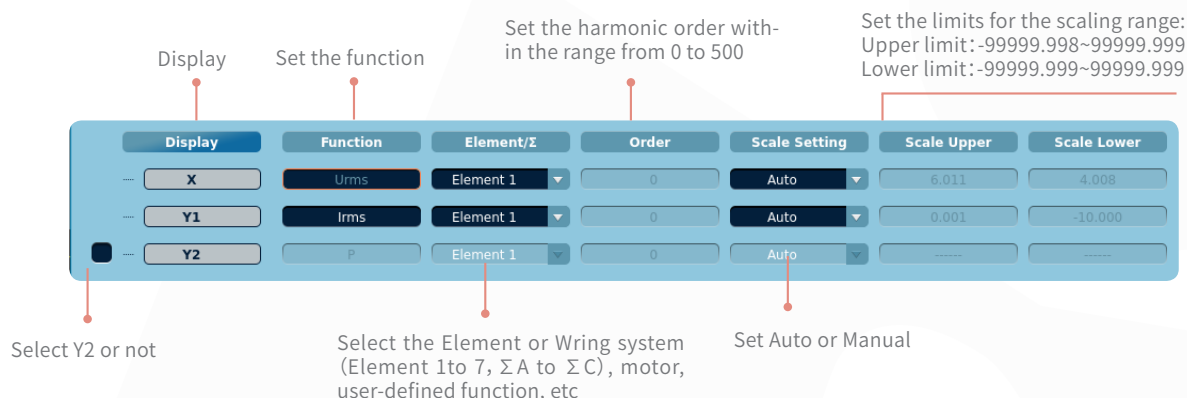

Function

Select Function, and a pop-up window with options of measurement functions included in this instrument will appear, then you can select the measurement functions that you need.

Element/ Σ

In the Element/ Σ menu, you can set the measurement functions of the elements which are needed to be displayed. The available options vary depending on the installed elements.

Harmonic Order

Only when the harmonic measurement function is selected can be harmonic order can be configured.

Scale Position

There are two modes of setting the scale position, including Manual and Auto.

Auto : The upper and lower limits of the trend window are automatically determined based on the maximum and minimum X-Y graph display data values.

Manual : You can set the upper and lower limits manually.

Scale upper limit and Scale Lower limit

You can set the upper and lower limits as needed after selecting the Manual.

⚠ Note:

- Only when Y2 is selected can the corresponding functions of Y2, Element/ Σ , Order, Scaling, Upper Scale, and Lower Scale be used.
- If the value of the **【Scale upper limit】** is set as less or equal to the value of the **【Lower Scale】**, it is invalid.
- If the value of the **【Scale lower limit】** is set as greater than or equal to the value of the **【Upper Scale】**, it is invalid.
- **【Order】** This function can only be enabled under the condition that the item of harmonic measurement is selected : U(*), I(*), P(*), S(*), Q(*), λ (*), ϕ (*), ϕU (*), ϕI (*), Z(*), Rs(*), Xs(*), Rp(*), Xp(*), Uhdf(*), Ihdf(*), Phdf(*).
- **【Element/ Σ 】** The available options vary depending on the installed elements.
- The contents in the X-Y graph should change along with the operations on the setup menu of the Measurement Item in real time.
- The data on the X-Y graph will be updated along with any change of the Measurement Item.

19.2 Setting Integration

Follows are the descriptions of conditions of setting the integration mode, integration timer, watt hour mode (WP± mode), and current mode (q mode).

- 1) Procedure : Integration→Integ setting
- 2) Setup menu :

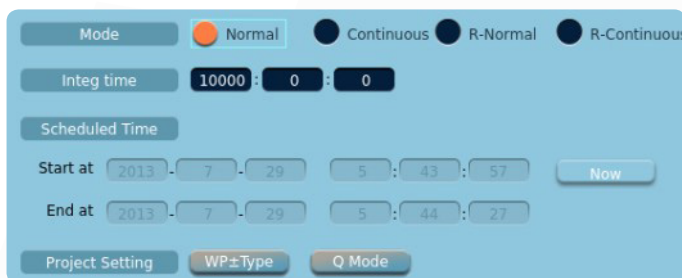

Set the integration mode (Normal, continuous, R-Normal, R-Continuous)

Set the integral time, control time (only in R-Normal or R-Continuous it can be set), WP± mode (watt hour integration mode), and q mode (current mode)

19.2.1 Setting Integration Mode

There are 4 modes in the integration function: normal integration mode, continuous integration mode, real-time normal integration mode(R-normal), and real-time repetitive integration mode (R-Continuous) . The setting procedures are as follows:

Normal Integration Mode

In this mode, the integration timer can be set. After you select Normal, the integration will start and operates within the specified integration duration. Once integration stops automatically, the time when the integration stops and the integration values can be stored.

Continuous Integration Mode

In this mode, the integration timer can be set. After you select Continuous, the integration will start and operates repeatedly as per the specified and scheduled integration time until Stop is pressed.

R-normal

In this mode, the Integration Timer and the Real-Time Control can be set. After you select R-normal, the integration will get ready until the scheduled integration time starts when the integration will start. Once integration operates until scheduled time stops, the integration will stop and the time when the integration stops and the integration values can be stored.

R-Continuous

In this mode, the Integration Timer and the Real-Time Control can be set. After you select R-Continuous, the integration will get ready until the scheduled integration time starts when the integration will start and repeat until time stops. After integration stops, this instrument can hold the time when the integration stoops and the integration values.

Conditions of Integration stop

- 1) In normal integration mode, the integration will stop until scheduled integration time stops.
- 2) In R-normal and R-continuous integration mode, the integration will stop until scheduled integration time stops.
- 3) The integration time reaches maximum.

19.2.2 Setting Integration Timer



Set the integration time within the range from 00:00:01 to 10000:59:59

The integration duration cannot be less than every data updating duration, i.e. the minimum integration duration is related to the current data update. For example, when the current data update rate is 5 seconds, the minimum values that can be set on the integration timer should be 5 seconds.

19.2.3 Setting the Real-Time Control

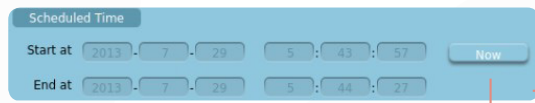

Set the scheduled start and stop time

Set the scheduled integration start & stop time as the current time

Note :

- Only in R-normal and R-continuous modes can the scheduled integration time be set.
- Real-time control can not be less than the time needed for one update based on the update rate when integral mode is R-Normal; Real-time control can not be less than the integral time when integral mode is R-Continuous.

19.2.4 Setting the WP±Type

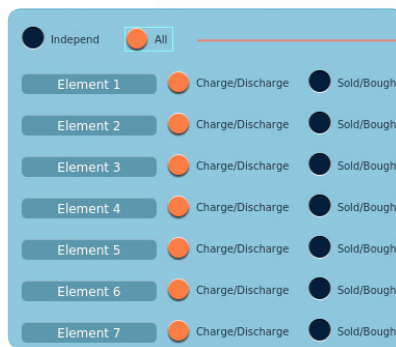

Select the integration settings for WP±Type(Each, all)

Integration methods of WP±Type include Charge/Discharge or Bought/Sold

Integration settings of WP±Type

- Each : The input element can be set respectively.
- All : All the installed input elements can be set simultaneously.

Integration methods of WP±Type

- Charge/Discharge : in the DC mode, this instrument can measure the WP+ (positive watt hour consumed), WP- (negative watt hour returned to the power supply)
- Bought/Sold : in the AC mode, this instrument can measure the WP+ (positive watt hour consumed), WP- (negative watt hour returned to the power supply).

19.2.5 Setting the Current Integration (q mode)

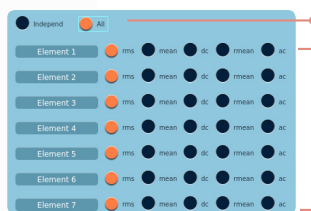

Select the integration settings for current integration (Each, all)

Select the current integration modes

Integration settings of the current integration mode

- Each : The input element can be set respectively.
- All : All the installed input elements can be set simultaneously.

Current integration mode

rms, mean, dc, rmean, ac.

19.3 Independent Integral settings

When this function is turned on, users can select all units to start, stop, and reset the integral simultaneously or separately. The integral mode is the same as the non-independent integral setting, which is not described here.

19.3.1 Independent Integral switch settings



- OFF: All units start, stop, and reset the integral simultaneously.
- ON: Integrate separately according to the settings of the input units separately set.

19.3.2 Element selection

Check the confirmation box of the unit to select a unit to be integrated by .

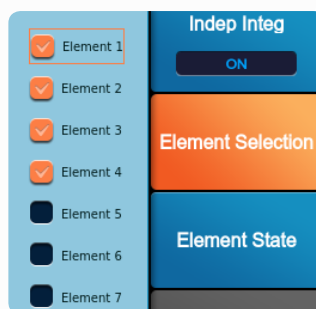

Unit channel adaptability is supported, and multiple units can be selected, but at least one unit is selected;

19.3.3 Element status

View the status of a unit.

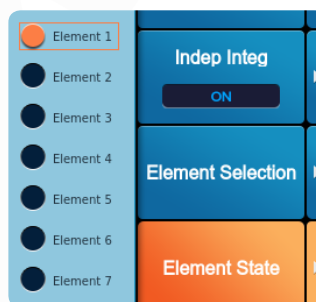

Unit channel adaptability is supported, and the unit status is single selection;

19.3.4 Integral time

Click "Integral Settings" to open the Integration Settings page. The setting of the integration time is shown, with the interface as follows :



The selected unit can be set in the integral time, while the unselected unit cannot be set in integral time;

19.3.5 Control time

Open the Integration Settings interface to control the time, with the interface as follows :

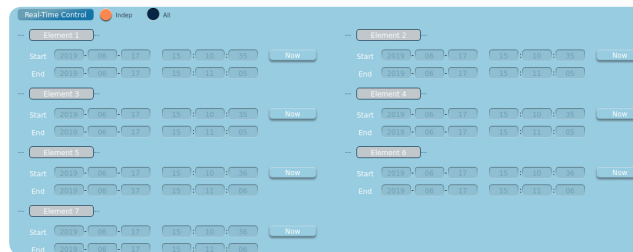

In the independent integration mode, the start and end time of each unit can be set separately.

⚠ Attention

- The time can be reserved for integration only in the R-normal and R-continuous modes.
- Real-time control can not be less than the time needed for one update based on the update rate when integral mode is R-Normal; Real-time control can not be less than the integral time when integral mode is R-Continuous.

19.3.6 Watt-hour integration method

Open the Integration Settings interface to see the "Watt-hour Integration Method" below. Click to open the settings interface. The setting method is the same as the watt-hour integration method setting for the non-independent integration . The interface is as follows :

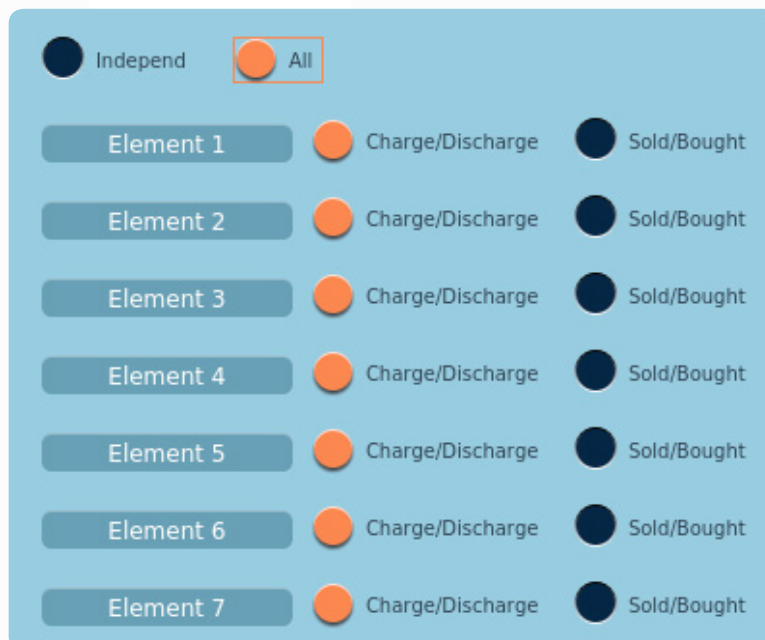

19.3.7 Current mode

Open the Integration Settings interface to show the "Current Mode" below. Click to open the settings interface. The setting method is the same as the current mode setting for the non-independent integration. The interface is as follows :

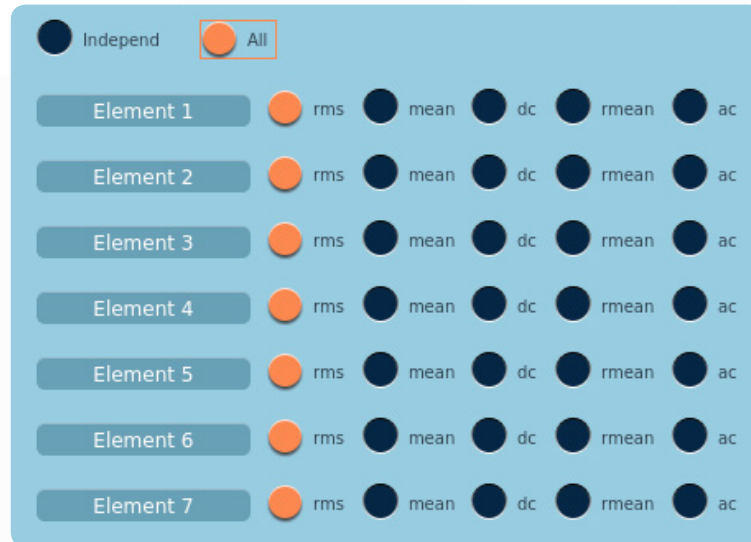

19.4 Restrictions on Instrument Settings by Integration

The following functions cannot be operated or executed while the integration is running

- When integrating, the integration setting cannot be performed
- When integrating, initialization is not available
- When integrating, voltage and current range cannot be set
- When integrating, flicker, FFT, IEC, cycle analysis cannot be set
- When integrating, the waveform display trigger does not work
- While in integration, Info interface cannot be set.
- When independent integration is turned on, the storage cannot be turned on if the storage mode is integration synchronization;

Integration can't start while the following function is being performed

- At the beginning of the cycle analysis
- When the original data is saved
- At initialization
- When upgrading
- When the flicker starts

Chapter 20 Setting the Data Storage

You can store numeric data in binary format to the internal hard disk drive (SSD) or a USB memory device at the data update interval or at a specified time interval. Then you can convert stored binary data to CSV file. You can analyze the converted data on a PC except using the power analyzer to recall and read stored data directly.

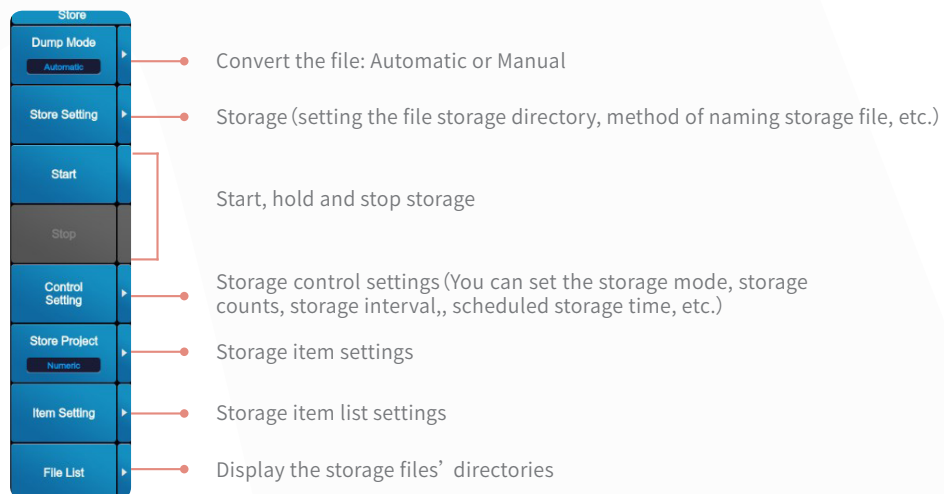

20.1 Setting the File Conversion Modes

- 1) Procedure : Press STORE→Convert
- 2) Setup menu :

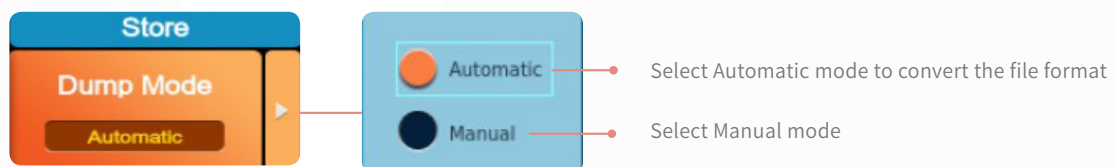

Explaining to the File Conversion Modes

Automatic Mode

If users select this mode, the stored data file will automatically convert to CSV file after storage completed.

Manual Mode

If users select this mode, after file storage completed, the stored file defaults to be binary format and it will not automatically convert to CSV file, but users still can convert this binary file to CSV file (Section 20.6 in detail).

20.2 Setting the Storage

Users can set the file storage directory, method of naming storage file, etc.

- 1) Procedure: Press STORE→Storage Setting
- 2) Setup menu

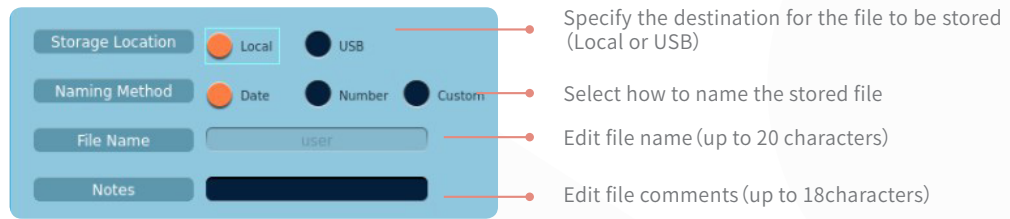

Storage Destination

When LOCAL is selected, the file will be saved to SSD (Save/FileSave);

When USB is selected, the file will be saved by USB device (USB/FileSave) .

⚠ Note:

- When USB device is undetected or disconnected to this instrument, you cannot select USB to store the file.
- If update rate is less than 50ms, you cannot save the file by selecting USB.

Naming Files

There are 3 modes by which users can name the stored file, by date, by serial number, or custom, as described in the following.

Date

The date and time when the file is saved are used as its name, including second, minute, hour, date, month, and year. In auto naming mode, you cannot input file name manually in the box. You can input the characters in the input box of the Comment.

Serial number (No.)

Serial number of file naming: you cannot input file name manually in the box, while the comment box is available. If one of the files included in the serial number is deleted, another new created file will be named in a manner so as not to affect the sequence of the files. The created files are sorted as “000001”, ”000002”, and “000003” by file created time.

Custom

Both the input boxes of file name and comment are available. After you selected the option, you can continue to input file names by the pop-up keyboard. If you keep the user-defined name of the file after it has been named, another new created file will be named by adding 1 to the end of its name for distinction; if more than one new file is created, they will be named by accumulative numerical values successively. For example, the previous file created is named as “main”, next, another new file created will be named as “main1”, and thirdly, the third new file created will be named as “main2”.

20.3 Starting, Holding and Stopping Storage

Starting and Holding Storage

- 1) Procedure : Press STORE→Start/Hold
- 2) Execution Menu :

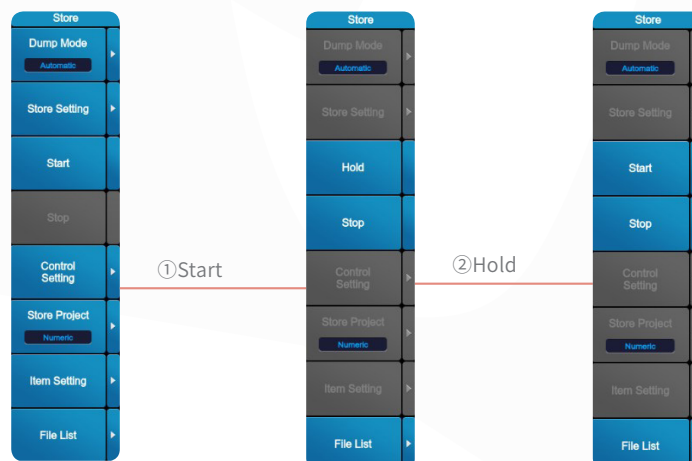

Stopping Storage

- 1) Procedure : Press Stop
- 2) Execution Menu :

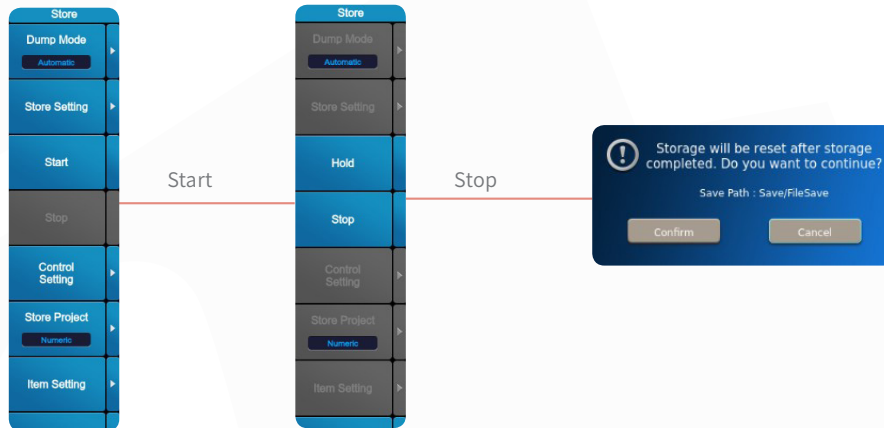

Storage Status

Starting storage

Click **Start** in the menu to start to store the file, when the **Start** will change to **Hold**, with "Store:Start" displayed on the screen as a storage status and STORE key indicator illuminated.

Holding storage

Click **Hold** in the menu to make file storage pause in process of file storage, when the **Hold** will change to **Start**, with "Store:Hold" displayed on the screen as a status and STORE key indicator blinking.

Stopping storage

Click **Stop** in the menu in process of file storage, select **Confirm** in the pop-up window with message to complete the storage, or select **Cancel** to continue the storage. After storage completed, the storage status will be reset, with "Store: Ready" displayed on the screen and STORE key indicator off.

If users select to stop the storage, on the condition that automatic CSV file conversion is enabled, a stored data file (.csv) will be created, but users can select "Cancel" to exit from CSV file conversion; on the condition that manual CSV file conversion is enabled, no CSV file will be created.

20.4 Setting the Storage Control

- 1) Procedure : Press STORE→Storage Control
- 2) Setup menu :

Set the storage count within the range from 1 to 9999999



Set the storage mode

When you select the storage mode as Event, you can select the trigger event (from Event1 to event8)

Set the storage interval within the range from 00:00:01 to 99:59:59

You can set that the storage starts and ends 30s later than Time Now; besides, storage start time is the same as end time

Schedule the storage start and end time, only in the Real Time Control mode

Storage Mode

The storage mode can be set as Manual storage, Real Time storage, Integration-synchronized storage, Event-synchronized storage, Single-shot storage.

The data will be saved immediately when you select manual storage mode.

After you select the Real Time Control mode, the data is ready to be stored. The data storage starts after the scheduled storage start time is reached.

After you select the Integration-synchronized Storage Mode, the data is ready to be stored. The data storage starts once the integration starts.

While in integration, the integration-synchronized is not available.

After you select the Event Mode, the data is ready to be stored. The storage starts once the user-defined event occurs.

After you select the Single-shot Storage Mode, the data will be stored immediately. Each time when you press START, the numeric data will be stored.

Storage Count

You can set the count of storage. The storage count can be set to a value from 1 to 9999999. The actual maximum storage count depends on the items to be stored. And user should not set the value of storage count bigger than the value of maximum storage count.

Storage Interval

You can set the storage interval. When it is set as "0:0:0", the storage interval is the same as the specified data update interval. However, the interval cannot be set if it is in the single-shot storage mode or Event mode.

Scheduled Storage Times for Real-Time Storage Mode

This setting is valid only when the storage mode is set as Real Time. You can set the scheduled storage start time and storage stop time. Be sure to set the storage stop time to a time after the storage start time.

20.5 Setting Storage Items and Lists

20.5.1 Storage Items

- 1) Procedure : Press STORE→Storage Item
- 2) Setup menu :

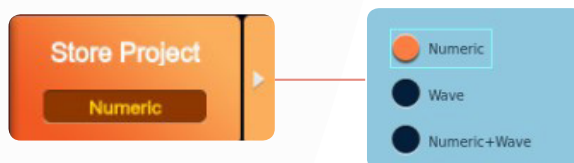

Storage items:

Numeric : Only the numeric data items displayed on the screen can be stored.

Wave : Only the waveform items displayed on the screen can be stored.

Numeric+Wave : Both the numeric data and the waveform items displayed on the screen can be stored.

⚠ Note :

- When the update rate is less than 50ms, you cannot select **【Numeric+Wave】** to store the file.

20.5.2 Storage File List

- 1) Procedure : Press STORE→File List
- 2) Setup menu :

Select the elements, wiring system and motor to be stored to the item lists. Or you can select custom function

copy the storage items of selected element
Select ALL ON or ALL OFF

Selectable storage item lists



[Numeric] Mode

Select Element

Element 1 ...Element 7, wiring system $\Sigma A \dots \Sigma C$, Motor, Custom

Numeric—Element storage items

Basic item: Urms, Irms, Umn, Imn, Udc, Idc, Uac, Iac, Urmn, Irmn, P, S, Q, λ , ϕ , FreqU, FreqI, U+peak, I+peak, U-peak, I-peak, P+peak, P-peak, CfU, CfI, Pc, Time, WP, WP+, WP-, q, q+, q-, WS, WQ, Uthd, Ithd, Pthd, K-factor, Uthf, Ithf, Utif, Itif, hvf, hcf

Harmonic item: U (*), I (*), P (*), S (*), Q (*), λ (*), ϕ (*), ϕU (*), ϕI (*), Z(*), Rs (*), Xs (*), Rp (*), Xp (*), Uhdf (*), Ihdf (*), Phdf (*)

Numeric— $\Sigma A \dots \Sigma C$ Storage Items

Basic item: Urms, Irms, Umn, Imn, Udc, Idc, Uac, Iac, Urmn, Irmn, P, S, Q, λ , ϕ , FreqU, FreqI, U+peak, I+peak, U-peak, I-peak, P+peak, P-peak, CfU, CfI, Pc, Time, WP, WP+, WP-, q, q+, q-, WS, WQ, $\Delta U1$, $\Delta U2$, $\Delta U3$, ΔI , $\Delta P1$, $\Delta P2$, $\Delta P3$, $\Delta P\Sigma$, $\phi Ui-Uj$, $\phi Ui-Uk$, $\phi Ui-li$, $\phi Ui-lj$, $\phi Ui-lk$, PosU, NegU, PosI, NegI, PosP

Harmonic item: U (*), I (*), P (*), S (*), Q (*), λ (*)

Numeric—Motor Storage Items

Motor Item: Speed1, Torque1, SyncSp1, Slip1, Pm1, Theta1, Speed2, Torque2, SyncSp2, Slip2, Pm2
there is not Theta1 when it is Double Motor mode.

Numeric—Custom storage items

Item: $\eta 1$, $\eta 2$, $\eta 3$, $\eta 4$, $\eta 5$, $\eta 6$, Udef1, Udef2, F1, F2, F3, F4, F5, F6, F7, F8, F9, F10, F11, F12, F13, F14, F15, F16, F17, F18, F19, F20

[Wave] Mode

Element

Element 1 ...Element 7, Motor

Wave—Element storage items

Wave Item: U, I

Wave—Motor Storage items

Motor Item: Speed1, Torque1

【Numeric+Wave】 Mode

Element

Element 1 …Element 7, Wiring system ΣA … ΣC , Motor, Custom

Numeric+Wave—Element Storage Items

Basic item: Urms, Irms, Umn, Imn, Udc, Idc, Uac, Iac, Urmn, Irmn, P, S, Q, λ , ϕ , FreqU, FreqI, U+peak, I+peak, U-peak, I-peak, P+peak, P-peak, CfU, Cfl, Pc, Time, WP, WP+, WP-, q, q+, q-, WS, WQ, Uthd, Ithd, Pthd, K-factor, Uthf, Ithf, Utif, Itif, hvf, hcf

Harmonic Item: U (*), I (*), P (*), S (*), Q (*), λ (*), ϕ (*), ϕU (*), ϕI (*), Z(*), Rs (*), Xs (*), Rp (*), Xp (*), Uhdf (*), Ihdf (*), Phdf (*)

Wave Item: U, I

Numeric+Wave— ΣA … ΣC Storage Items

Basic Item: Urms, Irms, Umn, Imn, Udc, Idc, Uac, Iac, Urmn, Irmn, P, S, Q, λ , ϕ , FreqU, FreqI, U+peak, I+peak, U-peak, I-peak, P+peak, P-peak, CfU, Cfl, Pc, Time, WP, WP+, WP-, q, q+, q-, WS, WQ, $\Delta F1$, $\Delta F2$, $\Delta F3$, $\Delta F4$, $\Delta P1$, $\Delta P2$, $\Delta P3$, $\phi Ui-Uj$, $\phi Ui-Uk$, $\phi Ui-li$, $\phi Ui-lj$, $\phi Ui-lk$, PosU, NegU, PosI, NegI, PosP

Harmonic Item: U (*), I (*), P (*), S (*), Q (*), λ (*)

Numeric+Wave—Motor Storage Items

Motor Item: Speed1, Torque1, SyncSp1, Slip1, Pm1, Theta1, Speed2, Torque2, SyncSp2, Slip2, Pm2

Numeric+Wave—Custom storage items

Item: $\eta 1$, $\eta 2$, $\eta 3$, $\eta 4$, $\eta 5$, $\eta 6$, Udef1, Udef2, F1, F2, F3, F4, F5, F6, F7, F8, F9, F10, F11, F12, F13, F14, F15, F16, F17, F18, F19, F20

20.6 Storage File Lists

- 1) Procedure : Press STORE→File List
- 2) Setup menu :

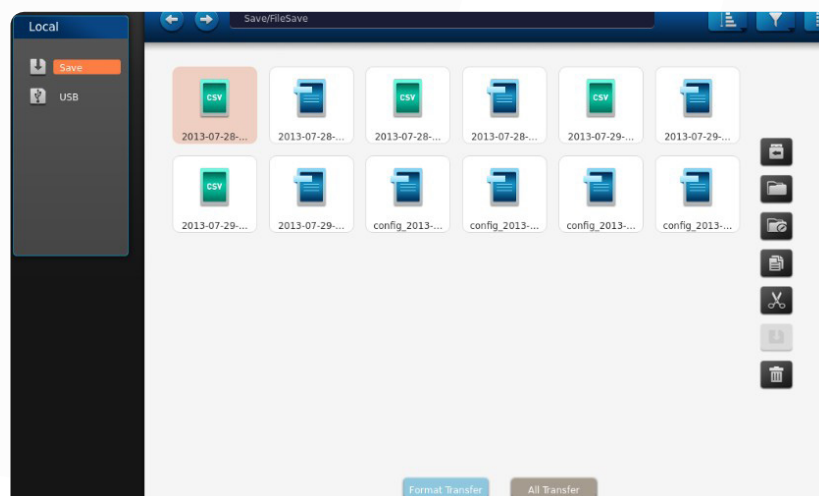

Convert File Convert All

Select File List to access to the menu of storage file directories, and then the users can perform the operation of storage file conversion.

File Conversion

Convert File : Users can press this key to convert the selected binary file to CSV file.

Convert All : Users can press this key to convert all the binary files to CSV file.

⚠ Note :

- The source files will not be removed when binary files are converted to CSV files. Same CSV files with same name will take the place of the previously converted files if same files are converted again.
- Interruption is allowed in process of file conversion.
- On the condition that the files are converted and stored in a USB memory device, disconnect the USB device, and then this instrument will automatically save the files to the defaulted directory, i.e. Save/FileSave.

Chapter 21 Files

The power analyzer provides the functions such as file management, including creating & removing the folder, renaming the folder, copying & cutting the folder, returning to previous menu, confirming operations, etc. Meanwhile, the saved files and image formats can be set as needed.

21.1 File Manager

- 1) Procedure : Press FILE→File Manager
- 2) Setup menu :

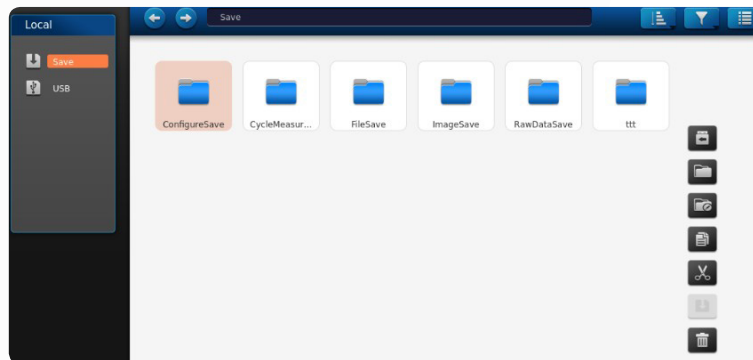

As shown in the above figure, in file management interface, storage path is shown at left side and specific file information is shown at right side. Users can rename, copy, cut, paste or delete files or folders, or create a new folder. In file view checkbox, file sort, filter or display style can be set.

Sort to

You can sort the file list by file name, size, type, or date and time.

Selecting the Type of File to List (File Filter)

You can limit the type of files that appear in the list by selecting an extension, including *.* , *.SSF、 *.CSV、 *.BMP、 *.PNG、 *.JPG、 *.TXT、 *.MAT、 *.INI.

Display Format

Select whether to display a list of files or folders in the form of Thumbnails or List. They are displayed as thumbnails by default.

21.2 Saving Image

- 1) Procedure : Press FILE→Save Image
- 2) Setup menu :

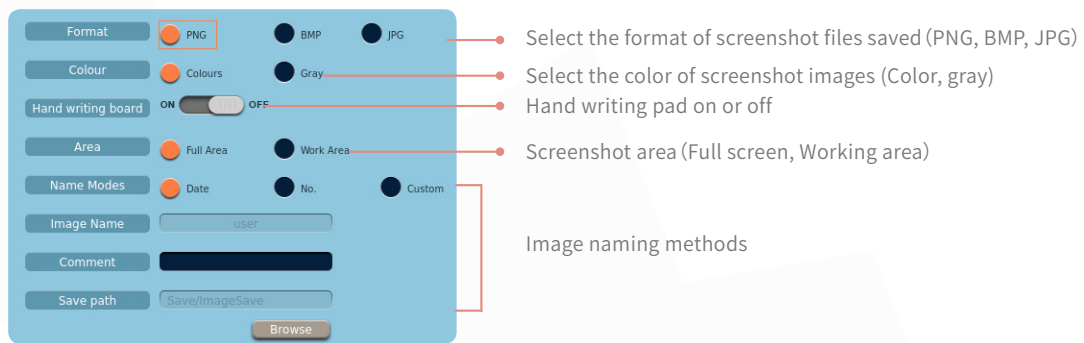

Hand Writing Pad

You can click the screen when the screenshots are displayed as thumbnails modes in the File Manager, and then a Printer icon is displayed at the bottom right, hand icon displayed at the upper right of the screen. You can print the image by clicking this Printer icon. The function of the Hand icon is the same as that of the Hand Writing Pad, by which you can add notes or remarks for the image. You can select the color (Black, Red, Blue) and size (Thick, Normal, Thin) of the pen, and perform the operations such as Undo, Clear, Save, and Save As.

Naming Images

There are 3 modes by which users can name the stored images, by date, by serial number, or custom, as described in the following.

Date

The date and time when the image is saved are used as its name, including second, minute, hour, date, month, and year. In auto naming mode, you cannot input image name manually in the box. You can input the characters in the input box of the Comment.

Serial number(No.)

Serial number of image naming: you cannot input image name manually in the box, while the comment box is available. If one of the images included in the serial number is deleted, another new created file will be named in a manner so as not to affect the sequence of images. The created images are sorted as "000001", "000002", and "000003" by file created time.

Custom

Both the input boxes of file name and comment are available. After you selected the option, you can continue to input file names by the pop-up keyboard. If you keep the user-defined name of the file after it has been named, another new created file will be named by adding 1 to the end of its name for distinction; if more than one new file is created, they will be named by accumulative numerical values successively. For example, the previous file created is named as "main", next, another new file created will be named as "main1", and thirdly, the third new file created will be named as "main2".

21.3 Setting the Printer

21.3.1 Print

- 1) Procedure : Press FILE→Print
- 2) Function : Printing functions, including real-time print and auto print, are available on this power analyzer. However, you need to connect an extended printer to this power analyzer because there is no built-in printer in this power analyzer. You can print screenshot files or the current interface on the power analyzer.

21.3.2 Setting Auto Print

- 1) procedure : Press FILE→Print
- 2) Setup menu :

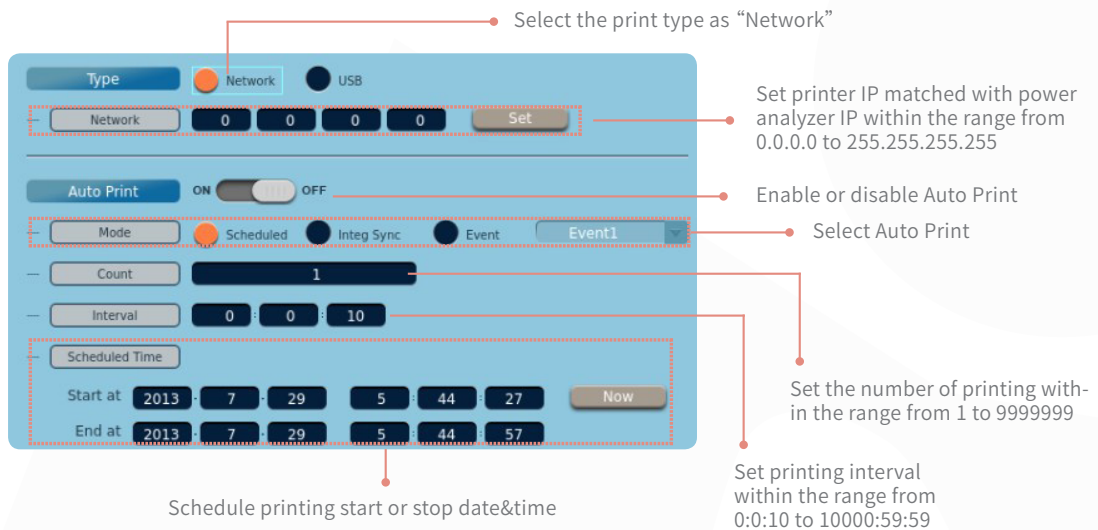

When the TYPE is selected as "USB", the setup menu will be displayed as follows :

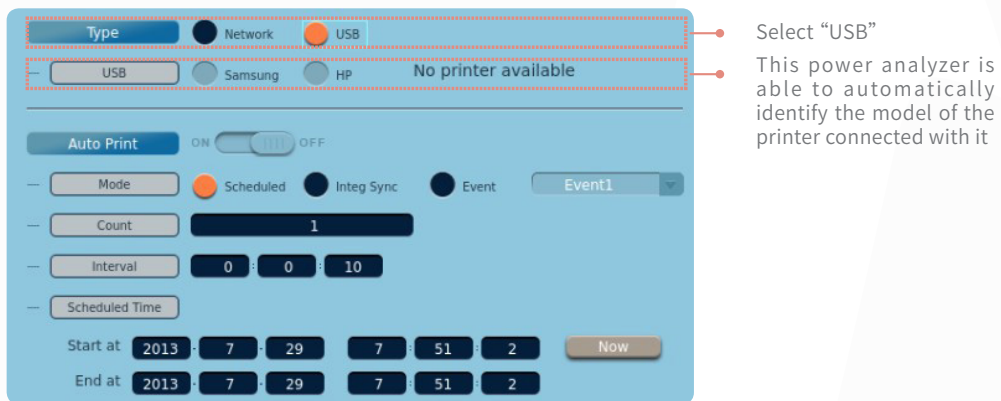

Type

When "Network" is selected, the IP address to be connected can be set.

When "USB" is selected, this power analyzer is able to automatically identify the model of the printer.

Auto Print Mode

Real-time print mode : Printing at real time

Integration-Synchronized Print : Select Integration-Synchronized Print mode to access to the ready status of printing. The printing will not start until integration begins.

Event-Synchronized Print Mode : Select Event-Synchronized Print Mode to access to the ready status of printing. The printing will not start until integration begins. You can set the items of the events only after you select Event-Synchronized Print Mode.

⚠ Note :

- After you select [Event] , Printing automatically starts . If there is not trigger event within the interval, there will be no printing.
- After you select [Event] , Printing automatically starts. If there is event within the interval, the event will be print out.

Number of Printing

You can set the number of the automatic printings. But in the Integration-Synchronized Print mode, the number of auto printing cannot be set.

Set the print interval

The print interval defaults to 10s (minimum). But you cannot set the print interval to be less than 10s.

Scheduled time for Real-Time Print mode

You can schedule the time for real time print starting or stopping only in Real-time Print Mode. The time of print stopping should be set at a time after print starting time. The printing cannot be scheduled either in the Integration-Synchronized Print mode or Event-Synchronized Print Mode.

Type of printer supported

- 1) Samsung_M262x
- 2) HP_P2035
- 3) HP_M203d

21.4 Configuration (Profile File)

You can save all the functional parameters' configurations of the power analyzer as configuration files. You can read all the functional parameters' configurations from the configuration files as well.

- 1) Procedure : FILE→Config
- 2) Setup menu :

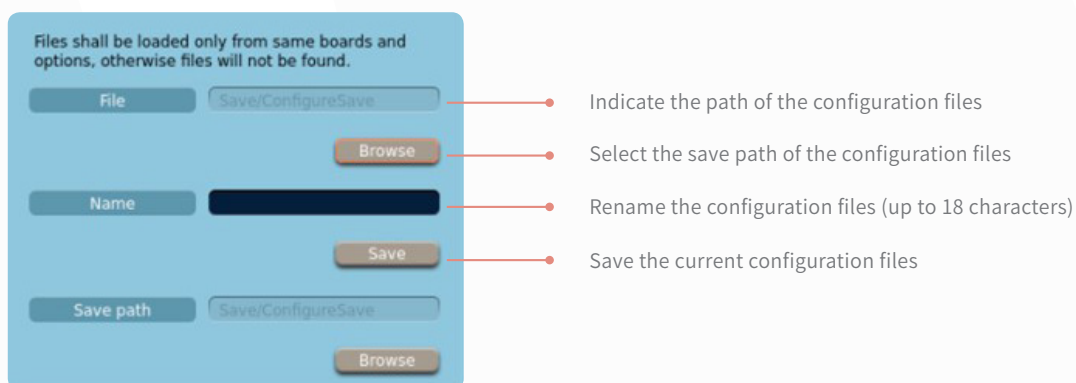

⚠ Note :

- There should be no such symbols as \、 /、 *、 ?、 <、 >、 | in the file name. Otherwise, error message will prompt out.
- There is no distinction for the capital and small English letters
- You cannot save the file name when it is till empty in the input box or when there is invalid character. In that case, error message will prompt out.
- Error message will prompt out when in renaming file.
- The edit box defaults to be empty.
- All the configurations of the editable items can be saved.
- Original configuration cannot be deleted. The configuration files defaults to be displayed as original.

21.5 File saving setting

- 1) Setting path: press File key and select File Saving menu
- 2) Settings interface is as follows

Select the naming method of files

File naming

Naming method for images can be divided into three kinds, including by date, by numbering and by user-defining, as described below.

Date

If an image is named by time, the date and time is the date and time when screenshot is captured, in the format of yy-mm-dd-h-m-s. The image name in the naming window cannot be edited; but the note can be edited and valid.

Numbering

If an image is named by numbering, the file name in the naming window cannot be edited; but the note can be edited and valid. In chronological order, file names are 000001, 000002, 000003..... Deleting the generated file will not affect the name order of new files.

Self-defining

Both the file name and the note are valid. Input keyboard will pop up after selection and the name prefix can be named by self-defining. After the file named by self-defining is saved, if the self-defined name is no longer changed and other files are constantly generated, the file name is the current name automatically plus 1. If the files are generated many times, accumulative value in sequence will be added to the file name. For example, the file is self-defined as main. If such name is no longer changed, the following file names will be main1, main2....., value is accumulated in sequence.

21.6 Single saving

- 1) Settings path: press File key and select "Single Saving" menu
- 2) Function: click "Single Saving" once to save the selected measured item.

NOTE :

1. "Single Saving" file format and the saving path can be set for "File Saving".
2. After Singlesave folder is deleted, a folder will be automatically generated in the default path for the next single saving
3. In the process of single saving, a progress bar will pop up: "Singlesave is saving"
4. In the process of single saving, any other operation is invalid, excluding Image Save
5. In the following cases: IEC harmonic view, FFT view, flicker view, periodic analysis view, manual saving, timing saving, integral synchronization saving, event saving, and printing, the single saving is unavailable;

Motor item: Speed1, Torque1, SyncSp1, Slip1, Pm1, Theta1, Speed2, Torque2, SyncSp2, Slip2, Pm2

User-defined function

Items: η1, η2, η3, η4, η5, η6, Udef, Udef2, F1, F2, F3, F4, F5, F6, F7, F8, F9, F10, F11,, F12, F13, F14, F15, F16, F17, F18, F19, F20

21.7 Item settings

- 1) Operation path: press File key and select "Item Settings" menu
- 2) Diagram of the settings interface

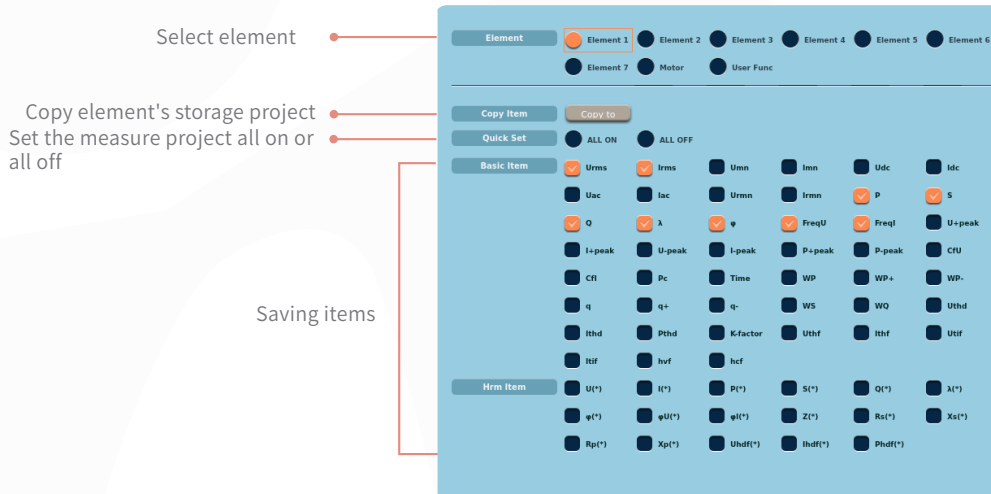

NUMERIC VALUE mode

Select a unit

Unit 1~ 7, wiring group Σ A~C, motor and user-defined function

Element saving item

Basic items: Urms, Irms, Umn, Imn, Udc, Idc, Uac, Iac, Urmn, Irmn, P, S, Q, λ , ϕ , FreqU, FreqI, U+peak, I+peak, U-peak, I-peak, P+peak, P-peak, CfU, Cfl, Pc, Time, WP, WP+, WP-, q, q+, q-, WSWQ, Uthd, Ithd, Pthd, K-factor, Uthf, Ithf, Utif, Itif, hvf, hcf

Harmonic items: U(*), I(*), P(*), S(*), Q(*), λ (*), ϕ (*), ϕ U(*), ϕ I(*), Z(*), Rs(*), Xs(*), Rp(*), Xp(*), Uhdf(*), Ihdf(*), Phdf(*)

Σ A~C saving item

Basic items: Urms, Irms, Umn, Imn, Udc, Idc, Uac, Iac, Urmn, Irmn, P, S, Q, λ , ϕ , FreqU, FreqI, U+peak, I+peak, U-peak, I-peak, P+peak, P-peak, CfU, Cfl, Pc, Time, WP, WP+, WP-, q, q+, q-, WS, WQ, Δ U1, Δ U2, Δ U3, Δ I, Δ P1, Δ P2, Δ P3, ϕ Ui-Uj, ϕ Ui-Uk, ϕ Ui-li, ϕ Ui-lj, ϕ Ui-lk, PosU, NegU, PosI, NegI, PosP

Harmonics projects: U (*), I (*), P (*), S (*), Q (*), λ (*)

Motor saving item

Motor item: Speed1, Torque1, SyncSp1, Slip1, Pm1, Theta1, Speed2, Torque2, SyncSp2, Slip2, Pm2

There is not Theta1 when it is Double Motor mode.

User-defined function

Items: η 1, η 2, η 3, η 4, η 5, η 6, Udef1, Udef2, F1, F2, F3, F4, F5, F6, F7, F8, F9, F10, F11, F12, F13, F14, F15, F16, F17, F18, F19, F20

WAVE mode

Unit

Unit 1~ Unit 7, motor

Element saving item

Wave projects: U, I

Motor saving item

Single motor : Speed1,Torque1

Double motors : Torque1,Torque2

NUMERIC VALUE + WAVE mode**Unit**

nit 1~ 7, wiring group $\Sigma A\sim C$, motor and user-defined function

Element saving item

Basic projects: Urms, Irms, Umn, Imn, Udc, Idc, Uac, Iac, Urmn, Irmn, P, S, Q, λ , ϕ , FreqU, FreqI, U+peak, I+peak, U-peak, I-peak, P+peak, P-peak, CfU, Cfl, Pc, Time, WP, WP+, WP-, q, q+, q-, WS, WQ, Uthd, Ithd, Pthd, K-factor, Uthf, Ithf, Utif, Itif, hvf, hcf

Harmonic items: U(*), I(*), P(*), S(*), Q(*), λ (*), ϕ (*), ϕU (*), ϕI (*), Z(*), Rs(*), Xs(*), Rp(*), Xp(*), Uhdf(*), Ihdf(*), Phdf(*)

Wave projects: U, I

 $\Sigma A\sim C$ saving item

Basic items: Urms, Irms, Umn, Imn, Udc, Idc, Uac, Iac, Urmn, Irmn, P, S, Q, λ , ϕ , FreqU, FreqI, U+peak, I+peak, U-peak, I-peak, P+peak, P-peak, CfU, Cfl, Pc, Time, WP, WP+, WP-, q, q+, q-, WS, WQ, $\Delta U1$, $\Delta U2$, $\Delta U3$, ΔI , $\Delta P1$, $\Delta P2$, $\Delta P3$, ϕU_i-U_j , ϕU_i-I_k , ϕU_i-I_l , ϕU_i-I_j , ϕU_i-I_k , PosU, NegU, PosI, NegI, PosP

Harmonics projects: U (*), I (*), P (*), S (*), Q (*), λ (*)

Motor saving item

Motor item: Speed1, Torque1, SyncSp1, Slip1, Pm1, Theta1, Speed2, Torque2, SyncSp2, Slip2, Pm2

There is not Theta1 when it is Double Motor mode.

User-defined function

Items: η_1 , η_2 , η_3 , η_4 , η_5 , η_6 , Udef1, Udef2, F1, F2, F3, F4, F5, F6, F7, F8, F9, F10, F11, F12, F13, F14, F15, F16, F17, F18, F19, F20

Chapter 22 System Configuration

The system functions which are able to be performed or set on this power analyzer include viewing the system information, initializing, setting the system (for example, language, time & date, display and preference), setting the touch screen lock or unlock, setting remote control & network control, calibrating the press keys and touch screens, etc.

22.1 System Information

- 1) Procedure : Press Utility→System Info
- 2) Setup menu :

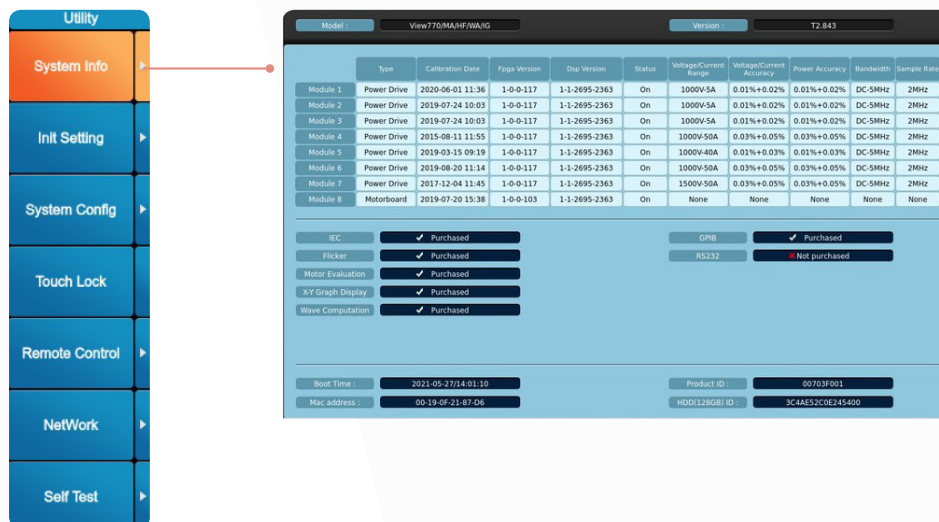

Following information is included in the System Info menu:

- 1) Model number & information of current version of the device.
- 2) Sub-module types, module calibration date, Fpga version, Dsp version, state, voltage/current range, voltage/current accuracy, power accuracy, bandwidth, sample rate and so on.
- 3) Function modules included : IEC harmonic, Flicker, Motor, X-Y Graph display, Waveform computation, AUX, DA, GPIB, RS232 interface and so on. Besides, the purchase status of options is displayed.
- 4) Start-up time and ID code of the instrument.
- 5) Mac address and ID code of the hard disk.

22.2 Initializing the Setting

You can reset the instrument settings to their factory default values.

- 1) Procedure : Press Utility→Init Setting
- 2) Setup menu :

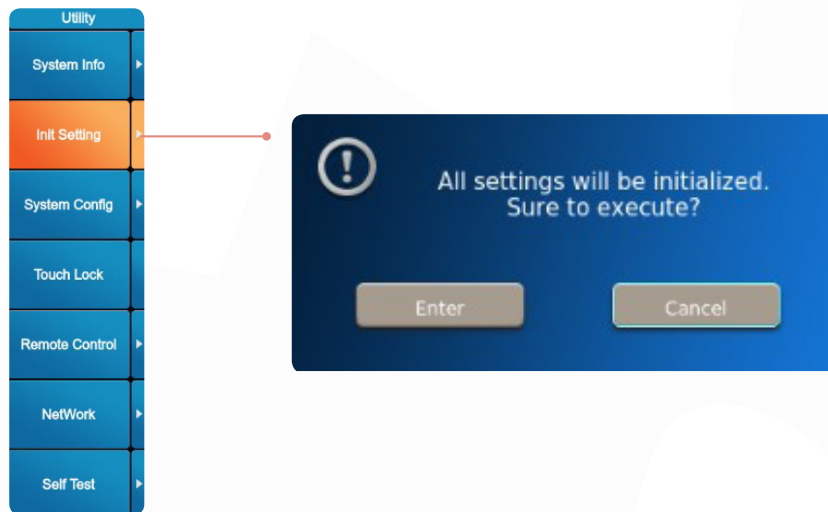

3) Press “Enter” to accomplish the initialization setting.

Note :

- Only initialize the instrument if you are sure that all of the settings returning to their initial values are necessary.
- You cannot undo an initialization. So you can save the setup parameters before initializing the instrument. See section 21.4 in detail.
- The setup parameters that cannot be initialized include: date of device start-up, system time and date, language, brightness, network and remote control.

22.3 System Setting

You can set the system, including the items such as languages, system time and date, display style, and preference.

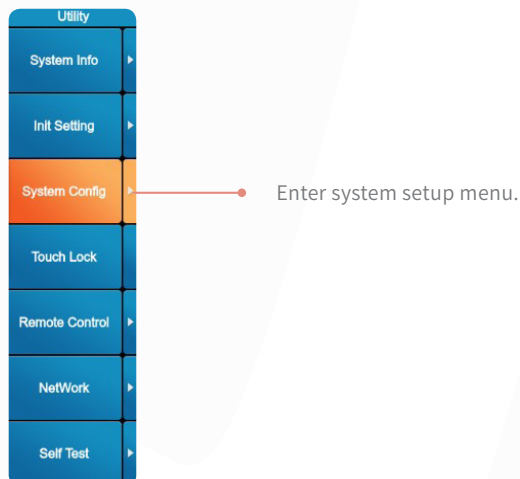

22.3.1 Language Setting

- 1) Procedure : Press Utility→System Config→language
- 2) Setup menu :

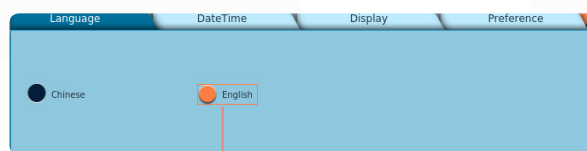

2 kinds of language can be configured, including Chinese and English

Note :

- The system language selected will not change depending on the initializations.

22.3.2 Setting the Time and Date

- 1) Procedure : Press Utility→System Config→Date/Time
- 2) Setup menu :

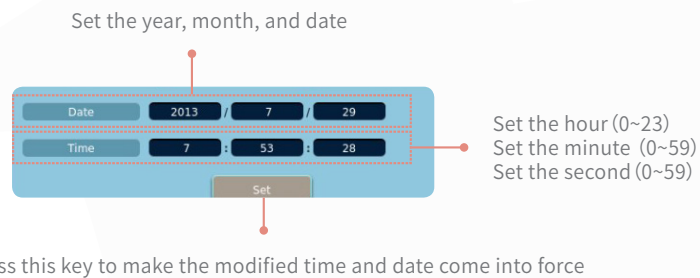
**Note :**

- This instrument can perform only once calibration every time when the instrument is started up. The Calibrate key will not appear after pressed until the instrument is restarted again.
- The system time and date configured will not change depending on the initializations.

22.3.3 Display Setting

- 1) Procedure : Press Utility→System Config→Display
- 2) Setup menu :



Adjust the brightness of the screen within the range from 1 to 100

Note :

- The display item which can be set is the brightness.
- The display settings will not change depending on the initializations.

22.3.4 Setting the Preferences

- 1) Procedure : Press Utility→System Config→Preference
- 2) Setup Menu :

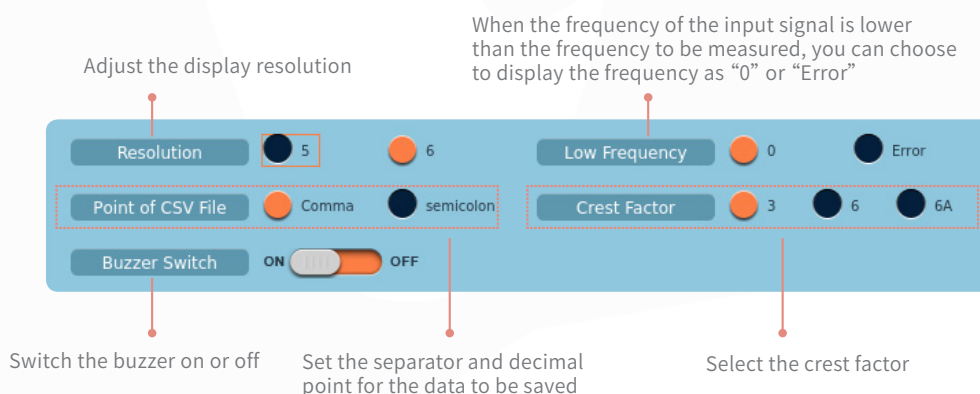

Resolution

You can set the display 5 digits or 6 digits of the numeric data.

Low frequency

When the frequency of the input signal is lower than the frequency that this instrument can measure, you can choose to display the frequency as “0” or “Error.”

(.csv) Decimal Point

When you save data, you can choose what type of decimal point to use. (Comma or period).

Buzzer Switch

It is used to control the buzzer.

- When the Buzzer is switched on, the sound of the buzzer can be heard if the keys are pressed.
- When the Buzzer is switched off, there is no any sound of the buzzer if the keys are pressed.

Crest Factor

When the crest factor is 3, 6 or 6A, the crest factor defaults to be 3.

22.4 Touch Lock/Unlock

The function of the touch operation can be enabled or disabled via the Lock key.

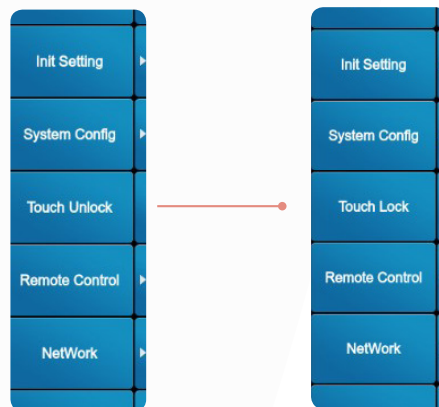

Touch Lock

You cannot operate on the instrument by touching on the screen, but the functions of the keys installed on the panel and Touch Unlock tab are available.

Touch Unlock

When you press Touch Unlock tab, you can operate on the instrument by touching on the screen.

22.5 Remote Control

There are a few communication interfaces available when power analyzer is controlled via the PC, including Network and RS-232/GP-IB Interface.

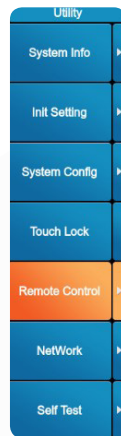

22.5.1 Network Display

- 1) Procedure : Press Utility→Remote Control→Network
- 2) Display menu



The network IP address is needed to be configured when the instrument is connected to PC via Ethernet communication. The IP address displayed on the instrument is the same as the TCP/IP setting that you specified in the Ethernet communication settings.

22.5.2 RS-232 Interface

- 1) Procedure : Press Utility→Remote control→RS-232
- 2) Setup menu :

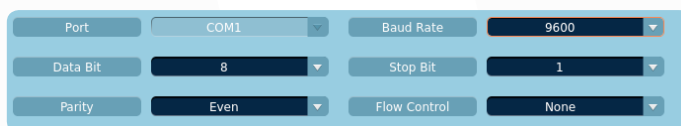

The instrument can be remotely controlled on the PC via RS232 port, of which the port number, baud rate, data bit, stop bit, parity and flow control should be configured

Port Number

COM1

Baud Rate

Baud rate refers to the rate of data transmitted from one device to another, at a rate of bits per second. The baud rate that you can set on this instrument includes 300, 1200, 2400, 4800, 9600, 19200, 38400 or 115200.

Data Bit

The data bit is transmitted after the start bit. The data bit that you can set on this instrument includes 7, 8 or 9.

Stop Bit

The stop bit can be transmitted after each byte has been sent, indicating the end of a character transmission. The stop bit that you can set on this instrument includes 1, 1.5 or 2.

Parity

There are a few modes including None, Odd, Even, Mark and Space. The Parity is available to verify the correctness of the

data. There are a few options that you can select to set on this instrument, including None, Odd, Even, Mark, or Space.

Flow Control

Other Settings need to be set when you need to send a handshake signal or perform data integrity check. There are a few options that you can select, including None, XON/XOFF, RTS/CTS or DTR/DSR.

22.5.3 GP-IB bus (an alternative to settings of RS232)

- 1) Operation path: press Utility key, select "Remote Control" menu and select GP-IB bus
- 2) Settings interface is as follows



- 3) Set GP-IB address of the instrument, connection and data transmission between the computer and the instrument

22.6 Network Setting

In this section, the procedures necessary for a certain parameter configuration to realize Ethernet communication with this instrument will be introduced.

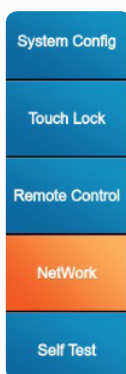

22.6.1 TCP/IP Setting

- 1) Procedure: Press Utility→Network→TCP/IP
- 2) Setup Menu :

Turn on the DHCP function and IP automatic addressing to obtain available IP address

DHCP function, DNS auto addressing, obtaining available DNS server address

DHCP	ON	OFF		
IP Address	192	168	20	206
Net Mask	255	255	255	0
Net Gate	192	168	20	1
DHCP DNS	ON	OFF		
DNS Server1	114	114	114	114
DNS Server2	0	0	0	0

Apply

Enter the IP address within the range from 0.0.0.0 to 255.255.255.255

Enter the Netmask address within the range from 0.0.0.0 to 255.255.255.255

Enter the gateway within the range from 0.0.0.0 to 255.255.255.255

Enter the DNS within the range from 0.0.0.0 to 255.255.255.255

The configuration including IP address, netmask and gateway are necessary when the instrument is connected with the Ethernet. You also need to specify the DNS server address. The server addresses assigned to connect with the power analyzer include: the server address and the standby server address. When it is failed to access to the DNS master server, the system will automatically search for the IP address compatible with the host name and domain name via the standby DNS server.

When the DHCP switch of IP is OFF, the instrument is connected to Ethernet, and it is required to set IP address, netmask and gateway. In addition, the DNS server address needs to be specified. The power analyzer can specify at most two server addresses: primary server address and standby server address. When the access to the DNS primary server fails, the system will automatically find the IP address corresponding to the host name and domain name through the standby DNS server.

When the DHCP switch of IP is ON, the instrument will automatically obtain available IP address, netmask and gateway in the network segment. When the DHCP switch of DNS is ON, DNS will automatically search available DNS server addresses.

22.6.2 FTP Setting

- 1) Procedure : Press Utility→Network→FTP server
- 2) Setup menu



The configuration including IP address, netmask and gateway are necessary when the instrument is connected with the Ethernet. You also need to specify the DNS server address. The server addresses assigned to connect with the power analyzer include: the server address and the standby server address. When it is failed to access to the DNS master server, the system will automatically search for the IP address compatible with the host name and domain name via the standby DNS server.

22.6.2 FTP Setting

- 1) Procedure : Press Utility→Network→FTP server
- 2) Setup menu

You can access this instrument from a PC via FTP server.

FTP server function : From a PC, you can view a list of files that are stored in this instrument's storage media (the internal RAM disk and the storage media that are connected to this instrument) and retrieve files.

22.6.3 Network Drive Setting

- 1) Procedure : Press Utility→Network→Net drive
- 2) Setup menu :

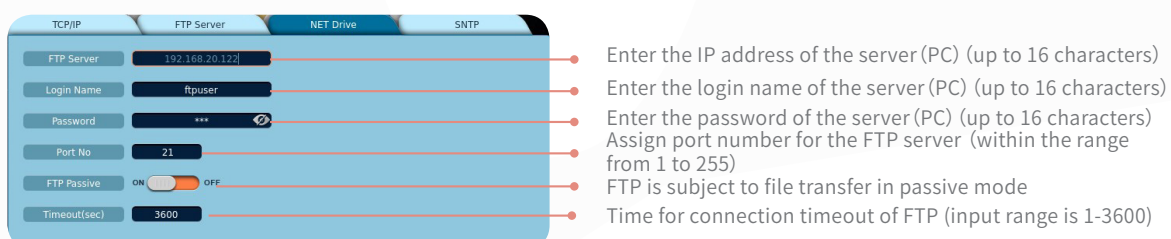

Assign IP address of FTP for connecting this instrument with PC.

Connect the instrument as the client side to the server (PC side), and specify IP address of the network FTP server. Set the timeout period, for example, if there's exception on user name or network, the connection will be disconnected within the timeout period. Turn on the FTP passive mode switch to make the FTP file data transferred in passive mode.

Note :

- A failure notice will prompt out if the FTP server name is not in correct IP address format, i.e. error or out-of-range.
- On the condition that the FTP server name is appropriately entered but there is still one other error, a failure notice will also prompt out after connection and about 10 seconds later.
- In disconnected status, the Disconnect key is invalid, but the Connect key is available.

22.6.4 SNTP Setting

1) Procedure : Press Utility→Network→SNTP

2) Setup menu :

Note :

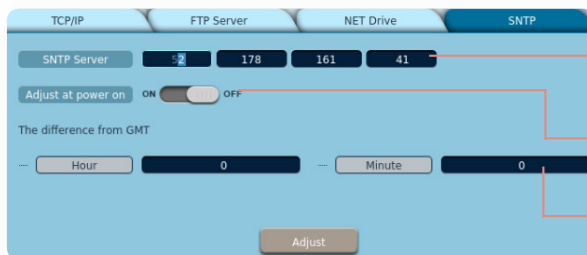

Assign the IP address of the SNTP
Within the range from 0.0.0.0 to 255.255.255.255

When on-line, auto time adjustment can
be turned on

Set the difference from GMT;
The time difference can be input within the
following range:
hour:-12~13
minute:0~59

- A failure notice will prompt out if the SNTP server name is not in correct IP address format, i.e. wrong IP address format or out-of-range.
- After the function of automatic adjustment is turned on, message will prompt out each time when you start up the instrument; press OK to realize time adjustment, or press No to cancel time adjustment. Message will also prompt out if connection failure occurs.
- This setting will finally appear on the screen when the method for setting the date and time is successfully set to SNTP. Set the time difference between the region where you are using this instrument and GMT to a value in the following method.

For example, in the edit box under the Difference from GMT, if you respectively input -1 hour and 30 minute, then the instrument will calculate the time to be displayed on the screen of it by subtracting that time acquired on the server by one hour and 30 minutes.

- Once SNTP server time is successfully acquired, pop-up message will appear to indicate time calibration has been successfully completed. The date in the system setting synchronizes with the time.

22.7 Self-Test Operation

This instrument possesses the functions such as screen calibration and keyboard self-test.

22.7.1 Key Self-Test

1) Procedure : Press Utility→Self Test→Button

2) Setup menu :

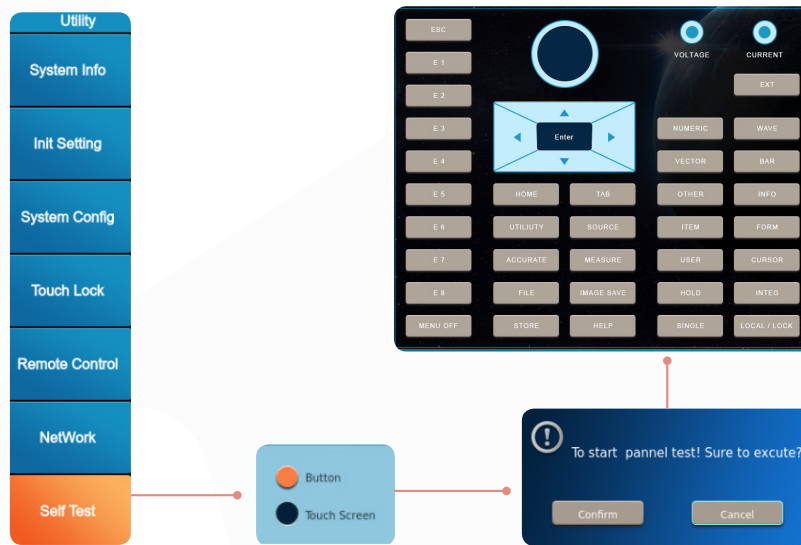

If you select Self-Test to the keys, a pop-up message will appear for your confirmation to access to the key self-test menu. In the key self-test menu, you can see that the icons on the screen will be illuminated along with the corresponding keys on the panel being pressed except the ESC key and the POWER key. The illuminated icons of the keys reflect the corresponding keys are normal and valid.

22.7.2 Touch Screen Self-Test

- 1) Procedure : Press Utility→Self Test→Screen
- 2) Setup menu :



There are 5 calibration locations(in sequence are top left corner, top right corner, bottom left corner, bottom right corner, middle) on the calibration screen. Each time when you click anywhere on the touch screen, the calibration locations/ points will appear then disappear in sequence.

On the touch screen calibration screen, calibration will repeat if you don't click on the screen according to the appropriate methods of operation. If you want to force the screen calibration to exit, you can use the ESC key; however, in this case, a larger screen positioning bias will arise.

Chapter 23 Other Settings and Operations

23.1 Setting the Press Key or Touch Screen

23.1.1 Screen Lock or Unlock

Procedure 1 : Press UTILITY→Touch Lock/Unlock

You can use the above method to switch the operations between the touch lock and touch unlock. This operation method will not affect the operations with the press keys on the panel. The operation procedures are the same as Section 22.4.

Procedure 2 : Press and hold the Press Key of LOCAL/LOCK on the panel for 3 seconds.

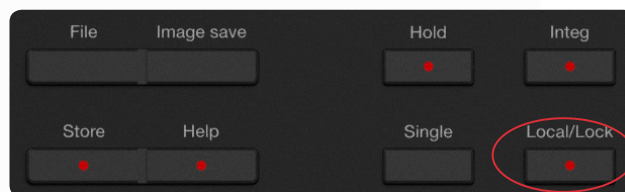

If you perform the operations according to the Procedure 2, not only the screen will be locked, but also the press keys on the panel except the Power key are all locked, indicator of the LOCAL/LOCK key illuminated. Only when you press and hold the LOCAL/LOCK key on the panel again for 3 seconds can the press keys on the panel and the touch screen be unlocked to be used again.

Second Features of the LOCAL/LOCK Key

When the function of Remote Control is enabled, press the LOCAL/LOCK key again to force Remote Control to be disconnected with the instrument, so that this instrument can exit from remote control mode and return to local operation mode.

23.1.2 Key Lock and Unlock

The methods of key lock and unlock operations are the same as the above operation procedure 2.

23.2 Holding the Data

1) Procedure : Press the HOLD key

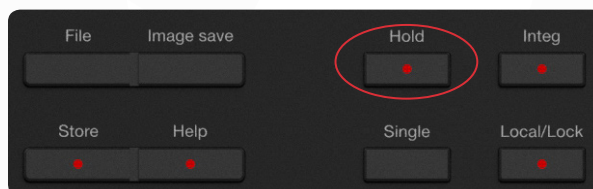

2) Function : This key is used to hold the current measurement data.

When the HOLD key is pressed and the HOLD indicator will illuminate, the data update will stopped being displayed on the screen, and the number of measurement display will be held. Pressing the HOLD key again turns off the HOLD indicator and restarts the updating of the numeric data display, with number of measurement added up and displayed at the bottom of the screen.

⚠ Note :

- In the flicker, period analysis, and raw data save mode, Hold cannot be set, where a prompt box will pop up if it is under the flicker and period analysis mode, or there will be no response if it's saving the raw data.
- This device will not stop measuring except display update during Hold status. Once Hold status is canceled, the latest measured data and counts of data package will be displayed.

23.3 Single Shot Measurement

1) Procedure : Press SINGLE key



2) Function : This instrument can perform single shot measurement and data update.

Single Measurement will be performed and Numeric Data will be updated whenever you press SINGLE key on the condition that the data is in Hold status. You can enable the function of the single shot measurement only when the HOLD key illuminates.

23.4 Combination Display

Multiple interfaces design: you can select 2 to 4 kinds of display interface from the 5 kinds of display interface for combined display, including Numeric, Wave, Vector, Bar, Trend.

1) Procedure : Press OTHERS→Combine

2) Display menu : Follows are the 4 formats of combination menu for data display



Click on the "Combine" menu, select several types of data to be shown on the screen. If you select the display types such as the waveform, numeric, vector graph and bar graph, they will be all displayed on the screen. The TAB key allows you to switch between menus to set the data to be displayed.

⚠ Note :

- Up to 4 options can be set in the combination display menu.
- repeatedly press the TAB key to switch between then menus in the order of “1→2→3→4→1”.

23.5 Setting Home Page

- 1) Procedure : Press and hold the HOME key

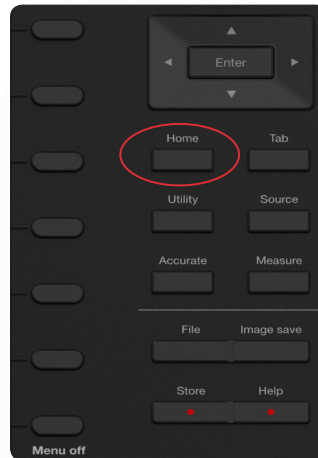

- 2) Function : You can set the current menu to be displayed as Main menu. You can press and hold the HOME key to set the current menu to be displayed as Home menu.

23.6 Menu Hide

- 1) Procedure : Press the MENU OFF key



- 2) Function : The function menus can be concealed, and then the menu regarding range can be displayed. If the menu bar of the element range is not displayed at the right of the screen, press the MENU OFF key to switch between the current menu and the element range menu. You can use the soft keys to select the input elements in the range menu so that the voltage and current ranges of these elements can be set.

23.7 Displaying the Setup Parameter List

You can view the menu of the setup parameter list on this power analyzer by pressing one key. You can modify or set various parameters in this setup menu.

- 1) Procedure : Press INFO key



The parameters can be set by the cursor: You can move the cursor to the option and then press ENTER key, select or edit appropriate parameters in the drop down menus, and then press ENTER to confirm the parameters.

2) Setup menu shown as follow :



The contents listed in the parameter list include voltage and current information of each input element module. Parameters that can be set include the wiring systems of each unit, voltage range, the current range, external sensor, scaling, VT ratio, CT ratio, SF ratio, synchronization source, line filter, voltage frequency filter and current frequency filter, etc.

23.8 Screenshot

1) Procedure : Press the IMAGE SAVE key

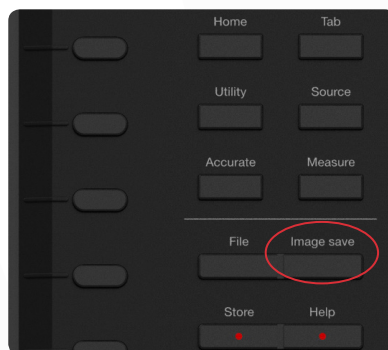

2) Function : The screen image can be saved in this instrument.

You can save the current screen image to files. The screen images are saved to the folder of IMAGE SAVE by default. When the external USB storage device is connected to this power analyzer, this power analyzer can auto save the screen images to the external USB storage device.

23.9 Help Function

The user's manual of this power analyzer can be shown via Help function. You can also tap the ESC or tap <Help> key again to exit from the HELP interface.

- 1) Procedure : Press HELP key



- 2) The HELP menu is shown as follows:

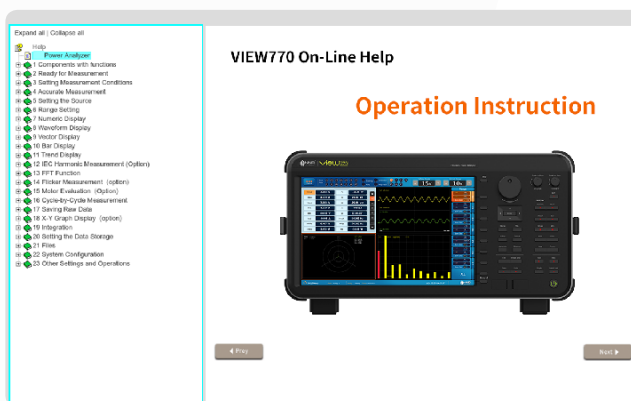

When you click any function (such as INTEG, STORE) in the HELP interface except <Help> key, you can access to the corresponding contents of descriptions and explanations. At the same time, you can use the arrow keys (up/down/left/right) and the “Enter” key r to select in the catalog of help document for related descriptions.

23.10 Function of Switching

- 1) Procedure : Press TAB key



2) Function : Switch

The TAB key is available for switching between the operation options or combination displays so that you can set the display items and formats conveniently.

The TAB key can be used when the following items should be configured.

- In Combination Menu: The TAB key can be used to switch between the functions to be enabled, such as the displays of waveform, numeric, vector, bar, trend.
- In Utility Menu: The TAB key can be used to switch between the items to be configured for the system, such as the settings of language, date and time, display, preference.
- In Remote Control Menu: The TAB key can be used to switch between the configurations of the network interfaces, such as the settings of network, RS 232 port and GPIB.
- In the Network Menu: The TAB key can be used to switch between the options of setting the network address and protocol, such as TCP/IP, FTP host name, network drive, SNTP.

23.11 Home Menu

- 1) Procedure: Tap the Menu icon on the screen or use mouse to click it.



The major measured items and parts of functions commonly used can be displayed on the main menu in the form of icons, which you can press and select to access to the corresponding menus easily. If want to go back to the previous menu, you can press the Menu icon again. The element ranges are displayed in the context menu at the right side of the main menu.

Following icons of the applications are included in the main menu: Numeric, Wave, Vector, Bar, Trend, Combination, IEC Harmonic, FFT, Flicker, Motor, Cycle-by-cycle measurement, Raw data save, X-Y graph, Information, Integration, Upgrade and Help.

Appendix

Appendix I Symbols and Definitions for Measurement Functions Normal Measurement (Function obtained for each input element)

Items	Symbols and Descriptions
Volage (V)	Urms: True RMS value, Umn: Rectified mean value calibrated to the RMS value, Udc: Simple mean value, Urmn: Rectified mean value, Uac: AC component
Current (A)	Urms: True RMS value, Imn: Rectified mean value calibrated to the RMS value, Idc: Simple mean value, Irmn: Rectified mean value, Iac: AC component
Active power (W)	P
Apparent power (VA)	S
Reative power (var)	Q
Power factor	λ
Phase angle (°)	ϕ
Frequency (Hz)	fU (FreqU) :Voltage frequency, fI (FreqI) :Current frequency; In frequency measurement option, all values of fU and fI of all elements allow to be measured simultaneously.
Maximun and minimum voltage values (V)	U+pk: Maximum voltage value, U-pk: Minimum voltage value
Maximum and Minimum current values (A)	I+pk: Maximum current value, I-pk: Minimum current value
Maximum and minimum power values (W)	P+pk: Maximum power value, P-pk: Minimum power value
Crest factor	CfU: Voltage crest factor, CfI: Current crest factor
Corrected power (W)	Pc Applicable standards IEC76-1 (1976) , IEC76-1 (1973)
Integration	Time: Integration time WP: Sum of the amount of both positive and negative power WP+: Sum of positive P (amount of power consumed) WP-: Sum of negative P (amount of power returned to the grid) q: Sum of the amount of both positive and negative current q+: Sum of positive I (amount of current) q-: Sum of negative I (amount of current) WS*: Amount of apparent power WQ*: Amount of reactive power However, the amount of current is integrated by selecting any one of Irms, Imn, Idc, Iac, and Irmn depending on the setting of the current mode.

Normal Measurement: Measurement function (Σ function) obtained for each connected unit (Wiring system)

Items	Symbols and Descriptions
Voltage (V)	Urms Σ : True RMS value, Umn Σ : Rectified mean value calibrated to the RMS value, Udc Σ : Simple mean value, Urmn: Rectified mean value, Uac Σ : AC component
Current (A)	Irms Σ : True RMS value, Imn Σ : Rectified mean value calibrated to the RMS value, Idc Σ : Simple mean value, Irmn Σ : Rectified mean value, Iac Σ : AC component
Active power (W)	P Σ
Apparent power (VA)	S Σ
Reactive power (var)	Q Σ
Power factor	λ Σ
Corrected power (W)	Pc Σ Applicable standards: IEC76-1 (1976), IEC76-1 (1973)
Integration	Time Σ : Integration time WP Σ : Sum of the amount of both positive and negative power WP+ Σ : Sum of positive P (amount of power consumed) WP- Σ : Sum of negative P (amount of power returned to the grid) q Σ : Sum of the amount of both positive and negative current q+ Σ : Sum of positive I (amount of current) q- Σ : Sum of negative I (amount of current) WS Σ : Integration of S Σ WQ Σ : Integration of Q Σ
voltage Positive and negative order	PosU Σ : Positive - sequence voltage NegU Σ : Negative - sequence voltage PosI Σ : Positive - sequence current NegI Σ : Negative - sequence voltage PosP Σ : Positive - sequence power

Harmonic Measurement (Function obtained for each input element)

Items	Symbols and Descriptions
Voltage (V)	UU(k): RMS value of the harmonic voltage of order k[1], U: Voltage RMS value (Total value[2])
Current (A)	I(k): RMS value of the harmonic current of order k, I: Current RMS value (Total value[2])
Active power (W)	P(k): Active power of the harmonic of order k, P: Active power (- Total value[2])
Apparent power (VA)	S(k): Apparent power of the harmonic of order k, S: Total appar- ent power (Total value[2])
Reactive power (var)	Q(k): Reactive power of the harmonic of order k, Q: Total reac- tive power (Total value[2])
Power factor	λ (k): Power factor of the harmonic of order k, λ : Total power factor (Total value[2])
Phase angle (°)	\varnothing (k): Phase angle between the harmonic voltage and current of order k \varnothing : Total phase angle \varnothing U(k): Phase angle of each harmonic voltage U(k) relative to the fundamental wave U(1) \varnothing I(k): Phase angle of each harmonic current I(k) relative to the fundamental wave I(1)
Impedance of the load circuit (Ω)	Z(k): Impedance of the load circuit for the harmonic of order k

Resistance and reactance of the load circuit (Ω)	$R_s(k)$: Resistance of the load circuit to the harmonic of order k when the resistance R , the inductance L , and the capacitor C are connected in series $X_s(k)$: Reactance of the load circuit to the harmonic of order k when the resistance R , the inductance L , and the capacitor C are connected in series $R_p(k)$: Resistance of the load circuit to the harmonic of order k when the resistance R , the inductance L , and the capacitor C are connected in parallel $X_p(k)$: Reactance of the load circuit to the harmonic of order k when the resistance R , the inductance L , and the capacitor C are connected in parallel
Harmonic content[%]	$U_{hdf}(k)$: Ratio of the harmonic voltage $U(k)$ to $U(1)$ or U $I_{hdf}(k)$: Ratio of the harmonic current $I(k)$ to $I(1)$ or I $P_{hdf}(k)$: Ratio of the active harmonic power $P(k)$ to $P(1)$ or P
Total harmonic distortion[%]	U_{thd} : Ratio of the total harmonic [3] voltage to $U(1)$ or U I_{thd} : Ratio of the total harmonic [3] current to $I(1)$ or I P_{thd} : Ratio of the total harmonic [3] active power to $P(1)$ or P
Telephone harmonic factor	U_{thf} : Voltage telephone harmonic factor, I_{thf} : Current telephone harmonic factor Applicable standard: IEC 34-1 (1996)
Telephoen influence factor	U_{tif} : Voltage telephone influence factor, I_{tif} : Current telephone influence factor Applicable standard: IEEE Std 100 (1996)
Harmonic voltage factor[4]	H_{vf} : harmonic voltage factor
Harmonic current factor[4]	H_{cf} : harmonic current factor
K-factor	Ratio of the sum of the squares of weighted harmonic components to the sum of the squares of the orders of harmonic current

⚠ Note:

- 1: Order k is an integer in the range from 0 to the upper limit value for the measured order. The 0th order is a DC current component (dc). The upper limit value for the measured order is automatically determined up to the 500th order depending on the frequency of the PLL source.
- The total value is calculated by obtaining the fundamental wave (the 1st order) and all harmonic components (from the 2nd order to the upper limit value for the measured order). Also, the DC component (dc) can be added to the equation.
- The total harmonic is calculated by obtaining the total harmonic component (from the 2nd order to the upper limit value for the measured order).
- The equations may vary depending on the definitions in the standards, etc. Check the standards for details.

This is a measurement function indicating the phase angle of the fundamental wave $U(1)$ or $I(1)$ of another element to the fundamental wave $U(1)$ of the element with the smallest number among input elements assigned to the connected unit. The following table shows measurement functions for the connected unit with a combination of the elements 1, 2, and 3.

Phase angle $U1-U2$ ($^\circ$)	$\angle U1-U2$: Phase angle of the fundamental wave ($U2(1)$) of the voltage of the element 2 to the fundamental wave ($U1(1)$) of the voltage of the element 1
Phase angle $U1-U3$ ($^\circ$)	$\angle U1-U3$: Phase angle of the fundamental wave ($U3(1)$) of the voltage of the element 3 to $U1(1)$
Phase angle $U1-I1$ ($^\circ$)	$\angle U1-I1$: Phase angle of the fundamental wave ($I1(1)$) of the current of the element 1 to $U1(1)$
Phase angle $U1-I2$ ($^\circ$)	$\angle U1-I2$: Phase angle of the fundamental wave ($I2(1)$) of the current of the element 2 to $U1(1)$
Phase angle $U1-I3$ ($^\circ$)	$\angle U1-I3$: Phase angle of the fundamental wave ($I3(1)$) of the current of the element 3 to $U1(1)$

Harmonic Measurement function (Σ function) obtained for each connected unit (Wiring system)

Items	Symbols and Descriptions
Voltage (V)	$U_{\Sigma(1)}$: RMS of the harmonic voltage of order 1, U_{Σ} : RMS of the voltage (Total value)
Current (A)	$I_{\Sigma(1)}$:RMS of the harmonic current of order 1, I_{Σ} : RMS of the current (Total value)
Active power (W)	$P_{\Sigma(1)}$:Harmonic active power of order 1, P_{Σ} : Total active power (Total value*)
Apparent power (VA)	$S_{\Sigma(1)}$: Harmonic apparent power of order 1, S_{Σ} : Total apparent power (Total value)
Reactive power (var)	$Q_{\Sigma(1)}$: Harmonic reactive power of order 1, Q_{Σ} : Total reactive power (Total value*)
Power factor	$\lambda_{\Sigma(1)}$: Harmonic power factor of order 1, λ_{Σ} : Total power factor (Total value)

The total value is calculated by obtaining the fundamental wave (the 1st order) and all harmonic components (from the 2nd order to the upper limit value for the measured order). Also, the DC component (dc) can be added to the equation.

Appendix II Formula Used in Power Analyzer Measurement

Normal Measurement Functions

Items and Definitions		Symbols	Formula	
Voltage U(V)	True rms value	U_{rms}	$U_{rms} = \sqrt{\frac{1}{N} \cdot \sum_{n=1}^N u(n)^2}$	
	Rectified mean value calibrated to the rms value	U_{mn}	$U_{mn} = \frac{\pi}{2\sqrt{2}} \cdot \frac{1}{N} \cdot \sum_{n=1}^N u(n) $	
	Simple average	U_{dc}	$U_{dc} = \frac{1}{N} \cdot \sum_{n=1}^N u(n)$	
	Rectified mean value	U_{rmn}	$U_{rmn} = \frac{1}{N} \cdot \sum_{n=1}^N u(n) $	
	AC component	U_{ac}	$U_{ac} = \sqrt{U_{rms}^2 - U_{dc}^2}$	
Current I(A)	True rms value	I_{rms}	$I_{rms} = \sqrt{\frac{1}{N} \cdot \sum_{n=1}^N i(n)^2}$	
	Rectified mean value calibrated to the rms value	I_{mn}	$I_{mn} = \frac{\pi}{2\sqrt{2}} \cdot \frac{1}{N} \cdot \sum_{n=1}^N i(n) $	
	Simple average	I_{dc}	$I_{dc} = \frac{1}{N} \cdot \sum_{n=1}^N i(n)$	
	Rectified mean value	I_{rmn}	$I_{rmn} = \frac{1}{N} \cdot \sum_{n=1}^N i(n) $	
	AC component	I_{ac}	$I_{ac} = \sqrt{I_{rms}^2 - I_{dc}^2}$	
Power	Active power	$P(W)$	$P = \frac{1}{N} \cdot \sum_{n=1}^N [u(n) \cdot i(n)]$	
	Apparent power	$S(VA)$	Type1&2	Select from $U_{rms} \cdot I_{rms}$, $U_{dc} \cdot I_{dc}$, $U_{mn} \cdot I_{rms}$, $U_{mn} \cdot I_{mn}$ and $U_{rmn} \cdot I_{rmn}$
			Type3	$S = \sqrt{P^2 + Q^2}$
	Reactive power	$Q(var)$	Type1&2	$Q = k \cdot \sqrt{S^2 - P^2}$ (k is -1 for a lead phase and 1 for a lag phase)
Type3			$Q = \sum_{n=\min}^{\max} [U_i(n) \cdot I_j(n) - U_j(n) \cdot I_i(n)]$ $U_i(n)$ and $I_i(n)$ are the real number components of $U(n)$ and $I(n)$; $U_j(n)$ and $I_j(n)$ are the imaginary components of $U(n)$ and $I(n)$; Valid only when harmonics are being measured correctly.	

Power factor	λ	$\lambda = \frac{P}{S}$	
Phase difference	$\Phi(^{\circ})$	$\Phi = \cos^{-1}\lambda$	
Voltage frequency	FreqU(Hz)	The fu (voltage frequency) and fl(current frequency) are measured by detecting the zero-crossing points. The fU and fl of all elements can be measured simultaneously.	
Current frequency	FreqI(Hz)		
Max voltage and Min voltage	$U \pm pk(V)$	The maximum u(n) and minimum u(n) for every data update	
Max current and Min current	$I \pm pk(A)$	The maximum i(n) and minimum i(n) for every data update	
Max power and Min power	$P \pm pk(W)$	The maximum [u(n) · i(n)] and minimum [u(n) · i(n)] for every data update	
Voltage crest factor	CfU	$CfU = \frac{Upk}{U_{rms}}$ $Upk = U+pk \text{ or } U-pk , \text{ whichever is larger}$	
Current crest factor	CfI	$CfI = \frac{Ipk}{I_{rms}}$ $Ipk = I+pk \text{ or } I-pk , \text{ whichever is larger}$	
Corrected Power	Pc (W)	IEC76-1(1976)	$Pc = \frac{P}{P1 + P2 \left(\frac{U_{rms}}{U_{mn}} \right)^2}$ P1 and P2 are the coefficients defined in the applicable standards.
		IEC76-1(1993)	$Pc = P \left(1 + \frac{U_{mn} - U_{rms}}{U_{mn}} \right)$

Integration Measurement Function

Items and Definitions	Symbols	Formula
Integration time (h:m:s)	Time(s)	Time from integration start to integration stop
Watt hours	Wp(Wh) Wp+(Wh) Wp-(Wh)	When watt-hour integration method is Charge/Discharge $WP = \left[\frac{1}{N} \cdot \sum_{n=1}^N \{u(n) \cdot i(n)\} \right] \cdot \text{Time}$ <p>[u(n) · i(n)] is the nth sampled data of the instantaneous power. N is the integration time sampling count. The unit of Time is hours. WP is the sum of positive and negative watt hours. WP+ is the sum of the above equations for all iterations where [u(n) · i(n)] is positive. WP- is the sum of the above equations for all iterations where [u(n) · i(n)] is negative.</p>
		When the watt-hour integration method is Sold/Bought $WP = \left[\frac{1}{N} \cdot \sum_{n=1}^N \{u(n) \cdot i(n)\} \right] \cdot \text{Time}$ <p>[u(n) · i(n)] is the nth active power at each data update interval. N is the integration time sampling count. The unit of Time is hours. WP is the sum of positive and negative watt hours. WP+ is the sum of the positive power values at each data update interval. WP- is the sum of the negative power values at each data update interval.</p>
Ampere hours	q(Ah) q+(Ah) q-(Ah)	In RMS, MEAN, R-MEAN, AC modes $q = \frac{1}{N} \cdot \sum_{n=1}^N I(n) \cdot \text{Time}$ <p>N is the number of data update within integration time period. I(n) is the nth sample data of the current signal (in rms, mean, r-mean, ac modes). The unit of Time is hours.</p> In DC mode $q = \frac{1}{N} \cdot \sum_{n=1}^N i(n) \cdot \text{Time}$ <p>N is the number of data samples, i(n) is the nth sampled data of the current signal. The unit of Time is hours.</p>

Volt-ampere hours	WS(VAh)	$WS = \frac{1}{N} \cdot \sum_{n=1}^N S(n) \cdot \text{Time}$ <p>S(n) is the nth measured apparent power value at update period. N is the number of data updates.</p>
Var hours	WQ(varh)	$WQ = \frac{1}{N} \cdot \sum_{n=1}^N Q(n) \cdot \text{Time}$ <p>Q(n) is the nth measured reactive power value at update period. N is the number of data updates within integration time period.</p>

Σ Function

Measurement Function	Single-phase, three-wire	Three-phase, three-wire	Three-phase, three-wire (three-voltage, three current method)	Three-phase, four-wire
Voltage U Σ [V]	(U1+U2) / 2		(U1+U2+U3) / 3	
Current I Σ [A]	(I1+I2) / 2		(I1+I2+I3) / 3	
Active power	P1+P2			P1+P2+P3
Apparent power S Σ [VA]	TYPE1	S1+S2	$\frac{\sqrt{3}}{2} (S1 + S2)$	$\frac{\sqrt{3}}{3} (S1 + S2 + S3)$
	TYPE2			
	TYPE3	$\sqrt{P\Sigma^2 + Q\Sigma^2}$		
Reactive power Q Σ [VA]	TYPE1	Q1+Q2		Q1+Q2+Q3
	TYPE2	$\sqrt{S\Sigma^2 - P\Sigma^2}$		
	TYPE3	Q1+Q2		Q1+Q2+Q3
Corrected power Pc Σ [W]	Pc1+Pc2			Pc1+Pc2+Pc3
Power integration WP Σ [Wh]	WP1+WP2			WP1+WP2+WP3
Power integration (positive) WP+ Σ [Wh]	WP+1+WP+2			WP+1+WP+2+WP+3
Power integration (negative) WP- Σ [Wh]	WP-1+WP-2			WP-1+WP-2+WP-3
Current integration q Σ [Ah]	q1+q2			q1+q2+q3
Current integration (positive) q+ Σ [Ah]	q+1+q+2			q+1+q+2+q+3
Current integration (negative) q- Σ [Ah]	q-1+q-2			q-1+q-2+q-3
Reactive power integration WQ Σ [varh]	$WQ = \frac{1}{N} \cdot \sum_{n=1}^N Q\Sigma(n) \cdot \text{Time}$ <p>Q Σ (n) is the nth reactive power Σ function. N is the number of data updates. The unit of Time is h.</p>			
Apparent power integration WS Σ [VAh]	$WS = \frac{1}{N} \cdot \sum_{n=1}^N S\Sigma(n) \cdot \text{Time}$ <p>S Σ (n) is the nth apparent power Σ function. N is the number of data updates. The unit of time is h.</p>			
Power factor λ Σ	$\frac{P\Sigma}{S\Sigma}$			
Phase difference φ Σ [°]	$\cos^{-1} \left(\frac{P\Sigma}{S\Sigma} \right)$			

⚠ Note :

- $u(n)$ denotes the instantaneous voltage(or sample data from voltage signal) ; $i(n)$ denotes the instantaneous current (or sample data from current signal).
- $P_{\Sigma A}$ and $P_{\Sigma B}$ respectively denote the active powers of wiring system ΣA and wiring system ΣB . Input elements assigned to wiring system ΣA and wiring system ΣB respectively vary depending on the number of input elements that are installed in this power analyzer and the types of selected wiring system.
- The numbers 1, 2, and 3 used in the equations for U_{Σ} , I_{Σ} , P_{Σ} , S_{Σ} , Q_{Σ} , $P_{c\Sigma}$, $W_{P\Sigma}$ and q_{Σ} indicate the case when input elements 1, 2, and 3 are set to the wiring system shown in the table. If input elements 2, 3 and 4 are set to the wiring system, use the numbers 2, 3 and 4 instead.
- On this instrument, S , Q , λ , and Φ are determined via the computation of the measured values of voltage, current, and active power (however, when Type 3 is selected, Q is determined directly from the sampled data). Therefore, for distorted signal input, the value obtained on this instrument may differ from that obtained on other instruments based on a different method.
- For Q [var], when the current leads the voltage, the Q value is displayed as a negative value; When the current lags the voltage, the Q value is displayed as a positive value.

Harmonic Measurement Function

Items and symbols	Formula		
	k denotes harmonic order, i denotes the real part, and j denotes the imaginary part.		
	K=0 (DC)	K=1~max(Fundamental harmonic +harmonics of each order)	Total(Total value)
Voltage of harmonic of order: k U(K) [V]	$U_{(dc)} = U_{i(0)}$	$U(k) = \sqrt{U_i(k)^2 + U_j(k)^2}$	$= \sqrt{\sum_{k=\min}^{\max} U(k)^2}$
Current of harmonic of order k: I(K) [A]	$I_{(dc)} = I_{i(0)}$	$I(k) = \sqrt{I_i(k)^2 + I_j(k)^2}$	$I = \sqrt{\sum_{k=\min}^{\max} I(k)^2}$
Active power of harmonic of order k: P(K) [W]	$P_{(dc)} = U_{i(0)} \cdot I_{i(0)}$	$P(k) = U_i(k) \cdot I_i(k) + U_j(k) \cdot I_j(k)$	$P = \sum_{k=\min}^{\max} P(k)$
Apparent power of harmonic of order k: S(K) [VA]	$S_{(dc)} = P_{(dc)}$	$S(k) = \sqrt{P(k)^2 + Q(k)^2}$	$S = \sqrt{P^2 + Q^2}$
Reactive power of harmonic of order k: Q(K) [W]	$Q_{(dc)} = 0$	$Q(k) = U_i(k) \cdot I_j(k) - U_j(k) \cdot I_i(k)$	$Q = \sum_{k=\min}^{\max} Q(k)$
Power factor of harmonic of order k: λ(k)	$\lambda_{(dc)} = \frac{P_{(dc)}}{S_{(dc)}}$	$\lambda(k) = \frac{P(k)}{S(k)}$	$\lambda = \frac{P}{S}$
Phase angle of harmonic of order k: Φ [°]	—	$\Phi(k) = \text{ATAN2}\{P(k), Q(k)\}$	$\Phi = \text{ATAN2}\{P, Q\}$
Phase difference between kth order harmonic voltage and fundamental U(1): ΦU(k) [°]	—	—	—
Phase difference between kth order harmonic current and fundamental I(1): ΦI(k) [°]	—	—	—
Impedance of the load circuit of kth order harmonic: Z(k) [Ω]	$Z_{(dc)} = \frac{ U_{(dc)} }{ I_{(dc)} }$	$Z(k) = \frac{ U(k) }{ I(k) }$	—
Series resistance of the load circuit of kth order harmonic: Rs(k) [Ω]	$R_{s(dc)} = \frac{P_{(dc)}}{I_{(dc)}^2}$	$R_s(k) = \frac{P(k)}{I(k)^2}$	—
Series reactance of the load circuit of kth order harmonic: Xs(k) [Ω]	$X_{s(dc)} = \frac{Q_{(dc)}}{I_{(dc)}^2}$	$X_s(k) = \frac{Q(k)}{I(k)^2}$	—
Parallel resistance of the load circuit of kth order harmonic: Rp(k) [Ω]	$R_{p(dc)} = \frac{U_{(dc)}^2}{P_{(dc)}}$	$R_p(k) = \frac{U(k)^2}{P(k)}$	—
Parallel reactance of the load circuit of kth order harmonic: Xp(k) [Ω]	$X_{p(dc)} = \frac{U_{(dc)}^2}{Q_{(dc)}}$	$X_p(k) = \frac{U(k)^2}{Q(k)}$	—

Items and Symbols	Formula	
	When the denominator of the distortion factor equation is the total value	When the denominator of the distortion factor equation is the fundamental wave
Harmonic voltage distortion factor Uhdf(k) [%]	$\frac{U(k)}{U(\text{Total})} \cdot 100$	$\frac{U(k)}{U(1)} \cdot 100$
Harmonic current distortion factor Ihdf(k) [%]	$\frac{I(k)}{I(\text{Total})} \cdot 100$	$\frac{I(k)}{I(1)} \cdot 100$
Harmonic active power distortion factor Phdf(k) [%]	$\frac{P(k)}{P(\text{Total})} \cdot 100$	$\frac{P(k)}{P(1)} \cdot 100$
Total harmonic voltage distortion Uthd [%]	$\frac{1}{U(\text{Total})} \cdot \sqrt{\sum_{k=2}^{\max} U(k)^2} \cdot 100$	$\frac{1}{U(1)} \cdot \sqrt{\sum_{k=2}^{\max} U(k)^2} \cdot 100$
Total harmonic current distortion Ithd [%]	$\frac{1}{I(\text{Total})} \cdot \sqrt{\sum_{k=2}^{\max} I(k)^2} \cdot 100$	$\frac{1}{I(1)} \cdot \sqrt{\sum_{k=2}^{\max} I(k)^2} \cdot 100$
Total harmonic active power distortion Pthd [%]	$\left \frac{1}{P(\text{Total})} \cdot \sum_{k=2}^{\max} P(k) \right \cdot 100$	$\left \frac{1}{P(1)} \cdot \sum_{k=2}^{\max} P(k) \right \cdot 100$
Voltage telephone harmonic factor Uthf [%]	$U_{thf} = \frac{1}{U(\text{Total})} \cdot \sqrt{\sum_{k=1}^{\max} \{\lambda(k) \cdot U(k)\}^2} \cdot 100$ <p>$\lambda(k)$: coefficient defined in the applicable standard (IEC34-1 (1996))</p>	
Current telephone harmonic factor Ithf [%]	$I_{thf} = \frac{1}{I(\text{Total})} \cdot \sqrt{\sum_{k=1}^{\max} \{\lambda(k) \cdot I(k)\}^2} \cdot 100$ <p>$\lambda(k)$: coefficient defined in the applicable standard (IEC34-1 (1996))</p>	
Voltage telephone influence factor Utif [%]	$U_{tif} = \frac{1}{U(\text{Total})} \cdot \sqrt{\sum_{k=1}^{\max} \{T(k) \cdot U(k)\}^2}$ <p>$T(k)$: coefficient defined in the applicable standard (IEEE Std 100 (1992))</p>	
Current telephone influence factor Itif [%]	$I_{tif} = \frac{1}{I(\text{Total})} \cdot \sqrt{\sum_{k=1}^{\max} \{T(k) \cdot I(k)\}^2}$ <p>$T(k)$: coefficient defined in the applicable standard (IEEE Std 100 (1992))</p>	
Harmonic voltage factor hvf [%]	$hvf = \frac{1}{U(\text{Total})} \cdot \sqrt{\sum_{k=2}^{\max} \frac{U(k)^2}{k}} \cdot 100$	
Harmonic current factor hcf [%]	$hcf = \frac{1}{I(\text{Total})} \cdot \sqrt{\sum_{k=2}^{\max} \frac{I(k)^2}{k}} \cdot 100$	
K factor K_factor	$K_factor = \sum_{k=1}^{\max} \{I(k)^2 \cdot k^2\} \cdot \frac{1}{\sum_{k=1}^{\max} I(k)^2}$	
Φ_{Ui-Uj}	Phase difference between $U_i(1)$ (fundamental voltage of element i) and $U_j(1)$ (fundamental voltage of element j)	
Φ_{Ui-Uk}	Phase difference between $U_i(1)$ (fundamental voltage of element i) and $U_k(1)$ (fundamental voltage of element k)	
Φ_{Ui-li}	Phase difference between $U_i(1)$ (fundamental voltage of element i) and $I_i(1)$ (fundamental current of element i)	
Φ_{Ui-lj}	Phase difference between $U_i(1)$ (fundamental voltage of element i) and $I_j(1)$ (fundamental current of element j)	
Φ_{Ui-lk}	Phase difference between $U_i(1)$ (fundamental voltage of element i) and $I_k(1)$ (fundamental current of element k)	

Appendix III Initial Settings

Item	Setting	Initializing Default
Numeric display	Display format	4-item display:Urms1,Irms1,P1,λ1 8-item display:Urms1,Irms1,P1,λ1,S1,Φ1,FreqU1,FreqI1 16-item display:Urms1,Irms1,Umn1,Imn1,Udc1,Idc1,Urmn1,Irmn1,P1,S1,Q1,λ1,Φ1,FreqU1,FreqI1,Pc1 All-item display:U,I,P,Q,S,λ,φ,fu,fi,Cfu,Cfi,U+peak,U-peak,I+peak,I-peak,Umn,Imn,Urmn,Irmn,Udc,Idc,Uac,Iac,Pc Single list for harmonics display:Urms,Irms,P,S,Q,λ,φ;Uthd,Ithd,Pthd,Uthf,Ithf,Utif,Itif,K-factor, values for harmonics from order 1 to 40 and hdf(%) Dual lists for harmonic display:Urms,Irms,P,S,Q,λ,φ;Uthd,Ithd,Pthd,Uthf,Ithf,Utif,Itif,K-factor, values for harmonics from order 1 to 20 and hdf(%)
	Display item	4-,8-,16-item Item No.:1 Item function:Urms Element/Σ:1 Single list Item function:U(*) Element/Σ:1 Dual lists Item function 1:U(*) Element/Σ 1:1 Item function 2:I(*) Element/Σ 2:1
Waveform display	Display format	Split screen:Single Time axis:50ms Trigger mode:Off Trigger slope:rising edge Trigger source:U1 Trigger level:0.0% Wave label:ON Scale value display:ON Interpolate:ON Graticule:Grid Wave mapping:Auto
	Display item	Display U1~U7,I1~I7,Speed1,Torque1:ON Math1,Math2:OFF Zoom:1.0 Location:0.00%
		Waveform Computation 1 Expression:U1*I1 Range:Auto Unit:W Label:Math1
		Waveform Computation 2 Expression:ABS(U1) Range:Auto Unit:V Label:Math2
Display cursor	Constant K1~K8:1~8	
Vector display	Display format	Cursor:OFF C1+Wave:U1 C2x Wave:U1 C1+Position:0 C2x Position:0 Linkage:OFF
	Display item	Split screen:Single Numeric:ON
	Display item	Item No.:Element 1 U/I ratio:1.0 Synchronization mode:ON

Bar display	Display format	Split screen:Single Start:0 End:10
	Display item	Item 1 Element/ Σ : Element 1 Function:U Sort:OFF Scale mode:Auto
		Item 2 Element/ Σ : Element1 Function:I Sort:OFF Scale mode:Auto
		Item 3 Element/ Σ : Element 1 Function:P Sort:OFF Scale mode:Auto
Display cursor	Cursor:OFF C1+harmonic order:0 C2x harmonic order:0 Linkage:OFF	
Trend display	Display format	Split screen:Single Time axis:1s Trend label:ON Scale value:ON Trend type:Line Graticule:Grid
	Display item	Display:ALL ON
	Display cursor	Cursor:OFF C1+Trend:T1 C2x Trend:T1 C1+Position:0 C2x Position:0 Linkage:OFF
System settings	Initialize setting	OFF
	System setting	Display brightness:48 Resolution:6 Decimal point for CSV file:Comma Buzzer:ON Low frequency:0 Crest factor:3
	Remote control	RS-232 interface Port:COM1 Baud rate:300 Data bit:7 Stop bit:1 Parity:None Flow control:None GPIB:22
Source	Sync source	U1
	PLL source	U1

Measurement	User-defined	Function:OFF Item:F1~F20 Unit:empty Expression:empty
	User-defined event	Event No.:1 Event:OFF Event name:Ev1 Expression: no expression
	Formula	S formula:Urms*Irms S,Q formula:type 1 Pc formula:IEC76-1(1993) P1:0.5000 P2:0.5000
	Wiring	Element (Element 1... element 7) :1P2W Σ compensation (Element 1... element 7) :OFF η computation:OFF Efficiency equation: (None/1) x 100% Udef1:None+None+None+None+None+None Udef2:None+None+None+None+None+None
	Degree	180°
	Scaling	Scaling:ALL ON VT/CT/SF (Element 1... element 7):1.000 External:ALL ON External (mv/A) (Element 1... element 7):1000.0000 Phase calibration (Element 1... element 7):0.00
	Update rate	500ms
	Range	All: ON Analog Auto Range:OFF
	Sync measurement	Master
	Harmonic setting	Min order:0 Max order:500 THD Formula:Fundamental
	Accurate	Line filter
Frequency filter		U1~U7:OFF I1~I7:OFF
Average		Average:OFF Type:Exponent Count:2
Null		ALL OFF
Zero level compensation		OFF
Auto zero		OFF
Integration setting	Mode	Normal
	Integ timer	10000:0:0
	integ method(WP±type):	Charge/Discharge
	integ method: q mode	rms
Storage setting	File conversion	Auto
	Storage path	Local
	Naming	Date
	Storage mode	Manual
	Count	999999
	Event	Event 1
	Interval	0:0:0
	Storage item	Numeric
Item setting	ALL OFF	

IEC harmonic	Display format	Standard:None Display format:Full view Start:10 End:1024 Frequency:50Hz Harmonics:ALL Display label:ON Display scale value:ON Vertical scale:Linear Graticule: Grid
	Display item	Harmonic group:U1 Power spectrum:P1
FFT Computation	Display format	Split screen:Single Dot:200k Sample rate:1:10 Interpolate:ON Graticule:Grid Scale value:ON FFT:line Window:rectangular Start:0 End:100000 Vertical scale:Linear
	Display item	FFT1~FFT4 Display:display Location:Diagram 1, Diagram 1, Diagram 1, Diagram 1 Source:U1 Label:FFT1、FFT2、FFT3、FFT4 Y ratio:1.00 X position:Bottom
	Display cursor	Cursor:OFF C1+:FFT1 C2x:FFT1 C1+ position:0 C2x position:0
Flicker	Display format	Measurement mode:Flicker Flicker setting Un mode:Set 230.00V Frequency:50Hz Count:12 Interval:60sec Dmin:1.00% Graph setting Display type:Numeric IFS max:1000 IFS setting:ALL ON CPF setting:ALL ON
	Limits	dc: ON 1.10% dmax:ON 1.10% d(t):ON 200% 3.00ms Pst:ON 1.00 Plt:ON 0.65

Motor	Speed 1	Sensor type:Analog Ratio:1.0000 Unit:Rpm Auto range status:OFF Range:20V Line A:1.000 Line B:0.000 Line filter:OFF
	Torque 1	Sensor type:Analog Ratio:1.0000 Unit:Nm Auto range status:OFF Range:1V Line A:1.000 Line B:0.000 Line filter:OFF
	Motor output 1	Ratio:1.000 Unit:W Number of motor poles:1
	Sync source	U1
	Torque 2	Sensor type:Pulse Ratio:1.0000 Unit:Rpm Pulse upper:1000.0000 Pulse lower:0.0001 Pulse per cycle:60
	Torque 2	Sensor type:Pulse Ratio:1.0000 Unit:Nm Pulse upper:50.0000 Pulse lower:-50.0000 Range upper:50.0000 Fixed frequency upper:15000 Range lower:-50.0000 Fixed frequency lower:5000
	Motor output 2	Ratio:1.000 Unit:W Number of motor poles:1
Cycle-by-cycle measurement	Display format	Cync source:U1 Cync slope:Rising edge Trigger mode:OFF Trigger slope:Rising edge Trigger source:U1 Trigger level:0.0% Cycle count:100 Timeout:10
	Display item	List item:1 Function:Urms Element:Element 1 Cursor item:1 Storage item:ALL OFF
Files	File manager	Naming the file to be saved:Date Image save format:PNG Color:Colors Hand writing pad:OFF Region:Full screen Naming image:Date
	Printer setting	Type:Network 0.0.0.0 Auto print:OFF Mode:Real-time Count:1 Interval:0:0:10

The End

* Products models and specifications are subject to change without prior notice.

