

Last Revised: 2014-11-06 07:14:06.0

2 GS/s High-Speed Digitizers: Optimized for Automated Test

NI PXI-5152, NI PCI-5152



- 2 GS/s maximum real-time sample rate
- 300 MHz, 500 MHz, and 1 GHz bandwidths
- Up to 20 GS/s equivalent-time sampling

- 2 channels simultaneously sampled
- Edge, window, hysteresis, digital, immediate, and software triggering

Overview

NI PXI-5152 and PCI-5152 high-speed digitizers/PC-based oscilloscopes provide the industry's first gigahertz solutions optimized for automated test. A digitizer optimized for automated test takes advantage of a high-throughput bus to lower test times, provides picosecond-level synchronization between modules, and integrates with the entire suite of NI hardware – including arbitrary waveform generators, high-speed digital I/O, and other digitizers – so you can build and customize a complete mixed-signal or high-channel-count test system.

[Back to Top](#)

Application and Technology

NI High-Speed Digitizers: Optimized for Automated Test

Prior to these products, high-bandwidth digitizers and oscilloscopes incorporated features and functionality best suited for benchtop use. An unaddressed area in this high-bandwidth space has been the automated test use model, where measurement throughput and test system footprint can dramatically affect overall cost of test. NI high-speed digitizers are the first high-bandwidth digitizers on the market to share three characteristics making them uniquely optimized for automated test: high data throughput, tight synchronization between channels, and ease of integration with other instruments.

High Data Throughput

Bus bandwidth and latency, two common considerations for an automated test system, dictate the overall speed of your measurement system. Latency describes the amount of time it takes for an instrument to respond to a remote command, like a measurement query. Bus bandwidth refers primarily to the data throughput capacity of the data bus that connects the measurement instrument with the host PC or controller.

The PXI platform – upon which NI high-speed digitizers are built – provides high speed due to the high-bandwidth and low-latency PCI and PCI Express buses. Both PXI and PCI Express data throughput rates are significantly faster than that of GPIB, USB, or LAN – other popular buses for automating test instrumentation. This translates to lower test times.

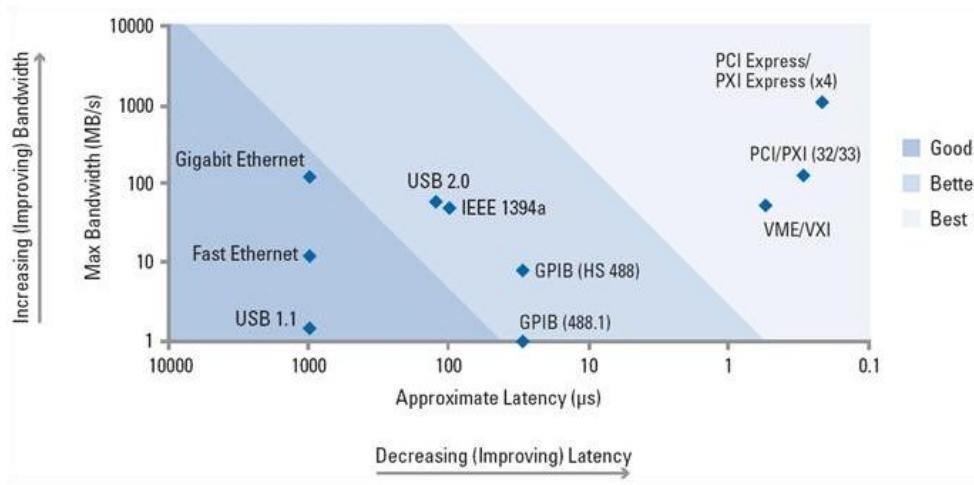

Figure 1. The PXI platform provides the best combination of high-bandwidth and low-latency measurement throughput.

Tight Synchronization between Channels

The PXI backplane offers a built-in common reference clock for synchronization of multiple digitizers in a measurement or control system. Each slot has a 10 MHz TTL clock, transmitted on equal-length traces, that provides picosecond-level synchronization between digitizer modules for high-channel-count systems. For example, it is possible to have 34 phase-synchronous 1 GS/s channels in a single PXI chassis, and scale to even higher-channel counts.

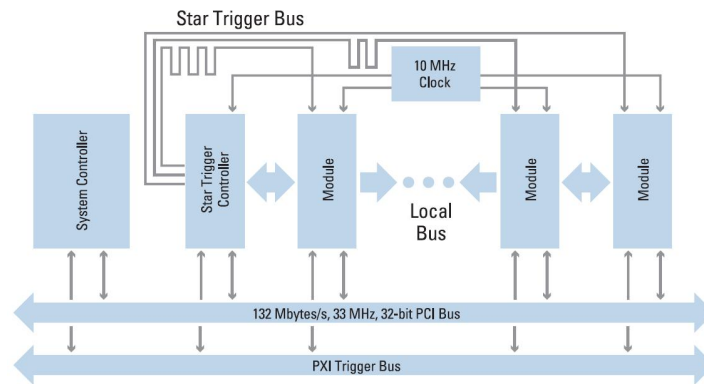

Figure 2. The PXI platform delivers picosecond-level synchronization.

Ease of Integration with Other Instrumentation

Test systems typically contain many instrument types, including signal sources, measurement devices, and switches. The PXI platform has unparalleled breadth, with modules for analog and digital I/O, high-speed instrumentation, vision, motion, and numerous bus interfaces. More than 1,500 PXI modules are available from the more than 70 members of the PXI Systems Alliance (PXISA). So you can not only build a comprehensive test system in a single chassis but also synchronize modules in that chassis to picosecond-level accuracy when using NI modular instruments.



Figure 3. The PXI platform supports more than 1,500 instrument modules.

Achieve Flexible Performance Using NI Software-Defined Instrumentation

NI high-speed digitizers offer several advantages over traditional stand-alone oscilloscopes by delivering an open architecture and flexible software. With an NI digitizer, you can not only perform standard oscilloscope measurements but also easily build other instruments such as spectrum analyzers, transient recorders, and ultrasonic receivers. And National Instruments offers a comprehensive library in the NI LabVIEW graphical development environment of prebuilt functions and example programs geared at getting you up and running quickly.

Open Architecture: NI-SCOPE Driver and the Application Programming Interface (API)

Using the full power of a PC-based measurement device requires the ability to programmatically define and control its behavior. You can programmatically control all NI digitizers using the NI-SCOPE instrument driver, which provides the following:

- High-level functions for getting started quickly as well as low-level control for accessing all the digitizer features
- More than 50 prewritten example programs that illustrate how to access the full functionality of any NI digitizer
- Programming examples available for LabVIEW, C++, and Visual Basic

Flexible Software: Define Your Instrument

In an automated test environment, there are times when the ability to quickly troubleshoot an issue is crucial. For those occasions, the NI-SCOPE driver offers the measurement features and responsiveness of a traditional benchtop oscilloscope through the NI-SCOPE Soft Front Panel user interface. Take advantage of the more than 50 prebuilt measurement and analysis functions included with the software.

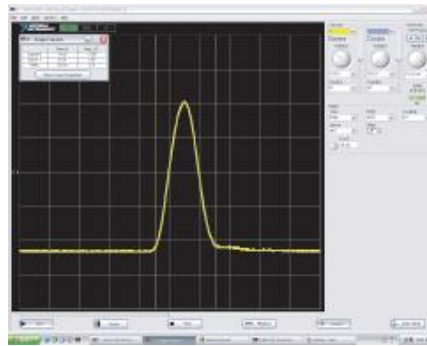

Figure 4. The NI-SCOPE Soft Front Panel provides measurement features and responsiveness comparable to traditional benchtop oscilloscopes.

For rapid initiation of an automated test sequence, use preconfigured Express VIs to quickly set up your digitizer to immediately acquire data. With the LabVIEW SignalExpress interactive environment, you can acquire, analyze, and log your data with no programming required.

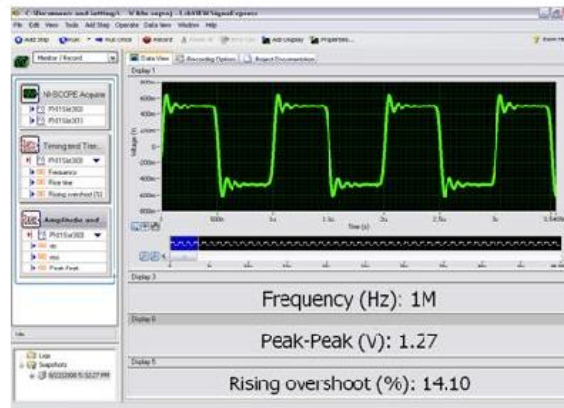

Figure 5. With LabVIEW SignalExpress, you can quickly set up your digitizer to immediately acquire data.

While a quick signal check is valuable at times, other circumstances may call for custom measurements. Stand-alone instruments such as dedicated oscilloscopes and spectrum analyzers deliver common functions that appeal to the needs of many engineers. As you can imagine, these standard functions do not meet every application need, particularly in automated test applications. But with LabVIEW and the NI-SCOPE API, the digitizer that you use as a general-purpose oscilloscope for one application can be used as a custom instrument for more specialized measurements.

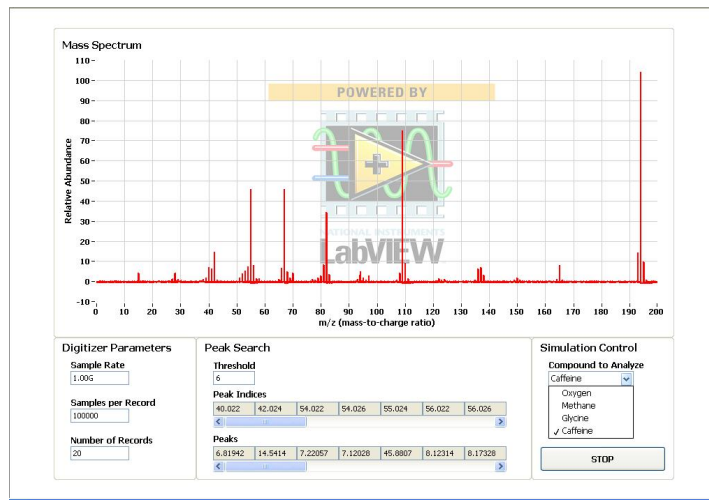

Figure 6. You can achieve custom measurements, such as those required for mass spectrometry, using the combination of LabVIEW and NI modular instruments.

[Back to Top](#)

Ordering Information

For a complete list of accessories, visit the product page on ni.com.

Products	Part Number	Recommended Accessories	Part Number
NI PXI-5152/64MB			
NI PXI-5152/64MB Requires: 1 Cables ;	779772-02	Cables: Unshielded - SMB112, Double Shielded SMB to BNC Male Coax Cable, 50 Ohm, 1m	778827-01
NI PCI-5152_64			
NI PCI-5152 64MB/ch Requires: 1 Cables ;	779945-02	Cables: Unshielded - SMB112, Double Shielded SMB to BNC Male Coax Cable, 50 Ohm, 1m	778827-01

[Back to Top](#)

Support and Services

System Assurance Programs

NI system assurance programs are designed to make it even easier for you to own an NI system. These programs include configuration and deployment services for your NI PXI, CompactRIO, or Compact FieldPoint system. The NI Basic System Assurance Program provides a simple integration test and ensures that your system is delivered completely assembled in one box. When you configure your system with the NI Standard System Assurance Program, you can select from available NI system driver sets and application development environments to create customized, reorderable software configurations. Your system arrives fully assembled and tested in one box with your software preinstalled. When you order your system with the standard program, you also receive system-specific documentation including a bill of materials, an integration test report, a recommended maintenance plan, and frequently asked question documents. Finally, the standard program reduces the total cost of owning an NI system by providing three years of warranty coverage and calibration service. Use the online product advisors at ni.com/advisor to find a system assurance program to meet your needs.

Calibration

NI measurement hardware is calibrated to ensure measurement accuracy and verify that the device meets its published specifications. To ensure the ongoing accuracy of your measurement hardware, NI offers basic or detailed recalibration service that provides ongoing ISO 9001 audit compliance and confidence in your measurements. To learn more about NI calibration services or to locate a qualified service center near you, contact your local sales office or visit ni.com/calibration.

Technical Support

Get answers to your technical questions using the following National Instruments resources.

- **Support** - Visit ni.com/support to access the NI KnowledgeBase, example programs, and tutorials or to contact our applications engineers who are located in NI sales offices around the world and speak the local language.
- **Discussion Forums** - Visit forums.ni.com for a diverse set of discussion boards on topics you care about.
- **Online Community** - Visit community.ni.com to find, contribute, or collaborate on customer-contributed technical content with users like you.

Repair

While you may never need your hardware repaired, NI understands that unexpected events may lead to necessary repairs. NI offers repair services performed by highly trained technicians who quickly return your device with the guarantee that it will perform to factory specifications. For more information, visit ni.com/repair.

Training and Certifications

The NI training and certification program delivers the fastest, most certain route to increased proficiency and productivity using NI software and hardware. Training builds the skills to more efficiently develop robust, maintainable applications, while certification validates your knowledge and ability.

- **Classroom training in cities worldwide** - the most comprehensive hands-on training taught by engineers.
- **On-site training at your facility** - an excellent option to train multiple employees at the same time.
- **Online instructor-led training** - lower-cost, remote training if classroom or on-site courses are not possible.
- **Course kits** - lowest-cost, self-paced training that you can use as reference guides.
- **Training memberships** and training credits - to buy now and schedule training later.

Visit ni.com/training for more information.

Extended Warranty

NI offers options for extending the standard product warranty to meet the life-cycle requirements of your project. In addition, because NI understands that your requirements may change, the extended warranty is flexible in length and easily renewed. For more information, visit ni.com/warranty.

OEM

NI offers design-in consulting and product integration assistance if you need NI products for OEM applications. For information about special pricing and services for OEM customers, visit ni.com/oem.

Alliance

Our Professional Services Team is comprised of NI applications engineers, NI Consulting Services, and a worldwide National Instruments Alliance Partner program of more than 700 independent consultants and integrators. Services range from start-up assistance to turnkey system integration. Visit ni.com/alliance.

[Back to Top](#)

Detailed Specifications

8-Bit 2 GS/s Digitizer

This topic lists the specifications for the NI PXI/PCI-5152 (NI 5152) high-speed digitizer. Unless otherwise noted, the following conditions were used for each specification:

- All filter settings
- All impedance selections
- Sample clock set to 1 GS/s

Real-Time Interleaved Sampling (TIS) mode provides a 2 GS/s real-time sample rate for a single channel.

Typical values are representative of an average unit operating at room temperature. Specifications are subject to change without notice. For the most recent NI 5152 specifications, visit ni.com/manuals.

To access the NI 5152 documentation, including the *NI High-Speed Digitizers Getting Started Guide*, go to **Start»All Programs»National Instruments»NI-SCOPE»Documentation**.



Hot Surface If the NI 5152 has been in use, it may exceed safe handling temperatures and cause burns. Allow the NI 5152 to cool before removing it from the PXI chassis or PC. Refer to the *Environment* section for operating temperatures of this device.



Caution Refer to the Read Me First: Safety and Electromagnetic Compatibility document for important safety and electromagnetic compatibility information. To obtain a copy of this document online, visit ni.com/manuals, and search for the document title.

Vertical

Analog Input (Channel 0 and Channel 1)

Specification	Value				Comments
Number of Channels	Two (simultaneously sampled)				—
Connectors	BNC				—
Impedance and Coupling					
Input Impedance	50 Ω ±1.5% 1 MΩ ±0.75% in parallel with a typical capacitance of 22 pF				Software selectable.
Input Coupling	AC, DC, GND				—
Voltage Levels					
Full Scale (FS) Input Range and Programmable Vertical Offset	50 Ω		1 MΩ		—
	Range (V _{pk-pk})	Offset (V)	Range (V _{pk-pk})	Offset (V)	
	0.1	±1	0.1	±1	
	0.2	±1	0.2	±1	
	0.4	±1	0.4	±1	
	1	±1	1	±1	
	2	±6	2	±10	

Specification	Value				Comments
		±5	4	±10	
	4	±5	4	±10	
	10	±2	10	±10	
Maximum Input Overload	50 Ω		1 MΩ		—
	7 V _{rms} with Peaks ≤ 10 V		Peaks ≤ 42 V		
Accuracy					
Resolution	8 bits				—
DC Accuracy (Programmable Vertical Offset = 0 Volts)	Range (V _{pk-pk})		50 Ω and 1 MΩ		Within ±5 °C of self-calibration temperature.
	0.1 to 1		± (1.26% of Input + 1.0% of FS + 500 μV)		
	2 to 10		± (1.26% of Input + 1.0% of FS + 5 mV)		
Programmable Vertical Offset Accuracy	±0.9% of offset setting				Within ±5 °C of self-calibration temperature.
DC Drift	Range (V _{pk-pk})		50 Ω and 1 MΩ		Use DC drift to calculate errors when temperature changes more than ±5 °C since the last self-calibration.
	0.1 to 1		± (0.052% of Input + 100 μV) per °C		
	2 to 10		± (0.052% of Input + 1.0 mV) per °C		
Crosstalk, Typical	CH 0 to/from CH 1*		Ext Trig to CH 0 or CH 1†		* Measured on one channel with test signal applied to another channel, with same range setting on both channels. † 10 V _{pk-pk} signal applied to external trigger channel. Applies to all ranges on CH 0 and CH 1.
	<-80 dB at 10 MHz		<-80 dB at 10 MHz		
	<-60 dB at 100 MHz		<-80 dB at 100 MHz		
Bandwidth and Transient Response					
Bandwidth (-3 dB)	Range (V _{pk-pk})		50 Ω	1 MΩ	Filter off.
	All ranges except 0.1		340 MHz typical, 300 MHz min	300 MHz typical, 260 MHz min	Bandwidth for 0 to 30 °C.
	0.1		165 MHz typical 135 MHz min	135 MHz typical 110 MHz min	Reduce by 0.25% per °C above 30 °C.
Rise/Fall Time, Typical	Range (V _{pk-pk})		50 Ω	1 MΩ	Filter off.
	All ranges except 0.1		1.2 ns	1.4 ns‡	‡ 50 Ω terminator connected to front panel BNC connector.
	0.1		2.4 ns	2.8 ns‡	
Bandwidth Limit Filter	20 MHz Noise Filter				—
AC Coupling Cutoff (-3 dB), Typical	50 Ω		1 MΩ		50 Ω source assumed.
	106 kHz		12 Hz		

NI 5152 Frequency Response, 50 Ω, 1 V (Typical)

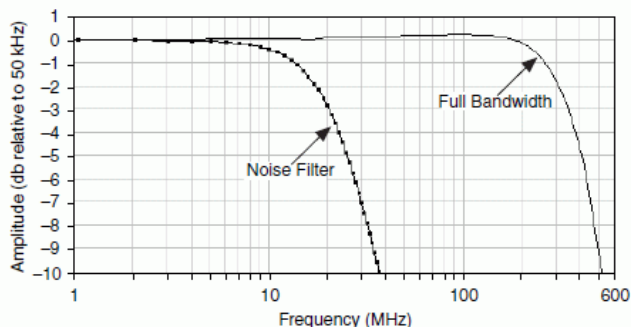

NI 5152 Frequency Response, 50 Ω, 1 V (Typical)

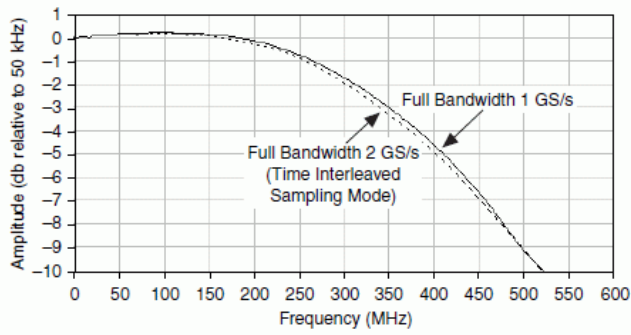

NI 5152 Step Response, 50 Ω , 10 V_{pk-pk} through 0.2 V_{pk-pk} Range (Typical)

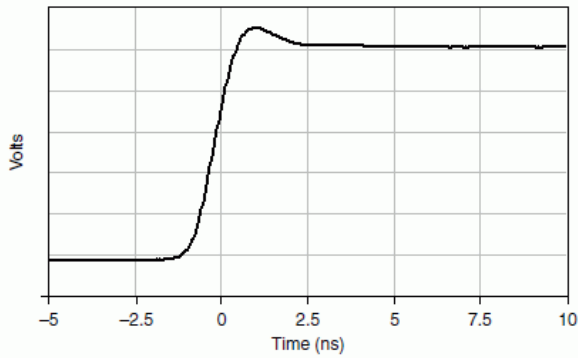

NI 5152 Step Response, 50 Ω , 0.1 V_{pk-pk} Range (Typical)

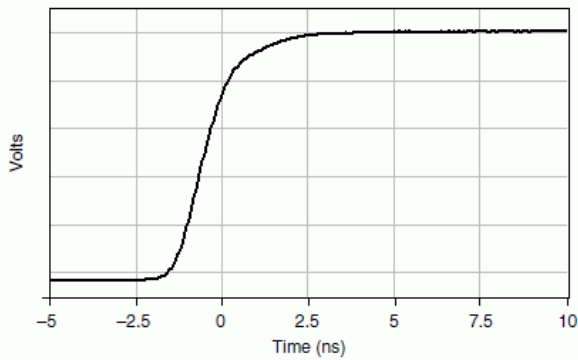

Specification	Value		Comments
Spectral Characteristics			
ENOB	Noise Filter On	Noise Filter Off	1 V _{pk-pk} range, 10 MHz, -1 dBFS input signal. Includes the 2 nd through the 5 th harmonics.
	7.3	7.1	
Signal to Noise and Distortion (SINAD), Typical	45 dB	43 dB	

NI 5152 Typical Dynamic Performance, 50 Ω , 1 V_{pk-pk} Range, 9.425 MHz, -1 dBFS Input Signal

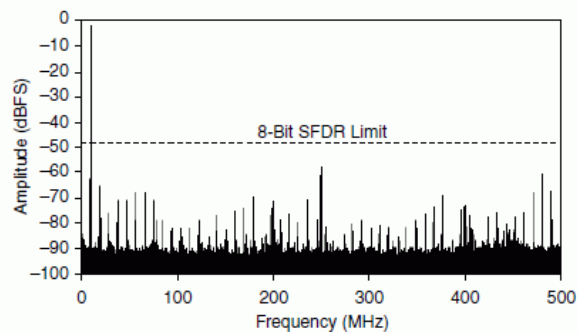

NI 5152 TIS Typical Dynamic Performance, 50 Ω , 1 V_{pk-pk} Range, 9.425 MHz, -1 dBFS Input Signal

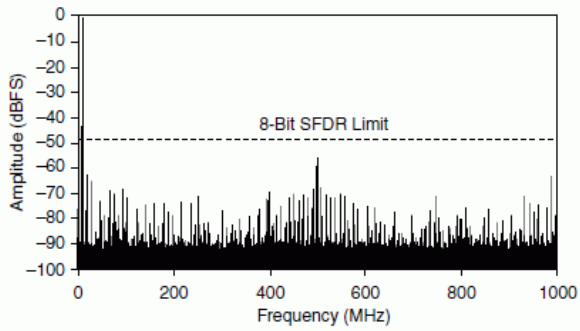

Specification	Value			Comments
RMS Noise	Range (V_{pk-pk})	Noise Filter On	Noise Filter Off	50 Ω terminator connected to input.
	0.1	240 μV_{rms} (0.24% FS)	320 μV_{rms} (0.32% FS)	
	0.2	480 μV_{rms} (0.24% FS)	600 μV_{rms} (0.30% FS)	
	0.4	960 μV_{rms} (0.24% FS)	1.12 mV _{rms} (0.28% FS)	
	1	2.4 mV _{rms} (0.24% FS)	2.6 mV _{rms} (0.26% FS)	
	2	4.8 mV _{rms} (0.24% FS)	6.0 mV _{rms} (0.30% FS)	
	4	9.6 mV _{rms} (0.24% FS)	11.2 mV _{rms} (0.28% FS)	
	10	24 mV _{rms} (0.24% FS)	26 mV _{rms} (0.26% FS)	
Skew				
Channel to Channel Skew, Typical	<100 ps			—

Horizontal

Sample Clock

Specification	Value			Comments
Sources	Internal: Onboard Clock (internal VCISO)* External: PFI 0 (front panel SMB connector)			* Internal Sample Clock is locked to the Reference Clock or derived from the onboard VCISO.
Onboard Clock (Internal VCISO)				
Sample Rate Range	Real-Time Sampling, Single-Shot	TIS† Mode, Single-Shot	Random Interleaved Sampling (RIS)‡ Mode	* Divide by n decimation used for all rates less than 1 GS/s. † TIS is a type of real-time sampling that is sometimes called ping-pong. ‡ RIS is a type of equivalent-time sampling.
	15.26 kS/s to 1 GS/s*	2 GS/s (Single channel only)	2 GS/s to 20 GS/s in increments of 1 GS/s (Repetitive waveforms only)	
Timebase Accuracy	Not Phase-Locked to Reference Clock		Phase-Locked to Reference Clock	Reference Clock accuracy is typically ± 25 ppm across all temperatures in most PXI chassis. When using the NI PXI-6652 module for the reference clock, the accuracy is ± 1 ppm. When using the NI PXI-6653 module, the accuracy is 0.05 ppm. ppm = parts per million (1×10^{-6})
	1 GHz ± 30 ppm within ± 3 °C of external calibration temperature		Equal to the reference clock accuracy	
Timebase Drift	Not Phase-Locked to Reference Clock		Phase-Locked to Reference Clock	—
	± 7 ppm per °C		Equal to reference clock drift	
Sample Clock Delay Range	± 1 Sample Clock period			—
Sample Clock Delay/Adjustment Resolution	≤ 5 ps			—
External Sample Clock				
Sources	PFI 0 (front panel SMB connector)			—
Frequency Range	350 MHz to 1 GHz			Divide by n decimation available where $1 \leq n \leq 65,535$. For more information about Sample Clock and decimation, refer to the <i>NI High-Speed Digitizers Help</i> .
Duty Cycle Tolerance	45% to 55%			—

Phase-Locked Loop (PLL) Reference Clock

Specification	Value	
Sources	NI PXI-5152	NI PCI-5152
	PXI_CLK10 (PXI backplane connector) PFI 0 (front panel SMB connector)	RTSI 7 PFI 0 (front panel SMB connector)
Frequency Range	1 MHz to 20 MHz in 1 MHz increments. Default of 10 MHz. The PLL Reference Clock frequency must be accurate to ± 50 ppm.	
Duty Cycle Tolerance	45% to 55%	
Exported Reference Clock Destinations	NI PXI-5152	NI PCI-5152
	PXI_Trig <0..7> (backplane connector) PFI 1 (front panel SMB connector)	RTSI <0..7> PFI 1 (front panel SMB connector)

PFI 0 (Sample Clock and Reference Clock Input, Front Panel Connector)

Specification	Value
Input Voltage Range	Sine wave: $0.65 V_{pk-pk}$ to $2.8 V_{pk-pk}$ (0 dBm to 13 dBm)
Maximum Input Overload	$7 V_{rms}$ with $ Peaks \leq 10 V$
Impedance	50 Ω
Coupling	AC

PFI 1 (Reference Clock Output, Front Panel Connector)

Specification	Value
Output Impedance	50 Ω
Logic Type	3.3 V CMOS
Maximum Drive Current	± 24 mA

Trigger

Reference (Stop) Trigger

Specification	Value		Comments
Trigger Types	Edge, Window, Hysteresis, Digital, Immediate, and Software		Refer to the following sections and to the <i>NI High-Speed Digitizers Help</i> for more information about what sources are available for each trigger type.
Trigger Sources	NI PXI-5152 CH 0, CH 1, TRIG, PFI <0..1> PXI_Trig <0..6>, PXI Star Trigger, and Software	NI PCI-5152 CH 0, CH 1, TRIG, PFI <0..1>, RTSI <0..6>, and Software	
Time Resolution	TDC	Onboard Clock	External Clock
	On	5 ps	N/A
	Off	1 ns	External Clock Period
Minimum Rearm Time	TDC	Rearm Time	
	On	8 μ s	
	Off	1 μ s	
Holdoff	From Rearm time up to $[(2^{32} - 1) \times \text{Sample Clock Period}]$		—
Trigger Delay	From 0 up to $[(2^{35} - 1) - \text{posttrigger samples}] \times (1/\text{sample rate})$, in seconds		—
Analog Trigger (Edge, Window, and Hysteresis Trigger Types)			
Sources	CH 0, CH 1, TRIG (front panel BNC connectors)		—
Trigger Level Range	CH 0, CH 1	TRIG (External Trigger)	DC to 300 MHz
	100% FS	$\pm 5 V$	
Voltage Resolution	8 bits (1 in 256)		—
Edge Trigger Sensitivity	CH 0, CH 1	TRIG (External Trigger)	DC to 300 MHz

Specification	Value		Comments
	10% FS	0.5 V _{pk-pk}	
Trigger Level Accuracy, Typical	CH 0, CH 1	TRIG (External Trigger)	—
	±5% FS up to 10 MHz	±1 V (±10% FS) up to 10 MHz	
Trigger Jitter	≤10 ps rms typical, ≤20 ps rms maximum		Within ±5 °C of self-calibration temperature.
Trigger Filters	Low Frequency (LF) Reject	High Frequency (HF) Reject	—
	50 kHz	50 kHz	
Digital Trigger (Digital Trigger Type)			
Sources	NI PXI-5152	NI PCI-5152	—
	PXI_Trig <0..6> (backplane connector)	RTSI <0..6>	
	PFI <0..1> (front panel SMB connectors)	PFI <0..1> (front panel SMB connector)	
	PXI Star Trigger (backplane connector)		
External Trigger Input (Front Panel Connector)			
Connector	BNC		—
Impedance	1 MΩ in parallel with a typical capacitance of 22 pF		—
Coupling	AC, DC		—
AC Coupling Cutoff (-3 dB)	12 Hz		—
Input Voltage Range	±5 V		—
Maximum Input Overload	Peaks ≤42 V		—
PFI 0 and PFI 1 (Programmable Function Interface, Front Panel Connectors)			
Connector	SMB jack		—
Direction	Bidirectional		—
As an Input (Trigger)			
Destination	Start Trigger (Acquisition Arm)		—
	Reference (Stop) Trigger		
	Arm Reference Trigger		
	Advance Trigger		
Input Impedance	150 kΩ		—
V _{IH}	2.0 V		—
V _{IL}	0.8 V		—
Maximum Input Overload	-0.5 V to 5.5 V		—
Maximum Frequency	25 MHz		—
As an Output (Event)			
Sources	Start Trigger (Acquisition Arm)		—
	Reference (Stop) Trigger		
	End of Record		
	Done (End of Acquisition)		
	Probe Compensation (1 kHz, 50% duty cycle square wave, PFI 1 only)		
Output Impedance	50 Ω		—
Logic Type	3.3 V CMOS		—
Maximum Drive Current	±24 mA		—
Maximum Frequency	25 MHz		—

TCIk Specifications

National Instruments TCIk synchronization method and the NI-TCIk driver are used to align the sample clocks on any number of SMC-based modules in a chassis. For more information about TCIk synchronization, refer to the *NI-TCIk Synchronization Help*, which is located within the *NI High-Speed Digitizers Help*.

- Specifications are valid for any number of PXI modules installed in one NI PXI-1042 chassis.
- All parameters set to identical values for each SMC-based module.

- * Sample Clock set to 1 GS/s and all filters are disabled.
- For other configurations, including multichassis systems, contact NI Technical Support at ni.com/support.



Note Although you can use NI-TCIk to synchronize nonidentical modules, these specifications apply only to synchronizing identical modules.

Specification	Value	Comments
Intermodule SMC Synchronization Using NI-TCIk for Identical Modules (Typical)		
Skew	500 ps	Caused by clock and analog path delay differences. No manual adjustment performed.
Average Skew After Manual Adjustment	≤5 ps	For information about manual adjustment, refer to the <i>Synchronization Repeatability Optimization</i> topic in the <i>NI-TCIk Synchronization Help</i> . For additional help with the adjustment process, contact NI Technical Support at ni.com/support .
Sample Clock Delay/Adjustment Resolution	≤5 ps	—

Waveform Specifications

Specification	Value		Comments
Onboard Memory Size	Real-Time and RIS Modes	Real-Time TIS Mode	* NI PXI-5152 only
	8 MB Standard (8 MS per channel)	8 MB Standard (8 MS)	
	64 MB Option (64 MS per channel)	64 MB Option (64 MS)	
	256 MB Option (256 MS per channel)	256 MB Option (256 MS)	
	512 MB Option [†] (512 MS per channel)	512 MB Option [†] (512 MS)	
Minimum Record Length	1 Sample		—
Number of Pretrigger Samples	Zero up to full record length		Single-record mode and multiple-record mode.
Number of Posttrigger Samples	Zero up to full record length		Single-record mode and multiple-record mode.
Maximum Number of Records in Onboard Memory	Memory Option	Real-Time Sampling Mode	[†] It is possible to exceed these numbers if you fetch records while acquiring data. For more information, refer to the <i>NI High-Speed Digitizers Help</i> .
	8 MB per channel	32,768 [†]	
	64 MB per channel	100,000 [†]	
	256 MB per channel	100,000 [†]	
Allocated Onboard Memory per Record	[(Record length × 1 byte/sample) + 400 bytes] rounded up to next multiple of 128 bytes		—

Calibration

Specification	Value
Self-Calibration	Self-calibration is done on software command. The calibration corrects for gain, offset, triggering, and timing errors for all input ranges.
External Calibration (Factory Calibration)	The external calibration calibrates the VCSO and the voltage reference. Appropriate constants are stored in nonvolatile memory.
Interval for External Calibration	2 years
Warm-Up Time	15 minutes

Power

Specification	Typical Value	
+3.3 VDC	NI PXI-5152	NI PCI-5152
	1.1 A	2.5 A
+5 VDC	1.9 A	2.4 A
+12 VDC	500 mA	200 mA
-12 VDC	210 mA	0 A
Total Power	21.65 W	22.65 W

Software

Specification	Value
Driver Software	NI-SCOPE 3.2 or later for NI PXI-5152 NI-SCOPE 3.3 or later for NI PCI-5152

Specification	Value
	NI-SCOPE is an IVI-compliant driver that allows you to configure, control, and calibrate the NI 5152. NI-SCOPE provides application programming interfaces for many development environments.
Application Software	NI-SCOPE provides programming interfaces, documentation, and examples for the following application development environments: <ul style="list-style-type: none"> ▪ LabVIEW ▪ LabWindows™/CVI™ ▪ Measurement Studio ▪ Microsoft Visual C/C++ ▪ Microsoft Visual Basic
Interactive Soft Front Panel and Configuration	The NI-SCOPE Soft Front Panel version 2.5 or later supports interactive control of the NI 5152. The NI-SCOPE Soft Front Panel is included on the NI-SCOPE CD. National Instruments Measurement & Automation Explorer (MAX) also provides interactive configuration and test tools for the NI 5152. MAX is included on the NI-SCOPE CD.

Environment

NI PXI-5152



Note To ensure that the NI PXI-5152 cools effectively, follow the guidelines in the *Maintain Forced-Air Cooling Note to Users* included in the hardware kit. The NI PXI-5152 is intended for indoor use only.

Specification	Value
Operating Temperature	0 °C to +55 °C in all NI PXI chassis except the following: 0 °C to +45 °C when installed in an NI PXI-1000/B or PXI-101x chassis. Meets IEC 60068-2-1 and IEC 60068-2-2.
Storage Temperature	–40 °C to +71 °C. Meets IEC 60068-2-1 and IEC 60068-2-2.
Operating Relative Humidity	10% to 90%, noncondensing. Meets IEC 60068-2-56.
Storage Relative Humidity	5% to 95%, noncondensing. Meets IEC 60068-2-56.
Operating Shock	30 g, half-sine, 11 ms pulse. Meets IEC 60068-2-27. Test profile developed in accordance with MIL-PRF-28800F.
Storage Shock	50 g, half-sine, 11 ms pulse. Meets IEC 60068-2-27. Test profile developed in accordance with MIL-PRF-28800F.
Operating Vibration	5 Hz to 500 Hz, 0.31 g _{rms} . Meets IEC 60068-2-64.
Storage Vibration	5 Hz to 500 Hz, 2.46 g _{rms} . Meets IEC 60068-2-64. Test profile exceeds requirements of MIL-PRF-28800F, Class 3.
Altitude	2,000 m maximum (at 25 °C ambient temperature)
Pollution Degree	2

NI PCI-5152



Note To ensure that the NI PCI-5152 cools effectively, make sure that the chassis in which it is used has active cooling that provides at least some airflow across the PCI card cage. To maximize airflow and extend the life of the device, leave any adjacent PCI slots empty. Refer to the *Maintain Forced-Air Cooling Note to Users* included in the NI PCI-5152 kit for important cooling information. The NI PCI-5152 is intended for indoor use only.

Specification	Value
Operating Temperature	0 °C to +45 °C. Meets IEC 60068-2-1 and IEC 60068-2-2.
Storage Temperature	–40 °C to +70 °C. Meets IEC 60068-2-1 and IEC 60068-2-2.
Operating Relative Humidity	10% to 90%, noncondensing. Meets IEC 60068-2-56.
Storage Relative Humidity	5% to 95%, noncondensing. Meets IEC 60068-2-56.
Storage Shock	50 g, half-sine, 11 ms pulse. Meets IEC 60068-2-27. Test profile developed in accordance with MIL-PRF-28800F.
Storage Vibration	5 Hz to 500 Hz, 2.46 g _{rms} . Meets IEC 60068-2-64. Test profile exceeds requirements of MIL-PRF-28800F, Class 3.
Altitude	2,000 m maximum (at 25 °C ambient temperature)
Pollution Degree	2

Safety, Electromagnetic Compatibility, and CE Compliance

Safety Standards

This product is designed to meet the requirements of the following standards of safety for electrical equipment for measurement, control, and laboratory use:

- IEC 61010-1, EN 61010-1
- UL 61010-1, CSA 61010-1



Note For UL and other safety certifications, refer to the product label or the *Online Product Certification* section.

Electromagnetic Compatibility

This product meets the requirements of the following EMC standards for electrical equipment for measurement, control, and laboratory use:

- EN 61326 (IEC 61326): Class A emissions; Basic immunity
- EN 55011 (CISPR 11): Group 1, Class A emissions
- AS/NZS CISPR 11: Group 1, Class A emissions
- FCC 47 CFR Part 15B: Class A emissions
- ICES-001: Class A emissions



Note For the standards applied to assess the EMC of this product, refer to the *Online Product Certification* section.



Note For EMC compliance, operate this device with RG223/U or equivalent shielded cable. Operate according to product documentation.

CE Compliance

This product meets the essential requirements of applicable European Directives, as amended for CE marking, as follows:

- 2006/95/EC; Low-Voltage Directive (safety)
- 2004/108/EC; Electromagnetic Compatibility Directive (EMC)

Online Product Certification

Refer to the product Declaration of Conformity (DoC) for additional regulatory compliance information. To obtain product certifications and the DoC for this product, visit ni.com/certification, search by module number or product line, and click the appropriate link in the Certification column.

Environmental Management

National Instruments is committed to designing and manufacturing products in an environmentally responsible manner. NI recognizes that eliminating certain hazardous substances from our products is beneficial not only to the environment but also to NI customers.

For additional environmental information, refer to the *NI and the Environment* Web page at ni.com/environment. This page contains the environmental regulations and directives with which NI complies, as well as other environmental information not included in this document.

Waste Electrical and Electronic Equipment (WEEE)



EU Customers At the end of the product life cycle, all products *must* be sent to a WEEE recycling center. For more information about WEEE recycling centers, National Instruments WEEE initiatives, and compliance with WEEE Directive 2002/96/EC on Waste Electrical and Electronic Equipment, visit ni.com/environment/weee.htm.

电子信息产品污染控制管理办法（中国 RoHS）



中国客户 National Instruments 符合中国电子信息产品中限制使用某些有害物质指令 (RoHS)。关于 National Instruments 中国 RoHS 合规性信息，请登录 ni.com/environment/rohs_china。(For information about China RoHS compliance, go to ni.com/environment/rohs_china.)

Physical

Front Panel Connectors

Label	Function	Connector Type
CH 0	Analog input	BNC female
CH 1	Analog input	BNC female
TRIG	External Trigger	BNC female
PFI 0	Sample Clock Input, Reference Clock Input Digital Trigger Input/Output	SMB jack
PFI 1	Reference Clock Output, Digital Trigger Input/Output	SMB jack

Dimensions and Weight

NI PXI-5152	
Dimensions	3U, One slot, PXI/cPCI Module 21.6 × 2.0 × 13.0 cm (8.5 × 0.8 × 5.1 in.)

NI PXI-5152	
Weight	462 g (16.3 oz)

NI PCI-5152	
Dimensions	35.5 × 2.0 × 11.3 cm (14.0 × 0.8 × 4.4 in.)
Weight	445 g (15.7 oz)

[Back to Top](#)

©2010 National Instruments. All rights reserved. CompactRIO, CVI, FieldPoint, LabVIEW, Measurement Studio, National Instruments, National Instruments Alliance Partner, NI, ni.com, and SignalExpress are trademarks of National Instruments. The mark LabWindows is used under a license from Microsoft Corporation. Windows is a registered trademark of Microsoft Corporation in the United States and other countries. Other product and company names listed are trademarks or trade names of their respective companies. A National Instruments Alliance Partner is a business entity independent from National Instruments and has no agency, partnership, or joint-venture relationship with National Instruments.

[My Profile](#) | [RSS](#) | [Privacy](#) | [Legal](#) | [Contact NI](#) © 2014 National Instruments Corporation. All rights reserved.

