



CellAdvisor™
JD700B Series FW3.085
User's Guide



CellAdvisor™

JD700B Series FW3.085

User's Guide

JD785B/JD745B Base Station Analyzer

JD786B/JD746B RF Analyzer

JD788B/JD748B Signal Analyzer



Viavi Solutions
1-844-GO-VIAVI
www.viavisolutions.com

Notice

Every effort was made to ensure that the information in this document was accurate at the time of release. However, information is subject to change without notice, and Viavi Solutions reserves the right to provide an addendum to this document with information not available at the time that this document was created.

Copyright/Trademarks

© Copyright 2017 Viavi Solutions Inc. All rights reserved. No part of this guide may be reproduced or transmitted, electronically or otherwise, without written permission of the publisher. Viavi Solutions, the Viavi logo, CellAdvisor, RANAdvisor TrueSite, StrataSync, and EZ-Cal are trademarks of Viavi Solutions Inc. (“Viavi”). All trademarks and registered trademarks are the property of their respective companies.

Google Maps and Google Earth are either trademarks or registered trademarks of Google in the United States and/or other countries.

Bluetooth is a trademark or a registered trademark of Bluetooth Special Interest Group (SIG) Inc. in the United States and/or other countries.

Android is a trademark or a registered trademark of Google in the United States and/or other countries.

iOS is a trademark or a registered trademark of Apple Inc. in the United States and/or other countries.

Windows and Windows 7 are either trademarks or registered trademarks of Microsoft Corporation in the United States and/or other countries.

Copyright release

Reproduction and distribution of this guide is authorized for US Government purposes only.

Ordering information

This document is a product of Viavi’s Technical Publications Department, issued as part of the JD700B Series. The catalog number for a published manual is JD700B362 - printed. The catalog number for an electronic manual on CD-ROM is JD700B361 - electronic.

Open source disclaimer – IMPORTANT READ CAREFULLY

The JD700B Series includes third party software licensed under the terms of separate open source software licenses. By using this software, you agree to comply with the terms and conditions of the applicable open source software licenses. Software originated by Viavi is not subject to third party licenses. Terms of the Viavi Software License different from applicable third party licenses are offered by Viavi alone.

This product incorporates open source software entitled “zlib”. The zlib is the compression library written by Jean-loup Gailly and Mark Adler, who granted permission to use this software for any purpose, including commercial applications.

This product includes open source software developed by the Apache Software Foundation (<http://www.apache.org/>).

This product used free library for JPEG image compression written and distributed by Independent JPEG Group or IJG (<http://www.ijg.org/>).

This product used free, open-source JavaScript library entitled “jQuery”. It is licensed under the MIT License (<http://jquery.org/license/>).

This product used open source software entitled “Libpcap-1.3.0”. The Libpcap-1.3.0 is the portable packet-capturing library developed by TCPDUMP (<http://www.tcpdump.org>)

See “Viewing OSS license” on page 44 for more information.

Terms and conditions

Specifications, terms, and conditions are subject to change without notice. The provision of hardware, services, and/or software is subject to Viavi’s standard terms and conditions, available at www.viavisolutions.com/en/terms-and-conditions.

NRTL compliance

This product was tested according to UL 61010-1:2012 and CAN/CSA C22.2 No. 61010-1-12. Conformity with these requirements is based upon compliance with the standard IEC 61010-1. A copy of the Declaration of Conformity is provided upon your request.

Ce produit a été testé selon la norme UL 61010-1 : 2012 et CAN / CSA C22.2 No. 61010-1-12. La conformité à ces exigences est fondée sur la conformité à la norme CEI 61010-1. Une copie de la déclaration de conformité est disponible sur demande.

EMC directive compliance

This product was tested and conforms to the EMC Directive, 2004/108/EC and its amending directives for electromagnetic compatibility. Conformity with this directive is based upon compliance with the harmonized European standards: EN61326-1 and CISPR11. A copy of the Declaration of Conformity is provided upon your request.

Low voltage directive compliance

This product was tested and conforms to the Low Voltage Directive, 2006/95/EC and its amending directives. Conformity with this directive is based upon compliance with the harmonized European standard EN61010-1. A copy of the Declaration of Conformity is provided upon your request.

WEEE and battery directive compliance

Viavi has established processes in compliance with the Waste Electrical and Electronic Equipment (WEEE) Directive, 2002/96/EC, and the Battery Directive, 2006/66/EC.

This product, and the batteries used to power the product, should not be disposed of as unsorted municipal waste and should be collected separately and disposed of according to your national regulations. In the European Union, all equipment and batteries purchased from Viavi after 2005-08-13 can be returned for disposal at the end of its

useful life. Viavi will ensure that all waste equipment and batteries returned are reused, recycled, or disposed of in an environmentally friendly manner, and in compliance with all applicable national and international waste legislation.

It is the responsibility of the equipment owner to return equipment and batteries to Viavi for appropriate disposal. If the equipment or battery was imported by a reseller whose name or logo is marked on the equipment or battery, then the owner should return the equipment or battery directly to the reseller.

Instructions for returning waste equipment and batteries to Viavi can be found in the Environmental section of Viavi's web site at www.viavisolutions.com. If you have questions concerning disposal of your equipment or batteries, contact Viavi's WEEE Program Management team.



Contents

About This Guide.....	20
Purpose and scope	21
Assumptions	21
Safety and compliance information.....	21
Conventions	22
Technical assistance	23
<hr/>	
Chapter 1 JD700B Series Overview	24
About the JD700B series.....	25
Features and capabilities	25
Options	26
Specifications.....	26
AC power	26
Physical specifications.....	26
<hr/>	
Chapter 2 Getting Started	27
Unpacking the JD700B series	28
Exploring the JD700B series	28
Front panel.....	29
Top panel.....	31
Installing battery pack.....	33
Starting up the JD700B series.....	33
Managing files.....	34
Using save	34
Using load	36
Using file manager	37
Configuring system	38
Setting frequency reference.....	38
Setting frequency reference for 28 GHz downconverter.....	38
Setting date and time.....	38
Setting language	38
Setting power on	39
Changing display mode.....	39
Setting sleep time.....	39
Adjusting LCD brightness	40
Adjusting volume	40
Upgrading firmware	40
Checking installed firmware version.....	40
Installing new firmware	41
Managing licenses	42
Checking installed or installable options	42
Installing purchased options	42
Loading temporary license.....	42
Viewing OSS license	44
Performing service diagnostic	44
Viewing system log.....	45
Running self-test	45
Performing factory reset	45
Re-aligning touch screen.....	45
Using system administration.....	46
Logging in.....	46
Changing password.....	46
Locking limit key	46

Running IP test.....	46
Activating StrataSync.....	47
Setting up Internet connection.....	47
Establishing a connection to StrataSync.....	48
StrataSync status indicators.....	49
Setting up 28 GHz downconverter.....	49
Establishing a connection to 28 GHz downconverter.....	50
Setting up SNMP traps.....	50
Using SNMP traps.....	51
Setting communication.....	51
Configuring Ethernet.....	51
Setting for JDViewer and JDRemote.....	52
Setting USBTMC mode.....	53
Setting SCP mode.....	53
Configuring LMF setting.....	53
Enabling Bluetooth connection.....	53
Enabling Wi-Fi connection.....	54
Enabling Web-based remote control.....	55
Managing help manual.....	56
Adding other help manual.....	57
Viewing help manual.....	57
<hr/>	
Chapter 3 Analyzing Measurement Results.....	59
Using marker.....	60
Using peak search.....	61
<hr/>	
Chapter 4 Using Spectrum Analyzer.....	62
Introduction.....	63
Display overview.....	63
Connecting a cable.....	64
Selecting measurement mode.....	65
Configuring test parameters.....	65
Setting frequency.....	65
Setting frequency for 28 GHz downconverter.....	67
Setting amplitude.....	67
Setting bandwidth.....	70
Setting average.....	70
Setting sweep.....	71
Using signal generator (RF source).....	72
Conducting spectrum measurements.....	73
Setting trace.....	75
Setting limit.....	76
Setting frequency offset.....	77
Conducting RF measurements.....	77
Channel power.....	77
Occupied bandwidth.....	80
Spectrum emission mask (SEM).....	82
Adjacent channel power (ACP).....	84
Multi-ACP.....	85
Spurious emissions.....	88
AM/FM audio demodulation.....	90
Field strength meter.....	92
Route map.....	95
Dual spectrum.....	99
PIM detection (single and multiple carriers).....	99
Total Harmonic Distortion (THD).....	102
<hr/>	
Chapter 5 Using Interference Analyzer.....	105
Introduction.....	106
Display overview.....	106
Connecting a cable.....	107
Using an Omni or Yagi antenna.....	107
Using an AntennaAdvisor handle.....	108
Selecting measurement mode.....	109
Configuring test parameters.....	109
Setting frequency.....	109
Setting frequency for 28 GHz downconverter.....	110

Setting amplitude.....	111
Setting bandwidth.....	113
Setting average.....	114
Setting sweep.....	114
Conducting spectrum measurements.....	116
Setting trace.....	116
Sound indicator.....	117
AM/FM audio demodulation.....	117
Interference ID.....	119
Conducting interference measurements.....	119
Spectrogram.....	119
Dual spectrogram.....	121
RSSI.....	123
Interference finder.....	125
Spectrum Replayer.....	130
Radar Chart.....	131
Setting limit for interference analyzer.....	136
Setting a single limit line.....	136
Setting a multi-segment line.....	136
Defining a channel limit.....	137
<hr/>	
Chapter 6 Using GSM/GPRS/EDGE Signal Analyzer.....	138
Introduction.....	139
Display overview.....	139
Connecting a cable.....	140
Direct connection.....	140
Indirect connection.....	140
Over the air (OTA).....	141
Selecting measurement mode.....	142
Configuring test parameters.....	142
Setting frequency.....	142
Setting amplitude.....	143
Setting average.....	145
Setting sweep mode.....	145
Setting trigger source.....	145
Conducting spectrum measurements.....	146
Setting measure setup.....	146
Setting trace.....	146
Conducting RF measurements.....	147
Channel power.....	147
Occupied bandwidth.....	148
Spectrum emission mask (SEM).....	149
Output RF spectrum.....	150
Spurious emissions.....	151
Setting limit for RF tests.....	152
Conducting power vs. time measurements.....	153
Power vs. time (slot).....	153
Power vs. time (frame).....	155
Conducting constellation measurements.....	156
Setting measure setup.....	156
Setting limit for constellation.....	157
Measurement example.....	158
Performing auto measurements.....	158
Setting limit for auto measure.....	159
Setting measure setup.....	159
Setting display.....	160
Conducting GSM OTA measurements.....	160
Channel scanner.....	160
Frequency scanner.....	162
Multipath profile.....	163
Modulation analyzer.....	164
<hr/>	
Chapter 7 Using WCDMA/HSPA+ Signal Analyzer.....	166
Introduction.....	167
Display overview.....	167
Connecting a cable.....	168
Direct connection.....	168

Indirect connection	168
Over the air (OTA)	169
Selecting measurement mode	170
Configuring test parameters	170
Setting frequency	170
Setting amplitude.....	171
Setting average	173
Setting sweep mode	173
Setting trigger source	173
Setting external clock	173
Conducting spectrum measurements	175
Setting trace	175
Conducting RF measurements	176
Channel power	176
Occupied bandwidth.....	177
Spectrum emission mask (SEM).....	178
ACLR	179
Multi-ACLR.....	180
Spurious emissions	181
Setting limit for RF tests	182
Conducting modulation measurements	183
Constellation	183
Code domain power	184
Relative code domain power	187
Codogram	189
RCSI	191
CDP Table.....	193
Setting limit for modulation tests	194
Performing auto measurements	195
Setting limit for auto measure	195
Setting measure setup.....	195
Setting display	196
Performing power statistics CCDF measurement	196
Setting measure setup.....	196
Measurement example	197
Conducting WCDMA/HSPA+ OTA measurements.....	197
Channel scanner	197
Scramble scanner	199
Multipath profile.....	199
Code domain power	200
Route map.....	202
Chapter 8 Using LTE-FDD Signal Analyzer	207
Introduction	208
Display overview	209
Connecting a cable	209
Direct connection.....	209
Indirect connection	210
Over the air (OTA)	210
Selecting measurement mode.....	211
Configuring test parameters	212
Setting frequency	212
Setting amplitude.....	212
Setting average	214
Setting sweep mode	214
Setting trigger source	215
Setting external clock	215
Conducting spectrum measurements	216
Setting measure setup.....	216
Setting trace	216
Conducting RF measurements	217
Channel power	217
Occupied bandwidth.....	218
Spectrum emission mask (SEM).....	219
ACLR	220
Multi-ACLR.....	221
Spurious emissions	222

Setting limit for RF tests	224
Conducting power vs. time (frame) measurements	224
Setting measure setup	224
Measurement example	225
Conducting modulation measurements	225
Constellation	225
Data channel	227
Control channel	231
Subframe	233
Frame	236
Time alignment error	239
Data allocation map	240
Setting limit for modulation tests	243
Performing auto measurements	244
Conformance test	244
Maintenance test	247
Signal performance test	249
DAS test	250
Performing power statistics CCDF measurements	251
Setting measure setup	251
Measurement example	252
Performing carrier aggregation measurements	252
Setting measure setup	252
Measurement example	254
Setting display	254
Measurement example	256
Using marker	257
Conducting LTE-FDD OTA measurements	257
Channel scanner	257
ID scanner	259
Multipath profile	260
Control channel	261
Datagram	264
Route map	266
Performing RAN performance testing	272
Preparing your smartphone for remote control via Bluetooth	272
Setting parameters on RANAdvisor TrueSite™	273
Performing RAN performance testing	274
Measurement example	274
Setting performance score level	275
Performing NB-IoT modulation analysis	275
Setting measure setup	275
Measurement example	276
Using marker	276

Chapter 9 Using LTE-TDD Signal Analyzer 278

Introduction	279
Display overview	280
Connecting a cable	280
Direct connection	280
Indirect connection	281
Over the air (OTA)	281
Selecting measurement mode	282
Configuring test parameters	283
Setting frequency	283
Setting amplitude	283
Setting average	285
Setting sweep mode	285
Setting trigger source	286
Setting external clock	286
Conducting spectrum measurements	287
Setting measure setup	287
Setting trace	288
Conducting RF measurements	289
Channel power	289
Occupied bandwidth	290
Spectrum emission mask (SEM)	291

ACLR	292
Multi-ACLR	293
Spurious emissions	295
Setting limit for RF tests	296
Conducting power vs. time measurements	297
Power vs. time (slot)	297
Power vs. time (frame)	299
Conducting modulation measurements	300
Constellation	300
Data channel	303
Control channel	306
Subframe	308
Time alignment error	312
Data allocation map	313
Setting limit for modulation tests	316
Performing auto measurements	317
Conformance test	317
Maintenance test	318
Signal performance test	320
DAS test	321
Performing power statistics CCDF measurements	323
Setting measure setup	323
Measurement example	324
Performing carrier aggregation measurements	324
Setting measure setup	324
Setting display	325
Measurement example	327
Using marker	328
Conducting LTE-TDD OTA measurements	328
Channel scanner	328
ID scanner	330
Multipath profile	332
Control channel	333
Datagram	335
Route map	337
Performing RAN performance testing	343
Preparing your smartphone for remote control via Bluetooth	343
Setting parameters on RANAdvisor TrueSite™	344
Performing RAN performance testing	344
Measurement example	345
Setting performance score level	345
Chapter 10 Using CDMA Signal Analyzer	347
Introduction	348
Display overview	349
Connecting a cable	349
Direct connection	349
Indirect connection	350
Over the air (OTA)	350
Selecting measurement mode	351
Configuring test parameters	351
Setting frequency	351
Setting amplitude	352
Setting average	354
Setting sweep mode	354
Setting trigger source	354
Setting external clock	355
Conducting spectrum measurements	356
Setting trace	356
Conducting RF measurements	357
Channel power	357
Occupied bandwidth	358
Spectrum emission mask (SEM)	359
ACPR	359
Multi-ACPR	360
Spurious emissions	361
Setting limit for RF tests	362

Conducting modulation measurements	363
Constellation	363
Code domain power	364
Codogram	365
RCSI	367
CDP Table	369
Setting limit for modulation tests	370
Performing auto measurements	371
Setting limit for auto measure	371
Setting measure setup	371
Setting display	372
Performing power statistics CCDF measurements	373
Setting measure setup	373
Measurement example	373
Conducting CDMA OTA measurements	373
Channel scanner	374
PN scanner	375
Multipath profile	376
Code domain power	377
Route map	379
<hr/>	
Chapter 11 Using EV-DO Signal Analyzer	384
Introduction	385
Display overview	385
Connecting a cable	386
Direct connection	386
Indirect connection	386
Over the air (OTA)	387
Selecting measurement mode	388
Configuring test parameters	388
Setting frequency	388
Setting amplitude	389
Setting average	391
Setting sweep mode	391
Setting trigger source	391
Setting external clock	391
Conducting spectrum measurements	393
Setting trace	393
Conducting RF measurements	394
Channel power	394
Occupied bandwidth	395
Spectrum emission mask (SEM)	395
ACPR	396
Multi-ACPR	397
Spurious emissions	398
Setting limit for RF tests	400
Conducting power vs. time measurements	400
Power vs. time (idle slot)	400
Power vs. time (active slot)	401
Setting limit for power vs. time tests	402
Conducting modulation measurements	402
Constellation	402
Code domain power	405
MAC Codogram	407
RCSI	408
MAC CDP Table	410
Setting limit for modulation tests	411
Performing auto measurements	412
Setting limit for auto measure	412
Setting measure setup	412
Setting display	413
Performing power statistics CCDF measurements	414
Setting measure setup	414
Measurement example	414
Conducting EV-DO OTA measurements	414
Channel scanner	415
PN scanner	416

Multipath profile.....	417
Code domain power	418
Route map.....	420
Chapter 12 Using TD-SCDMA Signal Analyzer	424
Introduction	425
Display overview	426
Connecting a cable	426
Direct connection.....	426
Indirect connection	427
Over the air (OTA)	427
Selecting measurement mode.....	428
Configuring test parameters	428
Setting frequency	428
Setting amplitude.....	429
Setting average	431
Setting sweep mode.....	431
Setting trigger source	431
Setting external clock	432
Conducting spectrum measurements	432
Setting measure setup.....	432
Setting trace	433
Conducting RF measurements	434
Channel power	434
Occupied bandwidth.....	435
Spectrum emission mask (SEM).....	436
ACLR	437
Multi-ACLR.....	438
Spurious emissions	439
Setting limit for RF tests	441
Conducting power vs. time measurements	441
Power vs. time (slot).....	441
Power vs. time (frame)	443
Power vs. time (mask).....	444
Timogram	445
Setting limit for power vs. time tests.....	447
Conducting modulation measurements	447
Constellation	448
Midamble power	449
Code power.....	450
Code error	452
Setting limit for modulation tests	453
Performing auto measurements	454
Setting limit.....	454
Setting measure setup.....	454
Setting display	455
Conducting TD-SCDMA OTA measurements.....	456
Sync-DL ID scanner	456
Sync-DL ID vs. Tau	456
Sync-DL ID multipath.....	457
Sync-DL ID analyzer.....	458
Route map.....	459
Chapter 13 Using Mobile WiMAX Signal Analyzer.....	463
Introduction	464
Display overview	465
Connecting a cable	465
Direct connection.....	465
Indirect connection	466
Over the air (OTA)	466
Selecting measurement mode.....	467
Configuring test parameters	467
Setting frequency	467
Setting amplitude.....	468
Setting average	470
Setting sweep mode	470
Setting trigger source	470

Setting external clock	470
Conducting spectrum measurements	471
Setting measure setup.....	471
Setting trace	472
Conducting RF measurements	473
Channel power	473
Occupied bandwidth.....	475
Spectrum emission mask (SEM).....	476
Spurious emissions	477
Setting limit for RF tests	479
Conducting power vs. time (frame) measurements.....	479
Setting measure setup.....	479
Setting limit for power vs. time tests.....	480
Measurement example	481
Conducting modulation measurements	481
Constellation	481
Spectral flatness.....	483
EVM vs. subcarrier	484
EVM vs. symbol.....	486
Setting limit for modulation tests	487
Performing auto measurements	488
Performing power statistics CCDF measurements	489
Setting measure setup.....	489
Measurement example	490
Conducting Mobile WiMAX OTA measurements.....	490
Preamble scanner	490
Multipath profile	492
Preamble power trend	493
Route map.....	494
<hr/>	
Chapter 14 Using NB-IoT Signal Analyzer.....	497
Introduction	498
Connecting a cable	499
Direct connection.....	499
Indirect connection	499
Over the air (OTA)	499
Selecting measurement mode.....	500
Configuring test parameters	501
Setting frequency	501
Setting amplitude.....	501
Setting average	503
Setting sweep mode	503
Setting trigger source	504
Setting external clock	504
Conducting NB-IoT in band spectrum measurement	505
Setting measure setup.....	505
Setting trace	505
Conducting NB-IoT in band modulation analysis	506
Setting measure setup.....	506
Conducting NB-IoT guard band spectrum measurement	508
Setting measure setup.....	508
Setting trace	508
Conducting NB-IoT guard band spectrum emission mask (SEM)	509
Setting measure setup.....	509
Conducting NB-IoT guard band modulation analysis	510
Setting measure setup.....	510
Conducting NB-IoT standalone RF measurements.....	511
Channel power	511
Occupied bandwidth.....	512
Spectrum emission mask (SEM).....	513
ACLR	513
Spurious emissions	514
Setting limit for RF tests	515
Conducting NB-IoT standalone modulation analysis.....	516
Setting measure setup.....	516
<hr/>	
Chapter 15 Using Cable and Antenna Analyzer.....	518

Introduction	519
Display overview	519
Selecting measurement mode.....	520
Configuring test parameters	520
Setting frequency	520
Setting distance.....	521
Adjusting scale	521
Setting sweep mode.....	522
Performing calibration	522
1-port calibration.....	523
2-port calibration.....	525
Calibration status indicators.....	527
Connecting a cable	527
Connecting a cable for reflection, DTF, 1-port phase, and Smith Chart measurements.....	527
Connecting a cable for cable loss (1 port) measurements.....	528
Connecting a cable for 2-port vector measurements.....	528
Connecting a cable for 2-port scalar measurements.....	529
Performing reflection measurements.....	530
Making a measurement.....	530
Measurement example	531
Performing DTF measurements	531
Making a measurement.....	531
Measurement example	533
Performing reflection-DTF measurements.....	534
Making a measurement.....	534
Measurement example	534
Performing cable loss (1 port) measurements	535
Making a measurement.....	535
Measurement example	536
Performing 1-port phase measurements	537
Making a measurement.....	537
Measurement example	537
Performing Smith chart measurements	538
Making a measurement.....	538
Measurement example	539
Performing 2-port vector measurements	539
Making a measurement.....	539
Measurement example	540
Performing 2-port scalar measurements.....	541
Making a measurement.....	541
Measurement example	541
Analyzing measurements	542
Setting trace and display	542
Setting zoom zones.....	542
Setting alternate sweep	543
Setting limit for cable and antenna analyzer	543
<hr/>	
Chapter 16 Performing RFoCPRI Testing.....	545
Introduction	546
Display overview	547
Selecting measurement mode.....	548
Performing layer 2 monitoring	548
Connecting cables.....	548
Selecting measurement mode	549
Selecting port	549
Setting measure setup.....	549
Setting Rx optic limit.....	550
Conducting layer 2 monitoring	550
Measurement example	551
Performing layer 2 term testing	551
Connecting cables.....	551
Selecting measurement mode	552
Selecting port	552
Setting measure setup.....	552
Setting Rx optic limit.....	552
Conducting layer 2 term test.....	553
Measurement example	554

Performing interference analysis	554
Connecting cables.....	554
Selecting measurement mode	555
Selecting port	555
Configuring test parameters	555
Setting measure setup.....	561
Using map profile list (custom).....	561
Using map profile list (system).....	563
Selecting network technology	565
Configuring Rx parameters.....	565
Conducting spectrum measurement	567
Conducting dual spectrum measurement.....	569
Conducting quad spectrum.....	571
Conducting spectrogram.....	573
Conducting dual spectrogram	574
Conducting RSSI.....	575
Zooming into spectrum using zoom in	576
Performing spectrum replayer.....	578
Setting limit for interference analysis	580
Performing PIM detection (single and multiple carriers).....	581
Connecting cables.....	581
Selecting measurement mode	581
Selecting port	582
Setting measure setup.....	582
Configuring Rx Parameters	582
Calculating possible PIM	584
Detecting PIM (single and multiple carriers).....	584
Measurement example	585
Performing LTE-FDD downlink signal analysis	585
Connecting cables.....	586
Selecting measurement mode	586
Selecting port	586
Configuring test parameters	587
Setting measure setup.....	589
Configuring Rx Parameters	589
Viewing decoded MIB and SIB1/2 information	590
Conducting spectrum measurement	591
Conducting channel power measurement.....	593
Occupied bandwidth.....	594
Conducting power vs. time (frame) measurement.....	595
Conducting constellation measurement	596
Conducting data channel measurement	598
Conducting control channel measurement.....	600
Conducting subframe measurement	602
Conducting frame measurement.....	605
Conducting time alignment error measurement	607
Conducting data allocation map measurement	608
Performing power statistics CCDF measurement	610
Setting limit for RFoCPRI signal analysis.....	611
Performing LTE-TDD downlink signal analysis	612
Connecting cables.....	613
Selecting measurement mode	613
Selecting port	613
Configuring test parameters	614
Setting measure setup.....	616
Configuring Rx Parameters	616
Conducting spectrum measurement	617
Conducting channel power measurement.....	619
Occupied bandwidth.....	620
Conducting power vs. time (frame) measurement.....	621
Conducting constellation measurement	622
Conducting data channel measurement	624
Conducting control channel measurement.....	626
Conducting subframe measurement	628
Conducting time alignment error measurement	631
Conducting data allocation map measurement	632
Performing power statistics CCDF measurement	634
Setting limit for RFoCPRI signal analysis.....	635

Using signal generator	636
Using RF source in RFoCPRI testing	636
Using CPRI source	637
Emulating a BBU	638
Selecting measurement mode	639
Selecting port	639
Performing RRH profiling	639
Verifying and configuring a RRH	643
Performing spectrum clearance	651
Checking coverage range	659
Performing PIM analysis	661
Optimizing RET information	667
<hr/>	
Chapter 17 Performing RFoOBSAI Testing	672
Introduction	673
Display overview	673
Selecting measurement mode	674
Performing layer 2 monitoring	674
Connecting cables	674
Selecting measurement mode	675
Selecting port	675
Setting measure setup	675
Setting Rx optic limit	676
Conducting layer 2 monitoring	676
Measurement example	677
Performing layer 2 term testing	677
Connecting cables	677
Selecting measurement mode	678
Selecting port	678
Setting measure setup	678
Setting Rx optic limit	678
Conducting layer 2 term test	679
Measurement example	680
Performing interference analysis	680
Connecting cables	680
Selecting measurement mode	681
Selecting port	681
Configuring test parameters	681
Setting measure setup	685
Conducting spectrum measurement	686
Conducting spectrogram	688
Conducting RSSI	689
Performing spectrum replayer	690
Setting limit for interference analysis	691
Performing PIM detection (single and multiple carriers)	692
Connecting cables	692
Selecting measurement mode	693
Selecting port	693
Setting measure setup	693
Calculating possible PIM	694
Detecting PIM (single and multiple carriers)	695
Measurement example	696
Performing LTE-FDD downlink signal analysis	696
Connecting cables	696
Selecting measurement mode	697
Selecting port	697
Configuring test parameters	697
Setting measure setup	699
Conducting spectrum measurement	701
Conducting channel power measurement	702
Occupied bandwidth	703
Conducting power vs. time (frame) measurement	704
Conducting constellation measurement	705
Conducting data channel measurement	707
Conducting control channel measurement	709
Conducting subframe measurement	711
Conducting frame measurement	714

Conducting time alignment error measurement	716
Conducting data allocation map measurement	717
Performing power statistics CCDF measurement	719
Setting limit for RFoOBSAI signal analysis	720
Using signal generator	721
Using RF source in RFoOBSAI testing	721
Using OBSAI source.....	722
<hr/>	
Chapter 18 Using Channel Scanner	723
Introduction	724
Display overview	724
Connecting a cable	724
Direct connection.....	724
Indirect connection	725
Over the air (OTA)	725
Selecting measurement mode.....	726
Configuring test parameters	726
Setting frequency	726
Setting amplitude.....	726
Setting average	728
Setting sweep mode.....	728
Making channel scanner measurements	729
Setting channel.....	729
Measurement example	729
Making frequency scanner measurements	730
Setting frequency	730
Measurement example	731
Making custom scanner measurements	731
Setting channel/frequency	731
Measurement example	732
Analyzing measurements	733
Setting limit for channel scanner.....	733
<hr/>	
Chapter 19 Using Power Meter	734
Introduction	735
Display overview	735
Performing internal RF power measurements	735
Connecting a cable.....	736
Selecting measurement mode	736
Setting frequency	737
Setting amplitude.....	738
Setting sweep mode.....	738
Making a measurement.....	739
Measurement example	739
Performing external RF power measurements.....	740
Connecting a cable.....	740
Selecting measurement mode	741
Setting frequency	741
Setting amplitude.....	741
Making a measurement	742
Measurement example	742
Performing optical power measurements	743
Connecting a power meter.....	743
Selecting measurement mode	744
Setting measurement parameters.....	744
Making a power measurement.....	744
Reading a relative power	745
Holding a measurement	745
<hr/>	
Chapter 20 Performing Fiber Inspection	746
Introduction	747
Display overview	747
Connecting a fiber microscope	747
Selecting measurement mode.....	748
Configuring test parameters	748
Selecting profile and tip	748
Setting preferences	748

Performing fiber inspection.....	749
Capturing fiber image	749
Testing a fiber.....	750
Chapter 21 Using EMF Analyzer.....	752
Introduction	753
Display overview	753
Connecting an isotropic antenna	753
Selecting measurement mode.....	754
Configuring test parameters	754
Setting frequency	754
Setting amplitude.....	756
Setting bandwidth.....	757
Conducting EMF spectrum measurements.....	758
Setting trace	759
Setting limit.....	759
Recording and replaying EMF logging data.....	760
Logging EMF spectrum data.....	760
Replaying EMF spectrum data.....	761
Appendix.....	763
Appendix A – Product general information.....	764
JD780B series.....	764
JD740B series.....	766
Appendix B – Cable list	768
Appendix C – Band, frequency & channel standard.....	769
Appendix D – VSWR-Return loss conversion table	772
Appendix E – Cyclic prefix table	773
Appendix F – Motorola CDMA/EV-DO LMF	774
Using JD700B series LMF interface.....	774
Setting up for a LMF test	774
Performing a LMF test.....	775
Appendix G – Bluetooth connection	776
Installing and setting up Bluetooth software.....	776
Making Bluetooth connection.....	776
Setting up communication in application.....	777
Turning Bluetooth mode on/off manually.....	778
Appendix H – Device driver installation	779
Appendix I – Ordering information	780
JD785B Base Station Analyzer.....	780
JD786B RF Analyzer	782
JD788B Signal Analyzer	783
JD745B Base Station Analyzer.....	786
JD746B RF Analyzer	788
JD748B Signal Analyzer.....	789
JD700B Series Common Options	792
Appendix J – RoHS information.....	795
JD780B series.....	795
JD740B series.....	796
Appendix K – On-screen keyboard.....	797
Adding or deleting letters.....	797
Editing or adding a custom keyword	797
Appending a keyword	798
Appendix L – Supported map display parameters.....	800



About This Guide

Topics discussed in this chapter include the following:

- Purpose and scope 21
- Assumptions 21
- Safety and compliance information 21
- Conventions 22
- Technical assistance 23

Sections “Safety and compliance information” and “Conventions” in this chapter contain information in French as well.

Purpose and scope

The purpose of this guide is to help you successfully operate the JD700B series (firmware version 3.066 and later) and use its features and capabilities. This document includes instructions that describe how to operate, set up, configure, and use the JD700B series, consisting of JD785B/JD745B Base Station Analyzer, JD786B/JD746B RF Analyzer, and JD788B/JD748B Signal Analyzer.

Objectif et champ d'application

Le but de ce guide est de vous aider à utiliser avec succès la série JD700B (version du firmware 3.066 et plus tard) et à utiliser ses fonctions et capacités. Ce document contient des instructions qui décrivent comment utiliser, créer, configurer et utiliser la série JD700B, composé de JD785B/JD745B Base Station Analyzer, JD786B/JD746B RF Analyzer, et JD788B/JD748B Signal Analyzer.

Assumptions

This guide is intended for novice, intermediate, and experienced users who want to use the JD700B series effectively and efficiently. We are assuming that you have basic operation experience and are familiar with basic mobile communication concepts and terminology.

Hypothèses

Ce guide est destiné aux débutants, intermédiaires et les utilisateurs avancés qui veulent utiliser série JD700B efficace et efficiente. Nous supposons que vous avez une expérience de base du fonctionnement et êtes familier avec les concepts de communication mobile et de la terminologie.

Safety and compliance information

It is mandatory to permanently connect this product to the protective earth.

When supplying power to this device, always use an AC power cable that includes an earth (safety) ground connection.

Informations de sécurité et de conformité

Il est obligatoire de se connecter en permanence ce produit à la protecteur terre. Lorsque alimenter en énergie cet appareil, utilisez toujours un câble d'alimentation secteur qui comprend une terre de sécurité.



WARNING

Do not attempt to service this product yourself, as opening or removing covers may expose you to dangerous voltage and other hazards. Refer all servicing to qualified service personnel.

AVERTISSEMENT

Ne pas tenter de réparer ce produit vous-même, car l'ouverture ou le retrait des capots peut vous exposer à des tensions dangereuses et autres risques. Confiez toute réparation à un personnel qualifié de service Viavi.



CAUTION

This equipment contains parts and assemblies sensitive to electrostatic discharge (ESD). Use ESD precautionary procedures when touching, removing, or inserting ESD sensitive parts and assemblies, or damage to components could result.

An electrostatic-sensitive device can only withstand voltage spikes of 10 to 100 volts. Any discharge greater than this can damage or effectively destroy such a device while going unnoticed by a technician. Common plastics (synthetic insulating materials), clothing, and paper or cardboard are the most common source of static charges.

MISE EN GARDE

Cet équipement contient des pièces et des assemblages sensibles aux décharges électrostatiques

(ESD). Utilisez ESD procédures de précaution en cas de contact, la suppression ou l'insertion de pièces de l'EDD et des assemblages sensibles, ou des dommages aux composants pourraient en résulter.

Un dispositif électrostatique sensible ne peut supporter des pointes de tension de 10 à 100 volts. Toute décharge supérieur à ce qui peut endommager ou détruire efficacement un tel dispositif alors passer inaperçu par un technicien. Matières plastiques (matériaux synthétiques isolants), les vêtements et le papier ou le carton sont la source la plus fréquente de charges statiques.



CAUTION

This instrument uses a Lithium Ion battery that, if not connected correctly, may lead to explosion. In case the battery needs to be exchanged, it must be the same kind as or compatible with the one shipped with your instrument.

The battery must not be disposed of in a landfill site or as municipal waste, and should be disposed of according to your national regulations.

MISE EN GARDE

Cet instrument utilise une batterie lithium-ion qui, s'il n'est pas connecté correctement, peut conduire à une explosion. Dans le cas où la batterie a besoin d'être remplacé, il doit être du même type ou compatible avec celui fourni avec votre instrument.

La batterie ne doit pas être éliminé dans un site d'enfouissement ou les déchets municipaux, et doit être éliminé conformément à la réglementation nationales.

Conventions

This guide uses typographical and symbols conventions as described in the following tables.

Conventions

Ce guide utilise les conventions typographiques et les symboles tels que décrits dans les tableaux suivants.

Table 1 Text formatting and other typographical conventions

Item	Text formatting/symbols used	Example(s)
Buttons or hard keys that the user presses on a physical device	Bold, all caps, default font	Press the ON button. Press the MODE hard key. Press the MARKER hard key.
Hot keys that the user presses on a physical device	Bold, all caps, italics, default font	Press the <i>SYSTEM</i> hot key. Press the <i>MEASURE</i> hot key.
Soft keys or toggle keys that the user presses on a physical device to select corresponding menus	Bold, default font	Press the Span soft key. Press the Channel Power soft key.
Soft key option separators	Denoted by a vertical bar that means “or”, only one option can be selected with a single press	Press the Zone [1 2 3] soft key.
File type	Courier New	In .tra file type.
Required arguments (text variables in code)	Denoted by slanted brackets < >.	Enter <password>

Table 2 Symbol conventions



This symbol indicates a note that includes important supplemental information or tips related to the main text.

Ce symbole indique une note qui inclut des importante supplémentaire informations ou des pointes relatifs au texte principal.



This symbol represents a general hazard. It may be associated with either a DANGER, WARNING, or CAUTION message.
Ce symbole signale la présence d'un danger général.



This symbol represents hazardous voltages. It may be associated with either a DANGER, WARNING, or CAUTION message.
Ce symbole signale la présence d'un risque d'électrocution.



This symbol represents a risk of explosion. It may be associated with either a DANGER, WARNING, or CAUTION message.
Ce symbole signale la présence d'un risque d'explosion.



This symbol, located on the equipment, battery, or the packaging indicates that the equipment or battery must not be disposed of in a landfill site or as municipal waste, and should be disposed of according to your national regulations.
Ce symbole, situé sur l'équipement, la batterie ou l'emballage indique que l'équipement ou de la batterie ne doivent pas être jetés dans un site d'enfouissement ou les déchets municipaux, et doivent être éliminés conformément à la réglementation nationales.

Table 3 Safety definitions

DANGER	Indicates a potentially hazardous situation that, if not avoided, <i>will</i> result in death or serious injury. It may be associated with either a general hazard, high voltage, or risk of explosion symbol.
DANGER	<i>Indique une situation potentiellement dangereuse qui, si elle n'est pas évitée, entraînera la mort ou des blessures graves.</i>
WARNING	Indicates a potentially hazardous situation that, if not avoided, <i>could</i> result in death or serious injury. It may be associated with either a general hazard, high voltage, or risk of explosion symbol.
AVERTISSEMENT	<i>Indique une situation de danger potentiel qui, si elle n'est pas évitée, peut entraîner la mort ou des dommages corporels graves.</i>
CAUTION	Indicates a potentially hazardous situation that, if not avoided, <i>could</i> result in minor or moderate injury and/or damage to equipment. It may be associated with either a general hazard, high voltage, or risk of explosion symbol. When applied to software actions, indicates a situation that, if not avoided, <i>could</i> result in loss of data or a disruption of software operation.
MISE EN GARDE	<i>Indique une situation de danger potentiel qui, si elle n'est pas évitée, peut entraîner des dommages corporels légers ou modérés.</i>

Technical assistance

If you require technical assistance, call 1-844-GO-VIAMI or send an email to TAC@viavisolutions.com. For the latest TAC information, go to <http://www.viavisolutions.com/en/services-and-support/support/technical-assistance>.

Chapter 1 JD700B Series Overview

This chapter provides a general description of the JD700B series. Topics discussed in this chapter include the following:

- About the JD700B series..... 25
- Features and capabilities 25
- Options 26
- Specifications 26

About the JD700B series

Viavi wireless RF and fiber test solutions for the field include base station analyzers, cable and antenna analyzers, and signaling analyzers for the installation and maintenance of modern wireless communication systems. RF and fiber test is critical for wireless operators facing challenges of signal quality and signaling interference, and maintaining quality high-bandwidth services.

The JD700B series addresses spectrum analysis, interference analysis, and cable, antenna and modulation analysis, covering current wideband technologies such as WiMAX and LTE/LTE-Advanced.

Base station analyzer JD785B and JD745B

The Base Station Analyzer contains all the features and capabilities required to perform field-testing of cell sites of all wireless technologies, from 2G to 4G.

RF analyzer JD786B and JD746B

The RF Analyzer provides multi-purpose solution for the analysis of RF systems covering all physical aspects of transmission, reception, and interference of RF systems up to 8 GHz and 4 GHz, respectively.

Signal analyzer JD788B and JD748B

The Signal Analyzer contains all the features and capabilities required to perform cell site field-testing for all wireless technologies from 2G to 4G.

Features and capabilities

The JD700B series is the optimal test solution for installation and maintenance of cellular base stations and cell sites, running with external AC power or battery for the field.

The user interface has been specifically designed with customized menus and simple calibration procedures, providing service providers with accurate and reliable measurement results.

Applicable Systems

- cdmaOne/cdma2000
- EV-DO
- WCDMA/HSPA+
- GSM/GPRS/EDGE
- TD-SCDMA
- WiMAX
- LTE/LTE-Advanced (FDD and TDD)
- RF over Fiber (RFoFiber – RFoCPRI and RFoOBSAI)

Key Features

Table 4 Key functions available in product models

Functionality	JD785B/JD745B	JD786B/JD746B	JD788B/JD748B
Spectrum Analyzer	■	■	■
Cable and Antenna Analyzer	■	■	
RF Power Meter	■	■	■
Optical Power Meter	■	■	■
Fiber Inspection	■	■	■
Signal Analyzers (optional)	■		■
RFoFiber (optional)	■	■	■
Interference Analyzer (optional)	■	■	■
Channel Scanner (optional)	■	■	■
OTA Measurement (optional)	■		■
EMF Analyzer (optional)	■	■	■

Options

This instrument is provided with various options/features that are available to be ordered. See “Appendix I – Ordering information” on page 780 for more information.

Specifications

AC power

Input voltage is automatically selected within the instrument’s tolerable input line voltage from 100 to 240 VAC. This instrument does not have a separate line protection fuse.

Table 5 AC power requirements

Item	JD780B Specification	JD740B Specification
AC Power	100 to 240 V AC, 50-60 Hz	100 to 240 V AC, 50-60 Hz
Power Consumption	42 W in operation 54 W with battery charging	42 W in operation 54 W with battery charging

Physical specifications

Table 6 shows weight with standard configurations and the battery pack installed.

Table 6 Physical specifications

Model	Dimension (H x W x D)
JD785B/JD786B/JD788B	7.7" x 11.6" x 3.2" (195 mm x 295 mm x 82 mm)
JD745B/JD746B/JD748B	7.7" x 11.6" x 3.2" (195 mm x 295 mm x 82 mm)

Chapter 2 Getting Started

This chapter provides general guides of how to get started with your JD700B series instrument. Topics discussed in this chapter are as follows:

■ Unpacking the JD700B series	28
■ Exploring the JD700B series	28
■ Installing battery pack.....	33
■ Starting up the JD700B series	33
■ Managing files	34
■ Configuring system.....	38
■ Upgrading firmware	40
■ Managing licenses.....	42
■ Performing service diagnostic	44
■ Using system administration	46
■ Running IP test	46
■ Activating StrataSync	47
■ Activating StrataSync	49
■ Activating StrataSync	51
■ Managing help manual	56

Unpacking the JD700B series

Unpack and inspect the shipping package thoroughly to ensure that nothing was damaged during the shipment. Also, check that your delivered package includes all of your ordered items in the shipment. If contents in the package are damaged or defective or if there are any missing items, keep the shipping list and materials for carrier’s inspection and contact your nearest Viavi’s authorized sales and service office.

A basic test set of JD700B series would include the following items in the package. For more options, see “Appendix I – Ordering information” on page 780.

Table 7 Items included in a basic test set shipment

Item	Quantity
JD700B series instrument (JD785B, JD786B, JD788B, JD745B, JD746B, or JD748B)	1
AC/DC power adapter and power cord	1
1.5 meter cross LAN cable	1
1.8 meter USB A-to-B cable	1
> 1 GB USB memory	1
Rechargeable Lithium Ion battery pack	1
12 V DC automotive adapter	1
Stylus pen	1
User’s guide and application software CD	1

Exploring the JD700B series

Figure 1 JD785B front panel view



Front panel







The JD700B series analyzers have the same front panel look as like **Figure 1**, except for the bumpers in different colors.

Power on/off button

Key	Description
	POWER ON/OFF – You can turn your instrument on or off. Two LEDs indicate power source and status. See “Starting up the JD700B series” on page 33.







Function hard keys





You can use these hard keys to activate specified functions as labeled on each key.

Key	Description
	MODE – You can select an analyzer mode from all the standard and optional modes available to your instrument.
	FREQ/DIST – You can configure frequency or distance settings.
	AMP/SCALE – You can configure amplitude and scale settings.
	BW/AVG – You can configure bandwidth and average settings.
	TRACE/DISPLAY – You can set up trace and display parameters.
	MARKER – You can analyze measurements with markers.
	PEAK SEARCH – You can set up peak search parameters.

Hot keys

When the user input field on the screen is inactive, you can use these hot keys to activate specific functions instead of numbers. When you see the user input field activated or highlighted, press the **ESC** hard key to use these hot keys.







Key	Description
	MEASURE – You can select measurements available for your selected analyzer mode.
	MEASURE SETUP – You can set measurement parameters available for your selected measurement mode.
	SAVE/LOAD – You can save or load your current screen, result, setup, or limit into or from the internal memory or an external USB memory drive.
	SWEEP – You can configure sweep parameters.
	TRIGGER – You can select trigger options such as internal, external, and GPS.
	SYSTEM – You can configure your system settings or view your current system information.

	PRESET – You can use this key to return to a known state and make measurements.
	HOLD – You can change the sweep mode: Continue or Single.
	LIMIT – You can set limit settings such as display line, multi segment line, save limits, recall limits, or test specification limits.
	BACKLIGHT – You can turn the key backlight feature on or off.
	HELP – You can have the online help screen on if available.

Soft keys

You can use not only the touchscreen keys but also these physical keys placed along the right side of the display to start a specific function associated with each soft key, invoke other screen keys, or select a unit. The **More** screen menu indicates that there are more than seven screen menus for the level. The small arrowhead symbol in the screen menu indicates that there are screen menus under the screen menu.

Data entry and other keys

Key	Description
	ROTARY KNOB WITH ENTER KEY – You can change a value with predefined increments or move marker position. Rotating this knob clockwise increases value or moves a marker to the right and rotating counter clockwise does vice versa. This knob works as the ENTER hard key as well.
	ARROW KEYS – You can increase or decrease value or move your selection up, down, to the left, or to the right.
	NUMERIC KEYS – You can manually enter a value for measurement parameters.
	DEL – You can delete data entry. After pressing the ENTER key or selecting a unit soft key, you cannot delete or remove data entered.
	ENTER – You can save and confirm data entry.
	ESC – You can cancel any input in the user input field or dismiss a pop-up window on the screen.
	PREV – You can go back to the previous menu without changing current setup.

Top panel

The JD700B series products have the same top view as **Figure 2** and Figure 3.

Figure 2 Top view of JD785B with optical hardware option

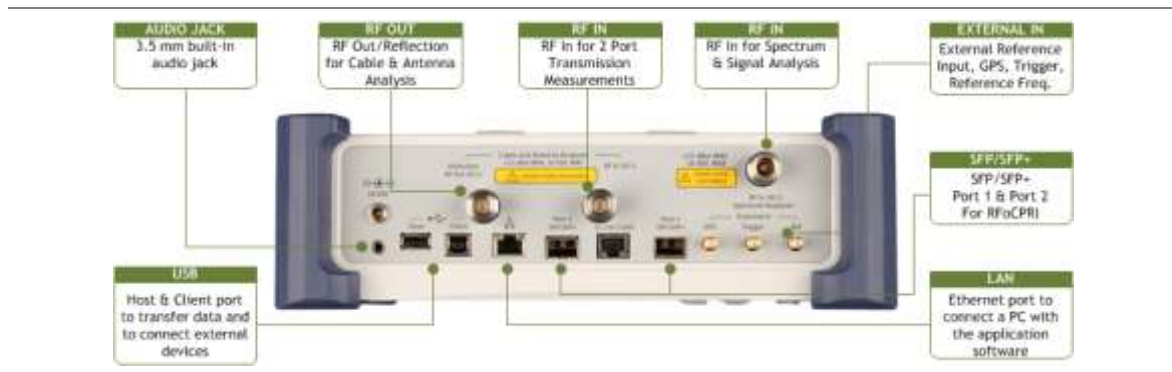
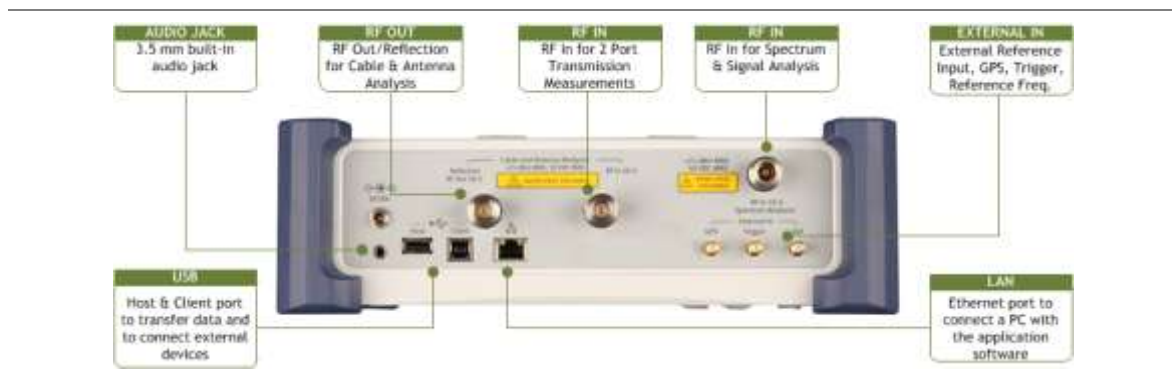

Figure 3 Top view of JD785B without optical hardware option



Reflection/RF Out (Cable and Antenna Analyzer)

The **Reflection/RF Out** port of the Cable and Antenna Analyzer is a precise 50 Ω N-type female connector that is used as the output signal port for the Cable and Antenna Analyzer mode.



CAUTION

Do not apply or connect power exceeding +25 dBm to this Reflection/RF Out port. If such power is applied, it will degrade the product's performance and can cause damage to the product in worst case.

RF In (Cable and Antenna Analyzer)

The **RF In** port is a precise 50 Ω N-type female connector that is used as the input signal port for 2-port vector measurements in the Cable and Antenna Analyzer mode.



CAUTION

The maximum power allowed to the RF In port is +25 dBm. If the input power exceeds the limit, it may degrade the product performance or cause damage to the instrument in a worst case. Do not connect any power feed exceeding 1 W directly to this port.

DC 18 V

The input power to this port shall be 18 V DC.

RF In (Spectrum Analyzer)

The **RF In** port is a precise 50 Ω N-type female connector that is used as the input signal port for spectrum analysis, signal analysis, and RF power measurement.



CAUTION

The maximum power allowed to the RF In port is +25 dBm for JD780B series and +20 dBm for JD740B series. If the input power exceeds the limit, it may degrade the product performance or cause damage to the instrument in a worst case.

Audio jack

The audio jack is labeled with a headphones icon. Plugging in headphones or earphones turns the speaker off.

USB

- **CLIENT:** This is a communication port that you can connect your instrument and your PC with application software JDViewer, JDRemote, or JDMapCreator. You must install driver software for the instrument on to the computer. See “Appendix H – Device driver installation” on page 779 for more information.
- **HOST:** You can use this port to plug in an external USB memory to extend storage capacity or to upgrade the instrument’s firmware. It supports most USB memory devices with 32-bit file system. You can also use this port to connect an external power sensor, Bluetooth USB adapter, or P5000i fiber microscope. See “Appendix G – Bluetooth connection” on page 776 on how to set up and use the Bluetooth connection.

LAN

You can use this Ethernet communication port to connect your instrument and your PC using the application software JDViewer or Motorola WinLMF, if necessary. Two LEDs indicate data transfer activity and link status.

- **ACTIVITY:** The yellow LED is illuminated during data transfer.
- **LINK:** The green LED is illuminated when there is a valid communication connection.

SFP/SFP+

The optical hardware option board for RFoCPRI and RFoOBSAI supports all types of MSA (Multi-Source Agreement) compliant SFP transceivers. You can use these SFP/SFP+ ports to connect SFP modules to test CPRI/OBSAI protocols, detect an error or alarm, perform interference analysis, and transmit test pattern over fiber link.

External In

- **GPS:** You can plug in a GPS antenna to this SMA type female connector in order to get location information and highly accurate reference.
- **TRIGGER:** You can use this SMA type female connector to receive PP2S clock or 10 ms synchronization signals from an external timing reference.
- **REF:** You can use this SMA type female connector to receive 10 MHz, 13 MHz, or 15 MHz reference clock signals from an external frequency source.

Installing battery pack

You need to install the Lithium Ion battery pack provided with your instrument. Follow the instruction to install or remove the battery pack as needed.

Procedure

To install the battery pack:

- 1 Loosen the latching screw of the battery cover by turning counter clockwise.
- 2 Slide out the battery cover to open.
- 3 Insert the battery pack with the connector terminal side up and push in until it stops.
- 4 Slide in the battery cover to close.
- 5 Tighten the latching screw of the battery cover by turning clockwise.

To remove the battery pack:

- 1 Loosen the latching screw of the battery cover by turning counter clockwise.
- 2 Slide out the battery cover.
- 3 Hold the battery strap and pull it out.

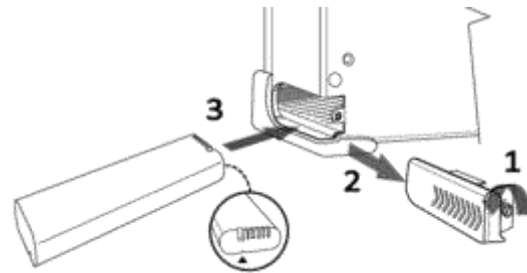

CAUTION

The battery pack that came with your instrument is Lithium Ion and it may, if not connected correctly, lead to explosion. In case you need to replace the battery, you must use one of the same kinds or compatible ones. You must dispose a battery according to your local safety and environmental regulations.



NOTE

It is recommended that you turn off the instrument to replace the battery. However, if you do not want to interrupt the current test, you can leave the module turned on with the AC power adapter plugged in.

Starting up the JD700B series

Use the power button to turn your JD700B series on or off. When external power is supplied via the AC/DC adapter, the upper orange LED is illuminated.

Procedure

To turn on:

- 1 Press and hold the  **POWER** button for a few seconds until the lower green LED indicator is illuminated.
- 2 Release the button and wait for a few seconds while booting up.

To turn off:

- 1 Press and hold the  **POWER** button for a few seconds until the lower green LED indicator goes out.
 - 2 Release the button.
-

Managing files

The JD700B series lets you save and load screen, result, setup, limit, logging data, or Fail events depending on your selected measurement modes and options.



NOTE
If you see greyed-out menus as you change measurement modes, this indicates that the menu(s) are not available to be used.

Using save

You can save your current screen, result, setup, and limit into the internal memory or your external USB memory drive.

Procedure

- 1 Press the **SAVE/LOAD** hot key. The Save/Load menu bar appears.
- 2 Press the **Save** soft key.
- 3 Select the save option, from the following choices:

To save	Select	File type
Current screen	Save Screen > Screen	.png
Measurement result in a report format with comments and captured screen images	Save Screen > Report	.pdf
Measurement result	Save Result	.tra .gom .grr .jdt
RRH profile (only available in BBU emulation mode)	Save Profile	.jcm
Measurement result (.csv)	Save Result as CSV Format	.csv
Setup and test configuration	Save Setup	.sta
Limit setting	Save Limit	.jml
Logging data	Save Logging Data	.grr .gsr .csv
Automatically screen or results that falls outside the defined limit settings (Failed event)	Save On Event	.png .tra .csv

The on-screen keyboard appears.



NOTE

- Save Setup saves a test configuration only, not a measurement limit setting. You must use Save Limit to save your limit settings.
- In the Spectrum measurement of Spectrum Analyzer and Interference Analyzer modes, Save Setup saves the test configuration and measurement limit settings.
- In the Cable and Antenna Analyzer mode, if the limit line is enabled and set, Save Result saves the trace together with the set limit line.
- In the Spectrum measurement of spectrum analyzer and Interference Analyzer modes, if the limit line is enabled and set, Save Result saves the trace together with the set limit line.
- An RFoCPRI/RFoOBSAI spectrum can be saved as a file, but the difference in its data

point does not allow the saved RFoCPRI/RFoOBSAI spectrum to be overlaid on a regular RF spectrum.

- 4 Toggle **Invert Colors** and select **On** to invert the image color.
- 5 Type the name of the file in the **File Name** field with or without using a keyword.
- 6 *Optional.*
 To create or edit keywords, touch the **Edit Keywords** button, select your desired keyword button in the upper screen, type a keyword, and then tap the **Save** button on the keyboard. See “Editing or adding a custom keyword” on page 797 for more information.
 To include a keyword in the file name, touch the **Append Keywords** button, select your desired keyword, and then tap the **Keyboard** button. See “Appending a keyword” on page 798 for more information.
 To change the file location in the internal memory or to your USB memory drive, tap the **Location** button, select your desired file path using the touch screen or the rotary knob, and then press the **Apply** soft key.
 To create a folder, press the **Create Folder** soft key, type a directory name, and then press the **Apply** soft key.
- 7 Press the **Save** soft key.
- 8 If you have selected **Save Screen > Report** in step 3, pressing the **Save** soft key in the previous step 6 gives you another window where you can specify details on your report.
- 9 Type the name of the person who performed testing in the Engineer field.
- 10 Enter a description about the site or place in the Site Information field.
- 11 Enter your test purpose in the Test Purpose field.
- 12 Enter a summary of your test results in the Result field.
- 13 Type your company name in the Company Name field.
- 14 Enter your company or site address in the Address field.
- 15 To attach your company logo and up to six captured screens to the report, tap the **Click to Attach** bar, attach image files as desired, and then tap the **Save** button.

Saving fail events

Depending on the measurement mode, you can let the instrument automatically save measurement screen or result that falls outside the defined limit settings or the Fail indicator is on. You can also set to save the first event and hold the measurement or to save all the events continuously.

Procedure

- 1 Press the **SAVE/LOAD** hot key.
The Save/Load menu bar appears.
- 2 Press the **Save** soft key.
- 3 Press the **Save On Event** soft key.
- 4 Press the **Save Type** soft key, and then select the save option from the choices: **Screen**, **Result**, or **Result as CSV Format**.
- 5 *Optional.* Toggle the **Save Then Stop** soft key to **On** in order to save the first event that falls outside the limit(s) and to hold the measurement. Otherwise, leave this feature off to save events continuously.
- 6 Press the **Start** soft key to start saving.
The on-screen keyboard appears.
- 7 Type the name of the file in the **File Name** field with or without using a keyword.
- 8 *Optional.* Complete the following steps:
 To create or edit keywords, touch the **Edit Keywords** button, select your desired keyword button in the upper screen, type a keyword, and then tap the **Save** button on the keyboard. See “Editing or adding a custom keyword” on page 797 for more information.
 To include a keyword in the file name, touch the **Append Keywords** button, select your

desired keyword, and then tap the **Keyboard** button. See “Appending a keyword” on page 798 for more information.

To change the file location in the internal memory or to your USB memory drive, touch the **Location** button, select your desired file path using the touch screen or the rotary knob, and then press the **Apply** soft key.

To create a folder, press the **Create Folder** soft key, type a directory name, and then press the **Apply** soft key.

- 9 Press the **Done** soft key.
The “**Event Save**” appears on the screen and the **Start** screen menu changes to **Stop**.
- 10 Press the **Stop** soft key to end the event saving.

Saving logging data

You can save logging data if the measurement mode supports the feature and has the activated Save Logging Data soft key.

Procedure

- 1 Press the **SAVE/LOAD** hot key.
The Save/Load menu bar appears.
 - 2 Press the **Save** soft key.
 - 3 Press the **Save Logging Data** soft key.
The on-screen keyboard appears.
 - 4 Type the name of the file in the **File Name** field with or without using a keyword.
 - 5 *Optional.* Complete the following steps:
 - To create or edit keywords, touch the **Edit Keywords** button, select your desired keyword button in the upper screen, type a keyword, and then tap the **Save** button on the keyboard. See “Editing or adding a custom keyword” on page 797 for more information.
 - To include a keyword in the file name, touch the **Append Keywords** button, select your desired keyword, and then tap the **Keyboard** button. See “Appending a keyword” on page 798 for more information.
 - To create a folder, press the **Create Folder** soft key, type a directory name, and then press the **Apply** soft key.
 - To change the file location in the internal memory or to your USB memory drive, touch the **Location** button, select your desired file path using the touch screen or the rotary knob, and then press the **Apply** soft key.
-  **NOTE**
It is recommended that you use an external USB memory drive to save logging data in the Auto Measure mode in order to have enough free space.
- 6 *Optional only in the Auto Measure mode.*
Toggle the **Save Screen** soft key and select **All** to save all the Auto Measure screens or **Fail** to save only the ones with the Fail on.
 - 7 Press the **Save** soft key to start logging.
The “**Recording**” appears on the screen.
 - 8 Press the **ESC** hard key to stop logging data and complete saving.

Using load

You can load your saved screen, result, setup, and limit from the internal memory or your external USB memory drive.

Procedure

- 1 Press the **SAVE/LOAD** hot key.

The Save/Load menu bar appears.

- 2 Press the **Load** soft key.
The Load menu bar appears.
- 3 Select the load option, from the following choices:

To load	Select
Saved screen or report	Load Screen
Measurement result	Load Result
Setup and test configuration	Load Setup
Limit setting	Load Limit
Logging data	Load Logging Data
Map file	Load Map
Scenario	Load Scenario

The file manager window appears.



NOTE

An RFoCPRI/RFoOBSAI spectrum can be recorded and replayed in the RFoCPRI/RFoOBSAI Interference Analyzer (IA) mode only. It is not compatible with a standard spectrum logging file in the Interference Analyzer mode.

- 4 Select the name of the file to be loaded from the internal memory or from your USB drive. Information of your selected file appears in the File Information pane.
- 5 Press the **Load** soft key.

Using file manager

The File Manager lets you copy, cut, paste, and delete data files saved in the internal memory or in your USB memory drive.

Procedure

- 1 Press the **SAVE/LOAD** hot key.
The Save/Load menu bar appears.
- 2 Press the **File Manager** soft key.
The file manager window appears.
- 3 To copy, cut, and paste, complete the following steps:
 - a Select a file or folder by using the touch screen or the rotary knob.
 - b Select the **Copy** or **Cut** soft key.
 - c Select the location to which the file or folder to be pasted.
 - d Press the **Paste** soft key.
- 4 To delete, complete the following steps:
 - a Select a file or folder by using the touch screen or the rotary knob.
 - b Press the **Delete** soft key.
The confirmation dialog box appears.
Once the file or folder is deleted, you cannot recover it.
 - c Select **OK** to delete.
- 5 Press the **Exit** soft key or the **ESC** hard key to close the file manager window.

Configuring system

Setting frequency reference

You can improve measurement accuracy by setting frequency reference.

Procedure

- 1 Press the **SYSTEM** hot key.
 - 2 Press the **Freq Reference** soft key.
 - 3 Select the frequency reference option: **Internal**, **External 10 MHz**, **External 13 MHz**, **External 15 MHz**, or **GPS**.
-

Setting frequency reference for 28 GHz downconverter

You can improve measurement accuracy by setting frequency reference.

Procedure

- 1 Press the **SYSTEM** hot key.
 - 2 Press the **Freq Reference** soft key.
 - 3 Once pressed **CellAdvisor** soft key, select the frequency reference option: **Internal**, **External 10 MHz**, **External 13 MHz**, **External 15 MHz**, or **GPS**.
 - 4 Once pressed **28G DC** soft key, select the option between **Internal** and **External**.
-

Setting date and time

You can set the instrument' system clock to your region.

Procedure

- 1 Press the **SYSTEM** hot key.
 - 2 Select **System Configuration > Date/Time**.
The current time zone information box appears.
 - 3 To change the standard time zone, complete the following steps:
 - a Press the **Std Time Zone** soft key.
 - b Select your time zone by using the rotary knob or arrow keys. You can also use the **Top/Bottom** or **Page Up/Down** soft keys.
 - c Press the **ENTER** hard key to save your change. You can also press the rotary knob.
 - 4 To change the date format, complete the following steps:
 - a Press the **Date Format** soft key.
 - b Select **YYMMDD**, **MMDDYY**, or **DDMMYY** as needed.
 - 5 To set the date and time manually, complete the following steps:
 - a Select **Year**, **Month**, **Day**, **Hour**, or **Minute** soft key as needed.
 - b Enter a value by using numeric keys.
 - c Press the **Enter** soft key to save your change.
 - 6 Press the **Apply** screen key to save and exit.
-

Setting language

You can change the system language for the menus, messages, and information on screen.

Procedure

- 1 Press the **SYSTEM** hot key.
 - 2 Select **System Configuration > Language**.
 - 3 Select the language option from the choices available.
-

Setting power on

Procedure

- 1 Press the **SYSTEM** hot key.
 - 2 Press the **Power On** soft key.
 - 3 Select the power-on option, from the following choices:
 - Last:** Boots up with the last state of the instrument before power-off or shut-down.
 - Preset:** Boots up with the default settings preset in the factory.
 - User:** Boots up with the user-defined setup.
When the User is selected, the User Setup menu under System becomes activated.
 - 4 *Optional.* If you have selected User in step 3, complete the following steps to specify a user setup file to be used:
 - a Press the **User Setup** soft key.
 - b Select the name of the user setup file.
 - c Press the **Done** soft key.
-

**NOTE**

The Preset is to revert to original factory settings. It is recommended that you use this option when you have experienced badly misadjusted settings.

Changing display mode

You can change the instrument's display mode as needed.

Procedure

- 1 Press the **SYSTEM** hot key.
 - 2 Select **System Configuration > Display Mode**.
 - 3 Select a display mode from the choices: **Indoor**, **Outdoor**, and **Night**.
 - 4 The instrument optimizes screen colors to each choice.
-

Setting sleep time

You can set the amount of time up to 255 minutes to let the instrument automatically turn the backlight off and enter into power saving mode after no actions or data entries. Default setting is zero, which indicates that the sleep mode is turned off and screen backlight is always on.

Procedure

- 1 Press the **SYSTEM** hot key.
 - 2 Select **System Configuration > Sleep Time**.
 - 3 Enter the amount of minutes by using the numeric keys. You can also use the rotary knob.
 - 4 Press the **Enter** soft key.
-

Adjusting LCD brightness

You can adjust display brightness from one to ten as needed. The larger number you set, the brighter the display becomes.

Procedure

- 1 Press the **SYSTEM** hot key.
 - 2 Select **System Configuration > LCD Brightness**.
 - 3 Enter a value by using the numeric keys. You can also use the rotary knob.
 - 4 Press the **Enter** soft key.
-

Adjusting volume

You can turn the sound on or off or adjust the volume from one to ten as needed.

Procedure

- 1 Press the **SYSTEM** hot key.
 - 2 Select the sound option, from the following choices:
 - To turn the sound or alarm off, toggle the **Sound** soft key to **Off**.
 - To turn the sound or alarm on, toggle the **Sound** soft key to **On**.
 - To adjust the volume, complete the following steps:
 - a Press the **Sound** soft key.
 - b Enter a value by using the numeric keys.
 - c Press the **Enter** soft key.
-

Upgrading firmware

It is recommended that you maintain your instrument up-to-date with its latest firmware in order to achieve the instrument's optimal performance.

Checking installed firmware version

Procedure

- 1 Press the **SYSTEM** hot key.
- 2 Press the **HW/FW Info** soft key.
- 3 Find the installed version number in the **Firmware** field.
- 4 From a computer with Internet access, visit [Viavi's Software Updates website](#) and check if your installed firmware is the latest one. Complete the steps **5-6** if you want to update your firmware with using your USB memory drive.
- 5 Download a latest firmware file from the website to the root directory of your USB memory drive.



NOTE

It is recommended that you format your memory drive to have enough space to download the file.

- 6 Unzip the download file into the root directory of your USB memory stick. A firmware file (*.fw) and a firmware release note (*.pdf) are extracted.
-

Installing new firmware

To update your firmware, you can choose either way of using your USB memory drive or accessing the FTP server over the network.

Upgrading from USB memory drive

Procedure

- 1 Power your instrument via the AC-DC adapter to prevent any severe damage to your instrument caused by a power-off in the middle of the upgrade, which may require a repair in the factory.
- 2 Plug in the USB memory drive to the **USB Host** port of your instrument.
- 3 Press the **SYSTEM** hot key.
- 4 Select **More (1/2) > Upgrade > USB**.
The file manager window appears.
- 5 Highlight the firmware file (.fw) saved in the root directory of your USB drive.
- 6 Press the **Select** soft key.
The Update Firmware dialog box appears.
- 7 Press the **OK** button to start to install the new firmware.
The Upgrade Status bar appears.



NOTE

Firmware upgrade will be done within 30 minutes or so in most cases, but depending on the number of files to be reconfigured, it may take longer than that.

- 8 After you have restarted the instrument, check the installed firmware version and DSP versions in the System settings. Refer to the firmware release note to find correct DSP version and compatible application software versions.
-



WARNING

Do not remove the USB drive while upgrading the firmware.

Upgrading from FTP server

Procedure

- 1 Power your instrument via the AC-DC adapter to prevent any severe damage to your instrument caused by a power-off in the middle of the upgrade, which may require a repair in the factory.
- 2 Press the **SYSTEM** hot key.
- 3 Select **More (1/2) > Upgrade > FTP Server**.
The upgrade server dialog box appears.



NOTE

Older version of firmware does not have the FTP Server option. It is recommended that you update your firmware with the USB option first.

- 4 Enter **ftp2.jdsu.com** in the server address field.
- 5 Enter your proxy server address in the proxy server field, if necessary.
Contact your system administrator for your proxy server information.
- 6 Tap the **Check** button to check if the installed firmware version is the latest one.
- 7 Do one of the following:
 - If you view the latest firmware version information, tap the **Install** button to continue.
 - If the message "**Your firmware is up to date.**" is displayed, tap the **Cancel** button.



NOTE

Firmware upgrade will be done within 30 minutes or so in most cases, but depending on the number of files to be reconfigured, it may take longer than that.

- 8 After you have started the instrument, check the installed firmware version and DSP versions in the System settings. Refer to the firmware release note to find correct DSP version and compatible application software versions.
-

Managing licenses

The License Manager lets you view installed options, install additional ones, and load evaluation licenses.

Checking installed or installable options

Procedure

- 1 Press the **SYSTEM** hot key.
- 2 Select **More (1/2) > License Manager**. The License Manager menu bar appears.
- 3 Select the menu, from the following choices:

To view the installed options, select the **Installed Options** soft key.
The list of options appears.



NOTE

- The "(P)" indicates permanent licenses.
- The "(T)" indicates temporary licenses.
- The "(FL)" indicates floating licenses.

To view the installable options, select the **Installable Options** soft key.

Installing purchased options

Procedure

- 1 Press the **SYSTEM** hot key.
 - 2 Select **More (1/2) > License Manager**.
The License Manager menu bar appears.
 - 3 Select the **Install an Option** soft key.
The Installable Options window appears.
 - 4 Highlight the name of the option from the list by using the rotary knob.
 - 5 Press the **ENTER** hard key. You can also press the rotary knob.
The License Code bar appears.
 - 6 Enter the number of the license to activate by using the numeric keys.
 - 7 Press the **ENTER** hard key. You can also select the **Enter** soft key.
-

Loading temporary license

The temporary license that you received from Viavi is intended for your evaluation only and it expires after its specified time limit.

Procedure

- 1 Press the **SYSTEM** hot key.
 - 2 Select **More (1/2) > License Manager**.
The License Manager menu bar appears.
 - 3 Select the **Load Temp License** soft key.
The file manager window appears.
 - 4 Select the name of the license file.
 - 5 Press the **Load** soft key.
 - 6 *Optional.* You can check the loaded license using the **Installed Options** menu.
-

Adding a floating license

If you have a Viavi StrataSync account, you can simply add a floating license by synchronizing your instrument with the StrataSync server. Before you begin, you need to verify that the necessary licenses have been deployed to the instrument. See “Activating StrataSync” on page 47 for more information.

Procedure

- 1 Press the **SYSTEM** hot key.
- 2 Select **More (1/2) > Utility > StrataSync**.
The StrataSync setting window appears as shown in Figure 4.
- 3 Enter **<server address>** in the **Server Address** field for StrataSync.
The server address at the time of this document production is “**stratasync.viavisolutions.com**”, which may change.



NOTE

Viavi provides you with the information required to access StrataSync at your purchase of StrataSync, including the **Server Address**, **Account ID**, and **Port number**. See “JD700B Series Common Options” on page 792 for more information on available options.

- 4 Enter **<account number>** in the Account ID field.
- 5 Enter **<technician number>** in the Technician ID field.
- 6 To set the port number and proxy server address, complete the following steps:
 - a Tap the **Detail Settings** button.
The input dialog box appears.
 - b Enter **<port number>** in the **Port** field.
 - c Enter **<proxy server address>** in the **Proxy Server** address, if necessary.
Contact your system administrator for your proxy server information.
 - d Tap the **Apply** button to save and exit.
- 7 Tap the **Start Sync** button, and then do one from the following steps:

When successfully synchronized, the text “**Reboot the instrument to update the license information**” appears. Tap the **Apply** button to exit and reboot the instrument.

When any errors occur during the synchronization:
The text “**Report log has been updated. Check report info**” appears and the **Report** button is activated at the same time.

 - a Tap the **Report** button.
The list of errors is displayed on the report window. See Figure 5.
 - b Review the error details, and then tap the **OK** button to exit.



NOTE

You can only revoke and deploy a floating license via StrataSync server at **stratasync.viavisolutions.com**. For more details on revoking and deploying a floating license, refer to the following StrataSync Help:
<http://blog.stratasync.jdsu.com/?resource=license-management>

Figure 4 StrataSync setting window

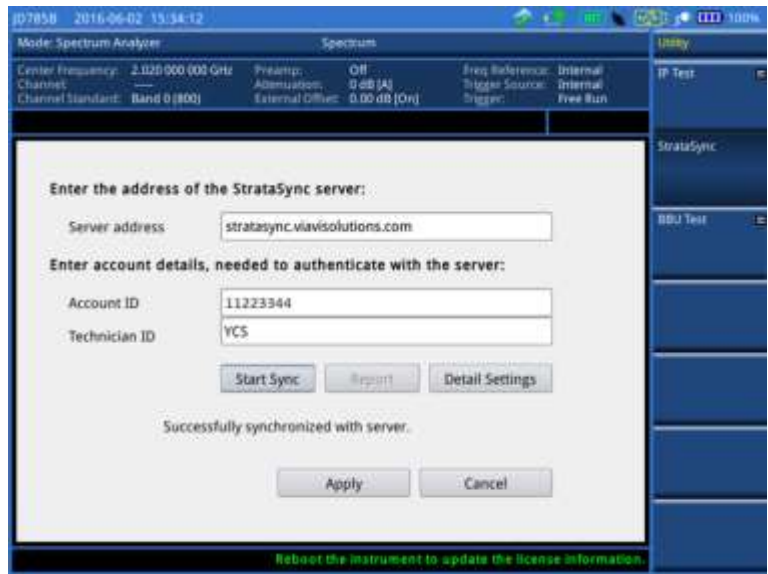
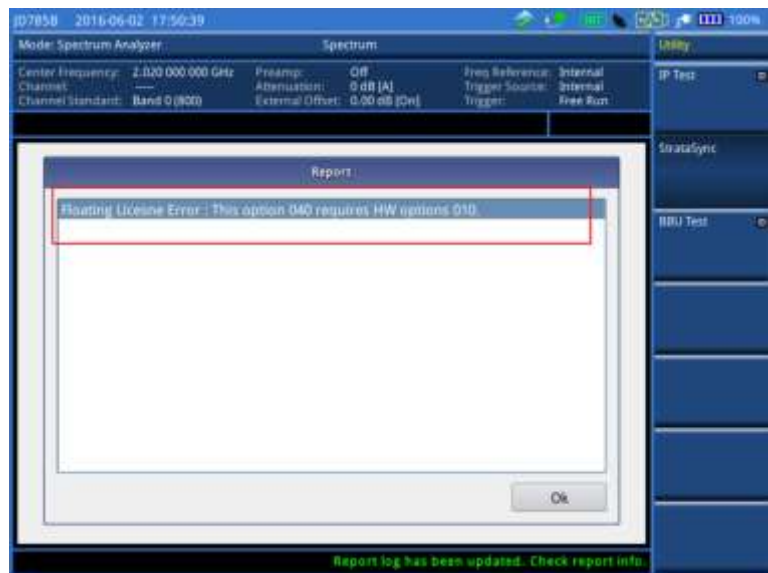

Figure 5 StrataSync report window



Viewing OSS license

Procedure

- 1 Press the **SYSTEM** hot key.
- 2 Select **More (1/2) > License Manager**.
The License Manager menu bar appears.
- 3 Select the **OSS License** soft key.
The Open Source Code Notification & Distribution screen appears.

Performing service diagnostic

The Service Diagnostic lets you view system log, perform self-test, revert the instrument settings to its factory settings, or perform touch alignment.

Viewing system log

Procedure

- 1 Press the **SYSTEM** hot key.
 - 2 Select **More (1/2) > Svc Diagnostic > System Logging**.
 - 3 *Optional.* Press the **Save** soft key to save the system log as a .log file type.
-

Running self-test

You can run a self-test on your instrument boards and modules.

Procedure

- 1 Press the **SYSTEM** hot key.
 - 2 Select **More (1/2) > Svc Diagnostic > Self Test**.
The on-screen instruction appears.
 - 3 Connect a test cable between the **Reflection/RF Out** port for Cable and Antenna Analyzer and the **RF In** port for Spectrum Analyzer.
 - 4 Press the **Start** soft key.
The test result window appears.
 - 5 *Optional.* Press the **Save Screen** soft key to save the self-test results.
-

Performing factory reset

The Factory Reset is used only when you want to purge all the user settings and data stored in the system and return to the instrument's factory state.

Procedure

- 1 Press the **SYSTEM** hot key.
 - 2 Select **More (1/2) > Svc Diagnostic > Factory Reset**.
The confirmation dialog box appears.
 - 3 Press the **Yes** soft key to continue. Otherwise, select **No**.
-



NOTE

It is recommended that you copy your setup or result data to an external USB memory drive so that you can restore them later.

Re-aligning touch screen

When you consistently experience of the instrument responding improperly to your touch on the screen, you may need to perform this touch-screen alignment.

Procedure

- 1 Press the **SYSTEM** hot key.
 - 2 Select **More (1/2) > Svc Diagnostic > Touch Alignment**.
The white screen with a plus sign (+) in the upper-left corner appears.
 - 3 Touch the plus sign and repeat until the previous screen is back on.
-

Using system administration

The Administration is used to disable editing limits, enable modifying help, or change administration password.

Logging in

You need to log in first to access the administration menus.

Procedure

- 1 Press the **SYSTEM** hot key.
 - 2 Select **More (1/2) > Administration**. The password box appears.
 - 3 Enter **<password>** by using the numeric keys.
Default password is "0000". To change the password, see "Changing password" on page 46.
 - 4 Press the **Apply** soft key.
-

Changing password

Procedure

- 1 Press the **SYSTEM** hot key.
 - 2 Select **More (1/2) > Administration**, and then enter your password.
 - 3 Press the **Change Password** soft key.
The new password box appears.
 - 4 Enter a new password up to eight digits by using the numeric keys.
 - 5 Press the **Apply** soft key.
The reconfirmation box appears.
 - 6 Enter the new password again by using the numeric keys.
 - 7 Press the **Apply** soft key to complete changing password.
-

Locking limit key

You can lock the **LIMIT** hot key and disable editing predefined limit settings to prevent any unintentional changes, which could result in incorrect measurements.

Procedure

- 1 Press the **SYSTEM** hot key.
 - 2 Select **More (1/2) > Administration**, and then enter your password.
 - 3 Toggle the **Edit Limit** soft key and select **Disable** to lock the **LIMIT** hot key or **Enable** to unlock the key.
-



NOTE

Disabling the Edit Limit limits the access to the **LIMIT** hot key only. The Limit features including displaying limit line(s) and Pass/Fail result function properly as predefined.

Running IP test

You can test an Internet Protocol (IP) configuration of the cell site's backhaul.

Procedure

- 1 Press the **SYSTEM** hot key.
 - 2 Select **More (1/2) > Utility > IP Test**.
 - 3 Select the command option, from the following choices:
 - To display the route and measure transit delays of packets, toggle the **Commands** soft key and select **Traceroute**.
 - To display the reachability and measure the round-trip time, toggle the **Commands** soft key and select **Ping**.
 - 4 To set the destination IP address to be tested, complete the following steps:
 - a Press the **Destination IP** soft key.
 - b Press the **First Octal** soft key.
 - c Enter a value, and then press the **Enter** soft key.
 - d Press the **Second Octal** soft key and repeat step c.
 - e Press the **Third Octal** soft key and repeat step c.
 - f Press the **Fourth Octal** soft key and repeat step c.
 - 5 Press the **Execute** soft key and select **Start** to start testing.
Test result is displayed on the screen as the test is progressing.
 - 6 Press the **Execute** soft key and select **Stop** to stop testing.
 - 7 *Optional.* Press the **Save** soft key to save the test result as a `.txt` file type.
-

Activating StrataSync

StrataSync is a cloud-based solution that provides asset, configuration, and test data management for Viavi instruments. StrataSync manages and tracks test instruments, collects and analyzes results from the entire network, and informs and trains the workforce.

The JD700B series is compatible with the Viavi StrataSync cloud. This optional capability allows you to manage your instrument inventory ensuring you know where all your valuable equipment is and which engineer is using it. In addition, it allows you to keep your instruments current through the remote upgrade capability that ensures all instruments have the latest firmware. It also enables the centralized distribution of configuration settings to ensure all your engineers use the same instrument settings resulting in consistent measurements.

Once testing is completed, the trace files can be uploaded onto StrataSync for secure storage and sharing. This sharing capability allows engineers who have a problem they cannot resolve to request help from an expert who can analyze the trace file via StrataSync using applications such as JDViewer, JDFileViewer, JDPowerMeter, etc. from anywhere without having to be at the instrument, helping resolve problems even faster.

Setting up Internet connection

Your JD700B series instrument must have Internet access to be able to connect to the StrataSync. You can set up for wireline or wireless Ethernet network connection. You can also use your mobile device's data network such as the Bluetooth tethering on an Android-based smartphone and the Personal Hotspot on an iOS-based smartphone. If you want to share your mobile's data network, you need to connect your instrument to your mobile device.

Procedure

- 1 Connect one of the Parani-UD100 Bluetooth adapters to the USB port of your JD780B or JD740B series.
- 2 Turn on Bluetooth on your mobile device, and then activate its tethering or hotspot.
 - On Android mobile devices:
 - a Go to **Settings > Connections > Bluetooth**.
 - b Check the box for **Visible to all nearby Bluetooth devices** to make your mobile device discoverable by your instrument.
 - c Go to **Settings > More networks > Tethering and portable hotspot**.
 - d Check the box for **Bluetooth tethering** to enable sharing your mobile device's Internet connection with your instrument.
 - On iOS mobile devices:
 - a Go to **Settings > Bluetooth**.
 - b Turn on **Bluetooth**.
 - c Go to **Settings > Personal Hotspot**.
 - d Turn on **Personal Hotspot** to make your mobile device discoverable by your instrument and enable sharing your mobile device's Internet connection with your instrument.
- 3 On your JD780B or JD740B series instrument, press the **SYSTEM** hot key.
- 4 Select **System Configuration > Remote Interface > Bluetooth > Connect**.
- 5 Press the **Scan** soft key to discover your mobile device.
You will find your mobile device from the list on the screen.
- 6 Highlight your mobile device name from the list, and then press the **Select** soft key.
A dialog box appears.
- 7 Tap the **Connect** button to pair and connect.
- 8 On your mobile device, enter **0000** in the PIN field, and then tap the **OK** button or **Pair** button.
If the connection is successful, "(Paired & Connected)" appears next to the name of your mobile device on your instrument. If the connection is unsuccessful, repeat steps 6 and 7.
- 9 Press the **PREV** hard key to return to the Bluetooth Information screen that displays the paired device and connected service including your CellAdvisor's IP Address.

**NOTE**

If you want to use the Web-based remote control described on page 55 using this Bluetooth tethering, record the IP address assigned to your JD700B series to have access to the instrument on your smartphone's Web browser.

Establishing a connection to StrataSync

Procedure

- 1 Press the **SYSTEM** hot key.
- 2 Select **More (1/2) > Utility > StrataSync**.
The StrataSync setting window appears as shown in **Figure 6**.
- 3 Enter **<server address>** in the **Server Address** field for StrataSync.
The server address at the time of this document production is "**stratasync.viavisolutions.com**", which may change.

**NOTE**

Viavi provides you with the information required to access StrataSync at your purchase of StrataSync, including the **Server Address**, **Account ID**, and **Port** number. See "JD700B Series Common Options" on page 792 for more information on available options.

- 4 Enter **<account number>** in the Account ID field.
 - 5 Enter **<technician number>** in the Technician ID field.
 - 6 To set the port number and proxy server address, complete the following steps:
 - a Tap the **Detail Settings** button.
-



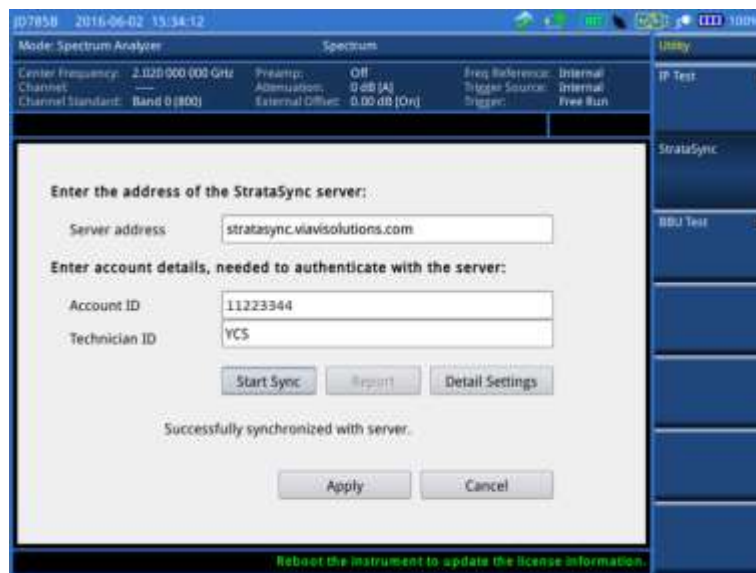

- The input dialog box appears.
- b Enter **<port number>** in the **Port** field.
 - c Enter **<proxy server address>** in the **Proxy Server** address, if necessary. Contact your system administrator for your proxy server information.
 - d Tap the **Apply** button to save and exit.
- 7 Tap the **Start Sync** button, and then do one from the following steps:
- When successfully synchronized, the text **"Reboot the instrument to update the license information"** appears. Tap the **Apply** button to exit and reboot the instrument.
- When any errors occur during the synchronization:
- The text **"Report log has been updated. Check report info"** appears and the **Report** button is activated at the same time.
- a Tap the **Report** button. The list of errors is displayed on the report window.
 - b Review the error details, and then tap the **OK** button to exit.

Figure 6 StrataSync setting window



StrataSync status indicators

The StrataSync indication icons provide you with the connection and activity status.

Indicator	Description
	Indicates that your instrument is idle to be connected and synchronized with the StrataSync server.
	Indicates that your instrument is acquiring an authentication, synchronizing with the server, and sharing data.
	Indicates that your instrument is synchronized successfully.
	Indicates that your instrument failed to synchronize with the StrataSync server or encountered an error.

Setting up 28 GHz downconverter

28 GHz Downconverter increases CellAdvisor RF frequency range from 27 GHz to 30 GHz targeting

spectrum and interference analysis of 5G millimeter wave networks. It enables to down convert RF input frequencies of 27 to 30 GHz into an intermediate frequency (IF) output to 3.6 GHz. This functionality is only enabled when your firmware version is 3.080xxx and above. Make sure the unit should be connected to CellAdvisor before starting measurements. Refer to *28 GHz Downconverter Quick Start Guide* for more details.

Establishing a connection to 28 GHz downconverter

Procedure

- 1 Press the **SYSTEM** hot key.
- 2 Select **More (1/2) > Utility > 28G Downconverter**.
- 3 Press **Connect** soft key or **Connect** button on the screen to connect 28G DC.
- 4 Wait until it boots up.
Once connected, the connection manager window automatically shuts down and **FREQ/DIST** setting screen is displayed.
- 5 Press **Shut Down** soft key or **Shut Down** button on the screen to disconnect 28G DC.
- 6 Press the **Exit** soft key or **Exit** button on the screen to exit from the connection manager window.



NOTE

The soft keys and hard keys are not available when the 28 GHz Downconverter connection manager window is displayed.

Figure 7 28 GHz Downconverter Connection Manager window



Setting up SNMP traps

JD700B series provides Simple Network Management Protocol (SNMP) traps which enable an agent to notify the management station of significant events by way of an unsolicited SNMP message. The following trap formats are provided: SNMPv1 (Simple Network Management Protocol), SNMPv2c, and the VIAVI's standard Management Information Base (MIB).

Using SNMP traps

The current SNMP only supports alarms occurred in EMF mode. The SNMP trap alarm message is sent when it reaches the user-defined MSL and ICNIRP limit.

Procedure

- 1 Press the **SYSTEM** hot key.
- 2 Select **More (1/2) > Utility > SNMP Trap**.
- 3 Once the screen appears, enter the SNMP information using the on-screen keyboard.
- 4 Select the trap format among the 3 options: **Disable**, **SNMPv1**, or **SNMPv2c**.
- 5 Tap the **Apply** button to apply the settings.
- 6 Tap the **Test** button to start testing.
- 7 Tap the **Cancel** button to cancel the SNMP setting process.



NOTE

You can use the **LIMIT** hot key to analyze your measurements with the display line, multi-segment line, and ICNIPR limit. See “Setting limit” on page 759 for more information.

Figure 8 SNMP trap information setting window



NOTE

You can only edit the server address and port number using the on-screen keyboard to send SNMP trap message.

Setting communication

JD700B series provides several methods for you to connect your instrument with application software or other instruments and devices.

Configuring Ethernet

You can configure a network to connect your JD700B series to a computer installed with Viavi software applications such as JDViewer or JDRemote via Ethernet. JD700B series supports both IPv4 and IPv6 protocols.

Setting for IPv4 protocol

Procedure

- 1 Press the **SYSTEM** hot key.
 - 2 Select **System Configuration > Ethernet Config > IPv4**.
The Ethernet Configuration box appears.
 - 3 Do one of the following:
 - To enable automatic IP addressing, toggle the **Mode** soft key to **DHCP**.
 - To manually assign fixed IP addresses, complete the following steps:
 - a Toggle the **Mode** soft key to **Static**.
 - b Press the **IP Address** soft key.
 - c Enter an address including dots in the user input field.
 - d Press the **ENTER** hard key or **Enter** soft key.
 - e Press the **Subnet Mask** soft key and repeat steps **c-d**.
 - f Press the **Gateway** soft key and repeat steps **c-d**.
 - g Press the **DNS** soft key and repeat steps **c-d**.
 - 4 Press the **Apply** soft key to apply and complete the network configuration.
The message “Applying Network Info...” appears.
-

Setting for IPv6 protocol

Procedure

- 1 Press the **SYSTEM** hot key.
 - 2 Select **System Configuration > Ethernet Config > IPv6**.
 - 3 Do one of the following:
 - To enable automatic IP addressing, toggle the **Mode** soft key to **Auto**.
 - To manually assign fixed IP addresses, complete the following steps:
 - a Toggle the **Mode** soft key to **Static**.
The Ethernet Configuration box appears.
 - b Press the **IP Address** soft key.
 - c Type in an address including colons using the on-screen keyboard.
 - d Press the **Apply** soft key to complete the input.
 - e Press the **Subnet Prefix Length** soft key.
 - f Enter a length value using the numeric keys, and then press the **Enter** soft key.
 - g Press the **Gateway** soft key and repeat steps **c-d**.
 - h Press the **DNS** soft key and repeat steps **c-d**.
 - 4 Press the **ESC** hard key, and then make sure to press the **Apply** soft key in the IPv6 menu bar in order to apply and complete the network configuration.
The message “Applying Network Info...” appears.
-

Setting for JDViewer and JDRemote

The **App SW** is set by default to make it easy to connect your instrument to JDViewer, JDRemote, JDMapCreator, and other applications. After using other remote interfaces such as SCPI, LMF, and USBTMC, it is recommended that you set the LAN and USB settings back to App SW.

Procedure

- 1 Press the **SYSTEM** hot key.
 - 2 Press the **System Configuration** soft key.
-

-
- 3 Press the **Remote Interface** soft key and then do the following:
 - Select the **LAN** soft key and then press the **App SW** soft key.
 - Select the **USB** soft key and then press the **App SW** soft key.
-

Setting USBTMC mode

The USB Test & Measurement Class (USBTMC) is a standard for programmatic control of USB-based test instruments that defines protocols used to send and receive messages. If you want to use the USBTMC protocol to communicate with the instrument remotely, you can turn this TMC Mode on.

Procedure

- 1 Press the **SYSTEM** hot key.
 - 2 Select **System Configuration > Remote Interface > USB**.
 - 3 Press the **USBTMC** soft key.
The confirmation dialog box appears.
 - 4 Press the **USBTMC** soft key again to confirm the mode change and reboot the instrument.
-



NOTE

After using the USBTMC mode, you may want to set this setting back to **App SW** if you use JDViewer mainly for remote controlling your JD700B series.

Setting SCPI mode

You can use SCPI commands to control your JD700B series remotely.

Procedure

- 1 Press the **SYSTEM** hot key.
 - 2 Select **System Configuration > Remote Interface > LAN**.
 - 3 Press the **SCPI** soft key.
-



NOTE

After using the SCPI mode, you may want to set this setting back to **App SW** if you use JDViewer or JDRemote mainly.

Configuring LMF setting

The Local Maintenance Facility (LMF) setting is used in order to perform TX Calibration and TX Audit on Motorola's CDMA/EV-DO BTS in the RF Power Meter mode. See "Appendix F – Motorola CDMA/EV-DO LMF" on page 774 for more information.

Enabling Bluetooth connection

If your JD700B series has the Bluetooth Connectivity option installed with a license, you can use the Bluetooth mode to enable communicate between your instrument and your computer with application software such as JDRemote and JDViewer or to transfer files to a Bluetooth storage device. See "Appendix G – Bluetooth connection" on page 776 for more information.

Enabling Wi-Fi connection

Wi-Fi Connectivity is an optional feature that you can activate by installing a purchased license on your JD700B series. After plugging a USB Wi-Fi LAN card using Realtek NICs into the instrument, you can join a wireless network from the instrument so that you can have access to StrataSync or control the instrument from the Web-based remote control on a computer.

Procedure

- 1 Plug in your USB Wi-Fi LAN card to the USB Host port of the JD700B series. The Wi-Fi LAN card is detected and the white Wi-Fi indicator appears on the screen to indicate it.



NOTE

CellAdvisor JD700B series is compatible only with a USB LAN card that uses Realtek NICs (RTL8188eu, RTL8192cu, and RTL8812au).

- 2 Press the **SYSTEM** hot key.
- 3 Select **System Configuration > Remote Interface > Wi-Fi**. The Wi-Fi mode is turned on automatically. After searching nearby networks, the instrument displays a list of networks.
- 4 To select a network to join, complete the following steps:
 - a To refresh the networks list, press the **Scan** soft key. The instrument displays all detected networks as **Detected** and previously connected ones as **Saved**.
 - b Highlight a network to join by using the arrow keys or rotary knob.
 - c Press the **Select** soft key. The Wi-Fi Connection Info window appears for entries. **Figure 9** is an example.
- 5 To enter a user identity and a password for the network, complete the following steps:
 - a Tap on the input box for **Identity**, if required. The on-screen keyboard appears.
 - b Type your identity, and then press the **Apply** soft key.
 - c Tap on the input box for **Password**, if required. The on-screen keyboard appears.
 - d Type a correct password that must be at least eight characters long.
 - e Press the **Apply** soft key.
 - f To view the password exactly as entered, tap the checkbox for **Show Password** to enable it.
- 6 To configure IP network settings, complete the following steps:
 - a Select the TCP/IP protocol option from the choices: **IPv4** and **IPv6**. Sub-selection options change according to your selection. If the selected network supports IPv6, you can configure IP settings for it.
 - b Do one of the following:
 - To enable automatic IP addressing, select **DHCP** for IPv4 or **Auto** for IPv6. It is recommended that you select DHCP unless otherwise you know static IP addresses.
 - To manually assign fixed IP addresses, select **Static**, and then enter addresses as required for IPv4 or IPv6. If you do not have required information, contact your network administrator.
 - To disable the IPv6 protocol, select **Off**.
- 7 Press the **Connect** soft key. Once connected, the Wi-Fi indicator turns to green and the Wi-Fi Connection Info window is updated with information about the connected network including SSID, status, authentication type, encryption method, BSSID, and assigned IP address(es). If you have selected **Auto** for IPv6 in step 6, you will have Link-Local, Stateless, and Stateful instead of IP Address. If you see the green Wi-Fi indication with a red exclamation mark in the center, it means that an IP address has not been assigned.



NOTE

It is important to record the IP address(es) if you want to use the Web Remote on your computer.

- 8 To disconnect the currently connected network, select the network and then press the
-

Disconnect soft key.

- 9 To forget the selected network and delete it permanently from the list, press the **Remove** soft key.

Figure 9 Example of Wi-Fi connection information window

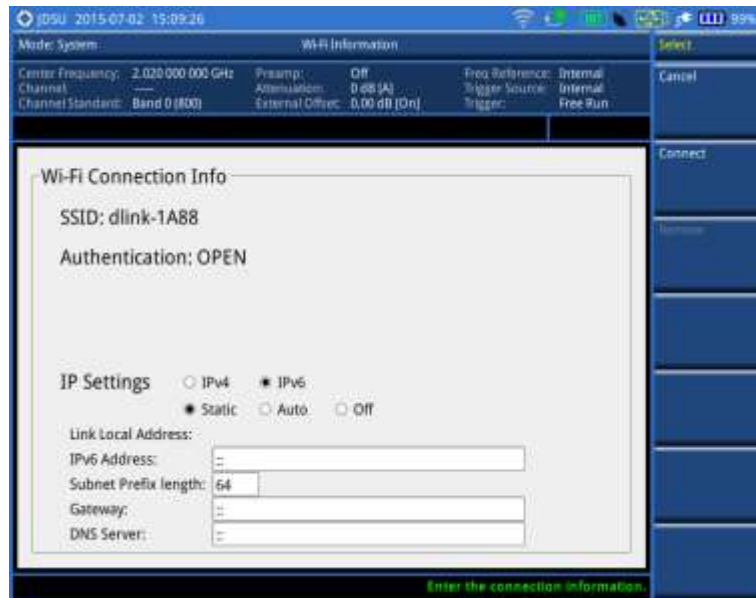

Enabling Web-based remote control

If your JD700B series has the Wi-Fi Connectivity option installed with a license, you can enable this Web Remote feature to control your instrument from most of Web browsers including Windows Internet Explorer (IE) 6 and later, Firefox, Chrome, Safari, and Android native browser in an accessible network. You can also use this feature to allow other users to access your instrument remotely and share the live screen concurrently with up to 10 clients in the network.

Procedure

- 1 Press the **SYSTEM** hot key.
- 2 To get the IP address assigned to your instrument, do one of the following:
 - For wireline LAN connection:
 - a Select **System Configuration > Ethernet Config > IPv4 or IPv6**.
 - b Toggle the **Mode** soft key and select **DHCP** or **Auto** for automatic IP addressing.
 - c Press the **Apply** soft key.
The Ethernet Configuration box is updated with assigned IP address(es). For IPv6 Auto, you will see Link-Local, Stateless, and Stateful instead of IP Address.
 - d Record the IP address(es).



NOTE

If your network does not support the automatic IP addressing, contact your network administrator to get a fixed IP address assigned to your instrument.

For wireless LAN connection:

- a Select **System Configuration > Remote Interface > Wi-Fi**.
- b Select the currently connected network from the list, and then press the **Select** soft key.
- c Record the IP address displayed at the bottom.

For Bluetooth tethering on an Android-based smartphone or Personal Hotspot on an iOS-based smartphone:

- a Select **System Configuration > Remote Interface > Bluetooth**.

- b Record the IP address assigned to your instrument under Connected Service.
- 3 Press the **SYSTEM** hot key again.
- 4 Select **System Configuration > Remote Interface**.
- 5 Toggle the **Web Remote** soft key and select **On** to enable it.
- 6 Open a Web browser on your computer or mobile device, and then enter the IP address you have obtained in step 2, depending on the TCP/IP protocol. Examples are the following:
 - IPv4:** 10.82.26.254 (put the entire address including dots in the URL bar)
 - IPv6:** [fe80::21b:22ff:fea1:924a] (make sure to add the brackets “[” and “]” and put the entire address including colons in the URL bar)

Your instrument’s live screen appears on the Web browser as shown like Figure 10 or Figure 11.



NOTE
The IPv6 protocol is supported on the operation system “Windows Vista” and later.

Figure 10 Example of Web remote on iPhone

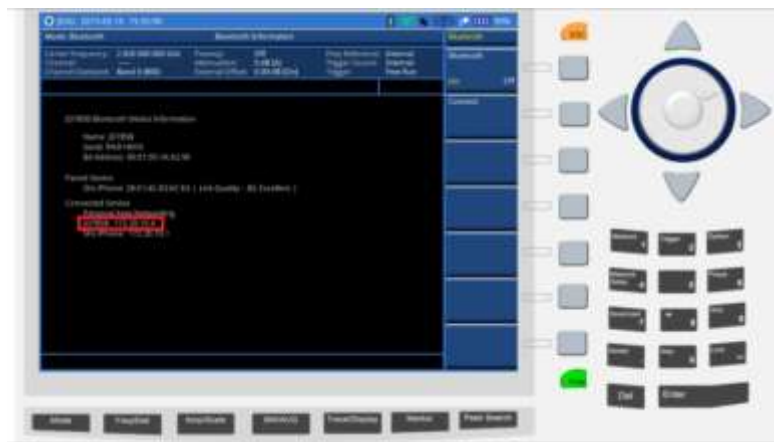

Figure 11 Example of Web remote on Chrome



Managing help manual

The JD700B series contains the JD700B series help manual by default. The name of default help manual is “**System_Help**”. You can browse the manual instantly from any screen by pressing the **HELP** hot key.

Adding other help manual

You can add other help manuals to your instrument by importing a folder of help manuals (.html) from a USB memory drive.

Procedure

- 1 Insert a USB memory drive that contains the folders of help manuals (.html).
- 2 Press the **HELP** hot key.
- 3 Select **Help manager > Import Help Files**.
The list of help folders appears on the import help files window.
- 4 Select a folder you want to add.



NOTE
You cannot copy the “**Internal**” folder.

- 5 Tap the **Copy** button to complete.
The text “Copy Completed” appears. The folder is copied under the **User_Help** folder in the **Select Help**. See Figure 12.



NOTE
The maximum storage size for user help is 10M. If the file exceeds the remained storage space, the text “Not enough space left” appears.

Viewing help manual

You can select a help manual to view on your instrument.

Procedure

- 1 Press the **Help** hot key.
- 2 Select **Help Manager > Select Help**.
The list of help files appears on the select help window.
- 3 Select a folder or a help file you want to view, and then tap the **Select** button.
The select help window is dismissed.
- 4 Press the **Home** soft key to view the selected help manual.
The selected help manual appears.
- 5 To copy a folder or a help file in the **User_Help** folder, select a help file, and then tap **Copy > Paste**.
- 6 To delete a folder or a help file, select a folder or a help file, and then tap **Delete > Yes**.



NOTE
You cannot delete the **User_Help** folder.

Figure 12 Example of select help screen

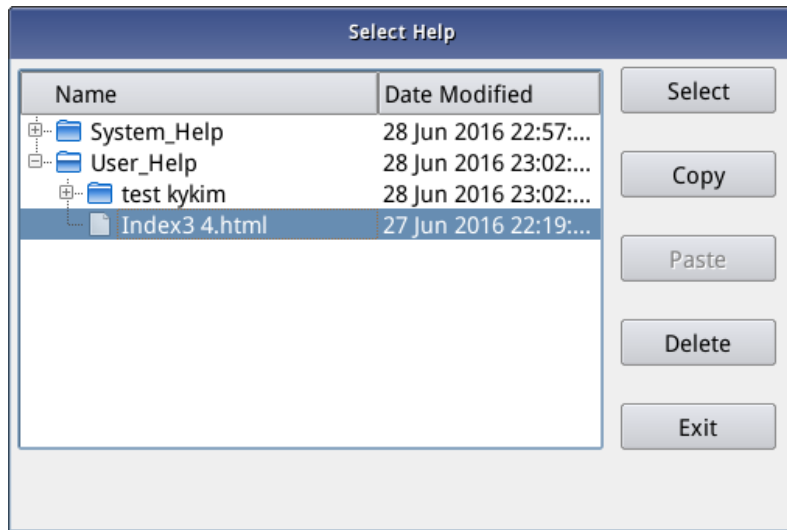

Chapter 3 Analyzing Measurement Results

This chapter provides instructions on how to use JD700B series' capabilities for measurement analysis. Topics discussed in this chapter are as follows:

- Using marker 60
- Using peak search..... 61

Using marker



Marker

Marker is used to get the information about a specific trace. Six markers can be set on the display and each marker can be used independently. The X and Y coordinates of the trace are displayed when the marker is placed on any position of the trace. The position displaying the marker's X and Y coordinates may be slightly different for each measurement mode and refer to the description of each measurement. There are three different marker types available: Normal, Delta, and Delta pair. Marker position can be set manually by entering numeric values (frequency) when one of the marker types is selected.

- **Select Marker:** Selects an active marker whose position can be changed with the rotary knob or the arrow keys. The assigned number of the active marker is displayed in the Select Marker menu box and the active marker number is also displayed right next to the active marker on the trace when the Marker View is set to On.
- **Marker View:** Displays the selected marker on the screen or hides it. When the Marker View is turned off and then on again in the same measurement mode, markers appear at the previous positions. If a measurement mode is changed, markers are not restored to their previous positions.
- **Normal:** This Normal marker type provides the reading of a marker position on the trace along with the marker number between one and six.
- **Delta:** This Delta marker type is associated with a Normal marker. A Normal marker must be set before a Delta marker is set. When the Delta marker is set, the position set by the Delta marker becomes the reference position of the Normal marker and the marker's X and Y values displays the difference compared with the Delta marker.
- **Delta Pair:** This Delta Pair marker type is associated with a Normal marker. A Normal marker must be set before a Delta Pair marker is set. When the Delta Pair marker is set, the position set by the Delta Pair marker becomes the reference position of the Normal marker and the marker's X and Y values displays the difference compared with the Delta Pair marker. The reference position will be varied in accordance with trace change.
- **Marker All Off:** Turns all the markers the screen off. When the Marker View is selected for those markers, the instrument displays those markers back at the previous position. If a measurement mode is changed, current settings are not restored.
- **Marker →:** Sets the X coordinate of the active marker as selected.
 - **Marker→Center:** Sets the frequency of the active marker to the center frequency of spectrum analyzer.
 - **Marker→Start:** Sets the frequency of the active marker to the start frequency of spectrum analyzer.
 - **Marker→Stop:** Sets the frequency of the active marker to the stop frequency of spectrum analyzer.
- **Frequency Count:** This Frequency Count is used when a highly accurate reading of the frequency is needed for the active marker on the signal. The measurement sweeps get significantly slower because the instrument runs the measurement of the signal peak with 1 Hz resolution in background. Toggle this key between **On** and **Off** to enable or disable the frequency count function for the selected marker.
- **Noise Marker:** This Noise Marker is used to measure a noise adjacent to a signal by averaging several data points to calculate the readout for the Noise Marker as if making a measurement using a 1 Hz bandwidth. Toggle this key between **On** and **Off** to enable or disable the noise marker function for the selected active marker.

**NOTE**

Frequency Count and Noise Marker functions are used only in the Spectrum Analyzer mode.

Using peak search

Peak search



Each time the Peak Search soft key is pressed, the active marker is positioned at the highest peak of the trace.

- **Peak Search:** Moves the active marker to the highest peak of the trace.
- **Next Peak:** Moves the active marker to the second highest peak of the trace.
- **Next Peak Right:** Moves the active marker to the highest peak to the right of its current position.
- **Next Peak Left:** Moves the active marker to the highest peak to the left of its current position.
- **Min Search:** Moves the active marker to the lowest peak of the trace.
- **Always Peak:** When the **Always Peak** is set to **On**, the instrument moves the active marker automatically to the highest peak of the trace every time the trace is refreshed.

Chapter 4 Using Spectrum Analyzer

This chapter provides instructions for using the Spectrum Analyzer function. Topics discussed in this chapter are as follows:

■ Introduction.....	63
■ Display overview	63
■ Connecting a cable.....	64
■ Selecting measurement mode	65
■ Conducting spectrum measurements	73
■ Conducting RF measurements	77

Introduction

The advantage of using the Spectrum Analyzer is easy to verify the presence of unwanted signals such as spurious and harmonics, which are normally very hard to identify in time domain analysis.

Performance assurance in wireless communication systems includes the observation of the out-of-band signal characteristics in order to identify the presence of harmonic signals. Harmonic signals of a carrier may interfere with other signals far out of the transmission band, or harmonic signals from other transmitter may interfere with in band signals affecting the spectral integrity.

In these days when wide variety of wireless communication services are provided in frequency bands assigned very closely to each other, it is critical to ensure that each communication service is carried out within their assigned frequency band minimizing interference with adjacent frequency bands. The Adjacent Channel Power Ratio (ACPR) characteristic of a power amplifier or other RF components is an important factor in evaluating the system performance.

The JD700B series is the optimal solution to perform following measurements:

- Spectrum Analysis
 - Spectrum
- RF Analysis
 - Channel Power
 - Occupied Bandwidth
 - Spectrum Emission Mask
 - Adjacent Channel Power (ACP)
 - Multi-ACP
 - Spurious Emissions
 - AM/FM Audio Demodulation
 - Field Strength
 - Route Map
 - Dual Spectrum
 - PIM Detection (Single and Multiple Carriers): not supported when 28 GHz downconverter is connected.
 - Total Harmonic Distortion (THD): not supported when 28 GHz downconverter is connected.

Display overview

Figure 13 provides overview of each segment of the measurement screen.

Figure 13 Spectrum measurement screen

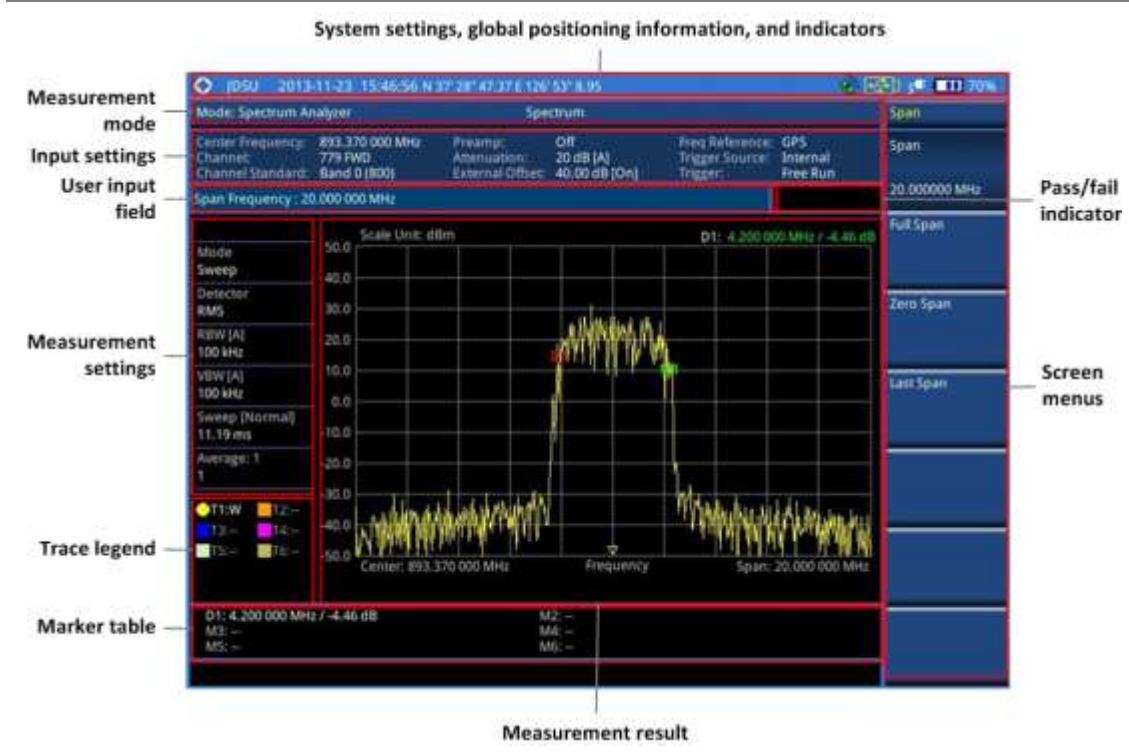

Connecting a cable

There are two ways that you can make a connection of your instrument and the base station to be tested: direct or indirect.

Procedure

To make a direct connection:

- 1 Connect the **Spectrum Analyzer RF In** port of the JD700B series and the PA output port of BTS as shown in **Figure 14**.

To make an indirect connection:

- 1 Connect the **Spectrum Analyzer RF In** port of the JD700B series and the monitor (test) port of BTS as shown in **Figure 15**.

Figure 14 Direct connection

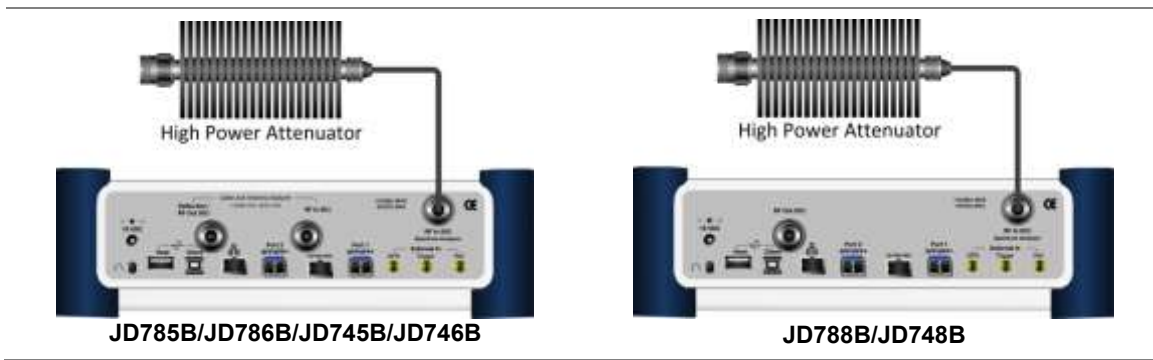

Figure 15 Indirect connection

**CAUTION**

The maximum power for the **Spectrum Analyzer RF In** port is +25 dBm (0.316 W) for JD780B series and +20 dBm (0.1 W) for JD740B series. If the level of the input signal to be measured is greater than this, use a **High Power Attenuator** to prevent damage when you directly connect the signal to the instrument or connect the signal from the coupling port of a directional coupler.

Selecting measurement mode

Procedure

- 1 Press the **MODE** hard key.
- 2 Press the **Spectrum Analyzer** soft key. The **Measure Off** mode is selected by default.
- 3 Press the **MEASURE** hot key, and then select the measurement mode from the following choices:
 - Channel Power
 - Occupied BW
 - Spectrum Emission Mask
 - Adjacent Channel Power
 - Multi-ACP
 - Spurious Emissions
 - AM/FM Audio Demod
 - Field Strength
 - Route Map
 - Dual Spectrum
 - PIM Detection > Single Carrier and Multiple Carriers (not supported when 28 GHz downconverter is connected).
 - Total Harmonic Distortion (not supported when 28 GHz downconverter is connected).

Configuring test parameters

Setting frequency

You need to set the frequency range to be measured with either the center frequency/span or the start/stop frequencies. You can also set the frequency with the channel number and span.

Procedure

To set the center frequency and span:

- 1 Press the **FREQ/DIST** hard key.
- 2 Toggle the **Unit** soft key to **Freq**.
- 3 Press the **Center Frequency** soft key.
- 4 Enter a value by using the numeric keys, the rotary knob, or the arrow keys.
- 5 Select the unit: **GHz**, **MHz**, **kHz**, or **Hz**.
- 6 Press the **Span** soft key, and then do one of the following:
 - To set the span manually, select **Span**, enter a value, and then select the unit.
 - To set the span automatically, select **Full Span**, **Zero Span**, or **Last Span** as needed.

**NOTE**

The **Zero Span** option is available only in the Spectrum mode. If you have selected **Zero Span**, select **TRIGGER > Free Run**, **External**, **GPS**, **Video**, or **Display Position**.

To set the start and stop frequencies:

- 1 Press the **FREQ/DIST** hard key.
- 2 Toggle the **Unit** soft key to **Freq**.
- 3 Press the **Start Frequency** soft key.
- 4 Enter a value by using the numeric keys, the rotary knob, or the arrow keys.
- 5 Select the unit: **GHz**, **MHz**, **kHz**, or **Hz**.
- 6 Press the **Stop Frequency** soft key.
- 7 Enter a value by using the numeric keys, the rotary knob, or the arrow keys.
- 8 Select the unit: **GHz**, **MHz**, **kHz**, or **Hz**.

To set the channel number and span:

- 1 Press the **FREQ/DIST** hard key.
- 2 Toggle the **Unit** soft key to **Channel**.
- 3 To select the standard channel, complete the following steps:
 - a Press the **Channel Std** soft key. The standard channel window appears. See “Appendix C – Band, frequency & channel standard” on page 769 for more information.
 - b Highlight the band to be measured by using the rotary knob, the arrow keys, or the **Page Up/Page Down** soft keys.
 - c Press the **Select** soft key or the rotary knob to confirm the selection.
- 4 Toggle the **Link** soft key between **Fwd** (forward) or **Rev** (reverse) to select the sweep direction.
- 5 To set the channel number, complete the following steps:
 - a Press the **Channel Number** soft key.
 - b Enter a value by using the numeric keys.
 - c Press the **Enter** soft key or **ENTER** hard key to complete the entry. The instrument automatically displays the corresponding center frequency value for the selected channel number.
- 6 To set the span, complete the following steps:
 - a Press the **Span** soft key.
 - b Select the span option, from the following choices:
 - To set the span manually, select **Span**, enter a value, and then select the unit.
 - To set the span automatically, select **Full Span**, **Zero Span**, or **Last Span** as needed.

**NOTE**

The **Zero Span** option is available only in the Spectrum mode. If you have selected **Zero Span**, select **TRIGGER > Free Run**, **External**, **GPS**, **Video**, or **Display Position**.

Optional. To define the amount of frequency increment for the rotary knob:

- 1 Press the **Frequency Step** soft key, if the **Freq** is selected.
 - 2 Enter a value by using the numeric keys.
 - 3 Press the unit: **GHz**, **MHz**, **kHz**, or **Hz**.
-

Optional. To define the amount of channel increment for the rotary knob:

- 1 Press the **Channel Step** soft key, if the **Channel** is selected.
 - 2 Enter a value by using the numeric keys.
 - 3 Press the **Enter** soft key.
-

**NOTE**

This setting option is not available in the Spurious Emissions mode.

Setting frequency for 28 GHz downconverter

Once the CellAdvisor is connect to 28 GHz downconverter, the center frequency is automatically set to 28 GHz. You can measure the center frequency ranged from 27 to 30 GHz with the span or the start/stop frequencies. You cannot set the frequency with the channel number and span when the 28 GHz downconverter is in operation.

Procedure

To set the center frequency and span:

- 1 Press the **FREQ/DIST** hard key.
- 2 Press the **Center Frequency** soft key.
- 3 Enter a value from 27 to 30 GHz by using the numeric keys, the rotary knob, or the arrow keys.
- 4 Select the unit as **GHz** among the 4 options: **GHz**, **MHz**, **kHz**, or **Hz**.
- 5 Press the **Span** soft key, and then do one of the following:
 - To set the span manually, select **Span**, enter a value, and then select the unit.
 - To set the span automatically, select **Full Span**, **Zero Span**, or **Last Span** as needed.

**NOTE**

The **Zero Span** option is available only in the Spectrum mode. If you have selected **Zero Span**, select **TRIGGER > Free Run**, **External**, **GPS**, **Video**, or **Display Position**.

Optional. To define the amount of frequency increment for the rotary knob:

- 1 Press the **Frequency Step** soft key, if the **Freq** is selected.
- 2 Enter a value by using the numeric keys.
- 3 Press the unit: **GHz**, **MHz**, **kHz**, or **Hz**.

To set the start and stop frequencies:

- 1 Press the **FREQ/DIST** hard key.
 - 2 Press the **Start Frequency** soft key.
 - 3 Enter a value from 27 to 30 GHz by using the numeric keys, the rotary knob, or the arrow keys.
 - 4 Select the unit as **GHz** among the 4 options: **GHz**, **MHz**, **kHz**, or **Hz**.
 - 5 Press the **Stop Frequency** soft key.
 - 6 Enter a value from 27 to 30 GHz by using the numeric keys, the rotary knob, or the arrow keys.
 - 7 Select the unit as **GHz** among the 4 options: **GHz**, **MHz**, **kHz**, or **Hz**.
-

Setting amplitude

Reference level and attenuation

You can set the reference and attenuation levels automatically or manually to optimize the display of the traces measured, as you desire.

Procedure

To automatically set the reference and attenuation level:

- 1 Press the **AMP/SCALE** hard key.
- 2 Press the **Auto Scale** soft key.
Each time you press this key, both of the Y-axis scale and input attenuation level change to be optimized with some margin.

To set the reference or attenuation level manually:

- 1 Press the **AMP/SCALE** hard key.
- 2 To set the maximum reference level on the Y-axis manually, complete the following steps:
 - a Press the **Reference Level** soft key.
 - b Enter a value by using the numeric keys or the rotary knob with 10 dB increments.
 - c Press the unit soft key or the **ENTER** hard key.
 - d This unit key name changes according to the setting in the **Units** menu.
- 3 To set the attenuation option, select one from the following choices:
To set the input attenuator's level automatically, select **Attenuation > Auto**.

To set the internal attenuation value (only when 28 GHz downconverter is in operation):

- 1 Press the **AMP/SCALE** hard key.
- 2 Press **Attenuation Value Internal** soft key.
- 3 Enter a value in fives by using the numeric keys.
- 4 Press the **dB** soft key or the **ENTER** hard key.



NOTE
It is recommended that you set the **Attenuation** to **Auto** in most situations so that the level of the input attenuator can be set automatically according to your input signal level.

To set the input attenuation manually up to 55 dB for JD780B series or 50 dB for JD740B series to optimize S/N, complete the following steps:

- a Select **Attenuation (Internal) > Manual**.
- b Press the **Attenuation Value (Internal)** soft key to set the level.
- c Enter a value in fives by using the numeric keys.
- d Press the **dB** soft key or the **ENTER** hard key.

To couple the input attenuator's level with your reference level setting, select **Attenuation (Internal) > Couple**.

When you increase the reference setting, the attenuation level also increases accordingly.



NOTE
The **Attenuation Value Internal** and **Attenuation Internal** menus are available when the 28 GHz downconverter is in operation.

Optional. To change the scale unit:

- 1 Select **More (1/2) > Units**.
- 2 Select the unit of the display scale: **dBm**, **dBV**, **dBmV**, **dBµV**, **V**, or **W**.
The scale unit on the screen changes accordingly.



NOTE
For the Field Strength mode, the units change to **dBµV/m**, **dBmV/m**, **dBV/m**, **V/m**, **Watt/m^2**, and **dBm/m^2**.

Pre-amplifier

You can turn the internal pre-amplifier on to correct and compensate for the gain of the preamplifier so that amplitude readings show the value at the input connector.

Procedure

- 1 Press the **AMP/SCALE** hard key.
-

-
- 2 Toggle the **Preamp** soft key and select **On** or **Off** as needed.
-

**NOTE**

You can turn the Preamp on when the input attenuation range is from 0 dB to 10 dB. If the attenuation value is manually set to greater than 10 dB, the instrument will automatically turn off the pre-amplifier to display low-level signal properly on the chart.

Pre-amplifier for 28 GHz downconverter

You can turn the external pre-amplifier on to correct and compensate for the gain of the preamplifier so that amplitude readings show the value at the input connector. The Preamp External is for 28 GHz downconverter, and the Preamp Internal is for CellAdvisor.

Procedure

- 1 Press the **AMP/SCALE** hard key.
 - 2 Press the **Preamp** soft key.
 - 3 Toggle the **Preamp Internal** soft key and select **On** or **Off** as needed.
 - 4 Toggle the **Preamp External** soft key and select **On** or **Off** as needed.
-

External offset

You can turn the **External Offset** on and manually set the external offset value. An offset consists of a cable loss and a user offset and the measurement result shows the value reflecting both offset values. When the external offset value is set at 40 dB in the Spectrum mode, the measurement result compensates 40 dB at both the Spectrum Analyzer and Signal Analyzer modes.

Procedure

To set the external offset:

- 1 Press the **AMP/SCALE** hard key.
- 2 Toggle the **External Offset** soft key to **On**.
- 3 Enter a value by using the numeric keys.
- 4 Press the **dB** soft key to complete the entry.

To turn the external offset off:

- 1 Press the **AMP/SCALE** hard key.
 - 2 Toggle the **External Offset** soft key to **Off**.
-

**NOTE**

This setting option is not available in the Field Strength mode.

Scale per division

You can use the **Scale/Div** feature available for the spectrum measurement screen. It represents the value of one division on the horizontal scale. The default setting is 10 dB per division and the maximum value can be set up to 20 dB.

Procedure

To set the scale per division:

- 1 Press the **AMP/SCALE** hard key.
-

- 2 Select **More (1/2) > Scale/Div.**
- 3 Enter a value between 1 and 20 by using the numeric keys.
- 4 Press the **dB** soft key to complete the entry.

Setting bandwidth

You can manually set the Resolution Bandwidth (RBW), Video Bandwidth (VBW), and the proportional VBW based on the designated RBW. Selecting **Auto** changes the value to correspond to your frequency span setting for RBW and to the current RBW and VBW/RBW settings for VBW.

Procedure

To automatically set the RBW and VBW to your selected VBW/RBW ratio:

- 1 Press the **BW/AVG** hard key.
- 2 Press the **VBW/RBW** soft key to set the proportional VBW based on the designated RBW. Table 9 shows the ratio example for 30 kHz RBW.
- 3 Select the ratio: **1, 0.3, 0.1, 0.03, 0.01, or 0.003.**
- 4 Toggle the **RBW** soft key to **Auto**.
- 5 Toggle the **VBW** soft key to **Auto**.
The RBW or VBW value on the screen changes accordingly based on the span.

To manually set the RBW or VBW to your selected VBW/RBW ratio:

- 1 Press the **BW/AVG** hard key.
- 2 Press the **RBW** soft key.
- 3 Enter a value between 1 Hz to 3 MHz in 1-3 sequence by using the numeric keys.
- 4 Select the unit: **MHz, kHz, or Hz.**
The RBW setting automatically changes to **Manual**.
- 5 Press the **VBW** soft key, and then enter a value by using the numeric keys.
- 6 Select the unit: **MHz, kHz, or Hz.**
The VBW setting automatically changes to **Manual**.
The RBW or VBW value on the screen changes accordingly.



NOTE

This setting option is not available in the Spurious Emissions mode.

Table 8 VBW/RBW ratio example

RBW	Ratio (VBW/RBW)	VBW
30 kHz	1:1	30 kHz
	1:0.3	10 kHz
	1:0.1	3 kHz
	1:0.03	1 kHz
	1:0.01	300 Hz
	1:0.003	100 Hz

Setting average

You can set the number of measurements to be averaged for the trace presentation. A maximum of 100 times of averaging can be set. When the averaging reaches to your setting, a new measurement value replaces the measurement value in sequence from the earliest.

Procedure

- 1 Press the **BW/AVG** hard key.
 - 2 Press the **Average** soft key.
 - 3 Enter a value between 1 and 100 as needed by using the numeric keys.
 - 4 Press the **Enter** soft key.
-

Setting sweep

The **SWEEP** hot key is used to set and control the sweep time, sweep mode, gated sweep settings, and gated sweep on or off.

Sweep time

You can set the sweep time automatically or manually. Manual setting allows you to set the sweep time beyond an automatic setting.

Procedure

- 1 Press the **SWEEP** hot key.
 - 2 Select the sweep time option, from the following choices:
 - To automatically set, toggle the **Sweep Time** soft key to **Auto**.
 - To manually set, complete the following steps:
 - a Press the **Sweep Time** soft key.
 - b Enter a value by using the numeric keys.
 - c Select the unit: **Sec**, **mSec**, or **µSec**.
The sweep time mode automatically changes to **Manual**.
-

**NOTE**

This setting option is not available in the Spurious Emissions mode.

Sweep mode

The default settings of the sweep mode are **Continue** and **Normal** to sweep continuously at a normal speed for most on-going measurements. If you want to hold the measurement or get a single sweep, you can change the sweep mode.

Procedure

To select the single sweep mode:

- 1 Press the **SWEEP** hot key.
- 2 Toggle the **Sweep Mode** soft key and select **Single**. You can also use the **HOLD** hot key. The letter **HOLD** in red appears and the sweeping is paused.
- 3 *Optional.* Press the **Sweep Once** soft key to get a new measurement.
- 4 *Optional.* To speed up sweeping, press the **Sweep Mode** soft key to **Fast**.

**NOTE**

Selecting **Sweep Mode > Fast** may reduce the measurement accuracy, but it is useful to identify the existence of interfering signals.

To return to the continuous sweep mode:

- 1 Toggle the **Sweep Mode** soft key to **Continue**. You can also use the **HOLD** hot key. The letter **HOLD** in red disappears and the sweeping resumes.
-

**NOTE**

This setting option is not available in the Field Strength mode, the AM/FM Audio Demodulation mode, and the Route Map mode.

Gated sweep

You can configure the gated sweep settings with an internal or external trigger source. If you select **Gated Sweep Settings**, you can view the signal in time domain.

Procedure

- 1 Press the **SWEEP** hot key.
- 2 Press the **Gated Sweep Settings** soft key.
- 3 *Optional.* Adjust sweep time to allow enough time for a cycle by completing the following steps:
 - a Press the **Zero Span Time** soft key.
 - b Enter a value by using the numeric keys.
 - c Select the unit: **Sec**, **mSec**, or **µSec**.
- 4 Set the period, if using the internal trigger source, by completing one of the followings:

To select the preset period, complete the following steps:

 - a Toggle the **Period** soft key to **StdSignal**.
 - b Press the **StdSignal** soft key, and then select the period from the choices: **GSM (4.615 ms)**, **WCDMA (10 ms)**, **LTE (10 ms)**, **EV-DO (5 ms)**, **TD-SCDMA (5 ms)**, or **WiMAX (10 ms)**.

To manually set the period, complete the following steps:

 - a Toggle the **Period** soft key to **Manual**.
 - b Press the **Period** soft key to enter the amount of time.
 - c Enter a value by using the numeric keys.
 - d Select the unit: **Sec**, **mSec**, or **µSec**.
- 5 Press the **TRIGGER** hot key, and then complete one of the followings:

Select **External** for an external trigger source.

Select **Video** or **Display Position** for the internal trigger source.
- 6 Press the **PREV** hard key to continue setting the gated sweep.
- 7 Set the gate delay by completing the following steps:
 - a Press the **Gate Delay** soft key.
 - b Enter a value by using the numeric keys.
 - c Select the unit: **Sec**, **mSec**, or **µSec**.
- 8 Set the gate length by completing the following steps:
 - a Press the **Gate Length** soft key.
 - b Enter a value by using the numeric keys.
 - c Select the unit: **Sec**, **mSec**, or **µSec**.
- 9 Press the **PREV** hard key to enable gated sweeping.
- 10 Toggle the **Gated Sweep** soft key to **On**.

**NOTE**

This setting option is not available in the in the Spurious Emissions mode, the Field Strength mode, and the Route Map mode.

Using signal generator (RF source)

You can turn on the RF Source feature to generate a CW signal of different output power levels. Note that this is not supported when the 28 GHz downconverter is in operation.

Procedure

- 1 Press the **MEASURE SETUP** hot key.
 - 2 Press the **RF Source** soft key.
 - 3 To set the frequency of the CW signal to be injected, complete the following steps:
 - a Press the **Frequency** soft key.
 - b Enter a value within the frequency range of your instrument.
 - **JD740B** series: **25 MHz to 4 GHz**
 - **JD780B** series: **5 MHz to 6 GHz**
 - c Select the unit option from the choices: **GHz, MHz, kHz, or Hz.**
 - 4 To set the output level of the CW signal to be injected, complete following steps:
 - a Press the **Power Level** soft key.
 - b Enter a value within the output range for the frequency you have set.
 - JD740B** series: **-80 dBm to -30 dBm, 0 dBm**
 - JD780B** series: **-60 dBm to 10 dBm**
 - c Press the **Enter** soft key.
 - 5 To start to inject the set signal, toggle the **RF Source** soft key to **On**.
 - 6 To stop injecting the signal, toggle the **RF Source** soft key to **Off**.
-

Conducting spectrum measurements

If you have configured test parameters as described in the “Configuring test parameters” on page 65, your measurement is displayed on the screen as like the following example, Figure 16.

Figure 16 Spectrum measurement with spectrum analyzer



Figure 17 Spectrum measurement with spectrum analyzer (on 28 GHz downconverter)



Figure 18 Gated sweep measurement with spectrum analyzer

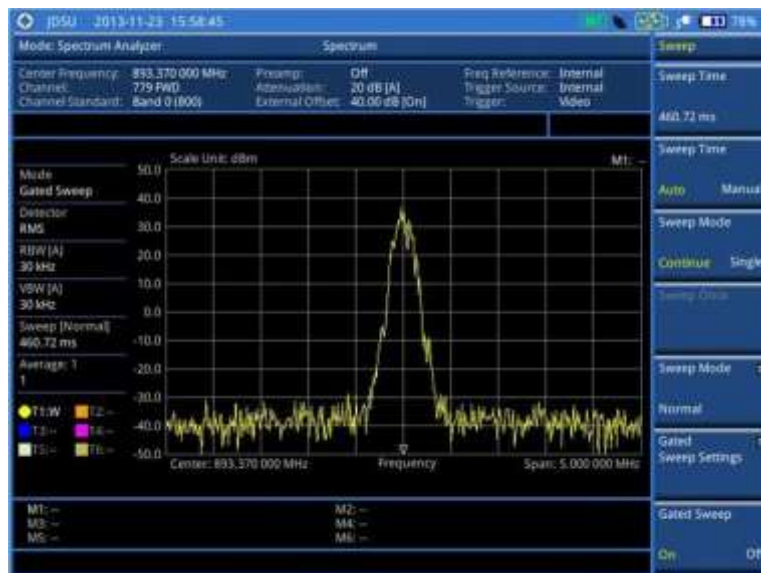

Figure 19 Gated sweep measurement with spectrum analyzer (on 28 GHz downconverter)



Setting trace

You can display up to six traces on the measurement chart simultaneously.

Procedure

- 1 Press the **TRACE/DISPLAY** hard key.
- 2 Press the **Select Trace** soft key, and then select the trace number: **T1**, **T2**, **T3**, **T4**, **T5**, or **T6**. The legend shape of the selected trace changes from square to round to indicate that the trace is the active one now.
- 3 Complete one of the followings:

To	Select	Trace Legend
Clear current data and display with new measurements	Clear Write	W
Display the input signal's maximum response only (unlimited or for a certain amount of time)	Max Hold	M
Display the input signal's minimum response only (unlimited or for a certain amount of time)	Min Hold	m
Capture the selected trace and compare traces	Capture	C
Load a saved trace	More (1/3) > Load	L
Hide the displayed trace	Trace View > Off	F
Remove all the traces and initialize the trace settings	More (1/3) > Trace Clear All	



NOTE

For the **Max Hold** and **Min Hold**, your instrument compares newly acquired data with the active trace and displays larger maximum values or smaller minimum values on the screen. You can set it to **Unlimited** to hold and view maximum or minimum data or specify a certain amount of time up to 60 seconds by using numeric keys or rotary knob.

- 4 To select the detection option, select **More (1/3) > Detectors**, and then complete one of the followings:

To display	Select
------------	--------

Random noise better than the peak without missing signals	Normal
The highest value in each data point	Peak
The root mean squared average power across the spectrum	RMS
The lowest value in each data point	Negative Peak
The center value in each data point	Sample

- 5 To detect Wi-Fi SSID in a user-specified bandwidth, complete the following steps and refer to Figure 19 below (this option is not available when the 28 GHz downconverter is in operation):
 - a Connect the WiFi device to the **USB Host** port of the instrument.
 - b Press **More (1/3) > Wi-Fi Info**.
 - c Toggle the **Wi-Fi Info** soft key and select **On**.
 - d Press the **FREQ/DIST** hard key.
 - e Press the **Center Frequency** soft key.
 - f Enter a value using the numeric keys. You can also turn the rotary knob to change the value.
- 6 *Optional.* Select **More (1/3) > Trace Info**, and then select the trace number to view the trace's setting information stored at the time of the measurement or **None** to hide the information.
- 7 *Optional.* If you have the two traces T1 and T2, you can perform trace math. To view the power difference between the traces, press the **T1 – T2 -> T5** or **T2 – T1 -> T6** soft key. The result is overlaid on the screen along with the second Y-axis.

NOTE
Wi-Fi SSID display is only enabled when the measure mode is set to spectrum and channel power and the center frequency needs to be set as desired.

NOTE
To be able to load a trace, the trace to be overlaid must be saved in the same measurement mode and frequency setting as the current measurement.

Figure 20 Wi-Fi SSID display with spectrum analyzer



Setting limit

Procedure

To use the display line:

- 1 Press the **LIMIT** hot key.
- 2 Press the **Display Line** soft key for a reference line.
- 3 Enter a value, and then press the **dBm** unit soft key.
- 4 Toggle the **Display Line** soft key between **On** and **Off** to display and dismiss the reference line. The straight line appears across the screen to be used as a visual reference only.

To display the multiple segment line:

- 1 Press the **LIMIT** hot key.
- 2 Press the **Multi Segment Line** soft key for Pass/Fail indication.
- 3 Toggle the **Limit** soft key between **Upper** and **Lower** to select the one to be displayed.
- 4 Set the number of segments for the selected upper or lower limit line, up to 50 segments.
 - a Press the **# of Line** soft key.
 - b Enter a value between 1 and 50 by using the numeric keys.
 - c Press the **Enter** soft key.
- 5 Press the **Autoset** soft key to let the instrument set the limit for each segment and display the line.
- 6 *Optional.* To move the limit line, complete the following steps:
 - a Select **Limit Up/Down** or **Limit Left/Right**.
 - b Turn the rotary knob to move the line as desired. You can also manually enter a value.
- 7 *Optional.* To edit the segment properties, complete the following steps:
 - a Press the **Edit Limit** soft key.
 - b Press the **Move** soft key and then turn the rotary knob to select the segment to edit.
 - c Select the menu option, from the following choices:
 - To hide the line for the selected segment, toggle the **Line** soft key to **Off**.
 - To add a new point, press the **Add Point** soft key.
 - To delete the selected point, press the **Delete Point** soft key.
 - To change the position, press the **Frequency** or **Amplitude** soft key, and then turn the rotary knob to change the value as desired.
- 8 *Optional.* Go to **SAVE/LOAD > Save**, and then select **Limit** to save the limit settings. See "Using save" on page 34 for more information.

Setting frequency offset

If you want to check how much the actual frequency has been drifted from the input center frequency on your spectrum, you can set the center frequency as a frequency reference or an offset to view the drifted amount in frequency easily.

Procedure

- 1 Press the **FREQ/DIST** hard key.
- 2 Press the **Frequency Offset** soft key.
- 3 Enter a value using the numeric keys. You can also turn the rotary knob to change the value. For example, if you have set the center frequency as 89.1 MHz and want to set it as a frequency reference, you need to enter "-89.1" in the user input field to view the center frequency as "0".
- 4 Select the unit: **GHz**, **MHz**, **kHz**, or **Hz**. All frequency information on the display changes accordingly.

Conducting RF measurements

Channel power

The Channel Power measurement is a common test used in the wireless industry to measure the total

transmitted power of a radio within a defined frequency channel. It acquires a number of points representing the input signal in the time domain, transforms this information into the frequency domain using Fast Fourier Transform (FFT), and then calculates the channel power. The effective resolution bandwidth of the frequency domain trace is proportional to the number of points acquired for the FFT.

The channel power measurement identifies the total RF power, power spectral density, and Peak to Average Ratio (PAR) of the signal within the channel bandwidth.

Setting measure setup

After configuring test parameters, you can set the measure setup to continue your measurement. The measurement settings can be saved and recalled as a file. You can also use JDViewer, PC application software to configure a measure setup, save as a file, and load the file on to the instrument.

Procedure

- 1 Configure test parameters as described in the “Configuring test parameters” on page 65.
 - 2 Press the **MEASURE SETUP** hot key.
 - 3 Set the channel power measurement bandwidth to be measured:
 - a Press the **Integrated BW** soft key.
 - b Enter a bandwidth by using the numeric keys. You can also use the rotary knob.
 - c Select the unit: **GHz**, **MHz**, **kHz**, or **Hz**.
 - 4 Set the frequency range over which the instrument will sweep:
 - a Press the **Span** soft key.
 - b Enter a span frequency value by using the numeric keys. You can also use the rotary knob.
 - c Select the unit: **GHz**, **MHz**, **kHz**, or **Hz**.
 - 5 Set the number of measurements to be averaged:
 - a Press the **Average** soft key.
 - b Enter a value between 1 and 100.
 - c Press the **Enter** soft key.
-

Setting limit

Procedure

- 1 Press the **LIMIT** hot key.
 - 2 Press the **Channel Power** soft key to set the limit parameters.
 - 3 Toggle the **Test Limits** soft key between **On** and **Off** to enable or disable the Pass/Fail indication.
 - 4 Set the upper threshold:
 - a Press the **High Limit** soft key.
 - b Enter a value for the upper limit, and then press the **dBm** unit soft key.
 - 5 Set the lower threshold:
 - a Press the **Low Limit** soft key.
 - b Enter a value for the lower limit, and then press the **dBm** unit soft key.
 - 6 *Optional.* Go to **SAVE/LOAD > Save**, and then select the save option from the choices available for your measurement mode. See “Using save” on page 34 for more information.
-

Measurement example

Figure 21 Channel power measurement with spectrum analyzer



Channel power measurement result shows channel power and spectrum density in a user specified channel bandwidth. The peak to average ratio (PAR) is shown at the bottom of the screen as well. The shaded area on the display indicates the channel bandwidth.

Figure 22 Channel power measurement with spectrum analyzer (on 28 GHz downconverter)



Figure 23 Wi-Fi SSID display in channel power measurement with spectrum analyzer



Occupied bandwidth

The Occupied Bandwidth measures the percentage of the transmitted power within a specified bandwidth. The percentage is typically 99%.

Setting measure setup

After configuring test parameters, you can set the measure setup to continue your measurement. The measurement settings can be saved and recalled as a file. You can also use JDViewer, PC application software to configure a measure setup, save as a file, and load the file on to the instrument.

Procedure

- 1 Configure test parameters as described in the “Configuring test parameters” on page 65.
- 2 Press the **MEASURE SETUP** hot key.
- 3 Set the percentage of power within the bandwidth to be measured:
 - a Press the **Occupied BW % Power** soft key.
 - b Enter a value by using the numeric keys. You can also use the rotary knob.
 - c Press the **Enter** soft key.
- 4 Set the frequency range over which the instrument will sweep:
 - a Press the **Span** soft key.
 - b Enter a span frequency value by using the numeric keys. You can also use the rotary knob.
 - c Select the unit: **GHz**, **MHz**, **kHz**, or **Hz**.
- 5 Set the number of measurements to be averaged:
 - a Press the **Average** soft key.
 - b Enter a value between 1 and 100.
 - c Press the **Enter** soft key.

Setting limit

Procedure

- 1 Press the **LIMIT** hot key.

- 2 Press the **Occupied BW** soft key to set the limit parameters.
- 3 Toggle the **Test Limits** soft key between **On** and **Off** to enable or disable the Pass/Fail indication.
- 4 Set the upper threshold:
 - a Press the **High Limit** soft key.
 - b Enter a value for the upper limit, and then select the unit: **MHz**, **kHz**, or **Hz**.
- 5 *Optional.* Go to **SAVE/LOAD > Save**, and then select **Limit** to save the limit settings. See "Using save" on page 34 for more information.

Measurement example

The Occupied Bandwidth measurement shows both of power across the band and power bandwidth in a user specified percentage to determine the amount of spectrum used by a modulated signal. Occupied bandwidth is typically calculated as the bandwidth containing 99% of the transmitted power.

Figure 24 Occupied bandwidth measurement with spectrum analyzer



Figure 25 Occupied bandwidth measurement with spectrum analyzer (on 28 GHz downconverter)



Spectrum emission mask (SEM)

The Spectrum Emission Mask (SEM) measurement is to identify and determine the power level of out-of-band spurious emission outside the necessary channel bandwidth and modulated signal. It measures the power ratio between in-band and adjacent channels. The JD700B series indicates either Pass or Fail based on the specified limit of the signal.

Setting measure setup

After configuring test parameters, you can set the measure setup to continue your measurement. The measurement settings can be saved and recalled as a file. You can also use JDViewer, PC application software to configure a measure setup, save as a file, and load the file on to the instrument.

Procedure

- 1 Configure test parameters as described in the “Configuring test parameters” on page 65.
 - 2 Press the **MEASURE SETUP** hot key.
 - 3 Set the main channel bandwidth to be measured:
 - a Press the **Main Channel BW** soft key.
 - b Enter a value by using the numeric keys. You can also use the rotary knob.
 - c Select the unit: **MHz**, **kHz**, or **Hz**.
 - 4 Set the frequency range over which the instrument will sweep:
 - a Press the **Span** soft key.
 - b Enter a span frequency value by using the numeric keys. You can also use the rotary knob.
 - c Select the unit: **GHz**, **MHz**, **kHz**, or **Hz**.
 - 5 Set the number of measurements to be averaged:
 - a Press the **Average** soft key.
 - b Enter a value between 1 and 100, and then press the **Enter** soft key.
 - 6 To configure an offset, up to five, complete the following steps:
 - a Press the **Offset/Limit** soft key.
The Offset/Limit menu bar appears.
 - b Press the **Offset** soft key, and then select the number for the active offset to configure.
 - c Toggle the **Offset** soft key and select **On** to display or **Off** to hide the active offset.
 - d Press the **Offset Frequency** soft key to set the center frequency of the offset.
 - e Enter a value by using the numeric keys. You can also use the rotary knob.
 - f Select the unit: **MHz**, **kHz**, or **Hz**.
 - g Press the **Measurement Bandwidth** soft key to set the bandwidth for the selected offset.
 - h Enter a value by using the numeric keys. You can also use the rotary knob.
 - i Select the unit: **MHz**, **kHz**, or **Hz**.
 - j Toggle the **Reference** soft key between Relative and Absolute and select **Relative** or **Absolute** depending on how to use the reference.
 - 7 To define the selected offset’s limits for Pass/Fail indication, complete the following steps:
 - a Press the **Start Offset Limit** soft key to set the threshold for the power difference between the main channel bandwidth and the selected offset bandwidth on the left.
 - b Enter a value by using the numeric keys. You can also use the rotary knob.
 - c Select the **dB** soft key.
 - d Press the **Stop Offset Limit** soft key to set the threshold for the power difference between the main channel bandwidth and the selected offset bandwidth on the right.
 - e Enter a value by using the numeric keys. You can also use the rotary knob.
 - f Select the **dB** soft key.
-

Setting limit

Procedure

- 1 Press the **LIMIT** hot key.
- 2 Press the **Spectrum Emission Mask** soft key.
- 3 Toggle the **Test Limits** soft key between **On** and **Off** to enable or disable the Pass/Fail indication.
- 4 *Optional.* Go to **SAVE/LOAD > Save**, and then select **Limit** to save the limit settings. See "Using save" on page 34 for more information.

Measurement example

Figure 26 Spectrum emission mask measurement with spectrum analyzer



Figure 27 Spectrum emission mask measurement with spectrum analyzer (on 28 GHz downconverter)



Adjacent channel power (ACP)

The Adjacent Channel Power (ACP) is the power contained in a specified frequency channel bandwidth relative to the total carrier power. It may also be expressed as a ratio of power spectral densities between the carrier and the specified offset frequency band.

Setting measure setup

After configuring test parameters, you can set the measure setup to continue your measurement. The measurement settings can be saved and recalled as a file. You can also use JDViewer, PC application software to configure a measure setup, save as a file, and load the file on to the instrument.

Procedure

- 1 Configure test parameters as described in the “Configuring test parameters” on page 65.
 - 2 Press the **MEASURE SETUP** hot key.
 - 3 Set the main channel bandwidth to be measured:
 - a Press the **Main Channel BW** soft key.
 - b Enter a value by using the numeric keys. You can also use the rotary knob.
 - c Select the unit: **MHz**, **kHz**, or **Hz**.
 - 4 Set the frequency range over which the instrument will sweep:
 - a Press the **Span** soft key.
 - b Enter a span frequency value by using the numeric keys. You can also use the rotary knob.
 - c Select the unit: **GHz**, **MHz**, **kHz**, or **Hz**.
 - 5 Set the number of measurements to be averaged:
 - a Press the **Average** soft key.
 - b Enter a value between 1 and 100, and then press the **Enter** soft key.
 - 6 To configure an offset, up to five, complete the following steps:
 - a Press the **Offset/Limit** soft key.
The Offset/Limit menu bar appears.
 - b Press the **Offset** soft key, and then select the number for the active offset to configure.
 - c Toggle the **Offset** soft key and select **On** to display or **Off** to hide the active offset.
 - d Press the **Offset Frequency** soft key to set the center frequency of the offset.
 - e Enter a value by using the numeric keys. You can also use the rotary knob.
 - f Select the unit: **MHz**, **kHz**, or **Hz**.
 - g Press the **Integration Bandwidth** soft key to set the bandwidth for the selected offset.
 - h Enter a value by using the numeric keys. You can also use the rotary knob.
 - i Select the unit: **MHz**, **kHz**, or **Hz**.
 - 7 To define the selected offset’s limits for Pass/Fail indication, complete the following steps:
 - a Press the **Lower** soft key to set the threshold for the power difference between the main channel bandwidth and the selected offset bandwidth on the left.
 - b Enter a value by using the numeric keys. You can also use the rotary knob.
 - c Select the **dBc** soft key.
 - d Press the **Upper** soft key to set the threshold for the power difference between the main channel bandwidth and the selected offset bandwidth on the right.
 - e Enter a value by using the numeric keys. You can also use the rotary knob.
 - f Select the **dBc** soft key.
-

Setting limit

Procedure

- 1 Press the **LIMIT** hot key.
-

- 2 Press the **ACP** soft key.
- 3 Toggle the **Test Limits** soft key between **On** and **Off** to enable or disable the Pass/Fail indication.
- 4 *Optional.* Go to **SAVE/LOAD > Save**, and then select **Limit** to save the limit settings. See “Using save” on page 34 for more information.

Measurement example

Figure 28 Adjacent channel power measurement with spectrum analyzer



Figure 29 Adjacent channel power measurement with spectrum analyzer (on 28 GHz downconverter)



Multi-ACP

The Multi-ACP measurement is used to do multi-channel ACP testing. It helps you to measure ACP in multi-channel transmitting base station environment.

Setting measure setup

After configuring test parameters as described in “Configuring test parameters” on page 65, you can set the measure setup to continue your measurement. The measurement settings can be saved and recalled as a file. You can also use JDViewer, PC application software to configure a measure setup, save as a file, and load the file on to the instrument.

Procedure

- 1 Press the **MEASURE SETUP** hot key.
 - 2 Toggle the **Unit** soft key and select **Freq** or **Channel** (only available for frequency setting when 28 GHz is in operation).
 - For the frequency setting, complete the following steps:
 - a Press the **Lowest Frequency** soft key.
 - b Enter a value by using the numeric keys. You can also use the rotary knob.
 - c Select the unit: **GHz**, **MHz**, **kHz**, or **Hz**.
 - d Press the **Highest Frequency** soft key.
 - e Enter a value by using the numeric keys. You can also use the rotary knob.
 - f Select the unit: **GHz**, **MHz**, **kHz**, or **Hz**.
 - For the channel setting, complete the following steps:
 - a Press the **Channel Std** soft key. The standard channel window appears.
 - b Select the band to be measured by using the rotary knob or the **Page p/Page Down** soft keys.
 - c Press the **Select** soft key or the rotary knob to confirm the selection.
 - d Toggle the **Link** soft key to select the sweep direction and select **Fwd** (forward) or **Rev** (reverse) as needed.
 - e Press the **Lowest Channel** soft key.
 - f Enter a value by using the numeric keys.
 - g Press the **Enter** soft key or **ENTER** hard key to complete the entry. The instrument automatically displays the corresponding center frequency value for the selected channel number.
 - h Press the **Highest Channel** soft key.
 - i Enter a value by using the numeric keys.
 - j Press the **Enter** soft key or **ENTER** hard key to complete the entry. The instrument automatically displays the corresponding center frequency value for the selected channel number.
 - 3 To set up ACP setting, press the **ACP Settings** soft key and then complete the following steps:
 - a Press the **Main Channel BW** soft key.
 - b Enter a value by using the numeric keys. You can also use the rotary knob.
 - c Select the unit: **MHz**, **kHz**, or **Hz**.
 - d Press the **Span** soft key to set the frequency range over which the instrument will sweep.
 - e Enter a span frequency value by using the numeric keys. You can also use the rotary knob.
 - f Select the unit: **GHz**, **MHz**, **kHz**, or **Hz**.
 - g Press the **Average** soft key to set the number of measurement to be averaged:
 - h Enter a value between 1 and 100.
 - i Press the **Enter** soft key.
 - 4 To configure an offset, up to five, complete the following steps:
 - a Press the **Offset/Limit** soft key. The Offset/Limit menu bar appears.
 - b Press the **Offset** soft key, and then select the number for the active offset to configure.
 - c Toggle the **Offset** soft key and select **On** to display or **Off** to hide the active offset.
 - d Press the **Offset Frequency** soft key to set the offset frequency.
 - e Enter a value by using the numeric keys. You can also use the rotary knob.
 - f Select the unit: **MHz**, **kHz**, or **Hz**.
 - g Press the **Integration Bandwidth** soft key.
 - h Enter a value by using the numeric keys. You can also use the rotary knob.
-

- i Select the unit: **MHz, kHz, or Hz.**
- 5 To define the selected offset's limits for Pass/Fail indication, complete the following steps:
 - a Press the **Lower** soft key to set the threshold for the power difference between the main channel bandwidth and the selected offset bandwidth on the left.
 - b Enter a value by using the numeric keys. You can also use the rotary knob.
 - c Select the **dBc** soft key.
 - d Press the **Upper** soft key to set the threshold for the power difference between the main channel bandwidth and the selected offset bandwidth on the right.
 - e Enter a value by using the numeric keys. You can also use the rotary knob.
 - f Select the **dBc** soft key.

Setting limit

Procedure

- 1 Press the **LIMIT** hot key.
- 2 Press the **Multi-ACP** soft key.
- 3 Toggle the **Test Limits** soft key between **On** and **Off** to enable or disable the Pass/Fail indication.
- 4 *Optional.* Go to **SAVE/LOAD > Save**, and then select **Limit** to save the limit settings. See "Using save" on page 34 for more information.

Measurement example

Figure 30 Multi-ACP measurement with spectrum analyzer



Figure 31 Multi-ACP measurement with spectrum analyzer (on 28 GHz downconverter)



Spurious emissions

The Spurious Emissions measurement is to identify or determine the power level of in-band or out-of-band spurious emissions within the necessary channel bandwidth and modulated signal. The JD700B series indicates either Pass or Fail based on the specified limit of the signal.

Setting measure setup

After configuring test parameters as described in the “Configuring test parameters” on page 65, you can set the measure setup to continue your measurement. The measurement settings can be saved and recalled as a file. You can also use JDViewer, PC application software to configure a measure setup, save as a file, and load the file on to the instrument.

Procedure

- 1 Press the **MEASURE SETUP** hot key.
- 2 To set up the range table and parameters, press the **Range Table** soft key and then complete the following steps:
 - a Press the **Range** soft key, and then select the range number between **1** and **20** to add as a new or change the existing settings.
 - b Do the following as desired:
 - Select **Start Frequency**, and then specify the start frequency for the selected range.
 - Select **Stop Frequency**, and then specify the stop frequency for the selected range.
 - Select **Start Limit**, and then specify the lower limit for Pass/Fail indication.
 - Select **Stop Limit**, and then specify the upper limit for Pass/Fail indication.
 - Select **More (1/2) > Attenuation**, and then specify an value in the multiple of five.
 - Select **More (1/2) > RBW**, and then specify a RBW value.
 - Select **More (1/2) > VBW**, and then specify a VBW value.
 - c Press the **PREV** hard key.
 - d Toggle the **Range** soft key and select **On** to display the selected range in the result table or **Off** to hide it from the table.
- 3 Toggle the **Measure Type** soft key between **Examine** and **Full** to select the measurement type.

**NOTE**

The **Examine** mode displays only the selected range while the **Full** mode lets the instrument automatically change the selected range from one another.

- 4 To set the number of measurements to be averaged, complete the following steps:
 - a Press the **Average** soft key.
 - b Enter a value between **1** and **100**.
 - c Press the **Enter** soft key.
- 5 To move the highlighted bar in the result table to other range, complete the following steps:
 - a Press the **Range** soft key in the Measure Setup menu bar.
 - b Enter a value between **1** and **20**.
 - c Press the **Enter** soft key.

Setting limit

Procedure

- 1 Press the **LIMIT** hot key.
- 2 Press the **Spurious Emissions** soft key.
- 3 Toggle the **Test Limits** soft key between **On** and **Off** to enable or disable the Pass/Fail indication.
- 4 *Optional.* Go to **SAVE/LOAD > Save**, and then select **Limit** to save the limit settings. See "Using save" on page 34 for more information.

Measurement example

Figure 32 Spurious emissions measurement with spectrum analyzer



Figure 33 Spurious emissions measurement with spectrum analyzer (on 28 GHz downconverter)



AM/FM audio demodulation

The AM/FM Audio Demodulator operates using the power received from radio waves and it serves as an alternative to identify interfering signals easily. The instrument sounds demodulated signals that can be heard through the built-in speaker or plugged-in headphones. You can hear the sound and identify interfering signals easily.

Setting measure setup

After configuring test parameters as described in the “Configuring test parameters” on page 65, you can set the measure setup to continue your measurement. The measurement settings can be saved and recalled as a file. You can also use JDViewer, PC application software to configure a measure setup, save as a file, and load the file on to the instrument.

Procedure

- 1 Press the **MEASURE SETUP** hot key.
- 2 Toggle the **Audio Demod** soft key between **On** and **Off** to turn the AM/FM audio demodulation on and off.
- 3 Press the **Demod at** soft key, and then select the marker number for the frequency to be demodulated.



NOTE

You must set the marker(s) first by using the **MARKER** hard key as the AM/FM demodulator uses the marker position to demodulate. See “Using marker” on page 60 for more information.

- 4 Press the **Demod Mode** soft key, and then select the demodulation mode: **AM**, **FM** and **CW**.
- 5 Press the **Dwell Time** soft key, and then turn the rotary knob to set the demodulation interval between 1 and 20.
- 6 Press the **Volume** soft key, and then turn the rotary knob to set the speaker volume.
- 7 Toggle the **Auto Gain** soft key between **On** and **Off** to enable or disable the automatic gain feature to adjust the interval gain of the demodulator.
- 8 *Optional.* You can use the **Save On Event** soft key to let the instrument automatically save measurement screen or result that falls outside the defined limit settings or the Fail indicator is on. You can also set to save the first event and hold the measurement or to save all the events continuously. See “Using save” on page 34 for more information.

Setting limit

You can show or hide the display line on the screen that is used as a visual reference only.

Procedure

To view the display line:

- 1 Press the **LIMIT** hot key.
- 2 Press the **Display Line** soft key.
- 3 Enter a value, and then press the **dBm** unit soft key.
- 4 Toggle the **Display Line On/Off** soft key and select **On**.
The straight line appears on the screen.

To dismiss the display line:

- 1 Press the **LIMIT** hot key.
 - 2 Toggle the **Display Line On/Off** soft key and select **Off**.
-

You can use the multiple segment limit line to set up different limits for different frequency ranges for Pass/Fail indication.

Procedure

To display the multiple segment line:

- 1 Press the **LIMIT** hot key.
 - 2 Press the **Multi Segment Line** soft key.
 - 3 Toggle the **Limit** soft key between **Upper** and **Lower** to select the one to be displayed.
 - 4 Set the number of segments for the selected upper or lower limit line, up to 50 segments.
 - a Press the **# of Line** soft key.
 - b Enter a value between 1 and 50 by using the numeric keys.
 - c Press the **Enter** soft key.
 - 5 Press the **Autoset** soft key to let the instrument set the limit for each segment and display the line.
 - 6 *Optional.* To move the limit line, complete the following steps:
 - a Select **Limit Up/Down** or **Limit Left/Right**.
 - b Turn the rotary knob to move the line as desired. You can also manually enter a value.
 - 7 *Optional.* To edit the segment properties, complete the following steps:
 - a Press the **Edit Limit** soft key.
 - b Press the **Move** soft key and then turn the rotary knob to select the segment to edit.
 - c Select the menu option, from the following choices:
 - To hide the line for the selected segment, toggle the **Line** soft key and select **Off**.
 - To add a new point, press the **Add Point** soft key.
 - To delete the selected point, press the **Delete Point** soft key.
 - To change the position, press the **Frequency** or **Amplitude** soft key, and then turn the rotary knob to change the value as desired.
 - 8 *Optional.* Go to **SAVE/LOAD > Save**, and then select **Limit** to save the limit settings.
See "Using save" on page 34 for more information.
-

Measurement example

Figure 34 AM/FM audio demodulation with spectrum analyzer



Figure 35 AM/FM audio demodulation with spectrum analyzer (on 28 GHz downconverter)



Field strength meter

The Field Strength Meter measures the field strength over the frequency range of a connected antenna, which is known with its specific bandwidth and gain characteristics. A standard or user-defined antenna can be selected from the antenna list in the JD700B series.

Setting measure setup

Procedure

- 1 Connect an antenna to be used with your instrument.
- 2 Configure test parameters as described in the “Configuring test parameters” on page 65.
- 3 Press the **MEASURE SETUP** hot key, and then do one of the following:

To select the connected antenna from the list stored in the instrument:

- a Press the **Antenna List** soft key to view the standard and custom antennas. The antenna list window appears.
- b Select an antenna to be used for the field strength measurement by using the rotary knob, the arrow keys, or **Page Up/Page Down** soft keys.
- c Press the **Select** soft key.



NOTE

You can use the JDViewer to edit or define a custom antenna and add to this list.

To edit the properties of the connected antenna:

- a Press the **Antenna Start Frequency** soft key.
- b Enter a value by using the numeric keys, and then select the unit: **GHz**, **MHz**, **kHz**, or **Hz**. You can also use the rotary knob.
- c Press the **Antenna Stop Frequency** soft key.
- d Enter a value by using the numeric keys, and then select the unit: **GHz**, **MHz**, **kHz**, or **Hz**. You can also use the rotary knob.
- e Press the **Gain** soft key to enter the gain information for the antenna.
- f Enter a value by using the numeric keys, and then select the **Enter** soft key.

Setting limit

You can show or hide the display line on the screen that is used as a visual reference only.

Procedure

To view the display line:

- 1 Press the **LIMIT** hot key.
- 2 Press the **Display Line** soft key.
- 3 Enter a value, and then press the **dBm** unit soft key.
- 4 Toggle the **Display Line On/Off** soft key and select **On**. The straight line appears on the screen.

To dismiss the display line:

- 1 Press the **LIMIT** hot key.
- 2 Toggle the **Display Line On/Off** soft key and select **Off**.

You can use the multiple segment limit line to set up different limits for different frequency ranges for Pass/Fail indication.

Procedure

To display the multiple segment line:

- 1 Press the **LIMIT** hot key.
- 2 Press the **Multi Segment Line** soft key.
- 3 Toggle the **Limit** soft key between **Upper** and **Lower** to select the one to be displayed.
- 4 Set the number of segments for the selected upper or lower limit line, up to 50 segments.
 - a Press the **# of Line** soft key.
 - b Enter a value between 1 and 50 by using the numeric keys.
 - c Press the **Enter** soft key.
- 5 Press the **Autoset** soft key to set and display the limit line for each segment automatically.
- 6 *Optional.* To move the limit line, complete the following steps:
 - a Select **Limit Up/Down** or **Limit Left/Right**.
 - b Turn the rotary knob to move the line as desired. You can also manually enter a value.
- 7 *Optional.* To edit the segment properties, complete the following steps:

- a Press the **Edit Limit** soft key.
 - b Press the **Move** soft key and then turn the rotary knob to select the segment to edit.
 - c Select the menu option, from the following choices:
 - To hide the line for the selected segment, toggle the **Line** soft key and select **Off**.
 - To add a new point, press the **Add Point** soft key.
 - To delete the selected point, press the **Delete Point** soft key.
 - To change the position, press the **Frequency** or **Amplitude** soft key, and then turn the rotary knob to change the value as desired.
- 8 *Optional.* Go to **SAVE/LOAD > Save**, and then select **Limit** to save the limit settings. See “Using save” on page 34 for more information.

Measurement example

Figure 36 Field strength measurement with spectrum analyzer



Figure 37 Field strength measurement with spectrum analyzer (on 28 GHz downconverter)



Route map

The JD700B Series provides the Route Map function that allows you to collect data of points in an indoor or outdoor environment and track the received signals and coverage of RF transmitters by plotting data real time directly on top of a loaded floor plan or a map.

The JD700B Series also supports the RAN-IL (Interference Location) feature that enables you to overlay user experience data obtained through Viavi's ariesoGEO on your base map to help you troubleshoot problems easily and quickly using your instrument. You can generate raster data files on the ariesoGEO application and load them on your instrument.

Setting measure setup

Procedure

- 1 If required, connect a GPS receiver to your JD700B series for outdoor mapping. Indoor mapping does not necessarily need a GPS antenna.
- 2 Configure test parameters as described in the "Configuring test parameters" on page 65.
- 3 To load your map file, complete the following steps:
 - a Plug in your USB drive that has a floor map or .mcf file type created in JMapCreator. If the JMapCreator application on your computer is connected to the instrument via USB or LAN, you can send a map file with a single layer to the instrument directly by using the **Send to EQP** menu in JMapCreator.



NOTE

The JMapCreator converts and resizes any scanned floor plan or layout to fit onto your instrument's display. JMapCreator 1.2.0 or later can save a multiple-layered map, providing **x1**, **x2**, and **x4** views, as a sizable map file so that you can zoom in and out after loading it.

- b Press **SAVE/LOAD** hot key, and then select **Load > Load Map**. See "Using load" on page 36 for more information.
- 4 Press the **MEASURE SETUP** hot key.
- 5 Press the **Plot Point** soft key, and then select the plot point option from the following choices:
To collect data/plot points automatically as you move around in a vehicle or outside, select **GPS** and then toggle the **Screen Mode** soft key between **Map** and **Full**.



NOTE

- With the **Map** setting, you can view only the collected points that can be seen within the boundary of the loaded map. If a point is off the map, the instrument displays an arrow to indicate the direction of the current location on the map and the distance from the center to the location at the top of the screen.

- With the **Full** setting, you can view all the collected points of the route without the loaded map.

To collect data/plot points manually without a GPS antenna, select **Position**.

To collect data/plot points based on time, select **Time**.

You do not need a GPS antenna as you would usually use this option indoor.

- 6 Press the **Plot Item** soft key, and then select the measurement option: **RSSI** or **ACP**.
- 7 *Optional.* If ACP is selected, set the **Main Channel BW** and **Offset/Limit** (it is not supported when 28 GHz downconverter is in operation):
 - a Press the **Main Channel BW** soft key.
 - b Enter a value, and then select the unit from the choices: **MHz**, **kHz**, and **Hz**.
 - c Press the **Offset/Limit** soft key.
 - d Toggle the **Offset** soft key and select **On** to display or **Off** to hide the offset.
 - e Press the **Integration Bandwidth** soft key.
 - f Enter a value, and then select the unit from the choices: **MHz**, **kHz**, and **Hz**.
 - g Press the **Offset Frequency** soft key to set the offset frequency.

-
- h Enter a value, and then select the unit from the choices: **MHz**, **kHz**, and **Hz**.
 - i Press the **Offset Limit** soft key to set the offset limit.
 - j Enter a value, and then select the **dB** soft key.
- 8 Toggle the **Plot** soft key and select **Start**.
- 9 Touch directly on the screen or press the **ENTER** hard key to collect data and plot points on the loaded map for the **Position** or **Time** setting.



NOTE

For the **Position** setting, you can change the direction of the route with screen touch or the arrow keys and the distance with the rotary knob. For the **Time** setting, the instrument interpolates points in between two enters on a straight dotted line. You can change the direction of the route with the arrow keys and the distance with the rotary knob.

- 10 Toggle the **Plot** soft key and select **Stop** to stop plotting.
- 11 Press the **SAVE/LOAD** hot key to save the result. See “Using save” on page 34 for more information.



NOTE

The instrument does not automatically save the collected data. It is recommended that you save the result. Otherwise, you will lose all the collected data.

Setting limit

You can set the thresholds for the four different color indicators.

Procedure

- 1 Press the **LIMIT** hot key.
 - 2 Press the **Excellent** soft key to set its threshold.
 - 3 Enter a value, and then press the **dBm** soft key. You can also use the rotary knob.
 - 4 Press the **Very Good** soft key to set its threshold.
 - 5 Enter a value, and then press the **dBm** soft key. You can also use the rotary knob.
 - 6 Press the **Good** soft key to set its threshold.
 - 7 Enter a value, and then press the **dBm** soft key. You can also use the rotary knob.
 - 8 Press the **Poor** soft key to set its threshold.
 - 9 Enter a value, and then press the **dBm** soft key. You can also use the rotary knob.
 - 10 *Optional.* Go to **SAVE/LOAD > Save**, and then select **Limit** to save the limit settings. See “Using save” on page 34 for more information.
-

Measurement example

Figure 38 Route map measurement screen with GPS



Controlling a map

If you have loaded a sizable map that was created in JDMapCreator 1.2.0 or later, you can use the Map Control feature that enables you to zoom into the map and view a specific area of interest in detail.

Procedure

- 1 Press the **TRACE/DISPLAY** hard key.
- 2 Press the **Map Control** soft key. This key is active only when you have loaded a sizable map.
- 3 To zoom in or zoom out, do one of the following:
 - To zoom into an area of interest directly, complete the following steps:
 - a Toggle the **Zoom to** soft key and select **Area**. The black rectangle appears on the map.
 - b Press the **Zoom In** and **Zoom Out** soft keys, as you need, to decrease and increase the selected area.
 - c Move the rectangle by using the four arrow keys, as you need, to place it in a specific area of interest.
 - d Press the center of the rotary knob to zoom into the selected area. You can also press the **Zoom to** soft key again to zoom into the selected area.
 - To zoom into the center or zoom out from the center, complete the following steps:
 - a Toggle the **Zoom to** soft key and select **Center**.
 - b Press the **Zoom In** and **Zoom Out** soft keys, as you need, to zoom in and zoom out.
 - c Move the zoomed-in area by using the four arrow keys, as you need.
- 4 To set the location mode, toggle the **Location Mode** soft key between **Auto** and **Manual** and select the one you desire.

Auto: The instrument compares the coordinates of the displayed map with received GPS information. If your current location goes out of the displayed area and enters into the next zoomed-in section within the base map, the map display changes automatically to the next section in which your current position is.

Manual: The map display of the zoomed-in area remains unchanged even if your current location goes out of the displayed area. You can change the displayed area manually by using the arrow keys.

Loading and displaying raster data

If you have a set of raster data files generated through the ariesoGEO application, you can load and overlay the data on your base map to help you check the signal quality and the strength of interferences while driving toward the area of interest.

Procedure

- 5 Copy a set of raster data files into your USB memory drive, including the following:

ASCII: .tab, .asc, and .c1r files

BIL: .tab, .hdr, .bil, and .c1r files



NOTE

The .tab file type is a geospatial vector data format used in many geographic information systems. The color file (.c1r) is an optional file, but the image will be displayed as a grayscale image without it. The size of the raster map must be **1024 x 1024** or smaller.

- 6 Plug in the USB memory drive to your instrument.
- 7 Press the **TRACE/DISPLAY** hard key.
- 8 Press the **Load Raster Map** soft key.
The file explorer window appears.
- 9 Navigate to the raster file (.tab) you want to open, and then press the **Load** soft key.
The raster image appears on top of your base map as shown in Figure 39.



NOTE

If the area of the loaded raster data is not within the boundary of the base map, you will not see the raster image on the screen.

- 10 To select the display option, complete the following steps:
 - a Press the **Display Options** soft key.
 - b Select the option you desire from the choices: **On**, **Off**, and **Blink**.
 - 11 To adjust the transparency level of the image, complete the following steps:
 - a Press the **Transparency** soft key.
 - b Enter a value between **0** for opaque and **100** for clear.
 - c Press the **Enter** soft key.
-

Figure 39 Raster image overlaid on the base map



Dual spectrum

The Dual Spectrum feature lets you view two spectrum measurements, both the Uplink and Downlink spectrum, simultaneously eliminating the need to swap between two screens back and forth.

Setting measure setup

Procedure

- 1 Configure test parameters as described in the “Configuring test parameters” on page 65.
- 2 Press the **MEASURE SETUP** hot key.
- 3 Toggle the **Active Window** soft key between **Top** and **Bottom** to select the measurement window to configure or work on. You can also tap on the top or bottom chart on the screen.

Measurement example

Figure 40 Dual spectrum measurement with spectrum analyzer



PIM detection (single and multiple carriers)

The Passive Intermodulation (PIM) Detection allows you to detect Uplink PIM across the full spectrum for any technology. When PIM is detected, the normal repair mode is to replace the offending cable and what you need to do is replacing the whole cable irrespective of the location of the fault. Note that this functionality is not supported when the 28 GHz downconverter is in operation.

Setting measure setup

Procedure

- 1 Press the **MEASURE SETUP** hot key.
- 2 Connect cables as instructed on the screen.
- 3 *Optional.* To check any possibility of PIM existence in red color by calculation, complete the following steps:
 - a Press the **Calculated PIM** soft key.
 - b Press the **Radio Band** soft key for single carrier. There are **Radio 1 Band** and **Radio 2 Band** soft keys for multiple carriers.

- c Highlight a desired band and then press the **Select** soft key.
 - d Press the **Return** soft key.
- 4 To set the uplink frequency to be measured, do one of the following:
- To set the center frequency and span, complete the following steps:
- a Toggle the **Unit** soft key and select **Freq.**
 - b Press the **Uplink Center Frequency** soft key.
 - c Enter a value by using the numeric keys. You can also use the rotary knob.
 - d Select the unit: **GHz, MHz, kHz, or Hz.**
 - e Press the **Uplink Span** soft key.
 - f Enter a value by using the numeric keys. You can also use the rotary knob.
 - g Select the unit: **GHz, MHz, kHz, or Hz.**
- To set the channel number and span, complete the following steps:
- a Toggle the **Unit** soft key and select **Channel.**
 - b Press the **Channel Std** soft key and select a desired band.
 - c Press the **Channel Number** soft key.
 - d Enter a value by using the numeric keys and then press the **Enter** soft key. The instrument automatically displays the corresponding center frequency value for the selected channel number.
 - e Press the **Uplink Span** soft key.
 - f Enter a value by using the numeric keys. You can also use the rotary knob.
 - g Select the unit: **GHz, MHz, kHz, or Hz.**
- 5 Press the **Continue** soft key and follow the instructions on the screen.

Measurement example

Figure 41 PIM detection for single carrier



Figure 42 PIM detection for multiple carriers



Total Harmonic Distortion (THD)

The JD700B series can measure the Total Harmonic Distortion using spectrum analyzer. The Total Harmonic Distortion is defined as the ratio of RMS voltage of the harmonics to that of the fundamental component. This is accomplished by using a spectrum analyzer to obtain the level of each harmonic with peak detector. Note that this functionality is not supported when the 28 GHz downconverter is in operation.

Figure 43 Total harmonic distortion screen



Setting fundamental frequency

You need to set the fundamental frequency to measure the total harmonic distortion. Once you set up, it will automatically collect the harmonic outputs (up to the tenth harmonics as shown in Figure 43) from the spectrum analyzer and calculate the corresponding THD value (%) and the distortion attenuation (dB).

Procedure

- 1 Press the **FREQ/DIST** hard key.
- 2 Press the **Fundamental Frequency** soft key.
- 3 Enter a value by using the numeric keys. You can also use the rotary knob or the arrow keys.
- 4 Select the unit: **GHz**, **MHz**, **kHz**, or **Hz**.
The total harmonic distortion screen changes accordingly.

Setting reference level

You can set the reference level automatically or manually to optimize the display of the traces measured, as you desire.

Procedure

To automatically set the reference level:

- 1 Press the **AMP/SCALE** hard key.
- 2 Press the **Auto Scale** soft key.
Each time you press this key, the Y-axis scale changes to be optimized with some margin.

To set the reference or attenuation level manually:

- 1 Press the **AMP/SCALE** hard key.

-
- 2 To set the maximum reference value on the Y-axis manually, complete the following steps:
 - a Press the **Reference Level** soft key.
 - b Enter a value by using the numeric keys or the rotary knob with 10 dB increments.
 - c Select the unit: **dBm** or **-dBm**, or press the **ENTER** hard key.
 - 3 To set the attenuation option, select one from the following choices:

To set the input attenuator's level automatically, select **Attenuation > Auto**.

To set the input attenuation manually up to 55 dB for JD780 series or 50 dB for JD740B series to optimize S/N, complete the following steps:

 - a Select **Attenuation > Manual**.
 - b Press the **Attenuation Value** soft key to set the level.
 - c Enter a value in fives by using the numeric keys.
 - d Press the **dB** soft key or the **ENTER** hard key.

To couple the input attenuator's level with your reference level setting, select **Attenuation > Couple**.

Optional. To change the scale unit:

- 1 Select **More (1/2) > Units**.
 - 2 Select the unit of the display scale: **dBm**, **dBV**, **dBmV**, **dBμV**, **V**, or **W**.
The scale unit on the screen changes accordingly.
-

Pre-amplifier

You can turn the internal pre-amplifier on to correct and compensate for the gain of the preamp so that amplitude readings show the value at the input connector.

Procedure

- 1 Press the **AMP/SCALE** hard key.
 - 2 Toggle the **Preamp** soft key and select **On** or **Off** as needed.
-



NOTE

You can turn the Preamp on when the input attenuation range is from 0 dB to 10 dB. If the attenuation value is manually set to greater than 10 dB, the instrument will automatically turn off the pre-amplifier to display low-level signal properly on the chart.

External offset

You can turn the External offset on and manually set the external offset value.

Procedure

To set the external offset:

- 1 Press the **AMP/SCALE** hard key.
- 2 Press the **External Offset** soft key and select **On**.
Enter a value by using the numeric keys between -120 to 120. You can also use the rotary knob or the arrow keys.
- 3 Press the **dB** soft key or the **ENTER** hard key.

To turn the external offset off:

- 1 Press the **AMP/SCALE** hard key.
 - 2 Press the **External Offset** soft key and select **Off**.
-

Scale per division

You can use the **Scale/Div** feature available for the total harmonic distortion screen. It represents the value of one division on the horizontal scale. The default setting is 10 dB per division and the maximum value can be set up to 20 dB.

Procedure

- 1 Press the **AMP/SCALE** hard key.
 - 2 Select **More (1/2) > Scale/Div**.
Enter a value between 1 and 20 by using the numeric keys. You can also use the rotary knob or the arrow keys.
 - 3 Press the **dB** soft key or the **ENTER** hard key.
-

Chapter 5 Using Interference Analyzer

This chapter provides instructions for using the Interference Analyzer function (option 011). Topics discussed in this chapter are as follows:

■ Introduction.....	106
■ Display overview	106
■ Connecting a cable.....	107
■ Selecting measurement mode	109
■ Configuring test parameters.....	109
■ Conducting spectrum measurements	116
■ Conducting interference measurements	119
■ Setting limit for interference analyzer	136

Introduction

Interference is becoming more prevalent in the wireless community with the increasing number of transmitters coming on the air. Wireless service providers have traditionally used spectrum analyzers to monitor service channels, frequencies, and adjacent spectrum and to locate sources of interference. A spectrum analyzer can only show you an interfering signal and you require determining the source of the interference. To solve interference problems, you must understand the RF environment, know adjacent operating transmitters, and identify any new or unlicensed emitters.

Once a potential interfering signal is identified in the Spectrum Analyzer mode, you can monitor the signal further in the Interference Analyzer mode. JD700B series provides two different methodologies to identify and determine interference signals: Spectrogram and Received Signal Strength Indicator (RSSI). Locating the source of interference signal can be done with geographical information received from the built-in GPS receiver.

The JD700B series is extremely effective for locating and identifying periodic or intermittent RF interference. Interference signals derive from several kinds of licensed or unlicensed transmitters that cause dropped calls and poor service quality.

The JD700B series provides following measurements for interference analysis:

- Spectrum
- Spectrogram
- Dual Spectrogram
- RSSI (Received Signal Strength Indicator)
- Interference Finder
- Spectrum Replayer
- Radar Chart

Using a set of the AntennaAdvisor Handle that holds a broadband directional antenna is mandatory in the Radar Chart mode and its built-in compass, GPS antenna, gyro sensor, and low-noise amplifier (LNA) benefits you to determine the direction of the interference.

Display overview

Figure 44 provides descriptions for each segment of the measurement screen.

Figure 44 Interference measurement screen

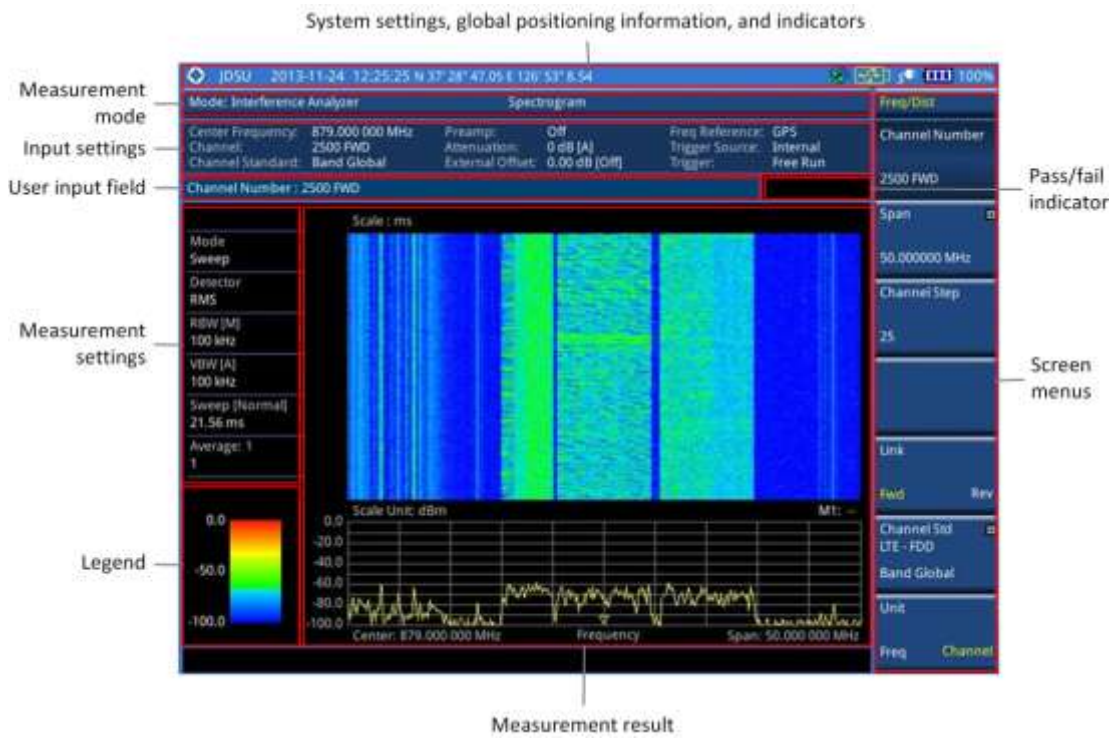

Connecting a cable

Using an Omni or Yagi antenna

Procedure

- 1 Connect an Omni/directional RF antenna to the **Spectrum Analyzer RF In** port of the JD700B series.
- 2 Connect a GPS antenna to the **GPS** port of the JD700B series.

Figure 45 Interference measurement connection

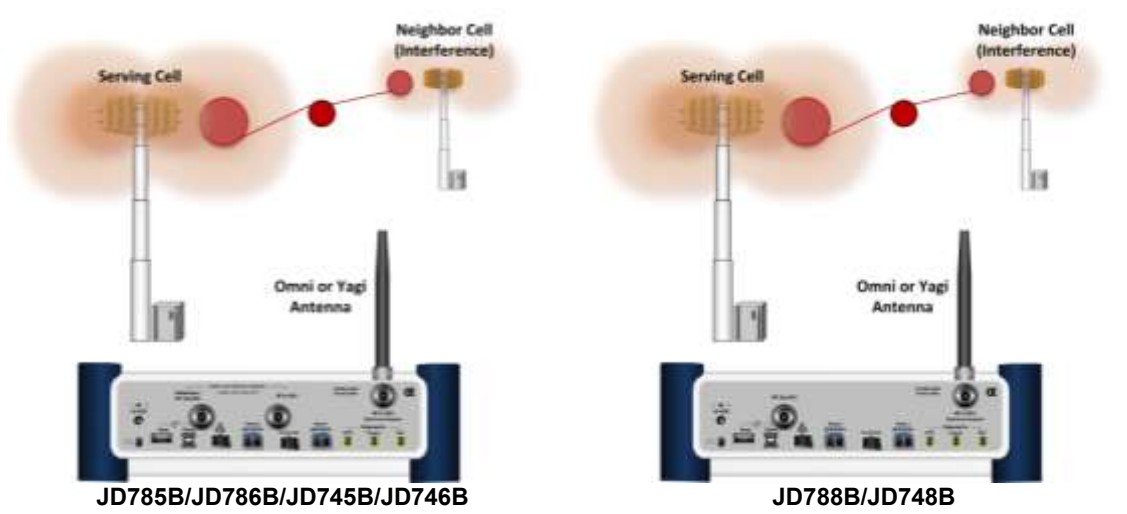



CAUTION

If the input signal level to be measured is less than 0 dBm, set it to 0 dB attenuation or turn on the preamp to have better dynamic range for the testing.

Using an AntennaAdvisor handle

In the Interference Finder mode and the Radar Chart mode, you can perform interference hunting using the AntennaAdvisor Handle after attaching a broadband directional antenna to it. The handle is a device that has a built-in GPS antenna and LNA.

Procedure

- 1 Mount a broadband antenna to your AntennaAdvisor Handle according to the quick start guide of the AntennaAdvisor Handle.
 - 2 Connect the **RF Type-N jack** of the handle to the **RF In port** of the instrument.
 - 3 Connect the **GPS SMA jack** of the handle to the **GPS port** of the instrument. The GPS status indicator appears on the instrument screen. If GPS is locked, the indicator turns green.
 - 4 Connect the **USB plug** of the handle to the **USB Host port** of the JD700B series. The device icon  appears in the system status bar on the screen.
-

Figure 46 Connection using AntennaAdvisor handle and log-periodic antenna



Selecting measurement mode

Procedure

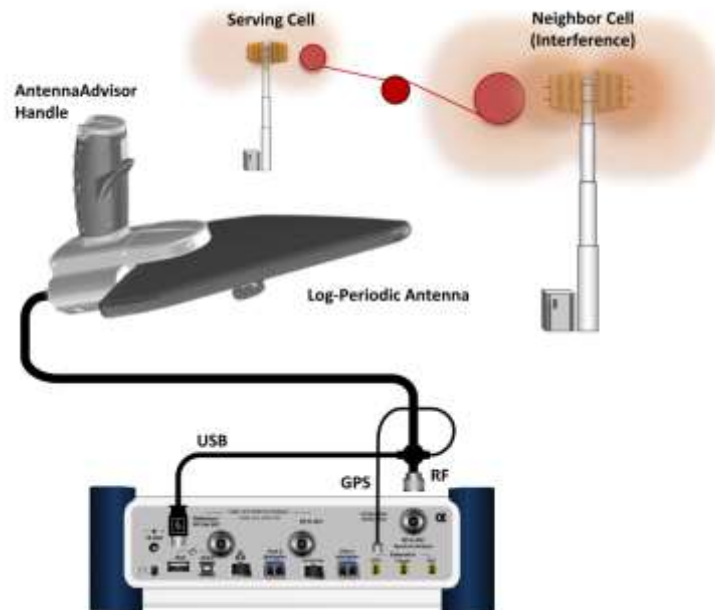
- 1 Press the **MODE** hard key.
 - 2 Press the **Interference Analyzer** soft key. The **Spectrum** mode is selected by default.
 - 3 To change the mode, press the **MEASURE** hot key and then select the measurement mode: **Spectrogram**, **Dual Spectrogram**, **RSSI**, **Interference Finder**, or **Spectrum Replayer**.
-



NOTE

If the **Dual Spectrogram** is selected, you can select the left or right measurement pane in **MEASURE SETUP** to configure measurement parameters for the selected spectrogram.

Configuring test parameters

Setting frequency

You need to set the frequency range to be measured with either the center frequency/span or the start/stop frequencies. You can also set the frequency with the channel number and span.

Procedure

To set the center frequency and span:

- 1 Press the **FREQ/DIST** hard key.
- 2 Toggle the **Unit** soft key and select **Freq**.
- 3 Press the **Center Frequency** soft key.
- 4 Enter a value by using the numeric keys. You can also use the rotary knob or the arrow keys.
- 5 Select the unit: **GHz**, **MHz**, **kHz**, or **Hz**.
- 6 Press the **Span** soft key, and then do one of the following:
 - To set the span manually, select **Span**, enter a value, and then select the unit.
 - To set the span automatically, select **Full Span**, **Zero Span**, or **Last Span** as needed.



NOTE

The **Zero Span** option is available only in the Spectrum mode. If you have selected **Zero Span**, select **TRIGGER > Free Run**, **External**, **GPS**, **Video**, or **Display Position**.

To set the start and stop frequencies:

- 1 Press the **FREQ/DIST** hard key.
- 2 Toggle the **Unit** soft key and select **Freq**.
- 3 Press the **Start Frequency** soft key.
- 4 Enter a value by using the numeric keys. You can also use the rotary knob or the arrow keys.
- 5 Select the unit: **GHz**, **MHz**, **kHz**, or **Hz**.
- 6 Press the **Stop Frequency** soft key.
- 7 Enter a value by using the numeric keys. You can also use the rotary knob or the arrow keys.
- 8 Select the unit: **GHz**, **MHz**, **kHz**, or **Hz**.

To set the channel number and span:

- 1 Press the **FREQ/DIST** hard key.
 - 2 Toggle the **Unit** soft key and select **Channel**.
 - 3 To select the standard channel, complete the following steps:
 - a Press the **Channel Std** soft key. The standard channel window appears. See “Appendix C – Band, frequency & channel standard” on page 769 for more information.
-

- b Highlight the band to be measured by using the rotary knob, the arrow keys, or the **Page Up/Page Down** soft keys.
 - c Press the **Select** soft key or the rotary knob to confirm the selection.
- 4 Toggle the **Link** soft key to select the sweep direction and select **Fwd** (forward) or **Rev** (reverse).
- 5 To set the channel number, complete the following steps:
- a Press the **Channel Number** soft key.
 - b Enter a value by using the numeric keys.
 - c Press the **Enter** soft key or **ENTER** hard key to complete the entry.
The instrument automatically displays the corresponding center frequency value for the selected channel number.
- 6 To set the span, complete the following steps:
- a Press the **Span** soft key.
 - b Select the span option, from the following choices:
To set the span manually, select **Span**, enter a value, and then select the unit.
To set the span automatically, select **Full Span**, **Zero Span**, or **Last Span** as needed.

**NOTE**

The **Zero Span** option is available only in the Spectrum mode. If you have selected **Zero Span**, select **TRIGGER > Free Run, External, GPS, Video, or Display Position**.

Optional. To define the amount of frequency increment for the rotary knob:

- 1 Press the **Frequency Step** soft key, if the **Freq** is selected.
- 2 Enter a value by using the numeric keys.
- 3 Press the unit: **GHz**, **MHz**, **kHz**, or **Hz**.

Optional. To define the amount of channel increment for the rotary knob:

- 1 Press the **Channel Step** soft key, if the **Channel** is selected.
- 2 Enter a value by using the numeric keys.
- 3 Press the **Enter** soft key.

Setting frequency for 28 GHz downconverter

Once the CellAdvisor is connect to 28 GHz downconverter, the center frequency is automatically set to 28 GHz. You can measure the center frequency ranged from 27 to 30 GHz with the span or the start/stop frequencies. You cannot set the frequency with the channel number and span when the 28 GHz downconverter is in operation.

Procedure

To set the center frequency and span:

- 1 Press the **FREQ/DIST** hard key.
- 2 Press the **Center Frequency** soft key.
- 3 Enter a value from 27 to 30 GHz by using the numeric keys, the rotary knob, or the arrow keys.
- 4 Select the unit as **GHz** among the 4 options: **GHz**, **MHz**, **kHz**, or **Hz**.
- 5 Press the **Span** soft key, and then do one of the following:
To set the span manually, select **Span**, enter a value, and then select the unit.
To set the span automatically, select **Full Span**, **Zero Span**, or **Last Span** as needed.

**NOTE**

The **Zero Span** option is available only in the Spectrum mode. If you have selected **Zero Span**, select **TRIGGER > Free Run, External, GPS, Video, or Display Position**.

Optional. To define the amount of frequency increment for the rotary knob:

- 1 Press the **Frequency Step** soft key, if the **Freq** is selected.
- 2 Enter a value by using the numeric keys.

- 3 Press the unit: **GHz**, **MHz**, **kHz**, or **Hz**.

To set the start and stop frequencies:

- 1 Press the **FREQ/DIST** hard key.
- 2 Press the **Start Frequency** soft key.
- 3 Enter a value from 27 to 30 GHz by using the numeric keys, the rotary knob, or the arrow keys.
- 4 Select the unit as **GHz** among the 4 options: **GHz**, **MHz**, **kHz**, or **Hz**.
- 5 Press the **Stop Frequency** soft key.
- 6 Enter a value from 27 to 30 GHz by using the numeric keys, the rotary knob, or the arrow keys.
- 7 Select the unit as **GHz** among the 4 options: **GHz**, **MHz**, **kHz**, or **Hz**.

Setting amplitude

Reference level and attenuation

You can set the reference and attenuation levels automatically or manually to optimize the display of the traces measured, as you desire.

Procedure

To automatically set the reference and attenuation level:

- 1 Press the **AMP/SCALE** hard key.
- 2 Press the **Auto Scale** soft key.
Each time you press this key, both of the Y-axis scale and input attenuation level change to be optimized with some margin.

To set the reference or attenuation level manually:

- 1 Press the **AMP/SCALE** hard key.
- 2 To set the maximum reference value on the Y-axis manually, complete the following steps:
 - a Press the **Reference Level** soft key.
 - b Enter a value by using the numeric keys or the rotary knob with 10 dB increments.
 - c Press the unit soft key or the **ENTER** hard key.
This unit key name changes according to the setting in the **Units** menu.
- 3 To set the attenuation option, select one from the following choices:
To set the input attenuator's level automatically, select **Attenuation (Internal) > Auto**.

To set the internal attenuation value (only when 28 GHz downconverter is in operation):

- 1 Press the **AMP/SCALE** hard key.
- 2 Press **Attenuation Value Internal** soft key.
- 3 Enter a value in fives by using the numeric keys.
- 4 Press the **dB** soft key or the **ENTER** hard key.



NOTE

It is recommended that you set the **Attenuation** to **Auto** in most situations so that the level of the input attenuator can be set automatically according to your input signal level.

To set the input attenuation manually up to 55 dB for JD780B series or 50 dB for JD740B series to optimize S/N, complete the following steps:

- a Select **Attenuation (Internal) > Manual**.
- b Press the **Attenuation Value (Internal)** soft key to set the level.
- c Enter a value in fives by using the numeric keys.
- d Press the **dB** soft key or the **ENTER** hard key.

To couple the input attenuator's level with your reference level setting, select **Attenuation (Internal) > Couple**.

As you increase the reference setting, the attenuation level also increases accordingly.



NOTE
The **Attenuation Value Internal** and **Attenuation Internal** menus are available when the 28 GHz downconverter is in operation.

Optional. To change the scale unit:

- 1 Select **More (1/2) > Units**.
- 2 Select the unit of the display scale: **dBm**, **dBV**, **dBmV**, **dBμV**, **V**, or **W**.
The scale unit on the screen changes accordingly.

Scale per division

You can use the **Scale/Div** feature available for the spectrum measurement screen. It represents the value of one division on the horizontal scale. The default setting is 10 dB per division and the maximum value can be set up to 20 dB.

Procedure

To set the scale per division:

- 1 Press the **AMP/SCALE** hard key.
- 2 Select **More (1/2) > Scale/Div**.
- 3 Enter a value between 1 and 20 by using the numeric keys.
- 4 Press the **dB** soft key to complete the entry.

Pre-amplifier

You can turn the internal pre-amplifier on to correct and compensate for the gain of the preamp so that amplitude readings show the value at the input connector.

Procedure

- 1 Press the **AMP/SCALE** hard key.
- 2 Toggle the **Preamp** soft key and select **On** or **Off** as needed.



NOTE
You can turn the Preamp on when the input attenuation range is from 0 dB to 10 dB. If the attenuation value is manually set to greater than 10 dB, the instrument will automatically turn off the pre-amplifier to display low-level signal properly on the chart.

Pre-amplifier for 28 GHz downconverter

You can turn the external pre-amplifier on to correct and compensate for the gain of the preamplifier so that amplitude readings show the value at the input connector. The Preamp External is for 28 GHz downconverter, and the Preamp Internal is for CellAdvisor.

Procedure

- 1 Press the **AMP/SCALE** hard key.
- 2 Press the **Preamp** soft key.
- 3 Toggle the **Preamp Internal** soft key and select **On** or **Off** as needed.
- 4 Toggle the **Preamp External** soft key and select **On** or **Off** as needed.

External offset

You can turn the **External Offset** on and manually set the external offset value. An offset consists of a cable loss and a user offset and the measurement result shows the value reflecting both offset values. When the external offset value is set at 40 dB in the Spectrum mode, the measurement result compensates 40 dB at both the Spectrum Analyzer and Signal Analyzer modes.

Procedure

To set the external offset:

- 1 Press the AMP/SCALE hard key.
- 2 Toggle the External Offset soft key to On.
- 3 Enter a value by using the numeric keys.
- 4 Press the dB soft key to complete the entry.

To turn the external offset off:

- 1 Press the AMP/SCALE hard key.
 - 2 Toggle the External Offset soft key to Off.
-

Setting bandwidth

VBW based on the designated RBW. Selecting **Auto** changes the value to correspond to your frequency span setting for RBW and to the current RBW and VBW/RBW settings for VBW.

Procedure

To automatically set the RBW and VBW to your selected VBW/RBW ratio:

- 1 Press the **BW/AVG** hard key.
- 2 Press the **VBW/RBW** soft key to set the proportional VBW based on the designated RBW. Table 9 shows the ratio example for 30 kHz RBW.
- 3 Select the ratio: **1**, **0.3**, **0.1**, **0.03**, **0.01**, or **0.003**.
- 4 Toggle the **RBW** soft key and select **Auto**.
- 5 Toggle the **VBW** soft key and select **Auto**.
The RBW or VBW value on the screen changes accordingly based on the span.

To manually set the RBW or VBW to your selected VBW/RBW ratio:

- 1 Press the **BW/AVG** hard key.
 - 2 Press the **RBW** soft key.
 - 3 Enter a value between 1 Hz to 3 MHz in 1-3 sequence by using the numeric keys.
 - 4 Select the unit: **MHz**, **kHz**, or **Hz**.
The RBW setting automatically changes to **Manual**.
 - 5 Press the **VBW** soft key.
 - 6 Enter a value by using the numeric keys.
 - 7 Select the unit: **MHz**, **kHz**, or **Hz**.
The VBW setting automatically changes to **Manual**.
The RBW or VBW value on the screen changes accordingly.
-

Table 9 VBW/RBW ratio example

RBW	Ratio (VBW/RBW)	VBW
30 kHz	1:1	30 kHz
	1:0.3	10 kHz
	1:0.1	3 kHz

1:0.03	1 kHz
1:0.01	300 Hz
1:0.003	100 Hz

Setting average

You can set the number of measurements to be averaged for the trace presentation. A maximum of 100 times of averaging can be set. When the averaging reaches to your setting, a new measurement value replaces the measurement value in sequence from the earliest.

Procedure

- 1 Press the **BW/AVG** hard key.
 - 2 Press the **Average** soft key.
 - 3 Enter a value between 1 and 100 as needed by using the numeric keys.
 - 4 Press the **Enter** soft key.
-

Setting sweep

The **SWEEP** hot key is used to set and control the sweep time, sweep mode, gated sweep settings, and gated sweep on or off. This key is not available in the Dual Spectrum mode.

Sweep time

You can set the sweep time automatically or manually. Manual setting allows you to set the sweep time beyond an automatic setting.

Procedure

- 1 Press the **SWEEP** hot key.
 - 2 Select the sweep time option, from the following choices:
 - To automatically set, toggle the **Sweep Time** soft key and select **Auto**.
 - To manually set, complete the following steps:
 - a Press the **Sweep Time** soft key.
 - b Enter a value by using the numeric keys.
 - c Select the unit: **Sec**, **mSec**, or **µSec**.
The sweep time mode automatically changes to **Manual**.
-

Sweep mode

The default settings of the sweep mode are **Continue** and **Normal** to sweep continuously at a normal speed for most on-going measurements. If you want to hold the measurement or get a single sweep, you can change the sweep mode.

Procedure

To select the single sweep mode:

- 1 Press the **SWEEP** hot key.
 - 2 Toggle the **Sweep Mode** soft key to **Single**. You can also use the **HOLD** hot key. The letter **HOLD** in red appears and the sweeping is paused.
-

- 3 *Optional.* Press the **Sweep Once** soft key to get a new measurement.
- 4 *Optional.* To speed up sweeping, press the **Sweep Mode** soft key to **Fast**.

**NOTE**

Selecting **Sweep Mode > Fast** may reduce the measurement accuracy, but it is useful to identify the existence of interfering signals.

To return to the continuous sweep mode:

- 1 Toggle the **Sweep Mode** soft key to **Continue**. You can also use the **HOLD** hot key. The letter **HOLD** in red disappears and the sweeping resumes.

Gated sweep

You can configure the gated sweep settings with an internal or external trigger source. If you select **Gated Sweep Settings**, you can view the signal in time domain.

Procedure

- 1 Press the **SWEEP** hot key.
- 2 Press the **Gated Sweep Settings** soft key.
- 3 *Optional.* Adjust sweep time to allow enough time for a cycle by completing the following steps:
 - a Press the **Zero Span Time** soft key.
 - b Enter a value by using the numeric keys.
 - c Select the unit: **Sec**, **mSec**, or **µSec**.
- 4 Set the period, if using the internal trigger source, by doing one of the following:

To select the preset period, complete the following steps:

 - a Toggle the **Period** soft key and select **StdSignal**.
 - b Press the **StdSignal** soft key, and then select the period from the choices: **GSM (4.615 ms)**, **WCDMA (10 ms)**, **LTE (10 ms)**, **EV-DO (5 ms)**, **TD-SCDMA (5 ms)**, and **WiMAX (10 ms)**.

To manually set the period, complete the following steps:

 - a Toggle the **Period** soft key and select **Manual**.
 - b Press the **Period** soft key to enter the amount of time.
 - c Enter a value by using the numeric keys.
 - d Select the unit: **Sec**, **mSec**, or **µSec**.
- 5 Press the **TRIGGER** hot key, and then do one of the following:

Select **External** for an external trigger source.

Select **Video** or **Display Position** for the internal trigger source.
- 6 Press the **PREV** hard key to continue setting the gated sweep.
- 7 Set the gate delay by completing the following steps:
 - a Press the **Gate Delay** soft key.
 - b Enter a value by using the numeric keys.
 - c Select the unit: **Sec**, **mSec**, or **µSec**.
- 8 Set the gate length by completing the following steps:
 - a Press the **Gate Length** soft key.
 - b Enter a value by using the numeric keys.
 - c Select the unit: **Sec**, **mSec**, or **µSec**.
- 9 Press the **PREV** hard key to enable gated sweeping.
- 10 Toggle the **Gated Sweep** soft key and select **On**.

**NOTE**

This setting option is not available in the Spectrum Replayer mode.

Conducting spectrum measurements

The spectrum measurement with an audible indicator is especially useful for locating interferer sources with a directional antenna.

Setting trace

You can display up to six traces on the measurement chart simultaneously.

Procedure

- 1 Press the **TRACE/DISPLAY** hard key.
- 2 Press the **Select Trace** soft key, and then select the trace number: **T1**, **T2**, **T3**, **T4**, **T5**, or **T6**. The legend shape of the selected trace changes from square to round to indicate that the trace is the active one now.
- 3 Do one of the following:

To	Select	Trace Legend
Clear current data and display with new measurements	Clear Write	W
Display the input signal's maximum response only (unlimited or for a certain amount of time)	Max Hold	M
Display the input signal's minimum response only (unlimited or for a certain amount of time)	Min Hold	m
Capture the selected trace and compare traces	Capture	C
Load a saved trace	More (1/2) > Load	L
Hide the displayed trace	Trace View > Off	F
Remove all the traces and initialize the trace settings	More (1/2) > Trace Clear All	



NOTE
For the **Max Hold** and **Min Hold**, your instrument compares newly acquired data with the active trace and displays larger maximum values or smaller minimum values on the screen. You can set it to **Unlimited** to hold and view maximum or minimum data or specify a certain amount of time up to 60 seconds by using numeric keys or rotary knob.

- 4 To select the detection option, select **More (1/2) > Detectors**, and then do one of the following:

To display	Select
Random noise better than the peak without missing signals	Normal
The highest value in each data point	Peak
The root mean squared average power across the spectrum	RMS
The lowest value in each data point	Negative Peak
The center value in each data point	Sample

- 5 *Optional.* Select **More (1/2) > Trace Info**, and then select the trace number to view the trace's parameter setting information stored at the time of the measurement or **None** to hide the information display.
 - 6 *Optional.* If you have the two traces T1 and T2, you can perform trace math. To view the power difference between the traces, press the **T1 – T2 -> T5** or **T2 – T1 -> T6** soft key. The result is overlaid on the screen along with the second Y-axis.
-

**NOTE**

To be able to load a trace, the trace to be overlaid must be saved in the same measurement mode and frequency setting as the current measurement.

Sound indicator

You can use the Sound Indicator to help you identify interfering signals by sounding an alarm.

Procedure

- 1 Configure test parameters as described in the “Configuring test parameters” on page 109.
 - 2 Press the **MEASURE SETUP** hot key.
 - 3 Press the **Sound Indicator** soft key.
 - 4 Toggle the **Sound** soft key between **On** and **Off** to enable and disable the alarm sound.
 - 5 Select the alarm reference option from the following choices:
 - To set the active marker position as the alarm reference, toggle the **Alarm Reference** soft key and select **Marker**.
 - To set the limit as the alarm reference, complete the following steps:
 - a Toggle the **Alarm Reference** soft key and select **Line**.
The Limit Line menu becomes activated to be set.
 - b Press the **Limit Line** soft key to define a threshold for the limit line.
 - c Enter a value by using the numeric keys. You can also use the rotary knob.
 - d Press the **dBm** soft key.
 - 6 *Optional.* To adjust the volume for alarm sound, press the **Volume** soft key and then turn the rotary knob clockwise or counter clockwise.
 - 7 *Optional.* To select the sound mode for alarm, toggle the **Sound Mode** soft key and select the option from the following choices:
 - a Select the **Mode 1** to create an alarm with a consistent tone (frequency) regardless of the interference signal.
 - b Select the **Mode 2** to apply the tone step from 1 to 20.
 - c Select the **Mode 3** to apply the tone step from 20 to 1.
 - 8 *Optional.* You can save logging data automatically so that you can load the measurement data and replay in the Spectrum Replayer mode. See “Using save” on page 34 for more information.
-

AM/FM audio demodulation

You can use the AM/FM Audio Demodulation to identify if the interfering signal is n^{th} harmonics of AM/FM audio. The instrument sounds demodulated signals that you can hear through the speaker or headphones.

Procedure

- 1 Configure test parameters as described in the “Configuring test parameters” on page 109.
- 2 Press the **MEASURE SETUP** hot key.
- 3 Toggle the **Audio Demod** soft key between **On** and **Off** to turn the AM/FM audio demodulation on and off.
- 4 Press the **Demod at** soft key, and then select the marker number for the frequency to be demodulated.

**NOTE**

You must set the marker(s) first by using the **MARKER** hard key as the AM/FM demodulator uses the marker position to demodulate. See “Using marker” on page 60 for more information.

- 5 Press the **Demod Mode** soft key, and then select the demodulation mode: **AM**, **FM** and **CW**.
 - 6 Press the **Dwell Time** soft key, and then turn the rotary knob to set the demodulation interval between 1 and 20.
-

- 7 Press the **Volume** soft key, and then turn the rotary knob to set the speaker volume.
 - 8 Toggle the **Auto Gain** soft key between **On** and **Off** to enable or disable the automatic gain feature to adjust the interval gain of the demodulator.
 - 9 *Optional.* Go to **SAVE/LOAD > Save**, and then select the save option from the choices available for your measurement mode. See “Using save” on page 34 for more information.
-

Interference ID

The Interference ID automatically classifies interfering signals over a designated spectrum and displays the list of possible signal types corresponding to the selected signal. This functionality is not available when the 28 GHz downconverter is in operation.

Procedure

- 1 Configure test parameters as described in the “Configuring test parameters” on page 109.
 - 2 Press the **MEASURE SETUP** hot key.
 - 3 Toggle the **Interference ID** soft key between **On** and **Off** to turn the Interference ID on and off.
 - 4 To set the threshold level manually, complete the following steps:
 - a Press the **Threshold** soft key.
 - b Enter a value by using the numeric keys.
 - c Press the **dBm** soft key.
 - 5 *Optional.* Go to **SAVE/LOAD > Save**, and then select the save option from the choices available for your measurement mode. See “Using save” on page 34 for more information.
-



NOTE

You can use the **LIMIT** hot key to analyze your measurements with the display line, multi-segment line, and channel limit. See “Setting limit for interference analyzer” on page 131 for more information.

Conducting interference measurements

Spectrogram

The Spectrogram is particularly useful when attempting to identify periodic or intermittent signals as it captures spectrum activity over time and uses various colors to differentiate spectrum power levels. When the directional antenna is used to receive the signal, you will see a change in the amplitude of the tracked signal as you change the direction of the antenna and see a change in the Spectrogram colors. The source of the signal is located in the direction that results in the highest signal strength.

Setting measure setup

Procedure

- 1 Configure test parameters as described in the “Configuring test parameters” on page 109.
- 2 Press the **MEASURE SETUP** hot key.
- 3 To set the amount of time between each trace measurement:
 - a Press the **Time Interval** soft key.
 - b Enter a value by using the numeric keys. You can also use the rotary knob.
 - c Press the **Sec** soft key.
- 4 To set the time cursor on a specific trace position, complete the following steps:
 - a Toggle the **Time Cursor** soft key and select **On**.
 - b Press the **Position** soft key.
 - c Turn the rotary knob to move the time cursor. You can also enter a value and then press the **Enter** soft key.



NOTE

Enabling the time cursor puts the measurement on hold and you can make post-processing analysis for each measurement over time using the time cursor.

- 5 To start a new measurement, press the **Reset/Restart** soft key.
-

- 6 *Optional.* Go to **SAVE/LOAD > Save**, and then select the save option from the choices available for your measurement mode. See “Using save” on page 34 for more information.

Measurement example

The spectrogram shows a vertical line on the chart when the marker is enabled on the screen.

Figure 47 Interference measurement in spectrogram

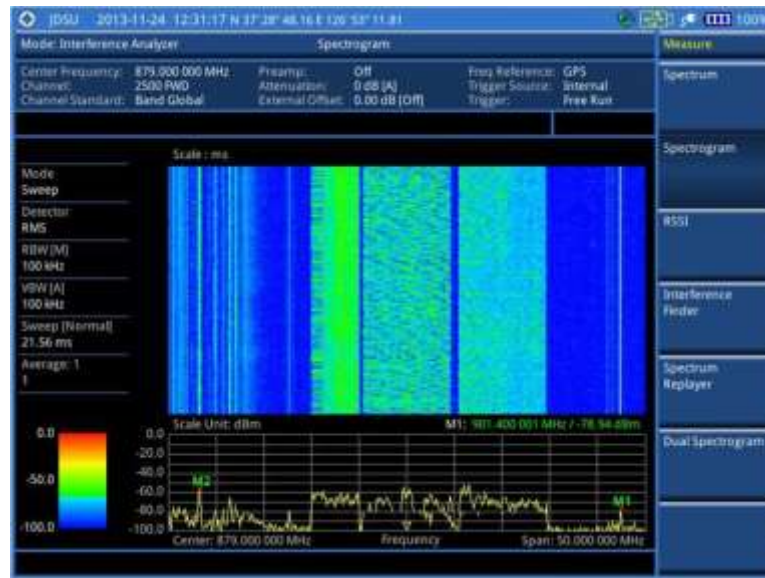

- The horizontal line or X-axis of the spectrogram is frequency.
- The vertical line or Y-axis is time.
- The color identification (Spectrogram) indicates power level of the tracked signal. As the signal strength increases, the color on the spectrogram changes accordingly.

Figure 48 Interference measurement in spectrogram (on 28 GHz downconverter)

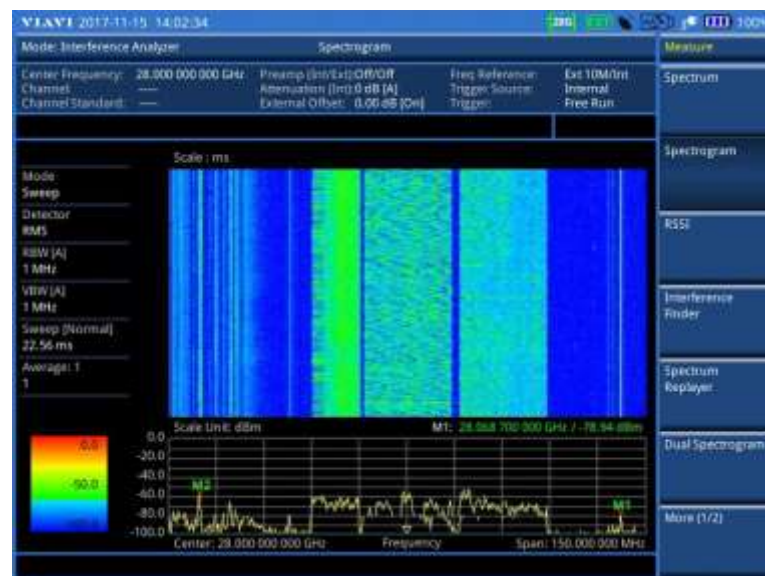

Figure 49 Interference measurement in spectrogram with gated sweep on

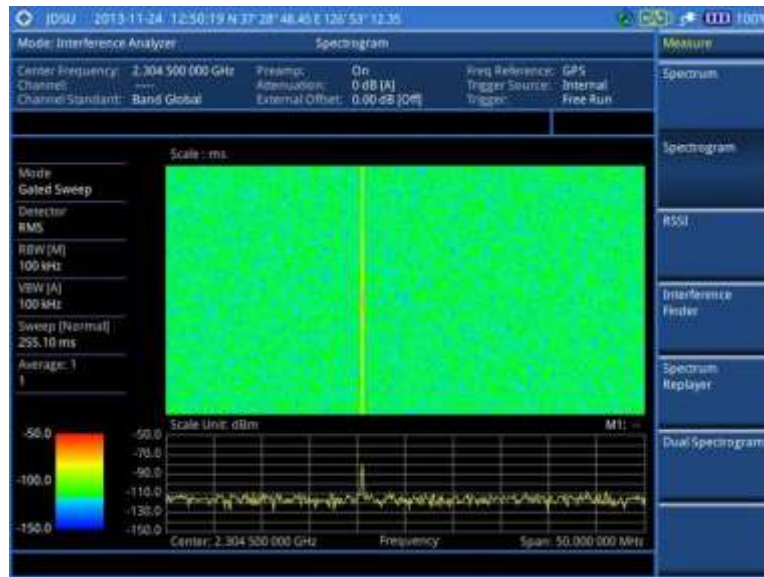
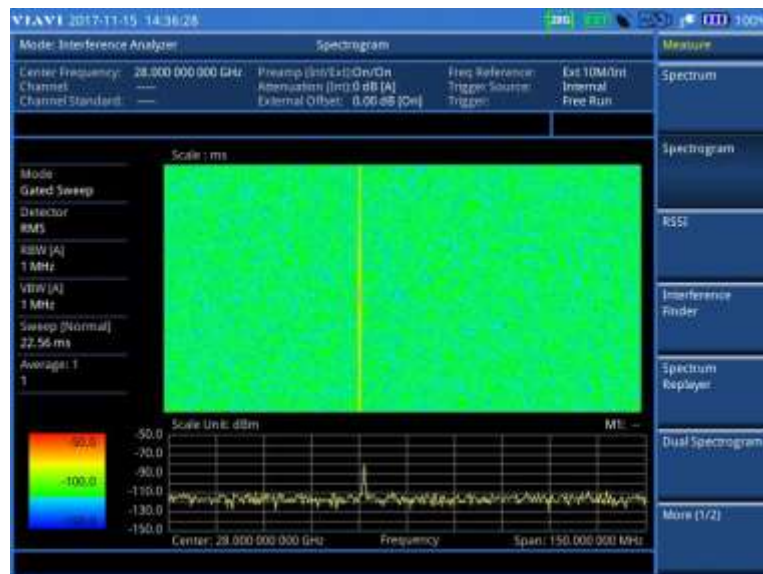

Figure 50 Interference measurement in spectrogram with gated sweep on (on 28 GHz downconverter)

**NOTE**

You can use the **LIMIT** hot key to analyze your measurements with the display line, multi-segment line, and channel limit. See “Setting limit for interference analyzer” on page 131 for more information.

Dual spectrogram

The Dual Spectrogram mode is useful to compare two spectrograms displayed simultaneously on the screen.

Setting measure setup

Procedure

- 1 Configure test parameters as described in the “Configuring test parameters” on page 109.
- 2 Press the **MEASURE SETUP** hot key.
- 3 Toggle the **Active Window** soft key and select **Left** or **Right** spectrogram to be set up. You can also tap on the left or right chart on the screen.
- 4 To set the amount of time between each trace measurement:
 - a Press the **Time Interval** soft key.
 - b Enter a value by using the numeric keys. You can also use the rotary knob.
 - c Press the **Sec** soft key.
- 5 To set the time cursor on a specific trace position, complete the following steps:
 - a Toggle the **Time Cursor** soft key and select **On**.
 - b Press the **Position** soft key.
 - c Turn the rotary knob to move the time cursor. You can also enter a value and then press the **Enter** soft key.



NOTE

Enabling the time cursor puts the measurement on hold and you can make post-processing analysis for each measurement over time using the time cursor.

- 6 To start a new measurement, press the **Reset/Restart** soft key.
- 7 *Optional.* Go to **SAVE/LOAD > Save**, and then select the save option from the choices available for your measurement mode. See “Using save” on page 34 for more information.

Measurement example

Figure 51 Interference measurement in dual spectrogram view

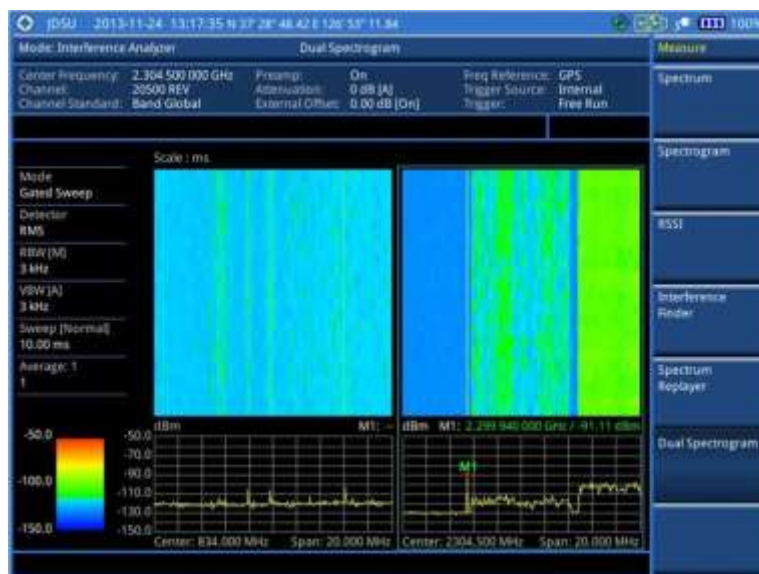
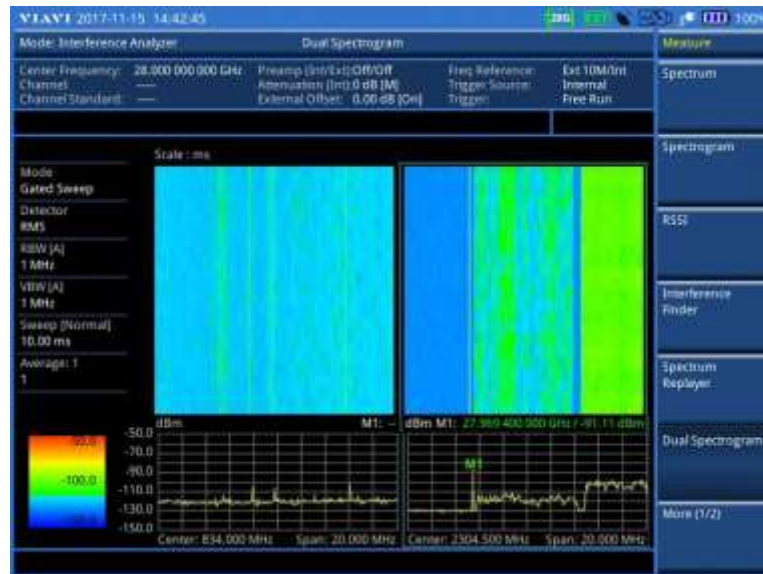

Figure 52 Interference measurement in dual spectrogram view (on 28 GHz downconverter)



RSSI

The Received Signal Strength Indicator (RSSI) is a multi-signal tracking metric that is particularly useful for measuring power-level variations over time. The RSSI measurement lets you assign power limit line for audible alarms and increase alarm counters every time a signal exceeds a defined limit line. For long-term analysis, the spectrogram and RSSI measurements can be automatically saved into an external USB memory. Post-analysis can be performed with JDViewer application software.

Setting measure setup

Procedure

- 1 Configure test parameters as described in the “Configuring test parameters” on page 109.
- 2 Press the **MEASURE SETUP** hot key.
- 3 To set up the alarm parameters, complete the following steps:
 - a Press the **Alarm** soft key.
 - b Press the **Alarm at** soft key and select the marker number: M1 to M6.
 - c Press the **Limit Line** soft key to set a threshold for the alarm.
 - d Enter a value by using the numeric keys. You can also use the rotary knob.
 - e Press the **dBm** soft key.
 - f Toggle the **Alarm** soft key between **On** and **Off** to turn the alarm feature on or off.
 - g *Optional.* Press the **Volume** soft key and adjust the volume.
- 4 To set up the AM/FM audio demodulation, complete the following steps:
 - a Press the **AM/FM Audio Demod** soft key.
 - b Toggle the **Audio Demod** soft key between **On** and **Off** to turn the AM/FM audio demodulation on or off.
 - c Press the **Demod at** soft key, and then select the marker number for the frequency to be demodulated.



NOTE

For the alarm and AM/FM audio demodulation, you must set the marker(s) first by using the **MARKER** hard key as these features use the marker position to sound alarm or demodulate. See “Using marker” on page 60 for more information.

- d Press the **Demod Mode** soft key, and then select the demodulation mode: **AM**, **FM**, and **CW**.
- e Press the **Dwell Time** soft key, and then turn the rotary knob to set the demodulation

- interval between 1 and 20.
- f Toggle the **Auto Gain** soft key between **On** and **Off** to enable or disable the automatic gain feature to adjust the interval gain of the demodulator.
- g *Optional.* Press the **Volume** soft key and adjust the volume.
- 5 To start a new measurement, press the **Reset/Restart** soft key.
- 6 *Optional.* Go to **SAVE/LOAD > Save**, and then select the save option from the choices available for your measurement mode. See “Using save” on page 34 for more information.

Measurement example

Figure 53 Interference measurement in RSSI



Figure 54 Interference measurement in RSSI (on 28 GHz downconverter)



NOTE

You can use the **LIMIT** hot key to analyze your measurements with the display line, multi-segment line, and channel limit. See “Setting limit for interference analyzer” on page 131 for more information.

Interference finder

The Interference Finder is an automatic triangulation algorithm that uses GPS coordinates to locate possible interference sources based on three measurements. The interference finder calculates possible interference locations using its inscribed circle or circumscribed circle based on measured intersection points. You can plot up to seven measurement points and select three that are more representative for triangulation. JD700B series automatically logs measurement positions not to lose them while changing measurement modes.

The JD700B Series also supports the RAN-IL (Interference Location) feature that enables you to overlay user experience data obtained through Viavi's ariesoGEO on your base map to help you troubleshoot problems easily and quickly using your instrument. You can generate raster data files on the ariesoGEO application and load them on your instrument.

Loading a map

After you have made connections as described in the "Using an Omni or Yagi antenna" on page 107 and configured test parameters as described in the "Configuring test parameters" on page 109, you need to load a map of the area where you want to go out and do interference hunting.

Procedure

- 1 Plug in your USB drive that has a map file in `.mcf` file type created in JMapCreator. If the JMapCreator application on your computer is connected to the instrument via USB or LAN, you can send a map file with a single layer to the instrument directly by using the **Send to EQP** menu in JMapCreator.



NOTE

The JMapCreator converts and resizes any scanned floor plan or layout to fit onto your instrument's display. JMapCreator 1.2.0 or later can save a multiple-layered map, providing **x1**, **x2**, and **x4** views, as a sizable map file so that you can zoom in and out after loading it.

- 2 Press **SAVE/LOAD** hot key, and then select **Load > Load Map**.
 - 3 Navigate to a map file you want to open.
The File Information pane displays file properties including file name, map type, and address. If you see "Sizable Map" for Map Type, you can zoom in and out the base map after loading.
 - 4 Press the **Load** soft key. The loaded map appears.
-

Initializing AntennaAdvisor

If you have connected the AntennaAdvisor Handle to your instrument, you need to initialize it so that you get azimuth data as accurately as possible.

Procedure

- 1 Press the **MEASURE SETUP** hot key.
A message appears at the bottom of the screen to alert you if you have not performed initialization of your connected the antenna handle set.
 - 2 To adjust the integration bandwidth based on the center frequency of the interfering signal that you have identified in the Spectrum view, complete the following steps:
 - a Press the **Bandwidth** soft key.
 - b Enter a value by using the numeric keys. You can also use the rotary knob.
 - c Select the unit option from the choices: **GHz**, **MHz**, **kHz**, and **Hz**.
 - 3 Initialize the antenna handle to calibrate the built-in compass by completing the following steps:
 - a Hold your antenna handle horizontally in its upright position.
 - b Point the antenna to the north, and then press the **Initialize AntennaAdvisor** soft key.
-

Setting location

As the Interference Finder uses triangulation to provide a circle of possible source of the interference, you must set three location points so that the straight lines started from the point can create three intersections. If you have the AntennaAdvisor Handle, it makes it easy to determine these points using its built-in compass and GPS antenna while measure power level of the received signal.

Procedure

- 1 Press the **Location Setup** soft key in the Measure Setup menu bar.
- 2 Press the **Location** soft key to set three location points.
- 3 Press the **Point [1|2|3]** soft key to set the first location point, and then do one of the following:
 - To automatically get the selected point's positioning information with GPS locked, press the **Get GPS Position**. The instrument displays the latitude and longitude information of the signal received by either the GPS antenna or AntennaAdvisor Handle.
 - To manually define a position for the selected point, complete the following steps:
 - a Press the **Latitude** soft key, and then set the properties: **North/South, Degree, Minute, and Second**.
 - b Press the **Longitude** soft key, and then set the properties: **East/West, Degree, Minute, and Second**.
- 4 To set an azimuth, do one of the following:
 - Using the AntennaAdvisor Handle, complete the following steps:
 - a Press and hold the **TRIGGER** button on the handle and pan the antenna handle to scan through until you find the strongest RSSI value. RSSI, polarization, elevation and azimuth readings are continuously updated on the screen while pressing the physical button.
 - b Release the **TRIGGER** button to stop scanning.
 - Using a compass, complete the following steps:
 - a Press the **Azimuth** soft key.
 - b Pan your Yagi antenna to find a signal with highest RSSI value, and then measure an azimuth of the interfering signal.
 - c Enter the measured angle using the numeric keys, and then press the **Enter** soft key.
 - Using your instrument without a compass, complete the following steps:
 - a Press the **Azimuth** soft key.
 - b Pan your Yagi antenna to find a signal with highest RSSI value.
 - c Turn the rotary knob to align the straight line on the base map with the direction of the interfering signal. The azimuth calculated by the instrument appears on the screen.



NOTE

The AntennaAdvisor Handle has a built-in low-noise amplifier (LNA) and you can turn it on and off using the physical On/Off button located on the rear side of the handle unit. For example, if the received signal is weak, you can turn on the switch to improve S/N.

- 5 To save the defined position, press the **Save Position** soft key and then select one of the soft keys to which you want to save the position information. The instrument stores the saved location points in the internal memory so that you can load them by using the **Load Position** soft key.
- 6 Press the **Location** soft key, and then repeat steps 3-5 to set the second location point.
- 7 Press the **Location** soft key, and then repeat steps 3-5 to set the third location point. The circumscribed circle appears when the lines from three location points create three intersections or vertices.

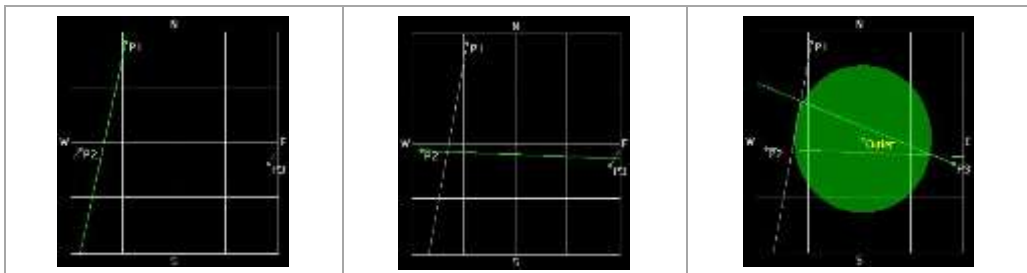

Setting display mode

When the triangulation is done with three location points and azimuth for each point, you can view a circumscribed circle by default. You can change the display mode to inscribed circle or double circles to view a narrower area. The center of the green-shaded circle is determined to be where the source of the interfering signal resides.

Procedure

- 1 Press the **Display Setup** soft key in the Measure Setup menu bar.
- 2 Press the **Display Mode** soft key, and then select the option from the following choices:

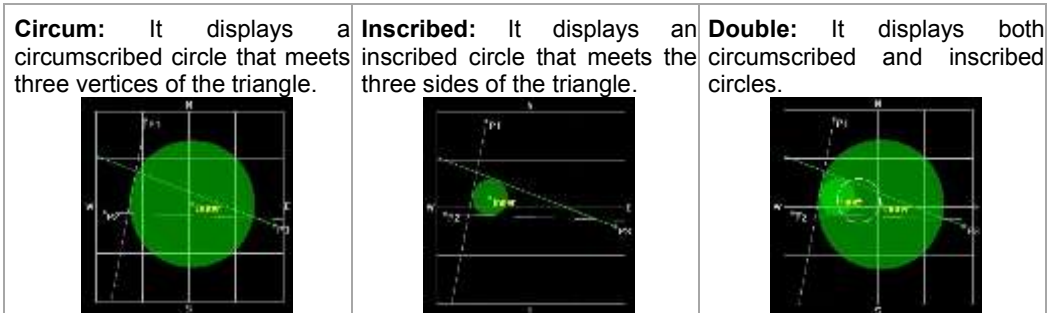

- 3 Toggle the **Screen Mode** soft key to select **Map** or **Full** as needed.
 - Map:** This option displays what are inside the base map with the map image.
 - Full:** This option displays three location points and defined circle without the map image.
-

Controlling a map

If you have loaded a sizable map that was created in JDMapCreator 1.2.0 or later, you can use the Map Control feature that enables you to zoom into the green-shaded area on the map and view the location of the interference source in detail.

Procedure

- 1 Press the **TRACE/DISPLAY** hard key.
 - 2 Press the **Map Control** soft key. This key is active only when you have loaded a sizable map.
 - 3 Do one of the following:
 - To zoom into an area of interest directly, complete the following steps:
 - a Toggle the **Zoom to** soft key and select **Area**.
The black rectangle appears on the map.
 - b Press the **Zoom In** and **Zoom Out** soft keys, as you need, to decrease and increase the selected area.
 - c Move the rectangle by using the four arrow keys, as you need, to place it in a specific area of interest.
 - d Press the center of the rotary knob to zoom into the selected area. You can also press the **Zoom to** soft key again to zoom into the selected area.
 - To zoom into the center or zoom out from the center, complete the following steps:
 - a Toggle the **Zoom to** soft key and select **Center**.
 - b Press the **Zoom In** and **Zoom Out** soft keys, as you need, to zoom in and zoom out.
 - c Move the zoomed-in area by using the four arrow keys, as you need.
-

Measurement example

Figure 55 Interference finder measurement in map view



Figure 56 Interference finder measurement in map view (on 28 GHz downconverter)



Loading and displaying raster data

If you have a set of raster data files generated through the ariesoGEO application, you can load and overlay the data on your base map to help you assume suspicious points of interference easily and pinpoint the source of the interference quickly.

Procedure

- 1 Copy a set of raster data files into your USB memory drive, including the following:
ASCII: .tab, .asc, and .c1r files
BIL: .tab, .hdr, .bil, and .c1r files



NOTE

The .tab file type is a geospatial vector data format used in many geographic

information systems. The color file (.c1r) is an optional file, but the image will be displayed as a grayscale image without it. The size of the raster map must be **1024 x 1024** or smaller.

- 2 Plug in the USB memory drive to your instrument.
- 3 Press the **TRACE/DISPLAY** hard key.
- 4 Press the **Load Raster Map** soft key.
The file explorer window appears.
- 5 Navigate to the raster file (.tab) you want to open, and then press the **Load** soft key.
The raster image appears on top of your base map as shown in Figure 57.

**NOTE**

If the area of the loaded raster data is not within the boundary of the base map, you will not see the raster image on the screen.

- 6 To select the display option, complete the following steps:
 - a Press the **Display Options** soft key.
 - b Select the option you desire from the choices: **On**, **Off**, and **Blink**.
- 7 To adjust the transparency level of the image, complete the following steps:
 - a Press the **Transparency** soft key.
 - b Enter a value between **0** for opaque and **100** for clear.
 - c Press the **Enter** soft key.

Figure 57 Raster image overlaid on the map in interference finder

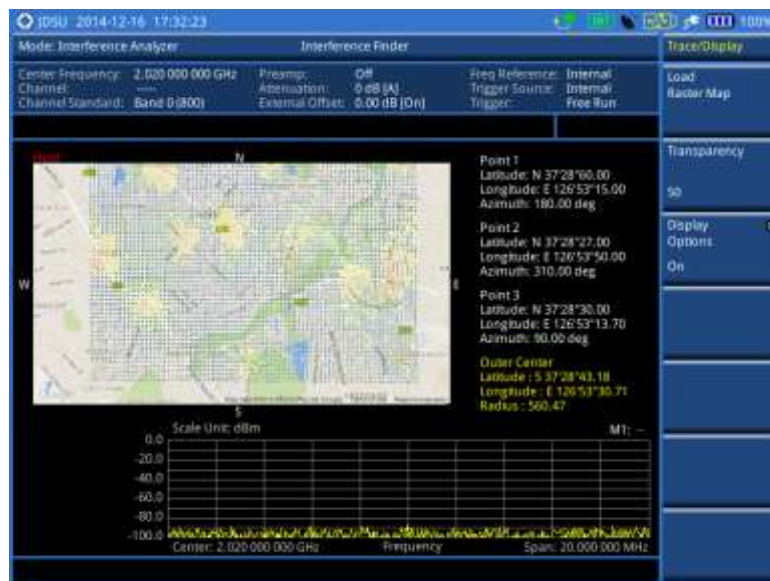

Figure 58 Raster image overlaid on the map in interference finder (on 28 GHz downconverter)



Spectrum Replayer

The Spectrum Replayer lets you retrieve and replay recorded spectrum analyzer traces in interference analysis mode. These traces can be played back in the spectrogram or RSSI. You can configure the limit line to create failure points when signals exceed it. The failure points are clearly displayed on the trace timeline for quick access during playback.

Setting measure setup

Procedure

- 1 Press the **MEASURE** hot key.
- 2 Press the **Spectrum Replayer** soft key. The file manager window appears.
- 3 Select a file to be loaded, and then press the **Load** soft key. The Measure Setup screen menus appear.
- 4 Toggle the **Replay Direction** soft key between **FWD** and **REV** to change play direction to forward or reverse.
- 5 Press the **Replay Speed** soft key, and then select the speed option: **x1**, **x2**, **x3**, and **x4**.
- 6 Press the **Play** soft key to start playing.
- 7 Press the **Pause** soft key to pause or stop playing data.
- 8 To move to a particular failure position directly and play from there, complete the following steps:
 - a Press the **Jump to Fail Index** soft key.
 - b Enter a value by using the numeric keys.
 - c Press the **Enter** soft key.
- 9 *Optional.* Toggle the **Time Cursor** soft key between **On** and **Off** to display or hide the time cursor on the screen. This key becomes activated when you play logged data in the Spectrogram mode.



NOTE

If you connected a USB drive, do not remove it while playing. Doing so may freeze the USB port, which will require you to restart the instrument to get a USB drive recognized again.

Setting display

You can select the display option.

Procedure

- 1 Press the **TRACE/DISPLAY** hard key.
 - 2 Select the display option: **Spectrum**, **Spectrogram**, or **RSSI**.
-



NOTE

You can use the **LIMIT** hot key to analyze your measurements with the display line, multi-segment line, and channel limit. See “Setting limit for interference analyzer” on page 136 for more information.

Radar Chart

If you have identified an interfering signal on your spectrum view, you can move to the Radar Chart mode and measure RSSI power level through 360 degrees at a location received by the connected broadband directional antenna so that you can determine the direction of the source of the interference. A set of the AntennaAdvisor Handle with the antenna is mandatory to perform measurements in this mode.

If you have obtained user experience data through Viavi’s ariesoGEO and generated raster data files from the application, you can load them onto your base map to help you troubleshoot problems easily and quickly.

Loading a map

After you have connected your AntennaAdvisor Handle set to the JD700B series as described in the “Using an AntennaAdvisor handle” on page 108 and configured test parameters as described in the “Configuring test parameters” on page 109, you need to load a map of the area where you want to go out and do interference hunting activities.

Procedure

- 1 Plug in your USB drive that has a map file in `.mcf` file type created in JDMaPCreator. If the JDMaPCreator application on your computer is connected to the instrument via USB or LAN, you can send a map file with a single layer to the instrument directly by using the **Send to EQP** menu in JDMaPCreator.



NOTE

The JDMaPCreator converts and resizes any scanned floor plan or layout to fit onto your instrument’s display. JDMaPCreator 1.2.0 or later can save a multiple-layered map, providing **x1**, **x2**, and **x4** views, as a sizable map file so that you can zoom in and out after loading it.

- 2 Press **SAVE/LOAD** hot key, and then select **Load > Load Map**.
 - 3 Navigate to a map file you want to open.
The File Information pane displays file properties including file name, map type, and address. If you see “Sizable Map” for Map Type, you can zoom in and out the base map after loading.
 - 4 Press the **Load** soft key.
The loaded map appears. Before pressing the **Get GPS Position** soft key, you should not interpret the center of the radar chart as your current geographical location on the map.
-

Controlling a map

If you have loaded a sizable map that was created in JDMaPCreator 1.2.0 or later, you can use the Map Control feature that enables you to zoom into the map and view a specific area of interest in detail.

Procedure

- 1 Press the **TRACE/DISPLAY** hard key.
 - 2 Press the **Map Control** soft key. This key is active only when you have loaded a sizable map.
 - 3 Do one of the following:
 - To zoom into an area of interest directly, complete the following steps:
 - a Toggle the **Zoom to** soft key and select **Area**.
The black rectangle appears on the map.
 - b Press the **Zoom In** and **Zoom Out** soft keys, as you need, to decrease and increase the selected area.
 - c Move the rectangle by using the four arrow keys, as you need, to place it in a specific area of interest.
 - d Press the center of the rotary knob to zoom into the selected area. You can also press the **Zoom to** soft key again to zoom into the selected area.
 - To zoom into the center or zoom out from the center, complete the following steps:
 - a Toggle the **Zoom to** soft key and select **Center**.
 - b Press the **Zoom In** and **Zoom Out** soft keys, as you need, to zoom in and zoom out.
 - c Move the zoomed-in area by using the four arrow keys, as you need.
-

Initializing AntennaAdvisor

After you have loaded a map for the area of interest, you need to initialize the AntennaAdvisor Handle to calibrate its built-in compass in order to obtain more accurate azimuth information.

Procedure

- 1 Press the **MEASURE SETUP** hot key.
A message appears at the bottom of the screen to alert you if you have not performed initialization of your connected the antenna handle set.
 - 2 To adjust the integration bandwidth based on the center frequency of the interfering signal that you have identified in the Spectrum view, complete the following steps:
 - a Press the **Bandwidth** soft key.
 - b Enter a value by using the numeric keys. You can also use the rotary knob.
 - c Select the unit option from the choices: **GHz**, **MHz**, **kHz**, and **Hz**.
 - 3 Initialize the antenna handle to calibrate the built-in compass by completing the following steps:
 - a Hold your antenna handle horizontally in its upright position. To avoid unnecessary impact of external magnetic field, position yourself at the location where the value of magnetic field strength displayed on the instrument is green.
 - b Point the antenna to the north, and then press the **Initialize AntennaAdvisor** soft key.
The message disappears and the red line for the current antenna direction moves to the 0-degree line and overlaps to let you know that the initialization is done successfully.
-

**NOTE**

If is recommended that you re-initialize the AntennaAdvisor Handle after measurements to re-calibrate the compass when you notice that the red line on the radar chart is not aligned with the north on the map even though you are pointing the antenna to the north.

Obtaining RSSI data

After you have connected your antenna handle set and done necessary setups, you can monitor the power level of the received signal, the amount of polarization, and elevation level real time. Using the Trigger button on the antenna handle set, you can plot the RSSI level through 360 degrees at your location.

Procedure

- 1 When you have the green GPS indicator, press the **Get GPS Position** soft key in the Measure Setup menu bar to set your current location with GPS locked as the center of the radar chart. The latitude and longitude information at the bottom of the display changes from 'Unknown Position' to the obtained position information.
- 2 *Optional.* To save a position to recall for triangulation in the **Interference Finder** mode, press the **Save Position** soft key and then select one of the soft keys to which you want to save.
- 3 Monitor the RSSI reading of the received signal. If the signal is weak, turn on the LNA switch on the antenna handle set to improve S/N.

**NOTE**

The AntennaAdvisor Handle has a built-in low-noise amplifier (LNA) and you can turn it on and off by toggling the physical On/Off switch located on the rear side of the handle unit.

- 4 Hold the antenna handle set horizontally and then make the following measurement:
To obtain a RSSI value, complete the following steps:
 - a Press the **TRIGGER** button located on the antenna handle.
Every time you press the physical button on the handle, a beep is sounded and a power level of the received signal is plotted as a blue dot on the radar chart. Depending on the strength of the measured value, you may hear different tones of beeping.
 - b With panning the antenna horizontally to vary the angle of the direction, repeat pressing the **TRIGGER** button to obtain at least five points if you want to do the localization.
 To obtain RSSI values continuously, complete the following steps:
 - a Press and hold the **TRIGGER** button located on the antenna handle to start a continuous measurement.
 - b Pan the antenna handle horizontally through the angle of 360 degrees you desire.
A beep is sounded repeatedly to let you know that the measurement is continuing and measured values are plotted on the radar chart. See Figure 59 for an example.
 - c Release the **TRIGGER** button to stop the continuous measurement.

**NOTE**

- The maximum number you can plot on the radar chart is **500 points** both in the single and continuous measurements. If your measurement reached to 500 points, you need to reset the measurement by pressing the Localization soft key twice or performing the initialization of the AntennaAdvisor Handle.
- Concentric circles indicate different levels of RSSI. The outer circle, the higher power level is. You can use the **AMP/SCALE** hard to adjust the amplitude scale of the chart.

- 5 To change the display mode, toggle the **Screen Mode** soft key and select **Map** or **Full** as needed.

Map: It displays measured points inside the base map image. If you are in the area outside the base map and continue your measurement with the Trigger button, the instrument continue obtaining data even though the radar chart disappears from the screen. You can view obtained data when you change this display option to Full.

Full: It displays measured points without the base map image. In case that you made measurements in the area outside the map image, selecting this option moves your measured data to the center of the display so that you can view the result.
-

Localizing RSSI data

The Localization feature lets you view averaged and smoothed measurement data with a bold green line on the radar chart that helps you determine the direction of the highest RSSI value. When you have five or more data points plotted on the radar chart, you can perform this localization.

Procedure

- 1 Press the **Localization** soft key in the Measure Setup menu bar.
-

All the measured points turn to green color and you can view the bold green line that indicates the possible direction of the interference source. See **Figure 61** for an example.

- 2 To clear all the data plots on the radar chart, press the **Localization** soft key again.

Measurement example

Figure 59 RSSI data plotted on the radar chart

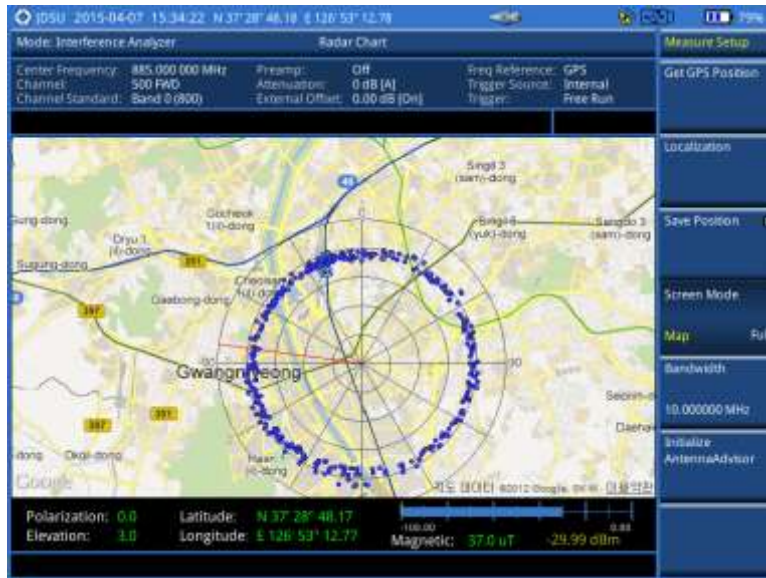

Figure 60 RSSI data plotted on the radar chart (on 28 GHz downconverter)

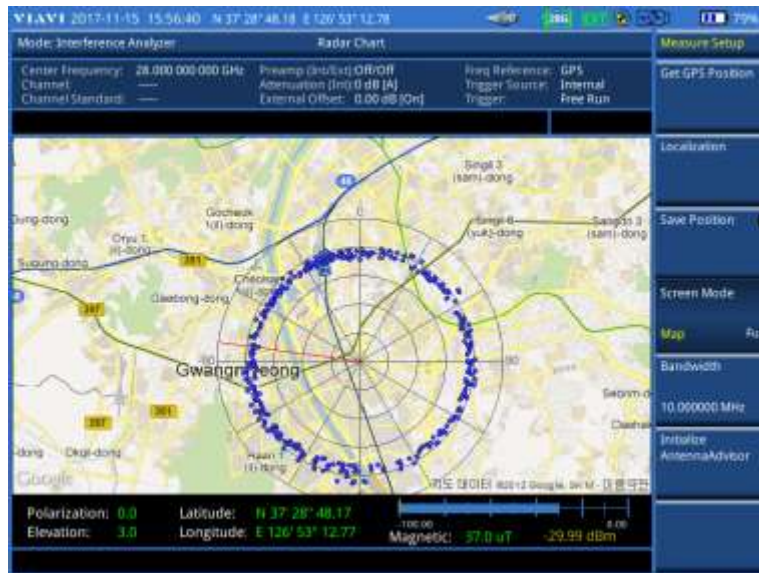

Figure 61 Localized RSSI data on the radar chart

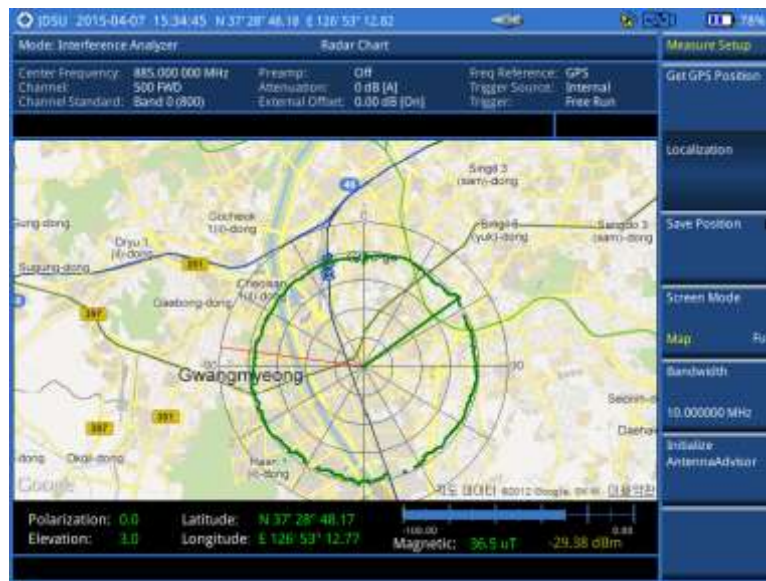

Figure 62 Localized RSSI data on the radar chart (on 28 GHz downconverter)



Loading and displaying raster data

If you have a set of raster data files generated through the ariesoGEO application, you can load and overlay the data on your background map to help you view suspicious points of interference easily and pinpoint the source of the interference quickly.

Procedure

- 1 Copy a set of raster data files into your USB memory drive, including the following:
 - ASCII:** `.tab`, `.asc`, and `.c1r` files
 - BIL:** `.tab`, `.hdr`, `.bil`, and `.c1r` files



NOTE

The `.tab` file type is a geospatial vector data format used in many geographic information systems. The color file (`.c1r`) is an optional file, but the image will be displayed as a grayscale image without it. The size of the raster map must be

1024 x 1024 or smaller.

- 2 Plug in the USB memory drive to your instrument.
- 3 Press the **TRACE/DISPLAY** hard key.
- 4 Press the **Load Raster Map** soft key.
The file explorer window appears.
- 5 Navigate to the raster file (.tab) you want to open, and then press the **Load** soft key.
The raster image appears on top of your base map.



NOTE

If the area of the loaded raster data is not within the boundary of the base map, you will not see the raster image on the screen.

- 6 To select the display option, complete the following steps:
 - a Press the **Display Options** soft key.
 - b Select the option you desire from the choices: **On**, **Off**, and **Blink**.
- 7 To adjust the transparency level of the image, complete the following steps:
 - a Press the **Transparency** soft key.
 - b Enter a value between **0** for opaque and **100** for clear.
 - c Press the **Enter** soft key.

Setting limit for interference analyzer

The Interference Analyzer function provides you with limit setting options for you to select, as you desire. They are a single line limit, a multi-segment line limit, and a channel limit.

Setting a single limit line

Procedure

- 1 Press the **LIMIT** hot key.
- 2 Press the **Display Line** soft key for a reference line.
- 3 Enter a value, and then press the **dBm** unit soft key.
- 4 Toggle the **Display Line** soft key between **On** and **Off** to display and dismiss the reference line.
The straight line appears across the screen to be used as a visual reference only.
- 5 *Optional.* Go to **SAVE/LOAD > Save**, and then select **Limit** to save the limit settings.
See "Using save" on page 34 for more information.

Setting a multi-segment line

Procedure

- 1 Press the **LIMIT** hot key.
- 2 Press the **Multi Segment Line** soft key for Pass/Fail indication.
- 3 Toggle the **Limit** soft key between **Upper** and **Lower** to select the one to be displayed.
- 4 Set the number of segments for the selected upper or lower limit, up to 50 segments.
 - a Press the **# of Line** soft key.
 - b Enter a value between **1** and **50** by using the numeric keys.
 - c Press the **Enter** soft key.
- 5 Press the **Autoset** soft key to automatically set the limit for each segment and display the line.
- 6 To move the limit line, complete the following steps:
 - a Select **Limit Up/Down** or **Limit Left/Right**.

-
- b Turn the rotary knob to move the line as desired. You can also manually enter a value.
- 7 To edit the segment properties, complete the following steps:
- a Press the **Edit Limit** soft key.
 - b Press the **Move** soft key and then turn the rotary knob to select the segment to edit.
 - c Select the menu option, from the following choices:
 - To hide the line for the selected segment, toggle the **Line** soft key and select **Off**.
 - To add a new point, press the **Add Point** soft key.
 - To delete the selected point, press the **Delete Point** soft key.
 - To change the position, press the Frequency or Amplitude soft key, and then turn the rotary knob to change the value as desired.
- 8 *Optional.* Go to **SAVE/LOAD > Save**, and then select **Limit** to save the limit settings. See "Using save" on page 34 for more information.
-

Defining a channel limit

Procedure

- 1 Press the **LIMIT** hot key.
 - 2 Press the **Channel Limit** soft key.
 - 3 To define the index table, complete the following steps:
 - a Toggle the **Table** soft key between **On** and **Off** to display and hide the channel index table on the screen.
 - b Press the **Index** soft key.
 - c Enter an index number to be set between 1 and 10 by using the numeric keys, and then press the **Enter** soft key.
 - d Press the **Start Frequency** or **Center Frequency** soft key depending on your prior frequency setting.
 - e Enter a value by using the numeric keys, and then select the unit from the choices: **GHz**, **MHz**, **kHz**, and **Hz**. You can also use the rotary knob or the arrow keys.
 - f Press the **Stop Frequency** or **Span Width** soft key depending on your prior frequency setting.
 - g Enter a value by using the numeric keys, and then select the unit from the choices: **GHz**, **MHz**, **kHz**, and **Hz**. You can also use the rotary knob or the arrow keys.
 - 4 To set the limits for Pass/Fail indication, complete the following steps:
 - a Toggle the **Limit** soft key between **On** and **Off** to enable and disable the limit.
 - b Press the **High Limit** soft key.
 - c Enter a value by using the numeric keys. You can also use the rotary knob or the arrow keys, and then press the **dBm** soft key.
 - d Press the **Low Limit** soft key.
 - e Enter a value by using the numeric keys. You can also use the rotary knob or the arrow keys, and then press the **dBm** soft key.
 - 5 *Optional.* Go to **SAVE/LOAD > Save**, and then select **Limit** to save the limit settings. See "Using save" on page 34 for more information.
-

Chapter 6 Using GSM/GPRS/EDGE Signal Analyzer

This chapter provides instructions for using the GSM/GPRS/EDGE Signal Analyzer function (option 022) with GSM//GPRS/EDGE OTA Analyzer function (option 042). Topics discussed in this chapter are as follows:

■ Introduction.....	139
■ Display overview	139
■ Connecting a cable.....	140
■ Selecting measurement mode	142
■ Configuring test parameters.....	142
■ Conducting spectrum measurements	146
■ Conducting RF measurements	147
■ Conducting power vs. time measurements	153
■ Conducting constellation measurements	156
■ Performing auto measurements.....	158
■ Conducting GSM OTA measurements.....	160

Introduction

The Global System for Mobile Communications (GSM) is a digital cellular standard that uses Time Division Multiple Access (TDMA) multiplexing scheme and Gaussian Minimum Shift Keying (GMSK) modulation. The Enhanced Data Rates for GSM Evolution (EDGE) is an enhancement to GSM that promises to deliver multimedia and other broadband applications. It uses TDMA and $3\pi/8$ 8PSK (phase shift keying) modulation.

This instrument performs measurements using the methods and limits as defined in the 3GPP TS 51.021 Base Station System (BSS) equipment specification: Radio Aspects V8.9.0 (2003-06) and 3GPP TS 45.005 Radio Transmission and Reception (version 12.5.0, release 12). The Pass/Fail indicator helps you to determine base station performance easily.

This instrument provides the following measurement tools for GSM/GPRS/EDGE system:

- Spectrum Analysis
- RF Analysis
 - Channel Power
 - Occupied Bandwidth
 - Spectrum Emission Mask (SEM)
 - Output RF Spectrum
 - Spurious Emissions
- Power vs. Time
 - Power vs. Time (Slot)
 - Power vs. Time (Frame)
- Modulation Analysis
 - Constellation
- Auto Measure
- Over The Air (OTA)
 - Channel Scanner
 - Frequency Scanner
 - Multipath Profile
 - Modulation Analyzer

Display overview

Figure 63 provides descriptions for each segment of the measurement screen.

Figure 63 GSM signal analyzer measurement screen

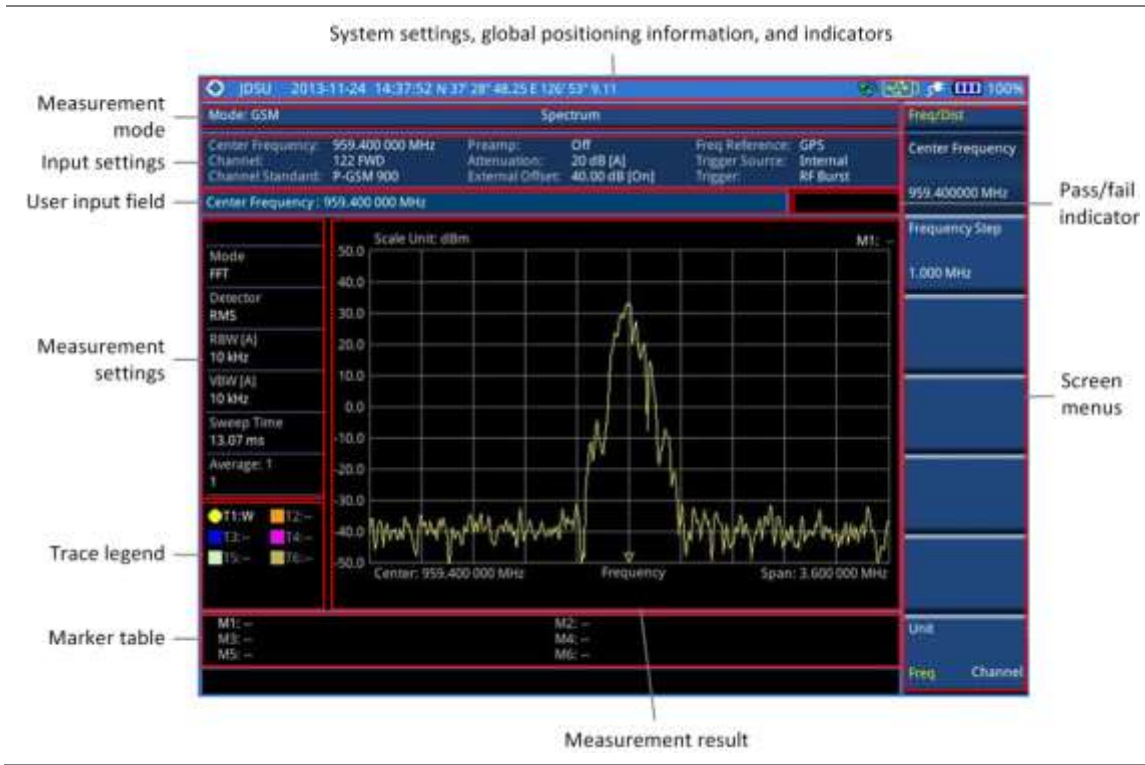

Connecting a cable

Direct connection

Procedure

- 1 Connect the **Spectrum Analyzer RF In** port of the JD700B series and the power amplifier output port of BTS.

Figure 64 Direct connection



Indirect connection

Procedure

- 1 Connect the **Spectrum Analyzer RF In** port of the JD700B series and the monitor (test) port of BTS.

Figure 65 Indirect connection



CAUTION

The maximum power for the **Spectrum Analyzer RF In** port is +25 dBm (0.316 W) for JD780B series and +20 dBm (0.1 W) for JD740B series. If the level of the input signal to be measured is greater than this, use a **High Power Attenuator** to prevent damage when you directly connect the signal to the instrument or connect the signal from the coupling port of a directional coupler.

Over the air (OTA)

Procedure

- 1 Connect an Omni/directional RF antenna to the **Spectrum Analyzer RF In** port of the JD700B series.
- 2 Connect a GPS antenna to the **GPS** port of the JD700B series.

Figure 66 OTA connection

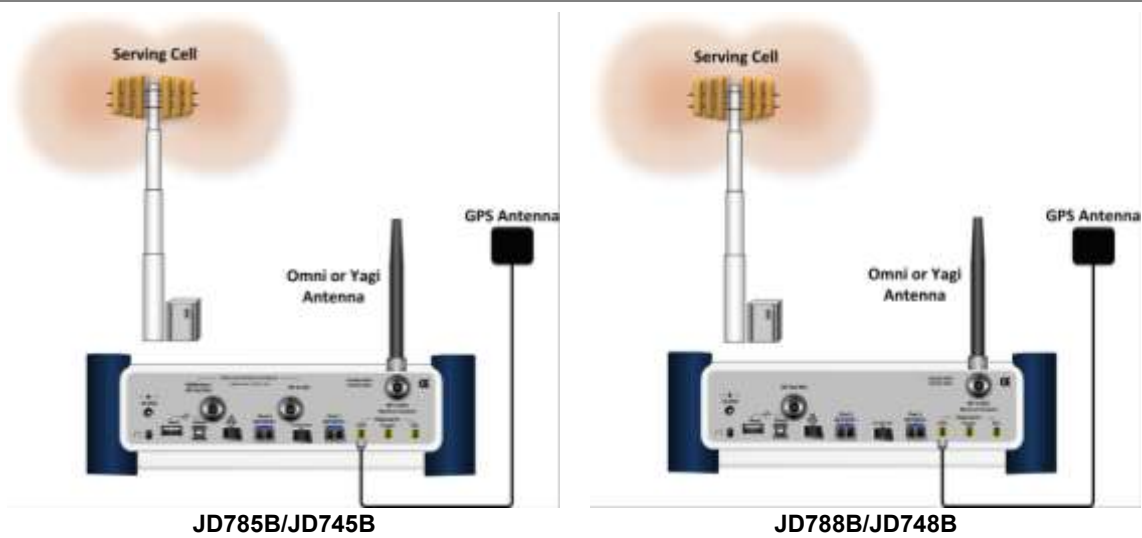

CAUTION

If the input signal level to be measured is less than 0 dBm, set 0 dB attenuation or turn on the preamp to have better dynamic range for the OTA testing.

Selecting measurement mode

Procedure

- 1 Press the **MODE** hard key.
- 2 Press the **Signal Analyzer** soft key.
- 3 Press the **GSM** soft key. The **Spectrum** mode is set by default.
- 4 Press the **MEASURE** hot key, and then select the measurement mode option from the following choices:

Spectrum

RF Analysis > Channel Power, Occupied BW, Spectrum Emission Mask, Output RF Spectrum, or Spurious Emissions

Power vs Time > Power vs Time (Slot) or Power vs Time (Frame)

Constellation

Auto Measure

OTA > Channel Scanner, Frequency Scanner, Multipath Profile, or Modulation Analyzer

Configuring test parameters

Setting frequency

You can set the frequency with either frequency or channel number. If a frequency to be set matches to the frequency corresponding to the selected channel standard, the instrument calculates its channel number and updates the screen with it automatically.

Procedure

To set the center frequency:

- 1 Press the **FREQ/DIST** hard key.
- 2 Toggle the **Unit** soft key and select **Freq.**
- 3 Press the **Center Frequency** soft key.
- 4 Enter a value by using the numeric keys. You can also use the rotary knob.
- 5 Select the unit: **GHz, MHz, kHz, or Hz.**
- 6 *Optional.* To define the amount of frequency increment for the rotary knob, complete the following steps:
 - a Press the **Frequency Step** soft key.
 - b Enter a value by using the numeric keys. You can also use the rotary knob.
 - c Press the unit: **GHz, MHz, kHz, or Hz.**

To set the channel number:

- 1 Press the **FREQ/DIST** hard key.
 - 2 Toggle the **Unit** soft key and select **Channel.**
 - 3 To select the standard channel, complete the following steps:
 - a Press the **Channel Std** soft key. The standard channel window appears. See "Appendix C – Band, frequency & channel standard" on page 769 for more information.
 - b Highlight the band to be measured by using the rotary knob, the arrow keys, or the **Page Up/Page Down** soft keys.
 - c Press the **Select** soft key or the rotary knob to confirm the selection.
 - 4 Press the **Channel Number** soft key.
 - 5 Enter a value by using the numeric keys. You can also use the rotary knob.
-

- 6 Press the **Enter** soft key.
- 7 The instrument automatically displays the corresponding center frequency value for the selected channel number.
- 8 *Optional.* To define the amount of channel increment for the rotary knob, complete the following steps:
 - a Press the **Channel Step** soft key.
 - b Enter a value by using the numeric keys. You can also use the rotary knob.
 - c Press the **Enter** soft key.

**NOTE**

This frequency setting is not used in the Spurious Emissions mode.

Setting amplitude

Reference level and attenuation

You can set the reference and attenuation levels automatically or manually to optimize the display of the traces measured, as you desire.

Procedure

To automatically set the reference and attenuation level:

- 1 Press the **AMP/SCALE** hard key.
- 2 Press the **Auto Scale** soft key.
Each time you press this key, both of the Y-axis scale and input attenuation level change to be optimized with some margin.

To set the reference or attenuation level manually:

- 1 Press the **AMP/SCALE** hard key.
- 2 To set the maximum reference value on the Y-axis manually, complete the following steps:
 - a Press the **Reference Level** soft key.
 - b Enter a value by using the numeric keys or the rotary knob with 10 dB increments.
 - c Press the unit soft key or the **ENTER** hard key.
This unit key name changes according to the setting in the **Units** menu.
- 3 To set the attenuation option, select one from the following choices:
To set the input attenuator's level automatically, select **Attenuation > Auto**.

**NOTE**

It is recommended that you set the **Attenuation** to **Auto** in most situations so that the level of the input attenuator can be set automatically according to your input signal level.

To set the input attenuation manually up to 55 dB for JD780B series or 50 dB for JD740B series to optimize S/N, complete the following steps:

- a Select **Attenuation > Manual**.
- b Press the **Attenuation Value** soft key to set the level.
- c Enter a value in fives by using the numeric keys.
- d Press the **dB** soft key or the **ENTER** hard key.

To couple the input attenuator's level with your reference level setting, select **Attenuation > Couple**.

As you increase the reference setting, the attenuation level also increases accordingly.

Optional. To change the scale unit:

- 1 Select **More (1/2) > Units**.
- 2 Select the unit of the display scale: **dBm**, **dBV**, **dBmV**, **dBμV**, **V**, or **W**.
The scale unit on the screen changes accordingly.

**NOTE**

This Units menu is available in the Spectrum and RF Analysis modes.

Scale per division

You can use the **Scale/Div** feature available for the spectrum and RF analysis. It represents the value of one division on the horizontal scale. The default setting is 10 dB per division and the maximum value can be set up to 20 dB.

Procedure

- 1 Press the **AMP/SCALE** hard key.
- 2 Select **More (1/2) > Scale/Div**.
- 3 Enter a value between 1 and 20 by using the numeric keys.
- 4 Press the **dB** soft key to complete the entry.

Pre-amplifier

You can turn the internal pre-amplifier on to correct and compensate for the gain of the preamp so that amplitude readings show the value at the input connector.

Procedure

- 1 Press the **AMP/SCALE** hard key.
- 2 Toggle the **Preamp** soft key and select **On** or **Off** as needed.

**NOTE**

You can turn the Preamp on when the input attenuation range is from 0 dB to 10 dB. If the attenuation value is manually set to greater than 10 dB, the instrument will automatically turn off the pre-amplifier to display low-level signal properly on the chart.

External offset

You can turn the **External Offset** on and manually set the external offset value. An offset consists of a cable loss and a user offset and the measurement result shows the value reflecting both offset values. When the external offset value is set at 40 dB in the Spectrum mode, the measurement result compensates 40 dB at both the Spectrum Analyzer and Signal Analyzer modes.

Procedure**To set the external offset:**

- 1 Press the **AMP/SCALE** hard key.
- 2 Toggle the **External Offset** soft key and select **On**.
- 3 Enter a value by using the numeric keys.
- 4 Press the **dB** soft key to complete the entry.

To turn the external offset off:

- 1 Press the **AMP/SCALE** hard key.
- 2 Toggle the **External Offset** soft key and select **Off**.

Setting average

You can set the number of measurements to be averaged for the trace presentation. A maximum of 100 times of averaging can be set. When the averaging reaches to your setting, a new measurement value replaces the measurement value in sequence from the earliest.

Procedure

- 1 Press the **BW/AVG** hard key.
 - 2 Press the **Average** soft key.
 - 3 Enter a value between 1 and 100 as needed by using the numeric keys.
 - 4 Press the **Enter** soft key.
-

Setting sweep mode

The default setting is **Continue** to sweep continuously for most on-going measurements. If you want to hold the measurement or get a single sweep, you can change the sweep mode.

Procedure

To select the single sweep mode:

- 1 Press the **SWEEP** hot key.
- 2 Toggle the **Sweep Mode** soft key and select **Single**. You can also use the **HOLD** hot key. The letter **HOLD** in red appears and the sweeping is paused.
- 3 *Optional.* Press the **Sweep Once** soft key to get a new measurement.

To return to the continuous sweep mode:

- 1 Toggle the **Sweep Mode** soft key and select **Continue**. You can also use the **HOLD** hot key. The letter **HOLD** in red disappears and the sweeping resumes.
-

Setting trigger source

You can set the trigger source option for your measurements.

Procedure

- 1 Press the **TRIGGER** hot key.
- 2 Select the trigger source option from the following choices:

To set the trigger level	Select
When using the RF burst (wideband) trigger	RF Burst
To free burst if there is a frequency burst signal	Internal FB
To training sequence code	RF Burst & TS
To external trigger reference	External
To the free trigger	Free
To the locked GPS	GPS



NOTE

There is a case where RF Burst is not transmitted when the instrument is not interworking with a device based on GSM basestation. In this case, you cannot measure RF Burst while conducting PvsT measurements.

Conducting spectrum measurements

If you have configured test parameters as described in the “Configuring test parameters” on page 142, your measurement result is displayed on the screen as like the following example, Figure 67.

Figure 67 Spectrum measurement screen with GSM signal analyzer



Setting measure setup

Procedure

- 1 Press the **MEASURE SETUP** hot key.
- 2 Press the **Time Slot** soft key to assign a time slot with which performs RF measurements, and then select your desired time slot number from **0** to **7**.
- 3 *Optional.* To set the delay, complete the following steps:
 - a Press the **Miscellaneous** soft key.
 - b Press the **Delay** soft key to set the amount of delay in μs .
 - c Enter a value by using the numeric keys. You can also use the rotary knob.
 - d Press the **μs** soft key.



NOTE

The Delay setting is used only when there is a time offset in the signals to be measured.

Setting trace

You can display up to six traces on the measurement chart simultaneously.

Procedure

- 1 Press the **TRACE/DISPLAY** hard key.
- 2 Press the **Select Trace** soft key, and then select the trace number: **T1**, **T2**, **T3**, **T4**, **T5**, or **T6**. The legend shape of the selected trace changes from square to round to indicate that the trace is the active one now.
- 3 Do one of the following:

To	Select	Trace Legend
Clear current data and display with new measurements	Clear Write	W
Display the input signal's maximum response only (unlimited or for a certain amount of time)	Max Hold	M
Display the input signal's minimum response only (unlimited or for a certain amount of time)	Min Hold	m
Capture the selected trace and compare traces	Capture	C
Load a saved trace	More (1/2) > Load	L
Hide the displayed trace	Trace View > Off	F
Remove all the traces and initialize the trace settings	More (1/2) > Trace Clear All	

**NOTE**

For the **Max Hold** and **Min Hold**, your instrument compares newly acquired data with the active trace and displays larger maximum values or smaller minimum values on the screen. You can set it to **Unlimited** to hold and view maximum or minimum data or specify a certain amount of time up to 60 seconds by using numeric keys or rotary knob.

- 4 *Optional.* Select **More (1/2) > Trace Info**, and then select the trace number to view the trace's parameter setting information stored at the time of the measurement or **None** to hide the information display.
- 5 *Optional.* If you have the two traces T1 and T2, you can perform trace math. To view the power difference between the traces, press the **T1 – T2 -> T5** or **T2 – T1 -> T6** soft key. The result is overlaid on the screen along with the second Y-axis.

Conducting RF measurements

Channel power

The Channel Power measures in-channel power for GSM/GPRS and EDGE systems, which use dynamic power control to ensure that each link is maintained with minimum power. It gives two fundamental benefits of keeping overall system interference to a minimum level and of maximizing battery life in the case of mobile stations. It determines the power delivered to the antenna system on the RF channel under test. The instrument acquires a GSM/GPRS or EDGE signal in the time domain. The average power level above the threshold is then computed and displayed.

Setting measure setup

After configuring test parameters as described in the “Configuring test parameters” on page 142, you can continue your measurement.

Procedure

- 1 Press the **MEASURE SETUP** hot key.
- 2 Press the **Time Slot** soft key to assign a time slot with which performs measurements, and then select your desired time slot number from **0** to **7**.
- 3 *Optional.* To set the delay, complete the following steps:
 - a Press the **Miscellaneous** soft key.
 - b Press the **Delay** soft key to set the amount of delay in μs .
 - c Enter a value by using the numeric keys. You can also use the rotary knob.
 - d Press the **μs** soft key.



NOTE

The Delay setting is used only when there is a time offset in the signals to be measured.

Measurement example

Figure 68 Channel power measurement with GSM signal analyzer



Channel power measurement result shows channel power and spectrum density in a user specified channel bandwidth. The peak to average ratio (PAR) is shown at the bottom of the screen as well. The shaded area on the display indicates the channel bandwidth.



NOTE

You can use the **LIMIT** hot key to analyze your measurements with the user-definable limit and Pass/Fail indication. See “Setting limit for RF tests” on page 152 for more information.

Occupied bandwidth

The Occupied Bandwidth measures the spectrum shape of the carrier. It is defined as the bandwidth, which includes 99% of the transmitted power among total transmitted power.

Setting measure setup

After configuring test parameters as described in the “Configuring test parameters” on page 142, you can continue your measurement.

Procedure

- 1 Press the **MEASURE SETUP** hot key.
- 2 Press the **Time Slot** soft key to assign a time slot with which performs measurements, and then select your desired time slot number from **0** to **7**.
- 3 *Optional.* To set the delay, complete the following steps:
 - a Press the **Miscellaneous** soft key.
 - b Press the **Delay** soft key to set the amount of delay in μ s.
 - c Enter a value by using the numeric keys. You can also use the rotary knob.

- d Press the **µs** soft key.

**NOTE**

The Delay setting is used only when there is a time offset in the signals to be measured.

Measurement example

The Occupied Bandwidth measurement shows both of power across the band and power bandwidth in a user specified percentage to determine the amount of spectrum used by a modulated signal. Occupied bandwidth is typically calculated as the bandwidth containing 99% of the transmitted power.

Figure 69 Occupied bandwidth measurement with GSM signal analyzer

**NOTE**

You can use the **LIMIT** hot key to analyze your measurements with the user-definable limit and Pass/Fail indication. See “Setting limit for RF tests” on page 152 for more information.

Spectrum emission mask (SEM)

The Spectrum Emission Mask (SEM) measurement is to identify and determine the power level of out-of-band spurious emission outside the necessary channel bandwidth and modulated signal. It measures the power ratio between in-band and adjacent channels. The JD700B series indicates either Pass or Fail based on the specified limit of the signal.

Setting measure setup

After configuring test parameters as described in the “Configuring test parameters” on page 142, you can continue your measurement.

Procedure

- 1 Press the **MEASURE SETUP** hot key.
- 2 Press the **Time Slot** soft key to assign a time slot with which performs measurements, and then select your desired time slot number from **0** to **7**.
- 3 *Optional.* To set the delay, complete the following steps:

- a Press the **Miscellaneous** soft key.
- b Press the **Delay** soft key to set the amount of delay in μ s.
- c Enter a value by using the numeric keys. You can also use the rotary knob.
- d Press the **μ s** soft key.



NOTE

The Delay setting is used only when there is a time offset in the signals to be measured.

Measurement example

Figure 70 SEM measurement with GSM signal analyzer



NOTE

You can use the **LIMIT** hot key to analyze your measurements with the user-definable limit and Pass/Fail indication. See “Setting limit for RF tests” on page 152 for more information.

Output RF spectrum

The Output RF Spectrum measures power of the output RF modulation spectrum of the carrier at different frequency offsets in different measurement bandwidths. It is used to determine if the output spectrum due to modulation and wideband noise for all supported RF channels meets the requirements specified in 3GPP TS 45.005 and conforms to the specification.

Setting measure setup

After configuring test parameters as described in the “Configuring test parameters” on page 142, you can continue your measurement.

Procedure

- 1 Press the **MEASURE SETUP** hot key.
- 2 Press the **Time Slot** soft key to assign a time slot with which performs measurements, and then select your desired time slot number from **0** to **7**.
- 3 *Optional.* To set the delay, complete the following steps:
 - a Press the **Miscellaneous** soft key.

- b Press the **Delay** soft key to set the amount of delay in μ s.
- c Enter a value by using the numeric keys. You can also use the rotary knob.
- d Press the **μ s** soft key.



NOTE
The Delay setting is used only when there is a time offset in the signals to be measured.

Measurement example

Figure 71 Output RF spectrum measurement with GSM signal analyzer



NOTE
A set of limit values are applied according to the current channel power and automatically displayed in the result table. You can use the **LIMIT** hot key to enable or disable the Pass/Fail indication. See "Setting limit for RF tests" on page 152 for more information.

Spurious emissions

Out-of-band emissions are unwanted emissions immediately outside the channel bandwidth resulting from the modulation process and non-linearity in the transmitter but excluding spurious emissions. The Spurious Emissions measurement is to identify and determine the power level of out-of-band spurious emission within the necessary channel bandwidth and modulated signal measured at the RF port of the Base Station.

Setting measure setup

After configuring test parameters as described in the "Configuring test parameters" on page 142, you can continue your measurement.

Procedure

- 1 Press the **MEASURE SETUP** hot key.
- 2 To set up the range table and parameters, press the **Range Table** soft key and then complete the following steps:
 - a Press the **Range** soft key, and then select the range number between **1** and **20** to add as a new or change the existing settings.
 - b Do the following as desired:
 - Select **Start Frequency**, and then specify the start frequency for the selected range.

- Select **Stop Frequency**, and then specify the stop frequency for the selected range.
- Select **Start Limit**, and then specify the lower limit for Pass/Fail indication.
- Select **Stop Limit**, and then specify the upper limit for Pass/Fail indication.
- Select **More (1/2) > Attenuation**, and then specify an value in the multiple of five.
- Select **More (1/2) > RBW**, and then specify a RBW value.
- Select **More (1/2) > VBW**, and then specify a VBW value.

- c Press the **PREV** hard key.
- d Toggle the **Range** soft key and select **On** to display the selected range in the result table or **Off** to hide it from the table.

3 Toggle the **Measure Type** soft key between **Examine** and **Full** to select the measurement type.



NOTE
The **Examine** mode displays only the selected range while the **Full** mode lets the instrument automatically changes the selected range from one another.

- 4 To set the number of measurements to be averaged, complete the following steps:
 - a Press the **Average** soft key.
 - b Enter a value between **1** and **100**.
 - c Press the **Enter** soft key.
- 5 To move the highlighted bar in the result table to other range, complete the following steps:
 - a Press the **Range** soft key in the Measure Setup menu bar.
 - b Enter a value between **1** and **20**.
 - c Press the **Enter** soft key.

Measurement example

Figure 72 Spurious emissions measurement with GSM signal analyzer



NOTE
You can use the **LIMIT** hot key to analyze your measurements with the user-definable limit and Pass/Fail indication. See “Setting limit for RF tests” on page 152 for more information.

Setting limit for RF tests

By default, test limits specified in the standard are set for you. You can change thresholds if you desire.

Procedure

- 1 Press the **LIMIT** hot key.
- 2 Press the **RF Test Limits** soft key.
- 3 Select the test item(s) and set the limit(s) depending on your selected measurement mode:

To set the limit for	Select	Set
Channel power	Channel Power	High Limit, Low Limit
Occupied bandwidth	Occupied BW	High Limit
Spectrum emission mask	Spectrum Emission Mask	(On/Off only)
Output RF spectrum	Output RF Spectrum	(On/Off only)
Spurious emissions	Spurious Emissions	(On/Off only)

- 4 *Optional.* You can enable alarm sound that goes off if the measurement falls outside of the limit. Toggle the Beep soft key between On and Off to enable or disable the beep sound.
 - 5 *Optional.* Go to **SAVE/LOAD > Save**, and then select **Limit** to save the limit settings. See "Using save" on page 34 for more information.
-

Conducting power vs. time measurements

The Power vs. Time measurement measures the mean transmission power during the useful part of GSM bursts and verifies that the power ramp fits within the defined mask. It also lets you view the rise, fall, and useful part of the GSM burst.

This measurement provides masks for both of Base Transceiver Station (BTS) and Mobile Station (MS). The timing masks are referenced to the transition from the bit 13 to the bit 14 of the mid-amble training sequence. For GMSK measurements, the 0 dB reference is determined by measuring the mean transmitted power during the useful part of the burst.

Power vs. time (slot)

Setting measure setup

After configuring test parameters as described in the "Configuring test parameters" on page 142, you can continue your measurement. The measurement settings can be saved and recalled as a file.

Procedure

- 1 Press the **MEASURE SETUP** hot key.
 - 2 Press the **Time Slot** soft key to assign a time slot with which performs measurements, and then select your desired time slot number from **0** to **7**.
 - 3 Press the **Detect Mode** soft key, and then select the signal standard option: **Auto**, **GSM**, or **EDGE**. Auto is set by default. The instrument applies a mask automatically based on the selected mode.
 - 4 *Optional.* To set the delay, complete the following steps:
 - a Press the **Miscellaneous** soft key.
 - b Press the **Delay** soft key to set the amount of delay in μs .
 - c Enter a value by using the numeric keys. You can also use the rotary knob.
 - d Press the **μs** soft key.
-

**NOTE**

The Delay setting is used only when there is a time offset in the signals to be measured.

Setting limit for burst power

Procedure

- 1 Press the **LIMIT** hot key.
- 2 Press the **PvsT Test Limits** soft key.
- 3 Press the **Burst Power** soft key to set the limit in the Power vs. Time (Slot) measurement.
- 4 Toggle the **Test Limits** soft key between **On** and **Off** to enable or disable the Pass/Fail indication.
- 5 Set the upper threshold:
 - a Press the **High Limit** soft key.
 - b Enter a value for the upper limit, and then press the **dBm** unit soft key.
- 6 Set the lower threshold:
 - a Press the **Low Limit** soft key.
 - b Enter a value for the lower limit, and then press the **dBm** unit soft key.
- 7 *Optional.* You can enable alarm sound that goes off if the measurement falls outside of the limit. Toggle the **Beep** soft key between **On** and **Off** to enable or disable the beep sound.
- 8 *Optional.* Go to **SAVE/LOAD > Save**, and then select **Limit** to save the limit settings. See "Using save" on page 34 for more information.

Measurement example

Figure 73 Power vs. time (slot) measurement with GSM signal analyzer



Figure 74 Power vs. time (slot) measurement with GSM signal analyzer



Power vs. time (frame)

Setting measure setup

After configuring test parameters as described in the “Configuring test parameters” on page 142, you can continue your measurement. The measurement settings can be saved and recalled as a file.

Procedure

- 1 Press the **MEASURE SETUP** hot key.
- 2 Press the **Detect Mode** soft key, and then select the signal standard option: **Auto**, **GSM**, or **EDGE**. Auto is set by default. The instrument applies a mask automatically based on the selected mode.
- 3 *Optional.* To set the delay, complete the following steps:
 - a Press the **Miscellaneous** soft key.
 - b Press the **Delay** soft key to set the amount of delay in μs .
 - c Enter a value by using the numeric keys. You can also use the rotary knob.
 - d Press the **μs** soft key.



NOTE

The Delay setting is used only when there is a time offset in the signals to be measured.

Setting limit for frame average power

Procedure

- 1 Press the **LIMIT** hot key.
- 2 Press the **PvsT Test Limits** soft key.
- 3 Press the **Frame Avg Power** soft key to set the limit in the Power vs. Time (Frame) measurement.
- 4 Toggle the **Test Limits** soft key between **On** and **Off** to enable or disable the Pass/Fail indication.
- 5 Set the upper threshold:
 - a Press the **High Limit** soft key.
 - b Enter a value for the upper limit.
 - c Press the **dBm** unit soft key.

- 6 Set the lower threshold:
 - a Press the **Low Limit** soft key.
 - b Enter a value for the lower limit.
 - c Press the **dBm** unit soft key.
- 7 *Optional.* You can enable alarm sound that goes off if the measurement falls outside of the limit. Toggle the **Beep** soft key between **On** and **Off** to enable or disable the beep sound.
- 8 *Optional.* Go to **SAVE/LOAD > Save**, and then select **Limit** to save the limit settings. See "Using save" on page 34 for more information.

Measurement example

Figure 75 Power vs. time (frame) measurement with GSM signal analyzer



Conducting constellation measurements

The Constellation is used to observe some aspects of modulation accuracy and can reveal certain fault mechanisms such as I/Q amplitude imbalance or quadrature imbalance. It displays constellation diagram by modulation types.

Setting measure setup

After configuring test parameters as described in the "Configuring test parameters" on page 142, you can continue your measurement. The measurement settings can be saved and recalled as a file.

Procedure

- 1 Press the **MEASURE SETUP** hot key.
- 2 Press the **Time Slot** soft key to assign a time slot with which performs measurements, and then select your desired time slot number from **0** to **7**.
- 3 Press the **Detect Mode** soft key, and then select the signal standard option: **Auto**, **GSM**, or **EDGE**. Auto is set by default. The instrument applies a mask automatically based on the selected mode.
- 4 Toggle the **PSK Constellation** soft key between **On** and **Off** to enable or disable the PSK constellation observation.

**NOTE**

The PSK constellation must be turned on to analyze EDGE signals.

- 5 *Optional.* To set the delay, complete the following steps:
 - a Press the **Miscellaneous** soft key.
 - b Press the **Delay** soft key to set the amount of delay in μs .
 - c Enter a value by using the numeric keys. You can also use the rotary knob.
 - d Press the **μs** soft key.

**NOTE**

The Delay setting is used only when there is a time offset in the signals to be measured.

Setting limit for constellation

Procedure

- 1 Press the **LIMIT** hot key.
- 2 Press the **Modulation Test Limits** soft key to set the limits in the Constellation measurement.
- 3 Select the test item(s) and set the limit(s) depending on your selected measurement mode:

To set the limit for	Select	Set
Frequency error	Frequency Error	High Limit, Low Limit
Phase error rms	Phase Error RMS	High Limit, Low Limit
Phase error peak	Phase Error Peak	High Limit, Low Limit
Error vector magnitude rms	EVM RMS	High Limit
Error vector magnitude peak	EVM Peak	High Limit
I/Q origin offset of the I and Q error (magnitude squared) offset from the origin	IQ Origin Offset	High Limit
Carrier to interference (C/I) ratio	C/I	Low Limit

- 4 *Optional.* You can enable alarm sound that goes off if the measurement falls outside of the limit. Toggle the Beep soft key between On and Off to enable or disable the beep sound.
- 5 *Optional.* Go to **SAVE/LOAD > Save**, and then select **Limit** to save the limit settings. See "Using save" on page 34 for more information.

Measurement example

Figure 76 Constellation measurement (PSK off) with GSM signal analyzer

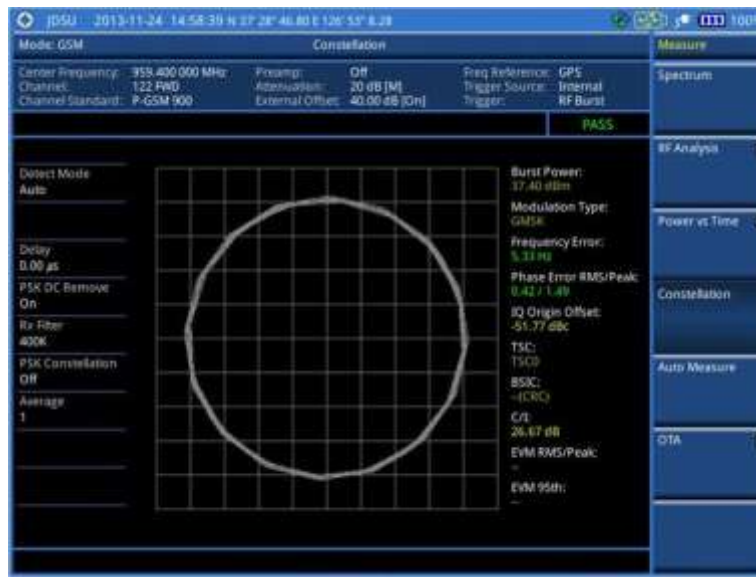

Figure 77 Constellation measurement (PSK on) with GSM signal analyzer



NOTE

Measurement items such as IQ Origin Offset, C/I, EVM RMS/Peak and EVM 95th are applicable only to EDGE signal measurements.

Performing auto measurements

The Auto Measure function of the JD700B series allows a complete signal profiling covering RF characterization and modulation quality parameters of up to 10 different carriers, particularly useful on an overlay architecture where base stations are transmitting in different frequencies.

The Auto Measure can be easily executed either by selecting a menu in the instrument or by running a programmed scenario in the PC-based application so that the instrument automatically configure and perform

tests on every aspect of all the carriers.

Setting limit for auto measure

You can set test limits for test item(s) in the auto measurement.

Procedure

- 1 Press the **LIMIT** hot key.
 - 2 Press the **RF Test Limits** soft key, and then enable test limits as desired.
 - 3 Press the **PvsT Test Limits** soft key, and then enable test limits as desired.
 - 4 Press the **Modulation Test Limits** soft key, and then enable test limits as desired.
 - 5 *Optional.* You can enable alarm sound that goes off if the measurement falls outside of the limit. Toggle the **Beep** soft key between **On** and **Off** to enable or disable the beep sound.
 - 6 *Optional.* Go to **SAVE/LOAD > Save**, and then select **Limit** to save the limit settings. See "Using save" on page 34 for more information.
-

Setting measure setup

After configuring test parameters as described in the "Configuring test parameters" on page 142, you can continue your measurement. The measurement settings can be saved and recalled as a file. You can also use JDViewer, PC application software to configure a measure setup, save as a file, and load the file on to the instrument.

Procedure

- 1 Press the **MEASURE SETUP** hot key.
 - 2 Toggle the **Configuration** soft key and select the configuration option:
 - Current:** Lets the instrument use current frequency (single carrier) and determine pass or fail based on the instrument's limit settings in Auto Measure.
 - Scenario:** Runs a test with a programmed scenario in JDViewer. The Scenario menu becomes activated.
 - 3 To load a scenario, press the **Scenario** soft key, and then select a scenario file to load.
 - 4 Toggle the **Test Time** soft key and select the test time option:
 - Now:** Lets the instrument run a test only once.
 - Schedule:** Lets the instrument repeat tests as defined in the Set Timing. The Set Timing menu becomes activated.
 - 5 To define a schedule for an auto measurement, complete the following steps:
 - a Press the **Set Timing** soft key.
 - b Press the **Start Time (HH:MM)** soft key.
 - c Enter the time in the HH:MM format, and then press the **Enter** soft key.
 - d Press the **Stop Time (HH:MM)** soft key.
 - e Enter the time in the HH:MM format, and then press the **Enter** soft key.
 - f Press the **Time Interval** soft key.
 - g Enter the amount of time in minutes, and then press the **Enter** soft key.
 - 6 To select the type of the measurement data to be taken for the determination of the results, press the **Data Type** soft key and then select the data type option from the following choices:
 - Sample:** The Auto Measure takes the last measurement data only.
 - RMS:** The Auto Measure takes data from all 20 measurements and averages them.
 - Peak:** The Auto Measure takes only the highest peak of all 20 measurements.
 - Negative Peak:** The Auto Measure takes only the lowest peak of all 20 measurements.
 - 7 To set external offset, complete the following steps:
-

-
- a Toggle the **External Offset** soft key and select **On**.
 - b Enter a value by using the numeric keys, and then press the **dB** soft key.
- 8 To save your settings and results, go to **SAVE/LOAD > Save** and then perform functions as you desire. See “Using save” on page 34 for more information.
 - 9 Press the **Run Test** soft key to start to run a test.
The Auto Measure Results window appears at the end of the test.
 - 10 To stop running the test, press the **Abort** soft key.
 - 11 To change the view on the screen during the test, press the **Display** and then select the view option from the following choices:
 - Screen:** You can view each measurement screen as the test progresses.
 - Results:** You can view a measurement result table as the test progresses.
 - Settings:** You can view a measurement setting table as the test progresses.
-

Setting display

After completion of the auto measurement, the screen menu changes to Trace/Display so that you can view the results in different forms.

Procedure

- 1 Toggle the **Display** soft key and select the display option:
 - Result:** You can view the result table. The Display Result menu becomes activated.
 - Settings:** You can view the measurement settings for the auto measurement.
 - 2 Toggle the **Display Result** soft key and select the display result option:
 - Full:** You can view detailed measurement readings with the pass/fail indication.
 - Quick:** You can view only the Pass/Fail results.
 - 3 To view the measurement results for a different carrier, press the **View Carrier** soft key and then select the carrier number to view.
-

Conducting GSM OTA measurements

This Over-The-Air (OTA) measurement has channel scanner, frequency scanner, multipath profile, and modulation analyzer screens. The GSM OTA has a function to display channel power and related information up to 128 GSM down link signals. This channel scanner can quickly identifies improper power levels that affect network performance. The transmitter performance can be made on a base station from the convenience of your vehicle without taking the base station out of service. It helps you to determine testing area's RF environmental condition with the multipath profile.

Channel scanner

Setting channel

Procedure

- 1 Press the **FREQ/DIST** hard key.
 - 2 To select the standard channel, complete the following steps:
 - a Press the **Channel Std** soft key. The standard channel window appears.
See “Appendix C – Band, frequency & channel standard” on page 769 for more information.
 - b Highlight the band to be measured by using the rotary knob, the arrow keys, or the **Page Up/Page Down** soft keys.
 - c Press the **Select** soft key or the rotary knob to confirm the selection.
-

-
- 3 To set the starting channel to be scanned, complete the following steps:
 - a Press the **Channel Number** soft key.
 - b Enter a value by using the numeric keys. You can also use the rotary knob.
 - c Press the **Enter** soft key.
 - 4 To set the amount of channel increment in scanning channels, complete the following steps:
 - a Press the **Channel Step** soft key.
 - b Enter a value by using the numeric keys. You can also use the rotary knob.
 - c Press the **Enter** soft key.
 - 5 To set the number of channels to be displayed, complete the following steps:
 - a Press the **# of Channels** soft key.
 - b Enter a value by using the numeric keys. You can also use the rotary knob.
 - c Press the **Enter** soft key.
-

Setting zoom position

You can set the starting channel for the Zoom In Window.

Procedure

- 1 Press the **TRACE/DISPLAY** hard key.
 - 2 Press the **Zoom Position** soft key.
 - 3 Enter a value by using the numeric keys. You can also use the rotary knob.
 - 4 Press the **Enter** soft key.
-

Setting limit for OTA channel scanner

Procedure

- 1 Press the **LIMIT** hot key.
 - 2 Press the **Limit Line** soft key to set a threshold for the limit line and Pass/Fail indication.
 - 3 Enter a value, and then press the **dBm** unit soft key.
 - 4 Toggle the **Limit Line** soft key between **On** and **Off** to display or dismiss the limit line.
 - 5 *Optional.* You can enable alarm sound that goes off if the measurement falls outside of the limit. Toggle the **Beep** soft key between **On** and **Off** to enable or disable the beep sound.
 - 6 *Optional.* Go to **SAVE/LOAD > Save**, and then select the save option from the choices available for your measurement mode. See "Using save" on page 34 for more information.
-

Measurement example

Figure 78 Channel scanner measurement with GSM OTA signal analyzer



Frequency scanner

Setting frequency

Procedure

- 1 Press the **FREQ/DIST** hard key.
- 2 To set the starting frequency to be scanned, complete the following steps:
 - a Press the **Start Frequency** soft key.
 - b Enter a value by using the numeric keys. You can also use the rotary knob.
 - c Select the unit: **GHz**, **MHz**, **kHz**, or **Hz**.
- 3 To set the amount of frequency increment in scanning frequencies, complete the following steps:
 - a Press the **Frequency Step** soft key.
 - b Enter a value by using the numeric keys. You can also use the rotary knob.
 - c Select the unit: **GHz**, **MHz**, **kHz**, or **Hz**.
- 4 To set the number of frequencies to be displayed, complete the following steps:
 - a Press the **# of Frequencies** soft key.
 - b Enter a value by using the numeric keys. You can also use the rotary knob.
 - c Press the **Enter** soft key.

Setting zoom position

You can set the starting channel for the Zoom Window.

Procedure

- 1 Press the **TRACE/DISPLAY** hard key.
- 2 Press the **Zoom Position** soft key.
- 3 Enter a value by using the numeric keys. You can also use the rotary knob.
- 4 Press the **Enter** soft key.

Setting limit for OTA frequency scanner

Procedure

- 1 Press the **LIMIT** hot key.
- 2 Press the **Limit Line** soft key to set a threshold for the limit line and Pass/Fail indication.
- 3 Enter a value, and then press the **dBm** unit soft key.
- 4 Toggle the **Limit Line** soft key between **On** and **Off** to display or dismiss the limit line.
- 5 *Optional.* You can enable alarm sound that goes off if the measurement falls outside of the limit. Toggle the **Beep** soft key between **On** and **Off** to enable or disable the beep sound.
- 6 *Optional.* Go to **SAVE/LOAD > Save**, and then select **Limit** to save the limit settings. See “Using save” on page 34 for more information.

Measurement example

Figure 79 Frequency scanner measurement with GSM OTA signal analyzer



Multipath profile

The Multipath Profile let you determine RF environmental conditions of testing area. The multipath profile is the result of portions of the original broadcast signal arriving at the receiving antenna out of phase. This can be caused by the signal being reflected off objects such as buildings, or being refracted through the atmosphere differently from the main signal.

Setting measure setup

After configuring test parameters as described in the “Configuring test parameters” on page 142, you can continue your measurement. The measurement settings can be saved and recalled as a file.

Procedure

- 1 Press the **MEASURE SETUP** hot key.
- 2 Press the **Detect Mode** soft key, and then select the signal standard option: **Auto**, **GSM**, or **EDGE**. Auto is set by default. The instrument applies a mask automatically based on the selected mode.
- 3 *Optional.* To set the delay, complete the following steps:
 - a Press the **Miscellaneous** soft key.

- b Press the **Delay** soft key to set the amount of delay in μs .
 - c Enter a value by using the numeric keys. You can also use the rotary knob.
 - d Press the **μs** soft key.
- 4 *Optional.* Go to **SAVE/LOAD > Save**, and then select the save option from the choices available for your measurement mode. See “Using save” on page 34 for more information.



NOTE
The Delay setting is used only when there is a time offset in the signals to be measured.

Measurement example

Figure 80 Multipath profile measurement with GSM OTA signal analyzer



Modulation analyzer

Setting measure setup

After configuring test parameters as described in the “Configuring test parameters” on page 142, you can continue your measurement. The measurement settings can be saved and recalled as a file.

Procedure

- 1 Press the **MEASURE SETUP** hot key.
- 2 Press the **Detect Mode** soft key, and then select the signal standard option: **Auto**, **GSM**, or **EDGE**. Auto is set by default. The instrument applies a mask automatically based on the selected mode.
- 3 *Optional.* To set the delay, complete the following steps:
 - a Press the **Miscellaneous** soft key.
 - b Press the **Delay** soft key to set the amount of delay in μs .
 - c Enter a value by using the numeric keys. You can also use the rotary knob.
 - d Press the **μs** soft key.
- 4 *Optional.* Go to **SAVE/LOAD > Save**, and then select the save option from the choices available for your measurement mode. See “Using save” on page 34 for more information.



NOTE
The Delay setting is used only when there is a time offset in the signals to be measured.

Setting limit for modulation analyzer

Procedure

- 1 Press the **LIMIT** hot key.
- 2 Select the test item(s) and set the limit(s):

To set the limit for	Select	Set
Frame average power	Frame Average Power	High Limit, Low Limit
Frequency error	Frequency Error	High Limit, Low Limit
Burst power	Burst Power	High Limit, Low Limit
ACLR	ACLR	(On/Off only)
Multi-ACLR	Multi-ACLR	(On/Off only)
Spurious emissions	Spurious Emissions	(On/Off only)

- 3 *Optional.* You can enable alarm sound that goes off if the measurement falls outside of the limit. Toggle the **Beep** soft key between **On** and **Off** to enable or disable the beep sound.
- 4 *Optional.* Go to **SAVE/LOAD > Save**, and then select **Limit** to save the limit settings. See "Using save" on page 34 for more information.

Measurement example

Figure 81 Modulation analyzer measurement with GSM OTA signal analyzer



Chapter 7 Using WCDMA/HSPA+ Signal Analyzer

This chapter provides instructions for using the WCDMA/HSPA+ Signal Analyzer function (option 023) with the WCDMA/HSPA+ OTA Analyzer function (option 043). Topics discussed in this chapter are as follows:

■ Introduction.....	167
■ Display overview	167
■ Connecting a cable.....	168
■ Selecting measurement mode	170
■ Configuring test parameters.....	170
■ Conducting spectrum measurements	175
■ Conducting RF measurements	176
■ Conducting modulation measurements.....	183
■ Performing auto measurements.....	195
■ Performing power statistics CCDF measurement.....	196
■ Conducting WCDMA/HSPA+ OTA measurements	197

Introduction

This WCDMA/HSPA+ Signal Analyzer can be used to test a WCDMA transmitter including HSDPA/HSPA+ signals to check the base station's compliance with following standards documentation.

- 3GPP TS 25.104 Base Station radio transmission and reception
- 3GPP TS 25.141 Base Station (BS) conformance test
- 3GPP TS 25.211 Physical channel and mapping of transport channels onto physical channels
- 3GPP TS 25.212 Multiplexing and channel coding
- 3GPP TS 25.213 Spreading and modulation

The instrument automatically makes standard defined measurements using the measurement methods and limits as defined in the standards. Detailed measurement results allow you to analyze WCDMA and HSPA+ system performance. You may alter the measurement parameters for specialized analysis. Pass/Fail testing with standard defined or user defined upper and lower limits and the Pass/Fail indicator help you to determine base station performance easily.

This instrument provides the following measurement tools for WCDMA/HSPA+ system:

- Spectrum Analysis
- RF Analysis
 - Channel Power
 - Occupied Bandwidth
 - Spectrum Emission Mask (SEM)
 - Adjacent Channel Leakage power Ratio (ACLR)
 - Multi-ACLR
 - Spurious Emissions
- Modulation Analysis
 - Constellation
 - Code Domain Power
 - Relative Code Domain Error
 - Codogram
 - Received Code Strength Indicator (RCSI)
 - CDP Table
- Auto Measure
- Power Statistics CCDF
- Over The Air (OTA)
 - Channel Scanner
 - Scramble Scanner
 - Multipath Profile
 - Code Domain Power
 - Route Map

Display overview

Figure 82 provides descriptions for each segment of the measurement screen.

Figure 82 WCDMA/HSPA+ signal analyzer measurement screen

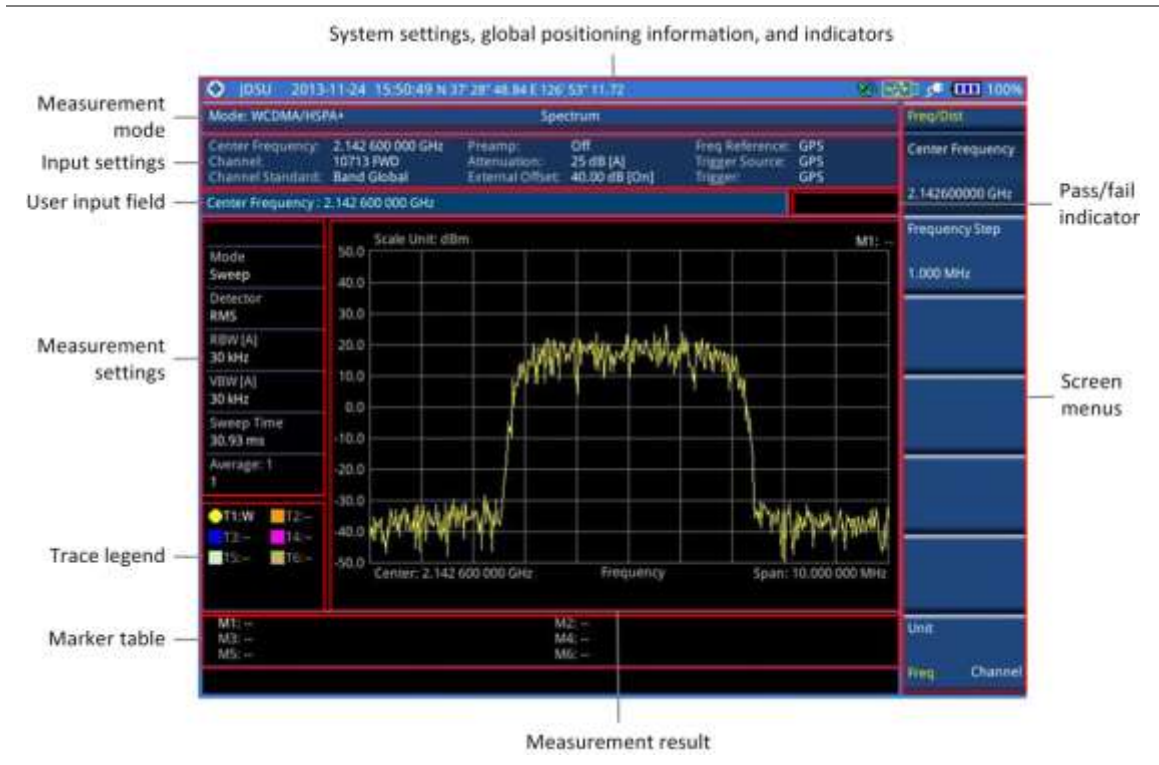

Connecting a cable

Direct connection

Procedure

- 1 Connect the **Spectrum Analyzer RF In** port of the JD700B series and the power amplifier output port of BTS.

Figure 83 Direct connection



Indirect connection

Procedure

- 1 Connect the **Spectrum Analyzer RF In** port of the JD700B series and the monitor (test) port of BTS.

Figure 84 Indirect connection



CAUTION

The maximum power for the **Spectrum Analyzer RF In** port is +25 dBm (0.316 W) for JD780B series and +20 dBm (0.1 W) for JD740B series. If the level of the input signal to be measured is greater than this, use a **High Power Attenuator** to prevent damage when you directly connect the signal to the instrument or connect the signal from the coupling port of a directional coupler.

Over the air (OTA)

Procedure

- 1 Connect an Omni/directional RF antenna to the **Spectrum Analyzer RF In** port of the JD700B series.
- 2 Connect a GPS antenna to the **GPS** port of the JD700B series.

Figure 85 OTA connection

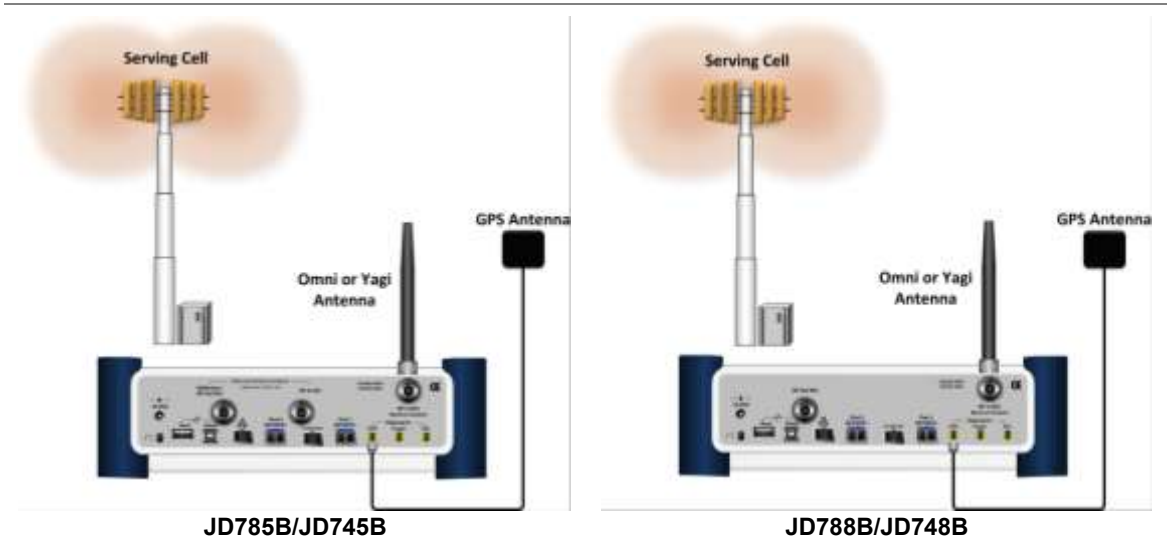

CAUTION

If the input signal level to be measured is less than 0 dBm, set 0 dB attenuation or turn on the preamp to have better dynamic range for the OTA testing.

Selecting measurement mode

Procedure

- 1 Press the **MODE** hard key.
- 2 Press the **Signal Analyzer** soft key.
- 3 Press the **WCDMA** soft key. The **Spectrum** mode is set by default.
- 4 Press the **MEASURE** hot key, and then select the measurement mode option from the following choices:

Spectrum

RF Analysis > Channel Power, Occupied BW, Spectrum Emission Mask, ACLR, Multi-ACLR, or Spurious Emissions

Modulation > Constellation, Code Domain Power, Relative Code Domain Error, Codogram, RCSI, or CDP Table

Auto Measure

Power Statistics CCDF

OTA > Channel Scanner, Scramble Scanner, Multipath Profile, Code Domain Power, or Route Map

Configuring test parameters

Setting frequency

You can set the frequency with either frequency or channel number. If a frequency to be set matches to the frequency corresponding to the selected channel standard, the instrument calculates its channel number and updates the screen with it automatically.

Procedure

To set the center frequency:

- 1 Press the **FREQ/DIST** hard key.
- 2 Toggle the **Unit** soft key and select **Freq.**
- 3 Press the **Center Frequency** soft key.
- 4 Enter a value by using the numeric keys. You can also use the rotary knob.
- 5 Select the unit: **GHz**, **MHz**, **kHz**, or **Hz**.
- 6 *Optional.* To define the amount of frequency increment for the rotary knob, complete the following steps:
 - a Press the **Frequency Step** soft key.
 - b Enter a value by using the numeric keys. You can also use the rotary knob.
 - c Press the unit: **GHz**, **MHz**, **kHz**, or **Hz**.

To set the channel number:

- 1 Press the **FREQ/DIST** hard key.
 - 2 Toggle the **Unit** soft key and select **Channel**.
 - 3 To select the standard channel, complete the following steps:
 - a Press the **Channel Std** soft key. The standard channel window appears. See “Appendix C – Band, frequency & channel standard” on page 769 for more information.
 - b Highlight the band to be measured by using the rotary knob, the arrow keys, or the **Page Up/Page Down** soft keys.
 - c Press the **Select** soft key or the rotary knob to confirm the selection.
 - 4 Press the **Channel Number** soft key.
-

- 5 Enter a value by using the numeric keys. You can also use the rotary knob.
- 6 Press the **Enter** soft key.
- 7 The instrument automatically displays the corresponding center frequency value for the selected channel number.
- 8 *Optional.* To define the amount of channel increment for the rotary knob, complete the following steps:
 - a Press the **Channel Step** soft key.
 - b Enter a value by using the numeric keys. You can also use the rotary knob.
 - c Press the **Enter** soft key.

**NOTE**

This frequency setting is not used in the Multi-ACLR and Spurious Emissions modes.

Setting amplitude

Reference level and attenuation

You can set the reference and attenuation levels automatically or manually to optimize the display of the traces measured, as you desire.

Procedure

To automatically set the reference and attenuation level:

- 1 Press the **AMP/SCALE** hard key.
- 2 Press the **Auto Scale** soft key.
Each time you press this key, both of the Y-axis scale and input attenuation level change to be optimized with some margin.

To set the reference or attenuation level manually:

- 1 Press the **AMP/SCALE** hard key.
- 2 To set the maximum reference value on the Y-axis manually, complete the following steps:
 - a Press the **Reference Level** soft key.
 - b Enter a value by using the numeric keys or the rotary knob with 10 dB increments.
 - c Press the unit soft key or the **ENTER** hard key.
This unit key name changes according to the setting in the **Units** menu.

**NOTE**

In the measurements such as **Code Domain Power**, **Codogram**, and **RCSI**, you may need to select the reference option between **Relative** and **Absolute** before setting the reference level.

- 3 To set the attenuation option, select one from the following choices:
To set the input attenuator's level automatically, select **Attenuation > Auto**.

**NOTE**

It is recommended that you set the **Attenuation** to **Auto** in most situations so that the level of the input attenuator can be set automatically according to your input signal level.

To set the input attenuation manually up to 55 dB for JD780B series or 50 dB for JD740B series to optimize S/N, complete the following steps:

- a Select **Attenuation > Manual**.
- b Press the **Attenuation Value** soft key to set the level.
- c Enter a value in fives by using the numeric keys.
- d Press the **dB** soft key or the **ENTER** hard key.

To couple the input attenuator's level with your reference level setting, select **Attenuation > Couple**.

As you increase the reference setting, the attenuation level also increases accordingly.

Optional. To change the scale unit:

- 1 Select **More (1/2) > Units**.
- 2 Select the unit of the display scale: **dBm**, **dBV**, **dBmV**, **dBμV**, **V**, or **W**.
The scale unit on the screen changes accordingly.



NOTE

This Units menu is available in the Spectrum and RF Analysis modes.

Scale per division

You can use the **Scale/Div** feature available for the spectrum and RF analysis. It represents the value of one division on the horizontal scale. The default setting is 10 dB per division and the maximum value can be set up to 20 dB.

Procedure

- 1 Press the **AMP/SCALE** hard key.
 - 2 Select **More (1/2) > Scale/Div**.
 - 3 Enter a value between 1 and 20 by using the numeric keys.
 - 4 Press the **dB** soft key to complete the entry.
-

Pre-amplifier

You can turn the internal pre-amplifier on to correct and compensate for the gain of the preamp so that amplitude readings show the value at the input connector.

Procedure

- 1 Press the **AMP/SCALE** hard key.
 - 2 Toggle the **Preamp** soft key and select **On** or **Off** as needed.
-



NOTE

You can turn the Preamp on when the input attenuation range is from 0 dB to 10 dB. If the attenuation value is manually set to greater than 10 dB, the instrument will automatically turn off the pre-amplifier to display low-level signal properly on the chart.

External offset

You can turn the **External Offset** on and manually set the external offset value. An offset consists of a cable loss and a user offset and the measurement result shows the value reflecting both offset values. When the external offset value is set at 40 dB in the Spectrum mode, the measurement result compensates 40 dB at both the Spectrum Analyzer and Signal Analyzer modes.

Procedure

To set the external offset:

- 1 Press the **AMP/SCALE** hard key.
- 2 Toggle the **External Offset** soft key and select **On**.
- 3 Enter a value by using the numeric keys.
- 4 Press the **dB** soft key to complete the entry.

To turn the external offset off:

- 1 Press the **AMP/SCALE** hard key.
-

-
- 2 Toggle the **External Offset** soft key and select **Off**.
-

Setting average

You can set the number of measurements to be averaged for the trace presentation. A maximum of 100 times of averaging can be set. When the averaging reaches to your setting, a new measurement value replaces the measurement value in sequence from the earliest.

Procedure

- 1 Press the **BW/AVG** hard key.
 - 2 Press the **Average** soft key.
 - 3 Enter a value between 1 and 100 as needed by using the numeric keys.
 - 4 Press the **Enter** soft key.
-

Setting sweep mode

The default setting is **Continue** to sweep continuously for most on-going measurements. If you want to hold the measurement or get a single sweep, you can change the sweep mode.

Procedure

To select the single sweep mode:

- 1 Press the **SWEEP** hot key.
- 2 Toggle the **Sweep Mode** soft key and select **Single**. You can also use the **HOLD** hot key. The letter **HOLD** in red appears and the sweeping is paused.
- 3 *Optional.* Press the **Sweep Once** soft key to get a new measurement.

To return to the continuous sweep mode:

- 1 Toggle the **Sweep Mode** soft key and select **Continue**. You can also use the **HOLD** hot key. The letter **HOLD** in red disappears and the sweeping resumes.
-

Setting trigger source

You can set the trigger source option for your measurements.

Procedure

- 1 Press the **TRIGGER** hot key.
 - 2 Select the trigger source option from the choices: **Internal**, **External**, and **GPS**.
-

Setting external clock

To enhance the reliability of modulation analysis measurements the JD700B series must be synchronized with a base station. When an external clock is not supplied, the instrument works with its built-in internal high-accuracy time base and some measurement results may exhibit inaccurate values. Therefore, it is highly recommended that you use the same reference clock as the signal source. You can use the **TRIGGER** hot key to set the external clock.

Table 10 Standards of external clock operation

Clock	Type	Reference	Port	Switching Standard
External Reference	Internal	Internal 10 MHz		Default
	External	External Ref Clock	Ext Ref (SMA)	Manual switching (Input signal level >-3 dBm)
	GPS	GPS Clock	GPS (SMA)	Automatic switching (GPS signal received)
Trigger	Internal	Internal Trigger		Default
	External	External Trigger	Trigger (SMA)	Manual switching
	GPS	GPS	GPS (SMA)	Manual switching

Figure 86 Connection ports for external reference clock









Procedure

- 1 Connect an external reference or a GPS antenna to the JD700B series.
- 2 Press the **SYSTEM** hot key.
- 3 Press the **Freq Reference** soft key, and then select the reference option from the choices: **Internal**, **External 10 MHz**, **External 13 MHz**, **External 15 MHz**, and **GPS**.



NOTE
When a GPS antenna is connected and locked, GPS coordinates (longitude and latitude) are displayed on the screen and frequency reference is automatically set to GPS in the **System > Freq Reference**.

Table 11 External reference indicators

Type	Indicator	Description
Internal	 (green)	The green INT icon indicates that the instrument uses the built-in internal time base.
External	 (green)	The green EXT icon indicates that an external reference is connected and locked and that the instrument uses the same reference clock as the signal source.
External	 (red)	The red EXT icon indicates that an external reference is connect but not locked.
GPS	 (green)	The green GPS antenna icon indicates that a GPS antenna is connected and locked.
GPS	 (yellow)	The yellow GPS antenna icon indicates that a GPS antenna is connected and locking is in progress.
GPS	 (grey)	The grey GPS antenna icon indicates that a GPS antenna is not connected, failed, or unable to be locked.

Conducting spectrum measurements

If you have configured test parameters as described in the “Configuring test parameters” on page 170, your measurement result is displayed on the screen as like the following example, **Figure 87**.

Figure 87 Spectrum measurement screen with WCDMA signal analyzer



Setting trace

You can display up to six traces on the measurement chart simultaneously.

Procedure

- 1 Press the **TRACE/DISPLAY** hard key.
- 2 Press the **Select Trace** soft key, and then select the trace number: **T1**, **T2**, **T3**, **T4**, **T5**, or **T6**. The legend shape of the selected trace changes from square to round to indicate that the trace is the active one now.
- 3 Do one of the following:

To	Select	Trace Legend
Clear current data and display with new measurements	Clear Write	W
Display the input signal's maximum response only (unlimited or for a certain amount of time)	Max Hold	M
Display the input signal's minimum response only (unlimited or for a certain amount of time)	Min Hold	m
Capture the selected trace and compare traces	Capture	C
Load a saved trace	More (1/2) > Load	L
Hide the displayed trace	Trace View > Off	F
Remove all the traces and initialize the trace settings	More (1/2) > Trace Clear All	



NOTE

For the **Max Hold** and **Min Hold**, your instrument compares newly acquired data with the active trace and displays larger maximum values or smaller minimum values on the

screen. You can set it to **Unlimited** to hold and view maximum or minimum data or specify a certain amount of time up to 60 seconds by using numeric keys or rotary knob.

- 4 To select the detection option, select **More (1/2) > Detectors**, and then do one of the following:

To display	Select
Random noise better than the peak without missing signals	Normal
The highest value in each data point	Peak
The root mean squared average power across the spectrum	RMS
The lowest value in each data point	Negative Peak
The center value in each data point	Sample

- 5 *Optional.* Select **More (1/2) > Trace Info**, and then select the trace number to view the trace's parameter setting information stored at the time of the measurement or **None** to hide the information display.
- 6 *Optional.* If you have the two traces T1 and T2, you can perform trace math. To view the power difference between the traces, press the **T1 – T2 -> T5** or **T2 – T1 -> T6** soft key. The result is overlaid on the screen along with the second Y-axis.

Conducting RF measurements

Channel power

The Channel Power measurement is a common test used in the wireless industry to measure the total transmitted power of a radio within a defined frequency channel. This procedure measures the total power within the defined channel for WCDMA. This measurement is applied to design, characterize, evaluate, and verify transmitters and their components or devices for base stations and mobile stations.

The channel power measurement identifies the channel power within a specified bandwidth (default is 5 MHz, as per the 3GPP WCDMA technical specifications) and the power spectral density (PSD) in dBm/Hz.

After configuring test parameters as described in the “Configuring test parameters” on page 170, your measurement result is displayed on the screen as like the following example, **Figure 88**.

Figure 88 Channel power measurement with WCDMA/HSPA+ signal analyzer

**NOTE**

You can use the **LIMIT** hot key to analyze your measurements with the user-definable limit and Pass/Fail indication. See “Setting limit for RF tests” on page 182 for more information.

Occupied bandwidth

The 3GPP specifications require the occupied bandwidth (OBW) of a transmitted WCDMA signal to be less than 5 MHz, where occupied bandwidth is defined as the bandwidth containing 99% of the total channel power. In this measurement, the total power of the displayed span is measured. Then the power is measured inward from the right and left extremes until 0.5% of the power is accounted for each of the upper and lower part of the span and the calculated difference is the occupied bandwidth.

The spectrum shape of a WCDMA signal can give a useful qualitative insight into the transmitter’s operation. Any distortion to the spectrum shape might be an indication of degradation of the transmitter’s performance.

After configuring test parameters as described in the “Configuring test parameters” on page 170, your measurement result is displayed on the screen as like the following example, Figure 89.

Figure 89 Occupied bandwidth measurement with WCDMA/HSPA+ signal analyzer



NOTE

You can use the **LIMIT** hot key to analyze your measurements with the user-definable limit and Pass/Fail indication. See “Setting limit for RF tests” on page 182 for more information.

Spectrum emission mask (SEM)

The Spectrum Emission Mask (SEM) measurement required by 3GPP specifications encompasses different power limits and different measurement bandwidths (resolution bandwidths) at various frequency offsets. It may be expressed as a ratio of power spectral densities between the carrier and the specified offset frequency band. It provides useful figures-of-merit for the spectral re-growth and emissions produced by components and circuit blocks, without the rigor of performing a full SEM measurement.

The SEM measures spurious signal levels in up to five pairs of offset or region frequencies and relates them to the carrier power.

Setting measure setup

After configuring test parameters as described in the “Configuring test parameters” on page 170, you can set the mask type according to the output power of the base station to be tested. Your measurement result is displayed on the screen as like the following example, Figure 90.

Procedure

- 1 Press the **MEASURE SETUP** hot key.
- 2 Press the **Mask Type** soft key.
- 3 Select the mask type option: **- 31 dBm, 31 - 39 dBm, 39 - 43 dBm, or 49 dBm -**.

Figure 90 SEM measurement with WCDMA/HSPA+ signal analyzer



NOTE
 You can use the **LIMIT** hot key to analyze your measurements with the user-definable limit and Pass/Fail indication. See “Setting limit for RF tests” on page 182 for more information.

ACLR

The Adjacent Channel Power Ratio (ACPR), designated by the 3GPP WCDMA specifications as the Adjacent Channel Leakage power Ratio (ACLR), is the power contained in a specified frequency channel bandwidth relative to the total carrier power. It may also be expressed as a ratio of power spectral densities between the carrier and the specified offset frequency band.

After configuring test parameters as described in the “Configuring test parameters” on page 170, your measurement result is displayed on the screen as like the following example, Figure 91.

Figure 91 ACLR measurement with WCDMA/HSPA+ signal analyzer



**NOTE**

You can use the **LIMIT** hot key to analyze your measurements with the user-definable limit and Pass/Fail indication. See “Setting limit for RF tests” on page 182 for more information.

Multi-ACLR

The Multi-ACLR measurement is used to perform multi-channel ACLR measurements with as many channels as possible. It helps you to measure ACLR in multi-channel transmitting Base Station environment.

Setting frequency for Multi-ACLR

You can set the frequency with either frequency or channel number.

Procedure

- 1 Press the **MEASURE SETUP** hot key.
 - 2 To set the frequency, do one of the following:
 - To set the center frequency, complete the following steps:
 - a Toggle the **Unit** soft key and select **Freq**.
 - b Press the **Lowest Frequency** soft key to set the starting center frequency.
 - c Enter a value by using the numeric keys. You can also use the rotary knob.
 - d Select the unit: **GHz**, **MHz**, **kHz**, or **Hz**.
 - e Press the **Highest Frequency** soft key to set the stopping center frequency.
 - f Enter a value by using the numeric keys. You can also use the rotary knob.
 - g Select the unit: **GHz**, **MHz**, **kHz**, or **Hz**.
 - To set the channel number, complete the following steps:
 - a Toggle the **Unit** soft key and select **Channel**.
 - b To select the standard channel, press the **Channel Std** soft key and then select the band to be measured.
 - c Press the **Lowest Channel** soft key to set the starting channel.
 - d Enter a value by using the numeric keys. You can also use the rotary knob.
 - e Press the **Enter** soft key.
 - f Press the **Highest Channel** soft key to set the stopping channel.
 - g Enter a value by using the numeric keys. You can also use the rotary knob.
 - h Press the **Enter** soft key.
-

After configuring test parameters, your measurement result is displayed on the screen as like the following example, Figure 92.

Figure 92 Multi-ACLR measurement with WCDMA/HSPA+ signal analyzer

**NOTE**

You can use the **LIMIT** hot key to analyze your measurements with the user-definable limit and Pass/Fail indication. See “Setting limit for RF tests” on page 182 for more information.

Spurious emissions

Out-of-band emissions are unwanted emissions immediately outside the channel bandwidth resulting from the modulation process and non-linearity in the transmitter but excluding spurious emissions. The Spurious Emissions measurement is to identify and determine the power level of out-of-band spurious emission within the necessary channel bandwidth and modulated signal measured at the RF port of the Base Station.

Setting measure setup

Procedure

- 1 Press the **MEASURE SETUP** hot key.
- 2 To set up the range table and parameters, press the **Range Table** soft key and then complete the following steps:
 - a Press the **Range** soft key, and then select the range number between **1** and **20** to add as a new or change the existing settings.
 - b Do the following as desired:
 - Select **Start Frequency**, and then specify the start frequency for the selected range.
 - Select **Stop Frequency**, and then specify the stop frequency for the selected range.
 - Select **Start Limit**, and then specify the lower limit for Pass/Fail indication.
 - Select **Stop Limit**, and then specify the upper limit for Pass/Fail indication.
 - Select **More (1/2) > Attenuation**, and then specify an value in the multiple of five.
 - Select **More (1/2) > RBW**, and then specify a RBW value.
 - Select **More (1/2) > VBW**, and then specify a VBW value.
 - c Press the **PREV** hard key.
 - d Toggle the **Range** soft key and select **On** to display the selected range in the result table or **Off** to hide it from the table.
- 3 Toggle the **Measure Type** soft key between **Examine** and **Full** to select the measurement type.



NOTE
The **Examine** mode displays only the selected range while the **Full** mode lets the instrument automatically changes the selected range from one another.

- 4 To set the number of measurements to be averaged, complete the following steps:
 - a Press the **Average** soft key.
 - b Enter a value between **1** and **100**.
 - c Press the **Enter** soft key.
- 5 To move the highlighted bar in the result table to other range, complete the following steps:
 - a Press the **Range** soft key in the Measure Setup menu bar.
 - b Enter a value between **1** and **20**.
 - c Press the **Enter** soft key.

After configuring test parameters as described in the “Configuring test parameters” on page 170, your measurement result is displayed on the screen as like the following example, Figure 93.

Figure 93 Spurious emissions measurement with WCDMA/HSPA+ signal analyzer



NOTE
You can use the **LIMIT** hot key to analyze your measurements with the user-definable limit and Pass/Fail indication. See “Setting limit for RF tests” on page 182 for more information.

Setting limit for RF tests

By default, test limits specified in the standard are set for you. You can change thresholds if you desire.

Procedure

- 1 Press the **LIMIT** hot key.
- 2 Press the **RF Test Limits** soft key.
- 3 Select the test item(s) and set the limit(s) depending on your selected measurement mode:

To set the limit for	Select	Set
Channel power	Channel Power	High Limit, Low Limit
Occupied bandwidth	Occupied BW	High Limit

Spectrum emission mask	Spectrum Emission Mask	(On/Off only)
ACLR	ACLR	(On/Off only)
Multi-ACLR	Multi-ACLR	(On/Off only)
Spurious emissions	Spurious Emissions	(On/Off only)

- 4 *Optional.* You can enable alarm sound that goes off if the measurement falls outside of the limit. Toggle the **Beep** soft key between **On** and **Off** to enable or disable the beep sound.
- 5 *Optional.* Go to **SAVE/LOAD > Save**, and then select **Limit** to save the limit settings. See “Using save” on page 34 for more information.

Conducting modulation measurements

Constellation

The Constellation is used to observe some aspects of modulation accuracy and can reveal certain fault mechanisms such as I/Q amplitude imbalance or quadrature imbalance. It displays constellation diagram by modulation types.

Setting measure setup

After configuring test parameters as described in the “Configuring test parameters” on page 170, you can continue your measurement. The measurement settings can be saved and recalled as a file.

Procedure

- 1 Press the **MEASURE SETUP** hot key.
- 2 To set the scramble code, complete the following steps:
 - a Toggle the **Scramble** soft key between **Auto** and **Manual**.
 - b Enter a value by using the numeric keys to set manually.
 - c Press the **Enter** soft key.
- 3 Press the **Detect Mode** soft key, and then select the signal standard option: **WCDMA**, **HSDPA**, or **HSPA+**. HSDPA is set by default.
- 4 To set the threshold, complete the following steps:
 - a Press the **Threshold** soft key.
 - b Enter a value by using the numeric keys.
 - c Press the **Enter** soft key.

Measurement example

Figure 94 Constellation measurement with WCDMA/HSPA+ signal analyzer

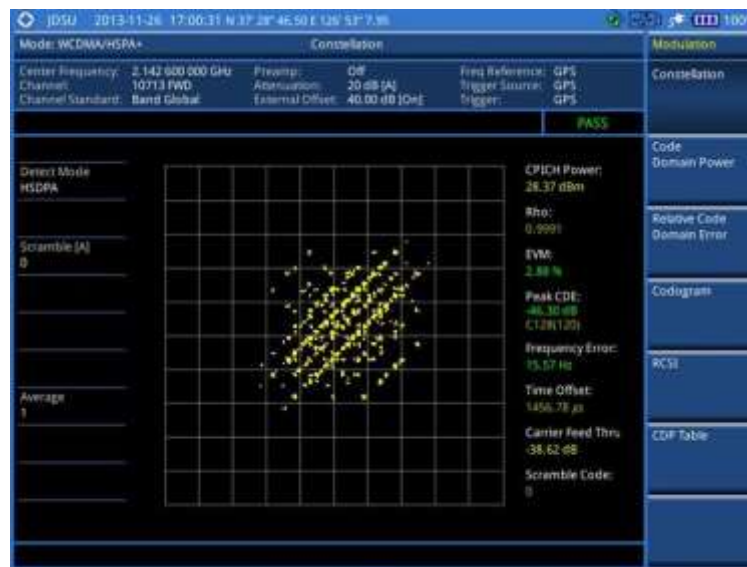
**NOTE**

You can use the **LIMIT** hot key to analyze your measurements with the user-definable limit and Pass/Fail indication. See “Setting limit for modulation tests” on page 194 for more information.

Code domain power

The Code Domain Power (CDP) measures the distribution of power across the set of code channels, normalized to the total power. It helps to verify that each code channel is operating at its proper level and to identify problems throughout the transmitter design from coding to the RF section. System imperfections such as amplifier non-linearity will present themselves as an undesired distribution of power in the code domain.

Setting measure setup

After configuring test parameters as described in the “Configuring test parameters” on page 170, you can continue your measurement. The measurement settings can be saved and recalled as a file. You can also use JDViewer, PC application software to configure a measure setup, save as a file, and load the file on to the instrument.

Procedure

- 1 Press the **MEASURE SETUP** hot key.
- 2 *Optional.* To set the scramble code, complete the following steps:
 - a Toggle the **Scramble** soft key between **Auto** and **Manual**.
 - b Enter a value by using the numeric keys to set manually.
 - c Press the **Enter** soft key.
- 3 *Optional.* Press the **Detect Mode** soft key, and then select the signal standard option: **WCDMA**, **HSDPA**, or **HSPA+**. HSDPA is set by default.
- 4 To set the S-CCPCH information of the system to be tested, complete the following steps:
 - a Press the **S-CCPCH** soft key.
 - b Toggle the **S-CCPCH** soft key between **On** and **Off** to enable or disable the S-CCPCH.
 - c Press the **Spread Factor** soft key, and then select the spread factor option: **4**, **8**, **16**, **32**, **64**, **128**, or **256**.

- d Press the **Spread Code** soft key to set the spread code.
 - e Enter a value by using the numeric keys.
 - f Press the **Enter** soft key.
- 5 To set the PICH information of the system to be tested, complete the following steps:
- a Press the **PICH** soft key.
 - b Toggle the **PICH** soft key between **On** and **Off** to enable or disable the PICH.
 - c Press the **Spread Factor** soft key, and then select the spread factor option: **4, 8, 16, 32, 64, 128, or 256**.
 - d Press the **Spread Code** soft key to set the spread code.
 - e Enter a value by using the numeric keys.
 - f Press the **Enter** soft key.
- 6 *Optional.* To set the threshold, complete the following steps:
- a Press the **Threshold** soft key.
 - b Enter a value by using the numeric keys.
 - c Press the **Enter** soft key.

Measurement example

Figure 95 Code domain power measurement with WCDMA/HSPA+ signal analyzer

1) Full screen



2) Full screen with constellation



3) Zoomed screen (Width 64)



4) Zoomed screen with constellation (Width 64)



**NOTE**

You can use the **LIMIT** hot key to analyze your measurements with the user-definable limit and Pass/Fail indication. See “Setting limit for modulation tests” on page 194 for more information.

Setting display

You can view your measurement results in a different view option.

Procedure

- 1 Press the **TRACE/DISPLAY** hard key.
 - 2 Toggle the **View** soft key and select the display option:
 - Zoom:** You can view the result in detail with zoom-in window. The Position and Width menus become activated.
 - Full:** You can view the full measurement result.
 - 3 To define the zoom start position and width, complete the following steps:
 - a Press the **Position** soft key.
 - b Enter a value of the position by using the numeric keys.
 - c Press the **Enter** soft key.
 - d Press the **Width** soft key, and then select the Walsh code option: **32**, **64**, **128**, or **256**.
 - 4 Toggle the **Constellation** soft key between **On** and **Off** to enable or disable the constellation chart on the Code Domain Power screen.
 - 5 Toggle the **Control Channel** soft key and select the control channel mode option:
 - Normal:** You can view the relative ratio of each control channel vs. total power.
 - Delta:** You can view the relative ratio of each control channel vs. CPICH channel.
-

Relative code domain power

The Relative Code Domain Error (RCDE) measurement provides relative code domain error analysis that is particularly required by HSPA+.

Setting measure setup

After configuring test parameters as described in the “Configuring test parameters” on page 170, you can continue your measurement. The measurement settings can be saved and recalled as a file. You can also use JDViewer, PC application software to configure a measure setup, save as a file, and load the file on to the instrument.

Procedure

- 1 Press the **MEASURE SETUP** hot key.
- 2 *Optional.* To set the scramble code, complete the following steps:
 - a Toggle the **Scramble** soft key between **Auto** and **Manual**.
 - b Enter a value by using the numeric keys to set manually.
 - c Press the **Enter** soft key.
- 3 *Optional.* Press the **Detect Mode** soft key, and then select the signal standard option: **WCDMA**, **HSDPA**, or **HSPA+**. HSDPA is set by default.

**NOTE**

It is recommended that you select **HSPA+** for RCDE testing.

- 4 To set the S-CCPCH information of the system to be tested, complete the following steps:
 - a Press the **S-CCPCH** soft key.
 - b Toggle the **S-CCPCH** soft key between **On** and **Off** to enable or disable the S-CCPCH.
-

- c Press the **Spread Factor** soft key, and then select the spread factor option: **4, 8, 16, 32, 64, 128, or 256**.
 - d Press the **Spread Code** soft key to set the spread code.
 - e Enter a value by using the numeric keys.
 - f Press the **Enter** soft key.
- 5** To set the PICH information of the system to be tested, complete the following steps:
- a Press the **PICH** soft key.
 - b Toggle the **PICH** soft key between **On** and **Off** to enable or disable the PICH.
 - c Press the **Spread Factor** soft key, and then select the spread factor option: **4, 8, 16, 32, 64, 128, or 256**.
 - d Press the **Spread Code** soft key to set the spread code.
 - e Enter a value by using the numeric keys.
 - f Press the **Enter** soft key.
- 6** *Optional.* To set the threshold, complete the following steps:
- a Press the **Threshold** soft key.
 - b Enter a value by using the numeric keys.
 - c Press the **Enter** soft key.
- 7** *Optional.* Go to **SAVE/LOAD > Save**, and then select the save option from the choices available for your measurement mode. See “Using save” on page 34 for more information.

Measurement example

Figure 96 Relative code domain error with WCDMA/HSPA+ signal analyzer



NOTE
You can use the **LIMIT** hot key to analyze your measurements with the user-definable limit and Pass/Fail indication. See “Setting limit for modulation tests” on page 194 for more information.

Setting display

You can view your measurement results in a different view option.

Procedure

- 1 Press the **TRACE/DISPLAY** hard key.

-
- 2 Toggle the **View** soft key and select the display option:
 - Zoom:** You can view the result in detail with zoom-in window. The Position and Width menus become activated.
 - Full:** You can view the full measurement result.
 - 3 To define the zoom start position and width, complete the following steps:
 - a Press the **Position** soft key.
 - b Enter a value of the position by using the numeric keys.
 - c Press the **Enter** soft key.
 - d Press the **Width** soft key, and then select the Walsh code option: **32, 64, 128, or 256**.
 - 4 Toggle the **Constellation** soft key between **On** and **Off** to enable or disable the constellation chart on the Code Domain Power screen.
 - 5 Toggle the **Control Channel** soft key and select the control channel mode option:
 - Normal:** You can view the relative ratio of each control channel vs. total power.
 - Delta:** You can view the relative ratio of each control channel vs. CPICH channel.
-

Codogram

The Codogram displays how the code level is changing over time and makes it easier for you to view traffic channels as they initiate and terminate and to track traffic channels call levels over time. The Codogram measurements can be saved into an external USB memory so that a post-analysis can be done with the application software JDViewer.

Setting measure setup

After configuring test parameters as described in the “Configuring test parameters” on page 170, you can continue your measurement. The measurement settings can be saved and recalled as a file. You can also use JDViewer, PC application software to configure a measure setup, save as a file, and load the file on to the instrument.

Procedure

- 1 Press the **MEASURE SETUP** hot key.
 - 2 *Optional.* To set the scramble code, complete the following steps:
 - a Toggle the **Scramble** soft key between **Auto** and **Manual**.
 - b Enter a value by using the numeric keys to set manually.
 - c Press the **Enter** soft key.
 - 3 *Optional.* Press the **Detect Mode** soft key, and then select the signal standard option: **WCDMA, HSDPA, or HSPA+**. HSDPA is set by default.
 - 4 To set the S-CCPCH information of the system to be tested, complete the following steps:
 - a Press the **S-CCPCH** soft key.
 - b Toggle the **S-CCPCH** soft key between **On** and **Off** to enable or disable the S-CCPCH.
 - c Press the **Spread Factor** soft key, and then select the spread factor option: **4, 8, 16, 32, 64, 128, or 256**.
 - d Press the **Spread Code** soft key to set the spread code.
 - e Enter a value by using the numeric keys.
 - f Press the **Enter** soft key.
 - 5 To set the PICH information of the system to be tested, complete the following steps:
 - a Press the **PICH** soft key.
 - b Toggle the **PICH** soft key between **On** and **Off** to enable or disable the PICH.
 - c Press the **Spread Factor** soft key, and then select the spread factor option: **4, 8, 16, 32, 64, 128, or 256**.
 - d Press the **Spread Code** soft key to set the spread code.
-

- e Enter a value by using the numeric keys.
 - f Press the **Enter** soft key.
 - 6 *Optional.* To set the threshold, complete the following steps:
 - a Press the **Threshold** soft key.
 - b Enter a value by using the numeric keys.
 - c Press the **Enter** soft key.
 - 7 To set the time interval, complete the following steps:
 - a Press the **Time Interval** soft key.
 - b Enter a value by using the numeric keys.
 - c Press the **Enter** soft key.
 - 8 To place the time cursor to analyze your measurements, complete the following steps:
 - a Toggle the **Time Cursor** soft key between **On** and **Off** to enable or disable the time cursor.
 - b Enter a value by using the numeric keys.
 - c Press the **Enter** soft key.
- NOTE**
When the time cursor is enabled, the measurement is put on hold and information about the time cursor is displayed.
- 9 To start a new measurement, press the **Reset/Restart** soft key.
 - 10 *Optional.* Go to **SAVE/LOAD > Save**, and then select the save option from the choices available for your measurement mode. See “Using save” on page 34 for more information.

Measurement example

Figure 97 Codogram in full view with WCDMA/HSPA+ signal analyzer



Setting display

You can view your measurement results in a different view option.

Procedure

- 1 Press the **TRACE/DISPLAY** hard key.
- 2 Toggle the **View** soft key and select the display option:
 - Zoom:** You can view the result in detail with zoom-in window. The Position and Width menus become activated.

Full: You can view the full measurement result.

- 3 To define the zoom start position and width, complete the following steps:
 - a Press the **Position** soft key.
 - b Enter a value of the position by using the numeric keys.
 - c Press the **Enter** soft key.
 - 4 Press the **Width** soft key, and then select the Walsh code option: **32, 64, 128, or 256**.
-

RCSI

The Received Code Strength indicator (RCSI) is used to track the code channels such as CPICH, P-CCPCH, S-CCPCH, PICH, P-SCH, and S-SCH. It is particularly useful to observe signal fluctuations of the dedicated control channels over the time. The RCSI measurements can be saved into an external USB memory so that a post-analysis can be done with the application software JDViewer.

Setting measure setup

After configuring test parameters as described in the “Configuring test parameters” on page 170, you can continue your measurement. The measurement settings can be saved and recalled as a file. You can also use JDViewer, PC application software to configure a measure setup, save as a file, and load the file on to the instrument.

Procedure

- 1 Press the **MEASURE SETUP** hot key.
 - 2 *Optional.* To set the scramble code, complete the following steps:
 - a Toggle the **Scramble** soft key between **Auto** and **Manual**.
 - b Enter a value by using the numeric keys to set manually.
 - c Press the **Enter** soft key.
 - 3 *Optional.* Press the **Detect Mode** soft key, and then select the signal standard option: **WCDMA, HSDPA, or HSPA+**. HSDPA is set by default.
 - 4 To set the S-CCPCH information of the system to be tested, complete the following steps:
 - a Press the **S-CCPCH** soft key.
 - b Toggle the **S-CCPCH** soft key between **On** and **Off** to enable or disable the S-CCPCH. Setting this on makes the S-CCPCH in the Alarm Code menu activated.
 - c Press the **Spread Factor** soft key, and then select the spread factor option: **4, 8, 16, 32, 64, 128, or 256**.
 - d Press the **Spread Code** soft key to set the spread code.
 - e Enter a value by using the numeric keys.
 - f Press the **Enter** soft key.
 - 5 To set the PICH information of the system to be tested, complete the following steps:
 - a Press the **PICH** soft key.
 - b Toggle the **PICH** soft key between **On** and **Off** to enable or disable the PICH. Setting this on makes the PICH in the Alarm Code menu activated.
 - c Press the **Spread Factor** soft key, and then select the spread factor option: **4, 8, 16, 32, 64, 128, or 256**.
 - d Press the **Spread Code** soft key to set the spread code.
 - e Enter a value by using the numeric keys.
 - f Press the **Enter** soft key.
 - 6 *Optional.* To set the threshold, complete the following steps:
 - a Press the **Threshold** soft key.
 - b Enter a value by using the numeric keys.
 - c Press the **Enter** soft key.
 - 7 Press the **Alarm Code** soft key, and then select the alarm code option: **None, CPICH, P-**
-

CCPCH, S-CCPCH, PICH, P-SCH, or S-SCH.



NOTE

The alarm codes S-CCPCH and PICH become activated in case that you have enabled the S-CCPCH and PICH respectively.

- 8 To set the alarm mask, complete the following steps:
 - a Press the **Set Mask** soft key.
 - b Enter a value by using the numeric keys.
 - c Press the **Enter** soft key.
- 9 *Optional.* Go to **SAVE/LOAD > Save**, and then select the save option from the choices available for your measurement mode. See “Using save” on page 34 for more information.

Measurement example

Figure 98 RCSI measurement with WCDMA/HSPA+ signal analyzer



Setting display

You can view your measurement results in a different view option.

Procedure

- 1 Press the **TRACE/DISPLAY** hard key.
- 2 Toggle the **View** soft key and select the display option:
 - Zoom:** You can view the result in detail with zoom-in window. The Position and Width menus become activated.
 - Full:** You can view the full measurement result.
- 3 To define the zoom start position and width, complete the following steps:
 - a Press the **Position** soft key.
 - b Enter a value of the position by using the numeric keys.
 - c Press the **Enter** soft key.
 - d Press the **Width** soft key, and then select the Walsh code option: **32, 64, 128, or 256**.

CDP Table

The CDP Table is used to look at a numeric and textual description of all the active code channels in the signal.

Setting measure setup

After configuring test parameters as described in the “Configuring test parameters” on page 170, you can continue your measurement. The measurement settings can be saved and recalled as a file. You can also use JDViewer, PC application software to configure a measure setup, save as a file, and load the file on to the instrument.

Procedure

- 1 Press the **MEASURE SETUP** hot key.
 - 2 *Optional.* To set the scramble code, complete the following steps:
 - a Toggle the **Scramble** soft key between **Auto** and **Manual**.
 - b Enter a value by using the numeric keys to set manually.
 - c Press the **Enter** soft key.
 - 3 *Optional.* Press the **Detect Mode** soft key, and then select the signal standard option: **WCDMA**, **HSDPA**, or **HSPA+**. HSDPA is set by default.
 - 4 To set the S-CCPCH information of the system to be tested, complete the following steps:
 - a Press the **S-CCPCH** soft key.
 - b Toggle the **S-CCPCH** soft key between **On** and **Off** to enable or disable the S-CCPCH.
 - c Press the **Spread Factor** soft key, and then select the spread factor option: **4**, **8**, **16**, **32**, **64**, **128**, or **256**.
 - d Press the **Spread Code** soft key to set the spread code.
 - e Enter a value by using the numeric keys.
 - f Press the **Enter** soft key.
 - 5 To set the PICH information of the system to be tested, complete the following steps:
 - a Press the **PICH** soft key.
 - b Toggle the **PICH** soft key between **On** and **Off** to enable or disable the PICH.
 - c Press the **Spread Factor** soft key, and then select the spread factor option: **4**, **8**, **16**, **32**, **64**, **128**, or **256**.
 - d Press the **Spread Code** soft key to set the spread code.
 - e Enter a value by using the numeric keys.
 - f Press the **Enter** soft key.
 - 6 *Optional.* To set the threshold, complete the following steps:
 - a Press the **Threshold** soft key.
 - b Enter a value by using the numeric keys.
 - c Press the **Enter** soft key.
-

Measurement example

Figure 99 CDP Table measurement with WCDMA/HSPA+ signal analyzer



Setting display

If the CDP table spans over to the next page(s), you can change pages up and down to view your measurement results.

Procedure

- 1 Press the **TRACE/DISPLAY** hard key.
- 2 Select **Page Up** or **Page Down** as needed.

Setting limit for modulation tests

Procedure

- 1 Press the **LIMIT** hot key.
- 2 Press the **Modulation Test Limits** soft key to set the limits.
- 3 Select the test item(s) and set the limit(s) depending on your selected measurement mode:

To set the limit for	Select	Set
Frequency error	Frequency Error	High Limit, Low Limit
Error vector magnitude	EVM	High Limit
Peak code domain error	PCDE	High Limit
Carrier feed through	Carrier Feed Through	High Limit
Correlated power in coded channel	CPICH	High Limit [Abs Rel] Low Limit [Abs Rel]
Highest level among inactive channels	Max Inactive	High Limit
Relative code domain error	RCDE	High Limit (QPSK) High Limit (16 QAM) High Limit (64 QAM)

-
- 4 *Optional.* You can enable alarm sound that goes off if the measurement falls outside of the limit. Toggle the **Beep** soft key between **On** and **Off** to enable or disable the beep sound.
 - 5 *Optional.* Go to **SAVE/LOAD > Save**, and then select **Limit** to save the limit settings. See “Using save” on page 34 for more information.
-

**NOTE**

The Carrier Feed Through is a result of the RF carrier signal feeding through the I/Q modulator and riding on the output circuitry without being modulated.

Performing auto measurements

The Auto Measure function of the JD700B series allows a complete signal profiling covering RF characterization and modulation quality parameters of up to 10 different carriers, particularly useful on an overlay architecture where base stations are transmitting in different frequencies.

The Auto Measure can be easily executed either by selecting a menu in the instrument or by running a programmed scenario in the PC-based application so that the instrument automatically configure and perform tests on every aspect of all the carriers.

Setting limit for auto measure

You can set test limits for test item(s) in the auto measurement.

Procedure

- 1 Press the **LIMIT** hot key.
 - 2 Press the **RF Test Limits** soft key, and then enable test limits as desired.
 - 3 Press the **Modulation Test Limits** soft key, and then enable test limits as desired.
 - 4 *Optional.* You can enable alarm sound that goes off if the measurement falls outside of the limit. Toggle the **Beep** soft key between **On** and **Off** to enable or disable the beep sound.
 - 5 *Optional.* Go to **SAVE/LOAD > Save**, and then select **Limit** to save the limit settings. See “Using save” on page 34 for more information.
-

Setting measure setup

After configuring test parameters as described in the “Configuring test parameters” on page 170, you can continue your measurement. The measurement settings can be saved and recalled as a file. You can also use JDViewer, PC application software to configure a measure setup, save as a file, and load the file on to the instrument.

Procedure

- 1 Press the **MEASURE SETUP** hot key.
 - 2 Toggle the **Configuration** soft key and select the configuration option:
 - Current:** Lets the instrument use current frequency (single carrier) and determine pass or fail based on the instrument’s limit settings in Auto Measure.
 - Scenario:** Runs a test with a programmed scenario in JDViewer. The Scenario menu becomes activated.
 - 3 To load a scenario, press the **Scenario** soft key, and then select a scenario file to load.
 - 4 Toggle the **Test Time** soft key and select the test time option:
 - Now:** Lets the instrument run a test only once.
-

Schedule: Lets the instrument repeat tests as defined in the Set Timing. The Set Timing menu becomes activated.

- 5 To define a schedule for an auto measurement, complete the following steps:
 - a Press the **Set Timing** soft key.
 - b Press the **Start Time (HH:MM)** soft key.
 - c Enter the time in the HH:MM format, and then press the **Enter** soft key.
 - d Press the **Stop Time (HH:MM)** soft key.
 - e Enter the time in the HH:MM format, and then press the **Enter** soft key.
 - f Press the **Time Interval** soft key.
 - g Enter the amount of time in minutes, and then press the **Enter** soft key.
 - 6 To set external offset, complete the following steps:
 - a Toggle the **External Offset** soft key and select **On**.
 - b Enter a value by using the numeric keys, and then press the **dB** soft key.
 - 7 To save your settings and results, go to **SAVE/LOAD > Save** and then perform functions as you desire. See "Using save" on page 34 for more information.
 - 8 Press the **Run Test** soft key to start to run a test. The Auto Measure Results window appears at the end of the test.
 - 9 To stop running the test, press the **Abort** soft key.
 - 10 To change the view on the screen during the test, press the **Display** and then select the view option from the following choices:
 - Screen:** You can view each measurement screen as the test progresses.
 - Results:** You can view a measurement result table as the test progresses.
 - Settings:** You can view a measurement setting table as the test progresses.
-

Setting display

After completion of the auto measurement, the screen menu changes to Trace/Display so that you can view the results in different forms.

Procedure

- 1 Toggle the **Display** soft key and select the display option:
 - Result:** You can view the result table. The Display Result menu becomes activated.
 - Settings:** You can view the measurement settings for the auto measurement.
 - 2 Toggle the **Display Result** soft key and select the display result option:
 - Full:** You can view detailed measurement readings with the pass/fail indication.
 - Quick:** You can view only the Pass/Fail results.
 - 3 To view the measurement results for a different carrier, press the **View Carrier** soft key and then select the carrier number to view.
-

Performing power statistics CCDF measurement

The Power Statistics Complementary Cumulative Distribution Function (CCDF) measurement characterizes the power statistics of the input signal. It provides PAR (Peak to Average power Ratio) versus different probabilities.

Setting measure setup

After configuring test parameters as described in the "Configuring test parameters" on page 170, you can

continue your measurement. The measurement settings can be saved and recalled as a file. You can also use JDViewer, PC application software to configure a measure setup, save as a file, and load the file on to the instrument.

Procedure

- 1 Press the **MEASURE SETUP** hot key.
 - 2 Press the **CCDF Length** soft key to set the length of the CCDF.
 - 3 Enter a value between 1 and 100 by using the numeric keys. You can also use the rotary knob.
 - 4 Press the **Enter** soft key.
-

Measurement example

Figure 100 CCDF measurement with WCDMA/HSPA+ signal analyzer



Conducting WCDMA/HSPA+ OTA measurements

This Over The Air (OTA) measurement has channel scanner, scramble scanner, multipath profile, code domain power, and route map screens. Scramble scanner displays six scrambling codes and powers to inform neighbor cells existence and its power. The multipath profile graph helps you to determine testing area's RF environmental condition. The code domain power shows not only modulation performance metric but also amplifier capacity and code utilization metric. The amplifier capacity (code utilization) measurement is an estimate of the amount of power amplifier capacity (code utilization) that is being used expressed in percent of maximum.

Channel scanner

Setting channel/frequency

Procedure

To set the channels to be scanned:

- 1 Press the **FREQ/DIST** hard key.
 - 2 Toggle the **Unit** soft key and select **Channel**.
-

- 3 Press the **Index** soft key, and then enter an index number by turning the rotary knob or using the numeric keys.
- 4 To select the standard channel, complete the following steps:
 - a Press the **Channel Std** soft key. The standard channel window appears. See “Appendix C – Band, frequency & channel standard” on page 769 for more information.
 - b Highlight the band to be measured by using the rotary knob, the arrow keys, or the **Page Up/Page Down** soft keys.
 - c Press the **Select** soft key or the rotary knob to confirm the selection.
- 5 To set the channel number for the selected index, complete the following steps:
 - a Press the **Channel Number** soft key.
 - b Enter a value by using the numeric keys. You can also use the rotary knob.
 - c Press the **Enter** soft key.
- 6 The instrument displays a corresponding center frequency for the channel number.
- 7 To set the integration bandwidth for the selected index, complete the following steps:
 - a Press the **Integration Bandwidth** soft key.
 - b Enter a value by using the numeric keys. You can also use the rotary knob.
 - c Select the unit: **GHz, MHz, kHz, or Hz**.
- 8 To add more channels to be scanned, repeat steps 3-6.
- 9 Press the **ESC** hard key to dismiss the channel list window and view the scanning result.

To set the frequencies to be scanned:

- 1 Press the **FREQ/DIST** hard key.
- 2 Toggle the **Unit** soft key and select **Freq**.
- 3 Press the **Index** soft key, and then enter an index number by turning the rotary knob or using the numeric keys.
- 4 To set the center frequency for the selected index, complete the following steps:
 - a Press the **Center Frequency** soft key.
 - b Enter a value by using the numeric keys. You can also use the rotary knob.
 - c Select the unit: **GHz, MHz, kHz, or Hz**.
- 5 To set the integration bandwidth for the selected index, complete the following steps:
 - a Press the **Integration Bandwidth** soft key.
 - b Enter a value by using the numeric keys. You can also use the rotary knob.
 - c Select the unit: **GHz, MHz, kHz, or Hz**.
- 6 To add more channels to be scanned, repeat steps 3-5.
- 7 Press the **ESC** hard key to dismiss the channel list window and view the scanning result.

Setting limit for OTA channel scanner

Procedure

- 1 Press the **LIMIT** hot key.
- 2 Press the **Limit Line** soft key to set a threshold for the limit line and Pass/Fail indication.
- 3 Enter a value, and then press the **dBm** unit soft key.
- 4 Toggle the **Limit Line** soft key between **On** and **Off** to display or dismiss the limit line.
- 5 *Optional.* You can enable alarm sound that goes off if the measurement falls outside of the limit. Toggle the **Beep** soft key between **On** and **Off** to enable or disable the beep sound.
- 6 *Optional.* Go to **SAVE/LOAD > Save**, and then select **Limit** to save the limit settings. See “Using save” on page 34 for more information.

Measurement example

Figure 101 Channel scanner measurement with WCDMA/HSPA+ OTA signal analyzer



Scramble scanner

The WCDMA/HSPA+ mobile receives signals from multiple base stations that all of these signals share the same spectrum and are present at the same time. Each base station has a unique scrambling code assigned to the particular base station and it differentiates its signal from other base stations in the area.

Measurement example

Figure 102 Scramble scanner measurement with WCDMA/HSPA+ OTA signal analyzer



Multipath profile

The Multipath Profile enables you to determine RF environmental conditions of testing area. It indicates the amount of power of the dominant pilot signal that is dispersed outside the main correlation peak due to multipath echoes that are expressed in dB. This value should be very small ideally.

The multipath profile is the result of portions of the original broadcast signal arriving at the receiving antenna out of phase. This can be caused by the signal being reflected off objects such as buildings, or being refracted through the atmosphere differently from the main signal.

Measurement example

Figure 103 Multipath profile measurement with WCDMA/HSPA+ OTA signal analyzer



Code domain power

Channels with high correlation factors are determined to be active channels and are indicated as such on the display. Once the channels are decoded, the analyzer determines the power of each channel relative to the total signal power.

This measurement helps to verify that each code channel is operating at its proper level and helps to identify problems throughout the transmitter design from the coding to the RF section. System imperfections, such as the non-linearity of amplifiers, will present themselves as an undesired distribution of power in the code domain.

Setting measure setup

After configuring test parameters, you can set the measure setup to continue your measurement. The measurement settings can be saved and recalled as a file. You can also use JDViewer, PC application software to configure a measure setup, save as a file, and load the file on to the instrument.

Procedure

- 1 Press the **MEASURE SETUP** hot key.
- 2 To set the scramble code, complete the following steps:
 - a Toggle the **Scramble** soft key between **Auto** and **Manual**.
 - b Enter a value by using the numeric keys to set manually.
 - c Press the **Enter** soft key.
- 3 Press the **Detect Mode** soft key, and then select the signal standard option: **WCDMA**, **HSDPA**, or **HSPA+**. HSDPA is set by default.
- 4 To set the threshold, complete the following steps:
 - a Press the **Threshold** soft key.

- b Enter a value by using the numeric keys.
 - c Press the **Enter** soft key.
- 5** To set the S-CCPCH information of the system to be tested, complete the following steps:
- a Press the **S-CCPCH** soft key.
 - b Toggle the **S-CCPCH** soft key between **On** and **Off** to enable or disable the S-CCPCH.
 - c Press the **Spread Factor** soft key, and then select the spread factor option: **4, 8, 16, 32, 64, 128, or 256**.
 - d Press the **Spread Code** soft key to set the spread code.
 - e Enter a value by using the numeric keys.
 - f Press the **Enter** soft key.
- 6** To set the PICH information of the system to be tested, complete the following steps:
- a Press the **PICH** soft key.
 - b Toggle the **PICH** soft key between **On** and **Off** to enable or disable the PICH.
 - c Press the **Spread Factor** soft key, and then select the spread factor option: **4, 8, 16, 32, 64, 128, or 256**.
 - d Press the **Spread Code** soft key to set the spread code.
 - e Enter a value by using the numeric keys.
 - f Press the **Enter** soft key.
- 7** To set the maximum amplifier power, complete the following steps:
- a Press the **Max Amplifier Power** soft key.
 - b Enter a value by using the numeric keys.
 - c Press the **dBm** soft key.
- 8** To set the CPICH power, complete the following steps:
- a Press the **More (1/2)** soft key.
 - b Press the **CPICH** soft key.
 - c Enter a value by using the numeric keys.
 - d Press the **dBm** soft key.
- 9** To set the threshold for CPICH dominance, complete the following steps:
- a Press the **CPICH Dominance >** soft key.
 - b Enter a value by using the numeric keys.
 - c Press the **Enter** soft key.

**NOTE**

Recommended value is 10. Color of the CPICH Dominance indicator on the screen bases on this setting.

- 10** To set the threshold for multipath power, complete the following steps:
- a Press the **Multipath Power <** soft key.
 - b Enter a value by using the numeric keys.
 - c Press the **Enter** soft key.

**NOTE**

Recommended value is one. Color of the multipath power indicator on the screen bases on this setting.

- 11** *Optional.* Go to **SAVE/LOAD > Save**, and then select the save option from the choices available for your measurement mode. See “Using save” on page 34 for more information.

Measurement example

Figure 104 Code domain power measurement with WCDMA/HSPA+ OTA signal analyzer



NOTE

You can use the **LIMIT** hot key to analyze your measurements with the user-definable limit and Pass/Fail indication.

Route map

The JD700B Series provides the Route Map function that allows you to collect data of points in an indoor or outdoor environment and track the received signals and coverage of RF transmitters by plotting data real time directly on top of a loaded floor plan or a map.

The JD700B Series also supports the RAN-IL (Interference Location) feature that enables you to overlay user experience data obtained through Viavi’s ariesoGEO on your base map to help you troubleshoot problems easily and quickly using your instrument. You can generate raster data files on the ariesoGEO application and load them on your instrument.

Setting measure setup

Procedure

- 1 If required, connect a GPS receiver to your JD700B series for outdoor mapping. Indoor mapping does not necessarily need a GPS antenna.
- 2 Configure test parameters as described in the “Configuring test parameters” on page 170.
- 3 To load your map file, complete the following steps:
 - a Plug in your USB drive that has a floor map or .mcf file type created in JDMapCreator. If the JDMapCreator application on your computer is connected to the instrument via USB or LAN, you can send a map file with a single layer to the instrument directly by using the **Send to EQP** menu in JDMapCreator.



NOTE

The JDMapCreator converts and resizes any scanned floor plan or layout to fit onto your instrument’s display. JDMapCreator 1.2.0 or later can save a multiple-layered map, providing **x1**, **x2**, and **x4** views, as a sizable map file so that you can zoom in and out after loading it.

- b Press **SAVE/LOAD** hot key, and then select **Load > Load Map**. See “Using load” on page 36 for more information.

- 4 Press the **MEASURE SETUP** hot key.
- 5 Press the **Plot Point** soft key, and then select the plot point option from the following choices:
To collect data/plot points automatically as you move around in a vehicle or outside, press the **GPS** soft key and then toggle the **Screen Mode** soft key between **Map** and **Full**.



NOTE
With the **Map** setting, you can view only the collected points that can be seen within the boundary of the loaded map. If a point is off the map, the instrument displays an arrow to indicate the direction of the current location on the map and the distance from the center to the location at the top of the screen.

With the **Full** setting, you can view all the collected points of the route without the loaded map.

To collect data/plot points manually without a GPS antenna in an indoor environment, press the **Position** soft key.

- 6 Press the **Plot Item** soft key, and then select the measurement option: **CPICH Power** or **Ec/lo**.
- 7 Toggle the **Plot** soft key and select **Start**.
- 8 Touch directly on the screen or press the **ENTER** hard key to collect data and plot points on the loaded map for the **Position** setting.



NOTE
For the **Position** setting, you can change the direction of the route with the arrow keys and the distance with the rotary knob.

- 9 Toggle the **Plot** soft key and select **Stop** to stop plotting.
- 10 Press the **SAVE/LOAD** hot key to save the result.
See "Using save" on page 34 for more information.



NOTE
The instrument does not automatically save the collected data. It is recommended that you save the result. Otherwise, you will lose all the collected data.

Setting limit

You can set the thresholds for the four different color indicators for CPICH power or Ec/lo.

Procedure

- 1 Press the **LIMIT** hot key.
- 2 Select the plot items and set the limits as needed:

To set the limit for	Select	Set
CPICH Power	CPICH Power	Excellent, Very Good, Good, Fair, Poor (dBm)
CPICH Ec/lo	Ec/lo	Good, Fair, Poor (dB)
- 3 *Optional.* Go to **SAVE/LOAD > Save**, and then select **Limit** to save the limit settings.
See "Using save" on page 34 for more information.

Measurement example

Figure 105 Route map measurement (CPICH Power) with WCDMA/HSPA+ OTA signal analyzer



Figure 106 Route map measurement (CPICH Ec/Io) with WCDMA/HSPA+ OTA signal analyzer

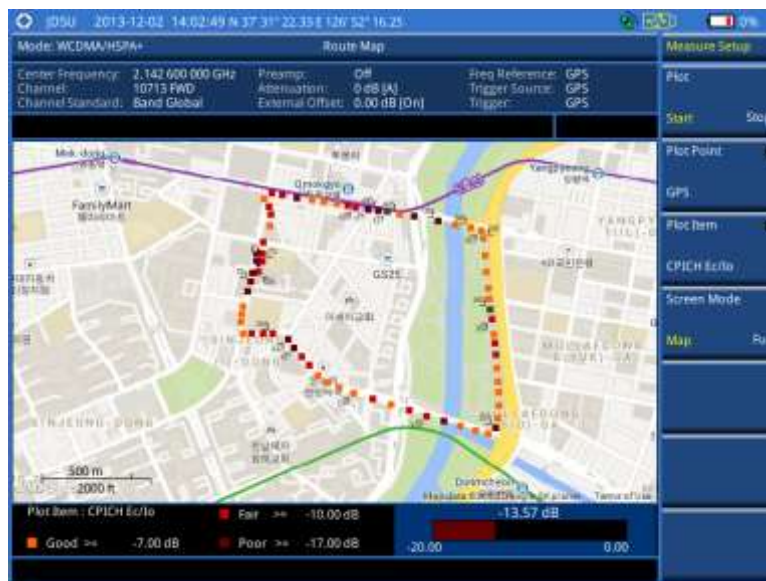

Controlling a map

If you have loaded a sizable map that was created in JDMapCreator 1.2.0 or later, you can use the Map Control feature that enables you to zoom into the map and view a specific area of interest in detail.

Procedure

- 1 Press the **TRACE/DISPLAY** hard key.
- 2 Press the **Map Control** soft key. This key is active only when you have loaded a sizable map.
- 3 Do one of the following:
 - To zoom into an area of interest directly, complete the following steps:
 - a Toggle the **Zoom to** soft key and select **Area**. The black rectangle appears on the map.

- b Press the **Zoom In** and **Zoom Out** soft keys, as you need, to decrease and increase the selected area.
- c Move the rectangle by using the four arrow keys, as you need, to place it in a specific area of interest.
- d Press the center of the rotary knob to zoom into the selected area. You can also press the **Zoom to** soft key again to zoom into the selected area.

To zoom into the center or zoom out from the center, complete the following steps:

- a Toggle the **Zoom to** soft key and select **Center**.
 - b Press the **Zoom In** and **Zoom Out** soft keys, as you need, to zoom in and zoom out.
 - c Move the zoomed-in area by using the four arrow keys, as you need.
- 4 To set the location mode, toggle the **Location Mode** soft key between **Auto** and **Manual** and select the one you desire.

Auto: The instrument compares the coordinates of the displayed map with received GPS information. If your current location goes out of the displayed area and enters into the next zoomed-in section within the base map, the map display changes automatically to the next section in which your current position is.

Manual: The map display of the zoomed-in area remains unchanged even if your current location goes out of the displayed area. You can change the displayed area manually by using the arrow keys.

Loading and displaying raster data

If you have a set of raster data files generated through the ariesoGEO application, you can load and overlay the data on your base map to help you check the signal quality and the strength of interferences while driving toward the area of interest.

Procedure

- 1 Copy a set of raster data files into your USB memory drive, including the following:
- ASCII:** `.tab`, `.asc`, and `.clr` files
 - BIL:** `.tab`, `.hdr`, `.bil`, and `.clr` files



NOTE

The `.tab` file type is a geospatial vector data format used in many geographic information systems. The color file (`.clr`) is an optional file, but the image will be displayed as a grayscale image without it. The size of the raster map must be **1024 x 1024** or smaller.

- 2 Plug in the USB memory drive to your instrument.
- 3 Press the **TRACE/DISPLAY** hard key.
- 4 Press the **Load Raster Map** soft key.
The file explorer window appears.
- 5 Navigate to the raster file (`.tab`) you want to open, and then press the **Load** soft key.
The raster image appears on top of your base map as shown in Figure 107.



NOTE

If the area of the loaded raster data is not within the boundary of the base map, you will not see the raster image on the screen.

- 6 To select the display option, complete the following steps:
- a Press the **Display Options** soft key.
 - b Select the option you desire from the choices: **On**, **Off**, and **Blink**.
- 7 To adjust the transparency level of the image, complete the following steps:
- a Press the **Transparency** soft key.
 - b Enter a value between **0** for opaque and **100** for clear.
 - c Press the **Enter** soft key.

Figure 107 Raster image overlaid on the base map in WCDMA/HSPA+ OTA signal analyzer



Chapter 8 Using LTE-FDD Signal Analyzer

This chapter provides instructions for using the LTE-FDD Signal Analyzer (option 028) and LTE-Advanced FDD Analyzer (option 030) with the LTE-FDD OTA Analyzer (option 048), LTE-FDD 256 QAM Demodulator (option 032), and the LTE-FDD RAN Performance Indicator (option 014). Topics discussed in this chapter are as follows:

■ Introduction.....	208
■ Display overview	209
■ Connecting a cable.....	209
■ Selecting measurement mode	211
■ Configuring test parameters.....	211
■ Conducting spectrum measurements	216
■ Conducting RF measurements	217
■ Conducting power vs. time (frame) measurements	224
■ Conducting modulation measurements.....	225
■ Performing auto measurements.....	244
■ Performing power statistics CCDF measurements	251
■ Performing carrier aggregation measurements	252
■ Conducting LTE-FDD OTA measurements	257
■ Performing RAN performance testing	272
■ Performing NB-IoT modulation analysis.....	275

Introduction

The LTE (Long-Term Evolution) Signal Analyzer of the JD700B series performs power and spectrum measurements as well as modulation analysis to test the proper transmitter performance of FDD LTE systems. It performs conformance testing according to the following standards providing a simple Pass/Fail indication on each test.

- 3GPP TS 36.104. Evolved Universal Terrestrial Radio Access (E-UTRA); Base Station (BS) Radio Transmission and Reception
- 3GPP TS 36.141. Evolved Universal Terrestrial Radio Access (E-UTRA); Base Station (BS) Conformance Testing
- 3GPP TS 36.211. Evolved Universal Terrestrial Radio Access (E-UTRA); Physical Channels and Modulation
- 3GPP TS 36.212. Evolved Universal Terrestrial Radio Access (E-UTRA); Multiplexing and Channel Coding
- 3GPP TS 36.213 V8.2.0. Evolved Universal Terrestrial Radio Access (E-UTRA); Physical Layer Procedures

This instrument provides the following measurement tools for FDD LTE system:

- Spectrum Analysis
- RF Analysis
 - Channel Power
 - Occupied Bandwidth
 - Spectrum Emission Mask
 - Adjacent Channel Leakage power Ratio (ACLR)
 - Multi-ACLR
 - Spurious Emissions
- Power vs. Time (Frame)
- Modulation Analysis
 - Constellation
 - Data Channel
 - Control Channel
 - Subframe
 - Frame
 - Time Alignment Error
 - Data Allocation Map
- Auto Measure:
 - Conformance Test
 - Maintenance Test
 - Signal Performance Test
 - DAS Test

- Power Statistics CCDF
- Carrier Aggregation
- Over The Air (OTA)
 - Channel Scanner
 - ID Scanner
 - Multipath Profile
 - Control Channel
 - Datagram
 - Route Map
- RAN Performance Indicator

Display overview

Figure 108 provides descriptions for each segment of the measurement screen.

Figure 108 LTE-FDD signal analyzer measurement screen

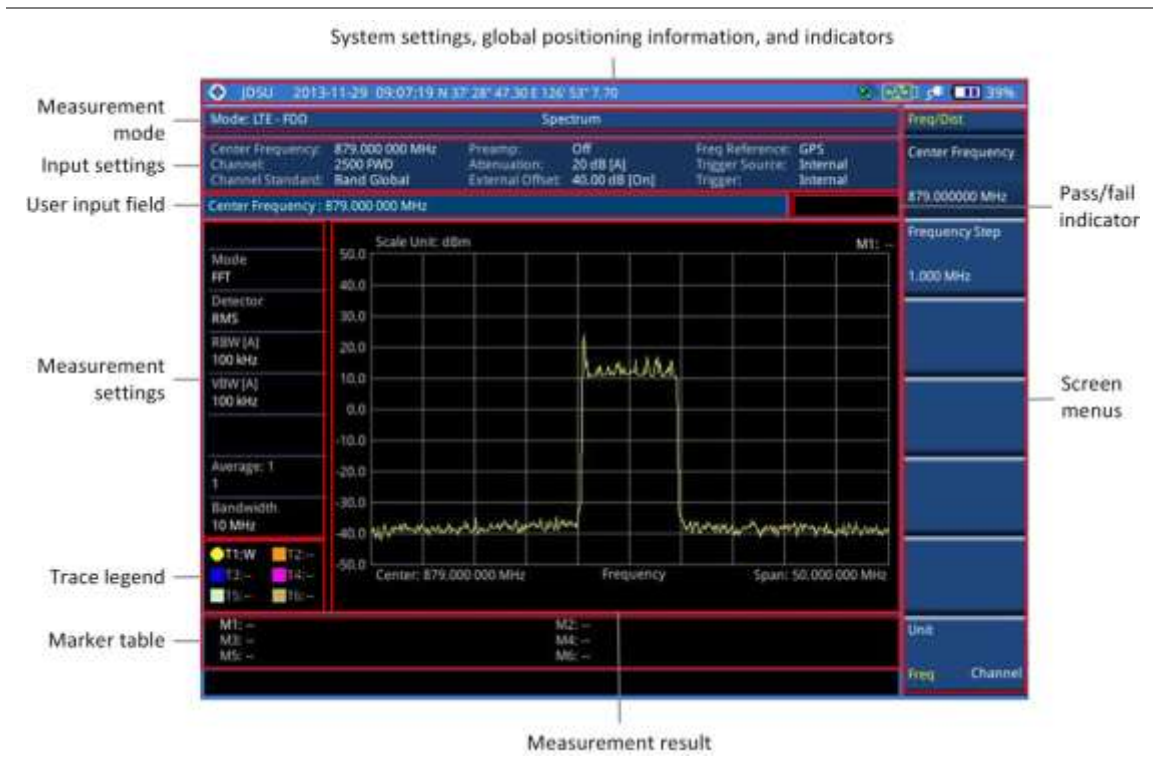

Connecting a cable

Direct connection

Procedure

- 1 Connect the **Spectrum Analyzer RF In** port of the JD700B series and the Power amplifier output port of BTS.

Figure 109 Direct connection

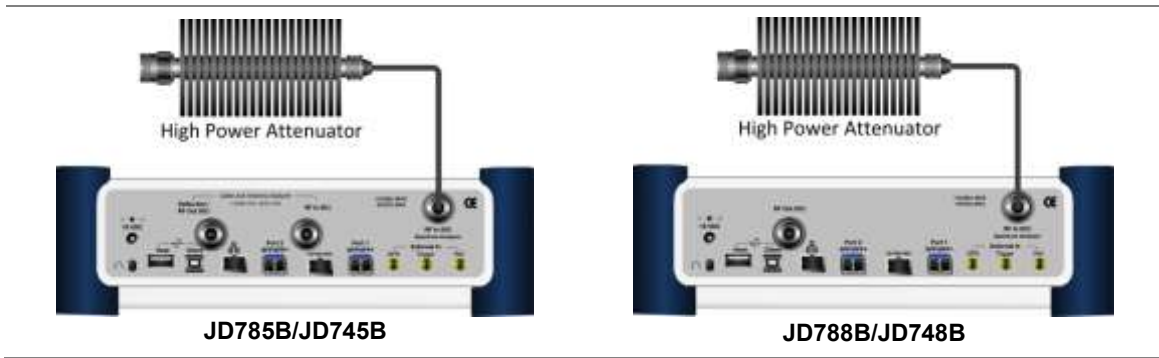

Indirect connection

Procedure

- 1 Connect the **Spectrum Analyzer RF In** port of the JD700B series and the monitor (test) port of BTS.

Figure 110 Indirect connection



CAUTION

The maximum power for the **Spectrum Analyzer RF In** port is +25 dBm (0.316 W) for JD780B series and +20 dBm (0.1 W) for JD740B series. If the level of the input signal to be measured is greater than this, use a **High Power Attenuator** to prevent damage when you directly connect the signal to the instrument or connect the signal from the coupling port of a directional coupler.

Over the air (OTA)

Procedure

- 1 Connect an Omni/directional RF antenna to the **Spectrum Analyzer RF In** port of the JD700B series.
- 2 Connect a GPS antenna to the **GPS** port of the JD700B series.

Figure 111 OTA connection

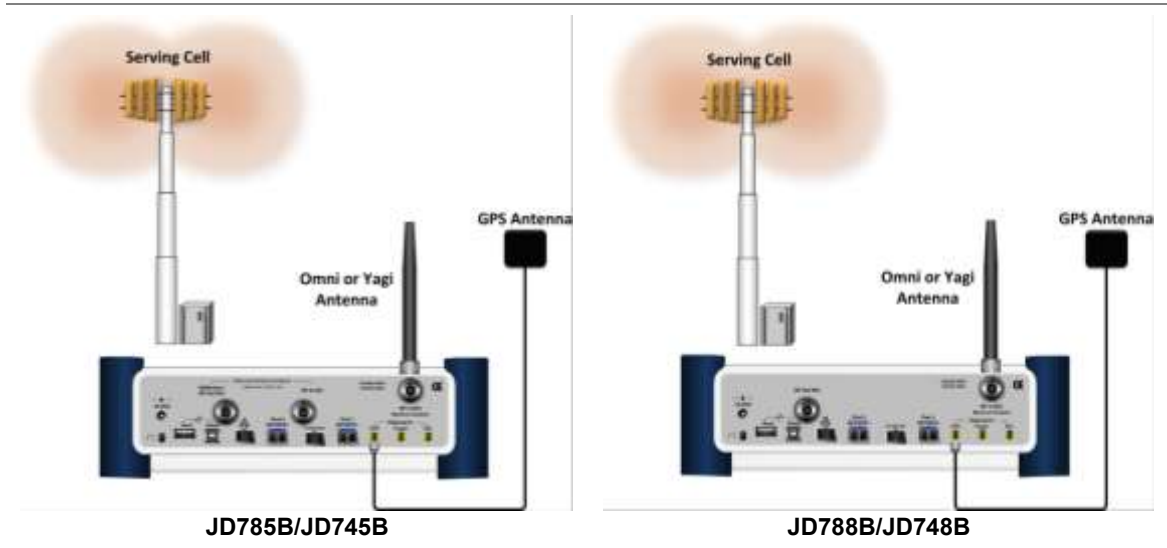
**CAUTION**

If the input signal level to be measured is less than 0 dBm, set 0 dB attenuation or turn on the preamp to have better dynamic range for the OTA testing.

Selecting measurement mode

Procedure

- 1 Press the **MODE** hard key.
- 2 Press the **Signal Analyzer** soft key.
- 3 Press the **LTE - FDD** soft key. The **Spectrum** mode is set by default.
- 4 Press the **MEASURE** hot key, and then select the measurement mode option from the following choices:

Spectrum

RF Analysis > Channel Power, Occupied BW, Spectrum Emission Mask, ACLR, Multi-ACLR, or Spurious Emissions

Power vs Time (Frame)

Modulation Analysis > Constellation, Data Channel, Control Channel, Subframe, Frame, Time Alignment Error, or Data Allocation Map

Auto Measure > Conformance Test, Maintenance Test, Signal Performance, or DAS Test

Power Statistics CCDF

More (1/2) > Carrier Aggregation

More (1/2) > OTA > Channel Scanner, ID Scanner, Multipath Profile, Control Channel, Datagram, or Route Map

More (1/2) > RAN Performance Indicator

More (1/2) > NB-IoT Modulation Analysis

**NOTE**

The **Carrier Aggregation** soft key is activated if the license for the option 030 LTE-Advanced FDD is installed and so does the **RAN Performance Indicator** for the option 014 LTE-FDD RAN Performance Indicator.

Configuring test parameters

Setting frequency

You can set the frequency with either frequency or channel number. If a frequency to be set matches to the frequency corresponding to the selected channel standard, the instrument calculates its channel number and updates the screen with it automatically.

Procedure

To set the center frequency:

- 1 Press the **FREQ/DIST** hard key.
- 2 Toggle the **Unit** soft key and select **Freq**.
- 3 Press the **Center Frequency** soft key.
- 4 Enter a value by using the numeric keys. You can also use the rotary knob.
- 5 Select the unit: **GHz**, **MHz**, **kHz**, or **Hz**.
- 6 *Optional.* To define the amount of frequency increment for the rotary knob, complete the following steps:
 - a Press the **Frequency Step** soft key.
 - b Enter a value by using the numeric keys. You can also use the rotary knob.
 - c Press the unit: **GHz**, **MHz**, **kHz**, or **Hz**.

To set the channel number:

- 1 Press the **FREQ/DIST** hard key.
- 2 Toggle the **Unit** soft key and select **Channel**.



NOTE

Selecting **Channel** sets the standard channel to **Band Global** automatically so that you can set the **Channel Number** without choosing a standard channel band from the list.

- 3 Press the **Channel Number** soft key.
- 4 Enter a value by using the numeric keys. You can also use the rotary knob.
- 5 Press the **Enter** soft key.
The instrument automatically displays the corresponding center frequency value for the selected channel number.
- 6 *Optional.* To define the amount of channel increment for the rotary knob, complete the following steps:
 - a Press the **Channel Step** soft key.
 - b Enter a value by using the numeric keys. You can also use the rotary knob.
 - c Press the **Enter** soft key.



NOTE

This frequency setting is not used in the Multi-ACLR and Spurious Emissions modes.

Setting amplitude

Reference level and attenuation

You can set the reference and attenuation levels automatically or manually to optimize the display of the traces measured, as you desire.

Procedure

To automatically set the reference and attenuation level:

- 1 Press the **AMP/SCALE** hard key.
 - 2 Press the **Auto Scale** soft key.
Each time you press this key, both of the Y-axis scale and input attenuation level change to be
-

optimized with some margin.

To set the reference or attenuation level manually:

- 1 Press the **AMP/SCALE** hard key.
- 2 To set the maximum reference value on the Y-axis manually, complete the following steps:
 - a Press the **Reference Level** soft key.
 - b Enter a value by using the numeric keys or the rotary knob with 10 dB increments.
 - c Press the unit soft key or the **ENTER** hard key.



NOTE

In the measurements such as **Control Channel**, **Subframe**, and **Frame**, you can select the reference option between **Relative** and **Absolute** instead.

- 3 To set the attenuation option, select one from the following choices:
To set the input attenuator's level automatically, select **Attenuation > Auto**.



NOTE

It is recommended that you set the **Attenuation** to **Auto** in most situations so that the level of the input attenuator can be set automatically according to your input signal level.

To set the input attenuation manually up to 55 dB for JD780B series or 50 dB for JD740B series to optimize S/N, complete the following steps:

- a Select **Attenuation > Manual**.
- b Press the **Attenuation Value** soft key to set the level.
- c Enter a value in fives by using the numeric keys.
- d Press the **dB** soft key or the **ENTER** hard key.

To couple the input attenuator's level with your reference level setting, select **Attenuation > Couple**. As you increase the reference setting, the attenuation level also increases accordingly.

Optional. To change the scale unit:

- 1 Select **More (1/2) > Units**.
- 2 Select the unit of the display scale: **dBm**, **dBV**, **dBmV**, **dBμV**, **V**, or **W**.
The scale unit on the screen changes accordingly.



NOTE

This Units menu is available in the Spectrum and RF Analysis modes.

Scale per division

You can use the **Scale/Div** feature available for the spectrum and RF analysis. It represents the value of one division on the horizontal scale. The default setting is 10 dB per division and the maximum value can be set up to 20 dB.

Procedure

- 1 Press the **AMP/SCALE** hard key.
- 2 Select **More (1/2) > Scale/Div**.
- 3 Enter a value between 1 and 20 by using the numeric keys.
- 4 Press the **dB** soft key to complete the entry.

Pre-amplifier

You can turn the internal pre-amplifier on to correct and compensate for the gain of the preamp so that amplitude readings show the value at the input connector.

Procedure

- 1 Press the **AMP/SCALE** hard key.
 - 2 Toggle the **Preamp** soft key and select **On** or **Off** as needed.
-

**NOTE**

You can turn the Preamp on when the input attenuation range is from 0 dB to 10 dB. If the attenuation value is manually set to greater than 10 dB, the instrument will automatically turn off the pre-amplifier to display low-level signal properly on the chart.

External offset

You can turn the **External Offset** on and manually set the external offset value. An offset consists of a cable loss and a user offset and the measurement result shows the value reflecting both offset values. When the external offset value is set at 40 dB in the Spectrum mode, the measurement result compensates 40 dB at both the Spectrum Analyzer and Signal Analyzer modes.

Procedure

To set the external offset:

- 1 Press the **AMP/SCALE** hard key.
- 2 Toggle the **External Offset** soft key and select **On**.
- 3 Enter a value by using the numeric keys.
- 4 Press the **dB** soft key to complete the entry.

To turn the external offset off:

- 1 Press the **AMP/SCALE** hard key.
 - 2 Toggle the **External Offset** soft key and select **Off**.
-

Setting average

You can set the number of measurements to be averaged for the trace presentation. A maximum of 100 times of averaging can be set. When the averaging reaches to your setting, a new measurement value replaces the measurement value in sequence from the earliest.

Procedure

- 1 Press the **BW/AVG** hard key.
 - 2 Press the **Average** soft key.
 - 3 Enter a value between 1 and 100 as needed by using the numeric keys.
 - 4 Press the **Enter** soft key.
-

Setting sweep mode

The default setting is **Continue** to sweep continuously for most on-going measurements. If you want to hold the measurement or get a single sweep, you can change the sweep mode.

Procedure

To select the single sweep mode:

- 1 Press the **SWEEP** hot key.
 - 2 Toggle the **Sweep Mode** soft key and select **Single**. You can also use the **HOLD** hot key. The letter **HOLD** in red appears and the sweeping is paused.
-

- 3 *Optional.* Press the **Sweep Once** soft key to get a new measurement.

To return to the continuous sweep mode:

- 1 Toggle the **Sweep Mode** soft key and select **Continue**. You can also use the **HOLD** hot key. The letter **HOLD** in red disappears and the sweeping resumes.

Setting trigger source

You can set the trigger source option for your measurements.

Procedure

- 1 Press the **TRIGGER** hot key.
- 2 Select the trigger source option from the choices: **Internal**, **External**, and **GPS**.

Setting external clock

To enhance the reliability of modulation analysis measurements the JD700B series must be synchronized with a base station. When an external clock is not supplied, the instrument works with its built-in internal high-accuracy time base and some measurement results may exhibit inaccurate values. Therefore, it is highly recommended that you use the same reference clock as the signal source. You can use the **TRIGGER** hot key to set the external clock.



Figure 112 Connection ports for external reference clock





Procedure

- 1 Connect an external reference or a GPS antenna to the JD700B series.
- 2 Press the **SYSTEM** hot key.
- 3 Press the **Freq Reference** soft key, and then select the reference option from the choices: **Internal**, **External 10 MHz**, **External 13 MHz**, **External 15 MHz**, and **GPS**.

Table 12 External reference indicators

Type	Indicator	Description
Internal	 (green)	The green INT icon indicates that the instrument uses the built-in internal time base.
External	 (green)	The green EXT icon indicates that an external reference is connected and locked and that the instrument uses the same reference clock as the signal source.
External	 (red)	The red EXT icon indicates that an external reference is connect but not locked.

GPS		(green)	The green GPS antenna icon indicates that a GPS antenna is connected and locked.
GPS		(yellow)	The yellow GPS antenna icon indicates that a GPS antenna is connected and locking is in progress.
GPS		(grey)	The grey GPS antenna icon indicates that a GPS antenna is not connected, failed, or unable to be locked.

Conducting spectrum measurements

Setting measure setup

After configuring test parameters as described in the “Configuring test parameters” on page 211, you can continue your measurement.

Procedure

- 1 Press the **MEASURE SETUP** hot key.
- 2 Press the **Bandwidth** soft key.
- 3 Select the nominal channel bandwidth to be measured, from the choices: **1.4 MHz**, **3 MHz**, **5 MHz**, **10 MHz**, **15 MHz**, and **20 MHz**.

Your measurement result is displayed on the screen as like the following example, Figure 113.

Figure 113 Spectrum measurement screen with LTE-FDD signal analyzer



Setting trace

You can display up to six traces on the measurement chart simultaneously.

Procedure

- 1 Press the **TRACE/DISPLAY** hard key.
- 2 Press the **Select Trace** soft key, and then select the trace number: **T1**, **T2**, **T3**, **T4**, **T5**, or **T6**. The legend shape of the selected trace changes from square to round to indicate that the trace is the active one now.

3 Do one of the following:

To	Select	Trace Legend
Clear current data and display with new measurements	Clear Write	W
Display the input signal's maximum response only (unlimited or for a certain amount of time)	Max Hold	M
Display the input signal's minimum response only (unlimited or for a certain amount of time)	Min Hold	m
Capture the selected trace and compare traces	Capture	C
Load a saved trace	More (1/2) > Load	L
Hide the displayed trace	Trace View > Off	F
Remove all the traces and initialize the trace settings	More (1/2) > Trace Clear All	

**NOTE**

For the **Max Hold** and **Min Hold**, your instrument compares newly acquired data with the active trace and displays larger maximum values or smaller minimum values on the screen. You can set it to **Unlimited** to hold and view maximum or minimum data or specify a certain amount of time up to 60 seconds by using numeric keys or rotary knob.

- 4 *Optional.* Select **More (1/2) > Trace Info**, and then select the trace number to view the trace's parameter setting information stored at the time of the measurement or **None** to hide the information display.
- 5 *Optional.* If you have the two traces T1 and T2, you can perform trace math. To view the power difference between the traces, press the **T1 – T2 -> T5** or **T2 – T1 -> T6** soft key. The result is overlaid on the screen along with the second Y-axis.

Conducting RF measurements

Channel power

The Channel Power measurement is a common test used in the wireless industry to measure the total transmitted power of a radio within a defined frequency channel. It acquires a number of points representing the input signal in the time domain, transforms this information into the frequency domain using Fast Fourier Transform (FFT), and then calculates the channel power. The effective resolution bandwidth of the frequency domain trace is proportional to the number of points acquired for the FFT.

The channel power measurement identifies the total RF power and power spectral density (PSD) of the signal in the LTE channel bandwidth.

Setting measure setup

After configuring test parameters as described in the “Configuring test parameters” on page 211, you can continue your measurement.

Procedure

- 1 Press the **MEASURE SETUP** hot key.
- 2 Press the **Bandwidth** soft key.
- 3 Select the nominal channel bandwidth to be measured, from the choices: **1.4 MHz**, **3 MHz**, **5 MHz**, **10 MHz**, **15 MHz**, and **20 MHz**.

Measurement example

Figure 114 Channel power measurement with LTE-FDD signal analyzer



NOTE

You can use the **LIMIT** hot key to analyze your measurements with the user-definable limit and Pass/Fail indication. See “Setting limit for RF tests” on page 224 for more information.

Occupied bandwidth

The Occupied Bandwidth measures the spectrum shape of the carrier. It is defined as the bandwidth, which includes 99% of the transmitted power among total transmitted power.

Setting measure setup

After configuring test parameters as described in the “Configuring test parameters” on page 211, you can continue your measurement.

Procedure

- 1 Press the **MEASURE SETUP** hot key.
- 2 Press the **Bandwidth** soft key.
- 3 Select the nominal channel bandwidth to be measured, from the choices: **1.4 MHz**, **3 MHz**, **5 MHz**, **10 MHz**, **15 MHz**, and **20 MHz**.

Measurement example

Figure 115 Occupied bandwidth measurement with LTE-FDD signal analyzer

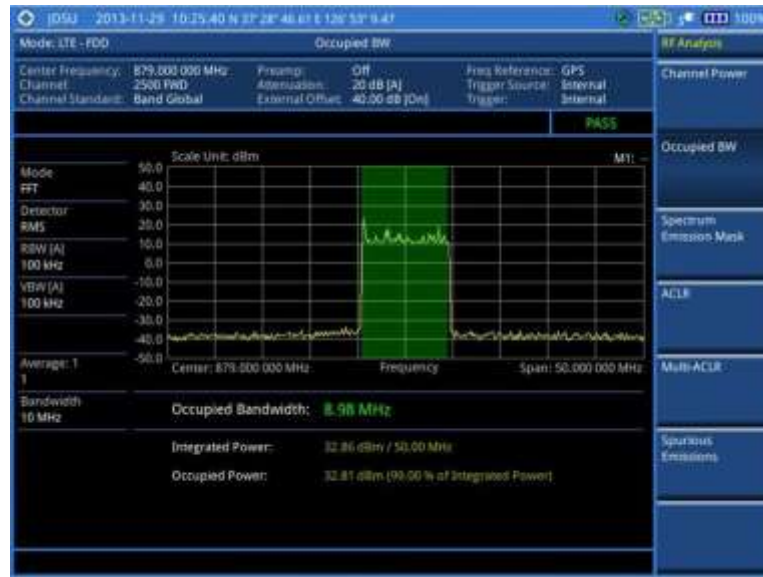

NOTE

You can use the **LIMIT** hot key to analyze your measurements with the user-definable limit and Pass/Fail indication. See “Setting limit for RF tests” on page 224 for more information.

Spectrum emission mask (SEM)

The Spectrum Emission Mask (SEM) measurement required by 3GPP specifications encompasses different power limits and different measurement bandwidths (resolution bandwidths) at various frequency offsets. It may be expressed as a ratio of power spectral densities between the carrier and the specified offset frequency band. It provides useful figures-of-merit for the spectral re-growth and emissions produced by components and circuit blocks, without the rigor of performing a full SEM measurement.

The SEM measures spurious signal levels in up to five pairs of offset or region frequencies and relates them to the carrier power.

Setting measure setup

After configuring test parameters as described in the “Configuring test parameters” on page 211, you can continue your measurement.

Procedure

- 1 Press the **MEASURE SETUP** hot key.
- 2 To set the nominal channel bandwidth to be measured, complete the following steps:
 - a Press the **Bandwidth** soft key.
 - b Select the bandwidth option from the choices: **1.4 MHz**, **3 MHz**, **5 MHz**, **10 MHz**, **15 MHz**, and **20 MHz**.
- 3 To select the mask type, complete the following steps:
 - a Press the **Mask Type** soft key.
 - b Select the mask type option, from the following choices:

Wide Area BS Category A

Wide Area BS Category B
Local Area BS
Home BS

Measurement example

Figure 116 SEM measurement with LTE-FDD signal analyzer



NOTE
You can use the **LIMIT** hot key to analyze your measurements with the user-definable limit and Pass/Fail indication. See “Setting limit for RF tests” on page 224 for more information.

ACLR

The Adjacent Channel Leakage power Ratio (ACLR) measures the amount of interference or power in an adjacent frequency channel according to the standards.

Setting measure setup

After configuring test parameters as described in the “Configuring test parameters” on page 211, you can continue your measurement.

Procedure

- 1 Press the **MEASURE SETUP** hot key.
 - 2 Press the **Bandwidth** soft key.
 - 3 Select the nominal channel bandwidth to be measured, from the following choices: **1.4 MHz**, **3 MHz**, **5 MHz**, **10 MHz**, **15 MHz**, and **20 MHz**.
-

Measurement example

Figure 117 ACLR measurement with LTE-FDD signal analyzer



NOTE

You can use the **LIMIT** hot key to analyze your measurements with the user-definable limit and Pass/Fail indication. See “Setting limit for RF tests” on page 224 for more information.

Multi-ACLR

The Multi-ACLR measurement is used to perform multi-channel ACLR measurements with as many channels as possible. It helps you to measure ACLR in multi-channel transmitting Base Station environment.

Setting measure setup

After configuring test parameters as described in the “Configuring test parameters” on page 211, you can continue your measurement.

Procedure

- 1 Press the **MEASURE SETUP** hot key.
- 2 To set the nominal channel bandwidth to be measured, complete the following steps:
 - a Press the **Bandwidth** soft key.
 - b Select the bandwidth option from the choices: **1.4 MHz**, **3 MHz**, **5 MHz**, **10 MHz**, **15 MHz**, and **20 MHz**.
- 3 To set the frequency, do one of the following:

To set the center frequency, complete the following steps:

 - a Toggle the **Unit** soft key and select **Freq**.
 - b Press the **Lowest Frequency** soft key to set the starting center frequency.
 - c Enter a value by using the numeric keys. You can also use the rotary knob.
 - d Select the unit: **GHz**, **MHz**, **kHz**, or **Hz**.
 - e Press the **Highest Frequency** soft key to set the stopping center frequency.
 - f Enter a value by using the numeric keys. You can also use the rotary knob.
 - g Select the unit: **GHz**, **MHz**, **kHz**, or **Hz**.

To set the channel number, complete the following steps:

 - a Toggle the **Unit** soft key and select **Channel**.



NOTE
 Selecting **Channel** sets the standard channel to **Band Global** automatically so that you can set the **Channel Number** without choosing a standard channel band from the list.

- b Press the **Lowest Channel** soft key to set the starting channel.
- c Enter a value by using the numeric keys. You can also use the rotary knob.
- d Press the **Enter** soft key.
- e Press the **Highest Channel** soft key to set the stopping channel.
- f Enter a value by using the numeric keys. You can also use the rotary knob.
- g Press the **Enter** soft key.

Measurement example

Figure 118 Multi-ACLR measurement with LTE-FDD signal analyzer



NOTE
 You can use the **LIMIT** hot key to analyze your measurements with the user-definable limit and Pass/Fail indication. See “Setting limit for RF tests” on page 224 for more information.

Spurious emissions

Out-of-band emissions are unwanted emissions immediately outside the channel bandwidth resulting from the modulation process and non-linearity in the transmitter but excluding spurious emissions. The Spurious Emissions measurement is to identify and determine the power level of out-of-band spurious emission within the necessary channel bandwidth and modulated signal measured at the RF port of the Base Station.

Setting measure setup

After configuring test parameters as described in the “Configuring test parameters” on page 211, you can continue your measurement.

Procedure

- 1 Press the **MEASURE SETUP** hot key.
- 2 To set up the range table and parameters, press the **Range Table** soft key and then complete the following steps:

- a Press the **Range** soft key, and then select the range number between **1** and **20** to add as a new or change the existing settings.
 - b Do the following as desired:
 - Select **Start Frequency**, and then specify the start frequency for the selected range.
 - Select **Stop Frequency**, and then specify the stop frequency for the selected range.
 - Select **Start Limit**, and then specify the lower limit for Pass/Fail indication.
 - Select **Stop Limit**, and then specify the upper limit for Pass/Fail indication.
 - Select **More (1/2) > Attenuation**, and then specify an value in the multiple of five.
 - Select **More (1/2) > RBW**, and then specify a RBW value.
 - Select **More (1/2) > VBW**, and then specify a VBW value.
 - c Press the **PREV** hard key.
 - d Toggle the **Range** soft key and select **On** to display the selected range in the result table or **Off** to hide it from the table.
- 3** Toggle the **Measure Type** soft key between **Examine** and **Full** to select the measurement type.

**NOTE**

The **Examine** mode displays only the selected range while the **Full** mode lets the instrument automatically changes the selected range from one another.

- a Press the **Average** soft key.
 - b Enter a value between **1** and **100**, and then press the **Enter** soft key.
- 5** To move the highlighted bar in the result table to other range, complete the following steps:
- a Press the **Range** soft key in the Measure Setup menu bar.
 - b Enter a value between **1** and **20**, and then press the **Enter** soft key.

Measurement example

Figure 119 Spurious emissions measurement with LTE-FDD signal analyzer

**NOTE**

You can use the **LIMIT** hot key to analyze your measurements with the user-definable limit and Pass/Fail indication. See “Setting limit for RF tests” on page 224 for more information.

Setting limit for RF tests

By default, test limits specified in the standard are set for you. You can change thresholds if you desire.

Procedure

- 1 Press the **LIMIT** hot key.
- 2 Press the **RF Test Limits** soft key.
- 3 Select the test item(s) and set the limit(s) depending on your selected measurement mode:

To set the limit for	Select	Set
Channel power	Channel Power	High Limit Low Limit
Occupied bandwidth	Occupied BW	High Limit
Spectrum emission mask	Spectrum Emission Mask	(On/Off only)
ACLR	ACLR	(On/Off only)
Multi-ACLR	Multi-ACLR	(On/Off only)
Spurious emissions	Spurious Emissions	(On/Off only)

- 4 *Optional.* You can enable alarm sound that goes off if the measurement falls outside of the limit. Toggle the **Beep** soft key between **On** and **Off** to enable or disable the beep sound.
 - 5 *Optional.* Go to **SAVE/LOAD > Save**, and then select **Limit** to save the limit settings. See “Using save” on page 34 for more information.
-

Conducting power vs. time (frame) measurements

The Power vs. Time (Frame) measures the modulation envelope in the time domain, showing the power of each time slot in an LTE signal.

Setting measure setup

After configuring test parameters as described in the “Configuring test parameters” on page 211, you can continue your measurement. The measurement settings can be saved and recalled as a file.

Procedure

- 1 Press the **MEASURE SETUP** hot key.
 - 2 To set the nominal channel bandwidth to be measured, complete the following steps:
 - a Press the **Bandwidth** soft key.
 - b Select the bandwidth option from the choices: **1.4 MHz**, **3 MHz**, **5 MHz**, **10 MHz**, **15 MHz**, and **20 MHz**.
 - 3 To select the subframe number to be measured, complete the following steps:
 - a Press the **Subframe No** soft key.
 - b Enter a value by using the numeric keys. You can also use the rotary knob.
 - c Press the **Enter** soft key.
 - 4 Toggle the **Physical Cell ID** soft key and select **Auto** or **Manual** as desired:
 - Auto:** Lets the instrument detect the Physical Cell ID for the LTE signal automatically.
 - Manual:** Sets a specific Physical Cell ID for the LTE signal manually in order to speed up the synchronization with a BTS.
-

5 *Optional.* Press the **Miscellaneous** soft key, and then do the following as needed:

To select the number of antenna ports, toggle the **MIMO** soft key and select **2x2** or **4x4**. This MIMO (Multiple Input Multiple Output) setting is activated only if the option 030 LTE-Advanced FDD is installed with a license number. If not, the instrument sets this option to 2x2 by default. A 2x1 or 4x1 RF combiner is also required to able to test on MIMO channels.

To assign a antenna port number automatically or manually, press the **Antenna Port** soft key and select the option: **Auto**, **0**, **1**, **2**, and **3**. If the option 030 LTE-Advanced FDD is not installed or if the MIMO is set to 2x2, the antenna ports 2 and 3 are disabled.

To select the cyclic prefix, toggle the **Cyclic Prefix** soft key and select **Normal** or **Extended**. See “Appendix E – Cyclic prefix table” on page 773 for OFDM parameter details by different bandwidth.

Measurement example

Figure 120 Power vs. time (frame) measurement with LTE – FDD signal analyzer



Conducting modulation measurements

Constellation

The Constellation is used to observe some aspects of modulation accuracy and can reveal certain fault mechanisms such as I/Q amplitude imbalance or quadrature imbalance. It displays constellation diagram by modulation types.

Setting measure setup

After configuring test parameters as described in the “Configuring test parameters” on page 211, you can continue your measurement. The measurement settings can be saved and recalled as a file.

Procedure

- 1 Press the **MEASURE SETUP** hot key.
- 2 To set the nominal channel bandwidth to be measured, complete the following steps:

- a Press the **Bandwidth** soft key.
 - b Select the bandwidth option from the choices: **1.4 MHz, 3 MHz, 5 MHz, 10 MHz, 15 MHz,** and **20 MHz.**
- 3 To select the subframe number to be measured, complete the following steps:
- a Press the **Subframe No** soft key.
 - b Enter a value by using the numeric keys. You can also use the rotary knob.



NOTE
For MBMS testing, this subframe number must be neither 0 nor 5 as these subframes 0 and 5 are not available for MBMS and it must be set to the MBMS transmitted channel's subframe number.

- c Press the **Enter** soft key.
- 4 *Optional.* Toggle the **Physical Cell ID** soft key and select **Auto** or **Manual** as desired:
Auto: Lets the instrument detect the Physical Cell ID for the LTE signal automatically.
Manual: Sets a specific Physical Cell ID for the LTE signal manually in order to speed up the synchronization with a BTS.
- 5 *Optional.* Toggle the **CFI** soft key and select **Auto** or **Manual** as desired:
Auto: Lets the instrument set the number of OFDM symbols used for transmitting PDCCHs in a subframe.
Manual: Sets the number of OFDM symbols manually. The set of OFDM symbols that can be used for PDCCH in a subframe is given by **0, 2, 3** or **4** in 1.4 MHz bandwidth and **1, 2,** or **3** in other bandwidths.

- 6 *Optional.* Press the **PHICH Ng** soft key, and then select the option for the number of PHICH groups (Ng): **1/6, 1/2, 1, 2, E-1/6, E-1/2, E-1,** or **E-2.**

- 7 *Optional.* Press the **Miscellaneous** soft key, and then do the following as needed:

To select the number of antenna ports, toggle the **MIMO** soft key and select **2x2** or **4x4**. This MIMO (Multiple Input Multiple Output) setting is activated only if the option 030 LTE-Advanced FDD is installed with a license number. If not, the instrument sets this option to 2x2 by default. A 2x1 or 4x1 RF combiner is also required to able to test on MIMO channels.

To assign a antenna port number automatically or manually, press the **Antenna Port** soft key and select the option: **Auto, 0, 1, 2,** and **3**. If the option 030 LTE-Advanced FDD is not installed or if the MIMO is set to 2x2, the antenna ports 2 and 3 are disabled.

To turn the Multimedia Broadcast Multicast Service (MBMS) feature on or off, toggle the **MBMS** soft key and select **On** or **Off**. For proper MBMS testing, you need to set the **Subframe No** with the same PMCH subframe number. If this setting is on, either PMCH or PDSCH appears on the screen depending on the detected channel.

To set the Multicast Broadcast Single Frequency Network (MBSFN) detection automatically or manually for MBMS testing, toggle the **MBSFN** soft key and select **Auto** or **Manual**. An automatically detected or manually entered MBSFN ID appears on the screen.

To select the cyclic prefix, toggle the **Cyclic Prefix** soft key and select **Normal** or **Extended**. See "Appendix E – Cyclic prefix table" on page 773 for OFDM parameter details by different bandwidth.

Press the **PDSCH Modulation Type** soft key, and then select the modulation type option: **Auto, QPSK, 16 QAM, 64 QAM, E-TM3.3, E-TM3.2, E-TM3.1, E-TM2, E-TM1.2,** and **E-TM1.1**. If two or more modulation types are used in a frame, select **Auto**. If the PDSCH uses the same modulation type in a frame or in a subframe, select a specific modulation type to get more accurate EVM.



NOTE
If you have installed a license for the option **032 LTE-FDD 256 QAM Demodulator** on your CellAdvisor, you will have additional PDSCH modulation types of **256 QAM, E-TM3.1a,** and **E-TM2a.**

To set the threshold for PDSCH, complete the following steps:

- a Press the **PDSCH Threshold** soft key.
- b Enter a value by using the numeric keys.
- c Press the **dB** soft key.

Toggle the **PDSCH Precoding** soft key between **On** and **Off** to enable or disable the PDSCH precoding.

Measurement example

Figure 121 Constellation measurement with LTE-FDD signal analyzer



Figure 122 Constellation measurement with LTE-FDD signal analyzer (MBMS On)



NOTE

You can use the **LIMIT** hot key to analyze your measurements with the user-definable limit and Pass/Fail indication. See “Setting limit for modulation tests” on page 243 for more information.

Data channel

The Data Channel measures the constellation for the specified resource block as well as the modulation accuracy of each PDSCH at the specified subframe.

Setting measure setup

After configuring test parameters as described in the “Configuring test parameters” on page 211, you can continue your measurement. The measurement settings can be saved and recalled as a file.

Procedure

- 1 Press the **MEASURE SETUP** hot key.
 - 2 To set the nominal channel bandwidth to be measured, complete the following steps:
 - a Press the **Bandwidth** soft key.
 - b Select the bandwidth option from the choices: **1.4 MHz**, **3 MHz**, **5 MHz**, **10 MHz**, **15 MHz**, or **20 MHz**.
 - 3 To select the subframe number to be measured, complete the following steps:
 - a Press the **Subframe No** soft key.
 - b Enter a value by using the numeric keys. You can also use the rotary knob.
-  **NOTE**
For MBMS testing, this subframe number must be neither 0 nor 5 as these subframes 0 and 5 are not available for MBMS and it must be set to the MBMS transmitted channel's subframe number.
- c Press the **Enter** soft key.
 - 4 *Optional.* Toggle the **Physical Cell ID** soft key and select **Auto** or **Manual** as desired:

Auto: Lets the instrument detect the Physical Cell ID for the LTE signal automatically.

Manual: Sets a specific Physical Cell ID for the LTE signal manually in order to speed up the synchronization with a BTS.
 - 5 *Optional.* Toggle the **CFI** soft key and select **Auto** or **Manual** as desired:

Auto: Lets the instrument set the number of OFDM symbols used for transmitting PDCCHs in a subframe.

Manual: Sets the number of OFDM symbols manually. The set of OFDM symbols that can be used for PDCCH in a subframe is given by **0, 2, 3** or **4** in 1.4 MHz bandwidth and **1, 2**, or **3** in other bandwidths.
 - 6 *Optional.* Press the **PHICH Ng** soft key, and then select the option for the number of PHICH groups (Ng): **1/6**, **1/2**, **1**, **2**, **E-1/6**, **E-1/2**, **E-1**, or **E-2**.
 - 7 Toggle the **Event Hold** soft key between **On** and **Off** to enable or disable the event hold feature. When enabled, the display line for the PDSCH threshold appears. When an event occurs, the measurement is put on hold until you press the **HOLD** hot key.
 - 8 *Optional.* Press the **Miscellaneous** soft key, and then do the following as needed:

To select the number of antenna ports, toggle the **MIMO** soft key and select **2x2** or **4x4**. This MIMO (Multiple Input Multiple Output) setting is activated only if the option 030 LTE-Advanced FDD is installed with a license number. If not, the instrument sets this option to 2x2 by default. A 2x1 or 4x1 RF combiner is also required to be able to test on MIMO channels.

To assign an antenna port number automatically or manually, press the **Antenna Port** soft key and select the option: **Auto**, **0**, **1**, **2**, and **3**. If the option 030 LTE-Advanced FDD is not installed or if the MIMO is set to 2x2, the antenna ports 2 and 3 are disabled.

To turn the Multimedia Broadcast Multicast Service (MBMS) feature on or off, toggle the **MBMS** soft key and select **On** or **Off**. For proper MBMS testing, you need to set the **Subframe No** with the same PMCH subframe number. If this setting is on, either PMCH or PDSCH appears on the screen depending on the detected channel.

To set the Multicast Broadcast Single Frequency Network (MBSFN) detection automatically or manually for MBMS testing, toggle the **MBSFN** soft key and select **Auto** or **Manual**. An automatically detected or manually entered MBSFN ID appears on the screen.

To select the cyclic prefix, toggle the **Cyclic Prefix** soft key and select **Normal** or **Extended**. See “Appendix E – Cyclic prefix table” on page 773 for OFDM parameter details by different bandwidth.

Press the **PDSCH Modulation Type** soft key, and then select the modulation type option:
-

Auto, QPSK, 16 QAM, 64 QAM, E-TM3.3, E-TM3.2, E-TM3.1, E-TM2, E-TM1.2, and E-TM1.1. If two or more modulation types are used in a frame, select **Auto**. If the PDSCH uses the same modulation type in a frame or in a subframe, select a specific modulation type to get more accurate EVM.

**NOTE**

If you have installed a license for the option **032 LTE-FDD 256 QAM Demodulator** on your CellAdvisor, you will have additional PDSCH modulation types of **256 QAM, E-TM3.1a, and E-TM2a.**

To set the threshold for PDSCH, complete the following steps:

- a Press the **PDSCH Threshold** soft key.
 - b Enter a value by using the numeric keys, and then press the **dB** soft key.
- Toggle the **PDSCH Precoding** soft key between **On** and **Off** to enable or disable the PDSCH precoding.

Setting display

You can use the **TRACE/DISPLAY** hard key to change the display mode to NB-IoT.

Procedure

- 1 Press the **TRACE/DISPLAY** hard key.
- 2 Toggle the **NB-IoT** soft key between **On** and **Off** to display or dismiss the result of the selected resource block. If this setting is on, the **MARKER** hard key is activated.
- 3 To adjust the NB-IoT PBR Index, press the **NB-IoT PBR Index** soft key, and then turn the rotary knob clockwise or counter clockwise.

Measurement example

Figure 123 Data channel measurement with LTE-FDD signal analyzer



Figure 124 Data channel measurement with LTE-FDD signal analyzer (MBMS On)



NOTE

You can use the **LIMIT** hot key to analyze your measurements with the user-definable limit and Pass/Fail indication. See “Setting limit for modulation tests” on page 243 for more information.

Figure 125 Data channel measurement with LTE-FDD signal analyzer (NB-IoT On)



NOTE

You can see the resource block displayed in red, and if the value of Marker and NB-IoT PRB Index are same, only RB Power is displayed.

Using marker

You can use the **MARKER** hard key to place a marker on a resource block and display the IQ diagram for the selected resource block.

Procedure

- 1 Press the **MARKER** hard key.
 - 2 Press the **RB Number** soft key to select the resource block to be marked.
 - 3 Enter the resource block number by using the numeric keys.
 - 4 Press the **Enter** soft key.
The marker appears on the selected resource block.
 - 5 Toggle the **Marker View** soft key between **On** and **Off** to display or dismiss the result of the selected resource block.
-

Control channel

The Control Channel measures the constellation for the specified control channel as well as modulation accuracy of the control channel at the specified subframe.

Setting measure setup

After configuring test parameters as described in the “Configuring test parameters” on page 211, you can continue your measurement. The measurement settings can be saved and recalled as a file.

Procedure

- 1 Press the **MEASURE SETUP** hot key.
- 2 To set the nominal channel bandwidth to be measured, complete the following steps:
 - a Press the **Bandwidth** soft key.
 - b Select the bandwidth option from the choices: **1.4 MHz, 3 MHz, 5 MHz, 10 MHz, 15 MHz, or 20 MHz**.
- 3 To select the subframe number to be measured, complete the following steps:
 - a Press the **Subframe No** soft key.
 - b Enter a value by using the numeric keys. You can also use the rotary knob.

NOTE

For MBMS testing, this subframe number must be neither 0 nor 5 as these subframes 0 and 5 are not available for MBMS and it must be set to the MBMS transmitted channel's subframe number.

- c Press the **Enter** soft key.
 - 4 *Optional.* Toggle the **Physical Cell ID** soft key and select **Auto** or **Manual** as desired:

Auto: Lets the instrument detect the Physical Cell ID for the LTE signal automatically.

Manual: Sets a specific Physical Cell ID for the LTE signal manually in order to speed up the synchronization with a BTS.
 - 5 *Optional.* Toggle the **CFI** soft key and select **Auto** or **Manual** as desired:

Auto: Lets the instrument set the number of OFDM symbols used for transmitting PDCCHs in a subframe.

Manual: Sets the number of OFDM symbols manually. The set of OFDM symbols that can be used for PDCCH in a subframe is given by **0, 2, 3** or **4** in 1.4 MHz bandwidth and **1, 2**, or **3** in other bandwidths.
 - 6 *Optional.* Press the **PHICH Ng** soft key, and then select the option for the number of PHICH groups (Ng): **1/6, 1/2, 1, 2, E-1/6, E-1/2, E-1**, or **E-2**.
 - 7 Toggle the **EVM Detection Mode** soft key and select **Single** or **Combine** as desired:

Single: Testing on one single antenna connected to your JD700B series with a cable.

Combine: Testing on multiple antennas connected to your JD700B series with a 2x1 or 4x1 combiner or an antenna.
 - 8 *Optional.* Press the **Miscellaneous** soft key, and then do the following as needed:

To select the number of antenna ports, toggle the **MIMO** soft key and select **2x2** or **4x4**.
-

This MIMO (Multiple Input Multiple Output) setting is activated only if the option 030 LTE-Advanced FDD is installed with a license number. If not, the instrument sets this option to 2x2 by default. A 2x1 or 4x1 RF combiner is also required to able to test on MIMO channels.

To assign a antenna port number automatically or manually, press the **Antenna Port** soft key and select the option: **Auto**, **0**, **1**, **2**, and **3**. If the option 030 LTE-Advanced FDD is not installed or if the MIMO is set to 2x2, the antenna ports 2 and 3 are disabled.

To turn the Multimedia Broadcast Multicast Service (MBMS) feature on or off, toggle the **MBMS** soft key and select **On** or **Off**. For proper MBMS testing, you need to set the **Subframe No** with the same PMCH subframe number. If this setting is on, the measurement item “MBSFN RS” appears in the result table.

To set the Multicast Broadcast Single Frequency Network (MBSFN) detection automatically or manually for MBMS testing, toggle the **MBSFN** soft key and select **Auto** or **Manual**. An automatically detected or manually entered MBSFN ID appears on the screen.

To select the cyclic prefix, toggle the **Cyclic Prefix** soft key and select **Normal** or **Extended**. See “Appendix E – Cyclic prefix table” on page 773 for OFDM parameter details by different bandwidth.

To set the threshold for PDCCH, complete the following steps:

- a Press the **PDCCH Threshold** soft key.
- b Enter a value by using the numeric keys.
- c Press the **dB** soft key.

Toggle the **PDCCH Mode** soft key and select **REG** to calculate EVM based on Resource Element Group or **Avg** to calculate EVM after adding all the PDCCH signals from one subframe.

Measurement example

Figure 126 Control channel measurement with LTE-FDD signal analyzer



Figure 127 Control channel measurement with LTE-FDD signal analyzer (MBMS On)

**NOTE**

You can use the **LIMIT** hot key to analyze your measurements with the user-definable limit and Pass/Fail indication. See “Setting limit for modulation tests” on page 243 for more information.

Using marker

You can use the **MARKER** hard key to place a marker on a control channel and display the IQ diagram for the selected channel.

Procedure

- 1 Press the **MARKER** hard key.
- 2 Press the **Channel** soft key to select the channel to be displayed in the IQ diagram. The channel P-SS is selected by default.
- 3 Turn the rotary knob to move the highlight from one to another in the channel summary table.
- 4 Toggle the **Marker View** soft key between **On** and **Off** to display or hide the result of the selected channel.

Subframe

The Subframe measures the modulation accuracy of all the data and control channels at the specified subframe (1 ms).

Setting measure setup

After configuring test parameters as described in the “Configuring test parameters” on page 211, you can continue your measurement. The measurement settings can be saved and recalled as a file.

Procedure

- 1 Press the **MEASURE SETUP** hot key.
- 2 To set the nominal channel bandwidth to be measured, complete the following steps:
 - a Press the **Bandwidth** soft key.
 - b Select the bandwidth option from the choices: **1.4 MHz, 3 MHz, 5 MHz, 10 MHz, 15 MHz,**

and **20 MHz**.

- 3 To select the subframe number to be measured, complete the following steps:
 - a Press the **Subframe No** soft key.
 - b Enter a value by using the numeric keys. You can also use the rotary knob.



NOTE

For MBMS testing, this subframe number must be neither 0 nor 5 as these subframes 0 and 5 are not available for MBMS and it must be set to the MBMS transmitted channel's subframe number.

- c Press the **Enter** soft key.
- 4 *Optional*. Toggle the **Physical Cell ID** soft key and select **Auto** or **Manual** as desired:

Auto: Lets the instrument detect the Physical Cell ID for the LTE signal automatically.

Manual: Sets a specific Physical Cell ID for the LTE signal manually in order to speed up the synchronization with a BTS.
- 5 *Optional*. Toggle the **CFI** soft key and select **Auto** or **Manual** as desired:

Auto: Lets the instrument set the number of OFDM symbols used for transmitting PDCCHs in a subframe.

Manual: Sets the number of OFDM symbols manually. The set of OFDM symbols that can be used for PDCCH in a subframe is given by **0, 2, 3** or **4** in 1.4 MHz bandwidth and **1, 2,** or **3** in other bandwidths.
- 6 *Optional*. Press the **PHICH Ng** soft key, and then select the option for the number of PHICH groups (Ng): **1/6, 1/2, 1, 2, E-1/6, E-1/2, E-1,** or **E-2**.

- 7 Toggle the **EVM Detection Mode** soft key and select **Single** or **Combine** as desired:

Single: Testing on one single antenna connected to your JD700B series with a cable.

Combine: Testing on multiple antennas connected to your JD700B series with a 2x1 or 4x1 combiner or an antenna.

- 8 *Optional*. Press the **Miscellaneous** soft key, and then do the following as needed:

To select the number of antenna ports, toggle the **MIMO** soft key and select **2x2** or **4x4**. This MIMO (Multiple Input Multiple Output) setting is activated only if the option 030 LTE-Advanced FDD is installed with a license number. If not, the instrument sets this option to 2x2 by default. A 2x1 or 4x1 RF combiner is also required to be able to test on MIMO channels.

To assign an antenna port number automatically or manually, press the **Antenna Port** soft key and select the option: **Auto, 0, 1, 2,** and **3**. If the option 030 LTE-Advanced FDD is not installed or if the MIMO is set to 2x2, the antenna ports 2 and 3 are disabled.

To turn the Multimedia Broadcast Multicast Service (MBMS) feature on or off, toggle the **MBMS** soft key and select **On** or **Off**. For proper MBMS testing, you need to set the **Subframe No** with the same PMCH subframe number. If this setting is on, the measurement item "MBSFN RS" appears in the result table and either PMCH or PDSCH appears as well depending on the detected channel.

To set the Multicast Broadcast Single Frequency Network (MBSFN) detection automatically or manually for MBMS testing, toggle the **MBSFN** soft key and select **Auto** or **Manual**. An automatically detected or manually entered MBSFN ID appears on the screen.

To select the cyclic prefix, toggle the **Cyclic Prefix** soft key and select **Normal** or **Extended**. See "Appendix E – Cyclic prefix table" on page 773 for OFDM parameter details by different bandwidth.

Press the **PDSCH Modulation Type** soft key, and then select the modulation type option: **Auto, QPSK, 16 QAM, 64 QAM, E-TM3.3, E-TM3.2, E-TM3.1, E-TM2, E-TM1.2,** and **E-TM1.1**. If two or more modulation types are used in a frame, select **Auto**. If the PDSCH uses the same modulation type in a frame or in a subframe, select a specific modulation type to get more accurate EVM.



NOTE

If you have installed a license for the option **032 LTE-FDD 256 QAM Demodulator** on your CellAdvisor, you will have additional PDSCH modulation types of **256 QAM, E-TM3.1a,** and **E-TM2a**.

To set the threshold for PDSCH, complete the following steps:

- a Press the **PDSCH Threshold** soft key.

- b** Enter a value by using the numeric keys, and then press the **dB** soft key.
- To set the threshold for PDCCH, complete the following steps:
- a** Press the **PDCCH Threshold** soft key.
 - b** Enter a value by using the numeric keys, and then press the **dB** soft key.
- Toggle the **PDCCH Mode** soft key and select **REG** to calculate EVM based on Resource Element Group or **Avg** to calculate EVM after adding all PDCCH signals from one subframe.
- Toggle the **PDSCH Precoding** soft key between **On** and **Off** to enable or disable the PDSCH precoding.

Measurement example

Figure 128 Subframe measurement with LTE-FDD signal analyzer



Figure 129 Subframe measurement with LTE-FDD signal analyzer (Chart On)



Figure 130 Subframe measurement with LTE-FDD signal analyzer (MBMS On)



NOTE

You can use the **LIMIT** hot key to analyze your measurements with the user-definable limit and Pass/Fail indication. See “Setting limit for modulation tests” on page 243 for more information.

Setting display

You can use the **TRACE/DISPLAY** hard key to view the RE and RS power at the symbol.

Procedure

- 1 Press the **TRACE/DISPLAY** hard key.
- 2 Toggle the **Chart** soft key between **On** and **Off** to display or dismiss the chart. If this setting is on, the **MARKER** hard key is activated.

Using marker

If you turn the Chart view on, you can use the **MARKER** hard key to place the marker at a specific symbol.

Procedure

- 1 Press the **MARKER** hard key.
- 2 Toggle the **Marker View** soft key between **On** and **Off** to display or dismiss the marker on the chart.
- 3 Press the **Symbol** soft key to select the symbol number, to which the marker is placed.
- 4 Enter a value by using the numeric keys.
- 5 Press the **Enter** soft key.

Frame

The Frame measures the modulation accuracy of all the data and control channels at the frame (10 ms).

Setting measure setup

After configuring test parameters as described in the “Configuring test parameters” on page 211, you can continue your measurement. The measurement settings can be saved and recalled as a file.

Procedure

- 1 Press the **MEASURE SETUP** hot key.
- 2 To set the nominal channel bandwidth to be measured, complete the following steps:
 - a Press the **Bandwidth** soft key.
 - b Select the bandwidth option from the choices: **1.4 MHz**, **3 MHz**, **5 MHz**, **10 MHz**, **15 MHz**, and **20 MHz**.
- 3 *Optional.* Toggle the **Physical Cell ID** soft key and select **Auto** or **Manual** as desired:

Auto: Lets the instrument detect the Physical Cell ID for the LTE signal automatically.

Manual: Sets a specific Physical Cell ID for the LTE signal manually in order to speed up the synchronization with a BTS.
- 4 *Optional.* Toggle the **CFI** soft key and select **Auto** or **Manual** as desired:

Auto: Lets the instrument set the number of OFDM symbols used for transmitting PDCCHs in a subframe.

Manual: Sets the number of OFDM symbols manually. The set of OFDM symbols that can be used for PDCCH in a subframe is given by **0**, **2**, **3** or **4** in 1.4 MHz bandwidth and **1**, **2**, or **3** in other bandwidths.
- 5 *Optional.* Press the **PHICH Ng** soft key, and then select the option for the number of PHICH groups (Ng): **1/6**, **1/2**, **1**, **2**, **E-1/6**, **E-1/2**, **E-1**, or **E-2**.
- 6 Toggle the **EVM Detection Mode** soft key and select **Single** or **Combine** as desired:

Single: Testing on one single antenna connected to your JD700B series with a cable.

Combine: Testing on multiple antennas connected to your JD700B series with a 2x1 or 4x1 combiner or an antenna.
- 7 *Optional.* Press the **Miscellaneous** soft key, and then do the following as needed:

To select the number of antenna ports, toggle the **MIMO** soft key and select **2x2** or **4x4**. This MIMO (Multiple Input Multiple Output) setting is activated only if the option 030 LTE-Advanced FDD is installed with a license number. If not, the instrument sets this option to 2x2 by default. A 2x1 or 4x1 RF combiner is also required to be able to test on MIMO channels.

To assign a antenna port number automatically or manually, press the **Antenna Port** soft key and select the option: **Auto**, **0**, **1**, **2**, and **3**. If the option 030 LTE-Advanced FDD is not installed or if the MIMO is set to 2x2, the antenna ports 2 and 3 are disabled.

To turn the Multimedia Broadcast Multicast Service (MBMS) feature on or off, toggle the **MBMS** soft key and select **On** or **Off**. If this setting is on, the measurement items MBSFN RS, PMCH QPSK, PMCH 16 QAM, and PMCH 64 QAM appear in the result table.

To set the Multicast Broadcast Single Frequency Network (MBSFN) detection automatically or manually for MBMS testing, toggle the **MBSFN** soft key and select **Auto** or **Manual**. An automatically detected or manually entered MBSFN ID appears on the screen.

To select the cyclic prefix, toggle the **Cyclic Prefix** soft key and select **Normal** or **Extended**. See “Appendix E – Cyclic prefix table” on page 773 for OFDM parameter details by different bandwidth.

Press the **PDSCH Modulation Type** soft key, and then select the modulation type option: **Auto**, **QPSK**, **16 QAM**, **64 QAM**, **E-TM3.3**, **E-TM3.2**, **E-TM3.1**, **E-TM2**, **E-TM1.2**, and **E-TM1.1**. If two or more modulation types are used in a frame, select **Auto**. If the PDSCH uses the same modulation type in a frame or in a subframe, select a specific modulation type to get more accurate EVM.



NOTE

If you have installed a license for the option **032 LTE-FDD 256 QAM Demodulator** on your CellAdvisor, you will have additional PDSCH modulation types of **256 QAM**, **E-TM3.1a**, and **E-TM2a**.

To set the threshold for PDSCH, complete the following steps:

- a Press the **PDSCH Threshold** soft key.
- b Enter a value by using the numeric keys.
- c Press the **dB** soft key.

To set the threshold for PDCCH, complete the following steps:

- a Press the **PDCCH Threshold** soft key.
- b Enter a value by using the numeric keys.
- c Press the **dB** soft key.

Toggle the **PDCCH Mode** soft key and select **REG** to calculate EVM based on Resource Element Group or **Avg** to calculate EVM after adding up all the PDCCH signals from one subframe.

Toggle the **PDSCH Precoding** soft key between **On** and **Off** to enable or disable the PDSCH precoding.

Measurement example

Figure 131 Frame measurement with LTE-FDD signal analyzer



Figure 132 Frame measurement with LTE-FDD signal analyzer (MBMS On)

**NOTE**

You can use the **LIMIT** hot key to analyze your measurements with the user-definable limit and Pass/Fail indication. See “Setting limit for modulation tests” on page 243 for more information.

Time alignment error

In eNode-B supporting Tx Diversity transmission, signals are transmitted from two or more antennas. These signals shall be aligned. The time alignment error in Tx diversity is specified as the delay between the signals from two antennas at the antenna ports.

Setting measure setup

After configuring test parameters as described in the “Configuring test parameters” on page 211, you can continue your measurement. The measurement settings can be saved and recalled as a file.

Procedure

- 1 Press the **MEASURE SETUP** hot key.
- 2 To set the nominal channel bandwidth to be measured, complete the following steps:
 - a Press the **Bandwidth** soft key.
 - b Select the bandwidth option from the choices: **1.4 MHz**, **3 MHz**, **5 MHz**, **10 MHz**, **15 MHz**, and **20 MHz**.
- 3 *Optional.* Toggle the **Physical Cell ID** soft key and select **Auto** or **Manual** as desired:
 - Auto:** Lets the instrument detect the Physical Cell ID for the LTE signal automatically.
 - Manual:** Sets a specific Physical Cell ID for the LTE signal manually in order to speed up the synchronization with a BTS.
- 4 *Optional.* Press the **Miscellaneous** soft key, and then do the following as needed:
 - To select the number of antenna ports, toggle the **MIMO** soft key and select **2x2** or **4x4**. This MIMO (Multiple Input Multiple Output) setting is activated only if the option 030 LTE-Advanced FDD is installed with a license number. If not, the instrument sets this option to 2x2 by default. A 2x1 or 4x1 RF combiner is also required to be able to test on MIMO channels.
 - To assign a antenna port number automatically or manually, press the **Antenna Port** soft key and select the option: **Auto**, **0**, **1**, **2**, and **3**. If the option 030 LTE-Advanced FDD is not

installed or if the MIMO is set to 2x2, the antenna ports 2 and 3 are disabled.
 To select the cyclic prefix, toggle the **Cyclic Prefix** soft key and select **Normal** or **Extended**. See “Appendix E – Cyclic prefix table” on page 773 for OFDM parameter details by different bandwidth.

Measurement example

Figure 133 Time alignment error measurement with LTE-FDD signal analyzer



NOTE

You can use the **LIMIT** hot key to analyze your measurements with the user-definable limit and Pass/Fail indication. See “Setting limit for modulation tests” on page 243 for more information.

Data allocation map

The Data Allocation Map function represents data allocation as a frame.

Setting measure setup

After configuring test parameters as described in the “Configuring test parameters” on page 211, you can continue your measurement. The measurement settings can be saved and recalled as a file. You can also use JDViewer, PC application software to configure a measure setup, save as a file, and load the file on to the instrument.

Procedure

- 1 Press the **MEASURE SETUP** hot key.
- 2 To set the nominal channel bandwidth to be measured, complete the following steps:
 - a Press the **Bandwidth** soft key.
 - b Select the bandwidth option from the choices: **1.4 MHz**, **3 MHz**, **5 MHz**, **10 MHz**, **15 MHz**, and **20 MHz**.
- 3 To select the subframe number to be measured, complete the following steps:
 - a Press the **Subframe No** soft key.
 - b Enter a value by using the numeric keys. You can also use the rotary knob.

**NOTE**

For MBMS testing, this subframe number must be neither 0 nor 5 as these subframes 0 and 5 are not available for MBMS and it must be set to the MBMS transmitted channel's subframe number.

- c Press the **Enter** soft key.
- 4 To set the threshold for PDSCH, complete the following steps:
 - a Press the **PDSCH Threshold** soft key.
 - b Enter a value by using the numeric keys.
 - c Press the **dB** soft key.
- 5 *Optional.* Toggle the **Physical Cell ID** soft key and select **Auto** or **Manual** as desired:
 - Auto:** Lets the instrument detect the Physical Cell ID for the LTE signal automatically.
 - Manual:** Sets a specific Physical Cell ID for the LTE signal manually in order to speed up the synchronization with a BTS.
- 6 *Optional.* Press the **Miscellaneous** soft key, and then do the following as needed:
 - To select the number of antenna ports, toggle the **MIMO** soft key and select **2x2** or **4x4**. This MIMO (Multiple Input Multiple Output) setting is activated only if the option 030 LTE-Advanced FDD is installed with a license number. If not, the instrument sets this option to 2x2 by default. A 2x1 or 4x1 RF combiner is also required to be able to test on MIMO channels.
 - To assign an antenna port number automatically or manually, press the **Antenna Port** soft key and select the option: **Auto**, **0**, **1**, **2**, and **3**. If the option 030 LTE-Advanced FDD is not installed or if the MIMO is set to 2x2, the antenna ports 2 and 3 are disabled.
 - To turn the Multimedia Broadcast Multicast Service (MBMS) feature on or off, toggle the **MBMS** soft key and select **On** or **Off**. For proper MBMS testing, you need to set the **Subframe No** with the same PMCH subframe number. If this setting is on, either PMCH or PDSCH appears on the screen depending on the detected channel.
 - To set the Multicast Broadcast Single Frequency Network (MBSFN) detection automatically or manually for MBMS testing, toggle the **MBSFN** soft key and select **Auto** or **Manual**. An automatically detected or manually entered MBSFN ID appears on the screen.
 - To select the cyclic prefix, toggle the **Cyclic Prefix** soft key and select **Normal** or **Extended**. See "Appendix E – Cyclic prefix table" on page 773 for OFDM parameter details by different bandwidth.

Setting display

You can use the **TRACE/DISPLAY** hard key to change the display mode to Display Channel and NB-IoT.

Procedure

- 1 Press the **TRACE/DISPLAY** hard key.
- 2 Press the **Display Channel** soft key.
- 3 Select the display mode from the choice: **PDSCH**, **PMCH**, and **Both**.
- 4 Toggle the **NB-IoT** soft key between **On** and **Off** to display or dismiss the result of the selected resource block. If this setting is on, the **MARKER** hard key is activated.
- 5 To adjust the NB-IoT PBR Index, press the **NB-IoT PBR Index** soft key, and then turn the rotary knob clockwise or counter clockwise.

Measurement example

Figure 134 Data allocation map measurement with LTE-FDD signal analyzer



Figure 135 Data allocation map measurement with LTE-FDD signal analyzer (MBMS On)



Figure 136 Data allocation map measurement with LTE-FDD signal analyzer (NB-IoT On)



Using marker

You can use the **MARKER** hard key to place the marker at a specific resource block and subframe.

Procedure

- 1 Press the **MARKER** hard key.
- 2 Toggle the **Marker View** soft key between **On** and **Off** to display or hide the marker on the chart.
- 3 To select the resource block number, complete the following steps:
 - a Press the **RB Number** soft key.
 - b Enter the resource block number to select by using the numeric keys. You can also use the rotary knob to move the marker side by side.
 - c Press the **Enter** soft key.
- 4 To select the subframe block number, complete the following steps:
 - a Press the **Subframe No** soft key.
 - b Enter the subframe number to select by using the numeric keys. You can also use the rotary knob to move the marker up and down.
 - c Press the **Enter** soft key.

Setting limit for modulation tests

Procedure

- 1 Press the **LIMIT** hot key.
- 2 Press the **Modulation Test Limits** soft key to set the limits.
- 3 Select the test item(s) and set the limit(s) depending on your selected measurement mode:

To set the limit for	Select	Set
Frequency error	Frequency Error	High Limit, Low Limit
PDSCH error vector magnitude if MBMS is off	EVM > PDSCH EVM	High Limit (QPSK) High Limit (16 QAM) High Limit (64 QAM) High Limit (256 QAM)*

PMCH error vector magnitude if MBMS is on and a PMCH is detected	EVM > PMCH EVM	High Limit (QPSK) High Limit (16 QAM) High Limit (64 QAM) <i>High Limit (256 QAM)*</i>
RMS for data error vector magnitude	EVM > Data EVM RMS	High Limit
Peak for data error vector magnitude	EVM > Data EVM Peak	High Limit
RS error vector magnitude	EVM > RS EVM	High Limit
P-SS error vector magnitude	EVM > P-SS EVM	High Limit
S-SS error vector magnitude	EVM > S-SS EVM	High Limit
Downlink RS power	Power > DL RS Power	High Limit, Low Limit
P-SS power	Power > P-SS Power	High Limit, Low Limit
S-SS power	Power > S-SS Power	High Limit, Low Limit
PBCH power	Power > PBCH Power	High Limit, Low Limit
Subframe power	Power > Subframe Power	High Limit, Low Limit
OFDM symbol power	Power > OFDM Symbol Power	High Limit, Low Limit
Frame average power	Power > Frame Avg Power	High Limit, Low Limit
Time alignment error for MIMO	Time Alignment Error > MIMO	High Limit
Time alignment error for aggregation of component carriers (intra-band contiguous, intra-band non-contiguous, and inter-band)	Time Alignment Error > Carrier Aggregation	Intra Cont Intra Non-cont Inter Band
Time error	Time Error	High Limit, Low Limit
I-Q origin offset	IQ Origin Offset	High Limit

- 4 *Optional.* You can enable alarm sound that goes off if the measurement falls outside of the limit. Toggle the **Beep** soft key between **On** and **Off** to enable or disable the beep sound.
- 5 *Optional.* Go to **SAVE/LOAD > Save**, and then select **Limit** to save the limit settings. See “Using save” on page 34 for more information.

Performing auto measurements

Conformance test

The Conformance Test is to test if eNode-B meets some specified standards that have been developed for verification. Its test procedure and test setups have been developed by 3GPP. Test results can be saved as a .csv file type.

Setting limit for conformance test

You can set test limits for test item(s) in the auto measurement. Turning the test limit on for a test item makes the test item included in the conformance test.

Procedure

- 1 Press the **LIMIT** hot key.
- 2 To set the limit for BTS output power, complete the following steps:
 - a Press the **BTS Output Power** soft key.
 - b Toggle the **Test Limits** soft key between **On** and **Off** to enable or disable the limit.
 - c Press the **High Limit** soft key.
 - d Enter a value for the upper limit, and then press the **dBm** unit soft key.
 - e Press the **Low Limit** soft key.
 - f Enter a value for the lower limit, and then press the **dBm** unit soft key.
- 3 To set the limit for total power dynamic, complete the following steps:
 - a Press the **Total Power Dynamic** soft key.
 - b Toggle the **Test Limits** soft key between **On** and **Off** to enable or disable the limit.
 - c Press the **Low Limit** soft key.
 - d Enter a value for the lower limit, and then press the **dBm** unit soft key.
- 4 To verify signal quality, press the **Signal Quality** soft key, and then do the following as needed:

To set the limit for	Select	Set
Frequency error	Frequency Error > Test Limits[E-TM2 E-TM2a E-TM3.1 E-TM3.1a E-TM3.2 E-TM3.3]	High Limit, Low Limit
Error vector magnitude	EVM > Test Limits [E-TM2 E-TM2a E-TM3.1 E-TM3.1a E-TM3.2 E-TM3.3]	High Limit (QPSK) High Limit (16 QAM) High Limit (64 QAM) High Limit (256 QAM)*
Time alignment error	Time Alignment Error	High Limit
RS power	RS Power	High Limit, Low Limit

- 5 To verify unwanted emissions, press the **Unwanted Emissions** soft key, and then do the following as needed:

To set the limit for	Select	Set
Occupied bandwidth	Occupied BW	High Limit
Adjacent channel power ratio	ACLR	
Spectrum emission mask	SEM	Mask Type
Spurious emissions	Spurious Emissions	Range Table

- 6 *Optional.* You can enable alarm sound that goes off if the measurement falls outside of the limit. Toggle the **Beep** soft key between **On** and **Off** to enable or disable the beep sound.
 - 7 *Optional.* Go to **SAVE/LOAD > Save**, and then select **Limit** to save the limit settings. See “Using save” on page 34 for more information.
-

Setting measure setup

After setting frequency as described in the “Configuring test parameters” on page 211, you can continue your measurement.

Procedure

- 1 Press the **MEASURE SETUP** hot key.
 - 2 Press the **Bandwidth** soft key.
 - 3 Select the nominal channel bandwidth to be measured, from the choices: **1.4 MHz**, **3 MHz**,
-

5 MHz, 10 MHz, 15 MHz, and 20 MHz.

- 4** Press the **Sector** soft key, and then select the sector option: **Alpha**, **Beta**, or **Gamma**.
 - 5** To set external offset, complete the following steps:
 - a** Toggle the **External Offset** soft key and select **On**.
 - b** Enter a value by using the numeric keys.
 - c** Press the **dB** soft key.
 - 6** To save your settings and results, go to **SAVE/LOAD > Save** and then perform functions as you desire. See "Using save" on page 34 for more information.
 - 7** Press the **Run Test** soft key to start to run a test.
The Auto Measure Results window appears at the end of the test.
 - 8** When prompted on the screen, connect the cable from the **Spectrum Analyzer RF In** port of the instrument to either **Antenna Port 0** or **Antenna Port 1** of the eNode-B, and then change the TM mode on the eNode-B side.
 - 9** Press the **Continue** soft key to continue testing.
 - 10** Repeat the steps 8-9 until completion of the test.
A conformance test report appears at the end of the test.
 - 11** *Optional.* To stop running the test, press the **Abort** soft key.
-

Maintenance test

The Auto Measure function of the JD700B series allows a complete signal profiling covering RF characterization and modulation quality parameters of up to 20 different carriers, particularly useful on an overlay architecture where base stations are transmitting in different frequencies.

Following settings are required only when you run the Auto Measure Maintenance Test on the instrument using “Current” configuration setting. Additional settings are not required when you run Auto Measure using a scenario generated in the PC application software, JDViewer.

Setting limit for maintenance test

You can set test limits for test item(s) in the auto measurement.

Procedure

- 1 Press the **LIMIT** hot key.
 - 2 Press the **RF Test Limits** soft key, and then enable test limits as desired.
 - 3 Press the **Modulation Test Limits** soft key, and then enable test limits as desired.
 - 4 *Optional.* You can enable alarm sound that goes off if the measurement falls outside of the limit. Toggle the **Beep** soft key between **On** and **Off** to enable or disable the beep sound.
 - 5 *Optional.* Go to **SAVE/LOAD > Save**, and then select **Limit** to save the limit settings. See “Using save” on page 34 for more information.
-



NOTE

You can use the **Allowed % Change** soft key for each test item to compare two measurement values displayed in the result table. This requires setting the **Display** mode to **Compare** in advance.

Setting measure setup

After configuring test parameters as described in the “Configuring test parameters” on page 211, you can continue your measurement. The measurement settings can be saved and recalled as a file. You can also use JDViewer, PC application software to configure a measure setup, save as a file, and load the file on to the instrument.

Procedure

- 1 Press the **MEASURE SETUP** hot key.
 - 2 Toggle the **Configuration** soft key and select the configuration option:
 - Current:** Lets the instrument use current frequency (single carrier) and determine pass or fail based on the instrument’s limit settings in Auto Measure.
 - Scenario:** Runs a test with a programmed scenario in JDViewer. The Scenario menu becomes activated.
 - 3 To load a scenario, press the **Scenario** soft key, and then select a scenario file to load.
 - 4 Toggle the **Test Time** soft key and select the test time option:
 - Now:** Lets the instrument run a test only once.
 - Schedule:** Lets the instrument repeat tests as defined in the Set Timing. The Set Timing menu becomes activated.
 - 5 To define a schedule for an auto measurement, complete the following steps:
 - a Press the **Set Timing** soft key.
 - b Press the **Start Time (HH:MM)** soft key.
 - c Enter the time in the HH:MM format, and then press the **Enter** soft key.
-

-
- d Press the **Stop Time (HH:MM)** soft key.
 - e Enter the time in the HH:MM format, and then press the **Enter** soft key.
 - f Press the **Time Interval** soft key.
 - g Enter the amount of time in minutes, and then press the **Enter** soft key.
- 6 Press the **Settings** soft key, and then set the following as needed:
- a Press the **Bandwidth** soft key, and then select the nominal channel bandwidth to be measured, from the choices: **1.4 MHz**, **3 MHz**, **5 MHz**, **10 MHz**, **15 MHz**, and **20 MHz**.
 - b Toggle the **Physical Cell ID** soft key and select **Auto** or **Manual** as desired:
 - Auto:** Lets the instrument detect the Physical Cell ID for the LTE signal automatically.
 - Manual:** Sets a specific Physical Cell ID for the LTE signal manually in order to speed up the synchronization with a BTS.
 - c Press the **MIMO** soft key, and then select the antenna number option: **2x2** or **4x4**. This MIMO (Multiple Input Multiple Output) setting is activated only if the option 030 LTE-Advanced FDD is installed with a license number. If not, the instrument sets this option to 2x2 by default. A 2x1 or 4x1 RF combiner is also required to be able to test on MIMO channels.
 - d Press the **Antenna Port** soft key, and then select the option: **Auto**, **0**, **1**, **2**, or **3**. If the option 030 LTE-Advanced FDD is not installed or if the MIMO is set to 2x2, the antenna ports 2 and 3 are disabled.
 - e Toggle the **External Offset** soft key and select **On**.
 - f Enter a value by using the numeric keys, and then press the **dB** soft key.
 - g To turn the Multimedia Broadcast Multicast Service (MBMS) feature on or off, toggle the **MBMS** soft key and select **On** or **Off**. For proper MBMS testing, you need to set the Subframe No with the same PMCH subframe number.
 - h To set the Multicast Broadcast Single Frequency Network (MBSFN) detection automatically or manually for MBMS testing, toggle the **MBSFN** soft key and select **Auto** or **Manual**. An automatically detected or manually entered MBSFN ID appears on the screen.
- 7 To save your settings and results, go to **SAVE/LOAD > Save** and then perform functions as you desire. See "Using save" on page 34 for more information.
- 8 Press the **Run Test** soft key to start to run a test. The Auto Measure Results window appears at the end of the test.
- 9 To stop running the test, press the **Abort** soft key.
- 10 To change the view on the screen during the test, press the **Display** and then select the view option from the following choices:
- Screen:** You can view each measurement screen as the test progresses.
 - Results:** You can view a measurement result table as the test progresses.
 - Settings:** You can view a measurement setting table as the test progresses.
-

Setting display

After completion of the auto measurement, the screen menu changes to Trace/Display so that you can view the results in different forms.

Procedure

- 1 Toggle the **Display** soft key and select the display option:
 - Result:** You can view the result table. The Display Result menu becomes activated.
 - Settings:** You can view the measurement settings for the auto measurement.
 - 2 Toggle the **Display Result** soft key and select the display result option:
 - Full:** You can view detailed measurement readings with the pass/fail indication.
 - Quick:** You can view only the Pass/Fail results.
 - Compare:** You can compare two measurement values for each test time with the Allowed % Change setting on. You can view results vs. factory-defined or user-defined
-

references.

- 3 To view the measurement results for a different carrier, press the **View Carrier** soft key and then select the carrier number to view.
 - 4 Press the **Replace Reference** soft key to replace existing reference values for comparison with new measurement data.
 - 5 Press the **Load From** soft key to select the location from which references file to be loaded.
-

Signal performance test

Unlike the other auto measurement tests, the Signal Performance Test runs measurements continuously.

Setting limit for signal performance test

You can set test limits for test item(s) in the auto measurement.

Procedure

- 1 Press the **LIMIT** hot key.
 - 2 Press the **RF Test Limits > Channel Power** soft key, and then set the limits for the channel power. Other RF test items are not used in the signal performance test.
 - 3 Press the **Modulation Test Limits** soft key, and then enable test limits as desired.
 - 4 *Optional.* You can enable alarm sound that goes off if the measurement falls outside of the limit. Toggle the **Beep** soft key between **On** and **Off** to enable or disable the beep sound.
 - 5 *Optional.* Go to **SAVE/LOAD > Save**, and then select **Limit** to save the limit settings. See “Using save” on page 34 for more information.
-

Setting measure setup

After configuring test parameters as described in the “Configuring test parameters” on page 211, you can continue your measurement. The measurement settings can be saved and recalled as a file. You can also use JDViewer, PC application software to configure a measure setup, save as a file, and load the file on to the instrument.

Procedure

- 1 Press the **MEASURE SETUP** hot key.
 - 2 Toggle the **Physical Cell ID** soft key and select **Auto** or **Manual** as desired:
 - Auto:** Lets the instrument detect the Physical Cell ID for the LTE signal automatically.
 - Manual:** Sets a specific Physical Cell ID for the LTE signal manually in order to speed up the synchronization with a BTS.
 - 3 Press the **MIMO** soft key, and then select the antenna number option: **2x2** or **4x4**. This MIMO (Multiple Input Multiple Output) setting is activated only if the option 030 LTE-Advanced FDD is installed with a license number. If not, the instrument sets this option to 2x2 by default. A 2x1 or 4x1 RF combiner is also required to be able to test on MIMO channels.
 - 4 Press the **Antenna Port** soft key, and then select the option: **Auto**, **0**, **1**, **2**, or **3**. If the option 030 LTE-Advanced FDD is not installed or if the MIMO is set to 2x2, the antenna ports 2 and 3 are disabled.
 - 5 Press the **Bandwidth** soft key, and then select the nominal channel bandwidth to be measured, from the choices: **1.4 MHz**, **3 MHz**, **5 MHz**, **10 MHz**, **15 MHz**, and **20 MHz**.
 - 6 Toggle the **RF Profile** soft key between **On** and **Off** to turn on or off the RF profiling such as channel power and subframe frequency error.
 - 7 Toggle the **Modulation Profile** soft key between **On** and **Off** to turn on or off the modulation profiling such as P-SS, S-SS, Data - QPSK, Data – 16 QAM, and Data – 64 QAM.
 - 8 Toggle the **MIMO Profile** soft key between **On** and **Off** to turn on or off the MIMO profiling such
-

as TX1 - RS0, TX2 - RS1, and time alignment error.

- 9 Toggle the **External Offset** soft key and select **On** to set the external offset value.
 - 10 To save your settings and results, go to **SAVE/LOAD > Save** and then perform functions as you desire. See “Using save” on page 34 for more information.
-

DAS test

The Distributed Antenna System (DAS) testing enables you to check the degradation of performance in the signal transmission from a radio band to antennas distributed from it. You can save measurement values at both the radio band and antennas and then compare results with percentage of changes. You can also save test results in the .CSV file format for ease of analysis.

Setting measure setup

Procedure

- 1 Press the **MEASURE SETUP** hot key.
 - 2 Press the **Settings** soft key and then set the following:
 - a Press the **Bandwidth** soft key and then select the nominal channel bandwidth to be measured from the choices: **1.4 MHz, 3 MHz, 5 MHz, 10 MHz, 15 MHz, and 20 MHz**.
 - b Press the **MIMO** soft key, and then select the antenna number option: **2x2** or **4x4**. This MIMO (Multiple Input Multiple Output) setting is activated only if the option 030 LTE-Advanced FDD is installed with a license number. If not, the instrument sets this option to 2x2 by default. A 2x1 or 4x1 RF combiner is also required to be able to test on MIMO channels.
 - c Toggle the **Physical Cell ID** soft key and select **Auto** or **Manual** as desired:
 - Auto:** Lets the instrument detect the Physical Cell ID for the LTE signal automatically.
 - Manual:** Sets a specific Physical Cell ID for the LTE signal manually in order to speed up the synchronization with a BTS.
 - d Press the **Antenna Port** soft key, and then select the option: **Auto, 0, 1, 2, or 3**. If the option 030 LTE-Advanced FDD is not installed or if the MIMO is set to 2x2, the antenna ports 2 and 3 are disabled.
 - e Toggle the **External Offset** soft key and select **On** to set the external offset value.
 - f To turn the Multimedia Broadcast Multicast Service (MBMS) feature on or off, toggle the **MBMS** soft key and select **On** or **Off**.
 - g To set the Multicast Broadcast Single Frequency Network (MBSFN) detection automatically or manually for MBMS testing, toggle the **MBSFN** soft key and select **Auto** or **Manual**. An automatically detected or manually entered MBSFN ID appears on the screen.
 - 3 To save your settings, go to **SAVE/LOAD > Save > Save Setup** and then perform functions as you desire. See “Using save” on page 34 for more information.
 - 4 Press the **Continue** soft key to do the reference test first or press the **Skip Reference Test** soft key if you already saved test results from the radio band under test.
 - 5 Press the **FREQ/DIST** hard key and then set the frequency to be measured. See “Setting frequency” on page 283 for more information.
 - 6 Press the **PREV** hard key.
 - 7 Press the **Limit** soft key and then set the limits and allowed percentage change for each test item. See “Maintenance test” on page 318 for more information on setting limits.
 - 8 Keep pressing the **PREV** hard key until you see the Run Test soft key.
 - 9 Press the **Run Test** soft key. The instrument runs specified tests to gather reference measurement values. The measurement table appears when the reference test is done.
 - 10 Press the **Continue** soft key to run the testing on an antenna (Ant 1).
 - 11 *Optional.* To change the settings such as **External Offset**, press the **Settings** and then change the settings as needed.
 - 12 Press the **Continue** soft key.
-

The instrument runs the testing on Ant 1. The Ant 1 tab appears with the updated result table when the test is done.

- 13 To run the testing on the next antenna (Ant 2), press the **Run Test** soft key and then repeat the steps 11-12. You can do the testing on up to 10 distributed antennas for one radio band.
- 14 To view test results for each antenna, press the **Select Antenna** soft key and then select the antenna tab number to display on the screen.
- 15 *Optional.* Press the **Delete Test** soft key to delete the selected antenna tab.
- 16 *Optional.* Press the **Retest Reference** soft key to obtain reference measurement values again.
- 17 *Optional.* To save your measurement results, go to **SAVE/LOAD > Save** and then perform functions as you desire. See “Using save” on page 34 for more information.

Measurement Example

Figure 137 DAS measurement with LTE-FDD signal analyzer

Measurement Description	Low Limit	High Limit	Allowed % Change	Measurement Reference	Measurement Value	Difference	Percent Change
Channel Power	40.00	42.00	5.00	38.95	38.89	-0.15	-0.38
CRBW	10.00	5.00	5.00	9.08	9.08	0.00	0.00
Frame Avg Power	36.00	40.00	5.00	38.88	38.87	-0.01	-0.02
TAF	90.00	5.00	5.00				
Frequency Error	-0.05	0.05	5.00	0.004	0.007	0.003	80.30
QPSK EVM	18.50	5.00	5.00				
16 QAM EVM	13.50	5.00	5.00				
64 QAM EVM	9.00	5.00	5.00	0.93	0.92	-0.00	-0.27
Data EVM RME	18.50	5.00	5.00	0.93	0.92	-0.00	-0.27
Data EVM Pwsk	18.50	5.00	5.00	4.46	4.23	-0.23	-5.15
RS EVM	18.50	5.00	5.00	0.85	0.96	0.11	12.49
P-SS EVM	18.50	5.00	5.00				
S-SS EVM	18.50	5.00	5.00				
RS Power	13.00	18.00	5.00				
P-SS Power	18.00	22.00	5.00				
S-SS Power	18.00	22.00	5.00				
PBCH Power	18.00	22.00	5.00				
Subframe Power	18.00	22.00	5.00				
OFDM Symbol Pwr	18.00	22.00	5.00				
Time Error	-2.00	2.00	5.00				
TD Drift/Offset	-30.00	5.00	5.00				
ID (Cell Grp Sec)				1/0/1	1/0/1		

Performing power statistics CCDF measurements

The Power Statistics Complementary Cumulative Distribution Function (CCDF) measurement characterizes the power statistics of the input signal. It provides PAR (Peak to Average power Ratio) versus different probabilities.

Setting measure setup

After configuring test parameters as described in the “Configuring test parameters” on page 211, you can continue your measurement. The measurement settings can be saved and recalled as a file. You can also use JDViewer, PC application software to configure a measure setup, save as a file, and load the file on to the instrument.

Procedure

- 1 Press the **MEASURE SETUP** hot key.
- 2 Press the **CCDF Length** soft key to set the length of the CCDF.
- 3 Enter a value between 1 and 100 by using the numeric keys. You can also use the rotary knob.
- 4 Press the **Enter** soft key.

Measurement example

Figure 138 CCDF measurement with LTE-FDD signal analyzer



Performing carrier aggregation measurements

Carrier aggregation enables a maximum of five multiple LTE carriers to be used together in order to provide high data rate required for LTE-Advanced. Component carriers to be aggregated can be intra-band contiguous, intra-band non-contiguous, or inter-band. The JD700B series provides carrier aggregation measurements supporting for all the different modes with carrier aggregation bands added to the channel standard. This functionality is activated if the license for the option 030 LTE-Advanced FDD is installed.

Setting measure setup

After configuring test parameters as described in the “Configuring test parameters” on page 211, you can continue your measurement. The measurement settings can be saved and recalled as a file. You can also use JDViewer, PC application software to configure a measure setup, save as a file, and load the file on to the instrument.

Procedure

- 1 Press the **MEASURE SETUP** hot key.
- 2 To configure parameters for up to 5 component carriers, complete the following steps:
 - a Press the **CA Configuration** soft key.
The component carrier configuration window appears.
 - b Press the **CA Range** soft key.
 - c Enter the number of the component carrier to be set between one and five.
 - d Press the **Enter** soft key.
 - e Toggle the **CC State** soft key and select **On** to set parameters and view the results for the selected component carrier on the screen or **Off** to turn it off.
 - f Toggle **LAA** (License Assisted Access) soft key and select one among the three options: **2.4 GHz**, **5 GHz**, or **Off**.



NOTE

You need to select an available Wi-Fi band (2.4 GHz or 5 GHz) first and then input the right channel number to get the right frequency conversion. If you use LTE band (Off), input the right channel number as needed. The CellAdvisor 745/748B do not support 5

GHz.

- g Set the following parameters as needed:

Center Frequency, Channel Number, Bandwidth, Physical Cell ID, CFI, PHICH Ng, Antenna Port, MBMS On/Off, Cyclic Prefix, and PDSCH Modulation Type



NOTE

You can set **PSS/SSS EVM** Threshold value by entering **Misc** menu only if **MA** is selected in **TRACE/DISPLAY**.

- h To set more component carriers, repeat the steps **c-g**.

- 3 Press the **MEASURE SETUP** hot key again

- 4 Toggle the **EVM Detection Mode** soft key and select **Single** or **Combine** as desired:

Single: Testing on one single antenna connected to your JD700B series with a cable.

Combine: Testing on multiple antennas connected to your JD700B series with a 2x1 or 4x1 combiner or an antenna.

- 5 To select the subframe number to be measured, do one of the following:

If the **EVM Detection Mode** is set to **Single**, press the **Subframe No** soft key and then set the subframe number.



NOTE

For MBMS testing, this subframe number must be neither 0 nor 5 as these subframes 0 and 5 are not available for MBMS and it must be set to the MBMS transmitted channel's subframe number.

If the **EVM Detection Mode** is set to **Combine**, toggle the **Subframe No** soft key, and then select **0** or **5**.

- 6 To set the threshold for PDSCH, complete the following steps:

- a Press the **PDSCH Threshold** soft key.
- b Enter a value by using the numeric keys.
- c Press the **dB** soft key.

- 7 Toggle the **PDSCH Precoding** soft key between **On** and **Off** to enable or disable the PDSCH precoding.

- 8 To select the number of antenna ports, toggle the **MIMO** soft key and select **2x2** or **4x4**. This MIMO (Multiple Input Multiple Output) setting is activated only if the option 030 LTE-Advanced FDD is installed with a license number. If not, the instrument sets this option to 2x2 by default. A 2x1 or 4x1 RF combiner is also required to able to test on MIMO channels.

Measurement example

Figure 139 LAA (Licensed Assited Access) measurement with LTE-FDD signal analyzer



- LAA is a radio access technology which provides LTE service on the 2.4 or 5 GHz band.
- LTE-LAA consists of an anchor or a primary carrier on the licensed band and the secondary carrier on the Wi-Fi band. The CC1 in the measurement screen shows the anchor carrier, and CC2 and CC3 show LAA carriers on Wi-Fi band.
- LTE channel bandwidth on 5 GHz and on 2.4 GHz unlicensed spectrum is 20 MHz, and 10 MHz or 20 MHz respectively.

Setting display

You can use the **TRACE/DISPLAY** hard key to select modulation analysis or spectrum analysis.

Procedure

- 1 Press the **TRACE/DISPLAY** hard key.
- 2 Toggle the **Display** soft key and select **MA** for modulation analysis, **SA** for spectrum analysis or **Dual Sp** for dual spectrogram analysis. The screen changes according to the selected option.
- 3 If **SA** is selected, complete the following steps:
 - a Press the **CC#** soft key, and then select between **CC1** and **CC2**.
 - b Press the **Select Trace** soft key and then select the trace number: **T1**, **T2**, **T3**, **T4**, **T5**, or **T6**. The legend shape of the selected trace changes from square to round to indicate that the trace is the active one now.
 - c Do one of the following:

To	Select	Trace Legend
Clear current data and display with new measurements	Clear Write	W
Display the input signal's maximum response only (unlimited or for a certain amount of time)	Max Hold	M

Display the input signal's minimum response only (unlimited or for a certain amount of time)	Min Hold	m
Capture the selected trace and compare traces	Capture	C
Load a saved trace	More (1/2) > Load	L
Hide the displayed trace	Trace View > Off	F
Remove all the traces and initialize the trace settings	More (1/2) > Trace Clear All	

**NOTE**

For the **Max Hold** and **Min Hold**, your instrument compares newly acquired data with the active trace and displays larger maximum values or smaller minimum values on the screen. You can set it to **Unlimited** to hold and view maximum or minimum data or specify a certain amount of time up to 60 seconds by using numeric keys or rotary knob.

- d Toggle the **Wi-Fi Info** soft key and select **On** or **Off**.

Setting measure setup for dual spectrogram

The Dual Spectrogram mode is useful to compare two spectrograms displayed simultaneously on the screen.

Procedure

- 1 Press the **MEASURE SETUP** hot key
- 2 Press the **More (1/2)** soft key.
- 3 Toggle the **Active Window** soft key and select **Left** or **Right** spectrogram to be set up. You can also tap on the left or right chart on the screen.
- 4 Press the **CC#** soft key and press the number from 1 to 5 using the numeric keys.
- 5 To set the time cursor on a specific trace position, complete the following steps:
 - a Toggle the **Time Cursor** soft key and select **On**.
- 6 Press the **Position** soft key.
- 7 Turn the rotary knob to move the time cursor. You can also enter a value and then press the **Enter** soft key.

**NOTE**

Enabling the time cursor puts the measurement on hold and you can make post-processing analysis for each measurement over time using the time cursor.

- 8 To start a new measurement, press the **Reset/Restart** soft key.
- 9 *Optional.* Go to **SAVE/LOAD > Save**, and then select the save option from the choices available for your measurement mode. See "Using save" on page 34 for more information.

Measurement example

Figure 140 Carrier aggregation measurement with LTE-FDD signal analyzer (MA)



- The MA (Modulation Analysis) result is updated only when the LAA is activated and paused when the Wi-Fi is activated.
- The availability of LTE-LAA is determined by the reference of PSS and SSS EVM. The default threshold is 50%, and it is a user-definable parameter.

Figure 141 Carrier aggregation measurement with LTE-FDD signal analyzer (SA with Wi-Fi on)

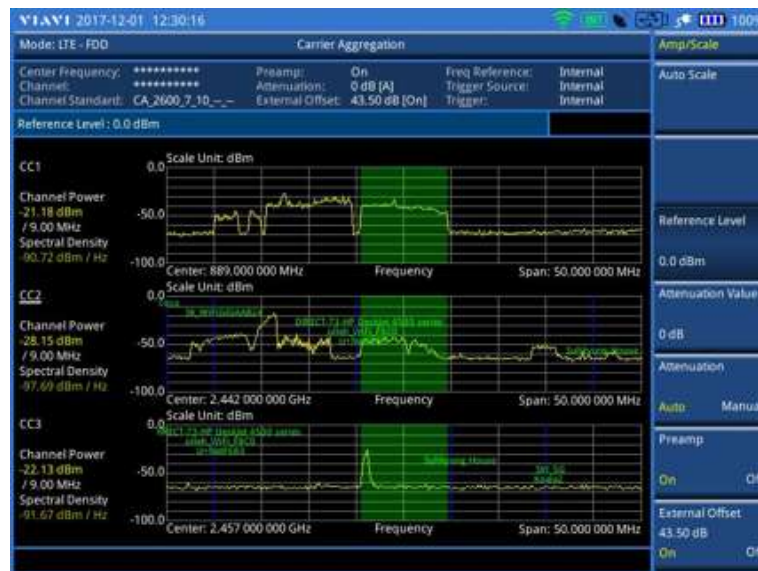

- The SA (Spectrum Analysis) result shows the spectrum trace without triggering.
- The example measurement screen shows Wi-Fi SSID on top of the current spectrum trace showing the Wi-Fi band, which is one of the functions that CellAdvisor 700B series provide.
- Up to five spectrums can be displayed on the same screen simultaneously. When three or more charts become activated, SSID will not be displayed on top of the spectrum traces.

Figure 142 Carrier aggregation measurement with LTE-FDD signal analyzer (Dual Sp)

**NOTE**

You can use the **LIMIT** hot key to analyze your measurements with the user-definable limit and Pass/Fail indication. See “Setting limit for modulation tests” on page 243 for more information.

Using marker

You can use the **MARKER** hard key to place the marker at a specific channel.

Procedure

- 1 Press the **MARKER** hard key.
- 2 Toggle the **Marker View** soft key between **On** and **Off** to display or dismiss the marker.
- 3 Press the **Channel** soft key to select the channel to be displayed on the IQ diagram.
- 4 Use the rotary knob or arrow keys to move and select a channel under EVM.

Conducting LTE-FDD OTA measurements

The FDD LTE Over The Air (OTA) measurement has Channel Scanner, ID Scanner, Multipath Profile, Datagram, and Control Channel screens. The ID Scanner displays key parameters such as RSRP, RSRQ, RS-SINR, and S-SS RSSI. The Multipath Profile enables you to determine RF environmental conditions of testing area. The OTA Control Channel provides summary of all control channels including RS power variation over time.

Channel scanner

The Channel Scanner is a radio receiver that can automatically tune or scan two or more discrete frequencies and multi-channels, indicating when it finds a signal on one of them and then continuing scanning when that frequency goes silent.

Setting channel/frequency

Procedure

To set the channels to be scanned:

- 1 Press the **FREQ/DIST** hard key.
- 2 Toggle the **Unit** soft key and select **Channel**.
- 3 Press the **Index** soft key, and then enter an index number between one and six by turning the rotary knob or using the numeric keys.
- 4 To select the standard channel, complete the following steps:
 - a Press the **Channel Std** soft key. The standard channel window appears. See “Appendix C – Band, frequency & channel standard” on page 769 for more information.
 - b Highlight the band to be measured by using the rotary knob, the arrow keys, or the **Page Up/Page Down** soft keys.
 - c Press the **Select** soft key or the rotary knob to confirm the selection.
- 5 To set the channel number for the selected index, complete the following steps:
 - a Press the **Channel Number** soft key.
 - b Enter a value by using the numeric keys. You can also use the rotary knob.
 - c Press the **Enter** soft key.
- 6 The instrument displays a corresponding center frequency for the channel number.
- 7 To set the integration bandwidth for the selected index, complete the following steps:
 - a Press the **Integration Bandwidth** soft key.
 - b Enter a value by using the numeric keys. You can also use the rotary knob.
 - c Select the unit: **GHz, MHz, kHz, or Hz**.
- 8 To add more channels to be scanned, repeat steps 3-6.
- 9 Press the **ESC** hard key to dismiss the channel list window and view the scanning result.

To set the frequencies to be scanned:

- 1 Press the **FREQ/DIST** hard key.
 - 2 Toggle the **Unit** soft key and select **Freq**.
 - 3 Press the **Index** soft key, and then enter an index number between one and six by turning the rotary knob or using the numeric keys.
 - 4 To set the center frequency for the selected index, complete the following steps:
 - a Press the **Center Frequency** soft key.
 - b Enter a value by using the numeric keys. You can also use the rotary knob.
 - c Select the unit: **GHz, MHz, kHz, or Hz**.
 - 5 To set the integration bandwidth for the selected index, complete the following steps:
 - a Press the **Integration Bandwidth** soft key.
 - b Enter a value by using the numeric keys. You can also use the rotary knob.
 - c Select the unit: **GHz, MHz, kHz, or Hz**.
 - 6 To add more channels to be scanned, repeat steps 3-5.
 - 7 Press the **ESC** hard key to dismiss the channel list window and view the scanning result.
-

Setting number of antenna ports

Procedure

- 1 Press the **MEASURE SETUP** hot key.
 - 2 Toggle the **MIMO** soft key and select **2x2** or **4x4**.
This MIMO (Multiple Input Multiple Output) setting is activated only if the option 030 LTE-Advanced FDD is installed with a license number. If not, the instrument sets this option to 2x2 by default. A 2x1 or 4x1 RF combiner is also required to be able to test on MIMO channels.
-

Measurement example

Figure 143 Channel scanner measurement with LTE-FDD OTA signal analyzer



ID scanner

The LTE mobile receives signals from multiple base stations that all of these signals share the same spectrum and are present at the same time. Each base station has unique scrambling code assigned to the particular base station and it differentiates its signal from other base stations in the area.

The ID Scanner shows key parameters such as RSRP (Reference Signal Received Power) and RSRQ (Reference Signal Received Quality) that predict the downlink coverage quickly.

- RSRPs from entire cells help to rank between the different cells as input for handover and cell reselection decisions.
- RSRQ provides additional information when RSRP is not sufficient to make a reliable handover or cell reselection decision.

All of the parameters for OTA ID scanner can be plotted on map data such as Google Maps and Google Earth by using JDViewer.

Setting measure setup

After configuring test parameters as described in the “Configuring test parameters” on page 211, you can continue your measurement.

Procedure

- 1 Press the **MEASURE SETUP** hot key.
- 2 To set the nominal channel bandwidth to be measured, complete the following steps:
 - a Press the **Bandwidth** soft key.
 - b Select the bandwidth option from the choices: **1.4 MHz**, **3 MHz**, **5 MHz**, **10 MHz**, **15 MHz**, and **20 MHz**.
- 3 *Optional.* Press the **Miscellaneous** soft key, and then do the following as needed:
 - To select the number of antenna ports, toggle the **MIMO** soft key and select **2x2** or **4x4**. This MIMO (Multiple Input Multiple Output) setting is activated only if the option 030 LTE-

Advanced FDD is installed with a license number. If not, the instrument sets this option to 2x2 by default. A 2x1 or 4x1 RF combiner is also required to be able to test on MIMO channels.

To select the cyclic prefix, toggle the **Cyclic Prefix** soft key and select **Normal** or **Extended**. See “Appendix E – Cyclic prefix table” on page 773 for OFDM parameter details by different bandwidth.

- 4 *Optional.* Go to **SAVE/LOAD > Save**, and then select the save option from the choices available for your measurement mode. See “Using save” on page 34 for more information.

Measurement example

Figure 144 ID scanner measurement with LTE-FDD OTA signal analyzer



Multipath profile

The Multipath Profile enables you to determine RF environmental conditions of testing area. It indicates the amount of power of the dominant pilot signal that is dispersed outside the main correlation peak due to multipath echoes that are expressed in dB. This value should be very small ideally.

The multipath profile is the result of portions of the original broadcast signal arriving at the receiving antenna out of phase. This can be caused by the signal being reflected off objects such as buildings, or being refracted through the atmosphere differently from the main signal.

Setting measure setup

After configuring test parameters as described in the “Configuring test parameters” on page 211, you can continue your measurement.

Procedure

- 1 Press the **MEASURE SETUP** hot key.
- 2 To set the nominal channel bandwidth to be measured, complete the following steps:
 - a Press the **Bandwidth** soft key.
 - b Select the bandwidth option from the choices: **1.4 MHz**, **3 MHz**, **5 MHz**, **10 MHz**, **15 MHz**, and **20 MHz**.

- 3 Toggle the **Display** soft key and select **RS** or **Sync**.
The RS Window soft key becomes activated if RS is selected.
- 4 Press the **RS Window** soft key, if RS is selected, and then select the RS window option: **2 μ s**, **4 μ s**, or **8 μ s**.
- 5 *Optional.* Press the **Miscellaneous** soft key, and then do the following as needed:
 - To select the number of antenna ports, toggle the **MIMO** soft key and select **2x2** or **4x4**.
This MIMO (Multiple Input Multiple Output) setting is activated only if the option 030 LTE-Advanced FDD is installed with a license number. If not, the instrument sets this option to 2x2 by default. A 2x1 or 4x1 RF combiner is also required to able to test on MIMO channels.
 - To select the cyclic prefix, toggle the **Cyclic Prefix** soft key and select **Normal** or **Extended**. See “Appendix E – Cyclic prefix table” on page 773 for OFDM parameter details by different bandwidth.
- 6 *Optional.* Go to **SAVE/LOAD > Save**, and then select the save option from the choices available for your measurement mode. See “Using save” on page 34 for more information.

Measurement example

Figure 145 Multipath profile measurement with LTE-FDD OTA signal analyzer



Control channel

DL RS power is the resource element power of Downlink Reference Symbol. The absolute DL RS power is indicated on the BCH. The absolute accuracy is defined as the maximum deviation between the DL RS power indicated on the BCH and the DL RS power at the BS antenna connector.

The OTA Control Channel provides summary of all control channels including RS power trend over time. GPS coordinates (latitude and longitude) will be displayed on the screen if a GPS antenna is connected and locked to the GPS satellites.

Setting measure setup

After configuring test parameters as described in the “Configuring test parameters” on page 211, you can continue your measurement. The measurement settings can be saved and recalled as a file. You can also use JDViewer, PC application software to configure a measure setup, save as a file, and load the file on to the instrument.

Procedure

- 1 Press the **MEASURE SETUP** hot key.
- 2 To set the nominal channel bandwidth to be measured, complete the following steps:
 - a Press the **Bandwidth** soft key.
 - b Select the bandwidth option from the choices: **1.4 MHz, 3 MHz, 5 MHz, 10 MHz, 15 MHz,** and **20 MHz**.
- 3 To select the subframe number to be measured, complete the following steps:
 - a Press the **Subframe No** soft key.
 - b Enter a value by using the numeric keys. You can also use the rotary knob.



NOTE
For MBMS testing, this subframe number must be neither 0 nor 5 as these subframes 0 and 5 are not available for MBMS and it must be set to the MBMS transmitted channel's subframe number.

- c Press the **Enter** soft key.
- 4 *Optional.* Toggle the **Physical Cell ID** soft key and select **Auto** or **Manual** as desired:

Auto: Lets the instrument detect the Physical Cell ID for the LTE signal automatically.

Manual: Sets a specific Physical Cell ID for the LTE signal manually in order to speed up the synchronization with a BTS.
- 5 *Optional.* Press the **Miscellaneous** soft key, and then do the following as needed:

To select the number of antenna ports, toggle the **MIMO** soft key and select **2x2** or **4x4**. This MIMO (Multiple Input Multiple Output) setting is activated only if the option 030 LTE-Advanced FDD is installed with a license number. If not, the instrument sets this option to 2x2 by default. A 2x1 or 4x1 RF combiner is also required to able to test on MIMO channels.

To assign a antenna port number automatically or manually, press the **Antenna Port** soft key and select the option: **Auto, 0, 1, 2,** and **3**. If the option 030 LTE-Advanced FDD is not installed or if the MIMO is set to 2x2, the antenna ports 2 and 3 are disabled.

To select the cyclic prefix, toggle the **Cyclic Prefix** soft key and select **Normal** or **Extended**. See "Appendix E – Cyclic prefix table" on page 773 for OFDM parameter details by different bandwidth.

To turn the Multimedia Broadcast Multicast Service (MBMS) feature on or off, toggle the **MBMS** soft key and select **On** or **Off**. For proper MBMS testing, you need to set the **Subframe No** with the same PMCH subframe number. If this setting is on, the measurement item "MBSFN RS" appears in the result table.

To set the Multicast Broadcast Single Frequency Network (MBSFN) detection automatically or manually for MBMS testing, toggle the **MBSFN** soft key and select **Auto** or **Manual**. An automatically detected or manually entered MBSFN ID appears on the screen.
- 6 *Optional.* Go to **SAVE/LOAD > Save**, and then select the save option from the choices available for your measurement mode. See "Using save" on page 34 for more information.

Setting limit for OTA control channel

Procedure

- 1 Press the **LIMIT** hot key.
- 2 Select the test item(s) and set the limit(s) as needed:

To set the limit for	Select	Set
P-SS error vector magnitude	P-SS EVM	High Limit
S-SS error vector magnitude	S-SS EVM	High Limit
RS error vector magnitude	RS EVM > RS0 EVM	High Limit

	RS EVM > RS1 EVM RS EVM > RS2 EVM RS EVM > RS3 EVM	
Frequency error	Frequency Error	High Limit, Low Limit
Time error	Time Error	High Limit, Low Limit
Time alignment error	Time Alignment Error	High Limit

- 3** *Optional.* Go to **SAVE/LOAD > Save**, and then select **Limit** to save the limit settings. See “Using save” on page 34 for more information.
-

Setting display

You can use the **TRACE/DISPLAY** hard key to select the display option.

Procedure

- 1 Press the **TRACE/DISPLAY** hard key.
 - 2 Toggle the **Display** soft key and select **Power** or **EVM**. The screen changes according to the selected option.
-

Measurement example

Figure 146 Control channel measurement with LTE-FDD OTA signal analyzer



Datagram

The OTA Datagram is a time-varying spectral representation that shows how the power of a signal varies with time. The power allocated to the specific resource block will be represented with an amplitude axis (in dBm) and the waterfall diagram will show the trend of past resource block power over certain period. Using a marker function facilitates analysis of accumulated resource block power for data utilization.

Setting measure setup

After configuring test parameters as described in the “Configuring test parameters” on page 211, you can continue your measurement. The measurement settings can be saved and recalled as a file. You can also use JDViewer, PC application software to configure a measure setup, save as a file, and load the file on to the instrument.

Procedure

- 1 Press the **MEASURE SETUP** hot key.
 - 2 To set the nominal channel bandwidth to be measured, complete the following steps:
 - a Press the **Bandwidth** soft key.
 - b Select the bandwidth option from the choices: **1.4 MHz**, **3 MHz**, **5 MHz**, **10 MHz**, **15 MHz**, and **20 MHz**.
 - 3 To select the subframe number to be measured, complete the following steps:
-

- a Press the **Subframe No** soft key.
 - b Enter a value by using the numeric keys. You can also use the rotary knob.
 - c Press the **Enter** soft key.
- 4 *Optional.* Toggle the **Physical Cell ID** soft key and select **Auto** or **Manual** as desired:
- Auto:** Lets the instrument detect the Physical Cell ID for the LTE signal automatically.
- Manual:** Sets a specific Physical Cell ID for the LTE signal manually in order to speed up the synchronization with a BTS.
- 5 *Optional.* To set the threshold for PDSCH, complete the following steps:
- a Press the **PDSCH Threshold** soft key.
 - b Enter a value by using the numeric keys.
 - c Press the **dB** soft key.
- 6 To set the time cursor at a specific position, complete the following steps:
- a Toggle the **Time Cursor** soft key and select **On**.
 - b Turn the rotary knob to move the time cursor. You can also enter a value and then press the **Enter** soft key.
-  **NOTE**
Enabling the time cursor puts the measurement on hold and you can make post-processing analysis for each measurement over time using the time cursor.
- 7 To start a new measurement, press the **Reset/Restart** soft key.
- 8 *Optional.* Press the **Miscellaneous** soft key, and then do the following as needed:
- To select the number of antenna ports, toggle the **MIMO** soft key and select **2x2** or **4x4**. This MIMO (Multiple Input Multiple Output) setting is activated only if the option 030 LTE-Advanced FDD is installed with a license number. If not, the instrument sets this option to 2x2 by default. A 2x1 or 4x1 RF combiner is also required to able to test on MIMO channels.
- To select the cyclic prefix, toggle the **Cyclic Prefix** soft key and select **Normal** or **Extended**. See “Appendix E – Cyclic prefix table” on page 773 for OFDM parameter details by different bandwidth.
- 9 *Optional.* Go to **SAVE/LOAD > Save**, and then select the save option from the choices available for your measurement mode. See “Using save” on page 34 for more information.

Measurement example

Figure 147 Datagram measurement with LTE-FDD signal analyzer



Route map

The JD700B Series provides the Route Map function that allows you to collect data of points in an indoor or outdoor environment and track the received signals and coverage of RF transmitters by plotting data real time directly on top of a loaded floor plan or a map.

The JD700B Series also supports the RAN-IL (Interference Location) feature that enables you to overlay user experience data obtained through Viavi's ariesoGEO on your base map to help you troubleshoot problems easily and quickly using your instrument. You can generate raster data files on the ariesoGEO application and load them on your instrument.

Setting measure setup

Procedure

- 1 If required, connect a GPS receiver to your JD700B series for outdoor mapping. Indoor mapping does not necessarily need a GPS antenna.
- 2 Configure test parameters as described in the "Configuring test parameters" on page 211.
- 3 To load your map file, complete the following steps:
 - a Plug in your USB drive that has a floor map or .mcf file type created in JMapCreator. If the JMapCreator application on your computer is connected to the instrument via USB or LAN, you can send a map file with a single layer to the instrument directly by using the **Send to EQP** menu in JMapCreator.



NOTE

The JMapCreator converts and resizes any scanned floor plan or layout to fit onto your instrument's display. JMapCreator 1.2.0 or later can save a multiple-layered map, providing **x1**, **x2**, and **x4** views, as a sizable map file so that you can zoom in and out after loading it.

- b Press **SAVE/LOAD** hot key, and then select **Load > Load Map**. See "Using load" on page 36 for more information.
- 4 Press the **MEASURE SETUP** hot key.
- 5 Press the **Plot Point** soft key, and then select the plot point option from the following choices:
To collect data/plot points automatically as you move around in a vehicle or outside, press the **GPS** soft key and then toggle the **Screen Mode** soft key between **Map** and **Full**.



NOTE

With the **Map** setting, you can view only the collected points that can be seen within the boundary of the loaded map. If a point is off the map, the instrument displays an arrow to indicate the direction of the current location on the map and the distance from the center to the location at the top of the screen.

With the **Full** setting, you can view all the collected points of the route without the loaded map.

To collect data/plot points manually without a GPS antenna in an indoor environment, press the **Position** soft key.

- 6 Press the **Plot Item** soft key, and then select the measurement option: **RSRP**, **RSRQ**, **RS-SINR**, **S-SS RSSI**, **P-SS Power**, **S-SS Power**, or **S-SS Ec/Io**.



NOTE

The instrument collects the strongest Physical Cell ID's data to plot points.

- 7 Press the **Bandwidth** soft key to set the nominal channel bandwidth to be measured, and then select the bandwidth option from the choices: **1.4 MHz**, **3 MHz**, **5 MHz**, **10 MHz**, **15 MHz**, and **20 MHz**.
- 8 Toggle the **Plot** soft key and select **Start** to start plotting.
- 9 Touch directly on the screen or press the **ENTER** hard key to collect data and plot points on the loaded map for the **Position** setting.



NOTE

For the **Position** setting, you can change the direction of the route with the arrow keys and the distance with the rotary knob.

- 10 Toggle the **Plot** soft key and select **Stop** to stop plotting.
- 11 Press the **SAVE/LOAD** hot key to save the result.
See “Using save” on page 34 for more information.



NOTE
The instrument does not automatically save the collected data. It is recommended that you save the result. Otherwise, you will lose all the collected data.

Setting limit for route map

You can set the thresholds for each test item.

Procedure

- 1 Press the **LIMIT** hot key.
- 2 Select the plot items and set the limits as needed:

To set the limit for	Select	Set
RSRP	RSRP	Excellent, Very Good, Good, Fair, Poor (dBm)
RSRQ	RSRQ	Good, Fair, Poor (dB)
RS-SINR	RS-SINR	Good, Fair, Poor (dB)
S-SS RSSI	S-SS RSSI	Excellent, Very Good, Good, Fair, Poor (dBm)
P-SS Power	P-SS Power	Excellent, Very Good, Good, Fair, Poor (dBm)
S-SS Power	S-SS Power	Excellent, Very Good, Good, Fair, Poor (dBm)
S-SS Ec/Io	S-SS Ec/Io	Good, Fair, Poor (dB)
- 3 *Optional.* Go to **SAVE/LOAD > Save**, and then select **Limit** to save the limit settings.
See “Using save” on page 34 for more information.

Measurement example

Figure 148 Route map measurement (RSRP) with LTE-FDD OTA signal analyzer



Figure 149 Route map measurement (RSRQ) with LTE-FDD OTA signal analyzer



Figure 150 Route map measurement (RS-SINR) with LTE-FDD OTA signal analyzer



Figure 151 Route map measurement (S-SS RSSI) with LTE-FDD OTA signal analyzer



Figure 152 Route map measurement (P-SS Power) with LTE-FDD OTA signal analyzer



Figure 153 Route map measurement (S-SS Power) with LTE-FDD OTA signal analyzer



Figure 154 Route map measurement (S-SS Ec/Io) with LTE-FDD OTA signal analyzer



Controlling a map

If you have loaded a sizable map that was created in JDMAPCreator 1.2.0 or later, you can use the Map Control feature that enables you to zoom into the map and view a specific area of interest in detail.

Procedure

- 1 Press the **TRACE/DISPLAY** hard key.
- 2 Press the **Map Control** soft key. This key is active only when you have loaded a sizable map.
- 3 Do one of the following:
 - To zoom into an area of interest directly, complete the following steps:
 - a Toggle the **Zoom to** soft key and select **Area**. The black rectangle appears on the map.
 - b Press the **Zoom In** and **Zoom Out** soft keys, as you need, to decrease and increase the selected area.

-
- c Move the rectangle by using the four arrow keys, as you need, to place it in a specific area of interest.
 - d Press the center of the rotary knob to zoom into the selected area. You can also press the **Zoom to** soft key again to zoom into the selected area.
- To zoom into the center or zoom out from the center, complete the following steps:
- a Toggle the **Zoom to** soft key and select **Center**.
 - b Press the **Zoom In** and **Zoom Out** soft keys, as you need, to zoom in and zoom out.
 - c Move the zoomed-in area by using the four arrow keys, as you need.
- 4 To set the location mode, toggle the **Location Mode** soft key between **Auto** and **Manual** and select the one you desire.
- Auto:** The instrument compares the coordinates of the displayed map with received GPS information. If your current location goes out of the displayed area and enters into the next zoomed-in section within the base map, the map display changes automatically to the next section in which your current position is.
- Manual:** The map display of the zoomed-in area remains unchanged even if your current location goes out of the displayed area. You can change the displayed area manually by using the arrow keys.
-

Loading and displaying raster data

If you have a set of raster data files generated through the ariesoGEO application, you can load and overlay the data on your base map to help you check the signal quality and the strength of interferences while driving toward the area of interest.

Procedure

- 1 Copy a set of raster data files into your USB memory drive, including the following:
 - ASCII:** .tab, .asc, and .clr files
 - BIL:** .tab, .hdr, .bil, and .clr files
- 

NOTE
The .tab file type is a geospatial vector data format used in many geographic information systems. The color file (.clr) is an optional file, but the image will be displayed as a grayscale image without it. The size of the raster map must be **1024 x 1024** or smaller.
- 2 Plug in the USB memory drive to your instrument.
 - 3 Press the **TRACE/DISPLAY** hard key.
 - 4 Press the **Load Raster Map** soft key.
The file explorer window appears.
 - 5 Navigate to the raster file (.tab) you want to open, and then press the **Load** soft key.
The raster image appears on top of your base map as shown in Figure 155.
- 

NOTE
If the area of the loaded raster data is not within the boundary of the base map, you will not see the raster image on the screen.
- 6 To select the display option, complete the following steps:
 - a Press the **Display Options** soft key.
 - b Select the option you desire from the choices: **On**, **Off**, and **Blink**.
 - 7 To adjust the transparency level of the image, complete the following steps:
 - a Press the **Transparency** soft key.
 - b Enter a value between **0** for opaque and **100** for clear.
 - c Press the **Enter** soft key.
-

Figure 155 Raster image overlaid on the base map with LTE-FDD OTA signal analyzer



Performing RAN performance testing

The JD700B series provides the optional feature that lets you conduct correlated uplink and downlink testing with your instrument connected to your mobile device via Bluetooth. The RANAdvisor TrueSite application installed on your smartphone collects data and transfers uplink data based on your parameter settings and then your instrument consolidates the data into the measurement results and displays them as performance indicators. It helps you troubleshoot a problem and identify the cause of the problem fast.

To perform this testing, you need both of these installed: the license for the option 014 LTE-FDD RAN Performance Indicator on your instrument and the RANAdvisor TrueSite app with the license on your smartphone.

Preparing your smartphone for remote control via Bluetooth

To set up a Bluetooth connection and enable data collection with remote control properly, you need to pair your instrument with your smartphone and set the app's local Bluetooth control option to Slave once at the beginning.

Procedure

- 1 Connect a Bluetooth adapter to the USB Host port and an Omni antenna to the RF In port of your CellAdvisor instrument.
The instrument detects the adapter and turns on its Bluetooth automatically.
- 2 Make your smartphone visible to your instrument by doing the following steps:
 - a On your smartphone, turn on **Bluetooth**.
 - b Check the checkbox for **Visible to all nearby Bluetooth devices** to enable this option.
- 3 Pair with your smartphone by doing the following steps:
 - a On your instrument, press the **MEASURE SETUP** hot key.
 - b Press the **Bluetooth Connect** soft key.
 - c Press the **Scan** soft key.
The instrument lists detected Bluetooth devices with their MAC address and status.
 - d Highlight your mobile device from the list by touching on the screen.
 - e Press the **Pair** soft key.

- The pairing dialog box appears on your smartphone.
- f On your smartphone, enter **0000** and then tap the **OK** button.
If pairing is successful, the status of your device on the list changes to “**Paired**”.
- 4 Make sure to set your smartphone as a slave by completing the following steps:
 - a On your smartphone, open the **RANAdvisor TrueSite** icon.
 - b Go to **Settings > General**.
 - c Tap the **Automation Control Mode** menu under Automation Control Options.
 - d Select the **Local Bluetooth Control** option.
 - e Tap **Slave**.
The application restart dialog box appears.
 - f Tap **Continue**.
The application closes itself.

**NOTE**

It is very important for you to set the local Bluetooth control option to **Slave** on the RANAdvisor TrueSite app in order to give your instrument a control to collect necessary data from the app over Bluetooth successfully.

Setting parameters on RANAdvisor TrueSite™

To specify uplink measurement data that will be transferred to your instrument, you need to set map display parameters of your choice on the RANAdvisor TrueSite application.

Procedure

- 1 After you have paired and set your smartphone as a slave, open the **RANAdvisor TrueSite** icon on your device again.
- 2 Tap the **(+)** button at the bottom of the Home screen.
The Main Screen appears.
- 3 Tap the **Customization** menu.
The Choose Operation menu box appears.
- 4 Select **Map Display Parameters > LTE Serving and Neighbor Parameters**.
- 5 Make sure to check the checkbox for the following two mandatory parameters:

Serving E-ARFCN

Serving Physical Cell-ID

**NOTE**

It is very important for you to select these two parameters to identify the Uplink Channel Number, Physical Cell ID, Group ID, and Sector ID.

- 6 Select other parameters up to six from the list of parameters supported by the CellAdvisor instrument. See “Appendix L – Supported map display parameters” on page 800 for more information.

**NOTE**

As the RANAdvisor TrueSite app can transfer data of up to eight parameters at a time, it limits you to select eight parameters in total: two compulsories and six electives. After you have selected all eight parameters, the app blocks any further selection. In this case, you need to uncheck any selected optional parameters in order to enable other optional parameters.

- 7 Tap the **OK** button and then the **Back** key to return to the Home Screen.

Performing RAN performance testing

After you have set the local Bluetooth control option and selected desired parameters on the app, you need to connect your instrument to your smartphone via Bluetooth to enable data collection from RANAdvisor TrueSite so that you can view consolidated measurement results on your instrument and save results as a file.

Procedure

- 1 Make sure to have the RANAdvisor TrueSite app opened on your device.
- 2 Press the **MEASURE SETUP** hot key on your instrument.
- 3 Press the **Bluetooth Connect** soft key.
- 4 Highlight your paired smartphone to connect from the list.
- 5 Press the **Connect** soft key.
The connected device information appears above the RAN Performance Indicator chart to indicate a successful connection.
- 6 The instrument automatically sets the correlated downlink channel number for the received uplink channel number and displays measurement results as like Figure 156. Observe the consolidated measurement results on the screen for your troubleshooting.



NOTE

If the Physical Cell ID of the uplink channel is not identical to the one of the downlink channel, the instrument displays “---” for the parameters to indicate invalid measurement results.

- 7 If you want to see measurement results for other parameters, select new parameters on the RANAdvisor TrueSite app. See “Setting parameters on RANAdvisor TrueSite™” on page 273.
- 8 *Optional.* To save your settings and results, go to **SAVE/LOAD > Save** and then perform functions as you desire. See “Using save” on page 34 for more information.

Measurement example

Figure 156 RAN performance indicator with LTE-FDD signal analyzer



Setting performance score level

To analyze your measurement data easily with color codes, you can use the limit feature and set a performance score level for each measurement parameter.

Procedure

- 1 Press the **LIMIT** hot key.
- 2 To analyze the quality of user experience, do the following as needed:

To set the level for	Select	Set
Data throughput	Data Throughput	Good, Bad (kbps)
Channel quality indicator	CQI	Good, Bad
Modulation type	Modulation Type	(On/Off only)

- 3 To check the performance of eNode-B, do the following as needed:

To set the level for	Select	Set
Reference signal received power	RSRP	Good, Bad (dBm)
Reference signal received quality	RSRQ	Good, Bad (dB)
Signal to interference and noise ratio	SINR	Good, Bad (dB)
Error vector magnitude	More (1/2) > EVM	Good, Bad (%)
Time alignment error	More (1/2) > Time Alignment Error	Good, Bad (ns)
Frequency error	More (1/2) > Frequency Error	Good, Bad (ppm)

Performing NB-IoT modulation analysis

NB-IoT modulation enables a 4.5G solution to be deployed on the LTE network as an in-band mode. By implementing demodulation capability, the JD700B series provides the power and EVM of NB-IoT channel measurements and display the results on the screen within LTE-FDD Signal Analyzer. This functionality is activated if the license for the 034 NB-IoT Analyzer with an option 028 LTE-FDD Signal Analyzer is installed. It is available on firmware version 3.066 and above but not on firmware version 3.070.

Setting measure setup

After configuring test parameters as described in the “Configuring test parameters” on page 211, you can continue your measurement. The measurement settings can be saved and recalled as a file.

Procedure

- 1 Press the **MEASURE SETUP** hot key.
 - 2 To set the nominal channel bandwidth to be measured, complete the following steps:
 - a Press the **Bandwidth** soft key.
 - b Select the bandwidth option from the choices: **1.4 MHz, 3 MHz, 5 MHz, 10 MHz, 15 MHz, or 20 MHz.**
 - 3 To select the subframe number to be measured, complete the following steps:
 - a Press the **Subframe No** soft key.
-

- b Enter a value by using the numeric keys. You can also use the rotary knob.



NOTE
You can use **Subframe No** soft key only if you toggle the **Measure Type** soft key and select **Subframe**.

- c Press the **Enter** soft key.
- 4 Press the **NB-IoT PRB Index** soft key, and then turn the rotary knob clockwise or counter clockwise.

Measurement example

Figure 157 NB-IoT modulation measurement with LTE-FDD signal analyzer (Frame)



Figure 158 NB-IoT modulation measurement with LTE-FDD signal analyzer (Subframe 2)



Using marker

You can use the **MARKER** hard key to place a marker on a control channel and display the IQ diagram for the selected channel.

Procedure

- 1 Press the **MARKER** hard key.
 - 2 Press the **Channel** soft key to select the channel to be displayed in the IQ diagram.
The channel P-SS is selected by default.
 - 3 Turn the rotary knob to move the highlight from one to another in the channel summary table.
 - 4 Toggle the **Marker View** soft key between **On** and **Off** to display or hide the result of the selected channel.
-

Chapter 9 Using LTE-TDD Signal Analyzer

This chapter provides instructions for using the LTE-TDD Signal Analyzer (option 029) and LTE-Advanced TDD Analyzer (option 031) with the LTE-TDD OTA Analyzer (option 049), LTE-TDD 256 QAM Demodulator (option 033), and the LTE-TDD RAN Performance Indicator (option 015). Topics discussed in this chapter are as follows:

■ Introduction.....	279
■ Display overview	280
■ Connecting a cable.....	280
■ Selecting measurement mode	282
■ Configuring test parameters.....	282
■ Conducting spectrum measurements	287
■ Conducting RF measurements	289
■ Conducting power vs. time measurements	297
■ Conducting modulation measurements.....	300
■ Performing auto measurements.....	317
■ Performing power statistics CCDF measurements	323
■ Performing carrier aggregation measurements	324
■ Conducting LTE-TDD OTA measurements	328
■ Performing RAN performance testing	343

Introduction

The LTE (Long-Term Evolution) Signal Analyzer of the JD700B series performs power and spectrum measurements as well as modulation analysis to test the proper transmitter performance of TDD LTE systems. It performs conformance testing according to the following standards providing a simple Pass/Fail indication on each test.

- 3GPP TS 36.104. Evolved Universal Terrestrial Radio Access (E-UTRA); Base Station (BS) Radio Transmission and Reception
- 3GPP TS 36.141. Evolved Universal Terrestrial Radio Access (E-UTRA); Base Station (BS) Conformance Testing
- 3GPP TS 36.211. Evolved Universal Terrestrial Radio Access (E-UTRA); Physical Channels and Modulation
- 3GPP TS 36.212. Evolved Universal Terrestrial Radio Access (E-UTRA); Multiplexing and Channel Coding
- 3GPP TS 36.213 V8.2.0. Evolved Universal Terrestrial Radio Access (E-UTRA); Physical Layer Procedures

This instrument provides the following measurement tools for TDD LTE system:

- Spectrum Analysis
- RF Analysis
 - Channel Power
 - Occupied Bandwidth
 - Spectrum Emission Mask
 - Adjacent Channel Leakage power Ratio (ACLR)
 - Multi-ACLR
 - Spurious Emissions
- Power vs. Time: Slot and Frame
- Modulation Analysis
 - Constellation
 - Data Channel
 - Control Channel
 - Subframe
 - Time Alignment Error
 - Data Allocation Map
- Auto Measure
 - Conformance Test
 - Maintenance Test
 - Signal Performance Test
 - DAS Test
- Power Statistics CCDF
- Carrier Aggregation
- Over The Air (OTA)

- Channel Scanner
- ID Scanner
- Multipath Profile
- Control Channel
- Datagram
- Route Map
- RAN Performance Indicator

Display overview

Figure 159 provides descriptions for each segment of the measurement screen.

Figure 159 LTE-TDD signal analyzer measurement screen

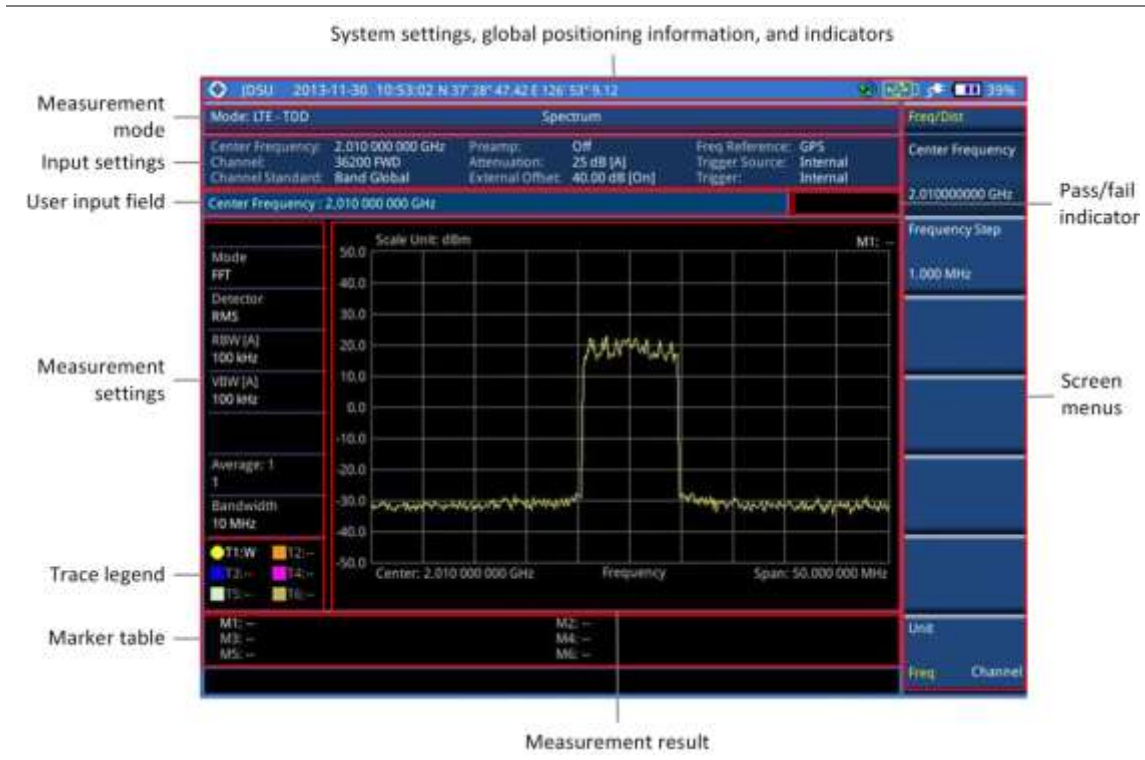

Connecting a cable

Direct connection

Procedure

- 1 Connect the **Spectrum Analyzer RF In** port of the JD700B series and the Power amplifier output port of BTS.

Figure 160 Direct connection



Indirect connection

Procedure

- 1 Connect the **Spectrum Analyzer RF In** port of the JD700B series and the monitor (test) port of BTS.

Figure 161 Indirect connection



CAUTION

The maximum power for the **Spectrum Analyzer RF In** port is +25 dBm (0.316 W) for JD780B series and +20 dBm (0.1 W) for JD740B series. If the level of the input signal to be measured is greater than this, use a **High Power Attenuator** to prevent damage when you directly connect the signal to the instrument or connect the signal from the coupling port of a directional coupler.

Over the air (OTA)

Procedure

- 1 Connect an Omni/directional RF antenna to the **Spectrum Analyzer RF In** port of the JD700B series.
- 2 Connect a GPS antenna to the **GPS** port of the JD700B series.

Figure 162 OTA connection

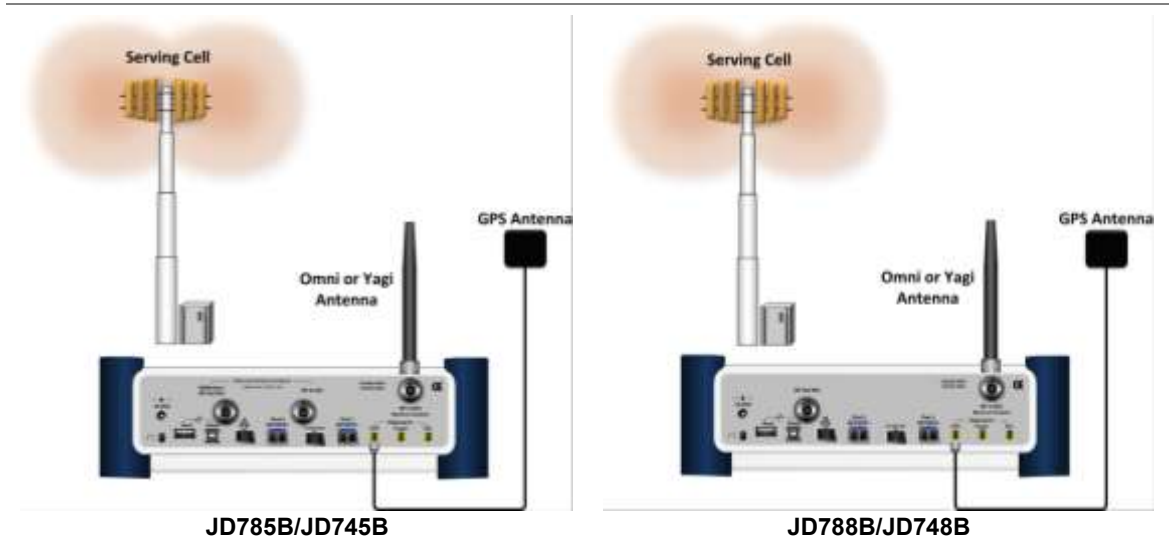

CAUTION

If the input signal level to be measured is less than 0 dBm, set 0 dB attenuation or turn on the preamp to have better dynamic range for the OTA testing.

Selecting measurement mode

Procedure

- 1 Press the **MODE** hard key.
- 2 Press the **Signal Analyzer** soft key.
- 3 Press the **LTE - TDD** soft key. The **Spectrum** mode is set by default.
- 4 Press the **MEASURE** hot key, and then select the measurement mode option from the following choices:

Spectrum

RF Analysis > Channel Power, Occupied BW, Spectrum Emission Mask, ACLR, Multi-ACLR, or Spurious Emissions

Power vs Time > Power vs Time (Slot) or Power vs Time (Frame)

Modulation Analysis > Constellation, Data Channel, Control Channel, Subframe, Time Alignment Error, or Data Allocation Map

Auto Measure > Conformance Test, Maintenance Test, Signal Performance, or DAS Test

Power Statistics CCDF

More (1/2) > Carrier Aggregation

More (1/2) > OTA > Channel Scanner, ID Scanner, Multipath Profile, Control Channel, Datagram, or Route Map

More (1/2) > RAN Performance Indicator



NOTE

The **Carrier Aggregation** soft key is activated if the license for the option 031 LTE-Advanced TDD is installed and so does the **RAN Performance Indicator** for the option 015 LTE-TDD RAN Performance Indicator.

Configuring test parameters

Setting frequency

You can set the frequency with either frequency or channel number. If a frequency to be set matches to the frequency corresponding to the selected channel standard, the instrument calculates its channel number and updates the screen with it automatically.

Procedure

To set the center frequency:

- 1 Press the **FREQ/DIST** hard key.
- 2 Toggle the **Unit** soft key and select **Freq**.
- 3 Press the **Center Frequency** soft key.
- 4 Enter a value by using the numeric keys. You can also use the rotary knob.
- 5 Select the unit: **GHz**, **MHz**, **kHz**, or **Hz**.
- 6 To define the amount of frequency increment for the rotary knob, complete the following steps:
 - a Press the **Frequency Step** soft key.
 - b Enter a value by using the numeric keys. You can also use the rotary knob.
 - c Press the unit: **GHz**, **MHz**, **kHz**, or **Hz**.

To set the channel number:

- 1 Press the **FREQ/DIST** hard key.
- 2 Toggle the **Unit** soft key and select **Channel**.



NOTE

Selecting **Channel** sets the standard channel to **Band Global** automatically so that you can set the **Channel Number** without choosing a standard channel band from the list.

- 3 Press the **Channel Number** soft key.
- 4 Enter a value by using the numeric keys. You can also use the rotary knob.
- 5 Press the **Enter** soft key.
The instrument automatically displays the corresponding center frequency value for the selected channel number.
- 6 To define the amount of channel increment for the rotary knob, complete the following steps:
 - a Press the **Channel Step** soft key.
 - b Enter a value by using the numeric keys. You can also use the rotary knob.
 - c Press the **Enter** soft key.



NOTE

This frequency setting is not used in the Multi-ACLR and Spurious Emissions modes.

Setting amplitude

Reference level and attenuation

You can set the reference and attenuation levels automatically or manually to optimize the display of the traces measured, as you desire.

Procedure

To automatically set the reference and attenuation level:

- 1 Press the **AMP/SCALE** hard key.
 - 2 Press the **Auto Scale** soft key.
Each time you press this key, both of the Y-axis scale and input attenuation level change to be
-

optimized with some margin.

To set the reference or attenuation level manually:

- 1 Press the **AMP/SCALE** hard key.
- 2 To set the maximum reference value on the Y-axis manually, complete the following steps:
 - a Press the **Reference Level** soft key.
 - b Enter a value by using the numeric keys or the rotary knob with 10 dB increments.
 - c Press the unit soft key or the **ENTER** hard key.
This unit key name changes according to the setting in the **Units** menu.



NOTE
In the measurements such as **Control Channel** and **Subframe**, you can select the reference option between **Relative** and **Absolute** instead.

- 3 To set the attenuation option, select one from the following choices:
To set the input attenuator's level automatically, select **Attenuation > Auto**.



NOTE
It is recommended that you set the **Attenuation** to **Auto** in most situations so that the level of the input attenuator can be set automatically according to your input signal level.

To set the input attenuation manually up to 55 dB for JD780B series or 50 dB for JD740B series to optimize S/N, complete the following steps:

- a Select **Attenuation > Manual**.
- b Press the **Attenuation Value** soft key to set the level.
- c Enter a value in fives by using the numeric keys.
- d Press the **dB** soft key or the **ENTER** hard key.

To couple the input attenuator's level with your reference level setting, select **Attenuation > Couple**.

As you increase the reference setting, the attenuation level also increases accordingly.

Optional. **To change the scale unit:**

- 1 Select **More (1/2) > Units**.
- 2 Select the unit of the display scale: **dBm**, **dBV**, **dBmV**, **dBμV**, **V**, or **W**.
The scale unit on the screen changes accordingly.



NOTE
This Units menu is available in the Spectrum and RF Analysis modes.

Scale per division

You can use the **Scale/Div** feature available for the spectrum and RF analysis. It represents the value of one division on the horizontal scale. The default setting is 10 dB per division and the maximum value can be set up to 20 dB.

Procedure

- 1 Press the **AMP/SCALE** hard key.
- 2 Select **More (1/2) > Scale/Div**.
- 3 Enter a value between 1 and 20 by using the numeric keys.
- 4 Press the **dB** soft key to complete the entry.

Pre-amplifier

You can turn the internal pre-amplifier on to correct and compensate for the gain of the preamp so that amplitude readings show the value at the input connector.

Procedure

- 1 Press the **AMP/SCALE** hard key.
 - 2 Toggle the **Preamp** soft key and select **On** or **Off** as needed.
-

**NOTE**

You can turn the Preamp on when the input attenuation range is from 0 dB to 10 dB. If the attenuation value is manually set to greater than 10 dB, the instrument will automatically turn off the pre-amplifier to display low-level signal properly on the chart.

External offset

You can turn the **External Offset** on and manually set the external offset value. An offset consists of a cable loss and a user offset and the measurement result shows the value reflecting both offset values. When the external offset value is set at 40 dB in the Spectrum mode, the measurement result compensates 40 dB at both the Spectrum Analyzer and Signal Analyzer modes.

Procedure

To set the external offset:

- 1 Press the **AMP/SCALE** hard key.
- 2 Toggle the **External Offset** soft key and select **On**.
- 3 Enter a value by using the numeric keys.
- 4 Press the **dB** soft key to complete the entry.

To turn the external offset off:

- 1 Press the **AMP/SCALE** hard key.
 - 2 Toggle the **External Offset** soft key and select **Off**.
-

Setting average

You can set the number of measurements to be averaged for the trace presentation. A maximum of 100 times of averaging can be set. When the averaging reaches to your setting, a new measurement value replaces the measurement value in sequence from the earliest.

Procedure

- 1 Press the **BW/AVG** hard key.
 - 2 Press the **Average** soft key.
 - 3 Enter a value between 1 and 100 as needed by using the numeric keys.
 - 4 Press the **Enter** soft key.
-

Setting sweep mode

The default setting is **Continue** to sweep continuously for most on-going measurements. If you want to hold the measurement or get a single sweep, you can change the sweep mode.

Procedure

To select the single sweep mode:

- 1 Press the **SWEEP** hot key.
 - 2 Toggle the **Sweep Mode** soft key and select **Single**. You can also use the **HOLD** hot key. The letter **HOLD** in red appears and the sweeping is paused.
-

- 3 *Optional.* Press the **Sweep Once** soft key to get a new measurement.

To return to the continuous sweep mode:

- 1 Toggle the **Sweep Mode** soft key and select **Continue**. You can also use the **HOLD** hot key. The letter **HOLD** in red disappears and the sweeping resumes.

Setting trigger source

You can set the trigger source option for your measurements.

Procedure

- 1 Press the **TRIGGER** hot key.
- 2 Select the trigger source option from the choices: **Internal**, **External**, and **GPS**.

Setting external clock

To enhance the reliability of modulation analysis measurements the JD700B series must be synchronized with a base station. When an external clock is not supplied, the instrument works with its built-in internal high-accuracy time base and some measurement results may exhibit inaccurate values. Therefore, it is highly recommended that you use the same reference clock as the signal source. You can use the **TRIGGER** hot key to set the external clock.





Figure 163 Connection ports for external reference clock





Procedure

- 1 Connect an external reference or a GPS antenna to the JD700B series.
- 2 Press the **SYSTEM** hot key.
- 3 Press the **Freq Reference** soft key, and then select the reference option: **Internal**, **External 10 MHz**, **External 13 MHz**, **External 15 MHz**, or **GPS**.

Table 13 External reference indicators

Type	Indicator	Description
Internal	 (green)	The green INT icon indicates that the instrument uses the built-in internal time base.
External	 (green)	The green EXT icon indicates that an external reference is connected and locked and that the instrument uses the same reference clock as the signal source.
External	 (red)	The red EXT icon indicates that an external reference is connect but not locked.
GPS	 (green)	The green GPS antenna icon indicates that a GPS antenna is connected and locked.

GPS	 (yellow)	The yellow GPS antenna icon indicates that a GPS antenna is connected and locking is in progress.
GPS	 (grey)	The grey GPS antenna icon indicates that a GPS antenna is not connected, failed, or unable to be locked.

Conducting spectrum measurements

Setting measure setup

After configuring test parameters as described in the “Configuring test parameters” on page 282, you can continue your measurement.

Procedure

- 1 Press the **MEASURE SETUP** hot key.
- 2 To set the nominal channel bandwidth to be measured, complete the following steps:
 - a Press the **Bandwidth** soft key.
 - b Select the bandwidth option from the choices: **1.4 MHz**, **3 MHz**, **5 MHz**, **10 MHz**, **15 MHz**, and **20 MHz**.
- 3 To select the subframe number to be measured, complete the following steps:
 - a Press the **Subframe No** soft key.
 - b Enter a value by using the numeric keys. You can also use the rotary knob.
 - c Press the **Enter** soft key.
- 4 If you enable the gated sweep for the guard period, you can easily identify the existence of the interference in uplink call activities.
 - a To turn it on, toggle the **Guard Period** soft key and select **Enable**. The Subframe No menu deactivates.
 - b To turn it off, toggle the **Guard Period** soft key and select **Disable**.



NOTE

In LTE-TDD, the guard period is a special subframe, normally Subframe #1 and optionally Subframe #6, where there happens the switching from DL to UL. You should not see any data transmission in the guard period spectrum.

- 5 Toggle the **Physical Cell ID** soft key and select **Auto** or **Manual** as desired:
 - Auto:** Lets the instrument detect the Physical Cell ID for the LTE signal automatically.
 - Manual:** Sets a specific Physical Cell ID for the LTE signal manually in order to speed up the synchronization with a BTS.

Your measurement result is displayed on the screen as like the following example, Figure 164.

Figure 164 Spectrum measurement screen with LTE-TDD signal analyzer



Setting trace

You can display up to six traces on the measurement chart simultaneously.

Procedure

- 1 Press the **TRACE/DISPLAY** hard key.
- 2 Press the **Select Trace** soft key, and then select the trace number: **T1**, **T2**, **T3**, **T4**, **T5**, or **T6**. The legend shape of the selected trace changes from square to round to indicate that the trace is the active one now.
- 3 Do one of the following:

To	Select	Trace Legend
Clear current data and display with new measurements	Clear Write	W
Display the input signal's maximum response only (unlimited or for a certain amount of time)	Max Hold	M
Display the input signal's minimum response only (unlimited or for a certain amount of time)	Min Hold	m
Capture the selected trace and compare traces	Capture	C
Load a saved trace	More (1/2) > Load	L
Hide the displayed trace	Trace View > Off	F
Remove all the traces and initialize the trace settings	More (1/2) > Trace Clear All	



NOTE

For the **Max Hold** and **Min Hold**, your instrument compares newly acquired data with the active trace and displays larger maximum values or smaller minimum values on the screen. You can set it to **Unlimited** to hold and view maximum or minimum data or specify a certain amount of time up to 60 seconds by using numeric keys or rotary knob.

- 4 *Optional.* Select **More (1/2) > Trace Info**, and then select the trace number to view the trace's parameter setting information stored at the time of the measurement or **None** to hide the information display.
- 5 *Optional.* If you have the two traces T1 and T2, you can perform trace math. To view the power

difference between the traces, press the **T1 – T2 -> T5** or **T2 – T1 -> T6** soft key. The result is overlaid on the screen along with the second Y-axis.

Conducting RF measurements

Channel power

The Channel Power measurement is a common test used in the wireless industry to measure the total transmitted power of a radio within a defined frequency channel. It acquires a number of points representing the input signal in the time domain, transforms this information into the frequency domain using Fast Fourier Transform (FFT), and then calculates the channel power. The effective resolution bandwidth of the frequency domain trace is proportional to the number of points acquired for the FFT.

The channel power measurement identifies the total RF power and power spectral density (PSD) of the signal in the LTE channel bandwidth.

Setting measure setup

After configuring test parameters as described in the “Configuring test parameters” on page 282, you can continue your measurement.

Procedure

- 1 Press the **MEASURE SETUP** hot key.
 - 2 To set the nominal channel bandwidth to be measured, complete the following steps:
 - a Press the **Bandwidth** soft key.
 - b Select the bandwidth option from the choices: **1.4 MHz**, **3 MHz**, **5 MHz**, **10 MHz**, **15 MHz**, and **20 MHz**.
 - 3 To select the subframe number to be measured, complete the following steps:
 - a Press the **Subframe No** soft key.
 - b Enter a value by using the numeric keys. You can also use the rotary knob.
 - c Press the **Enter** soft key.
 - 4 Toggle the **Physical Cell ID** soft key and select **Auto** or **Manual** as desired:
 - Auto:** Lets the instrument detect the Physical Cell ID for the LTE signal automatically.
 - Manual:** Sets a specific Physical Cell ID for the LTE signal manually in order to speed up the synchronization with a BTS.
-

Measurement example

Figure 165 Channel power measurement with LTE-TDD signal analyzer



NOTE

You can use the **LIMIT** hot key to analyze your measurements with the user-definable limit and Pass/Fail indication. See “Setting limit for RF tests” on page 296 for more information.

Occupied bandwidth

The Occupied Bandwidth measures the spectrum shape of the carrier. It is defined as the bandwidth, which includes 99% of the transmitted power among total transmitted power.

Setting measure setup

After configuring test parameters as described in the “Configuring test parameters” on page 282, you can continue your measurement.

Procedure

- 1 Press the **MEASURE SETUP** hot key.
- 2 To set the nominal channel bandwidth to be measured, complete the following steps:
 - a Press the **Bandwidth** soft key.
 - b Select the bandwidth option from the choices: **1.4 MHz**, **3 MHz**, **5 MHz**, **10 MHz**, **15 MHz**, and **20 MHz**.
- 3 To select the subframe number to be measured, complete the following steps:
 - a Press the **Subframe No** soft key.
 - b Enter a value by using the numeric keys. You can also use the rotary knob.
 - c Press the **Enter** soft key.
- 4 Toggle the **Physical Cell ID** soft key and select **Auto** or **Manual** as desired:
 - Auto:** Lets the instrument detect the Physical Cell ID for the LTE signal automatically.
 - Manual:** Sets a specific Physical Cell ID for the LTE signal manually in order to speed up the synchronization with a BTS.

Measurement example

Figure 166 Occupied bandwidth measurement with LTE-TDD signal analyzer



NOTE

You can use the **LIMIT** hot key to analyze your measurements with the user-definable limit and Pass/Fail indication. See “Setting limit for RF tests” on page 296 for more information.

Spectrum emission mask (SEM)

The Spectrum Emission Mask (SEM) measurement required by 3GPP specifications encompasses different power limits and different measurement bandwidths (resolution bandwidths) at various frequency offsets. It may be expressed as a ratio of power spectral densities between the carrier and the specified offset frequency band. It provides useful figures-of-merit for the spectral re-growth and emissions produced by components and circuit blocks, without the rigor of performing a full SEM measurement.

The SEM measures spurious signal levels in up to five pairs of offset or region frequencies and relates them to the carrier power.

Setting measure setup

After configuring test parameters as described in the “Configuring test parameters” on page 282, you can continue your measurement.

Procedure

- 1 Press the **MEASURE SETUP** hot key.
- 2 To set the nominal channel bandwidth to be measured, complete the following steps:
 - a Press the **Bandwidth** soft key.
 - b Select the bandwidth option from the choices: **1.4 MHz**, **3 MHz**, **5 MHz**, **10 MHz**, **15 MHz**, and **20 MHz**.
- 3 To select the mask type, complete the following steps:
 - a Press the **Mask Type** soft key.
 - b Select the mask type option, from the following choices:
 - Wide Area BS Category A**
 - Wide Area BS Category B**

Local Area BS

Home BS

- 4 To select the subframe number to be measured, complete the following steps:
 - a Press the **Subframe No** soft key.
 - b Enter a value by using the numeric keys. You can also use the rotary knob.
 - c Press the **Enter** soft key.
- 5 Toggle the **Physical Cell ID** soft key and select **Auto** or **Manual** as desired:
 - Auto:** Lets the instrument detect the Physical Cell ID for the LTE signal automatically.
 - Manual:** Sets a specific Physical Cell ID for the LTE signal manually in order to speed up the synchronization with a BTS.

Measurement example

Figure 167 SEM measurement with LTE-TDD signal analyzer



NOTE
You can use the **LIMIT** hot key to analyze your measurements with the user-definable limit and Pass/Fail indication. See “Setting limit for RF tests” on page 296 for more information.

ACLR

The Adjacent Channel Leakage power Ratio (ACLR) measures the amount of interference or power in an adjacent frequency channel according to the standards.

Setting measure setup

After configuring test parameters as described in the “Configuring test parameters” on page 282, you can continue your measurement.

Procedure

- 1 Press the **MEASURE SETUP** hot key.
- 2 To set the nominal channel bandwidth to be measured, complete the following steps:

- a Press the **Bandwidth** soft key.
 - b Select the bandwidth option from the choices: **1.4 MHz, 3 MHz, 5 MHz, 10 MHz, 15 MHz,** and **20 MHz.**
- 3** To select the subframe number to be measured, complete the following steps:
- a Press the **Subframe No** soft key.
 - b Enter a value by using the numeric keys. You can also use the rotary knob.
 - c Press the **Enter** soft key.
- 4** Toggle the **Physical Cell ID** soft key and select **Auto** or **Manual** as desired:
- Auto:** Lets the instrument detect the Physical Cell ID for the LTE signal automatically.
 - Manual:** Sets a specific Physical Cell ID for the LTE signal manually in order to speed up the synchronization with a BTS.

Measurement example

Figure 168 ACLR measurement with LTE-TDD signal analyzer



NOTE
 You can use the **LIMIT** hot key to analyze your measurements with the user-definable limit and Pass/Fail indication. See “Setting limit for RF tests” on page 296 for more information.

Multi-ACLR

The Multi-ACLR measurement is used to perform multi-channel ACLR measurements with as many channels as possible. It helps you to measure ACLR in multi-channel transmitting Base Station environment.

Setting measure setup

After configuring test parameters as described in the “Configuring test parameters” on page 282, you can continue your measurement.

Procedure

- 1** Press the **MEASURE SETUP** hot key.
- 2** To set the nominal channel bandwidth to be measured, complete the following steps:

- a Press the **Bandwidth** soft key.
 - b Select the bandwidth option from the choices: **1.4 MHz, 3 MHz, 5 MHz, 10 MHz, 15 MHz,** and **20 MHz.**
- 3 To set the frequency, do one of the following:
- To set the center frequency, complete the following steps:
- a Toggle the **Unit** soft key and select **Freq.**
 - b Press the **Lowest Frequency** soft key to set the starting center frequency.
 - c Enter a value by using the numeric keys. You can also use the rotary knob.
 - d Select the unit: **GHz, MHz, kHz, or Hz.**
 - e Press the **Highest Frequency** soft key to set the stopping center frequency.
 - f Enter a value by using the numeric keys. You can also use the rotary knob.
 - g Select the unit: **GHz, MHz, kHz, or Hz.**
- To set the channel number, complete the following steps:
- a Toggle the **Unit** soft key and select **Channel.**



NOTE
 Selecting **Channel** sets the standard channel to **Band Global** automatically so that you can set the **Channel Number** without choosing a standard channel band from the list.

- b Press the **Lowest Channel** soft key to set the starting channel.
- c Enter a value by using the numeric keys. You can also use the rotary knob.
- d Press the **Enter** soft key.
- e Press the **Highest Channel** soft key to set the stopping channel.
- f Enter a value by using the numeric keys. You can also use the rotary knob.
- g Press the **Enter** soft key.

Measurement example

Figure 169 Multi-ACLR measurement with LTE-TDD signal analyzer



NOTE
 You can use the **LIMIT** hot key to analyze your measurements with the user-definable limit and Pass/Fail indication. See “Setting limit for RF tests” on page 296 for more information.

Spurious emissions

Out-of-band emissions are unwanted emissions immediately outside the channel bandwidth resulting from the modulation process and non-linearity in the transmitter but excluding spurious emissions. The Spurious Emissions measurement is to identify and determine the power level of out-of-band spurious emission within the necessary channel bandwidth and modulated signal measured at the RF port of the Base Station.

Setting measure setup

After configuring test parameters as described in the “Configuring test parameters” on page 282, you can continue your measurement.

Procedure

- 1 Press the **MEASURE SETUP** hot key.
- 2 To set up the range table and parameters, press the **Range Table** soft key and then complete the following steps:
 - a Press the **Range** soft key, and then select the range number between **1** and **20** to add as a new or change the existing settings.
 - b Do the following as desired:
 - Select **Start Frequency**, and then specify the start frequency for the selected range.
 - Select **Stop Frequency**, and then specify the stop frequency for the selected range.
 - Select **Start Limit**, and then specify the lower limit for Pass/Fail indication.
 - Select **Stop Limit**, and then specify the upper limit for Pass/Fail indication.
 - Select **More (1/2) > Attenuation**, and then specify an value in the multiple of five.
 - Select **More (1/2) > RBW**, and then specify a RBW value.
 - Select **More (1/2) > VBW**, and then specify a VBW value.
 - c Press the **PREV** hard key.
 - d Toggle the **Range** soft key and select **On** to display the selected range in the result table or **Off** to hide it from the table.
- 3 Toggle the **Measure Type** soft key between **Examine** and **Full** to select the measurement type.



NOTE

The **Examine** mode displays only the selected range while the **Full** mode lets the instrument automatically changes the selected range from one another.

- 4 To set the number of measurements to be averaged, complete the following steps:
 - a Press the **Average** soft key.
 - b Enter a value between **1** and **100**.
 - c Press the **Enter** soft key.
 - 5 To move the highlighted bar in the result table to other range, complete the following steps:
 - a Press the **Range** soft key in the Measure Setup menu bar.
 - b Enter a value between **1** and **20**.
 - c Press the **Enter** soft key.
-

Measurement example

Figure 170 Spurious emissions measurement with LTE-TDD signal analyzer



NOTE

You can use the **LIMIT** hot key to analyze your measurements with the user-definable limit and Pass/Fail indication. See “Setting limit for RF tests” on page 296 for more information.

Setting limit for RF tests

By default, test limits specified in the standard are set for you. You can change thresholds if you desire.

Procedure

- 1 Press the **LIMIT** hot key.
- 2 Press the **RF Test Limits** soft key.
- 3 Select the test item(s) and set the limit(s) depending on your selected measurement mode:

To set the limit for	Select	Set
Channel power	Channel Power	High Limit, Low Limit
Occupied bandwidth	Occupied BW	High Limit
Spectrum emission mask	Spectrum Emission Mask	(On/Off only)
ACLR	ACLR	(On/Off only)
Multi-ACLR	Multi-ACLR	(On/Off only)
Spurious emissions	Spurious Emissions	(On/Off only)

- 4 *Optional.* You can enable alarm sound that goes off if the measurement falls outside of the limit. Toggle the **Beep** soft key between **On** and **Off** to enable or disable the beep sound.
- 5 *Optional.* Go to **SAVE/LOAD > Save**, and then select **Limit** to save the limit settings. See “Using save” on page 34 for more information.

Conducting power vs. time measurements

The Power vs. Time measurement measures the modulation envelope in the time domain, showing the signal rise and fall shape of LTE signal and the power of each time slot in an LTE signal.

Power vs. time (slot)

The Power vs. Time (Slot) in LTE-TDD Signal Analyzer measures the modulation envelope in the time domain, showing the signal rise and fall shapes of LTE signal.



NOTE

In this measurement, desirable level of the input power is lower than -10 dBm. If the input power to be measured is -10 dBm or higher, it is highly recommended that you use an external attenuator.

Setting measure setup

After configuring test parameters as described in the “Configuring test parameters” on page 282, you can continue your measurement. The measurement settings can be saved and recalled as a file.

Procedure

- 1 Press the **MEASURE SETUP** hot key.
 - 2 To set the nominal channel bandwidth to be measured, complete the following steps:
 - a Press the **Bandwidth** soft key.
 - b Select the bandwidth option from the choices: **1.4 MHz, 3 MHz, 5 MHz, 10 MHz, 15 MHz,** and **20 MHz**.
 - 3 To select the slot number to be measured, complete the following steps:
 - a Press the **Slot No** soft key.
 - b Enter a value by using the numeric keys. You can also use the rotary knob.
 - c Press the **Enter** soft key.
 - 4 Toggle the **Physical Cell ID** soft key and select **Auto** or **Manual** as desired:

Auto: Lets the instrument detect the Physical Cell ID for the LTE signal automatically.

Manual: Sets a specific Physical Cell ID for the LTE signal manually in order to speed up the synchronization with a BTS.
 - 5 *Optional.* Press the **Miscellaneous** soft key, and then do the following as needed:

To select the number of antenna ports, toggle the **MIMO** soft key and select **2x2** or **4x4**. This MIMO (Multiple Input Multiple Output) setting is activated only if the option 031 LTE-Advanced TDD is installed with a license number. If not, the instrument sets this option to 2x2 by default. A 2x1 or 4x1 RF combiner is also required to able to test on MIMO channels.

To assign a antenna port number automatically or manually, press the **Antenna Port** soft key and select the option: **Auto, 0, 1, 2,** and **3**. If the option 031 LTE-Advanced TDD is not installed or if the MIMO is set to 2x2, the antenna ports 2 and 3 are disabled.

To select the cyclic prefix, toggle the **Cyclic Prefix** soft key and select **Normal** or **Extended**. See “Appendix E – Cyclic prefix table” on page 773 for OFDM parameter details by different bandwidth.

To set the delay, complete the following steps:

 - a Press the **Delay** soft key to set the amount of delay in μs .
 - b Enter a value by using the numeric keys. You can also use the rotary knob.
 - c Press the **μs** soft key.
-



NOTE

The Delay setting is used only when there is a time offset in the signals to be measured.

Setting limit for power vs. time tests

Procedure

- 1 Press the **LIMIT** hot key.
- 2 Press the **PvsT Test Limits** soft key.
- 3 Select the test item(s) and set the limit(s):

To set the limit for	Select	Set
Slot average power	Slot Avg Power	High Limit, Low Limit
Off power	Off Power	High Limit
Transition period	Transition Period	High Limit

- 4 *Optional.* You can enable alarm sound that goes off if the measurement falls outside of the limit. Toggle the **Beep** soft key between **On** and **Off** to enable or disable the beep sound.
- 5 *Optional.* Go to **SAVE/LOAD > Save**, and then select **Limit** to save the limit settings. See "Using save" on page 34 for more information.

Measurement example

Figure 171 Power vs. time (slot) measurement with LTE – TDD signal analyzer

- 1) Off to on



2) On to off



Power vs. time (frame)

The Power vs. Time (Frame) measures the modulation envelope in the time domain, showing the power of each time slot in an LTE signal.

Setting measure setup

After configuring test parameters as described in the “Configuring test parameters” on page 282, you can continue your measurement. The measurement settings can be saved and recalled as a file.

Procedure

- 1 Press the **MEASURE SETUP** hot key.
- 2 To set the nominal channel bandwidth to be measured, complete the following steps:
 - a Press the **Bandwidth** soft key.
 - b Select the bandwidth option from the choices: **1.4 MHz**, **3 MHz**, **5 MHz**, **10 MHz**, **15 MHz**, and **20 MHz**.
- 3 To select the subframe number to be measured, complete the following steps:
 - a Press the **Subframe No** soft key.
 - b Enter a value by using the numeric keys. You can also use the rotary knob.
 - c Press the **Enter** soft key.
- 4 Toggle the **Physical Cell ID** soft key and select **Auto** or **Manual** as desired:
 - Auto:** Lets the instrument detect the Physical Cell ID for the LTE signal automatically.
 - Manual:** Sets a specific Physical Cell ID for the LTE signal manually in order to speed up the synchronization with a BTS.
- 5 *Optional.* Press the **Miscellaneous** soft key, and then do the following as needed:
 - To select the number of antenna ports, toggle the **MIMO** soft key and select **2x2** or **4x4**. This MIMO (Multiple Input Multiple Output) setting is activated only if the option 031 LTE-Advanced TDD is installed with a license number. If not, the instrument sets this option to 2x2 by default. A 2x1 or 4x1 RF combiner is also required to able to test on MIMO channels.
 - To assign a antenna port number automatically or manually, press the **Antenna Port** soft key and select the option: **Auto**, **0**, **1**, **2**, and **3**. If the option 031 LTE-Advanced TDD is not installed or if the MIMO is set to 2x2, the antenna ports 2 and 3 are disabled.
 - To select the cyclic prefix, toggle the **Cyclic Prefix** soft key and select **Normal** or

Extended. See “Appendix E – Cyclic prefix table” on page 773 for OFDM parameter details by different bandwidth.

To set the delay, complete the following steps:

- a Press the **Delay** soft key to set the amount of delay in μs .
- b Enter a value by using the numeric keys. You can also use the rotary knob.
- c Press the **μs** soft key.



NOTE
The Delay setting is used only when there is a time offset in the signals to be measured.

Measurement example

Figure 172 Power vs. time (frame) measurement with LTE – TDD signal analyzer



Conducting modulation measurements

Constellation

The Constellation is used to observe some aspects of modulation accuracy and can reveal certain fault mechanisms such as I/Q amplitude imbalance or quadrature imbalance. It displays constellation diagram by modulation types.

Setting measure setup

After configuring test parameters as described in the “Configuring test parameters” on page 282, you can continue your measurement. The measurement settings can be saved and recalled as a file. You can also use JDViewer, PC application software to configure a measure setup, save as a file, and load the file on to the instrument.

Procedure

- 1 Press the **MEASURE SETUP** hot key.
- 2 To set the nominal channel bandwidth to be measured, complete the following steps:
 - a Press the **Bandwidth** soft key.

- b Select the bandwidth option from the choices: **1.4 MHz, 3 MHz, 5 MHz, 10 MHz, 15 MHz,** and **20 MHz.**
- 3 To select the subframe number to be measured, complete the following steps:
- a Press the **Subframe No** soft key.
 - b Enter a value by using the numeric keys. You can also use the rotary knob.

**NOTE**

For MBMS testing, this subframe number must be neither 0 nor 5 as these subframes 0 and 5 are not available for MBMS and it must be set to the MBMS transmitted channel's subframe number.

- c Press the **Enter** soft key.
- 4 *Optional.* Toggle the **Physical Cell ID** soft key and select **Auto** or **Manual** as desired:
- Auto:** Lets the instrument detect the Physical Cell ID for the LTE signal automatically.
 - Manual:** Sets a specific Physical Cell ID for the LTE signal manually in order to speed up the synchronization with a BTS.
- 5 *Optional.* Toggle the **CFI** soft key and select **Auto** or **Manual** as desired:
- Auto:** Lets the instrument set the number of OFDM symbols used for transmitting PDCCHs in a subframe.
 - Manual:** Sets the number of OFDM symbols manually. The set of OFDM symbols that can be used for PDCCH in a subframe is given by **0, 2, 3** or **4** in 1.4 MHz bandwidth and **1, 2,** or **3** in other bandwidths.
- 6 *Optional.* Press the **PHICH Ng** soft key, and then select the option for the number of PHICH groups (Ng): **1/6, 1/2, 1, 2, E-1/6, E-1/2, E-1,** or **E-2.**
- 7 Press the **Uplink-Downlink Configuration** soft key, and then select the number of uplink/downlink between one and six.
- 8 *Optional.* Press the **Miscellaneous** soft key, and then do the following as needed:

To select the number of antenna ports, toggle the **MIMO** soft key and select **2x2** or **4x4**.

This MIMO (Multiple Input Multiple Output) setting is activated only if the option 031 LTE-Advanced TDD is installed with a license number. If not, the instrument sets this option to 2x2 by default. A 2x1 or 4x1 RF combiner is also required to able to test on MIMO channels.

To assign a antenna port number automatically or manually, press the **Antenna Port** soft key and select the option: **Auto, 0, 1, 2,** and **3.** If the option 031 LTE-Advanced TDD is not installed or if the MIMO is set to 2x2, the antenna ports 2 and 3 are disabled.

To turn the Multimedia Broadcast Multicast Service (MBMS) feature on or off, toggle the **MBMS** soft key and select **On** or **Off.** For proper MBMS testing, you need to set the **Subframe No** with the same PMCH subframe number. If this setting is on, either PMCH or PDSCH appears on the screen depending on the detected channel.

To set the Multicast Broadcast Single Frequency Network (MBSFN) detection automatically or manually for MBMS testing, toggle the **MBSFN** soft key and select **Auto** or **Manual.** An automatically detected or manually entered MBSFN ID appears on the screen.

To set the delay, complete the following steps:

- a Press the **Delay** soft key to set the amount of delay in μs .
- b Enter a value by using the numeric keys. You can also use the rotary knob.
- c Press the **μs** soft key.

**NOTE**

The Delay setting is used only when there is a time offset in the signals to be measured.

To select the cyclic prefix, toggle the **Cyclic Prefix** soft key and select **Normal** or **Extended.** See "Appendix E – Cyclic prefix table" on page 773 for OFDM parameter details by different bandwidth.

Press the **PDSCH Modulation Type** soft key, and then select the modulation type option: **Auto, QPSK, 16 QAM, 64 QAM, E-TM3.3, E-TM3.2, E-TM3.1, E-TM2, E-TM1.2,** and **E-TM1.1.** If two or more modulation types are used in a frame, select **Auto.** If the PDSCH uses the same modulation type in a frame or in a subframe, select a specific modulation type to get more accurate EVM.



NOTE
 If you have installed a license for the option **033 LTE-TDD 256 QAM Demodulator** on your CellAdvisor, you will have additional PDSCH modulation types of **256 QAM**, **E-TM3.1a**, and **E-TM2a**.

To set the threshold for PDSCH, complete the following steps:

- a Press the **PDSCH Threshold** soft key.
- b Enter a value by using the numeric keys.
- c Press the **dB** soft key.

Toggle the **PDSCH Precoding** soft key between **On** and **Off** to enable or disable the PDSCH precoding.

Measurement example

Figure 173 Constellation measurement with LTE-TDD signal analyzer



Figure 174 Constellation measurement with LTE-TDD signal analyzer (MBMS On)



**NOTE**

You can use the **LIMIT** hot key to analyze your measurements with the user-definable limit and Pass/Fail indication. See “Setting limit for modulation tests” on page 316 for more information.

Data channel

The Data Channel measures the constellation for the specified resource block as well as the modulation accuracy of each PDSCH at the specified subframe.

Setting measure setup

After configuring test parameters as described in the “Configuring test parameters” on page 282, you can continue your measurement. The measurement settings can be saved and recalled as a file. You can also use JDViewer, PC application software to configure a measure setup, save as a file, and load the file on to the instrument.

Procedure

- 1 Press the **MEASURE SETUP** hot key.
- 2 To set the nominal channel bandwidth to be measured, complete the following steps:
 - a Press the **Bandwidth** soft key.
 - b Select the bandwidth option from the choices: **1.4 MHz**, **3 MHz**, **5 MHz**, **10 MHz**, **15 MHz**, and **20 MHz**.
- 3 To select the subframe number to be measured, complete the following steps:
 - a Press the **Subframe No** soft key.
 - b Enter a value by using the numeric keys. You can also use the rotary knob.

**NOTE**

For MBMS testing, this subframe number must be neither 0 nor 5 as these subframes 0 and 5 are not available for MBMS and it must be set to the MBMS transmitted channel's subframe number.

- c Press the **Enter** soft key.
- 4 *Optional.* Toggle the **Physical Cell ID** soft key and select **Auto** or **Manual** as desired:

Auto: Lets the instrument detect the Physical Cell ID for the LTE signal automatically.

Manual: Sets a specific Physical Cell ID for the LTE signal manually in order to speed up the synchronization with a BTS.
- 5 *Optional.* Toggle the **CFI** soft key and select **Auto** or **Manual** as desired:

Auto: Lets the instrument set the number of OFDM symbols used for transmitting PDCCHs in a subframe.

Manual: Sets the number of OFDM symbols manually. The set of OFDM symbols that can be used for PDCCH in a subframe is given by **0**, **2**, **3** or **4** in 1.4 MHz bandwidth and **1**, **2**, or **3** in other bandwidths.
- 6 *Optional.* Press the **PHICH Ng** soft key, and then select the option for the number of PHICH groups (Ng): **1/6**, **1/2**, **1**, **2**, **E-1/6**, **E-1/2**, **E-1**, or **E-2**.
- 7 Toggle the **Event Hold** soft key between **On** and **Off** to enable or disable the event hold feature. When enabled, the display line for the PDSCH threshold appears. When an event occurs, the measurement is put on hold until you press the **HOLD** hot key.

**NOTE**

You can view detailed current resource block on the I-Q diagram, particularly in a dynamic field environment.

- 8 Select **More (1/2) > Uplink-Downlink Configuration**, and then select the number of uplink/downlink between one and six.
 - 9 *Optional.* Select **More (1/2) > Miscellaneous**, and then do the following as needed:

To select the number of antenna ports, toggle the **MIMO** soft key and select **2x2** or **4x4**. This MIMO (Multiple Input Multiple Output) setting is activated only if the option 031 LTE-
-

Advanced TDD is installed with a license number. If not, the instrument sets this option to 2x2 by default. A 2x1 or 4x1 RF combiner is also required to be able to test on MIMO channels.

To assign an antenna port number automatically or manually, press the **Antenna Port** soft key and select the option: **Auto**, **0**, **1**, **2**, and **3**. If the option 031 LTE-Advanced TDD is not installed or if the MIMO is set to 2x2, the antenna ports 2 and 3 are disabled.

To turn the Multimedia Broadcast Multicast Service (MBMS) feature on or off, toggle the **MBMS** soft key and select **On** or **Off**. For proper MBMS testing, you need to set the **Subframe No** with the same PMCH subframe number. If this setting is on, either PMCH or PDSCH appears on the screen depending on the detected channel.

To set the Multicast Broadcast Single Frequency Network (MBSFN) detection automatically or manually for MBMS testing, toggle the **MBSFN** soft key and select **Auto** or **Manual**. An automatically detected or manually entered MBSFN ID appears on the screen.

To set the delay, complete the following steps:

- a Press the **Delay** soft key to set the amount of delay in μs .
- b Enter a value by using the numeric keys. You can also use the rotary knob.
- c Press the **μs** soft key.



NOTE

The Delay setting is used only when there is a time offset in the signals to be measured.

To select the cyclic prefix, toggle the **Cyclic Prefix** soft key and select **Normal** or **Extended**. See “Appendix E – Cyclic prefix table” on page 773 for OFDM parameter details by different bandwidth.

Press the **PDSCH Modulation Type** soft key, and then select the modulation type option: **Auto**, **QPSK**, **16 QAM**, **64 QAM**, **E-TM3.3**, **E-TM3.2**, **E-TM3.1**, **E-TM2**, **E-TM1.2**, and **E-TM1.1**. If two or more modulation types are used in a frame, select **Auto**. If the PDSCH uses the same modulation type in a frame or in a subframe, select a specific modulation type to get more accurate EVM.



NOTE

If you have installed a license for the option **033 LTE-TDD 256 QAM Demodulator** on your CellAdvisor, you will have additional PDSCH modulation types of **256 QAM**, **E-TM3.1a**, and **E-TM2a**.

To set the threshold for PDSCH, complete the following steps:

- a Press the **PDSCH Threshold** soft key.
- b Enter a value by using the numeric keys.
- c Press the **dB** soft key.

Toggle the **PDSCH Precoding** soft key between **On** and **Off** to enable or disable the PDSCH precoding.

Measurement example

Figure 175 Data channel measurement with LTE-TDD signal analyzer



Figure 176 Data channel measurement with LTE-TDD signal analyzer (MBMS On)



NOTE

You can use the **LIMIT** hot key to analyze your measurements with the user-definable limit and Pass/Fail indication. See “Setting limit for modulation tests” on page 316 for more information.

Using marker

You can use the **MARKER** hard key to place a marker on a resource block and display the IQ diagram for the selected resource block.

Procedure

- 1 Press the **MARKER** hard key.
- 2 Press the **RB Number** soft key to select the resource block to be marked.

- 3 Enter the resource block number by using the numeric keys.
- 4 Press the **Enter** soft key.
The marker appears on the selected resource block.
- 5 Toggle the **Marker View** soft key between **On** and **Off** to display or dismiss the result of the selected resource block.

Control channel

The Control Channel measures the constellation for the specified control channel as well as modulation accuracy of the control channel at the specified subframe.

Setting measure setup

After configuring test parameters as described in the “Configuring test parameters” on page 282, you can continue your measurement. The measurement settings can be saved and recalled as a file. You can also use JDViewer, PC application software to configure a measure setup, save as a file, and load the file on to the instrument.

Procedure

- 1 Press the **MEASURE SETUP** hot key.
 - 2 To set the nominal channel bandwidth to be measured, complete the following steps:
 - a Press the **Bandwidth** soft key.
 - b Select the bandwidth option from the choices: **1.4 MHz**, **3 MHz**, **5 MHz**, **10 MHz**, **15 MHz**, and **20 MHz**.
 - 3 To select the subframe number to be measured, complete the following steps:
 - a Press the **Subframe No** soft key.
 - b Enter a value by using the numeric keys. You can also use the rotary knob.
-  **NOTE**
For MBMS testing, this subframe number must be neither 0 nor 5 as these subframes 0 and 5 are not available for MBMS and it must be set to the MBMS transmitted channel's subframe number.
- c Press the **Enter** soft key.
 - 4 *Optional.* Toggle the **Physical Cell ID** soft key and select **Auto** or **Manual** as desired:

Auto: Lets the instrument detect the Physical Cell ID for the LTE signal automatically.

Manual: Sets a specific Physical Cell ID for the LTE signal manually in order to speed up the synchronization with a BTS.
 - 5 *Optional.* Toggle the **CFI** soft key and select **Auto** or **Manual** as desired:

Auto: Lets the instrument set the number of OFDM symbols used for transmitting PDCCHs in a subframe.

Manual: Sets the number of OFDM symbols manually. The set of OFDM symbols that can be used for PDCCH in a subframe is given by **0**, **2**, **3** or **4** in 1.4 MHz bandwidth and **1**, **2**, or **3** in other bandwidths.
 - 6 *Optional.* Press the **PHICH Ng** soft key, and then select the option for the number of PHICH groups (Ng): **1/6**, **1/2**, **1**, **2**, **E-1/6**, **E-1/2**, **E-1**, or **E-2**.
 - 7 Toggle the **EVM Detection Mode** soft key and select **Single** or **Combine** as desired:

Single: Testing on one single antenna connected to your JD700B series with a cable.

Combine: Testing on multiple antennas connected to your JD700B series with a 2x1 or 4x1 combiner or an antenna.
 - 8 Press the **Uplink-Downlink Configuration** soft key, and then select the number of uplink/downlink between one and six.
 - 9 *Optional.* Press the **Miscellaneous** soft key, and then do the following as needed:

To select the number of antenna ports, toggle the **MIMO** soft key and select **2x2** or **4x4**.

This MIMO (Multiple Input Multiple Output) setting is activated only if the option 031 LTE-Advanced TDD is installed with a license number. If not, the instrument sets this option to 2x2 by default. A 2x1 or 4x1 RF combiner is also required to able to test on MIMO channels.

To assign a antenna port number automatically or manually, press the **Antenna Port** soft key and select the option: **Auto**, **0**, **1**, **2**, and **3**. If the option 031 LTE-Advanced TDD is not installed or if the MIMO is set to 2x2, the antenna ports 2 and 3 are disabled.

To turn the Multimedia Broadcast Multicast Service (MBMS) feature on or off, toggle the **MBMS** soft key and select **On** or **Off**. For proper MBMS testing, you need to set the **Subframe No** with the same PMCH subframe number. If this setting is on, the measurement item “MBSFN RS” appears in the result table.

To set the Multicast Broadcast Single Frequency Network (MBSFN) detection automatically or manually for MBMS testing, toggle the **MBSFN** soft key and select **Auto** or **Manual**. An automatically detected or manually entered MBSFN ID appears on the screen.

To set the delay, complete the following steps:

- a Press the **Delay** soft key to set the amount of delay in μ s.
- b Enter a value by using the numeric keys. You can also use the rotary knob.
- c Press the **μ s** soft key.



NOTE
The Delay setting is used only when there is a time offset in the signals to be measured.

To select the cyclic prefix, toggle the **Cyclic Prefix** soft key and select **Normal** or **Extended**. See “Appendix E – Cyclic prefix table” on page 773 for OFDM parameter details by different bandwidth.

To set the threshold for PDCCH, complete the following steps:

- a Press the **PDCCH Threshold** soft key.
- b Enter a value by using the numeric keys.
- c Press the **dB** soft key.

Toggle the **PDCCH Mode** soft key and select **REG** to calculate EVM based on Resource Element Group or **Avg** to calculate EVM after adding up all the PDCCH signals from one subframe.

Measurement example

Figure 177 Control channel measurement with LTE-TDD signal analyzer



Figure 178 Control channel measurement with LTE-TDD signal analyzer (MBMS On)



NOTE

You can use the **LIMIT** hot key to analyze your measurements with the user-definable limit and Pass/Fail indication. See “Setting limit for modulation tests” on page 316 for more information.

Using marker

You can use the **MARKER** hard key to place a marker on a resource block and display the IQ diagram for the selected resource block.

Procedure

- 1 Press the **MARKER** hard key.
- 2 Press the **Channel** soft key to select the channel to be displayed in the IQ diagram. The channel P-SS is selected by default.
- 3 Turn the rotary knob to move the highlight from one to another in the channel summary table.
- 4 Toggle the **Marker View** soft key between **On** and **Off** to display or dismiss the result of the selected channel.

Subframe

The Subframe measures the modulation accuracy of all the data and control channels at the specified subframe (1 ms).

Setting measure setup

After configuring test parameters as described in the “Configuring test parameters” on page 282, you can continue your measurement. The measurement settings can be saved and recalled as a file. You can also use JDViewer, PC application software to configure a measure setup, save as a file, and load the file on to the instrument.

Procedure

- 1 Press the **MEASURE SETUP** hot key.

- 2 To set the nominal channel bandwidth to be measured, complete the following steps:
 - a Press the **Bandwidth** soft key.
 - b Select the bandwidth option from the choices: **1.4 MHz**, **3 MHz**, **5 MHz**, **10 MHz**, **15 MHz**, and **20 MHz**.
 - 3 To select the subframe number to be measured, complete the following steps:
 - a Press the **Subframe No** soft key.
 - b Enter a value by using the numeric keys. You can also use the rotary knob.
-  **NOTE**
For MBMS testing, this subframe number must be neither 0 nor 5 as these subframes 0 and 5 are not available for MBMS and it must be set to the MBMS transmitted channel's subframe number.
- c Press the **Enter** soft key.
 - 4 *Optional.* Toggle the **Physical Cell ID** soft key and select **Auto** or **Manual** as desired:

Auto: Lets the instrument detect the Physical Cell ID for the LTE signal automatically.

Manual: Sets a specific Physical Cell ID for the LTE signal manually in order to speed up the synchronization with a BTS.
 - 5 *Optional.* Toggle the **CFI** soft key and select **Auto** or **Manual** as desired:

Auto: Lets the instrument set the number of OFDM symbols used for transmitting PDCCHs in a subframe.

Manual: Sets the number of OFDM symbols manually. The set of OFDM symbols that can be used for PDCCH in a subframe is given by **0**, **2**, **3** or **4** in 1.4 MHz bandwidth and **1**, **2**, or **3** in other bandwidths.
 - 6 *Optional.* Press the **PHICH Ng** soft key, and then select the option for the number of PHICH groups (Ng): **1/6**, **1/2**, **1**, **2**, **E-1/6**, **E-1/2**, **E-1**, or **E-2**.
 - 7 Toggle the **EVM Detection Mode** soft key and select **Single** or **Combine** as desired:

Single: Testing on one single antenna connected to your JD700B series with a cable.

Combine: Testing on multiple antennas connected to your JD700B series with a 2x1 or 4x1 combiner or an antenna.
 - 8 Press the **Uplink-Downlink Configuration** soft key, and then select the number of uplink/downlink between one and six.
 - 9 *Optional.* Press the **Miscellaneous** soft key, and then do the following as needed:

To select the number of antenna ports, toggle the **MIMO** soft key and select **2x2** or **4x4**. This MIMO (Multiple Input Multiple Output) setting is activated only if the option 031 LTE-Advanced TDD is installed with a license number. If not, the instrument sets this option to 2x2 by default. A 2x1 or 4x1 RF combiner is also required to able to test on MIMO channels.

To assign a antenna port number automatically or manually, press the **Antenna Port** soft key and select the option: **Auto**, **0**, **1**, **2**, and **3**. If the option 031 LTE-Advanced TDD is not installed or if the MIMO is set to 2x2, the antenna ports 2 and 3 are disabled.

To turn the Multimedia Broadcast Multicast Service (MBMS) feature on or off, toggle the **MBMS** soft key and select **On** or **Off**. For proper MBMS testing, you need to set the **Subframe No** with the same PMCH subframe number. If this setting is on, the measurement item "MBSFN RS" appears in the result table and either PMCH or PDSCH appears as well depending on the detected channel.

To set the Multicast Broadcast Single Frequency Network (MBSFN) detection automatically or manually for MBMS testing, toggle the **MBSFN** soft key and select **Auto** or **Manual**. An automatically detected or manually entered MBSFN ID appears on the screen.

To set the delay, complete the following steps:

 - a Press the **Delay** soft key to set the amount of delay in μs .
 - b Enter a value by using the numeric keys. You can also use the rotary knob.
 - c Press the **μs** soft key.



NOTE
The Delay setting is used only when there is a time offset in the signals to be measured.

To select the cyclic prefix, toggle the **Cyclic Prefix** soft key and select **Normal** or

Extended. See “Appendix E – Cyclic prefix table” on page 773 for OFDM parameter details by different bandwidth.

Press the **PDSCH Modulation Type** soft key, and then select the modulation type option: **Auto**, **QPSK**, **16 QAM**, **64 QAM**, **E-TM3.3**, **E-TM3.2**, **E-TM3.1**, **E-TM2**, **E-TM1.2**, and **E-TM1.1**. If two or more modulation types are used in a frame, select **Auto**. If the PDSCH uses the same modulation type in a frame or in a subframe, select a specific modulation type to get more accurate EVM.



NOTE
If you have installed a license for the option **033 LTE-TDD 256 QAM Demodulator** on your CellAdvisor, you will have additional PDSCH modulation types of **256 QAM**, **E-TM3.1a**, and **E-TM2a**.

To set the threshold for PDSCH, complete the following steps:

- a Press the **PDSCH Threshold** soft key.
- b Enter a value by using the numeric keys.
- c Press the **dB** soft key.

To set the threshold for PDCCH, complete the following steps:

- a Press the **PDCCH Threshold** soft key.
- b Enter a value by using the numeric keys.
- c Press the **dB** soft key.

Toggle the **PDCCH Mode** soft key and select **REG** to calculate EVM based on Resource Element Group or **Avg** to calculate EVM after adding up all the PDCCH signals from one subframe.

Toggle the **PDSCH Precoding** soft key between **On** and **Off** to enable or disable the PDSCH precoding.

Measurement example

Figure 179 Subframe measurement with LTE-TDD signal analyzer



Figure 180 Subframe measurement with LTE-TDD signal analyzer (Chart On)



Figure 181 Subframe measurement with LTE-TDD signal analyzer (MBMS On)



NOTE

You can use the **LIMIT** hot key to analyze your measurements with the user-definable limit and Pass/Fail indication. See “Setting limit for modulation tests” on page 316 for more information.

Setting display

You can use the **TRACE/DISPLAY** hard key to view your measurement result with the chart.

Procedure

- 1 Press the **TRACE/DISPLAY** hard key.
- 2 Toggle the **Chart** soft key between **On** and **Off** to display or dismiss the chart. If this setting is on, the **MARKER** hard key is activated.

Using marker

If you turn the Chart view on, you can use the **MARKER** hard key to place the marker at a specific symbol.

Procedure

- 1 Press the **MARKER** hard key.
 - 2 Toggle the **Marker View** soft key between **On** and **Off** to display or dismiss the marker on the chart.
 - 3 Press the **Symbol** soft key to select the symbol number, to which the marker is placed.
 - 4 Enter a value by using the numeric keys.
 - 5 Press the **Enter** soft key.
-

Time alignment error

In eNode B supporting Tx Diversity transmission, signals are transmitted from two or more antennas. These signals shall be aligned. The time alignment error in Tx diversity is specified as the delay between the signals from two antennas at the antenna ports.

Setting measure setup

After configuring test parameters as described in the “Configuring test parameters” on page 282, you can continue your measurement. The measurement settings can be saved and recalled as a file. You can also use JDViewer, PC application software to configure a measure setup, save as a file, and load the file on to the instrument.

Procedure

- 1 Press the **MEASURE SETUP** hot key.
- 2 To set the nominal channel bandwidth to be measured, complete the following steps:
 - a Press the **Bandwidth** soft key.
 - b Select the bandwidth option from the choices: **1.4 MHz**, **3 MHz**, **5 MHz**, **10 MHz**, **15 MHz**, and **20 MHz**.
- 3 *Optional.* Toggle the **Physical Cell ID** soft key and select **Auto** or **Manual** as desired:

Auto: Lets the instrument detect the Physical Cell ID for the LTE signal automatically.

Manual: Sets a specific Physical Cell ID for the LTE signal manually in order to speed up the synchronization with a BTS.
- 4 *Optional.* Press the **Miscellaneous** soft key, and then do the following as needed:

To select the number of antenna ports, toggle the **MIMO** soft key and select **2x2** or **4x4**. This MIMO (Multiple Input Multiple Output) setting is activated only if the option 031 LTE-Advanced TDD is installed with a license number. If not, the instrument sets this option to 2x2 by default. A 2x1 or 4x1 RF combiner is also required to able to test on MIMO channels.

To assign a antenna port number automatically or manually, press the **Antenna Port** soft key and select the option: **Auto**, **0**, **1**, **2**, and **3**. If the option 031 LTE-Advanced TDD is not installed or if the MIMO is set to 2x2, the antenna ports 2 and 3 are disabled.

To set the delay, complete the following steps:

 - a Press the **Delay** soft key to set the amount of delay in μs .
 - b Enter a value by using the numeric keys. You can also use the rotary knob.
 - c Press the **μs** soft key.



NOTE

The Delay setting is used only when there is a time offset in the signals to be measured.

To select the cyclic prefix, toggle the **Cyclic Prefix** soft key and select **Normal** or

Extended. See “Appendix E – Cyclic prefix table” on page 773 for OFDM parameter details by different bandwidth.

Measurement example

Figure 182 Time alignment error measurement with LTE-TDD signal analyzer



NOTE

You can use the **LIMIT** hot key to analyze your measurements with the user-definable limit and Pass/Fail indication. See “Setting limit for modulation tests” on page 316 for more information.

Data allocation map

The Data Allocation Map function represents data allocation as a mapping.

Setting measure setup

After configuring test parameters as described in the “Configuring test parameters” on page 282, you can continue your measurement. The measurement settings can be saved and recalled as a file. You can also use JDViewer, PC application software to configure a measure setup, save as a file, and load the file on to the instrument.

Procedure

- 1 Press the **MEASURE SETUP** hot key.
- 2 To set the nominal channel bandwidth to be measured, complete the following steps:
 - a Press the **Bandwidth** soft key.
 - b Select the bandwidth option from the choices: **1.4 MHz, 3 MHz, 5 MHz, 10 MHz, 15 MHz, and 20 MHz**.
- 3 To select the subframe number to be measured, complete the following steps:
 - a Press the **Subframe No** soft key.
 - b Enter a value by using the numeric keys. You can also use the rotary knob.



NOTE

For MBMS testing, this subframe number must be neither 0 nor 5 as these subframes 0 and 5 are not available for MBMS and it must be set to the MBMS transmitted channel's

subframe number.

- c Press the **Enter** soft key.
- 4 To set the threshold for PDSCH, complete the following steps:
 - a Press the **PDSCH Threshold** soft key.
 - b Enter a value by using the numeric keys.
 - c Press the **dB** soft key.
- 5 *Optional.* Toggle the **Physical Cell ID** soft key and select **Auto** or **Manual** as desired:
 - Auto:** Lets the instrument detect the Physical Cell ID for the LTE signal automatically.
 - Manual:** Sets a specific Physical Cell ID for the LTE signal manually in order to speed up the synchronization with a BTS.
- 6 *Optional.* Press the **Miscellaneous** soft key, and then do the following as needed:
 - To select the number of antenna ports, toggle the **MIMO** soft key and select **2x2** or **4x4**. This MIMO (Multiple Input Multiple Output) setting is activated only if the option 031 LTE-Advanced TDD is installed with a license number. If not, the instrument sets this option to 2x2 by default. A 2x1 or 4x1 RF combiner is also required to able to test on MIMO channels.
 - To assign a antenna port number automatically or manually, press the **Antenna Port** soft key and select the option: **Auto**, **0**, **1**, **2**, and **3**. If the option 031 LTE-Advanced TDD is not installed or if the MIMO is set to 2x2, the antenna ports 2 and 3 are disabled.
 - To turn the Multimedia Broadcast Multicast Service (MBMS) feature on or off, toggle the **MBMS** soft key and select **On** or **Off**. For proper MBMS testing, you need to set the **Subframe No** with the same PMCH subframe number. If this setting is on, either PMCH or PDSCH appears on the screen depending on the detected channel.
 - To set the Multicast Broadcast Single Frequency Network (MBSFN) detection automatically or manually for MBMS testing, toggle the **MBSFN** soft key and select **Auto** or **Manual**. An automatically detected or manually entered MBSFN ID appears on the screen.
 - To select the cyclic prefix, toggle the **Cyclic Prefix** soft key and select **Normal** or **Extended**. See “Appendix E – Cyclic prefix table” on page 773 for OFDM parameter details by different bandwidth.

Measurement example

Figure 183 Data allocation map measurement with LTE-TDD signal analyzer



Figure 184 Data allocation map measurement with LTE-TDD signal analyzer (MBMS On)

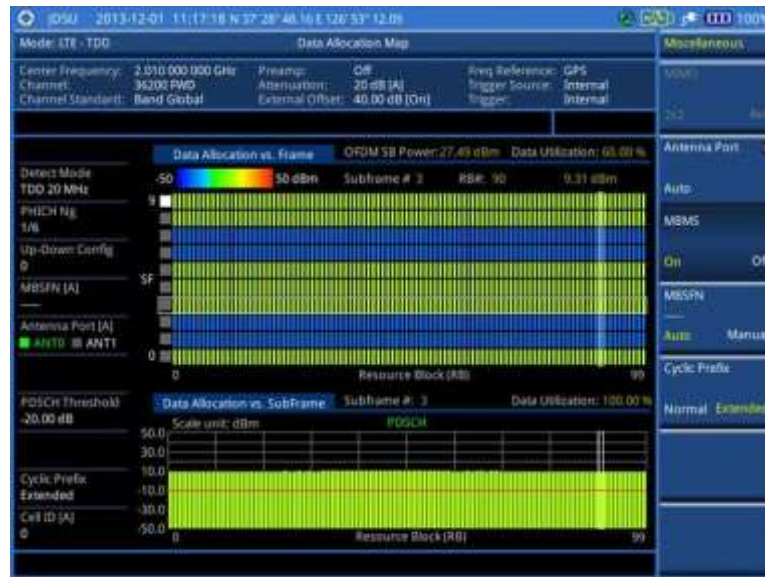

Setting display

You can use the **TRACE/DISPLAY** hard key to change the display mode to PDSCH, PMCH, or both.

Procedure

- 1 Press the **TRACE/DISPLAY** hard key.
- 2 Press the Display Channel soft key.
- 3 Select the display mode from the choice: **PDSCH**, **PMCH**, and **Both**.

Using marker

You can use the **MARKER** hard key to place the marker at a specific resource block and subframe.

Procedure

- 1 Press the **MARKER** hard key.
- 2 Toggle the **Marker View** soft key between **On** and **Off** to display or dismiss the marker on the chart.
- 3 To select the resource block number, complete the following steps:
 - a Press the **RB Number** soft key.
 - b Enter the resource block number to select by using the numeric keys. You can also use the rotary knob to move the marker side by side.
 - c Press the **Enter** soft key.
- 4 To select the subframe block number, complete the following steps:
 - a Press the **Subframe No** soft key.
 - b Enter the subframe number to select by using the numeric keys. You can also use the rotary knob to move the marker up and down.
 - c Press the **Enter** soft key.

Setting limit for modulation tests

Procedure

- 1 Press the **LIMIT** hot key.
- 2 Press the **Modulation Test Limits** soft key to set the limits.
- 3 Select the test item(s) and set the limit(s) depending on your selected measurement mode:

To set the limit for	Select	Set
Frequency error	Frequency Error	High Limit, Low Limit
PDSCH error vector magnitude if MBMS is off	EVM > PDSCH EVM	High Limit (QPSK) High Limit (16 QAM) High Limit (64 QAM) <i>High Limit (256 QAM)*</i>
PMCH error vector magnitude if MBMS is on and a PMCH is detected	EVM > PMCH EVM	High Limit (QPSK) High Limit (16 QAM) High Limit (64 QAM) <i>High Limit (256 QAM)*</i>
RMS for data error vector magnitude	EVM > Data EVM RMS	High Limit
Peak for data error vector magnitude	EVM> Data EVM Peak	High Limit
RS error vector magnitude	EVM > RS EVM	High Limit
P-SS error vector magnitude	EVM > P-SS EVM	High Limit
S-SS error vector magnitude	EVM > S-SS EVM	High Limit
Downlink RS power	Power > DL RS Power	High Limit, Low Limit
P-SS power	Power > P-SS Power	High Limit, Low Limit
S-SS power	Power > S-SS Power	High Limit, Low Limit
PBCH power	Power > PBCH Power	High Limit, Low Limit
Subframe power	Power > Subframe Power	High Limit, Low Limit
OFDM symbol power	Power > OFDM Symbol Power	High Limit, Low Limit
Time alignment error for MIMO	Time Alignment Error > MIMO	High Limit
Time alignment error for aggregation of component carriers (intra-band contiguous, intra-band non-contiguous, and inter-band)	Time Alignment Error > Carrier Aggregation	Intra Cont Intra Non-cont Inter Band
Time error	Time Error	High Limit, Low Limit
I-Q origin offset	IQ Origin Offset	High Limit

- 4 *Optional.* You can enable alarm sound that goes off if the measurement falls outside of the limit. Toggle the **Beep** soft key between **On** and **Off** to enable or disable the beep sound.
- 5 *Optional.* Go to **SAVE/LOAD > Save**, and then select **Limit** to save the limit settings. See "Using save" on page 34 for more information.

Performing auto measurements

Conformance test

The Conformance Test is to test if eNode-B meets some specified standards that have been developed for verification. Its test procedure and test setups have been developed by 3GPP. Test results can be saved as a .csv file type.

Setting limit for conformance test

You can set test limits for test item(s) in the auto measurement. Turning the test limit on for a test item makes the test item included in the conformance test.

Procedure

- 1 Press the **LIMIT** hot key.
- 2 To set the limit for BTS output power, complete the following steps:
 - a Press the **BTS Output Power** soft key.
 - b Toggle the **Test Limits** soft key between **On** and **Off** to enable or disable the limit.
 - c Press the **High Limit** soft key.
 - d Enter a value for the upper limit, and then press the **dBm** unit soft key.
 - e Press the **Low Limit** soft key.
 - f Enter a value for the lower limit, and then press the **dBm** unit soft key.
- 3 To set the limit for total power dynamic, complete the following steps:
 - a Press the **Total Power Dynamic** soft key.
 - b Toggle the **Test Limits** soft key between **On** and **Off** to enable or disable the limit.
 - c Press the **Low Limit** soft key.
 - d Enter a value for the lower limit, and then press the **dBm** unit soft key.
- 4 To set the limit for on/off power, press the **On/Off Power** soft key, and then do the following as needed:

To set the limit for	Select	Set
Off power	Off Power	High Limit
Transition period	Transition Period	High Limit

- 5 To verify signal quality, press the **Signal Quality** soft key, and then do the following as needed:

To set the limit for	Select	Set
Frequency error	Frequency Error	High Limit, Low Limit
Error vector magnitude	EVM	High Limit (QPSK) High Limit (16 QAM) High Limit (64 QAM)
Time alignment error	Time Alignment Error	High Limit
RS power	RS Power	High Limit, Low Limit

- 6 To verify unwanted emissions, press the **Unwanted Emissions** soft key, and then do the following as needed:

To set the limit for	Select	Set
Occupied bandwidth	Occupied BW	High Limit
Adjacent channel power ratio	ACLR	
Spectrum emission mask	SEM	Mask Type

Spurious emissions

Spurious Emissions

Range Table

- 7 *Optional.* You can enable alarm sound that goes off if the measurement falls outside of the limit. Toggle the **Beep** soft key between **On** and **Off** to enable or disable the beep sound.
- 8 *Optional.* Go to **SAVE/LOAD > Save**, and then select **Limit** to save the limit settings. See “Using save” on page 34 for more information.

Setting measure setup

After setting frequency as described in the “Configuring test parameters” on page 282, you can continue your measurement.

Procedure

- 1 Press the **MEASURE SETUP** hot key.
- 2 Press the **Bandwidth** soft key.
- 3 Select the nominal channel bandwidth to be measured, from the choices: **1.4 MHz**, **3 MHz**, **5 MHz**, **10 MHz**, **15 MHz**, and **20 MHz**.
- 4 Press the **Sector** soft key, and then select the sector option: **Alpha**, **Beta**, or **Gamma**.
- 5 To set external offset, complete the following steps:
 - a Toggle the **External Offset** soft key and select **On**.
 - b Enter a value by using the numeric keys.
 - c Press the **dB** soft key.
- 6 To save your settings and results, go to **SAVE/LOAD > Save** and then perform functions as you desire. See “Using save” on page 34 for more information.
- 7 Press the **Run Test** soft key to start to run a test. The Auto Measure Results window appears at the end of the test.
- 8 When prompted on the screen, connect the cable from the **Spectrum Analyzer RF In** port of the instrument to either **Antenna Port 0** or **Antenna Port 1** of the eNode-B, and then change the TM mode on the eNode-B side.
- 9 Press the **Continue** soft key to continue testing.
- 10 Repeat the steps **8-9** until completion of the test. A conformance test report appears at the end of the test.
- 11 *Optional.* To stop running the test, press the **Abort** soft key.

Maintenance test

The Auto Measure function of the JD700B series allows a complete signal profiling covering RF characterization and modulation quality parameters of up to 20 different carriers, particularly useful on an overlay architecture where base stations are transmitting in different frequencies.

Following settings are required only when you run the Auto Measure Maintenance Test on the instrument using “Current” configuration setting. Additional settings are not required when you run Auto Measure using a scenario generated in the PC application software, JDViewer.

Setting limit for maintenance test

You can set test limits for test item(s) in the auto measurement.

Procedure

- 1 Press the **LIMIT** hot key.
- 2 Press the **RF Test Limits** soft key, and then enable test limits as desired.

- 3 Press the **PvsT Test Limits** soft key, and then enable test limits as desired.
- 4 Press the **Modulation Test Limits** soft key, and then enable test limits as desired.
- 5 *Optional.* You can enable alarm sound that goes off if the measurement falls outside of the limit. Toggle the **Beep** soft key between **On** and **Off** to enable or disable the beep sound.
- 6 *Optional.* Go to **SAVE/LOAD > Save**, and then select **Limit** to save the limit settings. See “Using save” on page 34 for more information.

**NOTE**

You can use the **Allowed % Change** soft key for each test item to compare two measurement values displayed in the result table. This requires setting the **Display** mode to **Compare** in advance.

Setting measure setup

After configuring test parameters as described in the “Configuring test parameters” on page 282, you can continue your measurement. The measurement settings can be saved and recalled as a file. You can also use JDViewer, PC application software to configure a measure setup, save as a file, and load the file on to the instrument.

Procedure

- 1 Press the **MEASURE SETUP** hot key.
- 2 Toggle the **Configuration** soft key and select the configuration option:
 - Current:** Lets the instrument use current frequency (single carrier) and determine pass or fail based on the instrument’s limit settings in Auto Measure.
 - Scenario:** Runs a test with a programmed scenario in JDViewer. The Scenario menu becomes activated.
- 3 To load a scenario, press the **Scenario** soft key, and then select a scenario file to load.
- 4 Toggle the **Test Time** soft key and select the test time option:
 - Now:** Lets the instrument run a test only once.
 - Schedule:** Lets the instrument repeat tests as defined in the Set Timing. The Set Timing menu becomes activated.
- 5 To define a schedule for an auto measurement, complete the following steps:
 - a Press the **Set Timing** soft key.
 - b Press the **Start Time (HH:MM)** soft key.
 - c Enter the time in the HH:MM format, and then press the **Enter** soft key.
 - d Press the **Stop Time (HH:MM)** soft key.
 - e Enter the time in the HH:MM format, and then press the **Enter** soft key.
 - f Press the **Time Interval** soft key.
 - g Enter the amount of time in minutes, and then press the **Enter** soft key.
- 6 Press the **Settings** soft key, and then set the following:
 - a Press the **Bandwidth** soft key, and then select the nominal channel bandwidth to be measured, from the choices: **1.4 MHz**, **3 MHz**, **5 MHz**, **10 MHz**, **15 MHz**, and **20 MHz**.
 - b Toggle the **Physical Cell ID** soft key and select **Auto** or **Manual** as desired:
 - Auto:** Lets the instrument detect the Physical Cell ID for the LTE signal automatically.
 - Manual:** Sets a specific Physical Cell ID for the LTE signal manually in order to speed up the synchronization with a BTS.
 - c Press the **MIMO** soft key, and then select the antenna number option: **2x2** or **4x4**. This MIMO (Multiple Input Multiple Output) setting is activated only if the option 031 LTE-Advanced TDD is installed with a license number. If not, the instrument sets this option to 2x2 by default. A 2x1 or 4x1 RF combiner is also required to able to test on MIMO channels.
 - d Press the **Antenna Port** soft key, and then select the option: **Auto**, **0**, **1**, **2**, or **3**. If the option 031 LTE-Advanced TDD is not installed or if the MIMO is set to 2x2, the

-
- antenna ports 2 and 3 are disabled.
 - e Toggle the **External Offset** soft key and select **On**.
 - f Enter a value by using the numeric keys, and then press the **dB** soft key.
 - g To turn the Multimedia Broadcast Multicast Service (MBMS) feature on or off, toggle the **MBMS** soft key and select **On** or **Off**. For proper MBMS testing, you need to set the Subframe No with the same PMCH subframe number.
 - h To set the Multicast Broadcast Single Frequency Network (MBSFN) detection automatically or manually for MBMS testing, toggle the **MBSFN** soft key and select **Auto** or **Manual**. An automatically detected or manually entered MBSFN ID appears on the screen.
- 7 To save your settings and results, go to **SAVE/LOAD > Save** and then perform functions as you desire. See "Using save" on page 34 for more information.
 - 8 Press the **Run Test** soft key to start to run a test.
The Auto Measure Results window appears at the end of the test.
 - 9 To stop running the test, press the **Abort** soft key.
 - 10 To change the view on the screen during the test, press the **Display** and then select the view option from the following choices:
 - Screen:** You can view each measurement screen as the test progresses.
 - Results:** You can view a measurement result table as the test progresses.
 - Settings:** You can view a measurement setting table as the test progresses.
-

Setting display

After completion of the auto measurement, the screen menu changes to Trace/Display so that you can view the results in different forms.

Procedure

- 1 Toggle the **Display** soft key and select the display option:
 - Result:** You can view the result table. The Display Result menu becomes activated.
 - Settings:** You can view the measurement settings for the auto measurement.
 - 2 Toggle the **Display Result** soft key and select the display result option:
 - Full:** You can view detailed measurement readings with the pass/fail indication.
 - Quick:** You can view only the Pass/Fail results.
 - Compare:** You can compare two measurement values for each test time with the Allowed % Change setting on. You can view results vs. factory-defined or user-defined references.
 - 3 To view the measurement results for a different carrier, press the **View Carrier** soft key and then select the carrier number to view.
 - 4 Press the **Replace Reference** soft key to replace existing reference values for comparison with new measurement data.
 - 5 Press the **Load From** soft key to select the location from which references file to be loaded.
-

Signal performance test

Unlike the other auto measurement tests, the Signal Performance Test runs measurements continuously.

Setting limit for signal performance test

You can set test limits for test item(s) in the auto measurement.

Procedure

- 1 Press the **LIMIT** hot key.
-

- 2 Press the **RF Test Limits > Channel Power** soft key, and then set the limits for the channel power. Other RF test items are not used in the signal performance test.
- 3 Press the **Modulation Test Limits** soft key, and then enable test limits as desired.
- 4 *Optional.* You can enable alarm sound that goes off if the measurement falls outside of the limit. Toggle the **Beep** soft key between **On** and **Off** to enable or disable the beep sound.
- 5 *Optional.* Go to **SAVE/LOAD > Save**, and then select **Limit** to save the limit settings. See “Using save” on page 34 for more information.

Setting measure setup

After configuring test parameters as described in the “Configuring test parameters” on page 282, you can continue your measurement. The measurement settings can be saved and recalled as a file. You can also use JDViewer, PC application software to configure a measure setup, save as a file, and load the file on to the instrument.

Procedure

- 1 Press the **MEASURE SETUP** hot key.
 - 2 Toggle the **Physical Cell ID** soft key and select **Auto** or **Manual** as desired:
 - Auto:** Lets the instrument detect the Physical Cell ID for the LTE signal automatically.
 - Manual:** Sets a specific Physical Cell ID for the LTE signal manually in order to speed up the synchronization with a BTS.
 - 3 Press the **MIMO** soft key, and then select the antenna number option: **2x2** or **4x4**. This MIMO (Multiple Input Multiple Output) setting is activated only if the option 031 LTE-Advanced TDD is installed with a license number. If not, the instrument sets this option to 2x2 by default. A 2x1 or 4x1 RF combiner is also required to able to test on MIMO channels.
 - 4 Press the **Antenna Port** soft key, and then select the option: **Auto**, **0**, **1**, **2**, or **3**. If the option 031 LTE-Advanced TDD is not installed or if the MIMO is set to 2x2, the antenna ports 2 and 3 are disabled.
 - 5 Press the **Bandwidth** soft key, and then select the nominal channel bandwidth to be measured, from the choices: **1.4 MHz**, **3 MHz**, **5 MHz**, **10 MHz**, **15 MHz**, and **20 MHz**.
 - 6 Toggle the **RF Profile** soft key between **On** and **Off** to turn on or off the RF profiling such as channel power and subframe frequency error.
 - 7 Toggle the **Modulation Profile** soft key between **On** and **Off** to turn on or off the modulation profiling such as P-SS, S-SS, Data - QPSK, Data – 16 QAM, and Data – 64 QAM.
 - 8 Toggle the **MIMO Profile** soft key between **On** and **Off** to turn on or off the MIMO profiling such as TX1 - RS0, TX2 - RS1, and time alignment error.
 - 9 Toggle the **External Offset** soft key and select **On** to set the external offset value.
 - 10 To save your settings and results, go to **SAVE/LOAD > Save** and then perform functions as you desire. See “Using save” on page 34 for more information.
-

DAS test

The Distributed Antenna System (DAS) testing enables you to check the degradation of performance in the signal transmission from a radio band to antennas distributed from it. You can save measurement values at both the radio band and antennas and then compare results with percentage of changes. You can also save test results in the .csv file format for ease of analysis.

Setting measure setup

Procedure

- 1 Press the **MEASURE SETUP** hot key.
-

-
- 2 Press the **Settings** soft key and then set the following;
 - a Press the **Bandwidth** soft key and then select the nominal channel bandwidth to be measured from the choices: **1.4 MHz, 3 MHz, 5 MHz, 10 MHz, 15 MHz, and 20 MHz**.
 - b Press the **MIMO** soft key, and then select the antenna number option: **2x2** or **4x4**. This MIMO (Multiple Input Multiple Output) setting is activated only if the option 031 LTE-Advanced TDD is installed with a license number. If not, the instrument sets this option to 2x2 by default. A 2x1 or 4x1 RF combiner is also required to be able to test on MIMO channels.
 - c Toggle the **Physical Cell ID** soft key and select **Auto** or **Manual** as desired:
 - Auto:** Lets the instrument detect the Physical Cell ID for the LTE signal automatically.
 - Manual:** Sets a specific Physical Cell ID for the LTE signal manually in order to speed up the synchronization with a BTS.
 - d Press the **Antenna Port** soft key, and then select the option: **Auto, 0, 1, 2, or 3**. If the option 031 LTE-Advanced TDD is not installed or if the MIMO is set to 2x2, the antenna ports 2 and 3 are disabled.
 - e Toggle the **External Offset** soft key and select **On** to set the external offset value.
 - f To turn the Multimedia Broadcast Multicast Service (MBMS) feature on or off, toggle the **MBMS** soft key and select **On** or **Off**.
 - g To set the Multicast Broadcast Single Frequency Network (MBSFN) detection automatically or manually for MBMS testing, toggle the **MBSFN** soft key and select **Auto** or **Manual**. An automatically detected or manually entered MBSFN ID appears on the screen.
 - 3 To save your settings, go to **SAVE/LOAD > Save > Save Setup** and then perform functions as you desire. See "Using save" on page 34 for more information.
 - 4 Press the **Continue** soft key to do the reference test first or press the **Skip Reference Test** soft key if you already saved test results from the radio band under test.
 - 5 Press the **FREQ/DIST** hard key and then set the frequency to be measured. See "Setting frequency" on page 283 for more information.
 - 6 Press the **PREV** hard key.
 - 7 Press the **Limit** soft key and then set the limits and allowed percentage change for each test item. See "Maintenance test" on page 318 for more information on setting limits.
 - 8 Keep pressing the **PREV** hard key until you see the Run Test soft key.
 - 9 Press the **Run Test** soft key.

The instrument runs specified tests to gather reference measurement values. The measurement table appears when the reference test is done.
 - 10 Press the **Continue** soft key to run the testing on an antenna (Ant 1).
 - 11 *Optional.* To change the settings such as **External Offset**, press the **Settings** and then change the settings as needed.
 - 12 Press the **Continue** soft key.

The instrument runs the testing on Ant 1. The Ant 1 tab appears with the updated result table when the test is done.
 - 13 To run the testing on the next antenna (Ant 2), press the **Run Test** soft key and then repeat the steps 11-12. You can do the testing on up to 10 distributed antennas for one radio band.
 - 14 To view test results for each antenna, press the **Select Antenna** soft key and then select the antenna tab number to display on the screen.
 - 15 *Optional.* Press the **Delete Test** soft key to delete the selected antenna tab.
 - 16 *Optional.* Press the **Retest Reference** soft key to obtain reference measurement values again.
 - 17 *Optional.* To save your measurement results, go to **SAVE/LOAD > Save** and then perform functions as you desire. See "Using save" on page 34 for more information.
-

Measurement example

Figure 185 DAS measurement with LTE-TDD signal analyzer

Measurement Description	Low Limit	High Limit	Allowed % Change	Measurement Reference	Measurement Value	Difference	Percent Change
Channel Power	40.00	42.00	5.00	38.94	38.80	-0.14	-0.35
QIRW	10.00	5.00	5.00	9.08	9.08	0.00	0.00
Frame Avg Power	36.00	40.00	5.00	36.80	36.87	0.07	0.02
TAI	90.00	5.00	5.00				
Frequency Error	-0.05	0.05	5.00	0.004	0.007	0.003	80.30
QPSK EVM	18.50	5.00	5.00				
16 QAM EVM	13.50	5.00	5.00				
64 QAM EVM	9.00	5.00	5.00	0.93	0.92	-0.01	-0.27
Data EVM RMS	18.50	5.00	5.00	0.93	0.92	-0.01	-0.27
Data EVM Peak	18.50	5.00	5.00	4.46	4.23	-0.23	-5.13
RS EVM	18.50	5.00	5.00	0.85	0.90	0.11	12.40
P-SS EVM	18.50	5.00	5.00				
S-SS EVM	18.50	5.00	5.00				
RS Power	13.00	18.00	5.00				
P-SS Power	18.00	22.00	5.00				
S-SS Power	18.00	22.00	5.00				
PBCH Power	18.00	22.00	5.00				
Subframe Power	18.00	22.00	5.00				
OFDM Symbol Pwr	18.00	22.00	5.00				
Time Error	-2.00	2.00	5.00				
TD Drifts Offset	-30.00	5.00	5.00				
ID (Cell Grp, Sect)				1,0,1	1,0,1		

Performing power statistics CCDF measurements

The Power Statistics Complementary Cumulative Distribution Function (CCDF) measurement characterizes the power statistics of the input signal. It provides PAR (Peak to Average power Ratio) versus different probabilities.

Setting measure setup

After configuring test parameters as described in the “Configuring test parameters” on page 282, you can continue your measurement. The measurement settings can be saved and recalled as a file. You can also use JDViewer, PC application software to configure a measure setup, save as a file, and load the file on to the instrument.

Procedure

- 1 Press the **MEASURE SETUP** hot key.
- 2 Press the **CCDF Length** soft key to set the length of the CCDF.
- 3 Enter a value between 1 and 100 by using the numeric keys. You can also use the rotary knob.
- 4 Press the **Enter** soft key.

Measurement example

Figure 186 CCDF measurement with LTE-TDD signal analyzer



Performing carrier aggregation measurements

Carrier aggregation enables a maximum of five multiple LTE carriers to be used together in order to provide high data rate required for LTE-Advanced. Component carriers to be aggregated can be intra-band contiguous, intra-band non-contiguous, or inter-band. The JD700B series provides carrier aggregation measurements supporting for all the different modes with carrier aggregation bands added to the channel standard. This functionality is activated if the license for the option 031 LTE-Advanced TDD is installed.

Setting measure setup

After configuring test parameters as described in the “Configuring test parameters” on page 282, you can continue your measurement. The measurement settings can be saved and recalled as a file. You can also use JDViewer, PC application software to configure a measure setup, save as a file, and load the file on to the instrument.

Procedure

- 1 Press the **MEASURE SETUP** hot key.
- 2 To configure parameters for up to 5 component carriers, complete the following steps:
 - a Press the **CA Configuration** soft key.
The component carrier configuration window appears.
 - b Press the **CA Range** soft key.
 - c Enter the number of the component carrier to be set between one and five.
 - d Press the **Enter** soft key.
 - e Toggle the **CC State** soft key, and then select **On** to set parameters and view the results for the selected component carrier on the screen or **Off** to turn it off.
 - f Toggle the **LAA** (License Assisted Access) soft key and select one among the three options: **2.4 GHz**, **5 GHz**, or **Off**.



NOTE

You need to select an available Wi-Fi band (2.4 GHz or 5 GHz) first and then input the right channel number to get the right frequency conversion. If you use LTE band (Off), input the right channel number as needed. The CellAdvisor JD745/748B do not support

5 GHz.

- g Set the following parameters as needed:

Center Frequency, Channel Number, Bandwidth, Physical Cell ID, CFI, PHICH Ng, Antenna Port, MBMS On/Off, Cyclic Prefix, and PDSCH Modulation Type



NOTE

You can set **PSS/SSS EVM Threshold** value using the rotary knob, the arrow keys, or the numeric keys only if **MA** is selected in **TRACE/DISPLAY**.

- h To set more component carriers, repeat the steps **c-g**.

- 3 Press the **MEASURE SETUP** hot key again.

- 4 Toggle the **EVM Detection Mode** soft key and select **Single** or **Combine** as desired:

Single: Testing on one single antenna connected to your JD700B series with a cable.

Combine: Testing on multiple antennas connected to your JD700B series with a 2x1 or 4x1 combiner or an antenna.

- 5 To select the subframe number to be measured, do one of the following:

If the **EVM Detection Mode** is set to **Single**, press the **Subframe No** soft key and then set the subframe number.



NOTE

For MBMS testing, this subframe number must be neither 0 nor 5 as these subframes 0 and 5 are not available for MBMS and it must be set to the MBMS transmitted channel's subframe number.

If the **EVM Detection Mode** is set to **Combine**, toggle the **Subframe No** soft key and then select **0** or **5**.

- 6 To set the threshold for PDSCH, complete the following steps:

- a Press the **PDSCH Threshold** soft key.
- b Enter a value by using the numeric keys.
- c Press the **dB** soft key.

- 7 Toggle the **PDSCH Precoding** soft key between **On** and **Off** to enable or disable the PDSCH precoding.

- 8 To select the number of antenna ports, toggle the **MIMO** soft key and select **2x2** or **4x4**. This MIMO (Multiple Input Multiple Output) setting is activated only if the option 031 LTE-Advanced TDD is installed with a license number. If not, the instrument sets this option to 2x2 by default. A 2x1 or 4x1 RF combiner is also required to able to test on MIMO channels.

Setting display

You can use the **TRACE/DISPLAY** hard key to select modulation analysis or spectrum analysis.

Procedure

- 1 Press the **TRACE/DISPLAY** hard key.
- 2 Toggle the **Display** soft key and select **MA** for modulation analysis, **SA** for spectrum analysis or **Dual Sp** for dual spectrogram analysis. The screen changes according to the selected option.
- 3 If **SA** is selected, complete the following steps:
 - a Press the **CC#** soft key, and then select between **CC1** and **CC2**.
 - b Press the **Select Trace** soft key and then select the trace number: **T1**, **T2**, **T3**, **T4**, **T5**, or **T6**. The legend shape of the selected trace changes from square to round to indicate that the trace is the active one now.
 - c Do one of the following:

To	Select	Trace Legend
Clear current data and display with new measurements	Clear Write	W

Display the input signal's maximum response only (unlimited or for a certain amount of time)	Max Hold	M
Display the input signal's minimum response only (unlimited or for a certain amount of time)	Min Hold	m
Capture the selected trace and compare traces	Capture	C
Load a saved trace	More (1/2) > Load	L
Hide the displayed trace	Trace View > Off	F
Remove all the traces and initialize the trace settings	More (1/2) > Trace Clear All	



NOTE
For the **Max Hold** and **Min Hold**, your instrument compares newly acquired data with the active trace and displays larger maximum values or smaller minimum values on the screen. You can set it to **Unlimited** to hold and view maximum or minimum data or specify a certain amount of time up to 60 seconds by using numeric keys or rotary knob.

- d Toggle the **Wi-Fi Info** soft key and select **On** or **Off**.

Setting measure setup for dual spectrogram

The Dual Spectrogram mode is useful to compare two spectrograms displayed simultaneously on the screen.

Procedure

- 1 Press the **MEASURE SETUP** hot key.
- 2 Press the **More (1/2)** soft key.
- 3 Toggle the **Active Window** soft key and select **Left** or **Right** spectrogram to be set up. You can also tap on the left or right chart on the screen.
- 4 Press the **CC#** soft key and press the number from 1 to 5 using the numeric keys.
- 5 To set the time cursor on a specific trace position, complete the following steps:
 - a Toggle the **Time Cursor** soft key and select **On**.
- 6 Press the **Position** soft key.
- 7 Turn the rotary knob to move the time cursor. You can also enter a value and then press the **Enter** soft key.



NOTE
Enabling the time cursor puts the measurement on hold and you can make post-processing analysis for each measurement over time using the time cursor.

- 8 To start a new measurement, press the **Reset/Restart** soft key.
- 9 *Optional.* Go to **SAVE/LOAD > Save**, and then select the save option from the choices available for your measurement mode. See "Using save" on page 34 for more information.

Measurement example

Figure 187 Carrier aggregation measurement with LTE-TDD signal analyzer (MA)



Figure 188 Carrier aggregation measurement with LTE-TDD signal analyzer (SA with Wi-Fi on)

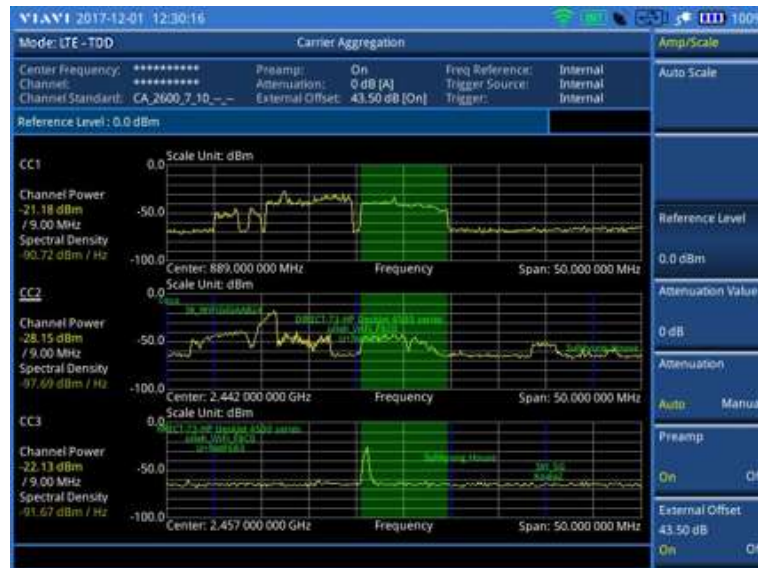

Figure 189 Carrier aggregation measurement with LTE-TDD signal analyzer (Dual Sp)



NOTE

You can use the **LIMIT** hot key to analyze your measurements with the user-definable limit and Pass/Fail indication. See “Setting limit for modulation tests” on page 316 for more information.

Using marker

You can use the **MARKER** hard key to place the marker at a specific channel.

Procedure

- 1 Press the **MARKER** hard key.
- 2 Toggle the **Marker View** soft key between **On** and **Off** to display or dismiss the marker.
- 3 Press the **Channel** soft key to select the channel to be displayed on the IQ diagram.
- 4 Use the rotary knob to move and select an item under EVM.

Conducting LTE-TDD OTA measurements

The TDD LTE Over The Air (OTA) measurement has Channel Scanner, ID Scanner, Multipath Profile, Datagram, and Control Channel screens. The ID Scanner displays key parameters such as RSRP, RSRQ, RS-SINR, and S-SS RSSI. The Multipath Profile enables you to determine RF environmental conditions of testing area. The OTA Control Channel provides summary of all control channels including RS power variation over time.

Channel scanner

The Channel Scanner is a radio receiver that can automatically tune or scan two or more discrete frequencies and multi-channels, indicating when it finds a signal on one of them and then continuing scanning when that frequency goes silent.

Setting channel/frequency

Procedure

To set the channels to be scanned:

- 1 Press the **FREQ/DIST** hard key.
- 2 Toggle the **Unit** soft key and select **Channel**.
- 3 Press the **Index** soft key, and then enter an index number between one and six by turning the rotary knob or using the numeric keys.
- 4 To select the standard channel, complete the following steps:
 - a Press the **Channel Std** soft key. The standard channel window appears. See “Appendix C – Band, frequency & channel standard” on page 769 for more information.
 - b Highlight the band to be measured by using the rotary knob, the arrow keys, or the **Page Up/Page Down** soft keys.
 - c Press the **Select** soft key or the rotary knob to confirm the selection.
- 5 To set the channel number for the selected index, complete the following steps:
 - a Press the **Channel Number** soft key.
 - b Enter a value by using the numeric keys. You can also use the rotary knob.
 - c Press the **Enter** soft key.
- 6 The instrument displays a corresponding center frequency for the channel number.
- 7 To set the integration bandwidth for the selected index, complete the following steps:
 - a Press the **Integration Bandwidth** soft key.
 - b Enter a value by using the numeric keys. You can also use the rotary knob.
 - c Select the unit: **GHz, MHz, kHz, or Hz**.
- 8 To add more channels to be scanned, repeat steps 3-6.
- 9 Press the **ESC** hard key to dismiss the channel list window and view the scanning result.

To set the frequencies to be scanned:

- 1 Press the **FREQ/DIST** hard key.
 - 2 Toggle the **Unit** soft key and select **Freq**.
 - 3 Press the **Index** soft key, and then enter an index number between one and six by turning the rotary knob or using the numeric keys.
 - 4 To set the center frequency for the selected index, complete the following steps:
 - a Press the **Center Frequency** soft key.
 - b Enter a value by using the numeric keys. You can also use the rotary knob.
 - c Select the unit: **GHz, MHz, kHz, or Hz**.
 - 5 To set the integration bandwidth for the selected index, complete the following steps:
 - a Press the **Integration Bandwidth** soft key.
 - b Enter a value by using the numeric keys. You can also use the rotary knob.
 - c Select the unit: **GHz, MHz, kHz, or Hz**.
 - 6 To add more channels to be scanned, repeat steps 3-5.
 - 7 Press the **ESC** hard key to dismiss the channel list window and view the scanning result.
-

Setting number of antenna ports

Procedure

- 1 Press the **MEASURE SETUP** hot key.
 - 2 Toggle the **MIMO** soft key and select **2x2** or **4x4**.
This MIMO (Multiple Input Multiple Output) setting is activated only if the option 031 LTE-Advanced TDD is installed with a license number. If not, the instrument sets this option to 2x2 by default. A 2x1 or 4x1 RF combiner is also required to be able to test on MIMO channels.
-

Measurement example

Figure 190 Channel scanner measurement with LTE-TDD OTA signal analyzer



ID scanner

The LTE mobile receives signals from multiple base stations that all of these signals share the same spectrum and are present at the same time. Each base station has unique scrambling code assigned to the particular base station and it differentiates its signal from other base stations in the area.

The ID Scanner shows key parameters such as RSRP (Reference Signal Received Power) and RSRQ (Reference Signal Received Quality) that predict the downlink coverage quickly.

- RSRPs from entire cells help to rank between the different cells as input for handover and cell reselection decisions.
- RSRQ provides additional information when RSRP is not sufficient to make a reliable handover or cell reselection decision.

All of the parameters for OTA ID scanner can be plotted on map data such as Google Maps and Google Earth by using JDViewer.

Setting measure setup

After configuring test parameters as described in the “Configuring test parameters” on page 282, you can continue your measurement.

Procedure

- 1 Press the **MEASURE SETUP** hot key.
- 2 To set the nominal channel bandwidth to be measured, complete the following steps:
 - a Press the **Bandwidth** soft key.
 - b Select the bandwidth option from the choices: **1.4 MHz**, **3 MHz**, **5 MHz**, **10 MHz**, **15 MHz**, and **20 MHz**.
- 3 *Optional.* Press the **Miscellaneous** soft key, and then do the following as needed:
 - To select the number of antenna ports, toggle the **MIMO** soft key and select **2x2** or **4x4**. This MIMO (Multiple Input Multiple Output) setting is activated only if the option 031 LTE-

Advanced TDD is installed with a license number. If not, the instrument sets this option to 2x2 by default. A 2x1 or 4x1 RF combiner is also required to able to test on MIMO channels.

To select the cyclic prefix, toggle the **Cyclic Prefix** soft key and select **Normal** or **Extended**. See “Appendix E – Cyclic prefix table” on page 773 for OFDM parameter details by different bandwidth.

- 4 *Optional.* Go to **SAVE/LOAD > Save**, and then select the save option from the choices available for your measurement mode. See “Using save” on page 34 for more information.

Measurement example

Figure 191 ID scanner measurement with LTE-TDD OTA signal analyzer



Multipath profile

The Multipath Profile enables you to determine RF environmental conditions of testing area. It indicates the amount of power of the dominant pilot signal that is dispersed outside the main correlation peak due to multipath echoes that are expressed in dB. This value should be very small ideally.

The multipath profile is the result of portions of the original broadcast signal arriving at the receiving antenna out of phase. This can be caused by the signal being reflected off objects such as buildings, or being refracted through the atmosphere differently from the main signal.

Setting measure setup

After configuring test parameters as described in the “Configuring test parameters” on page 282, you can continue your measurement.

Procedure

- 1 Press the **MEASURE SETUP** hot key.
 - 2 To set the nominal channel bandwidth to be measured, complete the following steps:
 - a Press the **Bandwidth** soft key.
 - b Select the bandwidth option from the choices: **1.4 MHz**, **3 MHz**, **5 MHz**, **10 MHz**, **15 MHz**, and **20 MHz**.
 - 3 Toggle the **Display** soft key and select **RS** or **Sync**.
The RS Window soft key becomes activated if RS is selected.
 - 4 Press the **RS Window** soft key, if RS is selected, and then select the RS window option: **2 μs**, **4 μs**, or **8 μs**.
 - 5 *Optional.* Press the **Miscellaneous** soft key, and then do the following as needed:
 - To select the number of antenna ports, toggle the **MIMO** soft key and select **2x2** or **4x4**. This MIMO (Multiple Input Multiple Output) setting is activated only if the option 031 LTE-Advanced TDD is installed with a license number. If not, the instrument sets this option to 2x2 by default. A 2x1 or 4x1 RF combiner is also required to able to test on MIMO channels.
 - To select the cyclic prefix, toggle the **Cyclic Prefix** soft key and select **Normal** or **Extended**. See “Appendix E – Cyclic prefix table” on page 773 for OFDM parameter details by different bandwidth.
 - 6 *Optional.* Go to **SAVE/LOAD > Save**, and then select the save option from the choices available for your measurement mode. See “Using save” on page 34 for more information.
-

Measurement example

Figure 192 Multipath profile measurement with LTE-TDD OTA signal analyzer



Control channel

DL RS power is the resource element power of Downlink Reference Symbol. The absolute DL RS power is indicated on the BCH. The absolute accuracy is defined as the maximum deviation between the DL RS power indicated on the BCH and the DL RS power at the BS antenna connector.

The OTA Control Channel provides summary of all control channels including RS power trend over time. GPS coordinates (latitude and longitude) will be displayed on the screen if a GPS antenna is connected and locked to the GPS satellites.

Setting measure setup

After configuring test parameters as described in the “Configuring test parameters” on page 282, you can continue your measurement. The measurement settings can be saved and recalled as a file. You can also use JDViewer, PC application software to configure a measure setup, save as a file, and load the file on to the instrument.

Procedure

- 1 Press the **MEASURE SETUP** hot key.
- 2 To set the nominal channel bandwidth to be measured, complete the following steps:
 - a Press the **Bandwidth** soft key.
 - b Select the bandwidth option from the choices: **1.4 MHz**, **3 MHz**, **5 MHz**, **10 MHz**, **15 MHz**, and **20 MHz**.
- 3 To select the subframe number to be measured, complete the following steps:
 - a Press the **Subframe No** soft key.
 - b Enter a value by using the numeric keys. You can also use the rotary knob.



NOTE

For MBMS testing, this subframe number must be neither 0 nor 5 as these subframes 0 and 5 are not available for MBMS and it must be set to the MBMS transmitted channel's subframe number.

- c Press the **Enter** soft key.

- 4 Toggle the **Physical Cell ID** soft key and select **Auto** or **Manual** as desired:
 - Auto:** Lets the instrument detect the Physical Cell ID for the LTE signal automatically.
 - Manual:** Sets a specific Physical Cell ID for the LTE signal manually in order to speed up the synchronization with a BTS.
- 5 *Optional.* Press the **Miscellaneous** soft key, and then do the following as needed:
 - To select the number of antenna ports, toggle the **MIMO** soft key and select **2x2** or **4x4**. This MIMO (Multiple Input Multiple Output) setting is activated only if the option 031 LTE-Advanced TDD is installed with a license number. If not, the instrument sets this option to 2x2 by default. A 2x1 or 4x1 RF combiner is also required to test on MIMO channels.
 - To assign a antenna port number automatically or manually, press the **Antenna Port** soft key and select the option: **Auto**, **0**, **1**, **2**, and **3**. If the option 031 LTE-Advanced TDD is not installed or if the MIMO is set to 2x2, the antenna ports 2 and 3 are disabled.
 - To select the cyclic prefix, toggle the **Cyclic Prefix** soft key and select **Normal** or **Extended**. See “Appendix E – Cyclic prefix table” on page 773 for OFDM parameter details by different bandwidth.
 - To turn the Multimedia Broadcast Multicast Service (MBMS) feature on or off, toggle the **MBMS** soft key and select **On** or **Off**. For proper MBMS testing, you need to set the **Subframe No** with the same PMCH subframe number. If this setting is on, the measurement item “MBSFN RS” appears in the result table.
 - To set the Multicast Broadcast Single Frequency Network (MBSFN) detection automatically or manually for MBMS testing, toggle the **MBSFN** soft key and select **Auto** or **Manual**. An automatically detected or manually entered MBSFN ID appears on the screen.
- 6 Go to **SAVE/LOAD > Save**, and then select the save option from the choices available for your measurement mode. See “Using save” on page 34 for more information.

Setting limit for OTA control channel

Procedure

- 1 Press the **LIMIT** hot key.
- 2 Select the test item(s) and set the limit(s) as needed:

To set the limit for	Select	Set
P-SS error vector magnitude	P-SS EVM	High Limit
S-SS error vector magnitude	S-SS EVM	High Limit
RS error vector magnitude	RS EVM > RS0 EVM RS EVM > RS1 EVM RS EVM > RS2 EVM RS EVM > RS3 EVM	High Limit
Frequency error	Frequency Error	High Limit, Low Limit
Time error	Time Error	High Limit, Low Limit
Time alignment error	Time Alignment Error	High Limit

- 3 *Optional.* Go to **SAVE/LOAD > Save**, and then select **Limit** to save the limit settings. See “Using save” on page 34 for more information.

Setting display

You can use the **TRACE/DISPLAY** hard key to select the display option.

Procedure

- 1 Press the **TRACE/DISPLAY** hard key.
- 2 Toggle the **Display** soft key and select **Power** or **EVM**. The screen changes according to the selected option.

Measurement example

Figure 193 Control channel measurement with LTE-TDD OTA signal analyzer



Datagram

The OTA Datagram is a time-varying spectral representation that shows how the power of a signal varies with time. The power allocated to the specific resource block will be represented with an amplitude axis (in dBm) and the waterfall diagram will show the trend of past resource block power over certain period. Using a marker function facilitates analysis of accumulated resource block power for data utilization.

Setting measure setup

After configuring test parameters as described in the “Configuring test parameters” on page 282, you can continue your measurement. The measurement settings can be saved and recalled as a file. You can also use JDViewer, PC application software to configure a measure setup, save as a file, and load the file on to the instrument.

Procedure

- 1 Press the **MEASURE SETUP** hot key.
- 2 To set the nominal channel bandwidth to be measured, complete the following steps:
 - a Press the **Bandwidth** soft key.
 - b Select the bandwidth option from the choices: **1.4 MHz**, **3 MHz**, **5 MHz**, **10 MHz**, **15 MHz**, and **20 MHz**.
- 3 To select the subframe number to be measured, complete the following steps:

- a Press the **Subframe No** soft key.
 - b Enter a value by using the numeric keys. You can also use the rotary knob.
 - c Press the **Enter** soft key.
- 4 *Optional.* Toggle the **Physical Cell ID** soft key and select **Auto** or **Manual** as desired:
- Auto:** Lets the instrument detect the Physical Cell ID for the LTE signal automatically.
 - Manual:** Sets a specific Physical Cell ID for the LTE signal manually in order to speed up the synchronization with a BTS.
- 5 *Optional.* To set the threshold for PDSCH, complete the following steps:
- a Press the **PDSCH Threshold** soft key.
 - b Enter a value by using the numeric keys.
 - c Press the **dB** soft key.
- 6 To set the time cursor at a specific position, complete the following steps:
- a Toggle the **Time Cursor** soft key and select **On**.
 - b Turn the rotary knob to move the time cursor. You can also enter a value and then press the **Enter** soft key.
-  **NOTE**
Enabling the time cursor puts the measurement on hold and you can make post-processing analysis for each measurement over time using the time cursor.
- 7 To start a new measurement, press the **Reset/Restart** soft key.
- 8 *Optional.* Press the **Miscellaneous** soft key, and then do the following as needed:
- To select the number of antenna ports, toggle the **MIMO** soft key and select **2x2** or **4x4**. This MIMO (Multiple Input Multiple Output) setting is activated only if the option 031 LTE-Advanced TDD is installed with a license number. If not, the instrument sets this option to 2x2 by default. A 2x1 or 4x1 RF combiner is also required to able to test on MIMO channels.
 - To select the cyclic prefix, toggle the **Cyclic Prefix** soft key and select **Normal** or **Extended**. See “Appendix E – Cyclic prefix table” on page 773 for OFDM parameter details by different bandwidth.
- 9 *Optional.* Go to **SAVE/LOAD > Save**, and then select the save option from the choices available for your measurement mode. See “Using save” on page 34 for more information.

Measurement example

Figure 194 Datagram measurement with LTE-TDD signal analyzer



Route map

The JD700B Series provides the Route Map function that allows you to collect data of points in an indoor or outdoor environment and track the received signals and coverage of RF transmitters by plotting data real time directly on top of a loaded floor plan or a map.

The JD700B Series also supports the RAN-IL (Interference Location) feature that enables you to overlay user experience data obtained through Viavi's ariesoGEO on your base map to help you troubleshoot problems easily and quickly using your instrument. You can generate raster data files on the ariesoGEO application and load them on your instrument.

Setting measure setup

Procedure

- 1 If required, connect a GPS receiver to your JD700B series for outdoor mapping. Indoor mapping does not necessarily need a GPS antenna.
- 2 Configure test parameters as described in the "Configuring test parameters" on page 282.
- 3 To load your map file, complete the following steps:
 - a Plug in your USB drive that has a floor map or .mcf file type created in JDMAPCreator. If the JDMAPCreator application on your computer is connected to the instrument via USB or LAN, you can send a map file with a single layer to the instrument directly by using the **Send to EQP** menu in JDMAPCreator.



NOTE

The JDMAPCreator converts and resizes any scanned floor plan or layout to fit onto your instrument's display. JDMAPCreator 1.2.0 or later can save a multiple-layered map, providing **x1**, **x2**, and **x4** views, as a sizable map file so that you can zoom in and out after loading it.

- b Press **SAVE/LOAD** hot key, and then select **Load > Load Map**. See "Using load" on page 36 for more information.
- 4 Press the **MEASURE SETUP** hot key.
- 5 Press the **Plot Point** soft key, and then select the plot point option from the following choices:
To collect data/plot points automatically as you move around in a vehicle or outside, press the **GPS** soft key and then toggle the **Screen Mode** soft key between **Map** and **Full**.



NOTE

With the **Map** setting, you can view only the collected points that can be seen within the boundary of the loaded map. If a point is off the map, the instrument displays an arrow to indicate the direction of the current location on the map and the distance from the center to the location at the top of the screen.

With the **Full** setting, you can view all the collected points of the route without the loaded map.

To collect data/plot points manually without a GPS antenna in an indoor environment, press the **Position** soft key.

- 6 Press the **Plot Item** soft key, and then select the measurement option: **RSRP**, **RSRQ**, **RS-SINR**, **S-SS RSSI**, **P-SS Power**, **S-SS Power**, or **S-SS Ec/Io**.



NOTE

The instrument collects the strongest Physical Cell ID's data to plot points.

- 7 Press the **Bandwidth** soft key to set the nominal channel bandwidth to be measured, and then select the bandwidth option from the choices: **1.4 MHz**, **3 MHz**, **5 MHz**, **10 MHz**, **15 MHz**, and **20 MHz**.
- 8 Toggle the **Plot** soft key and select **Start** to start plotting.
- 9 Touch directly on the screen or press the **ENTER** hard key to collect data and plot points on the loaded map for the **Position** setting.



NOTE

For the **Position** setting, you can change the direction of the route with the arrow keys and the distance with the rotary knob.

- 10 Toggle the **Plot** soft key and select **Stop** to stop plotting.
- 11 Press the **SAVE/LOAD** hot key to save the result.
See “Using save” on page 34 for more information.



NOTE

The instrument does not automatically save the collected data. It is recommended that you save the result. Otherwise, you will lose all the collected data.

Setting limit for route map

You can set the thresholds for each test item.

Procedure

- 1 Press the **LIMIT** hot key.
- 2 Select the plot items and set the limits as needed:

To set the limit for	Select	Set
RSRP	RSRP	Excellent, Very Good, Good, Fair, Poor (dBm)
RSRQ	RSRQ	Good, Fair, Poor (dB)
RS-SINR	RS-SINR	Good, Fair, Poor (dB)
S-SS RSSI	S-SS RSSI	Excellent, Very Good, Good, Fair, Poor (dBm)
P-SS Power	P-SS Power	Excellent, Very Good, Good, Fair, Poor (dBm)
S-SS Power	S-SS Power	Excellent, Very Good, Good, Fair, Poor (dBm)
S-SS Ec/Io	S-SS Ec/Io	Good, Fair, Poor (dB)

- 3 *Optional.* Go to **SAVE/LOAD > Save**, and then select **Limit** to save the limit settings.
See “Using save” on page 34 for more information.

Measurement example

Figure 195 Route map measurement (RSRP) with LTE-TDD OTA signal analyzer

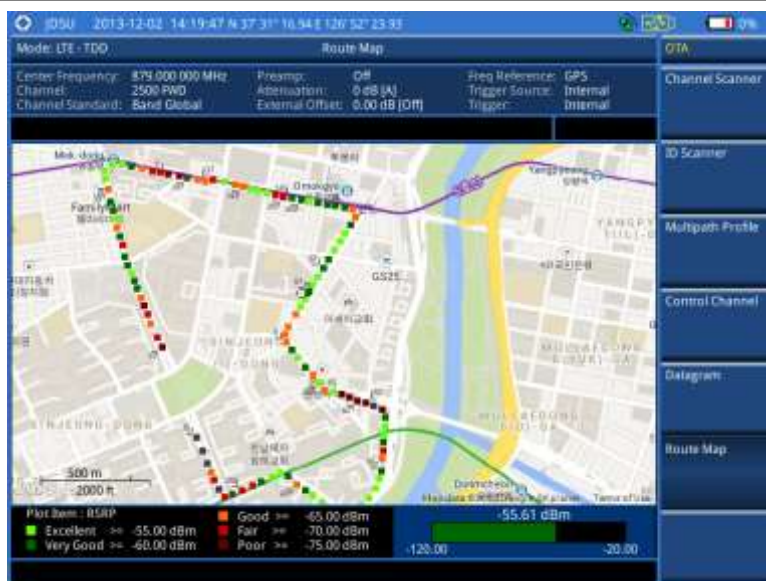

Figure 196 Route map measurement (RSRQ) with LTE-TDD OTA signal analyzer

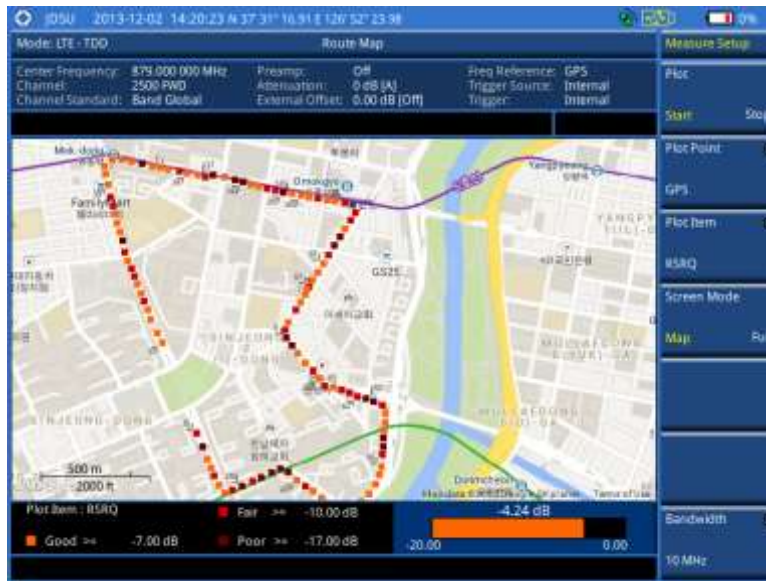

Figure 197 Route map measurement (RS-SINR) with LTE-TDD OTA signal analyzer



Figure 198 Route map measurement (S-SS RSSI) with LTE-TDD OTA signal analyzer



Figure 199 Route map measurement (P-SS Power) with LTE-TDD OTA signal analyzer



Figure 200 Route map measurement (S-SS Power) with LTE-TDD OTA signal analyzer



Figure 201 Route map measurement (S-SS Ec/Io) with LTE-TDD OTA signal analyzer

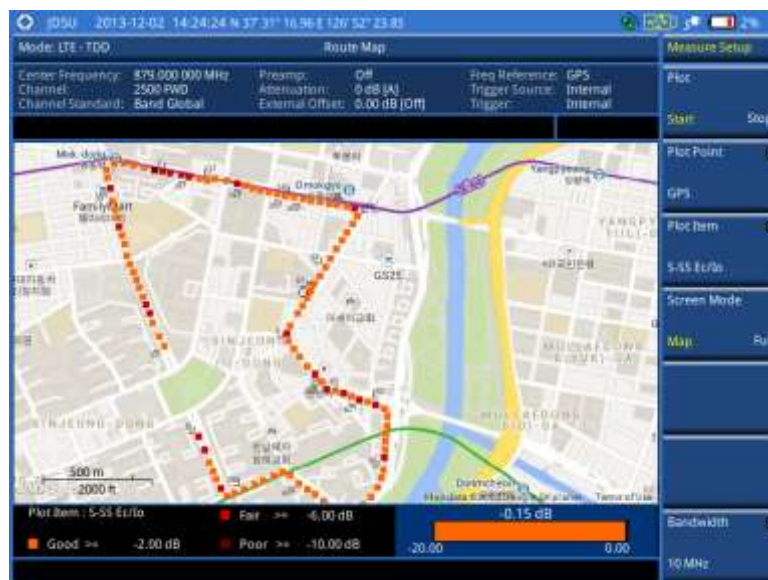

Controlling a map

If you have loaded a sizable map that was created in JDMapCreator 1.2.0 or later, you can use the Map Control feature that enables you to zoom into the map and view a specific area of interest in detail.

Procedure

- 1 Press the **TRACE/DISPLAY** hard key.
- 2 Press the **Map Control** soft key. This key is active only when you have loaded a sizable map.
- 3 Do one of the following:
 - To zoom into an area of interest directly, complete the following steps:
 - a Toggle the **Zoom to** soft key and select **Area**. The black rectangle appears on the map.
 - b Press the **Zoom In** and **Zoom Out** soft keys, as you need, to decrease and increase the selected area.

- c Move the rectangle by using the four arrow keys, as you need, to place it in a specific area of interest.
- d Press the center of the rotary knob to zoom into the selected area. You can also press the **Zoom to** soft key again to zoom into the selected area.

To zoom into the center or zoom out from the center, complete the following steps:

- a Toggle the **Zoom to** soft key and select **Center**.
 - b Press the **Zoom In** and **Zoom Out** soft keys, as you need, to zoom in and zoom out.
 - c Move the zoomed-in area by using the four arrow keys, as you need.
- 4 To set the location mode, toggle the **Location Mode** soft key between **Auto** and **Manual** and select the one you desire.

Auto: The instrument compares the coordinates of the displayed map with received GPS information. If your current location goes out of the displayed area and enters into the next zoomed-in section within the base map, the map display changes automatically to the next section in which your current position is.

Manual: The map display of the zoomed-in area remains unchanged even if your current location goes out of the displayed area. You can change the displayed area manually by using the arrow keys.

Loading and displaying raster data

If you have a set of raster data files generated through the ariesoGEO application, you can load and overlay the data on your base map to help you check the signal quality and the strength of interferences while driving toward the area of interest.

Procedure

- 1 Copy a set of raster data files into your USB memory drive, including the following:

ASCII: .tab, .asc, and .clr files

BIL: .tab, .hdr, .bil, and .clr files



NOTE

The .tab file type is a geospatial vector data format used in many geographic information systems. The color file (.clr) is an optional file, but the image will be displayed as a grayscale image without it. The size of the raster map must be **1024 x 1024** or smaller.

- 2 Plug in the USB memory drive to your instrument.
- 3 Press the **TRACE/DISPLAY** hard key.
- 4 Press the **Load Raster Map** soft key.
The file explorer window appears.
- 5 Navigate to the raster file (.tab) you want to open, and then press the **Load** soft key.
The raster image appears on top of your base map as shown in Figure 202.



NOTE

If the area of the loaded raster data is not within the boundary of the base map, you will not see the raster image on the screen.

- 6 To select the display option, complete the following steps:
- a Press the **Display Options** soft key.
 - b Select the option you desire from the choices: **On**, **Off**, and **Blink**.
- 7 To adjust the transparency level of the image, complete the following steps:
- a Press the **Transparency** soft key.
 - b Enter a value between **0** for opaque and **100** for clear.
 - c Press the **Enter** soft key.

Figure 202 Raster image overlaid on the base map with LTE-TDD OTA signal analyzer



Performing RAN performance testing

The JD700B series provides the optional feature that lets you conduct correlated uplink and downlink testing with your instrument connected to your mobile device via Bluetooth. The RANAdvisor TrueSite application installed on your smartphone collects data and transfers uplink data based on your parameter settings and then your instrument consolidates the data into the measurement results and displays them as performance indicators. It helps you troubleshoot a problem and identify the cause of the problem fast.

To perform this testing, you need both of these installed: the license for the option 015 LTE-TDD RAN Performance Indicator on your instrument and the RANAdvisor TrueSite app with the license on your smartphone.

Preparing your smartphone for remote control via Bluetooth

To set up a Bluetooth connection and enable data collection with remote control properly, you need to pair your instrument with your smartphone and set the app's local Bluetooth control option to Slave once at the beginning.

Procedure

- 1 Connect a Bluetooth adapter to the USB Host port and an Omni antenna to the RF In port of your CellAdvisor instrument.
The instrument detects the adapter and turns on its Bluetooth automatically.
- 2 Make your smartphone visible to your instrument by doing the following steps:
 - a On your smartphone, turn on **Bluetooth**.
 - b Check the checkbox for **Visible to all nearby Bluetooth devices** to enable this option.
- 3 Pair with your smartphone by doing the following steps:
 - a On your instrument, press the **MEASURE SETUP** hot key.
 - b Press the **Bluetooth Connect** soft key.
 - c Press the **Scan** soft key.
The instrument lists detected Bluetooth devices with their MAC address and status.
 - d Highlight your mobile device from the list by touching on the screen.
 - e Press the **Pair** soft key.

- The pairing dialog box appears on your smartphone.
- f On your smartphone, enter **0000** and then tap the **OK** button.
If pairing is successful, the status of your device on the list changes to **“Paired”**.
- 4 Make sure to set your smartphone as a slave by completing the following steps:
- a On your smartphone, open the **RANAdvisor TrueSite** icon.
 - b Go to **Settings > General**.
 - c Tap the **Automation Control Mode** menu under Automation Control Options.
 - d Select the **Local Bluetooth Control** option.
 - e Tap **Slave**.
The application restart dialog box appears.
 - f Tap **Continue**.
The application closes itself.



NOTE

It is very important for you to set the local Bluetooth control option to **Slave** on the RANAdvisor TrueSite app in order to give your instrument a control to collect necessary data from the app over Bluetooth successfully.

Setting parameters on RANAdvisor TrueSite™

To specify uplink measurement data that will be transferred to your instrument, you need to set map display parameters of your choice on the RANAdvisor TrueSite application.

Procedure

- 1 After you have paired and set your smartphone as a slave, open the **RANAdvisor TrueSite** icon on your device again.
- 2 Tap the **(+)** button at the bottom of the Home screen.
The Main Screen appears.
- 3 Tap the **Customization** menu.
The Choose Operation menu box appears.
- 4 Select **Map Display Parameters > LTE Serving and Neighbor Parameters**.
- 5 Make sure to check the checkbox for the following two mandatory parameters:

Serving E-ARFCN

Serving Physical Cell-ID



NOTE

It is very important for you to select these two parameters to identify the Uplink Channel Number, Physical Cell ID, Group ID, and Sector ID.

- 6 Select other parameters up to six from the list of parameters supported by the CellAdvisor instrument. See “Appendix L – Supported map display parameters” on page 800 for more information.



NOTE

As the RANAdvisor TrueSite app can transfer data of up to eight parameters at a time, it limits you to select eight parameters in total: two compulsories and six electives. After you have selected all eight parameters, the app blocks any further selection. In this case, you need to uncheck any selected optional parameters in order to enable other optional parameters.

- 7 Tap the **OK** button and then the **Back** key to return to the Home Screen.

Performing RAN performance testing

After you have set the local Bluetooth control option and selected desired parameters on the app, you need to connect your instrument to your smartphone via Bluetooth to enable data collection from RANAdvisor TrueSite so that you can view consolidated measurement results on your instrument and save results as a file.

Procedure

- 1 Make sure to have the RANAdvisor TrueSite app opened on your device.
- 2 Press the **MEASURE SETUP** hot key on your instrument.
- 3 Press the **Bluetooth Connect** soft key.
- 4 Highlight your paired smartphone to connect from the list.
- 5 Press the **Connect** soft key.
The connected device information appears above the RAN Performance Indicator chart to indicate a successful connection.
- 6 The instrument automatically sets the correlated downlink channel number for the received uplink channel number and displays measurement results as like Figure 203. Observe the consolidated measurement results on the screen for your troubleshooting.



NOTE
If the Physical Cell ID of the uplink channel is not identical to the one of the downlink channel, the instrument displays “---” for the parameters to indicate invalid measurement results.

- 7 If you want to see measurement results for other parameters, select new parameters on the RANAdvisor TrueSite app. See “Setting parameters on RANAdvisor TrueSite™” on page 273.
- 8 *Optional.* To save your settings and results, go to **SAVE/LOAD > Save** and then perform functions as you desire. See “Using save” on page 34 for more information.

Measurement example

Figure 203 RAN performance indicator with LTE-TDD signal analyzer



Setting performance score level

To analyze your measurement data easily with color codes, you can use the limit feature and set a performance score level for each measurement parameter.

Procedure

- 1 Press the **LIMIT** hot key.
- 2 To analyze the quality of user experience, do the following as needed:

To set the level for	Select	Set
----------------------	--------	-----

Data throughput	Data Throughput	Good, Bad (kbps)
Channel quality indicator	CQI	Good, Bad
Modulation type	Modulation Type	(On/Off only)

3 To check the performance of eNode-B, do the following as needed:

To set the level for	Select	Set
Reference signal received power	RSRP	Good, Bad (dBm)
Reference signal received quality	RSRQ	Good, Bad (dB)
Signal to interference and noise ratio	SINR	Good, Bad (dB)
Error vector magnitude	More (1/2) > EVM	Good, Bad (%)
Time alignment error	More (1/2) > Time Alignment Error	Good, Bad (ns)
Frequency error	More (1/2) > Frequency Error	Good, Bad (ppm)

Chapter 10 Using CDMA Signal Analyzer

This chapter provides instructions for using the CDMA Signal Analyzer function (option 020) with the CDMA OTA Analyzer function (option 040). Topics discussed in this chapter are as follows:

■ Introduction.....	348
■ Display overview	349
■ Connecting a cable.....	349
■ Selecting measurement mode	351
■ Configuring test parameters.....	351
■ Conducting spectrum measurements	356
■ Conducting RF measurements	357
■ Conducting modulation measurements.....	363
■ Performing auto measurements.....	371
■ Performing power statistics CCDF measurements	373
■ Conducting CDMA OTA measurements.....	373

Introduction

This CDMA Signal Analyzer can be used to test a CDMA transmitter including cdmaOne and cdma2000 signals to check the base station's compliance with following standards documentation.

- 3GPP2 C.S0002 Physical Layer Standard for cdma2000 Spread Spectrum Systems
- 3GPP2 C.S0010 Recommended Minimum Performance Standards for cdma2000 Spread Spectrum Base Station

This instrument automatically makes standard defined measurements using the measurement methods and limits as defined in the standards. Detailed measurement results allow you to analyze cdmaOne and cdma2000 system performance.

- cdmaOne uses dual BPSK (Binary Phase-Shifting Key) for the forward link and OQPSK (Offset Quadrature Phase Shift Keying) for the reverse link.
- cdma2000 uses QPSK (Quadrature Phase Shift Keying) modulation for the forward link and QPSK modulation with HPSK spreading for the reverse link. Both forward and reverse links may have several channels, and individual characteristics for each channel. The chip rate depends on the mode selected.

You may alter the measurement parameters for specialized analysis. Pass/Fail testing with standard defined or user defined upper and lower limits and the Pass/Fail indicator help you to determine base station performance easily.

This instrument provides the following measurement tools for CDMA system:

- Spectrum Analysis
- RF Analysis
 - Channel Power
 - Occupied Bandwidth
 - Spectrum Emission Mask (SEM)
 - Adjacent Channel Power Ratio (ACPR)
 - Multi-ACPR
 - Spurious Emissions
- Modulation Analysis
 - Constellation
 - Code Domain Power
 - Codogram
 - Received Code Strength Indicator (RCSI)
 - CDP Table
- Auto Measure
- Power Statistics CCDF
- Over The Air (OTA)
 - Channel Scanner
 - PN Scanner
 - Multipath Profile
 - Code Domain Power
 - Route Map

Display overview

Figure 204 provides descriptions for each segment of the measurement screen.

Figure 204 CDMA signal analyzer measurement screen

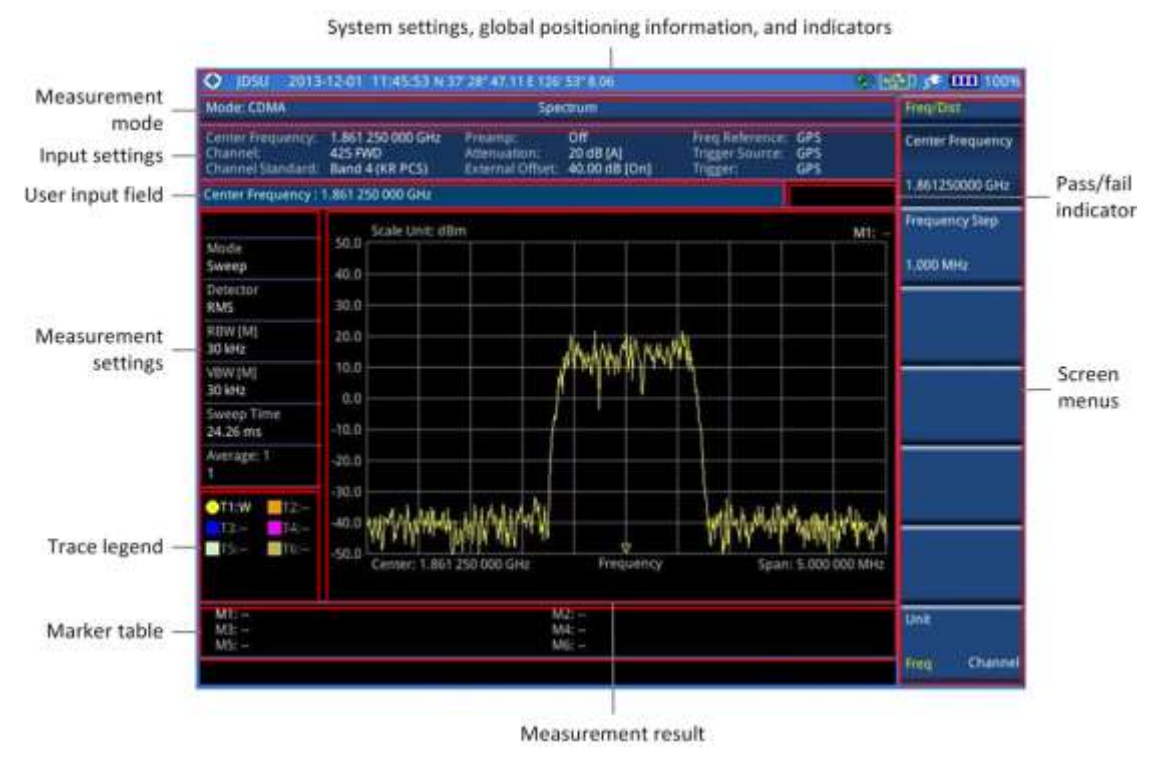

Connecting a cable

Direct connection

- Procedure**
- 1 Connect the **Spectrum Analyzer RF In** port of the JD700B series and the Power amplifier output port of BTS.

Figure 205 Direct connection



Indirect connection

Procedure

- 1 Connect the **Spectrum Analyzer RF In** port of the JD700B series and the monitor (test) port of BTS.

Figure 206 Indirect connection



CAUTION

The maximum power for the **Spectrum Analyzer RF In** port is +25 dBm (0.316 W) for JD780B series and +20 dBm (0.1 W) for JD740B series. If the level of the input signal to be measured is greater than this, use a **High Power Attenuator** to prevent damage when you directly connect the signal to the instrument or connect the signal from the coupling port of a directional coupler.



NOTE

For accurate PN Offset and Time Offset measurements with the CDMA Signal Analyzer function, a PP2S should be connected to the External Trigger. Without a GPS connection, measurement results could be invalid numbers.

Over the air (OTA)

Procedure

- 1 Connect an Omni/directional RF antenna to the **Spectrum Analyzer RF In** port of the JD700B series.
- 2 Connect a GPS antenna to the **GPS** port of the JD700B series.



CAUTION

If the input signal level to be measured is less than 0 dBm, set 0 dB attenuation or turn on the preamp to have better dynamic range for the OTA testing.

Figure 207 OTA connection

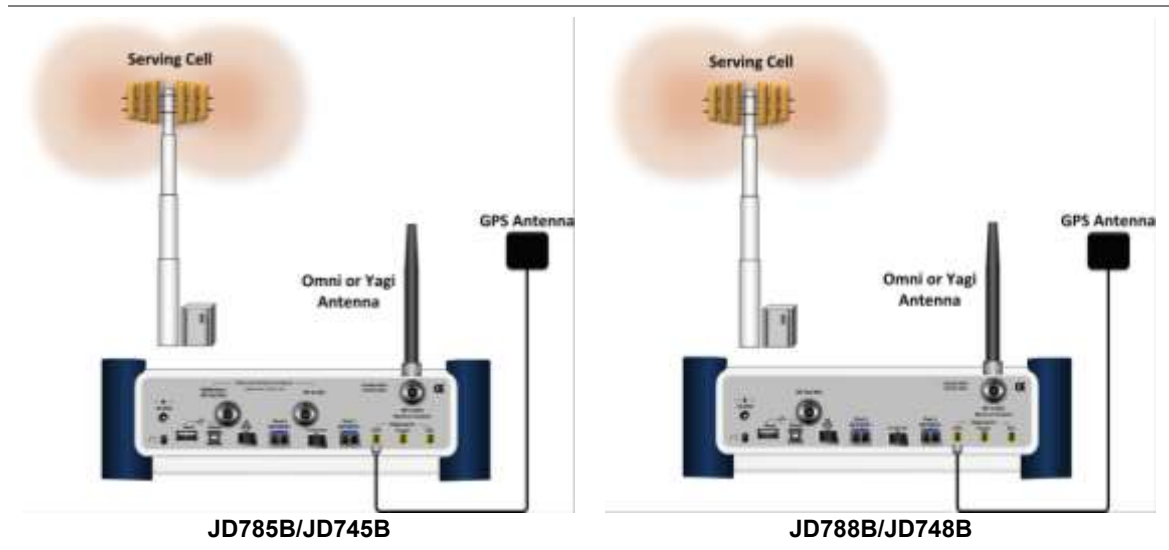

Selecting measurement mode

Procedure

- 1 Press the **MODE** hard key.
- 2 Press the **Signal Analyzer** soft key.
- 3 Press the **CDMA** soft key. The **Spectrum** mode is set by default.
- 4 Press the **MEASURE** hot key, and then select the measurement mode option from the following choices:
 - Spectrum**
 - RF Analysis > Channel Power, Occupied BW, Spectrum Emission Mask, ACPR, Multi-ACPR, or Spurious Emissions**
 - Modulation > Constellation, Code Domain Power, Codogram, RCSI, or CDP Table**
 - Auto Measure**
 - Power Statistics CCDF**
 - OTA > Channel Scanner, PN Scanner, Multipath Profile, Code Domain Power, or Route Map**

Configuring test parameters

Setting frequency

You can set the frequency with either frequency or channel number. If a frequency to be set matches to the frequency corresponding to the selected channel standard, the instrument calculates its channel number and updates the screen with it automatically.

Procedure

To set the center frequency:

- 1 Press the **FREQ/DIST** hard key.
- 2 Toggle the **Unit** soft key and select **Freq.**
- 3 Press the **Center Frequency** soft key.

- 4 Enter a value by using the numeric keys. You can also use the rotary knob.
- 5 Select the unit: **GHz**, **MHz**, **kHz**, or **Hz**.
- 6 *Optional.* To define the amount of frequency increment for the rotary knob, complete the following steps:
 - a Press the **Frequency Step** soft key.
 - b Enter a value by using the numeric keys. You can also use the rotary knob.
 - c Press the unit: **GHz**, **MHz**, **kHz**, or **Hz**.

To set the channel number:

- 1 Press the **FREQ/DIST** hard key.
- 2 Toggle the **Unit** soft key and select **Channel**.
- 3 To select the standard channel, complete the following steps:
 - a Press the **Channel Std** soft key. The standard channel window appears. See “Appendix C – Band, frequency & channel standard” on page 769 for more information.
 - b Highlight the band to be measured by using the rotary knob, the arrow keys, or the **Page Up/Page Down** soft keys.
 - c Press the **Select** soft key or the rotary knob to confirm the selection.
- 4 Press the **Channel Number** soft key.
- 5 Enter a value by using the numeric keys. You can also use the rotary knob.
- 6 Press the **Enter** soft key.
The instrument automatically displays the corresponding center frequency value for the selected channel number.
- 7 *Optional.* To define the amount of channel increment for the rotary knob, complete the following steps:
 - a Press the **Channel Step** soft key.
 - b Enter a value by using the numeric keys. You can also use the rotary knob.
 - c Press the **Enter** soft key.



NOTE

This frequency setting is not used in the Multi-ACLR and Spurious Emissions modes.

Setting amplitude

Reference level and attenuation

You can set the reference and attenuation levels automatically or manually to optimize the display of the traces measured, as you desire.

Procedure

To automatically set the reference and attenuation level:

- 1 Press the **AMP/SCALE** hard key.
- 2 Press the **Auto Scale** soft key.
Each time you press this key, both of the Y-axis scale and input attenuation level change to be optimized with some margin.

To set the reference or attenuation level manually:

- 1 Press the **AMP/SCALE** hard key.
- 2 To set the maximum reference value on the Y-axis manually, complete the following steps:
 - a Press the **Reference Level** soft key.
 - b Enter a value by using the numeric keys or the rotary knob with 10 dB increments.
 - c Press the unit soft key or the **ENTER** hard key.
This unit key name changes according to the setting in the Units menu.

**NOTE**

In the measurements such as **Code Domain Power**, **Codogram**, and **RCSI**, you may need to select the reference option between **Relative** and **Absolute** before setting the reference level.

- 3 To set the attenuation option, select one from the following choices:

To set the input attenuator's level automatically, select **Attenuation > Auto**.

**NOTE**

It is recommended that you set the **Attenuation** to **Auto** in most situations so that the level of the input attenuator can be set automatically according to your input signal level.

To set the input attenuation manually up to 55 dB for JD780B series or 50 dB for JD740B series to optimize S/N, complete the following steps:

- a Select **Attenuation > Manual**.
- b Press the **Attenuation Value** soft key to set the level.
- c Enter a value in fives by using the numeric keys.
- d Press the **dB** soft key or the **ENTER** hard key.

To couple the input attenuator's level with your reference level setting, select **Attenuation > Couple**.

As you increase the reference setting, the attenuation level also increases accordingly.

Optional. To change the scale unit:

- 1 Select **More (1/2) > Units**.
- 2 Select the unit of the display scale: **dBm**, **dBV**, **dBmV**, **dBμV**, **V**, or **W**.
The scale unit on the screen changes accordingly.

**NOTE**

This Units menu is available in the Spectrum and RF Analysis modes.

Scale per division

You can use the **Scale/Div** feature available for the spectrum and RF analysis. It represents the value of one division on the horizontal scale. The default setting is 10 dB per division and the maximum value can be set up to 20 dB.

Procedure

- 1 Press the **AMP/SCALE** hard key.
- 2 Select **More (1/2) > Scale/Div**.
- 3 Enter a value between 1 and 20 by using the numeric keys.
- 4 Press the **dB** soft key to complete the entry.

Pre-amplifier

You can turn the internal pre-amplifier on to correct and compensate for the gain of the preamp so that amplitude readings show the value at the input connector.

Procedure

- 1 Press the **AMP/SCALE** hard key.
- 2 Toggle the **Preamp** soft key and select **On** or **Off** as needed.

**NOTE**

You can turn the Preamp on when the input attenuation range is from 0 dB to 10 dB. If the attenuation value is manually set to greater than 10 dB, the instrument will automatically turn off the pre-amplifier to display low-level signal properly on the chart.

External offset

You can turn the **External Offset** on and manually set the external offset value. An offset consists of a cable loss and a user offset and the measurement result shows the value reflecting both offset values. When the external offset value is set at 40 dB in the Spectrum mode, the measurement result compensates 40 dB at both the Spectrum Analyzer and Signal Analyzer modes.

Procedure

To set the external offset:

- 1 Press the **AMP/SCALE** hard key.
- 2 Toggle the **External Offset** soft key and select **On**.
- 3 Enter a value by using the numeric keys.
- 4 Press the **dB** soft key to complete the entry.

To turn the external offset off:

- 1 Press the **AMP/SCALE** hard key.
 - 2 Toggle the **External Offset** soft key and select **Off**.
-

Setting average

You can set the number of measurements to be averaged for the trace presentation. A maximum of 100 times of averaging can be set. When the averaging reaches to your setting, a new measurement value replaces the measurement value in sequence from the earliest.

Procedure

- 1 Press the **BW/AVG** hard key.
 - 2 Press the **Average** soft key.
 - 3 Enter a value between 1 and 100 as needed by using the numeric keys.
 - 4 Press the **Enter** soft key.
-

Setting sweep mode

The default setting is **Continue** to sweep continuously for most on-going measurements. If you want to hold the measurement or get a single sweep, you can change the sweep mode.

Procedure

To select the single sweep mode:

- 1 Press the **SWEEP** hot key.
- 2 Toggle the **Sweep Mode** soft key and select **Single**. You can also use the **HOLD** hot key. The letter **HOLD** in red appears and the sweeping is paused.
- 3 *Optional.* Press the **Sweep Once** soft key to get a new measurement.

To return to the continuous sweep mode:

- 1 Toggle the **Sweep Mode** soft key and select **Continue**. You can also use the **HOLD** hot key. The letter **HOLD** in red disappears and the sweeping resumes.
-

Setting trigger source

You can set the trigger source option for your measurements. Connecting an external trigger is necessary for accurate modulation measurements on CDMA systems.

Procedure

- 1 Press the **TRIGGER** hot key.
 - 2 Select the trigger source option from the choices: **Internal**, **External**, and **GPS**.
-

Setting external clock

To enhance the reliability of modulation analysis measurements the JD700B series must be synchronized with a base station. When an external clock is not supplied, the instrument works with its built-in internal high-accuracy time base and some measurement results may exhibit inaccurate values. Therefore, it is highly recommended that you use the same reference clock as the signal source. You can use the **TRIGGER** hot key to set the external clock.

Table 14 Standards of external clock operation

Clock	Type	Reference	Port	Switching Standard
External Reference	Internal	Internal 10 MHz		Default
	External	External Ref Clock	Ext Ref (SMA)	Manual switching (Input signal level >-3 dBm)
	GPS	GPS Clock	GPS (SMA)	Automatic switching (GPS signal received)
Trigger	Internal	Internal Trigger		Default
	External	External Trigger	Trigger (SMA)	Manual switching
	GPS	GPS	GPS (SMA)	Manual switching

Figure 208 Connection ports for external reference clock



Procedure







- 1 Connect an external reference or a GPS antenna to the JD700B series.
 - 2 Press the **SYSTEM** hot key.
 - 3 Press the **Freq Reference** soft key, and then select the reference option: **Internal**, **External 10 MHz**, **External 13 MHz**, **External 15 MHz**, or **GPS**.
-



NOTE

When a GPS antenna is connected and locked, GPS coordinates (longitude and latitude) are displayed on the screen and frequency reference is automatically set to GPS in the **System > Freq Reference**.

Table 15 External reference indicators

Type	Indicator	Description
Internal	 (green)	The green INT icon indicates that the instrument uses the built-in internal time base.
External	 (green)	The green EXT icon indicates that an external reference is connected and locked and that the instrument uses the same reference clock as the signal source.
External	 (red)	The red EXT icon indicates that an external reference is connect but not locked.
GPS	 (green)	The green GPS antenna icon indicates that a GPS antenna is connected and locked.
GPS	 (yellow)	The yellow GPS antenna icon indicates that a GPS antenna is connected and locking is in progress.
GPS	 (grey)	The grey GPS antenna icon indicates that a GPS antenna is not connected, failed, or unable to be locked.

Conducting spectrum measurements

If you have configured test parameters as described in the “Configuring test parameters” on page 351, your measurement result is displayed on the screen as like the following example, **Figure 209**.

Figure 209 Spectrum measurement screen with CDMA signal analyzer



Setting trace

You can display up to six traces on the measurement chart simultaneously.

Procedure

- 1 Press the **TRACE/DISPLAY** hard key.
- 2 Press the **Select Trace** soft key, and then select the trace number: **T1**, **T2**, **T3**, **T4**, **T5**, or **T6**. The legend shape of the selected trace changes from square to round to indicate that the trace is the active one now.

3 Do one of the following:

To	Select	Trace Legend
Clear current data and display with new measurements	Clear Write	W
Display the input signal's maximum response only (unlimited or for a certain amount of time)	Max Hold	M
Display the input signal's minimum response only (unlimited or for a certain amount of time)	Min Hold	m
Capture the selected trace and compare traces	Capture	C
Load a saved trace	More (1/2) > Load	L
Hide the displayed trace	Trace View > Off	F
Remove all the traces and initialize the trace settings	More (1/2) > Trace Clear All	

**NOTE**

For the **Max Hold** and **Min Hold**, your instrument compares newly acquired data with the active trace and displays larger maximum values or smaller minimum values on the screen. You can set it to **Unlimited** to hold and view maximum or minimum data or specify a certain amount of time up to 60 seconds by using numeric keys or rotary knob.

4 To select the detection option, select **More (1/2) > Detectors**, and then do one of the following:

To display	Select
Random noise better than the peak without missing signals	Normal
The highest value in each data point	Peak
The root mean squared average power across the spectrum	RMS
The lowest value in each data point	Negative Peak
The center value in each data point	Sample

5 *Optional.* Select **More (1/2) > Trace Info**, and then select the trace number to view the trace's parameter setting information stored at the time of the measurement or **None** to hide the information display.6 *Optional.* If you have the two traces T1 and T2, you can perform trace math. To view the power difference between the traces, press the **T1 – T2 -> T5** or **T2 – T1 -> T6** soft key. The result is overlaid on the screen along with the second Y-axis.

Conducting RF measurements

Channel power

The Channel Power measurement is a common test used in the wireless industry to measure the total transmitted power of a radio within a defined frequency channel. It acquires a number of points representing the input signal in the time domain, transforms this information into the frequency domain using Fast Fourier Transform (FFT), and then calculates the channel power. The effective resolution bandwidth of the frequency domain trace is proportional to the number of points acquired for the FFT.

The channel power measurement identifies the total RF power, power spectral density (PSD) and peak to average ratio (PAR) of the signal within the channel bandwidth (1.23 MHz for cdmaOne).

After configuring test parameters as described in the "Configuring test parameters" on page 351, your measurement result is displayed on the screen as like the following example, **Figure 210**.

Figure 210 Channel power measurement with CDMA signal analyzer



NOTE
 You can use the **LIMIT** hot key to analyze your measurements with the user-definable limit and Pass/Fail indication. See “Setting limit for RF tests” on page 362 for more information.

Occupied bandwidth

The Occupied Bandwidth measures the spectrum shape of the carrier. It is defined as the bandwidth, which includes 99% of the transmitted power among total transmitted power.

After configuring test parameters as described in the “Configuring test parameters” on page 351, your measurement result is displayed on the screen as like the following example, **Figure 211**.

Figure 211 Occupied bandwidth measurement with CDMA signal analyzer



**NOTE**

You can use the **LIMIT** hot key to analyze your measurements with the user-definable limit and Pass/Fail indication. See “Setting limit for RF tests” on page 362 for more information.

Spectrum emission mask (SEM)

The Spectrum Emission Mask (SEM) measurement required by 3GPP2 specifications encompasses different power limits and different measurement bandwidths (resolution bandwidths) at various frequency offsets. It may be expressed as a ratio of power spectral densities between the carrier and the specified offset frequency band. It provides useful figures-of-merit for the spectral re-growth and emissions produced by components and circuit blocks, without the rigor of performing a full SEM measurement.

The SEM measures spurious signal levels in up to five pairs of offset or region frequencies and relates them to the carrier power.

Setting measure setup

After configuring test parameters as described in the “Configuring test parameters” on page 351, your measurement result is displayed on the screen as like the following example, **Figure 212**.

Figure 212 SEM measurement with CDMA signal analyzer

**NOTE**

You can use the **LIMIT** hot key to analyze your measurements with the user-definable limit and Pass/Fail indication. See “Setting limit for RF tests” on page 362 for more information.

ACPR

The Adjacent Channel Power Ratio (ACPR) is defined as the ratio of the average power in the adjacent frequency channel (or offset) to the average power in the transmitted frequency channel. It may be expressed as the ratio of the integrated signal power in the adjacent channel to the integrated signal power in the main channel.

After configuring test parameters as described in the “Configuring test parameters” on page 351, your measurement result is displayed on the screen as like the following example, **Figure 213**.

Figure 213 ACPR measurement with CDMA signal analyzer



NOTE
 You can use the **LIMIT** hot key to analyze your measurements with the user-definable limit and Pass/Fail indication. See “Setting limit for RF tests” on page 362 for more information.

Multi-ACPR

The Multi-ACPR measurement is used to perform multi-channel ACPR measurements with as many channels as possible. It helps you to measure ACPR in multi-channel transmitting base station environment.

Setting frequency for Multi-ACPR

You can set the frequency with either frequency or channel number.

Procedure

- 1 Press the **MEASURE SETUP** hot key.
- 2 To set the frequency, do one of the following:
 - To set the center frequency, complete the following steps:
 - a Toggle the **Unit** soft key and select **Freq**.
 - b Press the **Lowest Frequency** soft key to set the starting center frequency.
 - c Enter a value by using the numeric keys. You can also use the rotary knob.
 - d Select the unit: **GHz**, **MHz**, **kHz**, or **Hz**.
 - e Press the **Highest Frequency** soft key to set the stopping center frequency.
 - f Enter a value by using the numeric keys. You can also use the rotary knob.
 - g Select the unit: **GHz**, **MHz**, **kHz**, or **Hz**.
 - To set the channel number, complete the following steps:
 - a Toggle the **Unit** soft key and select **Channel**.
 - b To select the standard channel, press the **Channel Std** soft key and then select the band to be measured.
 - c Press the **Lowest Channel** soft key to set the starting channel.
 - d Enter a value by using the numeric keys. You can also use the rotary knob.
 - e Press the **Enter** soft key.
 - f Press the **Highest Channel** soft key to set the stopping channel.

- g Enter a value by using the numeric keys. You can also use the rotary knob.
- h Press the **Enter** soft key.

After configuring test parameters, your measurement result is displayed on the screen as like the following example, **Figure 214**.

Figure 214 Multi-ACPR measurement with CDMA signal analyzer



NOTE

You can use the **LIMIT** hot key to analyze your measurements with the user-definable limit and Pass/Fail indication. See “Setting limit for RF tests” on page 362 for more information.

Spurious emissions

Out-of-band emissions are unwanted emissions immediately outside the channel bandwidth resulting from the modulation process and non-linearity in the transmitter but excluding spurious emissions. The Spurious Emissions measurement is to identify and determine the power level of out-of-band spurious emission within the necessary channel bandwidth and modulated signal measured at the RF port of the Base Station.

Setting measure setup

Procedure

- 1 Press the **MEASURE SETUP** hot key.
- 2 To set up the range table and parameters, press the **Range Table** soft key and then complete the following steps:
 - a Press the **Range** soft key, and then select the range number between **1** and **20** to add as a new or change the existing settings.
 - b Do the following as desired:
 - Select **Start Frequency**, and then specify the start frequency for the selected range.
 - Select **Stop Frequency**, and then specify the stop frequency for the selected range.
 - Select **Start Limit**, and then specify the lower limit for Pass/Fail indication.
 - Select **Stop Limit**, and then specify the upper limit for Pass/Fail indication.
 - Select **More (1/2) > Attenuation**, and then specify an value in the multiple of five.

Select **More (1/2) > RBW**, and then specify a RBW value.

Select **More (1/2) > VBW**, and then specify a VBW value.

- c Press the **PREV** hard key.
- d Toggle the **Range** soft key and select **On** to display the selected range in the result table or **Off** to hide it from the table.

3 Toggle the **Measure Type** soft key between **Examine** and **Full** to select the measurement type.



NOTE

The **Examine** mode displays only the selected range while the **Full** mode lets the instrument automatically changes the selected range from one another.

- 4 To set the number of measurements to be averaged, complete the following steps:
 - a Press the **Average** soft key.
 - b Enter a value between **1** and **100**.
 - c Press the **Enter** soft key.
- 5 To move the highlighted bar in the result table to other range, complete the following steps:
 - a Press the **Range** soft key in the Measure Setup menu bar.
 - b Enter a value between **1** and **20**.
 - c Press the **Enter** soft key.

After configuring test parameters as described in the “Configuring test parameters” on page 351, your measurement result is displayed on the screen as like the following example, **Figure 215**.

Figure 215 Spurious emissions measurement with CDMA signal analyzer



NOTE

You can use the **LIMIT** hot key to analyze your measurements with the user-definable limit and Pass/Fail indication. See “Setting limit for RF tests” on page 362 for more information.

Setting limit for RF tests

By default, test limits specified in the standard are set for you. You can change thresholds if you desire.

Procedure

- 1 Press the **LIMIT** hot key.

- 2 Press the **RF Test Limits** soft key.
- 3 Select the test item(s) and set the limit(s) depending on your selected measurement mode:

To set the limit for	Select	Set
Channel power	Channel Power	High Limit, Low Limit
Occupied bandwidth	Occupied BW	High Limit
Spectrum emission mask	Spectrum Emission Mask	(On/Off only)
ACPR	ACPR	(On/Off only)
Multi-ACPR	Multi-ACPR	(On/Off only)
Spurious emissions	Spurious Emissions	(On/Off only)

- 4 *Optional.* You can enable alarm sound that goes off if the measurement falls outside of the limit. Toggle the **Beep** soft key between **On** and **Off** to enable or disable the beep sound.
- 5 *Optional.* Go to **SAVE/LOAD > Save**, and then select **Limit** to save the limit settings. See “Using save” on page 34 for more information.

Conducting modulation measurements

In order to make accurate measurements of time offset and PN, you must connect an external trigger before making a modulation measurement.

Constellation

The Constellation is used to observe some aspects of modulation accuracy and can reveal certain fault mechanisms such as I/Q amplitude imbalance or quadrature imbalance. It displays constellation diagram by modulation types.

Setting measure setup

After configuring test parameters as described in the “Configuring test parameters” on page 351, you can continue your measurement. The measurement settings can be saved and recalled as a file. You can also use JDViewer, PC application software to configure a measure setup, save as a file, and load the file on to the instrument.

Procedure

- 1 Press the **MEASURE SETUP** hot key.
- 2 To set the Pseudo-Noise (PN) offset, complete the following steps:
 - a Toggle the **PN Offset** soft key between **Auto** and **Manual**.
 - b Enter a value by using the numeric keys to set manually.
 - c Press the **Enter** soft key.
- 3 To set the incremental step for the PN offset, complete the following steps:
 - a Press the **PN Increment** soft key.
 - b Enter a value by using the numeric keys.
 - c Press the **Enter** soft key.
- 4 *Optional.* Go to **SAVE/LOAD > Save**, and then select the save option from the choices available for your measurement mode. See “Using save” on page 34 for more information.

Measurement example

Figure 216 Constellation measurement with CDMA signal analyzer



NOTE

You can use the **LIMIT** hot key to analyze your measurements with the user-definable limit and Pass/Fail indication. See “Setting limit for modulation tests” on page 370 for more information.

Code domain power

The Code Domain Power (CDP) measures the distribution of power across the set of code channels, normalized to the total power. It helps to verify that each code channel is operating at its proper level and to identify problems throughout the transmitter design from coding to the RF section. System imperfections such as amplifier non-linearity will present themselves as an undesired distribution of power in the code domain.

Setting measure setup

After configuring test parameters as described in the “Configuring test parameters” on page 351, you can continue your measurement. The measurement settings can be saved and recalled as a file. You can also use JDViewer, PC application software to configure a measure setup, save as a file, and load the file on to the instrument.

Procedure

- 1 Press the **MEASURE SETUP** hot key.
- 2 To set the Pseudo-Noise (PN) offset, complete the following steps:
 - a Toggle the **PN Offset** soft key between **Auto** and **Manual**.
 - b Enter a value by using the numeric keys to set manually.
 - c Press the **Enter** soft key.
- 3 To set the incremental step for the PN offset, complete the following steps:
 - a Press the **PN Increment** soft key.
 - b Enter a value by using the numeric keys.
 - c Press the **Enter** soft key.
- 4 To set the threshold between Auto and Manual, complete the following steps:
 - a Press the **Threshold** soft key. Its default setting is -27 dB.

- b Enter a value between -50 and zero by using the numeric keys to change the value in the Manual mode.
 - c Press the **Enter** soft key.
- 5 Toggle the **Q-Paging** soft key between **On** and **Off** to enable or disable the quick page channel that indicates the power of Quick Page Walsh code 80.
 - 6 *Optional.* Go to **SAVE/LOAD > Save**, and then select the save option from the choices available for your measurement mode. See “Using save” on page 34 for more information.

Measurement example

Figure 217 Code domain power measurement with CDMA signal analyzer



NOTE

You can use the **LIMIT** hot key to analyze your measurements with the user-definable limit and Pass/Fail indication. See “Setting limit for modulation tests” on page 370 for more information.

Setting display

You can view your measurement results in a different view option.

Procedure

- 1 Press the **TRACE/DISPLAY** hard key.
- 2 Press the **Code Order** soft key, and then select the code order option from the following choices:
 - Hadamard:** To assign the number based on Walsh code order and display the measured code power according to the assigned number in sequence.
 - Bit Reverse:** Code number in binary bit is reversed relative to the Hadamard method.
- 3 Toggle the **Base Code Length** soft key and select the base Walsh code number: **64** or **128**.

Codogram

The Codogram displays how the code level is changing over time and makes it easier for you to view traffic channels as they initiate and terminate and to track traffic channels call levels over time. The Codogram measurements can be saved into an external USB memory so that a post-analysis can be done with the application software JDViewer.

Setting measure setup

After configuring test parameters as described in the “Configuring test parameters” on page 351, you can continue your measurement. The measurement settings can be saved and recalled as a file. You can also use JDViewer, PC application software to configure a measure setup, save as a file, and load the file on to the instrument.

Procedure

- 1 Press the **MEASURE SETUP** hot key.
- 2 To set the Pseudo-Noise (PN) offset, complete the following steps:
 - a Toggle the **PN Offset** soft key between **Auto** and **Manual**.
 - b Enter a value by using the numeric keys to set manually.
 - c Press the **Enter** soft key.
- 3 To set the incremental step for the PN offset, complete the following steps:
 - a Press the **PN Increment** soft key.
 - b Enter a value by using the numeric keys.
 - c Press the **Enter** soft key.
- 4 To set the threshold between Auto and Manual, complete the following steps:
 - a Select **More (1/2) > Threshold**. Its default setting is -27 dB.
 - b Enter a value between -50 and zero by using the numeric keys to change the value in the Manual mode.
 - c Press the **Enter** soft key.
- 5 Toggle the **Q-Paging** soft key between **On** and **Off** to enable or disable the quick page channel that indicates the power of Quick Page Walsh code 80.
- 6 To set the time interval, complete the following steps:
 - a Press the **Time Interval** soft key.
 - b Enter a value by using the numeric keys.
 - c Press the **Enter** soft key.
- 7 To place the time cursor to analyze your measurements, complete the following steps:
 - a Toggle the **Time Cursor** soft key between **On** and **Off** to enable or disable the time cursor.
 - b Enter a value by using the numeric keys.
 - c Press the **Enter** soft key.



NOTE

When the time cursor is enabled, the measurement is put on hold and information about the time cursor is displayed.

- 8 To start a new measurement, press the **Reset/Restart** soft key.
 - 9 *Optional.* Go to **SAVE/LOAD > Save**, and then select the save option from the choices available for your measurement mode. See “Using save” on page 34 for more information.
-

Measurement example

Figure 218 Codogram in full view with CDMA signal analyzer



Setting display

You can view your measurement results in a different view option.

Procedure

- 1 Press the **TRACE/DISPLAY** hard key.
- 2 Press the **Code Order** soft key, and then select the code order option from the following choices:
 - Hadamard:** To assign the number based on Walsh code order and display the measured code power according to the assigned number in sequence.
 - Bit Reverse:** Code number in binary bit is reversed relative to the Hadamard method.
- 3 Toggle the **Base Code Length** soft key and select the base Walsh code number: **64** or **128**.

RCSI

The Received Code Strength Indicator (RCSI) is used to track the power variation of cdmaOne or cdma2000 control channels such as Pilot, Paging, Sync, and Q-Paging over time. The RCSI measurements can be saved into an external USB memory so that a post-analysis can be done with the application software JDViewer.

Setting measure setup

After configuring test parameters as described in the “Configuring test parameters” on page 351, you can continue your measurement. The measurement settings can be saved and recalled as a file. You can also use JDViewer, PC application software to configure a measure setup, save as a file, and load the file on to the instrument.

Procedure

- 1 Press the **MEASURE SETUP** hot key.
- 2 To set the Pseudo-Noise (PN) offset, complete the following steps:

- a Toggle the **PN Offset** soft key between **Auto** and **Manual**.
 - b Enter a value by using the numeric keys to set manually.
 - c Press the **Enter** soft key.
- 3 To set the incremental step for the PN offset, complete the following steps:
 - a Press the **PN Increment** soft key.
 - b Enter a value by using the numeric keys.
 - c Press the **Enter** soft key.
 - 4 To set the threshold between Auto and Manual, complete the following steps:
 - a Press the **Threshold** soft key. Its default setting is -27 dB.
 - b Enter a value between -50 and zero by using the numeric keys to change the value in the Manual mode.
 - c Press the **Enter** soft key.
 - 5 Toggle the **Q-Paging** soft key between **On** and **Off** to enable or disable the quick page channel that indicates the power of Quick Page Walsh code 80.
 - 6 Press the **Alarm Code** soft key, and then select the alarm code option: **None**, **Pilot**, **Page**, **Sync**, or **Quick Page**.
 - 7 To set the alarm mask, complete the following steps:
 - a Press the **Set Mask** soft key.
 - b Enter a value by using the numeric keys.
 - c Press the **[dB|dBm]** soft key.
 - 8 *Optional.* Go to **SAVE/LOAD > Save**, and then select the save option from the choices available for your measurement mode. See “Using save” on page 34 for more information.

Measurement example

Figure 219 RCSI measurement with CDMA signal analyzer



Setting display

You can view your measurement results in a different view option.

Procedure

- 1 Press the **TRACE/DISPLAY** hard key.
- 2 Press the **Code Order** soft key, and then select the code order option from the following choices:
Hadamard: To assign the number based on Walsh code order and display the measured

code power according to the assigned number in sequence.

Bit Reverse: Code number in binary bit is reversed relative to the Hadamard method.

- 3 Toggle the **Base Code Length** soft key and select the base Walsh code number: **64** or **128**.
-

CDP Table

The CDP Table is used to look at a numeric and textual description of all the active code channels in the signal.

Setting measure setup

After configuring test parameters as described in the “Configuring test parameters” on page 351, you can continue your measurement. The measurement settings can be saved and recalled as a file. You can also use JDViewer, PC application software to configure a measure setup, save as a file, and load the file on to the instrument.

Procedure

- 1 Press the **MEASURE SETUP** hot key.
 - 2 To set the Pseudo-Noise (PN) offset, complete the following steps:
 - a Toggle the **PN Offset** soft key between **Auto** and **Manual**.
 - b Enter a value by using the numeric keys to set manually.
 - c Press the **Enter** soft key.
 - 3 To set the incremental step for the PN offset, complete the following steps:
 - a Press the **PN Increment** soft key.
 - b Enter a value by using the numeric keys.
 - c Press the **Enter** soft key.
 - 4 To set the threshold between Auto and Manual, complete the following steps:
 - a Press the **Threshold** soft key. Its default setting is -27 dB.
 - b Enter a value between -50 and zero by using the numeric keys to change the value in the Manual mode.
 - c Press the **Enter** soft key.
 - 5 Toggle the **Q-Paging** soft key between **On** and **Off** to enable or disable the quick page channel that indicates the power of Quick Page Walsh code 80.
-

Measurement example

Figure 220 CDP Table measurement with CDMA signal analyzer



Setting display

If the CDP table spans over to the next page(s), you can change pages up and down to view your measurement results.

Procedure

- 1 Press the **TRACE/DISPLAY** hard key.
- 2 Press the **Code Order** soft key, and then select the code order option from the following choices:
 - Hadamard:** To assign the number based on Walsh code order and display the measured code power according to the assigned number in sequence.
 - Bit Reverse:** Code number in binary bit is reversed relative to the Hadamard method.
- 3 Toggle the **Base Code Length** soft key and select the base Walsh code number: **64** or **128**.
- 4 Select **Page Up** or **Page Down** as needed to scroll the screen up and down.

Setting limit for modulation tests

Procedure

- 1 Press the **LIMIT** hot key.
- 2 Press the Modulation Test Limits soft key.
- 3 Select the test item(s) and set the limit(s) depending on your selected measurement mode:

To set the limit for	Select	Set
Frequency error	Frequency Error	High Limit, Low Limit
Time offset	Time Offset	High Limit, Low Limit
Waveform quality (Rho)	Rho	Low Limit
Carrier feed through	Carrier Feed Through	High Limit
Pilot power	Pilot Power	High Limit [Abs Rel]

		Low Limit [Abs Rel]
Highest level among inactive channels	Max Inactive	High Limit

- 4 *Optional.* You can enable alarm sound that goes off if the measurement falls outside of the limit. Toggle the **Beep** soft key between **On** and **Off** to enable or disable the beep sound.
- 5 *Optional.* Go to **SAVE/LOAD > Save**, and then select **Limit** to save the limit settings. See “Using save” on page 34 for more information.

**NOTE**

The Time Offset compares the PN offset timing with the overall system time and the instrument checks the start of PN offset in comparison to either the GPS signal or the even second clock signal.

**NOTE**

The Rho measures the modulation quality for a CDMA transmitter along with EVM and Walsh Channel Power. It includes all errors occurred along the transmitter chain such as base band filtering, abnormality of I/Q modulator and distortion in power amplifier. A perfect Rho value is 1.0 indicating that all of the power is being transmitted correctly.

**NOTE**

The Carrier Feed Through is a result of the RF carrier signal feeding through the I/Q modulator and riding on the output circuitry without being modulated.

Performing auto measurements

The Auto Measure function of the JD700B series allows a complete signal profiling covering RF characterization and modulation quality parameters of up to 10 different carriers, particularly useful on an overlay architecture where base stations are transmitting in different frequencies.

The Auto Measure can be easily executed either by selecting a menu in the instrument or by running a programmed scenario in the PC-based application so that the instrument automatically configure and perform tests on every aspect of all the carriers.

Setting limit for auto measure

You can set test limits for test item(s) in the auto measurement.

Procedure

- 1 Press the **LIMIT** hot key.
- 2 Press the **RF Test Limits** soft key, and then enable test limits as desired.
- 3 Press the **Modulation Test Limits** soft key, and then enable test limits as desired.
- 4 *Optional.* You can enable alarm sound that goes off if the measurement falls outside of the limit. Toggle the **Beep** soft key between **On** and **Off** to enable or disable the beep sound.
- 5 *Optional.* Go to **SAVE/LOAD > Save**, and then select **Limit** to save the limit settings. See “Using save” on page 34 for more information.

Setting measure setup

After configuring test parameters as described in the “Configuring test parameters” on page 351, you can continue your measurement. The measurement settings can be saved and recalled as a file. You can also use JDViewer, PC application software to configure a measure setup, save as a file, and load the file on to the instrument.

Procedure

- 1 Press the **MEASURE SETUP** hot key.
 - 2 Toggle the **Configuration** soft key and select the configuration option:
 - Current:** Lets the instrument use current frequency (single carrier) and determine pass or fail based on the instrument's limit settings in Auto Measure.
 - Scenario:** Runs a test with a programmed scenario in JDViewer. The Scenario menu becomes activated.
 - 3 To load a scenario, press the **Scenario** soft key, and then select a scenario file to load.
 - 4 Toggle the **Test Time** soft key and select the test time option:
 - Now:** Lets the instrument run a test only once.
 - Schedule:** Lets the instrument repeat tests as defined in the Set Timing. The Set Timing menu becomes activated.
 - 5 To define a schedule for an auto measurement, complete the following steps:
 - a Press the **Set Timing** soft key.
 - b Press the **Start Time (HH:MM)** soft key.
 - c Enter the time in the HH:MM format, and then press the **Enter** soft key.
 - d Press the **Stop Time (HH:MM)** soft key.
 - e Enter the time in the HH:MM format, and then press the **Enter** soft key.
 - f Press the **Time Interval** soft key.
 - g Enter the amount of time in minutes, and then press the **Enter** soft key.
 - 6 To set external offset, complete the following steps:
 - a Toggle the **External Offset** soft key and select **On**.
 - b Enter a value by using the numeric keys, and then press the **dB** soft key.
 - 7 To save your settings and results, go to **SAVE/LOAD > Save** and then perform functions as you desire. See "Using save" on page 34 for more information.
 - 8 Press the **Run Test** soft key to start to run a test. The Auto Measure Results window appears at the end of the test.
 - 9 To stop running the test, press the **Abort** soft key.
 - 10 To change the view on the screen during the test, press the **Display** and then select the view option from the following choices:
 - Screen:** You can view each measurement screen as the test progresses.
 - Results:** You can view a measurement result table as the test progresses.
 - Settings:** You can view a measurement setting table as the test progresses.
-

Setting display

After completion of the auto measurement, the screen menu changes to Trace/Display so that you can view the results in different forms.

Procedure

- 1 Toggle the **Display** soft key and select the display option:
 - Result:** You can view the result table. The Display Result menu becomes activated.
 - Settings:** You can view the measurement settings for the auto measurement.
 - 2 Toggle the **Display Result** soft key and select the display result option:
 - Full:** You can view detailed measurement readings with the pass/fail indication.
 - Quick:** You can view only the Pass/Fail results.
 - 3 To view the measurement results for a different carrier, press the **View Carrier** soft key and then select the carrier number to view.
-

Performing power statistics CCDF measurements

The Power Statistics Complementary Cumulative Distribution Function (CCDF) measurement characterizes the power statistics of the input signal. It provides PAR (Peak to Average power Ratio) versus different probabilities.

Setting measure setup

After configuring test parameters as described in the “Configuring test parameters” on page 351, you can continue your measurement. The measurement settings can be saved and recalled as a file. You can also use JDViewer, PC application software to configure a measure setup, save as a file, and load the file on to the instrument.

Procedure

- 1 Press the **MEASURE SETUP** hot key.
- 2 Press the **CCDF Length** soft key to set the length of the CCDF.
- 3 Enter a value between 1 and 100 by using the numeric keys. You can also use the rotary knob.
- 4 Press the **Enter** soft key.

Measurement example

Figure 221 CCDF measurement with CDMA signal analyzer



Conducting CDMA OTA measurements

This Over The Air (OTA) measurement has channel scanner, PN scanner, multipath profile, and Code Domain power screens. It is used to verify CDMA transmitter performance at any location providing reflective measurements and identifying signals providing from different sites. The Code Domain power shows not only modulation performance metric but also amplifier capacity and code utilization metric. The Amplifier capacity (code utilization) measurement is an estimate of the amount of power amplifier capacity (code utilization) that is being used expressed in percent of maximum.

Channel scanner

Setting channel/frequency

Procedure

To set the channels to be scanned:

- 1 Press the **FREQ/DIST** hard key.
- 2 Toggle the **Unit** soft key and select **Channel**.
- 3 Press the **Index** soft key, and then enter an index number between one and six by turning the rotary knob or using the numeric keys.
- 4 To select the standard channel, complete the following steps:
 - a Press the **Channel Std** soft key. The standard channel window appears. See “Appendix C – Band, frequency & channel standard” on page 769 for more information.
 - b Highlight the band to be measured by using the rotary knob, the arrow keys, or the **Page Up/Page Down** soft keys.
 - c Press the **Select** soft key or the rotary knob to confirm the selection.
- 5 To set the channel number for the selected index, complete the following steps:
 - a Press the **Channel Number** soft key.
 - b Enter a value by using the numeric keys. You can also use the rotary knob.
 - c Press the **Enter** soft key.
- 6 The instrument displays a corresponding center frequency for the channel number.
- 7 To set the integration bandwidth for the selected index, complete the following steps:
 - a Press the **Integration Bandwidth** soft key.
 - b Enter a value by using the numeric keys. You can also use the rotary knob.
 - c Select the unit: **GHz, MHz, kHz, or Hz**.
- 8 To add more channels to be scanned, repeat steps 3-6.
- 9 Press the **ESC** hard key to dismiss the channel list window and view the scanning result.

To set the frequencies to be scanned:

- 1 Press the **FREQ/DIST** hard key.
 - 2 Toggle the **Unit** soft key and select **Freq**.
 - 3 Press the **Index** soft key, and then enter an index number between one and six by turning the rotary knob or using the numeric keys.
 - 4 To set the center frequency for the selected index, complete the following steps:
 - a Press the **Center Frequency** soft key.
 - b Enter a value by using the numeric keys. You can also use the rotary knob.
 - c Select the unit: **GHz, MHz, kHz, or Hz**.
 - 5 To set the integration bandwidth for the selected index, complete the following steps:
 - a Press the **Integration Bandwidth** soft key.
 - b Enter a value by using the numeric keys. You can also use the rotary knob.
 - c Select the unit: **GHz, MHz, kHz, or Hz**.
 - 6 To add more channels to be scanned, repeat steps 3-5.
 - 7 Press the **ESC** hard key to dismiss the channel list window and view the scanning result.
-

Setting measure setup

After configuring other test parameters as described in the “Configuring test parameters” on page 351, you can continue your measurement. The measurement settings can be saved and recalled as a file. You can also use JDViewer, PC application software to configure a measure setup, save as a file, and load the file on to the instrument.

Procedure

- 1 Press the **MEASURE SETUP** hot key.
 - 2 To set the incremental step for the PN offset, complete the following steps:
 - a Press the **PN Increment** soft key.
 - b Enter a value by using the numeric keys.
 - c Press the **Enter** soft key.
 - 3 *Optional.* Go to **SAVE/LOAD > Save**, and then select the save option from the choices available for your measurement mode. See “Using save” on page 34 for more information.
-

Setting limit for OTA channel scanner

Procedure

- 1 Press the **LIMIT** hot key.
 - 2 Press the **Limit Line** soft key to set a threshold for the limit line and Pass/Fail indication.
 - 3 Enter a value, and then press the **dBm** unit soft key.
 - 4 Toggle the **Limit Line** soft key between **On** and **Off** to display or dismiss the limit line.
 - 5 *Optional.* You can enable alarm sound that goes off if the measurement falls outside of the limit. Toggle the **Beep** soft key between **On** and **Off** to enable or disable the beep sound.
 - 6 *Optional.* Go to **SAVE/LOAD > Save**, and then select **Limit** to save the limit settings. See “Using save” on page 34 for more information.
-

Measurement example
Figure 222 Channel scanner measurement with CDMA OTA signal analyzer

PN scanner

Each access network sector has a unique PN offset. The PN Scanner is used to identify all the active PNs in an area.

Setting measure setup

After configuring test parameters as described in the “Configuring test parameters” on page 351, you can

continue your measurement. The measurement settings can be saved and recalled as a file. You can also use JDViewer, PC application software to configure a measure setup, save as a file, and load the file on to the instrument.

Procedure

- 1 Press the **MEASURE SETUP** hot key.
- 2 To set the incremental step for the PN offset, complete the following steps:
 - a Press the **PN Increment** soft key.
 - b Enter a value by using the numeric keys.
 - c Press the **Enter** soft key.
- 3 *Optional.* Go to **SAVE/LOAD > Save**, and then select the save option from the choices available for your measurement mode. See “Using save” on page 34 for more information.

Measurement example

Figure 223 PN scanner measurement with CDMA OTA signal analyzer



Multipath profile

The Multipath Profile enables you to determine RF environmental conditions of testing area. It indicates the amount of power of the dominant pilot signal that is dispersed outside the main correlation peak due to multipath echoes that are expressed in dB. This value should be very small ideally.

The multipath profile is the result of portions of the original broadcast signal arriving at the receiving antenna out of phase. This can be caused by the signal being reflected off objects such as buildings, or being refracted through the atmosphere differently from the main signal.

Setting measure setup

After configuring test parameters as described in the “Configuring test parameters” on page 351, you can continue your measurement. The measurement settings can be saved and recalled as a file. You can also use JDViewer, PC application software to configure a measure setup, save as a file, and load the file on to the instrument.

Procedure

- 1 Press the **MEASURE SETUP** hot key.
 - 2 To set the incremental step for the PN offset, complete the following steps:
 - a Press the **PN Increment** soft key.
 - b Enter a value by using the numeric keys.
 - c Press the **Enter** soft key.
 - 3 *Optional.* Go to **SAVE/LOAD > Save**, and then select the save option from the choices available for your measurement mode. See “Using save” on page 34 for more information.
-

Measurement example
Figure 224 Multipath profile measurement with CDMA OTA signal analyzer

Code domain power

Channels with high correlation factors are determined to be active channels and are indicated as such on the display. Once the channels are decoded, the analyzer determines the power of each channel relative to the total signal power.

This measurement helps to verify that each code channel is operating at its proper level and helps to identify problems throughout the transmitter design from the coding to the RF section. System imperfections, such as the non-linearity of amplifiers, will present themselves as an undesired distribution of power in the code domain.

Setting measure setup

After configuring test parameters as described in “Configuring test parameters” on page 351, you can continue your measurement. The measurement settings can be saved and recalled as a file. You can also use JDViewer, PC application software to configure a measure setup, save as a file, and load the file on to the instrument.

Procedure

- 1 Press the **MEASURE SETUP** hot key.
-

- 2 To set the Pseudo-Noise (PN) offset, complete the following steps:
 - a Toggle the **PN Offset** soft key between **Auto** and **Manual**.
 - b Enter a value by using the numeric keys to set manually.
 - c Press the **Enter** soft key.
- 3 To set the incremental step for the PN offset, complete the following steps:
 - a Press the **PN Increment** soft key.
 - b Enter a value by using the numeric keys.
 - c Press the **Enter** soft key.
- 4 To set the threshold between Auto and Manual, complete the following steps:
 - a Press the **Threshold** soft key. Its default setting is -27 dB.
 - b Enter a value between -50 and zero by using the numeric keys to change the value in the Manual mode.
 - c Press the **Enter** soft key.
- 5 Toggle the **Q-Paging** soft key between **On** and **Off** to enable or disable the quick page channel that indicates the power of Quick Page Walsh code 80.
- 6 To set the maximum amplifier power, complete the following steps:
 - a Press the **Max Amplifier Power** soft key.
 - b Enter a value by using the numeric keys.
 - c Press the **dBm** soft key.
- 7 To set the pilot power, complete the following steps:
 - a Press the **Pilot Power** soft key.
 - b Enter a value by using the numeric keys.
 - c Press the **dBm** soft key.
- 8 To set the threshold for pilot dominance, complete the following steps:
 - a Select **More (1/2) > Pilot Dominance >**.
 - b Enter a value by using the numeric keys.
 - c Press the **Enter** soft key.

**NOTE**

Recommended value is 10. Color of the Pilot Dominance indicator on the screen bases on this setting.

- 9 To set the threshold for multipath power, complete the following steps:
 - a Select **More (1/2) > Multipath Power <**.
 - b Enter a value by using the numeric keys.
 - c Press the **Enter** soft key.

**NOTE**

Recommended value is one. Color of the multipath power indicator on the screen bases on this setting.

- 10 *Optional.* Go to **SAVE/LOAD > Save**, and then select the save option from the choices available for your measurement mode. See “Using save” on page 34 for more information.

Measurement example

Figure 225 Code domain power measurement with CDMA OTA signal analyzer



NOTE

You can use the **LIMIT** hot key to analyze your measurements with the user-definable limit and Pass/Fail indication.

Setting display

You can view your measurement results in a different view option.

Procedure

- 1 Press the **TRACE/DISPLAY** hard key.
- 2 Press the **Code Order** soft key, and then select the code order option from the following choices:
 - Hadamard:** To assign the number based on Walsh code order and display the measured code power according to the assigned number in sequence.
 - Bit Reverse:** Code number in binary bit is reversed relative to the Hadamard method.
- 3 Toggle the **Base Code Length** soft key and select the base Walsh code number: **64** or **128**.

Route map

The JD700B Series provides the Route Map function that allows you to collect data of points in an indoor or outdoor environment and track the received signals and coverage of RF transmitters by plotting data real time directly on top of a loaded floor plan or a map.

Setting measure setup

Procedure

- 1 If required, connect a GPS receiver to your JD700B series for outdoor mapping. Indoor mapping does not necessarily need a GPS antenna.
- 2 Configure test parameters as described in the “Configuring test parameters” on page 351.
- 3 To load your map file, complete the following steps:
 - a Plug in your USB drive that has a floor map or .mcf file type created in JDMapCreator. If

the JMapCreator application on your computer is connected to the instrument via USB or LAN, you can send a map file with a single layer to the instrument directly by using the **Send to EQP** menu in JMapCreator.

**NOTE**

The JMapCreator converts and resizes any scanned floor plan or layout to fit onto your instrument's display. JMapCreator 1.2.0 or later can save a multiple-layered map, providing **x1**, **x2**, and **x4** views, as a sizable map file so that you can zoom in and out after loading it.

- b Press **SAVE/LOAD** hot key, and then select **Load > Load Map**. See "Using load" on page 36 for more information.
- 4 Press the **MEASURE SETUP** hot key.
- 5 Press the **Plot Point** soft key, and then select the plot point option from the following choices:
To collect data/plot points automatically as you move around in a vehicle or outside, press the **GPS** soft key and then toggle the **Screen Mode** soft key between **Map** and **Full**.

**NOTE**

With the **Map** setting, you can view only the collected points that can be seen within the boundary of the loaded map. If a point is off the map, the instrument displays an arrow to indicate the direction of the current location on the map and the distance from the center to the location at the top of the screen. With the **Full** setting, you can view all the collected points of the route without the loaded map.

To collect data/plot points manually without a GPS antenna in an indoor environment, press the **Position** soft key.

- 6 Press the **Plot Item** soft key, and then select the measurement option: **Pilot Power** or **Ec/Io**.
- 7 To set the incremental step for the PN offset, complete the following steps:
 - a Press the **PN Increment** soft key.
 - b Enter a value by using the numeric keys.
 - c Press the **Enter** soft key.
- 8 Toggle the **Plot** soft key and select **Start**.
- 9 Touch directly on the screen or press the **ENTER** hard key to collect data and plot points on the loaded map for the **Position** setting.

**NOTE**

For the **Position** setting, you can change the direction of the route with the arrow keys and the distance with the rotary knob.

- 10 Toggle the **Plot** soft key and select **Stop** to stop plotting.
- 11 Press the **SAVE/LOAD** hot key to save the result.
See "Using save" on page 34 for more information.

**NOTE**

The instrument does not automatically save the collected data. It is recommended that you save the result. Otherwise, you will lose all the collected data.

Setting limit

You can set the thresholds for the four different color indicators for Pilot power or Ec/Io.

Procedure

- 1 Press the **LIMIT** hot key.
- 2 To set the limits for pilot power if you have selected Pilot for the plot item, complete the following steps:
 - a Press the **Pilot Power** soft key.
 - b Press the **Excellent** soft key to set its threshold.
 - c Enter a value, and then press the **dBm** soft key. You can also use the rotary knob.
 - d Press the **Very Good** soft key to set its threshold.
 - e Enter a value, and then press the **dBm** soft key. You can also use the rotary knob.
 - f Press the **Good** soft key to set its threshold.

-
- g Enter a value, and then press the **dBm** soft key. You can also use the rotary knob.
 - h Press the **Fair** soft key to set its threshold.
 - i Enter a value, and then press the **dBm** soft key. You can also use the rotary knob.
 - j Press the **Poor** soft key to set its threshold.
 - k Enter a value, and then press the **dBm** soft key. You can also use the rotary knob.
- 3** To set the limits for E_c/I_o if you have selected as for the plot item , complete the following steps:
- a Press the **Ec/Io** soft key.
 - b Press the **Good** soft key to set its threshold.
 - c Enter a value, and then press the **Enter** soft key. You can also use the rotary knob.
 - d Press the **Fair** soft key to set its threshold.
 - e Enter a value, and then press the **Enter** soft key. You can also use the rotary knob.
 - f Press the **Poor** soft key to set its threshold.
 - g Enter a value, and then press the **Enter** soft key. You can also use the rotary knob.
- 4** *Optional.* Go to **SAVE/LOAD > Save**, and then select **Limit** to save the limit settings. See “Using save” on page 34 for more information.
-

Measurement example

Figure 226 Route map measurement with CDMA OTA signal analyzer

1) Pilot Power



2) Pilot Ec/Io

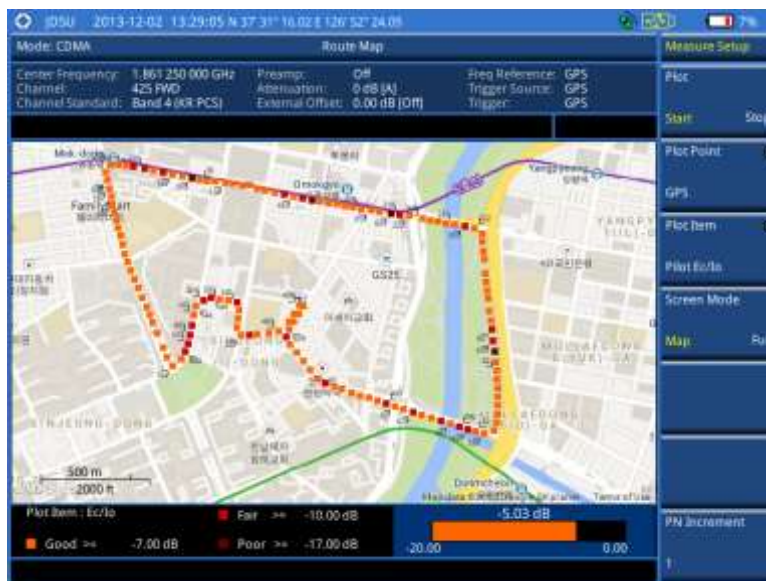

Controlling a map

If you have loaded a sizable map that was created in JDMapCreator 1.2.0 or later, you can use the Map Control feature that enables you to zoom into the map and view a specific area of interest in detail.

Procedure

- 1 Press the **TRACE/DISPLAY** hard key.
- 2 Press the **Map Control** soft key. This key is active only when you have loaded a sizable map.
- 3 Do one of the following:
 - To zoom into an area of interest directly, complete the following steps:
 - a Toggle the **Zoom to** soft key and select **Area**.

-
- The black rectangle appears on the map.
- b** Press the **Zoom In** and **Zoom Out** soft keys, as you need, to decrease and increase the selected area.
 - c** Move the rectangle by using the four arrow keys, as you need, to place it in a specific area of interest.
 - d** Press the center of the rotary knob to zoom into the selected area. You can also press the **Zoom to** soft key again to zoom into the selected area.
- To zoom into the center or zoom out from the center, complete the following steps:
- a** Toggle the **Zoom to** soft key and select **Center**.
 - b** Press the **Zoom In** and **Zoom Out** soft keys, as you need, to zoom in and zoom out.
 - c** Move the zoomed-in area by using the four arrow keys, as you need.
- 4** To set the location mode, toggle the **Location Mode** soft key between **Auto** and **Manual** and select the one you desire.

Auto: The instrument compares the coordinates of the displayed map with received GPS information. If your current location goes out of the displayed area and enters into the next zoomed-in section within the base map, the map display changes automatically to the next section in which your current position is.

Manual: The map display of the zoomed-in area remains unchanged even if your current location goes out of the displayed area. You can change the displayed area manually by using the arrow keys.

Chapter 11 Using EV-DO Signal Analyzer

This chapter provides instructions for using the EV-DO Signal Analyzer function (option 021) with the EV-DO OTA Analyzer function (option 041). Topics discussed in this chapter are as follows:

■ Introduction.....	385
■ Display overview	385
■ Connecting a cable.....	386
■ Selecting measurement mode	388
■ Configuring test parameters	388
■ Conducting spectrum measurements	393
■ Conducting RF measurements	394
■ Conducting power vs. time measurements	400
■ Conducting modulation measurements.....	402
■ Performing auto measurements	412
■ Performing power statistics CCDF measurements	414
■ Conducting EV-DO OTA measurements	414

Introduction

The EV-DO Signal Analyzer of the JD700B series performs power and spectrum measurements as well as modulation analysis to test the proper transmitter performance of EV-DO systems. It performs conformance testing according to the following standards providing a simple Pass/Fail indication on each test.

- 3GPP2 C.S0024-B. cdma2000 High Rate Packet Data Air Interface Specification
- 3GPP2 C.S0032-B. Recommended Minimum Performance Standards for cdma2000 High Rate Packet Data Access Network

You may alter the measurement parameters for specialized analysis. Pass/Fail testing with standard defined or user defined upper and lower limits and the Pass/Fail indicator help you to determine base station performance easily.

This instrument provides the following measurement tools for EV-DO system:

- Spectrum Analysis
- RF Analysis
 - Channel Power
 - Occupied Bandwidth
 - Spectrum Emission Mask (SEM)
 - Adjacent Channel Power Ratio (ACLR)
 - Multi-ACPR
 - Spurious Emissions
- Power vs. Time: Idle Slot and Active Slot
- Modulation Analysis
 - Constellation
 - Code Domain Power
 - MAC Codogram
 - Received Code Strength Indicator (RCSI)
 - MAC CDP Table
- Auto Measure
- Power Statistics CCDF
- Over The Air (OTA)
 - Channel Scanner
 - PN Scanner
 - Multipath Profile
 - Code Domain Power
 - Route Map

Display overview

Figure 227 provides descriptions for each segment of the measurement screen.

Figure 227 EV-DO signal analyzer measurement screen

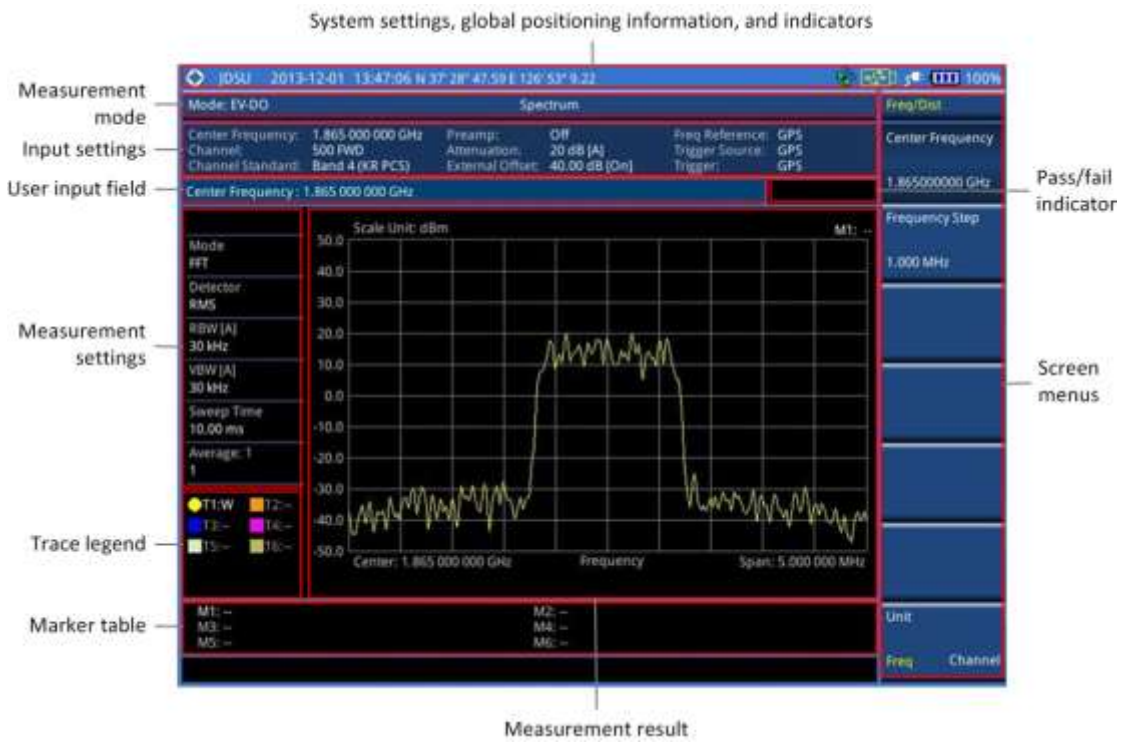

Connecting a cable

Direct connection

Procedure

- 1 Connect the **Spectrum Analyzer RF In** port of the JD700B series and the Power amplifier output port of BTS.

Figure 228 Direct connection



Indirect connection

Procedure

- 1 Connect the **Spectrum Analyzer RF In** port of the JD700B series and the monitor (test) port of BTS.

Figure 229 Indirect connection

**CAUTION**

The maximum power for the **Spectrum Analyzer RF In** port is +25 dBm (0.316 W) for JD780B series and +20 dBm (0.1 W) for JD740B series. If the level of the input signal to be measured is greater than this, use a **High Power Attenuator** to prevent damage when you directly connect the signal to the instrument or connect the signal from the coupling port of a directional coupler.

Over the air (OTA)

Procedure

- 1 Connect an Omni/directional RF antenna to the **Spectrum Analyzer RF In** port of the JD700B series.
- 2 Connect a GPS antenna to the **GPS** port of the JD700B series.

Figure 230 OTA connection

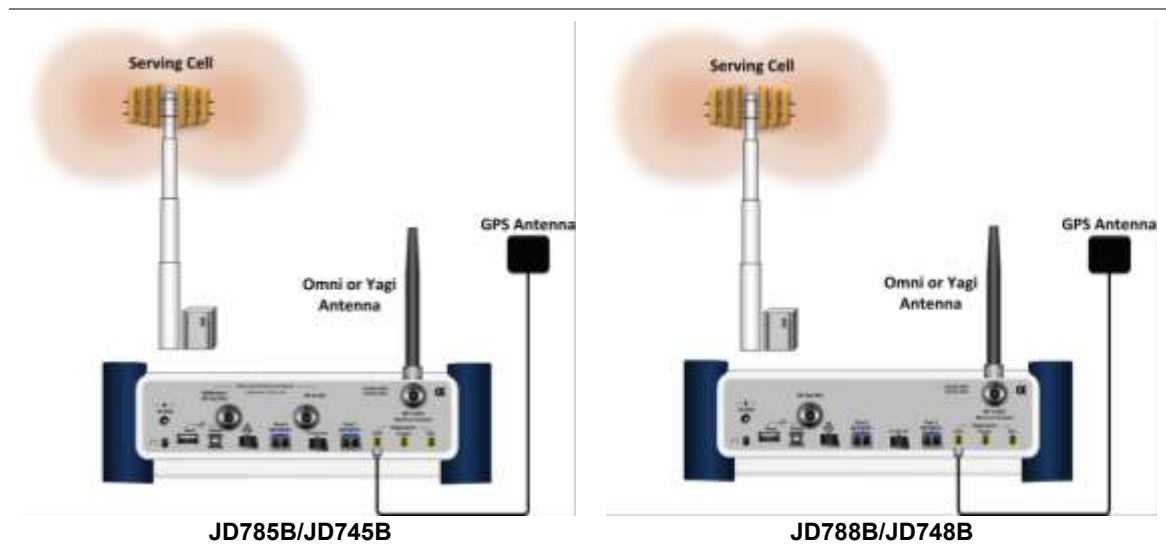
**CAUTION**

If the input signal level to be measured is less than 0 dBm, set 0 dB attenuation or turn on the preamp to have better dynamic range for the OTA testing.

Selecting measurement mode

Procedure

- 1 Press the **MODE** hard key.
- 2 Press the **Signal Analyzer** soft key.
- 3 Press the **EV-DO** soft key. The **Spectrum** mode is set by default.
- 4 Press the **MEASURE** hot key, and then select the measurement mode option from the following choices:

Spectrum

RF Analysis > Channel Power, Occupied BW, Spectrum Emission Mask, ACPR, Multi-ACPR, or Spurious Emissions

Power vs Time > Power vs Time (Idle Slot) or Power vs Time (Active Slot)

Modulation Analysis > Constellation > Composite 64, Composite 128, Pilot, MAC 64, MAC 128, or Data

Modulation Analysis > Code Domain Power > Pilot, MAC 64, MAC 128, or Data

Modulation Analysis > MAC Codogram, RCSI, or MAC CDP Table

Auto Measure

Power Statistics CCDF

OTA > Channel Scanner, PN Scanner, Multipath Profile, Code Domain Power, or Route Map

Configuring test parameters

Setting frequency

You can set the frequency with either frequency or channel number. If a frequency to be set matches to the frequency corresponding to the selected channel standard, the instrument calculates its channel number and updates the screen with it automatically.

Procedure

To set the center frequency:

- 1 Press the **FREQ/DIST** hard key.
- 2 Toggle the **Unit** soft key and select **Freq**.
- 3 Press the **Center Frequency** soft key.
- 4 Enter a value by using the numeric keys. You can also use the rotary knob.
- 5 Select the unit: **GHz**, **MHz**, **kHz**, or **Hz**.
- 6 *Optional.* To define the amount of frequency increment for the rotary knob, complete the following steps:
 - a Press the **Frequency Step** soft key.
 - b Enter a value by using the numeric keys. You can also use the rotary knob.
 - c Press the unit: **GHz**, **MHz**, **kHz**, or **Hz**.

To set the channel number:

- 1 Press the **FREQ/DIST** hard key.
 - 2 Toggle the **Unit** soft key and select **Channel**.
 - 3 To select the standard channel, complete the following steps:
 - a Press the **Channel Std** soft key. The standard channel window appears. See "Appendix C – Band, frequency & channel standard" on page 769 for more information.
 - b Highlight the band to be measured by using the rotary knob, the arrow keys, or the **Page**
-

Up/Page Down soft keys.

- c Press the **Select** soft key or the rotary knob to confirm the selection.
- 4 Press the **Channel Number** soft key.
- 5 Enter a value by using the numeric keys. You can also use the rotary knob.
- 6 Press the **Enter** soft key.
The instrument automatically displays the corresponding center frequency value for the selected channel number.
- 7 *Optional.* To define the amount of channel increment for the rotary knob, complete the following steps:
 - a Press the **Channel Step** soft key.
 - b Enter a value by using the numeric keys. You can also use the rotary knob.
 - c Press the **Enter** soft key.

**NOTE**

This frequency setting is not used in the Multi-ACLR and Spurious Emissions modes.

Setting amplitude

Reference level and attenuation

You can set the reference and attenuation levels automatically or manually to optimize the display of the traces measured, as you desire.

Procedure

To automatically set the reference and attenuation level:

- 1 Press the **AMP/SCALE** hard key.
- 2 Press the **Auto Scale** soft key.
Each time you press this key, both of the Y-axis scale and input attenuation level change to be optimized with some margin.

To set the reference or attenuation level manually:

- 1 Press the **AMP/SCALE** hard key.
- 2 To set the maximum reference value on the Y-axis manually, complete the following steps:
 - a Press the **Reference Level** soft key.
 - b Enter a value by using the numeric keys or the rotary knob with 10 dB increments.
 - c Press the unit soft key or the **ENTER** hard key.
This unit key name changes according to the setting in the **Units** menu.

**NOTE**

In the measurements such as **Code Domain Power** and **MAC Codogram**, you may need to select the reference option between **Relative** and **Absolute** before setting the reference level.

- 3 To set the attenuation option, select one from the following choices:
To set the input attenuator's level automatically, select **Attenuation > Auto**.

**NOTE**

It is recommended that you set the **Attenuation** to **Auto** in most situations so that the level of the input attenuator can be set automatically according to your input signal level.

To set the input attenuation manually up to 55 dB for JD780B series or 50 dB for JD740B series to optimize S/N, complete the following steps:

- a Select **Attenuation > Manual**.
- b Press the **Attenuation Value** soft key to set the level.
- c Enter a value in fives by using the numeric keys.
- d Press the **dB** soft key or the **ENTER** hard key.

To couple the input attenuator's level with your reference level setting, select **Attenuation >**

Couple.

As you increase the reference setting, the attenuation level also increases accordingly.

Optional. To change the scale unit:

- 1 Select **More (1/2) > Units**.
- 2 Select the unit of the display scale: **dBm**, **dBV**, **dBmV**, **dBμV**, **V**, or **W**.
The scale unit on the screen changes accordingly.



NOTE

This Units menu is available in the Spectrum and RF Analysis modes.

Scale per division

You can use the **Scale/Div** feature available for the spectrum and RF analysis. It represents the value of one division on the horizontal scale. The default setting is 10 dB per division and the maximum value can be set up to 20 dB.

Procedure

To set the scale per division:

- 1 Press the **AMP/SCALE** hard key.
 - 2 Select **More (1/2) > Scale/Div**.
 - 3 Enter a value between 1 and 20 by using the numeric keys.
 - 4 Press the **dB** soft key to complete the entry.
-

Pre-amplifier

You can turn the internal pre-amplifier on to correct and compensate for the gain of the preamp so that amplitude readings show the value at the input connector.

Procedure

- 1 Press the **AMP/SCALE** hard key.
 - 2 Toggle the **Preamp** soft key and select **On** or **Off** as needed.
-



NOTE

You can turn the Preamp on when the input attenuation range is from 0 dB to 10 dB. If the attenuation value is manually set to greater than 10 dB, the instrument will automatically turn off the pre-amplifier to display low-level signal properly on the chart.

External offset

You can turn the **External Offset** on and manually set the external offset value. An offset consists of a cable loss and a user offset and the measurement result shows the value reflecting both offset values. When the external offset value is set at 40 dB in the Spectrum mode, the measurement result compensates 40 dB at both the Spectrum Analyzer and Signal Analyzer modes.

Procedure

To set the external offset:

- 1 Press the **AMP/SCALE** hard key.
 - 2 Toggle the **External Offset** soft key and select **On**.
 - 3 Enter a value by using the numeric keys.
 - 4 Press the **dB** soft key to complete the entry.
-

To turn the external offset off:

- 1 Press the **AMP/SCALE** hard key.
- 2 Toggle the **External Offset** soft key and select **Off**.

Setting average

You can set the number of measurements to be averaged for the trace presentation. A maximum of 100 times of averaging can be set. When the averaging reaches to your setting, a new measurement value replaces the measurement value in sequence from the earliest.

Procedure

- 1 Press the **BW/AVG** hard key.
- 2 Press the **Average** soft key.
- 3 Enter a value between 1 and 100 as needed by using the numeric keys.
- 4 Press the **Enter** soft key.

Setting sweep mode

The default setting is **Continue** to sweep continuously for most on-going measurements. If you want to hold the measurement or get a single sweep, you can change the sweep mode.

Procedure**To select the single sweep mode:**

- 1 Press the **SWEEP** hot key.
- 2 Toggle the **Sweep Mode** soft key and select **Single**. You can also use the **HOLD** hot key. The letter **HOLD** in red appears and the sweeping is paused.
- 3 *Optional.* Press the **Sweep Once** soft key to get a new measurement.

To return to the continuous sweep mode:

- 1 Toggle the **Sweep Mode** soft key and select **Continue**. You can also use the **HOLD** hot key. The letter **HOLD** in red disappears and the sweeping resumes.

Setting trigger source

You can set the trigger source option for your measurements. Connecting an external trigger is necessary for accurate modulation measurements on EV-DO systems.

Procedure

- 1 Press the **TRIGGER** hot key.
- 2 Select the trigger source option from the choices: **Internal**, **External**, and **GPS**.

Setting external clock

To enhance the reliability of modulation analysis measurements the JD700B series must be synchronized with a base station. When an external clock is not supplied, the instrument works with its built-in internal high-accuracy time base and some measurement results may exhibit inaccurate values. Therefore, it is highly recommended that you use the same reference clock as the signal source. You can use the **TRIGGER** hot key to set the external clock.

Table 16 Standards of external clock operation

Clock	Type	Reference	Port	Switching Standard
External Reference	Internal	Internal 10 MHz		Default
	External	External Ref Clock	Ext Ref (SMA)	Manual switching (Input signal level >-3 dBm)
	GPS	GPS Clock	GPS (SMA)	Automatic switching (GPS signal received)
Trigger	Internal	Internal Trigger		Default
	External	External Trigger	Trigger (SMA)	Manual switching
	GPS	GPS	GPS (SMA)	Manual switching

Figure 231 Connection ports for external reference clock









Procedure

- 1 Connect an external reference or a GPS antenna to the JD700B series.
- 2 Press the **SYSTEM** hot key.
- 3 Press the **Freq Reference** soft key, and then select the reference option: **Internal**, **External 10 MHz**, **External 13 MHz**, **External 15 MHz**, or **GPS**.



NOTE
When a GPS antenna is connected and locked, GPS coordinates (longitude and latitude) are displayed on the screen and frequency reference is automatically set to GPS in the **System > Freq Reference**.

Table 17 External reference indicators

Type	Indicator	Description
Internal	 (green)	The green INT icon indicates that the instrument uses the built-in internal time base.
External	 (green)	The green EXT icon indicates that an external reference is connected and locked and that the instrument uses the same reference clock as the signal source.
External	 (red)	The red EXT icon indicates that an external reference is connect but not locked.
GPS	 (green)	The green GPS antenna icon indicates that a GPS antenna is connected and locked.
GPS	 (yellow)	The yellow GPS antenna icon indicates that a GPS antenna is connected and locking is in progress.
GPS	 (grey)	The grey GPS antenna icon indicates that a GPS antenna is not connected, failed, or unable to be locked.

Conducting spectrum measurements

If you have configured test parameters as described in the “Configuring test parameters” on page 388, your measurement result is displayed on the screen as like the following example, **Figure 232**.

Figure 232 Spectrum measurement screen with EV-DO signal analyzer



Setting trace

You can display up to six traces on the measurement chart simultaneously.

Procedure

- 1 Press the **TRACE/DISPLAY** hard key.
- 2 Press the **Select Trace** soft key, and then select the trace number: **T1**, **T2**, **T3**, **T4**, **T5**, or **T6**. The legend shape of the selected trace changes from square to round to indicate that the trace is the active one now.
- 3 Do one of the following:

To	Select	Trace Legend
Clear current data and display with new measurements	Clear Write	W
Display the input signal's maximum response only (unlimited or for a certain amount of time)	Max Hold	M
Display the input signal's minimum response only (unlimited or for a certain amount of time)	Min Hold	m
Capture the selected trace and compare traces	Capture	C
Load a saved trace	More (1/2) > Load	L
Hide the displayed trace	Trace View > Off	F
Remove all the traces and initialize the trace settings	More (1/2) > Trace Clear All	



NOTE

For the **Max Hold** and **Min Hold**, your instrument compares newly acquired data with the active trace and displays larger maximum values or smaller minimum values on the

screen. You can set it to **Unlimited** to hold and view maximum or minimum data or specify a certain amount of time up to 60 seconds by using numeric keys or rotary knob.

- 4 *Optional.* Select **More (1/2) > Trace Info**, and then select the trace number to view the trace's parameter setting information stored at the time of the measurement or **None** to hide the information display.
- 5 *Optional.* If you have the two traces T1 and T2, you can perform trace math. To view the power difference between the traces, press the **T1 – T2 -> T5** or **T2 – T1 -> T6** soft key. The result is overlaid on the screen along with the second Y-axis.

Conducting RF measurements

Channel power

The Channel Power measurement is a common test used in the wireless industry to measure the total transmitted power of a radio within a defined frequency channel. It acquires a number of points representing the input signal in the time domain, transforms this information into the frequency domain using Fast Fourier Transform (FFT), and then calculates the channel power. The effective resolution bandwidth of the frequency domain trace is proportional to the number of points acquired for the FFT.

The channel power measurement identifies the total RF power, power spectral density (PSD) and peak to average ratio (PAR) of the signal in the EV-DO channel bandwidth (1.23 MHz).

After configuring test parameters as described in the “Configuring test parameters” on page 388, your measurement result is displayed on the screen as like the following example, Figure 233.

Figure 233 Channel power measurement with EV-DO signal analyzer



NOTE

You can use the **LIMIT** hot key to analyze your measurements with the user-definable limit and Pass/Fail indication. See “Setting limit for RF tests” on page 400 for more information.

Occupied bandwidth

The Occupied Bandwidth measures the spectrum shape of the carrier. It is defined as the bandwidth, which includes 99% of the transmitted power among total transmitted power.

After configuring test parameters as described in the “Configuring test parameters” on page 388, your measurement result is displayed on the screen as like the following example, Figure 234.

Figure 234 Occupied bandwidth measurement with EV-DO signal analyzer



NOTE

You can use the **LIMIT** hot key to analyze your measurements with the user-definable limit and Pass/Fail indication. See “Setting limit for RF tests” on page 400 for more information.

Spectrum emission mask (SEM)

The Spectrum Emission Mask (SEM) measurement required by 3GPP2 specifications encompasses different power limits and different measurement bandwidths (resolution bandwidths) at various frequency offsets. It may be expressed as a ratio of power spectral densities between the carrier and the specified offset frequency band. It provides useful figures-of-merit for the spectral re-growth and emissions produced by components and circuit blocks, without the rigor of performing a full SEM measurement.

The SEM measures spurious signal levels in up to five pairs of offset or region frequencies and relates them to the carrier power.

Setting measure setup

After configuring test parameters as described in the “Configuring test parameters” on page 388, your measurement result is displayed on the screen as like the following example, Figure 235.

Figure 235 SEM measurement with EV-DO signal analyzer



NOTE
You can use the **LIMIT** hot key to analyze your measurements with the user-definable limit and Pass/Fail indication. See “Setting limit for RF tests” on page 400 for more information.

ACPR

The Adjacent Channel Power Ratio (ACPR) is defined as the ratio of the average power in the adjacent frequency channel (or offset) to the average power in the transmitted frequency channel. It may be expressed as the ratio of the integrated signal power in the adjacent channel to the integrated signal power in the main channel.

After configuring test parameters as described in the “Configuring test parameters” on page 388, your measurement result is displayed on the screen as like the following example, Figure 236.

Figure 236 ACPR measurement with EV-DO signal analyzer



**NOTE**

You can use the **LIMIT** hot key to analyze your measurements with the user-definable limit and Pass/Fail indication. See “Setting limit for RF tests” on page 400 for more information.

Multi-ACPR

The Multi-ACPR measurement is used to perform multi-channel ACPR measurements with as many channels as possible. It helps you to measure ACPR in multi-channel transmitting Base Station environment.

Setting frequency for Multi-ACPR

You can set the frequency with either frequency or channel number.

Procedure

- 1 Press the **MEASURE SETUP** hot key.
 - 2 To set the frequency, do one of the following:
 - To set the center frequency, complete the following steps:
 - a Toggle the **Unit** soft key and select **Freq**.
 - b Press the **Lowest Frequency** soft key to set the starting center frequency.
 - c Enter a value by using the numeric keys. You can also use the rotary knob.
 - d Select the unit: **GHz**, **MHz**, **kHz**, or **Hz**.
 - e Press the **Highest Frequency** soft key to set the stopping center frequency.
 - f Enter a value by using the numeric keys. You can also use the rotary knob.
 - g Select the unit: **GHz**, **MHz**, **kHz**, or **Hz**.
 - To set the channel number, complete the following steps:
 - a Toggle the **Unit** soft key and select **Channel**.
 - b To select the standard channel, press the **Channel Std** soft key and then select the band to be measured.
 - c Press the **Lowest Channel** soft key to set the starting channel.
 - d Enter a value by using the numeric keys. You can also use the rotary knob.
 - e Press the **Enter** soft key.
 - f Press the **Highest Channel** soft key to set the stopping channel.
 - g Enter a value by using the numeric keys. You can also use the rotary knob.
 - h Press the **Enter** soft key.
-

After configuring the test parameters, your measurement result is displayed on the screen as like the following example, **Figure 237**.

Figure 237 Multi-ACPR measurement with EV-DO signal analyzer



NOTE

You can use the **LIMIT** hot key to analyze your measurements with the user-definable limit and Pass/Fail indication. See “Setting limit for RF tests” on page 400 for more information.

Spurious emissions

Out-of-band emissions are unwanted emissions immediately outside the channel bandwidth resulting from the modulation process and non-linearity in the transmitter but excluding spurious emissions. The Spurious Emissions measurement is to identify and determine the power level of out-of-band spurious emission within the necessary channel bandwidth and modulated signal measured at the RF port of the Base Station.

Setting measure setup

Procedure

- 1 Press the **MEASURE SETUP** hot key.
- 2 To set up the range table and frequency range, press the **Range Table** soft key and then complete the following steps:
 - a Press the **Range** soft key, and then enter the range number to add a new range or change an existing one.
 - b Press the **Enter** soft key.
 - c Press the **Start Frequency** soft key to set up the frequency range.
 - d Enter a value by using the numeric keys. You can also use the rotary knob.
 - e Select the unit: **GHz**, **MHz**, **kHz**, or **Hz**.
 - f Press the **Stop Frequency** soft key to set up the frequency range.
 - g Enter a value by using the numeric keys. You can also use the rotary knob.
 - h Select the unit: **GHz**, **MHz**, **kHz**, or **Hz**.
- 3 Toggle the **Range** soft key between **On** and **Off** to display or hide the selected range.
- 4 To set up the test limits for Pass/Fail indication, complete the following steps:
 - a Press the **Start Limit** soft key.
 - b Enter a value by using the numeric keys. You can also use the rotary knob.
 - c Select the **dBm** soft key.
 - d Press the **Stop Limit** soft key.

- e Enter a value by using the numeric keys. You can also use the rotary knob.
 - f Select the **dBm** soft key.
- 5 To set up the other parameters, complete the following steps:
- a Select **More (1/2) > Attenuation** to set up the attenuation value.
 - a Enter a value in the multiple of five.
 - b Press the **dB** soft key or the **ENTER** hard key.
 - c Press the **RBW** soft key.
 - d Enter a value by using the numeric keys.
 - e Select the unit: **GHz, MHz, kHz, or Hz**.
 - f Press the **VBW** soft key.
 - g Enter a value by using the numeric keys.
 - h Select the unit: **GHz, MHz, kHz, or Hz**.
- 6 Press the **PREV** hard key.
- 7 Toggle the **Measure Type** soft key between **Examine** and **Full** to select the measurement type.
-  **NOTE**
The **Examine** mode displays only the selected range while the **Full** mode lets the instrument automatically changes the selected range from one another.
- 8 Set the number of measurements to be averaged:
- a Press the **Average** soft key.
 - b Enter a value between 1 and 100.
 - c Press the **Enter** soft key.

After configuring test parameters as described in the “Configuring test parameters” on page 388, your measurement result is displayed on the screen as like the following example, **Figure 238**.

Figure 238 Spurious emissions measurement with EV-DO signal analyzer



NOTE
You can use the **LIMIT** hot key to analyze your measurements with the user-definable limit and Pass/Fail indication. See “Setting limit for RF tests” on page 400 for more information.

Setting limit for RF tests

By default, test limits specified in the standard are set for you. You can change thresholds if you desire.

Procedure

- 1 Press the **LIMIT** hot key.
- 2 Press the **RF Test Limits** soft key.
- 3 Select the test item(s) and set the limit(s) depending on your selected measurement mode:

To set the limit for	Select	Set
Channel power	Channel Power	High Limit, Low Limit
Occupied bandwidth	Occupied BW	High Limit
Spectrum emission mask	Spectrum Emission Mask	(On/Off only)
ACPR	ACPR	(On/Off only)
Multi-ACPR	Multi-ACPR	(On/Off only)
Spurious emissions	Spurious Emissions	(On/Off only)

- 4 *Optional.* You can enable alarm sound that goes off if the measurement falls outside of the limit. Toggle the **Beep** soft key between **On** and **Off** to enable or disable the beep sound.
 - 5 *Optional.* Go to **SAVE/LOAD > Save**, and then select **Limit** to save the limit settings. See “Using save” on page 34 for more information.
-

Conducting power vs. time measurements

The Power vs. Time (Idle Slot and Active Slot) in EV-DO Signal Analyzer verifies that the transmitter output power has correct amplitude, shape, and timing for the EV-DO format.

- Idle Slot: Slot with no data in traffic channel.
- Active Slot: Slot with the loaded data in traffic channel.

Forward link of 1xEV-DO is a frame structure and each frame consists of 16 slots. The frame period for 1xEV-DO is 26.667 ms, which is also the period of one pilot channel. Each frame is divided into 16 slots of 1.666 ms. 1xEV-DO uses CDMA modulation scheme, but unlike its previous systems the Pilot, MAC (Media Access Control), and Data (Traffic) Channel are not transmitted simultaneously; instead they are transmitted in TDM (Time Division Multiplex).

Power vs. time (idle slot)

The Power vs. Time (Idle Slot) measurement provides the idle slot that includes the Pilot and MAC channels with the masks in all regions.

After configuring test parameters as described in the “Configuring test parameters” on page 388, your measurement result is displayed on the screen as like the following example, **Figure 239**.

Figure 239 Power vs. time (idle slot) measurement with EV-DO signal analyzer

**NOTE**

You can use the **LIMIT** hot key to analyze your measurements with the user-definable limit and Pass/Fail indication. See “Setting limit for power vs. time tests” on page 402 for more information.

Power vs. time (active slot)

The Power vs. Time (Active Slot) measurement includes the Pilot, MAC, and Data channels with the upper and lower masks.

After configuring test parameters as described in the “Configuring test parameters” on page 388, your measurement result is displayed on the screen as like the following example, **Figure 240**.

Figure 240 Power vs. time (active slot) measurement with EV-DO signal analyzer

**NOTE**

You can use the **LIMIT** hot key to analyze your measurements with the user-definable limit and Pass/Fail indication. See “Setting limit for power vs. time tests” on page 402 for more information.

Setting limit for power vs. time tests

Procedure

- 1 Press the **LIMIT** hot key.
- 2 Press the **PvsT Test Limits** soft key.
- 3 Select the test item(s) and set the limit(s):

To set the limit for	Select	Set
Pilot power	Pilot Power	High Limit, Low Limit
Medium access control power	MAC Power	High Limit, Low Limit
Data power during the data period	Data Power	High Limit, Low Limit
On/off power ratio of the pilot and MAC powers to the data power	On/Off Ratio	Low Limit

- 4 *Optional.* You can enable alarm sound that goes off if the measurement falls outside of the limit. Toggle the **Beep** soft key between **On** and **Off** to enable or disable the beep sound.
 - 5 *Optional.* Go to **SAVE/LOAD > Save**, and then select **Limit** to save the limit settings. See “Using save” on page 34 for more information.
-

Conducting modulation measurements

In order to make accurate measurements of time offset and PN, you must connect an external trigger before making a modulation measurement.

Constellation

The Constellation is used to observe some aspects of modulation accuracy and can reveal certain fault mechanisms such as I/Q amplitude imbalance or quadrature imbalance. It displays constellation diagram by modulation types.

Setting measure setup

After configuring test parameters as described in the “Configuring test parameters” on page 388, you can continue your measurement. The measurement settings can be saved and recalled as a file. You can also use JDViewer, PC application software to configure a measure setup, save as a file, and load the file on to the instrument.

Procedure

- 1 Press the **MEASURE SETUP** hot key.
 - 2 To set the Pseudo-Noise (PN) offset, complete the following steps:
 - a Toggle the **PN Offset** soft key between **Auto** and **Manual**.
 - b Enter a value by using the numeric keys to set manually, and then press the **Enter** soft key.
 - 3 To set the incremental step for the PN offset, complete the following steps:
 - a Press the **PN Increment** soft key.
 - b Enter a value by using the numeric keys, and then press the **Enter** soft key.
 - 4 Press the **Detect Mode** soft key, and then select the detection mode option: **Auto**, **QPSK**, **8PSK**, **16 QAM**, or **64 QAM**.
 - 5 *Optional.* Go to **SAVE/LOAD > Save**, and then select the save option from the choices available for your measurement mode. See “Using save” on page 34 for more information.
-



NOTE

You can use the **LIMIT** hot key to analyze your measurements with the user-definable limit and Pass/Fail indication. See “Setting limit for modulation tests” on page 411 for more information. *The Max Inactive is not used in the Constellation mode.*

Measurement example

Figure 241 Constellation measurement with EV-DO signal analyzer

1) Composite 64

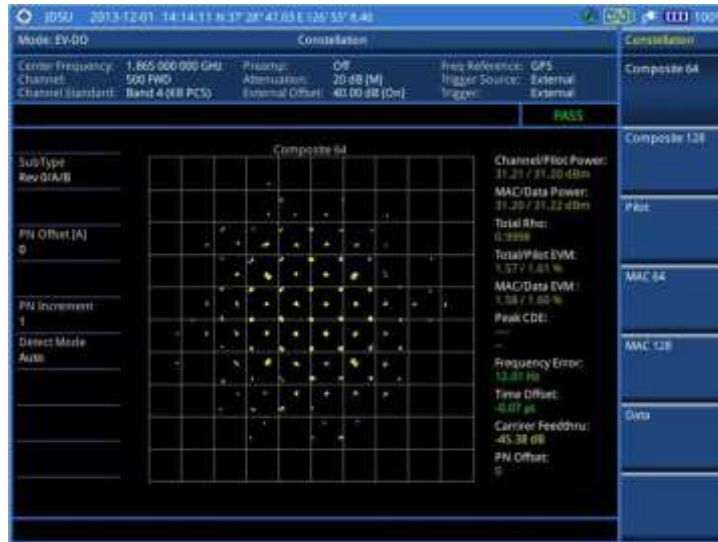

2) Composite 128



3) Pilot



4) MAC 64



5) MAC 128

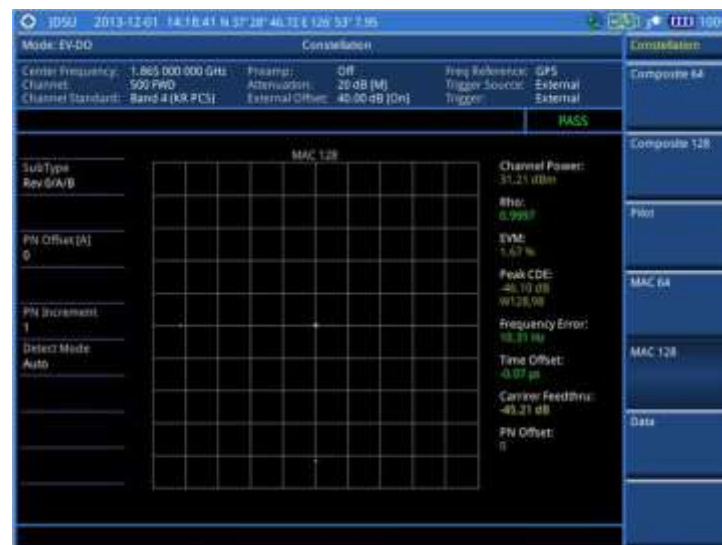

6) Data



Code domain power

The Code Domain Power (CDP) measures the distribution of power across the set of code channels, normalized to the total EV-DO power. It helps to verify that each code channel is operating at its proper level and to identify problems throughout the transmitter design from coding to the RF section. System imperfections such as amplifier non-linearity will present themselves as an undesired distribution of power in the code domain.

Setting measure setup

After configuring test parameters as described in the “Configuring test parameters” on page 388, you can continue your measurement. The measurement settings can be saved and recalled as a file. You can also use JDViewer, PC application software to configure a measure setup, save as a file, and load the file on to the instrument.

Procedure

- 1 Press the **MEASURE SETUP** hot key.
- 2 To set the Pseudo-Noise (PN) offset, complete the following steps:
 - a Toggle the **PN Offset** soft key between **Auto** and **Manual**.
 - b Enter a value by using the numeric keys to set manually.
 - c Press the **Enter** soft key.
- 3 To set the incremental step for the PN offset, complete the following steps:
 - a Press the **PN Increment** soft key.
 - b Enter a value by using the numeric keys.
 - c Press the **Enter** soft key.
- 4 To set the threshold between Auto and Manual, complete the following steps:
 - a Press the **Threshold** soft key. Its default setting is -27 dB.
 - b Enter a value between -50 and zero by using the numeric keys to change the value in the Manual mode.
 - c Press the **Enter** soft key.
- 5 Press the **Detect Mode** soft key, and then select the detection mode option: **Auto**, **QPSK**, **8PSK**, **16 QAM**, or **64 QAM**.
- 6 *Optional.* Go to **SAVE/LOAD > Save**, and then select the save option from the choices available

for your measurement mode. See “Using save” on page 34 for more information.



NOTE
 You can use the **LIMIT** hot key to analyze your measurements with the user-definable limit and Pass/Fail indication for the Max Inactive. See “Setting limit for modulation tests” on page 411 for more information.

Measurement example

Figure 242 Code domain power measurement with EV-DO signal analyzer

1) Pilot



2) MAC 64



3) MAC 128



4) Data



MAC Codogram

The MAC Codogram displays the power variation for every code over time, presenting a clear view of the traffic load per channels at any given time. The MAC Codogram measurements can be saved into an external USB memory so that a post-analysis can be done with the application software JDViewer.

Setting measure setup

After configuring test parameters as described in the “Configuring test parameters” on page 388, you can continue your measurement. The measurement settings can be saved and recalled as a file. You can also use JDViewer, PC application software to configure a measure setup, save as a file, and load the file on to the instrument.

Procedure

- 1 Press the **MEASURE SETUP** hot key.
- 2 To set the Pseudo-Noise (PN) offset, complete the following steps:

- a Toggle the **PN Offset** soft key between **Auto** and **Manual**.
 - b Enter a value by using the numeric keys to set manually.
 - c Press the **Enter** soft key.
- 3 To set the incremental step for the PN offset, complete the following steps:
 - a Press the **PN Increment** soft key.
 - b Enter a value by using the numeric keys.
 - c Press the **Enter** soft key.
- 4 To set the threshold between Auto and Manual, complete the following steps:
 - a Press the **Threshold** soft key. Its default setting is -27 dB.
 - b Enter a value between -50 and zero by using the numeric keys to change the value in the Manual mode.
 - c Press the **Enter** soft key.
- 5 Toggle the **MAC** soft key and select the MAC Walsh code option: **64** or **128**.
- 6 To set the time interval, complete the following steps:
 - a Press the **Time Interval** soft key.
 - b Enter a value by using the numeric keys.
 - c Press the **Enter** soft key.
- 7 To place the time cursor to analyze your measurements, complete the following steps:
 - a Toggle the **Time Cursor** soft key between **On** and **Off** to enable or disable the time cursor.
 - b Enter a value by using the numeric keys.
 - c Press the **Enter** soft key.



NOTE
When the time cursor is enabled, the measurement is put on hold and information about the time cursor is displayed.

- 8 To start a new measurement, press the **Reset/Restart** soft key.
- 9 *Optional.* Go to **SAVE/LOAD > Save**, and then select the save option from the choices available for your measurement mode. See “Using save” on page 34 for more information.

Measurement example

Figure 243 MAC Codogram in full view with EV-DO signal analyzer

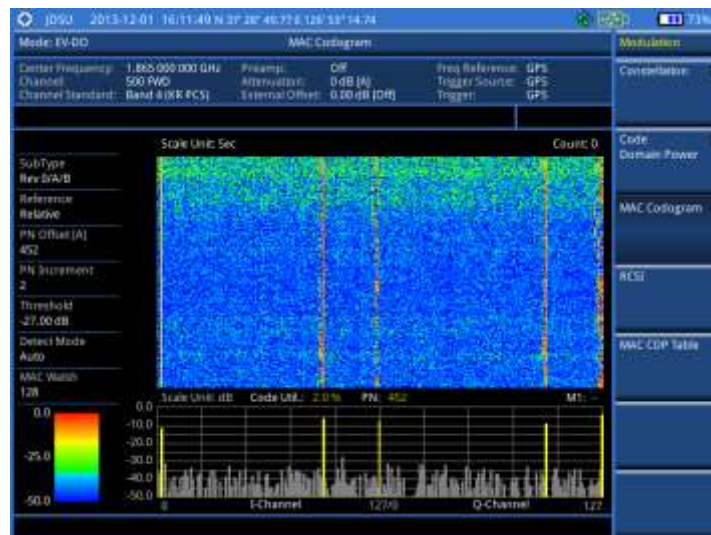

RCSI

The Received Code Strength Indicator (RCSI) is used to track the power variation over time of EV-DO channels: Pilot, MAC, Data, and Slot. The RCSI measurements can be saved into an external USB memory

so that a post-analysis can be done with the application software JDViewer.

Setting measure setup

After configuring test parameters as described in the “Configuring test parameters” on page 388, you can continue your measurement. The measurement settings can be saved and recalled as a file. You can also use JDViewer, PC application software to configure a measure setup, save as a file, and load the file on to the instrument.

Procedure

- 1 Press the **MEASURE SETUP** hot key.
 - 2 To set the Pseudo-Noise (PN) offset, complete the following steps:
 - a Toggle the **PN Offset** soft key between **Auto** and **Manual**.
 - b Enter a value by using the numeric keys to set manually.
 - c Press the **Enter** soft key.
 - 3 To set the incremental step for the PN offset, complete the following steps:
 - a Press the **PN Increment** soft key.
 - b Enter a value by using the numeric keys.
 - c Press the **Enter** soft key.
 - 4 To set the threshold between Auto and Manual, complete the following steps:
 - a Press the **Threshold** soft key. Its default setting is -27 dB.
 - b Enter a value between -50 and zero by using the numeric keys to change the value in the Manual mode.
 - c Press the **Enter** soft key.
 - 5 Toggle the **MAC** soft key and select the MAC Walsh code option: **64** or **128**.
 - 6 Press the **Alarm Code** soft key, and then select the alarm code option: **None**, **Pilot**, **MAC**, **Data**, or **Slot**.
 - 7 To set the alarm mask, complete the following steps:
 - a Press the **Set Mask** soft key.
 - b Enter a value by using the numeric keys.
 - c Press the **[dB|dBm]** soft key.
 - 8 *Optional.* Go to **SAVE/LOAD > Save**, and then select the save option from the choices available for your measurement mode. See “Using save” on page 34 for more information.
-

Measurement example

Figure 244 RCSI measurement with EV-DO signal analyzer



MAC CDP Table

The MAC CDP Table is used for the user to look at a numeric and textual description of all the active control channels in the signal.

Setting measure setup

After configuring test parameters as described in the “Configuring test parameters” on page 388, you can continue your measurement. The measurement settings can be saved and recalled as a file. You can also use JDViewer, PC application software to configure a measure setup, save as a file, and load the file on to the instrument.

Procedure

- 1 Press the **MEASURE SETUP** hot key.
- 2 To set the Pseudo-Noise (PN) offset, complete the following steps:
 - a Toggle the **PN Offset** soft key between **Auto** and **Manual**.
 - b Enter a value by using the numeric keys to set manually.
 - c Press the **Enter** soft key.
- 3 To set the incremental step for the PN offset, complete the following steps:
 - a Press the **PN Increment** soft key.
 - b Enter a value by using the numeric keys.
 - c Press the **Enter** soft key.
- 4 To set the threshold between Auto and Manual, complete the following steps:
 - a Press the **Threshold** soft key. Its default setting is -27 dB.
 - b Enter a value between -50 and zero by using the numeric keys to change the value in the Manual mode.
 - c Press the **Enter** soft key.
- 5 Toggle the **MAC** soft key and select the MAC Walsh code option: **64** or **128**.

Measurement example

Figure 245 MAC CDP Table measurement with EV-DO signal analyzer



Setting display

If the MAC CDP table spans over to the next page(s), you can change pages up and down to view your measurement results.

Procedure

- 1 Press the **TRACE/DISPLAY** hard key.
- 2 Select **Page Up** or **Page Down** as needed to scroll the screen up and down.

Setting limit for modulation tests

Procedure

- 1 Press the **LIMIT** hot key.
- 2 Press the Modulation Test Limits soft key.
- 3 Select the test item(s) and set the limit(s) depending on your selected measurement mode:

To set the limit for	Select	Set
Frequency error	Frequency Error	High Limit, Low Limit
Time offset	Time Offset	High Limit, Low Limit
Carrier feed through	Carrier Feed Through	High Limit
Highest level among inactive channels	Max Inactive	High Limit
Waveform quality (Rho) for pilot	Pilot Rho	Low Limit
Waveform quality (Rho) for MAC	MAC Rho	Low Limit
Waveform quality (Rho) for data	Data Rho	Low Limit

- 4 *Optional.* You can enable alarm sound that goes off if the measurement falls outside of the limit. Toggle the **Beep** soft key between **On** and **Off** to enable or disable the beep sound.
- 5 *Optional.* Go to **SAVE/LOAD > Save**, and then select **Limit** to save the limit settings.

See “Using save” on page 34 for more information.

**NOTE**

The Time Offset compares the PN offset timing with the overall system time and the instrument checks the start of PN offset in comparison to either the GPS signal or the even second clock signal.

**NOTE**

The Carrier Feed Through is a result of the RF carrier signal feeding through the I/Q modulator and riding on the output circuitry without being modulated.

Performing auto measurements

The Auto Measure function of the JD700B series allows a complete signal profiling covering RF characterization and modulation quality parameters of up to 10 different carriers, particularly useful on an overlay architecture where base stations are transmitting in different frequencies.

The Auto Measure can be easily executed either by selecting a menu in the instrument or by running a programmed scenario in the PC-based application so that the instrument automatically configure and perform tests on every aspect of all the carriers.

Setting limit for auto measure

You can set test limits for test item(s) in the auto measurement.

Procedure

- 1 Press the **LIMIT** hot key.
 - 2 Press the **RF Test Limits** soft key, and then enable test limits as desired.
 - 3 Press the **PvsT Test Limits** soft key, and then enable test limits as desired.
 - 4 Press the **Modulation Test Limits** soft key, and then enable test limits as desired.
 - 5 *Optional.* You can enable alarm sound that goes off if the measurement falls outside of the limit. Toggle the **Beep** soft key between **On** and **Off** to enable or disable the beep sound.
 - 6 *Optional.* Go to **SAVE/LOAD > Save**, and then select **Limit** to save the limit settings. See “Using save” on page 34 for more information.
-

Setting measure setup

After configuring test parameters as described in the “Configuring test parameters” on page 388, you can continue your measurement. The measurement settings can be saved and recalled as a file. You can also use JDViewer, PC application software to configure a measure setup, save as a file, and load the file on to the instrument.

Procedure

- 1 Press the **MEASURE SETUP** hot key.
 - 2 Toggle the **Configuration** soft key and select the configuration option:
 - Current:** Lets the instrument use current frequency (single carrier) and determine pass or fail based on the instrument’s limit settings in Auto Measure.
 - Scenario:** Runs a test with a programmed scenario in JDViewer. The Scenario menu becomes activated.
 - 3 To load a scenario, press the **Scenario** soft key, and then select a scenario file to load.
-

-
- 4 Toggle the **Test Time** soft key and select the test time option:
 - Now:** Lets the instrument run a test only once.
 - Schedule:** Lets the instrument repeat tests as defined in the Set Timing. The Set Timing menu becomes activated.
 - 5 To define a schedule for an auto measurement, complete the following steps:
 - a Press the **Set Timing** soft key.
 - b Press the **Start Time (HH:MM)** soft key.
 - c Enter the time in the HH:MM format, and then press the **Enter** soft key.
 - d Press the **Stop Time (HH:MM)** soft key.
 - e Enter the time in the HH:MM format, and then press the **Enter** soft key.
 - f Press the **Time Interval** soft key.
 - g Enter the amount of time in minutes, and then press the **Enter** soft key.
 - 6 Press the **Settings** soft key, and then set the following:
 - a Toggle the **MAC** soft key and select the MAC Walsh code option: **64** or **128**.
 - b Toggle the **PvsT** soft key and select the slot option: **Idle** or **Active**.
 - c Toggle the **External Offset** soft key and select **On**.
 - d Enter a value by using the numeric keys, and then press the **dB** soft key.
 - 7 To save your settings and results, go to **SAVE/LOAD > Save** and then perform functions as you desire. See "Using save" on page 34 for more information.
 - 8 Press the **Run Test** soft key to start to run a test. The Auto Measure Results window appears at the end of the test.
 - 9 To stop running the test, press the **Abort** soft key.
 - 10 To change the view on the screen during the test, press the **Display** and then select the view option from the following choices:
 - Screen:** You can view each measurement screen as the test progresses.
 - Results:** You can view a measurement result table as the test progresses.
 - Settings:** You can view a measurement setting table as the test progresses.
-

Setting display

After completion of the auto measurement, the screen menu changes to Trace/Display so that you can view the results in different forms.

Procedure

- 1 Toggle the **Display** soft key and select the display option:
 - Result:** You can view the result table. The Display Result menu becomes activated.
 - Settings:** You can view the measurement settings for the auto measurement.
 - 2 Toggle the **Display Result** soft key and select the display result option:
 - Full:** You can view detailed measurement readings with the pass/fail indication.
 - Quick:** You can view only the Pass/Fail results.
 - 3 To view the measurement results for a different carrier, press the **View Carrier** soft key and then select the carrier number to view.
-

Performing power statistics CCDF measurements

The Power Statistics Complementary Cumulative Distribution Function (CCDF) measurement characterizes the power statistics of the input signal. It provides PAR (Peak to Average power Ratio) versus different probabilities.

Setting measure setup

After configuring test parameters as described in the “Configuring test parameters” on page 388, you can continue your measurement. The measurement settings can be saved and recalled as a file. You can also use JDViewer, PC application software to configure a measure setup, save as a file, and load the file on to the instrument.

Procedure

- 1 Press the **MEASURE SETUP** hot key.
 - 2 Press the **CCDF Length** soft key to set the length of the CCDF.
 - 3 Enter a value between 1 and 100 by using the numeric keys. You can also use the rotary knob.
 - 4 Press the **Enter** soft key.
-

Measurement example

Figure 246 CCDF measurement with EV-DO signal analyzer



Conducting EV-DO OTA measurements

This Over The Air (OTA) measurement has channel scanner, PN scanner, multipath profile, and Code Domain power screens. It is used to verify EV-DO transmitter performance at any location providing reflective measurements and identifying signals providing from different sites. The Code Domain power shows not only modulation performance metric but also amplifier capacity and code utilization metric. The Amplifier capacity (code utilization) measurement is an estimate of the amount of power amplifier capacity (code utilization) that is being used expressed in percent of maximum.

Channel scanner

Setting channel/frequency

Procedure

To set the channels to be scanned:

- 1 Press the **FREQ/DIST** hard key.
- 2 Toggle the **Unit** soft key and select **Channel**.
- 3 Press the **Index** soft key, and then enter an index number between one and six by turning the rotary knob or using the numeric keys.
- 4 To select the standard channel, complete the following steps:
 - a Press the **Channel Std** soft key. The standard channel window appears. See “Appendix C – Band, frequency & channel standard” on page 769 for more information.
 - b Highlight the band to be measured by using the rotary knob, the arrow keys, or the **Page Up/Page Down** soft keys.
 - c Press the **Select** soft key or the rotary knob to confirm the selection.
- 5 To set the channel number for the selected index, complete the following steps:
 - a Press the **Channel Number** soft key.
 - b Enter a value by using the numeric keys. You can also use the rotary knob.
 - c Press the **Enter** soft key.
- 6 The instrument displays a corresponding center frequency for the channel number.
- 7 To set the integration bandwidth for the selected index, complete the following steps:
 - a Press the **Integration Bandwidth** soft key.
 - b Enter a value by using the numeric keys. You can also use the rotary knob.
 - c Select the unit: **GHz, MHz, kHz, or Hz**.
- 8 To add more channels to be scanned, repeat steps 3-6.
- 9 Press the **ESC** hard key to dismiss the channel list window and view the scanning result.

To set the frequencies to be scanned:

- 1 Press the **FREQ/DIST** hard key.
 - 2 Toggle the **Unit** soft key and select **Freq**.
 - 3 Press the **Index** soft key, and then enter an index number between one and six by turning the rotary knob or using the numeric keys.
 - 4 To set the center frequency for the selected index, complete the following steps:
 - a Press the **Center Frequency** soft key.
 - b Enter a value by using the numeric keys. You can also use the rotary knob.
 - c Select the unit: **GHz, MHz, kHz, or Hz**.
 - 5 To set the integration bandwidth for the selected index, complete the following steps:
 - a Press the **Integration Bandwidth** soft key.
 - b Enter a value by using the numeric keys. You can also use the rotary knob.
 - c Select the unit: **GHz, MHz, kHz, or Hz**.
 - 6 To add more channels to be scanned, repeat steps 3-5.
 - 7 Press the **ESC** hard key to dismiss the channel list window and view the scanning result.
-

Setting measure setup

After configuring other test parameters as described in the “Configuring test parameters” on page 388, you can continue your measurement. The measurement settings can be saved and recalled as a file. You can also use JDViewer, PC application software to configure a measure setup, save as a file, and load the file on to the instrument.

Procedure

- 1 Press the **MEASURE SETUP** hot key.
- 2 To set the incremental step for the PN offset, complete the following steps:
 - a Press the **PN Increment** soft key.
 - b Enter a value by using the numeric keys.
 - c Press the **Enter** soft key.
- 3 *Optional.* Go to **SAVE/LOAD > Save**, and then select the save option from the choices available for your measurement mode. See “Using save” on page 34 for more information.

Setting limit for OTA channel scanner

Procedure

- 1 Press the **LIMIT** hot key.
- 2 Press the **Limit Line** soft key to set a threshold for the limit line and Pass/Fail indication.
- 3 Enter a value, and then press the **dBm** unit soft key.
- 4 Toggle the **Limit Line** soft key between **On** and **Off** to display or dismiss the limit line.
- 5 *Optional.* You can enable alarm sound that goes off if the measurement falls outside of the limit. Toggle the **Beep** soft key between **On** and **Off** to enable or disable the beep sound.
- 6 *Optional.* Go to **SAVE/LOAD > Save**, and then select **Limit** to save the limit settings. See “Using save” on page 34 for more information.

Measurement example

Figure 247 Channel scanner measurement with EV-DO OTA signal analyzer



PN scanner

Each access network sector has a unique PN offset. The PN Scanner is used to identify all the active PNs in an area.

Setting measure setup

After configuring test parameters as described in the “Configuring test parameters” on page 388, you can continue your measurement. The measurement settings can be saved and recalled as a file. You can also

use JDViewer, PC application software to configure a measure setup, save as a file, and load the file on to the instrument.

Procedure

- 1 Press the **MEASURE SETUP** hot key.
 - 2 To set the incremental step for the PN offset, complete the following steps:
 - a Press the **PN Increment** soft key.
 - b Enter a value by using the numeric keys.
 - c Press the **Enter** soft key.
 - 3 *Optional.* Go to **SAVE/LOAD > Save**, and then select the save option from the choices available for your measurement mode. See “Using save” on page 34 for more information.
-

Measurement example

Figure 248 PN scanner measurement with EV-DO OTA signal analyzer



Multipath profile

The Multipath Profile enables you to determine RF environmental conditions of testing area. It indicates the amount of power of the dominant pilot signal that is dispersed outside the main correlation peak due to multipath echoes that are expressed in dB. This value should be very small ideally.

The multipath profile is the result of portions of the original broadcast signal arriving at the receiving antenna out of phase. This can be caused by the signal being reflected off objects such as buildings, or being refracted through the atmosphere differently from the main signal.

Setting measure setup

After configuring test parameters as described in the “Configuring test parameters” on page 388, you can continue your measurement. The measurement settings can be saved and recalled as a file. You can also use JDViewer, PC application software to configure a measure setup, save as a file, and load the file on to the instrument.

Procedure

- 1 Press the **MEASURE SETUP** hot key.
- 2 To set the incremental step for the PN offset, complete the following steps:
 - a Press the **PN Increment** soft key.
 - b Enter a value by using the numeric keys.
 - c Press the **Enter** soft key.
- 3 *Optional.* Go to **SAVE/LOAD > Save**, and then select the save option from the choices available for your measurement mode. See “Using save” on page 34 for more information.

Measurement example

Figure 249 Multipath profile measurement with EV-DO OTA signal analyzer



Code domain power

Channels with high correlation factors are determined to be active channels and are indicated as such on the display. Once the channels are decoded, the analyzer determines the power of each channel relative to the total signal power.

This measurement helps to verify that each code channel is operating at its proper level and helps to identify problems throughout the transmitter design from the coding to the RF section. System imperfections, such as the non-linearity of amplifiers, will present themselves as an undesired distribution of power in the code domain.

Setting measure setup

After configuring test parameters as described in “Configuring test parameters” on page 388, you can continue your measurement. The measurement settings can be saved and recalled as a file. You can also use JDViewer, PC application software to configure a measure setup, save as a file, and load the file on to the instrument.

Procedure

- 1 Press the **MEASURE SETUP** hot key.

- 2 To set the Pseudo-Noise (PN) offset, complete the following steps:
 - a Toggle the **PN Offset** soft key between **Auto** and **Manual**.
 - b Enter a value by using the numeric keys to set manually.
 - c Press the **Enter** soft key.
- 3 To set the incremental step for the PN offset, complete the following steps:
 - a Press the **PN Increment** soft key.
 - b Enter a value by using the numeric keys.
 - c Press the **Enter** soft key.
- 4 To set the threshold between **Auto** and **Manual**, complete the following steps:
 - a Press the **Threshold** soft key. Its default setting is -27 dB.
 - b Enter a value between -50 and zero by using the numeric keys to change the value in the Manual mode.
 - c Press the **Enter** soft key.
- 5 Toggle the **MAC** soft key and select the MAC Walsh code option: **64** or **128**.
- 6 Press the **Detect Mode** soft key, and then select the detection mode option: **Auto**, **QPSK**, **8PSK**, **16 QAM**, or **64 QAM**.
- 7 To set the threshold for pilot dominance, complete the following steps:
 - a Press the **Pilot Dominance >** soft key.
 - b Enter a value by using the numeric keys.
 - c Press the **Enter** soft key.

**NOTE**

Recommended value is 10. Color of the Pilot Dominance indicator on the screen bases on this setting.

- 8 To set the threshold for multipath power, complete the following steps:
 - a Press the **Multipath Power <** soft key.
 - b Enter a value by using the numeric keys.
 - c Press the **Enter** soft key.

**NOTE**

Recommended value is one. Color of the multipath power indicator on the screen bases on this setting.

- 9 *Optional.* Go to **SAVE/LOAD > Save**, and then select the save option from the choices available for your measurement mode. See "Using save" on page 34 for more information.

Measurement example

Figure 250 Code domain power measurement with EV-DO OTA signal analyzer



NOTE

You can use the **LIMIT** hot key to analyze your measurements with the user-definable limit and Pass/Fail indication.

Route map

The JD700B Series provides the Route Map function that allows you to collect data of points in an indoor or outdoor environment and track the received signals and coverage of RF transmitters by plotting data real time directly on top of a loaded floor plan or a map.

Setting measure setup

Procedure

- 1 If required, connect a GPS receiver to your JD700B series for outdoor mapping. Indoor mapping does not necessarily need a GPS antenna.
- 2 Configure test parameters as described in the “Configuring test parameters” on page 388.
- 3 To load your map file, complete the following steps:
 - a Plug in your USB drive that has a floor map or .mcf file type created in JDMapCreator. If the JDMapCreator application on your computer is connected to the instrument via USB or LAN, you can send a map file with a single layer to the instrument directly by using the **Send to EQP** menu in JDMapCreator.



NOTE

The JDMapCreator converts and resizes any scanned floor plan or layout to fit onto your instrument’s display. JDMapCreator 1.2.0 or later can save a multiple-layered map, providing **x1**, **x2**, and **x4** views, as a sizable map file so that you can zoom in and out after loading it.

- b Press **SAVE/LOAD** hot key, and then select **Load > Load Map**. See “Using load” on page 36 for more information.
- 4 Press the **MEASURE SETUP** hot key.
- 5 Press the **Plot Point** soft key, and then select the plot point option from the following choices:
 - To collect data/plot points automatically as you move around in a vehicle or outside, press the **GPS** soft key and then toggle the **Screen Mode** soft key between **Map** and **Full**.



NOTE

With the **Map** setting, you can view only the collected points that can be seen within the

boundary of the loaded map. If a point is off the map, the instrument displays an arrow to indicate the direction of the current location on the map and the distance from the center to the location at the top of the screen.

With the **Full** setting, you can view all the collected points of the route without the loaded map.

To collect data/plot points manually without a GPS antenna in an indoor environment, press the **Position** soft key.

- 6 Press the **Plot Item** soft key, and then select the measurement option: **Pilot Power** or **Ec/Io**.
- 7 To set the incremental step for the PN offset, complete the following steps:
 - a Press the **PN Increment** soft key.
 - b Enter a value by using the numeric keys.
 - c Press the **Enter** soft key.
- 8 Toggle the **Plot** soft key and select **Start**.
- 9 Touch directly on the screen or press the **ENTER** hard key to collect data and plot points on the loaded map for the **Position** setting.



NOTE
For the **Position** setting, you can change the direction of the route with the arrow keys and the distance with the rotary knob.

- 10 Toggle the **Plot** soft key and select **Stop** to stop plotting.
- 11 Press the **SAVE/LOAD** hot key to save the result.
See "Using save" on page 34 for more information.



NOTE
The instrument does not automatically save the collected data. It is recommended that you save the result. Otherwise, you will lose all the collected data.

Setting limit

You can set the thresholds for the four different color indicators for Pilot power or Ec/Io.

Procedure

- 1 Press the **LIMIT** hot key.
- 2 Select the plot items and set the limits as needed:

To set the limit for	Select	Set
Pilot Power	Pilot Power	Excellent, Very Good, Good, Fair, Poor (dBm)
Ec/Io	Ec/Io	Good, Fair, Poor (dB)
- 3 *Optional.* Go to **SAVE/LOAD > Save**, and then select **Limit** to save the limit settings.
See "Using save" on page 34 for more information.

Measurement example

Figure 251 Route map measurement with EV-DO OTA signal analyzer

1) Pilot Power



2) Pilot Ec/Io



Controlling a map

If you have loaded a sizable map that was created in JDMAPCreator 1.2.0 or later, you can use the Map Control feature that enables you to zoom into the map and view a specific area of interest in detail.

Procedure

- 1 Press the **TRACE/DISPLAY** hard key.
- 2 Press the **Map Control** soft key. This key is active only when you have loaded a sizable map.
- 3 Do one of the following:
 - To zoom into an area of interest directly, complete the following steps:
 - a Toggle the **Zoom to** soft key and select **Area**. The black rectangle appears on the map.
 - b Press the **Zoom In** and **Zoom Out** soft keys, as you need, to decrease and increase the selected area.
 - c Move the rectangle by using the four arrow keys, as you need, to place it in a specific area of interest.

-
- d Press the center of the rotary knob to zoom into the selected area. You can also press the **Zoom to** soft key again to zoom into the selected area.

To zoom into the center or zoom out from the center, complete the following steps:

- a Toggle the **Zoom to** soft key and select **Center**.
 - b Press the **Zoom In** and **Zoom Out** soft keys, as you need, to zoom in and zoom out.
 - c Move the zoomed-in area by using the four arrow keys, as you need.
- 4 To set the location mode, toggle the **Location Mode** soft key between **Auto** and **Manual** and select the one you desire.

Auto: The instrument compares the coordinates of the displayed map with received GPS information. If your current location goes out of the displayed area and enters into the next zoomed-in section within the base map, the map display changes automatically to the next section in which your current position is.

Manual: The map display of the zoomed-in area remains unchanged even if your current location goes out of the displayed area. You can change the displayed area manually by using the arrow keys.

Chapter 12 Using TD-SCDMA Signal Analyzer

This chapter provides instructions for using the TD-SCDMA Signal Analyzer function (option 025) with the TD-SCDMA OTA Analyzer function (option 045). Topics discussed in this chapter are as follows:

■ Introduction.....	425
■ Display overview	426
■ Connecting a cable.....	426
■ Selecting measurement mode	428
■ Configuring test parameters.....	428
■ Conducting spectrum measurements	432
■ Conducting RF measurements	434
■ Conducting power vs. time measurements	441
■ Conducting modulation measurements.....	447
■ Performing auto measurements.....	454
■ Conducting TD-SCDMA OTA measurements	456

Introduction

The Time Division-Synchronous Code Division Multiple Access, also known as TD-SCDMA, is a 3G mobile telecommunications standard that is pursued by the Chinese Academy of Telecommunications Technology (CATT) in the People's Republic of China. The TD-SCDMA uses the TDD scheme while the WCDMA uses the FDD.

This TD-SCDMA Signal Analyzer can be used for testing of TD-SCDMA systems, made according to the following standard documentation.

- 3GPP TS 25.105 Base Station radio transmission and reception (TDD)
- 3GPP TS 25.142 Base Station conformance testing (TDD)
- 3GPP TS 25.222 Multiplexing and channel coding (TDD)
- 3GPP TS 25.223 Spreading and modulation (TDD)

The instrument automatically makes standard defined measurements using the measurement methods and limits as defined in the standard. The detailed results allow you to analyze TD-SCDMA/HSDPA system performance. You may alter the measurement parameters for specialized analysis. Pass/Fail testing with standard defined or user defined upper and lower limits and the Pass/Fail indicator help you to determine base station performance easily.

This instrument provides the following measurement tools for TD-SCDMA system:

- Spectrum Analysis
- RF Analysis
 - Channel Power
 - Occupied Bandwidth
 - Spectrum Emission Mask
 - Adjacent Channel Leakage power Ratio (ACLR)
 - Multi-ACLR
 - Spurious Emissions
- Power vs. Time:
 - Power vs. Time (Slot)
 - Power vs. Time (Frame)
 - Power vs. Time (Mask)
 - Timogram
- Modulation Analysis
 - Constellation
 - Midamble Power
 - Code Power
 - Code Error
- Auto Measure
- Over The Air (OTA)
 - Sync-DL ID Scanner
 - Sync-DL ID vs. Tau
 - Sync-DL ID Multipath
 - Sync-DL ID Analyzer
 - Route Map

Display overview

Figure 252 provides descriptions for each segment of the measurement screen.

Figure 252 TD-SCDMA signal analyzer measurement screen

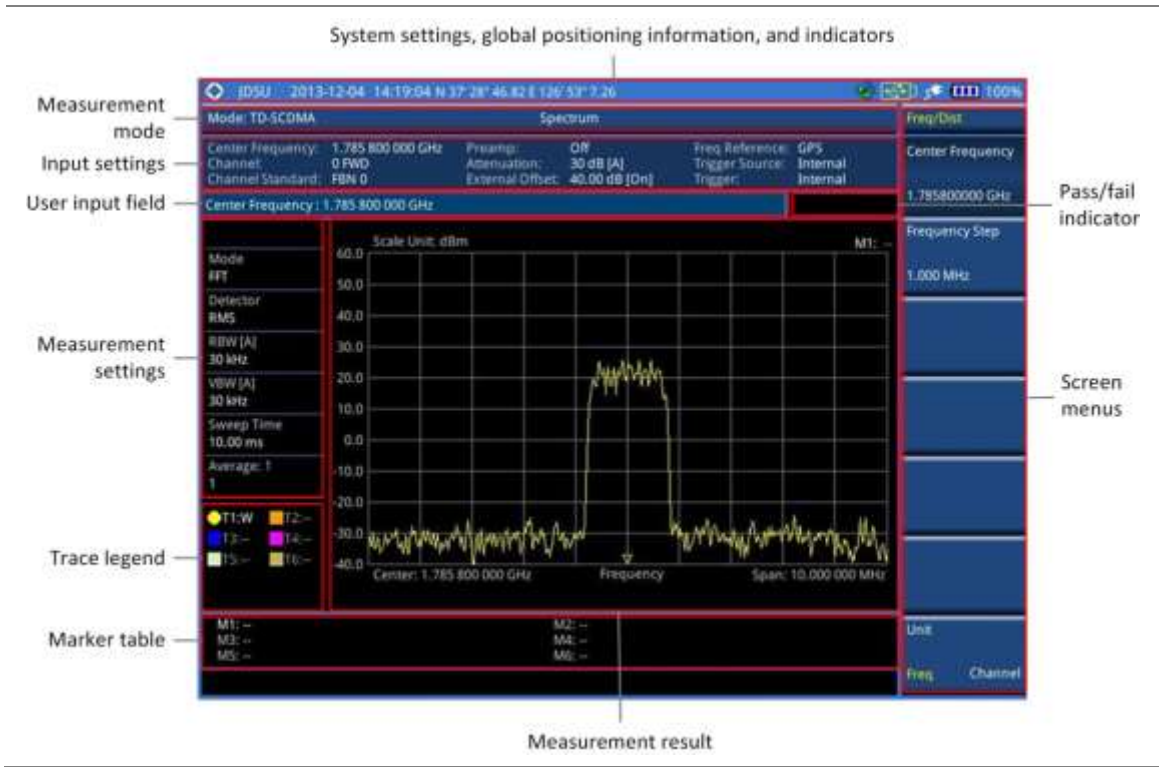

Connecting a cable

Direct connection

Procedure

- 1 Connect the **Spectrum Analyzer RF In** port of the JD700B series and the Power amplifier output port of BTS.

Figure 253 Direct connection



Indirect connection

Procedure

- 1 Connect the **Spectrum Analyzer RF In** port of the JD700B series and the monitor (test) port of BTS.

Figure 254 Indirect connection



CAUTION

The maximum power for the **Spectrum Analyzer RF In** port is +25 dBm (0.316 W) for JD780B series and +20 dBm (0.1 W) for JD740B series. If the level of the input signal to be measured is greater than this, use a **High Power Attenuator** to prevent damage when you directly connect the signal to the instrument or connect the signal from the coupling port of a directional coupler.

Over the air (OTA)

Procedure

- 1 Connect an Omni/directional RF antenna to the **Spectrum Analyzer RF In** port of the JD700B series.
- 2 Connect a GPS antenna to the **GPS** port of the JD700B series.

Figure 255 OTA connection

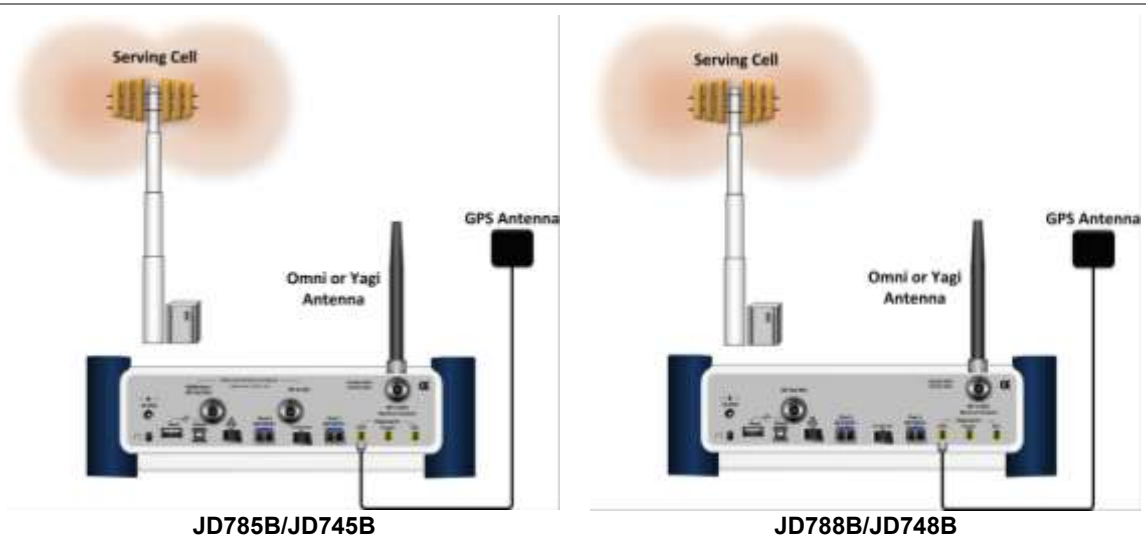

**CAUTION**

If the input signal level to be measured is less than 0 dBm, set 0 dB attenuation or turn on the preamp to have better dynamic range for the OTA testing.

Selecting measurement mode

Procedure

- 1 Press the **MODE** hard key.
- 2 Press the **Signal Analyzer** soft key.
- 3 Select **More (1/2) > TD-SCDMA**. The **Spectrum** mode is set by default.
- 4 Press the **MEASURE** hot key, and then select the measurement mode option from the following choices:

Spectrum

RF Analysis > Channel Power, Occupied BW, Spectrum Emission Mask, ACLR, Multi-ACLR, or Spurious Emissions

Power vs Time > Power vs Time (Slot), Power vs Time (Frame), Power vs Time (Frame), or Timogram

Modulation Analysis > Constellation, Midamble Power, Code Power, or Code Error

Auto Measure

OTA > Sync-DL ID Scanner, Sync-DL ID vs Tau, Sync-DL ID Multipath, Sync-DL ID Analyzer, or Route Map

Configuring test parameters

Setting frequency

You can set the frequency with either frequency or channel number. If a frequency to be set matches to the frequency corresponding to the selected channel standard, the instrument calculates its channel number and updates the screen with it automatically.

Procedure

To set the center frequency:

- 1 Press the **FREQ/DIST** hard key.
- 2 Toggle the **Unit** soft key and select **Freq**.
- 3 Press the **Center Frequency** soft key.
- 4 Enter a value by using the numeric keys. You can also use the rotary knob.
- 5 Select the unit: **GHz, MHz, kHz, or Hz**.
- 6 *Optional.* To define the amount of frequency increment for the rotary knob, complete the following steps:
 - a Press the **Frequency Step** soft key.
 - b Enter a value by using the numeric keys. You can also use the rotary knob.
 - c Press the unit: **GHz, MHz, kHz, or Hz**.

To set the channel number:

- 1 Press the **FREQ/DIST** hard key.
 - 2 Toggle the **Unit** soft key and select **Channel**.
 - 3 To select the standard channel, complete the following steps:
 - a Press the **Channel Std** soft key. The standard channel window appears.
-

-
- See “Appendix C – Band, frequency & channel standard” on page 769 for more information.
- b Highlight the band to be measured by using the rotary knob, the arrow keys, or the **Page Up/Page Down** soft keys.
 - c Press the **Select** soft key or the rotary knob to confirm the selection.
- 4 Press the **Channel Number** soft key.
 - 5 Enter a value by using the numeric keys. You can also use the rotary knob.
 - 6 Press the **Enter** soft key.
The instrument automatically displays the corresponding center frequency value for the selected channel number.
 - 7 *Optional.* To define the amount of channel increment for the rotary knob, complete the following steps:
 - a Press the **Channel Step** soft key.
 - b Enter a value by using the numeric keys. You can also use the rotary knob.
 - c Press the **Enter** soft key.
-

**NOTE**

This frequency setting is not used in the Multi-ACLR and Spurious Emissions modes.

Setting amplitude

Reference level and attenuation

You can set the reference and attenuation levels automatically or manually to optimize the display of the traces measured, as you desire.

Procedure

To automatically set the reference and attenuation level:

- 1 Press the **AMP/SCALE** hard key.
- 2 Press the **Auto Scale** soft key.
Each time you press this key, both of the Y-axis scale and input attenuation level change to be optimized with some margin.

To set the reference or attenuation level manually:

- 1 Press the **AMP/SCALE** hard key.
- 2 To set the maximum reference value on the Y-axis manually, complete the following steps:
 - a Press the **Reference Level** soft key.
 - b Enter a value by using the numeric keys or the rotary knob with 10 dB increments.
 - c Press the unit soft key or the **ENTER** hard key.
This unit key name changes according to the setting in the **Units** menu.

**NOTE**

In the measurements such as **Midamble Power**, **Code Power**, and **Code Error**, you may need to select the reference option between **Relative** and **Absolute** before setting the reference level.

- 3 To set the attenuation option, select one from the following choices:
To set the input attenuator's level automatically, select **Attenuation > Auto**.

**NOTE**

It is recommended that you set the **Attenuation** to **Auto** in most situations so that the level of the input attenuator can be set automatically according to your input signal level.

To set the input attenuation manually up to 55 dB for JD780B series or 50 dB for JD740B series to optimize S/N, complete the following steps:

- a Select **Attenuation > Manual**.
 - b Press the **Attenuation Value** soft key to set the level.
-

- c Enter a value in fives by using the numeric keys.
 - d Press the **dB** soft key or the **ENTER** hard key.
- To couple the input attenuator's level with your reference level setting, select **Attenuation > Couple**.
- As you increase the reference setting, the attenuation level also increases accordingly.

Optional. To change the scale unit:

- 1 Select **More (1/2) > Units**.
- 2 Select the unit of the display scale: **dBm**, **dBV**, **dBmV**, **dBμV**, **V**, or **W**.
The scale unit on the screen changes accordingly.



NOTE
This Units menu is available in the Spectrum and RF Analysis modes.

Scale per division

You can use the **Scale/Div** feature available for the spectrum and RF analysis. It represents the value of one division on the horizontal scale. The default setting is 10 dB per division and the maximum value can be set up to 20 dB.

Procedure

- 1 Press the **AMP/SCALE** hard key.
- 2 Select **More (1/2) > Scale/Div**.
- 3 Enter a value between 1 and 20 by using the numeric keys.
- 4 Press the **dB** soft key to complete the entry.

Pre-amplifier

You can turn the internal pre-amplifier on to correct and compensate for the gain of the preamp so that amplitude readings show the value at the input connector.

Procedure

- 1 Press the **AMP/SCALE** hard key.
- 2 Toggle the **Preamp** soft key and select **On** or **Off** as needed.



NOTE
You can turn the Preamp on when the input attenuation range is from 0 dB to 10 dB. If the attenuation value is manually set to greater than 10 dB, the instrument will automatically turn off the pre-amplifier to display low-level signal properly on the chart.

External offset

You can turn the **External Offset** on and manually set the external offset value. An offset consists of a cable loss and a user offset and the measurement result shows the value reflecting both offset values. When the external offset value is set at 40 dB in the Spectrum mode, the measurement result compensates 40 dB at both the Spectrum Analyzer and Signal Analyzer modes.

Procedure

To set the external offset:

-
- 1 Press the **AMP/SCALE** hard key.
 - 2 Toggle the **External Offset** soft key and select **On**.
 - 3 Enter a value by using the numeric keys.
 - 4 Press the **dB** soft key to complete the entry.

To turn the external offset off:

- 1 Press the **AMP/SCALE** hard key.
 - 2 Toggle the **External Offset** soft key and select **Off**.
-

Setting average

You can set the number of measurements to be averaged for the trace presentation in the spectrum and RF analysis. A maximum of 100 times of averaging can be set. When the averaging reaches to your setting, a new measurement value replaces the measurement value in sequence from the earliest.

Procedure

- 1 Press the **BW/AVG** hard key.
 - 2 Press the **Average** soft key.
 - 3 Enter a value between 1 and 100 as needed by using the numeric keys.
 - 4 Press the **Enter** soft key.
-

Setting sweep mode

The default setting is **Continue** to sweep continuously for most on-going measurements. If you want to hold the measurement or get a single sweep, you can change the sweep mode.

Procedure

To select the single sweep mode:

- 1 Press the **SWEEP** hot key.
- 2 Toggle the **Sweep Mode** soft key and select **Single**. You can also use the **HOLD** hot key. The letter **HOLD** in red appears and the sweeping is paused.
- 3 *Optional.* Press the **Sweep Once** soft key to get a new measurement.

To return to the continuous sweep mode:

- 1 Toggle the **Sweep Mode** soft key and select **Continue**. You can also use the **HOLD** hot key. The letter **HOLD** in red disappears and the sweeping resumes.
-

Setting trigger source

You can set the trigger source option for your measurements.

Procedure

- 1 Press the **TRIGGER** hot key.
 - 2 Select the trigger source option from the choices: **Internal**, **External**, and **GPS**.
-

Setting external clock

To enhance the reliability of modulation analysis measurements the JD700B series must be synchronized with a base station. When an external clock is not supplied, the instrument works with its built-in internal high-accuracy time base and some measurement results may exhibit inaccurate values. Therefore, it is highly recommended that you use the same reference clock as the signal source. You can use the **TRIGGER** hot key to set the external clock.







Figure 256 Connection ports for external reference clock



Procedure

- 1 Connect an external reference or a GPS antenna to the JD700B series.
- 2 Press the **SYSTEM** hot key.
- 3 Press the **Freq Reference** soft key, and then select the reference option: **Internal**, **External 10 MHz**, **External 13 MHz**, **External 15 MHz**, or **GPS**.

Table 18 External reference indicators

Type	Indicator	Description
Internal	 (green)	The green INT icon indicates that the instrument uses the built-in internal time base.
External	 (green)	The green EXT icon indicates that an external reference is connected and locked and that the instrument uses the same reference clock as the signal source.
External	 (red)	The red EXT icon indicates that an external reference is connect but not locked.
GPS	 (green)	The green GPS antenna icon indicates that a GPS antenna is connected and locked.
GPS	 (yellow)	The yellow GPS antenna icon indicates that a GPS antenna is connected and locking is in progress.
GPS	 (grey)	The grey GPS antenna icon indicates that a GPS antenna is not connected, failed, or unable to be locked.

Conducting spectrum measurements

Setting measure setup

After configuring test parameters as described in the “Configuring test parameters” on page 428, you can continue your measurement.

Procedure

- 1 Press the **MEASURE SETUP** hot key.
- 2 Press the **Slot Number** soft key, and then select the time slot number to be displayed: **TS0**, **TS1**, **TS2**, **TS3**, **TS4**, **TS5**, or **TS6**.
- 3 *Optional.* To set the delay, complete the following steps:
 - a Press the **Delay** soft key to set the amount of delay in μs .
 - b Enter a value by using the numeric keys. You can also use the rotary knob.
 - c Press the **μs** soft key.



NOTE
The Delay setting is used only when there is a time offset in the signals to be measured.

Your measurement result is displayed on the screen as like the following example, **Figure 257**.

Figure 257 Spectrum measurement screen with TD-SCDMA signal analyzer



Setting trace

You can display up to six traces on the measurement chart simultaneously.

Procedure

- 1 Press the **TRACE/DISPLAY** hard key.
- 2 Press the **Select Trace** soft key, and then select the trace number: **T1**, **T2**, **T3**, **T4**, **T5**, or **T6**. The legend shape of the selected trace changes from square to round to indicate that the trace is the active one now.
- 3 Do one of the following:

To	Select	Trace Legend
Clear current data and display with new measurements	Clear Write	W
Display the input signal's maximum response only (unlimited or for a certain amount of time)	Max Hold	M
Display the input signal's minimum response only (unlimited or for a certain amount of time)	Min Hold	m

Capture the selected trace and compare traces	Capture	C
Load a saved trace	More (1/2) > Load	L
Hide the displayed trace	Trace View > Off	F
Remove all the traces and initialize the trace settings	More (1/2) > Trace Clear All	



NOTE
For the **Max Hold** and **Min Hold**, your instrument compares newly acquired data with the active trace and displays larger maximum values or smaller minimum values on the screen. You can set it to **Unlimited** to hold and view maximum or minimum data or specify a certain amount of time up to 60 seconds by using numeric keys or rotary knob.

- 4 *Optional.* Select **More (1/2) > Trace Info**, and then select the trace number to view the trace's parameter setting information stored at the time of the measurement or **None** to hide the information display.
- 5 *Optional.* If you have the two traces T1 and T2, you can perform trace math. To view the power difference between the traces, press the **T1 – T2 -> T5** or **T2 – T1 -> T6** soft key. The result is overlaid on the screen along with the second Y-axis.

Conducting RF measurements

Channel power

The Channel Power measurement determines the average power of an RF signal burst at or above a specified threshold value.

The purpose of the Channel Power measurement is to determine the power delivered to the antenna system on the RF channel under test. The instrument acquires a TD-SCDMA signal in the time domain. The average power level above the threshold is then computed and displayed.

Setting measure setup

After configuring test parameters as described in the “Configuring test parameters” on page 428, you can continue your measurement.

Procedure

- 1 Press the **MEASURE SETUP** hot key.
- 2 Press the **Slot Number** soft key, and then select the time slot number to be displayed: **TS0**, **TS1**, **TS2**, **TS3**, **TS4**, **TS5**, or **TS6**.
- 3 *Optional.* To set the delay, complete the following steps:
 - a Press the **Delay** soft key to set the amount of delay in μ s.
 - b Enter a value by using the numeric keys. You can also use the rotary knob.
 - c Press the **μ s** soft key.



NOTE
The Delay setting is used only when there is a time offset in the signals to be measured.

Measurement example

Figure 258 Channel power measurement with TD-SCDMA signal analyzer



NOTE

You can use the **LIMIT** hot key to analyze your measurements with the user-definable limit and Pass/Fail indication. See “Setting limit for RF tests” on page 441 for more information.

Occupied bandwidth

The Occupied Bandwidth measures the spectrum shape of the carrier. It is defined as the bandwidth, which includes 99% of the transmitted power among total transmitted power.

Setting measure setup

After configuring test parameters as described in the “Configuring test parameters” on page 428, you can continue your measurement.

Procedure

- 1 Press the **MEASURE SETUP** hot key.
- 2 Press the **Slot Number** soft key, and then select the time slot number to be displayed: **TS0**, **TS1**, **TS2**, **TS3**, **TS4**, **TS5**, or **TS6**.
- 3 *Optional.* To set the delay, complete the following steps:
 - a Press the **Delay** soft key to set the amount of delay in μ s.
 - b Enter a value by using the numeric keys. You can also use the rotary knob.
 - c Press the **μ s** soft key.



NOTE

The Delay setting is used only when there is a time offset in the signals to be measured.

Measurement example

Figure 259 Occupied bandwidth measurement with TD-SCDMA signal analyzer

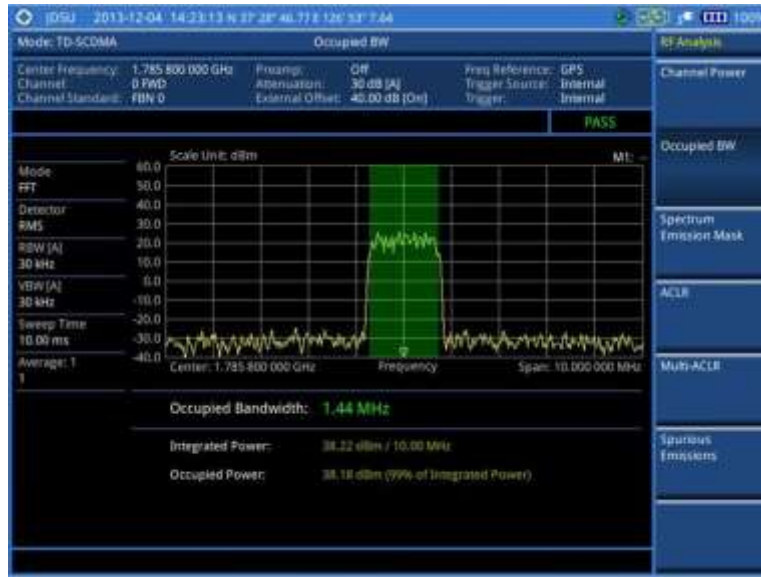

NOTE

You can use the **LIMIT** hot key to analyze your measurements with the user-definable limit and Pass/Fail indication. See “Setting limit for RF tests” on page 441 for more information.

Spectrum emission mask (SEM)

The Spectrum Emission Mask (SEM) measurement required by 3GPP specifications encompasses different power limits and different measurement bandwidths (resolution bandwidths) at various frequency offsets. It may be expressed as a ratio of power spectral densities between the carrier and the specified offset frequency band. It provides useful figures-of-merit for the spectral re-growth and emissions produced by components and circuit blocks, without the rigor of performing a full SEM measurement.

The SEM measures spurious signal levels in up to five pairs of offset or region frequencies and relates them to the carrier power.

Setting measure setup

After configuring test parameters as described in the “Configuring test parameters” on page 428, you can continue your measurement.

Procedure

- 1 Press the **MEASURE SETUP** hot key.
- 2 Press the **Slot Number** soft key, and then select the time slot number to be displayed: **TS0**, **TS1**, **TS2**, **TS3**, **TS4**, **TS5**, or **TS6**.
- 3 To select the mask type according to the output power of the base station, complete the following steps:
 - a Press the **Mask Type** soft key.
 - b Select the mask type option: **- 26 dBm**, **26 – 34 dBm**, or **34 dBm –**.
- 4 *Optional.* To set the delay, complete the following steps:
 - a Press the **Delay** soft key to set the amount of delay in μ s.

- b Enter a value by using the numeric keys. You can also use the rotary knob.
- c Press the **µs** soft key.



NOTE
The Delay setting is used only when there is a time offset in the signals to be measured.

Measurement example

Figure 260 SEM measurement with TD-SCDMA signal analyzer



NOTE
You can use the **LIMIT** hot key to analyze your measurements with the user-definable limit and Pass/Fail indication. See “Setting limit for RF tests” on page 441 for more information.

ACLR

The Adjacent Channel Leakage power Ratio (ACLR) measures the amount of interference or power in an adjacent frequency channel according to the standards.

Setting measure setup

After configuring test parameters as described in the “Configuring test parameters” on page 428, you can continue your measurement.

Procedure

- 1 Press the **MEASURE SETUP** hot key.
- 2 Press the **Slot Number** soft key, and then select the time slot number to be displayed: **TS0**, **TS1**, **TS2**, **TS3**, **TS4**, **TS5**, or **TS6**.
- 3 *Optional.* To set the delay, complete the following steps:
 - a Press the **Delay** soft key to set the amount of delay in µs.
 - b Enter a value by using the numeric keys. You can also use the rotary knob.
 - c Press the **µs** soft key.



NOTE
The Delay setting is used only when there is a time offset in the signals to be measured.

Measurement example

Figure 261 ACLR measurement with TD-SCDMA signal analyzer



NOTE

You can use the **LIMIT** hot key to analyze your measurements with the user-definable limit and Pass/Fail indication. See “Setting limit for RF tests” on page 441 for more information.

Multi-ACLR

The Multi-ACLR measurement is used to perform multi-channel ACLR measurements with as many channels as possible. It helps you to measure ACLR in multi-channel transmitting Base Station environment.

Setting measure setup

After configuring test parameters as described in the “Configuring test parameters” on page 428, you can continue your measurement.

Procedure

- 1 Press the **MEASURE SETUP** hot key.
- 2 To set the frequency, do one of the following:
 - To set the center frequency, complete the following steps:
 - a Toggle the **Unit** soft key and select **Freq**.
 - b Press the **Lowest Frequency** soft key to set the starting center frequency.
 - c Enter a value by using the numeric keys. You can also use the rotary knob.
 - d Select the unit: **GHz**, **MHz**, **kHz**, or **Hz**.
 - e Press the **Highest Frequency** soft key to set the stopping center frequency.
 - f Enter a value by using the numeric keys. You can also use the rotary knob.
 - g Select the unit: **GHz**, **MHz**, **kHz**, or **Hz**.
 - To set the channel number, complete the following steps:
 - a Toggle the **Unit** soft key and select **Channel**.
 - b To select the standard channel, press the **Channel Std** soft key and then select the band to be measured.
 - c Press the **Lowest Channel** soft key to set the starting channel.

- d Enter a value by using the numeric keys. You can also use the rotary knob.
- e Press the **Enter** soft key.
- f Press the **Highest Channel** soft key to set the stopping channel.
- g Enter a value by using the numeric keys. You can also use the rotary knob.
- h Press the **Enter** soft key.

Measurement example

Figure 262 Multi-ACLR measurement with TD-SCDMA signal analyzer



NOTE

You can use the **LIMIT** hot key to analyze your measurements with the user-definable limit and Pass/Fail indication. See “Setting limit for RF tests” on page 441 for more information.

Spurious emissions

Out-of-band emissions are unwanted emissions immediately outside the channel bandwidth resulting from the modulation process and non-linearity in the transmitter but excluding spurious emissions. The Spurious Emissions measurement is to identify and determine the power level of out-of-band spurious emission within the necessary channel bandwidth and modulated signal measured at the RF port of the Base Station.

Setting measure setup

After configuring test parameters as described in the “Configuring test parameters” on page 428, you can continue your measurement.

Procedure

- 1 Press the **MEASURE SETUP** hot key.
- 2 To set up the range table and parameters, press the **Range Table** soft key and then complete the following steps:
 - a Press the **Range** soft key, and then select the range number between **1** and **20** to add as a new or change the existing settings.
 - b Do the following as desired:

Select **Start Frequency**, and then specify the start frequency for the selected range.
 Select **Stop Frequency**, and then specify the stop frequency for the selected range.
 Select **Start Limit**, and then specify the lower limit for Pass/Fail indication.
 Select **Stop Limit**, and then specify the upper limit for Pass/Fail indication.
 Select **More (1/2) > Attenuation**, and then specify an value in the multiple of five.
 Select **More (1/2) > RBW**, and then specify a RBW value.
 Select **More (1/2) > VBW**, and then specify a VBW value.

- c Press the **PREV** hard key.
 - d Toggle the **Range** soft key and select **On** to display the selected range in the result table or **Off** to hide it from the table.
- 3 Toggle the **Measure Type** soft key between **Examine** and **Full** to select the measurement type.



NOTE
 The **Examine** mode displays only the selected range while the **Full** mode lets the instrument automatically changes the selected range from one another.

- 4 To set the number of measurements to be averaged, complete the following steps:
 - a Press the **Average** soft key.
 - b Enter a value between **1** and **100**, and then press the **Enter** soft key.
- 5 To move the highlighted bar in the result table to other range, complete the following steps:
 - a Press the **Range** soft key in the Measure Setup menu bar.
 - b Enter a value between **1** and **20**, and then press the **Enter** soft key.

Measurement example

Figure 263 Spurious emissions measurement with TD-SCDMA signal analyzer



NOTE
 You can use the **LIMIT** hot key to analyze your measurements with the user-definable limit and Pass/Fail indication. See “Setting limit for RF tests” on page 441 for more information.

Setting limit for RF tests

By default, test limits specified in the standard are set for you. You can change thresholds if you desire.

Procedure

- 1 Press the **LIMIT** hot key.
- 2 Press the **RF Test Limits** soft key.
- 3 Select the test item(s) and set the limit(s) depending on your selected measurement mode:

To set the limit for	Select	Set
Channel power	Channel Power	High Limit, Low Limit
Occupied bandwidth	Occupied BW	High Limit
Spectrum emission mask	Spectrum Emission Mask	(On/Off only)
ACLR	ACLR	(On/Off only)
Multi-ACLR	Multi-ACLR	(On/Off only)
Spurious emissions	Spurious Emissions	(On/Off only)

- 4 *Optional.* You can enable alarm sound that goes off if the measurement falls outside of the limit. Toggle the **Beep** soft key between **On** and **Off** to enable or disable the beep sound.
 - 5 *Optional.* Go to **SAVE/LOAD > Save**, and then select **Limit** to save the limit settings. See “Using save” on page 34 for more information.
-

Conducting power vs. time measurements

The Power vs. Time (P vs T) measurement analyzes the amplitude profile and timing of the burst signal and provides a time mask for the signal. It measures the mean transmit power during the “useful part” of TD-SCDMA bursts and verifies that the power ramp fits within the defined mask. TD-SCDMA is a Time Division Multiple Access (TDMA) scheme with seven time slots, or bursts, per RF channel and by using the “Multi-Slot” function, up to seven slots in a frame can be viewed at one time.

Power vs. time (slot)

The Power vs. Time (Slot) in TD-SCDMA Signal Analyzer measures the modulation envelope in the time domain, showing the signal rise and fall shape of TD-SCDMA signal.

Setting measure setup

After configuring test parameters as described in the “Configuring test parameters” on page 428, you can continue your measurement. The measurement settings can be saved and recalled as a file.

Procedure

- 1 Press the **MEASURE SETUP** hot key.
 - 2 Press the **Slot Number** soft key, and then select the time slot number to be displayed: **TS0**, **TS1**, **TS2**, **TS3**, **TS4**, **TS5**, or **TS6**.
 - 3 Press the **Spread Factor** soft key, and then select the spread factor option: **DL Auto** for auto detection of downlink, **UL Auto** for auto detection of uplink, **SF1**, **SF2**, **SF4**, **SF8**, or **SF16**.
 - 4 To set the number of maximum users, complete the following steps:
 - a Press the **Max Users** soft key.
-

- b Enter a value up to 16 by using the numeric keys.
 - c Press the **Enter** soft key.
- 5 *Optional.* To set the delay, complete the following steps:
- a Press the **Delay** soft key to set the amount of delay in μs .
 - b Enter a value by using the numeric keys. You can also use the rotary knob.
 - c Press the **μs** soft key.



NOTE
The Delay setting is used only when there is a time offset in the signals to be measured.

- 6 *Optional.* Press the **Miscellaneous** soft key, and then do the following as needed:
To select how to determine scrambling estimation, toggle the **Scramble** soft key and select **Spec** or **Full**.



NOTE
The Spec searches “Sync Sequence Number” from 0 to 31 based on the TD-SCDMA specification and determines “Scrambling Code Number” by using the sync sequence number, while the Full does from 0 to 127 fully.

To select how to determine the Midamble spread factor estimation either in full or maximum power search, toggle the **Mid SF Map** soft key and select **Max** or **Spec**.



NOTE
The Max determines the spread factor of the Midamble by using the maximum power of the received Midamble, while the Spec searches “Default Midamble Allocation” based on the TD-SCDMA specification.

To select the detect mode, press the **Detect Mode** soft key and then select the option: **Auto**, **QPSK/8PSK**, **QPSK**, **8PSK**, **16 QAM**, or **64 QAM**.

Measurement example

Figure 264 Power vs. time (slot) measurement with TD-SCDMA signal analyzer



NOTE
You can use the **LIMIT** hot key to analyze your measurements with the user-definable limit and Pass/Fail indication. See “Setting limit for power vs. time tests” on page 447 for more information.

Power vs. time (frame)

The Power vs. Time (Frame) measures the modulation envelope in the time domain, showing the power of each time slot of the TD-SCDMA signal.

Setting measure setup

After configuring test parameters as described in the “Configuring test parameters” on page 428, you can continue your measurement. The measurement settings can be saved and recalled as a file.

Procedure

- 1 Press the **MEASURE SETUP** hot key.
- 2 Press the **Slot Number** soft key, and then select the time slot number to be displayed: **TS0**, **TS1**, **TS2**, **TS3**, **TS4**, **TS5**, or **TS6**.
- 3 Press the **Spread Factor** soft key, and then select the spread factor option: **DL Auto** for auto detection of downlink, **UL Auto** for auto detection of uplink, **SF1**, **SF2**, **SF4**, **SF8**, or **SF16**.
- 4 To set the number of maximum users, complete the following steps:
 - a Press the **Max Users** soft key.
 - b Enter a value up to 16 by using the numeric keys.
 - c Press the **Enter** soft key.
- 5 *Optional.* To set the delay, complete the following steps:
 - a Press the **Delay** soft key to set the amount of delay in μs .
 - b Enter a value by using the numeric keys. You can also use the rotary knob.
 - c Press the **μs** soft key.



NOTE

The Delay setting is used only when there is a time offset in the signals to be measured.

- 6 *Optional.* Press the **Miscellaneous** soft key, and then do the following as needed:
To select how to determine scrambling estimation, toggle the **Scramble** soft key and select **Spec** or **Full**.



NOTE

The Spec searches “Sync Sequence Number” from 0 to 31 based on the TD-SCDMA specification and determines “Scrambling Code Number” by using the sync sequence number, while the Full does from 0 to 127 fully.

To select how to determine the Midamble spread factor estimation either in full or maximum power search, toggle the **Mid SF Map** soft key and select **Max** or **Spec**.



NOTE

The Max determines the spread factor of the Midamble by using the maximum power of the received Midamble, while the Spec searches “Default Midamble Allocation” based on the TD-SCDMA specification.

To select the detect mode, press the **Detect Mode** soft key and then select the option: **Auto**, **QPSK/8PSK**, **QPSK**, **8PSK**, **16 QAM**, or **64 QAM**.

Measurement example

Figure 265 Power vs. time (frame) measurement with TD-SCDMA signal analyzer



NOTE

You can use the **LIMIT** hot key to analyze your measurements with the user-definable limit and Pass/Fail indication. See “Setting limit for power vs. time tests” on page 447 for more information. The On/Off Ratio is not used in the power vs. time (frame) tests.

Power vs. time (mask)

Setting measure setup

After configuring test parameters as described in the “Configuring test parameters” on page 428, you can continue your measurement. The measurement settings can be saved and recalled as a file.

Procedure

- 1 Press the **MEASURE SETUP** hot key.
- 2 Press the **Slot Number** soft key, and then select the time slot number to be displayed: **TS0**, **TS1**, **TS2**, **TS3**, **TS4**, **TS5**, or **TS6**.
- 3 Press the **Spread Factor** soft key, and then select the spread factor option: **DL Auto** for auto detection of downlink, **UL Auto** for auto detection of uplink, **SF1**, **SF2**, **SF4**, **SF8**, or **SF16**.
- 4 To set the number of maximum users, complete the following steps:
 - a Press the **Max Users** soft key.
 - b Enter a value up to 16 by using the numeric keys.
 - c Press the **Enter** soft key.
- 5 *Optional.* To set the delay, complete the following steps:
 - a Press the **Delay** soft key to set the amount of delay in μs.
 - b Enter a value by using the numeric keys. You can also use the rotary knob.
 - c Press the **μs** soft key.



NOTE

The Delay setting is used only when there is a time offset in the signals to be measured.

- 6 *Optional.* Press the **Miscellaneous** soft key, and then do the following as needed:
 - To select how to determine scrambling estimation, toggle the **Scramble** soft key and select **Spec** or **Full**.



NOTE
The Spec searches “Sync Sequence Number” from 0 to 31 based on the TD-SCDMA specification and determines “Scrambling Code Number” by using the sync sequence number, while the Full does from 0 to 127 fully.

To select how to determine the Midamble spread factor estimation either in full or maximum power search, toggle the **Mid SF Map** soft key and select **Max** or **Spec**.



NOTE
The Max determines the spread factor of the Midamble by using the maximum power of the received Midamble, while the Spec searches “Default Midamble Allocation” based on the TD-SCDMA specification.

To select the detect mode, press the **Detect Mode** soft key and then select the option: **Auto**, **QPSK/8PSK**, **QPSK**, **8PSK**, **16 QAM**, or **64 QAM**.

Measurement example

Figure 266 Power vs. time (mask) measurement with TD-SCDMA signal analyzer



NOTE
You can use the **LIMIT** hot key to analyze your measurements with the user-definable limit and Pass/Fail indication. See “Setting limit for power vs. time tests” on page 447 for more information. The DwPTS Power and UpPTS Power are not used in the power vs. time (mask) tests.

Timogram

Setting measure setup

After configuring test parameters as described in the “Configuring test parameters” on page 428, you can continue your measurement. The measurement settings can be saved and recalled as a file.

Procedure

- 1 Press the **MEASURE SETUP** hot key.
- 2 Press the **Spread Factor** soft key, and then select the spread factor option: **DL Auto** for auto detection of downlink, **UL Auto** for auto detection of uplink, **SF1**, **SF2**, **SF4**, **SF8**, or **SF16**
- 3 To set the number of maximum users, complete the following steps:

-
- a Press the **Max Users** soft key.
 - b Enter a value up to 16 by using the numeric keys.
 - c Press the **Enter** soft key.
 - 4 To set the time interval, complete the following steps:
 - a Press the **Time Interval** soft key.
 - b Enter a value by using the numeric keys.
 - c Press the **Enter** soft key.
 - 5 To place the time cursor to analyze your measurements, complete the following steps:
 - a Toggle the **Time Cursor** soft key between **On** and **Off** to enable or disable the time cursor.
 - b Enter a value by using the numeric keys.
 - c Press the **Enter** soft key.



NOTE

When the time cursor is enabled, the measurement is put on hold and information about the time cursor is displayed.

- 6 *Optional.* Press the **Miscellaneous** soft key, and then do the following as needed:

To set the delay, complete the following steps:

- a Press the **Delay** soft key to set the amount of delay in μs .
- b Enter a value by using the numeric keys. You can also use the rotary knob.
- c Press the **μs** soft key.



NOTE

The Delay setting is used only when there is a time offset in the signals to be measured.

To select how to determine scrambling estimation, toggle the **Scramble** soft key and select **Spec** or **Full**.



NOTE

The Spec searches “Sync Sequence Number” from 0 to 31 based on the TD-SCDMA specification and determines “Scrambling Code Number” by using the sync sequence number, while the Full does from 0 to 127 fully.

To select how to determine the Midamble spread factor estimation either in full or maximum power search, toggle the **Mid SF Map** soft key and select **Max** or **Spec**.



NOTE

The Max determines the spread factor of the Midamble by using the maximum power of the received Midamble, while the Spec searches “Default Midamble Allocation” based on the TD-SCDMA specification.

To select the detect mode, press the **Detect Mode** soft key and then select the option: **Auto**, **QPSK/8PSK**, **QPSK**, **8PSK**, **16 QAM**, or **64 QAM**.

Measurement example

Figure 267 Timogram with TD-SCDMA signal analyzer



Setting limit for power vs. time tests

Procedure

- 1 Press the **LIMIT** hot key.
- 2 Press the **PvsT Test Limits** soft key.
- 3 Select the test item(s) and set the limit(s) depending on your selected measurement mode:

To set the limit for	Select	Set
Slot power	Slot Power	High Limit, Low Limit
Downlink pilot signal power	DwPTS Power	High Limit, Low Limit
Uplink pilot signal power	UpPTS Power	High Limit, Low Limit
Power between on and off portions of the downlink slots	On/Off Ratio	High Limit, Low Limit

- 4 *Optional.* You can enable alarm sound that goes off if the measurement falls outside of the limit. Toggle the **Beep** soft key between **On** and **Off** to enable or disable the beep sound.
- 5 *Optional.* Go to **SAVE/LOAD > Save**, and then select **Limit** to save the limit settings. See "Using save" on page 34 for more information.

Conducting modulation measurements

TD-SCDMA receivers rely on the frequency or phase quality of the QPSK or 8PSK signal in order to achieve the expected carrier to noise performance. A transmitter with high frequency or phase error is often still able to support phone calls during a functional test. It displays the frequency errors numerically and graphically, showing the binary representation of the demodulated data bits of the received signal using Constellation, Midamble Power, Code Power, and Code Error screens.

Constellation

The Constellation is used to observe some aspects of modulation accuracy and can reveal certain fault mechanisms such as I/Q amplitude imbalance or quadrature imbalance. It displays constellation diagram by modulation types.

Setting measure setup

After configuring test parameters as described in the “Configuring test parameters” on page 428, you can continue your measurement. The measurement settings can be saved and recalled as a file. You can also use JDViewer, PC application software to configure a measure setup, save as a file, and load the file on to the instrument.

Procedure

- 1 Press the **MEASURE SETUP** hot key.
- 2 Toggle the **Scramble** soft key and select **Auto** or **Manual** to set the scramble code automatically or manually.
- 3 Press the **Slot Number** soft key, and then select the time slot number to be displayed: **TS0**, **TS1**, **TS2**, **TS3**, **TS4**, **TS5**, or **TS6**.
- 4 Press the **Spread Factor** soft key, and then select the spread factor option: **DL Auto** for auto detection of downlink, **UL Auto** for auto detection of uplink, **SF1**, **SF2**, **SF4**, **SF8**, or **SF16**.
- 5 To set the number of maximum users, complete the following steps:
 - a Press the **Max Users** soft key.
 - b Enter a value up to 16 by using the numeric keys, and then press the **Enter** soft key.
- 6 *Optional.* Press the **Miscellaneous** soft key, and then do the following as needed:

To set the delay, complete the following steps:

 - a Press the **Delay** soft key to set the amount of delay in μ s.
 - b Enter a value by using the numeric keys. You can also use the rotary knob.
 - c Press the **μ s** soft key.



NOTE

The Delay setting is used only when there is a time offset in the signals to be measured.

To select how to determine scrambling estimation, toggle the **Scramble** soft key and select **Spec** or **Full**.



NOTE

The Spec searches “Sync Sequence Number” from 0 to 31 based on the TD-SCDMA specification and determines “Scrambling Code Number” by using the sync sequence number, while the Full does from 0 to 127 fully.

To select how to determine the Midamble spread factor estimation either in full or maximum power search, toggle the **Mid SF Map** soft key and select **Max** or **Spec**.



NOTE

The Max determines the spread factor of the Midamble by using the maximum power of the received Midamble, while the Spec searches “Default Midamble Allocation” based on the TD-SCDMA specification.

To select the detect mode, press the **Detect Mode** soft key and then select the option: **Auto**, **QPSK/8PSK**, **QPSK**, **8PSK**, **16 QAM**, or **64 QAM**.

To set the relative threshold, complete the following steps:

- a Press the **Threshold** soft key. Its default setting is -27 dB.
 - b Enter a value between -50 and zero by using the numeric keys.
 - c Press the **Enter** soft key.
-

Measurement example

Figure 268 Constellation measurement with TD-SCDMA signal analyzer

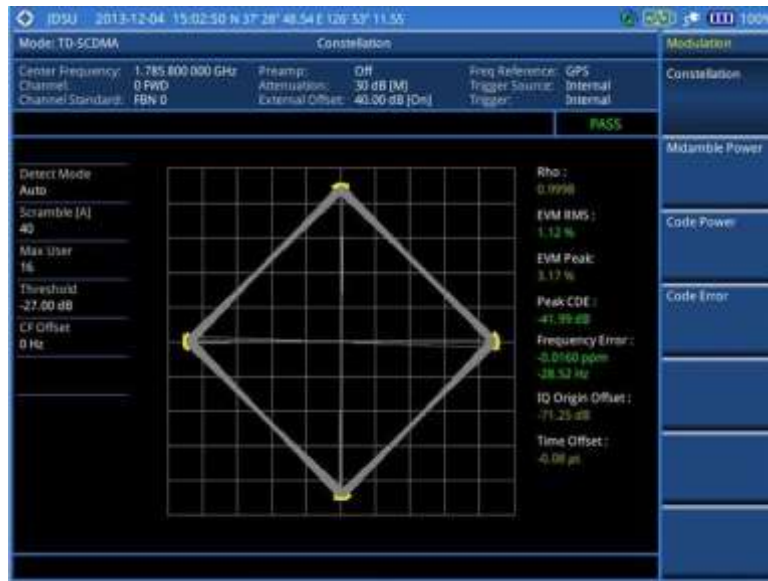

NOTE

You can use the **LIMIT** hot key to analyze your measurements with the user-definable limit and Pass/Fail indication. See “Setting limit for modulation tests” on page 453 for more information. The Max Inactive is not used in the Constellation mode.

Midamble power

Setting measure setup

After configuring test parameters as described in the “Configuring test parameters” on page 428, you can continue your measurement. The measurement settings can be saved and recalled as a file. You can also use JDViewer, PC application software to configure a measure setup, save as a file, and load the file on to the instrument.

Procedure

- 1 Press the **MEASURE SETUP** hot key.
- 2 Toggle the **Scramble** soft key and select **Auto** or **Manual** to set the scramble code automatically or manually.
- 3 Press the **Slot Number** soft key, and then select the time slot number to be displayed: **TS0**, **TS1**, **TS2**, **TS3**, **TS4**, **TS5**, or **TS6**.
- 4 Press the **Spread Factor** soft key, and then select the spread factor option: **DL Auto** for auto detection of downlink, **UL Auto** for auto detection of uplink, **SF1**, **SF2**, **SF4**, **SF8**, or **SF16**.
- 5 To set the number of maximum users, complete the following steps:
 - a Press the **Max Users** soft key.
 - b Enter a value up to 16 by using the numeric keys.
 - c Press the **Enter** soft key.
- 6 *Optional.* Press the **Miscellaneous** soft key, and then do the following as needed:

To set the delay, complete the following steps:

 - a Press the **Delay** soft key to set the amount of delay in μs.
 - b Enter a value by using the numeric keys. You can also use the rotary knob.
 - c Press the **μs** soft key.



NOTE
The Delay setting is used only when there is a time offset in the signals to be measured.

To select how to determine scrambling estimation, toggle the **Scramble** soft key and select **Spec** or **Full**.



NOTE
The Spec searches “Sync Sequence Number” from 0 to 31 based on the TD-SCDMA specification and determines “Scrambling Code Number” by using the sync sequence number, while the Full does from 0 to 127 fully.

To select how to determine the Midamble spread factor estimation either in full or maximum power search, toggle the **Mid SF Map** soft key and select **Max** or **Spec**.



NOTE
The Max determines the spread factor of the Midamble by using the maximum power of the received Midamble, while the Spec searches “Default Midamble Allocation” based on the TD-SCDMA specification.

To select the detect mode, press the **Detect Mode** soft key and then select the option: **Auto**, **QPSK/8PSK**, **QPSK**, **8PSK**, **16 QAM**, or **64 QAM**.

To set the relative threshold, complete the following steps:

- a Press the **Threshold** soft key. Its default setting is -27 dB.
- b Enter a value between -50 and zero by using the numeric keys.
- c Press the **Enter** soft key.

Measurement example

Figure 269 Midamble measurement with TD-SCDMA signal analyzer



Code power

Setting measure setup

After configuring test parameters as described in the “Configuring test parameters” on page 428, you can continue your measurement. The measurement settings can be saved and recalled as a file. You can also use JDViewer, PC application software to configure a measure setup, save as a file, and load the file on to the instrument.

Procedure

- 1 Press the **MEASURE SETUP** hot key.
- 2 Toggle the **Scramble** soft key and select **Auto** or **Manual** to set the scramble code automatically or manually.
- 3 Press the **Slot Number** soft key, and then select the time slot number to be displayed: **TS0**, **TS1**, **TS2**, **TS3**, **TS4**, **TS5**, or **TS6**.
- 4 Press the **Spread Factor** soft key, and then select the spread factor option: **DL Auto** for auto detection of downlink, **UL Auto** for auto detection of uplink, **SF1**, **SF2**, **SF4**, **SF8**, or **SF16**.
- 5 To set the number of maximum users, complete the following steps:
 - a Press the **Max Users** soft key.
 - b Enter a value up to 16 by using the numeric keys.
 - c Press the **Enter** soft key.
- 6 *Optional.* Press the **Miscellaneous** soft key, and then do the following as needed:

To set the delay, complete the following steps:

 - a Press the **Delay** soft key to set the amount of delay in μ s.
 - b Enter a value by using the numeric keys. You can also use the rotary knob.
 - c Press the **μ s** soft key.

**NOTE**

The Delay setting is used only when there is a time offset in the signals to be measured.

To select how to determine scrambling estimation, toggle the **Scramble** soft key and select **Spec** or **Full**.

**NOTE**

The Spec searches “Sync Sequence Number” from 0 to 31 based on the TD-SCDMA specification and determines “Scrambling Code Number” by using the sync sequence number, while the Full does from 0 to 127 fully.

To select how to determine the Midamble spread factor estimation either in full or maximum power search, toggle the **Mid SF Map** soft key and select **Max** or **Spec**.

**NOTE**

The Max determines the spread factor of the Midamble by using the maximum power of the received Midamble, while the Spec searches “Default Midamble Allocation” based on the TD-SCDMA specification.

To select the detect mode, press the **Detect Mode** soft key and then select the option: **Auto**, **QPSK/8PSK**, **QPSK**, **8PSK**, **16 QAM**, or **64 QAM**.

To set the relative threshold, complete the following steps:

- a Press the **Threshold** soft key. Its default setting is -27 dB.
 - b Enter a value between -50 and zero by using the numeric keys.
 - c Press the **Enter** soft key.
-

Measurement example

Figure 270 Code power measurement with TD-SCDMA signal analyzer



NOTE

You can use the **LIMIT** hot key to analyze your measurements with the user-definable limit and Pass/Fail indication for the Max Inactive. See “Setting limit for modulation tests” on page 453 for more information.

Code error

Setting measure setup

After configuring test parameters as described in the “Configuring test parameters” on page 428, you can continue your measurement. The measurement settings can be saved and recalled as a file. You can also use JDViewer, PC application software to configure a measure setup, save as a file, and load the file on to the instrument.

Procedure

- 1 Press the **MEASURE SETUP** hot key.
- 2 Toggle the **Scramble** soft key and select **Auto** or **Manual** to set the scramble code automatically or manually.
- 3 Press the **Slot Number** soft key, and then select the time slot number to be displayed: **TS0**, **TS1**, **TS2**, **TS3**, **TS4**, **TS5**, or **TS6**.
- 4 Press the **Spread Factor** soft key, and then select the spread factor option: **DL Auto** for auto detection of downlink, **UL Auto** for auto detection of uplink, **SF1**, **SF2**, **SF4**, **SF8**, or **SF16**.
- 5 To set the number of maximum users, complete the following steps:
 - a Press the **Max Users** soft key.
 - b Enter a value up to 16 by using the numeric keys.
 - c Press the **Enter** soft key.
- 6 *Optional.* Press the **Miscellaneous** soft key, and then do the following as needed:

To set the delay, complete the following steps:

 - a Press the **Delay** soft key to set the amount of delay in μ s.
 - b Enter a value by using the numeric keys. You can also use the rotary knob.
 - c Press the **μ s** soft key.

- NOTE**
The Delay setting is used only when there is a time offset in the signals to be measured.

To select how to determine scrambling estimation, toggle the **Scramble** soft key and select **Spec** or **Full**.
- NOTE**
The Spec searches “Sync Sequence Number” from 0 to 31 based on the TD-SCDMA specification and determines “Scrambling Code Number” by using the sync sequence number, while the Full does from 0 to 127 fully.

To select how to determine the Midamble spread factor estimation either in full or maximum power search, toggle the **Mid SF Map** soft key and select **Max** or **Spec**.
- NOTE**
The Max determines the spread factor of the Midamble by using the maximum power of the received Midamble, while the Spec searches “Default Midamble Allocation” based on the TD-SCDMA specification.

To select the detect mode, press the **Detect Mode** soft key and then select the option: **Auto**, **QPSK/8PSK**, **QPSK**, **8PSK**, **16 QAM**, or **64 QAM**.

To set the relative threshold, complete the following steps:

 - a Press the **Threshold** soft key. Its default setting is -27 dB.
 - b Enter a value between -50 and zero by using the numeric keys.
 - c Press the **Enter** soft key.

Measurement example

Figure 271 Code error measurement with TD-SCDMA signal analyzer



- NOTE**
You can use the **LIMIT** hot key to analyze your measurements with the user-definable limit and Pass/Fail indication for the Max Inactive. See “Setting limit for modulation tests” on page 453 for more information.

Setting limit for modulation tests

Procedure

- 1 Press the **LIMIT** hot key.

- 2 Press the Modulation Test Limits soft key.
- 3 Select the test item(s) and set the limit(s) depending on your selected measurement mode:

To set the limit for	Select	Set
Frequency error	Frequency Error	High Limit, Low Limit
Error vector magnitude rms	EVM RMS	High Limit
Peak code domain error	PCDE	High Limit
Highest level among inactive channels	Max Inactive	High Limit

- 4 *Optional.* You can enable alarm sound that goes off if the measurement falls outside of the limit. Toggle the **Beep** soft key between **On** and **Off** to enable or disable the beep sound.
- 5 *Optional.* Go to **SAVE/LOAD > Save**, and then select **Limit** to save the limit settings. See “Using save” on page 34 for more information.

Performing auto measurements

The Auto Measure function of the JD700B series allows a complete signal profiling covering RF characterization and modulation quality parameters of up to 10 different carriers, particularly useful on an overlay architecture where base stations are transmitting in different frequencies.

The Auto Measure can be easily executed either by selecting a menu in the instrument or by running a programmed scenario in the PC-based application so that the instrument automatically configure and perform tests on every aspect of all the carriers.

Setting limit

You can set test limits for test item(s) in the auto measurement.

Procedure

- 1 Press the **LIMIT** hot key.
- 2 Press the **RF Test Limits** soft key, and then enable test limits as desired.
- 3 Press the **PvsT Test Limits** soft key, and then enable test limits as desired.
- 4 Press the **Modulation Test Limits** soft key, and then enable test limits as desired.
- 5 *Optional.* You can enable alarm sound that goes off if the measurement falls outside of the limit. Toggle the **Beep** soft key between **On** and **Off** to enable or disable the beep sound.
- 6 *Optional.* Go to **SAVE/LOAD > Save**, and then select **Limit** to save the limit settings. See “Using save” on page 34 for more information.

Setting measure setup

After configuring test parameters as described in the “Configuring test parameters” on page 428, you can continue your measurement. The measurement settings can be saved and recalled as a file. You can also use JDViewer, PC application software to configure a measure setup, save as a file, and load the file on to the instrument.

Procedure

- 1 Press the **MEASURE SETUP** hot key.
- 2 Toggle the **Configuration** soft key and select the configuration option:

-
- Current:** Lets the instrument use current frequency (single carrier) and determine pass or fail based on the instrument's limit settings in Auto Measure.
- Scenario:** Runs a test with a programmed scenario in JDViewer.
The Scenario menu becomes activated.
- 3 To load a scenario, press the **Scenario** soft key, and then select a scenario file to load.
 - 4 Toggle the **Test Time** soft key and select the test time option:
 - Now:** Lets the instrument run a test only once.
 - Schedule:** Lets the instrument repeat tests as defined in the Set Timing.
The Set Timing menu becomes activated.
 - 5 To define a schedule for an auto measurement, complete the following steps:
 - a Press the **Set Timing** soft key.
 - b Press the **Start Time (HH:MM)** soft key.
 - c Enter the time in the HH:MM format, and then press the **Enter** soft key.
 - d Press the **Stop Time (HH:MM)** soft key.
 - e Enter the time in the HH:MM format, and then press the **Enter** soft key.
 - f Press the **Time Interval** soft key.
 - g Enter the amount of time in minutes, and then press the **Enter** soft key.
 - 6 Press the **Settings** soft key, and then set the following:
 - a Press the **Slot Number** soft key, and then select the time slot number to be displayed: **TS0**, **TS1**, **TS2**, **TS3**, **TS4**, **TS5**, or **TS6**.
 - b Toggle the **External Offset** soft key and select **On**.
 - c Enter a value by using the numeric keys, and then press the **dB** soft key.
 - 7 To save your settings and results, go to **SAVE/LOAD > Save** and then perform functions as you desire. See "Using save" on page 34 for more information.
 - 8 Press the **Run Test** soft key to start to run a test.
The Auto Measure Results window appears at the end of the test.
 - 9 To stop running the test, press the **Abort** soft key.
 - 10 To change the view on the screen during the test, press the **Display** and then select the view option from the following choices:
 - Screen:** You can view each measurement screen as the test progresses.
 - Results:** You can view a measurement result table as the test progresses.
 - Settings:** You can view a measurement setting table as the test progresses.
-

Setting display

After completion of the auto measurement, the screen menu changes to Trace/Display so that you can view the results in different forms.

Procedure

- 1 Toggle the **Display** soft key and select the display option:
 - Result:** You can view the result table.
The Display Result menu becomes activated.
 - Settings:** You can view the measurement settings for the auto measurement.
 - 2 Toggle the **Display Result** soft key and select the display result option:
 - Full:** You can view detailed measurement readings with the pass/fail indication.
 - Quick:** You can view only the Pass/Fail results.
 - 3 To view the measurement results for a different carrier, press the **View Carrier** soft key and then select the carrier number to view.
-

Conducting TD-SCDMA OTA measurements

Sync-DL ID scanner

Setting measure setup

After configuring test parameters as described in the “Configuring test parameters” on page 428, you can continue your measurement.

Procedure

- 1 Press the **MEASURE SETUP** hot key.
- 2 Toggle the **Sync-DL ID** soft key and select **Auto** or **Manual** to set the Sync Downlink ID automatically or manually.
- 3 *Optional.* To select the delay, complete the following steps:
 - a Press the **Miscellaneous** soft key.
 - b Press the **Delay** soft key to set the amount of delay in μs .
 - c Enter a value by using the numeric keys. You can also use the rotary knob.
 - d Press the **μs** soft key.



NOTE
The Delay setting is used only when there is a time offset in the signals to be measured.

- 4 *Optional.* Go to **SAVE/LOAD > Save**, and then select the save option from the choices available for your measurement mode. See “Using save” on page 34 for more information.

Measurement example

Figure 272 Sync-DL ID scanner measurement with TD-SCDMA OTA signal analyzer



Sync-DL ID vs. Tau

Setting measure setup

After configuring test parameters as described in the “Configuring test parameters” on page 428, you can continue your measurement.

Procedure

- 1 Press the **MEASURE SETUP** hot key.
- 2 Toggle the **Sync-DL ID** soft key and select **Auto** or **Manual** to set the Sync Downlink ID automatically or manually.
- 3 *Optional.* To select the delay, complete the following steps:
 - a Press the **Miscellaneous** soft key.
 - b Press the **Delay** soft key to set the amount of delay in μs .
 - c Enter a value by using the numeric keys. You can also use the rotary knob.
 - d Press the **μs** soft key.

**NOTE**

The Delay setting is used only when there is a time offset in the signals to be measured.

- 4 *Optional.* Go to **SAVE/LOAD > Save**, and then select the save option from the choices available for your measurement mode. See “Using save” on page 34 for more information.
-

Measurement example**Figure 273 Sync-DL ID vs. Tau measurement with TD-SCDMA OTA signal analyzer****Sync-DL ID multipath****Setting measure setup**

After configuring test parameters as described in the “Configuring test parameters” on page 428, you can continue your measurement.

Procedure

- 1 Press the **MEASURE SETUP** hot key.
 - 2 Toggle the **Sync-DL ID** soft key and select **Auto** or **Manual** to set the Sync Downlink ID automatically or manually.
 - 3 *Optional.* To select the delay, complete the following steps:
 - a Press the **Miscellaneous** soft key.
 - b Press the **Delay** soft key to set the amount of delay in μs .
 - c Enter a value by using the numeric keys. You can also use the rotary knob.
-

- d Press the **µs** soft key.



NOTE
The Delay setting is used only when there is a time offset in the signals to be measured.

- 4 *Optional.* Go to **SAVE/LOAD > Save**, and then select the save option from the choices available for your measurement mode. See “Using save” on page 34 for more information.

Measurement example

Figure 274 Sync-DL ID multipath measurement with TD-SCDMA OTA signal analyzer



Sync-DL ID analyzer

Setting measure setup

After configuring test parameters as described in the “Configuring test parameters” on page 428, you can continue your measurement.

Procedure

- 1 Press the **MEASURE SETUP** hot key.
- 2 Toggle the **Sync-DL ID** soft key and select **Auto** or **Manual** to set the Sync Downlink ID automatically or manually.
- 3 *Optional.* To select the delay, complete the following steps:
 - a Press the **Miscellaneous** soft key.
 - b Press the **Delay** soft key to set the amount of delay in **µs**.
 - c Enter a value by using the numeric keys. You can also use the rotary knob.
 - d Press the **µs** soft key.



NOTE
The Delay setting is used only when there is a time offset in the signals to be measured.

- 4 *Optional.* Go to **SAVE/LOAD > Save**, and then select the save option from the choices available for your measurement mode. See “Using save” on page 34 for more information.

Setting limit for Sync-DL ID analyzer

Procedure

- 1 Press the **LIMIT** hot key.
- 2 To set the limit for rms of the error vector magnitude, complete the following steps:
 - a Press the **EVM RMS** soft key.
 - b Toggle the **Test Limits** soft key between **On** and **Off** to enable or disable the limit.
 - c Press the **High Limit** soft key, and then enter a value for the upper threshold.
 - d Press the **Enter** soft key.
- 3 To set the limit for frequency error, complete the following steps:
 - a Press the **Frequency Error** soft key.
 - b Toggle the **Test Limits** soft key between **On** and **Off** to enable or disable the limit.
 - c Press the **High Limit** soft key, and then enter a value for the upper threshold.
 - d Press the **ppm** soft key.
 - e Press the **Low Limit** soft key, and then enter a value for the lower threshold.
 - f Press the **ppm** soft key.
- 4 *Optional.* You can enable alarm sound that goes off if the measurement falls outside of the limit. Toggle the **Beep** soft key between **On** and **Off** to enable or disable the beep sound.
- 5 *Optional.* Go to **SAVE/LOAD > Save**, and then select **Limit** to save the limit settings. See "Using save" on page 34 for more information.

Measurement example

Figure 275 Sync-DL ID analyzer measurement with TD-SCDMA OTA signal analyzer



Route map

The JD700B Series provides the Route Map function that allows you to collect data of points in an indoor or outdoor environment and track the received signals and coverage of RF transmitters by plotting data real time directly on top of a loaded floor plan or a map.

Setting measure setup

Procedure

- 1 If required, connect a GPS receiver to your JD700B series for outdoor mapping. Indoor mapping does not necessarily need a GPS antenna.
- 2 Configure test parameters as described in the “Configuring test parameters” on page 428.
- 3 To load your map file, complete the following steps:
 - a Plug in your USB drive that has a floor map or `.mcf` file type created in JMapCreator. If the JMapCreator application on your computer is connected to the instrument via USB or LAN, you can send a map file with a single layer to the instrument directly by using the **Send to EQP** menu in JMapCreator.



NOTE

The JMapCreator converts and resizes any scanned floor plan or layout to fit onto your instrument’s display. JMapCreator 1.2.0 or later can save a multiple-layered map, providing **x1**, **x2**, and **x4** views, as a sizable map file so that you can zoom in and out after loading it.

- b Press **SAVE/LOAD** hot key, and then select **Load > Load Map**. See “Using load” on page 36 for more information.
- 4 Press the **MEASURE SETUP** hot key.
- 5 Press the **Plot Point** soft key, and then select the plot point option from the following choices:

To collect data/plot points automatically as you move around in a vehicle or outside, press the **GPS** soft key and then toggle the **Screen Mode** soft key between **Map** and **Full**.



NOTE

With the **Map** setting, you can view only the collected points that can be seen within the boundary of the loaded map. If a point is off the map, the instrument displays an arrow to indicate the direction of the current location on the map and the distance from the center to the location at the top of the screen.

With the **Full** setting, you can view all the collected points of the route without the loaded map.

To collect data/plot points manually without a GPS antenna in an indoor environment, press the **Position** soft key.

- 6 Toggle the **Plot** soft key and select **Start** to start plotting.
- 7 Touch directly on the screen or press the **ENTER** hard key to collect data and plot points on the loaded map for the **Position** setting.



NOTE

For the **Position** setting, you can change the direction of the route with the arrow keys and the distance with the rotary knob.

- 8 Toggle the **Plot** soft key and select **Stop** to stop plotting.
- 9 Press the **SAVE/LOAD** hot key to save the result. See “Using save” on page 34 for more information.



NOTE

The instrument does not automatically save the collected data. It is recommended that you save the result. Otherwise, you will lose all the collected data.

Setting limit for route map

You can set the thresholds for each test item.

Procedure

- 1 Press the **LIMIT** hot key.
 - 2 Press the **Excellent** soft key to set its threshold.
 - 3 Enter a value, and then press the **Enter** soft key. You can also use the rotary knob.
 - 4 Press the **Very Good** soft key to set its threshold.
-

- 5 Enter a value, and then press the **Enter** soft key. You can also use the rotary knob.
- 6 Press the **Good** soft key to set its threshold.
- 7 Enter a value, and then press the **Enter** soft key. You can also use the rotary knob.
- 8 Press the **Fair** soft key to set its threshold.
- 9 Enter a value, and then press the **Enter** soft key. You can also use the rotary knob.
- 10 Press the **Poor** soft key to set its threshold.
- 11 Enter a value, and then press the **Enter** soft key. You can also use the rotary knob.
- 12 *Optional.* Go to **SAVE/LOAD > Save**, and then select **Limit** to save the limit settings. See “Using save” on page 34 for more information.

Measurement example

Figure 276 Route map measurement with TD-SCDMA OTA signal analyzer

1) Map view

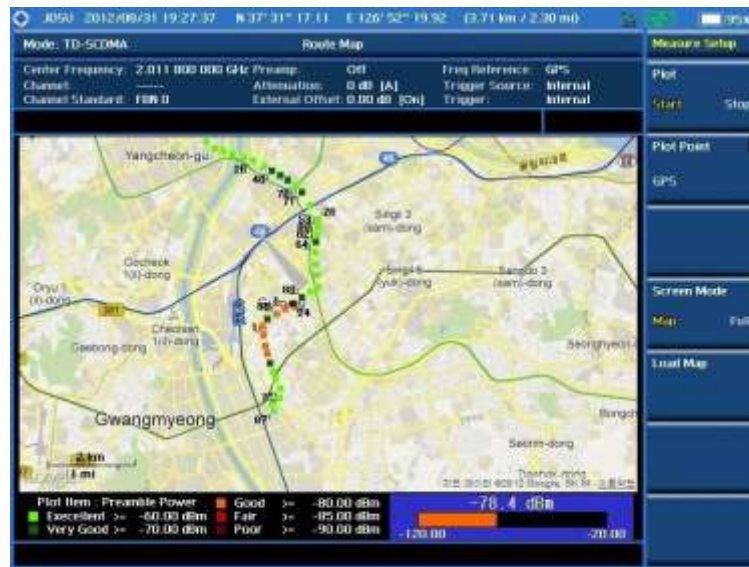

2) Full view



Controlling a map

If you have loaded a sizable map that was created in JDMapCreator 1.2.0 or later, you can use the Map Control feature that enables you to zoom into the map and view a specific area of interest in detail.

Procedure

- 1 Press the **TRACE/DISPLAY** hard key.
 - 2 Press the **Map Control** soft key. This key is active only when you have loaded a sizable map.
 - 3 Do one of the following:
 - To zoom into an area of interest directly, complete the following steps:
 - a Toggle the **Zoom to** soft key and select **Area**.
The black rectangle appears on the map.
 - b Press the **Zoom In** and **Zoom Out** soft keys, as you need, to decrease and increase the selected area.
 - c Move the rectangle by using the four arrow keys, as you need, to place it in a specific area of interest.
 - d Press the center of the rotary knob to zoom into the selected area. You can also press the **Zoom to** soft key again to zoom into the selected area.
 - To zoom into the center or zoom out from the center, complete the following steps:
 - a Toggle the **Zoom to** soft key and select **Center**.
 - b Press the **Zoom In** and **Zoom Out** soft keys, as you need, to zoom in and zoom out.
 - c Move the zoomed-in area by using the four arrow keys, as you need.
 - 4 To set the location mode, toggle the **Location Mode** soft key between **Auto** and **Manual** and select the one you desire.

Auto: The instrument compares the coordinates of the displayed map with received GPS information. If your current location goes out of the displayed area and enters into the next zoomed-in section within the base map, the map display changes automatically to the next section in which your current position is.

Manual: The map display of the zoomed-in area remains unchanged even if your current location goes out of the displayed area. You can change the displayed area manually by using the arrow keys.
-

Chapter 13 Using Mobile WiMAX Signal Analyzer

This chapter provides instructions for using the Mobile WiMAX Signal Analyzer function (option 026) with the Mobile WiMAX OTA Analyzer function (option 046). Topics discussed in this chapter are as follows:

■ Introduction.....	464
■ Display overview	465
■ Connecting a cable.....	465
■ Selecting measurement mode	467
■ Configuring test parameters.....	467
■ Conducting spectrum measurements	471
■ Conducting RF measurements	473
■ Conducting power vs. time (frame) measurements	479
■ Conducting modulation measurements.....	481
■ Performing auto measurements.....	488
■ Performing power statistics CCDF measurements	489
■ Conducting Mobile WiMAX OTA measurements.....	490

Introduction

The Mobile WiMAX Signal Analyzer performs power and spectrum measurements as well as modulation analysis to test the proper transmitter performance of Mobile WiMAX systems. It performs conformance testing according to the following standards providing a simple Pass/Fail indication on each test.

- IEEE 802.16e-2005
- WiBro (Korean Mobile WiMAX OFDMA Service)

This instrument provides the following measurement tools for Mobile WiMAX system:

- Spectrum Analysis
- RF Analysis
 - Channel Power
 - Occupied Bandwidth
 - Spectrum Emission Mask
 - Spurious Emissions
- Power vs. Time (Frame)
- Modulation Analysis
 - Constellation
 - Spectral Flatness
 - EVM vs. Subcarrier
 - EVM vs. Symbol
- Auto Measure
- Power Statistics CCDF
- Over The Air (OTA)
 - Preamble Scanner
 - Multipath Profile
 - Preamble Power Trend
 - Route Map

Display overview

Figure 277 provides descriptions for each segment of the measurement screen.

Figure 277 Mobile WiMAX signal analyzer measurement screen

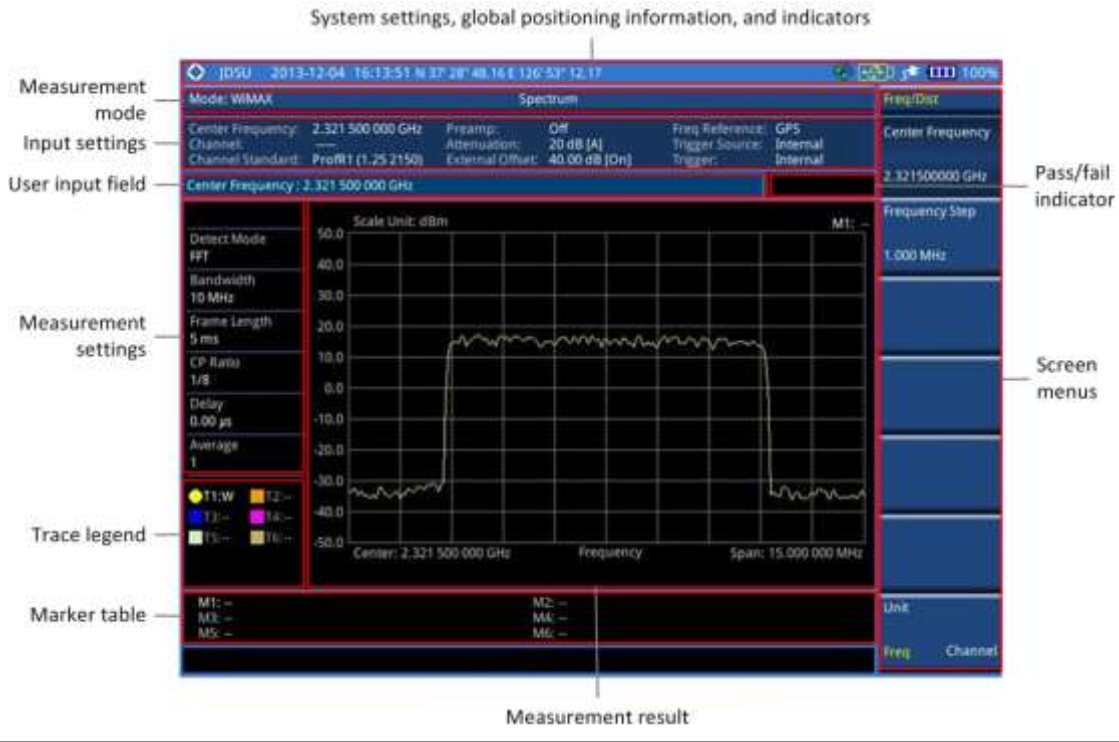

Connecting a cable

Direct connection

Procedure

- 1 Connect the **Spectrum Analyzer RF In** port of the JD700B series and the Power amplifier output port of BTS.

Figure 278 Direct connection



Indirect connection

Procedure

- 1 Connect the **Spectrum Analyzer RF In** port of the JD700B series and the monitor (test) port of BTS.

Figure 279 Indirect connection



CAUTION

The maximum power for the **Spectrum Analyzer RF In** port is +25 dBm (0.316 W) for JD780B series and +20 dBm (0.1 W) for JD740B series. If the level of the input signal to be measured is greater than this, use a **High Power Attenuator** to prevent damage when you directly connect the signal to the instrument or connect the signal from the coupling port of a directional coupler.

Over the air (OTA)

Procedure

- 1 Connect an Omni/directional RF antenna to the **Spectrum Analyzer RF In** port of the JD700B series.
- 2 Connect a GPS antenna to the **GPS** port of the JD700B series.

Figure 280 OTA connection

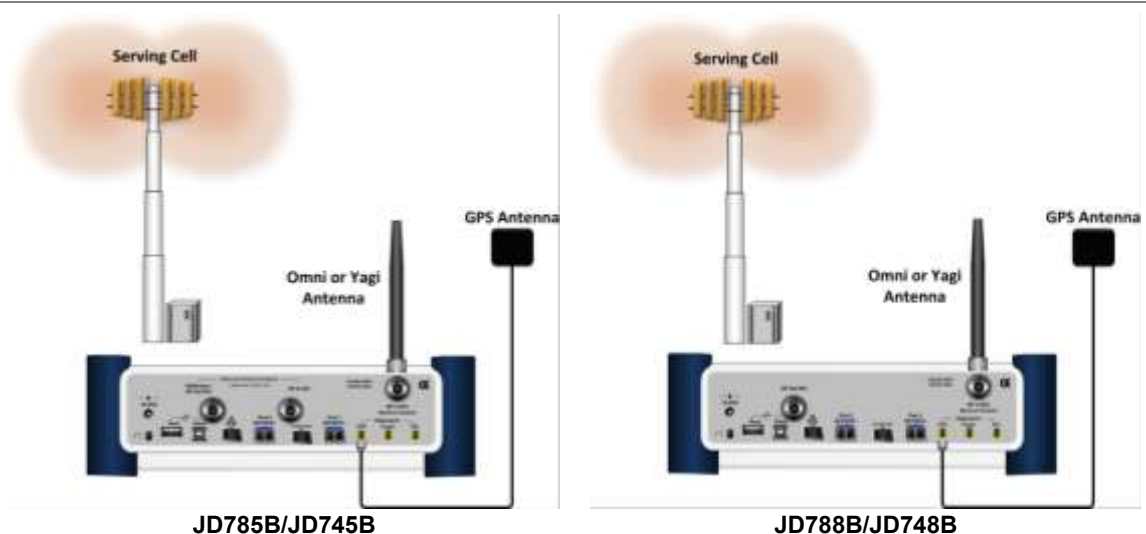

**CAUTION**

If the input signal level to be measured is less than 0 dBm, set 0 dB attenuation or turn on the preamp to have better dynamic range for the OTA testing.

Selecting measurement mode

Procedure

- 1 Press the **MODE** hard key.
- 2 Press the **Signal Analyzer** soft key.
- 3 Select **More (1/2) > Mobile WiMAX**. The **Spectrum** mode is set by default.
- 4 Press the **MEASURE** hot key, and then select the measurement mode option from the following choices:

Spectrum

RF Analysis > Channel Power, Occupied BW, Spectrum Emission Mask, or Spurious Emissions

Power vs Time (Frame)

Modulation Analysis > Constellation, Spectral Flatness, EVM vs Subcarrier, or EVM vs. Symbol

Auto Measure

Power Statistics CCDF

OTA > Preamble Scanner, Multipath Profile, Preamble Power Trend, or Route Map

Configuring test parameters

Setting frequency

You can set the frequency with either frequency or channel number. If a frequency to be set matches to the frequency corresponding to the selected channel standard, the instrument calculates its channel number and updates the screen with it automatically.

Procedure

To set the center frequency:

- 1 Press the **FREQ/DIST** hard key.
- 2 Toggle the **Unit** soft key and select **Freq**.
- 3 Press the **Center Frequency** soft key.
- 4 Enter a value by using the numeric keys. You can also use the rotary knob.
- 5 Select the unit: **GHz, MHz, kHz, or Hz**.
- 6 *Optional.* To define the amount of frequency increment for the rotary knob, complete the following steps:
 - a Press the **Frequency Step** soft key.
 - b Enter a value by using the numeric keys. You can also use the rotary knob.
 - c Press the unit: **GHz, MHz, kHz, or Hz**.

To set the channel number:

- 1 Press the **FREQ/DIST** hard key.
 - 2 Toggle the **Unit** soft key and select **Channel**.
 - 3 To select the standard channel, complete the following steps:
 - a Press the **Channel Std** soft key. The standard channel window appears.
-

-
- See “Appendix C – Band, frequency & channel standard” on page 769 for more information.
 - b Highlight the band to be measured by using the rotary knob, the arrow keys, or the **Page Up/Page Down** soft keys.
 - c Press the **Select** soft key or the rotary knob to confirm the selection.
- 4 Press the **Channel Number** soft key.
 - 5 Enter a value by using the numeric keys. You can also use the rotary knob.
 - 6 Press the **Enter** soft key.
The instrument automatically displays the corresponding center frequency value for the selected channel number.
 - 7 *Optional.* To define the amount of channel increment for the rotary knob, complete the following steps:
 - a Press the **Channel Step** soft key.
 - b Enter a value by using the numeric keys. You can also use the rotary knob.
 - c Press the **Enter** soft key.
-



NOTE

This frequency setting is not used in the Spurious Emissions mode.

Setting amplitude

Reference level and attenuation

You can set the reference and attenuation levels automatically or manually to optimize the display of the traces measured, as you desire.

Procedure

To automatically set the reference and attenuation level:

- 1 Press the **AMP/SCALE** hard key.
- 2 Press the **Auto Scale** soft key.
Each time you press this key, both of the Y-axis scale and input attenuation level change to be optimized with some margin.

To set the reference or attenuation level manually:

- 1 Press the **AMP/SCALE** hard key.
- 2 To set the maximum reference value on the Y-axis manually, complete the following steps:
 - a Press the **Reference Level** soft key.
 - b Enter a value by using the numeric keys or the rotary knob with 10 dB increments.
 - c Press the unit soft key or the **ENTER** hard key.
This unit key name changes according to the setting in the **Units** menu.



NOTE

In the measurements such as **Midamble Power**, **Code Power**, and **Code Error**, you may need to select the reference option between **Relative** and **Absolute** before setting the reference level.

- 3 To set the attenuation option, select one from the following choices:
To set the input attenuator’s level automatically, select **Attenuation > Auto**.



NOTE

It is recommended that you set the **Attenuation** to **Auto** in most situations so that the level of the input attenuator can be set automatically according to your input signal level.

To set the input attenuation manually up to 55 dB for JD780B series or 50 dB for JD740B series to optimize S/N, complete the following steps:

- a Select **Attenuation > Manual**.
 - b Press the **Attenuation Value** soft key to set the level.
 - c Enter a value in fives by using the numeric keys.
-

-
- d Press the **dB** soft key or the **ENTER** hard key.
 To couple the input attenuator's level with your reference level setting, select **Attenuation > Couple**.
 As you increase the reference setting, the attenuation level also increases accordingly.

Optional. To change the scale unit:

- 1 Select **More (1/2) > Units**.
- 2 Select the unit of the display scale: **dBm**, **dBV**, **dBmV**, **dBμV**, **V**, or **W**.
 The scale unit on the screen changes accordingly.



NOTE
 This Units menu is available in the Spectrum and RF Analysis modes.

Scale per division

You can use the **Scale/Div** feature available for the spectrum and RF analysis. It represents the value of one division on the horizontal scale. The default setting is 10 dB per division and the maximum value can be set up to 20 dB.

Procedure

- 1 Press the **AMP/SCALE** hard key.
 - 2 Select **More (1/2) > Scale/Div**.
 - 3 Enter a value between 1 and 20 by using the numeric keys.
 - 4 Press the **dB** soft key to complete the entry.
-

Pre-amplifier

You can turn the internal pre-amplifier on to correct and compensate for the gain of the preamp so that amplitude readings show the value at the input connector.

Procedure

- 1 Press the **AMP/SCALE** hard key.
 - 2 Toggle the **Preamp** soft key and select **On** or **Off** as needed.
-



NOTE
 You can turn the Preamp on when the input attenuation range is from 0 dB to 10 dB. If the attenuation value is manually set to greater than 10 dB, the instrument will automatically turn off the pre-amplifier to display low-level signal properly on the chart.

External offset

You can turn the **External Offset** on and manually set the external offset value. An offset consists of a cable loss and a user offset and the measurement result shows the value reflecting both offset values. When the external offset value is set at 40 dB in the Spectrum mode, the measurement result compensates 40 dB at both the Spectrum Analyzer and Signal Analyzer modes.

Procedure

To set the external offset:

- 1 Press the **AMP/SCALE** hard key.
 - 2 Toggle the **External Offset** soft key and select **On**.
 - 3 Enter a value by using the numeric keys.
-

-
- 4 Press the **dB** soft key to complete the entry.

To turn the external offset off:

- 1 Press the **AMP/SCALE** hard key.
 - 2 Toggle the **External Offset** soft key and select **Off**.
-

Setting average

You can set the number of measurements to be averaged for the trace presentation. A maximum of 100 times of averaging can be set. When the averaging reaches to your setting, a new measurement value replaces the measurement value in sequence from the earliest.

Procedure

- 1 Press the **BW/AVG** hard key.
 - 2 Press the **Average** soft key.
 - 3 Enter a value between 1 and 100 as needed by using the numeric keys.
 - 4 Press the **Enter** soft key.
-

Setting sweep mode

The default setting is **Continue** to sweep continuously for most on-going measurements. If you want to hold the measurement or get a single sweep, you can change the sweep mode.

Procedure

To select the single sweep mode:

- 1 Press the **SWEEP** hot key.
- 2 Toggle the **Sweep Mode** soft key and select **Single**. You can also use the **HOLD** hot key. The letter **HOLD** in red appears and the sweeping is paused.
- 3 *Optional.* Press the **Sweep Once** soft key to get a new measurement.

To return to the continuous sweep mode:

- 1 Toggle the **Sweep Mode** soft key and select **Continue**. You can also use the **HOLD** hot key. The letter **HOLD** in red disappears and the sweeping resumes.
-

Setting trigger source

You can set the trigger source option for your measurements.

Procedure

- 1 Press the **TRIGGER** hot key.
 - 2 Select the trigger source option from the choices: **Internal**, **External**, and **GPS**.
-

Setting external clock

To enhance the reliability of modulation analysis measurements the JD700B series must be synchronized with a base station. When an external clock is not supplied, the instrument works with its built-in internal high-accuracy time base and some measurement results may exhibit inaccurate values. Therefore, it is highly recommended that you use the same reference clock as the signal source. You can use the

TRIGGER hot key to set the external clock.







Figure 281 Connection ports for external reference clock



Procedure

- 1 Connect an external reference or a GPS antenna to the JD700B series.
- 2 Press the **SYSTEM** hot key.
- 3 Press the **Freq Reference** soft key, and then select the reference option: **Internal**, **External 10 MHz**, **External 13 MHz**, **External 15 MHz**, or **GPS**.

Table 19 External reference indicators

Type	Indicator	Description
Internal	 (green)	The green INT icon indicates that the instrument uses the built-in internal time base.
External	 (green)	The green EXT icon indicates that an external reference is connected and locked and that the instrument uses the same reference clock as the signal source.
External	 (red)	The red EXT icon indicates that an external reference is connect but not locked.
GPS	 (green)	The green GPS antenna icon indicates that a GPS antenna is connected and locked.
GPS	 (yellow)	The yellow GPS antenna icon indicates that a GPS antenna is connected and locking is in progress.
GPS	 (grey)	The grey GPS antenna icon indicates that a GPS antenna is not connected, failed, or unable to be locked.

Conducting spectrum measurements

Setting measure setup

After configuring test parameters as described in the “Configuring test parameters” on page 467, you can continue your measurement.

Procedure

- 1 Press the **MEASURE SETUP** hot key.
- 2 Press the **System Config** soft key, and then do the following:
 - a Press the **Bandwidth** soft key, and then select the nominal channel bandwidth to be measured from the following choices:
 - 7 MHz (8/7):** Sets the channel bandwidth to 7 MHz with sampling factor 8/7. In

conjunction with nominal channel bandwidth

8.75 MHz (8/7): Sets the channel bandwidth to 8.75 MHz with sampling factor 8/7

10 MHz (28/25): Sets the channel bandwidth to 10 MHz with sampling factor 28/25

- b Toggle the **Frame Length** soft key and select **5 ms** or **10 ms**.
 - c Press the **TTG (RTG)** soft key to set the transmit/receive transition gap between the last sample of the downlink burst and the first sample of the subsequent uplink burst.
 - d Enter a value by using the numeric keys, and then press the **Enter** soft key.
 - e Press the **CP Ratio** soft key, and then select the cyclic prefix ratio option: **1/4**, **1/8**, **1/16**, or **1/32**.
 - f Press the **DL Symbols** soft key to set the number of downlink symbols.
 - g Enter a value by using the numeric keys, and then press the **Enter** soft key.
 - h Press the **UL Symbols** soft key to set the number of uplink symbols.
 - i Enter a value by using the numeric keys, and then press the **Enter** soft key.
- 3 *Optional.* To set the delay, complete the following steps:
- a Press the **Delay** soft key to set the amount of delay in μs .
 - b Enter a value by using the numeric keys. You can also use the rotary knob.
 - c Press the **μs** soft key.



NOTE
The Delay setting is used only when there is a time offset in the signals to be measured.

Your measurement result is displayed on the screen as like the following example, Figure 282.

Figure 282 Spectrum measurement screen with Mobile WiMAX signal analyzer



Setting trace

You can display up to six traces on the measurement chart simultaneously.

Procedure

- 1 Press the **TRACE/DISPLAY** hard key.
- 2 Press the **Select Trace** soft key, and then select the trace number: **T1**, **T2**, **T3**, **T4**, **T5**, or **T6**. The legend shape of the selected trace changes from square to round to indicate that the trace is the active one now.
- 3 Complete one of the following:

To	Select	Trace Legend
Clear current data and display with new measurements	Clear Write	W
Display the input signal's maximum response only (unlimited or for a certain amount of time)	Max Hold	M
Display the input signal's minimum response only (unlimited or for a certain amount of time)	Min Hold	m
Capture the selected trace and compare traces	Capture	C
Load a saved trace	More (1/2) > Load	L
Hide the displayed trace	Trace View > Off	F
Remove all the traces and initialize the trace settings	More (1/2) > Trace Clear All	

**NOTE**

For the **Max Hold** and **Min Hold**, your instrument compares newly acquired data with the active trace and displays larger maximum values or smaller minimum values on the screen. You can set it to **Unlimited** to hold and view maximum or minimum data or specify a certain amount of time up to 60 seconds by using numeric keys or rotary knob.

- 4 *Optional.* Select **More (1/2) > Trace Info**, and then select the trace number to view the trace's parameter setting information stored at the time of the measurement or **None** to hide the information display.
- 5 *Optional.* If you have the two traces T1 and T2, you can perform trace math. To view the power difference between the traces, press the **T1 – T2 -> T5** or **T2 – T1 -> T6** soft key. The result is overlaid on the screen along with the second Y-axis.

Conducting RF measurements

Channel power

The Channel Power measurement is a common test used in the wireless industry to measure the total transmitted power of a radio within a defined frequency channel. It acquires a number of points representing the input signal in the time domain, transforms this information into the frequency domain using Fast Fourier Transform (FFT), and then calculates the channel power. The effective resolution bandwidth of the frequency domain trace is proportional to the number of points acquired for the FFT.

The channel power measurement identifies the total RF power, power spectral density (PSD) and peak to average ratio (PAR) of the signal in the Mobile WiMAX channel bandwidth.

Setting measure setup

After configuring test parameters as described in the “Configuring test parameters” on page 467, you can continue your measurement.

Procedure

- 1 Press the **MEASURE SETUP** hot key.
- 2 Press the **System Config** soft key, and then do the following:
 - a Press the **Bandwidth** soft key, and then select the nominal channel bandwidth to be measured from the following choices:
 - 7 MHz (8/7):** Sets the channel bandwidth to 7 MHz with sampling factor 8/7. In

conjunction with nominal channel bandwidth

8.75 MHz (8/7): Sets the channel bandwidth to 8.75 MHz with sampling factor 8/7

10 MHz (28/25): Sets the channel bandwidth to 10 MHz with sampling factor 28/25

- b Toggle the **Frame Length** soft key and select **5 ms** or **10 ms**.
 - c Press the **TTG (RTG)** soft key to set the transmit/receive transition gap between the last sample of the downlink burst and the first sample of the subsequent uplink burst.
 - d Enter a value by using the numeric keys, and then press the **Enter** soft key.
 - e Press the **CP Ratio** soft key, and then select the cyclic prefix ratio option: **1/4**, **1/8**, **1/16**, or **1/32**.
 - f Press the **DL Symbols** soft key to set the number of downlink symbols.
 - g Enter a value by using the numeric keys, and then press the **Enter** soft key.
 - h Press the **UL Symbols** soft key to set the number of uplink symbols.
 - i Enter a value by using the numeric keys, and then press the **Enter** soft key.
- 3 *Optional.* To set the delay, complete the following steps:
- a Press the **Delay** soft key to set the amount of delay in μs .
 - b Enter a value by using the numeric keys. You can also use the rotary knob.
 - c Press the **μs** soft key.



NOTE

The Delay setting is used only when there is a time offset in the signals to be measured.

- 4 To set the start/stop symbols, complete the following steps:
- a Press the **Start Symbol** soft key.
 - b Enter a value by using the numeric keys, and then press the **Enter** soft key.
 - c Press the **Stop Symbol** soft key.
 - d Enter a value by using the numeric keys, and then press the **Enter** soft key.

Measurement example

Figure 283 Channel power measurement with Mobile WiMAX signal analyzer



NOTE

You can use the **LIMIT** hot key to analyze your measurements with the user-definable limit and Pass/Fail indication. See “Setting limit for RF tests” on page 479 for more information.

Occupied bandwidth

The Occupied Bandwidth measures the spectrum shape of the carrier. It is defined as the bandwidth, which includes 99% of the transmitted power among total transmitted power.

Setting measure setup

After configuring test parameters as described in the “Configuring test parameters” on page 467, you can continue your measurement.

Procedure

- 1 Press the **MEASURE SETUP** hot key.
- 2 Press the **System Config** soft key, and then do the following:
 - a Press the **Bandwidth** soft key, and then select the nominal channel bandwidth to be measured from the following choices:
 - 7 MHz (8/7)**: Sets the channel bandwidth to 7 MHz with sampling factor 8/7. In conjunction with nominal channel bandwidth
 - 8.75 MHz (8/7)**: Sets the channel bandwidth to 8.75 MHz with sampling factor 8/7
 - 10 MHz (28/25)**: Sets the channel bandwidth to 10 MHz with sampling factor 28/25
 - b Toggle the **Frame Length** soft key and select **5 ms** or **10 ms**.
 - c Press the **TTG (RTG)** soft key to set the transmit/receive transition gap between the last sample of the downlink burst and the first sample of the subsequent uplink burst.
 - d Enter a value by using the numeric keys, and then press the **Enter** soft key.
 - e Press the **CP Ratio** soft key, and then select the cyclic prefix ratio option: **1/4**, **1/8**, **1/16**, or **1/32**.
 - f Press the **DL Symbols** soft key to set the number of downlink symbols.
 - g Enter a value by using the numeric keys, and then press the **Enter** soft key.
 - h Press the **UL Symbols** soft key to set the number of uplink symbols.
 - i Enter a value by using the numeric keys, and then press the **Enter** soft key.
- 3 *Optional*. To set the delay, complete the following steps:
 - a Press the **Delay** soft key to set the amount of delay in μs .
 - b Enter a value by using the numeric keys. You can also use the rotary knob.
 - c Press the **μs** soft key.



NOTE

The Delay setting is used only when there is a time offset in the signals to be measured.

- 4 To set the start/stop symbols, complete the following steps:
 - a Press the **Start Symbol** soft key.
 - b Enter a value by using the numeric keys, and then press the **Enter** soft key.
 - c Press the **Stop Symbol** soft key.
 - d Enter a value by using the numeric keys, and then press the **Enter** soft key.
-

Measurement example

Figure 284 Occupied bandwidth measurement with Mobile WiMAX signal analyzer

**NOTE**

You can use the **LIMIT** hot key to analyze your measurements with the user-definable limit and Pass/Fail indication. See “Setting limit for RF tests” on page 479 for more information.

Spectrum emission mask (SEM)

The Spectrum Emission Mask (SEM) measurement compares the total power level within the defined carrier bandwidth and the given offset channels according to the standards.

Setting measure setup

After configuring test parameters as described in the “Configuring test parameters” on page 467, you can continue your measurement.

Procedure

- 1 Press the **MEASURE SETUP** hot key.
- 2 Press the **System Config** soft key, and then do the following:
 - a Press the **Bandwidth** soft key, and then select the nominal channel bandwidth to be measured from the following choices:
 - 7 MHz (8/7):** Sets the channel bandwidth to 7 MHz with sampling factor 8/7. In conjunction with nominal channel bandwidth
 - 8.75 MHz (8/7):** Sets the channel bandwidth to 8.75 MHz with sampling factor 8/7
 - 10 MHz (28/25):** Sets the channel bandwidth to 10 MHz with sampling factor 28/25
 - b Toggle the **Frame Length** soft key and select **5 ms** or **10 ms**.
 - c Press the **TTG (RTG)** soft key to set the transmit/receive transition gap between the last sample of the downlink burst and the first sample of the subsequent uplink burst.
 - d Enter a value by using the numeric keys, and then press the **Enter** soft key.
 - e Press the **CP Ratio** soft key, and then select the cyclic prefix ratio option: **1/4**, **1/8**, **1/16**, or **1/32**.
 - f Press the **DL Symbols** soft key to set the number of downlink symbols.
 - g Enter a value by using the numeric keys, and then press the **Enter** soft key.

- h Press the **UL Symbols** soft key to set the number of uplink symbols.
 - i Enter a value by using the numeric keys, and then press the **Enter** soft key.
- 3 *Optional.* To set the delay, complete the following steps:
- a Press the **Delay** soft key to set the amount of delay in μs .
 - b Enter a value by using the numeric keys. You can also use the rotary knob.
 - c Press the **μs** soft key.

**NOTE**

The Delay setting is used only when there is a time offset in the signals to be measured.

- 4 To set the start/stop symbols, complete the following steps:
- a Press the **Start Symbol** soft key.
 - b Enter a value by using the numeric keys, and then press the **Enter** soft key.
 - c Press the **Stop Symbol** soft key.
 - d Enter a value by using the numeric keys, and then press the **Enter** soft key.

Measurement example

Figure 285 SEM measurement with Mobile WiMAX signal analyzer

**NOTE**

You can use the **LIMIT** hot key to analyze your measurements with the user-definable limit and Pass/Fail indication. See “Setting limit for RF tests” on page 479 for more information.

Spurious emissions

Out-of-band emissions are unwanted emissions immediately outside the channel bandwidth resulting from the modulation process and non-linearity in the transmitter but excluding spurious emissions. The Spurious Emissions measurement is to identify and determine the power level of out-of-band spurious emission within the necessary channel bandwidth and modulated signal measured at the RF port of the Base Station.

Setting measure setup

After configuring test parameters as described in the “Configuring test parameters” on page 467, you can continue your measurement.

Procedure

- 1 Press the **MEASURE SETUP** hot key.
- 2 To set up the range table and parameters, press the **Range Table** soft key and then complete the following steps:
 - a Press the **Range** soft key, and then select the range number between **1** and **20** to add as a new or change the existing settings.
 - b Do the following as desired:
 - Select **Start Frequency**, and then specify the start frequency for the selected range.
 - Select **Stop Frequency**, and then specify the stop frequency for the selected range.
 - Select **Start Limit**, and then specify the lower limit for Pass/Fail indication.
 - Select **Stop Limit**, and then specify the upper limit for Pass/Fail indication.
 - Select **More (1/2) > Attenuation**, and then specify an value in the multiple of five.
 - Select **More (1/2) > RBW**, and then specify a RBW value.
 - Select **More (1/2) > VBW**, and then specify a VBW value.
 - c Press the **PREV** hard key.
 - d Toggle the **Range** soft key and select **On** to display the selected range in the result table or **Off** to hide it from the table.
- 3 Toggle the **Measure Type** soft key between **Examine** and **Full** to select the measurement type.



NOTE
The **Examine** mode displays only the selected range while the **Full** mode lets the instrument automatically changes the selected range from one another.

- 4 To set the number of measurements to be averaged, complete the following steps:
 - a Press the **Average** soft key.
 - b Enter a value between **1** and **100**, and then press the **Enter** soft key.
- 5 To move the highlighted bar in the result table to other range, complete the following steps:
 - a Press the **Range** soft key in the Measure Setup menu bar.
 - b Enter a value between **1** and **20**, and then press the **Enter** soft key.

Measurement example

Figure 286 Spurious emissions measurement with Mobile WiMAX signal analyzer



NOTE
You can use the **LIMIT** hot key to analyze your measurements with the user-definable limit and Pass/Fail indication. See “Setting limit for RF tests” on page 479 for more information.

Setting limit for RF tests

By default, test limits specified in the standard are set for you. You can change thresholds if you desire.

Procedure

- 1 Press the **LIMIT** hot key.
- 2 Press the **RF Test Limits** soft key.
- 3 Select the test item(s) and set the limit(s) depending on your selected measurement mode:

To set the limit for	Select	Set
Channel power	Channel Power	High Limit, Low Limit
Occupied bandwidth	Occupied BW	High Limit
Spectrum emission mask	Spectrum Emission Mask	(On/Off only)
Spurious emissions	Spurious Emissions	(On/Off only)

- 4 *Optional.* You can enable alarm sound that goes off if the measurement falls outside of the limit. Toggle the **Beep** soft key between **On** and **Off** to enable or disable the beep sound.
 - 5 *Optional.* Go to **SAVE/LOAD > Save**, and then select **Limit** to save the limit settings. See “Using save” on page 34 for more information.
-

Conducting power vs. time (frame) measurements

The Power vs. Time (Frame) measures the modulation envelope in the time domain, showing the power of each time slot in a Mobile WiMAX signal.

Setting measure setup

After configuring test parameters as described in the “Configuring test parameters” on page 467, you can continue your measurement. The measurement settings can be saved and recalled as a file.

Procedure

- 1 Press the **MEASURE SETUP** hot key.
 - 2 Press the **System Config** soft key, and then do the following:
 - a Press the **Bandwidth** soft key, and then select the nominal channel bandwidth to be measured from the following choices:
 - 7 MHz (8/7):** Sets the channel bandwidth to 7 MHz with sampling factor 8/7. In conjunction with nominal channel bandwidth
 - 8.75 MHz (8/7):** Sets the channel bandwidth to 8.75 MHz with sampling factor 8/7
 - 10 MHz (28/25):** Sets the channel bandwidth to 10 MHz with sampling factor 28/25
 - b Toggle the **Frame Length** soft key and select **5 ms** or **10 ms**.
 - c Press the **TTG (RTG)** soft key to set the transmit/receive transition gap between the last sample of the downlink burst and the first sample of the subsequent uplink burst.
 - d Enter a value by using the numeric keys, and then press the **Enter** soft key.
 - e Press the **CP Ratio** soft key, and then select the cyclic prefix ratio option: **1/4**, **1/8**, **1/16**, or **1/32**.
 - f Press the **DL Symbols** soft key to set the number of downlink symbols.
 - g Enter a value by using the numeric keys, and then press the **Enter** soft key.
 - h Press the **UL Symbols** soft key to set the number of uplink symbols.
 - i Enter a value by using the numeric keys, and then press the **Enter** soft key.
-

- 3 To set the start/stop symbols, complete the following steps:
 - a Press the **Start Symbol** soft key.
 - b Enter a value by using the numeric keys, and then press the **Enter** soft key.
 - c Press the **Stop Symbol** soft key.
 - d Enter a value by using the numeric keys, and then press the **Enter** soft key.
- 4 Toggle the **Preamble Index** soft key and select the preamble search method: **Auto** or **Manual**.
- 5 Toggle the **Search Type** soft key and select **Full** or **Window**.
- 6 Toggle the **Video Filter** soft key and select **On** or **Off** to enable or disable the video filter.
- 7 *Optional*. Press the **Miscellaneous** soft key, and then do the following as needed:

To set the delay, complete the following steps:

 - a Press the **Delay** soft key to set the amount of delay in μ s.
 - b Enter a value by using the numeric keys. You can also use the rotary knob.
 - c Press the **μ s** soft key.



NOTE
The Delay setting is used only when there is a time offset in the signals to be measured.

To select the detect mode, press the **Detect Mode** soft key and then select the option: **Auto**, **QPSK**, **16 QAM**, or **64 QAM**.

Setting limit for power vs. time tests

Procedure

- 1 Press the **LIMIT** hot key.
- 2 Press the **PvsT Test Limits** soft key.
- 3 Select the test item(s) and set the limit(s):

To set the limit for	Select	Set
Preamble power	Preamble Power	High Limit, Low Limit
Downlink burst power	DL Burst Power	High Limit, Low Limit
Uplink burst power	UL Burst Power	High Limit, Low Limit
Frame average power	Frame Average Power	High Limit, Low Limit
Time offset	Time Offset	High Limit, Low Limit
I/Q origin offset	IQ Origin Offset	High Limit
- 4 *Optional*. You can enable alarm sound that goes off if the measurement falls outside of the limit. Toggle the **Beep** soft key between **On** and **Off** to enable or disable the beep sound.
- 5 *Optional*. Go to **SAVE/LOAD > Save**, and then select **Limit** to save the limit settings. See “Using save” on page 34 for more information.

Measurement example

Figure 287 Power vs. time (frame) measurement with Mobile WiMAX signal analyzer



Conducting modulation measurements

Constellation

The Constellation is used to observe some aspects of modulation accuracy and can reveal certain fault mechanisms such as I/Q amplitude imbalance or quadrature imbalance. It displays constellation diagram by modulation types.

Setting measure setup

After configuring test parameters as described in the “Configuring test parameters” on page 467, you can continue your measurement. The measurement settings can be saved and recalled as a file. You can also use JDViewer, PC application software to configure a measure setup, save as a file, and load the file on to the instrument.

Procedure

- 1 Press the **MEASURE SETUP** hot key.
- 2 Press the **System Config** soft key, and then do the following:
 - a Press the **Bandwidth** soft key, and then select the nominal channel bandwidth to be measured from the following choices:
 - 7 MHz (8/7)**: Sets the channel bandwidth to 7 MHz with sampling factor 8/7. In conjunction with nominal channel bandwidth
 - 8.75 MHz (8/7)**: Sets the channel bandwidth to 8.75 MHz with sampling factor 8/7
 - 10 MHz (28/25)**: Sets the channel bandwidth to 10 MHz with sampling factor 28/25
 - b Toggle the **Frame Length** soft key and select **5 ms** or **10 ms**.
 - c Press the **TTG (RTG)** soft key to set the transmit/receive transition gap between the last sample of the downlink burst and the first sample of the subsequent uplink burst.
 - d Enter a value by using the numeric keys, and then press the **Enter** soft key.
 - e Press the **CP Ratio** soft key, and then select the cyclic prefix ratio option: **1/4**, **1/8**, **1/16**, or **1/32**.

- f Press the **DL Symbols** soft key to set the number of downlink symbols.
 - g Enter a value by using the numeric keys, and then press the **Enter** soft key.
 - h Press the **UL Symbols** soft key to set the number of uplink symbols.
 - i Enter a value by using the numeric keys, and then press the **Enter** soft key.
- 3 To set the start/stop symbols, complete the following steps:
- a Press the **Start/Stop Symbol** soft key.
 - b Enter a value by using the numeric keys, and then press the **Enter** soft key.
- 4 Toggle the **Preamble Index** soft key and select the preamble search method: **Auto** or **Manual**.
- 5 Toggle the **Search Type** soft key and select **Full** or **Window**.
- 6 *Optional*. Press the **Miscellaneous** soft key, and then do the following as needed:
- To select the detect mode, press the **Detect Mode** soft key and then select the option: **Auto**, **QPSK**, **16 QAM**, or **64 QAM**.
 - To select the downlink zone, press the **DL Zone** soft key and then select the permutation zone option: **Auto**, **PUSC** for partial usage of subcarrier channels, **FUSC** for full usage of subcarrier channels, or **AMC2X3** for adaptive modulation and coding.



NOTE

The permutation zone that is a number of contiguous OFDMA symbols in downlink that use the same permutation. The DL subframe may contain more than one permutation zone. The maximum number of DL zone is 8 in one DL subframe.

To set the delay, complete the following steps:

- a Press the **Delay** soft key to set the amount of delay in μ s.
- b Enter a value by using the numeric keys. You can also use the rotary knob.
- c Press the **μ s** soft key.



NOTE

The Delay setting is used only when there is a time offset in the signals to be measured.

Measurement example

Figure 288 Constellation measurement with Mobile WiMAX signal analyzer



NOTE

You can use the **LIMIT** hot key to analyze your measurements with the user-definable limit and Pass/Fail indication. See “Setting limit for modulation tests” on page 487 for more information. The Spectral Flatness is not used in the Constellation mode.

Spectral flatness

The Spectral Flatness is used to measure the flatness energy of the constellation according to the WiMAX specification IEEE 802.16e.

Setting measure setup

After configuring test parameters as described in the “Configuring test parameters” on page 467, you can continue your measurement. The measurement settings can be saved and recalled as a file. You can also use JDViewer, PC application software to configure a measure setup, save as a file, and load the file on to the instrument.

Procedure

- 1 Press the **MEASURE SETUP** hot key.
- 2 Press the **System Config** soft key, and then do the following:
 - a Press the **Bandwidth** soft key, and then select the nominal channel bandwidth to be measured from the following choices:
 - 7 MHz (8/7)**: Sets the channel bandwidth to 7 MHz with sampling factor 8/7. In conjunction with nominal channel bandwidth
 - 8.75 MHz (8/7)**: Sets the channel bandwidth to 8.75 MHz with sampling factor 8/7
 - 10 MHz (28/25)**: Sets the channel bandwidth to 10 MHz with sampling factor 28/25
 - b Toggle the **Frame Length** soft key and select **5 ms** or **10 ms**.
 - c Press the **TTG (RTG)** soft key to set the transmit/receive transition gap between the last sample of the downlink burst and the first sample of the subsequent uplink burst.
 - d Enter a value by using the numeric keys, and then press the **Enter** soft key.
 - e Press the **CP Ratio** soft key, and then select the cyclic prefix ratio option: **1/4**, **1/8**, **1/16**, or **1/32**.
 - f Press the **DL Symbols** soft key to set the number of downlink symbols.
 - g Enter a value by using the numeric keys, and then press the **Enter** soft key.
 - h Press the **UL Symbols** soft key to set the number of uplink symbols.
 - i Enter a value by using the numeric keys, and then press the **Enter** soft key.
- 3 To set the start/stop symbols, complete the following steps:
 - a Press the **Start Symbol** soft key.
 - b Enter a value by using the numeric keys, and then press the **Enter** soft key.
 - c Press the **Stop Symbol** soft key.
 - d Enter a value by using the numeric keys, and then press the **Enter** soft key.
- 4 Toggle the **Preamble Index** soft key and select the preamble search method: **Auto** or **Manual**.
- 5 Toggle the **Search Type** soft key and select **Full** or **Window**.
- 6 *Optional.* Press the **Miscellaneous** soft key, and then do the following as needed:
 - To select the detect mode, press the **Detect Mode** soft key and then select the option: **Auto**, **QPSK**, **16 QAM**, or **64 QAM**.
 - To select the downlink zone, press the **DL Zone** soft key and then select the permutation zone option: **Auto**, **PUSC** for partial usage of subcarrier channels, **FUSC** for full usage of subcarrier channels, or **AMC2X3** for adaptive modulation and coding.



NOTE

The permutation zone, which is a number of contiguous OFDMA, symbols in downlink that use the same permutation. The DL subframe may contain more than one permutation zone. The maximum number of DL zone is 8 in one DL subframe.

To set the delay, complete the following steps:

- a Press the **Delay** soft key to set the amount of delay in μs .
 - b Enter a value by using the numeric keys. You can also use the rotary knob.
 - c Press the **μs** soft key.
-



NOTE
The Delay setting is used only when there is a time offset in the signals to be measured.

Measurement example

Figure 289 Spectral flatness measurement with Mobile WiMAX signal analyzer



NOTE
You can use the **LIMIT** hot key to analyze your measurements with the user-definable limit and Pass/Fail indication for the Spectral Flatness. See “Setting limit for modulation tests” on page 487 for more information.

EVM vs. subcarrier

The EVM vs Subcarrier shows the error vector magnitude representing the average constellation error of WiMAX OFDMA subcarriers.

Setting measure setup

After configuring test parameters as described in the “Configuring test parameters” on page 467, you can continue your measurement. The measurement settings can be saved and recalled as a file. You can also use JDViewer, PC application software to configure a measure setup, save as a file, and load the file on to the instrument.

Procedure

- 1 Press the **MEASURE SETUP** hot key.
- 2 Press the **System Config** soft key, and then do the following:
 - a Press the **Bandwidth** soft key, and then select the nominal channel bandwidth to be measured from the following choices:
 - 7 MHz (8/7):** Sets the channel bandwidth to 7 MHz with sampling factor 8/7. In conjunction with nominal channel bandwidth
 - 8.75 MHz (8/7):** Sets the channel bandwidth to 8.75 MHz with sampling factor 8/7
 - 10 MHz (28/25):** Sets the channel bandwidth to 10 MHz with sampling factor 28/25
 - b Toggle the **Frame Length** soft key and select **5 ms** or **10 ms**.
 - c Press the **TTG (RTG)** soft key to set the transmit/receive transition gap between the last

- d sample of the downlink burst and the first sample of the subsequent uplink burst.
 - d Enter a value by using the numeric keys, and then press the **Enter** soft key.
 - e Press the **CP Ratio** soft key, and then select the cyclic prefix ratio option: **1/4**, **1/8**, **1/16**, or **1/32**.
 - f Press the **DL Symbols** soft key to set the number of downlink symbols.
 - g Enter a value by using the numeric keys, and then press the **Enter** soft key.
 - h Press the **UL Symbols** soft key to set the number of uplink symbols.
 - i Enter a value by using the numeric keys, and then press the **Enter** soft key.
- 3 To set the start/stop symbols, complete the following steps:
 - a Press the **Start/Stop Symbol** soft key.
 - b Enter a value by using the numeric keys, and then press the **Enter** soft key.
 - 4 Toggle the **Preamble Index** soft key and select the preamble search method: **Auto** or **Manual**.
 - 5 Toggle the **Search Type** soft key and select **Full** or **Window**.
 - 6 *Optional.* Press the **Miscellaneous** soft key, and then do the following as needed:
 - To select the detect mode, press the **Detect Mode** soft key and then select the option: **Auto**, **QPSK**, **16 QAM**, or **64 QAM**.
 - To select the downlink zone, press the **DL Zone** soft key and then select the permutation zone option: **Auto**, **PUSC** for partial usage of subcarrier channels, **FUSC** for full usage of subcarrier channels, or **AMC2X3** for adaptive modulation and coding.



NOTE
The permutation zone, which is a number of contiguous OFDMA, symbols in downlink that use the same permutation. The DL subframe may contain more than one permutation zone. The maximum number of DL zone is 8 in one DL subframe.

To set the delay, complete the following steps:

- a Press the **Delay** soft key to set the amount of delay in μ s.
- b Enter a value by using the numeric keys. You can also use the rotary knob.
- c Press the **μ s** soft key.



NOTE
The Delay setting is used only when there is a time offset in the signals to be measured.

Measurement example

Figure 290 EVM vs. subcarrier measurement with Mobile WiMAX signal analyzer



**NOTE**

You can use the **LIMIT** hot key to analyze your measurements with the user-definable limit and Pass/Fail indication. See “Setting limit for modulation tests” on page 487 for more information. The Spectral Flatness and Frequency Error are not used in the EVM vs. Subcarrier mode.

EVM vs. symbol

The EVM vs Symbol is used to show the error vector magnitude representing the average constellation error of WiMAX OFDMA symbols.

Setting measure setup

After configuring test parameters as described in the “Configuring test parameters” on page 467, you can continue your measurement. The measurement settings can be saved and recalled as a file. You can also use JDViewer, PC application software to configure a measure setup, save as a file, and load the file on to the instrument.

Procedure

- 1 Press the **MEASURE SETUP** hot key.
- 2 Press the **System Config** soft key, and then do the following:
 - a Press the **Bandwidth** soft key, and then select the nominal channel bandwidth to be measured from the following choices:
 - 7 MHz (8/7)**: Sets the channel bandwidth to 7 MHz with sampling factor 8/7. In conjunction with nominal channel bandwidth
 - 8.75 MHz (8/7)**: Sets the channel bandwidth to 8.75 MHz with sampling factor 8/7
 - 10 MHz (28/25)**: Sets the channel bandwidth to 10 MHz with sampling factor 28/25
 - b Toggle the **Frame Length** soft key and select **5 ms** or **10 ms**.
 - c Press the **TTG (RTG)** soft key to set the transmit/receive transition gap between the last sample of the downlink burst and the first sample of the subsequent uplink burst.
 - d Enter a value by using the numeric keys, and then press the **Enter** soft key.
 - e Press the **CP Ratio** soft key, and then select the cyclic prefix ratio option: **1/4**, **1/8**, **1/16**, or **1/32**.
 - f Press the **DL Symbols** soft key to set the number of downlink symbols.
 - g Enter a value by using the numeric keys, and then press the **Enter** soft key.
 - h Press the **UL Symbols** soft key to set the number of uplink symbols.
 - i Enter a value by using the numeric keys, and then press the **Enter** soft key.
- 3 To set the start/stop symbols, complete the following steps:
 - a Press the **Start/Stop Symbol** soft key.
 - b Enter a value by using the numeric keys, and then press the **Enter** soft key.
- 4 Toggle the **Preamble Index** soft key and select the preamble search method: **Auto** or **Manual**.
- 5 Toggle the **Search Type** soft key and select **Full** or **Window**.
- 6 *Optional.* Press the **Miscellaneous** soft key, and then do the following as needed:
 - To select the detect mode, press the **Detect Mode** soft key and then select the option: **Auto**, **QPSK**, **16 QAM**, or **64 QAM**.
 - To select the downlink zone, press the **DL Zone** soft key and then select the permutation zone option: **Auto**, **PUSC** for partial usage of subcarrier channels, **FUSC** for full usage of subcarrier channels, or **AMC2X3** for adaptive modulation and coding.

**NOTE**

The permutation zone, which is a number of contiguous OFDMA, symbols in downlink that use the same permutation. The DL subframe may contain more than one permutation zone. The maximum number of DL zone is 8 in one DL subframe.

To set the delay, complete the following steps:

- a Press the **Delay** soft key to set the amount of delay in μs .
- b Enter a value by using the numeric keys. You can also use the rotary knob.
- c Press the **μs** soft key.



NOTE
The Delay setting is used only when there is a time offset in the signals to be measured.

Measurement example

Figure 291 EVM vs. symbol measurement with Mobile WiMAX signal analyzer



NOTE
You can use the **LIMIT** hot key to analyze your measurements with the user-definable limit and Pass/Fail indication. See “Setting limit for modulation tests” on page 487 for more information. The Spectral Flatness and Frequency Error are not used in the EVM vs. Subcarrier mode.

Setting limit for modulation tests

Procedure

- 1 Press the **LIMIT** hot key.
- 2 Press the **Modulation Test Limits** soft key to set the limits.
- 3 Select the test item(s) and set the limit(s) depending on your selected measurement mode:

To set the limit for	Select	Set
Spectral flatness	Spectral Flatness	On/Off
Frequency error	Frequency Error	High Limit, Low Limit
RMS for RCE	RCE RMS	High Limit
Peak for RCE	RCE Peak	High Limit
RMS for error vector magnitude	EVM RMS	High Limit
Peak for error vector magnitude	EVM Peak	High Limit

- 4 *Optional.* You can enable alarm sound that goes off if the measurement falls outside of the limit. Toggle the **Beep** soft key between **On** and **Off** to enable or disable the beep sound.

-
- 5 *Optional.* Go to **SAVE/LOAD > Save**, and then select **Limit** to save the limit settings. See “Using save” on page 34 for more information.
-

Performing auto measurements

The Auto Measure function of the JD700B series allows a complete signal profiling covering RF characterization and modulation quality parameters of up to 10 different carriers, particularly useful on an overlay architecture where base stations are transmitting in different frequencies.

The Auto Measure can be easily executed either by selecting a menu in the instrument or by running a programmed scenario in the PC-based application so that the instrument automatically configure and perform tests on every aspect of all the carriers.

Setting limit

You can set test limits for test item(s) in the auto measurement.

Procedure

- 1 Press the **LIMIT** hot key.
 - 2 Press the **RF Test Limits** soft key, and then enable test limits as desired.
 - 3 Press the **PvsT Test Limits** soft key, and then enable test limits as desired.
 - 4 Press the **Modulation Test Limits** soft key, and then enable test limits as desired.
 - 5 *Optional.* You can enable alarm sound that goes off if the measurement falls outside of the limit. Toggle the **Beep** soft key between **On** and **Off** to enable or disable the beep sound.
 - 6 *Optional.* Go to **SAVE/LOAD > Save**, and then select **Limit** to save the limit settings. See “Using save” on page 34 for more information.
-

Setting measure setup

After configuring test parameters as described in the “Configuring test parameters” on page 467, you can continue your measurement. The measurement settings can be saved and recalled as a file. You can also use JDViewer, PC application software to configure a measure setup, save as a file, and load the file on to the instrument.

Procedure

- 1 Press the **MEASURE SETUP** hot key.
 - 2 Toggle the **Configuration** soft key and select the configuration option:
 - Current:** Lets the instrument use current frequency (single carrier) and determine pass or fail based on the instrument’s limit settings in Auto Measure.
 - Scenario:** Runs a test with a programmed scenario in JDViewer. The Scenario menu becomes activated.
 - 3 To load a scenario, press the **Scenario** soft key, and then select a scenario file to load.
 - 4 Toggle the **Test Time** soft key and select the test time option:
 - Now:** Lets the instrument run a test only once.
 - Schedule:** Lets the instrument repeat tests as defined in the Set Timing. The Set Timing menu becomes activated.
 - 5 To define a schedule for an auto measurement, complete the following steps:
 - a Press the **Set Timing** soft key.
 - b Press the **Start Time (HH:MM)** soft key.
-

-
- c Enter the time in the HH:MM format, and then press the **Enter** soft key.
 - d Press the **Stop Time (HH:MM)** soft key.
 - e Enter the time in the HH:MM format, and then press the **Enter** soft key.
 - f Press the **Time Interval** soft key.
 - g Enter the amount of time in minutes, and then press the **Enter** soft key.
- 6 Press the **Settings** soft key, and then set the following:
 - a Press the **Start Symbol** soft key.
 - b Enter a value by using the numeric keys, and then press the **Enter** soft key.
 - c Press the **Stop Symbol** soft key.
 - d Enter a value by using the numeric keys, and then press the **Enter** soft key.
 - e Toggle the **External Offset** soft key and select **On** or **Off**.
 - f Enter a value by using the numeric keys, and then press the **dB** soft key.
 - 7 To save your settings and results, go to **SAVE/LOAD > Save** and then perform functions as you desire. See “Using save” on page 34 for more information.
 - 8 Press the **Run Test** soft key to start to run a test.
The Auto Measure Results window appears at the end of the test.
 - 9 To stop running the test, press the **Abort** soft key.
 - 10 To change the view on the screen during the test, press the **Display** and then select the view option from the following choices:
 - Screen:** You can view each measurement screen as the test progresses.
 - Results:** You can view a measurement result table as the test progresses.
 - Settings:** You can view a measurement setting table as the test progresses.
-

Setting display

After completion of the auto measurement, the screen menu changes to Trace/Display so that you can view the results in different forms.

Procedure

- 1 Toggle the **Display** soft key and select the display option:
 - Result:** You can view the result table.
The Display Result menu becomes activated.
 - Settings:** You can view the measurement settings for the auto measurement.
 - 2 Toggle the **Display Result** soft key and select the display result option:
 - Full:** You can view detailed measurement readings with the pass/fail indication.
 - Quick:** You can view only the Pass/Fail results.
 - 3 To view the measurement results for a different carrier, press the **View Carrier** soft key and then select the carrier number to view.
-

Performing power statistics CCDF measurements

The Power Statistics Complementary Cumulative Distribution Function (CCDF) measurement characterizes the power statistics of the input signal. It provides PAR (Peak to Average power Ratio) versus different probabilities.

Setting measure setup

After configuring test parameters as described in the “Configuring test parameters” on page 467, you can continue your measurement. The measurement settings can be saved and recalled as a file. You can also use JDViewer, PC application software to configure a measure setup, save as a file, and load the file on to

the instrument.

Procedure

- 1 Press the **MEASURE SETUP** hot key.
 - 2 Press the **CCDF Length** soft key to set the length of the CCDF.
 - 3 Enter a value between 1 and 100 by using the numeric keys. You can also use the rotary knob.
 - 4 Press the **Enter** soft key.
-

Measurement example

Figure 292 CCDF measurement with Mobile WiMAX signal analyzer



Conducting Mobile WiMAX OTA measurements

This Over The Air (OTA) measurement has preamble scanner, multipath profile, and preamble power trend screens. Preamble scanner displays six preambles and relative powers to inform neighbor cells existence. The multipath profile graph helps the user to determine testing area's RF environmental condition. The preamble power trend shows power variations of selected preamble over time along with relative power trend for strongest preamble.

Preamble scanner

The OTA Preamble Scanner displays the six strongest preambles to inform neighbor cells existence of testing area. Preamble Index, Relative Power, Physical Cell ID, and Sector ID are listed in for each preamble signal with Time Offset in us. Positioning information, latitude, and longitude will be displayed if a GPS antenna is supplied and locked to the GPS satellites on the bottom of the screen.

Setting measure setup

After configuring test parameters as described in the “Configuring test parameters” on page 467, you can continue your measurement.

Procedure

- 1 Press the **MEASURE SETUP** hot key.
- 2 Press the **System Config** soft key, and then do the following:
 - a Press the **Bandwidth** soft key, and then select the nominal channel bandwidth to be measured from the following choices:
 - 7 MHz (8/7)**: Sets the channel bandwidth to 7 MHz with sampling factor 8/7. In conjunction with nominal channel bandwidth
 - 8.75 MHz (8/7)**: Sets the channel bandwidth to 8.75 MHz with sampling factor 8/7
 - 10 MHz (28/25)**: Sets the channel bandwidth to 10 MHz with sampling factor 28/25
 - b Toggle the **Frame Length** soft key and select **5 ms** or **10 ms**.
 - c Press the **TTG (RTG)** soft key to set the transmit/receive transition gap between the last sample of the downlink burst and the first sample of the subsequent uplink burst.
 - d Enter a value by using the numeric keys, and then press the **Enter** soft key.
 - e Press the **CP Ratio** soft key, and then select the cyclic prefix ratio option: **1/4**, **1/8**, **1/16**, or **1/32**.
 - f Press the **DL Symbols** soft key to set the number of downlink symbols.
 - g Enter a value by using the numeric keys, and then press the **Enter** soft key.
 - h Press the **UL Symbols** soft key to set the number of uplink symbols.
 - i Enter a value by using the numeric keys, and then press the **Enter** soft key.
- 3 *Optional.* Press the **Miscellaneous** soft key, and then do the following steps:
 - a Press the **Delay** soft key to set the amount of delay in μ s.
 - b Enter a value by using the numeric keys. You can also use the rotary knob.
 - c Press the **μ s** soft key.

**NOTE**

The Delay setting is used only when there is a time offset in the signals to be measured.

- 4 *Optional.* Go to **SAVE/LOAD > Save**, and then select the save option from the choices available for your measurement mode. See “Using save” on page 34 for more information.
-

Measurement example**Figure 293 Preamble scanner measurement with Mobile WiMAX OTA signal analyzer**

Multipath profile

The Multipath Profile enables the user to determine RF environmental conditions of testing area. It indicates the multipath power with time delay in us up to six.

The multipath profile is the result of portions of the original broadcast signal arriving at the receiving antenna out of phase. This can be caused by the signal being reflected off objects such as buildings, or being refracted through the atmosphere differently from the main signal.

Setting measure setup

After configuring test parameters as described in the “Configuring test parameters” on page 467, you can continue your measurement.

Procedure

- 1 Press the **MEASURE SETUP** hot key.
- 2 Press the **System Config** soft key, and then do the following:
 - a Press the **Bandwidth** soft key, and then select the nominal channel bandwidth to be measured from the following choices:
 - 7 MHz (8/7)**: Sets the channel bandwidth to 7 MHz with sampling factor 8/7. In conjunction with nominal channel bandwidth
 - 8.75 MHz (8/7)**: Sets the channel bandwidth to 8.75 MHz with sampling factor 8/7
 - 10 MHz (28/25)**: Sets the channel bandwidth to 10 MHz with sampling factor 28/25
 - b Toggle the **Frame Length** soft key and select **5 ms** or **10 ms**.
 - c Press the **TTG (RTG)** soft key to set the transmit/receive transition gap between the last sample of the downlink burst and the first sample of the subsequent uplink burst.
 - d Enter a value by using the numeric keys, and then press the **Enter** soft key.
 - e Press the **CP Ratio** soft key, and then select the cyclic prefix ratio option: **1/4**, **1/8**, **1/16**, or **1/32**.
 - f Press the **DL Symbols** soft key to set the number of downlink symbols.
 - g Enter a value by using the numeric keys, and then press the **Enter** soft key.
 - h Press the **UL Symbols** soft key to set the number of uplink symbols.
 - i Enter a value by using the numeric keys, and then press the **Enter** soft key.
- 3 *Optional*. Press the **Miscellaneous** soft key, and then do the following steps:
 - a Press the **Delay** soft key to set the amount of delay in μ s.
 - b Enter a value by using the numeric keys. You can also use the rotary knob.
 - c Press the **μ s** soft key.



NOTE

The Delay setting is used only when there is a time offset in the signals to be measured.

- 4 *Optional*. Go to **SAVE/LOAD > Save**, and then select the save option from the choices available for your measurement mode. See “Using save” on page 34 for more information.
-

Measurement example

Figure 294 Multipath profile measurement with Mobile WiMAX OTA signal analyzer



Preamble power trend

The Preamble Power Trend shows power variations of a strongest preamble signal over time along with the relative power trend compare to total preamble power. Searching preamble index can be set auto to detect strongest or manual to search specific preamble. Positioning information, latitude, and longitude will be displayed if a GPS antenna is supplied and locked to the GPS satellites on the bottom of the screen.

Setting measure setup

After configuring test parameters as described in the “Configuring test parameters” on page 467, you can continue your measurement.

Procedure

- 1 Press the **MEASURE SETUP** hot key.
- 2 Press the **System Config** soft key, and then do the following:
 - a Press the **Bandwidth** soft key, and then select the nominal channel bandwidth to be measured from the following choices:
 - 7 MHz (8/7):** Sets the channel bandwidth to 7 MHz with sampling factor 8/7. In conjunction with nominal channel bandwidth
 - 8.75 MHz (8/7):** Sets the channel bandwidth to 8.75 MHz with sampling factor 8/7
 - 10 MHz (28/25):** Sets the channel bandwidth to 10 MHz with sampling factor 28/25
 - b Toggle the **Frame Length** soft key and select **5 ms** or **10 ms**.
 - c Press the **TTG (RTG)** soft key to set the transmit/receive transition gap between the last sample of the downlink burst and the first sample of the subsequent uplink burst.
 - d Enter a value by using the numeric keys, and then press the **Enter** soft key.
 - e Press the **CP Ratio** soft key, and then select the cyclic prefix ratio option: **1/4**, **1/8**, **1/16**, or **1/32**.
 - f Press the **DL Symbols** soft key to set the number of downlink symbols.
 - g Enter a value by using the numeric keys, and then press the **Enter** soft key.
 - h Press the **UL Symbols** soft key to set the number of uplink symbols.
 - i Enter a value by using the numeric keys, and then press the **Enter** soft key.

- 3 Toggle the **Preamble Index** soft key and select the preamble search method: **Auto** or **Manual**.
- 4 *Optional.* Press the **Miscellaneous** soft key, and then do the following steps:
 - a Press the **Delay** soft key to set the amount of delay in μs .
 - b Enter a value by using the numeric keys. You can also use the rotary knob.
 - c Press the μs soft key.



NOTE
The Delay setting is used only when there is a time offset in the signals to be measured.

- 5 *Optional.* Go to **SAVE/LOAD > Save**, and then select the save option from the choices available for your measurement mode. See “Using save” on page 34 for more information.

Measurement example

Figure 295 Preamble power trend with Mobile WiMAX OTA signal analyzer



Route map

The JD700B Series provides the Route Map function that allows you to collect data of points in an indoor or outdoor environment and track the received signals and coverage of RF transmitters by plotting data real time directly on top of a loaded floor plan or a map.

Setting measure setup

Procedure

- 1 If required, connect a GPS receiver to your JD700B series for outdoor mapping. Indoor mapping does not necessarily need a GPS antenna.
- 2 Configure test parameters as described in the “Configuring test parameters” on page 467.
- 3 To load your map file, complete the following steps:
 - a Plug in your USB drive that has a floor map or `.mcf` file type created in JDMAPCreator. If the JDMAPCreator application on your computer is connected to the instrument via USB or LAN, you can send a map file with a single layer to the instrument directly by using the **Send to EQP** menu in JDMAPCreator.



NOTE
The JDMAPCreator converts and resizes any scanned floor plan or layout to fit onto your instrument’s display. JDMAPCreator 1.2.0 or later can save a multiple-layered map, providing **x1**, **x2**, and **x4** views, as a sizable map file so that you can zoom in and out after loading it.

- b Press **SAVE/LOAD** hot key, and then select **Load > Load Map**. See “Using load” on page 36 for more information.
- 4 Press the **MEASURE SETUP** hot key.
- 5 Press the **Plot Point** soft key, and then select the plot point option from the following choices:
To collect data/plot points automatically as you move around in a vehicle or outside, press the **GPS** soft key and then toggle the **Screen Mode** soft key between **Map** and **Full**.

**NOTE**

With the **Map** setting, you can view only the collected points that can be seen within the boundary of the loaded map. If a point is off the map, the instrument displays an arrow to indicate the direction of the current location on the map and the distance from the center to the location at the top of the screen.

With the **Full** setting, you can view all the collected points of the route without the loaded map.

To collect data/plot points manually without a GPS antenna in an indoor environment, press the **Position** soft key.

- 6 Toggle the **Plot** soft key and select **Start** to start plotting.
- 7 Touch directly on the screen or press the **ENTER** hard key to collect data and plot points on the loaded map for the **Position** setting.

**NOTE**

For the **Position** setting, you can change the direction of the route with the arrow keys and the distance with the rotary knob.

- 8 Toggle the **Plot** soft key and select **Stop** to stop plotting.
- 9 Press the **SAVE/LOAD** hot key to save the result.
See “Using save” on page 34 for more information.

**NOTE**

The instrument does not automatically save the collected data. It is recommended that you save the result. Otherwise, you will lose all the collected data.

Setting limit for route map

You can set the thresholds for each test item.

Procedure

- 1 Press the **LIMIT** hot key.
- 2 Press the **Excellent** soft key to set its threshold.
- 3 Enter a value, and then press the **Enter** soft key. You can also use the rotary knob.
- 4 Press the **Very Good** soft key to set its threshold.
- 5 Enter a value, and then press the **Enter** soft key. You can also use the rotary knob.
- 6 Press the **Good** soft key to set its threshold.
- 7 Enter a value, and then press the **Enter** soft key. You can also use the rotary knob.
- 8 Press the **Fair** soft key to set its threshold.
- 9 Enter a value, and then press the **Enter** soft key. You can also use the rotary knob.
- 10 Press the **Poor** soft key to set its threshold.
- 11 Enter a value, and then press the **Enter** soft key. You can also use the rotary knob.
- 12 *Optional.* Go to **SAVE/LOAD > Save**, and then select **Limit** to save the limit settings.
See “Using save” on page 34 for more information.

Measurement example

Figure 296 Route map measurement with Mobile WiMAX OTA signal analyzer

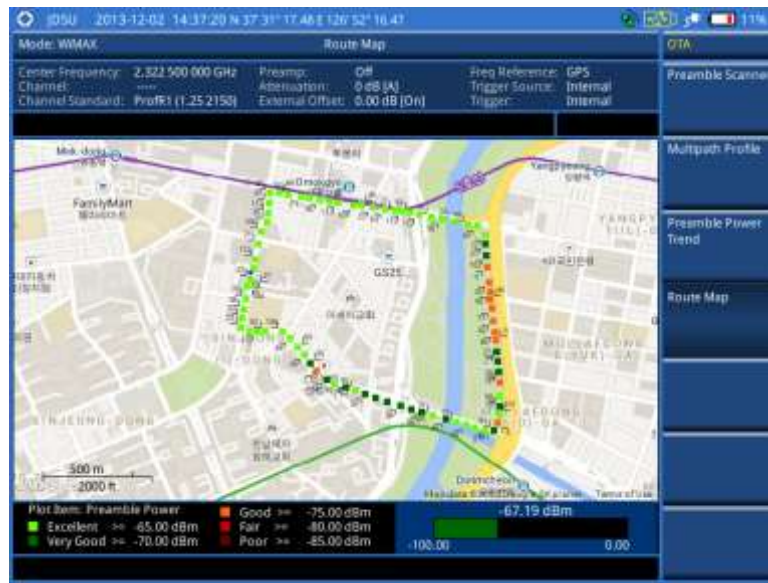

Controlling a map

If you have loaded a sizable map that was created in JDMAPCreator 1.2.0 or later, you can use the Map Control feature that enables you to zoom into the map and view a specific area of interest in detail.

Procedure

- 1 Press the **TRACE/DISPLAY** hard key.
- 2 Press the **Map Control** soft key. This key is active only when you have loaded a sizable map.
- 3 Do one of the following:
 - To zoom into an area of interest directly, complete the following steps:
 - a Toggle the **Zoom to** soft key and select **Area**. The black rectangle appears on the map.
 - b Press the **Zoom In** and **Zoom Out** soft keys, as you need, to decrease and increase the selected area.
 - c Move the rectangle by using the four arrow keys, as you need, to place it in a specific area of interest.
 - d Press the center of the rotary knob to zoom into the selected area. You can also press the **Zoom to** soft key again to zoom into the selected area.
 - To zoom into the center or zoom out from the center, complete the following steps:
 - a Toggle the **Zoom to** soft key and select **Center**.
 - b Press the **Zoom In** and **Zoom Out** soft keys, as you need, to zoom in and zoom out.
 - c Move the zoomed-in area by using the four arrow keys, as you need.
- 4 To set the location mode, toggle the **Location Mode** soft key between **Auto** and **Manual** and select the one you desire.

Auto: The instrument compares the coordinates of the displayed map with received GPS information. If your current location goes out of the displayed area and enters into the next zoomed-in section within the base map, the map display changes automatically to the next section in which your current position is.

Manual: The map display of the zoomed-in area remains unchanged even if your current location goes out of the displayed area. You can change the displayed area manually by using the arrow keys.

Chapter 14 Using NB-IoT Signal Analyzer

This chapter provides instructions for using the NB-IoT Signal Analyzer with the NB-IoT Analyzer function (option 034). Topics discussed in this chapter are as follows:

■ Introduction.....	498
■ Connecting a cable.....	499
■ Selecting measurement mode	500
■ Configuring test parameters.....	501
■ Conducting NB-IoT in band spectrum measurement.....	505
■ Conducting NB-IoT in band modulation analysis	506
■ Conducting NB-IoT guard band spectrum measurement	508
■ Conducting NB-IoT guard band spectrum emission mask (SEM)	509
■ Conducting NB-IoT guard band modulation analysis.....	510
■ Conducting NB-IoT standalone RF measurements	511
■ Conducting NB-IoT standalone modulation analysis	516

Introduction

The JD700B series provide features to analyze the NB-IoT signal running with in band, guard band, and standalone. By implementing demodulation capability for NB-IoT, the JD700B series can be a 4.5G solution being deployed on top of the existing LTE network.

The NB-IoT Signal Analyzer consists of the following operation modes:

- In Band mode
- Guard Band mode
- Standalone mode

This instrument provides the following measurement tools for the NB-IoT:

- Spectrum Analysis for In Band and Guard Band
- Modulation Analysis
- RF Analysis for Standalone
 - Channel Power
 - Occupied Bandwidth
 - Spectrum Emission Mask
 - ACLR
 - Spurious Emissions

Connecting a cable

Direct connection

Procedure

- 1 Connect the **Spectrum Analyzer RF In** port of the JD700B series and the Power amplifier output port of BTS.

Figure 297 Direct connection



Indirect connection

Procedure

- 1 Connect the **Spectrum Analyzer RF In** port of the JD700B series and the monitor (test) port of BTS.

Figure 298 Indirect connection



CAUTION

The maximum power for the **Spectrum Analyzer RF In** port is +25 dBm (0.316 W) for JD780B series and +20 dBm (0.1 W) for JD740B series. If the level of the input signal to be measured is greater than this, use a **High Power Attenuator** to prevent damage when you directly connect the signal to the instrument or connect the signal from the coupling port of a directional coupler.

Over the air (OTA)

Procedure

- 1 Connect an Omni/directional RF antenna to the **Spectrum Analyzer RF In** port of the JD700B

series.

- 2 Connect a GPS antenna to the **GPS** port of the JD700B series.

Figure 299 OTA connection

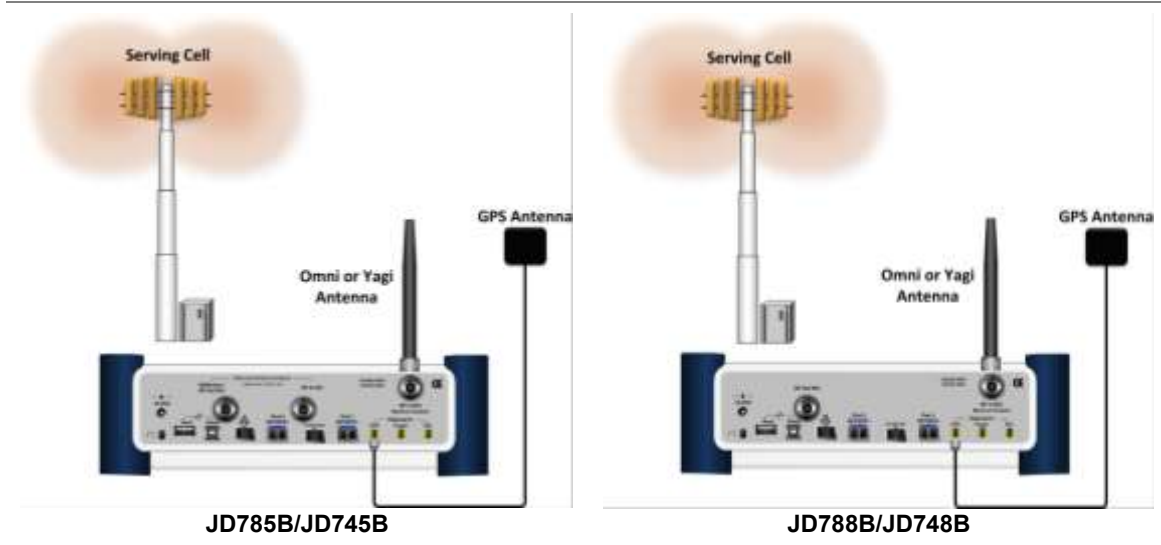

CAUTION

If the input signal level to be measured is less than 0 dBm, set 0 dB attenuation or turn on the preamp to have better dynamic range for the OTA testing.

Selecting measurement mode

Procedure

- 1 Press the **MODE** hard key.
- 2 Press the **Signal Analyzer** soft key.
- 3 Select **More (1/2) > NB-IoT**. The **Spectrum** mode is set by default.
- 4 Select between **In Band**, **Guard Band** and **Standalone** mode.
- 5 Press the **MEASURE** hot key for **In Band** mode, and then select the measurement mode option from the following choices:
 - Spectrum**
 - Modulation Analysis**
- 6 Press the **MEASURE** hot key for **Guard Band** mode, and then select the measurement mode option from the following choices:
 - Spectrum**
 - Spectrum Emission Mask**
 - Modulation Analysis**
- 7 Press the **MEASURE** hot key for **Standalone** mode, and then select the measurement mode option from the following choices:
 - Spectrum** (Only shows spectrum, not available to use *Measure Setup* hot key)
 - RF Analysis > Channel Power > Occupied BW > Spectrum Emission Mask > ACLR > Spurious Emissions**
 - Modulation Analysis**

Configuring test parameters

Setting frequency

You can set the frequency with either frequency or channel number. If a frequency to be set matches to the frequency corresponding to the selected channel standard, the instrument calculates its channel number and updates the screen with it automatically.

Procedure

To set the center frequency:

- 1 Press the **FREQ/DIST** hard key.
- 2 Toggle the **Unit** soft key and select **Freq**.
- 3 Press the **Center Frequency** soft key.
- 4 Enter a value by using the numeric keys. You can also use the rotary knob.
- 5 Select the unit: **GHz**, **MHz**, **kHz**, or **Hz**.
- 6 *Optional*. To define the amount of frequency increment for the rotary knob, complete the following steps:
 - a Press the **Frequency Step** soft key.
 - b Enter a value by using the numeric keys. You can also use the rotary knob.
 - c Press the unit: **GHz**, **MHz**, **kHz**, or **Hz**.

To set the channel number:

- 1 Press the **FREQ/DIST** hard key.
 - 2 Toggle the **Unit** soft key and select **Channel**.
 - 3 To select the standard channel, complete the following steps:
 - a Press the **Channel Std** soft key. The standard channel window appears. See “Appendix C – Band, frequency & channel standard” on page 769 for more information.
 - b Highlight the band to be measured by using the rotary knob, the arrow keys, or the **Page Up/Page Down** soft keys.
 - c Press the **Select** soft key or the rotary knob to confirm the selection.
 - 4 Press the **Channel Number** soft key.
 - 5 Enter a value by using the numeric keys. You can also use the rotary knob.
 - 6 Press the **Enter** soft key.
The instrument automatically displays the corresponding center frequency value for the selected channel number.
 - 7 *Optional*. To define the amount of channel increment for the rotary knob, complete the following steps:
 - a Press the **Channel Step** soft key.
 - b Enter a value by using the numeric keys. You can also use the rotary knob.
 - c Press the **Enter** soft key.
-



NOTE

This frequency setting is not used in the Spurious Emissions mode.

Setting amplitude

Reference level and attenuation

You can set the reference and attenuation levels automatically or manually to optimize the display of the traces measured, as you desire.

Procedure

To automatically set the reference and attenuation level:

- 1 Press the **AMP/SCALE** hard key.
- 2 Press the **Auto Scale** soft key.
Each time you press this key, both of the Y-axis scale and input attenuation level change to be optimized with some margin.

To set the reference or attenuation level manually:

- 1 Press the **AMP/SCALE** hard key.
- 2 To set the maximum reference value on the Y-axis manually, complete the following steps:
 - a Press the **Reference Level** soft key.
 - b Enter a value by using the numeric keys or the rotary knob with 10 dB increments.
 - c Press the unit soft key or the **ENTER** hard key.
This unit key name changes according to the setting in the **Units** menu.

**NOTE**

In the measurements such as **Midamble Power**, **Code Power**, and **Code Error**, you may need to select the reference option between **Relative** and **Absolute** before setting the reference level.

- 3 To set the attenuation option, select one from the following choices:

To set the input attenuator's level automatically, select **Attenuation > Auto**.

**NOTE**

It is recommended that you set the **Attenuation** to **Auto** in most situations so that the level of the input attenuator can be set automatically according to your input signal level.

To set the input attenuation manually up to 55 dB for JD780B series or 50 dB for JD740B series to optimize S/N, complete the following steps:

- a Select **Attenuation > Manual**.
- b Press the **Attenuation Value** soft key to set the level
- c Enter a value in fives by using the numeric keys.
- d Press the **dB** soft key or the **ENTER** hard key.

To couple the input attenuator's level with your reference level setting, select **Attenuation > Couple**.

As you increase the reference setting, the attenuation level also increases accordingly.

Optional. **To change the scale unit:**

- 1 Select **More (1/2) > Units**.
- 2 Select the unit of the display scale: **dBm**, **dBV**, **dBmV**, **dBμV**, **V**, or **W**.
The scale unit on the screen changes accordingly.

**NOTE**

This Units menu is available in the Spectrum and RF Analysis modes.

Scale per division

You can use the **Scale/Div** feature available for the spectrum and RF analysis. It represents the value of one division on the horizontal scale. The default setting is 10 dB per division and the maximum value can be set up to 20 dB.

Procedure

- 1 Press the **AMP/SCALE** hard key.
 - 2 Select **More (1/2) > Scale/Div**.
 - 3 Enter a value between 1 and 20 by using the numeric keys.
 - 4 Press the **dB** soft key to complete the entry.
-

Pre-amplifier

You can turn the internal pre-amplifier on to correct and compensate for the gain of the preamp so that amplitude readings show the value at the input connector.

Procedure

- 1 Press the **AMP/SCALE** hard key.
 - 2 Toggle the **Preamp** soft key and select **On** or **Off** as needed.
-



NOTE

You can turn the Preamp on when the input attenuation range is from 0 dB to 10 dB. If the attenuation value is manually set to greater than 10 dB, the instrument will automatically turn off the pre-amplifier to display low-level signal properly on the chart.

External offset

You can turn the **External Offset** on and manually set the external offset value. An offset consists of a cable loss and a user offset and the measurement result shows the value reflecting both offset values. When the external offset value is set at 40 dB in the Spectrum mode, the measurement result compensates 40 dB at both the Spectrum Analyzer and Signal Analyzer modes.

Procedure

To set the external offset:

- 1 Press the **AMP/SCALE** hard key.
- 2 Toggle the **External Offset** soft key and select **On**.
- 3 Enter a value by using the numeric keys.
- 4 Press the **dB** soft key to complete the entry.

To turn the external offset off:

- 1 Press the **AMP/SCALE** hard key.
 - 2 Toggle the **External Offset** soft key and select **Off**.
-

Setting average

You can set the number of measurements to be averaged for the trace presentation. A maximum of 100 times of averaging can be set. When the averaging reaches to your setting, a new measurement value replaces the measurement value in sequence from the earliest.

Procedure

- 1 Press the **BW/AVG** hard key.
 - 2 Press the **Average** soft key.
 - 3 Enter a value between 1 and 100 as needed by using the numeric keys.
 - 4 Press the **Enter** soft key.
-

Setting sweep mode

The default setting is **Continue** to sweep continuously for most on-going measurements. If you want to hold the measurement or get a single sweep, you can change the sweep mode.

Procedure

To select the single sweep mode:

- 1 Press the **SWEEP** hot key.
- 2 Toggle the **Sweep Mode** soft key and select **Single**. You can also use the **HOLD** hot key. The letter **HOLD** in red appears and the sweeping is paused.
- 3 *Optional.* Press the **Sweep Once** soft key to get a new measurement.

To return to the continuous sweep mode:

- 1 Toggle the **Sweep Mode** soft key and select **Continue**. You can also use the **HOLD** hot key. The letter **HOLD** in red disappears and the sweeping resumes.

Setting trigger source

You can set the trigger source option for your measurements.

Procedure

- 1 Press the **TRIGGER** hot key.
- 2 Select the trigger source option from the choices: **Internal**, **External**, and **GPS**.

Setting external clock

To enhance the reliability of modulation analysis measurements the JD700B series must be synchronized with a base station. When an external clock is not supplied, the instrument works with its built-in internal high-accuracy time base and some measurement results may exhibit inaccurate values. Therefore, it is highly recommended that you use the same reference clock as the signal source. You can use the **TRIGGER** hot key to set the external clock.

Figure 300 Connection ports for external reference clock







Procedure

- 1 Connect an external reference or a GPS antenna to the JD700B series.
- 2 Press the **SYSTEM** hot key.
- 3 Press the **Freq Reference** soft key, and then select the reference option: **Internal**, **External 10 MHz**, **External 13 MHz**, **External 15 MHz**, or **GPS**.

Table 20 External reference indicators

Type	Indicator	Description
Internal	 (green)	The green INT icon indicates that the instrument uses the built-in internal time base.

External	 (green)	The green EXT icon indicates that an external reference is connected and locked and that the instrument uses the same reference clock as the signal source.
External	 (red)	The red EXT icon indicates that an external reference is connect but not locked.
GPS	 (green)	The green GPS antenna icon indicates that a GPS antenna is connected and locked.
GPS	 (yellow)	The yellow GPS antenna icon indicates that a GPS antenna is connected and locking is in progress.
GPS	 (grey)	The grey GPS antenna icon indicates that a GPS antenna is not connected, failed, or unable to be locked.

Conducting NB-IoT in band spectrum measurement

Setting measure setup

After configuring test parameters as described in the “Configuring test parameters” on page 501, you can continue your measurement. You can just check the spectrum based on the bandwidth you chose.

Procedure

- 1 Press the **MEASURE SETUP** hot key
- 2 To set the nominal channel bandwidth to be measured, complete the following steps:
 - a Press the **Bandwidth** soft key.
 - b Select the bandwidth option from the choices: **1.4 MHz, 3 MHz, 5 MHz, 10 MHz, 15 MHz, or 20 MHz.**

Setting trace

You can display up to six traces on the measurement chart simultaneously.

Procedure

- 1 Press the **TRACE/DISPLAY** hard key.
- 2 Press the **Select Trace** soft key, and then select the trace number: **T1, T2, T3, T4, T5, or T6.** The legend shape of the selected trace changes from square to round to indicate that the trace is the active one now.
- 3 Complete one of the following:

To	Select	Trace Legend
Clear current data and display with new measurements	Clear Write	W
Display the input signal's maximum response only (unlimited or for a certain amount of time)	Max Hold	M
Display the input signal's minimum response only (unlimited or for a certain amount of time)	Min Hold	m
Capture the selected trace and compare traces	Capture	C
Load a saved trace	More (1/2) > Load	L
Hide the displayed trace	Trace View > Off	F

Remove all the traces and initialize the trace settings

More (1/2) > Trace
Clear All



NOTE

For the **Max Hold** and **Min Hold**, your instrument compares newly acquired data with the active trace and displays larger maximum values or smaller minimum values on the screen. You can set it to **Unlimited** to hold and view maximum or minimum data or specify a certain amount of time up to 60 seconds by using numeric keys or rotary knob.

- 4 To select the detection option, select **More (1/2) > Detectors**, and then complete one of the followings:

To display	Select
Random noise better than the peak without missing signals	Normal
The highest value in each data point	Peak
The root mean squared average power across the spectrum	RMS
The lowest value in each data point	Negative Peak
The center value in each data point	Sample

- 5 *Optional.* Select **More (1/2) > Trace Info**, and then select the trace number to view the trace’s parameter setting information stored at the time of the measurement or **None** to hide the information display.
- 6 *Optional.* If you have the two traces T1 and T2, you can perform trace math. To view the power difference between the traces, press the **T1 – T2 -> T5** or **T2 – T1 -> T6** soft key. The result is overlaid on the screen along with the second Y-axis.

Conducting NB-IoT in band modulation analysis

Setting measure setup

After configuring test parameters as described in the “Configuring test parameters” on page 501, you can continue your measurement.

Procedure

- 1 Press the **MEASURE SETUP** hot key.
- 2 To set the nominal channel bandwidth to be measured, complete the following steps:
 - a Press the **Bandwidth** soft key.
 - b Select the bandwidth option from the choices: **1.4 MHz, 3 MHz, 5 MHz, 10 MHz, 15 MHz, or 20 MHz.**
- 3 To select the subframe number to be measured, complete the following steps:
 - a Press the **Subframe No** soft key.
 - b Enter a value from 0 to 9 by using the numeric keys. You can also use the rotary knob.
 - c Press the **Enter** soft key.



NOTE

You can use **Subframe No** soft key only if you toggle the **Measure Type** soft key and select **Subframe**.

- 4 Press the **NB-IoT PRB Index** soft key.
- 5 Enter a value from 0 to 49 by using the numeric keys. You can also use the rotary knob. The following is a table which defines PRB number values based on 3GPP standard. You can refer to the setting value.

LTE System Bandwidth	3 MHz	5 MHz	10 MHz	15 MHz	20 MHz
LTE PRB Indices for NB-IoT Synchronization	2, 12	2, 7, 17, 22	4, 9, 14, 19, 30, 35, 40, 45	2, 7, 17, 22, 27, 32, 42, 47, 52, 57, 62, 67, 72	4, 9, 14, 19, 24, 29, 34, 39, 44, 55, 60, 65, 70, 75, 80, 85, 90, 95

- 6 To measure the I-Q diagram by each channel shown on the screen, complete the following steps:
 - a Press the **MARKER** hard key.
 - b Toggle the **Marker View** soft key and select **On**.
 - c Press the **Channel** and then turn the rotary knob.

Your measurement result is displayed on the screen as like the following examples. Note that the example measurement screens in this chapter consist of outdoor mode images or images with inverted colors for better visibility.

Figure 301 NB-IoT In Band Modulation Analysis measurement screen (Frame)



Figure 302 NB-IoT In Band Modulation Analysis measurement screen (Subframe 5- NPSS)

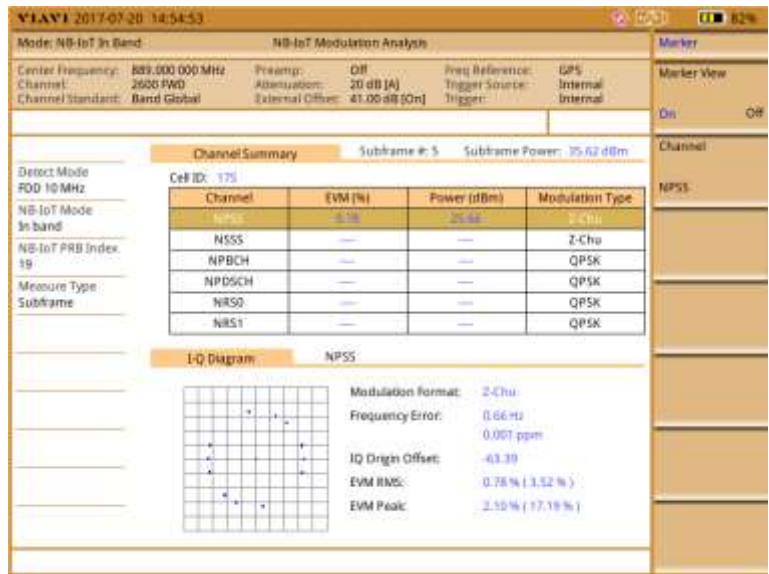

Conducting NB-IoT guard band spectrum measurement

Setting measure setup

After configuring test parameters as described in the “Configuring test parameters” on page 501, you can continue your measurement. You can just check the spectrum based on the bandwidth you chose.

Procedure

- 1 Press the **MEASURE SETUP** hot key
- 2 To set the nominal channel bandwidth to be measured, complete the following steps:
 - a Press the **Bandwidth** soft key.
 - b Select the bandwidth option from the choices: **5 MHz**, **10 MHz**, **15 MHz**, or **20 MHz**.

Setting trace

You can display up to six traces on the measurement chart simultaneously.

Procedure

- 3 Press the **TRACE/DISPLAY** hard key.
- 4 Press the **Select Trace** soft key, and then select the trace number: **T1**, **T2**, **T3**, **T4**, **T5**, or **T6**. The legend shape of the selected trace changes from square to round to indicate that the trace is the active one now.
- 5 Complete one of the following:

To	Select	Trace Legend
Clear current data and display with new measurements	Clear Write	W
Display the input signal's maximum response only (unlimited or for a certain amount of time)	Max Hold	M

Display the input signal's minimum response only (unlimited or for a certain amount of time)	Min Hold	m
Capture the selected trace and compare traces	Capture	C
Load a saved trace	More (1/2) > Load	L
Hide the displayed trace	Trace View > Off	F
Remove all the traces and initialize the trace settings	More (1/2) > Trace Clear All	

**NOTE**

For the **Max Hold** and **Min Hold**, your instrument compares newly acquired data with the active trace and displays larger maximum values or smaller minimum values on the screen. You can set it to **Unlimited** to hold and view maximum or minimum data or specify a certain amount of time up to 60 seconds by using numeric keys or rotary knob.

- 6 To select the detection option, select **More (1/2) > Detectors**, and then complete one of the followings:

To display	Select
Random noise better than the peak without missing signals	Normal
The highest value in each data point	Peak
The root mean squared average power across the spectrum	RMS
The lowest value in each data point	Negative Peak
The center value in each data point	Sample

- 7 *Optional.* Select **More (1/2) > Trace Info**, and then select the trace number to view the trace's parameter setting information stored at the time of the measurement or **None** to hide the information display.
- 8 *Optional.* If you have the two traces T1 and T2, you can perform trace math. To view the power difference between the traces, press the **T1 – T2 -> T5** or **T2 – T1 -> T6** soft key. The result is overlaid on the screen along with the second Y-axis.

Conducting NB-IoT guard band spectrum emission mask (SEM)

Setting measure setup

After configuring test parameters as described in the “Configuring test parameters” on page 501, you can continue your measurement.

Procedure

- 1 Press the **MEASURE SETUP** hot key.
- 2 To set the nominal channel bandwidth to be measured, complete the following steps:
 - a Press the **Bandwidth** soft key.
 - b Select the bandwidth option from the choices: **5 MHz**, **10 MHz**, **15 MHz**, and **20 MHz**.
- 3 To select the mask type, complete the following steps:
 - a Press the **Mask Type** soft key.
 - b Select the mask type option, from the following choices:
 - Wide Area BS Category A**
 - Wide Area BS Category B**
 - Local Area BS**

Your measurement result is displayed on the screen as like the following example.

Figure 303 Spectrum Emission Mask measurement screen

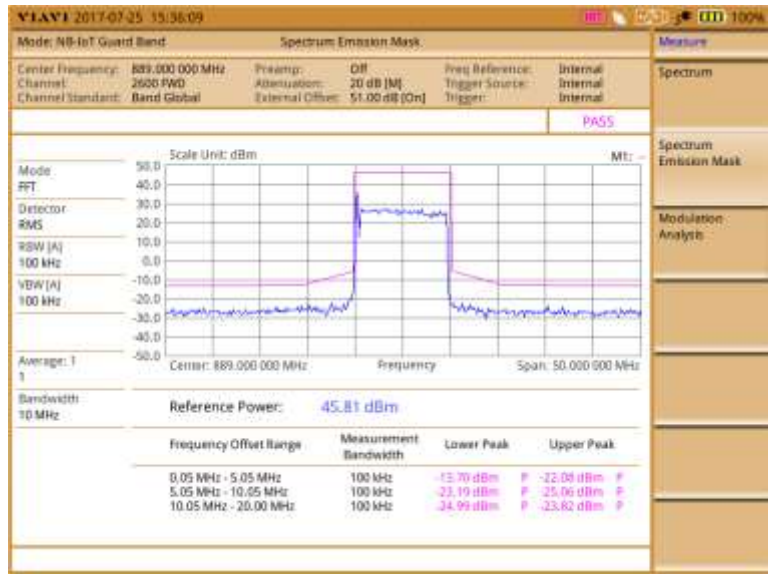

Conducting NB-IoT guard band modulation analysis

Setting measure setup

After configuring test parameters as described in the “Configuring test parameters” on page 501, you can continue your measurement.

Procedure

- 1 Press the **MEASURE SETUP** hot key.
- 2 To set the nominal channel bandwidth to be measured, complete the following steps:
 - a Press the **Bandwidth** soft key.
 - b Select the bandwidth option from the choices: **5 MHz**, **10 MHz**, **15 MHz**, or **20 MHz**.
- 3 To select the subframe number to be measured, complete the following steps:
 - a Press the **Subframe No** soft key.
 - b Enter a value from 0 to 9 by using the numeric keys. You can also use the rotary knob.
 - c Press the **Enter** soft key.



NOTE

You can use **Subframe No** soft key only if you toggle the **Measure Type** soft key and select **Subframe**.

- 4 Press the **NB-IoT Center Frequency** soft key.
- 5 Enter a value using the numeric keys or rotate the rotary knob clockwise or counter clockwise.
- 6 To measure the I-Q diagram by each channel shown on the screen, complete the following steps:
 - a Press the **MARKER** hard key.
 - b Toggle the **Marker View** soft key and select **On**.
 - c Press the **Channel** and then turn the rotary knob.

Your measurement result is displayed on the screen as like the following examples.

Figure 304 NB-IoT Guard Band Modulation Analysis measurement screen (Frame)

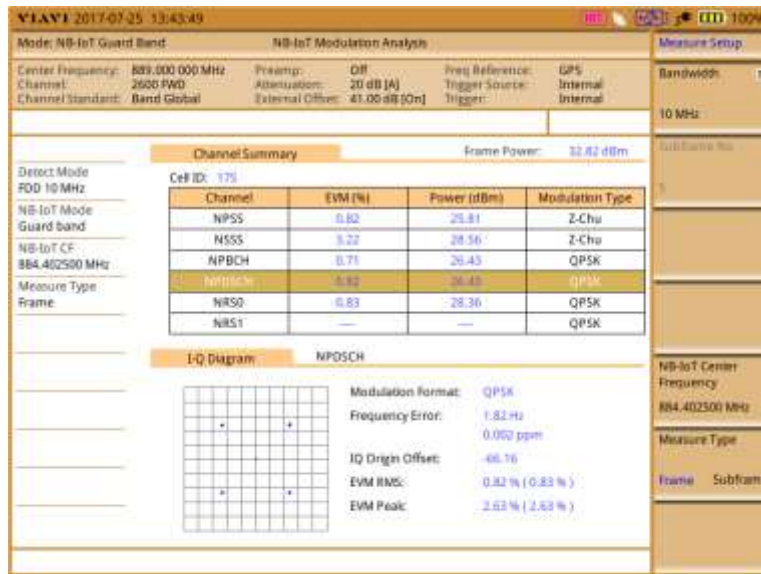
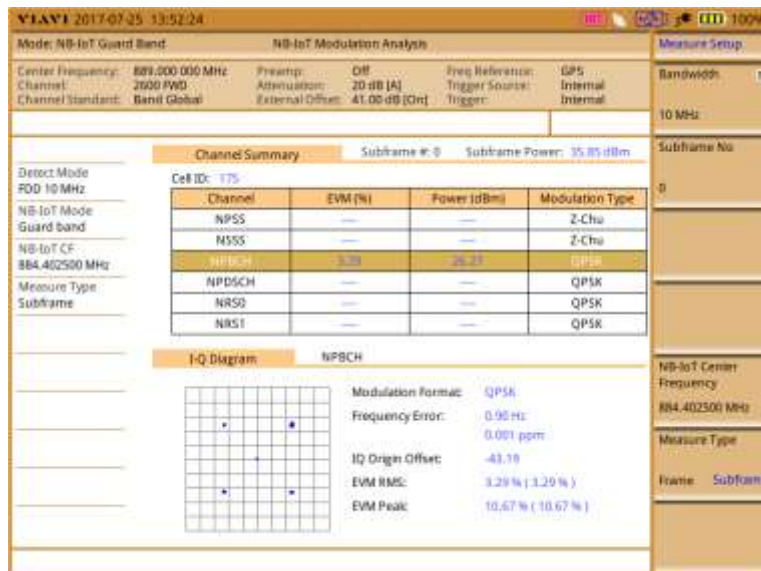

Figure 305 NB-IoT Guard Band Modulation Analysis measurement screen (Subframe 0- NPBCH)



Conducting NB-IoT standalone RF measurements

Channel power

The Channel Power measurement is a common test used in the wireless industry to measure the total transmitted power of a radio within a defined frequency channel. It acquires a number of points representing the input signal in the time domain, transforms this information into the frequency domain using Fast Fourier Transform (FFT), and then calculates the channel power. The effective resolution bandwidth of the frequency domain trace is proportional to the number of points acquired for the FFT.

The channel power measurement identifies the total RF power, power spectral density (PSD) and peak to average ratio (PAR) of the signal in the NB-IoT channel bandwidth.

Measurement example

Figure 306 Channel power measurement with NB-IoT Standalone signal analyzer

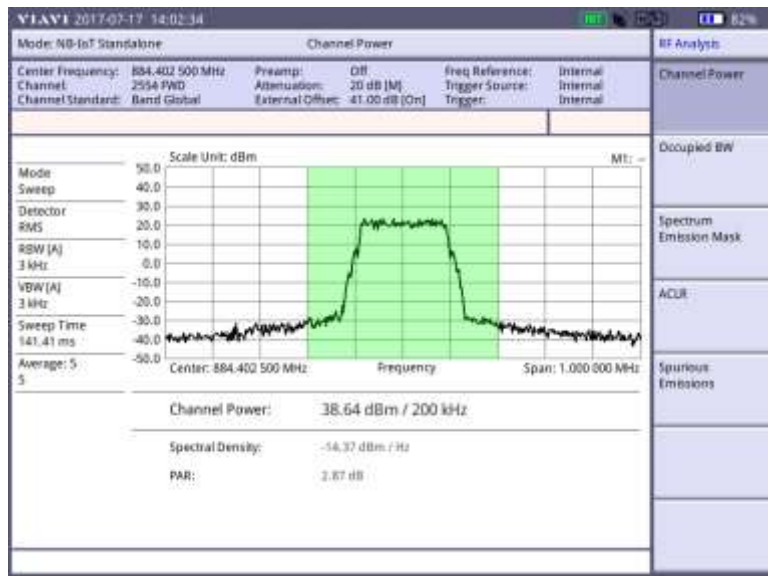

NOTE
 You can use the **LIMIT** hot key to analyze your measurements with the user-definable limit and Pass/Fail indication. See “Setting limit for RF tests” on page 515 for more information.

Occupied bandwidth

The Occupied Bandwidth measures the spectrum shape of the carrier. It is defined as the bandwidth, which includes 99% of the transmitted power among total transmitted power.

Measurement example

Figure 307 Occupied bandwidth measurement with NB-IoT Standalone signal analyzer

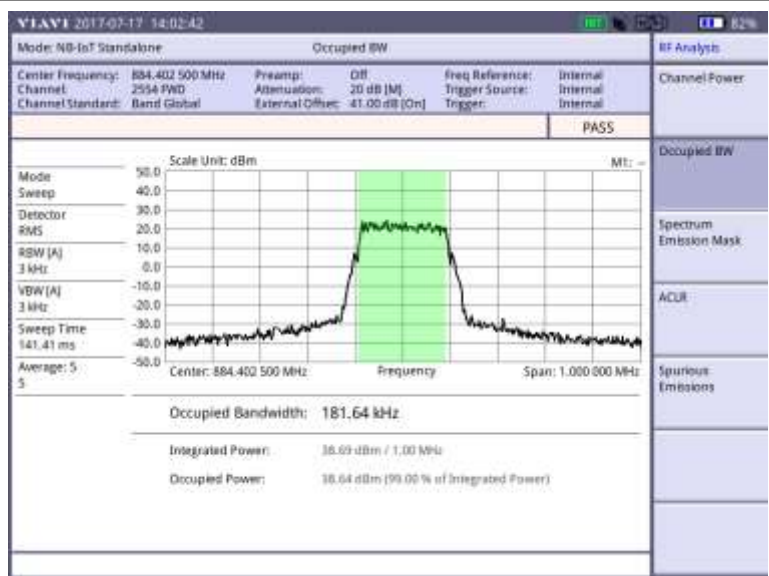



NOTE

You can use the **LIMIT** hot key to analyze your measurements with the user-definable limit and Pass/Fail indication. See “Setting limit for RF tests” on page 515 for more information.

Spectrum emission mask (SEM)

The Spectrum Emission Mask (SEM) measurement compares the total power level within the defined carrier bandwidth and the given offset channels according to the standards.

Measurement example

Figure 308 SEM measurement with NB-IoT Standalone signal analyzer

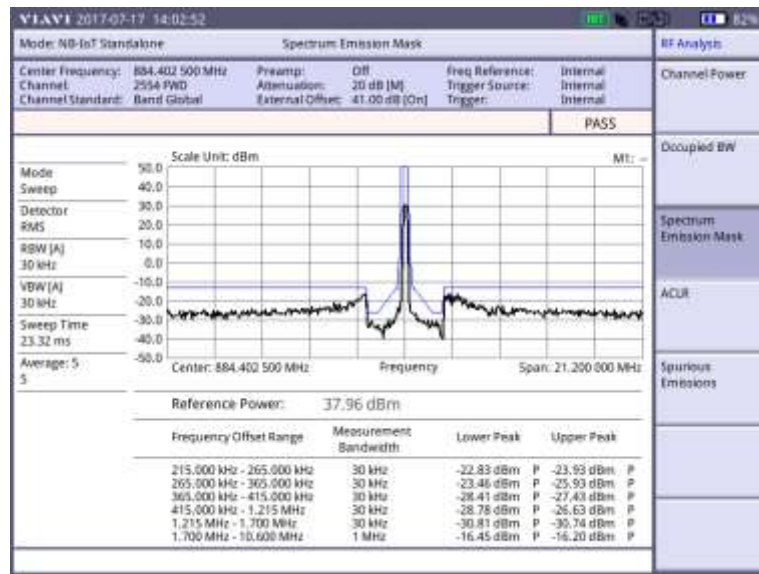

NOTE

You can use the **LIMIT** hot key to analyze your measurements with the user-definable limit and Pass/Fail indication. See “Setting limit for RF tests” on page 515 for more information.

ACLR

The Adjacent Channel Leakage power Ratio (ACLR) measures the amount of interference or power in an adjacent frequency channel according to the standards.

Measurement example

Figure 309 ACLR measurement with NB-IoT Standalone signal analyzer

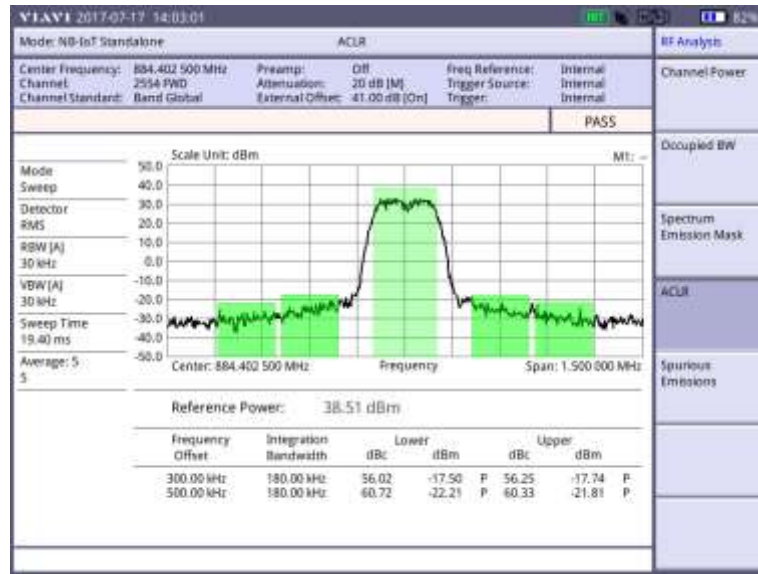

NOTE

You can use the **LIMIT** hot key to analyze your measurements with the user-definable limit and Pass/Fail indication. See “Setting limit for RF tests” on page 515 for more information.

Spurious emissions

Out-of-band emissions are unwanted emissions immediately outside the channel bandwidth resulting from the modulation process and non-linearity in the transmitter but excluding spurious emissions. The Spurious Emissions measurement is to identify and determine the power level of out-of-band spurious emission within the necessary channel bandwidth and modulated signal measured at the RF port of the Base Station.

Setting measure setup

After configuring test parameters as described in the “Configuring test parameters” on page 501, you can continue your measurement.

Procedure

- 1 Press the **MEASURE SETUP** hot key.
- 2 To set up the range table and parameters, press the **Range Table** soft key and then complete the following steps:
 - a Press the **Range** soft key, and then select the range number between **1** and **20** to add as a new or change the existing settings.
 - b Do the following as desired:
 - Select **Start Frequency**, and then specify the start frequency for the selected range.
 - Select **Stop Frequency**, and then specify the stop frequency for the selected range.
 - Select **Start Limit**, and then specify the lower limit for Pass/Fail indication.
 - Select **Stop Limit**, and then specify the upper limit for Pass/Fail indication.
 - Select **More (1/2) > Attenuation**, and then specify an value in the multiple of five.
 - Select **More (1/2) > RBW**, and then specify a RBW value.
 - Select **More (1/2) > VBW**, and then specify a VBW value.

- c Press the **PREV** hard key.
 - d Toggle the **Range** soft key and select **On** to display the selected range in the result table or **Off** to hide it from the table.
- 3 Toggle the **Measure Type** soft key between **Examine** and **Full** to select the measurement type.



NOTE
The **Examine** mode displays only the selected range while the **Full** mode lets the instrument automatically changes the selected range from one another.

- 4 To set the number of measurements to be averaged, complete the following steps:
 - a Press the **Average** soft key.
 - b Enter a value between **1** and **100**, and then press the **Enter** soft key.
- 5 To move the highlighted bar in the result table to other range, complete the following steps:
 - a Press the **Range** soft key in the Measure Setup menu bar.
 - b Enter a value between **1** and **20**, and then press the **Enter** soft key.

Measurement example

Figure 310 Spurious emissions measurement with NB-IoT Standalone signal analyzer

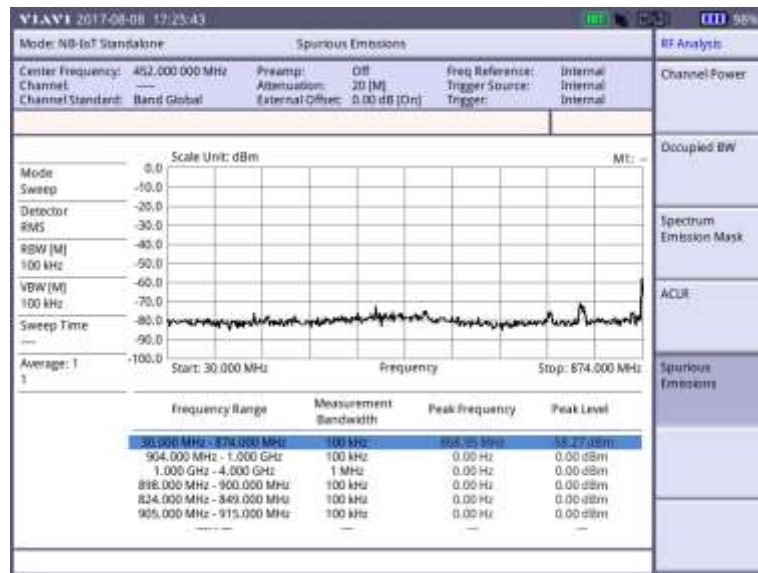

NOTE
You can use the **LIMIT** hot key to analyze your measurements with the user-definable limit and Pass/Fail indication. See “Setting limit for RF tests” on page 515 for more information.

Setting limit for RF tests

By default, test limits specified in the standard are set for you. You can change thresholds if you desire.

Procedure

- 1 Press the **LIMIT** hot key.
- 2 Press the **RF Test Limits** soft key.
- 3 Select the test item(s) and set the limit(s) depending on your selected measurement mode:

To set the limit for	Select	Set
Channel power	Channel Power	High Limit, Low Limit

Occupied bandwidth	Occupied BW	High Limit
Spectrum emission mask	Spectrum Emission Mask	(On/Off only)
Spurious emissions	Spurious Emissions	(On/Off only)

- 4 *Optional.* You can enable alarm sound that goes off if the measurement falls outside of the limit. Toggle the **Beep** soft key between **On** and **Off** to enable or disable the beep sound.
- 5 *Optional.* Go to **SAVE/LOAD > Save**, and then select **Limit** to save the limit settings. See “Using save” on page 34 for more information.

Conducting NB-IoT standalone modulation analysis

Setting measure setup

After configuring test parameters as described in the “Configuring test parameters” on page 501, you can continue your measurement.

Procedure

- 1 Press the **MEASURE SETUP** hot key.
- 2 Toggle the **Measure Type** soft key and select **Frame** or **Subframe**.

 **NOTE**
You can use **Subframe No** soft key only if you toggle the **Measure Type** soft key and select **Subframe**.
- 3 To select **Subframe No** do the following steps:
 - a Press the **Subframe No** soft key.
 - b Enter a value from 0 to 9 by using the numeric keys. You can also use the rotary knob.
 - c Press the **Enter** soft key.
- 4 To measure the I-Q diagram by each channel shown on the screen, complete the following steps:
 - a Press the **MARKER** hard key.
 - b Toggle the **Marker View** soft key and select **On**.
 - c Press the **Channel** and then turn the rotary knob.

Your measurement result is displayed on the screen as like the following examples.

Measurement example

Figure 311 NB-IoT Standalone Modulation Analysis measurement screen (Frame)

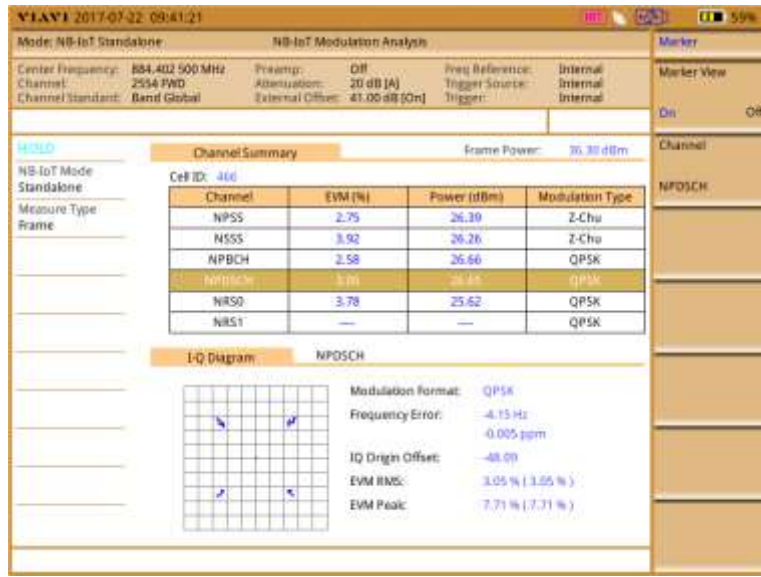
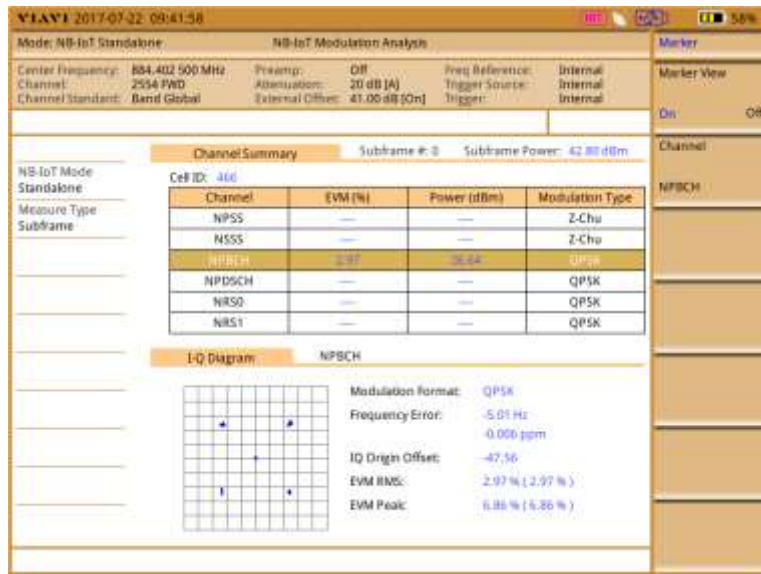

Figure 312 NB-IoT Standalone Modulation Analysis measurement screen (Subframe 0- NPBCH)



Chapter 15 Using Cable and Antenna Analyzer

This chapter provides instructions for using the Cable and Antenna Analyzer function, which is available for the JD785B/JD745B Base Station Analyzer and the JD786B/JD746B RF Analyzer. Topics discussed in this chapter are as follows:

■ Introduction.....	519
■ Display overview	519
■ Selecting measurement mode	520
■ Configuring test parameters.....	520
■ Performing calibration	522
■ Connecting a cable.....	527
■ Performing reflection measurements	530
■ Performing DTF measurements.....	531
■ Performing reflection-DTF measurements	534
■ Performing cable loss (1 port) measurements	535
■ Performing 1-port phase measurements.....	537
■ Performing Smith chart measurements.....	538
■ Performing 2-port vector measurements.....	539
■ Performing 2-port scalar measurements.....	541
■ Analyzing measurements.....	542

Introduction

The Cable and Antenna Analyzer is a diagnostic tool needed to accurately detect operational problems by performing cable and antenna measurements to verify the base station's infrastructure, including feed lines, connectors, antennas, cables, jumpers, amplifiers, and filters. The JD785B/JD745B Base Station Analyzer and the JD786B/JD746B RF Analyzer have all of the measurement functions necessary to verify cable and antenna systems from Voltage Standing Wave Ratio (VSWR) to power measurements. In addition, the JD785B/JD745B and the JD786B/JD746B make distance-to-fault measurements to pinpoint a faulty location accurately.

To get maximum power into a load it is required that the load impedance match the generator impedance. Any difference in impedance or mismatching would not produce maximum power transfer. An impedance mismatch at the antenna system produces a reflective 'traveling wave', which goes in the opposite direction from the incident wave. As the two traveling waves cross each other in opposite direction, it is produce an interference pattern called a "standing wave". VSWR is the ratio between the power sent forward to the cable and/or antenna and the amount of power that is reflected back to the transmitter.

Some of the consequences of having a high VSWR condition in cellular services include dropped calls, poor reception, and an overall unacceptable performance in the cell (or section of cell) covered by the base station antenna. Therefore, the VSWR of the antenna system including the feed line is one of the most critical factors in the service and maintenance of the RF transmitter systems.

This Cable and Antenna Analyzer function performs following measurements:

- Reflection: VSWR and Return Loss
- Distance to Fault (DTF): VSWR and Return Loss
- Reflection-DTF (dual measurement)
- 2 Port Measurements: Vector and Scalar (Optional)
- Cable Loss (1 Port)
- 1 Port Phase
- Smith Chart

Display overview

Figure 313 provides descriptions for each segment of the measurement screen.

Figure 313 Reflection measurement screen



Selecting measurement mode

Procedure

- 1 Press the **MODE** hard key.
- 2 Press the **Cable & Antenna Analyzer** soft key. The **Reflection (VSWR)** mode is selected by default.
- 3 To change the mode, press the **MEASURE** hot key and then select the measurement mode:
 - Reflection (Return Loss)**
 - DTF (VSWR)**
 - DTF (Return Loss)**
 - Reflection-DTF**
 - Cable Loss (1 Port)**
 - 1 Port Phase, Smith Chart**
 - 2 Port Measurement (Vector/Scalar)**

Configuring test parameters

Setting frequency

You can set frequencies manually using the Start Frequency/Stop Frequency or Center Frequency/Span. You can also select from the band list stored in the instrument. It is recommended to set the frequency to a value that covers the normal range of the measurement with enough margins.

Procedure

To set the start and stop frequencies:

- 1 Press the **FREQ/DIST** hard key.
- 2 Press the **Start Frequency** soft key.
- 3 Enter a value by using the numeric keys. You can also use the rotary knob or the arrow keys.
- 4 Select the unit: **GHz**, **MHz**, **kHz**, or **Hz**.
- 5 Press the **Stop Frequency** soft key.
- 6 Enter a value by using the numeric keys. You can also use the rotary knob or the arrow keys.
- 7 Select the unit: **GHz**, **MHz**, **kHz**, or **Hz**.

To set the center frequency and span:

- 1 Press the **FREQ/DIST** hard key.
- 2 Press the **Center Frequency** soft key.
- 3 Enter a value by using the numeric keys. You can also use the rotary knob or the arrow keys.
- 4 Select the unit: **GHz**, **MHz**, **kHz**, or **Hz**.
- 5 Press the **Span** soft key.
- 6 Enter a value by using the numeric keys. You can also use the rotary knob or the arrow keys.
- 7 Select the unit: **GHz**, **MHz**, **kHz**, or **Hz**.

To select the band from the band list:

- 1 Press the **FREQ/DIST** hard key.
 - 2 Press the **Band List** soft key, and then select **Standard Band** or **Custom Band**.
The band list window appears.
 - 3 Select a frequency band from the list, and then press the **Select** soft key.
The start and stop frequency information on the screen changes according to your choice.
-

Setting distance

In the DTF measurement mode, you need to set the start and stop distances. The maximum measurable distance is displayed on the left side of the screen depending on the frequency setting. You can set any distance within the maximum measurable distance. Optimum resolution is achieved when the user setting distance is the same as the maximum measurable distance.

Procedure

- 1 Press the **FREQ/DIST** hard key.
 - 2 Press the **Start Distance** soft key.
 - 3 Enter a value by using the numeric keys. You can also use the rotary knob or the arrow keys.
 - 4 Select the **Enter** soft key.
 - 5 Press the **Stop Frequency** soft key.
 - 6 Enter a value by using the numeric keys. You can also use the rotary knob or the arrow keys.
 - 7 Select the **Enter** soft key.
-

Adjusting scale

You can adjust the Y-axis scale to optimize the display of measurement trace(s). Adjusting scale does not affect the calibration state.

Procedure

- 1 Press the **AMP/SCALE** hard key.
 - 2 Do one of the following choices:
 - Press the **Auto Scale** to optimize the display of the measured trace by letting the instrument set the minimum and maximum values for the Y-axis automatically. Each time this key is pressed, the top and bottom scales are set to the minimum and maximum values with margin on the Y-axis of the chart.
 - Press the **Full Scale** to restore the instrument's default amplitude range for the Y-scale automatically.
 - To set the minimum and maximum values for the Y-axis manually, complete the following steps:
 - a Press the **Maximum (Top)** soft key.
 - b Enter a value by using the numeric keys.
 - c Press the **Enter** soft key.
 - d Press the **Minimum (Top)** soft key.
 - e Enter a value by using the numeric keys.
 - f Press the **Enter** soft key.
-

**NOTE**

This setting option is not available in the Smith Chart measurement mode.

Setting sweep mode

The default setting is **Continue** to sweep continuously for most on-going measurements. If you want to hold the measurement or get a single sweep, you can change the sweep mode.

Procedure

To select the single sweep mode:

- 1 Press the **SWEEP** hot key.
- 2 Toggle the **Sweep Mode** soft key and select **Single**. You can also use the **HOLD** hot key. The letter **HOLD** in red appears and the sweeping is paused.
- 3 *Optional.* Press the **Sweep Once** soft key to get a new measurement.

To return to the continuous sweep mode:

- 1 Toggle the **Sweep Mode** soft key and select **Continue**. You can also use the **HOLD** hot key. The letter **HOLD** in red disappears and the sweeping resumes.
-

Performing calibration

To get reliable and accurate measurement results, you must perform a calibration on your instrument after setting frequencies and prior to making a measurement. To perform the calibration, you need to have the following ready:

- Calibration accessories (optional)
- Mechanical Y-Cal kit or electronic EZ-Cal kit
- Phase-stabilized test cable

1-port calibration

Measurement modes that need the 1-port calibration are Reflection, DTF, Cable Loss, 1 Port Phase, and Smith Chart.

It is recommended that you perform an O-S-L calibration right at the Reflection/RF Out port of the instrument without using an extension cable in order to minimize a measurement error. If using an extension cable is inevitable, you need to use a phase stable cable and perform the O-S-L calibration at the open end of the extension cable.



NOTE

If the O-S-L calibration is done at the end of the port extension cable for DTF measurement, the length of the port extension cable is compensated automatically and is not included in the distance to the point of discontinuity.

Bending or moving the extension cable while making a measurement may cause errors in the measurement.

O-S-L calibration using mechanical Y-Cal kit

Figure 314 illustrates the connection when a port extension cable is used for calibration.

Figure 314 1-port calibration connection with mechanical Y-Cal kit



Procedure

- 1 Press the **MEASURE SETUP** hot key.
- 2 Press the **Calibrate** soft key.
The on-screen instruction for the calibration appears.
- 3 Connect the **OPEN** connector of the CAL Kit directly to the **Reflection/RF Out** port or at the end of the connected extension cable.
- 4 Press the **Continue** soft key to start calibration.
The calibration progress bar appears.
- 5 Connect the **SHORT** connector of the CAL Kit directly to the **Reflection/RF Out** port or at the end of the connected extension cable.
- 6 Press the **Continue** soft key to continue calibration.
The calibration progress bar appears.
- 7 Connect the **LOAD** connector of the CAL Kit directly to the **Reflection/RF Out** port or at the end of the connected extension cable.
- 8 Press the **Continue** soft key to continue calibration.
The calibration progress bar appears.
After completion, the calibration status on the screen changes to **ON**.

O-S-L calibration using electronic EZ-Cal kit

The e-Calibration is an Open-Short-Load calibration using the electronic EZ-Cal kit, which lets you perform the O-S-L calibration easy and fast with only one connection of the kit to the instrument.

The O-S-L calibration must be performed after setting the frequencies and connecting an extension cable as like any mechanical calibration. Figure 315 illustrates the connection when a port extension cable is used for calibration.

Figure 315 1-port calibration connection with electronic EZ-Cal kit

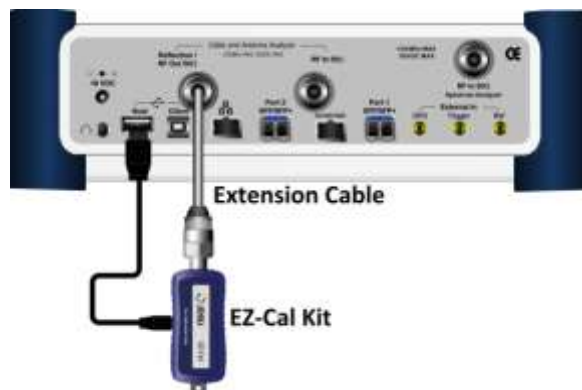

Procedure

- 1 Connect an extension cable, if necessary, to the **Reflection/RF Out** port of the instrument.
- 2 Connect your **EZ-Cal** to the other open end of the extension cable or to your instrument's **Reflection/RF Out** port directly.
- 3 Connect the USB cable to the side of the **EZ-Cal** and then to the **USB Host** port to power the e-calibration kit.
The instrument detects the EZ-Cal automatically and displays the EZ-Cal icon.
- 4 Press the **MEASURE SETUP** hot key.
- 5 Press the **Calibrate** soft key.
The on-screen instruction appears. to guide you through the e-calibration.
- 6 Press the **Continue** soft key to continue calibration.
The calibration progress bar appears.
After completion, the calibration status on the screen changes to **ON (E)**.
- 7 Make sure to disconnect the EZ-Cal kit including its USB connection.

Quick calibration in DTF

The Quick calibration that is available only in the DTF measurement mode is useful when you want to measure the cable length only, without having to perform a full O-S-L calibration with a mechanical Y-Cal kit.

Procedure

- 1 Press the **MEASURE SETUP** hot key.
- 2 Press the **Calibrate** soft key.
- 3 Connect the **OPEN** connector of your mechanical Y-Cal kit directly to the **Reflection/RF Out** port or at the end of the connected extension cable.
- 4 Press the **Quick Cal.** soft key to start the quick calibration.
The calibration status on the screen appears.
After completion, the calibration status on the screen changes to **ON (Q)**.

2-port calibration

Measurement modes that need the 2-port calibration are 2 Port Vector and Scalar measurements and 2 Port Phase. You must perform 2-port calibration before making a measurement.

O-S-L-Thru calibration using mechanical Y-Cal kit for vector measurements

Figure 316 illustrates the connection using the Y-Cal kit for calibration in Vector measurements.

Figure 316 2-port calibration connection with Y-Cal in vector measurements

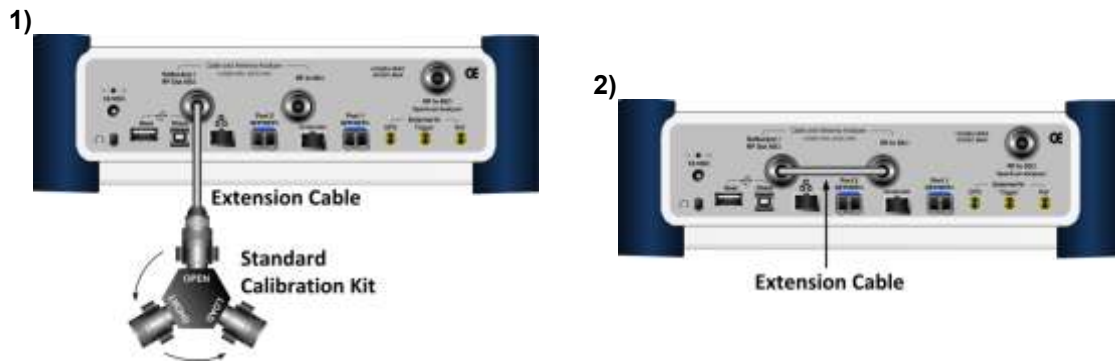

Procedure

- 1 Press the **MEASURE SETUP** hot key.
- 2 Press the **Calibrate** soft key.
The on-screen instruction for the calibration appears.
- 3 Connect the **OPEN** connector of the CAL Kit directly to the **Reflection/RF Out** port or at the end of the connected test cable as illustrated in **Figure 316-1**.
- 4 Press the **Continue** soft key to start calibration.
The calibration progress bar appears.
- 5 Connect the **SHORT** connector of the CAL Kit directly to the **Reflection/RF Out** port or at the end of the connected test cable.
- 6 Press the **Continue** soft key to continue calibration.
The calibration progress bar appears.
- 7 Connect the **LOAD** connector of the CAL Kit directly to the **Reflection/RF Out** port or at the end of the connected test cable.
- 8 Press the **Continue** soft key to continue calibration.
The calibration progress bar appears.
- 9 Connect the **Reflection/RF Out** port and the **RF In** port for the Cable and Antenna Analyzer with the test cable and the proper adapter as illustrated in **Figure 316-2**.
- 10 Press the **Continue** soft key to continue calibration.
The calibration progress bar appears.
After completion, the calibration status on the screen changes to **ON**.

O-S-L-Thru calibration using electronic EZ-Cal kit for vector measurements

Figure 317 illustrates the connection using the EZ-Cal kit for calibration in Vector measurements.

Figure 317 2-port calibration connection with EZ-Cal in vector measurements

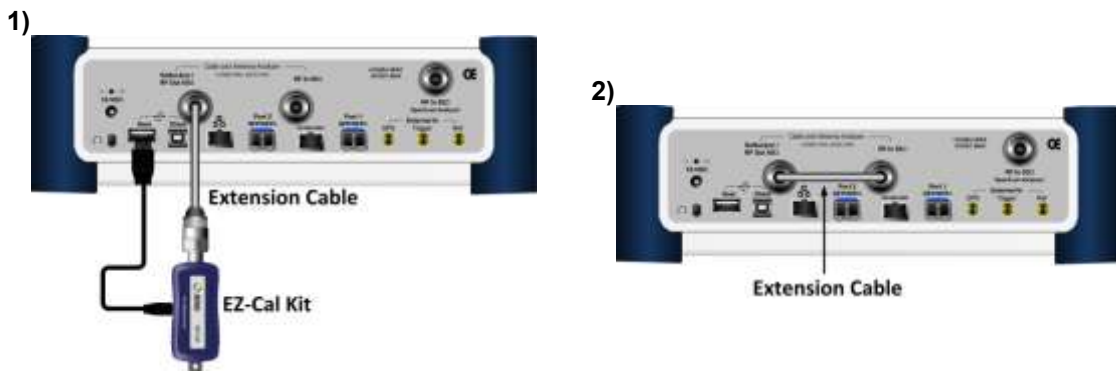

Procedure

- 1 Connect an extension cable, if necessary, to the **Reflection/RF Out** port of the instrument.
- 2 Connect your **EZ-Cal** to the other open end of the extension cable or to your instrument's **Reflection/RF Out** port directly.
- 3 Connect the USB cable to the side of the **EZ-Cal** and then to the **USB Host** port to power the e-calibration kit as illustrated in Figure 317-1. The instrument detects the EZ-Cal automatically and displays the EZ-Cal icon.
- 4 Press the **MEASURE SETUP** hot key.
- 5 Press the **Calibrate** soft key. The on-screen instruction appears to guide you through the e-calibration.
- 6 When the O-S-L calibration is done, make sure to disconnect the EZ-Cal kit including its USB connection.
- 7 Connect the **Reflection/RF Out** port and the **RF In** port for the Cable and Antenna Analyzer with the test cable and the proper adapter as illustrated in Figure 317-2.
- 8 Press the **Continue** soft key to continue calibration. The calibration progress bar appears. After completion, the calibration status on the screen changes to **ON**.

Scalar measurement

Figure 318 illustrates the connection for calibration in Scalar measurements.

Figure 318 2-port calibration connection in Scalar measurements

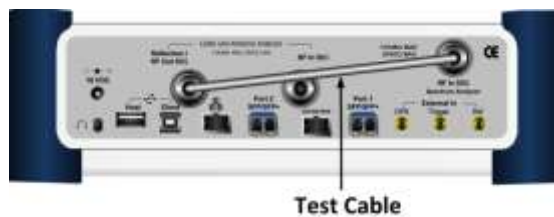

Procedure

- 1 Press the **MEASURE SETUP** hot key.
- 2 Press the **Calibrate** soft key. The on-screen instruction for the calibration appears.
- 3 Connect the **Cable and Antenna Analyzer Reflection/RF Out** port and the **Spectrum Analyzer RF In** port with a test cable as illustrated in Figure 318.
- 4 Press the **Continue** soft key to continue calibration. The calibration progress bar appears.

After completion, the calibration status on the screen changes to **ON**.

Calibration status indicators

The instrument displays calibration status that is an important indicator to get reliable and accurate measurement results from CAA testing. The calibration status includes **ON**, **ON (E)**, **ON (I)**, **ON (Q)**, **OFF (T)**, and **OFF**.

Table 21 Calibration status indicators

Indicator(s)	Description
ON	Indicates that a mechanical O-S-L calibration is performed using a Y-Cal kit and the instrument is ready to make a measurement.
ON (E)	Indicates that an electronic O-S-L calibration or e-calibration is performed using Viavi's EZ-Cal kit and the instrument is ready to make a measurement.
ON (I)	Indicates that the frequency setting is changed within the frequency range registered for the O-S-L calibration and so the calibration is still valid. When the calibration status changes from ON to ON (I), re-calibration is not necessarily required.
ON (Q)	Indicates that quick calibration (Quick Cal) is performed. It is useful only if cable length measurement is needed.
OFF (T)	Indicates that the temperature registered during the calibration is changed by $\pm 10^{\circ}\text{C}$ or greater. It is recommended that you perform a new O-S-L calibration to obtain accurate measurement results. When the temperature comes back within the registered range, the status may be changed to ON.
OFF	Indicates that the frequency setting is changed off the frequency range registered for the calibration. The calibration is no longer valid.

Connecting a cable

Connecting a cable for reflection, DTF, 1-port phase, and Smith Chart measurements

Figure 319 Connection for reflection measurement

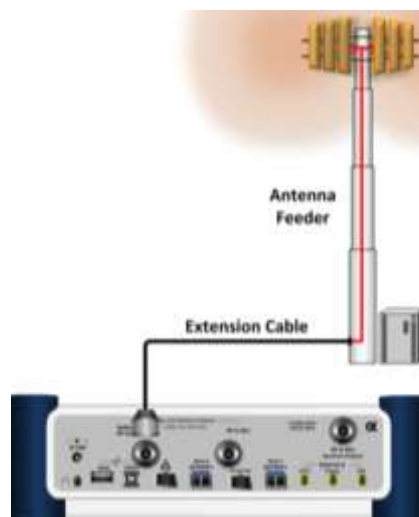

Procedure

- 1 Connect the one end of the port extension cable to the **Cable and Antenna Analyzer Reflection/RF Out** port of the instrument.
 - 2 Connect the other end of the port extension cable to an antenna or feed line as illustrated in Figure 319. Measurement result is displayed on the screen.
-



NOTE

After calibration, do not change the connection of the port extension cable or the frequency setting. It may cause a measurement error.

Changing any frequency settings will automatically turn the calibration status to OFF on the display screen, which requires re-calibration to proceed next measurement.



CAUTION

The maximum input power for the **Cable and Antenna Analyzer Reflection/RF Out** port is +25 dBm. Do not connect this port directly to the output port of the system to prevent degraded performance or malfunctioning.



WARNING

Do not attempt to connect the instrument to the antenna when there is a risk of lightning. Electric shock may cause malfunction of or damage to the instrument.

Connecting a cable for cable loss (1 port) measurements

Procedure

- 1 Connect the one end of the cable under test to the **Cable and Antenna Analyzer Reflection/RF Out** port of the instrument.
 - 2 Connect the **SHORT** standard of the Cal Kit to the other end of the cable under test as illustrated in Figure 320. Measurement result is displayed on the screen.
-

Figure 320 Connection for cable loss (1 port) measurement

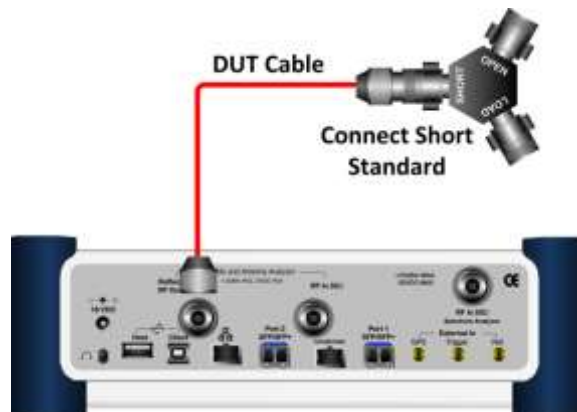

Connecting a cable for 2-port vector measurements

Procedure

- 1 Connect the one end of the Thru test cable to the Cable and Antenna Analyzer Reflection/RF Out port of the instrument and the other end of the cable to DUT.
 - 2 Connect the DUT to the **Cable and Antenna Analyzer RF In** port of the instrument as illustrated in Figure 321. Measurement result is displayed on the screen.
-

Figure 321 Connection for 2-port vector measurement

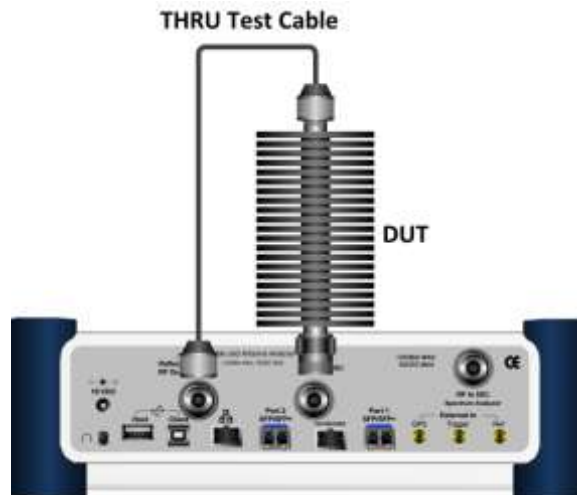
**CAUTION**

The maximum input power for the **Cable and Antenna Analyzer RF In** port is +25 dBm. However, a proper level of input to the **Cable and Antenna Analyzer RF In** port is 0 dBm. When the input power is expected to be greater than 0 dBm, you must adjust the output power for the RF Out.

Connecting a cable for 2-port scalar measurements

Procedure

- 1 Connect the one end of the Thru test cable to the Cable and Antenna Analyzer Reflection/RF Out port of the instrument and the other end of the cable to DUT.
- 2 Connect the DUT to the **Spectrum Analyzer RF In** port of the instrument as illustrated in **Figure 322**. Measurement result is displayed on the screen.

Figure 322 Connection for 2-port scalar measurement

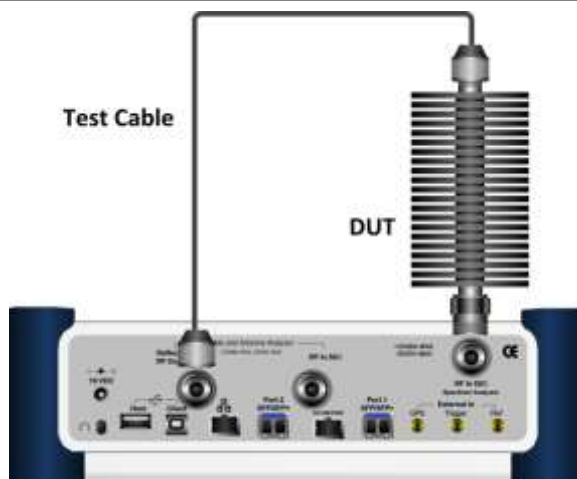
**CAUTION**

The maximum input power for the **Spectrum Analyzer RF In** port is +25 dBm for JD780B series and +20 dBm for JD740B series.

Performing reflection measurements

The Reflection measurement can be used to characterize cable and antenna system to ensure transmission line impedance performance and signal reflection characteristics of cell-site across a specific frequency range in voltage standing-wave ration (VSWR) or return loss.

Making a measurement

Procedure

- 1 Make a proper cable connection as described in “Connecting a cable for reflection, DTF, 1-port phase, and Smith Chart measurements” on page 527.
- 2 Press the **MEASURE SETUP** hot key.
- 3 Press the **Data Points** soft key to change the resolution of your measurement, and then select the data point option: **126**, **251**, **501**, **1001**, and **2001**. Changing the data point does not affect current calibration.



NOTE

The larger number you choose, the higher resolution you get and the longer the instrument takes to sweep and display results. Selecting the data point larger than what you need for a measurement will result in unnecessarily long sweep time. It is recommended that you select high resolution data points only for an instance of measuring wide frequency bands or requiring precise measurement data.

- 4 *Optional.* To turn the bias tee on, complete the following steps:
 - a Toggle the **Bias Tee** soft key and select **On**.
 - b Enter a value between 12 and 32 with 0.1 V step, and then press the **V** soft key.



NOTE

The instrument's built-in bias tee function (option 002) supplies 12-32 VDC bias to active devices through the **RF In** port, eliminating the need of an external power supply.

- 5 *Optional.* To select the output power, toggle the **Output Power** soft key between **0 dBm** and **-30 dBm**.



NOTE

When an amplifier's reflection is measured, it is recommended that you change this output power level to -30 dBm and then re-calibrate. Changing to -30 dBm may result in reduced measurement dynamic range.

- 6 *Optional.* To turn the interference rejection on, toggle the **Interference Rej** soft key between **On** and **Off** to enable or disable the feature.



NOTE

It is recommended that you use this feature only when you suspect interfering signals in the area as turning this on slows down the measurement.

Measurement example

Figure 323 Reflection measurement in return loss scale



NOTE

You can use the **LIMIT** hot key to analyze your measurements with the user-definable limit and Pass/Fail indication. See “Setting limit for cable and antenna analyzer” on page 543 for more information.



NOTE

You can go to **MEASURE SETUP > Zoom** to view your measurements in detail with the user-definable zoom zones. See “Setting zoom zones” on page 542 for more information.

Performing DTF measurements

The Distance-To-Fault (DTF) measurement can be used to accurately identify fault locations in the cell-site transmission (cable and feed line) system, indicating signal discontinuities in VSWR or return loss over distance in meter or foot. This measurement precisely pinpoints the location of such things as damaged or degraded antennas, connectors, amplifiers, filters, and duplexers.

Making a measurement

Procedure

- 1 Make a proper cable connection as described in “Connecting a cable for reflection, DTF, 1-port phase, and Smith Chart measurements” on page 527.
- 2 Press the **MEASURE SETUP** hot key.
- 3 Press the **Data Points** soft key to change the resolution of your measurement, and then select the data point option: **126**, **251**, **501**, **1001**, and **2001**. Changing the data point does not affect current calibration.



NOTE

The larger number you choose, the higher resolution you get and the longer the instrument takes to sweep and display results. Selecting the data point larger than what you need for a measurement will result in unnecessarily long sweep time. It is recommended that you select high resolution data points only for an instance of measuring wide frequency bands or requiring precise measurement data.

- 4 Press the **DTF Settings** soft key, and then do the following:
- To select a cable from the list, complete the following steps:
- Press the **Cable List** soft key, and then select **Standard Cable** or **Custom Cable**. The cable list window appears.
 - Select a cable by using the rotary knob or the **Page Up/Page Down** soft keys.
 - Press the **Select** soft key.
 - Optional.* In the standard cable list window, press the **Add to Custom** soft key to add the selected cable to the custom list.
- To define a new cable, complete the following steps:
- Press the **Prop Velocity** soft key to define the cable's relative propagation delay.
 - Enter a value by using the numeric keys. You can also use the rotary knob.
 - Press the **Enter** soft key.
 - Press the **Cable Loss** soft key to define the cable's cable loss.
 - Enter a value by using the numeric keys. You can also use the rotary knob.
 - Press the **Enter** soft key.

**NOTE**

The propagation velocity affects the calculation of the distance and the cable loss does the peak level of the discontinuity in a DTF measurement.

Toggle the **Metrics** soft key and select the unit option for the X-axis: **Meter** or **Foot**.

Press the Windowing soft key, and then select the video filtering option: **Rectangular**, **Blackman**, **Nominal Side Lobe**, **Low Side Lobe**, or **Minimum Side Lobe**.

- 5 *Optional.* To turn the bias tee on, complete the following steps:
- Toggle the **Bias Tee** soft key and select **On**.
 - Enter a value between 12 and 32 with 0.1 V step, and then press the **V** soft key.

**NOTE**

The instrument's built-in bias tee function (option 002) supplies 12-32 VDC bias to active devices through the **RF In** port, eliminating the need of an external power supply.

- 6 *Optional.* To select the output power, toggle the **Output Power** soft key between **0 dBm** and **-30 dBm**.

**NOTE**

When an amplifier's reflection is measured, it is recommended that you change this output power level to -30 dBm and then re-calibrate. Changing to -30 dBm may result in reduced measurement dynamic range.

- 7 *Optional.* To turn the interference rejection on, toggle the **Interference Rej** soft key between **On** and **Off** to enable or disable the feature.

**NOTE**

It is recommended that you use this feature only when you suspect interfering signals in the area as turning this on slows down the measurement.

Measurement example

Figure 324 DTF measurement



NOTE

You can use the **LIMIT** hot key to analyze your measurements with the user-definable limit and Pass/Fail indication. See “Setting limit for cable and antenna analyzer” on page 543 for more information.

Figure 325 DTF measurement with the alternate sweep on



NOTE

You can go to **MEASURE SETUP > Alternate Sweep Settings** to scale down a specific sub-band. See “Setting alternate sweep” on page 543 for more information.

Performing reflection-DTF measurements

You can view two measurement results simultaneously on the screen as you configure each measurement setting.

Making a measurement

Procedure

- 1 Make a proper cable connection as described in “Connecting a cable for reflection, DTF, 1-port phase, and Smith Chart measurements” on page 527.
- 2 Press the **MEASURE SETUP** hot key.
- 3 Toggle the **Active Window** soft key between **Top** and **Bottom** and select the window to be active for setting.
- 4 Press the **Dual Config** soft key, and then select the dual configuration option:
 - To select the measurement mode for the top window, press the **Top** soft key, and then select **Reflection (VSWR)** or **Reflection (Return Loss)**.
 - To select the measurement mode for the bottom window, press the **Bottom** soft key, and then select **DTF (VSWR)** or **DTF (Return Loss)**.
 - To configure DTF settings for the bottom window, select **Bottom > DTF Settings**. See “Performing DTF measurements” on page 531 for more information.
 - To set the alternate sweep settings for the bottom window, select **Bottom > Alternate Sweep Settings**. See “Setting alternate sweep” on page 543 for more information.



NOTE

See “Performing reflection measurements” and “Performing DTF measurements” for more information on how to set other measurement setup parameters for the Reflection-DTF measurement.

Measurement example

Figure 326 Reflection-DTF dual measurement

- 1) Alternate sweep off:



2) Alternate sweep on:

**NOTE**

You can use the **LIMIT** hot key to analyze your measurements with the user-definable limit and Pass/Fail indication. See “Setting limit for cable and antenna analyzer” on page 543 for more information.

Performing cable loss (1 port) measurements

The Cable Loss (1 Port) measurement quantifies signal loss through a cable or other device over a defined frequency range by range by connecting one end of the cable to the instrument measurement port and terminating the other end of the cable with a short, or leaving it open altogether. This measurement can be particularly useful in measuring the loss of feed line connected to the antenna.

Making a measurement

Procedure

- 1 Make a proper cable connection as described in “Connecting a cable for cable loss (1 port) measurements” on page 528.
- 2 Press the **MEASURE SETUP** hot key.
- 3 Press the **Data Points** soft key to change the resolution of your measurement, and then select the data point option: **126**, **251**, **501**, **1001**, and **2001**. Changing the data point does not affect current calibration.

**NOTE**

The larger number you choose, the higher resolution you get and the longer the instrument takes to sweep and display results. Selecting the data point larger than what you need for a measurement will result in unnecessarily long sweep time. It is recommended that you select high resolution data points only for an instance of measuring wide frequency bands or requiring precise measurement data.

- 4 *Optional.* To turn the bias tee on, complete the following steps:
 - a Toggle the **Bias Tee** soft key and select **On**.
 - b Enter a value between 12 and 32 with 0.1 V step, and then press the **V** soft key.

**NOTE**

The instrument’s built-in bias tee function (option 002) supplies 12-32 VDC bias to active devices through the **RF In** port, eliminating the need of an external power supply.



NOTE

See “Performing reflection measurements” for more information on how to set other measurement setup parameters for the Cable Loss (1 Port) measurement.

Measurement example

Figure 327 Cable loss (1 port) measurement

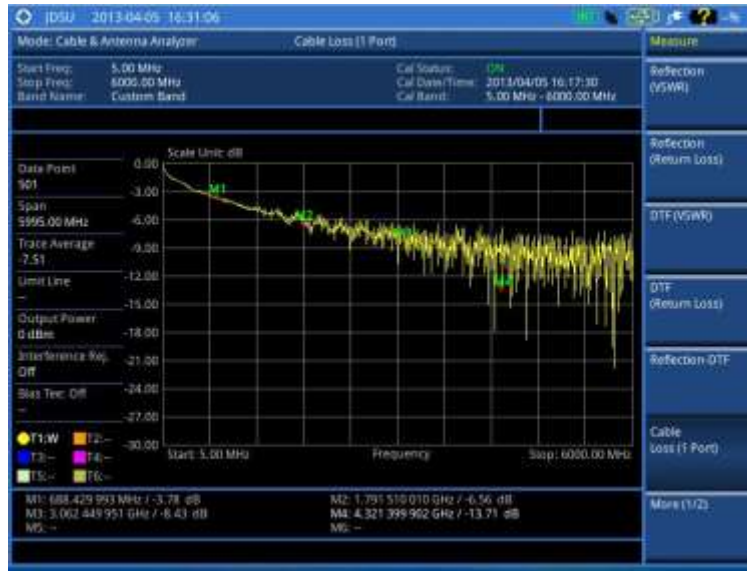

NOTE

You can use the **LIMIT** hot key to analyze your measurements with the user-definable limit and Pass/Fail indication. See “Setting limit for cable and antenna analyzer” on page 543 for more information.

Figure 328 Cable loss (1 port) measurement with the zone enabled

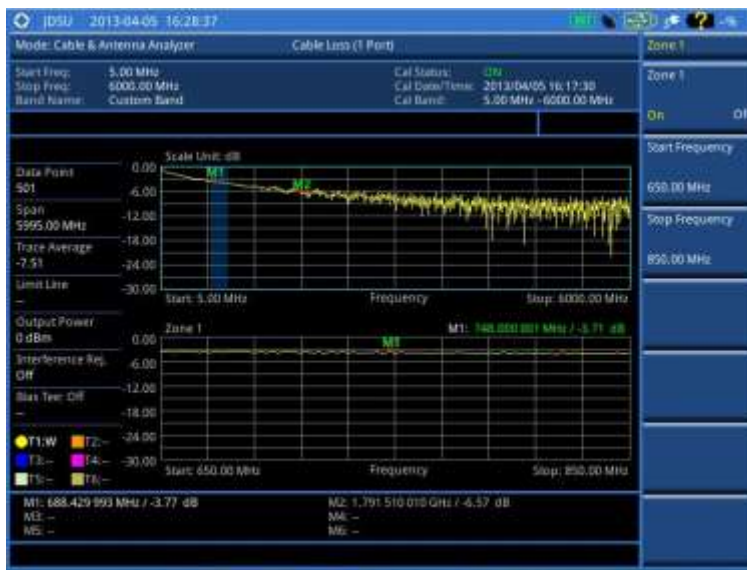

NOTE

You can go to **MEASURE SETUP > Zoom** to view your measurements in detail with the user-definable zoom zones. See “Setting zoom zones” on page 542 for more information.

Performing 1-port phase measurements

The 1-port Phase measurement is used to measure S_{11} phase to tune antennas and to phase-match cables.

Making a measurement

Procedure

- 1 Make a proper cable connection as described in “Connecting a cable for reflection, DTF, 1-port phase, and Smith Chart measurements” on page 527.
- 2 Press the **MEASURE SETUP** hot key.
- 3 Press the **Data Points** soft key to change the resolution of your measurement, and then select the data point option: **126**, **251**, **501**, **1001**, and **2001**. Changing the data point does not affect current calibration.



NOTE

The larger number you choose, the higher resolution you get and the longer the instrument takes to sweep and display results. Selecting the data point larger than what you need for a measurement will result in unnecessarily long sweep time. It is recommended that you select high resolution data points only for an instance of measuring wide frequency bands or requiring precise measurement data.

- 4 *Optional.* To turn the bias tee on, complete the following steps:
 - a Toggle the **Bias Tee** soft key and select **On**.
 - b Enter a value between 12 and 32 with 0.1 V step, and then press the **V** soft key.



NOTE

The instrument's built-in bias tee function (option 002) supplies 12-32 VDC bias to active devices through the **RF In** port, eliminating the need of an external power supply.



NOTE

See “Performing reflection measurements” on page 530 for more information on how to set other measurement setup parameters for the Cable Loss (1 Port) measurement.

Measurement example

Figure 329 Cable loss (1 port) measurement



Figure 330 Cable loss (1 port) measurement with zoom

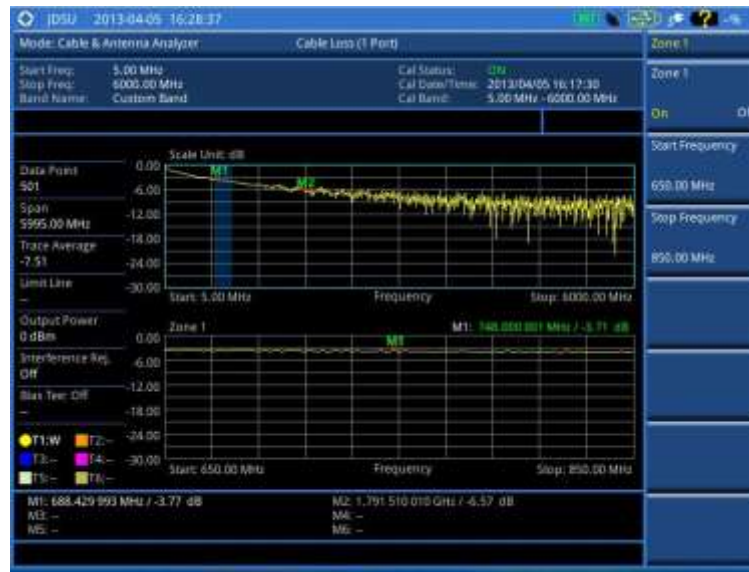

NOTE
You can use the **LIMIT** hot key to analyze your measurements with the user-definable limit and Pass/Fail indication. See “Setting limit for cable and antenna analyzer” on page 543 for more information.



NOTE
You can go to **MEASURE SETUP > Zoom** to view your measurements in detail with the user-definable zoom zones. See “Setting zoom zones” on page 542 for more information.

Performing Smith chart measurements

The Smith Chart measurement is used to measure DUTs’ impedance and phase to properly tune RF devices. Smith chart also displays impedance-matching characteristics in cable and antenna systems or filter and duplexer devices.

Making a measurement

Procedure

- 1 Make a proper cable connection as described in “Connecting a cable for reflection, DTF, 1-port phase, and Smith Chart measurements” on page 527.
- 2 Press the **MEASURE SETUP** hot key.
- 3 Press the **Data Points** soft key to change the resolution of your measurement, and then select the data point option: **126**, **251**, **501**, **1001**, and **2001**. Changing the data point does not affect current calibration.



NOTE
The larger number you choose, the higher resolution you get and the longer the instrument takes to sweep and display results. Selecting the data point larger than what you need for a measurement will result in unnecessarily long sweep time. It is recommended that you select high resolution data points only for an instance of measuring wide frequency bands or requiring precise measurement data.

- 4 *Optional.* To turn the bias tee on, complete the following steps:
 - a Toggle the **Bias Tee** soft key and select **On**.
 - b Enter a value between 12 and 32 with 0.1 V step, and then press the **V** soft key.

**NOTE**

The instrument's built-in bias tee function (option 002) supplies 12-32 VDC bias to active devices through the **RF In** port, eliminating the need of an external power supply.

**NOTE**

See “Performing reflection measurements” on page 530 for more information on how to set other measurement setup parameters for the Smith Chart measurement.

Measurement example

Figure 331 Smith chart measurement



Performing 2-port vector measurements

The Vector measurement is used to perform faster and more accurate measurement with around 80 dB dynamic range. It also provides antenna isolation measurement. You can determine DUT's S_{21} phase characteristic by selecting the measurement display type as Phase.

Making a measurement

Procedure

- 1 Make a proper cable connection as described in “Connecting a cable for 2-port vector measurements” on page 528.
- 2 Press the **MEASURE SETUP** hot key.
- 3 Press the **Data Points** soft key to change the resolution of your measurement, and then select the data point option: **126**, **251**, **501**, **1001**, and **2001**. Changing the data point does not affect current calibration.

**NOTE**

The larger number you choose, the higher resolution you get and the longer the instrument takes to sweep and display results. Selecting the data point larger than what you need for a measurement will result in unnecessarily long sweep time. It is recommended that you select high resolution data points only for an instance of measuring wide frequency bands or requiring precise measurement data.

- 4 Toggle the **Display** soft key and select **Magnitude** to view measurements in dB or **Phase** in degree.

- 5 *Optional.* To turn the bias tee on, complete the following steps:
 - a Toggle the **Bias Tee** soft key and select **On**.
 - b Enter a value between 12 and 32 with 0.1 V step, and then press the **V** soft key.



NOTE
The instrument's built-in bias tee function (option 002) supplies 12-32 VDC bias to active devices through the **RF In** port, eliminating the need of an external power supply.

- 6 *Optional.* To set the level of the output power to be inserted, complete the following steps:
 - a Press the **Output Power** soft key.
 - b Enter the following value by rotating the knob or using the numeric keys:
 - 0 dBm:** To test a passive RF device's loss such as a cable or a filter.
 - 30 dBm:** To test an active RF device's gain such as an amplifier with JD740B series.
 - 50 – -30 dBm:** To test an active RF device's gain such as an amplifier with JD780B series. You need to enter a value with an increment of 5 dBm.



NOTE
Changing the output power to a value between -50 dBm and -30 dBm may result in reduced measurement dynamic range and re-calibration is required.

- 7 *Optional.* To set the number of measurements to be averaged, press the **Average** soft key and then adjust the number between one and five by using the rotary knob.
- 8 *Optional.* To turn the interference rejection on, toggle the **Interference Rej** soft key between **On** and **Off** to enable or disable the feature.



NOTE
It is recommended that you use this feature only when you suspect interfering signals in the area as turning this on slows down the measurement.

Measurement example

Figure 332 2-port vector measurement



Performing 2-port scalar measurements

The Scalar measurement enables full characterization of DUT with dynamics over 100 dB.

Making a measurement

Procedure

- 1 Make a proper cable connection as described in “Connecting a cable for 2-port scalar measurements” on page 529.
- 2 Press the **MEASURE SETUP** hot key.
- 3 Press the **Data Points** soft key to change the resolution of your measurement, and then select the data point option: **126**, **251**, **501**, **1001**, and **2001**. Changing the data point does not affect current calibration.



NOTE

The larger number you choose, the higher resolution you get and the longer the instrument takes to sweep and display results. Selecting the data point larger than what you need for a measurement will result in unnecessarily long sweep time. It is recommended that you select high resolution data points only for an instance of measuring wide frequency bands or requiring precise measurement data.

- 4 *Optional.* To set the level of the output power to be inserted, complete the following steps:
 - a Press the **Output Power** soft key.
 - b Enter the following value by rotating the knob or using the numeric keys:
 - 0 dBm:** To test a passive RF device’s loss such as a cable or a filter.
 - 30 dBm:** To test an active RF device’s gain such as an amplifier with JD740B series.
 - 50 – -30 dBm:** To test an active RF device’s gain such as an amplifier with JD780B series. You need to enter a value with an increment of 5 dBm.



NOTE

Changing the output power to a value between -50 dBm and -30 dBm may result in reduced measurement dynamic range and re-calibration is required.

Measurement example

Figure 333 2-port scalar measurement



Analyzing measurements

Setting trace and display

You can display up to six traces on the measurement chart simultaneously.

Procedure

- 1 Press the **TRACE/DISPLAY** hard key.
- 2 Press the **Select Trace** soft key, and then select the trace number: **T1**, **T2**, **T3**, **T4**, **T5**, or **T6**. The legend shape of the selected trace changes from square to round to indicate that the trace is the active one now.
- 3 Do one of the following:

To	Select	Trace Legend
Clear current data and display with new measurements	Clear Write	W
Capture the selected trace and compare traces	Capture	C
Load a saved trace	Load	L
Hide the selected trace	Trace View > Off	F
Remove all the traces and initialize the trace settings	Trace Clear All	

- 4 *Optional.* If you have at least two traces (T1 and T2), you can perform trace math:
 - a Press the **Trace Math** soft key.
 - b Press the **T1 – T2 -> T5** or **T2 – T1 -> T6** soft key.
-



NOTE

The trace to be loaded must be in the same measurement mode and has the same frequency setting as the current measurement.

Setting zoom zones

You can define up to three zoom-in zones so that you can view uplink and downlink frequencies in detail on a single measurement window for compliance verification.

Procedure

- 1 Press the **MEASURE SETUP** hot key.
 - 2 Press the **Zoom** soft key.
 - 3 To view a zoom zone in a separate chart, complete the following steps:
 - a Press the **Zoom** soft key, and then select the zone number to zoom in: **Zone 1**, **Zone 2**, or **Zone 3**.
 - b Toggle the **Zoom** soft key and select **On**. The zoom-in chart for the selected zone appears under the measurement result.
 - 4 To define a zone range, complete the following steps:
 - a Press the **Zone [1|2|3]** soft key.
 - b Toggle the **Zone [1|2|3]** soft key between **On** and **Off** to view or dismiss the zone.
 - c Press the **Start Frequency** soft key.
 - d Enter a value by using the numeric keys. You can also use the rotary knob.
 - e Select the unit: **GHz**, **MHz**, **kHz**, or **Hz**.
 - f Press the **Stop Frequency** soft key.
 - g Enter a value by using the numeric keys. You can also use the rotary knob.
-

-
- h Select the unit: **GHz**, **MHz**, **kHz**, or **Hz**.
 - 5 To clear all the zones, press the **Clear All** soft key.
-

Setting alternate sweep

You can use the Alternate Sweep in DTF measurements to scale down a specific sub-band without a need of an additional calibration.

Procedure

- 1 Press the **MEASURE SETUP** hot key.
 - 2 Press the Alternate Sweep Settings soft key.
 - 3 Toggle the **Alternate Sweep** soft key and select **On** or **Off** to enable or disable the alternate sweep feature.
 - 4 To set the start and stop distances for the alternate sweep, complete the following steps:
 - a Press the **Start Distance** soft key.
 - b Enter a value by using the numeric keys. You can also use the rotary knob or the arrow keys.
 - c Select the **Enter** soft key.
 - d Press the **Stop Frequency** soft key.
 - e Enter a value by using the numeric keys. You can also use the rotary knob or the arrow keys.
 - f Select the **Enter** soft key.
 - 5 To set the start and stop frequencies for the alternate sweep, complete the following steps:
 - a Press the Alternate Start Frequency soft key.
 - b Enter a value by using the numeric keys. You can also use the rotary knob or the arrow keys.
 - c Select the unit: **GHz**, **MHz**, **kHz**, or **Hz**.
 - d Press the Alternate Stop Frequency soft key.
 - e Enter a value by using the numeric keys. You can also use the rotary knob or the arrow keys.
 - f Select the unit: **GHz**, **MHz**, **kHz**, or **Hz**.
 - 6 To set the center and span frequencies for the alternate sweep, complete the following steps:
 - a Press the Alternate Center Frequency soft key.
 - b Enter a value by using the numeric keys. You can also use the rotary knob or the arrow keys.
 - c Select the unit: **GHz**, **MHz**, **kHz**, or **Hz**.
 - d Press the Alternate Span Frequency soft key.
 - e Enter a value by using the numeric keys. You can also use the rotary knob or the arrow keys.
 - f Select the unit: **GHz**, **MHz**, **kHz**, or **Hz**.
-

Setting limit for cable and antenna analyzer

Procedure

- 1 Press the **LIMIT** hot key.
 - 2 Press the **Multi Segment Line** soft key for Pass/Fail indication.
 - 3 Toggle the **Limit** soft key between **Upper** and **Lower** to select the one to be displayed.
 - 4 Set the number of segments for the selected upper or lower limit line, up to 50 segments.
 - a Press the **# of Line** soft key.
 - b Enter a value between 1 and 50 by using the numeric keys.
 - c Press the **Enter** soft key.
-

- 5 Press the **Autoset** soft key to let the instrument set the limit for each segment and display the line.
 - 6 *Optional.* To move the limit line, complete the following steps:
 - a Select **Limit Up/Down** or **Limit Left/Right**.
 - b Turn the rotary knob to move the line as desired. You can also manually enter a value.
 - 7 *Optional.* To edit the segment properties, complete the following steps:
 - a Press the **Edit Limit** soft key.
 - b Press the **Move** soft key and then turn the rotary knob to select the segment to edit.
 - c Select the menu option, from the following choices:
 - To hide the line for the selected segment, toggle the **Line** soft key and select **Off**.
 - To add a new point, press the **Add Point** soft key.
 - To delete the selected point, press the **Delete Point** soft key.
 - To change the position, press the **Frequency** or **Amplitude** soft key, and then turn the rotary knob to change the value as desired.
 - 8 *Optional.* Go to **SAVE/LOAD > Save**, and then select **Limit** to save the limit settings. See "Using save" on page 34 for more information.
-

Chapter 16 Performing RFoCPRI Testing

This chapter provides instructions for using the RFoCPRI function that requires. Topics discussed in this chapter are as follows:

■ Introduction.....	546
■ Display overview	547
■ Selecting measurement mode	548
■ Performing layer 2 monitoring	548
■ Performing layer 2 term testing	551
■ Performing interference analysis.....	554
■ Performing PIM detection (single and multiple carriers)	581
■ Performing LTE-FDD downlink signal analysis	585
■ Performing LTE-TDD downlink signal analysis	612
■ Using signal generator	636
■ Emulating a BBU	638

Introduction

Cell sites today have a distributed architecture of the radio that consists of the radio equipment control (REC) or base band unit (BBU) installed at the bottom of the tower and the radio equipment (RE) or remote radio head (RRH) installed at the top of the tower. These two elements communicate with each other via the Common Public Radio Interference (CPRI) protocol over fiber links.

This distributed architecture provides the benefit of replacing coax-based feeders with fiber-based feeders, significantly reducing the problems of signal loss and reflections. However, since all the RF interfaces reside on the RRH, any RF maintenance or troubleshooting requires climbing to the top of the tower to access the RRH, increasing operational cost and unnecessary safety issues.

JD700B series analyzers provide the option of RFoCPRI that allows you to perform RF maintenance and troubleshooting activities on the ground via the fiber interfaces at the BBU, significantly reducing maintenance time and operational expenses. Thanks to the RFoCPRI technology, you can verify the CPRI control signals and extract the IQ data transmitted between the BBU and RRH to monitor and analyze the uplink interferences and the downlink signals.

The RFoCPRI testing provides following measurements and analysis:

- Layer 2 monitoring of link maintenance alarms and optical power
 - Loss of Signal (LOS) – Code violation or low optical power
 - Loss of Frame (LOF) – Frame synchronization or alignment
 - Remote Alarm Indication (RAI) – Any error including LOS and LOF
 - SAP Defect Indication (SDI) – Link not to be used for service access points
 - Optical Rx and Tx power levels
- Layer 2 terminate testing
- Interference analysis
 - Spectrum
 - Spectrogram
 - Received Signal Strength Indicator (RSSI)
 - Spectrum replayer
 - Dual Spectrum
 - Dual Spectrogram
 - Quad Spectrum
- PIM detection of single or multiple carrier(s)
- LTE-FDD downlink signal analysis over CPRI
 - Spectrum
 - RF analysis – Channel Power and Occupied Bandwidth
 - Power vs. Time (Frame)
 - Modulation analysis – Constellation, Data Channel, Control Channel, Subframe, Frame, Time Alignment Error, and Data Allocation Map
 - Power Statistics CCDF
- LTE-TDD downlink signal analysis over CPRI
 - Spectrum
 - RF analysis – Channel Power and Occupied Bandwidth
 - Power vs. Time (Frame)

- Modulation analysis – Constellation, Data Channel, Control Channel, Subframe, Time Alignment Error, and Data Allocation Map
- Power Statistics CCDF
- Alcatel-Lucent BBU emulation
 - Profiling
 - Configuration verification – Carrier Information, CPRI & Active SW, SFP Information, and RTD Information
 - Spectrum clearance – Spectrum, Spectrogram, RSSI, Dual Spectrum, and Dual Spectrum
 - Coverage range
 - PIM analysis
 - RET-Information

Full function of RFoCPRI testing requires the following options installed on your CellAdvisor. For more information on available options for your instrument, see “Appendix I – Ordering information” on page 780.

- Optical Hardware (option 008)
- RFoCPRI Interference Analyzer (options 060 – 065)
- RFoCPRI GSM Interference Analyzer (option 068)
- RFoCPRI LTE-FDD Signal Generator (option 081)
- RFoCPRI LTE-TDD Signal Generator (option 082)
- RFoCPRI LTE-FDD Multi Carrier Signal Generator (option 083)
- RFoCPRI LTE-TDD Multi Carrier Signal Generator (option 084)
- RFoCPRI LTE-FDD Signal Analyzer (option 091)
- RFoCPRI LTE-TDD Signal Analyzer (option 092)
- RFoCPRI Alcatel-Lucent BBU Emulation (option 101)

Display overview

Figure 334 provides descriptions for each segment of the measurement screen.

Figure 334 RFoCPRI analysis screen



Selecting measurement mode

Procedure

- 1 Press the **MODE** hard key.
- 2 Select **RFoFiber > RFoCPRI**. The Layer 2 Monitoring mode is set by default.
- 3 Press the **MEASURE** hot key, and then select the measurement mode as desired:

Layer 2 Monitoring

Layer 2 Term

Interference Analyzer > Spectrum, Spectrogram, RSSI, Spectrum Replayer, Dual Spectrum, Dual Spectrogram, or Quad spectrum

PIM Detection > PIM Detection Single Carrier, PIM Detection Multiple Carriers, or Calculated PIM

Signal Analyzer > LTE-FDD > Spectrum, RF Analysis, P vs T (Frame), Modulation Analysis, or Power Statistics CCDF

Signal Analyzer > LTE-TDD > Spectrum, RF Analysis, P vs T (Frame), Modulation Analysis, or Power Statistics CCDF

BBU Emulation > Alcatel-Lucent > Profiling, Configuration Verification, Spectrum Clearance, Coverage Range, PIM Analysis, or RET-Information

Performing layer 2 monitoring

The in-service Layer 2 Monitoring is used to monitor link maintenance alarms of the physical layer (Layer 1) that is delivered on the L1 in-band protocol, which resides on the layer 2 of CPRI. It also verifies proper optical power level of the received signal.

Connecting cables

The monitoring mode lets you perform in-service testing by using coupler(s) or nTap(s). You can connect cables with a tap or without a tap as illustrated in Figure 335. If you have connected cables directly from

RRH and BBU without using the nTap, you must turn on the through mode (Thru) in the CPRI parameter settings.

A SFP/SFP+ transceiver that is connected to your JD700B series must be compatible with your DUT and you must have your module information such as line rate, wavelength, and mode (MM or SM) handy.

Figure 335 Connection diagram for Layer-2 monitoring mode



Selecting measurement mode

Procedure

- 1 Press the **MEASURE** hot key.
- 2 Select **Layer 2 Monitoring**.

Selecting port

JD700B series supports two antenna ports for signal transmission, and each port can generate up to four different waveforms selectively and simultaneously. User can select the port to use for the measurement in any measurement modes of RFoCPRI mode.

Procedure

- 1 In any measurement mode, press the **MEASURE SETUP** hot key.
- 2 Toggle the **Select Port** soft key between **Port 1** and **Port 2** to select the desired port.

Setting measure setup

Procedure

- 1 Press the **MEASURE SETUP** hot key
- 2 To set the CPRI line bit rate of the fronthaul under test, complete the following steps:
 - a Press the **Link Rate** soft key.
 - b Select the CPRI link rate option from: **614.4 Mbps**, **1228.8 Mbps**, **2457.6 Mbps**, **3072.0 Mbps**, **4915.2 Mbps**, **6144.0 Mbps**, or **9830.4 Mbps**.



NOTE

It is important that you set the link rate correctly to avoid any misleading LOS and LOF alarms displayed on the screen.

Setting Rx optic limit

A RRH has a finite dynamic range for input optic power and it can cause an abnormal behavior of the RRH if the optical power is weaker than certain level. To differentiate intermittent low optic power issues from any RSSI, interference and signal quality issues, it is important for you to monitor the input optic power level during the monitoring of the spectrum and the signal quality. Using this Rx optic limit feature, you can set lower and upper limits and monitor the Rx optic level with Pass/Fail indication in green and red colors.

Procedure

- 1 Press the **LIMIT** hot key.
 - 2 Press the **Rx Optic Level** soft key.
 - 3 Set a threshold for **High Limit** and **Low Limit**.
 - 4 To enable the Rx optic limit, toggle the **Test Limits** soft key to **On**.
If the optic power level falls out of the specified thresholds, the color of the power reading or indicator turns red.
 - 5 To disable the Rx optic limit, toggle the **Test Limits** soft key to **Off**.
-

Conducting layer 2 monitoring

After you have configured test parameters, you can monitor the alarms of the Layer 1 as you desire.

Procedure

- 1 Monitor the following alarm indicators and the optical signal level. Green dots indicate no occurrence of an alarm while red ones mean occurrence(s).
 - LOS:** Loss of Signal (code violation or low optical power)
 - LOF:** Loss of Frame (frame synchronization or alignment)
 - RAI:** Remote Alarm Indication (any errors including LOS and LOF)
 - SDI:** SAP Defect Indication (link not to be used for service access points)
 - Optic Rx Level:** If the optical signal level is lower than the threshold, the CPRI link may not work properly and the RRH may not be in service mode.
 - 2 *Optional.* You can use the **Save Logging Data** soft key to record the event logging in .csv file format. See “Using save” on page 34 for more information.
 - 3 To clear the previous event history and start a new monitoring, press the **MEASURE SETUP** hot key and then the **Clear History** soft key.
-

Measurement example

Figure 336 CPRI layer 2 monitoring



Performing layer 2 term testing

The out-of-service Layer 2 Term is to test CPRI fronthaul in the terminated state and it is used to monitor link maintenance alarms of the physical layer (Layer 1) that is delivered on the L1 in-band protocol, which resides on the layer 2 of CPRI. It also monitors the received optical power level.

In addition, CellAdvisor JD700B series can emulate the Base Band Unit (BBU) without C&M messages. Once the RRH enters the operation state, JD700B series can generate an alarm or error and send it to the RRH so that you can verify the optical cabling and proper RRH operation at the ground.

Connecting cables

In the terminate mode, you can perform the out-of-service testing. Before starting the test, you need to connect cables with a tap or without a tap as illustrated in Figure 337.

A SFP/SFP+ transceiver that is connected to your JD700B series must be compatible with your DUT and you must have your module information such as line rate, wavelength, and mode (MM or SM) handy.

Figure 337 Connection diagram for Layer-2 term testing mode

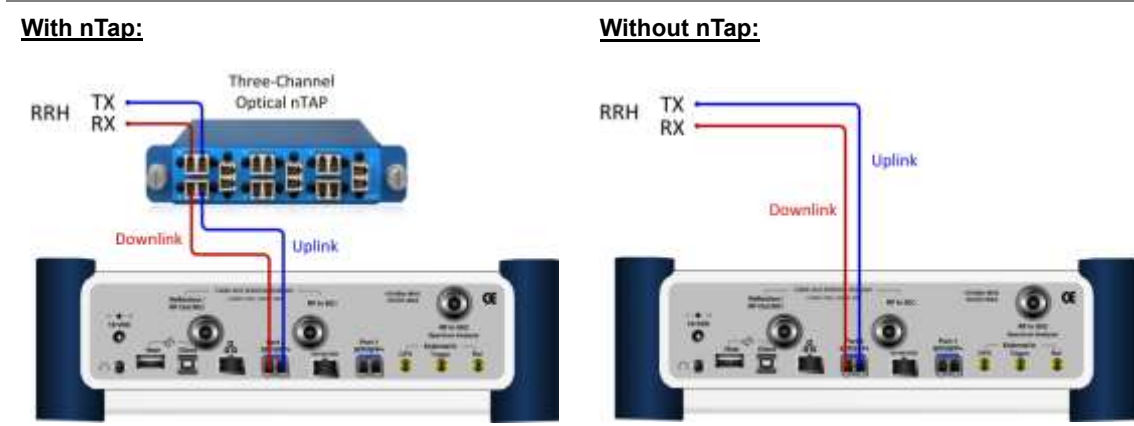

Selecting measurement mode

Procedure

- 1 Press the **MEASURE** hot key.
 - 2 Select **Layer 2 Term**.
-

Selecting port

JD700B series supports two antenna ports for signal transmission, and each port can generate up to four different waveforms selectively and simultaneously. User can select the port to use for the measurement in any measurement modes of RFoCPRI mode.

Procedure

- 1 In any measurement mode, press the **MEASURE SETUP** hot key.
 - 2 Toggle the **Select Port** soft key between **Port 1** and **Port 2** to select the desired port.
-

Setting measure setup

You need to set the measure setup before starting the measurement.

Procedure

- 1 Press the **MEASURE SETUP** hot key.
- 2 To set the CPRI line bit rate of the fronthaul under test, complete the following steps:
 - a Press the **Link Rate** soft key.
 - b Select the CPRI link rate option from: **614.4 Mbps**, **1228.8 Mbps**, **2457.6 Mbps**, **3072.0 Mbps**, **4915.2 Mbps**, **6144.0 Mbps**, or **9830.4 Mbps**.



NOTE

It is important that you set the link rate correctly to avoid any misleading LOS and LOF alarms displayed on the screen.

Setting Rx optic limit

A RRH has a finite dynamic range for input optic power and it can cause an abnormal behavior of the RRH if the optical power is weaker than certain level. To differentiate intermittent low optic power issues from any RSSI, interference and signal quality issues, it is important for you to monitor the input optic power level during the monitoring of the spectrum and the signal quality. Using this Rx optic limit feature, you can set lower and upper limits and monitor the Rx optic level with Pass/Fail indication in green and red colors.

Procedure

- 1 Press the **LIMIT** hot key.
 - 2 Press the **Rx Optic Level** soft key.
 - 3 Set a threshold for **High Limit** and **Low Limit**.
 - 4 To enable the Rx optic limit, toggle the **Test Limits** soft key to **On**.
If the optic power level falls out of the specified thresholds, the color of the power reading or indicator turns red.
 - 5 To disable the Rx optic limit, toggle the **Test Limits** soft key to **Off**.
-

Conducting layer 2 term test

Procedure

- 1 Press the **MEASURE SETUP** hot key.
- 2 Activate the transmission by toggling the **Laser** soft key to **On**.
- 3 To configure BBU emulation parameters, select **More (1/2) > BBU Emulation** and then complete one of the following:
 - To negotiate with RRH to support the start-up process, toggle the **Start-up Sequence** soft key to **Normal**.
 - To force the RRH to configure the predefined parameters, complete the following steps:
 - a Toggle the **Start-up Sequence** soft key to **Bypass**.
Setting it to Bypass will activate the additional soft keys.
 - b Press the **Protocol Version** soft key.
 - c Enter a value between 1 and 10 by using the rotary knob. You can also use the numeric keys and then press the **Enter** soft key.
 - d Press the **HDLC Rate** soft key.
 - e Select the High level Data Link Control (HDLC) rate option from: **No HDLC, 240, 480, 960, 1920, or 2400**.
 - f Toggle the **Eth Channel** soft key between **Enable** and **Disable**.
Enabling the Ethernet Channel activates the Eth Subchannel Number menu.
 - g Press the **Eth Subchannel Number** soft key.
 - h Enter a value between 20 and 63 by using the rotary knob. You can also use the numeric keys and then press the **Enter** soft key.



NOTE

This BBU emulation capability in the Layer-2 Term Testing does not include capturing C&M (Control and Management) messages.

- 4 Return to the Measure Setup menu by pressing the **PREV** hard key.
- 5 To insert an alarm signal, complete the following steps:
 - a Press the **Alarm/Error** soft key.
 - b Press the **Alarm Type** soft key.
 - c Select the alarm type option from: **R-LOS, R-LOF, RAI, or SDI**.
 - d Start the insertion by toggling the **Alarm Insertion** soft key to **On**.
 - e To stop inserting the alarm, toggle the **Alarm Insertion** soft key to **Off**.
- 6 To insert a code error signal, complete the following steps:
 - a Toggle the **Error Type** soft key to **Code**.
 - b Toggle the **Insert Type** soft key between **Single** and **Rate**, and then select the insert type option you want.
 - Single:** It inserts an error once and then turns off the error insertion.
 - Rate:** It inserts an error according to the set error rate in the Error Rate menu.
 - c If you have selected **Rate** in step b, press the **Error Rate** and then select the error rate option from: **1E-3, 1E-4, 1E-5, 1E-6, 1E-7, 1E-8, or 1E-9**.
 - d Start the insertion by toggling the **Error Insertion** soft key to **On**.
 - e To start inserting the error, toggle the **Error Insertion** soft key to **On**.
 - f To stop inserting the error, toggle the **Error Insertion** soft key to **Off**.
- 7 To insert a K30.7 error signal, complete the following steps:
 - a Toggle the **Error Type** soft key to **K30.7**.
 - b Start the insertion by toggling the **Error Insertion** soft key to **On**.
The K30.7 error signal is one time insertion. This setting changes back to **Off** after the insertion.
- 8 To insert a bit error signal, complete the following steps:
 - a Toggle the **Error Type** soft key to **Bit**.
 - b Start the insertion by toggling the **Error Insertion** soft key to **On**.
 - c To stop the insertion, toggle the **Error Insertion** soft key to **Off**.
- 9 Check the real time results on the screen.

- 10 *Optional.* You can use the **Save Logging Data** soft key to record the event logging in the .csv file format. See “Using save” on page 34 for more information.
- 11 To clear the previous event history and start a new testing, press the **MEASURE SETUP** hot key and then the **Clear History** soft key.

Measurement example

Figure 338 CPRI layer 2 term test



Performing interference analysis

The RF over CPRI (RFoCPRI) technology enables you to perform interference analysis without disrupting service by monitoring the CPRI signals. It covers multiple network technologies such as LTE, WCDMA, and GSM/EDGE.

After checking that the link connection is good with no errors and alarms, you can proceed to the interference analysis activities including spectrum, spectrogram, RSSI, spectrum replayer, dual spectrum, dual spectrogram, and quad spectrum. You can also monitor current and history CPRI alarm status for LOS and LOF displayed on the interference measurement screen.

Connecting cables

You can connect cables with a tap or without a tap as illustrated in Figure 339. If you have connected cables directly from RRH and BBU without using the nTap, you must turn on the through mode (Thru) in the CPRI parameter settings.

A SFP/SFP+ transceiver that is connected to your JD700B series must be compatible with your DUT and you must have your module information such as line rate, wavelength, and mode (MM or SM) handy.

Figure 339 Connection diagram for interference analysis

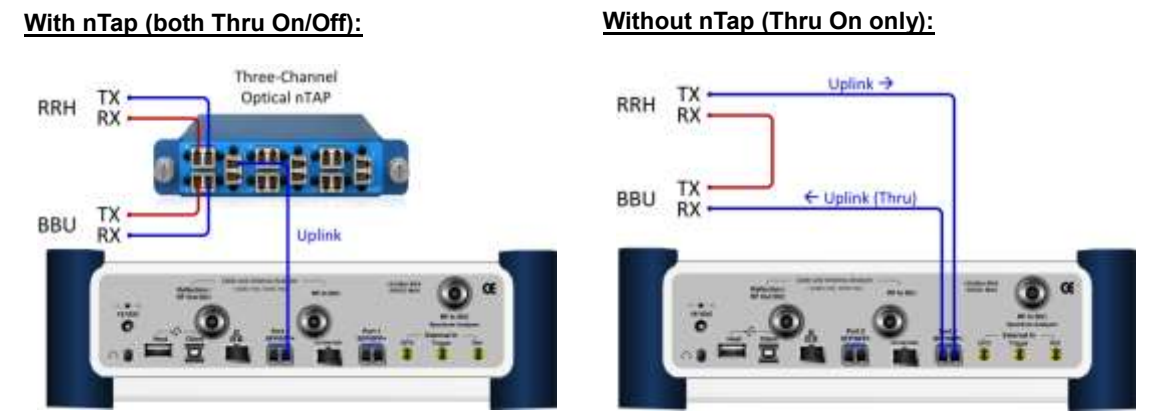

Selecting measurement mode

Procedure

- 1 Press the **MEASURE** hot key.
- 2 Press the **Interference Analyzer** soft key.
- 3 Select the interference measurement mode from the following choices:
 - Spectrum**
 - Spectrogram**
 - RSSI**
 - Spectrum Replayer**
 - Dual Spectrum**
 - Dual Spectrogram**
 - Quad Spectrum**

Selecting port

JD700B series supports two antenna ports for signal transmission, and each port can generate up to four different waveforms selectively and simultaneously. User can select the port to use for the measurement in any measurement modes of RFoCPRI mode.

Procedure

- 1 In any measurement mode, press the **MEASURE SETUP** hot key.
- 2 Toggle the **Select Port** soft key between **Port 1** and **Port 2** to select the desired port.

Configuring test parameters

Configuration of test parameters described in this section is used in the Interference Analyzer mode including spectrum measurements, spectrogram, RSSI, dual spectrum, dual spectrogram, and quad spectrum.

Setting frequency

You can set the frequency with either frequency or channel number. If a frequency to be set matches to the frequency corresponding to the selected channel standard, the instrument calculates its channel number and updates the screen with it automatically.

Procedure

To set the frequency with center frequency:

- 1 Press the **FREQ/DIST** hard key.
- 2 Toggle the **Unit** soft key to **Freq**.
- 3 Press the **Center Frequency** soft key.
- 4 Enter a value by using the numeric keys or the rotary knob.
- 5 Select a unit from: **GHz**, **MHz**, **kHz**, or **Hz**.
- 6 *Optional.* To define the amount of increment for rotary operation, complete the following steps:
 - a Press the **Frequency Step** soft key.
 - b Enter a value by using the numeric keys or the rotary knob.
 - c Press a unit from: **GHz**, **MHz**, **kHz**, or **Hz**.

To set the frequency with channel number:

- 1 Press the **FREQ/DIST** hard key.
 - 2 Toggle the **Unit** soft key to **Channel**.
 - 3 To select the standard channel, complete the following steps:
 - a Press the **Channel Std** soft key.
The standard channel window appears. See “Appendix C – Band, frequency & channel standard” on page 769 for more information.
 - b Highlight the band to be measured by using the rotary knob, the arrow keys, or the **Page Up/Page Down** soft keys.
 - c Press the **Select** soft key or the rotary knob to confirm the selection.
 - 4 Select the scanning direction by toggling the **Link** soft key between **Fwd** (forward) and **Rev** (reverse).
 - 5 Press the **Channel Number** soft key.
 - 6 Enter a value by using the numeric keys or the rotary knob.
 - 7 Press the **Enter** soft key.
The instrument automatically displays the corresponding center frequency value for the selected channel number.
 - 8 *Optional.* To define the amount of increment for rotary operation, complete the following steps:
 - a Press the **Channel Step** soft key.
 - b Enter a value by using the numeric keys or the rotary knob.
 - c Press the **Enter** soft key.
-

Setting reference level

You can set the reference level automatically or manually to optimize the display of the traces measured, as you desire.

Procedure

To automatically set the reference level:

- 1 Press the **AMP/SCALE** hard key.
- 2 Press the **Auto Scale** soft key.
Each time you press this key, the Y-axis scale changes to be optimized with some margin.

To set the reference level manually:

- 1 Press the **AMP/SCALE** hard key.
 - 2 To set the maximum reference value on the Y-axis manually, complete the following steps:
 - a Press the **Reference Level** soft key.
 - b Enter a value by using the numeric keys or the rotary knob with 10 dB increments.
 - c Press the unit soft key or the **ENTER** hard key.
This unit key name changes according to the setting in the **Units** menu.
-

Optional. To change the scale unit:

- 1 Select **More (1/2) > Units**.
 - 2 Select the unit of the display scale from: **dBm**, **dBV**, **dBmV**, **dBμV**, **V**, or **W**.
The scale unit on the screen changes accordingly.
-

Setting scale per division

You can use the **Scale/Div** feature to change the scale per division, representing the value of one division on the horizontal scale. The default setting is 10 dB per division and the maximum value can be set up to 20 dB.

Procedure

- 1 Press the **AMP/SCALE** hard key.
 - 2 Select **More (1/2) > Scale/Div**.
 - 3 Enter a value between 1 and 20 by using the numeric keys.
 - 4 Press the **dB** soft key to complete the entry.
-

Setting external offset

You can turn the **External Offset** on and manually set the external offset value. An offset consists of a cable loss and a user offset, and the measurement result shows the value reflecting both offset values. When the external offset value is set at 40 dB, the measurement result compensates 40 dB.

Procedure

To set the external offset:

- 1 Press the **AMP/SCALE** hard key.
- 2 Toggle the **External Offset** soft key to **On**.
- 3 Enter a value by using the numeric keys.
- 4 Press the **dB** soft key to complete the entry.

To turn the external offset off:

- 1 Press the **AMP/SCALE** hard key.
 - 2 Toggle the **External Offset** soft key to **Off**.
-

Enabling auto leveling

It is normal that you see higher level of RSSI in CPRI spectrum than you have seen in RF spectrum because the digital signal has a different gain level from RF's. If you use the Auto Leveling feature and enter the Noise Figure (NF) for the system to be tested, the instrument calculates an offset that compensates the digital gain of RRH and applies it to the spectrum automatically to displace the level of spectrum to a known RSSI power even though its accuracy cannot be guaranteed. Offset calculation for Auto Leveling is based on the following:

Auto Level offset = (Noise Floor of RFoCPRI) – (Ideal Noise Floor of RRH), where (Idea Noise Floor) = N.F (RRH) + Thermal Noise + 10log (RBW)

Procedure

- 1 Press the **AMP/SCALE** hard key.
 - 2 Press the **Auto Leveling** soft key.
-

A calculated level of offset without NF is applied as the external offset and the user input field is activated for entry of the noise figure value.

- 3 Enter a noise figure value by using the numeric keys.



NOTE

Having the noise figure factored in the offset calculation for Auto Leveling will enable you to view the CPRI spectrum closer to what you can view in the RF spectrum, but if you do not know the noise figure, you can skip this noise figure setting.

- 4 Press the **dB** soft key to complete the entry.
New external offset value appears in the **External Offset** menu box.

Figure 340 Before enabling Auto Leveling



Figure 341 After enabling Auto Leveling



Setting RBW

You can set the RBW and VBW in the Spectrum, Spectrogram, and RSSI modes. The RBW range is limited as per the bandwidth of the signal under test.

Procedure

- 1 Press the **BW/AVG** hard key.
 - 2 Press the **RBW** soft key to set the resolution bandwidth.
 - 3 Enter a value in 1-3 sequence by using the numeric keys, and then select **kHz** soft key.
You can also use the rotary knob.
For signal bandwidths 1.4 MHz and 3 MHz: RBW from 1 kHz to 30 kHz
For signal bandwidths 5 MHz, 10 MHz, 15 MHz, and 20 MHz: RBW from 1 kHz to 100 kHz
 - 4 Press the **VBW** soft key to set the video bandwidth.
 - 5 Enter a value by using the numeric keys or the rotary knob.
 - 6 Select the unit option from: **MHz**, **kHz**, or **Hz**.
-

Setting average

You can set the number of measurements to be averaged for the trace presentation in the Spectrum, Spectrogram, and RSSI modes. A maximum of 100 times of averaging can be set. When the averaging reaches to your setting, a new measurement value replaces the measurement value in sequence from the earliest.

Procedure

- 1 Press the **BW/AVG** hard key.
 - 2 Press the **Average** soft key.
 - 3 Enter a value between 1 and 100 as needed by using the numeric keys.
 - 4 Press the **Enter** soft key.
-

Setting sweep mode

In the RFoCPRI Spectrum, Spectrogram, and RSSI measure modes, various sweep settings are available for better measurement, including the sweep run mode (**Single**, **Continuous**) and the sweep speed mode (**Normal**, **Fast**).

Procedure

- 1 Press the **SWEEP** hot key.
 - 2 Select the desired sweep run mode by toggling the **Sweep Mode** soft key between **Single** and **Continuous**. You can also use the **HOLD** hot key.
Single: In this mode, the instrument performs a single sweep and waits for further entries. The letter **HOLD** in red appears and the sweeping is paused.
Continuous (default): In this mode, the instrument is continuously measuring and updating result.
The letter **HOLD** in red disappears and the sweeping resumes.
 - 3 Select the desired sweep speed mode by toggling the **Sweep Mode** soft key between **Normal** and **Fast**:
Normal: The signal processing and update rate is set to normal levels.
Fast (default): It speeds up the signal processing and the display update rate to increase the overall sweep time.
 - 4 *Optional*. In the Single mode, press the **Sweep Once** soft key to get a new measurement.
-

Setting trace

You can display up to six traces on the measurement chart simultaneously.

Procedure

- 1 Press the **TRACE/DISPLAY** hard key.
- 2 Press the **Select Trace** soft key, and then select the trace number: **T1**, **T2**, **T3**, **T4**, **T5**, or **T6**. The legend shape of the selected trace changes from square to round to indicate that the trace is the active one now.
- 3 Complete one of the followings:

To	Select	Trace Legend
Clear current data and display with new measurements	Clear Write	W
Display the input signal's maximum response only (unlimited or for a certain amount of time)	Max Hold	M
Display the input signal's minimum response only (unlimited or for a certain amount of time)	Min Hold	m
Capture the selected trace and compare traces	Capture	C
Load a saved trace	More (1/2) > Load	L
Hide the displayed trace	Trace View > Off	F
Remove all the traces and initialize the trace settings	More (1/2) > Trace Clear All	



NOTE

For the **Max Hold** and **Min Hold**, your instrument compares newly acquired data with the active trace and displays larger maximum values or smaller minimum values on the screen. You can set it to **Unlimited** to hold and view maximum or minimum data or specify a certain amount of time up to 60 seconds by using numeric keys or rotary knob.

- 4 To select the detection option, select **More (1/2) > Detectors**, and then complete one of the followings:

To display	Select
Random noise better than the peak without missing signals	Normal
The highest value in each data point	Peak
The root mean squared average power across the spectrum	RMS
The lowest value in each data point	Negative Peak
The center value in each data point	Sample

- 5 *Optional.* Select **More (1/2) > Trace Info**, and then select the trace number to view the trace's parameter setting information stored at the time of the measurement or **None** to hide the information display.
- 6 *Optional.* If you have the two traces T1 and T2, you can perform trace math. To view the power difference between the traces, press the **T1 - T2 -> T5** or **T2 - T1 -> T6** soft key. The result is overlaid on the screen along with the second Y-axis.



NOTE

To be able to load a trace, the trace to be overlaid must be saved in the same measurement mode and frequency setting as the current measurement.

Setting measure setup

Procedure

- 1 Press the **MEASURE SETUP** hot key.
- 2 To set the CPRI line bit rate of the fronthaul under test, complete the following steps:
 - a Press the **Link Rate** soft key.
 - b Select the CPRI link rate option from: **614.4 Mbps, 1228.8 Mbps, 2457.6 Mbps, 3072.0 Mbps, 4915.2 Mbps, 6144.0 Mbps, or 9830.4 Mbps.**



NOTE

It is important that you set the link rate correctly to avoid any misleading LOS and LOF alarms displayed on the screen.

- 3 To turn on the through mode, go to **More (2/3) > Thru**, and then toggle the **Thru** soft key to **On**.
 - 4 To set the **Tx Clock**, go to **More (3/3) > Tx Clock**, and then toggle the **Tx Clock** soft key to **Recovered** (default).
 - 5 Toggle the **Port Type** soft key to **Slave** (default).
 - 6 *Optional.* To set the Rx Parameters, see “Configuring Rx parameters” on page 565.
 - 7 *Optional.* To use the Source menu, see “Using signal generator” on page 585.
 - 8 *Optional.* To use the CPRI signal generator function, see “Using CPRI source” on page 590.
-

Using map profile list (custom)

Along with features provided for the map profile list (system), you can create new map profiles, edit the map profiles, save the map profiles as a file format and load the saved files whenever you need.

Procedure

- 1 In the **Spectrum, Spectrogram, RSSI, Dual Spectrum, Dual Spectrogram, or Quad Spectrum** mode, press the **MEASURE SETUP** hot key.
- 2 Press the **Map Profile List (Custom)**.
The Map Profile window appears on the screen as shown in Figure 323.
- 3 To search the map profile databased on the list, scroll up and down the list using the rotary knob.
- 4 To search the map profile database by keyword, complete the following steps:
 - a Scroll up and down the list using the rotary knob.
 - a Tap on the input box in the **By Keyword** row.
The edit keywords window appears.
 - b Enter the keywords by tapping the on-screen keyboard, and then press the **Apply** soft key.



NOTE

To learn how to use the on-screen keyboard, see “Appendix K – On-screen keyboard” on page 743.

- c Tap the **Search** key.
The map profiles with the keywords are listed on the screen.
 - d Select a desired map profile by scrolling up and down the list using the rotary knob.
 - 5 To search the map profile database with the filters, complete the following steps:
 - a Tap on the first (or leftmost) drop-down box in the **By Field Value** row.
The drop-down list appears.
 - b Select a desired keyword by tapping on the drop-down list.
 - c Tap on the second drop-down box in the **By Field Value** row.
The drop-down list appears.
 - d Select a desired keyword by tapping on the drop-down list.
 - e Tap the **Filter** key.
The map profiles with the keywords are listed on the screen.
 - f Select a desired map profile by scrolling up and down the list using the rotary knob.
-

- 6 To search the map profile database using the keyword and filters, complete the following steps:
 - a Enter the keyword on the input box in the **By Keyword** row.
 - a Select the filtering keyword on the **By Field Value** row.
 - b Tap the **Search with Filter** key.
The map profiles with the keywords are listed on the screen.
 - c Select a desired map profile by scrolling up and down the list using the rotary knob.
- 7 To apply the selected map profile to the current measurement, tap the **Apply** key or press the **Apply** soft key.
The spectrum measurement screen with the selected test parameters appears.
- 8 *Optional.* To create a new map profile to the database, complete the following steps:
 - a Tap the **Create** key.
The editing screen appears.
 - b Edit the test parameters as needed, and then press the **Apply** soft key.
 - c The map profile is created on the map profile list.
- 9 *Optional.* To edit the map profiles, complete the following steps:
 - a Search and select a desired map profile.
 - b Tap the **Edit** key.
The editing screen appears.
 - c Edit the test parameters as needed.
 - d To apply the changes, press the **Apply** soft key.
- 10 *Optional.* To delete the map profiles, complete the following steps:
 - a Search and select a desired map profile.
 - b Tap the **Delete** key.
A pop-up window appears.
 - c Tap **OK** to delete the profile, tap **Cancel** to cancel the delete process.
- 9 *Optional.* To save the map profiles, complete the following steps:
 - a Tap the **Save** key.
 - b Enter a file name using the on-screen keyboards.
 - c To apply the changes, press the **Apply** soft key.
- 10 *Optional.* To load the map profiles, complete the following steps:
 - a Tap the **Load** key.
The loading screen appears with the **MapProfile** folder highlighted.
 - b Select the file to load.
 - c Press the **Apply** soft key.

**NOTE**

You can press **SAVE/LOAD > File Manager > Save folder > MapProfile** folder and easily copy and paste the map profile files you want.

Figure 342 Example of Map Profile DB screen (custom)

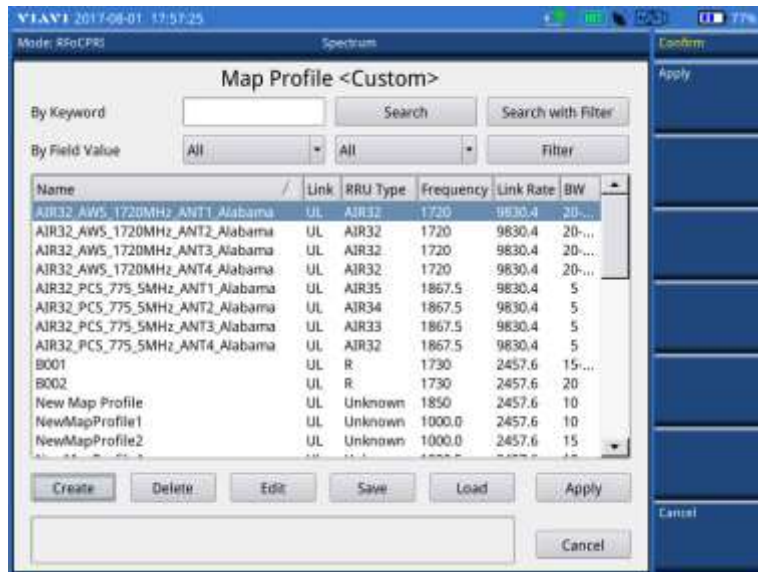
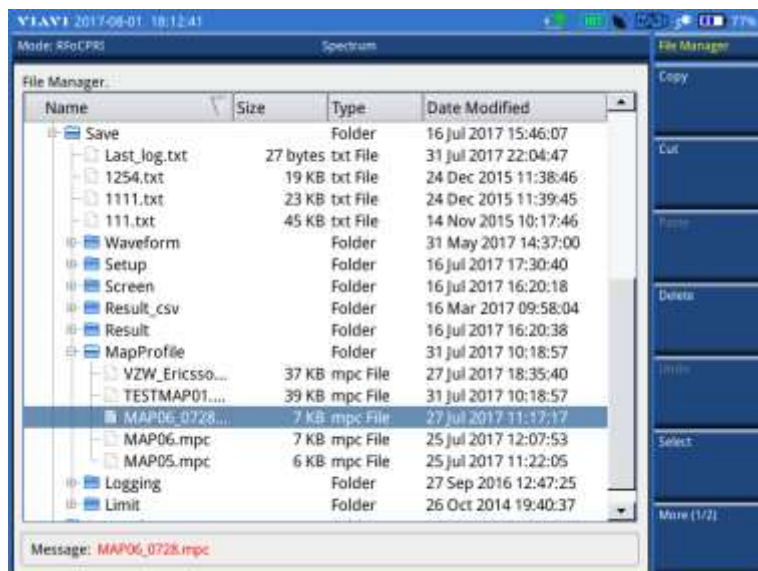

Figure 343 Example of Map Profile DB copy and paste using File Manager



Using map profile list (system)

The JD700B series provide the map profile database with more than 160 default test parameters. In the Spectrum mode, you can search the map profile database and apply a desired test parameters to your current measurement.

Procedure

- 1 In the **Spectrum, Spectrogram, RSSI, Dual Spectrum, Dual Spectrogram, or Quad Spectrum** mode, press the **MEASURE SETUP** hot key.
- 2 Press **More (3/3)**.
- 3 Press the **Map Profile List (System)**.
The Map Profile window appears on the screen as shown in Figure 325.
- 4 To search the map profile databased on the list, scroll up and down the list using the rotary knob.
- 5 To search the map profile database by keyword, complete the following steps:

- a Scroll up and down the list using the rotary knob.
- b Tap on the input box in the **By Keyword** row.
The edit keywords window appears.
- c Enter the keywords by tapping the on-screen keyboard, and then press the **Apply** soft key.



NOTE
To learn how to use the on-screen keyboard, see "Appendix K – On-screen keyboard" on page 743.

- d Tap the **Search** key.
The map profiles with the keywords are listed on the screen.
 - e Select a desired map profile by scrolling up and down the list using the rotary knob.
- 6** To search the map profile database with the filters, complete the following steps:
- a Tap on the first (or leftmost) drop-down box in the **By Field Value** row.
The drop-down list appears.
 - b Select a desired keyword by tapping on the drop-down list.
 - c Tap on the second drop-down box in the **By Field Value** row.
The drop-down list appears.
 - d Select a desired keyword by tapping on the drop-down list.
 - e Tap the **Filter** key.
The map profiles with the keywords are listed on the screen.
 - f Select a desired map profile by scrolling up and down the list using the rotary knob.
- 7** To search the map profile database using the keyword and filters, complete the following steps:
- a Enter the keyword on the input box in the **By Keyword** row.
 - b Select the filtering keyword on the **By Field Value** row.
 - c Tap the **Search with Filter** key.
The map profiles with the keywords are listed on the screen.
 - d Select a desired map profile by scrolling up and down the list using the rotary knob.
- 8** To apply the selected map profile to the current measurement, tap the **Apply** key or press the **Apply** soft key.
The spectrum measurement screen with the selected test parameters appears.

Figure 344 Example of Map Profile DB screen (system)

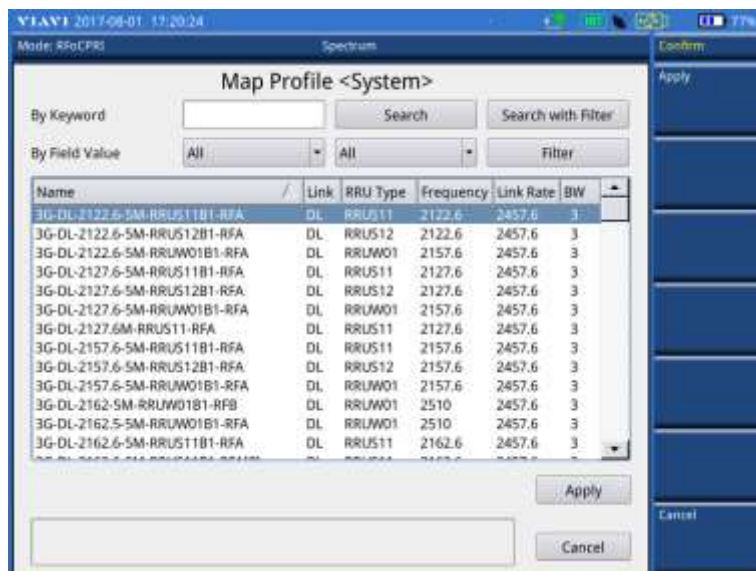

Selecting network technology

Before you start performing the interference analysis, you need to choose a network technology to analyze.

Procedure

- 1 Press the **MEASURE SETUP** hot key.
- 1 Press **Rx Parameters > Technology**.
- 2 Select a desired network technology from the menu bar:
 - LTE** (default)
 - WCDMA**
 - GSM/EDGE**

Depending on the network technology you selected, the settings appear on the Rx Parameter menu bar changes accordingly.

Configuring Rx parameters

Because each network technology requires different Rx parameter settings, you need to configure the Rx parameters for the network technology you selected.

Procedure

To configure Rx parameters for LTE, WCDMA, and GSM/EDGE:

- 1 Press the **MEASURE SETUP** hot key.
- 2 Press the **Rx Parameters** soft key.
- 3 To set the antenna per carrier group, complete the following steps:
 - a Press the **AxC Group** soft key.
 - b Enter a value by using the numeric keys or the rotary knob.
 - c Press the **Enter** soft key.



NOTE

Maximum number of the AxC Group is determined by the factors of link rate, sample width, oversampling, and signal bandwidth.

- 4 To set the I and Q sample widths, complete the following steps:
 - a Press the **IQ Sample Width** soft key
 - b Enter a value between 4 and 20 by using the numeric keys or the rotary knob, and then press the **Enter** soft key.



NOTE

According to the CPRI specification, the IQ sample width shall be between 4 and 20 bits for I and Q in the uplink and between 8 and 20 bits in the downlink.

- 5 To set the stuffing bit, complete the following steps:
 - a Press the **Stuffing Bit** soft key.
 - b Enter a value between 0 and 20 by using the numeric keys or the rotary knob.
- 6 To set the first bit position of each AxC Container in the IQ data block of a basic frame, complete the following steps:
 - a Press the **Map Position** soft key.
 - b Select the AxC Container number you want to set from: **AxC 0**, **AxC 1**, **AxC 2**, **AxC 3**, **AxC 4**, **AxC 5**, **AxC 6**, or **AxC 7**. Not all of these are activated depending on the bandwidth setting of the network technology you selected.
 - c Enter a value by using the numeric keys or the rotary knob.
 - d Press the **Enter** soft key.



NOTE

The Antenna-Carrier (AxC) is the amount of digital baseband (IQ) U-plane data necessary for either reception or transmission of one carrier at one independent antenna element. The number of required AxC Container for a basic frame are two AxCs for 5 MHz, four AxCs for 10 MHz, and eight AxCs for 20 MHz.

Following is an example of test configuration for a DUT.

DUT		Test Configuration	
CPRI Line Rate (Mbps)	614.4	Link Rate (Mbps)	614.4
UMTS Channel (MHz)	3.84	Bandwidth (MHz)	3
Carriers	2	NEM	None
AxC Positioning	Packed	AxC Group	1 – 2
IQ Sampling	15	IQ Sample Width	15
Over Sampling	1	Map Position	AxC 0 0 AxC 1 15

For this test configuration, IQ allocation will be like this in the CPRI basic frame.

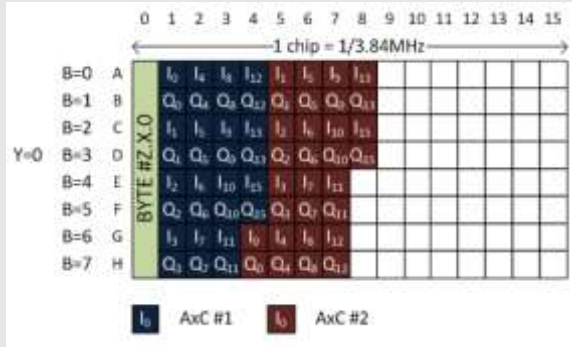

To configure Rx parameters for LTE:

- 7 To set the bandwidth of the downlink signal, complete the following steps:
 - a Press the **Bandwidth** soft key.
 - b Select the bandwidth option from: **1.4 MHz, 3 MHz, 5 MHz, 10 MHz, 15 MHz, 15 MHz (4 AxC), 20 MHz, or 20 MHz (6 AxC)**.
The RBW range changes depending on the bandwidth you selected.
Required number of AxC containers may vary depending on the bandwidth you selected.
- 8 To use the pre-configured settings for a NEM, complete the following steps:
 - a Press the **NEM** soft key.
 - b Select an NEM from the following choices:
 - None** (no pre-configuration)
 - Ericsson > Ericsson (UL) and Ericsson (DL)**
 - Alcatel-Lucent (UL/DL)**
 - Samsung (UL/DL)**
 - Huawei > Huawei (UL) and Huawei (DL)**
 - ZTE (UL/DL)**



NOTE
If you have selected a NEM, the instrument sets the Map Position and other related settings automatically based on the selected NEM and you cannot edit the map position setting. The pre-configured information may be subject to changes at any times by NEMs.

To configure Rx parameters for LTE:

- 9 To set the GSM sample rate, complete the following steps:
 - a Press the **GSM Sample Rate** soft key.
 - b Select a desired GSM sample rates



NOTE
CellAdvisor FW3.065 supports only 960 kHz (NA1) for GSM sample rate.

Conducting spectrum measurement

After setting test parameters as described in “Configuring test parameters” on page 555, you can perform spectrum measurements with an audible indicator. You can also turn on the interference ID.

Procedure

- 1 Press the **MEASURE SETUP** hot key.
- 2 To set the sound indicator, complete the following steps:
 - a Press the **Sound Indicator** soft key.
 - b Toggle the **Alarm Reference** soft key between **Marker** and **Line**:
 - Marker:** Sets the active marker position as the alarm reference if you have enabled a marker on the spectrum.
 - Line:** Makes the limit line as the alarm reference.
 - c If you have set the alarm reference to Line, press the **Limit Line** soft key to set a threshold for an alarm.
 - d Enter a value, and then press the **dBm** soft key.
 - e Toggle the **Sound** soft key between **On** and **Off** to turn on/off the alarm sound.
 - f *Optional.* To adjust the volume for alarm sound, press the **Volume** soft key, and then turn the rotary knob clockwise or counter clockwise.
 - g *Optional.* To select the sound mode for alarm, toggle the **Sound Mode** soft key and select the option from the following choices:
 - Select the **Mode 1** to create an alarm with a consistent tone (frequency) regardless of the interference signal.
 - Select the **Mode 2** to apply the tone step from 1 to 20.
 - Select the **Mode 3** to apply the tone step from 20 to 1.



NOTE

The Sound Indicator is used to identify interfering signals with alarm sound. It is especially useful for locating interferer sources with a directional antenna.

- 3 To set the interference ID, complete the following steps:
 - a Press the **Interference ID**.
 - b Press the **Threshold** soft key.
 - c Enter a value, and then press the **dBm** soft key.
 - d Toggle the **Interference ID** soft key between **On** and **Off** to turn on/off the interference ID.



NOTE

The Interference ID automatically classifies interfering signals over a designated spectrum and displays a list of possible signal types corresponding to the selected signal.

- 4 To clear current (C) and history (H) status of CPRI alarm on LOS and LOF and start a new monitoring, press the **MEASURE SETUP** hot key and then the **Clear History** soft key.
- 5 *Optional.* Go to **SAVE/LOAD > Save**, and then select the save option from the choices available for your measurement mode. See “Using save” on page 34 for more information. If you have saved logging data, you can play them in the Spectrum Replayer mode.



NOTE

You can use the **LIMIT** hot key to analyze your measurements with the display line, multi-segment line, and channel limit. See “Setting limit for interference analysis” on page 580 for more information.

Figure 345 RFoCPRI spectrum measurement



Figure 346 RFoCPRI spectrum analysis on LTE Uplink 10 MHz, antenna 1



Figure 347 RFoCPRI spectrum analysis on LTE Uplink 10 MHz, antenna 2



Conducting dual spectrum measurement

With the Dual Spectrum feature, you can monitor two spectrums for different map positions on the same link simultaneously. If you enable the new Dual Active Trace function in the Dual Spectrum mode, the instrument displays the two sweeping traces overlaid on a single chart.

After setting test parameters as described in the “Configuring test parameters” on page 555, you can perform dual spectrum measurements.

Procedure

- 1 Press the **MEASURE SETUP** hot key.
- 2 Toggle the **Active Window** soft key between **Top** and **Bottom**. You can also tap the chart on the screen.
- 3 To change the AxC group and map position settings for the window you have selected, complete the following steps:
 - a Press **Rx Parameters**.
 - b Press the **AxC Group** soft key.
 - c Enter a value between 1 and 24, and then press the **Enter** soft key.
 - d Press the **Map Position** soft key, and then select the AxC Container number you want to set from: **AxC 0**, **AxC 1**, **AxC 2**, **AxC 3**, **AxC 4**, **AxC 5**, **AxC 6**, or **AxC 7**.
 - e Enter a value, and then press the **Enter** soft key.



NOTE

The AxC Group and Map Position settings for the top and bottom windows work independently each other while all other parameter settings change concurrently. If you have selected one of the NEMs, you cannot change the Map Position setting.

- 4 To view both traces writing currently in each window together on a single chart with overlapping, complete the following steps:
 - a To enable the overlaid view, toggle the **Dual Active Trace** to **On**.
Traces from the top and bottom charts appear overlapped on a single chart.



NOTE

As shown in Figure 350, there appears [Top] or [Bottom] at the top left of the chart to indicate which window is active now. Currently selected active window's trace is brought to front in its bold color while the inactive window's trace sent to back with lighter color.

- b To change the selection of the active window and trace(s), toggle the **Active Window** soft key between **Top** and **Bottom**. You can also tap on the upper or lower portion of the chart

- on the screen.
- c To disable the overlap view and return to the dual spectrum view, toggle the **Dual Active Trace** soft key to **Off**.
- 5 To clear current (C) and history (H) status of CPRI alarm on LOS and LOF and start a new monitoring, press the **MEASURE SETUP** hot key and then the **Clear History** soft key.
- 6 *Optional.* Go to **SAVE/LOAD > Save**, and then select a desired save option for your measurement mode. See “Using save” on page 34 for more information. If you have saved logging data, you can play them in the Spectrum Replayer mode.

Figure 348 RfCPRI dual spectrum analysis



NOTE
You can use the **LIMIT** hot key to analyze your measurements with the display line, multi-segment line, and channel limit. See “Setting limit for interference analysis” on page 580 for more information.

Figure 349 RfCPRI dual spectrum with dual active trace off

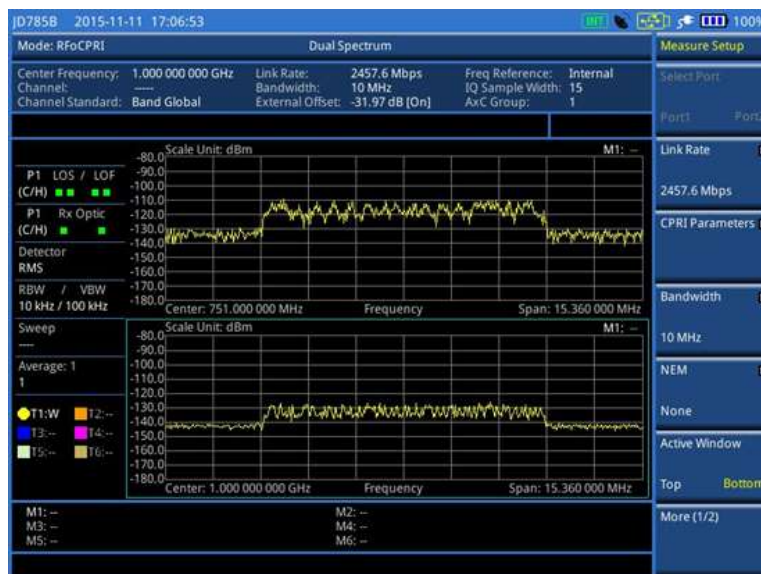

Figure 350 RFoCPRI dual spectrum with dual active trace on



Conducting quad spectrum

In the Quad Spectrum mode, you can monitor four spectrums for different map positions on the same link simultaneously. If you enable the new Quad Active Trace function, the instrument displays the four sweeping traces overlaid on a single chart. You can also monitor the two spectrograms of the selected sweeping traces using the Dual Spectrogram function in this mode.

After setting test parameters as described in the “Configuring test parameters” on page 510, you can perform the quad spectrum measurements.

Procedure

- 1 Press the **MEASURE SETUP** hot key.
- 2 Toggle the **Active Window** soft key among **Trace 1**, **Trace 2**, **Trace 3**, and **Trace 4** to select a desired chart. You can also tap the chart on the screen.
- 3 To change the AxC group and map position settings for the selected chart, complete the following steps:
 - a Press the **Rx Parameters** soft key.
 - b Press the **AxC Group** soft key.
 - c Enter a value between 1 and 24, and then press the **Enter** soft key.
 - d Press the **Map Position** soft key, and then select the AxC Container number you want to set from: **AxC 0**, **AxC 1**, **AxC 2**, **AxC 3**, **AxC 4**, **AxC 5**, **AxC 6**, or **AxC 7**.
 - e Enter a value, and then press the **Enter** soft key.



NOTE

The AxC Group and Map Position settings for the top and bottom windows work independently each other while all other parameter settings change concurrently. If you have selected one of the NEMs, you cannot change the Map Position setting.

- 4 To view all traces overlaid on a single chart, complete the following steps:
 - a Toggle the **Quad Active Trace** to **On**.
The screen displays the traces overlaid on a single chart.



NOTE

The currently active trace is brought to front of all traces and highlighted in bold. You can check the currently active trace at the top left of the chart as shown in Figure 352.

- b To change the active trace, press the **PREV** hard key, and then toggle the **Active Window** soft key to desired trace number.

- c To exit the overlaid view and return to the quad spectrum view, toggle the **Quad Active Trace** soft key to **Off**.
- 5 To view the dual spectrograms of selected traces, complete the following steps:
 - a In the Quad Spectrum view, press the **More (2/3)** soft key.
 - b press the **Dual Spectrogram** soft key. The Dual Trace Selection window appears.
 - c Select two traces by tapping on the screen, and then tap **OK**.
 - d Press the **More (1/3)** soft key.
 - e Select the active trace by toggling the **Active Window** soft key between **Left** and **Right**. You can also tap the trace on the screen.
 - f Set the amount of time between each trace measurement by pressing the **Time Interval** soft key and then enter a value.
 - g Enter a value, and the press the **Sec** soft key.
- 6 To set the time cursor on a specific trace position, complete the following steps:
 - a Toggle the **Time Cursor** soft key to **On**.
 - b Press the **Position** soft key.
 - c Turn the rotary knob to move the time cursor. You can also enter a value and then press the **Enter** soft key.
- 7 To clear current (C) and history (H) status of CPRI alarm on LOS and LOF and start a new monitoring, press the **MEASURE SETUP** hot key and then the **Clear History** soft key.
- 8 *Optional.* Go to **SAVE/LOAD > Save**, and then select a desired save option for your measurement mode. See “Using save” on page 34 for more information. You can play the saved logging data in the Spectrum Replayer mode.

Figure 351 RFoCPRI quad spectrum with quad active trace off



Figure 352 RFoCPRI quad spectrum with quad active trace on



Conducting spectrogram

The Spectrogram is particularly useful when attempting to identify periodic or intermittent signals as it captures spectrum activity over time and uses various colors to differentiate spectrum power levels. When the directional antenna is used to receive the signal, you will see a change in the amplitude of the tracked signal as you change the direction of the antenna and see a change in the Spectrogram colors. The source of the signal is located in the direction that results in the highest signal strength.

After setting test parameters as described in “Configuring test parameters” on page 555, you can perform spectrogram measurements.

Procedure

- 1 Press the **MEASURE SETUP** hot key.
- 2 To set the amount of time between each trace measurement:
 - a Press **More (2/3)**.
 - b Press the **Time Interval** soft key.
 - c Enter a value, and then press the **Sec** soft key.
- 3 To set the time cursor on a specific trace position, complete the following steps:
 - a Toggle the **Time Cursor** soft key to **On**.
 - b Press the **Position** soft key.
 - c Turn the rotary knob to move the time cursor. You can also enter a value and then press the **Enter** soft key.
 - d To turn the time cursor off, toggle the **Time Cursor** soft key to **Off**.



NOTE

Enabling the time cursor puts the measurement on hold and you can make post-processing analysis for each measurement over time using the time cursor.

- 4 To start a new measurement, press the **Reset/Restart** soft key.
- 5 To clear current (C) and history (H) status of CPRI alarm on LOS and LOF and start a new monitoring, press the **MEASURE SETUP** hot key and then the **Clear History** soft key.
- 6 *Optional.* Go to **SAVE/LOAD > Save**, and then select the save option from the choices available for your measurement mode. See “Using save” on page 34 for more information.

The spectrogram shows a vertical line on the chart when the marker is enabled on the screen.

Figure 353 RFoCPRI interference measurement in spectrogram

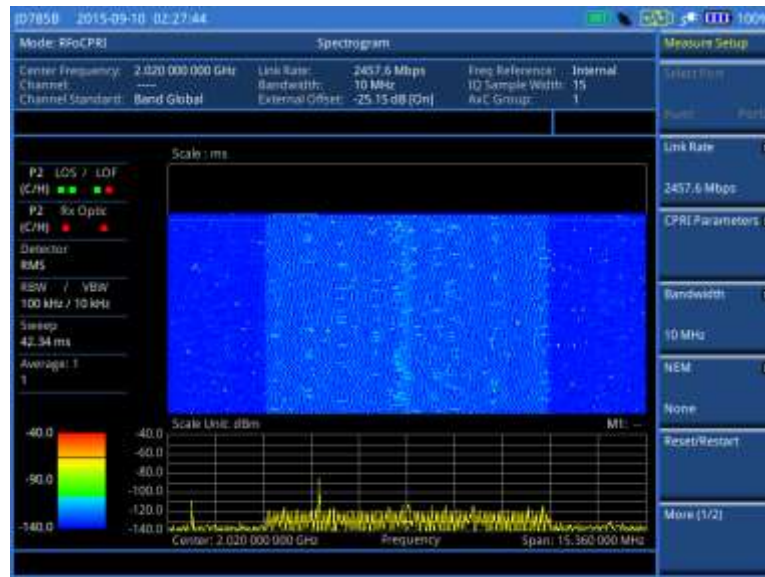
**NOTE**

You can use the **LIMIT** hot key to analyze your measurements with the display line, multi-segment line, and channel limit. See “Setting limit for interference analysis” on page 580 for more information.

Conducting dual spectrogram

The Dual Spectrogram feature lets you observe two spectrograms for different map positions on the same link simultaneously.

After configuring test parameters as described in the “Configuring test parameters” on page 555, you can perform dual spectrogram measurements.

Procedure

- 1 In the Dual Spectrogram mode, press the **MEASURE SETUP** hot key.
- 2 Press the **More (1/2)** soft key.
- 3 Toggle the **Active Window** soft key and select **[Left|Right]**. You can also tap on the left or right chart on the screen.
- 4 To change the AxC group and map position settings for the window you have selected, complete the following steps:
 - a Press the **Rx Parameters** soft key.
 - b Press the **AxC Group** soft key.
 - c Enter a value between 1 and 24, and then press the **Enter** soft key.
 - d Press the **Map Position** soft key, and then select the AxC Container number you want to set from: **AxC 0**, **AxC 1**, **AxC 2**, **AxC 3**, **AxC 4**, **AxC 5**, **AxC 6**, or **AxC 7**.
 - e Enter a value, and then press the **Enter** soft key.

**NOTE**

The AxC Group and Map Position settings for the top and bottom windows work independently each other while all other parameter settings change concurrently.

- 5 To set the amount of time between each trace measurement, complete the following steps:
 - a Press the **Time Interval** soft key.
 - b Enter a value, and then press the **Sec** soft key.
- 6 To set the time cursor on a specific trace position, complete the following steps:

- a Toggle the **Time Cursor** soft key to **On**.
- b Press the **Position** soft key.
- c Turn the rotary knob to move the time cursor. You can also enter a value and then press the **Enter** soft key.

**NOTE**

Enabling the time cursor puts the measurement on hold and you can make post-processing analysis for each measurement over time using the time cursor.

- 7 To start a new measurement, press the **Reset/Restart** soft key.
- 8 To clear current (C) and history (H) status of CPRI alarm on LOS and LOF and start a new monitoring, press the **MEASURE SETUP** hot key and then the **Clear History** soft key.
- 9 *Optional.* Go to **SAVE/LOAD > Save**, and then select the save option from the choices available for your measurement mode. See “Using save” on page 34 for more information.

Figure 354 RFoCPRI dual spectrogram analysis

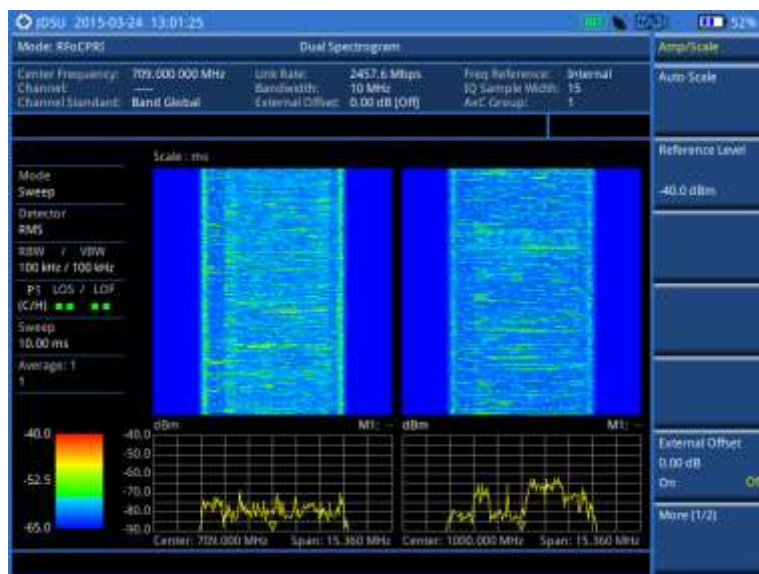
**NOTE**

You can use the **LIMIT** hot key to analyze your measurements with the display line, multi-segment line, and channel limit. See “Setting limit for interference analysis” on page 580 for more information.

Conducting RSSI

The Received Signal Strength Indicator (RSSI) is a multi-signal tracking metric that is particularly useful for measuring power-level variations over time. The RSSI measurement lets you assign power limit line for audible alarms and increase alarm counters every time a signal exceeds a defined limit line. For long-term analysis, the spectrogram and RSSI measurements can be automatically saved into an external USB memory. Post-analysis can be performed with JDViewer application software.

After configuring test parameters as described in the “Configuring test parameters” on page 555, you can continue to proceed to the spectrogram measurement.

Procedure

- 1 Press the **MEASURE SETUP** hot key.
- 2 To set up the alarm parameters, complete the following steps:
 - a Press the **Alarm** soft key.

- b Press the **Alarm at** soft key, and then select the marker number you want to set.
- c Press the **Limit Line** soft key to set a threshold for the alarm.
- d Enter a value by using the numeric keys or the rotary knob.
- e Press the **dBm** soft key.
- f Toggle the **Alarm** soft key between **On** and **Off** to turn the alarm feature on or off.



NOTE
You must set the marker(s) first by using the **MARKER** hard key as these features use the marker position to sound an alarm. See “Using marker” on page 60 for more information.

- g *Optional.* Press the **Volume** soft key to adjust the volume.
- 3 Press the **PREV** hard key to return to the Measure Setup menu bar.
- 4 To start a new measurement, press the **Reset/Restart** soft key.
- 5 To clear current (C) and history (H) status of CPRI alarm on LOS and LOF and start a new monitoring, press the **MEASURE SETUP** hot key and then the **Clear History** soft key.
- 6 *Optional.* Go to **SAVE/LOAD > Save**, and then select the save option from the choices available for your measurement mode. See “Using save” on page 34 for more information.

Figure 355 RFoCPRI interference measurement in RSSI

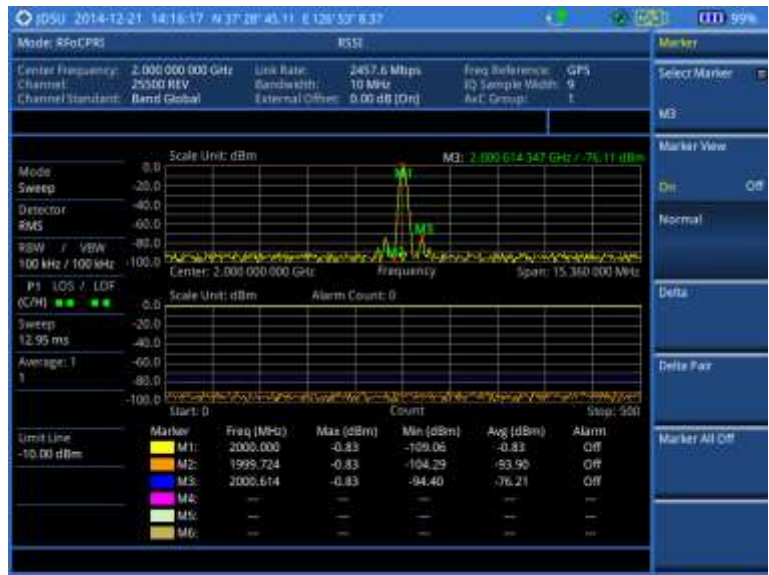

NOTE
You can use the **LIMIT** hot key to analyze your measurements with the display line, multi-segment line, and channel limit. See “Setting limit for interference analysis” on page 580 for more information.

Zooming into spectrum using zoom in

CPRI delivers spectrum bandwidth information based on the sampling frequency of a carrier as specified in the 3GPP specification.

Signal Bandwidth	3 MHz	5 MHz	10 MHz	15 MHz	20 MHz
Transmission Bandwidth	2.7 MHz	4.5 MHz	9 MHz	13.5 MHz	18 MHz
Sampling Frequency	3.84 MHz	7.68 MHz	15.36 MHz	23.04 MHz	30.72 MHz

Even though it limits that you can view spectrum only within the sampling frequency, the Zoom In feature in JD700B series makes it easy to view the spectrum in detail. This feature is available in RFoCPRI Spectrum,

Spectrogram, RSSI, Dual Spectrum, Dual Spectrogram, and Quad Spectrum modes.

**NOTE**

Make sure that the sweep mode is set to **Normal** to use the Zoom In feature.

Procedure

- 1 Press the **MARKER** hard key and place the marker at the frequency that you want to zoom in.
- 2 Press the **MARKER** or **FREQ/DIST** hard key.
- 3 Press the **Zoom In** soft key.
- 4 The display refreshes with the marker frequency centered in the current spectrum view. You will notice “Zoom-in Frequency” at the bottom of the chart.

**NOTE**

Turning on **Zoom In** does not affect the center frequency that you have set with the **FREQ/DIST** hard key. You can still view your original center frequency information in the input settings pane at the top.

- 5 To change the zoom-in center frequency, complete the following steps.
 - a Press the **Zoom-in Center Frequency** soft key.
 - b Enter a value, and then press one of the unit soft keys that you want to select. You can also turn the rotary knob.
- 6 To change the zoom-in span, complete the following steps:
 - a Press the **Zoom-in Span** soft key.
 - b Enter a value, and then press one of the unit soft keys that you want to select. You can also turn the rotary knob.

**NOTE**

You can have the span as low as 10 kHz. An error message appears if you change the zoom-in center frequency or span out of the range, which is automatically determined by the instrument based on the sampling frequency.

- 7 To view a different position on the original spectrum, complete the following steps:
 - a Toggle the **Zoom In** soft key to **Off**.
The screen goes back to the original spectrum.
 - b Move the marker to a new position on the spectrum.
 - c Turn the rotary knob to change the marker position.
 - d Toggle the **Zoom In** soft key to **On** again.
The display refreshes with the new marker frequency centered in the current spectrum view. You will notice “Zoom-in Frequency” at the bottom of the chart.
 - 8 To disable **Zoom In**, toggle the **Zoom In** soft key to **Off**.
-

Figure 356 Zoomed-in spectrum view in RFoCPRI interference analyzer



Performing spectrum replayer

The Spectrum Replayer lets you retrieve and replay recorded spectrum analyzer traces in interference analysis mode. These traces can be played back in the spectrogram or RSSI. You can configure the limit line to create failure points when signals exceed it. The failure points are clearly displayed on the trace timeline for quick access during playback.

Procedure

- 1 Press the **MEASURE** hot key.
- 2 Press the **Spectrum Replayer** soft key.
The file manager window appears.
- 3 Select a file to be loaded, and then press the **Load** soft key.
The Measure Setup menu appears.
- 4 Toggle the **Replay Direction** soft key between **FWD** and **REV** to change play direction to forward or reverse.
- 5 Press the **Replay Speed** soft key, and then select the speed option: **X1**, **X2**, **X3**, or **X4**.
- 6 Press the **Play** soft key to start playing.
- 7 Press the **Pause** soft key to pause or stop playing data.
- 8 To move to a particular failure position directly and play from there, complete the following steps:
 - a Press the **Jump to Fail Index** soft key.
 - b Enter a value by using the numeric keys, and then press the **Enter** soft key.
- 9 *Optional.* Toggle the **Time Cursor** soft key between **On** and **Off** to display or dismiss the time cursor on the screen. This key becomes activated when you play logged data in the Spectrogram mode.



NOTE

If you connected a USB drive, do not remove it while playing to prevent freezing the USB port, which will require you to restart the instrument to get a USB drive recognized again.

Figure 357 RFoCPRI spectrum replay

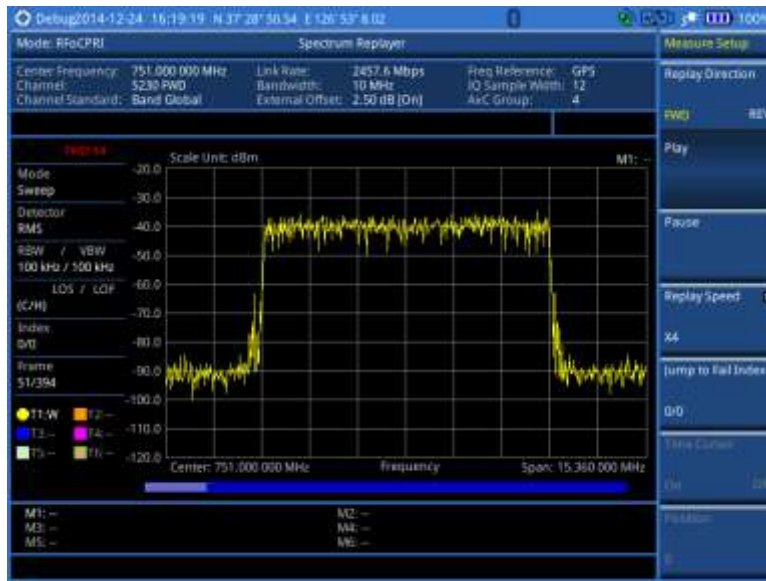

Setting display

You can select the display option to view data in a different mode.

Procedure

- 1 Press the **TRACE/DISPLAY** hard key.
 - 2 Select the display option from: **Spectrum**, **Spectrogram**, or **RSSI**.
-



NOTE

You can use the **LIMIT** hot key to analyze your measurements with the display line, multi-segment line, and channel limit. See “Setting limit for interference analysis” on page 580 for more information.

Setting limit for interference analysis

You can set threshold(s) and display either a single segment line or multi-segment line to analyze the result better.

Setting a single limit line

Procedure

- 1 Press the **LIMIT** hot key.
 - 2 Press the **Display Line** soft key for a reference line.
 - 3 Enter a value, and then press the **dBm** unit soft key.
 - 4 Toggle the **Display Line** soft key between **On** and **Off** to display and hide the reference line. The straight line appears across the screen to be used as a visual reference only.
 - 5 *Optional.* Go to **SAVE/LOAD > Save**, and then select **Save Limit** to save the limit settings. See “Using save” on page 34 for more information.
-

Setting a multi-segment limit line

Procedure

- 1 Press the **LIMIT** hot key.
 - 2 Press the **Multi Segment Line** soft key for Pass/Fail indication.
 - 3 Toggle the **Limit** soft key between **Upper** and **Lower** to select the one to be displayed.
 - 4 Set the number of segments for the selected upper or lower limit line, up to 50 segments.
 - a Press the **# of Line** soft key.
 - b Enter a value between 1 and 50 by using the numeric keys.
 - c Press the **Enter** soft key.
 - 5 Press the **Autoset** soft key to let the instrument set the limit for each segment and display the line.
 - 6 To move the limit line, complete the following steps:
 - a Select **Limit Up/Down** or **Limit Left/Right**.
 - b Turn the rotary knob to move the line as desired. You can also manually enter a value.
 - 7 To edit the segment properties, complete the following steps:
 - a Press the **Edit Limit** soft key.
 - b Press the **Move** soft key and then turn the rotary knob to select the segment to edit.
 - c Select the menu option from the following choices:
 - To hide the line for the selected segment, toggle the **Line** soft key to **Off**.
 - To add a new point, press the **Add Point** soft key.
-

To delete the selected point, press the **Delete Point** soft key.

To change the position, press the **Frequency** soft key or the **Amplitude** soft key, and then turn the rotary knob to change the value as desired.

- 8 *Optional.* Go to **SAVE/LOAD > Save**, and then select **Limit** to save the limit settings. See “Using save” on page 34 for more information.

Performing PIM detection (single and multiple carriers)

The Passive Intermodulation (PIM) Detection allows you to detect Uplink PIM across the full spectrum for any technology. When PIM is detected, the normal repair mode is to replace the offending cable and what you need to do is replacing the whole cable irrespective of the location of the fault.

Connecting cables

You can connect cables with a tap or without a tap as illustrated in Figure 358. If you have connected cables directly from RRH and BBU without using the nTap, you must turn on the through mode (Thru) in the CPRI parameter settings.

A SFP/SFP+ transceiver that is connected to your JD700B series must be compatible with your DUT and you must have your module information such as line rate, wavelength, and mode (MM or SM) handy.

Figure 358 Connection diagram for PIM detection

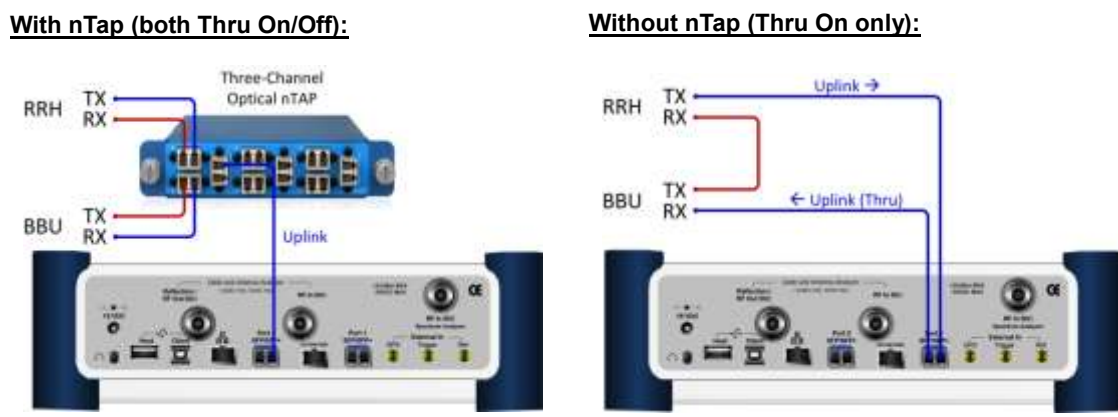

Selecting measurement mode

Procedure

- 1 Press the **MEASURE** hot key.
- 2 Press the **PIM Detection** soft key.
- 3 Select the PIM detection mode from the following choices:
 - PIM Detection Single Carrier**
 - PIM Detection Multiple Carriers**
 - Calculated PIM**

Selecting port

JD700B series supports two antenna ports for signal transmission, and each port can generate up to four different waveforms selectively and simultaneously. User can select the port to use for the measurement in any measurement modes of RFoCPRI mode.

Procedure

- 1 In any measurement mode, press the **MEASURE SETUP** hot key.
 - 2 Toggle the **Select Port** soft key between **Port 1** and **Port 2** to select the desired port.
-

Setting measure setup

Procedure

- 1 Press the **MEASURE SETUP** hot key.
 - 2 To set the CPRI line bit rate of the fronthaul under test, complete the following steps:
 - a Press the **Link Rate** soft key.
 - b Select the CPRI link rate option from the choices: **614.4 Mbps**, **1228.8 Mbps**, **2457.6 Mbps**, **3072.0 Mbps**, **4915.2 Mbps**, **6144.0 Mbps**, or **9830.4 Mbps**.
- 

NOTE
It is important that you set the link rate correctly to avoid any misleading LOS and LOF alarms displayed on the screen.
- 3 Toggle the **Tx Clock** soft key to **Recovered** (default).
 - 4 Toggle the **Port Type** soft key and select **Slave** (default).
 - 5 To turn on the through mode, go to **More (1/2) > Thru**, and then toggle the **Thru** soft key to **On**. To turn off, toggle to **Off**.
 - 6 To configure Rx parameters, see “Configuring Rx Parameters” on page 582.
 - 7 *Optional.* To use the RF signal generator function, see “Using RF source in RFoCPRI testing” on page 636.
 - 8 *Optional.* To use the CPRI signal generator function, see “Using CPRI source” on page 637.
-

Configuring Rx Parameters

Procedure

- 1 Press the **MEASURE SETUP** hot key.
 - 2 Press the **Rx Parameters** soft key.
 - 3 To set the antenna per carrier group, complete the following steps:
 - a Press the **AxC Group** soft key.
 - b Enter a value by using the numeric keys. You can also use the rotary knob.
 - c Press the **Enter** soft key.
- 

NOTE
Maximum number of the AxC Group is determined by the factors of link rate, sample width, oversampling, and signal bandwidth.
- 4 To set the I and Q sample widths, complete the following steps:
 - a Press the **IQ Sample Width** soft key
 - b Enter a value between 4 and 20 by using the rotary knob. You can also use the numeric keys, and then press the **Enter** soft key.

- 

NOTE
According to the CPRI specification, the IQ sample width shall be between 4 and 20 bits for I and Q in the uplink and between 8 and 20 bits in the downlink.
-

- 5 To set the first bit position of each AxC Container in the IQ data block of a basic frame, complete the following steps:
 - a Press the **Map Position** soft key.
 - b Select the AxC Container number you want to set from: **AxC 0, AxC 1, AxC 2, AxC 3, AxC 4, AxC 5, AxC 6, or AxC 7**. Not all of these are activated depending on your bandwidth setting.
 - c Enter a value by using the numeric keys. You can also use the rotary knob.
 - d Press the **Enter** soft key.



NOTE
 The Antenna-Carrier (AxC) is the amount of digital baseband (IQ) U-plane data necessary for either reception or transmission of one carrier at one independent antenna element. The number of required AxC Container for a basic frame are two AxCs for 5 MHz, four AxCs for 10 MHz, and eight AxCs for 20 MHz.
 Following is an example of test configuration for a DUT.

DUT		Test Configuration	
CPRI Line Rate (Mbps)	614.4	Link Rate (Mbps)	614.4
UMTS Channel (MHz)	3.84	Bandwidth (MHz)	3
Carriers	2	NEM	None
AxC Positioning	Packed	AxC Group	1 – 2
IQ Sampling	15	IQ Sample Width	15
Over Sampling	1	Map Position	AxC 0 0 AxC 1 15

For this test configuration, IQ allocation will be like this in the CPRI basic frame.

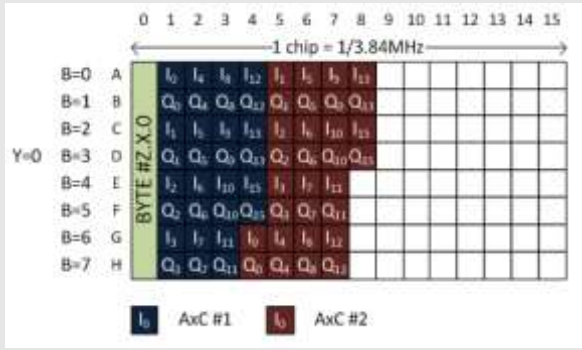

- 6 To set the bandwidth of the downlink signal, complete the following steps:
 - a Press the **Bandwidth** soft key.
 - b Select the bandwidth option from: **1.4 MHz, 3 MHz, 5 MHz, 10 MHz, 15 MHz, 15 MHz (4 AxC), 20 MHz, or 20 MHz (6 AxC)**.
 The RBW range changes based on this bandwidth setting.
 Required number of AxC containers varies depending on the selected bandwidth.
- 7 To use the pre-configured settings for a NEM, complete the following steps:
 - a Press the **NEM** soft key.
 - b Select an NEM from the following choices:
 - None** (no pre-configuration)
 - Ericsson > Ericsson (UL) and Ericsson (DL)**
 - Alcatel-Lucent (UL/DL)**
 - Samsung (UL/DL)**
 - Huawei > Huawei (UL) and Huawei (DL)**
 - ZTE (UL/DL)**



NOTE
 If you have selected a NEM, the instrument sets the Map Position and other related settings automatically based on the selected NEM and you cannot edit the map position setting. The pre-configured information may be subject to changes at any times by NEMs.

Calculating possible PIM

The Calculated PIM is used when you want to check any possible existence of PIM before the actual measurement. The instrument displays possible PIM in red color.

Procedure

- 1 Press the **MEASURE SETUP** hot key.
 - 2 Press the **Calculated PIM** soft key.
 - 3 Toggle the **Radio Config** soft key between **Single** and **Multi** to select the mode you want to use.
 - Single:** Sets the frequency of Radio 1.
 - Multi:** Sets the frequency of Radio 1 and Radio 2.
 - 4 Do one of the following:
 - To set the frequency and span, complete the following steps:
 - a Toggle the **Mode** soft key to **Freq.**
 - b Press the **Radio [1]2] Frequency** soft key.
 - c Enter a value by using the numeric keys.
 - d Select the unit option from: **GHz, MHz, kHz, or Hz.**
 - e Press the **Radio [1]2] Span** soft key.
 - f Enter a value by using the numeric keys.
 - g Select the unit option from: **GHz, MHz, kHz, or Hz.**
 - To set the radio band, complete the following steps:
 - a Toggle the **Mode** soft key to **Band.**
 - b Press the **Radio [1]2] Band** soft key.
 - c Highlight the radio band to select by using the rotary knob.
 - d Press the **Select** soft key.
-

Detecting PIM (single and multiple carriers)

Procedure

- 1 Press the **MEASURE SETUP** hot key.
- 2 Connect cables as instructed on the screen.



NOTE

Make sure that the Tx of RRH is connected to the Rx port of SFP/SFP+ installed in your CellAdvisor.

- 3 Complete one of the followings:
 - To set the uplink center frequency and span to be measured, complete the following steps:
 - a Toggle the **Unit** soft key to **Freq.**
 - b Press the **Uplink Center Frequency** soft key.
 - c Enter a value by using the numeric keys or the rotary knob.
 - d Select the unit from: **GHz, MHz, kHz, or Hz.**
 - To set the channel number to be measured, complete the following steps:
 - a Toggle the **Unit** soft key to **Channel.**
 - b Press the **Channel Std** soft key, and then highlight a desired band.
 - c Press the **Select** soft key.
 - d Press the **Channel Number** soft key.
 - e Enter a value by using the numeric keys, and then press the **Enter** soft key.
The instrument automatically displays the corresponding center frequency value for the selected channel number.
 - 4 Press the **Continue** soft key, and then follow the instructions on the screen.
 - 5 To clear current (C) and history (H) status of CPRI alarm on LOS and LOF and start a new
-

monitoring, press the **MEASURE SETUP** hot key and then the **Clear History** soft key.

Measurement example

Figure 359 PIM detection of single radio



Performing LTE-FDD downlink signal analysis

If your JD700B series has the option 091 RFoCPRI LTE-FDD Signal Analyzer installed with a license, you can perform power and spectrum measurements as well as modulation analysis to test the proper transmitter performance of FDD LTE systems over CPRI.

This instrument provides the following measurement tools for FDD LTE system over CPRI:

- Spectrum Analysis
- RF Analysis
 - Channel Power
 - Occupied Bandwidth
- Power vs. Time (Frame)
- Modulation Analysis
 - Constellation
 - Data Channel
 - Control Channel
 - Subframe
 - Frame
 - Time Alignment Error
 - Data Allocation Map
- Power Statistics CCDF

Connecting cables

You can connect cables with a tap or without a tap as illustrated in Figure 360. If you have connected cables directly from RRH and BBU without using the nTap, you must turn on the through mode (Thru) in the CPRI parameter settings.

A SFP/SFP+ transceiver that is connected to your JD700B series must be compatible with your DUT and you must have your module information such as line rate, wavelength, and mode (MM or SM) handy.

Figure 360 Connection diagram for downlink signal analysis

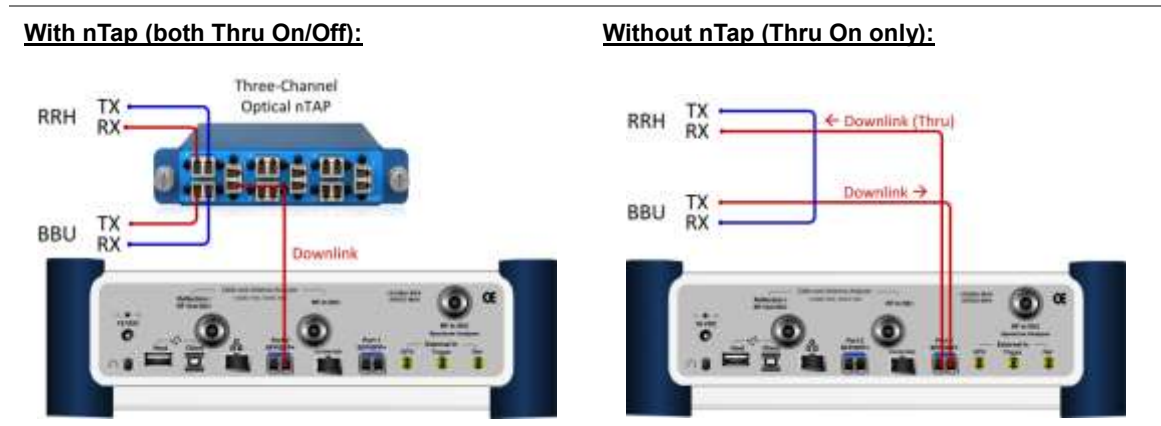

Selecting measurement mode

Procedure

- 1 Press the **MEASURE** hot key.
- 2 Select **Signal Analyzer > LTE-FDD**.
- 3 Select the downlink signal analysis mode from the following choices:
 - Spectrum**
 - RF Analysis > Channel Power or Occupied BW**
 - Power vs Time (Frame)**
 - Modulation Analysis > Constellation, Data Channel, Control Channel, Subframe, Frame, Time Alignment Error, or Data Allocation Map**
 - Power Statistics CCDF**

Selecting port

JD700B series supports two antenna ports for signal transmission, and each port can generate up to four different waveforms selectively and simultaneously. User can select the port to use for the measurement in any measurement modes of RFoCPRI mode.

Procedure

- 1 In any measurement mode, press the **MEASURE SETUP** hot key.
- 2 Toggle the **Select Port** soft key between **Port 1** and **Port 2** to select the desired port.

Configuring test parameters

Setting frequency

You can set the frequency with either frequency or channel number. If a frequency to be set matches to the frequency corresponding to the selected channel standard, the instrument calculates its channel number and updates the screen with it automatically.

Procedure

To set the center frequency:

- 1 Press the **FREQ/DIST** hard key.
- 2 Toggle the **Unit** soft key to **Freq**.
- 3 Press the **Center Frequency** soft key.
- 4 Enter a value by using the numeric keys or the rotary knob.
- 5 Select the unit: **GHz**, **MHz**, **kHz**, or **Hz**.
- 6 *Optional.* To define the amount of frequency increment for the rotary knob, complete the following steps:
 - a Press the **Frequency Step** soft key.
 - b Enter a value by using the numeric keys or the rotary knob.
 - c Press the unit: **GHz**, **MHz**, **kHz**, or **Hz**.

To set the channel number:

- 1 Press the **FREQ/DIST** hard key.
- 2 Toggle the **Unit** soft to **Channel**.



NOTE

Selecting **Channel** sets the standard channel to **Band Global** automatically so that you can set the **Channel Number** without choosing a standard channel band from the list.

- 3 Press the **Channel Number** soft key.
 - 4 Enter a value by using the numeric keys or the rotary knob.
 - 5 Press the **Enter** soft key.
The instrument automatically displays the corresponding center frequency value for the selected channel number.
 - 6 *Optional.* To define the amount of channel increment for the rotary knob, complete the following steps:
 - a Press the **Channel Step** soft key.
 - b Enter a value by using the numeric keys or the rotary knob.
 - c Press the **Enter** soft key.
-

Setting amplitude

You can set the reference automatically or manually to optimize the display of the trace, as you desire.

Procedure

- 1 Press the **AMP/SCALE** hard key.
- 2 Complete one of the followings:
 - To optimize the Y-axis scale automatically, press the **Auto Scale** soft key.
 - To set the maximum reference value on the Y-axis manually, complete the following steps:
 - a Press the **Reference Level** soft key.
 - b Enter a value by using the numeric keys or the rotary knob with 10 dB increments.
 - c Press the **Unit** soft key or the **ENTER** hard key.



NOTE

In the **Control Channel**, **Subframe**, and **Frame** measurement modes, you can select a reference option between **Relative** and **Absolute** instead.

- 3 To set an external offset, complete the following steps:
 - a Toggle the **External Offset** soft key to **On**.
 - b Enter a value by using the numeric keys.
 - c Press the **dB** soft key to complete the entry.

**NOTE**

The instrument displays a measurement result with the set value reflected. For example, if you set it to 40 dB, the measurement result compensates 40 dB.

- 4 To change the setting of the scale per division, complete the following steps:
 - a Select **More (1/2) > Scale/Div**.
 - b Enter a value between 1 and 20 by using the numeric keys.
 - c Press the **dB** soft key to complete the entry.
- 5 To change the scale unit, select **More (1/2) > Units**, and then select the display unit option from: **dBm**, **dBV**, **dBmV**, **dBμV**, **V**, or **W**.
The scale unit on the screen changes accordingly.

**NOTE**

The Scale/Div and Units menus are available in the Spectrum and RF Analysis modes.

Setting average

In the spectrum and RF analysis, you can set the number of measurements to be averaged for the trace presentation. A maximum of 100 times of averaging can be set. When the averaging reaches to your setting, a new measurement value replaces the measurement value in sequence from the earliest.

Procedure

- 1 Press the **BW/AVG** hard key.
- 2 Press the **Average** soft key.
- 3 Enter a value between 1 and 100 as needed by using the numeric keys.
- 4 Press the **Enter** soft key.

Setting sweep mode

The default setting is **Continue** to sweep continuously for most on-going measurements. If you want to hold the measurement or get a single sweep, you can change the sweep mode.

Procedure

- 1 Press the **SWEEP** hot key.
- 2 Complete the following steps:
 - To select the single sweep mode, complete the following steps:
 - a Toggle the **Sweep Mode** soft key to **Single** or press the **HOLD** hot key.
The letter **HOLD** in red appears and the sweeping is paused.
 - b To get a new measurement, press the **Sweep Once** soft key.
 - To return to the continuous sweep mode, toggle the **Sweep Mode** soft key to **Continue** or press the **HOLD** hot key.
The letter **HOLD** in red disappears and the sweeping resumes.



Setting measure setup

Procedure

- 1 Press the **MEASURE SETUP** hot key.
 - 2 To set the CPRI line bit rate of the fronthaul under test, complete the following steps:
 - a Press the **Link Rate** soft key.
 - b Select the CPRI link rate option from: **614.4 Mbps**, **1228.8 Mbps**, **2457.6 Mbps**, **3072.0 Mbps**, **4915.2 Mbps**, **6144.0 Mbps**, or **9830.4 Mbps**.
-  **NOTE**
It is important that you set the link rate correctly to avoid any misleading LOS and LOF alarms displayed on the screen.
- 3 Press the **Tx Clock** soft key, and then select **Recovered** (default).
 - 4 Toggle the **Port Type** soft key to **Slave** (default).
 - 5 To turn on the through mode if you have not used a tap, go to **More (1/2) > Thru**, and then toggle the **Thru** soft key to **On**. To turn off, toggle to **Off**.
 - 6 To configure Rx parameters, see “Configuring Rx Parameters” on page 589.
 - 7 *Optional*. To use the RF signal generator function, see “Using RF source in RFoCPRI testing” on page 636.
 - 8 *Optional*. To use the CPRI signal generator function, see “Using CPRI source” on page 637.

Configuring Rx Parameters

Procedure

- 1 Press the **MEASURE SETUP** hot key.
 - 2 Press the **Rx Parameters** soft key.
 - 3 To set the antenna per carrier group, complete the following steps:
 - a Press the **AxC Group** soft key.
 - b Enter a value by using the numeric keys or the rotary knob.
 - c Press the **Enter** soft key.
-  **NOTE**
Maximum number of the AxC Group is determined by the factors of link rate, sample width, oversampling, and signal bandwidth.
- 4 To set the I and Q sample widths, complete the following steps:
 - a Press the **IQ Sample Width** soft key
 - b Enter a value between 4 and 20 by using the rotary knob or the numeric keys, and then press the **Enter** soft key.
-  **NOTE**
According to the CPRI specification, the IQ sample width shall be between 4 and 20 bits for I and Q in the uplink and between 8 and 20 bits in the downlink.
- 5 To set the first bit position of each AxC Container in the IQ data block of a basic frame, complete the following steps:
 - a Press the **Map Position** soft key.
 - b Select the AxC Container number you want to set from the choices: **AxC 0**, **AxC 1**, **AxC 2**, **AxC 3**, **AxC 4**, **AxC 5**, **AxC 6**, or **AxC 7**. Not all of these are activated depending on your bandwidth setting.
 - c Enter a value by using the numeric keys or the rotary knob.
 - d Press the **Enter** soft key.

-  **NOTE**
The Antenna-Carrier (AxC) is the amount of digital baseband (IQ) U-plane data necessary for either reception or transmission of one carrier at one independent antenna element. The number of required AxC Container for a basic frame are two AxCs for 5 MHz, four AxCs for 10 MHz, and eight AxCs for 20 MHz.

Following is an example of test configuration for a DUT.

DUT		Test Configuration	
CPRI Line Rate (Mbps)	614.4	Link Rate (Mbps)	614.4
UMTS Channel (MHz)	3.84	Bandwidth (MHz)	3
Carriers	2	NEM	None
AxC Positioning	Packed	AxC Group	1 – 2
IQ Sampling	15	IQ Sample Width	15
Over Sampling	1	Map Position	AxC 0 0
			AxC 1 15

For this test configuration, IQ allocation will be like this in the CPRI basic frame.

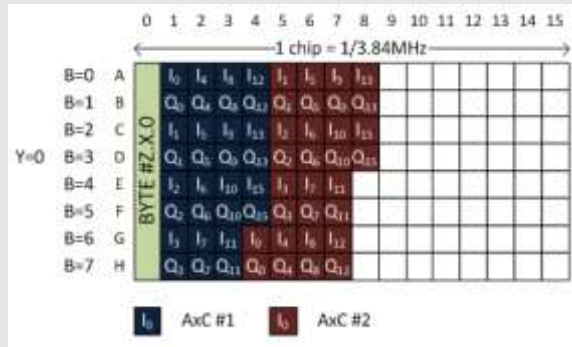

- 6 To set the bandwidth of the downlink signal, complete the following steps:
 - a Press the **Bandwidth** soft key.
 - b Select the bandwidth option from: **1.4 MHz, 3 MHz, 5 MHz, 10 MHz, 15 MHz, 15 MHz (4 AxC), 20 MHz, or 20 MHz (6 AxC)**.
The RBW range changes based on this bandwidth setting.
Required number of AxC containers varies depending on the selected bandwidth.
- 7 To use the pre-configured settings for a NEM, complete the following steps:
 - a Press the **NEM** soft key.
 - b Select an NEM from the following choices:
 - None** (no pre-configuration)
 - Ericsson > Ericsson (UL) and Ericsson (DL)**
 - Alcatel-Lucent (UL/DL)**
 - Samsung (UL/DL)**
 - Huawei > Huawei (UL) and Huawei (DL)**
 - ZTE (UL/DL)**



NOTE
If you have selected a NEM, the instrument sets the Map Position and other related settings automatically based on the selected NEM and you cannot edit the map position setting. The pre-configured information may be subject to changes at any times by NEMs.

Viewing decoded MIB and SIB1/2 information

In LTE system, the System Information (SI) that is carried over transport channel BCH or by DL-SCH consists of two parts: static part called MIB (Master Information Block) and dynamic part called SIBs (System Information Blocks). MIB contains important information such as system bandwidth, System Frame Number (SFN), PHICH configuration while SIBs contain other useful information including transmit power, number of antenna, and SIB scheduling information for UE to read to access a cell.

JD700B series decodes MIB, the first of SIB (SIB1), and the second of SIB (SIB2) and provides you with decoded information of several parameters. If you are not familiar with matching the system information between IQ spectrum and RF spectrum, this feature enables you to identify the uplink carrier frequency and bandwidth so that you can map AxC container to the RF carrier by combining the decoded information with

other system parameters obtained by RFoCPRI signal analysis. As not all LTE frames have transmitted SIB, it may take time for the instrument to capture frames with the system information and decode MIB and SIB1/2.

Procedure

- 1 Make sure that you have set the frequency to “**Band Global**” for the technology.
- 2 Press the **TRACE/DISPLAY** hard key.
- 3 Press the **MIB & SIB1/2 Information** soft key.

The MIB and SIB1/2 Information window appears with the following parameters:

SFN: System Frame Number.

p-Max: Maximum allowed UL transmit power of the cell

systemInfoValueTag: It indicates if a change has occurred in the SI messages. UEs may use this, e.g. upon return from out of coverage, to verify if the previously stored SI messages are still valid.

Freqinfo-ul-CarrierFreq: Uplink channel number

Freqinfo-ul-Bandwidth: Uplink bandwidth

timeAlignmentTimerCommon: It is used to control how long the UE should consider to be time aligned in uplink. The value is in subframes.



NOTE

Some or entire parameters may not be available depending on the system configuration or the NEM of the system. Also, this feature may not work for Ericsson RRHs.

Figure 361 Decoded MIB & SIB1/2 information in RFoCPRI LTE-FDD signal analyzer



Conducting spectrum measurement

Making a measurement

Procedure

- 1 Press the **MEASURE** hot key to select the measurement mode.
- 2 Select **Signal Analyzer > LTE-FDD > Spectrum**.
- 3 Configure test parameters as described in the “Configuring test parameters” on page 587.
- 4 Press the **MEASURE SETUP** hot key, and then set the following parameters:
 - Measurement setups as described in the “Setting measure setup” on page 589
 - Rx Parameters as described in the “Configuring Rx Parameters” on page 589

- 5 Check your measurement result displayed on the screen.
- 6 To clear current (C) and history (H) status of CPRI alarm on LOS and LOF and start a new monitoring, press the **MEASURE SETUP** hot key and then the **Clear History** soft key.
- 7 *Optional.* Go to **SAVE/LOAD > Save**, and then select the save option from the choices available for your measurement mode. See “Using save” on page 34 for more information.

Setting trace

You can display up to six traces on the measurement chart simultaneously.

Procedure

- 1 Press the **TRACE/DISPLAY** hard key.
- 2 Press the **Select Trace** soft key, and then select the trace number: **T1**, **T2**, **T3**, **T4**, **T5**, or **T6**. The legend shape of the selected trace changes from square to round to indicate that the trace is the active one now.
- 3 Do one of the following:

To	Select	Trace Legend
Clear current data and display with new measurements	Clear Write	W
Display the input signal's maximum response only (unlimited or for a certain amount of time)	Max Hold	M
Display the input signal's minimum response only (unlimited or for a certain amount of time)	Min Hold	m
Capture the selected trace and compare traces	Capture	C
Load a saved trace	More (1/2) > Load	L
Hide the displayed trace	Trace View > Off	F
Remove all the traces and initialize the trace settings	More (1/2) > Trace Clear All	



NOTE

For the **Max Hold** and **Min Hold**, your instrument compares newly acquired data with the active trace and displays larger maximum values or smaller minimum values on the screen. You can set it to **Unlimited** to hold and view maximum or minimum data or specify a certain amount of time up to 60 seconds by using numeric keys or rotary knob.

- 4 *Optional.* Select **More (1/2) > Trace Info**, and then select the trace number to view the trace's parameter setting information stored at the time of the measurement or **None** to hide the information display.
- 5 *Optional.* If you have the two traces T1 and T2, you can perform trace math. To view the power difference between the traces, press the **T1 – T2 -> T5** or **T2 – T1 -> T6** soft key. The result is overlaid on the screen along with the second Y-axis.

Measurement example

Figure 362 Spectrum measurement with RFoCPRI LTE-FDD signal analyzer



Conducting channel power measurement

The Channel Power measurement is a common test used in the wireless industry to measure the total transmitted power of a radio within a defined frequency channel. It acquires a number of points representing the input signal in the time domain, transforms this information into the frequency domain using Fast Fourier Transform (FFT), and then calculates the channel power. The effective resolution bandwidth of the frequency domain trace is proportional to the number of points acquired for the FFT.

The channel power measurement identifies the total RF power and power spectral density (PSD) of the signal in the LTE channel bandwidth.

Making a measurement

Procedure

- 1 Press the **MEASURE** hot key to select the measurement mode.
- 2 Select **Signal Analyzer > LTE-FDD > RF Analysis > Channel Power**.
- 3 Configure test parameters as described in the “Configuring test parameters” on page 587.
- 4 Press the **MEASURE SETUP** hot key, and then set the following parameters:
 - Measurement setups as described in the “Setting measure setup” on page 589
 - Rx Parameters as described in the “Configuring Rx Parameters” on page 589
- 5 Check your measurement result displayed on the screen.
- 6 To clear current (C) and history (H) status of CPRI alarm on LOS and LOF and start a new monitoring, press the **MEASURE SETUP** hot key and then the **Clear History** soft key.
- 7 *Optional.* Go to **SAVE/LOAD > Save**, and then select the save option from the choices available for your measurement mode. See “Using save” on page 34 for more information.

Measurement example

Figure 363 Channel power measurement with RFoCPRI LTE-FDD signal analyzer



NOTE

You can use the **LIMIT** hot key to analyze your measurements with the user-definable limit and Pass/Fail indication. See “Setting limit for RFoCPRI signal analysis” on page 611 for more information.

Occupied bandwidth

The Occupied Bandwidth measures the spectrum shape of the carrier. It is defined as the bandwidth, which includes 99% of the transmitted power among total transmitted power.

Making a measurement

Procedure

- 1 Press the **MEASURE** hot key to select the measurement mode.
- 2 Select **Signal Analyzer > LTE-FDD > RF Analysis > Occupied BW**.
- 3 Configure test parameters as described in the “Configuring test parameters” on page 587.
- 4 Press the **MEASURE SETUP** hot key, and then set the following parameters:
 - Measurement setups as described in the “Setting measure setup” on page 589
 - Rx Parameters as described in the “Configuring Rx Parameters” on page 589
- 5 Check your measurement result displayed on the screen.
- 6 To clear current (C) and history (H) status of CPRI alarm on LOS and LOF and start a new monitoring, press the **MEASURE SETUP** hot key and then the **Clear History** soft key.
- 7 *Optional.* Go to **SAVE/LOAD > Save**, and then select the save option from the choices available for your measurement mode. See “Using save” on page 34 for more information.

Measurement example

Figure 364 Occupied bandwidth measurement with RFoCPRI LTE-FDD signal analyzer



NOTE

You can use the **LIMIT** hot key to analyze your measurements with the user-definable limit and Pass/Fail indication. See “Setting limit for RFoCPRI signal analysis” on page 611 for more information.

Conducting power vs. time (frame) measurement

The Power vs. Time (Frame) measures the modulation envelope in the time domain, showing the power of each time slot in an LTE signal.

Making a measurement

Procedure

- 1 Press the **MEASURE** hot key to select the measurement mode.
- 2 Select **Signal Analyzer > LTE-FDD > P vs T (Frame)**.
- 3 Configure test parameters as described in the “Configuring test parameters” on page 587.
- 4 Press the **MEASURE SETUP** hot key, and then set the following parameters:
 - Measurement setups as described in the “Setting measure setup” on page 589
 - Rx Parameters as described in the “Configuring Rx Parameters” on page 589
- 5 To select the subframe number to be measured, complete the following steps:
 - a Press the **Subframe No** soft key.
 - b Enter a value by using the numeric keys or the rotary knob.
 - c Press the **Enter** soft key.
- 6 Toggle the **Physical Cell ID** soft key to **Auto** or **Manual** as desired:
 - Auto:** Makes the instrument detect the Physical Cell ID for the LTE signal automatically.
 - Manual:** Sets a specific Physical Cell ID for the LTE signal manually in order to speed up the synchronization.
- 7 Depending on your selected NEM, you may need to turn on or off the inversion of the I and Q order by toggling the **IQ Swap** soft key to **On** or **Off**.
- 8 *Optional.* Press the **Miscellaneous** soft key, and then do the following as needed:
 - To assign a antenna port number automatically or manually, press the **Antenna Port** soft

key and select the option: **Auto**, **0**, and **1**.

To select the cyclic prefix, toggle the **Cyclic Prefix** soft key to **Normal** or **Extended**. See “Appendix E – Cyclic prefix table” on page 773 for OFDM parameter details by different bandwidth.

- 9 Check your measurement result displayed on the screen.
- 10 To clear current (C) and history (H) status of CPRI alarm on LOS and LOF and start a new monitoring, press the **MEASURE SETUP** hot key and then the **Clear History** soft key.
- 11 *Optional.* Go to **SAVE/LOAD > Save**, and then select the save option from the choices available for your measurement mode. See “Using save” on page 34 for more information.

Measurement example

Figure 365 Power vs. time (frame) measurement with RFoCPRI LTE-FDD signal analyzer



Conducting constellation measurement

The Constellation is used to observe some aspects of modulation accuracy and can reveal certain fault mechanisms such as I/Q amplitude imbalance or quadrature imbalance. It displays constellation diagram by modulation types.

Making a measurement

Procedure

- 1 Press the **MEASURE** hot key to select the measurement mode.
- 2 Select **Signal Analyzer > LTE-FDD > Modulation Analysis > Constellation**.
- 3 Configure test parameters as described in the “Configuring test parameters” on page 587.
- 4 Press the **MEASURE SETUP** hot key, and then set the following parameters:
 - Measurement setups as described in the “Setting measure setup” on page 589
 - Rx Parameters as described in the “Configuring Rx Parameters” on page 589
- 5 To select the subframe number to be measured, complete the following steps:
 - a Press the **Subframe No** soft key.
 - b Enter a value by using the numeric keys or the rotary knob.



NOTE

For MBMS testing, this subframe number must be neither 0 nor 5 as these subframes 0

and 5 are not available for MBMS and it must be set to the MBMS transmitted channel's subframe number.

- c Press the **Enter** soft key.
- 6 Toggle the **Physical Cell ID** soft key between **Auto** and **Manual**:
 - Auto**: Makes the instrument detect the Physical Cell ID for the LTE signal automatically.
 - Manual**: Sets a specific Physical Cell ID for the LTE signal manually in order to speed up the synchronization.
- 7 Depending on your selected NEM, you may need to turn on or off the inversion of the I and Q order by toggling the **IQ Swap** soft key to **On** or **Off**.
- 8 *Optional*. Press the **Miscellaneous** soft key, and then set other miscellaneous setups as described in the following section.
- 9 Check your measurement result displayed on the screen.
- 10 To clear current (C) and history (H) status of CPRI alarm on LOS and LOF and start a new monitoring, press the **MEASURE SETUP** hot key and then the **Clear History** soft key.
- 11 *Optional*. Go to **SAVE/LOAD > Save**, and then select the save option from the choices available for your measurement mode. See "Using save" on page 34 for more information.

Setting other miscellaneous setups

Procedure

- 1 To assign an antenna port number automatically or manually, press the **Antenna Port** soft key and select the option from: **Auto**, **0**, or **1**.
 - 2 To select the cyclic prefix, toggle the **Cyclic Prefix** soft key to **Normal** or **Extended**. See "Appendix E – Cyclic prefix table" on page 773 for OFDM parameter details by different bandwidth.
 - 3 To turn on or off the Multimedia Broadcast Multicast Service (MBMS) feature, toggle the **MBMS** soft key to **On** or **Off**. For proper MBMS testing, you need to set **Subframe No** with the same PMCH subframe number. If this setting is on, either PMCH or PDSCH appears on the screen depending on the detected channel.
 - 4 To set the Multicast Broadcast Single Frequency Network (MBSFN) detection automatically or manually for MBMS testing, toggle the **MBSFN** soft key to **Auto** or **Manual**. An automatically detected or manually entered MBSFN ID appears on the screen.
 - 5 To select the PDSCH modulation type, press the **PDSCH Modulation Type** soft key and then select an option from: **Auto**, **QPSK**, **16 QAM**, **64 QAM**, **E-TM3.3**, **E-TM3.2**, **E-TM3.1**, **E-TM2**, **E-TM1.2**, or **E-TM1.1**.
-  **NOTE**
If two or more modulation types are used in a frame, select **Auto**. If the PDSCH uses the same modulation type in a frame or in a subframe, select a specific modulation type to get more accurate EVM.
- 6 To set the threshold for PDSCH, complete the following steps:
 - a Press the **PDSCH Threshold** soft key.
 - b Enter a value by using the numeric keys.
 - c Press the **Enter** soft key.
 - 7 To enable or disable the PDSCH precoding, toggle the **PDSCH Precoding** soft key to **On** or **Off**.
 - 8 To set the Control Format Indicator, toggle the **CFI** soft key to **Auto** or **Manual**:
 - Auto**: Makes the instrument set the number of OFDM symbols used for transmitting PDCCHs in a subframe.
 - Manual**: Sets the number of OFDM symbols manually.
 - 9 To select the number of PHICH groups (Ng), press the **PHICH Ng** soft key and then select an option: **1/6**, **1/2**, **1**, **2**, **E-1/6**, **E-1/2**, **E-1**, or **E-2**.

Measurement example

Figure 366 Constellation measurement with RFoCPRI LTE-FDD signal analyzer

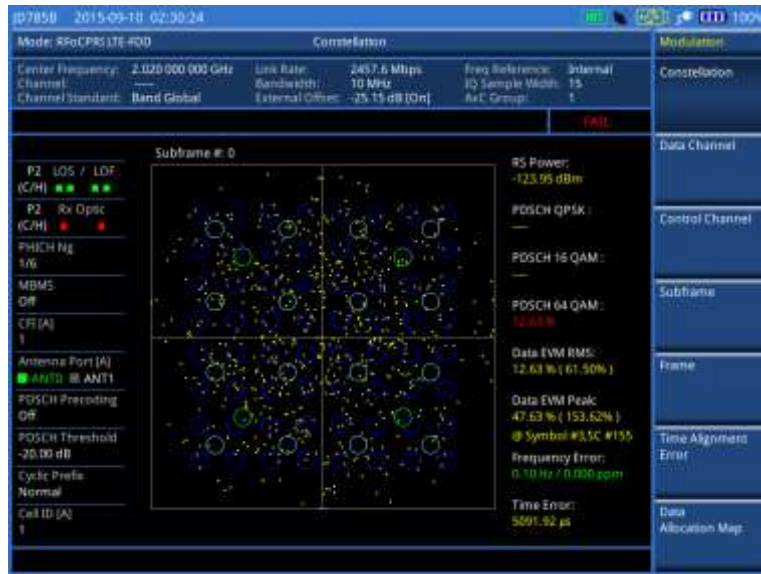

NOTE

You can use the **LIMIT** hot key to analyze your measurements with the user-definable limit and Pass/Fail indication. See “Setting limit for RFoCPRI signal analysis” on page 611 for more information.

Conducting data channel measurement

The Data Channel measures the constellation for the specified resource block as well as the modulation accuracy of each PDSCH at the specified subframe.

Making a measurement

Procedure

- 1 Press the **MEASURE** hot key to select the measurement mode.
- 2 Select **Signal Analyzer > LTE-FDD > Modulation Analysis > Data Channel**.
- 3 Configure test parameters as described in the “Configuring test parameters” on page 587.
- 4 Press the **MEASURE SETUP** hot key, and then set the following parameters:
 - Measurement setups as described in the “Setting measure setup” on page 589
 - Rx Parameters as described in the “Configuring Rx Parameters” on page 589
- 5 To select the subframe number to be measured, complete the following steps:
 - a Press the **Subframe No** soft key.
 - b Enter a value by using the numeric keys or the rotary knob.



NOTE

For MBMS testing, this subframe number must be neither 0 nor 5 as these subframes 0 and 5 are not available for MBMS and it must be set to the MBMS transmitted channel’s subframe number.

- c Press the **Enter** soft key.
- 6 Toggle the **Physical Cell ID** soft key to **Auto** or **Manual** as desired:
 - Auto:** Detects the Physical Cell ID for the LTE signal automatically.
 - Manual:** Sets a specific Physical Cell ID for the LTE signal manually in order to speed up the synchronization.

- 7 To enable or disable the event hold feature, toggle the **Event Hold** soft key to **On** or **Off**. When enabled, the display line for the PDSCH threshold appears. When an event occurs, the measurement is put on hold until you press the **HOLD** hot key.
- 8 Depending on your selected NEM, you may need to turn on or off the inversion of the I and Q order by toggling the **IQ Swap** soft key to **On** or **Off**.
- 9 *Optional.* Press the **Miscellaneous** soft key, and then set other miscellaneous setups as described in the following section.
- 10 Check your measurement result displayed on the screen.
- 11 To clear current (C) and history (H) status of CPRI alarm on LOS and LOF and start a new monitoring, press the **MEASURE SETUP** hot key and then the **Clear History** soft key.
- 12 *Optional.* Go to **SAVE/LOAD > Save**, and then select the save option from the choices available for your measurement mode. See “Using save” on page 34 for more information.

Setting other miscellaneous setups

Procedure

- 1 To assign a antenna port number automatically or manually, press the **Antenna Port** soft key and select the option from: **Auto**, **0**, or **1**.
- 2 To select the cyclic prefix, toggle the **Cyclic Prefix** soft key to **Normal** or **Extended**. See “Appendix E – Cyclic prefix table” on page 773 for OFDM parameter details by different bandwidth.
- 3 To turn on or off the Multimedia Broadcast Multicast Service (MBMS) feature, toggle the **MBMS** soft key to **On** or **Off**. For proper MBMS testing, you need to set the **Subframe No** with the same PMCH subframe number. If this setting is on, either PMCH or PDSCH appears on the screen depending on the detected channel.
- 4 To set the Multicast Broadcast Single Frequency Network (MBSFN) detection automatically or manually for MBMS testing, toggle the **MBSFN** soft key to **Auto** or **Manual**. An automatically detected or manually entered MBSFN ID appears on the screen.
- 5 To select the PDSCH modulation type, press the **PDSCH Modulation Type** soft key and then select the option from: **Auto**, **QPSK**, **16 QAM**, **64 QAM**, **E-TM3.3**, **E-TM3.2**, **E-TM3.1**, **E-TM2**, **E-TM1.2**, or **E-TM1.1**.



NOTE

If two or more modulation types are used in a frame, select **Auto**. If the PDSCH uses the same modulation type in a frame or in a subframe, select a specific modulation type to get more accurate EVM.

- 6 To set the threshold for PDSCH, complete the following steps:
 - a Press the **PDSCH Threshold** soft key.
 - b Enter a value by using the numeric keys.
 - c Press the **Enter** soft key.
- 7 To enable or disable the PDSCH precoding, toggle the **PDSCH Precoding** soft key to **On** or **Off**.
- 8 To set the Control Format Indicator, toggle the **CFI** soft key to **Auto** or **Manual**:
 - Auto:** Makes the instrument set the number of OFDM symbols used for transmitting PDCCHs in a subframe.
 - Manual:** Sets the number of OFDM symbols manually.
- 9 To select the number of PHICH groups (Ng), press the **PHICH Ng** soft key and then select the option from: **1/6**, **1/2**, **1**, **2**, **E-1/6**, **E-1/2**, **E-1**, or **E-2**.

Using marker

You can use the **MARKER** hard key to place a marker on a resource block and display the IQ diagram for the selected resource block.

Procedure

- 1 Press the **MARKER** hard key.
- 2 Press the **RB Number** soft key to select the resource block to be marked.
- 3 Enter the resource block number by using the numeric keys.
- 4 Press the **Enter** soft key.
The marker appears on the selected resource block.
- 5 Toggle the **Marker View** soft key between **On** and **Off** to display or hide the result of the selected resource block.

Measurement example

Figure 367 Data channel measurement with RFoCPRI LTE-FDD signal analyzer



NOTE
You can use the **LIMIT** hot key to analyze your measurements with the user-definable limit and Pass/Fail indication. See “Setting limit for RFoCPRI signal analysis” on page 611 for more information.

Conducting control channel measurement

The Control Channel measures the constellation for the specified control channel as well as modulation accuracy of the control channel at the specified subframe.

Making a measurement

Procedure

- 1 Press the **MEASURE** hot key to select the measurement mode.
- 2 Select **Signal Analyzer > LTE-FDD > Modulation Analysis > Control Channel**.
- 3 Configure test parameters as described in the “Configuring test parameters” on page 587.
- 4 Press the **MEASURE SETUP** hot key, and then set the following parameters:
Measurement setups as described in the “Setting measure setup” on page 589
Rx Parameters as described in the “Configuring Rx Parameters” on page 589
- 5 To select the subframe number to be measured, complete the following steps:

- a Press the **Subframe No** soft key.
- b Enter a value by using the numeric keys. You can also use the rotary knob.

**NOTE**

For MBMS testing, this subframe number must be neither 0 nor 5 as these subframes 0 and 5 are not available for MBMS and it must be set to the MBMS transmitted channel's subframe number.

- c Press the **Enter** soft key.
- 6 Toggle the **Physical Cell ID** soft key to **Auto** or **Manual** as desired:
 - Auto:** Detects the Physical Cell ID for the LTE signal automatically.
 - Manual:** Sets a specific Physical Cell ID for the LTE signal manually in order to speed up the synchronization.
- 7 Toggle the **EVM Detection Mode** soft key to **Single** or **Combine** as desired:
 - Single:** Testing on one single antenna connected to your JD700B series with a cable.
 - Combine:** Testing on multiple antennas connected to your JD700B series with a 2x1 combiner or an antenna.
- 8 Depending on your selected NEM, you may need to turn on or off the inversion of the I and Q order by toggling the **IQ Swap** soft key to **On** or **Off**.
- 9 *Optional.* Press the **Miscellaneous** soft key, and then set other miscellaneous setups as described in the following section.
- 10 Check your measurement result displayed on the screen.
- 11 To clear current (C) and history (H) status of CPRI alarm on LOS and LOF and start a new monitoring, press the **MEASURE SETUP** hot key and then the **Clear History** soft key.
- 12 *Optional.* Go to **SAVE/LOAD > Save**, and then select the save option from the choices available for your measurement mode. See "Using save" on page 34 for more information.

Setting other miscellaneous setups

Procedure

- 1 To assign a antenna port number automatically or manually, press the **Antenna Port** soft key and select the option from: **Auto**, **0**, or **1**.
- 2 To select the cyclic prefix, toggle the **Cyclic Prefix** soft key to **Normal** or **Extended**. See "Appendix E – Cyclic prefix table" on page 773 for OFDM parameter details by different bandwidth.
- 3 To turn on or off the Multimedia Broadcast Multicast Service (MBMS) feature, toggle the **MBMS** soft key to **On** or **Off**. For proper MBMS testing, you need to set the **Subframe No** with the same PMCH subframe number. If this setting is on, either PMCH or PDSCH appears on the screen depending on the detected channel.
- 4 To set the Multicast Broadcast Single Frequency Network (MBSFN) detection automatically or manually for MBMS testing, toggle the **MBSFN** soft key to **Auto** or **Manual**. An automatically detected or manually entered MBSFN ID appears on the screen.
- 5 To set the threshold for PDCCH, complete the following steps:
 - a Press the **PDCCH Threshold** soft key.
 - b Enter a value by using the numeric keys.
 - c Press the **Enter** soft key.
- 6 Toggle the **PDCCH Mode** soft key between **REG** and **Avg**.
 - REG:** Calculates EVM based on Resource Element Group
 - Avg:** Calculates EVM after adding all the PDCCH signals from one subframe.
- 7 To set the Control Format Indicator, toggle the **CFI** soft key between **Auto** and **Manual**:
 - Auto:** Makes the instrument set the number of OFDM symbols used for transmitting PDCCHs in a subframe.
 - Manual:** Sets the number of OFDM symbols manually.
- 8 To select the number of PHICH groups (Ng), press the **PHICH Ng** soft key and then select the option from: **1/6**, **1/2**, **1**, **2**, **E-1/6**, **E-1/2**, **E-1**, or **E-2**.

Using marker

You can use the **MARKER** hard key to place a marker on a control channel and display the IQ diagram for the selected channel.

Procedure

- 1 Press the **MARKER** hard key.
- 2 Press the **Channel** soft key to select a channel to be displayed in the IQ diagram. The channel P-SS is selected by default.
- 3 Press the up/down arrow keys or turn the rotary knob to highlight a channel in the channel summary table, and then press the center of the rotary knob.
- 4 Toggle the **Marker View** soft key between **On** and **Off** to display or hide the result of the selected channel.

Measurement example

Figure 368 Control channel measurement with RFoCPRI LTE-FDD signal analyzer



NOTE

You can use the **LIMIT** hot key to analyze your measurements with the user-definable limit and Pass/Fail indication. See “Setting limit for RFoCPRI signal analysis” on page 611 for more information.

Conducting subframe measurement

The Subframe measures the modulation accuracy of all the data and control channels at the specified subframe (1 ms).

Making a measurement

Procedure

- 1 Press the **MEASURE** hot key to select the measurement mode.
- 2 Select **Signal Analyzer > LTE-FDD > Modulation Analysis > Subframe**.
- 3 Configure test parameters as described in the “Configuring test parameters” on page 587.
- 4 Press the **MEASURE SETUP** hot key, and then set the following parameters:

Measurement setups as described in the “Setting measure setup” on page 589

Rx Parameters as described in the “Configuring Rx Parameters” on page 589

- 5 To select the subframe number to be measured, complete the following steps:
 - a Press the **Subframe No** soft key.
 - b Enter a value by using the numeric keys or the rotary knob.
-  **NOTE**
For MBMS testing, this subframe number must be neither 0 nor 5 as these subframes 0 and 5 are not available for MBMS and it must be set to the MBMS transmitted channel's subframe number.
- c Press the **Enter** soft key.
 - 6 Toggle the **Physical Cell ID** soft key between **Auto** and **Manual**:

Auto: Detects the Physical Cell ID for the LTE signal automatically.

Manual: Sets a specific Physical Cell ID for the LTE signal manually in order to speed up the synchronization.
 - 7 Toggle the **EVM Detection Mode** soft key between **Single** and **Combine**:

Single: Testing on one single antenna connected to your JD700B series with a cable.

Combine: Testing on multiple antennas connected to your JD700B series with a 2x1 combiner or an antenna.
 - 8 Depending on your selected NEM, you may need to turn on or off the inversion of the I and Q order by toggling the **IQ Swap** soft key to **On** or **Off**.
 - 9 *Optional.* Press the **Miscellaneous** soft key, and then set other miscellaneous setups as described in the following section.
 - 10 Check your measurement result displayed on the screen.
 - 11 To clear current (C) and history (H) status of CPRI alarm on LOS and LOF and start a new monitoring, press the **MEASURE SETUP** hot key and then the **Clear History** soft key.
 - 12 *Optional.* Go to **SAVE/LOAD > Save**, and then select the save option from the choices available for your measurement mode. See “Using save” on page 34 for more information.

Setting other miscellaneous setups

Procedure

- 1 To assign a antenna port number automatically or manually, press the **Antenna Port** soft key and select the option from: **Auto**, **0**, or **1**.
- 2 To select the cyclic prefix, toggle the **Cyclic Prefix** soft key between **Normal** and **Extended**. See “Appendix E – Cyclic prefix table” on page 773 for OFDM parameter details by different bandwidth.
- 3 To turn on or off the Multimedia Broadcast Multicast Service (MBMS) feature, toggle the **MBMS** soft key to **On** or **Off**. For proper MBMS testing, you need to set the **Subframe No** with the same PMCH subframe number. If this setting is on, either PMCH or PDSCH appears on the screen depending on the detected channel.
- 4 To set the Multicast Broadcast Single Frequency Network (MBSFN) detection automatically or manually for MBMS testing, toggle the **MBSFN** soft key to **Auto** or **Manual**. An automatically detected or manually entered MBSFN ID appears on the screen.
- 5 To select the PDSCH modulation type, press the **PDSCH Modulation Type** soft key and then select the option from: **Auto**, **QPSK**, **16 QAM**, **64 QAM**, **E-TM3.3**, **E-TM3.2**, **E-TM3.1**, **E-TM2**, **E-TM1.2**, or **E-TM1.1**.



NOTE
If two or more modulation types are used in a frame, select **Auto**. If the PDSCH uses the same modulation type in a frame or in a subframe, select a specific modulation type to get more accurate EVM.

- 6 To set the threshold for PDSCH, complete the following steps:
 - a Press the **PDSCH Threshold** soft key.
 - b Enter a value by using the numeric keys.
 - c Press the **Enter** soft key.

- 7 To set the threshold for PDCCH, complete the following steps:
 - a Press the **PDCCH Threshold** soft key.
 - b Enter a value by using the numeric keys.
 - c Press the **Enter** soft key.
 - 8 Toggle the **PDCCH Mode** soft key between **REG** and **Avg**.
 - REG**: Calculates EVM based on Resource Element Group
 - Avg**: Calculates EVM after adding all the PDCCH signals from one subframe.
 - 9 To enable or disable the PDSCH precoding, toggle the **PDSCH Precoding** soft key to **On** or **Off**.
 - 10 To set the Control Format Indicator, toggle the **CFI** soft key between **Auto** and **Manual**:
 - Auto**: Makes the instrument set the number of OFDM symbols used for transmitting PDCCHs in a subframe.
 - Manual**: Sets the number of OFDM symbols manually.
 - 11 To select the number of PHICH groups (Ng), press the **PHICH Ng** soft key and then select the option from: **1/6**, **1/2**, **1**, **2**, **E-1/6**, **E-1/2**, **E-1**, or **E-2**.
-

Setting display

You can use the **TRACE/DISPLAY** hard key to view the RE and RS power at a specific symbol.

Procedure

- 1 Press the **TRACE/DISPLAY** hard key.
 - 2 Toggle the **Chart** soft key between **On** and **Off** to display or hide the chart. If this setting is on, the **MARKER** hard key is activated.
-

Using marker

If you turn the Chart view on, you can use the **MARKER** hard key to place the marker at a specific symbol.

Procedure

- 1 Press the **MARKER** hard key.
 - 2 Toggle the **Marker View** soft key between **On** and **Off** to display or hide the marker on the chart.
 - 3 Press the **Symbol** soft key to select the symbol number, to which the marker is placed.
 - 4 Enter a value by using the numeric keys.
 - 5 Press the **Enter** soft key.
-

Measurement example

Figure 369 Subframe measurement (regular view) with RFoCPRI LTE-FDD signal analyzer



NOTE

You can use the **LIMIT** hot key to analyze your measurements with the user-definable limit and Pass/Fail indication. See “Setting limit for RFoCPRI signal analysis” on page 611 for more information.

Conducting frame measurement

The Frame measures the modulation accuracy of all the data and control channels at the frame (10 ms).

Making a measurement

Procedure

- 1 Press the **MEASURE** hot key to select the measurement mode.
- 2 Select **Signal Analyzer > LTE-FDD > Modulation Analysis > Frame**.
- 3 Configure test parameters as described in the “Configuring test parameters” on page 587.
- 4 Press the **MEASURE SETUP** hot key, and then set the following parameters:
 - Measurement setups as described in the “Setting measure setup” on page 589
 - Rx Parameters as described in the “Configuring Rx Parameters” on page 589
- 5 Toggle the **Physical Cell ID** soft key between **Auto** and **Manual**:
 - Auto**: Detects the Physical Cell ID for the LTE signal automatically.
 - Manual**: Sets a specific Physical Cell ID for the LTE signal manually in order to speed up the synchronization.
- 6 Toggle the **EVM Detection Mode** soft key between **Single** and **Combine**:
 - Single**: Testing on one single antenna connected to your JD700B series with a cable.
 - Combine**: Testing on multiple antennas connected to your JD700B series with a 2x1 combiner or an antenna.
- 7 Depending on your selected NEM, you may need to turn on or off the inversion of the I and Q order by toggling the **IQ Swap** soft key to **On** or **Off**.
- 8 *Optional*. Press the **Miscellaneous** soft key, and then set other miscellaneous setups as described in the following section.
- 9 Check your measurement result displayed on the screen.

-
- 10 To clear current (C) and history (H) status of CPRI alarm on LOS and LOF and start a new monitoring, press the **MEASURE SETUP** hot key and then the **Clear History** soft key.
 - 11 *Optional.* Go to **SAVE/LOAD > Save**, and then select the save option from the choices available for your measurement mode. See “Using save” on page 34 for more information.
-

Setting other miscellaneous setups

Procedure

- 1 To assign an antenna port number automatically or manually, press the **Antenna Port** soft key and select the option from: **Auto**, **0**, or **1**.
- 2 To select the cyclic prefix, toggle the **Cyclic Prefix** soft key to **Normal** or **Extended**. See “Appendix E – Cyclic prefix table” on page 773 for OFDM parameter details by different bandwidth.
- 3 To turn on or off the Multimedia Broadcast Multicast Service (MBMS) feature, toggle the **MBMS** soft key to **On** or **Off**. For proper MBMS testing, you need to set the **Subframe No** with the same PMCH subframe number. If this setting is on, either PMCH or PDSCH appears on the screen depending on the detected channel.
- 4 To set the Multicast Broadcast Single Frequency Network (MBSFN) detection automatically or manually for MBMS testing, toggle the **MBSFN** soft key to **Auto** or **Manual**. An automatically detected or manually entered MBSFN ID appears on the screen.
- 5 To select the PDSCH modulation type, press the **PDSCH Modulation Type** soft key and then select the option from: **Auto**, **QPSK**, **16 QAM**, **64 QAM**, **E-TM3.3**, **E-TM3.2**, **E-TM3.1**, **E-TM2**, **E-TM1.2**, or **E-TM1.1**.



NOTE

If two or more modulation types are used in a frame, select **Auto**. If the PDSCH uses the same modulation type in a frame or in a subframe, select a specific modulation type to get more accurate EVM.

- 6 To set the threshold for PDSCH, complete the following steps:
 - a Press the **PDSCH Threshold** soft key.
 - b Enter a value by using the numeric keys.
 - c Press the **Enter** soft key.
 - 7 To set the threshold for PDCCH, complete the following steps:
 - a Press the **PDCCH Threshold** soft key.
 - b Enter a value by using the numeric keys.
 - c Press the **Enter** soft key.
 - 8 Toggle the **PDCCH Mode** soft key between **REG** and **Avg**.
 - REG:** Calculates EVM based on Resource Element Group
 - Avg:** Calculates EVM after adding all the PDCCH signals from one subframe.
 - 9 To enable or disable the PDSCH precoding, toggle the **PDSCH Precoding** soft key to **On** or **Off**.
 - 10 To set the Control Format Indicator, toggle the **CFI** soft key between **Auto** and **Manual**:
 - Auto:** Makes the instrument set the number of OFDM symbols used for transmitting PDCCHs in a subframe.
 - Manual:** Sets the number of OFDM symbols manually.
 - 11 To select the number of PHICH groups (Ng), press the **PHICH Ng** soft key and then select the option from: **1/6**, **1/2**, **1**, **2**, **E-1/6**, **E-1/2**, **E-1**, or **E-2**.
-

Measurement example

Figure 370 Frame measurement with RFoCPRI LTE-FDD signal analyzer



NOTE

You can use the **LIMIT** hot key to analyze your measurements with the user-definable limit and Pass/Fail indication. See “Setting limit for RFoCPRI signal analysis” on page 611 for more information.

Conducting time alignment error measurement

In eNode-B supporting Tx Diversity transmission, signals are transmitted from two or more antennas. These signals shall be aligned. The time alignment error in Tx diversity is specified as the delay between the signals from two antennas at the antenna ports.

Making a measurement

Procedure

- 1 Press the **MEASURE** hot key to select the measurement mode.
- 2 Select **Signal Analyzer > LTE-FDD > Modulation Analysis > Time Alignment Error**.
- 3 Configure test parameters as described in the “Configuring test parameters” on page 587.
- 4 Press the **MEASURE SETUP** hot key, and then set the following parameters:
 - Measurement setups as described in the “Setting measure setup” on page 589
 - Rx Parameters as described in the “Configuring Rx Parameters” on page 589
- 5 Toggle the **Antenna Config** soft key between **Ant0** and **Ant1**.
- 6 Toggle the **Physical Cell ID** soft key between **Auto** and **Manual**:
 - Auto**: Detects the Physical Cell ID for the LTE signal automatically.
 - Manual**: Sets a specific Physical Cell ID for the LTE signal manually in order to speed up the synchronization.
- 7 Depending on your selected NEM, you may need to turn on or off the inversion of the I and Q order by toggling the **IQ Swap** soft key between **On** and **Off**.
- 8 *Optional*. To select the cyclic prefix, complete the following steps:
 - a Press the **Miscellaneous** soft key.
 - b Toggle the **Cyclic Prefix** soft key to **Normal** or **Extended**. See “Appendix E – Cyclic prefix table” on page 773 for OFDM parameter details by different bandwidth.

- 9 Check your measurement result displayed on the screen.
- 10 To clear current (C) and history (H) status of CPRI alarm on LOS and LOF and start a new monitoring, press the **MEASURE SETUP** hot key and then the **Clear History** soft key.
- 11 *Optional.* Go to **SAVE/LOAD > Save**, and then select the save option from the choices available for your measurement mode. See “Using save” on page 34 for more information.

Measurement example

Figure 371 Time alignment error measurement with RFoCPRI LTE-FDD signal analyzer



NOTE

You can use the **LIMIT** hot key to analyze your measurements with the user-definable limit and Pass/Fail indication. See “Setting limit for RFoCPRI signal analysis” on page 611 for more information.

Conducting data allocation map measurement

The Data Allocation Map function represents data allocation as a frame.

Making a measurement

Procedure

- 1 Press the **MEASURE** hot key to select the measurement mode.
- 2 Select **Signal Analyzer > LTE-FDD > Modulation Analysis > Data Allocation Map**.
- 3 Configure test parameters as described in the “Configuring test parameters” on page 587.
- 4 Press the **MEASURE SETUP** hot key, and then set the following parameters:
 - Measurement setups as described in the “Setting measure setup” on page 589
 - Rx Parameters as described in the “Configuring Rx Parameters” on page 589
- 5 To select the subframe number to be measured, complete the following steps:
 - a Press the **Subframe No** soft key.
 - b Enter a value by using the numeric keys or the rotary knob.



NOTE

For MBMS testing, this subframe number must be neither 0 nor 5 as these subframes 0 and 5 are not available for MBMS and it must be set to the MBMS transmitted channel’s subframe number.

-
- c Press the **Enter** soft key.
 - 6 Toggle the **Physical Cell ID** soft key between **Auto** and **Manual**:
 - Auto**: Detects the Physical Cell ID for the LTE signal automatically.
 - Manual**: Sets a specific Physical Cell ID for the LTE signal manually in order to speed up the synchronization.
 - 7 To set the threshold for PDSCH, complete the following steps:
 - a Press the **PDSCH Threshold** soft key.
 - b Enter a value by using the numeric keys.
 - c Press the **Enter** soft key.
 - 8 Depending on your selected NEM, you may need to turn on or off the inversion of the I and Q order by toggling the **IQ Swap** soft key to **On** or **Off**.
 - 9 *Optional*. Press the **Miscellaneous** soft key, and then set other miscellaneous setups as described in the following section.
 - 10 Check your measurement result displayed on the screen.
 - 11 To clear current (C) and history (H) status of CPRI alarm on LOS and LOF and start a new monitoring, press the **MEASURE SETUP** hot key and then the **Clear History** soft key.
 - 12 *Optional*. Go to **SAVE/LOAD > Save**, and then select the save option from the choices available for your measurement mode. See “Using save” on page 34 for more information.
-

Setting other miscellaneous setups

Procedure

- 1 To assign a antenna port number automatically or manually, press the **Antenna Port** soft key and select the option from: **Auto**, **0**, or **1**.
 - 2 To select the cyclic prefix, toggle the **Cyclic Prefix** soft key to **Normal** or **Extended**. See “Appendix E – Cyclic prefix table” on page 773 for OFDM parameter details by different bandwidth.
 - 3 To turn on or off the Multimedia Broadcast Multicast Service (MBMS) feature, toggle the **MBMS** soft key to **On** or **Off**. For proper MBMS testing, you need to set the **Subframe No** with the same PMCH subframe number. If this setting is on, either PMCH or PDSCH appears on the screen depending on the detected channel.
 - 4 To set the Multicast Broadcast Single Frequency Network (MBSFN) detection automatically or manually for MBMS testing, toggle the **MBSFN** soft key to **Auto** or **Manual**. An automatically detected or manually entered MBSFN ID appears on the screen.
-

Setting display

You can use the **TRACE/DISPLAY** hard key to change the display mode to PDSCH, PMCH, or both.

Procedure

- 1 Press the **TRACE/DISPLAY** hard key.
 - 2 Press the **Display Channel** soft key.
 - 3 Select the display mode from: **PDSCH**, **PMCH**, or **Both**.
-

Using marker

You can use the **MARKER** hard key to place the marker at a specific resource block and subframe.

Procedure

- 1 Press the **MARKER** hard key.
-

- 2 Toggle the **Marker View** soft key between **On** and **Off** to display or hide the marker on the chart.
- 3 To select the resource block number, complete the following steps:
 - a Press the **RB Number** soft key.
 - b Enter the resource block number by using the numeric keys or the rotary knob to move the marker side by side.
 - c Press the **Enter** soft key.
- 4 To select the subframe block number, complete the following steps:
 - a Press the **Subframe No** soft key.
 - b Enter the subframe number by using the numeric keys or the rotary knob to move the marker up and down.
 - c Press the **Enter** soft key.

Measurement example

Figure 372 Data allocation map measurement with RFoCPRI LTE-FDD signal analyzer



Performing power statistics CCDF measurement

The Power Statistics Complementary Cumulative Distribution Function (CCDF) measurement characterizes the power statistics of the input signal. It provides PAR (Peak to Average power Ratio) versus different probabilities.

Making a measurement

Procedure

- 1 Press the **MEASURE** hot key to select the measurement mode.
- 2 Select **Signal Analyzer > LTE-FDD > Power Statistics CCDF**.
- 3 Configure test parameters as described in the “Configuring test parameters” on page 587.
- 4 Press the **MEASURE SETUP** hot key, and then set the following parameters:
 - Measurement setups as described in the “Setting measure setup” on page 589
 - Rx Parameters as described in the “Configuring Rx Parameters” on page 589
- 5 To set the length of the CCDF, complete the following steps:
 - a Press the **CCDF Length** soft key.
 - b Enter a value between 1 and 100 by using the numeric keys or the rotary knob.

- c Press the **Enter** soft key.
- 6 Check your measurement result displayed on the screen.
- 7 To clear current (C) and history (H) status of CPRI alarm on LOS and LOF and start a new monitoring, press the **MEASURE SETUP** hot key and then the **Clear History** soft key.
- 8 *Optional.* Go to **SAVE/LOAD > Save**, and then select the save option from the choices available for your measurement mode. See “Using save” on page 34 for more information.

Measurement example

Figure 373 CCDF measurement with RFoCPRI LTE-FDD signal analyzer



Setting limit for RFoCPRI signal analysis

By default, test limits specified in the standard are set for you. You can change thresholds if you desire.

Procedure

- 1 Press the **LIMIT** hot key.
- 2 To set a limit for RF analysis tests, press the **RF Test Limits** soft key and then set limits as needed, depending on where you are in the measurement mode.

To set the limit for	Select	Set
Channel power	Channel Power	High Limit, Low Limit
Occupied bandwidth	Occupied BW	High Limit

- 3 To set a limit for modulation tests, press the **Modulation Test Limits** soft key and then set limits as needed, depending on where you are in the measurement mode.

To set the limit for	Select	Set
Frequency error	Frequency Error	High Limit, Low Limit
PDSCH error vector magnitude if MBMS is off	EVM > PDSCH EVM	High Limit (QPSK) High Limit (16 QAM) High Limit (64 QAM)
PMCH error vector magnitude if MBMS is on and a PMCH is	EVM > PMCH EVM	High Limit (QPSK) High Limit (16 QAM)

detected		High Limit (64 QAM)
RMS for data error vector magnitude	EVM > Data EVM RMS	High Limit
Peak for data error vector magnitude	EVM> Data EVM Peak	High Limit
RS error vector magnitude	EVM > RS EVM	High Limit
P-SS error vector magnitude	EVM > P-SS EVM	High Limit
S-SS error vector magnitude	EVM > S-SS EVM	High Limit
Downlink RS power	Power > DL RS Power	High Limit, Low Limit
P-SS power	Power > P-SS Power	High Limit, Low Limit
S-SS power	Power > S-SS Power	High Limit, Low Limit
PBCH power	Power > PBCH Power	High Limit, Low Limit
Subframe power	Power > Subframe Power	High Limit, Low Limit
OFDM symbol power	Power > OFDM Symbol Power	High Limit, Low Limit
Frame average power	Power > Frame Avg Power	High Limit, Low Limit
Time alignment error for MIMO	Time Alignment Error > MIMO	High Limit
Time error	Time Error	High Limit, Low Limit
I-Q origin offset	IQ Origin Offset	High Limit

- 4 *Optional.* You can enable alarm sound that goes off if the measurement falls outside of the limit. Toggle the **Beep** soft key between **On** and **Off** to enable or disable the beep sound.
- 5 *Optional.* Go to **SAVE/LOAD > Save**, and then select **Limit** to save the limit settings. See “Using save” on page 34 for more information.

Performing LTE-TDD downlink signal analysis

If your JD700B series has the option 092 RFoCPRI LTE-TDD Signal Analyzer installed with a license, you can perform power and spectrum measurements as well as modulation analysis to test the proper transmitter performance of TDD LTE systems over CPRI.

This instrument provides the following measurement tools for TDD LTE system over CPRI:

- Spectrum Analysis
- RF Analysis
 - Channel Power
 - Occupied Bandwidth
- Power vs. Time (Frame)
- Modulation Analysis
 - Constellation
 - Data Channel
 - Control Channel
 - Subframe
 - Time Alignment Error

- Data Allocation Map
- Power Statistics CCDF

Connecting cables

You can connect cables with a tap or without a tap as illustrated in Figure 374. If you have connected cables directly from RRH and BBU without using the nTap, you must turn on the through mode (Thru) in the CPRI parameter settings.

A SFP/SFP+ transceiver that is connected to your JD700B series must be compatible with your DUT and you must have your module information such as line rate, wavelength, and mode (MM or SM) handy.

Figure 374 Connection diagram for downlink signal analysis

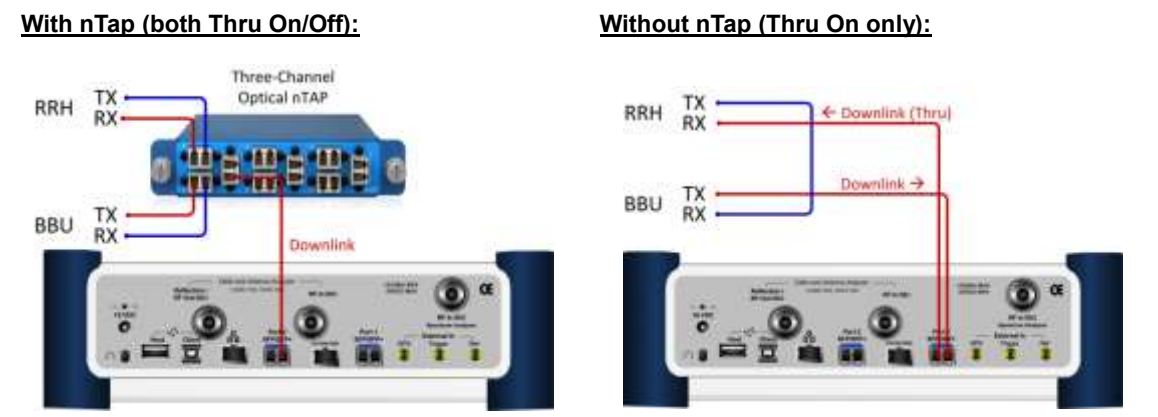

Selecting measurement mode

Procedure

- 1 Press the **MEASURE** hot key.
- 2 Select **Signal Analyzer > LTE-TDD**.
- 3 Select the downlink signal analysis mode from the following choices:
 - Spectrum**
 - RF Analysis > Channel Power or Occupied BW**
 - Power vs Time (Frame)**
 - Modulation Analysis > Constellation, Data Channel, Control Channel, Subframe, Time Alignment Error, or Data Allocation Map**
 - Power Statistics CCDF**

Selecting port

JD700B series supports two antenna ports for signal transmission, and each port can generate different waveforms selectively and simultaneously. User can select the port to use for the measurement in any measurement mode of RFoCPRI mode.

Procedure

- 1 In any measurement mode, press the **MEASURE SETUP** hot key.
- 2 Toggle the **Select Port** soft key between **Port 1** and **Port 2** to select the desired port.

Configuring test parameters

Setting frequency

You can set the frequency with either frequency or channel number. If a frequency to be set matches to the frequency corresponding to the selected channel standard, the instrument calculates its channel number and updates the screen with it automatically.

Procedure

To set the center frequency:

- 1 Press the **FREQ/DIST** hard key.
- 2 Toggle the **Unit** soft key to **Freq**.
- 3 Press the **Center Frequency** soft key.
- 4 Enter a value by using the numeric keys or the rotary knob.
- 5 Select the unit: **GHz**, **MHz**, **kHz**, or **Hz**.
- 6 *Optional.* To define the amount of frequency increment for the rotary knob, complete the following steps:
 - a Press the **Frequency Step** soft key.
 - b Enter a value by using the numeric keys or the rotary knob.
 - c Press the unit: **GHz**, **MHz**, **kHz**, or **Hz**.

To set the channel number:

- 1 Press the **FREQ/DIST** hard key.
- 2 Toggle the **Unit** soft key to **Channel**.



NOTE

Selecting **Channel** sets the standard channel to **Band Global** automatically so that you can set the **Channel Number** without choosing a standard channel band from the list.

- 3 Press the **Channel Number** soft key.
 - 4 Enter a value by using the numeric keys or the rotary knob.
 - 5 Press the **Enter** soft key.
The instrument automatically displays the corresponding center frequency value for the selected channel number.
 - 6 *Optional.* To define the amount of channel increment for the rotary knob, complete the following steps:
 - a Press the **Channel Step** soft key.
 - b Enter a value by using the numeric keys or the rotary knob.
 - c Press the **Enter** soft key.
-

Setting amplitude

You can set the reference automatically or manually to optimize the display of the trace, as you desire.

Procedure

- 1 Press the **AMP/SCALE** hard key.
- 2 Complete one of the followings:
 - To optimize the Y-axis scale automatically, press the **Auto Scale** soft key.
 - To set the maximum reference value on the Y-axis manually, complete the following steps:
 - a Press the **Reference Level** soft key.
 - b Enter a value by using the numeric keys or the rotary knob with 10 dB increments.
 - c Press the unit soft key or the **ENTER** hard key.



NOTE

In the **Control Channel**, **Subframe**, and **Frame** measurement modes, you can select the reference option between **Relative** and **Absolute** instead.

- 3 To set an external offset, complete the following steps:
 - a Toggle the **External Offset** soft key to **On**.
 - b Enter a value by using the numeric keys.
 - c Press the **dB** soft key to complete the entry.

**NOTE**

The instrument displays a measurement result with the set value reflected. For example, if you set it to 40 dB, the measurement result compensates 40 dB.

- 4 To change the setting of the scale per division, complete the following steps:
 - a Select **More (1/2) > Scale/Div**.
 - b Enter a value between 1 and 20 by using the numeric keys.
 - c Press the **dB** soft key to complete the entry.
- 5 To change the scale unit, select **More (1/2) > Units**, and then select the display unit option from: **dBm**, **dBV**, **dBmV**, **dBμV**, **V**, or **W**.
The scale unit on the screen changes accordingly.

**NOTE**

The Scale/Div and Units menus are available in the Spectrum and RF Analysis modes.

Setting average

In the spectrum and RF analysis, you can set the number of measurements to be averaged for the trace presentation. A maximum of 100 times of averaging can be set. When the averaging reaches to your setting, a new measurement value replaces the measurement value in sequence from the earliest.

Procedure

- 1 Press the **BW/AVG** hard key.
- 2 Press the **Average** soft key.
- 3 Enter a value between 1 and 100 as needed by using the numeric keys.
- 4 Press the **Enter** soft key.

Setting sweep mode

The default setting is **Continue** to sweep continuously for most on-going measurements. If you want to hold the measurement or get a single sweep, you can change the sweep mode.

Procedure

- 1 Press the **SWEEP** hot key.
- 2 Do the following:
 - To select the single sweep mode, complete the following steps:
 - a Toggle the **Sweep Mode** soft key to **Single** or press the **HOLD** hot key.
The letter **HOLD** in red appears and the sweeping is paused.
 - b To get a new measurement, press the **Sweep Once** soft key.
 - To return to the continuous sweep mode, toggle the **Sweep Mode** soft key to **Continue** or press the **HOLD** hot key.
The letter **HOLD** in red disappears and the sweeping resumes.



Setting measure setup

Procedure

- 1 Press the **MEASURE SETUP** hot key.
 - 2 To set the CPRI line bit rate of the fronthaul under test, complete the following steps:
 - a Press the **Link Rate** soft key.
 - b Select the CPRI link rate option from: **614.4 Mbps**, **1228.8 Mbps**, **2457.6 Mbps**, **3072.0 Mbps**, **4915.2 Mbps**, **6144.0 Mbps**, or **9830.4 Mbps**.
-  **NOTE**
It is important that you set the link rate correctly to avoid any misleading LOS and LOF alarms displayed on the screen.
- 3 Press the **Tx Clock** soft key, and then select **Recovered** (default).
 - 4 Toggle the **Port Type** soft key to **Slave** (default).
 - 5 To turn on the through mode if you have not used a tap, go to **More (1/2) > Thru**, and then toggle the **Thru** soft key to **On**. To turn off, toggle to **Off**.
 - 6 To configure Rx parameters, see “Configuring Rx Parameters” on page 616.
 - 7 *Optional*. To use the RF signal generator function, see “Using RF source in RFoCPRI testing” on page 636.
 - 8 *Optional*. To use the CPRI signal generator function, see “Using CPRI source” on page 637.

Configuring Rx Parameters

Procedure

- 1 Press the **MEASURE SETUP** hot key.
 - 2 Press the **Rx Parameters** soft key.
 - 3 To set the antenna per carrier group, complete the following steps:
 - a Press the **AxC Group** soft key.
 - b Enter a value by using the numeric keys or the rotary knob.
 - c Press the **Enter** soft key.
-  **NOTE**
Maximum number of the AxC Group is determined by the factors of link rate, sample width, oversampling, and signal bandwidth.
- 4 To set the I and Q sample widths, complete the following steps:
 - a Press the **IQ Sample Width** soft key
 - b Enter a value between 4 and 20 by using the rotary knob or the numeric keys, and then press the **Enter** soft key.
-  **NOTE**
According to the CPRI specification, the IQ sample width shall be between 4 and 20 bits for I and Q in the uplink and between 8 and 20 bits in the downlink.
- 5 To set the first bit position of each AxC Container in the IQ data block of a basic frame, complete the following steps:
 - a Press the **Map Position** soft key.
 - b Select the AxC Container number you want to set from the choices: **AxC 0**, **AxC 1**, **AxC 2**, **AxC 3**, **AxC 4**, **AxC 5**, **AxC 6**, or **AxC 7**. Not all of these are activated depending on your bandwidth setting.
 - c Enter a value by using the numeric keys or the rotary knob.
 - d Press the **Enter** soft key.

-  **NOTE**
The Antenna-Carrier (AxC) is the amount of digital baseband (IQ) U-plane data necessary for either reception or transmission of one carrier at one independent antenna element. The number of required AxC Container for a basic frame are two AxCs for 5 MHz, four AxCs for 10 MHz, and eight AxCs for 20 MHz.

Following is an example of test configuration for a DUT.

DUT		Test Configuration	
CPRI Line Rate (Mbps)	614.4	Link Rate (Mbps)	614.4
UMTS Channel (MHz)	3.84	Bandwidth (MHz)	3
Carriers	2	NEM	None
AxC Positioning	Packed	AxC Group	1 – 2
IQ Sampling	15	IQ Sample Width	15
Over Sampling	1	Map Position	AxC 0 0
			AxC 1 15

For this test configuration, IQ allocation will be like this in the CPRI basic frame.

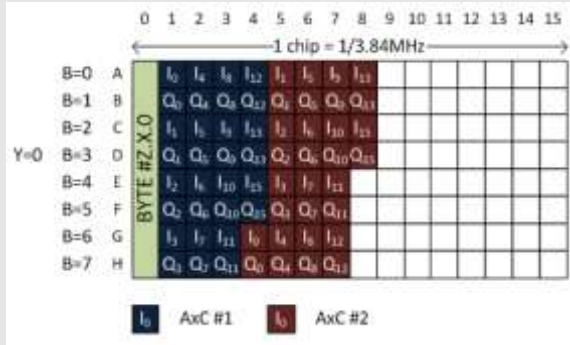

- 6 To set the bandwidth of the downlink signal, complete the following steps:
 - a Press the **Bandwidth** soft key.
 - b Select the bandwidth option from: **1.4 MHz, 3 MHz, 5 MHz, 10 MHz, 15 MHz, 15 MHz (4 AxC), 20 MHz, or 20 MHz (6 AxC)**.
The RBW range changes based on this bandwidth setting.
Required number of AxC containers varies depending on the selected bandwidth.
- 7 To use the pre-configured settings for a NEM, complete the following steps:
 - a Press the **NEM** soft key.
 - b Select an NEM from the following choices:
 - None** (no pre-configuration)
 - Ericsson > Ericsson (UL) and Ericsson (DL)**
 - Alcatel-Lucent (UL/DL)**
 - Samsung (UL/DL)**
 - Huawei > Huawei (UL) and Huawei (DL)**
 - ZTE (UL/DL)**



NOTE
If you have selected a NEM, the instrument sets the Map Position and other related settings automatically based on the selected NEM and you cannot edit the map position setting. The pre-configured information may be subject to changes at any times by NEMs.

Conducting spectrum measurement

Making a measurement

Procedure

- 1 Press the **MEASURE** hot key to select the measurement mode.
- 2 Select **Signal Analyzer > LTE-TDD > Spectrum**.
- 3 Configure test parameters as described in the “Configuring test parameters” on page 614.
- 4 Press the **MEASURE SETUP** hot key, and then set the following parameters:
Measurement setups as described in the “Setting measure setup” on page 616

Rx Parameters as described in the “Configuring Rx Parameters” on page 616

- 5 Check your measurement result displayed on the screen.
- 6 To clear current (C) and history (H) status of CPRI alarm on LOS and LOF and start a new monitoring, press the **MEASURE SETUP** hot key and then the **Clear History** soft key.
- 7 *Optional.* Go to **SAVE/LOAD > Save**, and then select the save option from the choices available for your measurement mode. See “Using save” on page 34 for more information.

Setting trace

You can display up to six traces on the measurement chart simultaneously.

Procedure

- 1 Press the **TRACE/DISPLAY** hard key.
- 2 Press the **Select Trace** soft key, and then select the trace number: **T1**, **T2**, **T3**, **T4**, **T5**, or **T6**. The legend shape of the selected trace changes from square to round to indicate that the trace is the active one now.
- 3 Complete one of the following:

To	Select	Trace Legend
Clear current data and display with new measurements	Clear Write	W
Display the input signal’s maximum response only (unlimited or for a certain amount of time)	Max Hold	M
Display the input signal’s minimum response only (unlimited or for a certain amount of time)	Min Hold	m
Capture the selected trace and compare traces	Capture	C
Load a saved trace	More (1/2) > Load	L
Hide the displayed trace	Trace View > Off	F
Remove all the traces and initialize the trace settings	More (1/2) > Trace Clear All	



NOTE

For the **Max Hold** and **Min Hold**, your instrument compares newly acquired data with the active trace and displays larger maximum values or smaller minimum values on the screen. You can set it to **Unlimited** to hold and view maximum or minimum data or specify a certain amount of time up to 60 seconds by using numeric keys or rotary knob.

- 4 *Optional.* Select **More (1/2) > Trace Info**, and then select the trace number to view the trace’s parameter setting information stored at the time of the measurement or **None** to hide the information display.
- 5 *Optional.* If you have the two traces T1 and T2, you can perform trace math. To view the power difference between the traces, press the **T1 – T2 -> T5** or **T2 – T1 -> T6** soft key. The result is overlaid on the screen along with the second Y-axis.

Measurement example

Figure 375 Spectrum measurement with RFoCPRI LTE-TDD signal analyzer



Conducting channel power measurement

The Channel Power measurement is a common test used in the wireless industry to measure the total transmitted power of a radio within a defined frequency channel. It acquires a number of points representing the input signal in the time domain, transforms this information into the frequency domain using Fast Fourier Transform (FFT), and then calculates the channel power. The effective resolution bandwidth of the frequency domain trace is proportional to the number of points acquired for the FFT.

The channel power measurement identifies the total RF power and power spectral density (PSD) of the signal in the LTE channel bandwidth.

Making a measurement

Procedure

- 1 Press the **MEASURE** hot key to select the measurement mode.
- 2 Select **Signal Analyzer > LTE-TDD > RF Analysis > Channel Power**.
- 3 Configure test parameters as described in the “Configuring test parameters” on page 614.
- 4 Press the **MEASURE SETUP** hot key, and then set the following parameters:
 - Measurement setups as described in the “Setting measure setup” on page 616
 - Rx Parameters as described in the “Configuring Rx Parameters” on page 616
- 5 Check your measurement result displayed on the screen.
- 6 To clear current (C) and history (H) status of CPRI alarm on LOS and LOF and start a new monitoring, press the **MEASURE SETUP** hot key and then the **Clear History** soft key.
- 7 *Optional.* Go to **SAVE/LOAD > Save**, and then select the save option from the choices available for your measurement mode. See “Using save” on page 34 for more information.

Measurement example

Figure 376 Channel power measurement with RFoCPRI LTE-TDD signal analyzer

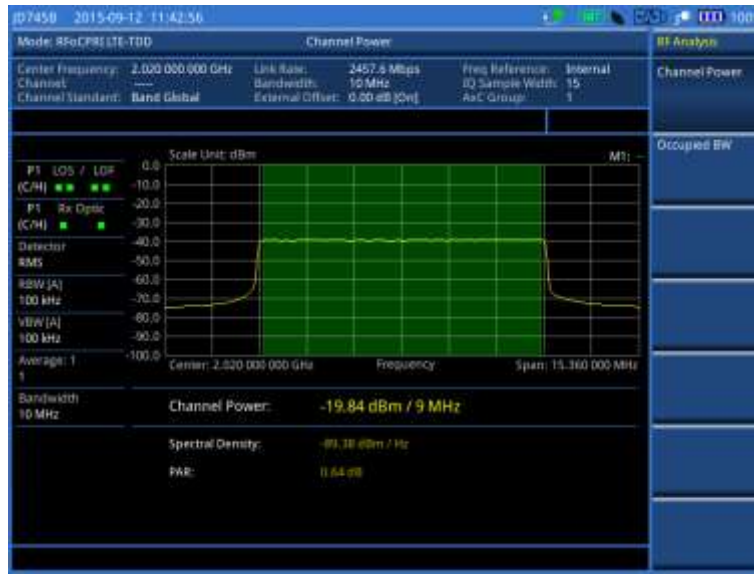

NOTE

You can use the **LIMIT** hot key to analyze your measurements with the user-definable limit and Pass/Fail indication. See “Setting limit for RFoCPRI signal analysis” on page 611 for more information.

Occupied bandwidth

The Occupied Bandwidth measures the spectrum shape of the carrier. It is defined as the bandwidth, which includes 99% of the transmitted power among total transmitted power.

Making a measurement

Procedure

- 1 Press the **MEASURE** hot key to select the measurement mode.
- 2 Select **Signal Analyzer > LTE-TDD > RF Analysis > Occupied BW**.
- 3 Configure test parameters as described in the “Configuring test parameters” on page 614.
- 4 Press the **MEASURE SETUP** hot key, and then set the following parameters:
 - Measurement setups as described in the “Setting measure setup” on page 616
 - Rx Parameters as described in the “Configuring Rx Parameters” on page 616
- 5 Check your measurement result displayed on the screen.
- 6 To clear current (C) and history (H) status of CPRI alarm on LOS and LOF and start a new monitoring, press the **MEASURE SETUP** hot key and then the **Clear History** soft key.
- 7 *Optional.* Go to **SAVE/LOAD > Save**, and then select the save option from the choices available for your measurement mode. See “Using save” on page 34 for more information.

Measurement example

Figure 377 Occupied bandwidth measurement with RFoCPRI LTE-TDD signal analyzer



NOTE

You can use the **LIMIT** hot key to analyze your measurements with the user-definable limit and Pass/Fail indication. See “Setting limit for RFoCPRI signal analysis” on page 611 for more information.

Conducting power vs. time (frame) measurement

The Power vs. Time (Frame) measures the modulation envelope in the time domain, showing the power of each time slot in an LTE signal.

Making a measurement

Procedure

- 1 Press the **MEASURE** hot key to select the measurement mode.
- 2 Select **Signal Analyzer > LTE-TDD > P vs T (Frame)**.
- 3 Configure test parameters as described in the “Configuring test parameters” on page 614.
- 4 Press the **MEASURE SETUP** hot key, and then set the following parameters:
 - Measurement setups as described in the “Setting measure setup” on page 616
 - Rx Parameters as described in the “Configuring Rx Parameters” on page 616
- 5 To select the subframe number to be measured, complete the following steps:
 - a Press the **Subframe No** soft key.
 - b Enter a value by using the numeric keys or the rotary knob.
 - c Press the **Enter** soft key.
- 6 Toggle the **Physical Cell ID** soft key between **Auto** and **Manual**:
 - Auto:** Makes the instrument detect the Physical Cell ID for the LTE signal automatically.
 - Manual:** Sets a specific Physical Cell ID for the LTE signal manually in order to speed up the synchronization.
- 7 Depending on your selected NEM, you may need to turn on or off the inversion of the I and Q order by toggling the **IQ Swap** soft key to **On** or **Off**.
- 8 *Optional.* Press the **Miscellaneous** soft key, and then do the following as needed:
 - To assign a antenna port number automatically or manually, press the **Antenna Port** soft

key and select the option from: **Auto, 0, or 1.**

To select the cyclic prefix, toggle the **Cyclic Prefix** soft key to **Normal** or **Extended**. See “Appendix E – Cyclic prefix table” on page 773 for OFDM parameter details by different bandwidth.

- 9 Check your measurement result displayed on the screen.
- 10 To clear current (C) and history (H) status of CPRI alarm on LOS and LOF and start a new monitoring, press the **MEASURE SETUP** hot key and then the **Clear History** soft key.
- 11 *Optional.* Go to **SAVE/LOAD > Save**, and then select the save option from the choices available for your measurement mode. See “Using save” on page 34 for more information.

Measurement example

Figure 378 Power vs. time (frame) measurement with RFoCPRI LTE-TDD signal analyzer



Conducting constellation measurement

The Constellation is used to observe some aspects of modulation accuracy and can reveal certain fault mechanisms such as I/Q amplitude imbalance or quadrature imbalance. It displays constellation diagram by modulation types.

Making a measurement

Procedure

- 1 Press the **MEASURE** hot key to select the measurement mode.
- 2 Select **Signal Analyzer > LTE-TDD > Modulation Analysis > Constellation**.
- 3 Configure test parameters as described in the “Configuring test parameters” on page 614.
- 4 Press the **MEASURE SETUP** hot key, and then set the following parameters:
 Measurement setups as described in the “Setting measure setup” on page 616
 Rx Parameters as described in the “Configuring Rx Parameters” on page 616
- 5 To select the subframe number to be measured, complete the following steps:
 - a Press the **Subframe No** soft key.
 - b Enter a value by using the numeric keys or the rotary knob.



NOTE

For MBMS testing, this subframe number must be neither 0 nor 5 as these subframes 0

and 5 are not available for MBMS and it must be set to the MBMS transmitted channel's subframe number.

- c Press the **Enter** soft key.
- 6 Toggle the **Physical Cell ID** soft key between **Auto** and **Manual**:
 - Auto**: Detects the Physical Cell ID for the LTE signal automatically.
 - Manual**: Sets a specific Physical Cell ID for the LTE signal manually in order to speed up the synchronization.
- 7 Depending on your selected NEM, you may need to turn on or off the inversion of the I and Q order by toggling the **IQ Swap** soft key to **On** or **Off**.
- 8 *Optional*. Press the **Miscellaneous** soft key, and then set other miscellaneous setups as described in the following section.
- 9 Check your measurement result displayed on the screen.
- 10 To clear current (C) and history (H) status of CPRI alarm on LOS and LOF and start a new monitoring, press the **MEASURE SETUP** hot key and then the **Clear History** soft key.
- 11 *Optional*. Go to **SAVE/LOAD > Save**, and then select the save option from the choices available for your measurement mode. See "Using save" on page 34 for more information.

Setting other miscellaneous setups

Procedure

- 1 To assign an antenna port number automatically or manually, press the **Antenna Port** soft key and select the option from: **Auto**, **0**, or **1**.
- 2 To select the cyclic prefix, toggle the **Cyclic Prefix** soft key to **Normal** or **Extended**. See "Appendix E – Cyclic prefix table" on page 773 for OFDM parameter details by different bandwidth.
- 3 To turn on or off the Multimedia Broadcast Multicast Service (MBMS) feature, toggle the **MBMS** soft key to **On** or **Off**. For proper MBMS testing, you need to set the **Subframe No** with the same PMCH subframe number. If this setting is on, either PMCH or PDSCH appears on the screen depending on the detected channel.
- 4 To set the Multicast Broadcast Single Frequency Network (MBSFN) detection automatically or manually for MBMS testing, toggle the **MBSFN** soft key to **Auto** or **Manual**. An automatically detected or manually entered MBSFN ID appears on the screen.
- 5 To select the PDSCH modulation type, press the **PDSCH Modulation Type** soft key and then select the option from: **Auto**, **QPSK**, **16 QAM**, **64 QAM**, **E-TM3.3**, **E-TM3.2**, **E-TM3.1**, **E-TM2**, **E-TM1.2**, or **E-TM1.1**.



NOTE

If two or more modulation types are used in a frame, select **Auto**. If the PDSCH uses the same modulation type in a frame or in a subframe, select a specific modulation type to get more accurate EVM.

- 6 To set the threshold for PDSCH, complete the following steps:
 - a Press the **PDSCH Threshold** soft key.
 - b Enter a value by using the numeric keys.
 - c Press the **Enter** soft key.
- 7 To enable or disable the PDSCH precoding, toggle the **PDSCH Precoding** soft key to **On** or **Off**.
- 8 To set the Control Format Indicator, toggle the **CFI** soft key between **Auto** and **Manual**:
 - Auto**: Makes the instrument set the number of OFDM symbols used for transmitting PDCCHs in a subframe.
 - Manual**: Sets the number of OFDM symbols manually.
- 9 To select the number of PHICH groups (Ng), press the **PHICH Ng** soft key and then select the option from: **1/6**, **1/2**, **1**, **2**, **E-1/6**, **E-1/2**, **E-1**, or **E-2**.

Measurement example

Figure 379 Constellation measurement with RFoCPRI LTE-TDD signal analyzer



NOTE

You can use the **LIMIT** hot key to analyze your measurements with the user-definable limit and Pass/Fail indication. See “Setting limit for RFoCPRI signal analysis” on page 611 for more information.

Conducting data channel measurement

The Data Channel measures the constellation for the specified resource block as well as the modulation accuracy of each PDSCH at the specified subframe.

Making a measurement

Procedure

- 1 Press the **MEASURE** hot key to select the measurement mode.
- 2 Select **Signal Analyzer > LTE-TDD > Modulation Analysis > Data Channel**.
- 3 Configure test parameters as described in the “Configuring test parameters” on page 614.
- 4 Press the **MEASURE SETUP** hot key, and then set the following parameters:
 - Measurement setups as described in the “Setting measure setup” on page 616
 - Rx Parameters as described in the “Configuring Rx Parameters” on page 616
- 5 To select the subframe number to be measured, complete the following steps:
 - a Press the **Subframe No** soft key.
 - b Enter a value by using the numeric keys or the rotary knob.



NOTE

For MBMS testing, this subframe number must be neither 0 nor 5 as these subframes 0 and 5 are not available for MBMS and it must be set to the MBMS transmitted channel’s subframe number.

- c Press the **Enter** soft key.
- 6 Toggle the **Physical Cell ID** soft key between **Auto** and **Manual**:
 - Auto:** Makes the instrument detect the Physical Cell ID for the LTE signal automatically.
 - Manual:** Sets a specific Physical Cell ID for the LTE signal manually in order to speed up the synchronization.

- 7 To enable or disable the event hold feature, toggle the **Event Hold** soft key to **On** or **Off**. When enabled, the display line for the PDSCH threshold appears. When an event occurs, the measurement is put on hold until you press the **HOLD** hot key.
- 8 Depending on your selected NEM, you may need to turn on or off the inversion of the I and Q order by toggling the **IQ Swap** soft key to **On** or **Off**.
- 9 *Optional.* Press the **Miscellaneous** soft key, and then set other miscellaneous setups as described in the following section.
- 10 Check your measurement result displayed on the screen.
- 11 To clear current (C) and history (H) status of CPRI alarm on LOS and LOF and start a new monitoring, press the **MEASURE SETUP** hot key and then the **Clear History** soft key.
- 12 *Optional.* Go to **SAVE/LOAD > Save**, and then select the save option from the choices available for your measurement mode. See “Using save” on page 34 for more information.

Setting other miscellaneous setups

Procedure

- 1 To assign a antenna port number automatically or manually, press the **Antenna Port** soft key and select the option from: **Auto**, **0**, or **1**.
- 2 To select the cyclic prefix, toggle the **Cyclic Prefix** soft key to **Normal** or **Extended**. See “Appendix E – Cyclic prefix table” on page 773 for OFDM parameter details by different bandwidth.
- 3 To turn on or off the Multimedia Broadcast Multicast Service (MBMS) feature, toggle the **MBMS** soft key to **On** or **Off**. For proper MBMS testing, you need to set the **Subframe No** with the same PMCH subframe number. If this setting is on, either PMCH or PDSCH appears on the screen depending on the detected channel.
- 4 To set the Multicast Broadcast Single Frequency Network (MBSFN) detection automatically or manually for MBMS testing, toggle the **MBSFN** soft key to **Auto** or **Manual**. An automatically detected or manually entered MBSFN ID appears on the screen.
- 5 To select the PDSCH modulation type, press the **PDSCH Modulation Type** soft key and then select the option from: **Auto**, **QPSK**, **16 QAM**, **64 QAM**, **E-TM3.3**, **E-TM3.2**, **E-TM3.1**, **E-TM2**, **E-TM1.2**, or **E-TM1.1**.



NOTE

If two or more modulation types are used in a frame, select **Auto**. If the PDSCH uses the same modulation type in a frame or in a subframe, select a specific modulation type to get more accurate EVM.

- 6 To set the threshold for PDSCH, complete the following steps:
 - a Press the **PDSCH Threshold** soft key.
 - b Enter a value by using the numeric keys.
 - c Press the **Enter** soft key.
- 7 To enable or disable the PDSCH precoding, toggle the **PDSCH Precoding** soft key to **On** or **Off**.
- 8 To set the Control Format Indicator, toggle the **CFI** soft key to **Auto** or **Manual**:
 - Auto:** Makes the instrument set the number of OFDM symbols used for transmitting PDCCHs in a subframe.
 - Manual:** Sets the number of OFDM symbols manually.
- 9 To select the number of PHICH groups (Ng), press the **PHICH Ng** soft key and then select the option from: **1/6**, **1/2**, **1**, **2**, **E-1/6**, **E-1/2**, **E-1**, or **E-2**.

Using marker

You can use the **MARKER** hard key to place a marker on a resource block and display the IQ diagram for the selected resource block.

Procedure

- 1 Press the **MARKER** hard key.
- 2 Press the **RB Number** soft key to select the resource block to be marked.
- 3 Enter the resource block number by using the numeric keys.
- 4 Press the **Enter** soft key.
The marker appears on the selected resource block.
- 5 Toggle the **Marker View** soft key between **On** and **Off** to display or hide the result of the selected resource block.

Measurement example

Figure 380 Data channel measurement with RFoCPRI LTE-FDD signal analyzer



NOTE

You can use the **LIMIT** hot key to analyze your measurements with the user-definable limit and Pass/Fail indication. See “Setting limit for RFoCPRI signal analysis” on page 611 for more information.

Conducting control channel measurement

The Control Channel measures the constellation for the specified control channel as well as modulation accuracy of the control channel at the specified subframe.

Making a measurement

Procedure

- 1 Press the **MEASURE** hot key to select the measurement mode.
- 2 Select **Signal Analyzer > LTE-TDD > Modulation Analysis > Control Channel**.
- 3 Configure test parameters as described in the “Configuring test parameters” on page 614.
- 4 Press the **MEASURE SETUP** hot key, and then set the following parameters:
Measurement setups as described in the “Setting measure setup” on page 616
Rx Parameters as described in the “Configuring Rx Parameters” on page 616
- 5 To select the subframe number to be measured, complete the following steps:

- a Press the **Subframe No** soft key.
- b Enter a value by using the numeric keys or the rotary knob.

**NOTE**

For MBMS testing, this subframe number must be neither 0 nor 5 as these subframes 0 and 5 are not available for MBMS and it must be set to the MBMS transmitted channel's subframe number.

- c Press the **Enter** soft key.
- 6 Toggle the **Physical Cell ID** soft key between **Auto** and **Manual**:
 - Auto**: Detects the Physical Cell ID for the LTE signal automatically.
 - Manual**: Sets a specific Physical Cell ID for the LTE signal manually in order to speed up the synchronization.
- 7 Toggle the **EVM Detection Mode** soft key between **Single** and **Combine**:
 - Single**: Testing on one single antenna connected to your JD700B series with a cable.
 - Combine**: Testing on multiple antennas connected to your JD700B series with a 2x1 combiner or an antenna.
- 8 Depending on your selected NEM, you may need to turn on or off the inversion of the I and Q order by toggling the **IQ Swap** soft key between **On** and **Off**.
- 9 *Optional*. Press the **Miscellaneous** soft key, and then set other miscellaneous setups as described in the following section.
- 10 Check your measurement result displayed on the screen.
- 11 To clear current (C) and history (H) status of CPRI alarm on LOS and LOF and start a new monitoring, press the **MEASURE SETUP** hot key and then the **Clear History** soft key.
- 12 *Optional*. Go to **SAVE/LOAD > Save**, and then select the save option from the choices available for your measurement mode. See "Using save" on page 34 for more information.

Setting other miscellaneous setups

Procedure

- 1 To assign a antenna port number automatically or manually, press the **Antenna Port** soft key and select the option from: **Auto**, **0**, or **1**.
- 2 To select the cyclic prefix, toggle the **Cyclic Prefix** soft key to **Normal** or **Extended**. See "Appendix E – Cyclic prefix table" on page 773 for OFDM parameter details by different bandwidth.
- 3 To turn on or off the Multimedia Broadcast Multicast Service (MBMS) feature, toggle the **MBMS** soft key to **On** or **Off**. For proper MBMS testing, you need to set the **Subframe No** with the same PMCH subframe number. If this setting is on, either PMCH or PDSCH appears on the screen depending on the detected channel.
- 4 To set the Multicast Broadcast Single Frequency Network (MBSFN) detection automatically or manually for MBMS testing, toggle the **MBSFN** soft key to **Auto** or **Manual**. An automatically detected or manually entered MBSFN ID appears on the screen.
- 5 To set the threshold for PDCCH, complete the following steps:
 - a Press the **PDCCH Threshold** soft key.
 - b Enter a value by using the numeric keys.
 - c Press the **Enter** soft key.
- 6 Toggle the **PDCCH Mode** soft key between **REG** and **Avg**.
 - REG**: Calculates EVM based on Resource Element Group
 - Avg**: Calculates EVM after adding all the PDCCH signals from one subframe.
- 7 To set the Control Format Indicator, toggle the **CFI** soft key between **Auto** and **Manual**:
 - Auto**: Makes the instrument set the number of OFDM symbols used for transmitting PDCCHs in a subframe.
 - Manual**: Sets the number of OFDM symbols manually.
- 8 To select the number of PHICH groups (Ng), press the **PHICH Ng** soft key and then select the option from: **1/6**, **1/2**, **1**, **2**, **E-1/6**, **E-1/2**, **E-1**, or **E-2**.

Using marker

You can use the **MARKER** hard key to place a marker on a control channel and display the IQ diagram for the selected channel.

Procedure

- 1 Press the **MARKER** hard key.
- 2 Press the **Channel** soft key to select a channel to be displayed in the IQ diagram. The channel P-SS is selected by default.
- 3 Press the up/down arrow keys or turn the rotary knob to highlight a channel in the channel summary table, and then press the center of the rotary knob.
- 4 Toggle the **Marker View** soft key between **On** and **Off** to display or hide the result of the selected channel.

Measurement example

Figure 381 Control channel measurement with RFoCPRI LTE-TDD signal analyzer



NOTE
You can use the **LIMIT** hot key to analyze your measurements with the user-definable limit and Pass/Fail indication. See “Setting limit for RFoCPRI signal analysis” on page 611 for more information.

Conducting subframe measurement

The Subframe measures the modulation accuracy of all the data and control channels at the specified subframe (1 ms).

Making a measurement

Procedure

- 1 Press the **MEASURE** hot key to select the measurement mode.
- 2 Select **Signal Analyzer > LTE-TDD > Modulation Analysis > Subframe**.
- 3 Configure test parameters as described in the “Configuring test parameters” on page 614.
- 4 Press the **MEASURE SETUP** hot key, and then set the following parameters:

Measurement setups as described in the “Setting measure setup” on page 616

Rx Parameters as described in the “Configuring Rx Parameters” on page 616

- 5 To select the subframe number to be measured, complete the following steps:
 - a Press the **Subframe No** soft key.
 - b Enter a value by using the numeric keys or the rotary knob.
-  **NOTE**
For MBMS testing, this subframe number must be neither 0 nor 5 as these subframes 0 and 5 are not available for MBMS and it must be set to the MBMS transmitted channel's subframe number.
- c Press the **Enter** soft key.
 - 6 Toggle the **Physical Cell ID** soft key between **Auto** and **Manual**:

Auto: Detects the Physical Cell ID for the LTE signal automatically.

Manual: Sets a specific Physical Cell ID for the LTE signal manually in order to speed up the synchronization.
 - 7 Toggle the **EVM Detection Mode** soft key between **Single** and **Combine**:

Single: Testing on one single antenna connected to your JD700B series with a cable.

Combine: Testing on multiple antennas connected to your JD700B series with a 2x1 combiner or an antenna.
 - 8 Depending on your selected NEM, you may need to turn on or off the inversion of the I and Q order by toggling the **IQ Swap** soft key to **On** or **Off**.
 - 9 *Optional.* Press the **Miscellaneous** soft key, and then set other miscellaneous setups as described in the following section.
 - 10 Check your measurement result displayed on the screen.
 - 11 To clear current (C) and history (H) status of CPRI alarm on LOS and LOF and start a new monitoring, press the **MEASURE SETUP** hot key and then the **Clear History** soft key.
 - 12 *Optional.* Go to **SAVE/LOAD > Save**, and then select the save option from the choices available for your measurement mode. See “Using save” on page 34 for more information.

Setting other miscellaneous setups

Procedure

- 1 To assign a antenna port number automatically or manually, press the **Antenna Port** soft key and select the option from: **Auto**, **0**, or **1**.
- 2 To select the cyclic prefix, toggle the **Cyclic Prefix** soft key to **Normal** or **Extended**. See “Appendix E – Cyclic prefix table” on page 773 for OFDM parameter details by different bandwidth.
- 3 To turn on or off the Multimedia Broadcast Multicast Service (MBMS) feature, toggle the **MBMS** soft key to **On** or **Off**. For proper MBMS testing, you need to set the **Subframe No** with the same PMCH subframe number. If this setting is on, either PMCH or PDSCH appears on the screen depending on the detected channel.
- 4 To set the Multicast Broadcast Single Frequency Network (MBSFN) detection automatically or manually for MBMS testing, toggle the **MBSFN** soft key to **Auto** or **Manual**. An automatically detected or manually entered MBSFN ID appears on the screen.
- 5 To select the PDSCH modulation type, press the **PDSCH Modulation Type** soft key and then select the option from: **Auto**, **QPSK**, **16 QAM**, **64 QAM**, **E-TM3.3**, **E-TM3.2**, **E-TM3.1**, **E-TM2**, **E-TM1.2**, or **E-TM1.1**.



NOTE

If two or more modulation types are used in a frame, select **Auto**. If the PDSCH uses the same modulation type in a frame or in a subframe, select a specific modulation type to get more accurate EVM.

- 6 To set the threshold for PDSCH, complete the following steps:
 - a Press the **PDSCH Threshold** soft key.
 - b Enter a value by using the numeric keys.
 - c Press the **Enter** soft key.

- 7 To set the threshold for PDCCH, complete the following steps:
 - a Press the **PDCCH Threshold** soft key.
 - b Enter a value by using the numeric keys.
 - c Press the **Enter** soft key.
 - 8 Toggle the **PDCCH Mode** soft key between **REG** and **Avg**:
 - REG**: Calculates EVM based on Resource Element Group
 - Avg**: Calculates EVM after adding all the PDCCH signals from one subframe.
 - 9 To enable or disable the PDSCH precoding, toggle the **PDSCH Precoding** soft key to **On** or **Off**.
 - 10 To set the Control Format Indicator, toggle the **CFI** soft key between **Auto** and **Manual**:
 - Auto**: Makes the instrument set the number of OFDM symbols used for transmitting PDCCHs in a subframe.
 - Manual**: Sets the number of OFDM symbols manually.
 - 11 To select the number of PHICH groups (Ng), press the **PHICH Ng** soft key and then select the option from: **1/6**, **1/2**, **1**, **2**, **E-1/6**, **E-1/2**, **E-1**, or **E-2**.
-

Setting display

You can use the **TRACE/DISPLAY** hard key to view the RE and RS power at a specific symbol.

Procedure

- 1 Press the **TRACE/DISPLAY** hard key.
 - 2 Toggle the **Chart** soft key between **On** and **Off** to display or hide the chart. If this setting is on, the **MARKER** hard key is activated.
-

Using marker

If you turn the Chart view on, you can use the **MARKER** hard key to place the marker at a specific symbol.

Procedure

- 1 Press the **MARKER** hard key.
 - 2 Toggle the **Marker View** soft key between **On** and **Off** to display or hide the marker on the chart.
 - 3 Press the **Symbol** soft key to select the symbol number, to which the marker is placed.
 - 4 Enter a value by using the numeric keys.
 - 5 Press the **Enter** soft key.
-

Measurement example

Figure 382 Subframe measurement (regular view) with RFoCPRI LTE-TDD signal analyzer



NOTE

You can use the **LIMIT** hot key to analyze your measurements with the user-definable limit and Pass/Fail indication. See “Setting limit for RFoCPRI signal analysis” on page 614 for more information.

Conducting time alignment error measurement

In eNode-B supporting Tx Diversity transmission, signals are transmitted from two or more antennas. These signals shall be aligned. The time alignment error in Tx diversity is specified as the delay between the signals from two antennas at the antenna ports.

Making a measurement

Procedure

- 1 Press the **MEASURE** hot key to select the measurement mode.
- 2 Select **Signal Analyzer > LTE-TDD > Modulation Analysis > Time Alignment Error**.
- 3 Configure test parameters as described in the “Configuring test parameters” on page 614.
- 4 Press the **MEASURE SETUP** hot key, and then set the following parameters:
 - Measurement setups as described in the “Setting measure setup” on page 616
 - Rx Parameters as described in the “Configuring Rx Parameters” on page 616
- 5 Toggle the **Antenna Config** soft key between **Ant0** and **Ant1**.
- 6 Toggle the **Physical Cell ID** soft key between **Auto** and **Manual**:
 - Auto**: Detects the Physical Cell ID for the LTE signal automatically.
 - Manual**: Sets a specific Physical Cell ID for the LTE signal manually in order to speed up the synchronization.
- 7 Depending on your selected NEM, you may need to turn on or off the inversion of the I and Q order by toggling the **IQ Swap** soft key between **On** and **Off**.
- 8 *Optional*. To select the cyclic prefix, complete the following steps:
 - a Press the **Miscellaneous** soft key.
 - b Toggle the **Cyclic Prefix** soft key between **Normal** and **Extended**. See “Appendix E – Cyclic prefix table” on page 773 for OFDM parameter details by different bandwidth.

- 9 Check your measurement result displayed on the screen.
- 10 To clear current (C) and history (H) status of CPRI alarm on LOS and LOF and start a new monitoring, press the **MEASURE SETUP** hot key and then the **Clear History** soft key.
- 11 *Optional.* Go to **SAVE/LOAD > Save**, and then select the save option from the choices available for your measurement mode. See “Using save” on page 34 for more information.

Measurement example

Figure 383 Time alignment error measurement with RFoCPRI LTE-TDD signal analyzer



NOTE

You can use the **LIMIT** hot key to analyze your measurements with the user-definable limit and Pass/Fail indication. See “Setting limit for RFoCPRI signal analysis” on page 611 for more information.

Conducting data allocation map measurement

The Data Allocation Map function represents data allocation as a frame.

Making a measurement

Procedure

- 1 Press the **MEASURE** hot key to select the measurement mode.
- 2 Select **Signal Analyzer > LTE-TDD > Modulation Analysis > Data Allocation Map**.
- 3 Configure test parameters as described in the “Configuring test parameters” on page 614.
- 4 Press the **MEASURE SETUP** hot key, and then set the following parameters:
 - Measurement setups as described in the “Setting measure setup” on page 616
 - Rx Parameters as described in the “Configuring Rx Parameters” on page 616
- 5 To select the subframe number to be measured, complete the following steps:
 - a Press the **Subframe No** soft key.
 - b Enter a value by using the numeric keys or the rotary knob.



NOTE

For MBMS testing, this subframe number must be neither 0 nor 5 as these subframes 0 and 5 are not available for MBMS and it must be set to the MBMS transmitted channel's subframe number.

-
- c Press the **Enter** soft key.
 - 6 Toggle the **Physical Cell ID** soft key between **Auto** and **Manual**:
 - Auto**: Detects the Physical Cell ID for the LTE signal automatically.
 - Manual**: Sets a specific Physical Cell ID for the LTE signal manually in order to speed up the synchronization.
 - 7 To set the threshold for PDSCH, complete the following steps:
 - a Press the **PDSCH Threshold** soft key.
 - b Enter a value by using the numeric keys.
 - c Press the **Enter** soft key.
 - 8 Depending on your selected NEM, you may need to turn on or off the inversion of the I and Q order by toggling the **IQ Swap** soft key between **On** and **Off**.
 - 9 *Optional*. Press the **Miscellaneous** soft key, and then set other miscellaneous setups as described in the following section.
 - 10 Check your measurement result displayed on the screen.
 - 11 To clear current (C) and history (H) status of CPRI alarm on LOS and LOF and start a new monitoring, press the **MEASURE SETUP** hot key and then the **Clear History** soft key.
 - 12 *Optional*. Go to **SAVE/LOAD > Save**, and then select the save option from the choices available for your measurement mode. See “Using save” on page 34 for more information.
-

Setting other miscellaneous setups

Procedure

- 1 To assign a antenna port number automatically or manually, press the **Antenna Port** soft key and select the option: **Auto**, **0**, or **1**.
 - 2 To select the cyclic prefix, toggle the **Cyclic Prefix** soft key between **Normal** and **Extended**. See “Appendix E – Cyclic prefix table” on page 773 for OFDM parameter details by different bandwidth.
 - 3 To turn on or off the Multimedia Broadcast Multicast Service (MBMS) feature, toggle the **MBMS** soft key between **On** and **Off**. For proper MBMS testing, you need to set the **Subframe No** with the same PMCH subframe number. If this setting is on, either PMCH or PDSCH appears on the screen depending on the detected channel.
 - 4 To set the Multicast Broadcast Single Frequency Network (MBSFN) detection automatically or manually for MBMS testing, toggle the **MBSFN** soft key to **Auto** or **Manual**. An automatically detected or manually entered MBSFN ID appears on the screen.
-

Setting display

You can use the **TRACE/DISPLAY** hard key to change the display mode to PDSCH, PMCH, or both.

Procedure

- 1 Press the **TRACE/DISPLAY** hard key.
 - 2 Press the **Display Channel** soft key.
 - 3 Select the display mode from: **PDSCH**, **PMCH**, or **Both**.
-

Using marker

You can use the **MARKER** hard key to place the marker at a specific resource block and subframe.

Procedure

- 1 Press the **MARKER** hard key.
-

- 2 Toggle the **Marker View** soft key between **On** and **Off** to display or hide the marker on the chart.
- 3 To select the resource block number, complete the following steps:
 - a Press the **RB Number** soft key.
 - b Enter the resource block number to select by using the numeric keys. You can also use the rotary knob to move the marker side by side.
 - c Press the **Enter** soft key.
- 4 To select the subframe block number, complete the following steps:
 - a Press the **Subframe No** soft key.
 - b Enter the subframe number to select by using the numeric keys. You can also use the rotary knob to move the marker up and down.
 - c Press the **Enter** soft key.

Measurement example

Figure 384 Data allocation map measurement with RFoCPRI LTE-TDD signal analyzer



Performing power statistics CCDF measurement

The Power Statistics Complementary Cumulative Distribution Function (CCDF) measurement characterizes the power statistics of the input signal. It provides PAR (Peak to Average power Ratio) versus different probabilities.

Making a measurement

Procedure

- 1 Press the **MEASURE** hot key to select the measurement mode.
- 2 Select **Signal Analyzer > LTE-TDD > Power Statistics CCDF**.
- 3 Configure test parameters as described in the “Configuring test parameters” on page 614.
- 4 Press the **MEASURE SETUP** hot key, and then set the following parameters:
 - Measurement setups as described in the “Setting measure setup” on page 616
 - Rx Parameters as described in the “Configuring Rx Parameters” on page 616
- 5 To set the length of the CCDF, complete the following steps:
 - a Press the **CCDF Length** soft key.
 - b Enter a value between 1 and 100 by using the numeric keys. You can also use the rotary

- knob.
- c Press the **Enter** soft key.
- 6 Check your measurement result displayed on the screen.
- 7 To clear current (C) and history (H) status of CPRI alarm on LOS and LOF and start a new monitoring, press the **MEASURE SETUP** hot key and then the **Clear History** soft key.
- 8 *Optional.* Go to **SAVE/LOAD > Save**, and then select the save option from the choices available for your measurement mode. See “Using save” on page 34 for more information.

Measurement example

Figure 385 CCDF measurement with RFoCPRI LTE-TDD signal analyzer



Setting limit for RFoCPRI signal analysis

By default, test limits specified in the standard are set for you. You can change thresholds if you desire.

Procedure

- 1 Press the **LIMIT** hot key.
- 2 To set a limit for RF analysis tests, press the **RF Test Limits** soft key and then set limits as needed, depending on where you are in the measurement mode.

To set the limit for	Select	Set
Channel power	Channel Power	High Limit, Low Limit
Occupied bandwidth	Occupied BW	High Limit

- 3 To set a limit for modulation tests, press the **Modulation Test Limits** soft key and then set limits as needed, depending on where you are in the measurement mode.

To set the limit for	Select	Set
Frequency error	Frequency Error	High Limit, Low Limit
PDSCH error vector magnitude if MBMS is off	EVM > PDSCH EVM	High Limit (QPSK) High Limit (16 QAM) High Limit (64 QAM)
PMCH error vector magnitude	EVM > PMCH EVM	High Limit (QPSK)

if MBMS is on and a PMCH is detected		High Limit (16 QAM) High Limit (64 QAM)
RMS for data error vector magnitude	EVM > Data EVM RMS	High Limit
Peak for data error vector magnitude	EVM> Data EVM Peak	High Limit
RS error vector magnitude	EVM > RS EVM	High Limit
P-SS error vector magnitude	EVM > P-SS EVM	High Limit
S-SS error vector magnitude	EVM > S-SS EVM	High Limit
Downlink RS power	Power > DL RS Power	High Limit, Low Limit
P-SS power	Power > P-SS Power	High Limit, Low Limit
S-SS power	Power > S-SS Power	High Limit, Low Limit
PBCH power	Power > PBCH Power	High Limit, Low Limit
Subframe power	Power > Subframe Power	High Limit, Low Limit
OFDM symbol power	Power > OFDM Symbol Power	High Limit, Low Limit
Frame average power	Power > Frame Avg Power	High Limit, Low Limit
Time alignment error for MIMO	Time Alignment Error > MIMO	High Limit
Time error	Time Error	High Limit, Low Limit
I-Q origin offset	IQ Origin Offset	High Limit

- 4 *Optional.* You can enable alarm sound that goes off if the measurement falls outside of the limit. Toggle the **Beep** soft key between **On** and **Off** to enable or disable the beep sound.
- 5 *Optional.* Go to **SAVE/LOAD > Save**, and then select **Limit** to save the limit settings. See “Using save” on page 34 for more information.

Using signal generator

If your JD700B series has the signal generator options installed with a license, you can use RF Source or CPRI Source, or both.

Using RF source in RFoCPRI testing

You can use the RF Source feature to calibrate the uplink noise floor at a given point, check the uplink gain and dynamic range, and verify that current AxC configuration including map positioning is correct.

Procedure

- 1 Press the **MEASURE SETUP** hot key.
- 2 Press the **Source** soft key. Depending on your selection of measurement mode, you may need to select **More (1/2) > Source**.
- 3 Press the **RF Source** soft key.
- 4 To set the frequency of the CW signal to be injected, complete the following steps:
 - a Press the **Frequency** soft key.
 - b Enter a value within the frequency range of your instrument.

JD740B series: 25 MHz to 4 GHz

JD780B series: 5 MHz to 6 GHz**NOTE**

The frequency of the CW signal must be in the uplink band of the RRH under test.

- c Select the unit option from: **GHz, MHz, kHz, or Hz.**
- 5 To set the output level of the CW signal to be injected, complete following steps:
 - a Press the **Power Level** soft key.
 - b Enter a value within the output range for the frequency you have set in step 4.
 - JD740B series: -80 dBm to -30 dBm, 0 dBm**
 - JD780B series: -60 dBm to 10 dBm**
 - c Press the unit soft key.
- 6 To start to inject the set signal, toggle the **RF Source** soft key to **On**.
- 7 To stop injecting the signal, toggle the **RF Source** soft key to **Off**.

Using CPRI source

You can use the CPRI Source feature to generate CW and various types of E-UTRA Test Model waveforms in RFoCPRI testing for LTE-FDD and LTE-TDD: **CW, CW (Two Tone), E-TM1.1, E-TM1.2, E-TM2, E-TM3.1, E-TM3.2, and E-TM3.3**. You can also select the Tx signals to inject and configure the TX parameters of the selected signals.

Procedure

- 1 Make the Tx of a SFP/SFP+ module looped back to the Rx of the same module.

**NOTE**

When two SFP/SFP+ modules are installed in both Port 1 and Port 2, the CPRI source always works via the Port 1, which is the primary port. If you want to use the Port 2 for this CPRI signal generation, make sure to eject the module from the Port 1.

- 2 Press the **MEASURE SETUP** hot key.
- 3 To set the Tx Clock and Port Type settings correctly, complete the following steps:
 - a Press the **Rx Parameters** soft key.
 - b Press the **Tx Clock** soft key and then select **Internal**.
 - c Toggle the **Port Type** soft key to **Master**.
 - d Press the **PREV** hard key to return to the Measure Setup menu.
- 4 Press the **Source** soft key. Depending on your selection of measurement mode, you may need to select **More (1/2) > Source**.
- 5 Press the **CPRI Source** soft key.
- 6 Select a desired Tx Parameters you want to inject from the menu bar: **Tx1 Parameters, Tx2 Parameters, Tx3 Parameters, or Tx4 Parameters**.
- 7 To select a Tx carrier, complete following steps:
 - a Press the **Select Tx Carrier** soft key.
 - b Select a desired Tx carrier number from the menu bar.
Up to 12 selections for carriers are available based upon configuration.
- 8 To select a Tx container, complete the following steps:
 - a Press the **Select Tx Container** soft key.
 - b Select a desired Tx container from the menu bar.
Total 4 containers are available.
- 9 To set the bandwidth of the downlink signal, complete the following steps:
 - a Press the **Bandwidth** soft key.
 - b Select the bandwidth option from: **1.4 MHz, 3 MHz, 5 MHz, 10 MHz, 15 MHz, or 20 MHz**.
- 10 To select a waveform to be generated, complete the following steps:
 - a Press the **Waveforms** soft key.
The Waveform list dialog box appears.

Figure 386 High-level workflow of BBU emulation

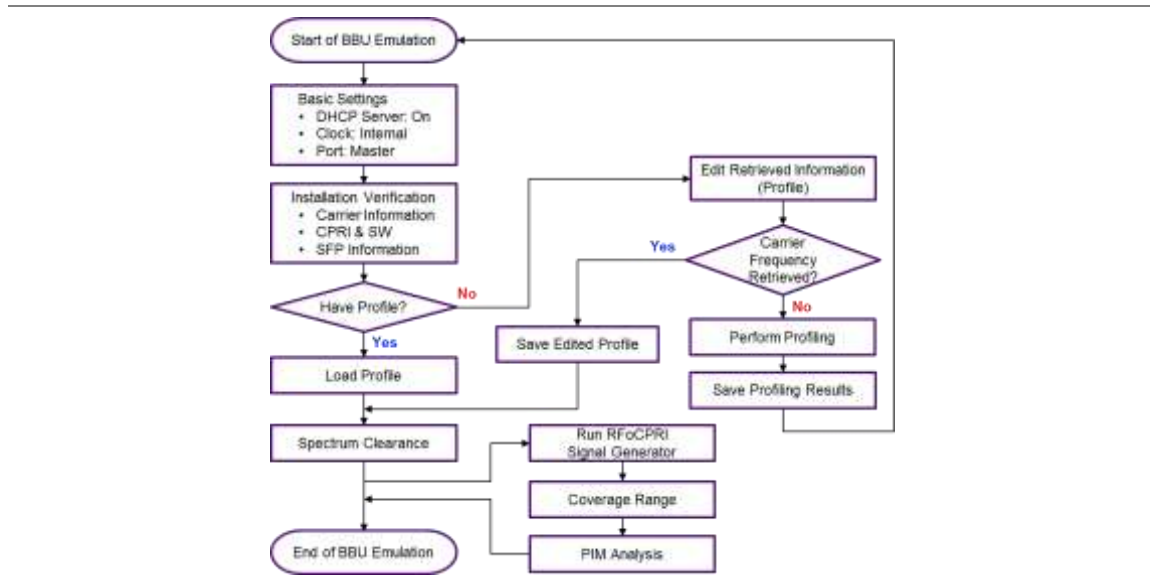

Selecting measurement mode

Procedure

- 1 Press the **MODE** hard key.
- 2 Select **RFoFiber > RFoCPRI**.
- 3 Press the **MEASURE** hot key.
- 4 Select **BBU Emulation > Alcatel-Lucent**.
- 5 Select the mode that you want to open:

Profiling

Configuration Verification > Carrier Information, CPRI & Active SW, SFP Information, or RTD information

Spectrum Clearance > Spectrum, Spectrogram, RSSI, Dual Spectrum, or Dual Spectrogram

Coverage Range

PIM Analysis

RET-Information

Selecting port

JD700B series supports two antenna ports for signal transmission, and each port can generate up to four different Tx waveforms selectively and simultaneously. User can select the port to use for the measurement in any measurement mode of RFoCPRI mode.

Procedure

- 1 In any measurement mode, press the **MEASURE SETUP** hot key.
- 2 Toggle the **Select Port** soft key between **Port 1** and **Port 2** to select the desired port.

Performing RRH profiling

If the RRH is new and no file has been saved that can be used for the RRH configuration, you need to run

the RRH Profiling and capture the C&M messages first, and then retrieve profile parameter values the RRH Profiling to capture C&M messages, and retrieve profile parameter values, such as RHH vendor, technology, VSWR level, RSSI level, carrier frequency, Link ID, and RE ID, from both BBU and RRH. If you already have a saved profile that works for the RRH, you can skip this RRH Profiling.

Connecting cables

To perform the RRH profiling, make the Thru mode cable connection as illustrated in Figure 387.

Figure 387 Thru connection diagram



Enabling Thru mode in CellAdvisor

Procedure

- 1 Press the **MEASURE** hot key.
- 2 Select **BBU Emulation > Alcatel-Lucent > Profiling**.
- 3 Press the **MEASURE SETUP** hot key.
- 4 Toggle the **Laser** soft key to **On**.
- 5 Press the **More (1/2)** soft key.
- 6 Toggle the **Thru** soft key to **On**.

Setting measure setup

After you have connected cables and set up your CellAdvisor for the Thru mode, you need to configure measure parameters to capture C&M messages.

Procedure

- 1 Press the **MEASURE SETUP** hot key.
- 2 To set the CPRI line bit rate of the fronthaul link between BBU and RRH, complete the following steps:
 - a Press the **Link Rate** soft key.
 - b Select the CPRI link rate option from: **614.4 Mbps**, **1228.8 Mbps**, **2457.6 Mbps**, **3072.0 Mbps**, **4915.2 Mbps**, **6144.0 Mbps**, or **9830.4 Mbps**.
 - c Make sure the current LOS and LOF alarms are all green.



NOTE

It is important that you set the link rate correctly to avoid any misleading LOS and LOF alarms displayed on the screen.

- 3 To set the Rx optic limit to for the visual check of whether the received power is within specified

range, complete the following steps:

- a Press the **LIMIT** hot key.
- b Press the **Rx Optic Level** soft key.
- c Set the threshold for **High Limit** and **Low Limit**.
- d To enable the Rx optic limit, toggle the **Test Limits** soft key to **On**.
If the optic power level falls out of the specified threshold, the power reading or indicator turns red.

Starting and stopping profiling

After all measurement parameters have been configured, you can capture the C&M messages and retrieve the profile information.

Procedure

- 1 Press the **MEASURE SETUP** hot key.
- 2 Press the **More (1/2)** soft key.
- 3 To start the profiling, toggle the **Profiling** soft key to **On**.
The screen displays the elapsed profiling time and the size of captured data.
The Profiling screen is updated with the retrieved RRH and carrier information.
- 4 Toggle the **Profiling** soft key to **Off** to stop the RRH profiling. An example is shown in Figure 388.



NOTE

All carriers in use must display “Enable” and have valid information for all parameters.

Figure 388 Example of RRH profiling results with carrier information



Reading profile information

As you can see in the example of RRH profiling results in Figure 388, RRH profiling provides the following information:

- **RRH Description** – It contains the RRH information, specified by its manufacturer. It may not be identical with the field-optimized information. Some of BBUs may not request this information to the RRH depending on its version.
- **Carrier Information** – It is field-optimized information that includes carrier frequency and CPRI

mapping. You can edit the carrier information using the Profile Editor.

- **Carrier:** It means a set of signals assigned to and transmitted at a certain frequency. A different carrier should be at a different frequency. For example, a triple band RRH activates three carriers: Carrier 1, Carrier 2, and Carrier 3.
- **Number of Tx Container:** It means how many antenna branches the RRH has. A different Tx container is sent to a different antenna branch. For example, a 2x2 MIMO system activated two Tx Containers: Tx Container 1 and Tx Container 2.
- **State:** It indicates the state of the carrier use. If the carrier is in use, the state changes from None to Disable, and then to Enable.
- **Carrier Type:** It is the technology and the signal bandwidth information.
- **Uplink and Downlink Frequencies:** They are center frequencies of the carrier actually being serviced.
- **Uplink Noise:** It is the threshold for UL RSSI, expressed in dBFS (Full Scale).

Changing display of profiling results

After you have retrieved all necessary information and stopped the RRH profiling, you can change the display option to view other parameters than carrier information.

Procedure

- 1 Press the **TRACE/DISPLAY** hard key.
- 2 Press the **Select Parameter** soft key.
- 3 Select the display option that you want from the following choices:
 - Carrier Information:** It contains information of carrier frequencies and CPRI mapping.
 - CPRI & Active SW:** It contains information of CPRI configuration including MAC address and activated software in the RRH.
 - SFP Information:** It contains information of the SFP installed in the RRH.

Figure 389 Example of RRH profiling results with CPRI state and activated SW



Figure 390 Example of RRH profiling results with SFP information



Saving profiling results as a file

After you have checked that you have retrieved all required information, you need to save your RRH profiling results as a file so that you can use it to configure and bring up a new RRH of the same kind later.

Procedure

- 1 Press the **SAVE/LOAD** hard key.
- 2 Select **Save > Save Profile**.
- 3 Type a file name that you want to use.
- 4 Press the **Save** soft key.
It saves the profile as a file with `.jcm` extension.

Verifying and configuring a RRH

A baseband unit (BBU) connected to a network can send and receive C&M messages to and from a RRH to configure the RRH correctly and start it up and running successfully. Using the BBU Emulation feature of JD700B series, you can work with the RRH, without connecting to a BBU, to configure it correctly as if you do from the BBU.

Connecting cables

Before starting to verify RRH configuration using your CellAdvisor as a BBU, you need to make the Term mode cable connection as illustrated in Figure 391 and configure the instrument.

Figure 391 Term mode connection diagram

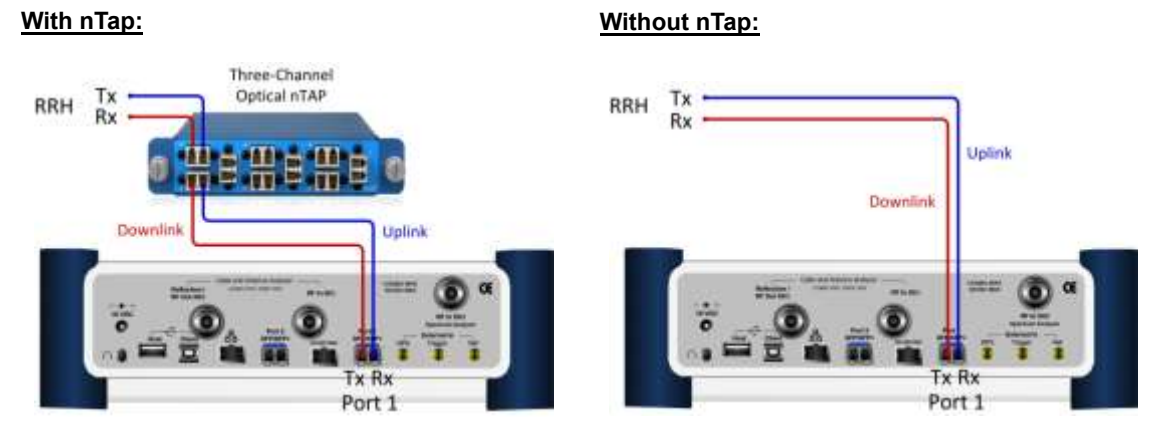

NOTE

When your CellAdvisor has two SFP transceivers installed in Port 1 and Port 2, you must connect the cables to the SFP in Port 1 because BBU emulation in FW3.060 supports and works with Port 1 only.

Setting CellAdvisor for BBU emulation

After you have made the Term mode cable connection, you need to get your CellAdvisor ready to work as a BBU.

Procedure

- 1 Press the **MEASURE** hot key.
- 2 Select **BBU Emulation > Alcatel-Lucent > Configuration Verification > Carrier Information**.
- 3 Once you change the measure mode in step 2, the instrument automatically sets itself to be ready for the communication with the RRH and starts to update the screen with retrieved RRH profile, including RRH and carrier information. Following are the indications of successful connection that you can find on the screen:
 - The status of RRH connection changes to “**RRH Connection: On**”.
 - The RRH symbol () appears in the system status bar at the top.
- 4 If you do not have these indicators on the screen, press the **MEASURE SETUP** hot key and check the following parameters have been set up correctly:
 - Laser: On**
 - Tx Clock: Internal**
 - Port Type: Master**
 - Rx Parameters > More (1/2) > CPRI Network > Standard Indicator: LTE**
 - Rx Parameters > More (1/2) > CPRI Network > DHCP Server: On**
- 5 If the type of the connected RRH is not LTE, you can change it to others as needed.



NOTE

Make sure to keep the RRH connection status to On throughout the BBU emulation.

Verifying carrier configuration

Once you have enabled the DHCP session, your CellAdvisor starts to retrieve the profile of the connected RRH sequentially, updating the RRH description first and then the carrier information. It may take a few minutes to complete.

Procedure

- 1 In the **Carrier Information** screen, check the state of the carriers. You must have at least one carrier with its state of Disable or Enable.
 - None:** It indicates that the carrier is not in use.
 - Disable:** It indicates that the carrier is in use and your CellAdvisor is waiting for mapping information from the RRH.
 - Enable:** It indicates that the carrier is in use and your CellAdvisor retrieved mapping information.
- 2 Check that the number of the Tx container for the carrier in use is equal to or greater than “1”.
- 3 Check if the uplink and downlink frequencies for the carrier are retrieved. Most of the cases you will see these fields are “None”, requiring you to use the Profile Editor to send frequency values to the RRH.

Figure 392 Example of verification of carrier configuration



Figure 392 is an example of missing carrier frequencies for Carrier 1 and Carrier 2. If any of the required fields for the carriers in use were not retrieved, it means that you have to send C&M messages with new parameter values using Profile Editor. You can also load a profile using Load Profile that you have saved in the same type of the RRH before to re-configure the RRH. For more information, see “Loading a saved RRH profile” on page 647 and “Editing RRH Information” on page 648.

Verifying CPRI state and active software

You can also verify that the RRH has set for CPRI and activated software correctly.

Procedure

- 1 Press the **MEASURE** hot key.
- 2 Select **BBU Emulation > Alcatel-Lucent > Configuration Verification > CPRI & Active SW**. The CPRI & Active SW screen appears with “RRH Connection: On”.

Figure 393 Example of verification of CPRI state and active software



Verifying SFP information

You can also view the SFP information to verify if correct SFPs are installed in the RRH.

Procedure

- 1 Press the **MEASURE** hot key.
- 1 Select **BBU Emulation > Alcatel-Lucent > Configuration Verification > SFP Information**. The SFP Information screen appears with “RRH Connection: On”.

Figure 394 Example of verification of SFP information



Verifying RTD information

You can also view the RTD (Round Trip Delay) information in the RRH.

Procedure

- 1 Press the **MEASURE** hot key.
 - 2 Select **BBU Emulation > Alcatel-Lucent > Configuration Verification > RTD Information**.
The RTD Information screen appears with “RRH Connection: On”.
-

Figure 395 Example of verification of RTD

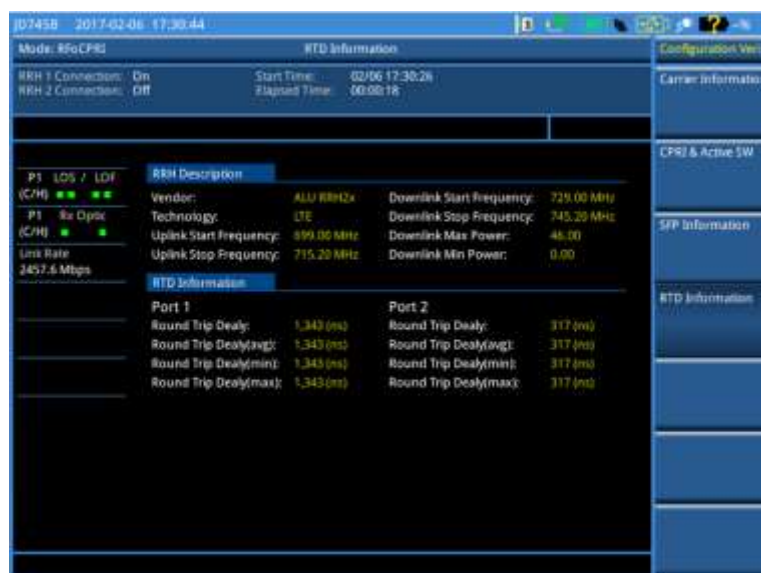

Loading a saved RRH profile

If you already have a saved profile that matches with the RRH, you can load it instead of editing parameters.

Procedure

- 1 Press the **SAVE/LOAD** hard key.
 - 2 Select **Load > Load Profile**.
 - 3 Navigate to the `.jcm` file that you want to load and send to the connected RRH.
If the RRH description stored in the file does not match with the description of the connected RRH, you will encounter an error message “File Mismatch”.
 - 4 Press the **Load** soft key.
It sends the profile to the RRH to try to set it up with new values as stored in the file. If you are viewing all the fields filled with values, you are now done with bringing up the RRH with correct configuration.
-

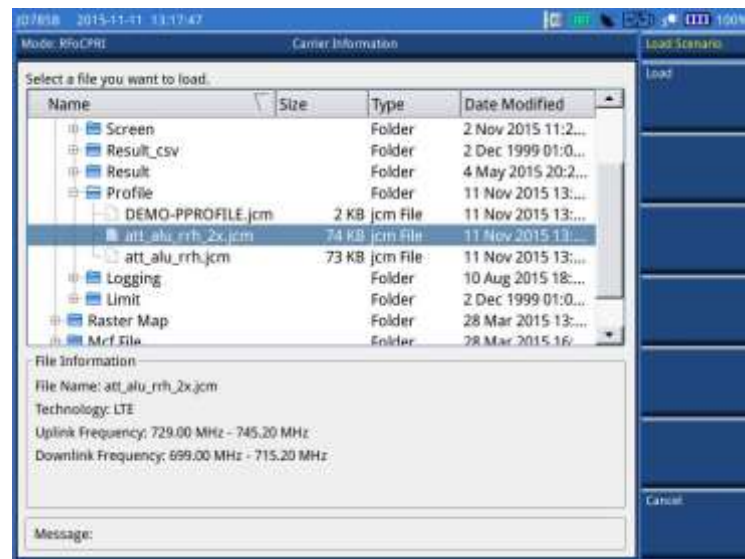
Figure 396 Example of loading a saved RRH profile



Editing RRH Information

You can edit the RRH information.

Procedure

- 1 Make sure that you maintain the RRH connection on.
- 2 In the **Carrier Information** screen, press the **MEASURE SETUP** hot key.
- 3 Press the **More (1/2)** soft key.
- 4 Press the **RRH Information Editor** soft key.
The RRH Information Editor screen appears.
- 5 To import the RRH information from the connected RRH device, tap the **OverWrite** button.
The imported RRH information appears in the bottom window.
- 6 Tap on the top window, and then edit the RRH information as desired.
- 7 Tap the **Apply** button.
The RRH information you have edited will be instantly applied to the connected RRH device, and the applied RRH information will appear in the bottom window.
- 8 Check whether the updated RRH information is correct. If yes, tap the **Exit** button to exit. If not, repeat step 6-7.

Editing RRH profile

If you do not have a saved profile that can bring up the connected RRH, you need to edit profile parameters with values that work for the RRH. You can edit carrier parameters.

Procedure

- 1 Make sure that you maintain the RRH connection on.
- 2 In the **Carrier Information** screen, press the **MEASURE SETUP** hot key.
- 3 Press the **More (1/2)** soft key.
- 4 Press the **Profile Editor** soft key.
The Profile Editor menu bar appears with the soft keys activated for the carriers in use. For example, carriers with their state DISABLE or ENABLE, you will have Carrier 1 and Carrier 2 soft keys activated.
- 5 Select the carrier number soft key for which you want to edit values.
The Profile Editor screen for the selected carrier number appears with the on-screen keyboard as

shown in Figure 397.



NOTE
Not always is the order of the parameter names the same. In addition, parameters can vary depending on the RRH vendor or technology.

- 6 To edit a value in the Value column, complete the following steps:
 - a Scroll up or down to navigate to the value field that you want to edit.
 - b Tap on the value field, and then enter a new value. Here are some of examples when you may need to edit the profile.

If you want to change the carrier state from DISABLE to ENABLE, tap on the value field next to the STATE and then type ENABLE.

If you want to enter a downlink frequency of 709 MHz, tap on the value field next to the TXFREQ and then enter 709000 in kHz.

If you need to change the retrieved carrier type, select one of the following buttons: **LTE5**, **LTE10**, **LTE15**, or **LTE20**. The standard profile parameters for the selected carrier type will be automatically set. You can change edit the value as you needed.



NOTE
In Profile Editor, you can rename a parameter name or add a new parameter with a value for some cases. As doing this requires much knowledge and experience with RRH configuration, it is not recommended for general users.



NOTE
In Profile Editor, 2xMIMO and 4xMIMO buttons are deactivated. It will be activated only if the RRH supports TX2 or TX4. In cases where it supports TX4, the two buttons are activated. If you select 2xMIMO button, you need to set TX3CONTAINER, TX4CONTAINER, RX3CONTAINER, and RX4CONTAINER to 0, and if you select 4xMIMO button, you need to set TX3CONTAINER, TX4CONTAINER, RX3CONTAINER, and RX4CONTAINER based on GRPSIZE.

- 7 To apply your changes and send your edited C&M message to the RRH, tap the **APPLY** button.
- 8 Verify that you have received all required information.

If you have set up the RRH correctly and the RRH has been brought up and running successfully, you will have all fields in the Carrier Information filled properly.

If not, the profile parameters will be initialized. You can repeat steps 4-7, or tap the **Last** button to import the most recently applied profile parameters and modify only the necessary part.

Figure 397 Example of RRH profile editor



Following is an example of parameters and values that you can find in Profile Editor.

Table 22 Example of RRH profile parameters and values for 2x2 MIMO

Parameters	Description												
STATE	This is the carrier status. There are three available states: - None: Unused - Disable: Used but inactivated - Enable: Used and activated This value must be "ENABLE" for every carrier being used by RRH.												
TXCONTAINER	It means the first Tx Container (antenna branch for downlink) that is equivalent to AxC Group. Zero (0) is no activation. This value must not be used by other containers.												
TX2CONTAINER	It means the second Tx Container (antenna branch for downlink) that is equivalent to AxC Group. Zero (0) is no activation. This value must not be used by other containers.												
RX1CONTAINER	It means the first Rx Container (antenna branch for uplink) that is equivalent to AxC Group. Zero (0) is no activation. This value must not be used by other containers.												
RX2CONTAINER	It means the second Rx Container (antenna branch for downlink) that is equivalent to AxC Group. Zero (0) is no activation. This value must not be used by other containers.												
GRPSIZEDOWN	It means four downlink AxC containers are used for Tx Container. <table border="1"> <thead> <tr> <th>Signal Bandwidth</th> <th>3 MHz</th> <th>5 MHz</th> <th>10 MHz</th> <th>15 MHz</th> <th>20 MHz</th> </tr> </thead> <tbody> <tr> <td>GRPSIZEDOWN</td> <td>1</td> <td>2</td> <td>4</td> <td>6</td> <td>8</td> </tr> </tbody> </table>	Signal Bandwidth	3 MHz	5 MHz	10 MHz	15 MHz	20 MHz	GRPSIZEDOWN	1	2	4	6	8
Signal Bandwidth	3 MHz	5 MHz	10 MHz	15 MHz	20 MHz								
GRPSIZEDOWN	1	2	4	6	8								
GRPSIZEUP	It means four uplink AxC containers used for Rx Container. <table border="1"> <thead> <tr> <th>Signal Bandwidth</th> <th>3 MHz</th> <th>5 MHz</th> <th>10 MHz</th> <th>15 MHz</th> <th>20 MHz</th> </tr> </thead> <tbody> <tr> <td>GRPSIZEUP</td> <td>1</td> <td>2</td> <td>4</td> <td>6</td> <td>8</td> </tr> </tbody> </table>	Signal Bandwidth	3 MHz	5 MHz	10 MHz	15 MHz	20 MHz	GRPSIZEUP	1	2	4	6	8
Signal Bandwidth	3 MHz	5 MHz	10 MHz	15 MHz	20 MHz								
GRPSIZEUP	1	2	4	6	8								
TXFREQ	This value is the carrier's downlink center frequency in kHz.												
RXFREQ	This value is the carrier's uplink center frequency in kHz.												
POWER	This value must be between the minimum and the maximum Tx power levels that are displayed in the RRH Description pane and be expressed in 0.1 dB.												
SIGTYPE	This is a default setting for RRH. Do not change.												
CARRTYPE	This is a default setting for RRH. It is not recommended, but you can change the signal bandwidth as needed when you have to.												
ULNOISE	It means the uplink noise floor threshold expressed in 0.01 dBFS. This is a default setting for RRH. Do not change.												
APCFPOWER	This is for RFM overload protection. This is a default setting for RRH. Do not change.												

Saving your edited profile as a file

After you have successfully brought up and running the RRH, you can save your complete profile as a file so that you can use it to configure and bring up other RRHs of the same kind later.

Procedure

- 1 Press the **SAVE/LOAD** hard key.
 - 2 Select **Save > Save Profile**.
 - 3 Type a file name that you want to use.
-

-
- 4 Press the **Save** soft key.
It saves the profile as a file with `.jcm` extension.
-

Performing spectrum clearance

After you have started up the RRH successfully, meaning that you have at least one enabled carrier with uplink and downlink frequency information, you can move to Spectrum Clearance to identify any interfering signals in the uplink carrier by performing the following measurements while keeping your CellAdvisor to work as a BBU.

This instrument provides the following measurements in the BBU Emulation mode:

- Spectrum
- Spectrogram
- RSSI
- Dual spectrum
- Dual spectrogram



NOTE

It is very important that you maintain the Term mode cable connection as illustrated in Figure 391 and keep the RRH connection on as you have done in the RRH configuration verification.

Conducting spectrum measurement

In this Spectrum mode, you only need to change the following settings as needed.

Procedure

- 1 Press the **MEASURE** hot key.
- 2 Select **BBU Emulation > Alcatel-Lucent > Spectrum Clearance > Spectrum**.
- 3 Press the **MEASURE SETUP** hot key.
- 4 To select the Rx carrier and Rx container to measure, complete the following steps:
 - a Press the **Rx Parameters** soft key.
 - b Press the **Rx Carrier** soft key.
The Rx carrier soft key is active only if the Rx carrier is enabled.
 - c Select a desired Rx carrier number from the menu bar.
Up to 12 selections for carriers are available based upon configuration.
 - d Press the **Rx Container** soft key, and then select a desired Rx container from the menu bar.
Total 4 Rx containers are available.



NOTE

In the BBU Emulation mode, retrieved Rx carrier and Rx container information is used for de-mapping and signal transmission instead of Map Position.

- 5 To enable alarm sound, complete the following steps:
 - a Press the **MEASURE SETUP** hot key.
 - b Press the **Sound Indicator** soft key.
 - c Toggle the **Alarm Reference** soft key between **Marker** and **Line**:
 - Marker:** Sets the active marker position as the alarm reference if you have enabled a marker on the spectrum.
 - Line:** Makes the limit line as the alarm reference.
 - d If you have set the alarm reference to Line, press the **Limit Line** soft key to set a threshold for an alarm.
-

- e Enter a value, and then press the **dBm** soft key.
 - f To turn on the alarm sound, toggle the **Sound** soft key to **On**. To turn off, toggle to **Off**.
 - g *Optional*. To adjust the volume for alarm sound, press the **Volume** soft key, and then turn the rotary knob clockwise or counter clockwise.
 - h *Optional*. To select the sound mode for alarm, toggle the **Sound Mode** soft key and select the option from the following choices:
 - Select the **Mode 1** to create an alarm with a consistent tone (frequency) regardless of the interference signal.
 - Select the **Mode 2** to apply the tone step from 1 to 20.
 - Select the **Mode 3** to apply the tone step from 20 to 1.
- 6 To set the interference ID, complete the following steps:
- a Press the **MEASURE SETUP** hot key.
 - b Press the **Interference ID** soft key.
 - c Press the **Threshold** soft key.
 - d Enter a value, and then press the **dBm** soft key.
 - e To turn on the Interference ID, toggle the **Interference ID** soft key to **On**. To turn off, toggle to **Off**.



NOTE
The Interference ID automatically classifies interfering signals over a designated spectrum and displays a list of possible signal types corresponding to the selected signal.

- 7 To clear current (C) and history (H) status of CPRI alarm on LOS and LOF, press the **MEASURE SETUP** hot key, the **More (2/3)** soft key, and then the **Clear History** soft key.

Figure 398 Example of spectrum measurement in BBU emulation



NOTE
You can use the **LIMIT** hot key to analyze your measurements with the limit line or multi-segment line. See “Setting limit for spectrum clearance” on page 658 for more information.

Conducting dual spectrum measurement

If you have two or more carriers enabled, you can view two spectrums for different Rx carriers and Rx containers simultaneously. If you enable the Dual Active Trace function in the Dual Spectrum mode, you can view two sweeping traces, one from the top window and the other from the bottom window, overlapped on a single chart.

Procedure

- 1 Press the **MEASURE** hot key.
- 2 Select **BBU Emulation > Alcatel-Lucent > Spectrum Clearance > Dual Spectrum**.
- 3 Press the **MEASURE SETUP** hot key.
- 4 Press the **More (1/2)** soft key.
- 5 Toggle the **Active Window** soft key between **Top** and **Bottom**. You can also tap the chart on the screen.
- 6 To select the Rx carrier and Rx container to measure, complete the following steps:
 - a Press **More (2/2) > Rx Parameters**.
 - b Press the **Rx Carrier** soft key.
The Rx carrier soft key is active only if the Rx carrier is enabled.
 - c Select a desired Rx carrier number from the menu bar.
Up to 12 selections for Rx carriers are available based upon configuration.
 - d Press the **Rx Container** soft key, and then select a desired Rx container from the menu bar.
Total 4 selections for Rx containers are available

**NOTE**

In the BBU Emulation mode, retrieved Rx carrier and Rx container information is used for de-mapping and signal transmission instead of Map Position.

- 7 To view all traces overlaid on a single chart, complete the following steps:
 - a Press the **More (1/2)** soft key.
 - b Toggle the **Dual Active Trace** to **On**.
The screen displays the traces overlaid on a single chart.

**NOTE**

The currently active trace is brought to front of all traces and highlighted in bold. You can check which trace is currently active at the top left of the chart.

- c To change the active trace, press the **PREV** hard key and then toggle the **Active Window** soft key between **Top** and **Bottom**. You can also tap on the chart on the screen.
 - d To exit the overlaid view and return to the dual spectrum view, toggle the **Dual Active Trace** to **Off**.
 - 8 To clear current (C) and history (H) status of CPRI alarm on LOS and LOF, press the **MEASURE SETUP** hot key, the **More (1/2)** soft key, and then the **Clear History** soft key.
-

Figure 399 Example of dual spectrum analysis in BBU emulation

**NOTE**

You can use the **LIMIT** hot key to analyze your measurements with the limit line or multi-segment line. See “Setting limit for spectrum clearance” on page 658 for more information.

Conducting spectrogram

In this Spectrogram mode, you only need to change the following settings as needed.

Procedure

- 1 Press the **MEASURE** hot key.
- 2 Select **BBU Emulation > Alcatel-Lucent > Spectrum Clearance > Spectrogram**.
- 3 Press the **MEASURE SETUP** hot key.
- 4 To select the Rx carrier and Rx container to measure, complete the following steps:
 - a Press the **Rx Parameters** soft key.
 - b Press the **Rx Carrier** soft key.
The Rx carrier soft key is active only if the Rx carrier is enabled.
 - c Select a desired Rx carrier number from the menu bar.
Up to 12 selections for carriers are available based upon configuration.
 - a Press the **Rx Container** soft key, and then select a desired Rx container from the menu bar.
Total 4 selections for Rx containers are available.

**NOTE**

In the BBU Emulation mode, retrieved Rx carrier and Rx container information is used for de-mapping and signal transmission instead of Map Position.

- 5 To set the amount of time between each trace measurement:
 - a Press the **MEASURE SETUP** hot key.
 - b Press the **More (1/2)** soft key and then the **Time Interval** soft key.
 - c Enter a value, and then press the **Sec** soft key.
- 6 To set the time cursor on a specific trace position, complete the following steps:
 - a Toggle the **Time Cursor** soft key to **On**.
The Position soft key is activated.
 - b Press the **Position** soft key.
 - c To move the time cursor, turn the rotary or enter a value and then press the **Enter** soft key.
 - d To turn off the time cursor, toggle the **Time Cursor** soft key to **Off**.

**NOTE**

Enabling the time cursor puts the measurement on hold and you can make post-processing analysis for each measurement over time using the time cursor.

- 7 To start a new measurement, press the **Reset/Restart** soft key.
 - 8 To clear current (C) and history (H) status of CPRI alarm on LOS and LOF, press the **MEASURE SETUP** hot key, the **More (1/2)** soft key, and then the **Clear History** soft key.
-

Figure 400 Example of spectrogram in BBU emulation

**NOTE**

You can use the **LIMIT** hot key to analyze your measurements with the limit line or multi-segment line. See “Setting limit for spectrum clearance” on page 658 for more information.

Conducting dual spectrogram

The Dual Spectrogram feature lets you observe two spectrograms for different carriers and Tx containers simultaneously.

Procedure

- 1 Press the **MEASURE** hot key.
- 2 Select **BBU Emulation > Alcatel-Lucent > Spectrum Clearance > Dual Spectrogram**.
- 3 Press the **MEASURE SETUP** hot key.
- 4 Press the **More (1/2)** soft key.
- 5 Toggle the **Active Window** soft key between **Left** and **Right**. You can also tap the chart on the screen.
- 6 To select the Rx carrier and Rx container to measure, complete the following steps:
 - a Press the **More (2/2)** soft key.
 - b Press the **Rx Parameters** soft key.
 - c Press the **Rx Carrier** soft key.
The Rx carrier soft key is active only if the Rx carrier is enabled.
 - d Select a desired Rx carrier number from the menu bar.
Up to 12 selections for carriers are available based upon configuration.
 - e Press the **Rx Container** soft key, and then select a desired Rx container from the menu bar.
Total 4 selections for Rx containers are available.

**NOTE**

In the BBU Emulation mode, retrieved Rx carrier and Rx container information is used for de-mapping and signal transmission instead of Map Position.

- 7 To set the amount of time between each trace measurement:
 - a Press the **MEASURE SETUP** hot key.
 - b Press **More (1/2) > Time Interval**.
 - c Enter a value, and then press the **Sec** soft key.
- 8 To set the time cursor on a specific trace position, complete the following steps:

- a Toggle the **Time Cursor** soft key to **On**.
- b Press the **Position** soft key.
- c To move the time cursor, turn the rotary knob or enter a value and then press the **Enter** soft key.
- d To turn off the time cursor, toggle the **Time Cursor** soft key to **Off**.



NOTE
Enabling the time cursor puts the measurement on hold and you can make post-processing analysis for each measurement over time using the time cursor.

- 9 To start a new measurement, press the **Reset/Restart** soft key.
- 10 To clear current (C) and history (H) status of CPRI alarm on LOS and LOF, press the **MEASURE SETUP** hot key, the **More (1/2)** soft key, and then the **Clear History** soft key.

Figure 401 Example of dual spectrogram analysis in BBU emulation



NOTE
You can use the **LIMIT** hot key to analyze your measurements with the limit line or multi-segment line. See “Setting limit for spectrum clearance” on page 658 for more information.

Conducting RSSI

The Received Signal Strength Indicator (RSSI) is a multi-signal tracking metric that is particularly useful for measuring power-level variations over time. The RSSI measurement lets you assign power limit line for audible alarms and increase alarm counters every time a signal exceeds a defined limit line.

Procedure

- 1 Press the **MEASURE** hot key.
- 2 Select **BBU Emulation > Alcatel-Lucent > Spectrum Clearance > RSSI**.
- 3 Press the **MEASURE SETUP** hot key.
- 4 To select the Rx carrier and Rx container to measure, complete the following steps:
 - a Press the **Rx Parameters** soft key.
 - b Press the **Rx Carrier** soft key.
The Rx carrier soft key is active only if the Rx carrier is enabled.
 - c Select a desired Rx carrier number from the menu bar.
Up to 12 selections for carriers are available based upon configuration.
 - a Press the **Rx Container** soft key, and then select a desired Rx container from the menu

bar.
Total 4 selections for Rx containers are available.



NOTE
In the BBU Emulation mode, retrieved Rx carrier and Rx container information is used for de-mapping and signal transmission instead of Map Position.

- 5 To set up the alarm parameters, complete the following steps:
 - a Press **More (1/2) > Alarm**.
 - b Press the **Alarm at** soft key, and then select a marker number to set.
 - c Press the **Limit Line** soft key to set a threshold for the alarm.
 - d Enter a value by using the numeric keys or the rotary knob, and then press the **dBm** soft key.
 - e Toggle the **Alarm** soft key between **On** and **Off** to turn on/off the alarm.



NOTE
You must set the marker(s) first by using the **MARKER** hard key as these features use the marker position to sound an alarm. See “Using marker” on page 60 for more information.

- f *Optional.* Press the **Volume** soft key and adjust the volume.
- 6 Press the **PREV** hard key to return to the Measure Setup menu bar.
- 7 To start a new measurement, press the **Reset/Restart** soft key.
- 8 To clear current (C) and history (H) status of CPRI alarm on LOS and LOF, press the **MEASURE SETUP** hot key, the **More (1/2)** soft key, and then the **Clear History** soft key.

Figure 402 Example of RSSI in BBU emulation



NOTE
You can use the **LIMIT** hot key to analyze your measurements with the limit line or multi-segment line. See “Setting limit for spectrum clearance” on page 658 for more information.

Setting sweep mode

You can select various sweep settings for better measurement, including the sweep run mode (**Single**, **Continuous**) and the sweep speed mode (**Normal**, **Fast**).

Procedure

- 1 Press the **SWEEP** hot key.
- 2 Select the desired sweep run mode by toggling the **Sweep Mode** soft key between **Single** and

Continuous. You can also use the **HOLD** hot key.

Single: In this mode, the instrument performs a single sweep and waits for further entries. The letter **HOLD** in red appears and the sweeping is paused.

Continuous (default): In this mode, the instrument is continuously measuring and updating result.

The letter **HOLD** in red disappears and the sweeping resumes.

- 3 Select the desired sweep speed mode by toggling the **Sweep Mode** soft key between **Normal** and **Fast**:

Normal: The signal processing and update rate is set to normal levels.

Fast (default): It speeds up the signal processing and the display update rate to increase the overall sweep time.

- 4 *Optional.* In the Single mode, press the **Sweep Once** soft key to get a new measurement.
-

Setting limit for spectrum clearance

You can set a display line or multi-segment limit line to analyze results better.

Procedure

To set a single limit line:

- 1 Press the **LIMIT** hot key.
- 2 Press the **Display Line** soft key for a reference line.
- 3 Enter a value, and then press the **dBm** unit soft key.
- 4 Toggle the **Display Line** soft key between **On** and **Off** to display and hide the reference line. The straight line appears across the screen to be used as a visual reference only.

To set a multi-segment limit line:

- 1 Press the **LIMIT** hot key.
 - 2 Press the **Multi Segment Line** soft key for Pass/Fail indication.
 - 3 Toggle the **Limit** soft key between **Upper** and **Lower** to select the one to be displayed.
 - 4 Set the number of segments for the selected upper or lower limit line, up to 50 segments.
 - a Press the **# of Line** soft key.
 - b Enter a value between 1 and 50 by using the numeric keys.
 - c Press the **Enter** soft key.
 - 5 Press the **Autoset** soft key to let the instrument set the limit for each segment and display the line.
 - 6 To move the limit line, complete the following steps:
 - a Select **Limit Up/Down** or **Limit Left/Right**.
 - b Turn the rotary knob to move the line as desired. You can also manually enter a value.
 - 7 To edit the segment properties, complete the following steps:
 - a Press the **Edit Limit** soft key.
 - b Press the **Move** soft key and then turn the rotary knob to select the segment to edit.
 - c Select the menu option, from the following choices:
 - To hide the line for the selected segment, toggle the **Line** soft key to **Off**.
 - To add a new point, press the **Add Point** soft key.
 - To delete the selected point, press the **Delete Point** soft key.
 - To change the position, press the **Frequency** or **Amplitude** soft key, and then turn the rotary knob to change the value as desired.
 - 8 *Optional.* Go to **SAVE/LOAD > Save**, and then select **Limit** to save the limit settings. See "Using save" on page 34 for more information
-

Checking coverage range

If your CellAdvisor has the CPRI source installed, you can use it to check the coverage range of the antenna and adjust its tilt to maximize the coverage range as much as possible.



NOTE

It is very important that you maintain the Term mode cable connection as illustrated in Figure 391 and keep the RRH connection on as you have done in the RRH configuration verification.

Checking coverage range

Procedure

- 1 Press the **MEASURE** hot key.
- 2 Select **BBU Emulation > Alcatel-Lucent > Coverage Range**.
- 3 Press the **MEASURE SETUP** hot key.
- 4 Select **More (1/2) > Source > CPRI Source**.
- 5 Select one of the Tx parameters to configure from: **Tx1 Parameters**, **Tx2 Parameters**, **Tx3 Parameters**, or **Tx4 Parameters**.
Tx Parameters menu bar appears.
- 6 Press the **Tx Carrier** soft key.
Only carriers that are currently active have the active soft keys.
- 7 Select a desired Tx carrier from the menu bar.
Up to 12 selections for carriers are available based upon configuration.
- 8 Press the **Tx Container** soft key, and then select one of the Tx Container from the menu bar.
Total 4 selections for Tx containers are available.



NOTE

In the BBU Emulation mode, retrieved carrier and Tx container information is used for de-mapping and signal transmission instead of Map Position.

- 9 To select the CW waveform, complete the following steps:
 - a Press the **Waveforms** soft key.
The Waveform list dialog box appears.
 - b From the list, select **CW** or one of the LTE signals that you want to transmit to the RRH.



NOTE

If you have a second unit of JD700B series or a scanner, you can use it to measure RS Power and RS SINR with transmitting a LTE signal from your CellAdvisor to the RRH so that you can optimize the coverage more accurately.

- c Tap the **Apply** button on the screen or press the **ENTER** hard key.
- 10 To set the power level, complete the following steps:
 - a Press the **Power Level** soft key.
 - b Enter a value, and then press the **Enter** soft key.
- 11 To start to inject the CW signal, toggle the **CPRI Source** soft key to **On**.
- 12 *Optional.* To enable alarm sound, complete the following steps:
 - a Press the **MEASURE SETUP** hot key.
 - b Press the **More (1/2)** soft key and then **Sound Indicator** soft key.
 - c Toggle the **Alarm Reference** soft key between **Marker** and **Line**:
 - Marker:** Sets the active marker position as the alarm reference if you have enabled a marker on the spectrum.
 - Line:** Makes the limit line as the alarm reference.
 - d If you have set the alarm reference to Line, press the **Limit Line** soft key to set a threshold for an alarm.
 - e Enter a value, and then press the **dBm** soft key.
 - f To turn on/off the alarm sound, toggle the **Sound** soft key to **On** or **Off**.
 - g To adjust the volume for alarm sound, press the **Volume** soft key, and then turn the rotary

knob clockwise or counter clockwise.

- h *Optional.* To select the sound mode for alarm, toggle the **Sound Mode** soft key and select the option from the following choices:

Select the **Mode 1** to create an alarm with a consistent tone (frequency) regardless of the interference signal.

Select the **Mode 2** to apply the tone step from 1 to 20.

Select the **Mode 3** to apply the tone step from 20 to 1.

- 13 To clear current (C) and history (H) status of CPRI alarm on LOS and LOF, press the **MEASURE SETUP** hot key, the **More (1/2)** soft key, and then the **Clear History** soft key.

Figure 403 Example of coverage range in BBU emulation

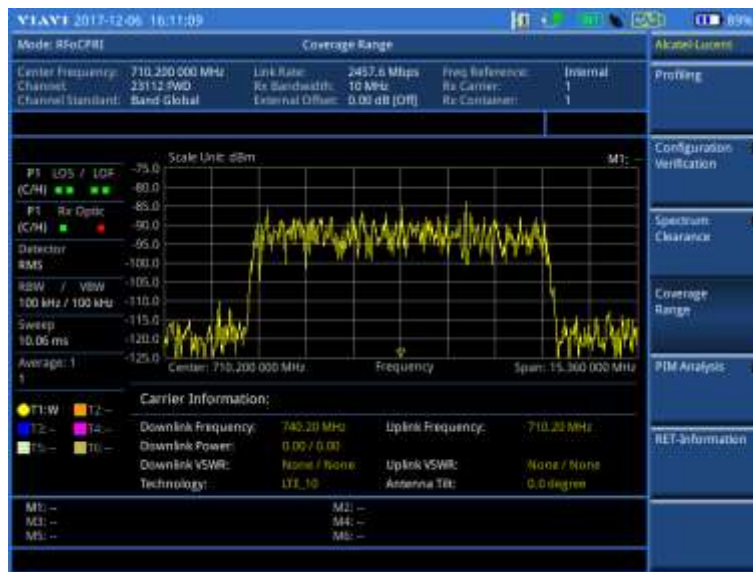

Adjusting antenna tilt

Procedure

- 1 In the **Coverage Range** mode, press the **MEASURE SETUP** hot key.
- 2 Select **More (1/2) > Antenna Control**.
- 3 To select the antenna that you want to manipulate, complete the following steps:
 - a Press the **Select ALD Device** soft key.
 - b Select Scanned ALD Device List, and then press the **Apply** button.
 - c If there are more than one antenna chained for the selected antenna port, press the **ALD SUB** soft key to select the antenna line device subscription number.
 - d Enter the value that you know, and then press the **Enter** soft key.
- 4 To manipulate the tilt of the selected antenna, complete the following steps:
 - a Press the **Degree** soft key.
 - b Enter a value within the range that you know for the selected antenna.
 - c Press the **Enter** soft key.
The antenna tilts forward accordingly.



NOTE

It is recommended that you wait for a few minutes because it may take two minutes or so to get the antenna actually tilted.

- 5 Check the coverage range again to see if you have the antenna tilt at its best.

Setting sweep mode

You can select various sweep settings for better measurement, including the sweep run mode (**Single**, **Continuous**) and the sweep speed mode (**Normal**, **Fast**).

Procedure

- 1 Press the **SWEEP** hot key.
 - 2 Select the desired sweep run mode by toggling the **Sweep Mode** soft key between **Single** and **Continuous**. You can also use the **HOLD** hot key.
 - Single:** In this mode, the instrument performs a single sweep and waits for further entries. The letter **HOLD** in red appears and the sweeping is paused.
 - Continuous** (default): In this mode, the instrument is continuously measuring and updating result. The letter **HOLD** in red disappears and the sweeping resumes.
 - 3 Select the desired sweep speed mode by toggling the **Sweep Mode** soft key between **Normal** and **Fast**:
 - Normal:** The signal processing and update rate is set to normal levels.
 - Fast** (default): It speeds up the signal processing and the display update rate to increase the overall sweep time.
 - 4 *Optional.* In the Single mode, press the **Sweep Once** soft key to get a new measurement.
-

Performing PIM analysis

The PIM analyzer enables you to measure PIM characteristics of RRH and antenna feeder by injecting test signal to RRH over fiber link while de-mapping IQ spectrum for uplink simultaneously.

With the PIM analyzer feature, CellAdvisor can calculate the possible location of PIM position and provide the information of the possible PIM location.



NOTE

It is very important that you maintain the Term mode cable connection as illustrated in Figure 391 and keep the RRH connection on as you have done in the RRH configuration verification.

Selecting measurement mode

Procedure

- 1 Press the **MEASURE** hot key.
 - 2 Select **BBU Emulation > Alcatel-Lucent > PIM Analysis**.
 - 3 Select the PIM analysis mode from the following choices:
 - Single Port Sweep Mode:** Measures PIM using two-CW tone from a single port sweeping across the transmission bandwidth. The Sweep Mode soft key is activated only after you have installed the license on your CellAdvisor.
 - Multi Port Sweep Mode:** Measures PIM using two CW tone sweeping across the transmission bandwidth.
 - Multi Port Wideband Mode:** Detects PIM using wideband multiple carriers
-



NOTE

The Sweep Mode is activated if the below license(s) are installed on your JD700B series:

- RFoCPRI LTE-FDD Multi Carrier Signal Generator (option 083)
- RFoCPRI LTE-TDD Multi Carrier Signal Generator (option 084)

See “Appendix I – Ordering information” on page 780 for more information.

Checking single port sweep

To perform Single Port Sweep Mode PIM analysis, your JD700B series has the RFoCPRI multi carrier signal generator option which allows PIM analysis using two-tone CW: base tone and supplementary tone sweeping within the span equal to the sampling frequency of the DUT carrier. Minimum frequency step of CW tone is 0.96 MHz. While the base and supplementary tones sweep across the transmission bandwidth, your CellAdvisor displays the two-tone PIM Analyzer including UL Spectrum, calculated RF frequencies of the two tones, and potential PIM location along with PIM order information.

Procedure

- 1 Press the **MEASURE** hot key.
 - 2 Select **BBU Emulation > Alcatel-Lucent > PIM Analysis > Single Port Sweep Mode**.
 - 3 Press the **MEASURE SETUP** hot key.
 - 4 Press the **Sweep Mode** soft key and then select the sweep measure mode option from:
 - Full** (default): Detects the potential PIM with two single tones sweeping the DL span from left to right by moving 0.96 MHz per step. PIM detection is done when one base tone moves to the right end and the other tone completes sweeping from the left and the right end.
 - Auto**: Detects the potential PIM of two tones after calculating a PIM occurrence based on the location of a specific tone on DL. Not sweep within a specified frequency range but performs PIM analysis for specific two tones.
 - Manual**: Detects any PIM issues within a user-defined two-tone frequency range. The frequency input range is limited to $C.F \pm 0.98 * n$, so if you input frequency randomly, the input value is changed to a settable value automatically.
 - 5 To select the Rx parameters, complete the following steps:
 - a Press the **Rx Settings** soft key.
 - b Press the **Rx Carrier** soft key, and then select the carrier of your choice. Only carriers that are currently available have the active soft keys. Up to 12 selections for carriers are available based upon configuration.
 - c Press the **Rx Container** soft key, and then select the Rx container of your choice. Up to 4 selections for containers are available based upon configuration.
 - d To set the bandwidth, press the **Bandwidth** soft key, and then select the bandwidth option from: **1.4 MHz, 3 MHz, 5 MHz, 10 MHz, 15 MHz, 15 MHz (4 AxC), 20 MHz, or 20 MHz (6 AxC)**.
 - 6 To enable the auto leveling, complete the following steps:
 - a Press the **AMP/SCALE** hard key.
 - b Press the **Auto Leveling** soft key.
 - c Enter a noise figure value by using the numeric keys or the rotary knob.



NOTE
You need to set the exact noise figure to improve accuracy of the Auto Leveling.
 - d Press the **dB** soft key or the **ENTER** hot key to complete the entry. New external offset value appears in the **External Offset** menu box.
 - 7 To select the Tx parameters, complete the following steps:
 - a Press the **Select Tx1** or **Select Tx2** soft keys.
 - b Press the **Tx Carrier** soft key, and then select the carrier of your choice. Only carriers that are currently available have the active soft keys. Up to 12 selections for carriers are available based upon configuration.
 - c Press the **Tx Container** soft key, and then select the Tx container of your choice. Up to 4 selections for containers are available based upon configuration.
 - d *Optional.* To adjust the gain of the waveform to be transmitted in order to prevent an overrun or underrun of the RRH, press the **Gain** soft key, enter a value between **-50** and 0.00 by using the
-

- rotary knob or the numeric keys, and then press the **dB** soft key or the **ENTER** hard key.
- e *Optional.* To set the power level, press the **Power Level** soft key, enter a value by using the numeric keys or the rotary knob, and then press the **Enter** soft key or the **ENTER** hard key.
 - f To start injecting the signal, toggle the **CPRI Source** soft key to **On**.
At this time, the waveform is automatically set to **CW**.
- 8 Press the **PREV** hard key to return to the measure setup menu bar.
 - 9 To start the measurement, toggle the **Run Test** soft key to **Start**.
The potential PIM frequencies are displayed on the chart with the colored bar graphs.
 - 10 To clear current (C) and history (H) status of CPRI alarm on LOS and LOF, press the **MEASURE SETUP** hot key, and then the **Clear History** soft key.

Figure 404 Example of single port sweep mode PIM Analysis in BBU emulation



Checking multi port sweep

To perform Multi Port Sweep Mode PIM analysis, your JD700B series has the RFoCPRI multi carrier signal generator option which allows PIM analysis using two CW tones sweeping within the span equal to the sampling frequency of the DUT carrier. Minimum frequency step of CW tone is 0.96 MHz. User can use Auto sweep that covers full span, or can configure the frequency of two CW tones manually.

Procedure

- 1 Press the **MEASURE** hot key.
- 2 Select **BBU Emulation > Alcatel-Lucent > PIM Analysis > Muti Port Sweep Mode**.
- 3 Press the **MEASURE SETUP** hot key.
- 4 Press the **Sweep Mode** soft key and then select the sweep measure mode option from:
 - Full** (default): Detects the potential PIM with two single tones sweeping the DL span from left to right by moving 0.96 MHz per step. PIM detection is done when one base tone moves to the right end and the other tone completes sweeping from the left and the right end.
 - Auto**: Detects the potential PIM of two tones after calculating a PIM occurrence based on the location of a specific tone on DL. Not sweep within a specified frequency range but performs PIM analysis for specific two tones.
 - Manual**: Detects any PIM issues within a user-defined two-tone frequency range. The frequency input range is limited to C.F +/- 0.98*n, so if you input frequency randomly, the input value is changed to a settable value automatically.

- 5 To select the Rx parameters, complete the following steps:
 - a Press the **Rx Settings** soft key.
 - b Toggle the **Select RRH** soft key between **Port1** and **Port2** to select a RRH to check the spectrum.
 - c Press the **Rx Carrier** soft key, and then select the carrier of your choice. Only carriers that are currently available have the active soft keys. Up to 12 selections for carriers are available based upon configuration.
 - d Press the **Rx Container** soft key, and then select the Rx container of your choice. Up to 4 selections for containers are available based upon configuration.
 - e To set the bandwidth, press the **Bandwidth** soft key, and then select the bandwidth option from: **1.4 MHz**, **3 MHz**, **5 MHz**, **10 MHz**, **15 MHz**, **15 MHz (6 AxC)**, **20 MHz**, or **20 MHz (6 AxC)**.
- 6 To enable the auto leveling, complete the following steps:
 - a Press the **AMP/SCALE** hard key.
 - b Press the **Auto Leveling** soft key.
 - c Enter a noise figure value by using the numeric keys or the rotary knob.



NOTE
You need to set the exact noise figure to improve accuracy of the Auto Leveling.

- d Press the **dB** soft key or the **ENTER** hot key to complete the entry. New external offset value appears in the **External Offset** menu box.
- 7 To select the Tx parameters, complete the following steps:
 - a Press the **Select Tx1** or **Select Tx2** soft keys.
 - b Press the **Tx Carrier** soft key, and then select the carrier of your choice. Only carriers that are currently available have the active soft keys. Up to 12 selections for carriers are available based upon configuration.
 - c Press the **Tx Container** soft key, and then select the Tx container of your choice. Up to 4 selections for containers are available based upon configuration.
 - d *Optional.* To adjust the gain of the waveform to be transmitted in order to prevent an overrun or underrun of the RRH, press the **Gain** soft key, enter a value between **-50** and **0.00** by using the rotary knob or the numeric keys, and then press the **dB** soft key or the **ENTER** hard key.
 - e *Optional.* To set the power level, press the **Power Level** soft key, enter a value by using the numeric keys or the rotary knob, and then press the **Enter** soft key or the **ENTER** hard key.
 - f To start injecting the signal, toggle the **CPRI Source** soft key to **On**. At this time, the waveform is automatically set to **CW**.
- 8 Press the **PREV** hard key to return to the measure setup menu bar.
- 9 To start the measurement, toggle the **Run Test** soft key to **Start**. The potential PIM frequencies are displayed on the chart with the colored bar graphs.
- 10 To clear current (C) and history (H) status of CPRI alarm on LOS and LOF, press the **MEASURE SETUP** hot key, and then the **Clear History** soft key.

-
- 7 To clear current (C) and history (H) status of CPRI alarm on LOS and LOF, press the **MEASURE SETUP** hot key, the **More (1/2)** soft key, and then the **Clear History** soft key.
-

Checking flatness

The flatness in Wideband Mode PIM analysis is an elevation angle that two points create, resulting from the difference in power level at the two ends.

Procedure

- 1 Press the **MEASURE** hot key.
 - 2 Select **BBU Emulation > Alcatel-Lucent > PIM Analysis > Multi Port Wideband Mode**.
 - 3 Press the **MEASURE SETUP** hot key.
 - 4 Select the **Flatness** soft key.
 - 5 To set the bandwidth for the flatness calculation, complete the following steps:
 - a Press the **Bandwidth** soft key.
 - b Enter a value that is smaller than the transmission bandwidth to prevent the spectrum data points from being at the edges of the chart.
 - 6 Toggle the **Flatness** soft key to **On**.
 - 7 To turn it off, toggle the **Flatness** soft key to **Off**.
-

Setting sweep mode

You can select various sweep settings for better measurement, including the sweep run mode (**Single, Continuous**) and the sweep speed mode (**Normal, Fast**).

Procedure

- 8 Press the **SWEEP** hot key.
 - 9 Select the desired sweep run mode by toggling the **Sweep Mode** soft key between **Single** and **Continuous**. You can also use the **HOLD** hot key.

Single: In this mode, the instrument performs a single sweep and waits for further entries. The letter **HOLD** in red appears and the sweeping is paused.

Continuous (default): In this mode, the instrument is continuously measuring and updating result. The letter **HOLD** in red disappears and the sweeping resumes.
 - 10 Select the desired sweep speed mode by toggling the **Sweep Mode** soft key between **Normal** and **Fast**:

Normal: The signal processing and update rate is set to normal levels.

Fast (default): It speeds up the signal processing and the display update rate to increase the overall sweep time.
 - 11 *Optional.* In the Single mode, press the **Sweep Once** soft key to get a new measurement.
-

Setting limit line

You can set threshold(s) and display either a single segment line or multi-segment line to analyze the result better.

Procedure

To set a single limit line:

- 1 Press the **LIMIT** hot key.
-

- 2 Press the **Display Line** soft key for a reference line.
- 3 Enter a value, and then press the **dBm** unit soft key.
- 4 Toggle the **Display Line** soft key between **On** and **Off** to display and hide the reference line. The straight line appears across the screen to be used as a visual reference only.

To set a multi-segment limit line:

- 5 Press the **LIMIT** hot key.
- 6 Press the **Multi Segment Line** soft key for Pass/Fail indication.
- 7 Toggle the **Limit** soft key between **Upper** and **Lower** to select the one to be displayed.
- 8 Set the number of segments for the selected upper or lower limit line, up to 50 segments.
 - a Press the **# of Line** soft key.
 - b Enter a value between 1 and 50 by using the numeric keys.
 - c Press the **Enter** soft key.
- 9 Press the **Autoset** soft key to let the instrument set the limit for each segment and display the line.
- 10 To move the limit line, complete the following steps:
 - a Select **Limit Up/Down** or **Limit Left/Right**.
 - b Turn the rotary knob to move the line as desired. You can also manually enter a value.
- 11 To edit the segment properties, complete the following steps:
 - a Press the **Edit Limit** soft key.
 - b Press the **Move** soft key and then turn the rotary knob to select the segment to edit.
 - c Select the menu option, from the following choices:
 - To hide the line for the selected segment, toggle the **Line** soft key to **Off**.
 - To add a new point, press the **Add Point** soft key.
 - To delete the selected point, press the **Delete Point** soft key.
 - To change the position, press the **Frequency** or **Amplitude** soft key, and then turn the rotary knob to change the value as desired.
- 12 *Optional.* Go to **SAVE/LOAD > Save**, and then select **Save Limit** to save the limit settings. See “Using save” on page 34 for more information

Figure 406 Example of Wideband Mode PIM analysis in BBU emulation



Optimizing RET information

The JD700B series provide the remote electrical downtilt (RET) feature that enables you to optimize, control and maintain the antenna's tilt position in real-time and anywhere.

Scanning antenna line devices

You can check the connected antenna line devices information. Devices are sorted by Index number, and the device list is updated after each scan.

Procedure

- 1 Press the **MEASURE** hot key.
- 2 Select **BBU Emulation > Alcatel-Lucent > RET-Information**.
- 3 Press the **MEASURE SETUP** hot key.
- 4 Select **Scan ALD Information** to start the scan process.
The scanning time appears. The scanning time may vary depending on the number of connected devices. Once the scan is completed, the Scanned ALD Device list will be updated.



NOTE

You can select and apply the ALD appeared in the Scanned ALD Device list pop-up window of the **Select ALD Device** menu.

- 5 *Optional.* Tap the **Exit** button to stop the scanning.

Figure 407 Example of ALD scanning in RET information



Getting antenna device data

After scanning of the antenna line devices, you can get antenna device data of the selected ALD.

Procedure

- 1 Press the **MEASURE** hot key.
- 2 Select **BBU Emulation > Alcatel-Lucent > RET-Information**.
- 3 Press the **MEASURE SETUP** hot key.
- 4 Select **Get Antenna Device Data** to get the data..

Figure 408 Example of antenna device data in RET information



Getting alarm status

You can get the latest alarm status.

Procedure

- 1 Press the **MEASURE** hot key.
- 2 Select **BBU Emulation > Alcatel-Lucent > RET-Information**.
- 3 Press the **MEASURE SETUP** hot key.
- 4 Select **Get Alarm Status** to get the current alarm status.

Figure 409 Example of getting alarm status in RET information

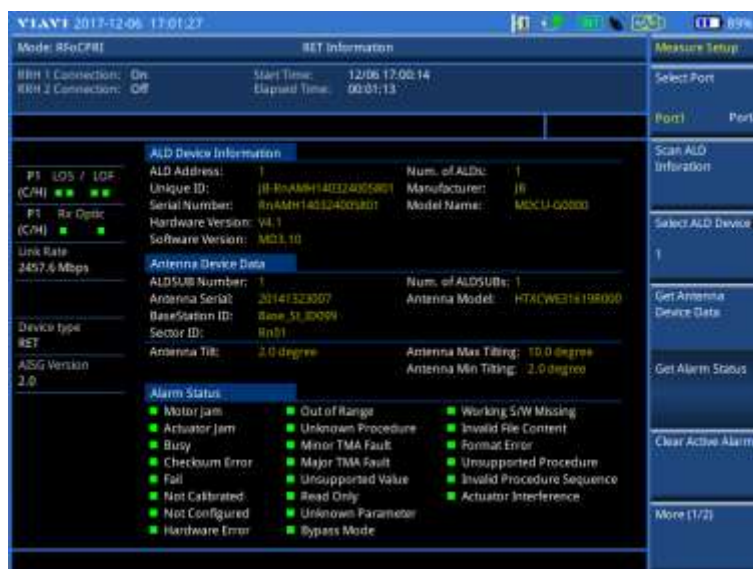

Clearing active alarm

You can clear current active alarms. You will get the latest alarm status once you complete clearing, and then operate getting alarm status.

Procedure

- 1 Press the **MEASURE** hot key.
 - 2 Select **BBU Emulation > Alcatel-Lucent > RET-Information**.
 - 3 Press the **MEASURE SETUP** hot key.
 - 4 Select **Clear Active Alarm** to clear the active alarms.
-

Adjusting antenna tilt

Procedure

- 1 Press the **MEASURE** hot key.
- 2 Select **BBU Emulation > Alcatel-Lucent > RET-Information**.
- 3 Press the **MEASURE SETUP** hot key.
- 4 Press **More (1/2) > Antenna Control** soft key.
- 5 To select the antenna that you want to manipulate, complete the following steps:
 - a Press the **Select ALD Device** soft key.
 - b Select Scanned ALD Device List, and then press the **Apply** button.
 - c If there are more than one antenna chained for the selected antenna port, press the **ALD SUB** soft key to select the antenna line device subscription number.
 - d Enter the value that you know, and then press the **Enter** soft key.
- 6 To manipulate the tilt of the selected antenna, complete the following steps:
 - a Press the **Degree** soft key.
 - b Enter a value within the range that you know for the selected antenna.
 - c Press the **Enter** soft key.
The antenna tilts forward accordingly.



NOTE

You need to adjust antenna tilting within the range between Antenna Min Tilting and Antenna Max Tilting.

Figure 410 Example of antenna tilting in RET information



Performing RET calibration

After scanning of the antenna line devices, you can progress the calibration.

Procedure

- 1 Press the **MEASURE** hot key.
- 2 Select **BBU Emulation > Alcatel-Lucent > RET-Information**.
- 3 Press the **MEASURE SETUP** hot key.
- 4 Press **More (1/2) > Antenna Control** soft key.
- 5 Select **RET Calibration** to start the calibration.
The calibration time appears. The calibration time may vary depending on the number of connected devices. Once the calibration is completed, the changes are applied to the antennas.

Figure 411 Example of RET calibration in RET information



Chapter 17 Performing RFoOBSAI Testing

This chapter provides instructions for using the RFoOBSAI function that requires Optical Hardware (option 008), RFoOBSAI Interference Analyzer (options 070 – 073), and RFoOBSAI LTE-FDD Signal Analyzer (option 096). Topics discussed in this chapter are as follows:

■ Introduction.....	673
■ Display overview	673
■ Selecting measurement mode	674
■ Performing layer 2 monitoring	674
■ Performing layer 2 term testing	677
■ Performing interference analysis.....	680
■ Performing PIM detection (single and multiple carriers)	692
■ Performing LTE-FDD downlink signal analysis	696
■ Using signal generator	721

Introduction

Cell sites today have a distributed architecture of the radio that consists of the baseband (BB) module or baseband unit (BBU) installed at the bottom of the tower and the remote RF unit (RRU) or remote radio head (RRH) installed at the top of the tower. These two elements interface with each other for data transfer over fiber links via the Reference Point 3 (RP3) protocol, which is specified by Open Base Station Architecture Initiative (OBSAI).

This distributed architecture provides the benefit of replacing coax-based feeders with fiber-based feeders, significantly reducing the problems of signal loss and reflections. However, since all the RF modules reside on the RRU, any RF maintenance or troubleshooting requires climbing to the top of the tower to access the RRU, increasing operational cost and unnecessary safety issues.

JD700B series analyzers provide the option of RFoOBSAI that allows you to perform RF maintenance and troubleshooting activities on the ground via the fiber interfaces at the BB module, significantly reducing maintenance time and operational expenses. Thanks to the RFoOBSAI technology, you can verify the OBSAI RP3 protocol and extract the RP3 messages transmitted between the BBU and RRU to monitor and analyze the uplink interferences and the downlink signals.

The RFoOBSAI testing provides following measurements and analysis:

- Layer 2 monitoring of link maintenance errors and optical power
 - Loss of Signal (LOS)
 - Loss of Frame (LOF) – Frame synchronization or alignment
 - Optical Rx and Tx power levels
 - Line Code Violation
 - Rx K30.7 words
 - RP3 address/message counts
- Layer 2 terminate testing
- Interference analysis
 - Spectrum
 - Spectrogram
 - Received Signal Strength Indicator (RSSI)
 - Spectrum replayer
- PIM detection of single or multiple carrier(s)
- LTE-FDD downlink signal analysis over OBSAI
 - Spectrum
 - RF analysis – Channel Power and Occupied Bandwidth
 - Power vs. Time (Frame)
 - Modulation analysis – Constellation, Data Channel, Control Channel, Subframe, Frame, Time Alignment Error, and Data Allocation Map
 - Power Statistics CCDF

Display overview

Figure 412 provides descriptions for each segment of the measurement screen.

Figure 412 RFoBSAI analysis screen



Selecting measurement mode

Procedure

- 1 Press the **MODE** hard key.
- 2 Press the **RFoFiber** soft key.
- 3 Press the **RFoBSAI** soft key. The Layer 2 Monitoring mode is set by default.
- 4 Press the **MEASURE** hot key, and then select the measurement mode option from the following choices:

Layer 2 Monitoring

Layer 2 Term

Interference Analyzer > Spectrum, Spectrogram, RSSI, or Spectrum Replayer

PIM Detection > PIM Detection Single Carrier, PIM Detection Multiple Carriers, or Calculated PIM

Signal Analyzer > LTE-FDD > Spectrum, RF Analysis, P vs T (Frame),

Modulation Analysis, or Power Statistics CCDF

Performing layer 2 monitoring

The in-service Layer 2 Monitoring is used to monitor link maintenance errors of the physical layer (Layer 1) of the RP3 bus protocol. It also verifies proper optical power levels of the received and transmitted signals.

Connecting cables

The monitoring mode lets you perform in-service testing by using coupler(s) or nTap(s). You can connect cables with a tap or without a tap as illustrated in Figure 413. If you have connected cables directly from RRU and BBU without using the nTap, you must turn on the through mode (Thru) in the Measure Setup menu.

A SFP/SFP+ transceiver that is connected to your JD700B series must be compatible with your DUT and you must have your module information such as line rate, wavelength, and mode (MM or SM) handy.

Figure 413 Connection diagram for Layer-2 monitoring mode

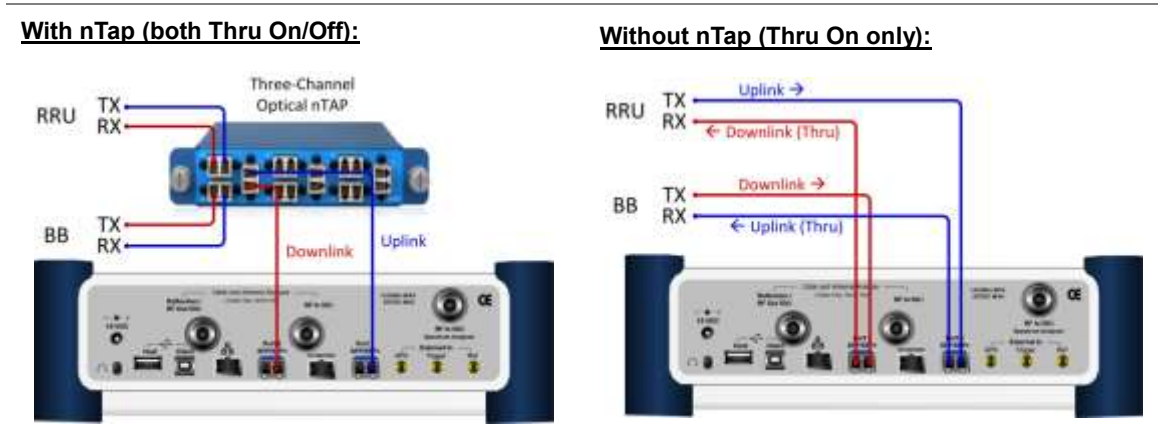

Selecting measurement mode

Procedure

- 1 Press the **MEASURE** hot key.
- 2 Select **Layer 2 Monitoring**.

Selecting port

JD700B series supports two antenna ports for signal transmission, and each port can generate different waveforms selectively and simultaneously. User can select the port to use for the measurement in any measurement mode of RFoBSAI mode.

Procedure

- 1 In any measurement mode, press the **MEASURE SETUP** hot key.
- 2 Toggle the **Select Port** soft key between **Port 1** and **Port 2** to select the desired port.

Setting measure setup

Procedure

- 1 Press the **MEASURE SETUP** hot key.
- 2 Press the **Link Rate** soft key to set the line rate of the OBSAI RP3 interface between the BB and the RRU.
- 3 Select the RP3 line rate option from the choices: **768 Mbps**, **1536 Mbps**, **3072 Mbps**, and **6144 Mbps**.



NOTE

It is important that you set the link rate correctly to avoid any misleading LOS and LOF alarms displayed on the screen.

If you select **6144 Mbps**, the **Scrambler Seed** soft key becomes active in the OBSAI Parameters menu so that you can specify a seed value to avoid false byte alignment.

- 4 To turn on the through mode if you have not used a tap, toggle the **Thru** soft key and select **On**.

To turn it off, select **Off**.

Setting Rx optic limit

A RRH has a finite dynamic range for input optic power and it can cause an abnormal behavior of the RRH if the optical power is weaker than certain level. To differentiate intermittent low optic power issues from any RSSI, interference and signal quality issues, it is important for you to monitor the input optic power level during the monitoring of the spectrum and the signal quality. Using this Rx optic limit feature, you can set lower and upper limits and monitor the Rx optic level with Pass/Fail indication in green and red colors.

Procedure

- 1 Press the **LIMIT** hot key.
 - 2 Press the **Rx Optic Level** soft key.
 - 3 Set a threshold for **High Limit** and **Low Limit**.
 - 4 To enable the Rx optic limit, toggle the **Test Limits** soft key and select **On**.
If the optic power level falls out of the specified thresholds, the color of the power reading or indicator turns red.
 - 5 To disable the Rx optic limit, toggle the **Test Limits** soft key and select **Off**.
-

Conducting layer 2 monitoring

After you have set the test parameters, you can monitor errors in OBSAI L2 signals.

Procedure

- 1 Monitor the following error indicators and the optical signal level. Test results in green indicate no detection of errors and red ones represent occurrence(s) of errors.
 - LOS:** Loss of Signal (code violation or low optical power)
 - LOF:** Loss of Frame (frame synchronization or alignment)
 - Optic Rx Level:** If the optical signal level is lower than the threshold, the OBSAI RP3 link may not work properly and the RRU may not be in service mode.
 - Code Violations:** Number of occurrence of invalid line codes
 - Rx K30.7 Words:** Number of counts of K30.7 character, which indicates an error in the byte
 - RP3 Address:** Rx RP3 addresses in the received messages
 - Message Counts:** Number of counts of received messages addressed to the same RP3 address specified in the Measure Setup > OBSAI Parameters > Rx RP3 Address
-  **NOTE**
If you have selected the link rate **6144 Mbps**, displayed RP3 addresses may include invalid or erroneous addresses.
- 2 *Optional.* You can use the **Save Logging Data** soft key to record the event logging in .csv file format. See “Using save” on page 34 for more information.
 - 3 To clear the previous event history and start a new monitoring, press the **MEASURE SETUP** hot key and then the **Clear History** soft key.
-

Measurement example

Figure 414 OBSAI RP3 layer 2 monitoring



Performing layer 2 term testing

The out-of-service Layer 2 Term is to test the OBSAI RP3 fronthaul in the terminated state and it is used to monitor link maintenance errors of the physical layer (Layer 1) of the RP3 bus protocol. It also verifies proper optical power levels of received and transmitted signals.

Connecting cables

The terminate mode allows you to do out-of-service testing. You can connect cables with a tap or without a tap as illustrated in Figure 415.

A SFP/SFP+ transceiver that is connected to your JD700B series must be compatible with your DUT and you must have your module information such as line rate, wavelength, and mode (MM or SM) handy.

Figure 415 Connection diagram for Layer-2 term testing mode



Selecting measurement mode

Procedure

- 1 Press the **MEASURE** hot key.
 - 2 Select **Layer 2 Term**.
-

Selecting port

JD700B series supports two antenna ports for signal transmission, and each port can generate different waveforms selectively and simultaneously. User can select the port to use for the measurement in any measurement mode of RFoOBSAI mode.

Procedure

- 1 In any measurement mode, press the **MEASURE SETUP** hot key.
 - 2 Toggle the **Select Port** soft key between **Port 1** and **Port 2** to select the desired port.
-

Setting measure setup

Procedure

- 1 Press the **MEASURE SETUP** hot key
- 2 Press the **Link Rate** soft key to set the line rate of the OBSAI RP3 interface between the BB and the RRU.
- 3 Select the RP3 line rate option from the choices: **768 Mbps**, **1536 Mbps**, **3072 Mbps**, and **6144 Mbps**.



NOTE

It is important that you set the link rate correctly to avoid any misleading LOS and LOF alarms displayed on the screen.

If you select **6144 Mbps**, the **Scrambler Seed** soft key becomes active in the OBSAI Parameters menu so that you can specify a scrambler seed.

- 4 Make sure to turn off the through mode by toggling the **Thru** soft key and selecting **Off**.
 - 5 Press the **OBSAI Parameters** soft key to select the port type and the clock reference.
 - 6 Toggle the **Port Type** soft key and select **Master**.
 - 7 Press the **Tx Clock** soft key, and then select **Internal** for transmission clock reference.
-

Setting Rx optic limit

A RRH has a finite dynamic range for input optic power and it can cause an abnormal behavior of the RRH if the optical power is weaker than certain level. To differentiate intermittent low optic power issues from any RSSI, interference and signal quality issues, it is important for you to monitor the input optic power level during the monitoring of the spectrum and the signal quality. Using this Rx optic limit feature, you can set lower and upper limits and monitor the Rx optic level with Pass/Fail indication in green and red colors.

Procedure

- 1 Press the **LIMIT** hot key.
 - 2 Press the **Rx Optic Level** soft key.
 - 3 Set a threshold for **High Limit** and **Low Limit**.
 - 4 To enable the Rx optic limit, toggle the **Test Limits** soft key and select **On**.
-

If the optic power level falls out of the specified thresholds, the color of the power reading or indicator turns red.

- 5 To disable the Rx optic limit, toggle the **Test Limits** soft key and select **Off**.
-

Conducting layer 2 term test

Procedure

- 1 Press the **MEASURE SETUP** hot key.
 - 2 Press the **More (1/2)** soft key to go to the Alarm/Error and Laser menus.
 - 3 Toggle the **Laser** soft key and select **On** to activate the transmission.
 - 4 To insert a code error, complete the following steps:
 - a Toggle the **Error Type** soft key between **Code** and **K30.7** and select **Code**.
 - b Toggle the **Insert Type** soft key between **Single** and **Rate** and select the insert type option you want.
 - Single:** It inserts an error once and then turns off the error insertion.
 - Rate:** It inserts an error according to the set error rate in the Error Rate menu.
 - c If you have selected Rate in step b, press the **Error Rate** and then select the error rate option from the choices: **1E-3**, **1E-4**, **1E-5**, **1E-6**, **1E-7**, **1E-8**, and **1E-9**.
 - d Toggle the **Error Insertion** soft key and select **On** to start to insert the specified error.
 - e To stop inserting the error, toggle the **Error Insertion** soft key and select **Off**.
 - 5 To insert a K30.7 error signal, complete the following steps:
 - a Toggle the **Error Type** soft key between **Code** and **K30.7** and select **K30.7**.
 - b Toggle the **Error Insertion** soft key and select **On** to insert the specified error. The K30.7 error signal is one time insertion. This setting changes back to Off after insertion.
 - 6 Check the real time results on the screen.
 - LOS:** Loss of Signal (code violation or low optical power)
 - LOF:** Loss of Frame (frame synchronization or alignment)
 - Optic Rx Level:** If the optical signal level is lower than the threshold, the OBSAI RP3 link may not work properly and the RRU may not be in service mode.
 - Optic Tx Level:** If the optical signal level is lower than the threshold, the OBSAI RP3 link may not work properly and the BB may not be in service mode.
 - Word Sync Loss Events:** Number of occurrence of word sync losses
 - Code Violations:** Number of occurrence of invalid line codes
 - Rx K30.7 Words:** Number of counts of K30.7 character, which indicates an error in the byte
 - Frame Sync Loss Events:** Number of detected frame sync losses
 - 7 *Optional.* You can use the **Save Logging Data** soft key to record the event logging in .csv file format. See “Using save” on page 34 for more information.
 - 8 To clear the previous event history and start a new testing, press the **PREV** hard key and then press the **MEASURE SETUP** hot key and then the **Clear History** soft key.
-

Measurement example

Figure 416 OBSAI layer 2 term test



Performing interference analysis

After checking that the link connection is good with no errors, you can proceed to the interference analysis activities including spectrum, spectrogram, RSSI, and spectrum replayer. You can also monitor current and history OBSAI alarm status for LOS and LOF displayed on the interference measurement screen.

Connecting cables

You can connect cables with a tap or without a tap as illustrated in Figure 417. If you have connected cables directly from RRU and BBU without using the nTap, you must turn on the through mode (Thru) in the Measure Setup menu.

A SFP/SFP+ transceiver that is connected to your JD700B series must be compatible with your DUT and you must have your module information such as line rate, wavelength, and mode (MM or SM) handy.

Figure 417 Connection diagram for interference analysis

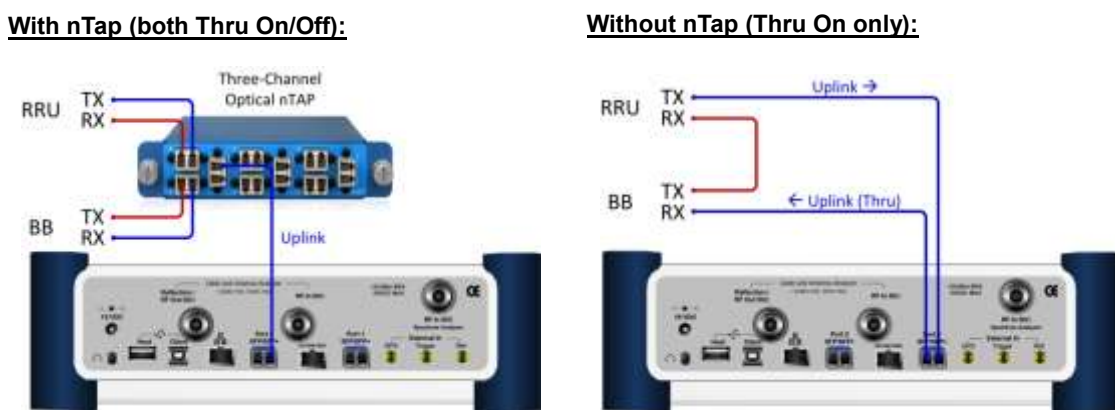

Selecting measurement mode

Procedure

- 1 Press the **MEASURE** hot key.
 - 2 Press the **Interference Analyzer** soft key.
 - 3 Select the interference measurement mode from the following choices:
 - Spectrum**
 - Spectrogram**
 - RSSI**
 - Spectrum Replayer**
-

Selecting port

JD700B series supports two antenna ports for signal transmission, and each port can generate different waveforms selectively and simultaneously. User can select the port to use for the measurement in any measurement mode of RFoBSAI mode.

Procedure

- 1 In any measurement mode, press the **MEASURE SETUP** hot key.
 - 2 Toggle the **Select Port** soft key between **Port 1** and **Port 2** to select the desired port.
-

Configuring test parameters

Configuration of test parameters described in this section is used in the Interference Analyzer mode including spectrum measurements, spectrogram, and RSSI.

Setting frequency

You can set the frequency with either frequency or channel number. If a frequency to be set matches to the frequency corresponding to the selected channel standard, the instrument calculates its channel number and updates the screen with it automatically.

Procedure

To set the frequency with center frequency:

- 1 Press the **FREQ/DIST** hard key.
- 2 Toggle the **Unit** soft key and select **Freq**.
- 3 Press the **Center Frequency** soft key.
- 4 Enter a value by using the numeric keys. You can also use the rotary knob.
- 5 Select the unit: **GHz**, **MHz**, **kHz**, or **Hz**.
- 6 *Optional.* To define the amount of increment for rotary operation, complete the following steps:
 - a Press the **Frequency Step** soft key.
 - b Enter a value by using the numeric keys. You can also use the rotary knob.
 - c Press the unit: **GHz**, **MHz**, **kHz**, or **Hz**.

To set the frequency with channel number:

- 1 Press the **FREQ/DIST** hard key.
 - 2 Toggle the **Unit** soft key and select **Channel**.
 - 3 To select the standard channel, complete the following steps:
-

-
- a Press the **Channel Std** soft key. The standard channel window appears. See “Appendix C – Band, frequency & channel standard” on page 769 for more information.
 - b Highlight the band to be measured by using the rotary knob, the arrow keys, or the **Page Up/Page Down** soft keys.
 - c Press the **Select** soft key or the rotary knob to confirm the selection.
- 4 Toggle the **Link** soft key to select the scanning direction and select **Fwd** (forward) or **Rev** (reverse).
 - 5 Press the **Channel Number** soft key.
 - 6 Enter a value by using the numeric keys. You can also use the rotary knob.
 - 7 Press the **Enter** soft key.
The instrument automatically displays the corresponding center frequency value for the selected channel number.
 - 8 *Optional.* To define the amount of increment for rotary operation, complete the following steps:
 - a Press the **Channel Step** soft key.
 - b Enter a value by using the numeric keys. You can also use the rotary knob.
 - c Press the **Enter** soft key.
-

Setting reference level

You can set the reference level automatically or manually to optimize the display of the traces measured, as you desire.

Procedure

To automatically set the reference level:

- 1 Press the **AMP/SCALE** hard key.
- 2 Press the **Auto Scale** soft key.
Each time you press this key, the Y-axis scale changes to be optimized with some margin.

To set the reference level manually:

- 1 Press the **AMP/SCALE** hard key.
- 2 To set the maximum reference value on the Y-axis manually, complete the following steps:
 - a Press the **Reference Level** soft key.
 - b Enter a value by using the numeric keys or the rotary knob with 10 dB increments.
 - c Press the unit soft key or the **ENTER** hard key.
This unit key name changes according to the setting in the **Units** menu.

Optional. To change the scale unit:

- 1 Select **More (1/2) > Units**.
 - 2 Select the unit of the display scale: **dBm**, **dBV**, **dBmV**, **dB μ V**, **V**, or **W**.
The scale unit on the screen changes accordingly.
-

Setting scale per division

You can use the **Scale/Div** feature to change the scale per division, representing the value of one division on the horizontal scale. The default setting is 10 dB per division and the maximum value can be set up to 20 dB.

Procedure

- 1 Press the **AMP/SCALE** hard key.
 - 2 Select **More (1/2) > Scale/Div**.
 - 3 Enter a value between 1 and 20 by using the numeric keys.
-

-
- 4 Press the **dB** soft key to complete the entry.
-

Setting external offset

You can turn the **External Offset** on and manually set the external offset value. An offset consists of a cable loss and a user offset, and the measurement result shows the value reflecting both offset values. When the external offset value is set at 40 dB, the measurement result compensates 40 dB.

Procedure

To set the external offset:

- 1 Press the **AMP/SCALE** hard key.
- 2 Toggle the **External Offset** soft key and select **On**.
- 3 Enter a value by using the numeric keys.
- 4 Press the **dB** soft key to complete the entry.

To turn the external offset off:

- 1 Press the **AMP/SCALE** hard key.
 - 2 Toggle the **External Offset** soft key and select **Off**.
-

Enabling auto leveling

It is normal that you see higher level of RSSI in OBSAI spectrum than you have seen in RF spectrum because the digital signal has a different gain level from RF's. If you use the Auto Leveling feature and enter the Noise Figure (NF) for the system to be tested, the instrument calculates an offset that compensates the digital gain of RRH and applies it to the spectrum automatically to displace the level of spectrum to a known RSSI power even though its accuracy cannot be guaranteed. Offset calculation for Auto Leveling is based on the following:

Auto Level offset = (Noise Floor of RFoBSAI) – (Ideal Noise Floor of RRH), where (Idea Noise Floor) = N.F (RRH) + Thermal Noise + 10log (RBW)

Procedure

- 1 Press the **AMP/SCALE** hard key.
- 2 Press the **Auto Leveling** soft key.
A calculated level of offset without NF is applied as the external offset and the user input field is activated for entry of the noise figure value.
- 3 Enter a noise figure value by using the numeric keys.



NOTE

Having the noise figure factored in the offset calculation for Auto Leveling will enable you to view the OBSAI spectrum closer to what you can view in the RF spectrum, but if you do not know the noise figure, you can skip this noise figure setting.

- 4 Press the **dB** soft key to complete the entry.
New external offset value appears in the **External Offset** menu box.
-

Setting RBW

You can set the RBW and VBW in the Spectrum, Spectrogram, and RSSI modes. The RBW range is limited as per the bandwidth of the signal under test.

Procedure

- 1 Press the **BW/AVG** hard key.
 - 2 Press the **RBW** soft key to set the resolution bandwidth.
 - 3 Enter a value in 1-3 sequence by using the numeric keys, and then select **kHz** soft key.
You can also use the rotary knob.
For signal bandwidths 1.4 MHz and 3 MHz: RBW from 1 kHz to 30 kHz
For signal bandwidths 5 MHz, 10 MHz, 15 MHz, and 20 MHz: RBW from 1 kHz to 100 kHz
 - 4 Press the **VBW** soft key to set the video bandwidth.
 - 5 Enter a value by using the numeric keys, and then select the unit option from the choices: **MHz**, **kHz**, and **Hz**. You can also use the rotary knob.
-

Setting average

You can set the number of measurements to be averaged for the trace presentation in the Spectrum, Spectrogram, and RSSI modes. A maximum of 100 times of averaging can be set. When the averaging reaches to your setting, a new measurement value replaces the measurement value in sequence from the earliest.

Procedure

- 1 Press the **BW/AVG** hard key.
 - 2 Press the **Average** soft key.
 - 3 Enter a value between one and 100 as needed by using the numeric keys.
 - 4 Press the **Enter** soft key.
-

Setting sweep mode

The default setting is **Continue** to sweep continuously for most on-going measurements. If you want to hold the measurement or get a single sweep, you can change the sweep mode. This setting is used in the Spectrum, Spectrogram, and RSSI modes.

Procedure

To select the single sweep mode:

- 1 Press the **SWEEP** hot key.
- 2 Toggle the **Sweep Mode** soft key and select **Single**. You can also use the **HOLD** hot key. The letter **HOLD** in red appears and the sweeping is paused.
- 3 *Optional.* Press the **Sweep Once** soft key to get a new measurement.

To return to the continuous sweep mode:

- 1 Toggle the **Sweep Mode** soft key and select **Continue**. You can also use the **HOLD** hot key. The letter **HOLD** in red disappears and the sweeping resumes.
-

Setting trace

You can display up to six traces on the measurement chart simultaneously.

Procedure

- 1 Press the **TRACE/DISPLAY** hard key.
 - 2 Press the **Select Trace** soft key, and then select the trace number: **T1**, **T2**, **T3**, **T4**, **T5**, or **T6**. The legend shape of the selected trace changes from square to round to indicate that the trace is
-

the active one now.

- 3 Do one of the following:

To	Select	Trace Legend
Clear current data and display with new measurements	Clear Write	W
Display the input signal's maximum response only (unlimited or for a certain amount of time)	Max Hold	M
Display the input signal's minimum response only (unlimited or for a certain amount of time)	Min Hold	m
Capture the selected trace and compare traces	Capture	C
Load a saved trace	More (1/2) > Load	L
Hide the displayed trace	Trace View > Off	F
Remove all the traces and initialize the trace settings	More (1/2) > Trace Clear All	



NOTE
For the **Max Hold** and **Min Hold**, your instrument compares newly acquired data with the active trace and displays larger maximum values or smaller minimum values on the screen. You can set it to **Unlimited** to hold and view maximum or minimum data or specify a certain amount of time up to 60 seconds by using numeric keys or rotary knob.

- 4 To select the detection option, select **More (1/2) > Detectors**, and then do one of the following:

To display	Select
Random noise better than the peak without missing signals	Normal
The highest value in each data point	Peak
The root mean squared average power across the spectrum	RMS
The lowest value in each data point	Negative Peak
The center value in each data point	Sample

- 5 *Optional.* Select **More (1/2) > Trace Info**, and then select the trace number to view the trace's parameter setting information stored at the time of the measurement or **None** to hide the information display.
- 6 *Optional.* If you have the two traces T1 and T2, you can perform trace math. To view the power difference between the traces, press the **T1 – T2 -> T5** or **T2 – T1 -> T6** soft key. The result is overlaid on the screen along with the second Y-axis.



NOTE
To be able to load a trace, the trace to be overlaid must be saved in the same measurement mode and frequency setting as the current measurement.

Setting measure setup

Procedure

- 1 Press the **MEASURE SETUP** hot key
- 2 Press the **Link Rate** soft key to set the line rate of the OBSAI RP3 interface between the BB and the RRU.
- 3 Select the RP3 line rate option from the choices: **768 Mbps**, **1536 Mbps**, **3072 Mbps**, and **6144 Mbps**.



NOTE
It is important that you set the link rate correctly to avoid any misleading LOS and LOF

alarms displayed on the screen.

If you select **6144 Mbps**, the **Scrambler Seed** soft key becomes active in the OBSAI Parameters menu so that you can specify a scrambler seed.

- 4 To turn on the through mode if you have not used a tap, toggle the **Thru** soft key and select **On**. To turn it off, select **Off**.
- 5 Press the **OBSAI Parameters** soft key, and then do the following:
 - To specify Rx RP3 Type and RP3 Address of the received message for link rates **768 Mbps**, **1536 Mbps**, and **3072 Mbps**, complete the following steps:
 - a Select **More (1/2) > Rx Address List**.
The Rx Address List box appears. JD700B series lists all Rx messages detected by the instrument with RP3 Address and RP3 Type values.
 - b From the list, select the message to monitor.
 - c Tap the **Apply** button.
The instrument automatically sets the RP3 Address and RP3 Type with the selected values.



NOTE
You can also manually specify the RP3 Address and RP3 Type for the received message using the **Rx RP3 Type** and **Rx RP3 Address** soft keys.

- d If you have selected a WCDMA/FDD message, toggle the **WCDMA Link** soft key and select the link direction between **FWD** for forward (downlink) and **REV** for reverse (uplink).

To specify Rx RP3 Type and RP3 Address of the received message for link rate **6144 Mbps**, complete the following steps:

- a Select **More (1/2) > Rx Address Valid List**.
The Rx Address List box appears. Unlike the Rx Address List, the **Rx Address Valid List** feature shows only the messages that contain scrambling code seed values.
- b From the list, select the message to monitor.
- c Tap the **Apply** button.
The instrument automatically sets the RP3 Address, RP3 Type, and Scrambler Seed with the selected values.



NOTE
You can also manually specify the RP3 Address, RP3 Type, and Scrambler Seed for the received message using the **Rx RP3 Type**, **Rx RP3 Address**, and **Scrambler Seed** soft keys.

- d If you have selected a WCDMA/FDD message, toggle the **WCDMA Link** soft key and select the link direction between **FWD** for forward (downlink) and **REV** for reverse (uplink).

To set the port type and transmission clock reference, complete the following steps:

- a Toggle the **Port Type** soft key and select **Slave** (default).
- b Press the **Tx Clock** soft key, and then select **Recovered** (default).

- 6 Press the **Bandwidth** soft key, and then specify the bandwidth depending on the RP3 type of the received signal.

WCDMA/FDD REV (uplink): 5 MHz

WCDMA/FDD FWD (downlink): 3 MHz

LTE: 1.4 MHz, 3 MHz, 5 MHz, 10 MHz, 15 MHz, and 20 MHz

The RBW range changes based on this bandwidth setting.

- 7 *Optional.* To use the RF signal generator function, see “Using RF source in RFoBSAI testing” on page 721.

Conducting spectrum measurement

After setting test parameters as described in “Configuring test parameters” on page 681, you can perform spectrum measurements with an audible indicator. You can also turn on the interference ID.

Procedure

- 1 Press the **MEASURE SETUP** hot key.
- 2 To set the sound indicator, complete the following steps:
 - a Press the **Sound Indicator** soft key.
 - b Select the alarm reference option from the choices: **Marker** and **Line**.
 - Marker:** Sets the active marker position as the alarm reference.
 - Line:** Lets the limit line as the alarm reference.
 - c Press the **Limit Line** soft key to set a threshold for an alarm.
 - d Enter a value, and then press the **dBm** soft key.
 - e Toggle the **Sound** soft key and select **On** to enable to sound or **Off** to turn it off.
 - f *Optional.* To adjust the volume for alarm sound, press the **Volume** soft key, and then turn the rotary knob clockwise or counter clockwise.
 - g *Optional.* To select the sound mode for alarm, toggle the **Sound Mode** soft key and select the option from the following choices:
 - Select the **Mode 1** to create an alarm with a consistent tone (frequency) regardless of the interference signal.
 - Select the **Mode 2** to apply the tone step from 1 to 20.
 - Select the **Mode 3** to apply the tone step from 20 to 1.

**NOTE**

The Sound Indicator is used to identify interfering signals with alarm sound. It is especially useful for locating interferer sources with a directional antenna.

- 3 To set the interference ID, complete the following steps:
 - a Press the **Interference ID** soft key.
 - b Press the **Threshold** soft key.
 - c Enter a value, and then press the **dBm** soft key.
 - d Toggle the **Interference ID** soft key and select **On** to turn on Interference ID or **Off** to turn it off.

**NOTE**

The Interference ID automatically classifies interfering signals over a designated spectrum and displays a list of possible signal types corresponding to the selected signal.

- 4 To clear current (C) and history (H) status of OBSAI alarm on LOS and LOF and start a new monitoring, press the **MEASURE SETUP** hot key and then the **Clear History** soft key.
 - 5 *Optional.* Go to **SAVE/LOAD > Save**, and then select the save option from the choices available for your measurement mode. See “Using save” on page 34 for more information. If you have saved logging data, you can play them in the Spectrum Replayer mode.
-

**NOTE**

You can use the **LIMIT** hot key to analyze your measurements with the display line, multi-segment line, and channel limit. See “Setting limit for interference analysis” on page 691 for more information.

Figure 418 RFoBSAI spectrum measurement



Conducting spectrogram

The Spectrogram is particularly useful when attempting to identify periodic or intermittent signals as it captures spectrum activity over time and uses various colors to differentiate spectrum power levels. When the directional antenna is used to receive the signal, you will see a change in the amplitude of the tracked signal as you change the direction of the antenna and see a change in the Spectrogram colors. The source of the signal is located in the direction that results in the highest signal strength.

After setting test parameters as described in “Configuring test parameters” on page 681, you can perform spectrogram measurements.

Procedure

- 1 Press the **MEASURE SETUP** hot key.
- 2 To set the amount of time between each trace measurement:
 - a Press the **Time Interval** soft key.
 - b Enter a value, and then press the **Sec** soft key.
- 3 To set the time cursor on a specific trace position, complete the following steps:
 - a Toggle the **Time Cursor** soft key and select **On**.
 - b Press the **Position** soft key.
 - c Turn the rotary knob to move the time cursor. You can also enter a value and then press the **Enter** soft key.
 - d To turn the time cursor off, toggle the **Time Cursor** soft key and select **Off**.



NOTE

Enabling the time cursor puts the measurement on hold and you can make post-processing analysis for each measurement over time using the time cursor.

- 4 To start a new measurement, press the **Reset/Restart** soft key.
- 5 To clear current (C) and history (H) status of OBSAI alarm on LOS and LOF and start a new monitoring, press the **MEASURE SETUP** hot key and then the **Clear History** soft key.
- 6 *Optional.* Go to **SAVE/LOAD > Save**, and then select the save option from the choices available for your measurement mode. See “Using save” on page 34 for more information.

The spectrogram shows a vertical line on the chart when the marker is enabled on the screen.

Figure 419 RFoBSAI interference measurement in spectrogram

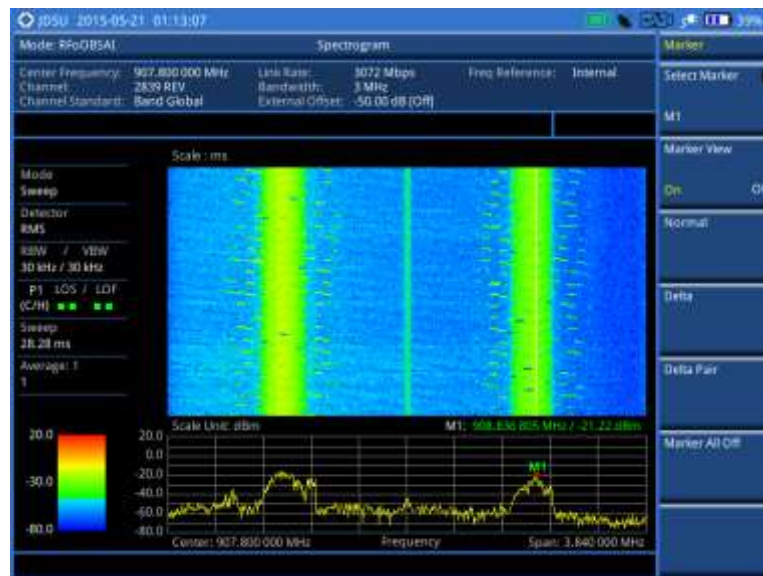
**NOTE**

You can use the **LIMIT** hot key to analyze your measurements with the display line, multi-segment line, and channel limit. See “Setting limit for interference analysis” on page 691 for more information.

Conducting RSSI

The Received Signal Strength Indicator (RSSI) is a multi-signal tracking metric that is particularly useful for measuring power-level variations over time. The RSSI measurement lets you assign power limit line for audible alarms and increase alarm counters every time a signal exceeds a defined limit line. For long-term analysis, the spectrogram and RSSI measurements can be automatically saved into an external USB memory. Post-analysis can be performed with JDViewer application software.

After configuring test parameters as described in “Configuring test parameters” on page 681, you can continue to proceed to the spectrogram measurement.

Procedure

- 1 Press the **MEASURE SETUP** hot key.
- 2 To set up the alarm parameters, complete the following steps:
 - a Press the **Alarm** soft key.
 - b Press the **Alarm at** soft key, and then select the marker number you want to set.
 - c Press the **Limit Line** soft key to set a threshold for the alarm.
 - d Enter a value by using the numeric keys. You can also use the rotary knob.
 - e Press the **dBm** soft key.
 - f Toggle the **Alarm** soft key between **On** and **Off** to turn the alarm feature on or off.

**NOTE**

You must set the marker(s) first by using the **MARKER** hard key as these features use the marker position to sound an alarm. See “Using marker” on page 60 for more information.

- g *Optional.* Press the **Volume** soft key and adjust the volume.
- 3 Press the **PREV** hard key to return to the Measure Setup screen bar.
- 4 To start a new measurement, press the **Reset/Restart** soft key.
- 5 To clear current (C) and history (H) status of OBSAI alarm on LOS and LOF and start a new

monitoring, press the **MEASURE SETUP** hot key and then the **Clear History** soft key.

- 6 *Optional.* Go to **SAVE/LOAD > Save**, and then select the save option from the choices available for your measurement mode. See “Using save” on page 34 for more information.

Figure 420 RFoBSAI interference measurement in RSSI

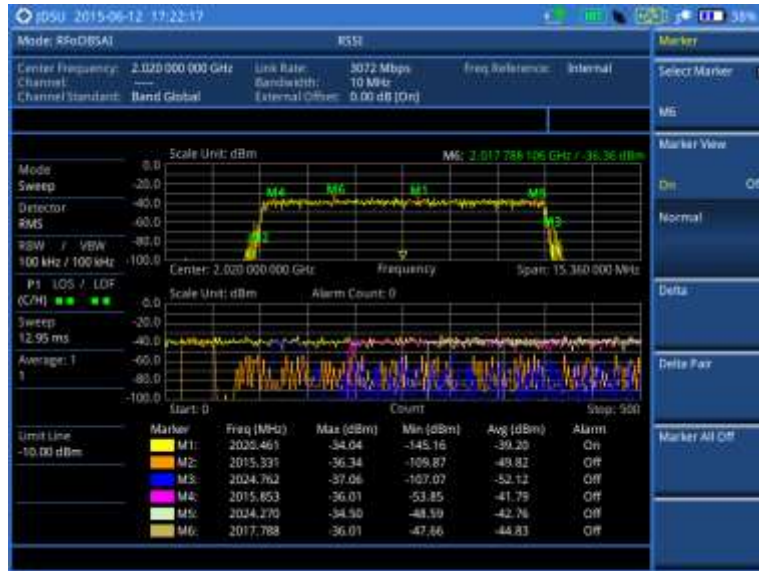

NOTE

You can use the **LIMIT** hot key to analyze your measurements with the display line, multi-segment line, and channel limit. See “Setting limit for interference analysis” on page 691 for more information.

Performing spectrum replayer

The Spectrum Replayer lets you retrieve and replay recorded spectrum analyzer traces in interference analysis mode. These traces can be played back in the spectrogram or RSSI. You can configure the limit line to create failure points when signals exceed it. The failure points are clearly displayed on the trace timeline for quick access during playback.

Procedure

- 1 Press the **MEASURE** hot key.
- 2 Press the **Spectrum Replayer** soft key. The file manager window appears.
- 3 Select a file to be loaded, and then press the **Load** soft key. The Measure Setup screen menus appear.
- 4 Toggle the **Replay Direction** soft key between **FWD** and **REV** to change play direction to forward or reverse.
- 5 Press the **Replay Speed** soft key, and then select the speed option: **X1**, **X2**, **X3**, and **X4**.
- 6 Press the **Play** soft key to start playing.
- 7 Press the **Pause** soft key to pause or stop playing data.
- 8 To move to a particular failure position directly and play from there, complete the following steps:
 - a Press the **Jump to Fail Index** soft key.
 - b Enter a value by using the numeric keys, and then press the **Enter** soft key.
- 9 *Optional.* Toggle the **Time Cursor** soft key between **On** and **Off** to display or dismiss the time cursor on the screen. This key becomes activated when you play logged data in the Spectrogram mode.

**NOTE**

If you connected a USB drive, do not remove it while playing to prevent freezing the USB port, which will require you to restart the instrument to get a USB drive recognized again.

Figure 421 RFoBSAI spectrum replay



Setting display

You can select the display option to view data in a different mode.

Procedure

- 1 Press the **TRACE/DISPLAY** hard key.
- 2 Select the display option from the choices: **Spectrum**, **Spectrogram**, and **RSSI**.

**NOTE**

You can use the **LIMIT** hot key to analyze your measurements with the display line, multi-segment line, and channel limit. See “Setting limit for interference analysis” on page 691 for more information.

Setting limit for interference analysis

You can set threshold(s) and display either a single segment line or multi-segment line to analyze the result better.

Setting a single limit line

Procedure

- 1 Press the **LIMIT** hot key.
- 2 Press the **Display Line** soft key for a reference line.
- 3 Enter a value, and then press the **dBm** unit soft key.
- 4 Toggle the **Display Line** soft key between **On** and **Off** to display and hide the reference line. The straight line appears across the screen to be used as a visual reference only.

Setting a multi-segment limit line

Procedure

- 1 Press the **LIMIT** hot key.
 - 2 Press the **Multi Segment Line** soft key for Pass/Fail indication.
 - 3 Toggle the **Limit** soft key between **Upper** and **Lower** to select the one to be displayed.
 - 4 Set the number of segments for the selected upper or lower limit line, up to 50 segments.
 - a Press the **# of Line** soft key.
 - b Enter a value between 1 and 50 by using the numeric keys.
 - c Press the **Enter** soft key.
 - 5 Press the **Autoset** soft key to let the instrument set the limit for each segment and display the line.
 - 6 To move the limit line, complete the following steps:
 - a Select **Limit Up/Down** or **Limit Left/Right**.
 - b Turn the rotary knob to move the line as desired. You can also manually enter a value.
 - 7 To edit the segment properties, complete the following steps:
 - a Press the **Edit Limit** soft key.
 - b Press the **Move** soft key and then turn the rotary knob to select the segment to edit.
 - c Select the menu option, from the following choices:
 - To hide the line for the selected segment, toggle the **Line** soft key and select **Off**.
 - To add a new point, press the **Add Point** soft key.
 - To delete the selected point, press the **Delete Point** soft key.
 - To change the position, press the **Frequency** or **Amplitude** soft key, and then turn the rotary knob to change the value as desired.
 - 8 *Optional.* Go to **SAVE/LOAD > Save**, and then select **Limit** to save the limit settings. See "Using save" on page 34 for more information.
-

Performing PIM detection (single and multiple carriers)

The Passive Intermodulation (PIM) Detection allows you to detect Uplink PIM across the full spectrum for any technology. When PIM is detected, the normal repair mode is to replace the offending cable and what you need to do is replacing the whole cable irrespective of the location of the fault.

Connecting cables

You can connect cables with a tap or without a tap as illustrated in Figure 422. If you have connected cables directly from RRH and BBU without using the nTap, you must turn on the through mode (Thru) in the Measure Setup menu.

A SFP/SFP+ transceiver that is connected to your JD700B series must be compatible with your DUT and you must have your module information such as line rate, wavelength, and mode (MM or SM) handy.

Figure 422 Connection diagram for PIM detection

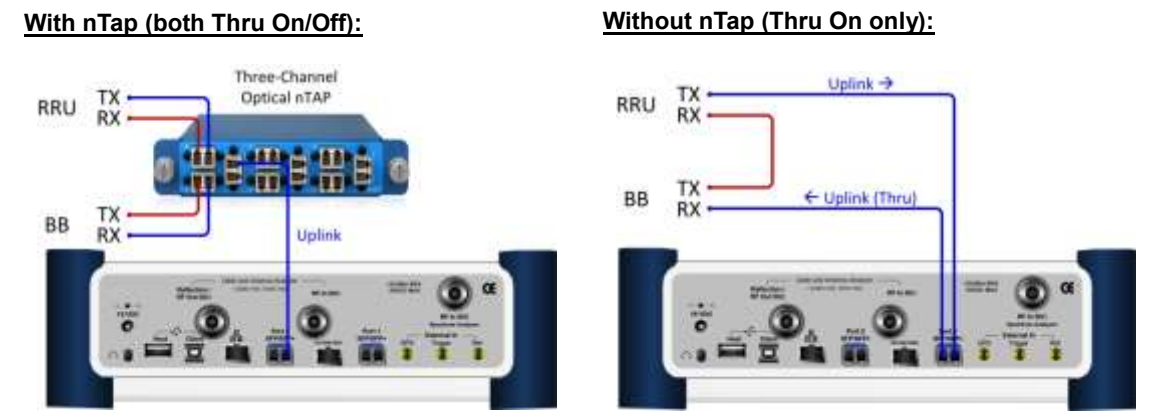

Selecting measurement mode

Procedure

- 1 Press the **MEASURE** hot key.
- 2 Press the **PIM Detection** soft key.
- 3 Select the PIM detection mode from the following choices:
 - PIM Detection Single Carrier**
 - PIM Detection Multiple Carriers**
 - Calculated PIM**

Selecting port

JD700B series supports two antenna ports for signal transmission, and each port can generate different waveforms selectively and simultaneously. User can select the port to use for the measurement in any measurement mode of RFoBSAI mode.

Procedure

- 1 In any measurement mode, press the **MEASURE SETUP** hot key.
- 2 Toggle the **Select Port** soft key between **Port 1** and **Port 2** to select the desired port.

Setting measure setup

Procedure

- 1 Press the **MEASURE SETUP** hot key.
- 2 Press the **Link Rate** soft key to set the line rate of the OBSAI RP3 interface between the BB and the RRU.
- 3 Select the RP3 line rate option from the choices: **768 Mbps**, **1536 Mbps**, **3072 Mbps**, and **6144 Mbps**.



NOTE

It is important that you set the link rate correctly to avoid any misleading LOS and LOF alarms displayed on the screen.

If you select **6144 Mbps**, the **Scrambler Seed** soft key becomes active in the OBSAI Parameters menu so that you can specify a scrambler seed.

- 4 To turn on the through mode if you have not used a tap, toggle the **Thru** soft key and select **On**. To turn it off, select **Off**.
- 5 Press the **OBSAI Parameters** soft key, and then do the following:
 - To specify Rx RP3 Type and RP3 Address of the received message for link rates **768 Mbps**, **1536 Mbps**, and **3072 Mbps**, complete the following steps:
 - a Select **More (1/2) > Rx Address List**.
The Rx Address List box appears. JD700B series lists all Rx messages detected by the instrument with RP3 Address and RP3 Type values.
 - b From the list, select the message to monitor.
 - c Tap the **Apply** button.
The instrument automatically sets the RP3 Address and RP3 Type with the selected values.

**NOTE**

You can also manually specify the RP3 Address and RP3 Type for the received message using the **Rx RP3 Type** and **Rx RP3 Address** soft keys.

- d If you have selected a WCDMA/FDD message, toggle the **WCDMA Link** soft key and select the link direction between **FWD** for forward (downlink) and **REV** for reverse (uplink).

To specify Rx RP3 Type and RP3 Address of the received message for link rate **6144 Mbps**, complete the following steps:

- a Select **More (1/2) > Rx Address Valid List**.
The Rx Address List box appears. Unlike the Rx Address List, the **Rx Address Valid List** feature shows only the messages that contain scrambling code seed values.
- b From the list, select the message to monitor.
- c Tap the **Apply** button.
The instrument automatically sets the RP3 Address, RP3 Type, and Scrambler Seed with the selected values.

**NOTE**

You can also manually specify the RP3 Address, RP3 Type, and Scrambler Seed for the received message using the **Rx RP3 Type**, **Rx RP3 Address**, and **Scrambler Seed** soft keys.

- d If you have selected a WCDMA/FDD message, toggle the **WCDMA Link** soft key and select the link direction between **FWD** for forward (downlink) and **REV** for reverse (uplink).

To set the port type and transmission clock reference, complete the following steps:

- a Toggle the **Port Type** soft key and select **Slave** (default).
- b Press the **Tx Clock** soft key, and then select **Recovered** (default).

- 6 Press the **Bandwidth** soft key, and then specify the bandwidth depending on the RP3 type of the received signal.

WCDMA/FDD REV (uplink): 5 MHz

WCDMA/FDD FWD (downlink): 3 MHz

LTE: 1.4 MHz, 3 MHz, 5 MHz, 10 MHz, 15 MHz, and 20 MHz

The RBW range changes based on this bandwidth setting.

- 7 *Optional.* To use the RF signal generator function, see “Using RF source in RFoBSAI testing” on page 721.

Calculating possible PIM

The Calculated PIM is used when you want to check any possible existence of PIM before the actual measurement. The instrument displays possible PIM in red color.

Procedure

- 1 Press the **MEASURE SETUP** hot key.
 - 2 Press the **Calculated PIM** soft key.
-

- 3 Toggle the **Radio Config** soft key between **Single** and **Multi** to select the desired mode.
 - Single:** Sets the frequency of Radio 1.
 - Multi:** Sets the frequency of Radio 1 and Radio 2.
- 4 Do one of the following:
 - To set the frequency and span, complete the following steps:
 - a Toggle the **Mode** soft key to **Freq**.
 - b Press the **Radio [1|2] Frequency** soft key.
 - c Enter a value by using the numeric keys.
 - d Select the unit option from the choices: **GHz**, **MHz**, **kHz**, or **Hz**.
 - e Press the **Radio [1|2] Span** soft key.
 - f Enter a value by using the numeric keys.
 - g Select the unit option from the choices: **GHz**, **MHz**, **kHz**, or **Hz**.
 - To set the radio band, complete the following steps:
 - a Toggle the **Mode** soft key to **Band**.
 - b Press the **Radio [1|2] Band** soft key.
 - c Highlight the radio band to select by using the rotary knob.
 - d Press the **Select** soft key.

Detecting PIM (single and multiple carriers)

Procedure

- 1 Press the **MEASURE SETUP** hot key.
- 2 Connect cables as instructed on the screen.



NOTE

Make sure that the Tx of RRH is connected to the Rx port of SFP/SFP+ installed in your CellAdvisor.

- 3 Complete one of the following:
 - To set the uplink center frequency and span to be measured, complete the following steps:
 - a Toggle the **Unit** soft key to **Freq**.
 - b Press the **Uplink Center Frequency** soft key.
 - c Enter a value by using the numeric keys or the rotary knob.
 - d Select the unit from the choices: **GHz**, **MHz**, **kHz**, or **Hz**.
 - To set the channel number to be measured, complete the following steps:
 - a Toggle the **Unit** soft key to **Channel**.
 - b Press the **Channel Std** soft key, and then highlight a desired band.
 - c Press the **Select** soft key.
 - d Press the **Channel Number** soft key.
 - e Enter a value by using the numeric keys, and then press the **Enter** soft key.
The instrument automatically displays the corresponding center frequency value for the selected channel number.
- 4 Press the **Continue** soft key, and then follow the on-screen instructions.
- 5 To clear current (C) and history (H) status of OBSAI alarm on LOS and LOF and start a new monitoring, press the **MEASURE SETUP** hot key and then the **Clear History** soft key.

Measurement example

Figure 423 PIM detection of single radio



Performing LTE-FDD downlink signal analysis

If your JD700B series has the option 096 RFoBSAI LTE-FDD Signal Analyzer installed with a license, you can perform power and spectrum measurements as well as modulation analysis to test the proper transmitter performance of FDD LTE systems over OBSAI.

This instrument provides the following measurement tools for FDD LTE system over OBSAI:

- Spectrum Analysis
- RF Analysis
 - Channel Power
 - Occupied Bandwidth
- Power vs. Time (Frame)
- Modulation Analysis
 - Constellation
 - Data Channel
 - Control Channel
 - Subframe
 - Frame
 - Time Alignment Error
 - Data Allocation Map
- Power Statistics CCDF

Connecting cables

You can connect cables with a tap or without a tap as illustrated in Figure 424. If you have connected cables directly from RRH and BBU without using the nTap, you must turn on the through mode (Thru) in the

Measure Setup menu.

A SFP/SFP+ transceiver that is connected to your JD700B series must be compatible with your DUT and you must have your module information such as line rate, wavelength, and mode (MM or SM) handy.

Figure 424 Connection diagram for downlink signal analysis

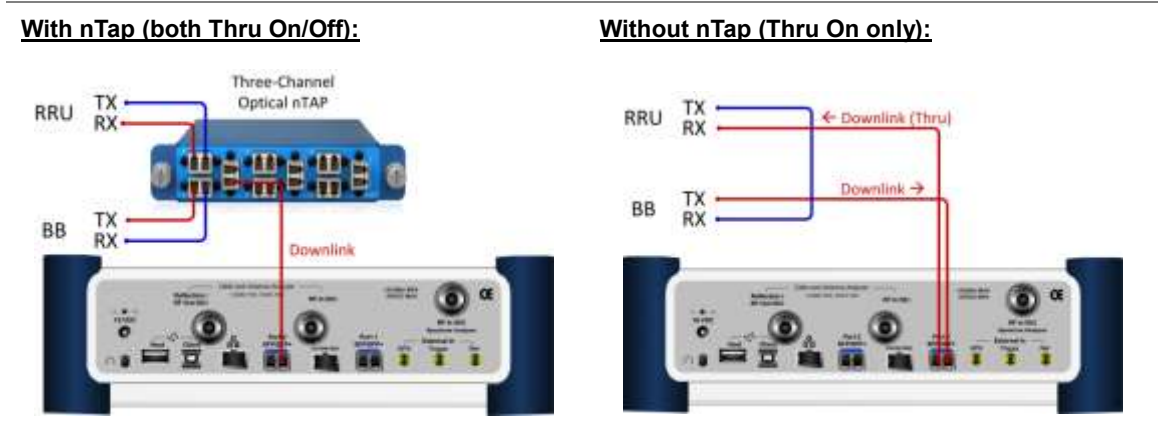

Selecting measurement mode

Procedure

- 1 Press the **MEASURE** hot key.
- 2 Select **Signal Analyzer > LTE-FDD**.
- 3 Select the downlink signal analysis mode from the following choices:
 - Spectrum**
 - RF Analysis > Channel Power or Occupied BW**
 - Power vs Time (Frame)**
 - Modulation Analysis > Constellation, Data Channel, Control Channel, Subframe, Frame, Time Alignment Error, or Data Allocation Map**
 - Power Statistics CCDF**

Selecting port

JD700B series supports two antenna ports for signal transmission, and each port can generate different waveforms selectively and simultaneously. User can select the port to use for the measurement in any measurement mode of RFoBSAI mode.

Procedure

- 1 In any measurement mode, press the **MEASURE SETUP** hot key.
- 2 Toggle the **Select Port** soft key between **Port 1** and **Port 2** to select the desired port.

Configuring test parameters

Setting frequency

You can set the frequency with either frequency or channel number. If a frequency to be set matches to the frequency corresponding to the selected channel standard, the instrument calculates its channel number and updates the screen with it automatically.

Procedure

To set the center frequency:

- 1 Press the **FREQ/DIST** hard key.
- 2 Toggle the **Unit** soft key and select **Freq**.
- 3 Press the **Center Frequency** soft key.
- 4 Enter a value by using the numeric keys or the rotary knob.
- 5 Select the unit: **GHz**, **MHz**, **kHz**, or **Hz**.
- 6 *Optional.* To define the amount of frequency increment for the rotary knob, complete the following steps:
 - a Press the **Frequency Step** soft key.
 - b Enter a value by using the numeric keys. You can also use the rotary knob.
 - c Press the unit: **GHz**, **MHz**, **kHz**, or **Hz**.

To set the channel number:

- 1 Press the **FREQ/DIST** hard key.
- 2 Toggle the **Unit** soft key to **Channel**.

**NOTE**

Selecting **Channel** sets the standard channel to **Band Global** automatically so that you can set the **Channel Number** without choosing a standard channel band from the list.

- 3 Press the **Channel Number** soft key.
 - 4 Enter a value by using the numeric keys or the rotary knob.
 - 5 Press the **Enter** soft key.
The instrument automatically displays the corresponding center frequency value for the selected channel number.
 - 6 *Optional.* To define the amount of channel increment for the rotary knob, complete the following steps:
 - a Press the **Channel Step** soft key.
 - b Enter a value by using the numeric keys or the rotary knob.
 - c Press the **Enter** soft key.
-

Setting amplitude

You can set the reference automatically or manually to optimize the display of the trace, as you desire.

Procedure

- 1 Press the **AMP/SCALE** hard key.
- 2 Do the following:
 - To optimize the Y-axis scale automatically, press the **Auto Scale** soft key.
 - To set the maximum reference value on the Y-axis manually, complete the following steps:
 - a Press the **Reference Level** soft key.
 - b Enter a value by using the numeric keys or the rotary knob with 10 dB increments.
 - c Press the unit soft key or the **ENTER** hard key.

**NOTE**

In the measurements such as **Control Channel**, **Subframe**, and **Frame**, you can select the reference option between **Relative** and **Absolute** instead.

- 3 To set an external offset, complete the following steps:
 - a Toggle the **External Offset** soft key and select **On**.
 - b Enter a value by using the numeric keys.
 - c Press the **dB** soft key to complete the entry.
-

**NOTE**

The instrument displays a measurement result with the set value reflected. For example, if you set it to 40 dB, the measurement result compensates 40 dB.

- 4 To change the setting of the scale per division, complete the following steps:
 - a Select **More (1/2) > Scale/Div**.
 - b Enter a value between 1 and 20 by using the numeric keys.
 - c Press the **dB** soft key to complete the entry.
- 5 To change the scale unit, select **More (1/2) > Units**, and then select the display unit option from the choices: **dBm**, **dBV**, **dBmV**, **dBμV**, **V**, and **W**. The scale unit on the screen changes accordingly.

**NOTE**

The Scale/Div and Units menus are available in the Spectrum and RF Analysis modes.

Setting average

In the spectrum and RF analysis, you can set the number of measurements to be averaged for the trace presentation. A maximum of 100 times of averaging can be set. When the averaging reaches to your setting, a new measurement value replaces the measurement value in sequence from the earliest.

Procedure

- 1 Press the **BW/AVG** hard key.
 - 2 Press the **Average** soft key.
 - 3 Enter a value between 1 and 100 as needed by using the numeric keys.
 - 4 Press the **Enter** soft key.
-

Setting sweep mode

The default setting is **Continue** to sweep continuously for most on-going measurements. If you want to hold the measurement or get a single sweep, you can change the sweep mode.

Procedure

- 1 Press the **SWEEP** hot key.
 - 2 Do the following:
 - To select the single sweep mode, complete the following steps:
 - a Toggle the **Sweep Mode** soft key and select **Single**. You can also use the **HOLD** hot key. The letter **HOLD** in red appears and the sweeping is paused.
 - b To get a new measurement, press the **Sweep Once** soft key.
 - To return to the continuous sweep mode, toggle the **Sweep Mode** soft key and select **Continue**. You can also use the **HOLD** hot key. The letter **HOLD** in red disappears and the sweeping resumes.
-

Setting measure setup

Procedure

- 1 Press the **MEASURE SETUP** hot key
 - 2 Press the **Link Rate** soft key to set the line rate of the OBSAI RP3 interface between the BB and the RRU.
 - 3 Select the RP3 line rate option from the choices: **768 Mbps**, **1536 Mbps**, **3072 Mbps**, and
-

6144 Mbps.**NOTE**

It is important that you set the link rate correctly to avoid any misleading LOS and LOF alarms displayed on the screen.

If you select **6144 Mbps**, the **Scrambler Seed** soft key becomes active in the OBSAI Parameters menu so that you can specify a scrambler seed.

- 4 To turn on the through mode if you have not used a tap, toggle the **Thru** soft key and select **On**. To turn it off, select **Off**.
- 5 Press the **OBSAI Parameters** soft key, and then do the following:
 - To specify Rx RP3 Type and RP3 Address of the received message for link rates **768 Mbps**, **1536 Mbps**, and **3072 Mbps**, complete the following steps:
 - a Select **More (1/2) > Rx Address List**.
The Rx Address List box appears. JD700B series lists all Rx messages detected by the instrument with RP3 Address and RP3 Type values.
 - b From the list, select the message to monitor.
 - c Tap the **Apply** button.
The instrument automatically sets the RP3 Address and RP3 Type with the selected values.

**NOTE**

You can also manually specify the RP3 Address and RP3 Type for the received message using the **Rx RP3 Type** and **Rx RP3 Address** soft keys.

- d If you have selected a WCDMA/FDD message, toggle the **WCDMA Link** soft key and select the link direction between **FWD** for forward (downlink) and **REV** for reverse (uplink).

To specify Rx RP3 Type and RP3 Address of the received message for link rate **6144 Mbps**, complete the following steps:

- a Select **More (1/2) > Rx Address Valid List**.
The Rx Address List box appears. Unlike the Rx Address List, the **Rx Address Valid List** feature shows only the messages that contain scrambling code seed values.
- b From the list, select the message to monitor.
- c Tap the **Apply** button.
The instrument automatically sets the RP3 Address, RP3 Type, and Scrambler Seed with the selected values.

**NOTE**

You can also manually specify the RP3 Address, RP3 Type, and Scrambler Seed for the received message using the **Rx RP3 Type**, **Rx RP3 Address**, and **Scrambler Seed** soft keys.

- d If you have selected a WCDMA/FDD message, toggle the **WCDMA Link** soft key and select the link direction between **FWD** for forward (downlink) and **REV** for reverse (uplink).

To set the port type and transmission clock reference, complete the following steps:

- a Toggle the **Port Type** soft key to **Slave** (default).
- b Press the **Tx Clock** soft key, and then select **Recovered** (default).

- 6 To set the bandwidth of the downlink signal, complete the following steps:
 - a Press the **Bandwidth** soft key.
 - b Select the bandwidth option from the choices: **5 MHz**, **10 MHz**, **15 MHz**, or **20 MHz**.
The RBW range changes based on this bandwidth setting.
- 7 *Optional.* To use the RF signal generator function, see “Using RF source in RFoOBSAI testing” on page 721.

Conducting spectrum measurement

Making a measurement

Procedure

- 1 Press the **MEASURE** hot key to select the measurement mode.
- 2 Select **Signal Analyzer > LTE-FDD > Spectrum**.
- 3 Configure test parameters as described in the “Configuring test parameters” on page 697.
- 4 Press the **MEASURE SETUP** hot key and set the measurement setups as described in the “Setting measure setup” on page 699.
- 5 Check your measurement result displayed on the screen.
- 6 To clear current (C) and history (H) status of OBSAI alarm on LOS and LOF and start a new monitoring, press the **MEASURE SETUP** hot key and then the **Clear History** soft key.
- 7 *Optional.* Go to **SAVE/LOAD > Save**, and then select the save option from the choices available for your measurement mode. See “Using save” on page 34 for more information.

Setting trace

You can display up to six traces on the measurement chart simultaneously.

Procedure

- 1 Press the **TRACE/DISPLAY** hard key.
- 2 Press the **Select Trace** soft key, and then select the trace number: **T1**, **T2**, **T3**, **T4**, **T5**, or **T6**. The legend shape of the selected trace changes from square to round to indicate that the trace is the active one now.
- 3 Do one of the following:

To	Select	Trace Legend
Clear current data and display with new measurements	Clear Write	W
Display the input signal's maximum response only (unlimited or for a certain amount of time)	Max Hold	M
Display the input signal's minimum response only (unlimited or for a certain amount of time)	Min Hold	m
Capture the selected trace and compare traces	Capture	C
Load a saved trace	More (1/2) > Load	L
Hide the displayed trace	Trace View > Off	F
Remove all the traces and initialize the trace settings	More (1/2) > Trace Clear All	



NOTE

For the **Max Hold** and **Min Hold**, your instrument compares newly acquired data with the active trace and displays larger maximum values or smaller minimum values on the screen. You can set it to **Unlimited** to hold and view maximum or minimum data or specify a certain amount of time up to 60 seconds by using numeric keys or rotary knob.

- 4 *Optional.* Select **More (1/2) > Trace Info**, and then select the trace number to view the trace's parameter setting information stored at the time of the measurement or **None** to hide the information display.
- 5 *Optional.* If you have the two traces T1 and T2, you can perform trace math. To view the power difference between the traces, press the **T1 – T2 -> T5** or **T2 – T1 -> T6** soft key. The result is overlaid on the screen along with the second Y-axis.

Measurement example

Figure 425 Spectrum measurement with RFoBSAI LTE-FDD signal analyzer



Conducting channel power measurement

The Channel Power measurement is a common test used in the wireless industry to measure the total transmitted power of a radio within a defined frequency channel. It acquires a number of points representing the input signal in the time domain, transforms this information into the frequency domain using Fast Fourier Transform (FFT), and then calculates the channel power. The effective resolution bandwidth of the frequency domain trace is proportional to the number of points acquired for the FFT.

The channel power measurement identifies the total RF power and power spectral density (PSD) of the signal in the LTE channel bandwidth.

Making a measurement

Procedure

- 1 Press the **MEASURE** hot key to select the measurement mode.
- 2 Select **Signal Analyzer > LTE-FDD > RF Analysis > Channel Power**.
- 3 Configure test parameters as described in the “Configuring test parameters” on page 697.
- 4 Press the **MEASURE SETUP** hot key and set the measurement setups as described in the “Setting measure setup” on page 699.
- 5 Check your measurement result displayed on the screen.
- 6 To clear current (C) and history (H) status of OBSAI alarm on LOS and LOF and start a new monitoring, press the **MEASURE SETUP** hot key and then the **Clear History** soft key.
- 7 *Optional.* Go to **SAVE/LOAD > Save**, and then select the save option from the choices available for your measurement mode. See “Using save” on page 34 for more information.

Measurement example

Figure 426 Channel power measurement with RFoOBSAI LTE-FDD signal analyzer



NOTE

You can use the **LIMIT** hot key to analyze your measurements with the user-definable limit and Pass/Fail indication. See “Setting limit for RFoOBSAI signal analysis” on page 720 for more information.

Occupied bandwidth

The Occupied Bandwidth measures the spectrum shape of the carrier. It is defined as the bandwidth, which includes 99% of the transmitted power among total transmitted power.

Making a measurement

Procedure

- 1 Press the **MEASURE** hot key to select the measurement mode.
- 2 Select **Signal Analyzer > LTE-FDD > RF Analysis > Occupied BW**.
- 3 Configure test parameters as described in the “Configuring test parameters” on page 697.
- 4 Press the **MEASURE SETUP** hot key and set the measurement setups as described in the “Setting measure setup” on page 699.
- 5 Check your measurement result displayed on the screen.
- 6 To clear current (C) and history (H) status of OBSAI alarm on LOS and LOF and start a new monitoring, press the **MEASURE SETUP** hot key and then the **Clear History** soft key.
- 7 *Optional.* Go to **SAVE/LOAD > Save**, and then select the save option from the choices available for your measurement mode. See “Using save” on page 34 for more information.

Measurement example

Figure 427 Occupied bandwidth measurement with RFoBSAI LTE-FDD signal analyzer



NOTE

You can use the **LIMIT** hot key to analyze your measurements with the user-definable limit and Pass/Fail indication. See “Setting limit for RFoBSAI signal analysis” on page 720 for more information.

Conducting power vs. time (frame) measurement

The Power vs. Time (Frame) measures the modulation envelope in the time domain, showing the power of each time slot in an LTE signal.

Making a measurement

Procedure

- 1 Press the **MEASURE** hot key to select the measurement mode.
- 2 Select **Signal Analyzer > LTE-FDD > P vs T (Frame)**.
- 3 Configure test parameters as described in the “Configuring test parameters” on page 697.
- 4 Press the **MEASURE SETUP** hot key and set the measurement setups as described in the “Setting measure setup” on page 699.
- 5 To select the subframe number to be measured, complete the following steps:
 - a Press the **Subframe No** soft key.
 - b Enter a value by using the numeric keys. You can also use the rotary knob.
 - c Press the **Enter** soft key.
- 6 Toggle the **Physical Cell ID** soft key and select **Auto** or **Manual** as desired:
 - Auto:** Lets the instrument detect the Physical Cell ID for the LTE signal automatically.
 - Manual:** Sets a specific Physical Cell ID for the LTE signal manually in order to speed up the synchronization.
- 7 Depending on your selected NEM, you may need to turn on or off the inversion of the I and Q order by toggling the **IQ Swap** soft key and selecting **On** or **Off**.
- 8 *Optional.* Press the **Miscellaneous** soft key, and then do the following as needed:
 - To assign a antenna port number automatically or manually, press the **Antenna Port** soft key and select the option: **Auto**, **0**, and **1**.
 - To select the cyclic prefix, toggle the **Cyclic Prefix** soft key and select **Normal** or

Extended. See “Appendix E – Cyclic prefix table” on page 773 for OFDM parameter details by different bandwidth.

- 9 Check your measurement result displayed on the screen.
- 10 To clear current (C) and history (H) status of OBSAI alarm on LOS and LOF and start a new monitoring, press the **MEASURE SETUP** hot key and then the **Clear History** soft key.
- 11 *Optional.* Go to **SAVE/LOAD > Save**, and then select the save option from the choices available for your measurement mode. See “Using save” on page 34 for more information.

Measurement example

Figure 428 Power vs. time (frame) measurement with RFoOBSAI LTE-FDD signal analyzer



Conducting constellation measurement

The Constellation is used to observe some aspects of modulation accuracy and can reveal certain fault mechanisms such as I/Q amplitude imbalance or quadrature imbalance. It displays constellation diagram by modulation types.

Making a measurement

Procedure

- 1 Press the **MEASURE** hot key to select the measurement mode.
- 2 Select **Signal Analyzer > LTE-FDD > Modulation Analysis > Constellation**.
- 3 Configure test parameters as described in the “Configuring test parameters” on page 697.
- 4 Press the **MEASURE SETUP** hot key and set the measurement setups as described in the “Setting measure setup” on page 699.
- 5 To select the subframe number to be measured, complete the following steps:
 - a Press the **Subframe No** soft key.
 - b Enter a value by using the numeric keys. You can also use the rotary knob.



NOTE

For MBMS testing, this subframe number must be neither 0 nor 5 as these subframes 0 and 5 are not available for MBMS and it must be set to the MBMS transmitted channel's subframe number.

- c Press the **Enter** soft key.

- 6 Toggle the **Physical Cell ID** soft key and select **Auto** or **Manual** as desired:
 - Auto:** Lets the instrument detect the Physical Cell ID for the LTE signal automatically.
 - Manual:** Sets a specific Physical Cell ID for the LTE signal manually in order to speed up the synchronization.
- 7 Depending on your selected NEM, you may need to turn on or off the inversion of the I and Q order by toggling the **IQ Swap** soft key and selecting **On** or **Off**.
- 8 *Optional.* Press the **Miscellaneous** soft key, and then set other miscellaneous setups as described in the following section.
- 9 Check your measurement result displayed on the screen.
- 10 To clear current (C) and history (H) status of OBSAI alarm on LOS and LOF and start a new monitoring, press the **MEASURE SETUP** hot key and then the **Clear History** soft key.
- 11 *Optional.* Go to **SAVE/LOAD > Save**, and then select the save option from the choices available for your measurement mode. See “Using save” on page 34 for more information.

Setting other miscellaneous setups

Procedure

- 1 To assign a antenna port number automatically or manually, press the **Antenna Port** soft key and select the option: **Auto**, **0**, and **1**.
- 2 To select the cyclic prefix, toggle the **Cyclic Prefix** soft key and select **Normal** or **Extended**. See “Appendix E – Cyclic prefix table” on page 773 for OFDM parameter details by different bandwidth.
- 3 To turn on or off the Multimedia Broadcast Multicast Service (MBMS) feature, toggle the **MBMS** soft key and select **On** or **Off**. For proper MBMS testing, you need to set the **Subframe No** with the same PMCH subframe number. If this setting is on, either PMCH or PDSCH appears on the screen depending on the detected channel.
- 4 To set the Multicast Broadcast Single Frequency Network (MBSFN) detection automatically or manually for MBMS testing, toggle the **MBSFN** soft key and select **Auto** or **Manual**. An automatically detected or manually entered MBSFN ID appears on the screen.
- 5 To select the PDSCH modulation type, press the **PDSCH Modulation Type** soft key and then select the option from the choices: **Auto**, **QPSK**, **16 QAM**, **64 QAM**, **E-TM3.3**, **E-TM3.2**, **E-TM3.1**, **E-TM2**, **E-TM1.2**, and **E-TM1.1**.



NOTE

If two or more modulation types are used in a frame, select **Auto**. If the PDSCH uses the same modulation type in a frame or in a subframe, select a specific modulation type to get more accurate EVM.

- 6 To set the threshold for PDSCH, complete the following steps:
 - a Press the **PDSCH Threshold** soft key.
 - b Enter a value by using the numeric keys.
 - c Press the **Enter** soft key.
- 7 To enable or disable the PDSCH precoding, toggle the **PDSCH Precoding** soft key and select **On** or **Off**.
- 8 To set the Control Format Indicator, toggle the **CFI** soft key and select **Auto** or **Manual**:
 - Auto:** Lets the instrument set the number of OFDM symbols used for transmitting PDCCHs in a subframe.
 - Manual:** Sets the number of OFDM symbols manually.
- 9 To select the number of PHICH groups (Ng), press the **PHICH Ng** soft key and then select the option from the choices: **1/6**, **1/2**, **1**, **2**, **E-1/6**, **E-1/2**, **E-1**, or **E-2**.

-
- When enabled, the display line for the PDSCH threshold appears.
When an event occurs, the measurement is put on hold until you press the **HOLD** hot key.
- 8 Depending on your selected NEM, you may need to turn on or off the inversion of the I and Q order by toggling the **IQ Swap** soft key and selecting **On** or **Off**.
 - 9 *Optional.* Press the **Miscellaneous** soft key, and then set other miscellaneous setups as described in the following section.
 - 10 Check your measurement result displayed on the screen.
 - 11 To clear current (C) and history (H) status of OBSAI alarm on LOS and LOF and start a new monitoring, press the **MEASURE SETUP** hot key and then the **Clear History** soft key.
 - 12 *Optional.* Go to **SAVE/LOAD > Save**, and then select the save option from the choices available for your measurement mode. See “Using save” on page 34 for more information.
-

Setting other miscellaneous setups

Procedure

- 1 To assign an antenna port number automatically or manually, press the **Antenna Port** soft key and select the option: **Auto**, **0**, and **1**.
- 2 To select the cyclic prefix, toggle the **Cyclic Prefix** soft key and select **Normal** or **Extended**. See “Appendix E – Cyclic prefix table” on page 773 for OFDM parameter details by different bandwidth.
- 3 To turn on or off the Multimedia Broadcast Multicast Service (MBMS) feature, toggle the **MBMS** soft key and select **On** or **Off**. For proper MBMS testing, you need to set the **Subframe No** with the same PMCH subframe number. If this setting is on, either PMCH or PDSCH appears on the screen depending on the detected channel.
- 4 To set the Multicast Broadcast Single Frequency Network (MBSFN) detection automatically or manually for MBMS testing, toggle the **MBSFN** soft key and select **Auto** or **Manual**. An automatically detected or manually entered MBSFN ID appears on the screen.
- 5 To select the PDSCH modulation type, press the **PDSCH Modulation Type** soft key and then select the option from the choices: **Auto**, **QPSK**, **16 QAM**, **64 QAM**, **E-TM3.3**, **E-TM3.2**, **E-TM3.1**, **E-TM2**, **E-TM1.2**, and **E-TM1.1**.



NOTE

If two or more modulation types are used in a frame, select **Auto**. If the PDSCH uses the same modulation type in a frame or in a subframe, select a specific modulation type to get more accurate EVM.

- 6 To set the threshold for PDSCH, complete the following steps:
 - a Press the **PDSCH Threshold** soft key.
 - b Enter a value by using the numeric keys.
 - c Press the **Enter** soft key.
 - 7 To enable or disable the PDSCH precoding, toggle the **PDSCH Precoding** soft key and select **On** or **Off**.
 - 8 To set the Control Format Indicator, toggle the **CFI** soft key and select **Auto** or **Manual**:
 - Auto:** Lets the instrument set the number of OFDM symbols used for transmitting PDCCHs in a subframe.
 - Manual:** Sets the number of OFDM symbols manually.
 - 9 To select the number of PHICH groups (Ng), press the **PHICH Ng** soft key and then select the option from the choices: **1/6**, **1/2**, **1**, **2**, **E-1/6**, **E-1/2**, **E-1**, or **E-2**.
-

Using marker

You can use the **MARKER** hard key to place a marker on a resource block and display the IQ diagram for the selected resource block.

Procedure

- 1 Press the **MARKER** hard key.
 - 2 Press the **RB Number** soft key to select the resource block to be marked.
 - 3 Enter the resource block number by using the numeric keys.
 - 4 Press the **Enter** soft key.
The marker appears on the selected resource block.
 - 5 Toggle the **Marker View** soft key between **On** and **Off** to display or hide the result of the selected resource block.
-

Measurement example
Figure 430 Data channel measurement with RFoBSAI LTE-FDD signal analyzer

NOTE

You can use the **LIMIT** hot key to analyze your measurements with the user-definable limit and Pass/Fail indication. See “Setting limit for RFoBSAI signal analysis” on page 720 for more information.

Conducting control channel measurement

The Control Channel measures the constellation for the specified control channel as well as modulation accuracy of the control channel at the specified subframe.

Making a measurement

Procedure

- 1 Press the **MEASURE** hot key to select the measurement mode.
 - 2 Select **Signal Analyzer > LTE-FDD > Modulation Analysis > Control Channel**.
 - 3 Configure test parameters as described in the “Configuring test parameters” on page 697.
 - 4 Press the **MEASURE SETUP** hot key and set the measurement setups as described in the “Setting measure setup” on page 699.
 - 5 To select the subframe number to be measured, complete the following steps:
 - a Press the **Subframe No** soft key.
 - b Enter a value by using the numeric keys. You can also use the rotary knob.
-

**NOTE**

For MBMS testing, this subframe number must be neither 0 nor 5 as these subframes 0 and 5 are not available for MBMS and it must be set to the MBMS transmitted channel's subframe number.

- c Press the **Enter** soft key.
- 6 Toggle the **Physical Cell ID** soft key and select **Auto** or **Manual** as desired:
 - Auto:** Lets the instrument detect the Physical Cell ID for the LTE signal automatically.
 - Manual:** Sets a specific Physical Cell ID for the LTE signal manually in order to speed up the synchronization.
- 7 Toggle the **EVM Detection Mode** soft key and select **Single** or **Combine** as desired:
 - Single:** Testing on one single antenna connected to your JD700B series with a cable.
 - Combine:** Testing on multiple antennas connected to your JD700B series with a 2x1 combiner or an antenna.
- 8 Depending on your selected NEM, you may need to turn on or off the inversion of the I and Q order by toggling the **IQ Swap** soft key and selecting **On** or **Off**.
- 9 *Optional.* Press the **Miscellaneous** soft key, and then set other miscellaneous setups as described in the following section.
- 10 Check your measurement result displayed on the screen.
- 11 To clear current (C) and history (H) status of OBSAI alarm on LOS and LOF and start a new monitoring, press the **MEASURE SETUP** hot key and then the **Clear History** soft key.
- 12 *Optional.* Go to **SAVE/LOAD > Save**, and then select the save option from the choices available for your measurement mode. See "Using save" on page 34 for more information.

Setting other miscellaneous setups

Procedure

- 1 To assign a antenna port number automatically or manually, press the **Antenna Port** soft key and select the option: **Auto**, **0**, and **1**.
- 2 To select the cyclic prefix, toggle the **Cyclic Prefix** soft key and select **Normal** or **Extended**. See "Appendix E – Cyclic prefix table" on page 773 for OFDM parameter details by different bandwidth.
- 3 To turn on or off the Multimedia Broadcast Multicast Service (MBMS) feature, toggle the **MBMS** soft key and select **On** or **Off**. For proper MBMS testing, you need to set the **Subframe No** with the same PMCH subframe number. If this setting is on, either PMCH or PDSCH appears on the screen depending on the detected channel.
- 4 To set the Multicast Broadcast Single Frequency Network (MBSFN) detection automatically or manually for MBMS testing, toggle the **MBSFN** soft key and select **Auto** or **Manual**. An automatically detected or manually entered MBSFN ID appears on the screen.
- 5 To set the threshold for PDCCH, complete the following steps:
 - a Press the **PDCCH Threshold** soft key.
 - b Enter a value by using the numeric keys.
 - c Press the **Enter** soft key.
- 6 Toggle the **PDCCH Mode** soft key and select **REG** or **Avg**.
 - REG:** Calculates EVM based on Resource Element Group
 - Avg:** Calculates EVM after adding all the PDCCH signals from one subframe.
- 7 To set the Control Format Indicator, toggle the **CFI** soft key and select **Auto** or **Manual**:
 - Auto:** Lets the instrument set the number of OFDM symbols used for transmitting PDCCHs in a subframe.
 - Manual:** Sets the number of OFDM symbols manually.
- 8 To select the number of PHICH groups (Ng), press the **PHICH Ng** soft key and then select the option from the choices: **1/6**, **1/2**, **1**, **2**, **E-1/6**, **E-1/2**, **E-1**, or **E-2**.

Using marker

You can use the **MARKER** hard key to place a marker on a control channel and display the IQ diagram for the selected channel.

Procedure

- 1 Press the **MARKER** hard key.
- 2 Press the **Channel** soft key to select a channel to be displayed in the IQ diagram. The channel P-SS is selected by default.
- 3 Press the up/down arrow keys or turn the rotary knob to highlight a channel in the channel summary table, and then press the center of the rotary knob.
- 4 Toggle the **Marker View** soft key between **On** and **Off** to display or hide the result of the selected channel.

Measurement example

Figure 431 Control channel measurement with RFoOBSAI LTE-FDD signal analyzer



NOTE

You can use the **LIMIT** hot key to analyze your measurements with the user-definable limit and Pass/Fail indication. See "Setting limit for RFoOBSAI signal analysis" on page 720 for more information.

Conducting subframe measurement

The Subframe measures the modulation accuracy of all the data and control channels at the specified subframe (1 ms).

Making a measurement

Procedure

- 1 Press the **MEASURE** hot key to select the measurement mode.
- 2 Select **Signal Analyzer > LTE-FDD > Modulation Analysis > Subframe**.
- 3 Configure test parameters as described in the "Configuring test parameters" on page 697.
- 4 Press the **MEASURE SETUP** hot key and set the measurement setups as described in the

“Setting measure setup” on page 699.

- 5 To select the subframe number to be measured, complete the following steps:
 - a Press the **Subframe No** soft key.
 - b Enter a value by using the numeric keys. You can also use the rotary knob.
-  **NOTE**
For MBMS testing, this subframe number must be neither 0 nor 5 as these subframes 0 and 5 are not available for MBMS and it must be set to the MBMS transmitted channel's subframe number.
- c Press the **Enter** soft key.
 - 6 Toggle the **Physical Cell ID** soft key and select **Auto** or **Manual** as desired:
 - Auto:** Lets the instrument detect the Physical Cell ID for the LTE signal automatically.
 - Manual:** Sets a specific Physical Cell ID for the LTE signal manually in order to speed up the synchronization.
 - 7 Toggle the **EVM Detection Mode** soft key and select **Single** or **Combine** as desired:
 - Single:** Testing on one single antenna connected to your JD700B series with a cable.
 - Combine:** Testing on multiple antennas connected to your JD700B series with a 2x1 combiner or an antenna.
 - 8 Depending on your selected NEM, you may need to turn on or off the inversion of the I and Q order by toggling the **IQ Swap** soft key and selecting **On** or **Off**.
 - 9 *Optional.* Press the **Miscellaneous** soft key, and then set other miscellaneous setups as described in the following section.
 - 10 Check your measurement result displayed on the screen.
 - 11 To clear current (C) and history (H) status of OBSAI alarm on LOS and LOF and start a new monitoring, press the **MEASURE SETUP** hot key and then the **Clear History** soft key.
 - 12 *Optional.* Go to **SAVE/LOAD > Save**, and then select the save option from the choices available for your measurement mode. See “Using save” on page 34 for more information.

Setting other miscellaneous setups

Procedure

- 1 To assign an antenna port number automatically or manually, press the **Antenna Port** soft key and select the option: **Auto**, **0**, and **1**.
- 2 To select the cyclic prefix, toggle the **Cyclic Prefix** soft key and select **Normal** or **Extended**. See “Appendix E – Cyclic prefix table” on page 773 for OFDM parameter details by different bandwidth.
- 3 To turn on or off the Multimedia Broadcast Multicast Service (MBMS) feature, toggle the **MBMS** soft key and select **On** or **Off**. For proper MBMS testing, you need to set the **Subframe No** with the same PMCH subframe number. If this setting is on, either PMCH or PDSCH appears on the screen depending on the detected channel.
- 4 To set the Multicast Broadcast Single Frequency Network (MBSFN) detection automatically or manually for MBMS testing, toggle the **MBSFN** soft key and select **Auto** or **Manual**. An automatically detected or manually entered MBSFN ID appears on the screen.
- 5 To select the PDSCH modulation type, press the **PDSCH Modulation Type** soft key and then select the option from the choices: **Auto**, **QPSK**, **16 QAM**, **64 QAM**, **E-TM3.3**, **E-TM3.2**, **E-TM3.1**, **E-TM2**, **E-TM1.2**, and **E-TM1.1**.



NOTE
If two or more modulation types are used in a frame, select **Auto**. If the PDSCH uses the same modulation type in a frame or in a subframe, select a specific modulation type to get more accurate EVM.

- a Press the **PDSCH Threshold** soft key.
 - b Enter a value by using the numeric keys.
 - c Press the **Enter** soft key.
- 6 To set the threshold for PDSCH, complete the following steps:
 - a Press the **PDSCH Threshold** soft key.
 - b Enter a value by using the numeric keys.
 - c Press the **Enter** soft key.
- 7 To set the threshold for PDCCH, complete the following steps:

-
- a Press the **PDCCH Threshold** soft key.
 - b Enter a value by using the numeric keys.
 - c Press the **Enter** soft key.
- 8** Toggle the **PDCCH Mode** soft key and select **REG** or **Avg**.
REG: Calculates EVM based on Resource Element Group
Avg: Calculates EVM after adding all the PDCCH signals from one subframe.
- 9** To enable or disable the PDSCH precoding, toggle the **PDSCH Precoding** soft key and select **On** or **Off**.
- 10** To set the Control Format Indicator, toggle the **CFI** soft key and select **Auto** or **Manual**:
Auto: Lets the instrument set the number of OFDM symbols used for transmitting PDCCHs in a subframe.
Manual: Sets the number of OFDM symbols manually.
- 11** To select the number of PHICH groups (Ng), press the **PHICH Ng** soft key and then select the option from the choices: **1/6**, **1/2**, **1**, **2**, **E-1/6**, **E-1/2**, **E-1**, or **E-2**.
-

Setting display

You can use the **TRACE/DISPLAY** hard key to view the RE and RS power at a specific symbol.

Procedure

- 1 Press the **TRACE/DISPLAY** hard key.
 - 2 Toggle the **Chart** soft key between **On** and **Off** to display or hide the chart.
If this setting is on, the **MARKER** hard key is activated.
-

Using marker

If you turn the Chart view on, you can use the **MARKER** hard key to place the marker at a specific symbol.

Procedure

- 1 Press the **MARKER** hard key.
 - 2 Toggle the **Marker View** soft key between **On** and **Off** to display or hide the marker on the chart.
 - 3 Press the **Symbol** soft key to select the symbol number, to which the marker is placed.
 - 4 Enter a value by using the numeric keys.
 - 5 Press the **Enter** soft key.
-

Measurement example

Figure 432 Subframe measurement with RFoOBSAI LTE-FDD signal analyzer



NOTE

You can use the **LIMIT** hot key to analyze your measurements with the user-definable limit and Pass/Fail indication. See “Setting limit for RFoOBSAI signal analysis” on page 720 for more information.

Conducting frame measurement

The Frame measures the modulation accuracy of all the data and control channels at the frame (10 ms).

Making a measurement

Procedure

- 1 Press the **MEASURE** hot key to select the measurement mode.
- 2 Select **Signal Analyzer > LTE-FDD > Modulation Analysis > Frame**.
- 3 Configure test parameters as described in the “Configuring test parameters” on page 697.
- 4 Press the **MEASURE SETUP** hot key and set the measurement setups as described in the “Setting measure setup” on page 699.
- 5 Toggle the **Physical Cell ID** soft key and select **Auto** or **Manual** as desired:
 - Auto:** Lets the instrument detect the Physical Cell ID for the LTE signal automatically.
 - Manual:** Sets a specific Physical Cell ID for the LTE signal manually in order to speed up the synchronization.
- 6 Toggle the **EVM Detection Mode** soft key and select **Single** or **Combine** as desired:
 - Single:** Testing on one single antenna connected to your JD700B series with a cable.
 - Combine:** Testing on multiple antennas connected to your JD700B series with a 2x1 combiner or an antenna.
- 7 Depending on your selected NEM, you may need to turn on or off the inversion of the I and Q order by toggling the **IQ Swap** soft key and selecting **On** or **Off**.
- 8 *Optional.* Press the **Miscellaneous** soft key, and then set other miscellaneous setups as described in the following section.
- 9 Check your measurement result displayed on the screen.
- 10 To clear current (C) and history (H) status of OBSAI alarm on LOS and LOF and start a new

monitoring, press the **MEASURE SETUP** hot key and then the **Clear History** soft key.

- 11 *Optional.* Go to **SAVE/LOAD > Save**, and then select the save option from the choices available for your measurement mode. See “Using save” on page 34 for more information.

Setting other miscellaneous setups

Procedure

- 1 To assign an antenna port number automatically or manually, press the **Antenna Port** soft key and select the option: **Auto**, **0**, and **1**.
- 2 To select the cyclic prefix, toggle the **Cyclic Prefix** soft key and select **Normal** or **Extended**. See “Appendix E – Cyclic prefix table” on page 773 for OFDM parameter details by different bandwidth.
- 3 To turn on or off the Multimedia Broadcast Multicast Service (MBMS) feature, toggle the **MBMS** soft key and select **On** or **Off**. For proper MBMS testing, you need to set the **Subframe No** with the same PMCH subframe number. If this setting is on, either PMCH or PDSCH appears on the screen depending on the detected channel.
- 4 To set the Multicast Broadcast Single Frequency Network (MBSFN) detection automatically or manually for MBMS testing, toggle the **MBSFN** soft key and select **Auto** or **Manual**. An automatically detected or manually entered MBSFN ID appears on the screen.
- 5 To select the PDSCH modulation type, press the **PDSCH Modulation Type** soft key and then select the option from the choices: **Auto**, **QPSK**, **16 QAM**, **64 QAM**, **E-TM3.3**, **E-TM3.2**, **E-TM3.1**, **E-TM2**, **E-TM1.2**, and **E-TM1.1**.



NOTE

If two or more modulation types are used in a frame, select **Auto**. If the PDSCH uses the same modulation type in a frame or in a subframe, select a specific modulation type to get more accurate EVM.

- 6 To set the threshold for PDSCH, complete the following steps:
 - a Press the **PDSCH Threshold** soft key.
 - b Enter a value by using the numeric keys.
 - c Press the **Enter** soft key.
- 7 To set the threshold for PDCCH, complete the following steps:
 - a Press the **PDCCH Threshold** soft key.
 - b Enter a value by using the numeric keys.
 - c Press the **Enter** soft key.
- 8 Toggle the **PDCCH Mode** soft key and select **REG** or **Avg**.
 - REG:** Calculates EVM based on Resource Element Group
 - Avg:** Calculates EVM after adding all the PDCCH signals from one subframe.
- 9 To enable or disable the PDSCH precoding, toggle the **PDSCH Precoding** soft key and select **On** or **Off**.
- 10 To set the Control Format Indicator, toggle the **CFI** soft key and select **Auto** or **Manual**:
 - Auto:** Lets the instrument set the number of OFDM symbols used for transmitting PDCCHs in a subframe.
 - Manual:** Sets the number of OFDM symbols manually.
- 11 To select the number of PHICH groups (N_g), press the **PHICH N_g** soft key and then select the option from the choices: **1/6**, **1/2**, **1**, **2**, **E-1/6**, **E-1/2**, **E-1**, or **E-2**.

Measurement example

Figure 433 Frame measurement with RFoBSAI LTE-FDD signal analyzer



NOTE

You can use the **LIMIT** hot key to analyze your measurements with the user-definable limit and Pass/Fail indication. See “Setting limit for RFoBSAI signal analysis” on page 720 for more information.

Conducting time alignment error measurement

In eNode-B supporting Tx Diversity transmission, signals are transmitted from two or more antennas. These signals shall be aligned. The time alignment error in Tx diversity is specified as the delay between the signals from two antennas at the antenna ports.

Making a measurement

Procedure

- 1 Press the **MEASURE** hot key to select the measurement mode.
- 2 Select **Signal Analyzer > LTE-FDD > Modulation Analysis > Time Alignment Error**.
- 3 Configure test parameters as described in the “Configuring test parameters” on page 697.
- 4 Press the **MEASURE SETUP** hot key and set the measurement setups as described in the “Setting measure setup” on page 699.
- 5 Toggle the **Antenna Config** soft key and select **Ant0** or **Ant1** as needed.
- 6 Toggle the **Physical Cell ID** soft key and select **Auto** or **Manual** as desired:
 - Auto:** Lets the instrument detect the Physical Cell ID for the LTE signal automatically.
 - Manual:** Sets a specific Physical Cell ID for the LTE signal manually in order to speed up the synchronization.
- 7 Depending on your selected NEM, you may need to turn on or off the inversion of the I and Q order by toggling the **IQ Swap** soft key and selecting **On** or **Off**.
- 8 *Optional.* To select the cyclic prefix, complete the following steps:
 - d Press the **Miscellaneous** soft key.
 - e Toggle the **Cyclic Prefix** soft key and select **Normal** or **Extended**. See “Appendix E – Cyclic prefix table” on page 773 for OFDM parameter details by different bandwidth.
- 9 Check your measurement result displayed on the screen.
- 10 To clear current (C) and history (H) status of OBSAI alarm on LOS and LOF and start a new

monitoring, press the **MEASURE SETUP** hot key and then the **Clear History** soft key.

- 11 *Optional.* Go to **SAVE/LOAD > Save**, and then select the save option from the choices available for your measurement mode. See “Using save” on page 34 for more information.

Measurement example

Figure 434 Time alignment error measurement with RFoBSAI LTE-FDD signal analyzer



NOTE

You can use the **LIMIT** hot key to analyze your measurements with the user-definable limit and Pass/Fail indication. See “Setting limit for RFoBSAI signal analysis” on page 720 for more information.

Conducting data allocation map measurement

The Data Allocation Map function (A) represents data allocation as a frame.

Making a measurement

Procedure

- 1 Press the **MEASURE** hot key to select the measurement mode.
- 2 Select **Signal Analyzer > LTE-FDD > Modulation Analysis > Data Allocation Map**.
- 3 Configure test parameters as described in the “Configuring test parameters” on page 697.
- 4 Press the **MEASURE SETUP** hot key and set the measurement setups as described in the “Setting measure setup” on page 699.
- 5 To select the subframe number to be measured, complete the following steps:
 - a Press the **Subframe No** soft key.
 - b Enter a value by using the numeric keys. You can also use the rotary knob.



NOTE

For MBMS testing, this subframe number must be neither 0 nor 5 as these subframes 0 and 5 are not available for MBMS and it must be set to the MBMS transmitted channel’s subframe number.

- c Press the **Enter** soft key.
- 6 Toggle the **Physical Cell ID** soft key and select **Auto** or **Manual** as desired:
 - Auto:** Lets the instrument detect the Physical Cell ID for the LTE signal automatically.

Manual: Sets a specific Physical Cell ID for the LTE signal manually in order to speed up the synchronization.

- 7 To set the threshold for PDSCH, complete the following steps:
 - a Press the **PDSCH Threshold** soft key.
 - b Enter a value by using the numeric keys.
 - c Press the **Enter** soft key.
 - 8 Depending on your selected NEM, you may need to turn on or off the inversion of the I and Q order by toggling the **IQ Swap** soft key and selecting **On** or **Off**.
 - 9 *Optional.* Press the **Miscellaneous** soft key, and then set other miscellaneous setups as described in the following section.
 - 10 Check your measurement result displayed on the screen.
 - 11 To clear current (C) and history (H) status of OBSAI alarm on LOS and LOF and start a new monitoring, press the **MEASURE SETUP** hot key and then the **Clear History** soft key.
 - 12 *Optional.* Go to **SAVE/LOAD > Save**, and then select the save option from the choices available for your measurement mode. See “Using save” on page 34 for more information.
-

Setting other miscellaneous setups

Procedure

- 1 To assign a antenna port number automatically or manually, press the **Antenna Port** soft key and select the option: **Auto**, **0**, and **1**.
 - 2 To select the cyclic prefix, toggle the **Cyclic Prefix** soft key and select **Normal** or **Extended**. See “Appendix E – Cyclic prefix table” on page 773 for OFDM parameter details by different bandwidth.
 - 3 To turn on or off the Multimedia Broadcast Multicast Service (MBMS) feature, toggle the **MBMS** soft key and select **On** or **Off**. For proper MBMS testing, you need to set the **Subframe No** with the same PMCH subframe number. If this setting is on, either PMCH or PDSCH appears on the screen depending on the detected channel.
 - 4 To set the Multicast Broadcast Single Frequency Network (MBSFN) detection automatically or manually for MBMS testing, toggle the **MBSFN** soft key and select **Auto** or **Manual**. An automatically detected or manually entered MBSFN ID appears on the screen.
-

Setting display

You can use the **TRACE/DISPLAY** hard key to change the display mode to PDSCH, PMCH, or both.

Procedure

- 1 Press the **TRACE/DISPLAY** hard key.
 - 2 Press the Display Channel soft key.
 - 3 Select the display mode from the choice: **PDSCH**, **PMCH**, and **Both**.
-

Using marker

You can use the **MARKER** hard key to place the marker at a specific resource block and subframe.

Procedure

- 1 Press the **MARKER** hard key.
 - 2 Toggle the **Marker View** soft key between **On** and **Off** to display or hide the marker on the chart.
 - 3 To select the resource block number, complete the following steps:
 - a Press the **RB Number** soft key.
-

- b Enter the resource block number to select by using the numeric keys. You can also use the rotary knob to move the marker side by side.
 - c Press the **Enter** soft key.
- 4 To select the subframe block number, complete the following steps:
 - a Press the **Subframe No** soft key.
 - b Enter the subframe number to select by using the numeric keys. You can also use the rotary knob to move the marker up and down.
 - c Press the **Enter** soft key.

Measurement example

Figure 435 Data allocation map measurement with RFoOBSAI LTE-FDD signal analyzer



Performing power statistics CCDF measurement

The Power Statistics Complementary Cumulative Distribution Function (CCDF) measurement characterizes the power statistics of the input signal. It provides PAR (Peak to Average power Ratio) versus different probabilities.

Making a measurement

Procedure

- 1 Press the **MEASURE** hot key to select the measurement mode.
- 2 Select **Signal Analyzer > LTE-FDD > Power Statistics CCDF**.
- 3 Configure test parameters as described in the “Configuring test parameters” on page 697.
- 4 Press the **MEASURE SETUP** hot key and set the measurement setups as described in the “Setting measure setup” on page 699.
- 5 To set the length of the CCDF, complete the following steps:
 - a Press the **CCDF Length** soft key.
 - b Enter a value between 1 and 100 by using the numeric keys. You can also use the rotary knob.
 - c Press the **Enter** soft key.
- 6 Check your measurement result displayed on the screen.
- 7 To clear current (C) and history (H) status of OBSAI alarm on LOS and LOF and start a new monitoring, press the **MEASURE SETUP** hot key and then the **Clear History** soft key.

- 8 *Optional.* Go to **SAVE/LOAD > Save**, and then select the save option from the choices available for your measurement mode. See “Using save” on page 34 for more information.

Measurement example

Figure 436 CCDF measurement with RFoBSAI LTE-FDD signal analyzer



Setting limit for RFoBSAI signal analysis

By default, test limits specified in the standard are set for you. You can change thresholds if you desire.

Procedure

- 1 Press the **LIMIT** hot key.
- 2 To set a limit for RF analysis tests, press the **RF Test Limits** soft key and then set limits as needed, depending on where you are in the measurement mode.

To set the limit for	Select	Set
Channel power	Channel Power	High Limit, Low Limit
Occupied bandwidth	Occupied BW	High Limit

- 3 To set a limit for modulation tests, press the **Modulation Test Limits** soft key and then set limits as needed, depending on where you are in the measurement mode.

To set the limit for	Select	Set
Frequency error	Frequency Error	High Limit, Low Limit
PDSCH error vector magnitude if MBMS is off	EVM > PDSCH EVM	High Limit (QPSK) High Limit (16 QAM) High Limit (64 QAM)
PMCH error vector magnitude if MBMS is on and a PMCH is detected	EVM > PMCH EVM	High Limit (QPSK) High Limit (16 QAM) High Limit (64 QAM)
RMS for data error vector magnitude	EVM > Data EVM RMS	High Limit
Peak for data error vector	EVM > Data EVM Peak	High Limit

magnitude		
RS error vector magnitude	EVM > RS EVM	High Limit
P-SS error vector magnitude	EVM > P-SS EVM	High Limit
S-SS error vector magnitude	EVM > S-SS EVM	High Limit
Downlink RS power	Power > DL RS Power	High Limit, Low Limit
P-SS power	Power > P-SS Power	High Limit, Low Limit
S-SS power	Power > S-SS Power	High Limit, Low Limit
PBCH power	Power > PBCH Power	High Limit, Low Limit
Subframe power	Power > Subframe Power	High Limit, Low Limit
OFDM symbol power	Power > OFDM Symbol Power	High Limit, Low Limit
Frame average power	Power > Frame Avg Power	High Limit, Low Limit
Time alignment error for MIMO	Time Alignment Error > MIMO	High Limit
Time error	Time Error	High Limit, Low Limit
I-Q origin offset	IQ Origin Offset	High Limit

- 4 *Optional.* You can enable alarm sound that goes off if the measurement falls outside of the limit. Toggle the **Beep** soft key between **On** and **Off** to enable or disable the beep sound.
- 5 *Optional.* Go to **SAVE/LOAD > Save**, and then select **Limit** to save the limit settings. See “Using save” on page 34 for more information.

Using signal generator

If your JD700B series has the signal generator options installed with a license, you can use RF Source or OBSAI Source, or both.

Using RF source in RFoBSAI testing

You can use the RF Source feature to calibrate the uplink noise floor at a given point, check the uplink gain and dynamic range, and verify the current RP3 link.

Procedure

- 1 Press the **MEASURE SETUP** hot key.
- 2 Press the **Source** soft key. Depending on your selection of measurement mode, you may need to select **More (1/2) > Source**.
- 3 Press the **RF Source** soft key.
- 4 To set the frequency of the CW signal to be injected, complete the following steps:
 - a Press the **Frequency** soft key.
 - b Enter a value within the frequency range of your instrument.
JD740B series: 25 MHz to 4 GHz
JD780B series: 5 MHz to 6 GHz



NOTE

The frequency of the CW signal must be in the uplink band of the RRH under test.

- c Select the unit option from the choices: **GHz**, **MHz**, **kHz**, and **Hz**.
- 5 To set the output level of the CW signal to be injected, complete following steps:

-
- a Press the **Power Level** soft key.
 - b Enter a value within the output range for the frequency you have set in step 4.
JD740B series: -80 dBm to -30 dBm, 0 dBm
JD780B series: -60 dBm to 10 dBm
 - c Press the unit soft key.
- 6 To start to inject the set signal, toggle the **RF Source** soft key and select **On**.
 - 7 To stop injecting the signal, toggle the **RF Source** soft key and select **Off**.
-

Using OBSAI source

You can use the OBSAI Source feature to generate CW and six types of E-UTRA Test Model waveforms in RFoBSAI testing for LTE-FDD: **CW**, **E-TM1.1**, **E-TM1.2**, **E-TM2**, **E-TM3.1**, **E-TM3.2**, and **E-TM3.3**.

Procedure

- 1 Make the Tx of a SFP/SFP+ module looped back to the Rx of the same module.



NOTE

When two SFP/SFP+ modules are installed in both Port 1 and Port 2, the OBSAI source always works via the Port 1, which is the primary port. If you want to use the Port 2 for this OBSAI signal generation, make sure to eject the module from the Port 1.

- 2 Press the **MEASURE SETUP** hot key.
 - 3 To set the Tx Clock and Port Type settings correctly, complete the following steps:
 - a Press the **OBSAI Parameters** soft key.
 - b Press the **Tx Clock** soft key and then select **Internal**.
 - c Toggle the **Port Type** soft key and then select **Master**.
 - d Press the **PREV** hard key to return to the Measure Setup main menu.
 - 4 Press the **Source** soft key. Depending on your selection of measurement mode, you may need to select **More (1/2) > Source**.
 - 5 Press the **OBSAI Source** soft key.
 - 6 To adjust the gain of the waveform to be transmitted in order to prevent an overrun or underrun of the RRU, complete the following steps:
 - a Press the **Gain** soft key.
 - b Enter a value between **-50.00** and **0.00**.
 - c Press the **dB** soft key or the **ENTER** hard key.
 - 7 To select a waveform to be generated, complete the following steps:
 - a Press the **Waveforms** soft key.
The Waveform list dialog box appears.
 - b Select a signal that you want to generate for your selected NEM. Supported bandwidths are **5 MHz**, **10 MHz**, **15 MHz**, and **20 MHz**.
 - c Tap the **Apply** button on the screen or press the **ENTER** hard key.
 - 8 To start to inject the selected signal, toggle the **OBSAI Source** soft key and select **On**.
 - 9 To stop injecting the signal, toggle the **OBSAI Source** soft key and select **Off**.
-

Chapter 18 Using Channel Scanner

This chapter provides instructions for using the Channel Scanner function (option 012). Topics discussed in this chapter are as follows:

■ Introduction.....	724
■ Display overview	724
■ Connecting a cable.....	724
■ Selecting measurement mode	726
■ Configuring test parameters.....	726
■ Making channel scanner measurements	729
■ Making frequency scanner measurements	730
■ Making custom scanner measurements	731
■ Analyzing measurements.....	733

Introduction

A Channel Scanner is a radio receiver that can automatically tune or scan two or more discrete frequencies and multi-channels, indicating when it finds a signal on one of them and then continuing scanning when that frequency goes silent.

You can measure up to 20 channels with this channel scanner. Using existing format-based or custom parameters, you will be able to easily verify improper multi-channel power levels.

- Channel Scanner
- Frequency Scanner
- Custom Scanner (Channel or Frequency)

Display overview

Figure 437 provides descriptions for each segment of the measurement screen.

Figure 437 Channel scanner screen



Connecting a cable

Direct connection

Procedure

- 1 Connect the **Spectrum Analyzer RF In** port of the JD700B series and the Power amplifier output port of BTS.

Figure 438 Direct connection



Indirect connection

Procedure

- 1 Connect the **Spectrum Analyzer RF In** port of the JD700B series and the monitor (test) port of BTS.

Figure 439 Indirect connection



CAUTION

The maximum power for the **Spectrum Analyzer RF In** port is +25 dBm (0.316 W) for JD780B series and +20 dBm (0.1 W) for JD740B series. If the level of the input signal to be measured is greater than this, use a **High Power Attenuator** to prevent damage when you directly connect the signal to the instrument or connect the signal from the coupling port of a directional coupler.

Over the air (OTA)

Procedure

- 1 Connect an Omni/directional RF antenna to the **Spectrum Analyzer RF In** port of the JD700B series.
- 2 Connect a GPS antenna to the **GPS** port of the JD700B series.

Figure 440 OTA connection

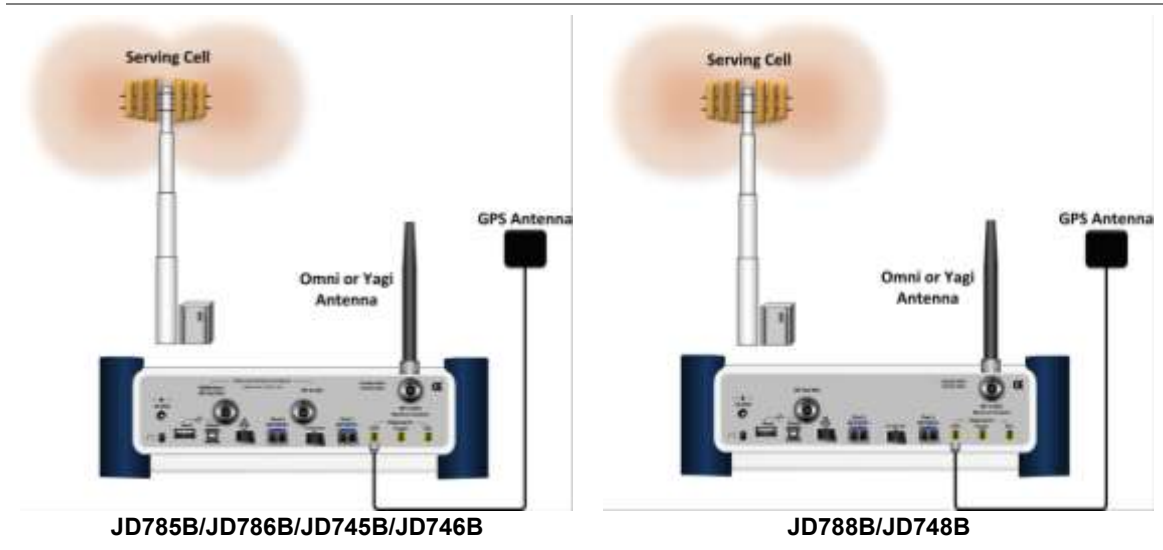

CAUTION

If the input signal level to be measured is less than 0 dBm, set 0 dB attenuation or turn on the preamp to have better dynamic range for the OTA testing.

Selecting measurement mode

Procedure

- 1 Press the **MODE** hard key.
- 2 Press the **Channel Scanner** soft key. The Channel Scanner mode is selected by default.
- 3 To change the measurement mode, press the **MEASURE** hot key and then select the measurement mode:
 - Channel Scanner**
 - Frequency Scanner**
 - Custom Scanner**

Configuring test parameters

Setting frequency

You need to set the channel or frequency to be scanned depending on the scanner mode: channel scanner, frequency scanner, and custom scanner. Refer to each scanner mode for how to set the channel or frequency.

Setting amplitude

Reference level and attenuation

You can set the reference and attenuation levels automatically or manually to optimize the display of the traces measured, as you desire.

Procedure

To automatically set the reference and attenuation level:

- 1 Press the **AMP/SCALE** hard key.
- 2 Press the **Auto Scale** soft key.
Each time you press this key, both of the Y-axis scale and input attenuation level change to be optimized with some margin.

To set the reference or attenuation level manually:

- 1 Press the **AMP/SCALE** hard key.
- 2 To set the maximum reference value on the Y-axis manually, complete the following steps:
 - a Press the **Reference Level** soft key.
 - b Enter a value by using the numeric keys or the rotary knob with 10 dB increments.
 - c Press the unit soft key or the **ENTER** hard key.
This unit key name changes according to the setting in the **Units** menu.
- 3 To set the attenuation option, select one from the following choices:
To set the input attenuator's level automatically, select **Attenuation > Auto**.

**NOTE**

It is recommended that you set the **Attenuation** to **Auto** in most situations so that the level of the input attenuator can be set automatically according to your input signal level.

To set the input attenuation manually up to 55 dB for JD780B series or 50 dB for JD740B series to optimize S/N, complete the following steps:

- a Select **Attenuation > Manual**.
- b Press the **Attenuation Value** soft key to set the level.
- c Enter a value in fives by using the numeric keys.
- d Press the **dB** soft key or the **ENTER** hard key.

To couple the input attenuator's level with your reference level setting, select **Attenuation > Couple**.

As you increase the reference setting, the attenuation level also increases accordingly.

Optional. To change the scale unit:

- 1 Select **More (1/2) > Units**.
 - 2 Select the unit of the display scale: **dBm**, **dBV**, **dBmV**, **dBμV**, **V**, or **W**.
The scale unit on the screen changes accordingly.
-

Pre-amplifier

You can turn the internal pre-amplifier on to correct and compensate for the gain of the preamp so that amplitude readings show the value at the input connector.

Procedure

- 1 Press the **AMP/SCALE** hard key.
 - 2 Toggle the **Preamp** soft key and select **On** or **Off** as needed.
-

**NOTE**

You can turn the Preamp on when the input attenuation range is from 0 dB to 10 dB. If the attenuation value is manually set to greater than 10 dB, the instrument will automatically turn off the pre-amplifier to display low-level signal properly on the chart.

External offset

You can turn the **External Offset** on and manually set the external offset value. An offset consists of a cable loss and a user offset and the measurement result shows the value reflecting both offset values. When the

external offset value is set at 40 dB in the Spectrum mode, the measurement result compensates 40 dB at both the Spectrum Analyzer and Signal Analyzer modes.

Procedure

To set the external offset:

- 1 Press the **AMP/SCALE** hard key.
- 2 Toggle the **External Offset** soft key and select **On**.
- 3 Enter a value by using the numeric keys.
- 4 Press the **dB** soft key to complete the entry.

To turn the external offset off:

- 1 Press the **AMP/SCALE** hard key.
 - 2 Toggle the **External Offset** soft key and select **Off**.
-

Setting average

You can set the number of measurements to be averaged for the trace presentation. A maximum of 100 times of averaging can be set. When the averaging reaches to your setting, a new measurement value replaces the measurement value in sequence from the earliest.

Procedure

- 1 Press the **BW/AVG** hard key.
 - 2 Press the **Average** soft key.
 - 3 Enter a value between 1 and 100 as needed by using the numeric keys.
 - 4 Press the **Enter** soft key.
-

Setting sweep mode

The default setting is **Continue** to sweep continuously for most on-going measurements. If you want to hold the measurement or get a single sweep, you can change the sweep mode.

Procedure

To select the single sweep mode:

- 1 Press the **SWEEP** hot key.
- 2 Toggle the **Sweep Mode** soft key and select **Single**. You can also use the **HOLD** hot key. The letter **HOLD** in red appears and the sweeping is paused.
- 3 *Optional.* Press the **Sweep Once** soft key to get a new measurement.

To return to the continuous sweep mode:

- 1 Toggle the **Sweep Mode** soft key and select **Continue**. You can also use the **HOLD** hot key. The letter **HOLD** in red disappears and the sweeping resumes.
-



NOTE

Selecting **Sweep Mode > Fast** may reduce the measurement accuracy, but you can use this fast sweep mode to identify the existence of interfering signals.

Making channel scanner measurements

Setting channel

You need to set the channel to be scanned.

Procedure

- 1 Press the **FREQ/DIST** hard key.
 - 2 To select the standard channel, complete the following steps:
 - a Press the **Channel Std** soft key. The standard channel window appears. See “Appendix C – Band, frequency & channel standard” on page 769 for more information.
 - b Highlight the band to be measured by using the rotary knob, the arrow keys, or the **Page Up/Page Down** soft keys.
 - c Press the **Select** soft key or the rotary knob to confirm the selection.
 - 3 Toggle the **Link** soft key to select the scanning direction and select **Fwd** (forward) or **Rev** (reverse).
 - 4 To set the starting channel, complete the following steps:
 - a Press the **Start Channel** soft key.
 - b Enter a value by using the numeric keys. You can also use the rotary knob.
 - c Press the **Enter** soft key.
 - 5 To set the amount of channel increment in scanning channels, complete the following steps:
 - a Press the **Channel Step** soft key.
 - b Enter a value by using the numeric keys. You can also use the rotary knob.
 - c Press the **Enter** soft key.
 - 6 To set the integration bandwidth, complete the following steps:
 - a Press the **Integration Bandwidth** soft key.
 - b Enter a value by using the numeric keys. You can also use the rotary knob.
 - c Select the unit: **GHz**, **MHz**, **kHz**, or **Hz**.
 - 7 To set the number of channels to be displayed in the measurement table, complete the following steps:
 - a Press the **# of Channels** soft key.
 - b Enter a value by using the numeric keys. You can also use the rotary knob.
 - c Press the **Enter** soft key.
-

Measurement example

Test results can be saved as a `.csv` file format so that you can work on it in any spreadsheet software.

Figure 441 Channel scanner measurement

**NOTE**

You can use the **LIMIT** hot key to analyze your measurements with the display line and channel limit. See “Setting limit for channel scanner” on page 733 for more information.

Making frequency scanner measurements

Setting frequency

You need to set the frequency to be scanned.

Procedure

- 1 Press the **FREQ/DIST** hard key.
- 2 To set the starting center frequency, complete the following steps:
 - a Press the **Start Frequency** soft key.
 - b Enter a value by using the numeric keys. You can also use the rotary knob.
 - c Select the unit: **GHz**, **MHz**, **kHz**, or **Hz**.
- 3 To set the amount of frequency increment in scanning channels, complete the following steps:
 - a Press the **Frequency Step** soft key.
 - b Enter a value by using the numeric keys. You can also use the rotary knob.
 - c Select the unit: **GHz**, **MHz**, **kHz**, or **Hz**.
- 4 To set the integration bandwidth, complete the following steps:
 - a Press the **Integration Bandwidth** soft key.
 - b Enter a value by using the numeric keys. You can also use the rotary knob.
 - c Select the unit: **GHz**, **MHz**, **kHz**, or **Hz**.
- 5 To set the number of frequencies to be displayed in the measurement table, complete the following steps:
 - a Press the **# of Frequency** soft key.
 - b Enter a value by using the numeric keys. You can also use the rotary knob.
 - c Press the **Enter** soft key.

Measurement example

Figure 442 Frequency scanner measurement



NOTE

You can use the **LIMIT** hot key to analyze your measurements with the display line and channel limit. See “Setting limit for channel scanner” on page 733 for more information.

Making custom scanner measurements

Setting channel/frequency

You can customize channels or frequencies to be scanned as you desire.

Procedure

To set the channels to be scanned:

- 1 Press the **FREQ/DIST** hard key.
- 2 Toggle the **Unit** soft key and select **Channel**.
- 3 To select the standard channel, complete the following steps:
 - a Press the **Channel Std** soft key. The standard channel window appears. See “Appendix C – Band, frequency & channel standard” on page 769 for more information.
 - b Highlight the band to be measured by using the rotary knob, the arrow keys, or the **Page Up/Page Down** soft keys.
 - c Press the **Select** soft key or the rotary knob to confirm the selection.
- 4 Toggle the **Link** soft key to select the scanning direction and select **Fwd** (forward) or **Rev** (reverse).
- 5 Press the **Index** soft key, and then enter an index number by turning the rotary knob or using the numeric keys.
- 6 To set the channel number for the selected index, complete the following steps:
 - a Press the **Channel Number** soft key.
 - b Enter a value by using the numeric keys. You can also use the rotary knob.
 - c Press the **Enter** soft key. The instrument displays a corresponding center frequency for the channel number.
- 7 To set the integration bandwidth for the selected index, complete the following steps:
 - a Press the **Integration Bandwidth** soft key.

- b Enter a value by using the numeric keys. You can also use the rotary knob.
- c Select the unit: **GHz**, **MHz**, **kHz**, or **Hz**.
- 8 To add more channels to be scanned, repeat steps 5-7.
- 9 Press the **ESC** hard key to dismiss the channel list window and view the scanning result.

To set the frequencies to be scanned:

- 1 Press the **FREQ/DIST** hard key.
- 2 Toggle the **Unit** soft key and select **Freq**.
- 3 Press the **Index** soft key, and then enter an index number by turning the rotary knob or using the numeric keys.
- 4 To set the center frequency for the selected index, complete the following steps:
 - a Press the **Center Frequency** soft key.
 - b Enter a value by using the numeric keys. You can also use the rotary knob.
 - c Select the unit: **GHz**, **MHz**, **kHz**, or **Hz**.
- 5 To set the integration bandwidth for the selected index, complete the following steps:
 - a Press the **Integration Bandwidth** soft key.
 - b Enter a value by using the numeric keys. You can also use the rotary knob.
 - c Select the unit: **GHz**, **MHz**, **kHz**, or **Hz**.
- 6 To add more channels to be scanned, repeat steps 3-5.
- 7 Press the **ESC** hard key to dismiss the channel list window and view the scanning result.

Measurement example

Figure 443 Custom scanner measurement



NOTE

You can use the **LIMIT** hot key to analyze your measurements with the display line and channel limit. See "Setting limit for channel scanner" on page 733 for more information.

Analyzing measurements

Setting limit for channel scanner

Procedure

To use the display line:

- 1 Press the **LIMIT** hot key.
- 2 Press the **Display Line** soft key to set a threshold for the limit line and Pass/Fail indication.
- 3 Enter a value, and then press the **dBm** unit soft key.
- 4 Toggle the **Display Line** soft key between **On** and **Off** to display or dismiss the limit line.

To use the channel limit:

- 1 Press the **LIMIT** hot key.
 - 2 Press the **Channel Limit** soft key to set the limits for each channel index.
 - 3 Press the **Index** soft key, and then select the channel/frequency index number by turning the rotary knob or using the numeric keys.
 - 4 Toggle the **Limit** soft key between **On** and **Off** to enable or disable the Pass/Fail indication.
 - 5 Set the upper threshold:
 - a Press the **High Limit** soft key.
 - b Enter a value for the upper limit.
 - c Press the **dBm** unit soft key.
 - 6 Set the lower threshold:
 - a Press the **Low Limit** soft key.
 - b Enter a value for the lower limit.
 - c Press the **dBm** unit soft key.
 - 7 *Optional.* Go to **SAVE/LOAD > Save**, and then select the save option from the choices available for your measurement mode. See “Using save” on page 34 for more information.
-

Chapter 19 Using Power Meter

This chapter provides instructions for using the RF Power Meter function and the Optical Power Meter function. Topics discussed in this chapter are as follows:

- Introduction..... 735
- Display overview 735
- Performing internal RF power measurements 735
- Performing external RF power measurements 740
- Performing optical power measurements..... 743

Introduction

The Power Meter of the JD700B series uses power measurement based on spectrum measurement results to provide an accurate power measurement result unlike a general spectrum analyzer, of which power accuracy may be degraded if the span is set too wide.

The power meter also provides Pass/Fail indication with user-defined lower and upper limits.

The Power Meter function provides following measurements:

- Internal RF Power Measurement
- External RF Power Measurement
- Optical Power Measurement

Display overview

Figure 444 provides descriptions for each segment of the measurement screen.

Figure 444 Power measurement screen



Performing internal RF power measurements

The internal power measurement of the JD700B series collects powers from the raw data of spectrum analyzer in the optimal span and integrates the powers up to the specified user span, which results in an accurate power measurement, independent of the span setting.

Connecting a cable

Direct connection

Procedure

- 1 Connect the **Spectrum Analyzer RF In** port of the JD700B series and the Power amplifier output port of BTS as shown in Figure 445.
-

Figure 445 Direct connection

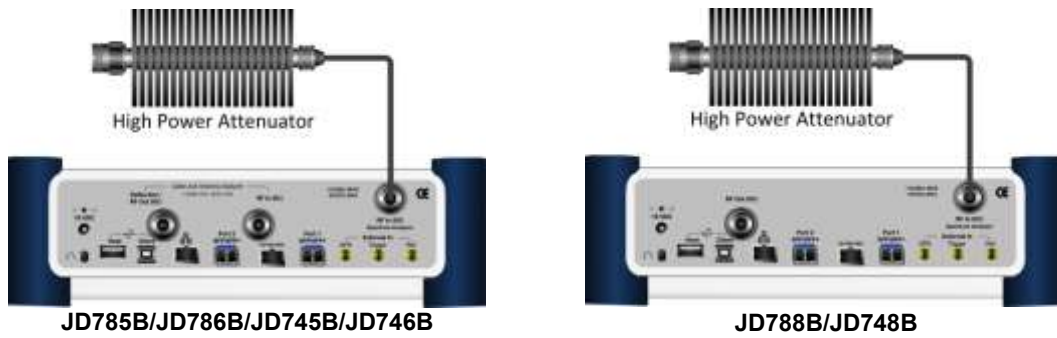

Indirect connection

Procedure

- 1 Connect the **Spectrum Analyzer RF In** port of the JD700B series and the monitor (test) port of BTS as shown in Figure 446.
-

Figure 446 Indirect connection



CAUTION

The maximum power for the **Spectrum Analyzer RF In** port is +25 dBm (0.316 W) for JD780B series and +20 dBm (0.1 W) for JD740B series. If the level of the input signal to be measured is greater than this, use a **High Power Attenuator** to prevent damage when you directly connect the signal to the instrument or connect the signal from the coupling port of a directional coupler.

Selecting measurement mode

Procedure

- 1 Press the **MODE** hard key.
 - 2 Select **More (1/2) > Power Meter > Internal RF Power Meter**.
-

Setting frequency

You need to set the frequency range to be measured with either the center frequency/span or the start/stop frequencies. You can also set the frequency with the channel number and span.

Procedure

To set the center frequency and span:

- 1 Press the **FREQ/DIST** hard key.
- 2 Toggle the **Unit** soft key and select **Freq**.
- 3 Press the **Center Frequency** soft key.
- 4 Enter a value by using the numeric keys. You can also use the rotary knob or the arrow keys.
- 5 Select the unit: **GHz**, **MHz**, **kHz**, or **Hz**.
- 6 Press the **Span** soft key, and then do one of the following:
 - To set the span manually, select **Span**, enter a value, and then select the unit.
 - To set the span automatically, select **Full Span**, **Zero Span**, or **Last Span** as needed.



NOTE

The **Zero Span** option is available only in the Spectrum mode. If you have selected **Zero Span**, select **TRIGGER > Free Run**, **External**, **GPS**, **Video**, or **Display Position**.

To set the start and stop frequencies:

- 1 Press the **FREQ/DIST** hard key.
- 2 Toggle the **Unit** soft key and select **Freq**.
- 3 Press the **Start Frequency** soft key.
- 4 Enter a value by using the numeric keys. You can also use the rotary knob or the arrow keys.
- 5 Select the unit: **GHz**, **MHz**, **kHz**, or **Hz**.
- 6 Press the **Stop Frequency** soft key.
- 7 Enter a value by using the numeric keys. You can also use the rotary knob or the arrow keys.
- 8 Select the unit: **GHz**, **MHz**, **kHz**, or **Hz**.

To set the channel number and span:

- 1 Press the **FREQ/DIST** hard key.
 - 2 Toggle the **Unit** soft key and select **Channel**.
 - 3 To select the standard channel, complete the following steps:
 - a Press the **Channel Std** soft key. The standard channel window appears. See "Appendix C – Band, frequency & channel standard" on page 769 for more information.
 - b Highlight the band to be measured by using the rotary knob, the arrow keys, or the **Page Up/Page Down** soft keys.
 - c Press the **Select** soft key or the rotary knob to confirm the selection.
 - 4 Toggle the **Link** soft key to select the sweep direction and select **Fwd** (forward) or **Rev** (reverse).
 - 5 To set the channel number, complete the following steps:
 - a Press the **Channel Number** soft key.
 - b Enter a value by using the numeric keys.
 - c Press the **Enter** soft key or **ENTER** hard key to complete the entry. The instrument automatically displays the corresponding center frequency value for the selected channel number.
 - 6 To set the span, complete the following steps:
 - a Press the **Span** soft key.
 - b Select the span option, from the following choices:
 - To set the span manually, select **Span**, enter a value, and then select the unit.
 - To set the span automatically, select **Full Span**, **Zero Span**, or **Last Span** as needed.
-

**NOTE**

The **Zero Span** option is available only in the Spectrum mode. If you have selected **Zero Span**, select **TRIGGER > Free Run, External, GPS, Video, or Display Position**.

Optional. To define the amount of frequency increment for the rotary knob:

- 1 Press the **Frequency Step** soft key, if the **Freq** is selected.
- 2 Enter a value by using the numeric keys.
- 3 Press the unit: **GHz, MHz, kHz, or Hz**.

Optional. To define the amount of channel increment for the rotary knob:

- 1 Press the **Channel Step** soft key, if the **Channel** is selected.
- 2 Enter a value by using the numeric keys.
- 3 Press the **Enter** soft key.

Setting amplitude

Procedure

- 1 Press the **AMP/SCALE** hard key.
- 2 Toggle the **Display** soft key and select the display method: **Relative** or **Absolute**.
- 3 If the **Relative** is selected, press the **Set Reference** soft key to set the current value as the reference.
- 4 To specify the display range, complete the following steps:
 - a Press the **Display Maximum** soft key to set the maximum value for the power meter.
 - b Enter a value by using the numeric keys. You can also use the rotary knob.
 - c Press the **dBm** soft key.
 - d Press the **Display Minimum** soft key to set the minimum value for the power meter.
 - e Enter a value by using the numeric keys. You can also use the rotary knob.
 - f Press the **dBm** soft key.
- 5 *Optional.* To enable the external offset, complete the following steps:
 - a Toggle the **External Offset** soft key and select **On**.
 - b Enter a value between 0 and 60 by using the numeric keys.
 - c Press the **dB** soft key.

Setting sweep mode

The default setting of the sweep mode is **Continue**. If you want to hold the measurement, you can change the sweep mode.

Procedure

- 1 Press the **SWEEP** hot key.
- 2 To select the single sweep mode, toggle the **Sweep Mode** soft key and select **Single**. You can also use the **HOLD** hot key. The letter **HOLD** in red appears and the sweeping is paused.
- 3 To return to the continuous sweep mode, toggle the **Sweep Mode** soft key and select **Continue**. You can also use the **HOLD** hot key. The letter **HOLD** in red disappears and the sweeping resumes.

Making a measurement

Procedure

- 1 Press the **MEASURE SETUP** hot key.
- 2 Press the **Resolution** soft key, and then select the resolution option from the following choices:
 - 0: Displays the reading with no decimal place
 - 1: Displays the reading with one decimal place
 - 2: Displays the reading with two decimal places
- 3 To set the resolution bandwidth, complete the following steps:
 - a Press the **RBW** soft key.
 - b Enter a value by using the numeric keys.
 - c Press the unit: **MHz**, **kHz**, or **Hz**.
- 4 Press the **Accuracy Mode** soft key, and then select the accuracy mode option: **Low**, **Middle**, and **High**.
- 5 To specify the number of measurements to be averaged, complete the following steps:
 - a Press the **Average** soft key.
 - b Enter a value between 1 and 100 by using the numeric keys.
 - c Press the **Enter** soft key.
- 6 To set a threshold and view the results with Pass/Fail indication, complete the following steps:
 - a Press the **LIMIT** hot key.
 - b Toggle the **Limit** soft key between **On** and **Off** to enable or disable the Pass/Fail indication.
 - c Press the **High Limit** soft key, and then enter a threshold value.
 - d Press the **dBm** unit soft key.
 - e Press the **Low Limit** soft key, and then enter a threshold value.
 - f Press the **dBm** unit soft key.
- 7 *Optional.* Go to **SAVE/LOAD > Save**, and then select the save option from the choices available for your measurement mode. See “Using save” on page 34 for more information.

Measurement example

Figure 447 Internal power measurement



Performing external RF power measurements

This instrument performs radio output power measurement with the use of optional external power sensors including JD730 series power sensors. It serves as the highly accurate RF power meter and gives wider range of power measurement.

Connecting a cable

There are two types of power sensors. Directional power sensors are used in in-service power measurement. Terminating power sensors are used in out-of-service power measurement.

Table 23 External power sensor type

Part No.	Description	Frequency Range	Power Range
JD731B	Directional Power Sensor	300-3800 MHz	Average: +21.76 to +51.76 dBm (0.15 to 150 W) Peak: +36.02 to +56.02 dBm (4 to 400 W)
JD732B	Terminating Power Sensor	20-3800 MHz	Average: -30 to +20 dBm
JD733A	Directional Power Sensor	150-3500 MHz	Average/Peak: +20 to +47 dBm (0.1 to 50 W)
JD734B	Terminating Power Sensor	20-3800 MHz	Peak: -30 to +20 dBm
JD736B	Terminating Power Sensor	20-3800 MHz	Average/Peak: -30 to +20 dBm

Terminating power sensor connection

Procedure

- 1 Connect an external power sensor to the **USB Host** port of the JD700B series and to the RF output port of BTS. The JD700B series automatically detects and initializes the power sensor connected to the instrument. Connecting an external power sensor is mandatory.

Table 24 Terminating power sensor connection



Directional power sensor connection

Procedure

- 1 Connect an external power sensor to the **USB Host** port of the JD700B series and to the RF output port of BTS as shown in Figure 448. The JD700B series automatically detects and initializes the power sensor connected to the

instrument. Connecting an external power sensor is mandatory.

Figure 448 Directional power sensor connection



Selecting measurement mode

Procedure

- 1 Press the **MODE** hard key.
- 2 Select **More (1/2) > Power Meter > External RF Power Meter**.

Setting frequency

You need to set the frequency to be measured depending on your connected external power sensor.

Procedure

- 1 Press the **FREQ/DIST** hard key.
- 2 Press the **Frequency** soft key.
- 3 Enter a value by using the numeric keys. You can also use the rotary knob.
- 4 Select the unit: **GHz**, **MHz**, **kHz**, or **Hz**.

Setting amplitude

Procedure

- 1 Press the **AMP/SCALE** hard key.
- 2 Toggle the **Display** soft key and select the display method: **Relative** or **Absolute**.
- 3 If the **Relative** is selected, press the Set Reference soft key to set the current value as the reference.
- 4 To specify the display range, complete the following steps:
 - a Press the **Display Maximum** soft key to set the maximum value for the power meter.
 - b Enter a value by using the numeric keys. You can also use the rotary knob.
 - c Press the **dBm** soft key.
 - d Press the **Display Minimum** soft key to set the minimum value for the power meter.
 - e Enter a value by using the numeric keys. You can also use the rotary knob.
 - f Press the **dBm** soft key.

-
- 5 *Optional.* To enable the external offset, complete the following steps:
 - a Toggle the **External Offset** soft key and select **On**.
 - b Enter a value between 0 and 60 by using the numeric keys.
 - c Press the **dB** soft key.
-

Making a measurement

Procedure

- 1 Press the **MEASURE** hot key.
 - 2 Depending your connected power sensor, do one of the following:
 - For JD736B, select the power range option: **Average Power**, **Peak Power**, or **Pulse Power**.
 - For JD734B, select **Peak Power**.
 - For JD732B, select **Average Power**.
 - For JD731B, select the power range option: **Forward Avg Power**, **Reverse Avg Power**, **Forward Peak Power**, **Pulse Power**, or **VSWR**.
 - For JD733A, select the power range option: **Forward Avg Power**, **Reverse Avg Power**, **Forward Peak Power**, or **VSWR**.
 - 3 Press the **MEASURE SETUP** hot key.
 - 4 Press the **Resolution** soft key, and then select the resolution option from the following choices:
 - 0: Displays the reading with no zero decimal place
 - 1: Displays the reading with one decimal place
 - 2: Displays the reading with two decimal places
 - 5 To set a threshold and view the results with Pass/Fail indication, complete the following steps:
 - a Press the **LIMIT** hot key.
 - b Toggle the **Limit** soft key between **On** and **Off** to enable or disable the Pass/Fail indication.
 - c Press the **High Limit** soft key, and then enter a threshold value.
 - d Press the **dBm** unit soft key.
 - e Press the **Low Limit** soft key, and then enter a threshold value.
 - f Press the **dBm** unit soft key.
 - 6 *Optional.* Go to **SAVE/LOAD > Save**, and then select the save option from the choices available for your measurement mode. See “Using save” on page 34 for more information.
-

Measurement example

You can measure and understand a trend of a system output in operation where output power constantly varies depending on the amount of calls being processed by the BTS or Repeater. In addition, the Log graph benefits you to easily examine the discontinuance of output power caused by the transmission problems or defective connection.

Figure 449 External power measurement of pulse power



Performing optical power measurements

The optical power measurement is available in conjunction with MP-series power sensor, which measures optical power via a USB connection.

Connecting a power meter

Connecting an external optical power meter is mandatory for power measurements in the Optical Power Meter mode. There are two optical power meters (sensors) those can be connected to the instrument via USB. See “JD700B Series Common Options” on page 792 for the optional power meters.

Procedure

- 1 Connect a MP-series optical power sensor to the **USB Host** port of the JD700B series as shown in Figure 450. The OPS indicator appears in the system status bar.
- 2 Connect the optical cable from the output port of BTS to the power meter.

Figure 450 Optical power sensor connection



Selecting measurement mode

Procedure

- 1 Press the **MODE** hard key.
 - 2 Select **More (1/2) > Power Meter > Optical Power Meter**.
The Optical Power Meter screen appears.
-

Setting measurement parameters

Procedure

- 1 Press the **MEASURE SETUP** hot key.
 - 2 To select your desired wavelength for testing, do one of the following:
 - To let your instrument detect the wavelength automatically, toggle the **Wavelength** soft key and select **Auto**.
 - To select a wavelength from the wavelength list, complete the following steps:
 - a Toggle the **Wavelength** soft key and select **Manual**.
 - b Press the **Stdwave** soft key.
The wavelength list box appears.
 - c Select the wavelength you want from the list, and then tap the **Apply** button.
 - 3 *Optional.* To edit the wavelength list, complete the following steps:
 - a Press the **Stored Wavelength** soft key.
The Stored Wavelength dialog box appears.
 - b Do the following:
 - To add a new wavelength, enter a value between 780 and 1650 in the input box, and then tap the **Add** button.
 - To edit an existing wavelength, highlight a wavelength in the list, enter a new value between 780 and 1650 in the input box, and then tap the **Edit** button.
 - To delete an existing wavelength from the list, highlight a wavelength in the list, and then tap the **Delete** button.
 - c Tap the **Apply** button to save your changes.
-

Making a power measurement

Procedure

- 1 After setting the parameters, read the absolute measurement value in dBm on the screen. Figure 451 is an example of the measurement screen. To view a relative power, see “Reading a relative power” on page 745.
 - 2 To view the result in mW, complete the following steps:
 - a Press the **AMP/SCALE** hard key.
 - b Press the **Units** soft key, and then select **mW**.
 - 3 To set a threshold and view the result with Pass/Fail indication, complete the following steps:
 - a Press the **LIMIT** hot key.
 - b Toggle the **Threshold** soft key between **On** and **Off** to enable or disable the Pass/Fail indication.
 - c Press the **Threshold** soft key, and then enter a value.
 - d Press the **dBm** unit soft key.
 - e Toggle the **Alarm** soft key between **On** and **Off** to enable or disable alarming.
 - 4 *Optional.* Go to **SAVE/LOAD > Save**, and then select the save option from the choices available for your measurement mode. See “Using save” on page 34 for more information.
-

Figure 451 optical power measurement

**NOTE**

If the Wavelength is set to Auto, it displays “Auto” for the modulation frequency. If it is set to Manual, the instrument displays a detected modulation frequency.

Reading a relative power

To view a relative power in dB, you can set a reference value automatically or manually.

Procedure

- 1 Press the **AMP/SCALE** hard key.
- 2 Toggle the **Display** soft key and select **Relative**.
- 3 Do one of the following:
 - To let the instrument set the last measurement as a reference, complete the following steps:
 - a Toggle the **Relative Reference** soft key and select **Last**.
 - b Press the **Reference Last** soft key.

**NOTE**

To set or release reference, you can also press and hold the physical round button on the connected MP-series power meter for a few seconds until you hear a beep.

To set the reference manually, complete the following steps:

- a Toggle the **Relative Reference** soft key and select **Manual**.
- b Press the **Reference Manual** soft key.
- c Enter a value manually as you desire, and then press the **Enter** soft key.

Holding a measurement

Procedure

- 1 To hold the measurement, press the **HOLD** hard key. Measurement is paused and the text “**Hold**” appears.
- 2 To resume the measurement, press the **HOLD** hard key again. Measurement is resumed and the text “**Hold**” disappears.

Chapter 20 Performing Fiber Inspection

This chapter provides instructions for using the fiber testing function with a P5000i fiberscope. Topics discussed in this chapter are as follows:

■ Introduction.....	747
■ Display overview	747
■ Connecting a fiber microscope.....	747
■ Selecting measurement mode	748
■ Configuring test parameters.....	748
■ Performing fiber inspection.....	749

Introduction

Inspection of fiber optic connections is essential for the optimal performance and longevity of fiber optic connectivity. Throughout their lives, fiber connectors must be inspected, analyzed, and cleaned to maintain an acceptable level of functionality. The JD700B series makes it fast and easy to troubleshoot and certify that every connection at a cell site is optimized for a lifetime of performance.

The JD700B series supports the handheld fiber microscope P5000i that can capture video images from the sensor and analyzes the images for fiber end face defects and contamination with reliable PASS/FAIL results to guarantee the performance of your optical connections.

Display overview

Figure 452 provides descriptions for each segment of the measurement screen.

Figure 452 Fiber inspection screen

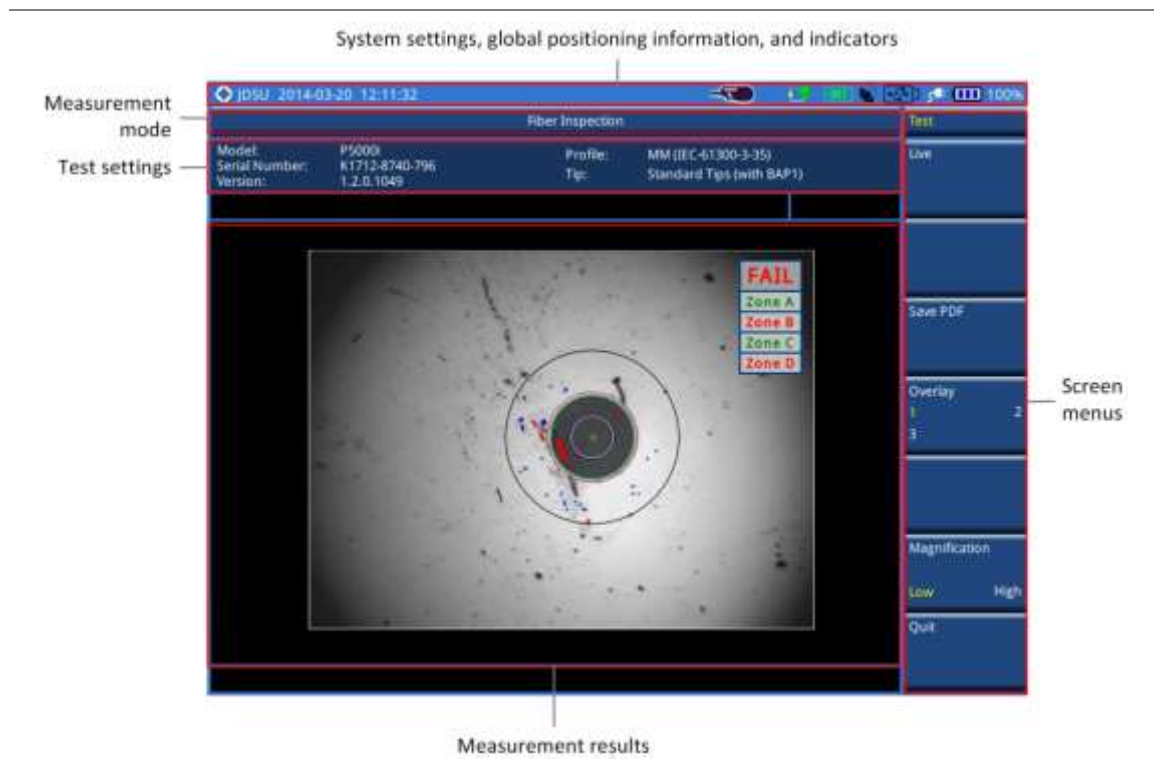

Connecting a fiber microscope

Connecting an optional fiber microscope P5000i is mandatory for fiber inspection and analysis. See “JD700B Series Common Options” on page 792 for available options.

Procedure

- 1 Connect your fiber microscope P5000i to the **USB Host** port of the JD700B series. The instrument detects the connected microscope automatically and displays the icon.

Selecting measurement mode

Procedure

- 1 Press the **MODE** hard key.
 - 2 Select **More (1/2) > Fiber Inspection**.
-

Configuring test parameters

Selecting profile and tip

You can select analysis profiles and inspection tips from the list.

Procedure

- 1 Press the **MEASURE SETUP** hot key.
- 2 Press the **Profile & Tip** soft key.
The profile and tip pane appears.
- 3 To select one of the pre-configured analysis profiles that match the PASS/FAIL criteria in the IEC visual inspection standard, complete the following steps:
 - a Tap the drop-down list button for the **Profile**.
 - b Select the profile that you want to use, from the following choices:
 - MM (IEC-61300-3-35)**
 - Ribbon, MM (IEC-61300-3-35)**
 - Ribbon, SM APC (IEC-61300-3-35)**
 - SM APC (IEC-61300-3-35)**
 - SM PC (IEC-61300-3-35)**
 - SM UPC (IEC-61300-3-35)**



NOTE

All of the profiles are factory set and cannot be edited or removed.

- 4 To select the inspection tip (optical settings) that you want to use, complete the following steps:
 - a Tap the drop-down list button for the **Tip**.
 - b Select one of the tips available to your selected profile, from the following choices:
 - Standard Tips (with BAP1) and Simplex Long Reach (-L) Tips**
 - Ribbon Tips and Ribbon Tips – Long Reach**



NOTE

This setting allows you to select the best optical settings for the type of inspection tip that is attached to your microscope probe.

- 5 Tap the **Apply** button or press the **Apply** soft key to save and return to the previous state.
-

Setting preferences

You can set your preferences of auto center and QuickCapture button function. The QuickCapture button is the small grey round button on the side of the microscope.

Procedure

- 1 To set the function of the QuickCapture button on the side of the P5000i, toggle the **Test Button**
-

soft key and select the option from the following choices:

Test: Sets the capture button to function as Test. Pressing the Quickcapture button analyzes fiber image as like the **Test** soft key on your JD700B series.

Freeze: Sets the capture button to function as Freeze. Pressing the Quickcapture button captures fiber image as like the **Freeze** soft key on your JD700B series.

- 2 To turn the auto center feature on or off, toggle the **Auto Center** soft key between **On** and **Off** and select the option you want to set. Default setting is **On**. It automatically displays the center of the fiber when viewing at high magnification.

Performing fiber inspection

Capturing fiber image

Procedure

- 1 Connect the fiber to be inspected to the tip of your microscope P5000i. The live image of the fiber is displayed on the screen. See the user manual of your fiber microscope for details on using the P5000i.
- 2 Focus the image by rotating the **Focus Control** on the P5000i until the image is in focus.
- 3 Toggle the **Magnification** soft key between **Low** and **High** and select the option you want to use. You can also press the **Magnification Control** button on either side of the P5000i.
- 4 Press the **Freeze** soft key to capture the properly focused image. The text “Capturing...” appears. See Figure 453 for an example of captured image.
- 5 *Optional.* To save the captured image as a file (.png), complete the following steps:
 - a Tap the **Save PNG** soft key. The Save window appears with the on-screen key.
 - b Type a file name in the **File Name** field.
 - c Select a folder where you want to save the file, if desired.
 - d Press the **Save** soft key.
- 6 Press the **Live** soft key to return to the live image screen or press the **Quit** soft key to exit.

Figure 453 Captured fiber image



Testing a fiber

Procedure

- 1 Connect the fiber to be inspected to the tip of your microscope P5000i.
The live image of the fiber is displayed on the screen.
See the user manual of your fiber microscope for details on using the P5000i.
- 2 Focus the image by rotating the **Focus Control** on the P5000i until the image is in focus.
- 3 Toggle the **Magnification** soft key between **Low** and **High** and select the option you want to use.
You can also press the **Magnification Control** button on either side of the P5000i.
- 4 Press the **Test** soft key to start fiber analysis.
The text “Analyzing...” appears. See Figure 454 for an example of fiber analysis results.
- 5 Once the test is completed, check the result displayed on the screen with the following information:
 - Image overlay of the zone locations, defects, and scratches
 - PASS or FAIL result
 - Specific test result for each zone
- 6 To show or hide image overlays, press the **Overlay** soft key.
Each time this key is pressed, the selection changes.
- 7 *Optional.* To save the fiber inspection result with specific details as a report (.pdf), complete the following steps:
 - a Tap the **Save PDF** soft key.
The Save window appears with the on-screen key.
 - b Type a file name in the **File Name** field.
 - c Select a folder where you want to save the file, if desired.
 - d Press the **Save** soft key.
The information input window appears.
 - e Type in information as required.
 - f Tap the **Apply** button or press the **Apply** soft key to save and return to the previous state.
See Figure 455 for an example of generated report.
- 8 Press the **Live** soft key to return to the live image screen or press the **Quit** soft key to exit the fiber inspection.

Figure 454 Analyzed fiber image and fiber inspection result



Figure 455 Fiber inspection report



Chapter 21 Using EMF Analyzer

This chapter provides instructions for using the EMF Analyzer function (option 050). Topics discussed in this chapter are as follows:

■ Introduction.....	753
■ Display overview	753
■ Connecting an isotropic antenna.....	753
■ Selecting measurement mode	754
■ Configuring test parameters.....	754
■ Conducting EMF spectrum measurements.....	758
■ Recording and replaying EMF logging data	760

Introduction

Base stations emit electro-magnetic fields (EMF) of high frequency, which varies between wireless technologies and countries. As personal exposure to high frequency fields from base stations can provoke health effect, the International Commission on Non-Ionizing Radiation Protection (ICNIRP) has provided general guidelines on limitations regarding high frequency exposure. Using the EMF Analyzer in JD700B series with an isotropic antenna connected, you can now measure the level of EMF onsite in the field in order to verify if the level of emission from of your base station is compliant with the guidelines.

The JD700B series is the solution to perform following measurement and analysis:

- EMF Spectrum
- EMF Replayer

Display overview

Figure 456 provides overview of each segment of the measurement screen.

Figure 456 EMF Spectrum measurement screen

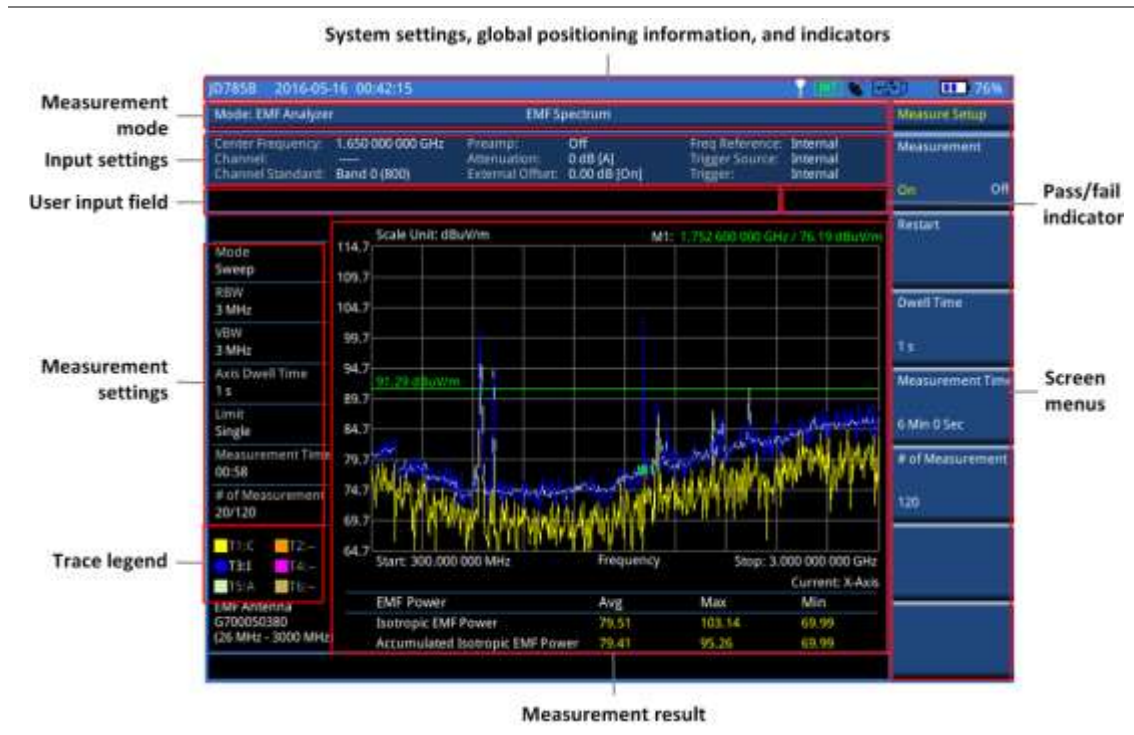

Connecting an isotropic antenna

In the EMF Analyzer mode, connecting an isotropic antenna is mandatory and the part number is G700050380. Using this isotropic antenna, you can make three-dimensional measurements.

Procedure

- 1 Connect the **RF Type-N connector** of the isotropic antenna to the **RF In port** of the instrument.
- 2 Connect the **USB plug** of the isotropic antenna to the **USB Host port** of the JD700B series. The device icon appears in the system status bar on the screen.

Figure 457 Connection using an isotropic antenna

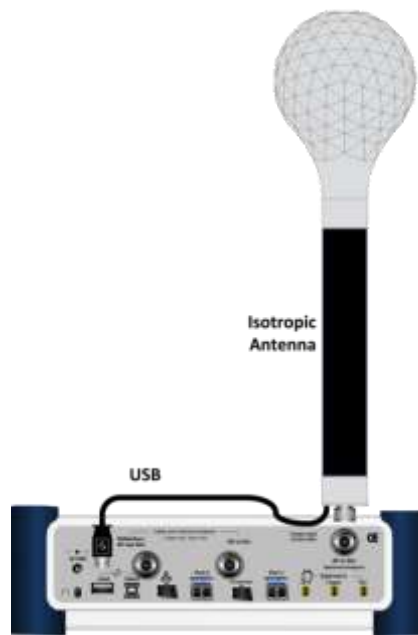

CAUTION

The maximum power for the **Spectrum Analyzer RF In** port is +25 dBm (0.316 W) for JD780B series and +20 dBm (0.1 W) for JD740B series.

Selecting measurement mode

Procedure

- 1 Press the **MODE** hard key.
- 2 Press the **More (1/2)** soft key and then the **EMF Analyzer** soft key.
This menu is activated only after you have not installed the license on your CellAdvisor.
- 3 Press the **MEASURE** hot key, and then select the measurement mode from the following choices:
 - EMF Spectrum**
 - EMF Replayer**

Configuring test parameters

Setting frequency

You need to set the frequency range to be measured with either the center frequency/span or the start/stop frequencies. You can also set the frequency with the channel number and span.

Procedure

To set the center frequency and span:

- 1 Press the **FREQ/DIST** hard key.
- 2 Toggle the **Unit** soft key and select **Freq.**
- 3 To set the center frequency, complete the following steps:
 - a Press the **Center Frequency** soft key.

- b Enter a value by using the numeric keys. You can also use the rotary knob or the arrow keys.
 - c Select the unit from the choices: **GHz**, **MHz**, **kHz**, and **Hz**.
- 4 To set the span frequency, complete the following steps:
- a Press the **Span** soft key.
 - b Enter a value by using the numeric keys. You can also use the rotary knob or the arrow keys.
 - c Select the unit from the choices: **GHz**, **MHz**, **kHz**, and **Hz**.

To set the start and stop frequencies:

- 1 Press the **FREQ/DIST** hard key.
- 2 Toggle the **Unit** soft key and select **Freq**.
- 3 To set the start frequency, complete the following steps:
 - a Press the **Start Frequency** soft key.
 - b Enter a value by using the numeric keys. You can also use the rotary knob or the arrow keys.
 - c Select the unit from the choices: **GHz**, **MHz**, **kHz**, and **Hz**.
- 4 To set the stop frequency, complete the following steps:
 - a Press the **Stop Frequency** soft key.
 - b Enter a value by using the numeric keys. You can also use the rotary knob or the arrow keys.
 - c Select the unit from the choices: **GHz**, **MHz**, **kHz**, and **Hz**.
- 5 *Optional.* To define the amount of frequency increment for the rotary knob:
 - a Press the **Frequency Step** soft key, if the **Freq** is selected.
 - b Enter a value by using the numeric keys.
 - c Press the unit: **GHz**, **MHz**, **kHz**, or **Hz**.

To set the channel number and span:

- 1 Press the **FREQ/DIST** hard key.
- 2 Toggle the **Unit** soft key and select **Channel**.
- 3 To select the standard channel, complete the following steps:
 - a Press the **Channel Std** soft key. The standard channel window appears.
See "Appendix C – Band, frequency & channel standard" on page 769 for more information.
 - b Highlight the band to be measured by using the rotary knob, the arrow keys, or the **Page Up/Page Down** soft keys.
 - c Press the **Select** soft key or the rotary knob to confirm the selection.
- 4 Toggle the **Link** soft key to select the sweep direction and select **Fwd** (forward) or **Rev** (reverse) as you desire.
- 5 To set the channel number, complete the following steps:
 - a Press the **Channel Number** soft key.
 - b Enter a value by using the numeric keys.
 - c Press the **Enter** soft key or **ENTER** hard key to complete the entry.
The instrument automatically displays the corresponding center frequency value for the selected channel number.
- 6 To set the span frequency, complete the following steps:
 - a Press the **Span** soft key.
 - b Enter a value by using the numeric keys. You can also use the rotary knob or the arrow keys.
 - c Select the unit from the choices: **GHz**, **MHz**, **kHz**, and **Hz**.
- 7 *Optional.* To define the amount of channel increment for the rotary knob:
 - a Press the **Channel Step** soft key, if the **Channel** is selected.
 - b Enter a value by using the numeric keys.
 - c Press the **Enter** soft key.

Setting amplitude

Reference level and attenuation

You can set the reference and attenuation levels automatically or manually to optimize the display of the traces measured, as you desire.

Procedure

To automatically set the reference and attenuation level:

- 1 Press the **AMP/SCALE** hard key.
- 2 Press the **Auto Scale** soft key.
Each time you press this key, both of the Y-axis scale and input attenuation level change to be optimized with some margin.

To set the reference or attenuation level manually:

- 1 Press the **AMP/SCALE** hard key.
- 2 To set the maximum reference level on the Y-axis manually, complete the following steps:
 - a Press the **Reference Level** soft key.
 - b Enter a value by using the numeric keys or the rotary knob.
 - c Press your desired unit soft key from the available choices, which vary depending on your selection of the unit in the **Units** setting.
- 3 To set the input attenuation level, select one from the following choices:
To set the input attenuator's level automatically, select **Attenuation > Auto**.



NOTE

It is recommended that you set the **Attenuation** to **Auto** in most situations so that the level of the input attenuator can be set automatically according to your input signal level.

To set the input attenuation manually up to 55 dB for JD780B series or 50 dB for JD740B series to optimize S/N, complete the following steps:

- a Select **Attenuation > Manual**.
- b Press the **Attenuation Value** soft key to set the level.
- c Enter a value in fives by using the numeric keys.
- d Press the **dB** soft key or the **ENTER** hard key.

To change the scale unit:

- 1 Select **More (1/2) > Units**.
 - 2 Select the unit of the display scale: **dBμV/m**, **dBmV/m**, **dBV/m**, **V/m**, **Watt/m²**, **dBm/m²**, **dBW/m²**, **A/m**, **dB A/m**, and **Watt/cm²**.
The scale unit on the screen changes accordingly.
-

Pre-amplifier

You can turn on the internal pre-amplifier to correct and compensate for the gain of the preamplifier so that amplitude readings show the values at the input connector.

Procedure

- 1 Press the **AMP/SCALE** hard key.
 - 2 Toggle the **Preamp** soft key and select **On** or **Off** as needed.
-



NOTE

You can turn on the Preamp when the input attenuation range is from 0 dB to 10 dB. If the attenuation value is manually set to greater than 10 dB, the instrument will automatically turn off the pre-amplifier to display low-level signal properly on the chart.

External offset

You can turn on the **External Offset** and manually set the external offset value.

Procedure

To set the external offset:

- 1 Press the **AMP/SCALE** hard key.
- 2 Toggle the **External Offset** soft key and select **On**.
- 3 Enter a value by using the numeric keys.
- 4 Press the **dB** soft key to complete the entry.

To turn the external offset off:

- 1 Press the **AMP/SCALE** hard key.
 - 2 Toggle the **External Offset** soft key and select **Off**.
-

Scale per division

You can use the **Scale/Div** feature available for the spectrum measurement screen. It represents the value of one division on the horizontal scale. The default setting is 10 dB per division and the maximum value can be set up to 20 dB.

Procedure

To set the scale per division:

- 1 Press the **AMP/SCALE** hard key.
 - 2 Select **More (1/2) > Scale/Div**.
 - 3 Enter a value between 1 and 20 by using the numeric keys.
 - 4 Press the **dB** soft key to complete the entry.
-

Setting bandwidth

You can set the Resolution Bandwidth (RBW) and Video Bandwidth (VBW) manually or automatically. Selecting **Auto** changes the value to correspond to your frequency span setting for RBW and VBW.

Procedure

To automatically set the RBW and VBW:

- 1 Press the **BW/AVG** hard key.
- 2 Toggle the **RBW** soft key and select **Auto**.
- 3 Toggle the **VBW** soft key and select **Auto**.
The RBW or VBW value on the screen changes accordingly based on the span.

To manually set the RBW or VBW:

- 1 Press the **BW/AVG** hard key.
 - 2 Press the **RBW** soft key.
 - 3 Enter a value in 1-3 sequence by using the numeric keys.
 - 4 Select the unit from the choices: **MHz**, **kHz**, and **Hz**.
The RBW setting automatically changes to **Manual**.
 - 5 Press the **VBW** soft key.
 - 6 Enter a value by using the numeric keys.
 - 7 Select the unit from the choices: **MHz**, **kHz**, and **Hz**.
The VBW setting automatically changes to **Manual**.
-

The RBW or VBW value on the screen changes accordingly.

Conducting EMF spectrum measurements

After you have configured test parameters as described in the “Configuring test parameters” on page 754, you can start your EMF measurements. If you log your measurement, you can play back using the EMF Replayer. For more information on saving logging data, see “Logging EMF spectrum data” on page 760.

Procedure

- 1 Press the **MEASURE SETUP** hot key.
- 2 To specify the amount of measurement time that you want the instrument to stay for on each axis:
 - a Press the **Dwell Time** soft key.
 - b Enter a value in seconds between one and 60.
 - c Press the unit soft key or the **ENTER** hard key.
- 3 To specify the amount of measurement time that you want the instrument to stay for on all three axes in order to display current and accumulated EMF power:
 - a Press the **Measurement Time** soft key.
 - b Enter a value in minutes or in seconds. You can set this up to 30 minutes.
 - c Select the unit from the choices: **Minute** and **Second**.



NOTE

The Isotropic EMF Power is the current or the latest average power measured with three axes for the specified dwell time for the axis while the Accumulated Isotropic EMF Power is the average, maximum, and minimum power taken from the number (n) times of measurements.

- 4 To specify the number of EMF measurements that you want to make:
 - a Press the **# of Measurement** soft key.
 - b Enter a value. Depending on your settings for Dwell Time and Measurement Time, you can set this up to 600.
 - c Press the **Enter** soft key or the **ENTER** hard key.



NOTE

The dwell time, measurement time, and number of measurement are correlated based on the equation of “**# of Measurement = Measurement Time / (Dwell Time x 3)**”. For example, if you set the Dwell Time to 60 seconds and the Measurement Time to 30 minutes, you can enter “10” for the # of Measurement”.

- 5 To start the measurement, toggle the **Measurement** soft key and select **On**. The instrument displays measurement results on the screen. Figure 458 is an example.
 - 6 To hold the display, press the **HOLD** hot key.
 - 7 To release the display, press the **HOLD** hot key again.
 - 8 To stop the measurement, toggle the **Measurement** soft key and select **Off**.
 - 9 To clear current display and start new measurement, press the **Restart** soft key.
-

Figure 458 EMF spectrum measurement with EMF analyzer

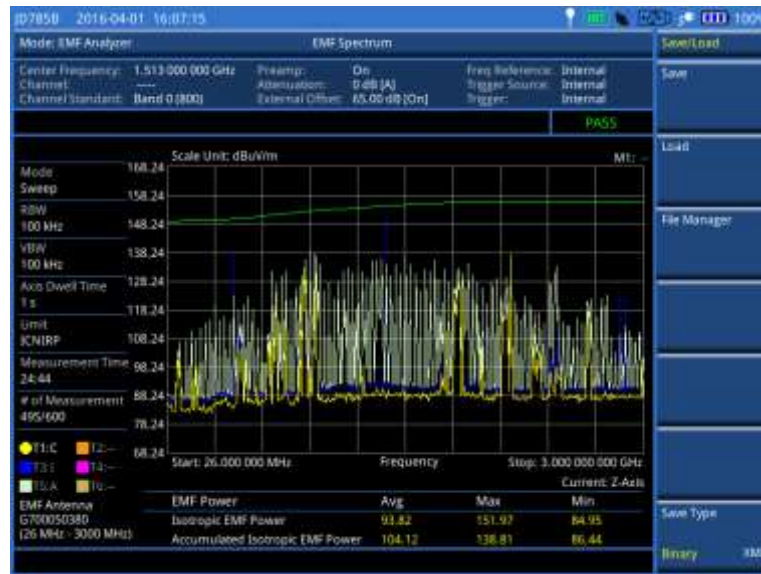

Setting trace

You can display up to six traces on the measurement chart simultaneously.

Procedure

- 1 Press the **TRACE/DISPLAY** hard key.
- 2 Press the **Select Trace** soft key, and then select the trace number from the following choices:
 - T1: Current EMF Trace
 - T2: EMF Trace of X-axis
 - T3: Isotropic EMF Trace
 - T4: EMF Trace of Y-axis
 - T5: Accumulated Isotropic EMF Trace
 - T6: EMF Trace of Z-axis

The legend shape of the selected trace changes from square to round to indicate that the trace is the active one now.

- 3 Toggle the **Trace View** soft key to **On** to show the selected trace on the display or to **Off** to hide it from the display.

Setting limit

You can set three different limits to analyze the results, as you desire.

Procedure

To set the display line:

- 1 Press the **LIMIT** hot key.
- 2 Toggle the **Display Line** soft key to **On**.
The straight horizontal line appears to be used as a visual reference only.
- 3 Press the **Display Line** soft key, and then enter a value that you want to set as a reference.
- 4 Select your desired unit soft key from the available choices, which vary depending on your selection of the unit in the **Units** setting in Amp/Scale.

To set the multiple segment line:

- 1 Press the **LIMIT** hot key.
- 2 Press the **Multi Segment Line** soft key for Pass/Fail indication.
- 3 Toggle the **Limit** soft key between **Upper** and **Lower** to select the one to be displayed.
- 4 Set the number of segments for the selected upper or lower limit line, up to 50 segments.
 - a Press the **# of Line** soft key.
 - b Enter a value between 1 and 50 by using the numeric keys.
 - c Press the **Enter** soft key.
- 5 Press the **Autoset** soft key to let the instrument set the limit for each segment and display the line.
- 6 *Optional.* To move the limit line, complete the following steps:
 - a Select **Limit Up/Down** or **Limit Left/Right**.
 - b Turn the rotary knob to move the line as desired. You can also manually enter a value.
- 7 *Optional.* To edit the segment properties, complete the following steps:
 - a Press the **Edit Limit** soft key.
 - b Press the **Move** soft key and then turn the rotary knob to select the segment to edit.
 - c Select the menu option, from the following choices:
 - To hide the line for the selected segment, toggle the **Line** soft key and select **Off**.
 - To add a new point, press the **Add Point** soft key.
 - To delete the selected point, press the **Delete Point** soft key.
 - To change the position, press the **Frequency** or **Amplitude** soft key, and then turn the rotary knob to change the value as desired.
- 8 *Optional.* Go to **SAVE/LOAD > Save**, and then select **Limit** to save the limit settings. See "Using save" on page 34 for more information.

To set the ICNIRP limit:

- 1 Press the **LIMIT** hot key.
- 2 Toggle the **ICNIRP Limit** soft key to **On** to show a reference line for the set span frequency range based on the ICNIRP guidelines or to **Off** to hide the line from the display.

Recording and replaying EMF logging data

Logging EMF spectrum data

You can record EMF spectrum measurement as a logging file in `.grr` file type so that you can play it back in the spectrogram chart view for data analysis.

Procedure

- 1 Press the **SAVE/LOAD** hot key.
 - 2 Select the **Save** soft key.
 - 3 Select the **Save Logging Data** soft key. The on-screen keyboard appears.
 - 4 Type the name of the file in the **File Name** field.
-  **NOTE**
It is recommended that you use an external USB memory drive to save logging data in order to have enough free space.
- 5 Press the **Save** soft key to start logging. The "**Recording**" appears on the screen.
 - 6 Press the **ESC** hard key to stop logging data and complete saving.
-

Replaying EMF spectrum data

If you have recorded logging data in the EMF Spectrum mode, you can load the saved data in the EMF Replayer mode and view them in the spectrogram chart for your analysis.

Loading a saved logging file

Procedure

- 1 In the EMF Analyzer mode, press the **MEASURE** hot key.
- 2 Press the **EMF Replayer** soft key.
The file explorer window appears.
- 3 Navigate to the `.grr` file that you have saved in the EMF Spectrum mode.



NOTE

In the File Information pane, you can find the properties of the file that you want to open. If the selected logging data have been saved in a measurement mode other than EMF Spectrum, the instrument will display an error message at the bottom of the window.

- 4 Press the **Load** soft key.
The EMF Replayer window appears with the upper spectrogram chart and the lower spectrum chart. The spectrum chart displays two traces: isotropic trace and isotropic average trace.
-

Changing play options

Procedure

- 1 Press the **MEASURE** hot key.
 - 2 Toggle the **Replay Direction** soft key between **FWD** and **REV** to change play direction to forward or reverse.
 - 3 Press the **Replay Speed** soft key, and then select the speed option: **x1**, **x2**, **x3**, and **x4**.
 - 4 Press the **Play** soft key to start playing the recorded logging data.
 - 5 Press the **Pause** soft key to pause or stop playing the recorded logging data.
 - 6 To move to a particular failure position directly and play from there, complete the following steps:
 - a Press the **Jump to Fail Index** soft key.
 - b Enter a value by using the numeric keys.
 - c Press the **Enter** soft key.
-



NOTE

If you connected a USB drive, do not remove it while playing. Doing so may freeze the USB port, which will require you to restart the instrument to get a USB drive recognized again.

Changing amplitude settings

You can change the reference level, scale per division, and units to optimize the display of the recorded data while replaying, as you desire.

Procedure

- 1 Press the **AMP/SCALE** hard key.
 - 2 To set the maximum reference level on the Y-axis, complete the following steps:
 - a Press the **Reference Level** soft key.
 - b Enter a value by using the numeric keys or the rotary knob with 10 dB increments.
 - c Press your desired unit soft key from the choices, which vary depending on your selection of the unit in the **Units** setting.
-

- 3** To change the scale unit, select **Units** and then select the unit of the display scale from the choices: **dB μ V/m**, **dBmV/m**, **dBV/m**, **V/m**, **Watt/m²**, **dBm/m²**, **dBW/m²**, **A/m**, **dBa/m**, and **Watt/cm²**.
The scale unit on the screen changes accordingly.
-



Appendix

Topics discussed in this chapter are as follows:

■ Appendix A – Product general information	764
■ Appendix B – Cable list	768
■ Appendix C – Band, frequency & channel standard	769
■ Appendix D – VSWR-Return loss conversion table	772
■ Appendix E – Cyclic prefix table.....	773
■ Appendix F – Motorola CDMA/EV-DO LMF	774
■ Appendix G – Bluetooth connection	776
■ Appendix H – Device driver installation.....	779
■ Appendix I – Ordering information	780
■ Appendix J – RoHS information	795
■ Appendix K – On-screen keyboard	797
■ Appendix L – Supported map display parameters	800

Appendix A – Product general information

JD780B series

	JD785B/JD786B	JD788B	Supplemental Information
Inputs and Outputs			
RF In			Spectrum Analyzer
Connector	Type-N female	Type-N female	
Impedance	50 Ω	50 Ω	Nominal
Damage Level	>+33 dBm, \pm 50 V DC	>+33 dBm, \pm 50 V DC	Nominal
Reflection/RF Out			Cable and Antenna Analyzer
Connector	Type-N female	Type-N female	
Impedance	50 Ω	50 Ω	Nominal
Damage Level	>+40 dBm, \pm 50 V DC	>+40 dBm, \pm 50 V DC	Nominal
RF In			Cable and Antenna Analyzer
Connector	Type-N female	N/A	
Impedance	50 Ω	N/A	Nominal
Damage Level	>+25 dBm, \pm 50 V DC	N/A	Nominal
External Trigger, GPS			
Connector	SMA female	SMA female	
Impedance	50 Ω	50 Ω	Nominal
External Ref			
Connector	SMA female	SMA female	
Impedance	50 Ω	50 Ω	Nominal
Input Frequency	10, 13, 15 MHz	10, 13, 15 MHz	
Input Range	-5 to +5 dBm	-5 to +5 dBm	
USB			
USB Host	Type A, 1 port	Type A, 1 port	
USB Client	Type B, 1 port	Type B, 1 port	
LAN	RJ45, 10/100 Base-T	RJ45, 10/100 Base-T	
SFP/SFP+	MSA compliant	MSA compliant	In optical hardware option
Audio Jack	3.5 mm headphone jack	3.5 mm headphone jack	
External Power	5.5 mm barrel connector	5.5 mm barrel connector	
Speaker	Built-in speaker	Built-in speaker	
Display			
Type	Resistive touch screen	Resistive touch screen	
Size	8"	8"	LCD backlight, transfective LCD with anti-glare coating
Resolution	800 x 600	800 x 600	

	JD785B/JD786B	JD788B	Supplemental Information
Power			
External DC Input	18 V DC	18 V DC	
Power Consumption	42 W	42 W	54 W maximum when charging battery
Battery			
Operating Time	10.8 V, 7800 mA-h > 3 hours (Typical)	10.8 V, 7800 mA-h > 3 hours (Typical)	Lithium Ion In balance mode
Charge Time	2.5 hours (80 %) 5 hours (100 %)	2.5 hours (80 %) 5 hours (100 %)	In case of a fully discharged battery
Storage Temperature	0 to 25°C (32 to 77°F)	0 to 25°C (32 to 77°F)	The battery pack should be stored in an environment with low humidity. Extended exposure to temperature above 45°C could degrade battery performance and life.
Data Storage			
Internal	Maximum 500 MB	Maximum 500 MB	
External	Limited to the size of USB flash drive	Limited to the size of USB flash drive	Supports USB 2.0 compatible memory devices
Environmental			
Operating Temperature			
AC Power	0 to 40°C (32 to 104°F)	0 to 40°C (32 to 104°F)	With no derating
Battery	0 to 40°C (32 to 104°F) -10 to 55 °C (14 to 131 °F)	0 to 40°C (32 to 104°F) -10 to 55 °C (14 to 131 °F)	At charging At discharging
Maximum Humidity	95% RH	95% RH	Non-condensing
Shock and Vibration	MIL-PRF-28800F Class 2	MIL-PRF-28800F Class 2	
Storage Temperature	-30 to 71°C (-22 to 160°F)	-30 to 71°C (-22 to 160°F)	With the battery pack removed
EMC			
	EN 61326-1:2013 CISPR11:2009 Class A	EN 61326-1:2013 CISPR11:2009 Class A	Complies with European EMC
Safety			
	EN 61010-1:2010 UL 61010-1:2012 & CAN/CSA C22.2 No. 61010-1-12	EN 61010-1:2010 UL 61010-4:2012 & CAN/CSA C22.2 No. 61010-1-12	Complies with European LVD Complies with TUV NRTL
Size and Weight (Standard Configuration)			
Weight	<4.6 kg (10.1 lb.)	<4.2 kg (9.3 lb.)	With battery
Size	295 x 195 x 82 (mm) 11.6 x 7.7 x 3.2 (Inch)	295 x 195 x 82 (mm) 11.6 x 7.7 x 3.2 (Inch)	Approximately (W x H x D)
Warranty			
	3 years	3 years	
Calibration Cycle			
	1 year	1 year	

JD740B series

	JD745B/JD746B	JD748B	Supplemental Information
Inputs and Outputs			
RF In			Spectrum Analyzer
Connector	Type-N female	Type-N female	
Impedance	50 Ω	50 Ω	Nominal
Damage Level	>+40 dBm, \pm 50 V DC	>+40 dBm, \pm 50 V DC	Nominal
Reflection/RF Out			Cable and Antenna Analyzer
Connector	Type-N female	Type-N female	
Impedance	50 Ω	50 Ω	Nominal
Damage Level	>+37 dBm, \pm 50 V DC	>+37 dBm, \pm 50 V DC	Nominal
RF In			Cable and Antenna Analyzer
Connector	Type-N female	N/A	
Impedance	50 Ω	N/A	Nominal
Damage Level	>+25 dBm, \pm 50 V DC	N/A	Nominal
External Trigger, GPS			
Connector	SMA female	SMA female	
Impedance	50 Ω	50 Ω	Nominal
External Ref			
Connector	SMA female	SMA female	
Impedance	50 Ω	50 Ω	Nominal
Input Frequency	10, 13, 15 MHz	10, 13, 15 MHz	
Input Range	-5 to +5 dBm	-5 to +5 dBm	
USB			
USB Host	Type A, 1 port	Type A, 1 port	
USB Client	Type B, 1 port	Type B, 1 port	
LAN	RJ45, 10/100 Base-T	RJ45, 10/100 Base-T	
SFP/SFP+	MSA compliant	MSA compliant	In optical hardware option
Audio Jack	3.5 mm headphone jack	3.5 mm headphone jack	
External Power	5.5 mm barrel connector	5.5 mm barrel connector	
Speaker	Built-in speaker	Built-in speaker	
Display			
Type	Resistive touch screen	Resistive touch screen	
Size	8"	8"	LCD backlight, transfective LCD with anti-glare coating
Resolution	800 x 600	800 x 600	

	JD745B/JD746B	JD748B	Supplemental Information
Power			
External DC Input	18 V DC	18 V DC	
Power Consumption	42 W	42 W	54 W maximum when charging battery
Battery			
Operating Time	10.8 V, 7800 mA-h > 3 hours (Typical)	10.8 V, 7800 mA-h > 3 hours (Typical)	Lithium Ion In balance mode
Charge Time	2.5 hours (80 %) 5 hours (100 %)	2.5 hours (80 %) 5 hours (100 %)	In case of a fully discharged battery
Storage Temperature	0 to 25°C (32 to 77°F)	0 to 25°C (32 to 77°F)	The battery pack should be stored in an environment with low humidity. Extended exposure to temperature above 45°C could degrade battery performance and life.
Data Storage			
Internal	Maximum 500 MB	Maximum 500 MB	
External	Limited to the size of USB flash drive	Limited to the size of USB flash drive	Supports USB 2.0 compatible memory devices
Environmental			
Operating Temperature			
AC Power	0 to 40°C (32 to 104°F)	0 to 40°C (32 to 104°F)	With no derating
Battery	0 to 40°C (32 to 104°F)	0 to 40°C (32 to 104°F)	At charging
	-10 to 55 °C (14 to 131 °F)	-10 to 55 °C (14 to 131 °F)	At discharging
Maximum Humidity	95% RH	95% RH	Non-condensing
Shock and Vibration	MIL-PRF-28800F Class 2	MIL-PRF-28800F Class 2	
Storage Temperature	-30 to 71°C (-22 to 160°F)	-30 to 71°C (-22 to 160°F)	With the battery pack removed
EMC			
	IEC/EN 61326-1:2013 CISPR11:2009 Class A	IEC/EN 61326-1:2013 CISPR11:2009 Class A	Complies with European EMC
Safety			
	EN 61010-1:2010 UL 61010-1:2012 & CAN/CSA C22.2 No. 61010-1-12	EN 61010-1:2010 UL 61010-4:2012 & CAN/CSA C22.2 No. 61010-1-12	Complies with European LVD Complies with TUV NRTL
Size and Weight (Standard Configuration)			
Weight	<4.17 kg (9.19 lb.)	<3.77 kg (8.31 lb.)	With battery
Size	295 x 195 x 82 (mm) 11.6 x 7.7 x 3.2 (Inch)	295 x 195 x 82 (mm) 11.6 x 7.7 x 3.2 (Inch)	Approximately (W x H x D)
Warranty			
	3 years	3 years	
Calibration Cycle			
	1 year	1 year	

Appendix B – Cable list

Cable Type	Relative Propagation Velocity (V _p)	Nominal Attenuation dB/m @ 1000 MHz
FSJ1-50A	0.84	0.197
FSJ250	0.83	0.134
FSJ4-50B	0.81	0.119
HCC 12-50J	0.915	0.092
HCC 158-50J	0.95	0.023
HCC 300-50J	0.96	0.014
HCC 312-50J	0.96	0.013
HCC 78-50J	0.915	0.042
HF 4-1/8" Cu2Y	0.97	0.01
HF 5" Cu2Y	0.96	0.007
HF 6-1/8" Cu2Y	0.97	0.006
HJ4.5-50	0.92	0.054
HJ4-50	0.914	0.087
HJ5-50	0.916	0.042
HJ7-50A	0.921	0.023
LDF12-50	0.88	0.022
LDF4-50A	0.88	0.077
LDF5-50A	0.89	0.043
LDF6-50	0.89	0.032
LDF7-50A	0.88	0.027
LMR100	0.8	0.792
LMR1200	0.88	0.044
LMR1700	0.89	0.033
LMR200	0.83	0.344
LMR240	0.84	0.262
LMR400	0.85	0.135
LMR500	0.86	0.109
LMR600	0.87	0.087
LMR900	0.87	0.056
RG142	0.69	0.443
RG17, 17A	0.659	0.18
RG174	0.66	0.984
RG178B	0.69	1.509
RG187, 188	0.69	1.017
RG213/U	0.66	0.292
RG214	0.659	0.292
RG223	0.659	0.165
RG55, 55A, 55B	0.659	0.541
RG58, 58B	0.659	1.574
RG58A, 58C	0.659	0.787
RG8, 8A, 10, 10A	0.659	0.262
RG9, 9A	0.659	0.289
HFSC-12D(1/2")	0.81	0.112
HFC-12D(1/2")	0.88	0.072
HFC-22D(7/8")	0.88	0.041
HFC-33D(1_1/4")	0.88	0.0294
HFC-42D(1_5/8")	0.87	0.0243
RFCX-12D(1/2")	0.88	0.088
RFCX-22D(7/8")	0.88	0.049
RFCX-33D(1_1/4")	0.88	0.038
RFCX-42D(1_5/8")	0.87	0.028
RFCL-22D(7/8")	0.88	0.044
RFCL-33D(1_1/4")	0.88	0.034
RFCL-42D(1_5/8")	0.87	0.0315

Appendix C – Band, frequency & channel standard

Standard	Uplink			Downlink		
	Start Freq (MHz)	Stop Freq (MHz)	Valid Channels	Start Freq (MHz)	Stop Freq (MHz)	Valid Channels
GSM						
GSM 450	450.40	457.60	259≤n≤293	460.40	467.60	259≤n≤293
GSM 480	478.80	486.00	306≤n≤340	488.80	496.00	306≤n≤340
GSM 850	824.00	849.00	128≤n≤251	869.00	894.00	128≤n≤251
P-GSM 900	890.00	915.00	1≤n≤124	935.00	960.00	1≤n≤124
E-GSM 900	880.00	915.00	0≤n≤124	925.00	960.00	0≤n≤124
			975≤n≤1023			975≤n≤1023
R-GSM 900	876.00	915.00	0≤n≤124	921.00	960.00	0≤n≤124
			955≤n≤1023			955≤n≤1023
R-GSM 900 (China)	885.00	889.00	999≤n≤1019	930.00	934.00	999≤n≤1019
DCS 1800	1710.00	1785.00	512≤n≤885	1805.00	1880.00	512≤n≤885
PCS 1900	1850.00	1910.00	512≤n≤810	1930.00	1990.00	512≤n≤810
CDMA						
Band 0 (800)	824.00	849.00	1≤n≤799	869.00	894.00	1≤n≤799
			991≤n≤1023			991≤n≤1023
Band 1 (NA PCS)	1850.00	1910.00	0≤n≤1199	1930.00	1990.00	0≤n≤1199
Band 2 (TACS)	872.0125	914.9875	0≤n≤1000	917.0125	959.9875	0≤n≤1000
			1329≤n≤2047			1329≤n≤2047
Band 3 (JTACS)	887.0125	924.9875	1≤n≤799	832.0125	869.9875	1≤n≤799
			801≤n≤1039			801≤n≤1039
			1041≤n≤1199			1041≤n≤1199
Band 4 (KR PCS)	1750.00	1780.00	0≤n≤599	1840.00	1870.00	0≤n≤599
			1≤n≤300			1≤n≤300
Band 5 (450)	411.675	483.480	539≤n≤871	421.6750	493.4800	539≤n≤871
			1039≤n≤1473			1039≤n≤1473
			1792≤n≤2016			1792≤n≤2016
Band 6 (2100)	1920.00	1980.00	0≤n≤1199	2100.00	2170.00	0≤n≤1199
Band 7 (700)	776.00	794.00	0≤n≤359	746.00	764.00	0≤n≤359
Band 8 (1800)	1710.00	1784.95	0≤n≤1499	1805.00	1879.95	0≤n≤1499
Band 9 (900)	880.00	914.95	0≤n≤699	925.00	959.95	0≤n≤699
Band 10 (2nd 800)	806.000	900.975	0≤n≤719	851.000	939.975	0≤n≤719
			720≤n≤919			720≤n≤919
WCDMA						
Band Global						
Band 1 (2100-General)	1920.0	1980.0	9612≤n≤9888	2110.0	2170.0	10562≤n≤10838
Band 2 (1900-General)	1850.0	1910.0	9262≤n≤9538	1930.0	1990.0	9662≤n≤9938
Band 2 (1900-Additional)			12≤n≤287			412≤n≤687
Band 3 (1800-General)	1710.0	1780.0	937≤n≤1288	1805.0	1880.0	1162≤n≤1513
Band 4 (1700-General)	1710.0	1775.0	1312≤n≤1513	2110.0	2155.0	1537≤n≤1738
Band 4 (1700-Additional)			1662≤n≤1862			1887≤n≤2087
Band 5 (850-General)	824.0	849.0	4132≤n≤4233	869.0	894.0	4357≤n≤4458
Band 5 (850-Additional)			782≤n≤862			1007≤n≤1087
Band 6 (800-General)	830.0	840.0	4162≤n≤4188	875.0	885.0	4387≤n≤4413
Band 6 (800-Additional)			812≤n≤837			1037≤n≤1062
Band 7 (2600-General)	2500.0	2570.0	2012≤n≤2338	2620.0	2690.0	2237≤n≤2563
Band 7 (2600-Additional)			2362≤n≤2687			2587≤n≤2912
Band 8 (900-General)	880.0	915.0	2712≤n≤2863	925.0	960.0	2937≤n≤3088
Band 9 (1700-General)	1749.9	1784.9	8762≤n≤8912	1844.9	1879.9	9237≤n≤9387
Band 10 (1700-General)	1710.0	1770.0	2887≤n≤3163	2110.0	2170.0	3112≤n≤3388
Band 10 (1700-Additional)			3187≤n≤3462			3412≤n≤3687
Band 11 (1500-General)	1427.9	1447.9	3487≤n≤3562	1475.9	1495.9	3712≤n≤3787
Band 12 (700-General)	699.0	716.0	3617≤n≤3678	729.0	746.0	3842≤n≤3903
Band 12 (700-Additional)			3707≤n≤3767			3932≤n≤3992
Band 13 (700-General)	777.0	787.0	3792≤n≤3818	746.0	756.0	4017≤n≤4043
Band 13 (700-Additional)			3842≤n≤3867			4067≤n≤4092
Band 14 (700-General)	788.0	798.0	3892≤n≤3918	758.0	768.0	4117≤n≤4143
Band 14 (700-Additional)			3942≤n≤3967			4167≤n≤4192
Band 19 (800-General)	830.0	845.0	312≤n≤363	875.0	890.0	712≤n≤763
Band 19 (800-Additional)			387≤n≤437			787≤n≤837
Band 20 (800-General)	832.0	862.0	4287≤n≤4413	791.0	821.0	4512≤n≤4638
Band 21 (1500-General)	1447.9	1462.9	462≤n≤512	1495.9	1510.9	862≤n≤912

Appendix

Band 22 (3500-General)	3410.0	3490.0	4437≤n≤4813	3510.0	3590.0	4662≤n≤5038
Band 25 (1900-General)	1850.0	1915.0	4887≤n≤5188	1930.0	1995.0	5112≤n≤5413
Band 25 (1900-Additional)			5212≤n≤5512			5437≤n≤5737
Band 26 (800-General)	814.0	849.0	5537≤n≤5688	859.0	894.0	5762≤n≤5913
Band 26 (800-Additional)			5712≤n≤5862			5937≤n≤6087

LTE-FDD

Band Global						
Band 1 (2100)	1920.0	1980.0	18000≤n≤18599	2110.0	2170.0	0≤n≤599
Band 2 (1900)	1850.0	1910.0	18600≤n≤19199	1930.0	1990.0	600≤n≤1199
Band 3 (1800)	1710.0	1785.0	19200≤n≤19949	1805.0	1880.0	1200≤n≤1949
Band 4 (1700)	1710.0	1755.0	19950≤n≤20399	2110.0	2155.0	1950≤n≤2399
Band 5 (850)	824.0	849.0	20400≤n≤20649	869.0	894.0	2400≤n≤2649
Band 7 (2600)	2500.0	2570.0	20750≤n≤21449	2620.0	2690.0	2750≤n≤3449
Band 8 (900)	880.0	915.0	21450≤n≤21799	925.0	960.0	3450≤n≤3799
Band 9 (1700)	1749.9	1784.9	21800≤n≤22149	1844.9	1879.9	3800≤n≤4149
Band 10 (1700)	1710.0	1770.0	22150≤n≤22749	2110.0	2170.0	4150≤n≤4749
Band 11 (1500)	1427.9	1447.9	22750≤n≤22949	1475.9	1495.9	4750≤n≤4949
Band 12 (700)	699.0	716.0	23010≤n≤23179	729.0	746.0	5010≤n≤5179
Band 13 (700)	777.0	787.0	23180≤n≤23279	746.0	756.0	5180≤n≤5279
Band 14 (700)	788.0	798.0	23280≤n≤23379	758.0	768.0	5280≤n≤5379
Band 17 (700)	704.0	716.0	23730≤n≤23849	734.0	746.0	5730≤n≤5849
Band 18 (800)	815.0	830.0	23850≤n≤23999	860.0	875.0	5850≤n≤5999
Band 19 (800)	830.0	845.0	24000≤n≤24149	875.0	890.0	6000≤n≤6149
Band 20 (800)	832.0	862.0	24150≤n≤24449	791.0	821.0	6150≤n≤6449
Band 21 (1500)	1447.9	1462.9	24450≤n≤24599	1495.9	1510.9	6450≤n≤6599
Band 22 (3500)	3410.0	3490.0	24600≤n≤25399	3510.0	3590.0	6600≤n≤7399
Band 23 (2100)	2000.0	2020.0	25500≤n≤25699	2180.0	2200.0	7500≤n≤7699
Band 24 (1500)	1626.5	1660.5	25700≤n≤26039	1525.0	1559.0	7700≤n≤8039
Band 25 (1900)	1850.0	1915.0	26040≤n≤26689	1930.0	1995.0	8040≤n≤8689
Band 26 (800)	814.0	849.0	26690≤n≤27039	859.0	894.0	8690≤n≤9039

LTE-TDD

Band Global					
Band 33 (1900)	1900.0	1920.0	36000≤n≤36199		
Band 34 (2100)	2010.0	2025.0	36200≤n≤36349		
Band 35 (1850)	1850.0	1910.0	36350≤n≤36949		
Band 36 (1930)	1930.0	1990.0	36950≤n≤37549		
Band 37 (1910)	1910.0	1930.0	37550≤n≤37749		
Band 38 (2570)	2570.0	2620.0	37750≤n≤38249		
Band 39 (1880)	1880.0	1920.0	38250≤n≤38649		
Band 40 (2300)	2300.0	2400.0	38650≤n≤39649		
Band 41 (2496)	2496.0	2690.0	39650≤n≤41589		
Band 42 (3400)	3400.0	3600.0	41590≤n≤43589		
Band 43 (3600)	3600.0	3800.0	43590≤n≤45589		

TD-SCDMA

FBN 0	1785.0	1805.0	0≤n≤92		
FBN 1	1900.0	1920.0	0≤n≤92		
FBN 2	1920.0	1980.0	0≤n≤255		
FBN 3	1920.0	1980.0	0≤n≤36		
FBN 4	1980.0	2010.0	0≤n≤142		
FBN 5	2010.0	2025.0	0≤n≤67		
FBN 6	2100.0	2170.0	0≤n≤255		
FBN 7	2100.0	2170.0	0≤n≤36		
FBN 8	2170.0	2220.0	0≤n≤242		

WIMAX

ProfR1 (1.25 2150)	2150.625	2159.375	0≤n≤7			
ProfR2 (1.25 2305)	2305.625	2320.625	0≤n≤12			
ProfR3 (1.25 2361)	2361.875	2375.625	13≤n≤24			
ProfR4 (1.25 2500)	2500.625	2688.125	0≤n≤150			
ProfR5 (1.25 3400)	3400.625	3700.625	0≤n≤240			
ProfR6 (3.5 2598)	2524.750	2591.250	0≤n≤38	2598.750	2665.250	0≤n≤38
ProfR7 (3.5 3461)	3411.750	3443.250	0≤n≤18	3461.750	3493.250	0≤n≤18
ProfR8 (3.5 3551)	3501.750	3598.000	0≤n≤55	3551.750	3648.000	0≤n≤55
ProfR9 (3.5 3651)	3601.750	3698.000	0≤n≤55	3651.750	3748.000	0≤n≤55
ProfR10 (3.5 3751)	3701.750	3798.000	0≤n≤55	3751.750	3848.000	0≤n≤55
ProfR11 (7 2600)	2526.500	2589.500	0≤n≤36	2600.500	2663.500	0≤n≤36
ProfR12 (7 3463)	2413.500	3441.500	0≤n≤16	3463.500	3491.500	0≤n≤16
ProfR13 (7 3553)	3503.500	3596.250	0≤n≤53	3553.500	3646.250	0≤n≤53
ProfR14 (7 3653)	3603.500	3696.250	0≤n≤53	3653.500	3746.250	0≤n≤53
ProfR15 (7 3753)	3703.500	3796.250	0≤n≤53	3753.500	3846.250	0≤n≤53

ProfR26 (10 5275)	5275.000	5335.000	55≤n≤67	
ProfR27 (10 5740)	5740.000	5830.000	148≤n≤166	
ProfR28 (10 5735)	5735.000	5845.000	147≤n≤169	
ProfR29 (8.75 2304)	2304.375	2395.625	0≤n≤730	

Appendix D – VSWR-Return loss conversion table

This information is for the Cable and Antenna Analyzer mode of the JD785B/JD745B Base Station Analyzer and the JD786B/JD746B RF Analyzer.

- $\text{Return Loss} = 20 \log_{10}(\text{VSWR} + 1 / \text{VSWR} - 1)$ (dB)
- $\text{VSWR} = (10^{\text{R.L./20}} + 1 / 10^{\text{R.L./20}} - 1)$

VSWR	Return Loss (dB)	Trans. Loss (dB)	Volt. Refl Coeff	Power Trans (%)	Power Refl (%)	VSWR	Return Loss (dB)	Trans. Loss (dB)	Volt. Refl Coeff	Power Trans (%)	Power Refl (%)
1.00	—	0.000	0.00	100.0	0.0	1.64	12.3	0.263	0.24	94.1	5.9
1.01	46.1	0.000	0.00	100.0	0.0	1.66	12.1	0.276	0.25	93.8	6.2
1.02	40.1	0.000	0.01	100.0	0.0	1.68	11.9	0.289	0.25	93.6	6.4
1.03	36.6	0.001	0.01	100.0	0.0	1.70	11.7	0.302	0.26	93.3	6.7
1.04	34.2	0.002	0.02	100.0	0.0	1.72	11.5	0.315	0.26	93.0	7.0
1.05	32.3	0.003	0.02	99.9	0.1	1.74	11.4	0.329	0.27	92.7	7.3
1.06	30.7	0.004	0.03	99.9	0.1	1.76	11.2	0.342	0.28	92.4	7.6
1.07	29.4	0.005	0.03	99.9	0.1	1.78	11.0	0.356	0.28	92.1	7.9
1.08	28.3	0.006	0.04	99.9	0.1	1.80	10.9	0.370	0.29	91.8	8.2
1.09	27.3	0.008	0.04	99.8	0.2	1.82	10.7	0.384	0.29	91.5	8.5
1.10	26.4	0.010	0.05	99.8	0.2	1.84	10.6	0.398	0.30	91.3	8.7
1.11	25.7	0.012	0.05	99.7	0.3	1.86	10.4	0.412	0.30	91.0	9.0
1.12	24.9	0.014	0.06	99.7	0.3	1.88	10.3	0.426	0.31	90.7	9.3
1.13	24.3	0.016	0.06	99.6	0.4	1.90	10.2	0.440	0.31	90.4	9.6
1.14	23.7	0.019	0.07	99.6	0.4	1.92	10.0	0.454	0.32	90.1	9.9
1.15	23.1	0.021	0.07	99.5	0.5	1.94	9.9	0.468	0.32	89.8	10.2
1.16	22.6	0.024	0.07	99.5	0.5	1.96	9.8	0.483	0.32	89.5	10.5
1.17	22.1	0.027	0.08	99.4	0.6	1.98	9.7	0.497	0.33	89.2	10.8
1.18	21.7	0.030	0.08	99.3	0.7	2.00	9.5	0.512	0.33	88.9	11.1
1.19	21.2	0.033	0.09	99.2	0.8	2.50	7.4	0.881	0.43	81.6	18.4
1.20	20.8	0.036	0.09	99.2	0.8	3.00	6.0	1.249	0.50	75.0	25.0
1.21	20.4	0.039	0.10	99.1	0.9	3.50	5.1	1.603	0.56	69.1	30.9
1.22	20.1	0.043	0.10	99.0	1.0	4.00	4.4	1.938	0.60	64.0	36.0
1.23	19.7	0.046	0.10	98.9	1.1	4.50	3.9	2.255	0.64	59.5	40.5
1.24	19.4	0.050	0.11	98.9	1.1	5.00	3.5	2.553	0.67	55.6	44.4
1.25	19.1	0.054	0.11	98.8	1.2	5.50	3.2	2.834	0.69	52.1	47.9
1.26	18.8	0.058	0.12	98.7	1.3	6.00	2.9	3.100	0.71	49.0	51.0
1.27	18.5	0.062	0.12	98.6	1.4	6.50	2.7	3.351	0.73	46.2	53.8
1.28	18.2	0.066	0.12	98.5	1.5	7.00	2.5	3.590	0.75	43.7	56.3
1.29	17.9	0.070	0.13	98.4	1.6	7.50	2.3	3.817	0.76	41.5	58.5
1.30	17.7	0.075	0.13	98.3	1.7	8.00	2.2	4.033	0.78	39.5	60.5
1.32	17.2	0.083	0.14	98.1	1.9	8.50	2.1	4.240	0.79	37.7	62.3
1.34	16.8	0.093	0.15	97.9	2.1	9.00	1.9	4.437	0.80	36.0	64.0
1.36	16.3	0.102	0.15	97.7	2.3	9.50	1.8	4.626	0.81	34.5	65.5
1.38	15.9	0.112	0.16	97.5	2.5	10.00	1.7	4.807	0.82	33.1	66.9
1.40	15.8	0.122	0.17	97.2	2.8	11.00	1.6	5.149	0.83	30.6	69.4
1.42	15.2	0.133	0.17	97.0	3.0	12.00	1.5	5.466	0.85	28.4	71.6
1.44	14.9	0.144	0.18	96.7	3.3	13.00	1.3	5.762	0.86	26.5	73.5
1.46	14.6	0.155	0.19	96.5	3.5	14.00	1.2	6.040	0.87	24.9	75.1
1.48	14.3	0.166	0.19	96.3	3.7	15.00	1.2	6.301	0.88	23.4	76.6
1.50	14.0	0.177	0.20	96.0	4.0	16.00	1.1	6.547	0.88	22.1	77.9
1.52	13.7	0.189	0.21	95.7	4.3	17.00	1.0	6.780	0.89	21.0	79.0
1.54	13.4	0.201	0.21	95.5	4.5	18.00	1.0	7.002	0.89	19.9	80.1
1.56	13.2	0.213	0.22	95.2	4.8	19.00	0.9	7.212	0.90	19.0	81.0
1.58	13.0	0.225	0.22	94.9	5.1	20.00	0.9	7.413	0.90	18.1	81.9
1.60	12.7	0.238	0.23	94.7	5.3	25.00	0.7	8.299	0.92	14.8	85.2
1.62	12.5	0.250	0.24	94.4	5.6	30.00	0.6	9.035	0.94	12.5	87.5

Appendix E – Cyclic prefix table

This information is for the LTE – FDD Signal Analyzer mode and the LTE – TDD Signal Analyzer mode of the JD785B/JD745B Base Station Analyzer and the JD788B/JD748B Signal Analyzer. Following table shows OFDM parameter details by different bandwidth.

Bandwidth	Configuration (Downlink)		Cyclic Prefix Length	
			TS	μs
20 MHz	Normal CP	$\Delta f=15$ kHz	160 for $l=0$	5.208
			144 for $l=1,2,\dots,6$	4.6875
	Extended CP	$\Delta f=15$ kHz	512 for $l=0,1,\dots,5$	16.667
			$\Delta f=7.5$ kHz	1024 for $l=0,1,2$
15 MHz	Normal CP	$\Delta f=15$ kHz	120 for $l=0$	5.208
			108 for $l=1,2,\dots,6$	4.6875
	Extended CP	$\Delta f=15$ kHz	384 for $l=0,1,\dots,5$	16.667
			$\Delta f=7.5$ kHz	768 for $l=0,1,2$
10 MHz	Normal CP	$\Delta f=15$ kHz	80 for $l=0$	5.208
			72 for $l=1,2,\dots,6$	4.6875
	Extended CP	$\Delta f=15$ kHz	256 for $l=0,1,\dots,5$	16.667
			$\Delta f=7.5$ kHz	512 for $l=0,1,2$
5 MHz	Normal CP	$\Delta f=15$ kHz	40 for $l=0$	5.208
			36 for $l=1,2,\dots,6$	4.6875
	Extended CP	$\Delta f=15$ kHz	128 for $l=0,1,\dots,5$	16.667
			$\Delta f=7.5$ kHz	248 for $l=0,1,2$
3 MHz	Normal CP	$\Delta f=15$ kHz	20 for $l=0$	5.208
			18 for $l=1,2,\dots,6$	4.6875
	Extended CP	$\Delta f=15$ kHz	64 for $l=0,1,\dots,5$	16.667
			$\Delta f=7.5$ kHz	128 for $l=0,1,2$
1.4 MHz	Normal CP	$\Delta f=15$ kHz	10 for $l=0$	5.208
			9 for $l=1,2,\dots,6$	4.6875
	Extended CP	$\Delta f=15$ kHz	32 for $l=0,1,\dots,5$	16.667
			$\Delta f=7.5$ kHz	64 for $l=0,1,2$

Appendix F – Motorola CDMA/EV-DO LMF

Motorola's CDMA/EV-DO base stations (BTS) are optimized with the assistance of Local Maintenance Facility (LMF), a Motorola's software tool that interfaces with the cell site and the instrument. The optimization process identifies the accumulated loss (or gain) for all receiving and transmitting paths at the cell site and stores that value in the system's database.

Using JD700B series LMF interface

An emulation interface to LMF has been implemented in Viavi's base station analyzer (JD785B/ JD745B) in order to perform BTS optimization procedures. The scope of this emulation is to do maintenance tests of TX Calibration and TX Audit required in routine maintenance practices with or without the use of an external power sensor. Using the external power sensor, you can get highly accurate measurement results.

Setting up for a LMF test

Procedure

- To connect your instrument both with BTS and PC, do one of the following:
 - Internal power sensor: Connect the Motorola CDMA/EV-DO BTS with the Spectrum Analyzer RF In 50 Ω port of JD785B/ JD745B and connect the WinLMF running PC with JD785B/ JD745B via a hub as illustrated in the **Figure 459**.
 - External power sensor: Connect an external power sensor to the USB Host port of JD785B/ JD745B and to the BTS and connect the WinLMF running PC with JD785B/ JD745B via a hub as illustrated in the **Figure 460**.
-

Figure 459 Using internal power sensor

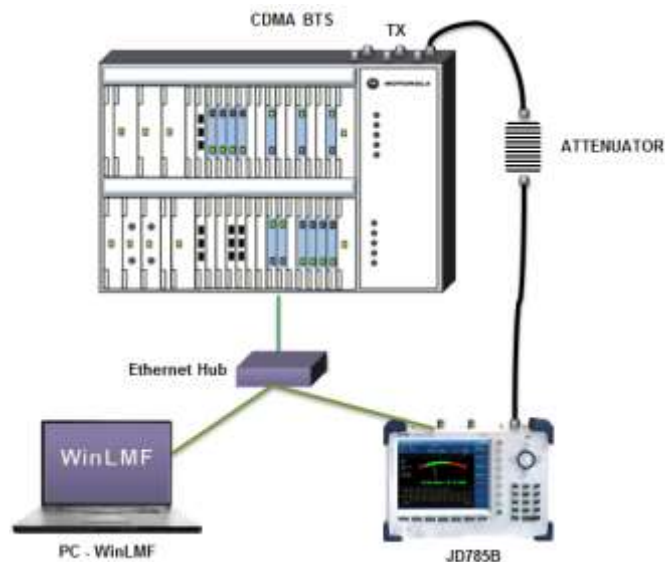
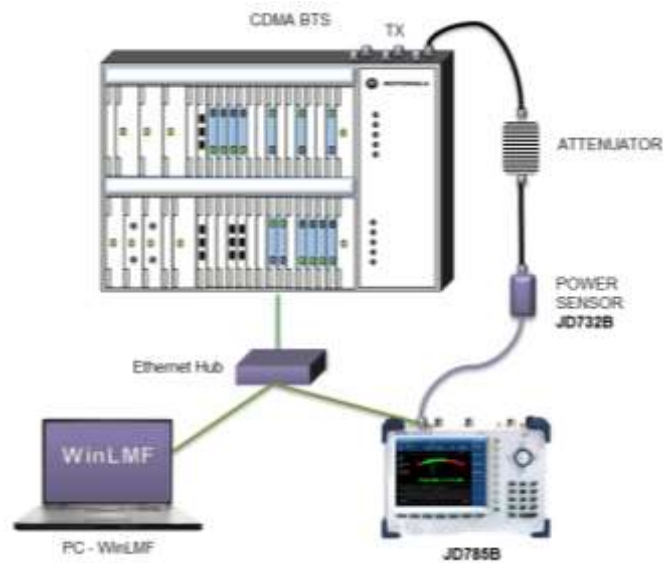

Figure 460 Using external power sensor



Performing a LMF test

Procedure

- 1 Press the **SYSTEM** hot key.
- 2 To set the IP address, complete the following steps:
 - a Select **System Configuration > Ethernet Config > IPv4**.
 - b Toggle the **Mode** soft key and select **Static**.
 - c Press the **Field > IP Address** soft key.
 - d Set the IP address as "192.167.10.1".
- 3 Select **Remote Interface > LAN > LMF**.
- 4 To set up the LMF settings, complete the following steps:
 - a Press the **LMF Settings** soft key.
 - b Select the power measurement and BTS option from the following choices:
 - External PM 800 MHz Band** for external measurement on cellular basestation
 - External PM 1900 MHz Band** for external measurement on PCS basestation
 - Internal PM 800 MHz Band** for internal measurement on cellular basestation
 - Internal PM 1900 MHz Band** for internal measurement on PCS basestation
- 5 To select the measurement mode, complete the following steps:
 - a Press the **MODE** hard key.
 - b Press the **Power Meter** soft key.
 - c Select **Internal RF Power Meter** or **External RF Power Meter** depending on your LMF settings. The measurement result is displayed on the screen.

Appendix G – Bluetooth connection

JD700B series' Bluetooth mode is used for communication between the instrument and your computer with JDRemote or a storage device in order to use the following services if needed.

- Bluetooth Personal Area Network (PAN) profile service for JDRemote.
- Bluetooth File Transfer Profile (FTP) or Object Push Profile (OPP) service for file transfer from the instrument to a Bluetooth storage device.

The Bluetooth Connectivity option includes a pair of Bluetooth USB Parani-UD100 Adapters and 5 dBi Dipole Antennas as well as the BlueSoleil application software.

Installing and setting up Bluetooth software

The BlueSoleil application must be installed in your computer prior to making a Bluetooth connection. After installing the software, you must disable DHCP Server option in order to use the PAN service properly.

Procedure

- 1 Insert the provided CD-ROM into your computer and install the software as instructed. The BlueSoleil Space shortcut icon appears on the desktop.



NOTE

For more information on installation, refer to the Quick Start Guide or the User Guide provided with the adapter.

- 2 Double-click the **BlueSoleil Space** shortcut icon on your computer desktop to launch the application. The BlueSoleil program window appears.
- 3 Right-click the **My Device** icon (the orange ball) in the center of the window, and then click **Properties > Services** tab. The My Device Properties window appears.
- 4 Select the **Bluetooth Personal Area Network** from the list, and then click the **Properties** button. The Bluetooth Personal Area Network Properties window appears.
- 5 Click the **Options** tab, and then uncheck the **Enable DHCP Server** option.



NOTE

You must uncheck it to disable this option as the Enable DHCP Server option is checked by default.

- 6 Click the **OK** button. The Bluetooth Personal Area Network Properties window dismisses.
 - 7 Click the **OK** button. The My Device Properties window dismisses.
-

Making Bluetooth connection

The JD700B series detects a connected Parani-UD100 USB Bluetooth Adapter automatically.

Procedure

- 1 Connect the 5 dBi Dipole Antenna to the Parani-UD100 Bluetooth USB Adapter: one for the computer and the other for JD700B series.
 - 2 Plug in the Bluetooth adapters to the USB port of the computer and the instrument. The instrument detects the connected adapter and turns the Bluetooth mode on automatically.
-

The Bluetooth icon appears in the status bar at the top of the instrument screen.

- 3 Double-click the **BlueSoleil Space** icon on the computer desktop to launch the application if not opened already.
The BlueSoleil program window appears.
- 4 Double-click the **My Device** icon (orange ball) in the center of the application window to search the JD700B series.
You can view an added icon around the orange ball labeled with the detected JD700B series' BD address or model and serial numbers.
- 5 Right-click the device icon for the JD700B series, and then click the **Pair**.
The Bluetooth Passkey window appears.
- 6 Enter **0000** in the Passkey box, and then click the **OK** button.
The word "Paired" appears on the window. The instrument also turns the Bluetooth Mode on automatically and displays the paired device and service information on the screen.
- 7 Double-click the device icon for the JD700B series to search services.
- 8 Right-click the icon for the JD700B series, and then select either the **Connect Bluetooth Personal Area Network** or the **Connect Bluetooth File Transfer**.

**NOTE**

Select one of these services as needed. If the Connect Bluetooth Personal Area Network is selected, a fixed IP address (192.168.10.10) is assigned for JD700B series and this address must be typed into the TCP/IP setting on JDViewer or JDRemote. See "Setting up communication in application" on page 777 for more information.

Setting up communication in application

If the Connect Bluetooth Personal Area Network service is selected on BlueSoleil, you need to configure communication setting on the application JDViewer or JDRemote by entering the fixed IP address for the instrument.

JDViewer setup

Procedure

- 1 Launch the JDViewer application.
 - 2 Go to **Settings > Communication**.
The Settings dialog box appears.
 - 3 Click the drop-down list in the Instrument pane, and then select the instrument series to be communicated.
 - 4 In the Connection Method pane, select the **TCP/IP**, and then enter **192.168.10.10** without dots.
 - 5 Click **OK** to finish the communication setup.
 - 6 Go to **Load > Connect** to make a connection between the instrument and JDViewer.
JD700B series and JDViewer become ready for communication.
-

JDRemote setup

Procedure

- 1 Launch the JDRemote application.
The Select Model dialog box appears.
 - 2 Select the **740A/B, 780A/B Series**, and then click the **OK** button.
 - 3 Right-click on the JDRemote window, and then click the **Communication**.
The Communication dialog box appears.
 - 4 Select the **TCP/IP**, and then enter **192.168.10.10** without dots.
 - 5 Click **OK** to finish the communication setup.
 - 6 Right-click on the JDRemote window, and then click the **Connect**.
-

This enables communication between the instrument and JDRemote.

- 7** Right-click on the JDRemote window, and then click the **Start**.
JD700B series and JDRemote become ready for communication.
 - 8** *Optional.* To adjust the image quality, complete the following steps:
 - a** Right-click on the JDRemote.
 - b** Click the **Quality**.
 - c** Select the image quality option among **High**, **Medium**, or **Low**.
You can improve refresh rate, if experiencing low-quality signal, by adjusting the image quality in JDRemote.
-

Turning Bluetooth mode on/off manually

JD700B series turns the Bluetooth Mode on automatically if connected. You can also turn it on and off manually.

Procedure

- 1** Press the **SYSTEM** hot key.
 - 2** Press the **System Configuration > Remote Interface > Bluetooth** soft key.
The Bluetooth screen appears with the device information.
 - 3** Toggle the **Bluetooth** soft key between **On** and **Off** to turn it on and off.
Connecting or disconnecting the adapter also turns the mode on or off automatically.
-

Appendix H – Device driver installation

JD700B series can be controlled from the application software JDViewer or JDRemote installed on your computer. You must install driver software for the instrument on to the computer if USB Client connection is used for communication.

Procedure

- 1 Go to **Control Panel > System > Device Manager**.
The Device Manager window appears.
 - 2 Right-click the **Unknown Device** under the **Other Devices**, and then click the **Update Driver Software**.
The Update Driver Software – Unknown Device window appears as shown in Figure 461 below.
 - 3 Select the **Browse my computer for driver software**, and then click the **Browse** button to search for the location where the driver software is.
The Browse For Folder window appears.
 - 4 Search for the **JDRemote** folder, and then select the driver folder for the installed OS.
For example, OSDisk (C:) > Program Files (x86) > JDRemote > Driver > Win7 > 64bit.
 - 5 Click the **OK** button.
The Browse For Folder window dismisses.
 - 6 Click the **Next** button to start installation.
If the Windows Security window appears, select the **Install this driver software anyway**.
Installing driver software starts.
 - 7 Click the **Close** button at the end of the installation.
-

Figure 461 Device manager screen

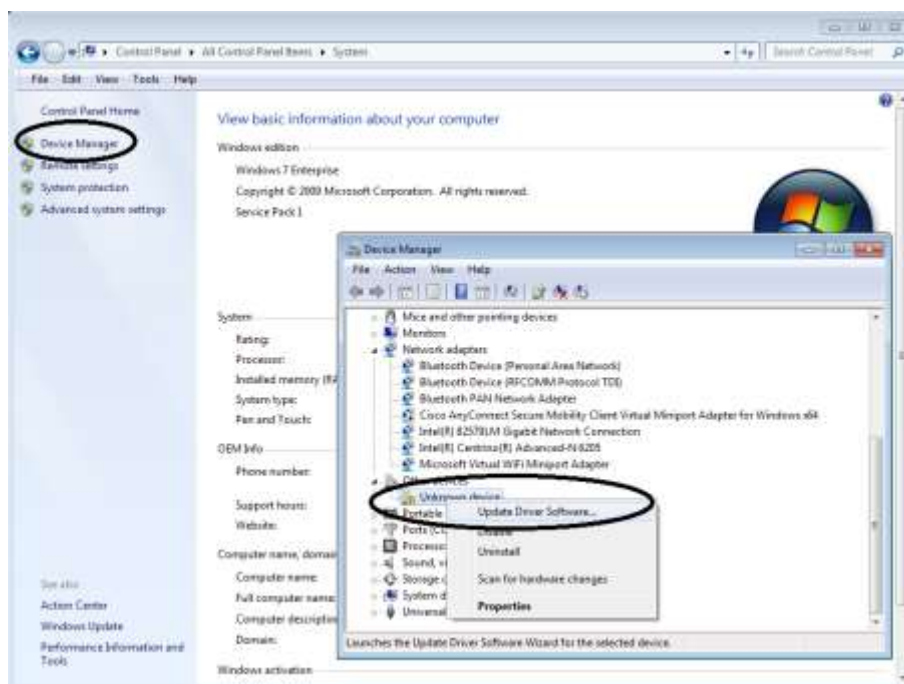

Appendix I – Ordering information

The Warranty Period for Viavi Solutions Accessories shall apply to the all standard and optional accessories listed below. The warranty period varies by product and is generally one (1) year unless otherwise specified.

JD785B Base Station Analyzer

JD785B

9 kHz to 8 GHz	Spectrum Analyzer	
5 MHz to 6 GHz	Cable and Antenna Analyzer ¹	
10 MHz to 8 GHz	RF Power Meter	Internal mode

Options

NOTE: Upgrade options for the JD785B use the designation JD785BU before the respective last three-digit option number.

JD785B001	2-Port Transmission Measurements ²	
JD785B002	Bias Tee	(Requires option 01)
JD785B003	High Power CW Signal Generator	
JD785B008	Optical Hardware ³	
JD785B010	GPS Receiver and Antenna	
JD785B011	Interference Analyzer ^{4,5}	
JD785B012	Channel Scanner	
JD785B013	Bluetooth Connectivity	
JD785B014	LTE-FDD RAN Performance Indicator	
JD785B015	LTE-TDD RAN Performance Indicator	
JD785B016	Wi-Fi Connectivity	
JD785B020	cdmaOne/cdma2000 Signal Analyzer	
JD785B021	EV-DO Signal Analyzer	(Requires option 20)
JD785B022	GSM/GPRS/EDGE Signal Analyzer	
JD785B023	WCDMA/HSPA+ Signal Analyzer	
JD785B025	TD-SCDMA Signal Analyzer	
JD785B026	Mobile WiMAX Signal Analyzer	
JD785B028	LTE-FDD Signal Analyzer	
JD785B029	LTE-TDD Signal Analyzer	
JD785B030	LTE Advanced-FDD Signal Analyzer	(Requires option 28)
JD785B031	LTE Advanced-TDD Signal Analyzer	(Requires option 29)
JD785B032	LTE-FDD 256 QAM Demodulator	(Requires options 28 and 30)
JD785B033	LTE-TDD 256 QAM Demodulator	(Requires options 29 and 31)
JD785B040	cdmaOne/cdma2000 OTA Analyzer ⁵	(Requires option 10)
JD785B041	EV-DO OTA Analyzer ⁵	(Requires option 10)
JD785B042	GSM/GPRS/EDGE OTA Analyzer ⁵	(Requires option 10)
JD785B043	WCDMA/HSPA+ OTA Analyzer ⁵	(Requires option 10)
JD785B045	TD-SCDMA OTA Analyzer ⁵	(Requires option 10)
JD785B046	Mobile WiMAX OTA Analyzer ⁵	(Requires option 10)
JD785B048	LTE-FDD OTA Analyzer ⁵	(Requires option 10)
JD785B049	LTE-TDD OTA Analyzer ⁵	(Requires option 10)
JD785B050	EMF Analyzer ⁸	
JD785B060	RFoCPRI 614M & 1.2G Interference Analyzer ⁶	(Requires option 08)
JD785B061	RFoCPRI 2.4G Interference Analyzer ⁶	(Requires option 08)
JD785B062	RFoCPRI 3.1G Interference Analyzer ⁶	(Requires option 08)
JD785B063	RFoCPRI 4.9G Interference Analyzer ⁶	(Requires option 08)
JD785B064	RFoCPRI 6.1G Interference Analyzer ⁶	(Requires option 08)
JD785B065	RFoCPRI 9.8G Interference Analyzer ⁶	(Requires option 08)
JD785B068	RFoCPRI GSM Interference Analyzer ⁶	(Requires option 08)
JD785B070	RFoBSAI 768M Interference Analyzer ⁶	(Requires option 08)
JD785B071	RFoBSAI 1.5G Interference Analyzer ⁶	(Requires option 08)
JD785B072	RFoBSAI 3.1G Interference Analyzer ⁶	(Requires option 08)
JD785B073	RFoBSAI 6.1G Interference Analyzer ⁶	(Requires option 08)
JD785B081	RFoCPRI LTE-FDD Signal Generator ⁶	(Requires options 08, 60-65)

JD785B082	RFoCPRI LTE-TDD Signal Generator ⁶	(Requires options 08, 60-65)
JD785B083	RFoCPRI LTE-FDD Multi Carrier Signal Generator ⁶	(Requires options 08, 60-65)
JD785B084	RFoCPRI LTE-TDD Multi Carrier Signal Generator ⁶	(Requires options 08, 60-65)
JD785B086	RFoBSAI LTE-FDD Signal Generator ⁶	(Requires options 08, 70-73)
JD785B091	RFoCPRI LTE-FDD Signal Analyzer ⁶	(Requires options 08, 60-65)
JD785B092	RFoCPRI LTE-TDD Signal Analyzer ⁶	(Requires options 08, 60-65)
JD785B096	RFoBSAI LTE-FDD Signal Analyzer ⁶	(Requires options 08, 70-73)
JD785B101	Alcatel-Lucent BBU Emulation ⁶	(Requires options 08)
JD785B200	Calibration Service for Asia, North America	
JD785B201	Calibration Service for Latin America, EMEA	
JD785B250	Warranty extension of 1 year for Asia, North America	
JD785B251	Warranty extension of 1 year for Latin America, EMEA	
JD780B001-FL	2 Port Transmission Measurements	
JD780B010-FL	GPS receiver and antenna	
JD780B011-FL	Interference Analyzer	
JD780B012-FL	Channel Scanner	
JD780B013-FL	Bluetooth connectivity	
JD780B014-FL	LTE-FDD RAN performance	
JD780B015-FL	LTE-TDD RAN performance	
JD780B016-FL	Wi-Fi connectivity	
JD780B020-FL	cdmaOne/cdma2000 Analyzer	
JD780B021-FL	EV-DO Analyzer	
JD780B022-FL	GSM/GPRS/EDGE Analyzer	
JD780B023-FL	WCDMA/HSPA+ analyzer	
JD780B025-FL	TD-SCDMA Analyzer	
JD780B026-FL	Mobile WiMAX Analyzer	
JD780B028-FL	LTE - FDD Analyzer	
JD780B029-FL	LTE - TDD Analyzer	
JD780B030-FL	LTE Advanced - FDD Analyzer	
JD780B031-FL	LTE Advanced - TDD Analyzer	
JD780B032-FL	LTE-FDD 256 QAM Demodulator	
JD780B033-FL	LTE-TDD 256 QAM Demodulator	
JD780B040-FL	GSM/GPRS/EDGE OTA	
JD780B041-FL	WCDMA/HSPA+ OTA	
JD780B042-FL	TD-SCDMA OTA	
JD780B043-FL	Mobile WiMAX OTA	
JD780B045-FL	LTE - FDD OTA	
JD780B046-FL	LTE - TDD OTA	
JD780B048-FL	cdmaOne/cdma2000 OTA	
JD780B049-FL	EV-DO OTA	
JD780B050-FL	EMF Analyzer	
JD780B060-FL	RFoCPRI 2.4G interference analyzer	
JD780B061-FL	RFoCPRI 3.1G interference analyzer	
JD780B062-FL	RFoCPRI 4.9G interference analyzer	
JD780B063-FL	RFoCPRI 6.1G interference analyzer	
JD780B064-FL	RFoCPRI 9.8G interference analyzer	
JD780B065-FL	RFoCPRI 614M & 1.2G interference analyzer	
JD780B068-FL	RFoCPRI GSM interference analyzer	
JD780B070-FL	RFoBSAI 768M interference analyzer	
JD780B071-FL	RFoBSAI 1.5G interference analyzer	
JD780B072-FL	RFoBSAI 3.1G interference analyzer	
JD780B073-FL	RFoBSAI 6.1G interference analyzer	
JD780B081-FL	RFoCPRI LTE-FDD signal generator	
JD780B082-FL	RFoCPRI LTE-TDD signal generator	
JD780B083-FL	RFoCPRI LTE-FDD multi carrier signal generator	
JD780B084-FL	RFoCPRI LTE-TDD multi carrier signal generator	
JD780B086-FL	RFoBSAI LTE-FDD signal generator	
JD780B091-FL	RFoCPRI LTE-FDD signal analyzer	

JD780B092-FL	RFoCPRI LTE-TDD signal analyzer
JD780B096-FL	RFoBSAI LTE-FDD signal analyzer
JD780B101-FL	ALU BBU emulation

Standard Accessories

JD70050008	USB Wi-Fi Dongle ⁷
JD70050326	AC/DC Power Adapter for JD700B Series ⁷
G710550335	Cross LAN Cable (1.5 m) ⁷
GC73050515	USB A to B Cable (1.8 m) ⁷
GC72450518	> 1 G Byte USB Memory ⁷
G710550325	Rechargeable Lithium Ion Battery ⁷
G710550323	Automotive Cigarette Lighter 12 V DC Adapter ⁷
G710550316	Stylus Pen ⁷
JD700B361	JD700B Series User's Guide and Application Software – CD

¹ Requires calibration kit

² Requires dual port calibration kit

³ Requires RFoCPRI or RFoBSAI options

⁴ Highly recommended adding JD785B010

⁵ Highly recommended adding G70005035x and/or G70005036x

⁶ Requires proper SFP/SFP+ transceiver and optical tap.

⁷ Standard accessories can be purchased separately.

⁸ Requires G700050380

JD786B RF Analyzer

JD786B

9 kHz to 8 GHz	Spectrum Analyzer	
5 MHz to 6 GHz	Cable and Antenna Analyzer ¹	
10 MHz to 8 GHz	RF Power Meter	Internal mode

Options

NOTE: Upgrade options for the JD786B use the designation JD786BU before the respective last three-digit option number.

JD786B001	2-Port Transmission Measurements ²	
JD786B002	Bias Tee	(Requires option 01)
JD786B003	High Power CW Signal Generator	
JD786B008	Optical Hardware ³	
JD786B010	GPS Receiver and Antenna	
JD786B011	Interference Analyzer ^{4,5}	
JD786B012	Channel Scanner	
JD786B013	Bluetooth Connectivity	
JD786B016	Wi-Fi Connectivity	
JD786B050	EMF Analyzer ⁸	
JD786B060	RFoCPRI 614M & 1.2G Interference Analyzer ⁶	(Requires option 08)
JD786B061	RFoCPRI 2.4G Interference Analyzer ⁶	(Requires option 08)
JD786B062	RFoCPRI 3.1G Interference Analyzer ⁶	(Requires option 08)
JD786B063	RFoCPRI 4.9G Interference Analyzer ⁶	(Requires option 08)
JD786B064	RFoCPRI 6.1G Interference Analyzer ⁶	(Requires option 08)
JD786B065	RFoCPRI 9.8G Interference Analyzer ⁶	(Requires option 08)
JD786B068	RFoCPRI GSM Interference Analyzer ⁶	(Requires option 08)
JD786B070	RFoBSAI 768M Interference Analyzer ⁶	(Requires option 08)
JD786B071	RFoBSAI 1.5G Interference Analyzer ⁶	(Requires option 08)
JD786B072	RFoBSAI 3.1G Interference Analyzer ⁶	(Requires option 08)
JD786B073	RFoBSAI 6.1G Interference Analyzer ⁶	(Requires option 08)
JD786B081	RFoCPRI LTE-FDD Signal Generator ⁶	(Requires options 08, 60-65)
JD786B082	RFoCPRI LTE-TDD Signal Generator ⁶	(Requires options 08, 60-65)
JD786B083	RFoCPRI LTE-FDD Multi Carrier Signal Generator ⁶	(Requires options 08, 60-65)
JD786B084	RFoCPRI LTE-TDD Multi Carrier Signal Generator ⁶	(Requires options 08, 60-65)
JD786B086	RFoBSAI LTE-FDD Signal Generator ⁶	(Requires options 08, 70-73)

JD786B101	Alcatel-Lucent BBU Emulation ⁶	(Requires options 08)
JD786B200	Calibration Service for Asia, North America	
JD786B201	Calibration Service for Latin America, EMEA	
JD786B250	Warranty extension of 1 year for Asia, North America	
JD786B251	Warranty extension of 1 year for Latin America, EMEA	
JD780B001-FL	2 Port Transmission Measurements	
JD780B010-FL	GPS receiver and antenna	
JD780B011-FL	Interference Analyzer	
JD780B012-FL	Channel Scanner	
JD780B013-FL	Bluetooth connectivity	
JD780B016-FL	Wi-Fi connectivity	
JD780B050-FL	EMF Analyzer	
JD780B060-FL	RFoCPRI 2.4G interference analyzer	
JD780B061-FL	RFoCPRI 3.1G interference analyzer	
JD780B062-FL	RFoCPRI 4.9G interference analyzer	
JD780B063-FL	RFoCPRI 6.1G interference analyzer	
JD780B064-FL	RFoCPRI 9.8G interference analyzer	
JD780B065-FL	RFoCPRI 614M & 1.2G interference analyzer	
JD780B068-FL	RFoCPRI GSM interference analyzer	
JD780B070-FL	RFoBSAI 768M interference analyzer	
JD780B071-FL	RFoBSAI 1.5G interference analyzer	
JD780B072-FL	RFoBSAI 3.1G interference analyzer	
JD780B073-FL	RFoBSAI 6.1G interference analyzer	
JD780B081-FL	RFoCPRI LTE-FDD signal generator	
JD780B082-FL	RFoCPRI LTE-TDD signal generator	
JD780B083-FL	RFoCPRI LTE-FDD multi carrier signal generator	
JD780B084-FL	RFoCPRI LTE-TDD multi carrier signal generator	
JD780B086-FL	RFoBSAI LTE-FDD signal generator	
JD780B101-FL	ALU BBU emulation	

Standard Accessories

JD70050008	USB Wi-Fi Dongle ⁷
JD70050326	AC/DC Power Adapter for JD700B Series ⁷
G710550335	Cross LAN Cable (1.5 m) ⁷
GC73050515	USB A to B Cable (1.8 m) ⁷
GC72450518	> 1 G Byte USB Memory ⁷
G710550325	Rechargeable Lithium Ion Battery ⁷
G710550323	Automotive Cigarette Lighter 12 V DC Adapter ⁷
G710550316	Stylus Pen ⁷
JD700B361	JD700B Series User's Guide and Application Software – CD

¹ Requires calibration kit

² Requires dual port calibration kit

³ Requires RFoCPRI or RFoBSAI options

⁴ Highly recommended adding JD786B010

⁵ Highly recommended adding G70005035x and/or G70005036x

⁶ Requires proper SFP/SFP+ transceiver and optical tap

⁷ Standard accessories can be purchased separately.

⁸ Requires G700050380

JD788B Signal Analyzer

JD788B

9 kHz to 8 GHz	Spectrum Analyzer	
10 MHz to 8 GHz	RF Power Meter	Internal mode

Options

NOTE: Upgrade options for the JD788B use the designation JD788BU before the respective last three-digit option number.

JD788B001	2-Port Transmission Measurements ¹	(Requires option 07)
JD788B003	High Power CW Signal Generator	(Requires option 07)
JD788B007	Signal Generator Hardware	
JD788B008	Optical Hardware ²	
JD788B009	20 MHz Demodulation Hardware	
JD788B010	GPS Receiver and Antenna	
JD788B011	Interference Analyzer ^{3,4}	
JD788B012	Channel Scanner	
JD788B013	Bluetooth Connectivity	
JD788B014	LTE-FDD RAN Performance Indicator	
JD788B015	LTE-TDD RAN Performance Indicator	
JD786B016	Wi-Fi Connectivity	
JD788B020	cdmaOne/cdma2000 Signal Analyzer	(Requires option 09)
JD788B021	EV-DO Signal Analyzer	(Requires options 09 and 20)
JD788B022	GSM/GPRS/EDGE Signal Analyzer	(Requires option 09)
JD788B023	WCDMA/HSPA+ Signal Analyzer	(Requires option 09)
JD788B025	TD-SCDMA Signal Analyzer	(Requires option 09)
JD788B026	Mobile WiMAX Signal Analyzer	(Requires option 09)
JD788B028	LTE-FDD Signal Analyzer	(Requires option 09)
JD788B029	LTE-TDD Signal Analyzer	(Requires option 09)
JD788B030	LTE Advanced-FDD Signal Analyzer	(Requires options 09 and 28)
JD788B031	LTE Advanced-TDD Signal Analyzer	(Requires options 09 and 29)
JD788B032	LTE-FDD 256 QAM Demodulator	(Requires options 09, 28 and 30)
JD788B033	LTE-TDD 256 QAM Demodulator	(Requires options 09, 29 and 31)
JD788B040	cdmaOne/cdma2000 OTA Analyzer ⁴	(Requires options 09 and 10)
JD788B041	EV-DO OTA Analyzer ⁴	(Requires options 09 and 10)
JD788B042	GSM/GPRS/EDGE OTA Analyzer ⁴	(Requires options 09 and 10)
JD788B043	WCDMA/HSPA+ OTA Analyzer ⁴	(Requires options 09 and 10)
JD788B045	TD-SCDMA OTA Analyzer ⁴	(Requires options 09 and 10)
JD788B046	Mobile WiMAX OTA Analyzer ⁴	(Requires options 09 and 10)
JD788B048	LTE-FDD OTA Analyzer ⁴	(Requires options 09 and 10)
JD788B049	LTE-TDD OTA Analyzer ⁴	(Requires options 09 and 10)
JD788B050	EMF Analyzer ⁷	
JD788B060	RFoCPRI 614M & 1.2G Interference Analyzer ⁵	(Requires option 08)
JD788B061	RFoCPRI 2.4G Interference Analyzer ⁵	(Requires option 08)
JD788B062	RFoCPRI 3.1G Interference Analyzer ⁵	(Requires option 08)
JD788B063	RFoCPRI 4.9G Interference Analyzer ⁵	(Requires option 08)
JD788B064	RFoCPRI 6.1G Interference Analyzer ⁵	(Requires option 08)
JD788B065	RFoCPRI 9.8G Interference Analyzer ⁵	(Requires option 08)
JD788B068	RFoCPRI GSM Interference Analyzer ⁵	(Requires option 08)
JD788B070	RFoBSAI 768M Interference Analyzer ⁵	(Requires option 08)
JD788B071	RFoBSAI 1.5G Interference Analyzer ⁵	(Requires option 08)
JD788B072	RFoBSAI 3.1G Interference Analyzer ⁵	(Requires option 08)
JD788B073	RFoBSAI 6.1G Interference Analyzer ⁵	(Requires option 08)
JD788B081	RFoCPRI LTE-FDD Signal Generator ⁵	(Requires options 08, 60-65)
JD788B082	RFoCPRI LTE-TDD Signal Generator ⁵	(Requires options 08, 60-65)
JD788B083	RFoCPRI LTE-FDD Multi Carrier Signal Generator ⁵	(Requires options 08, 60-65)
JD788B084	RFoCPRI LTE-TDD Multi Carrier Signal Generator ⁵	(Requires options 08, 60-65)
JD788B086	RFoBSAI LTE-FDD Signal Generator ⁵	(Requires options 08, 70-73)
JD788B091	RFoCPRI LTE-FDD Signal Analyzer ⁵	(Requires options 08, 60-65)
JD788B092	RFoCPRI LTE-TDD Signal Analyzer ⁵	(Requires options 08, 60-65)
JD788B096	RFoBSAI LTE-FDD Signal Analyzer ⁵	(Requires options 08, 70-73)
JD788B101	Alcatel-Lucent BBU Emulation ⁵	(Requires options 08)
JD788B200	Calibration Service for Asia, North America	
JD788B201	Calibration Service for Latin America, EMEA	
JD788B250	Warranty extension of 1 year for Asia, North America	
JD788B251	Warranty extension of 1 year for Latin America, EMEA	
JD780B001-FL	2 Port Transmission Measurements	

JD780B010-FL	GPS receiver and antenna
JD780B011-FL	Interference Analyzer
JD780B012-FL	Channel Scanner
JD780B013-FL	Bluetooth connectivity
JD780B014-FL	LTE-FDD RAN performance
JD780B015-FL	LTE-TDD RAN performance
JD780B016-FL	Wi-Fi connectivity
JD780B020-FL	cdmaOne/cdma2000 Analyzer
JD780B021-FL	EV-DO Analyzer
JD780B022-FL	GSM/GPRS/EDGE Analyzer
JD780B023-FL	WCDMA/HSPA+ analyzer
JD780B025-FL	TD-SCDMA Analyzer
JD780B026-FL	Mobile WiMAX Analyzer
JD780B028-FL	LTE - FDD Analyzer
JD780B029-FL	LTE - TDD Analyzer
JD780B030-FL	LTE Advanced - FDD Analyzer
JD780B031-FL	LTE Advanced - TDD Analyzer
JD780B032-FL	LTE-FDD 256 QAM Demodulator
JD780B033-FL	LTE-TDD 256 QAM Demodulator
JD780B040-FL	GSM/GPRS/EDGE OTA
JD780B041-FL	WCDMA/HSPA+ OTA
JD780B042-FL	TD-SCDMA OTA
JD780B043-FL	Mobile WiMAX OTA
JD780B045-FL	LTE - FDD OTA
JD780B046-FL	LTE - TDD OTA
JD780B048-FL	cdmaOne/cdma2000 OTA
JD780B049-FL	EV-DO OTA
JD780B050-FL	EMF Analyzer
JD780B060-FL	RFoCPRI 2.4G interference analyzer
JD780B061-FL	RFoCPRI 3.1G interference analyzer
JD780B062-FL	RFoCPRI 4.9G interference analyzer
JD780B063-FL	RFoCPRI 6.1G interference analyzer
JD780B064-FL	RFoCPRI 9.8G interference analyzer
JD780B065-FL	RFoCPRI 614M & 1.2G interference analyzer
JD780B068-FL	RFoCPRI GSM interference analyzer
JD780B070-FL	RFoBSAI 768M interference analyzer
JD780B071-FL	RFoBSAI 1.5G interference analyzer
JD780B072-FL	RFoBSAI 3.1G interference analyzer
JD780B073-FL	RFoBSAI 6.1G interference analyzer
JD780B081-FL	RFoCPRI LTE-FDD signal generator
JD780B082-FL	RFoCPRI LTE-TDD signal generator
JD780B083-FL	RFoCPRI LTE-FDD multi carrier signal generator
JD780B084-FL	RFoCPRI LTE-TDD multi carrier signal generator
JD780B086-FL	RFoBSAI LTE-FDD signal generator
JD780B091-FL	RFoCPRI LTE-FDD signal analyzer
JD780B092-FL	RFoCPRI LTE-TDD signal analyzer
JD780B096-FL	RFoBSAI LTE-FDD signal analyzer
JD780B101-FL	ALU BBU emulation

Standard Accessories

JD70050008	USB Wi-Fi Dongle ⁶
JD70050326	AC/DC Power Adapter for JD700B Series ⁶
G710550335	Cross LAN Cable (1.5 m) ⁶
GC73050515	USB A to B Cable (1.8 m) ⁶
GC72450518	> 1 G Byte USB Memory ⁶
G710550325	Rechargeable Lithium Ion Battery ⁶
G710550323	Automotive Cigarette Lighter 12 V DC Adapter ⁶
G710550316	Stylus Pen ⁶

¹ Requires dual port calibration kit² Requires RFoCPRI or RFoBSAI options³ Highly recommended adding JD788B010⁴ Highly recommended adding G70005035x and/or G70005036x⁵ Requires proper SFP/SFP+ transceiver and optical pad⁶ Standard accessories can be purchased separately.⁷ Requires G700050380

JD745B Base Station Analyzer

JD745B

100 kHz to 4 GHz	Spectrum Analyzer	
5 MHz to 4 GHz	Cable and Antenna Analyzer ¹	
10 MHz to 4 GHz	RF Power Meter	Internal mode

Options

NOTE: Upgrade options for the JD745B use the designation JD745BU before the respective last three-digit option number.

JD745B001	2-Port Transmission Measurements ²	
JD745B002	Bias Tee	(Requires option 01)
JD745B003	CW Signal Generator	
JD745B008	Optical Hardware ³	
JD745B010	GPS Receiver and Antenna	
JD745B011	Interference Analyzer ^{4,5}	
JD745B012	Channel Scanner	
JD745B013	Bluetooth Connectivity	
JD745B014	LTE-FDD RAN Performance Indicator	
JD745B015	LTE-TDD RAN Performance Indicator	
JD745B016	Wi-Fi Connectivity	
JD745B020	cdmaOne/cdma2000 Signal Analyzer	
JD745B021	EV-DO Signal Analyzer	(Requires option 20)
JD745B022	GSM/GPRS/EDGE Signal Analyzer	
JD745B023	WCDMA/HSPA+ Signal Analyzer	
JD745B025	TD-SCDMA Signal Analyzer	
JD745B026	Mobile WiMAX Signal Analyzer	
JD745B028	LTE-FDD Signal Analyzer	
JD745B029	LTE-TDD Signal Analyzer	
JD745B030	LTE Advanced-FDD Signal Analyzer	(Requires option 28)
JD745B031	LTE Advanced-TDD Signal Analyzer	(Requires option 29)
JD745B032	LTE-FDD 256Q AM Demodulator	(Requires options 28 and 30)
JD745B033	LTE-TDD 256Q AM Demodulator	(Requires options 29 and 31)
JD745B040	cdmaOne/cdma2000 OTA Analyzer ⁵	(Requires option 10)
JD745B041	EV-DO OTA Analyzer ⁵	(Requires option 10)
JD745B042	GSM/GPRS/EDGE OTA Analyzer ⁵	(Requires option 10)
JD745B043	WCDMA/HSPA+ OTA Analyzer ⁵	(Requires option 10)
JD745B045	TD-SCDMA OTA Analyzer ⁵	(Requires option 10)
JD745B046	Mobile WiMAX OTA Analyzer ⁵	(Requires option 10)
JD745B048	LTE-FDD OTA Analyzer ⁵	(Requires option 10)
JD745B049	LTE-TDD OTA Analyzer ⁵	(Requires option 10)
JD745B050	EMF Analyzer ⁸	
JD745B060	RFoCPRI 614M & 1.2G Interference Analyzer ⁶	(Requires option 08)
JD745B061	RFoCPRI 2.4G Interference Analyzer ⁶	(Requires option 08)
JD745B062	RFoCPRI 3.1G Interference Analyzer ⁶	(Requires option 08)
JD745B063	RFoCPRI 4.9G Interference Analyzer ⁶	(Requires option 08)
JD745B064	RFoCPRI 6.1G Interference Analyzer ⁶	(Requires option 08)
JD745B065	RFoCPRI 9.8G Interference Analyzer ⁶	(Requires option 08)
JD745B068	RFoCPRI GSM Interference Analyzer ⁶	(Requires option 08)
JD745B070	RFoBSAI 768M Interference Analyzer ⁶	(Requires option 08)

JD745B071	RFoBSAI 1.5G Interference Analyzer ⁶	(Requires option 08)
JD745B072	RFoBSAI 3.1G Interference Analyzer ⁶	(Requires option 08)
JD745B073	RFoBSAI 6.1G Interference Analyzer ⁶	(Requires option 08)
JD745B081	RFoCPRI LTE-FDD Signal Generator ⁶	(Requires options 08, 60-65)
JD745B082	RFoCPRI LTE-TDD Signal Generator ⁶	(Requires options 08, 60-65)
JD745B083	RFoCPRI LTE-FDD Multi Carrier Signal Generator ⁶	(Requires options 08, 60-65)
JD745B084	RFoCPRI LTE-TDD Multi Carrier Signal Generator ⁶	(Requires options 08, 60-65)
JD745B086	RFoBSAI LTE-FDD Signal Generator ⁶	(Requires options 08, 70-73)
JD745B091	RFoCPRI LTE-FDD Signal Analyzer ⁶	(Requires options 08, 60-65)
JD745B092	RFoCPRI LTE-TDD Signal Analyzer ⁶	(Requires options 08, 60-65)
JD745B096	RFoBSAI LTE-FDD Signal Analyzer ⁶	(Requires options 08, 70-73)
JD745B101	Alcatel-Lucent BBU Emulation ⁶	(Requires options 08)
JD788B200	Calibration Service for Asia, North America	
JD788B201	Calibration Service for Latin America, EMEA	
JD788B250	Warranty extension of 1 year for Asia, North America	
JD788B251	Warranty extension of 1 year for Latin America, EMEA	
JD780B001-FL	2 Port Transmission Measurements	
JD780B010-FL	GPS receiver and antenna	
JD780B011-FL	Interference Analyzer	
JD780B012-FL	Channel Scanner	
JD780B013-FL	Bluetooth connectivity	
JD780B014-FL	LTE-FDD RAN performance	
JD780B015-FL	LTE-TDD RAN performance	
JD780B016-FL	Wi-Fi connectivity	
JD780B020-FL	cdmaOne/cdma2000 Analyzer	
JD780B021-FL	EV-DO Analyzer	
JD780B022-FL	GSM/GPRS/EDGE Analyzer	
JD780B023-FL	WCDMA/HSPA+ analyzer	
JD780B025-FL	TD-SCDMA Analyzer	
JD780B026-FL	Mobile WiMAX Analyzer	
JD780B028-FL	LTE - FDD Analyzer	
JD780B029-FL	LTE - TDD Analyzer	
JD780B030-FL	LTE Advanced - FDD Analyzer	
JD780B031-FL	LTE Advanced - TDD Analyzer	
JD780B032-FL	LTE-FDD 256 QAM Demodulator	
JD780B033-FL	LTE-TDD 256 QAM Demodulator	
JD780B040-FL	GSM/GPRS/EDGE OTA	
JD780B041-FL	WCDMA/HSPA+ OTA	
JD780B042-FL	TD-SCDMA OTA	
JD780B043-FL	Mobile WiMAX OTA	
JD780B045-FL	LTE - FDD OTA	
JD780B046-FL	LTE - TDD OTA	
JD780B048-FL	cdmaOne/cdma2000 OTA	
JD780B049-FL	EV-DO OTA	
JD780B050-FL	EMF Analyzer	
JD780B060-FL	RFoCPRI 2.4G interference analyzer	
JD780B061-FL	RFoCPRI 3.1G interference analyzer	
JD780B062-FL	RFoCPRI 4.9G interference analyzer	
JD780B063-FL	RFoCPRI 6.1G interference analyzer	
JD780B064-FL	RFoCPRI 9.8G interference analyzer	
JD780B065-FL	RFoCPRI 614M & 1.2G interference analyzer	
JD780B068-FL	RFoCPRI GSM interference analyzer	
JD780B070-FL	RFoBSAI 768M interference analyzer	
JD780B071-FL	RFoBSAI 1.5G interference analyzer	
JD780B072-FL	RFoBSAI 3.1G interference analyzer	
JD780B073-FL	RFoBSAI 6.1G interference analyzer	
JD780B081-FL	RFoCPRI LTE-FDD signal generator	
JD780B082-FL	RFoCPRI LTE-TDD signal generator	

JD780B083-FL	RFoCPRI LTE-FDD multi carrier signal generator
JD780B084-FL	RFoCPRI LTE-TDD multi carrier signal generator
JD780B086-FL	RFoOBSAI LTE-FDD signal generator
JD780B091-FL	RFoCPRI LTE-FDD signal analyzer
JD780B092-FL	RFoCPRI LTE-TDD signal analyzer
JD780B096-FL	RFoOBSAI LTE-FDD signal analyzer
JD780B101-FL	ALU BBU emulation

Standard Accessories

JD70050008	USB Wi-Fi Dongle ⁷
JD70050326	AC/DC Power Adapter for JD700B Series ⁷
G710550335	Cross LAN Cable (1.5 m) ⁷
GC73050515	USB A to B Cable (1.8 m) ⁷
GC72450518	> 1 G Byte USB Memory ⁷
G710550325	Rechargeable Lithium Ion Battery ⁷
G710550323	Automotive Cigarette Lighter 12 V DC Adapter ⁷
G710550316	Stylus Pen ⁷
JD700B361	JD700B Series User's Guide and Application Software – CD

¹ Requires calibration kit

² Requires dual port calibration kit

³ Requires RFoCPRI or RFoOBSAI options

⁴ Highly recommended adding JD745B010

⁵ Highly recommended adding G70005035x and/or G70005036x

⁶ Requires proper SFP/SFP+ transceiver and optical tap.

⁷ Standard accessories can be purchased separately.

⁸ Requires G700050380

JD746B RF Analyzer

JD746B

100 kHz to 4 GHz	Spectrum Analyzer	
5 MHz to 4 GHz	Cable and Antenna Analyzer ¹	
10 MHz to 4 GHz	RF Power Meter	Internal mode

Options

NOTE: Upgrade options for the JD746B use the designation JD746BU before the respective last three-digit option number.

JD746B001	2-Port Transmission Measurements ²	
JD746B002	Bias Tee	(Requires option 01)
JD746B003	CW Signal Generator	
JD746B008	Optical Hardware ³	
JD746B010	GPS Receiver and Antenna	
JD746B011	Interference Analyzer ^{4,5}	
JD746B012	Channel Scanner	
JD746B013	Bluetooth Connectivity	
JD746B016	Wi-Fi Connectivity	
JD746B050	EMF Analyzer ⁸	
JD746B060	RFoCPRI 614M & 1.2G Interference Analyzer ⁶	(Requires option 08)
JD746B061	RFoCPRI 2.4G Interference Analyzer ⁶	(Requires option 08)
JD746B062	RFoCPRI 3.1G Interference Analyzer ⁶	(Requires option 08)
JD746B063	RFoCPRI 4.9G Interference Analyzer ⁶	(Requires option 08)
JD746B064	RFoCPRI 6.1G Interference Analyzer ⁶	(Requires option 08)
JD746B065	RFoCPRI 9.8G Interference Analyzer ⁶	(Requires option 08)
JD746B068	RFoCPRI GSM Interference Analyzer ⁶	(Requires option 08)
JD746B070	RFoOBSAI 768M Interference Analyzer ⁶	(Requires option 08)
JD746B071	RFoOBSAI 1.5G Interference Analyzer ⁶	(Requires option 08)
JD746B072	RFoOBSAI 3.1G Interference Analyzer ⁶	(Requires option 08)
JD746B073	RFoOBSAI 6.1G Interference Analyzer ⁶	(Requires option 08)

JD746B081	RFoCPRI LTE-FDD Signal Generator ⁶	(Requires options 08, 60-65)
JD746B082	RFoCPRI LTE-TDD Signal Generator ⁶	(Requires options 08, 60-65)
JD746B083	RFoCPRI LTE-FDD Multi Carrier Signal Generator ⁶	(Requires options 08, 60-65)
JD746B084	RFoCPRI LTE-TDD Multi Carrier Signal Generator ⁶	(Requires options 08, 60-65)
JD746B086	RFoBSAI LTE-FDD Signal Generator ⁶	(Requires options 08, 70-73)
JD746B101	Alcatel-Lucent BBU Emulation ⁶	(Requires options 08)
JD786B200	Calibration Service for Asia, North America	
JD786B201	Calibration Service for Latin America, EMEA	
JD786B250	Warranty extension of 1 year for Asia, North America	
JD786B251	Warranty extension of 1 year for Latin America, EMEA	
JD780B001-FL	2 Port Transmission Measurements	
JD780B010-FL	GPS receiver and antenna	
JD780B011-FL	Interference Analyzer	
JD780B012-FL	Channel Scanner	
JD780B013-FL	Bluetooth connectivity	
JD780B016-FL	Wi-Fi connectivity	
JD780B050-FL	EMF Analyzer	
JD780B060-FL	RFoCPRI 2.4G interference analyzer	
JD780B061-FL	RFoCPRI 3.1G interference analyzer	
JD780B062-FL	RFoCPRI 4.9G interference analyzer	
JD780B063-FL	RFoCPRI 6.1G interference analyzer	
JD780B064-FL	RFoCPRI 9.8G interference analyzer	
JD780B065-FL	RFoCPRI 614M & 1.2G interference analyzer	
JD780B068-FL	RFoCPRI GSM interference analyzer	
JD780B070-FL	RFoBSAI 768M interference analyzer	
JD780B071-FL	RFoBSAI 1.5G interference analyzer	
JD780B072-FL	RFoBSAI 3.1G interference analyzer	
JD780B073-FL	RFoBSAI 6.1G interference analyzer	
JD780B081-FL	RFoCPRI LTE-FDD signal generator	
JD780B082-FL	RFoCPRI LTE-TDD signal generator	
JD780B083-FL	RFoCPRI LTE-FDD multi carrier signal generator	
JD780B084-FL	RFoCPRI LTE-TDD multi carrier signal generator	
JD780B086-FL	RFoBSAI LTE-FDD signal generator	
JD780B101-FL	ALU BBU emulation	

Standard Accessories

JD70050008	USB Wi-Fi Dongle ⁷
JD70050326	AC/DC Power Adapter for JD700B Series ⁷
G710550335	Cross LAN Cable (1.5 m) ⁷
GC73050515	USB A to B Cable (1.8 m) ⁷
GC72450518	> 1 G Byte USB Memory ⁷
G710550325	Rechargeable Lithium Ion Battery ⁷
G710550323	Automotive Cigarette Lighter 12 V DC Adapter ⁷
G710550316	Stylus Pen ⁷
JD700B361	JD700B Series User's Guide and Application Software – CD

¹ Requires calibration kit

² Requires dual port calibration kit

³ Requires RFoCPRI or RFoBSAI options

⁴ Highly recommended adding JD746B010

⁵ Highly recommended adding G70005035x and/or G70005036x

⁶ Requires proper SFP/SFP+ transceiver and optical tap

⁷ Standard accessories can be purchased separately.

⁸ Requires G700050380

JD748B Signal Analyzer

JD748B

100 kHz to 4 GHz Spectrum Analyzer

10 MHz to 4 GHz

RF Power Meter

Internal mode

Options

NOTE: Upgrade options for the JD748B use the designation JD748BU before the respective last three-digit option number.

JD748B001	2-Port Transmission Measurements ¹	(Requires option 07)
JD748B003	CW Signal Generator	(Requires option 07)
JD748B007	Signal Generator Hardware	
JD748B008	Optical Hardware ²	
JD748B009	20 MHz Demodulation Hardware	
JD748B010	GPS Receiver and Antenna	
JD748B011	Interference Analyzer ^{3,4}	
JD748B012	Channel Scanner	
JD748B013	Bluetooth Connectivity	
JD748B014	LTE-FDD RAN Performance Indicator	
JD748B015	LTE-TDD RAN Performance Indicator	
JD748B016	Wi-Fi Connectivity	
JD748B020	cdmaOne/cdma2000 Signal Analyzer	(Requires option 09)
JD748B021	EV-DO Signal Analyzer	(Requires options 09 and 20)
JD748B022	GSM/GPRS/EDGE Signal Analyzer	(Requires option 09)
JD748B023	WCDMA/HSPA+ Signal Analyzer	(Requires option 09)
JD748B025	TD-SCDMA Signal Analyzer	(Requires option 09)
JD748B026	Mobile WiMAX Signal Analyzer	(Requires option 09)
JD748B028	LTE-FDD Signal Analyzer	(Requires option 09)
JD748B029	LTE-TDD Signal Analyzer	(Requires option 09)
JD748B030	LTE Advanced-FDD Signal Analyzer	(Requires options 09 and 28)
JD748B031	LTE Advanced-TDD Signal Analyzer	(Requires options 09 and 29)
JD748B032	LTE-FDD 256 QAM Demodulator	(Requires options 09, 28 and 30)
JD748B033	LTE-TDD 256 QAM Demodulator	(Requires options 09, 29 and 31)
JD748B040	cdmaOne/cdma2000 OTA Analyzer ⁴	(Requires options 09 and 10)
JD748B041	EV-DO OTA Analyzer ⁴	(Requires options 09 and 10)
JD748B042	GSM/GPRS/EDGE OTA Analyzer ⁴	(Requires options 09 and 10)
JD748B043	WCDMA/HSPA+ OTA Analyzer ⁴	(Requires options 09 and 10)
JD748B045	TD-SCDMA OTA Analyzer ⁴	(Requires options 09 and 10)
JD748B046	Mobile WiMAX OTA Analyzer ⁴	(Requires options 09 and 10)
JD748B048	LTE-FDD OTA Analyzer ⁴	(Requires options 09 and 10)
JD748B049	LTE-TDD OTA Analyzer ⁴	(Requires options 09 and 10)
JD748B050	EMF Analyzer ⁷	
JD748B060	RFoCPRI 614M & 1.2G Interference Analyzer ⁵	(Requires option 08)
JD748B061	RFoCPRI 2.4G Interference Analyzer ⁵	(Requires option 08)
JD748B062	RFoCPRI 3.1G Interference Analyzer ⁵	(Requires option 08)
JD748B063	RFoCPRI 4.9G Interference Analyzer ⁵	(Requires option 08)
JD748B064	RFoCPRI 6.1G Interference Analyzer ⁵	(Requires option 08)
JD748B065	RFoCPRI 9.8G Interference Analyzer ⁵	(Requires option 08)
JD748B068	RFoCPRI GSM Interference Analyzer ⁵	(Requires option 08)
JD748B070	RFoBSAI 768M Interference Analyzer ⁵	(Requires option 08)
JD748B071	RFoBSAI 1.5G Interference Analyzer ⁵	(Requires option 08)
JD748B072	RFoBSAI 3.1G Interference Analyzer ⁵	(Requires option 08)
JD748B073	RFoBSAI 6.1G Interference Analyzer ⁵	(Requires option 08)
JD748B081	RFoCPRI LTE-FDD Signal Generator ⁵	(Requires options 08, 60-65)
JD748B082	RFoCPRI LTE-TDD Signal Generator ⁶	(Requires options 08, 60-65)
JD748B083	RFoCPRI LTE-FDD Multi Carrier Signal Generator ⁵	(Requires options 08, 60-65)
JD748B084	RFoCPRI LTE-TDD Multi Carrier Signal Generator ⁶	(Requires options 08, 60-65)
JD748B086	RFoBSAI LTE-FDD Signal Generator ⁶	(Requires options 08, 70-73)
JD748B091	RFoCPRI LTE-FDD Signal Analyzer ⁵	(Requires options 08, 60-65)
JD748B092	RFoCPRI LTE-TDD Signal Analyzer ⁶	(Requires options 08, 60-65)
JD748B096	RFoBSAI LTE-FDD Signal Analyzer ⁶	(Requires options 08, 70-73)
JD788B101	Alcatel-Lucent BBU Emulation ⁶	(Requires options 08)

JD788B200	Calibration Service for Asia, North America
JD788B201	Calibration Service for Latin America, EMEA
JD788B250	Warranty extension of 1 year for Asia, North America
JD788B251	Warranty extension of 1 year for Latin America, EMEA
JD780B001-FL	2 Port Transmission Measurements
JD780B010-FL	GPS receiver and antenna
JD780B011-FL	Interference Analyzer
JD780B012-FL	Channel Scanner
JD780B013-FL	Bluetooth connectivity
JD780B014-FL	LTE-FDD RAN performance
JD780B015-FL	LTE-TDD RAN performance
JD780B016-FL	Wi-Fi connectivity
JD780B020-FL	cdmaOne/cdma2000 Analyzer
JD780B021-FL	EV-DO Analyzer
JD780B022-FL	GSM/GPRS/EDGE Analyzer
JD780B023-FL	WCDMA/HSPA+ analyzer
JD780B025-FL	TD-SCDMA Analyzer
JD780B026-FL	Mobile WiMAX Analyzer
JD780B028-FL	LTE - FDD Analyzer
JD780B029-FL	LTE - TDD Analyzer
JD780B030-FL	LTE Advanced - FDD Analyzer
JD780B031-FL	LTE Advanced - TDD Analyzer
JD780B032-FL	LTE-FDD 256 QAM Demodulator
JD780B033-FL	LTE-TDD 256 QAM Demodulator
JD780B040-FL	GSM/GPRS/EDGE OTA
JD780B041-FL	WCDMA/HSPA+ OTA
JD780B042-FL	TD-SCDMA OTA
JD780B043-FL	Mobile WiMAX OTA
JD780B045-FL	LTE - FDD OTA
JD780B046-FL	LTE - TDD OTA
JD780B048-FL	cdmaOne/cdma2000 OTA
JD780B049-FL	EV-DO OTA
JD780B050-FL	EMF Analyzer
JD780B060-FL	RFoCPRI 2.4G interference analyzer
JD780B061-FL	RFoCPRI 3.1G interference analyzer
JD780B062-FL	RFoCPRI 4.9G interference analyzer
JD780B063-FL	RFoCPRI 6.1G interference analyzer
JD780B064-FL	RFoCPRI 9.8G interference analyzer
JD780B065-FL	RFoCPRI 614M & 1.2G interference analyzer
JD780B070-FL	RFoBSAI 768M interference analyzer
JD780B071-FL	RFoBSAI 1.5G interference analyzer
JD780B072-FL	RFoBSAI 3.1G interference analyzer
JD780B073-FL	RFoBSAI 6.1G interference analyzer
JD780B081-FL	RFoCPRI LTE-FDD signal generator
JD780B082-FL	RFoCPRI LTE-TDD signal generator
JD780B083-FL	RFoCPRI LTE-FDD multi carrier signal generator
JD780B084-FL	RFoCPRI LTE-TDD multi carrier signal generator
JD780B086-FL	RFoBSAI LTE-FDD signal generator
JD780B091-FL	RFoCPRI LTE-FDD signal analyzer
JD780B092-FL	RFoCPRI LTE-TDD signal analyzer
JD780B096-FL	RFoBSAI LTE-FDD signal analyzer
JD780B101-FL	ALU BBU emulation

Standard Accessories

JD70050008	USB Wi-Fi Dongle ⁶
JD70050326	AC/DC Power Adapter for JD700B Series ⁶
G710550335	Cross LAN Cable (1.5 m) ⁶
GC73050515	USB A to B Cable (1.8 m) ⁶

GC72450518	> 1 G Byte USB Memory ⁶
G710550325	Rechargeable Lithium Ion Battery ⁶
G710550323	Automotive Cigarette Lighter 12 V DC Adapter ⁶
G710550316	Stylus Pen ⁶
JD700B361	JD700B Series User's Guide and Application Software – CD

¹ Requires dual port calibration kit

² Requires RFoCPRI or RFoOBSAI options

³ Highly recommended adding JD748B010

⁴ Highly recommended adding G70005035x and/or G70005036x

⁵ Requires proper SFP/SFP+ transceiver and optical pad

⁶ Standard accessories can be purchased separately.

⁷ Requires G700050380

JD700B Series Common Options

Optional RF Power Sensors

JD731B	Directional Power Sensor, Peak and Average power 300 to 3800 MHz
JD732B	Terminating Power Sensor, Average Power 20 to 3800 MHz
JD733A	Directional Power Sensor, Peak and Average power 150 to 3500 MHz
JD734B	Terminating Power Sensor, Peak power 20 to 3800 MHz
JD736B	Terminating Power Sensor, Dual (Average/Peak) power 20 to 3800 MHz

Optional Optical Power Meters

MP-60A	USB Optical Power Meter, with software, 2.5 mm and 1.25 mm interfaces, 30" USB extender, carrying pouch
MP-80A	USB Optical Power Meter-High Power, with software, 2.5 mm and 1.25 mm interfaces, 30" USB extender, carrying pouch

Optional Fiber Microscope Kits

FBP-SD101	FBP-P5000i Digital Probe, FiberChekPRO SW, Case, and 4 Tips
FBP-MTS-101	FBP-P5000i Digital Probe, FiberChekPRO SW, Case, and 7 Tips
FIT-SD103	FBP-P5000i Digital Probe, MP-60A USB Power Meter, FiberChekPRO SW, Case, Tips and Adapters
FIT-SD103-C	FBP-P5000i Digital Probe, MP-60A USB Power Meter, FiberChekPRO SW, Case, Tips and Adapters
FIT-SD113	FBP-P5000i Digital Probe, MP-80A USB Power Meter, FiberChekPRO SW, Case, Tips and Adapters

Optional RF Cables

G710050530	RF Cable DC to 8 GHz Type-N(m) to Type-N(m), 1.0 m
G710050531	RF Cable DC to 8 GHz Type-N(m) to Type-N(f), 1.5 m
G710050532	RF Cable DC to 8 GHz Type-N(m) to Type-N(f), 3.0 m
G710050533	RF Cable DC to 18 GHz Type-N(m) to SMA(m), 1.5 m
G710050534	RF Cable DC to 18 GHz Type-N(m) to QMA(m), 1.5 m
G710050535	RF Cable DC to 18 GHz Type-N(m) to SMB(m), 1.5 m
G710050536	RF Cable DC to 6 GHz Type-N(m) to DIN(f), 1.5 m
G710050537	RF Cable DC to 4 GHz Type-N(m) to 1.0/2.3 (m), 1.5 m
G700050540	Phase-Stable RF Cable w Grip DC to 6 GHz Type-N(m) to Type-N(f), 1.5 m
G700050541	Phase-Stable RF Cable w Grip DC to 6 GHz Type-N(m) to DIN(f), 1.5 m

Optional Optic Cables

G700050401	SM/LC T-Jumper and 1.5 m fiber cable
G700050402	MM/LC T-Jumper and 1.5 m fiber cable

Optional Antennas

G700050353	RF Omni Antenna	Type-N(m), 806 MHz to 896 MHz
G700050354	RF Omni Antenna	Type-N(m), 870 MHz to 960 MHz
G700050355	RF Omni Antenna	Type-N(m), 1.71 GHz to 2.17 GHz
G700050356	RF Omni Antenna	Type-N(m), 720 MHz to 800 MHz
G700050357	RF Omni Antenna	Type-N(m), 2.3 GHz to 2.7 GHz
G700050363	RF Yagi Antenna	Type-N(f), 1.75 GHz to 2.39 GHz, 9.8 dBd
G700050364	RF Yagi Antenna	Type-N(f), 806 MHz to 896 MHz, 10.2 dBd
G700050365	RF Yagi Antenna	Type-N(f), 866 MHz to 960 MHz, 10.2 dBd
G700050366	RF Log-periodic Antenna	SMA(f), 700 MHz to 4 GHz, 1.85 dBd
G700050367	RF Log-periodic Antenna	SMA(f), 700 MHz to 6 GHz, 2.85 dBd
G700050380	Isotropic Antenna	Type-N(m), 70 MHz to 3 GHz

Optional RF Adapters

G700050571	Adapter Type-N(m) to DIN(f), DC to 7.5 GHz, 50 Ω
G700050572	Adapter DIN(m) to DIN(m), DC to 7.5 GHz, 50 Ω
G700050573	Adapter Type-N(m) to SMA(f) DC to 18 GHz, 50 Ω
G700050574	Adapter Type-N(m) to BNC(f), DC to 4 GHz, 50 Ω
G700050575	Adapter Type-N(f) to Type-N(f), DC to 18 GHz, 50 Ω
G700050576	Adapter Type-N(m) to DIN(m), DC to 7.5 GHz, 50 Ω
G700050577	Adapter Type-N(f) to DIN(f), DC to 7.5 GHz, 50 Ω
G700050578	Adapter Type-N(f) to DIN(m), DC to 7.5 GHz, 50 Ω
G700050579	Adapter DIN(f) to DIN(f), DC to 7.5 GHz, 50 Ω
G700050580	Adapter Type-N(m) to Type-N(m), DC to 11 GHz, 50 Ω
G700050581	Adapter N(m) to QMA(f), DC to 6.0 GHz, 50 Ω
G700050582	Adapter N(m) to QMA(m), DC to 6.0 GHz, 50 Ω
G700050583	Adapter N(m) to 4.1/9.5 MINI DIN (f), DC to 6.0 GHz, 50 Ω
G700050584	Adapter N(m) to 4.1/9.5 MINI DIN (m), DC to 6.0 GHz, 50 Ω
G700050585	Adapter N(m) to 4.3-10 (f), DC to 6.0 GHz, 50 ohm
G700050586	Adapter N(m) to 4.3-10 (m), DC to 6.0 GHz, 50 ohm

StrataSync Subscription

SS-CA-BSA-AM-01	StrataSync for CellAdvisor BSA - Asset Management-1 Yr.
SS-CA-BSA-TDM-01	StrataSync for CellAdvisor BSA - Test Data Management-1 Yr.
SS-CA-RFA-AM-01	StrataSync for CellAdvisor RFA - Asset Management-1 Yr.
SS-CA-RFA-TDM-01	StrataSync for CellAdvisor RFA - Test Data Management-1 Yr.
SS-CA-SA-AM-01	StrataSync for CellAdvisor SA - Asset Management-1 Yr.
SS-CA-SA-TDM-01	StrataSync for CellAdvisor SA - Test Data Management-1 Yr.

Optional Miscellaneous

G710050581	Attenuator 40 dB, 100 W, DC to 4 GHz (Unidirectional)
G710050585	RF Directional Coupler, 700 to 4000 MHz, 30 dB, 50 W Input/Output; Type-N(m) to Type-N(f), Tap Off; Type-N(f) ¹
G710050586	RF combiner, 700 to 4000 MHz, Type-N(f) to Type-N(m) ¹
G710050587	4x1 RF combiner, 700 to 4000 MHz, Type-N(f) to Type-N(m) ²
G700050601	Bandpass filter 696 MHz to 716 MHz, N(m) to N(f), 50 ohm
G700050602	Bandpass filter 776 MHz to 788 MHz, N(m) to N(f), 50 ohm
G700050603	Bandpass filter 806 MHz to 849 MHz, N(m) to N(f), 50 ohm
G700050604	Bandpass filter 1710 MHz to 1755 MHz, N(m) to N(f), 50 ohm
G700050605	Bandpass filter 1850 MHz to 1910 MHz, N(m) to N(f), 50 ohm
JD74050341	Soft carrying case
JD71050342	Hard Carrying Case
JD70050342	Hard Carrying Case with wheels
JD70050343	CellAdvisor Backpack Carrying Case
JD70050006	USB Bluetooth Dongle and 5 dBi Dipole Antenna

Appendix

JD70050007	AntennaAdvisor Handle ³
JD71050351	GPS Antenna for JD740 and JD780 Series
G710550324	External Battery Charger
JD700B362	JD700B Series User's Guide – Printed Version

¹ Highly recommended for LTE testing

² Highly recommended for LTE Advanced testing

³ Requires G700050366 or G700050367 RF Log-Periodic Antenna

Appendix J – RoHS information

This appendix describes the RoHS (Restriction of Hazardous Substances) information, which is a mandatory requirement from China. The RoHS directive consists in the restriction on the use of certain hazardous substances in electrical or electronic equipment sold or used in the European Union, after July 1, 2006. These substances are: lead, mercury, cadmium, hexavalent chromium, polybrominated biphenyls, and polybrominated diphenyl ethers.

JD780B series

Concerned products : JD785B, JD786B, JD788B

“中国 RoHS”

《电子信息产品污染控制管理办法》（信息产业部，第 39 号）

附录 (Additional Information required for the Chinese Market only)

本附录按照“中国 RoHS”的要求说明了有关电子信息产品环保使用期限的情况，并列出了产品中含有的有毒、有害物质的种类和所在部件。本附录适用于产品主体和所有配件。

产品系列: **JD780B**

(Product Family)

环保使用期限:



本标识标注于产品主体之上，表明该产品或其配件含有有毒、有害物质（详情见下表）。

其中的数字代表在正常操作条件下至少在产品生产日期之后数年内该产品或其配件内含有的有毒、有害物质不会变异或泄漏。该期限不适用于诸如电池等易耗品。

有关正常操作条件，请参见产品用户手册。

产品生产日期请参见产品的原始校准证书。

有毒、有害物质的类型和所在部件

元器件 (Component)	有毒、有害物质和元素					
	铅(Pb)	汞(Hg)	镉(Cd)	六价铬(CR ⁶⁺)	多溴联苯(PBB)	多溴二苯醚(PBDE)
产品主体 (Main Product)						
印刷电路板组件 (PCB Assemblies)	X	O	O	O	O	O
内部配线 (Internal wiring)	O	O	O	O	O	O
显示器 (Display)	O	O	O	O	O	O
键盘 (Keyboard)	O	O	O	O	O	O
电池 (Batteries)	O	O	O	O	O	O
电工零件 (Electro-mechanical parts)	O	O	O	O	O	O
金属外壳零件和紧固件 (Metal case parts and fixings)	O	O	O	O	O	O
塑料外壳零件 (Plastic case parts)	O	O	O	O	O	O
标签和胶带 (Labels and tapes)	O	O	O	O	O	O
配件 (Accessories)						
外接电缆和适配器 (External cables and adapters)	X	O	O	O	X	X
USB 记忆 (USB Memory)	X	O	O	O	O	O
手册和其它印刷材料 (Handbooks and other printed material)	O	O	O	O	O	O
包装箱和携带 (Carrying case and strap)	O	O	O	O	O	O
其它配件 (Other accessories)	X	O	O	O	X	X
AC/DC 电源适配器 (AC/DC Power Adapters)	O	O	O	O	O	O

O: 代表该部分中所有均质材料含有的该有毒、有害物质含量低于 SJ/T11363-2006 标准的限值。
X: 代表该部分中所有均质材料含有的该有毒、有害物质含量高于 SJ/T11363-2006 标准的限值。

JD740B series

Concerned products : JD745B, JD746B, JD748B

“中国 RoHS”

《电子信息产品污染控制管理办法》（信息产业部，第 39 号）

附录 (Additional Information required for the Chinese Market only)

本附录按照“中国 RoHS”的要求说明了有关电子信息产品环保使用期限的情况，并列出了产品中含有的有毒、有害物质的种类和所在部件。本附录适用于产品主体和所有配件。

产品系列: JD740B

(Product Family)

环保使用期限:



本标识标注于产品主体之上，表明该产品或其配件含有有毒、有害物质（详情见下表）。

其中的数字代表在正常操作条件下至少在产品生产日期之后数年内该产品或其配件内含有的有毒、有害物质不会变异或泄漏。该期限不适用于诸如电池等易耗品。

有关正常操作条件，请参见产品用户手册。

产品生产日期请参见产品的原始校准证书。

有毒、有害物质的类型和所在部件

元器件 (Component)	有毒、有害物质和元素					
	铅(Pb)	汞(Hg)	镉(Cd)	六价铬(CR ⁶⁺)	多溴联苯(PBB)	多溴二苯醚(PBDE)
产品主体 (Main Product)						
印刷电路板组件 (PCB Assemblies)	X	O	O	O	O	O
内部配线 (Internal wiring)	O	O	O	O	O	O
显示器 (Display)	O	O	O	O	O	O
键盘 (Keypad)	O	O	O	O	O	O
电池 (Batteries)	O	O	O	O	O	O
电工零件 (Electro-mechanical parts)	O	O	O	O	O	O
金属外壳零件和紧固件 (Metal case parts and fixings)	O	O	O	O	O	O
塑料外壳零件 (Plastic case parts)	O	O	O	O	O	O
标签和胶带 (Labels and tapes)	O	O	O	O	O	O
配件 (Accessories)						
外接电缆和适配器 (External cables and adapters)	X	O	O	O	X	X
USB 记忆 (USB Memory)	X	O	O	O	O	O
手册和其它印刷材料 (Handbooks and other printed material)	O	O	O	O	O	O
包装箱和提带 (Carrying case and strap)	O	O	O	O	O	O
其它配件 (Other accessories)	X	O	O	O	X	X
AC/DC 电源适配器 (AC/DC Power Adapters)	O	O	O	O	O	O
O: 代表该部分中所有均质材料含有的该有毒、有害物质含量低于 SJ/T11363-2006 标准的限值。 X: 代表该部分中所有均质材料含有的该有毒、有害物质含量高于 SJ/T11363-2006 标准的限值。						

Appendix K – On-screen keyboard

You can use the on-screen keyboard to type in texts, file names, and folder names.

Adding or deleting letters

Procedure

- 1 Tap keys on the on-screen keyboard. As you type, each letter is displayed in the name field. If you want to change the letter case between uppercase and lowercase, tap the **Caps** key.
 - 2 To delete a letter, tap the **Back** key on the keyboard or press the backspace key on the keypad.
 - 3 To move the cursor along the name field, tap the < or > key, turn the rotary knob, or touch in between letters in the name field.
 - 4 To delete all the letters displayed in the name field, tap the **Clear** key on the on-screen keyboard.
-

Figure 462 On-screen keyboard



Editing or adding a custom keyword

You can edit and delete a keyword or add a new one, as you desire.

Procedure

- 1 Tap the **Edit Keywords** bar on the on-screen keyboard. The edit keywords keyboard appears.
 - 2 To edit a keyword, select the keyword box and then change the letters.
 - 3 To delete a keyword, select the keyword box and then tap the **Clear** key.
 - 4 To add a keyword, select a blank keyword box and then type in a keyword.
 - 5 Tap the **Save** key on the keyboard to save and continue saving.
-

Figure 463 Edit keywords keyboard



Appending a keyword

You can append a factory-stored or custom-defined keyword, as you want.

Procedure

- 1 Tap the **Append Keywords** bar on the on-screen keyboard. The append keywords window appears.
- 2 To append a keyword, complete the following steps:
 - a Select the keyword tag button to view available keywords for the tag.
 - b Select one keyword, from the following choices for each keyword tag:

Keyword tag	Keyword (tag value)
Site-ID*	SiteA, SiteB, and SiteC
Sector*	Alpha, Beta, and Gamma
Technology*	GSM900, WCDMA850, and LTE180
Test Type*	RL, VSWR, DTF-RL, DTF-VSWR, and CL
Termination*	Open, Load, and Antenna
Custom	Any keywords you have added

- c To delete the keyword you have added to the keyword field, tap the **Delete** button.
 - d To clear the keyword field, tap the **Clear** button.
- 3 *Optional.* You can edit any of the custom keyword tags or tag values by tapping the **Edit Tags Values** or **Edit Tags** button, but not the factory keyword tags marked with the asterisk (*).



NOTE

You must keep the keywords marked with the asterisk (*) intact as the StrataSync server uses them when transferring data.

- 4 Select the **Separator** option from the choices: hyphen [-], underscore [_], and **None**.
- 5 Select the **As a filename** option between **On** and **Off**. If you select **Off**, the keyword will not be placed in a file name, but in the trace/PNG file information.
- 6 Tap the **Save and Exit** button to save and exit or the **Keyboard** button to return to the keyboard.

Figure 464 Append keywords window



Appendix L – Supported map display parameters

Your CellAdvisor instrument provides the RAN Performance Indicator feature in the LTE signal analyzer mode. Setting map display parameters that your instrument supports is important to have test results as you desire as the instrument supports RANAdvisor's map display parameters with limitations. Following table will help you select parameters properly by showing what are supported.

Parameter Category	Parameter Name	Support	Parameter Category	Parameter Name	Support
LTE Cell Info Parameters	Cell Name		LTE Serving and Neighbor Parameters (continued)	N1 RSRP Rx(1) (dBm)	
	Physical Cell IDentity			N1 RSRP (dBm)	
	Physical Physical Cell ID			N1 RSRQ (dB)	
	Tracking Area Code			N2 PCI	
	MCC			N2 RSRP Rx(0) (dBm)	
	MNC			N2 RSRP Rx(1) (dBm)	
	DL E-ARFCN			N2 RSRP (dBm)	
	UL E-ARFCN			N2 RSRQ (dB)	
	DL Bandwidth			N3 PCI	
	UL Bandwidth			N3 RSRP Rx(0) (dBm)	
	Band Indicator			N3 RSRP Rx(1) (dBm)	
	Allowed Access			N3 RSRP (dBm)	
	RLC Tx Throughput	YES		N3 RSRQ (dB)	
	RLC Rx Throughput	YES		N4 PCI	
	MAC Tx Throughput	YES		N4 RSRP Rx(0) (dBm)	
	MAX Rx Throughput	YES		N4 RSRP Rx(1) (dBm)	
	LTE Mode			N4 RSRP (dBm)	
	LTE TDD SF Assignment			N4 RSRQ (dB)	
	LTE TDD Special SF Patterns			N5 PCI	
		CQI CW0		YES	N5 RSRP Rx(0) (dBm)
	CQI CW1	YES	N5 RSRP Rx(1) (dBm)		
LTE ML1 Serving Cell Measurement	RSSI RX (0) (dBm)	YES	N5 RSRP (dBm)		
	RSSI RX (1) (dBm)	YES	N5 RSRQ (dB)		
	RSSI (dBm)	YES	N6 PCI		
	RSRP Rx(0) (dBm)	YES	N6 RSRP Rx(0) (dBm)		
	RSRP Rx(1) (dBm)	YES	N6 RSRP Rx(1) (dBm)		
	RSRP (dBm)	YES	N6 RSRP (dBm)		
	RSRQ Rx(0) (dBm)	YES	LTE Demod Config Parameters	PDSCH RNTI ID	
	RSRQ RX(1) (dBm)	YES		PDSCH RNTI Type	
	RSRQ (dB)	YES		eNodeB Tx Antennas	
	SINR Rx(0) (dB)	YES		eNodeB Rx Antennas	
	SINR Rx(1) (dB)	YES		Transmission Mode	
	PUSCH Tx (dBm)	YES		Spatial Rank	
	PUCCH Tx (dBm)	YES		RB Alloc for Slot 0 (%)	
	SRS Tx (dBm)	YES		RB Alloc for Slot 1 (%)	
LTE Serving and Neighbor Parameters	Serving E-ARFCN	YES		Freq Selective PMI	
	Serving Physical Cell-ID	YES		PMI Index	
	Serving RSRP (dBm)	YES		Stream 0 TBS (bits)	
	Serving RSRQ (dB)	YES		Stream 0 Modulation	YES
	Detected Cells PCI			Traffic to Pilot Block Ratio	
	Neighbor Cell Count			Stream 1 TBS (bits)	
	N1 PCI			Stream 1 Modulation	
N1 RSRP Rx(0) (dBm)			PB		



Document No. 22079955
Rev. 16.0, January 2018
English

Viavi Solutions

North America:	1.844.GO VIAVI / 1.844.468.4284
Latin America:	+52 55 5543 6644
EMEA:	+49 7121 862273
APAC:	+1 512 201 6534
All Other Regions:	viavisolutions.com/contacts