

RIGOL

快速指南 Quick Guide



© 2016 RIGOL TECHNOLOGIES, INC. All Rights Reserved.

DSA800E 系列频谱分析仪

DSA800E Series Spectrum Analyzer

一般性检查

1. 请检查运输包装

如运输包装已损坏，请保留被损坏的包装或防震材料，直到货物经过完全检查且仪器通过电性和机械测试。因运输造成仪器损坏，由发货方和承运方联系赔偿事宜。**RIGOL**公司恕不进行免费维修或更换。

2. 请检查整机

若存在机械损坏或缺失，或者仪器未通过电性和机械测试，请联系您的**RIGOL**经销商。

3. 请检查随机附件

请根据装箱单检查随机附件，如有损坏或缺失，请联系您的**RIGOL**经销商。

一般安全概要

1. 请使用所在国家认可的本产品专用电源线。
2. 请确保产品可靠接地。
3. 请勿开盖操作。
4. 请使用合适的保险丝。
5. 请避免电路外露。
6. 怀疑产品出故障时，请勿进行操作。
7. 请保持适当的通风。
8. 请勿在潮湿环境下操作。
9. 请勿在易燃易爆的环境下操作。
10. 请保持产品表面的清洁和干燥。
11. 请注意防静电保护。
12. 请注意搬运安全。

产品简介

DSA800E 系列是一款体积小、重量轻、性价比高、入门级的便携式频谱分析仪，现提供 DSA832E 一个型号。它拥有易于操作的键盘布局、高度清晰的彩色液晶显示屏、丰富的远程通信接口，可广泛应用于教育科学、企业研发和工业生产等诸多领域中。

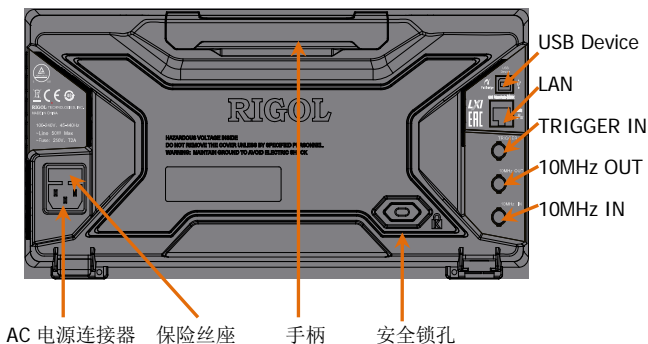
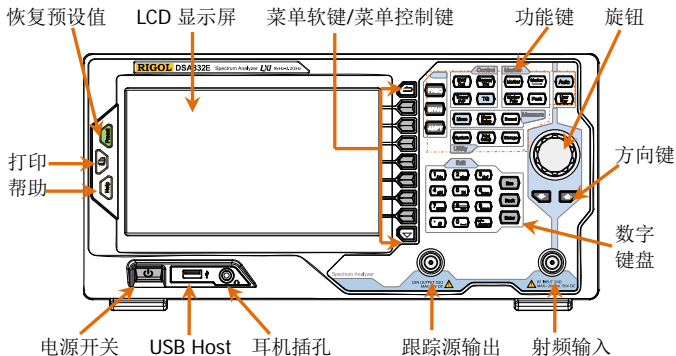

调整支撑脚

DSA800E 允许用户在使用仪器时打开支撑脚以作为支架使仪器向上倾斜，便于操作和观察。在不使用仪器时，用户可以合上支撑脚以方便放置或搬运。

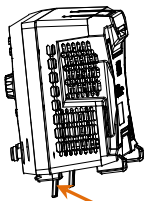

打开支撑脚

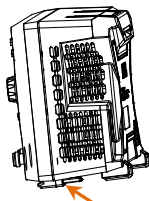

合上支撑脚

连接电源

请使用附件提供的电源线将频谱仪连接至 AC 电源中。DSA800E 支持的 AC 电源规格为 100 V - 240 V，45 Hz - 440 Hz；保险丝规格为 5 mm×20 mm，250V AC，T2A。



注意

为避免电击，请确保仪器正确接地。

开机与自校正

正确连接电源后，按下前面板的电源开关  打开频谱仪。您可以通过开机进度指示获得开机初始化过程信息。开机画面结束后，屏幕出现扫频曲线。按 **System** → **校准** → **立即校准**，使用系统内部的校准源对系统进行自校正，更多信息请查看本产品用户手册。

使用注意事项

1. 使用跟踪源输出端:



注意

为了避免损坏跟踪源，频率低于 10 MHz 时反向功率不得超过 +10 dBm；频率大于 10 MHz 时反向功率不得超过 +20 dBm。反向直流电压不得超过 50 V。



GEN OUTPUT 50Ω
MAX 50V DC

2. 使用射频输入端:



注意

为避免损坏仪器，输入到射频输入端的信号，直流电压分量不得超过 50 V，交流（射频）信号分量最大连续功率不得超过 +20 dBm。



RF INPUT 50Ω
MAX+20dBm/50V DC

远程控制概述

DSA800E支持通过USB、LAN或GPIB（选件）接口与计算机进行通信从而实现远程控制。远程控制基于SCPI命令集（Standard Commands for Programmable Instruments）实现，主要包括两种方式：用户自定义编程和使用PC软件（如**RIGOL** Ultra Sigma）。当仪器工作在远程模式时，用户界面显示 图标，前面板按键被锁定（ 除外）。此时，您可以按 键退出远程模式。

更多产品信息

您可以使用菜单 **System** → **信息** → **系统信息** 获取您的设备信息，包括型号、序列号、硬件和软件版本号等；您还可以通过菜单 **System** → **序列号** 查看已安装的选件列表。

欲了解本产品更多信息，请查阅如下手册（您可登录 **RIGOL** 网站下载）：

《DSA800E 系列频谱分析仪用户手册》：提供本产品功能的详细说明；

《DSA800E 系列频谱分析仪编程手册》：提供本产品 SCPI 命令及编程的详细说明；

《DSA800E 系列频谱分析仪数据手册》：提供本产品的主要特色和技术指标；

《DSA800E 系列频谱分析仪附件与选件手册》：提供本产品附件和选件的详细说明。

联系我们

如您在使用此产品或本手册的过程中有任何问题或需求，请与 **RIGOL** 联系：

电子邮箱：service@rigol.com

网址：www.rigol.com

General Inspection

1. Inspect the shipping container for damage

If your shipping container appears to be damaged, keep the shipping container or cushioning material until you have inspected the contents of the shipment for completeness and have checked the instrument electrically and mechanically. If your instrument has been damaged during shipping, please contact your shipper and carrier for compensation. **RIGOL** will provide no free repair or replacement.

2. Inspect the instrument

If there is any mechanical damage or defect, or if the instrument does not pass electrical and mechanical tests, please contact your **RIGOL** sales representative.

3. Check the accessories

Please check the accessories according to the packing lists. If the accessories are incomplete or damaged, please contact your **RIGOL** sales representative.

General Safety Summary

1. Use power cords designed for the instrument and authorized by local country.
2. Make sure the instrument is grounded properly.
3. Do not operate without covers.
4. Use proper fuse.
5. Avoid circuit or wire exposure.
6. Do not operate with suspected failures.
7. Keep proper ventilation.
8. Do not operate in wet conditions.
9. Do not operate in flammable and explosive environment.
10. Keep product surface clean and dry.
11. Protect the instrument from static electricity.
12. Pay attention to handling safety.

Product Overview

Featuring light weight, compact structure, low cost, and high performance, DSA800E series spectrum analyzers are portable spectrum analyzers designed for starters. It includes DSA832E one model. Configured with easy-to-operate keyboard, high-resolution color LCD display and various remote communication interfaces, they can be widely used in various fields, such as education, company research and development as well as industrial manufacture.

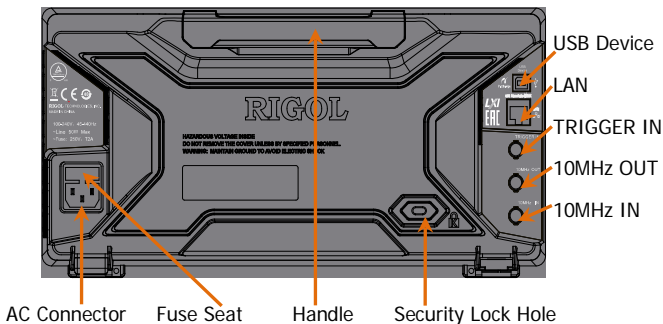
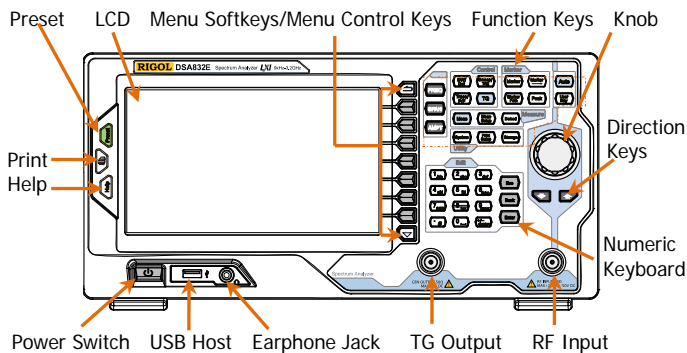

To Adjust the Supporting Legs

Users can unfold the supporting legs to use them as stands to tilt the instrument upwards for easier operation and observation. Users can also fold the supporting legs when the instrument is not in use for easier storage or shipment.

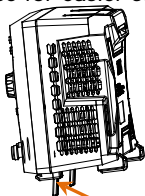

Unfold the Supporting Legs

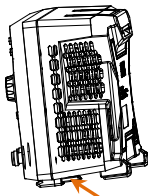

Fold the Supporting Legs

To Connect Power

Connect the spectrum analyzer to AC power source using the power cord supplied with the accessories. DSA800E supports 100 V - 240 V, 45 Hz - 440 Hz AC power source and 5 mm×20 mm, 250V AC, T2A fuse.



CAUTION

Make sure that the instrument is properly grounded to avoid electric shock.

Start-up and Self-calibration

After connecting the instrument to power source correctly, press  at the front panel to start the spectrum analyzer. You can obtain information about the start-up initialization process through the start-up progress indications. Following the start-up screen, the sweep curve is displayed. Press **System** → **Calibrate** → **Cal Now** and the instrument will perform self-calibration using the internal calibration source (for more information, refer to the *DSA800E Series User's Guide*).

Using Notices

1. To use the tracking generator output terminal:



CAUTION

To avoid damage to the tracking generator, the reverse power cannot exceed +10 dBm when the frequency less than 10 MHz; the reverse power cannot exceed +20 dBm when the frequency more than 10 MHz. The reverse DC voltage cannot exceed 50 V.

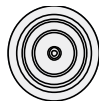

GEN OUTPUT 50Ω
MAX 50V DC

2. To use the RF input terminal:





CAUTION

To avoid damage to the instrument, for the signal input from the RF input terminal, the DC voltage component and the maximum continuous power of the AC (RF) signal component cannot exceed 50 V and +20 dBm respectively.



RF INPUT 50Ω
MAX+20dBm/50V DC

Remote Control Overview

DSA800E supports communication with PC via USB, LAN or GPIB (option) interface for remote control. The remote control is realized on the basis of SCPI (Standard Commands for Programmable Instruments) command set through two ways: user-defined programming and PC software (such as **RIGOL Ultra Sigma**). When the instrument is in remote mode, the  icon is displayed in the user interface and the front panel keys (except ) are locked. At this point, you can press  to exit remote mode.

For More Product Information

You can obtain the instrument information including model, serial number as well as hardware and software version numbers through **System** → **Information** → **System Info**. You can also view the list of installed options through **System** → **License**. For more information of this product, please refer to the following manuals (you can download them from the **RIGOL** network):

DSA800E Series User's Guide: provide detailed introductions of the functions of this product;

DSA800E Series Programming Guide: provide detailed introductions of the SCPI commands and programming of this product;

DSA800E Series Datasheet: provide the main characteristics and specifications of this product;

DSA800E Series Accessories and Options: provide detailed introductions of the accessories and options of this product.

Contact Us

If you have any problem or requirement when using our products or this manual, please contact **RIGOL**.

E-mail: service@rigol.com

Websites: www.rigol.com



ZN1020003750