



# SmartClass™ TPS

## Broadband DSL Test Instrument

The Viavi Solutions® SmartClass TPS handheld test instrument helps field technicians roll out broadband access networks and services, delivering a pristine copper access infrastructure that can support triple-play services and meet critical quality-of-service (QoS) and quality-of-experience (QoE) requirements.

This all-in-one tool can test copper, fiber, asymmetrical, and very-high-speed digital subscriber lines (ADSL2+/VDSL2 annex A and B, bonding, vectoring), WiFi, coax and HPNA networks, internet protocol (IP) data, voice over IP (VoIP), and IP video with straightforward pass/fail results and detailed analyses of physical and application-layer-related problems.

To ensure that installation and repair jobs have been completed successfully, the SmartClass TPS verifies the access copper loop's physical health, digital subscriber line (DSL) performance, QoS/QoE of triple-play services, and home distribution networks. In addition, the CableCheck and OneCheck automated test suites improve technician efficiency by simplifying test configurations and results, cutting test times by more than half. The iOS® and Android™ mobile apps expand this efficiency, enabling mobile integration. Overall, with SmartClass TPS, operators and service providers can locate and repair faults more quickly to confidently guarantee service quality.

- VDSL 
- ADSL 
- Copper 
- Coax 
- Web 
- OneCheck 
- Mobile 
- StrataSync 

### Key Benefits

- Reduce repeat faults, save money with comprehensive testing in an all-in-one tool
- Cut test times in half for xDSL and triple-play services with OneCheck™
- Avoid the complexity of copper testing with one-button CableCheck™
- Save time using SmartIDs™ to troubleshoot an entire multipoint coax network in one test
- Improve overall technician efficiency with mobile apps and simplified, one-button testing

### Key Features

- Tests ADSL2+/VDSL2 (annex A and B) including bonded and vectored pairs, broadband services (data, VoIP, and IP video), copper, POTS, fiber, WiFi, and coax/HPNA
- Web browser
- Supports WiFi
- OneCheck automates all ADSL2+/VDSL2, data, VoIP, and IP video tests and reports all key quality metrics
- CableCheck verifies copper-pair health with balance testing and ground checks
- Mobile App for iPhone/iPad (iOS app) and Android phones/tablets (Android app) provides remote control, job management, and technical support content, including tutorials
- StrataSync™ cloud-enabled architecture provides easy asset and test data management

## All-in-One Design

With the advent of cloud-based applications and always-on, always-connected smartphones and tablets, service providers have high expectations for seamless integration between their devices and the back office.

SmartClass TPS design highlights include:

SmartClass TPS Feature	What It Does	Why It Is Needed
All-in-one hardware	Enables tests for all DSL, Copper (optional), and all triple-play/HPNA services, as well as coax and fiber (with accessories)	Complete test set for broadband DSL maintenance
2-DSL variant hardware	HW1 supports DSL bonding; HW2 supports ADSL annexB; both support vectoring and DSL RTX (G.INP)	More flexibility to fit local DSL standards
Remote software upgrades	Software can be enhanced and upgraded in the field	Keeps hardware updated with the latest best-practice applications
WiFi connectivity	Optional wireless connectivity	Easy communication with mobile devices, WiFi testing and triple-play test through WiFi interface
OneCheck	Automated Viavi suite of tests, many with pass/fail results	Leverages best practices to make complex tasks easy
StrataSync	Cloud-based solution manages Viavi instrument assets and field data results	Plug-and-play back-office integration



## ADSL2+/VDSL2

A common DSL sync test is performed with every dispatch because it is essential to helping field technicians understand DSL link quality (bandwidth rates, margins, errors, and likelihood for errors). This same test also helps determine whether issues are coming from the equipment (CPE or DSLAM ports) or from the profile settings.

SmartClass TPS supports ADSL2/2+ Annex A and Annex B, and VDSL2 on single-line (up to 30a). It also supports DSL physical layer retransmission (G.INP). The table below shows the typical tests technicians are required to perform:

DSL Test	What It Does	Why It Is Needed
Synchronization test	Synchronization in auto mode or with a dedicated profile	Connection and provisioning problems
Profile	Current profile set	Mismatch between DSLAM profile, CPE settings, and customer's expectations
Margins and attenuation	SNR ratio margins and loop attenuations	Copper loops are exposed to external noise. Adequate noise margins maintain DSL connection quality. Higher attenuation results in lower SNR.
DSL errors	CRC, FEC, LOS, LOF, and LOP	DSL errors will transfer to application layers such as IP video
DSL RTX (G.INP)	DSL retransmission: status, retransmitted DTUs, corrected DTUs, uncorrected DTUs, INP REIN	DSL RTX support to match CPE and statistics to highlight DSL lines at risk, already using retransmission
BPT graph	Number of BPT identifies disturbers/interferers	Number of BPT identifies disturbers/interferers.
Hlog graph	Loop attenuation component of the channel transfer function (during the modem training phase)	Can detect bridged taps, degraded contacts, and bad joints
QLN graph	External noise floor of the DSL line	Shows frequency of potential disturbers/interferers on the DSL line

**DSL Summary** Signal

VDSL2 17a PTM 3:57  
Showtime (0:23)

	Up	Down
<b>Actual Rate</b>	53.9 Mbps	92.5 Mbps
<b>Max Rate</b>	62.1 Mbps	132 Mbps
<b>Capacity</b>	86%	69%
<b>Actual Margin</b>	14.3 dB	16.7 dB
<b>1 MHz ATN</b>		1.8 dB

\* Setup Results #

**DSL Signal** Summary Margins

Signal

	Up	Down
<b>SATN</b>	0.0 dB	0.1 dB
<b>LATN</b>	0.0 dB	0.1 dB
<b>1 MHz ATN</b>		1.8 dB
<b>Tx Power</b>	-0.9 dBm	12.5 dBm
<b>INTLV Delay</b>	0 ms	0 ms
<b>Actual INP</b>	67	72

Results #

**Noise Margin** Signal Errors

Margins

	Up	Down
<b>Max</b>	15.2 dB	16.8 dB
<b>Actual</b>	14.9 dB	16.8 dB
<b>Min</b>	14.4 dB	16.8 dB

\* Clear Results #

## Copper

The SmartClass TPS provides an automatic one-button CableCheck function with pass/fail results for important copper test parameters, even in environments that produce a high level of noise and interference. The CableCheck test sequence lets users secure accurate test results and identify obvious copper faults, such as misconnections or copper loops that are too long, with minimal training.

Basic tests required in today's copper network include:

Copper Test	What it Tests	Why it is Needed
Digital volt-ohm meter (DVOM)	DC/AC voltage, loop current, loop resistance, distance-to-short, and leakage	Overall copper health, risk of no DSL synchronization
Opens	Capacitance and loop length	Cable damage, to determine if loop length is acceptable for DSL
Balance	Longitudinal balance, resistive balance, capacitive balance	Robustness against noise, otherwise reduced bits per tone
Load coil	Presence of load coils and location	Load coils act as low-pass filters and must be removed for DSL to function properly

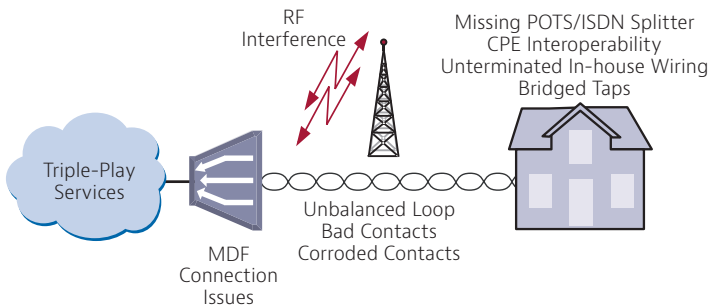

The SmartClass TPS CableCheck script automates copper qualification with a single-ended line test (SELT) and pass/fail results to simplify copper testing.

## Hlog

Copper loops that perform well for ADSL2+ may fail dramatically with full VDSL2 performance. Short bridged taps (between 2 – 50 m/ 5 – 150 ft) located in homes can degrade VDSL2 data rates significantly.

The graphical Hlog diagnostic mode on the SmartClass TPS easily detects bridged taps, including their approximate length and frequency areas of noise interference. A bridged tap causes a dip on the Hlog graph, which represents the attenuation per frequency of the line. The Hlog data is assessed during the DSL training phase.

Removing bridged tap faults lets operators provide more reliable DSL lines with higher data rates. Also, it is easy to recheck with Hlog to ensure that there's no more dip: meaning no more bridged tap.

DSL Test	What it Tests	Why it is Needed
Hlog	Loop attenuation component of the channel transfer function (during the modem training phase)	Can detect bridged taps, degraded contacts and bad joints



A bridged tap causes a dip on the Hlog graph; this example shows a bridged tap length of approximately 8 m

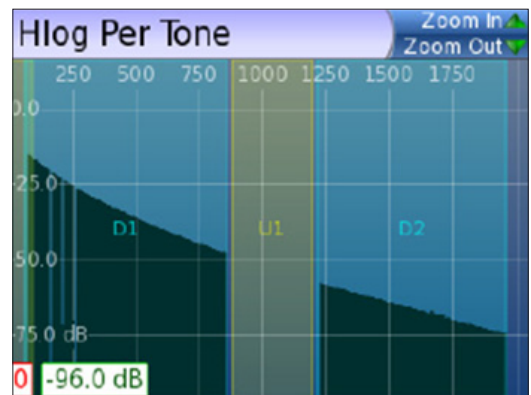

No more bridged tap

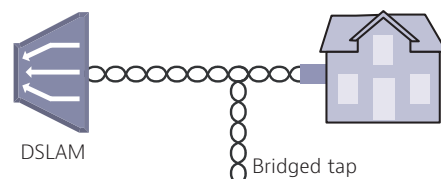

Bridged taps can impact DSL performance

## OneCheck

OneCheck is a fully automated, single-button application that tests with clear pass/fail results, data throughput, VoIP, and video over DSL, Ethernet, or WiFi.

This application lets technicians overcome the complexity of testing all technologies simultaneously. OneCheck significantly reduces test times and lets technicians test all services with minimal training. Consistently following test methods and procedures, operators also reduce working CPE swap outs, second customer visits to solve problems, and repeats; all services are checked before closing a job. OneCheck results also provide insightful test data from the field which can help improve network design and overall QoS.

Test	What it tests	Why is it needed?
Physical link*	DSL with pass/fail on connection rate, maximum rate, noise margin, and attenuation	High data rates achieved with VDSL and/or DSL bonding are more susceptible to impairments due to a higher transmission frequency range and complex protocols. Good data, VoIP, and video services QoS require a pristine physical link.
Network authentication	Network authentication using IPoE/IPoE6 or PPPoE, with user login status information	Certifying the network during customer service turn-up.
IP ping	Connectivity and delay time through the network with pass/fail results for receiving a successful ping reply within set timing thresholds (average or maximum ping time)	Network delay is crucial, especially with high-interaction applications such as gaming.
File upload	File upload rates using FTP or HTTP protocol with pass/fail results for targeted rates	DSL profile parameters, such as impulse noise protection (INP) and delay and network aggregation issues, determine user-experienced data speeds.
File download	File download rate using FTP or HTTP protocol with pass/fail results for targeted rates	DSL profile parameters, such as INP and delay and network aggregation issues, determine user-experienced data speeds.
Video	Verifies that all video channels based on a loaded channel list are available and perform according to QoS thresholds (latency, jitter, loss) with pass/fail results	Verify video channel availability and quality to meet customer expectations.
VoIP	Registration at the gateway by placing an automated or manual call with call quality according to QoS thresholds (loss, jitter, delay) with pass/fail results and includes an MOS result.	Ensure that service setup and provisioning match the customer profile. Verify connectivity beyond the signaling gateway and ensure user-perceived premium call quality.

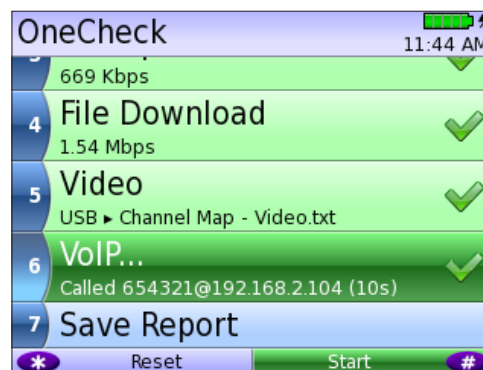
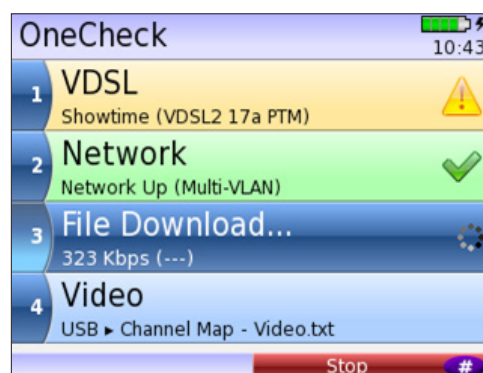
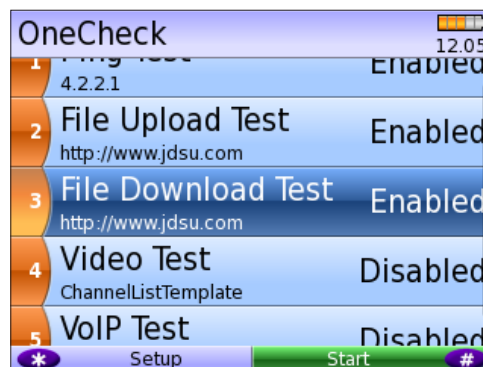

Technicians can choose which OneCheck tests to run, stop, resume, reset, and receive clear pass/fail results in CSV, HTML, or PDF file format.

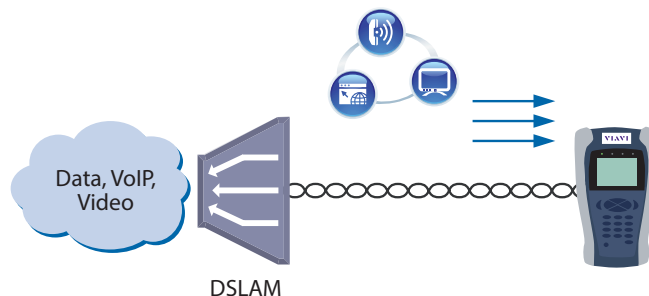

SmartClass TPS OneCheck automates DSL, data, VoIP, and video testing with pass/fail results to significantly reduce test time.



## IP Video

The SmartClass TPS can test multiple standard- (SDTV) and high-definition television (HDTV) streams regardless of compression format (Motion Picture Experts Group 2 [MPEG-2], MPEG-4p10/H.264 or VC-1, and others) and automatically detects the stream type with the Broadcast Auto feature.

The SmartClass TPS IP Video application allows for termination of the IP video stream anywhere in the access network using the DSL, Ethernet terminal equipment (TE), or WiFi interface. The SmartClass TPS Monitor and Through mode also helps users identify faulty equipment.

Key performance indicators for real-time protocol (RTP), the correlation to DSL errors, along with an optional video mean opinion score (VMOS) test enables the SmartClass TPS to truly measure network QoS and QoE.

Ch	Name	Status	QoS
202	AXN	Available	Good
203	Cinemagic	Available	Good
209	TNT Serie	Available	Good
232	Fashion TV	Available	Good
234	MTV	Available	Good

The SmartClass TPS VideoCheck channel summary shows each channel's availability as well as the QoS.

202 AXN	
Loss	0.00%
Jitter	8 ms
Join Latency	76 ms
Leave Latency	6 ms
Error Ind	0
Channel Settings	
Stream Type	MPEG-2 TS Broadcast-RTP-UDP
IP Address	239.35.40.27

Detailed QoS results for each channel tested in the SmartClass TPS VideoCheck

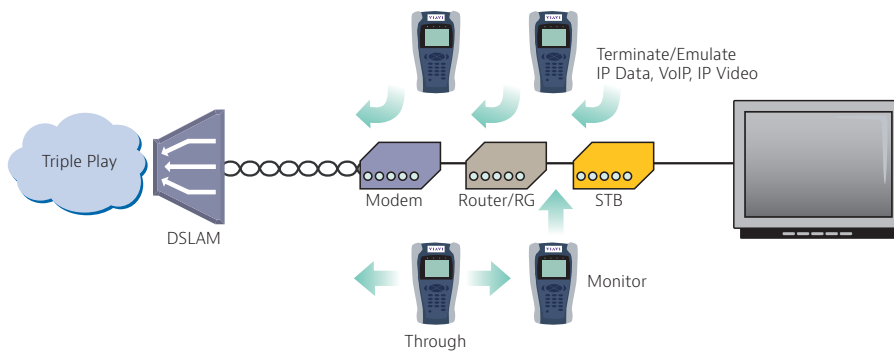

Through, Monitor, and Emulation modes

## VoIP

The SmartClass TPS is the ideal test tool to quickly place VoIP calls and verify QoS via mean opinion score (MOS) values.

A DSL, Ethernet TE, or WiFi interface allows for testing VoIP anywhere in the access network, replacing either the DSL modem, VoIP phone, or both. The SmartClass TPS also includes an Auto Answer mode in which the unit automatically responds to an incoming call.

Viavi provides a wide range of signaling protocols including SIP, H.323, MGCP and SCCP, and voice decoding (G.711, G.722, G.723, G.726, and G.729).

Typical VoIP tests that today's field technicians require include:

VoIP Test	What it Tests	Why it is Needed
Service setup/provisioning	Registration with gateway: SIP, H.323, MGCP, SCCP	User setup and server availability. VoIP clients and servers allow complex setups.
Connectivity beyond signaling gateway	Placing test calls on and off network	Call connection from VoIP-to-VoIP and VoIP-to-Public Switched Telephone Network (PSTN).
Call quality	MOS, near- and far-end QoS with packet loss, jitter, delay, and R-Factor	Tests how VoIP calls are transferred through the network and received at the customer premises.

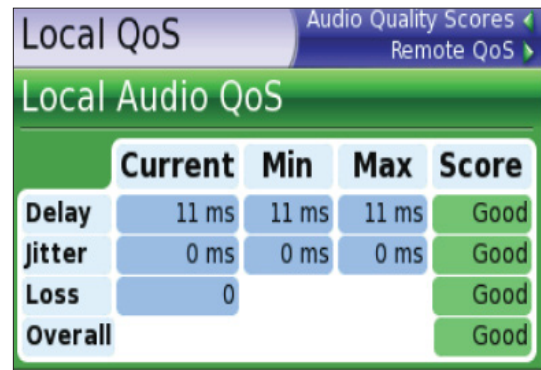

VoIP Audio QoS screen

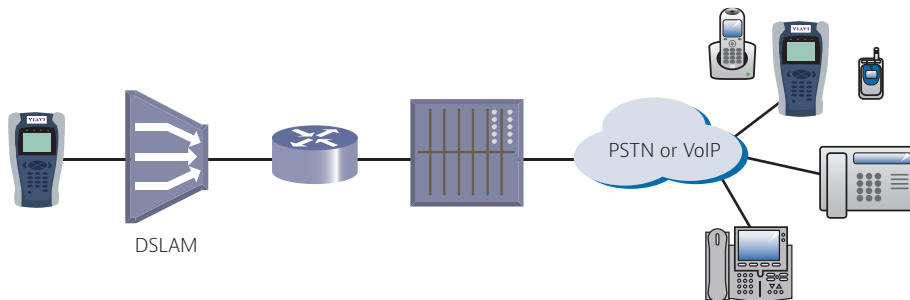

The SmartClass TPS tests VoIP throughout the IP network registration with gateway, test calls on and off the network, and measures near- and far-end IP QoS and MoS.

## WiFi

The use of wireless devices and wireless networks is becoming a common part of every household. With the addition of WiFi in the SmartClass TPS, technicians are equipped with wireless 802.11b/g/n (2.4 GHz) testing capability to show the signal strength, secure set identification (SSID), configured channel, security, MAC address, and 802.11 protocol at the test location of each wireless 802.11b/g/n network in the area. It also indicates whether a network is secure or vulnerable to security threats. This capability lets technicians properly set up the subscriber's network to find optimal wireless router placement and troubleshoot wireless connectivity or issues with web-surfing speed.

SmartClass TPS WiFi tests and configurations include:

WiFi Tests	What it Tests	Why it is Needed
WiFi Scan	WiFi access point (AP) station scan	Discover potential interfering networks (which could cause slow surfing/data transfer speeds), and locate weak spots in the WiFi signal to suggest a better location of the router
WiFi Network	Connect SC-TPS wirelessly to a WiFi AP as an endpoint	Understand wireless network quality by viewing connection statistics or running tests such as OneCheck, IP Data, and Web Browser
WiFi AP	Connect SC-TPS via Ethernet cable to a router or residential gateway to configure as a WiFi AP (Ethernet bridge to WiFi)	Verify internet connectivity, configure CPE, and run tests from mobile devices
DSL Bridge to WiFi	After normal DSL synchronization, then can enable SC-TPS as WiFi AP (DSL bridge to WiFi)	Verify internet connectivity and run tests from mobile devices
Remote Access WiFi Interface	Enable SC-TPS for wireless remote access	Use the Viavi mobile device application to remotely control the SC-TPS to improve efficiency

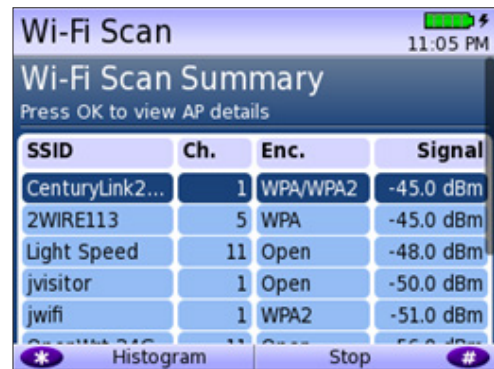

WiFi scan summary

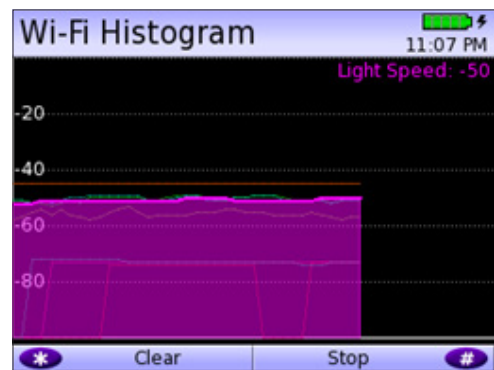

WiFi histogram

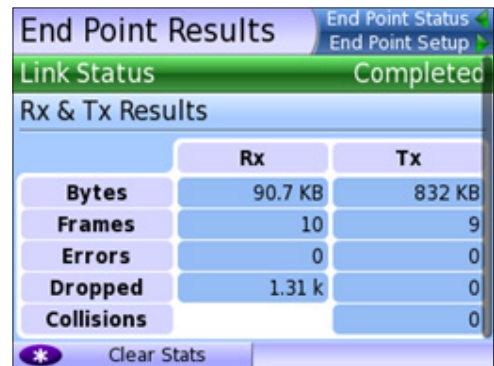

Endpoint results



# Coax

SmartID test mode is a standard feature in SmartClass TPS meters with hardware type of "CPU Gen 2" or later, which was released with software version 3.0.5. The SmartID test works with optional SmartID coax probes to quickly display and certify subscriber coax topology. It identifies and locates physical-layer impairments that affect both triple-play and multiroom DVR services which use HPNA communication.



SmartID coax probe

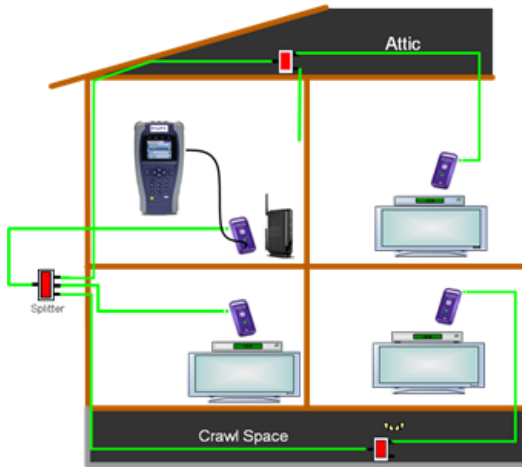

Coax home network under test with SmartIDs

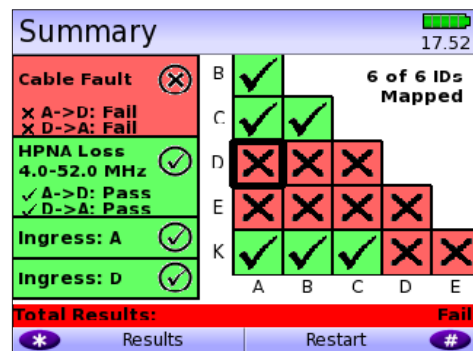

SmartID test summary results screen

Testing with a SmartID probe at each outlet that will supply customer premise equipment (CPE), such as a set-top box (STB) or residential gateway (RG), lets a technician verify that each coax path can handle all planned services.

The SmartID system saves troubleshooting time by showing technicians impairment locations immediately. Technicians don't have to repeatedly segment the network, make a change, and then retest. Often, when technicians determine that a coax cable is faulty, they simply replace it when it could be easily fixed. Time and money wasted to re-run, bury, or hang a new drop adds up quickly. SmartIDs provide information to the technicians so they can determine whether they can quickly fix the drop, need to replace it with a new one, or use an alternative means to supply service to the desired location.

Drilling down, the technician can determine exactly how far the impairment is from the outlet, simplifying and speeding the process of locating and fixing the problem. SmartID probes are available in kits that let a technician test the whole home network in one test that typically takes less than 2 minutes.

After completing physical-layer testing with SmartIDs, a technician can verify the coax network with the CPE using the HPNA Test.

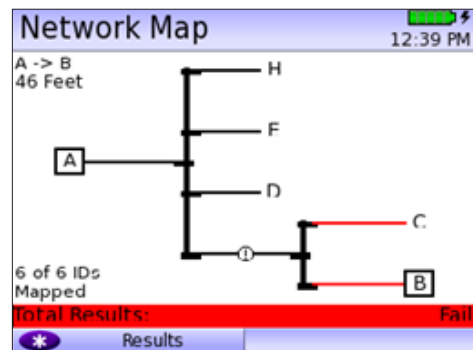

SmartID network map screen

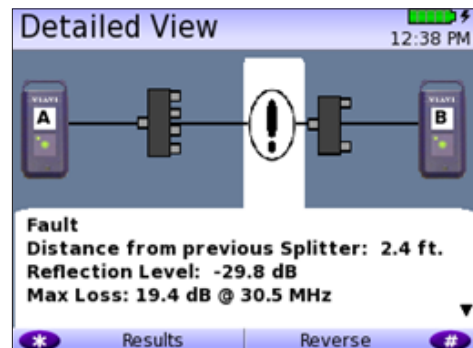

SmartID detailed view screen

## HPNA

HPNA, a technology standard developed by the Home Phoneline Network Alliance (HomePNA™), builds on Ethernet and allows all the components of a home network to connect and integrate over an unpredictable wiring topology. The HPNA communication is used to pass information around a home to other HPNA-connected devices.

In the HPNA test, the SmartClass TPS connects to the HPNA network via CPE and communicates with the HPNA host of the network to initiate the test. Each communication path between all HPNA nodes will be tested on the network, letting users segment problem node paths, node-to-node communication issues, and verify correct functionality of the whole network. The SmartClass TPS lets users verify that HPNA networks are operating within expected service quality metrics and set up pass/fail limits to help simplify testing.

Link	Rate, Mode	PER	SNR
1-> 2	112Mbps, 16/7	0.00e+00	38.85 dB
1-> 3	112Mbps, 16/7	0.00e+00	39.46 dB
2-> 1	112Mbps, 16/7	0.00e+00	41.00 dB
2-> 3	112Mbps, 16/7	0.00e+00	39.64 dB
3-> 1	112Mbps, 16/7	0.00e+00	38.82 dB
3-> 2	112Mbps, 16/7	0.00e+00	39.58 dB

HPNA test results summary screen

## Mobile Device Application

The SC TPS mobile device application is available for iOS and Android devices and enables quicker, more efficient testing with immediate access to technical support information. Now, the SmartClass TPS can remain plugged into one location in the house while technicians move easily and quickly to remote locations simply using the app via a wireless connection back to the SmartClass TPS tester. The app also lets technicians see all test results screens from SmartID measurements on one screen, saving time and eliminating the need to switch test results, as well as easily managing job files and exporting completed jobs to a server.

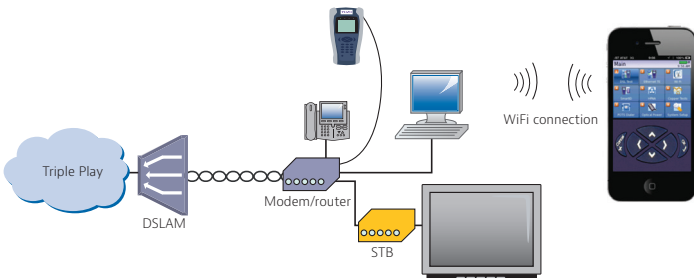

Remote access to SmartClass TPS from mobile device

## Fiber

Broadband DSL networks and broadband triple-play services often rely on fiber networks. An example is fiber-to-the-cabinet (FTTC) that brings the DSLAM closer to the customer for greater VDSL bandwidth. The DSLAM is served with a fiber back to the exchange to carry broadband signals. Another example is business customers connected to their service providers via ADSL2+/VDSL and via fiber. This drives the need for field technicians who work in these environments to have both DSL and fiber test capabilities.

For point-to-point fiber installation such as FTTC or business connections, field technicians can use the SmartClass TPS together with the Viavi MP-60 or MP-80 USB Optical Power Meter (OPM) to ensure that fiber cable attenuation meets system requirement performance and is ready to survive network aging and environmental impacts.

In combination with a Viavi SmartPocket OLS (optical laser source), the SmartClass TPS equipped with an MP-60 or MP-80 OPM can automatically perform optical link loss measurement at different wavelengths—resulting in a faster and more comprehensive fiber test.

Fiber Test	What it Tests	Why it is Needed
Optical power level	Optical power level with pass/fail and reference values	Optical loss must be within budget at ONU site

Min	Max	Average
-10.5 dBm	-10.5 dBm	-10.5 dBm

Optical Power Meter screen



MP-60 or MP-80 USB OPM (optical power meter)

SmartPocket OLS (optical laser source)

## Navigating the SmartClass TPS

The SmartClass TPS adopts a new navigation concept with a user interface that offers a wide range of personalization features, letting users customize it based on job task and preferences. They can increase or decrease the font size, move menu items up or down, hide or highlight specific menu selections, and change language options.

With remote operation included, training users becomes easy and also provides additional value when coaching users remotely or performing onsite troubleshooting.

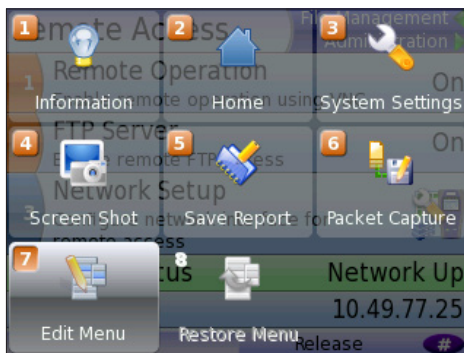

Utility screen

## Instrument Handling

The SmartClass TPS makes transferring results and test configuration files easy using a USB memory device or directly accessing the file manager on the test instrument through the embedded FTP server, or via the integrated Viavi StrataSync capabilities. Result files are available in .pdf, .csv, and .html file formats.

Technicians can also easily add new features and functions to units while in the field using StrataSync, a USB, or FTP.

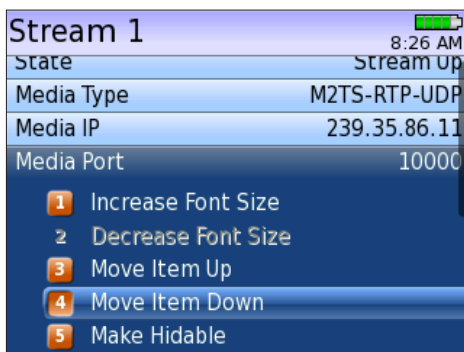

Customizable features

## StrataSync

Field operations must maintain the latest firmware and software on their assets and then find solutions to more easily add new functionalities once they are deployed in the field. At the same time, they face challenges implementing best practices for specific configurations or regional automated tests on a wider scale. Also, most field test results gathered after spending valuable time on a customer line are lost and cannot be reused. Manual operation limits the reach of good ideas—but StrataSync fixes these issues and expands SmartClass TPS benefits.

StrataSync is a hosted, cloud-based solution that manages assets, configurations, and test data for Viavi instruments to ensure they are all equipped with the latest software and installed options. It manages inventory, test results, and performance data from anywhere with browser-based ease improving both technician and instrument efficiency. StrataSync manages and tracks test instruments and collects data from the entire network that can be leveraged for results analysis, and informs and trains the workforce.

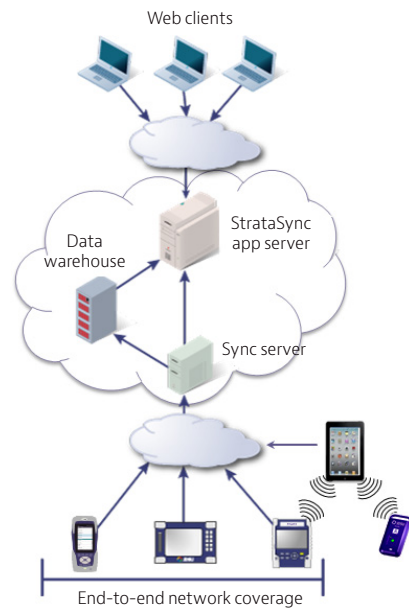

StrataSync architecture

StrataSync	What It Does	Why It Is Needed
Asset management	Manages and tracks test instruments by displaying assets, versions, and locations. Maintains accurate instrument configuration. Provides visibility into instrument utilization.	Save time by eliminating time wasted on instrument setup. Reduce repeats with correctly configured instruments. Improve results and reduce operating costs.
Data-result management	Collects and analyzes results with centralized collection and storage, secure visibility from anywhere, and consolidated test data/metrics.	Access more data with centrally collected results for better use. Speed problem resolution by sharing data for faster troubleshooting. Drive compliance by tracking and comparing technician performance.
Updates the workforce	Informs and trains the workforce through alerts, release notes and manuals, and a comprehensive product-knowledge library.	Inform the workforce using a single source for instrument status, new capabilities, and educational content. Improve performance with quick access to training and troubleshooting information. Stay current with alerts for expiring warranties.

## Specifications

DSL Modem	
<b>Test Interface</b>	
ADSL2+/VDSL2, RJ45 (single pair and bonded)	
<b>Configurations</b>	
<b>Modem Chipset</b>	<b>Broadcom 63168</b>
<b>Catalog #</b>	<b>Configuration</b>
SCTPS-BONDED	SmartClass TPS VDSL Mainframe (17a BONDED)
SCTPS-BONDED-CU	SmartClass TPS VDSL/Copper Mainframe (17a BONDED)
<b>VDSL Standard Compliance</b>	
ITU-T G.993.2 VDSL2	
ITU-T G.998.1 ATM bonding	
ITU-T G.998.2 PTM bonding	
ITU-T G.993.5 Self-FEXT cancellation (vectoring)	
ITU-T G.998.4 Improved impulse noise protection for DSL transceivers	
Single-pair profiles: 8a/8b/8c/8d, 12a/12b, 17a, 30a	
Dual-pair profiles: 8a/8b/8c/8d, 12a/12b, 17a	
Band plan 997 and 998, U0 band	
Bonding mode for all specified profiles	
Vectoring and bonding for all specified profiles	
Vector-friendly mode	
<b>ADSL Standard Compliance</b>	
ITU-T G.992.1 Annex A (ADSL)	
ITU-T G.992.3 Annex A, L, M (ADSL2)	
ITU-T G.992.5 Annex A, M (ADSL2+)	
ITU-T-G.998.1 ATM bonding	
ITU-T-G.998.2 PTM bonding	
ANSI T1.413-1998, Issue 2	
ITU-T G.992.5 INP Amendment 3	
<b>Modem Chipset</b>	<b>Broadcom 63168</b>
<b>Catalog #</b>	<b>Configuration</b>
SCTPS-AB	SmartClass TPS VDSL mainframe ANX A/B VDSL 30a
SCTPS-AB-CU	SmartClass TPS VDSL/copper mainframe ANX A/B — VDSL 30a
<b>VDSL Standard Compliance</b>	
ITU-T G.993.2 Annex A, B (VDSL2)	
ITU-T G.993.5 Self-FEXT cancellation (vectoring)	
ITU-T G.998.4 Improved impulse noise protection for DSL transceivers	
Single-pair profiles: 8a/8b/8c/8d, 12a/12b, 17a, 30a	
Band plan 997 and 998, U0 band	
Vectoring for single-pair profiles: 8a/8b/8c/8d, 12a/12b, 17a	
Vector-friendly mode	

<b>ADSL Standard Compliance</b>
ITU-T G.992.1 Annex A, B (ADSL)
ITU-T G.992.3 Annex A, B, J, L, M (ADSL2)
ITU-T G.992.5 Annex A, B, J, M (ADSL2+)
ANSI T1.413-1998, Issue 2
ITU-T G.992.5 INP Amendment 3
<b>General Settings and Features</b>
Auto sync
Auto, incremental, ADSL, VDSL technology modes configurable
Auto or Manual Framing mode
PTM mode for ADSL2+ and VDSL2
ATM mode for ADSL2+ and VDSL2
Auto, ATM, PTM modes configurable
G.INP support for ADSL2+ and VDSL2 (configurable for upstream/downstream)
Vectoring support for VDSL2
SOS mode support in VDSL2 and VDSL bonded
<b>Modem Summary Results</b>
Modem state
ADSL mode, VDSL profile
Actual and maximum attainable bit rate (payload)
Capacity
Actual margin
1 MHz attenuation
Group rate for DSL bonded
Group maximum attainable bit rate for DSL bonded
<b>DSL Signal</b>
Sync counter
Trained path
Loop length
Vectoring status
SATN (signal attenuation)
LATN (line attenuation)
1 MHz attenuation
TX power
Interleave delay
Actual INP
<b>Noise Margin</b>
Maximum noise margin
Actual noise margin
Minimum noise margin
<b>DSL Errors</b>
FEC (forward error correction)
CRC (cyclic redundancy check)
HEC (in ATM mode)
ES (errored seconds)
SES (severely errored seconds)
UAS (unavailable seconds)



## Specifications

<b>DSL Alarm Seconds</b>
LOF (loss of frame) seconds
LOS (loss of sync) seconds
LOM (loss of margin) seconds
<b>Band Statistics</b>
LATN per band (line attenuation)
SATN per band (signal attenuation)
TX power per band
<b>Graphical Results</b>
SNR (signal to noise ratio-per-tone)
BPT (bits-per-tone)
QLN (quiet line noise-per-tone)
Hlog (including bridged tap length conversion)
<b>DSL Identity</b>
Vendor code
Vendor revision
Vendor software revision
Vendor PHY revision
Modem chipset (hardware revision)
SC-TPS serial number
SC-TPS software version
<b>Data Mode Selection</b>
PTM, ATM, Auto
<b>ATM Results</b>
Cell count user (RX/TX), OAM (RX/TX), bad (RX), dropped (RX)
HEC, OCD, LCD errors
<b>DSL Retransmission (Upstream/Downstream)</b>
Status
RTX-TX
RTX-C
RTX-UC
INP rein
<b>Vectoring Status</b>
V-Not Configured, V-Running, V-Full, V-Friendly

<b>Network</b>
<b>Data Modes</b>
Bridged Ethernet
IPoE
PPPoE
Multi-VLAN
IPv6oE
IPv6 Multi-VLAN
<b>VLAN for DSL Bridge Mode (Ethernet Mode – Bridge and Router)</b>
Tag On/Off
VLAN interface count 1,2,3
ID selection 0 – 4095
Priority selection 0 – 7
<b>MAC Setting</b>
Factory default, user-defined
<b>IP Setup and Status</b>
WAN/LAN status
Gateway/DNS
Static or DHCP
DHCP server on LAN
DHCP user class
DHCP vendor class
IP release/renew
DNS support WAN and LAN
IPv6 mode: Manual, Stateless, DHCPv6 Stateful
DHCPv6 option: none, IA_PD
IPv6 global address
Local address mode: Manual, Automatic
Local IPv6 address
Subnet prefix length
IPv6 gateway
DNS server
<b>WAN/LAN Results</b>
IP address, net mask, gateway, DNS, MAC address
<b>PPP/IP Connectivity</b>
BRAS: PAP/CHAP IPCP
NAT
PPPoA, PPPoE, IPoA, IPoE, bridged
RFCs 2364, 2516, 1483, 2684
<b>DSL Bridge to WiFi</b>
Configure SSID over 802.11b/g/n (2.4 GHz)
Optional security using WEP, WPA, WPA2
Configured via WiFi interface in remote access (requires Mobile App Connectivity software option)

## Specifications

<b>10/100 Ethernet TE</b>
<b>Test Interface</b>
10/100 Ethernet, RJ45
<b>Data Modes</b>
IPoE, PPPoE, Data off
<b>MAC Setting</b>
Factory default, user-defined
<b>IP Setup and Status</b>
LAN status
Gateway/DNS
Static or DHCP
DHCP user class
DHCP vendor class
IP release/renew
DNS support
IPv6 Mode: Manual, Stateless, DHCPv6 Stateful
DHCPv6 option, none, IA_PD
IPv6 global address
Local address mode: Manual, Automatic
Local IPv6 address
Subnet prefix length
IPv6 gateway
DNS Server
<b>LAN Results</b>
IP address, net mask, gateway, DNS, MAC address
<b>VLAN (on Ethernet 10/100)</b>
Tag on/off
VLAN interface count 1, 2, 3
ID selection 0 – 4095
Priority selection 0 – 7
<b>Ethernet Results</b>
Link status, RX/TX bytes, RX/TX frames, RX/TX errors
<b>IP Data</b>
<b>Test Interface</b>
10/100 Ethernet, RJ45
ADSL2+/VDSL2, RJ45
<b>Ping and UDP Statistics</b>
IP ping mode: IPv4, IPv6
Echoes sent/received, ping delay (cur/ave/max/min), lost count/percentage, packet size
Supports IP address, DNS name, or gateway destination
<b>Traceroute ICMP and UDP Statistics</b>
Hop count, name lookup, and IP address of hops
Supports IP address and DNS address destination

<b>File Transfer Throughput Test</b>	
Transfer protocol	FTP, HTTP
Transfer direction	download, upload
HTTP authentication type	none, basic, digest
Save downloaded file	yes, no
Concurrent download	disabled, 1, 2, 3
Auto repeat	disabled, enabled
Results on status, byte transferred, total transfer rate, total transfer time, pre-transfer time, start transfer time, nake lookup time, connection time, redirection count, HTTP code, header size, request size	
<b>Additional IP Data Test Software Option</b>	
Web connectivity through browser	
Proxy server	
<b>VoIP</b>	
<b>Test Interface</b>	
10/100 Ethernet, RJ45	
ADSL2+/VDSL2, RJ45	
<b>Supported Signaling Protocols</b>	
H.323 ITU-T H.323 version 3 fast connect	
H.323 ITU-T H.323 version 3 full connect	
SIP RFS 3621	
MGCP	
<b>Supported Codec Configuration</b>	
ITU-T G.711 u-law/A-law (PCM/64 kbps)	
ITU-T G.722 64K	
ITU-T G.723.1 (ACELP/5.3, 6.3 kbps)	
ITU-T G.726 (ADPCM/32 kbps)	
ITU-T G.729a (GS-ACELP/8 kbps)	
User-selectable silence suppression, jitter buffer	
User-selectable transmit source (live voice conversation, tone transmit, IP voice announcement)	
DTMF in-band	
<b>General VoIP Settings</b>	
User-selectable calling alias	
User-selectable or default MAC address	
STUN server	
SIP query with URL	
<b>Gateway Settings</b>	
User-selectable static or no gatekeeper direct connect mode	
Supports inbound and outbound calls, with or without gatekeeper support	

## Specifications

### Reported Results – VoIP

#### Call Stats

Full incoming call statistics, including IP address, far-end alias, far-end name, RTCP availability/ports, codec and rate, call signaling support, silence suppression enabled, and call duration

#### Throughput Audio

Sent/received in bytes and packets, out-of-sequence packets, remote packets

#### Audio Delay

Network, encoding, packetization, buffering, and total delay

#### Local QoS

Audio packets lost

Audio overall QoS current/min/max/QoS

#### Voice Stream

Packet delay, packet jitter, packet loss, overall QoS

### Additional VoIP Software Options

#### MOS Software Option (requires VoIP)

##### Audio Quality

Call quality R-Factor current/min/max/average

Line quality R-Factor current/min/max/average

R-Factor G.107 current/min/max/average

R-Factor burst current/min/max/average

R-Factor gap current/min/max/average

CQ MOS current/min/max/average

LQ MOS current/min/max/average

PQ MOS current/min/max/average

Voice and video quality rating based on user-defined packet metric thresholds

MOS rating and R-Factor

#### Signaling Software Option (requires VoIP)

Skippy Cisco client protocol (SCCP)

### IP Video

#### Test Interface

10/100 Ethernet, RJ45

ADSL2+/VDSL2, RJ45

#### Modes

Terminate, Monitor

#### Set-Top Box Emulation

IGMPv2 and v3 emulation client

IGMP message status/decode status/error message

RTSP emulation client

### Service Selection

Broadcast auto

Broadcast MPEG2-TS/UDP

Broadcast MPEG2-TS/RTP/UDP

Broadcast RTP/UDP

Broadcast rolling stream

Broadcast TTS/UDP

Broadcast TTS/RTP/UDP

RTSP MPEG2-TS/(RTP)/UDP

RTSP MPEG2-TS/(RTP)/TCP

RTSP RTP/UDP

RTSP RTP/TCP

### Video Source Address Selection

IP address and port number

IP address, port number, and VoD URL extension

RTSP port select

RTSP vendor select

### Video Analysis Per Video Stream

Simultaneous Stream Support

3 terminate, 3 monitor

### Packet Loss Statistics

Loss QoS threshold selection, current/history

Continuity errors count

Continuity errors current/max count %

RTP packets lost count

RTP packets lost current/max count %

RTP loss distance errors current/max/total

RTP loss period errors current/max/total

Minimum RTP loss distance

Maximum RTP loss period

Total RTP OOS count

Total RTP headers errors count

### Packet Jitter Statistics

Jitter QoS threshold selection, current/history

PCR jitter current/average/max

RTP jitter current/max

### Latency Results

Latency threshold selection, current/history

IGMP latency ms

RTSP latency ms

Maximum latency ms

## Specifications

### Video Stream Data Results

Total current/min/max/average

IP current/min/max/average

Video current/min/max/average

Audio current/min/max/average

Data current/min/max/average

Unknown current/min/max/average

### Stream Quality

Error indicator QoS

Error indicator count

Sync errors count

PAT errors count

PMT errors count

PID timeouts count

Service name

Program name

### PID Analysis (each stream)

PID number

PID type (video, audio, data, unknown)

PID description

### Signaling Protocol Message Decode

IGMP messages

RTSP messages

### Standards

RFS 2236, IGMP

RFC 2326, RTSP

ISO (IEC 13818), video transport stream and analysis

ETSI TR 10-290 V2.1, video measurements

TFC 1483; 2684, ATM AAL5

RFC 2364, PPPoAAL5

### Layer Correlation

Combined result view for DSL LOS, DN (downstream) CRC, DN FEC, Ethernet RX errors, RX dropped, video continuity error, video RTP lost, video loss distance total, video loss period total

### Additional IP Video Software Options

VMOS Software option (requires IP video)

Video Relative MOS PID/Class

Video Absolute MOS PID/Class

Audio MOS PID/Class

AV MOS PID/Class

## WiFi

### Modes

WiFi Scan, WiFi Network Test, WiFi Access Point

### WiFi Scan Features

Detects all available 802.11b/g/n 2.4 GHz WiFi networks

Reports SSID, channel, security setting, power level, MAC address, 802.11 protocol

Histogram to view all WiFi network signal strengths over time

### WiFi Network Features

Connect to a WiFi station as an endpoint to view connection results and run tests such as OneCheck or Web Browser

End Point results reported: RX and TX bytes, frames, errors, dropped, collisions

### WiFi Access Point (AP) Features

Configure the meter as a WiFi AP (Ethernet to WiFi bridge)

## Coaxial Cable Testing

### SmartIDs

Now supported on SmartClass TPS mainframe BN numbers CSC-TPSVW, CSC-TPSVW-CU, SCTPS-AB, and SCTPS-AB-CU

### Settings

Support any cable coax type with configurable velocity of propagation (VOP) and cable compensation

### Tests

Locate SmartIDs	Identify cable runs
VDSL Home Run Check	Test coax home runs to be used for VDSL
Whole Home Check	Test entire coax network at physical layer prior to HPNA test

### Features

Test Summary	Pass/fail results of cable faults, noise ingress, and frequency sweep
Network Map	Visual overview of coax network
Detailed View	View cable lengths, faults, splitters, etc.
Sweep Data	Frequency sweep data graph

## HPNA Network Test

### Features

Supports testing over RJ45 interface

Quick and Chronic test available

### Settings

Configurable minimum PHY rate	12 – 256
Configurable SNR	0 – 40
Configurable max packet loss	0 – 99 (quick) 0 – 9,999 (chronic)
Payload length size	6 – 1482
Number of packets to send	0 – 5,000 (quick) 0 – 500,000 (chronic)

## Specifications

General Connection Status			
Station list including indication of the host			
Device ID number			
Device MAC address			
Device HPNA Coppergate chipset firmware and version identification			
HPNA Network Results			
Segment specific rate, constellation, and baud			
Segment specific packet error rate (PER)			
Segment specific SNR			
Segment specific receive power			
Segment MAC addresses			
Fiber Test			
Optical Power Meter			
USB optical power meter			MP-60,MP-80
Min/Max/Average optical power level			dBm, mW
Selectable pass/fail threshold			
Reference value			
Copper Test			
	Range	Resolution	Accuracy
AC Volts	0 – 300 peak	1 V	2% ±1 V
DC Volts	0 – 300	1 V	2% ±1 V
Resistance	0 – 999 Ω	1	2% ±2.5 Ω
	1 – 9.99 kΩ	10	2%
	10 – 99.9 kΩ	100	2%
	100 – 999 kΩ	1 k	2%
	1.0 – 9.9 MΩ	10 k	6.5%
Leakage	10.0 – 100 MΩ	100 k	10%
	0 – 49.99 Ω	1	2% ±2.5 Ω
	50 – 999 kΩ	1	5% ±2.5 Ω
	1.0 – 9.99 kΩ	10	5%
	10.0 – 99.9 kΩ	100	5%
Distance to Short	100 – 999 kΩ	1 k	5%
	1.0 – 9.9 MΩ	10 k	10%
	10 – 100 MΩ	100 k	15%
	0 – 999 m (0 – 3 k ft)	9 m (30 ft)	
	1 – 10 km (3 – 30 k ft)	30.5 m (100 ft)	
Capacitance/Opens	0 – 44.9 nF	3% ±45 pF	
	45 nF – 1.04 μF	3%	
	0 – 999 m (0 – 2,999 ft)	0.1 m (1 ft)	
	1 – 20 km (3 – 66 k ft)	0.1 m (1 ft)	
DC Current	0 – 110 mA	1 mA	±2% ±1 mA
	35 – 70 dB	1 dB	2 dB
Longitudinal Balance	Good ground check to verify longitudinal balance results		
Load Coil Counter	0 – 8230 m (0 – 27 k ft)	up to 5	±1
POTS Dialer	DTMF or Pulse Dial mode		

Job Manager and Test Results	
Features	
Create a job to save test results in an XML file to be uploaded to an FTP server	
Settings	
Each job file consists of: Circuit ID, Work Ticket, Tech ID	
Configurable FTP server address, directory, username, and password	
Mobile Device Application	
Features	
Available for iOS devices (iPad®, iPhone®, iPod touch®)	
Available for Android™ phone and tablet devices (Android 3.0 OS and later)	
Remote Control SmartClass TPS over 802.11 wireless connection	
Access to technician support content such as the users' manual, quick cards, training videos, and accessory guides	
General	
Power Supply	
Battery	LiION internal rechargeable, field-replaceable 4400 mA
Operating time	>4 hours
Auto power down (adjustable)	
Charging time	Approx. 6 hours
AC line operation	Via external adapter/car charger
Connector	
DSL	8-pin modular (RJ45)
Ethernet	8-pin modular (RJ45)
T/A, R/B, ground	2 mm recessed banana
POTS	8-pin modular (RJ45)
USB	USB 2.0
SmartClass TPS mainframe BN numbers CSC-TPSVW, CSC-TPSVW-CU, SCTPS-AB, and SCTPS-AB-CU support USB high power ≤500 mA; whereas previous hardware supported USB low power ≤100 mA only	
Connectivity	
USB flash drive	
Remote access through FTP	
Remote operation	Ethernet, DSL, and WiFi (Mobile App Connectivity Software option required for WiFi)
Mobile Device Application (used with Mobile App Connectivity Software option)	
Bluetooth (not yet supported in software)	
Permissible Ambient Temperature	
Nominal range of use	±0 to +40°C (±32 to 122°F)
Storage and transport	–30 to +60°C (–22 to 140°F)
Humidity	
Operating humidity	
Physical	
Size (H x W x D)	230 x 120 x 70 mm (9.05 x 4.72 x 2.75 in)
Weight, including batteries	<1.1 kg (2.5 lb)
Display	320 x 240 LCD color
CE marked	



## Ordering Information – Available Packages

The SmartClass TPS can be ordered in full configuration for high-end triple-play test demands, or it can be scaled down for specific needs and applications. All packages include IP data support for FTP/HTTP throughput, traceroute, and IP ping test. The unit is delivered in a carrying case with test leads.

Description	Package #	ADSL2+	VDSL2	Bonded ADSL	Bonded VDSL	WiFi	Copper	Web	VoIP	MOS	IPTV	VMOS
<b>Non-Copper Mainframe Packages</b>												
SmartClass TPS ADSL Best Value package	SCTP-V-PO	■				SW option						
SmartClass TPS VDSL Silver package	SCTP-V-P1	■	■			SW option						
SmartClass TPS web Silver package	SCTP-V-P3	■	■			SW option		■				
SmartClass TPS web and video Silver package	SCTP-V-P8	■	■			SW option		■			■	■
SmartClass triple play Silver package	SCTP-V-P11	■	■			SW option		■	■	■	■	■
SmartClass TPS bonded ADSL/VDSL Silver package	SCTP-V-P31	■	■	■	■	SW option						
SmartClass TPS bonded ADSL/VDSL and web Silver package	SCTP-V-P33	■	■	■	■	SW option		■				
SmartClass TPS bonded ADSL/VDSL, web, and video Silver package	SCTP-V-P38	■	■	■	■	SW option		■			■	■
SmartClass triple-play with bonded ADSL/VDSL Silver package	SCTP-V-P311	■	■	■	■	SW option		■	■	■	■	■
SmartClass TPS ADSL Gold package	SCTPC-V-P0	■				SW option	■					
SmartClass TPS VDSL Gold package	SCTPC-V-P1	■	■			SW option	■					
SmartClass TPS Web Gold package	SCTPC-V-P3	■	■			SW option	■	■				
SmartClass TPS web and video Gold package	SCTPC-V-P8	■	■			SW option	■	■			■	■
SmartClass triple play Gold package	SCTPC-V-P11	■	■			SW option	■	■	■	■	■	■
SmartClass TPS bonded ADSL/VDSL Gold package	SCTPC-V-P31	■	■	■	■	SW option	■					
SmartClass TPS bonded ADSL/VDSL and web Gold package	SCTPC-V-P33	■	■	■	■	SW option	■	■				
SmartClass TPS bonded ADSL/VDSL, web, and video Gold package	SCTPC-V-P38	■	■	■	■	SW option	■	■			■	■
SmartClass triple-play with bonded ADSL/VDSL Gold package	SCTPC-V-P311	■	■	■	■	SW option	■	■	■	■	■	■

## Ordering Information – Available Packages

Description	Package Number	ADSL2+	VDSL2	ADSL Annex B	WiFi	Copper
<b>Packages with the Broadcom 63168 Modem that Support ADSL Annex B (bonded is not supported)</b>						
SmartClass TPS ADSL (Annex A only) Silver package	SCTP-AB-P0	■			SW option	
SmartClass TPS ADSL (Annex A/B) and VDSL (30a) Silver package	SCTP-AB-P1	■	■	■	SW option	
SmartClass TPS ADSL (Annex A/B), VDSL (30a) WEB Silver package	SCTP-AB-P3	■	■	■	SW option	
SmartClass TPS ADSL (Annex A only) Gold package	SCTPC-AB-P0	■			SW option	■
	SCTPC-AB-P1	■	■	■	SW option	■
SmartClass TPS ADSL (Annex A/B), VDSL (30a) WEB Gold package	SCTPC-AB-P3	■	■	■	SW option	■

### Software Options\*

Description	Code	Mainframe Version Support	
		SCTPS-BONDED SCTPS-BONDED-CU	SCTPS-AB SCTPS-AB-CU
ADSL (bonded) option	SCTP-ADSL-BONDED	■	
VDSL (bonded) option	SCTP-VDSL-BONDED	■	
Web browser option	SCTP-WEB	■	■
VoIP option includes SIP, H.323, and MGCP signaling	SCTP-VOIP	■	■
SCCP signaling option (requires VoIP option)	SCTP-SCCP	■	■
MOS option for VoIP (requires VoIP option)	SCTP-MOS	■	■
IP video option	SCTP-IPVIDEO	■	■
VMOS option for IPTV (requires IP video option)	SCTP-VMOS	■	■
WiFi test option	SCTP-WIFI	■	■
HPNA test option	SCTP-HPNA	■	■
Mobile app connectivity (revision 1) option	SCTP-APP-REV01	■	■
ADSL1/2/2+ Annex B software option	SCTP-ANXB		■

\* Software options can be factory installed before delivery or are field upgradeable.



Contact Us **+1 844 GO VIAVI**  
(+1 844 468 4284)

To reach the Viavi office nearest you,  
visit [viavisolutions.com/contacts](http://viavisolutions.com/contacts).

© 2017 Viavi Solutions Inc.  
Product specifications and descriptions in this  
document are subject to change without notice.  
smclasstpsVDSL-ds-nse-ae  
30168392 900 0217