



**364X Series
Millimeter-Wave VNA
Extender
User Manual**

Ceyear Technologies Co., Ltd

Jan. 2022

Preface

Thank you very much for choosing and using the 364X series Millimeter-Wave VNA Extender manufactured by China Electronics Technology Instruments Co., Ltd. To facilitate your use of this product, please read this manual carefully.

We will try our best to meet your demands, to provide you with high-quality measuring instruments, while bringing you first-class after-sales service. Our consistent purpose is "to provide high-quality products and thoughtful service", and to provide satisfactory products and services is our commitment to users. Please feel free to contact us by the contact methods below:

Tel: +86-0532-86896691

Website: www.ceyear.com

E-mail: sales@ceyear.com

Address: No.98 Xiang Jiang Road, Qingdao City, China

Post Code: 266555

This manual introduces the usage, performance index, basic working principle, usage method and precautions of Ceyear 364X series Millimeter-Wave VNA Extender manufactured by China Electronics Technology Instruments Co., Ltd, helping you to familiarize and master the operation method and key operation points of the instrument as soon as possible. Please read this manual carefully and follow the instructions in this manual for proper operation.

Due to the shortage of time and the limited level of the writer, errors and omissions in this manual are unavoidable. Your criticism and correction will be appreciated. We apologize for the inconvenience caused by our work mistakes.

This manual is the first edition of the user manual of Ceyear 364X series Millimeter-Wave VNA Extender.

The contents of this manual are subject to change without prior notice. The contents of this manual and the right to interpret the terms used belong to China Electronics Technology Instruments Co., Ltd.



Statement:

The copyright of this manual belongs to China Electronics Technology Instruments Co., Ltd. No organization or individual may modify or tamper this manual without authorization of our institute, and the copying and dissemination of this manual for profit-making purposes shall be prohibited. China Electronics Technology Instruments Co., Ltd. reserves the right to pursue legal liability for infringers.

Editor

Jan., 2022

Table of Contents

| | |
|---|----|
| Chapter I Overview..... | 1 |
| Part I Instructions | 3 |
| Chapter II Unpacking..... | 4 |
| Chapter III User Inspection | 6 |
| Chapter IV Routine Maintenance | 7 |
| Chapter V Interface Description | 10 |
| Chapter VI Operation Instructions..... | 11 |
| Part II Technical Description | 12 |
| Chapter VII Working Principle | 13 |
| Chapter VIII Main Technical Indicators | 14 |
| Chapter IX Performance Feature Test..... | 15 |
| Section I Functional Feature Check..... | 15 |
| Section II Performance Feature Test..... | 15 |
| Section III Record of Performance Feature Test | 21 |
| Part III Maintenance Instructions..... | 22 |
| Chapter X Fault Information Description and Methods for Obtaining Repair Services | 23 |
| Section I Fault Information Description..... | 23 |
| Section II Methods for Obtaining Repair Services..... | 23 |

Chapter I Overview

Ceyear 364X series Millimeter-Wave VNA Extender is a new product launched by China Electronics Technology Instruments Co., Ltd. In terms of hardware, new design concepts and technical solutions are adopted, especially frequency doubling link design, so that the key technical performance indicators of the whole machine have been significantly improved; in terms of software, the application of high-performance power processing chips has greatly improved the interconnection and usability of the whole machine, and the millimeter wave spread spectrum system is shown in Figure 1-1.

Ceyear 364X series Millimeter-Wave VNA Extender provides multiple stability modes, such as frequency doubling amplification of RF signal, intermediate frequency preprocessing, etc. With standard cable connection interface, it can form millimeter wave spread spectrum system together with network analyzer produced by China Electronics Technology Instruments Co., Ltd., and can also form spread spectrum system together with PNA-X series network analyzer produced by Agilent. It is widely used in millimeter wave passive devices, active devices, MMIC measurement, antenna and RCS, material analysis, stealth and anti-stealth technology development and application of military and other civilian electronic fields. It is a kind of indispensable testing equipment in the scientific research and production process of phased array radar, communication, millimeter wave components and other systems.

Main features:

- ◆ Local oscillator and RF back panel input
- ◆ DC power supply



Figure 1-1 Millimeter wave spread spectrum system

With this manual, you can use the Ceyear 364X series Millimeter-Wave VNA Extender handily. In case you encounter any problem in use, or if you have any comments and suggestions, please contact us in time according to the contact information provided in the preface. It is our consistent aim to constantly improve products and satisfy users' requirements to the maximum extent.

This user manual is divided into three parts and ten chapters:

Chapter I gives a brief introduction of some basic conditions of the Ceyear 364X series Millimeter-Wave VNA Extender, some advanced technologies adopted by the test module, various functions available or can be realized, as well as a brief description of this manual.

Chapters II to VI are using instructions: including how to open and check a new millimeter-wave VNA extender; matters needing attention in the use of millimeter-wave VNA extender and daily maintenance methods; front and back panel joint instructions; Ceyear 364X series millimeter-wave VNA extender basic operation methods.

Chapters VII, VIII and IX are technical descriptions: the working principle and key technology of Ceyear 364X series millimeter-wave VNA extender are described in detail in this part, and the main technical specifications and performance characteristics test methods of Ceyear 364X series millimeter-wave VNA extender are given.

Chapter X is the maintenance description part, including fault information description and methods to obtain repair service.

We sincerely hope that our products will bring convenience and speed to your work. If you have any question in use, please feel free to contact us.

Part I Instructions

Chapter II Unpacking

1 Model Confirmation

When you open the packing box, for each type of instrument, you will see the following items:

| | |
|---|--------|
| Ceyear 364X series millimeter-wave VNA extender | 2 Sets |
| Certificate | 2 pc |
| Packing list | 1 pc |

Please check the items above carefully according to the order contract and packing list. If there is any problem, please contact our service consultation center through the service hotline provided in the preface. We will solve the problems as soon as possible.

2 Appearance Check

Carefully check whether the instrument is damaged in transportation. When the instrument has obvious damage, it is forbidden to turn on the power. Please contact our service consultation center through the service hotline provided in the preface. We will promptly repair or replace it according to circumstances.

3 Operating Environment

Refer to the environmental adaptability part of the technical index part of this manual. In addition, special attention should be paid to the power requirements listed in table 2-1.

Table 2-1 Power requirements

| Power Parameters | Application Scope |
|----------------------|-------------------|
| Output voltage | +12V DC |
| Rated output current | >2A |
| Output power | >30W |



Warning:

In order to prevent or reduce the mutual interference caused by multiple devices through the power supply, especially the peak pulse interference caused by high-power equipment which may cause the destruction of the hardware of the spread spectrum test module, it is better to use the millimeter wave spread spectrum controller to supply power to the test module.



Warning:

Bad or wrong grounding may damage the instrument, or even cause personal injury. Make sure that the instrument ground wire is in good contact with the power supply ground wire before powering on the test module. Before the test module is electrified and turned on, verify that the supply voltage is normal.

4 Electrostatic Protection

Electrostatic protection is often neglected. The accumulated electrostatic discharge from the human body can easily damage the sensitive circuit elements inside the instrument, greatly reducing the reliability of the instrument. Even a small electrostatic release can cause permanent damage to the device. Therefore, electrostatic protection measures should be taken as far as possible. We usually take the following two anti-static measures:

- a) Combination of conductive table mat and wrist strap.
- b) Combination of conductive floor mat and foot wrist strap.

To use the two methods above simultaneously can provide good anti-static protection, if only one method is to be used, only the former can provide reliable protection. Good anti-static work habits can reduce the damage of components and instruments, so when using the instrument, try to meet the requirements below:

- a) Work in an environment with antistatic measures.
- b) When you are going to touch electrostatic sensitive components, accessories or to make connections, be sure to wear anti-static wrist strap.
- c) Ensure you are grounded before cleaning and checking electrostatic sensitive devices, instrument test ports, or making connections. This can be achieved by touching the instrument test port or the grounding housing of the test cable connector.
- d) Ensure that all instruments are properly grounded to prevent static accumulation.

Chapter III User Inspection

1 Starting up millimeter-wave VNA extender

To start up the spread spectrum test module, perform as follows:

- a) Connect the test module to the DC power supply that meets the requirements with the qualified power cord.
- b) Turn on the DC power switch.
- c) The fan of test module works normally. In order to make the instrument to meet the required performance requirements, the test module should be preheated for at least 30 minutes before measuring.



Warning:

Before the test module is electrified, verify that the supply voltage is normal, so as to prevent the instrument from being damaged! When the instrument is placed in the cabinet, the air convection inside and outside the instrument must be ensured. Every 100 W of thermal power in the cabinet requires environmental temperature (outside the cabinet) to be 4 °C lower than the maximum temperature of the instrument. If the total thermal power in the cabinet exceeds 800W, forced ventilation must be taken!

2 Shutting down millimeter-wave VNA extender

- a) Turn off the RF local oscillator input of the test module.
- b) Turn off DC power supply and enter shutdown state.
- c) When the millimeter-wave VNA extender is shut down, unplug the power cord of the back panel of the millimeter-wave VNA extender if necessary.

Chapter IV Routine Maintenance

1 Regular cleaning of the front panel of the test module:

After being used for a period of time, the front panel of the test module should be cleaned. To do this, perform the following steps:

- a) Shut down and unplug the power cord.
- b) Use clean soft cotton cloth to dip in the special detergent (no alcohol) for the instrument, and then gently wipe.
- c) Dry it with clean soft cotton cloth.
- d) When the special cleaning agent is dried, the power cord can be connected.



Caution: Do not use cleaning agent containing fluoride, acidic or alkaline substances. Do not spray the cleaning agent directly onto the panel, otherwise it may penetrate into the machine and damage the instrument.

2 Connector maintenance and measurement connection:

Although the connectors for the test module ports are designed and manufactured according to the highest standards, the lifetime of all these connectors is limited. Due to the unavoidable wear and tear during normal operation, the performance index of the connector will decrease or even fail to meet the measurement requirements. Correct maintenance of the connector and measurement connection can not only obtain accurate and repeatable measurement results, but also prolong the service life of the connector and reduce the measurement cost. In the actual use process, pay attention to the following aspects:

2.1 Checking the connector:

When carrying out connector inspection, you should wear an anti-static wrist strap and use a magnifying glass to check the following items:

- a) Whether the electroplating surface of the connector is worn, and whether there is a deep scratch.
- b) Whether the connector thread is deformed.



Warning: Any damaged connector may damage a good connector to which it is connected even at the first time of measurement connection. The defective connector should be marked for processing or repairing.

2.2 Cleaning the connector:

When clean the connector, you should wear an anti-static wrist strap, and clean the connector as the following steps:

- a) Use clean low pressure air to remove loose particles in connector thread and on the joint surface. Thoroughly inspect the connector. If further cleaning is required, do as the following steps:
- b) Make the cotton swabs (no fuzz) wet (but not soaked) with isopropyl alcohol.
- c) Use cotton swabs to remove dirt and debris on the joint surface and in the threads of the connector. When cleaning the inner surface, be careful not to apply external force to the inner conductor of the center, do not leave the fiber of the swab on the central conductor of the connector.
- d) Let the alcohol evaporate and then use the compressed air to clean the surface.
- e) Check the connector, confirm there are no particles and residues.
- f) If the defect of the connector is still visible after cleaning, it means that the connector may have been damaged, it should not be used again. Confirm the cause of the damage of the connector before carry out measurement connection.

2.3 Connecting the connectors:

Before measurement connection, the connector should be inspected and cleaned to ensure that the connector is clean and without defects. The anti-static wrist strap should be worn when connecting. The correct connection methods and procedures are as follows:

a) Align the axes of the two interconnecting devices to ensure that the axes are in a straight line, so that the plug pin of the male connector concentric may slide into the socket finger hole of the female connector. As shown in Figure 4-1:

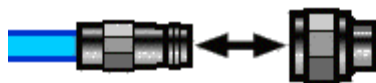

Figure 4-1 Axes of the interconnect devices in a straight line

b) Move the two connectors together straightly so that they can engage smoothly. Rotate the screw sleeve of the connector (note not to rotate the connector itself) until it is tightened. There should be no relative rotation between the connectors during the connection. As shown in Figure 4-2:

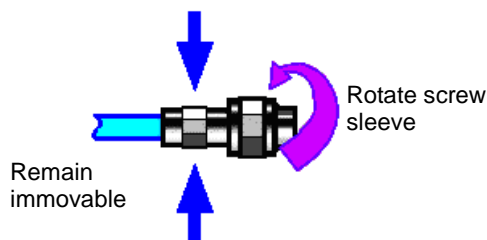

Figure 4-2 Connection method

c) Use the torque wrench to tighten the final connection. Pay attention to that the torque wrench should not exceed the starting break point. Use an auxiliary wrench to prevent the connector from turning. As shown in Figure 4-3:

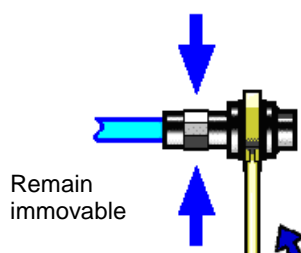

Figure 4-3. Use the torque wrench to tighten the final connection

2.4 Disconnecting the connectors:

- Support connectors to prevent distorting, shaking or bending forces to be applied on any connector.
- An open end wrench can be used to prevent the connector from rotating.
- Use another wrench to loosen the screw sleeve of the connector.
- Rotate the screw sleeve by hand to the final disconnection.
- Pull the two connectors straightly to separate them.

2.5 Using the torque wrench:

- Make sure the torque of the torque wrench is set correctly before use.
- Make sure that the angle between the torque wrench and another wrench (used to support connectors or cables) is within 90 degrees before applying force.
- Grab the end of the torque wrench handle gently and apply force perpendicular to the handle until the wrench breaks. As shown in Figure 4-4:

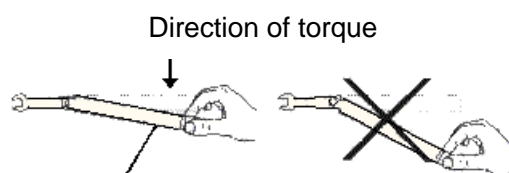

Stop applying force when the handle is bent.

Figure 4-4. Use-method of torque wrench

2.6 Using and storing the connectors:

- a) Protective sheath should be applied to the connector when it is not used.
- b) Do not keep various connectors, air lines, and calibration pieces in one box at random, this is one of the most common causes of connector damage.
- c) Keep the connector and test module at the same temperature. The temperature of the connector can be significantly changed when it is held by hand or cleaned by compressed air. It should be used for calibration when the temperature of the connector is stabilized.
- d) Do not touch the joint surface of the connector. It is difficult to remove grease and dust particles from the joint surface.
- e) Do not place the contact face of the connector on a hard table. Contacting with any hard surface can damage the electroplated coating and joint surface of the connector.
- f) Wear an anti-static wrist strap and work on a grounded conductive table pad to protect the test module and connector from electrostatic discharge.

Chapter V Interface Description

1 Description of the front panel

The front panel is shown in Figure 5-1, where the test connection port is on the front panel of the test module.



Figure 5-1. Front panel of test module

2 Description of the back panel

The back panel of the controller is shown as Figure 5-2. It is mainly composed of local oscillator input, test intermediate frequency output, reference intermediate frequency output, radio frequency input and DC power interface.

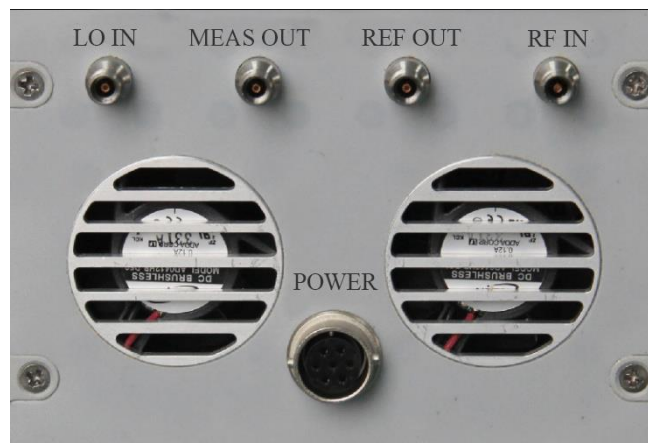

Figure 5-2. Back panel of the controller

Chapter VI Operation Instructions

This chapter introduces the basic operation method of Ceyear 364X series millimeter-wave VNA extender.

1 Connection

Connect the local oscillator input, the test intermediate frequency output, the reference intermediate frequency output, the radio frequency input and the DC power supply interface with the corresponding interface of the spread spectrum controller respectively.

2 Calibration

Select [system] → [settings] → [millimeter wave module settings], select the corresponding 364X model for spread spectrum module model. At this point, the frequency range from the vector network host to the S parameter module is about 9GHz to 23GHz, and the corresponding frequencies of RF and number of times of local oscillator are shown in Table 6-1. After setting up, the vector network analyzer system works in the corresponding frequency range. Select [calibration] [mechanical calibration] [single port calibration]/ [dual port calibration], and connect the calibration kits in turn according to the screen prompt steps to carry out single port calibration or dual port calibration.

| Model | 3643 K | 3643 NA | 3643 N | 3643 P | 3643 QA | 3643 Q | 3643 SA | 3643 R | 3643 S | 3643 TA | 3649B |
|---------------------------------|-----------|------------|-----------|------------|------------|-------------|-------------|-------------|-------------|-------------|-------------|
| Frequency Range (GHz) | 40~ 60 | 50~ 75 | 60~ 90 | 75~ 110 | 90~ 140 | 110~ 170 | 140~ 220 | 170~ 260 | 220~ 325 | 260 ~400 | 325~ 500 |
| Multiplier of RFs | 4 | 4 | 6 | 6 | 6 | 12 | 12 | 12 | 18 | 27 | 36 |
| Multiplier of local oscillators | 3 | 4 | 6 | 6 | 8 | 12 | 12 | 12 | 24 | 36 | 24 |

Table 6-1 Module configuration information

3 Measurement

After the calibration of step 2 is completed, connect the tested parts and select [measurement] → [S21] on the vector network host to carry out direct connection test or select different test items according to different test parameters. The operation method is the same as the vector network host.

Part II Technical Description

Chapter VII Working Principle

The millimeter-wave VNA extender is a millimeter wave spread spectrum module, and the block diagram of its realization principle is shown in Figure 7-1. The main functions of millimeter-wave VNA extender are: generating millimeter wave excitation signal by frequency doubling, extracting forward and reverse signals by signal separation device, and mixing millimeter wave signal to intermediate frequency signal.

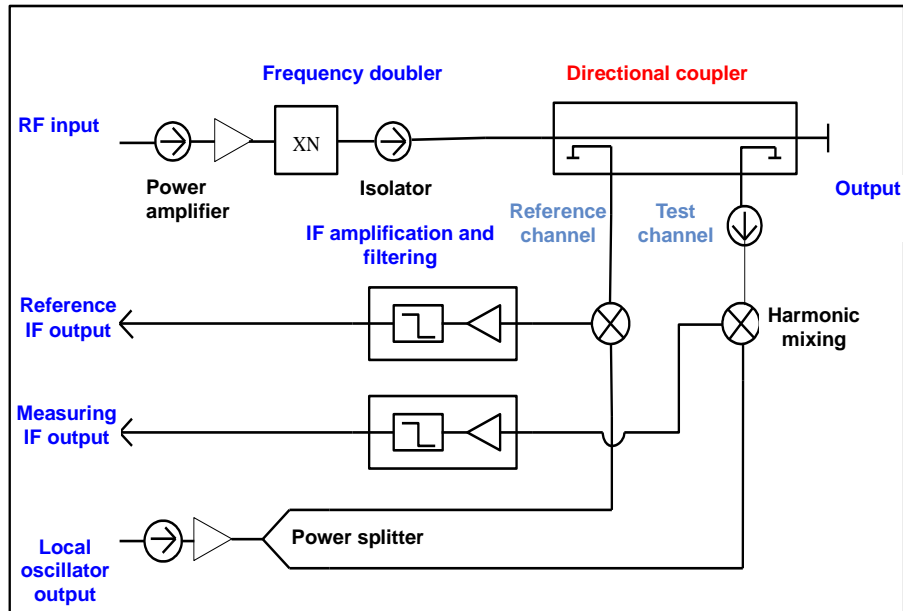

Figure-1. Schematic diagram of whole machine

Chapter VIII Main Technical Indicators

This chapter lists the performance indexes and technical parameters of Ceyear 364X series millimeter-wave VNA extender in detail. Through reading this chapter, users can have a more accurate understanding of the main performance indexes of this product. The normal working conditions of the machine are ambient temperature 0℃ ~ +40℃, and 1 standard atmospheric pressure.

Table 8-1 provides the main technical specifications of the Ceyear 364X series millimeter-wave VNA extender. It is required that the testing environment of the test data is 23±3℃, and the ambient temperature change does not exceed ±1℃ after calibration, and under normal atmospheric pressure.

Table 8-1 Main technical parameters

| Model | 3643 K | 3643 NA | 3643 N | 3643 P | 3643 QA | 3643 Q | 3643 SA | 3643 R | 3643 S | 3643 TA | 3649 B |
|--|------------|------------|-----------|-----------|------------|-----------|------------|-----------|-----------|------------|-----------|
| Frequency Range (GHz) | 40~60 | 50~75 | 60~90 | 75~110 | 90~140 | 110~170 | 140~220 | 170~260 | 220~325 | 260~400 | 325~500 |
| System Dynamic Range (Intermediate Frequency Bandwidth 10hz, dB) | ≥100 | ≥100 | ≥100 | ≥100 | ≥100 | ≥100 | ≥100 | ≥100 | ≥95 | ≥85 | ≥80 |
| Effective Directivity (dB) | ≤-35 | ≤-35 | ≤-35 | ≤-35 | ≤-34 | ≤-34 | ≤-30 | ≤-25 | ≤-25 | ≤-20 | ≤-20 |
| Payload Matching (dB) | ≤-35 | ≤-35 | ≤-35 | ≤-35 | ≤-34 | ≤-34 | ≤-30 | ≤-25 | ≤-25 | ≤-20 | ≤-20 |
| Reflection Tracking (±) dB | ≤0.12 | ≤0.12 | ≤0.12 | ≤0.12 | ≤0.15 | ≤0.15 | ≤0.25 | ≤0.2 | ≤0.2 | ≤0.3 | ≤0.3 |
| Transmission Tracking (±) dB | ≤0.12 | ≤0.12 | ≤0.12 | ≤0.12 | ≤0.15 | ≤0.15 | ≤0.25 | ≤0.2 | ≤0.2 | ≤0.3 | ≤0.3 |
| Connector Type | WR19 | WR15 | WR12 | WR10 | WR8.0 | WR6.5 | WR5.1 | WR4.3 | WR3.4 | WR2.8 | WR2.2 |
| External Dimensions (Width×Height×Depth, No Angle Protection) | 120*90*240 | | | | | | | | | | |

Chapter IX Performance Feature Test

**Note:**

The following specific operating procedures for each indicator testing are based on the test instrument shown in the diagram. When other test instrument with the same performance characteristics is used, the specific operating methods should be according to the use instructions of the instrument. The “reset instrument” mentioned in the test step refers to the manufacturer's reset mode. If the device is in the user-defined reset state, it should be changed to the manufacturer's reset state and reset again to ensure that the initial state of the device is in a known state.

Table 9-1 Instrument and equipment for testing

| SN | Device Name | Main Technical Indicators | Recommended Model |
|----|----------------------------|------------------------------|-------------------|
| 1 | Vector network analyzer | Frequency range: 3Hz~26.5GHz | Ceyear 3672B |
| 2 | Spread spectrum controller | - | Ceyear 3640 |

*: The instruments and equipment in the table can be replaced by test equipment of the same performance characteristics.

Section I Functional Feature Check

1 Starting up and calibration

Connecting the millimeter-wave VNA extender with the vector network spread spectrum controller, the system can start and calibrate normally, it means that the function of millimeter-wave VNA extender is normal.

Section II Performance Feature Test

1 System dynamic range test

a) Test item description

The system dynamic range is the difference between the maximum output power of the network analyzer port and the measurement sensitivity of the port. The testing method is: firstly, the two ports of the vector network analyzer system are connected and normalized, and then the two ports are disconnected and connected with matching load respectively. At this point, the curve displayed by the vector network analyzer is the system dynamic range curve after calibration.

The purpose of this test item is to test the dynamic range index of the system composed of the spread spectrum module of CEYEAR 364X series vector network analyzer, the host computer of vector network analyzer and the spread spectrum device after calibration. Its index requirements are:

b) Required test instruments and accessories

1) Waveguide calibration kit

2) 2 straight waveguides

c) Test steps

1) Connect the system as shown in Figure 9-1, and preheat for more than 30 minutes.

2) Select [system] → [Settings] → [Millimeter wave module settings], select the type of spread spectrum module, set the vector network analyzer system as the spread spectrum state of CEYEAR 364X series vector network analyzer.



Figure 9-1. System dynamic range calibration test block diagram 1



Figure 9-2. System dynamic range calibration test block diagram 2

Test the system dynamic range of Port 1

- 3) Select [track] → [measure] → [S12].
- 4) Select [scan] → [scan points] → [101].
- 5) Select [scan] → [intermediate frequency bandwidth] and type "10Hz".
- 6) Select [channel] → [average] → [average factor] and type "8" to open the "average".
- 7) Select [analysis] → [normalization] to implement normalized calibration.
- 8) After the normalization is completed, the two modules shall be separated as shown in Figure 9-2 and the load shall be connected to the ports of the two modules. At this point, the curve displayed by the vector network analyzer is the dynamic range curve of the port 1 vector network. Select [cursor] → [cursor search] and select [search type] as the "maximum" to record the cursor value; and the absolute value of this cursor value is the vector network port dynamic range index.
- 9) Fill the CEYEAR 364X series dynamic range indexes in Appendix A: Test Record - System Dynamic Range - Port 1, respectively.

Test the dynamic range of Port 2 System

- 10) Select [track] → [measure] → [S21].
- 11) Repeat the above steps (7) - (9) . Fill the CEYEAR 364X series dynamic range indexes in Appendix A: Test Record - System Dynamic Range - Port 2.

2 Test the reflection tracking, effective directivity and effective source matching

a) Test item description

It is used to test whether the technical indexes of the reflection tracking (system stability after the calibration port is calibrated and connected with short-circuit plate) and effective directivity (system directivity after Calibration) of the vector network analyzer spread spectrum system composed of spread spectrum module of CEYEAR 364X series vector network analyzer after single port calibration meet the requirements. The index requirements are as follows:

b) Required test instruments and accessories

- 1) Waveguide calibration kit
- 2) 2 straight waveguides

c) Test steps

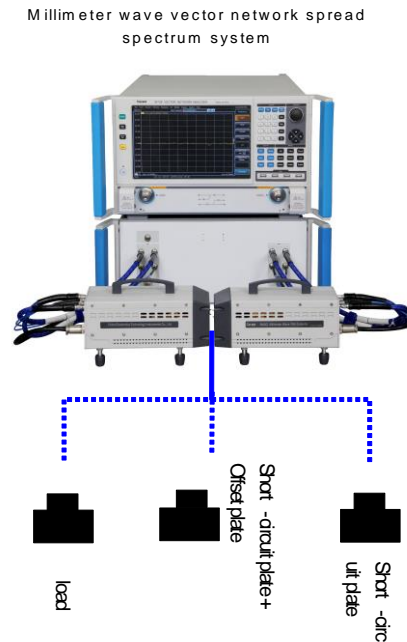

Figure 9-3. Connection diagram of single port calibration

- 1) Connect the system as shown in Figure 9-3, and preheat for more than 30 minutes.
- 2) [System] → [Settings] → [Millimeter Wave Module Settings], set the vector network analyzer as CEYEAR 364X series vector network spread spectrum state, the number of scanning points is 51, the intermediate frequency bandwidth is 10Hz, selected [track] → [measurement] → [S11].
- 3) According to the instrument prompt, as shown in Figure 9-3, complete port 1 single port calibration. The calibration sequence is “load → offset plate + short circuit plate → short circuit plate”.

Test the reflection tracking of Port 1

- 4) At test port 1, connect the short circuit device, press [save] → [normalization]; press [trigger] → [single time].
- 5) Press [Search][Cursor Search], set the range of [User Domain] to CEYEAR 364X series and select [Search Type] as "Maximum" or "Minimum" respectively. The worst cursor value between the two is the reflection tracking index of Port 1. Fill it in Appendix A: Test Record - Reflection Tracking, and close the cursor search dialog box after measurement.

Test the effective directivity of Port 1

- 6) At test port 1, connect to the load, close the track computing function, and re trigger the measurement data for a single time.
- 7) After the scan is completed, open the cursor search dialog box to search for the maximum value in the frequency range of CEYEAR 364X series. The absolute value of the maximum value is the effective directivity index of port 1. Fill it in Appendix A: Test Record - Effective directivity. Close the cursor search dialog box after the measurement is completed.

Test the effective source matching of Port 1

- 7) Set the track computing mode of CEYEAR 364X series vector network analyzer as [data + storage].
- 8) At test port 1, connect offset plate + short circuit plate, set the reference value to - 50dB, and re trigger the measurement data for a single time.
- 9) After the scan is completed, use the cursor search function to search for the minimum value in the frequency range of CEYEAR 364X series, and this value is the effective source matching of the port. Fill this value in Appendix A: Test Record - Effective Source Matching.

Test the reflection tracking of Port 2

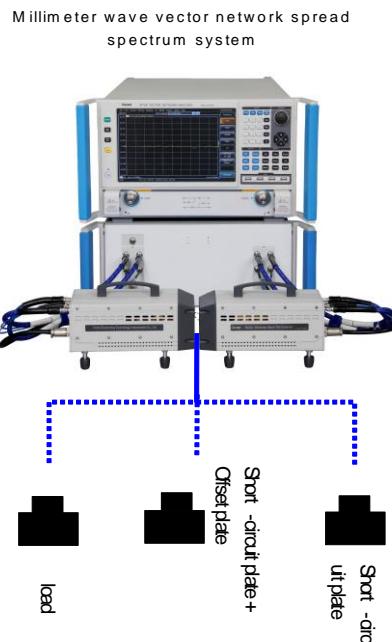

Figure 9-4. Single port calibration connection

- 1) Select [Track] → [Measure] → [S22], and the number of scan points and intermediate frequency bandwidth shall be unchanged.
- 2) According to the instrument prompt, as shown in Figure 9-4, complete port 1 single port calibration. The calibration sequence is “load→ offset plate + short circuit plate →short circuit plate”.
- 3) Confirm that test port 2 carries out data normalization after connecting short circuit plate and set trigger mode as single time.
- 4) After the scan is completed, open the cursor search dialog box to use the cursor search function to search for the maximum and minimum values in the frequency range of CEYEAR 364X series. The worst cursor value between them is the reflection tracking index of port 1. Fill it in Appendix A: Test Record - Reflection Tracking. Close the cursor search dialog box after the measurement is completed.

Test the effective directivity of Port 2

- 5) Connect test port 2 to the load, close the track computing function, and re trigger the measurement data for a single time.
- 6) After the scan is completed, search the maximum value in the frequency range of CEYEAR 364X series. The absolute value of the maximum value is the effective directivity index of port 2. Fill the value is in Appendix A: Test Record - Effective Directivity.

Test the effective source matching of Port 2

- 7) Set the track computing mode of CEYEAR 364X series vector network analyzer as [data + storage].
- 8) Connect the offset plate + short circuit plate at test port 2, set the reference value to - 50dB, and re trigger the measurement data for a single time.
- 9) After the scan is completed, use the cursor search function to search for the minimum value in the frequency range of 325-500GHz. This value is the valid source matching for the port. Fill this value in Appendix A: Test Record - Valid Source Matching.

3 Payload matching and transmission tracking test

- a) Test item description

This test item is used to test the payload matching (the matching of another port to test port after calibration) and transmission tracking index (stability of transmission index after calibration) of the vector network spread spectrum system composed of the spread spectrum module of CEYEAR 364X series vector network analyzer after full dual port calibration:

b) Required test instruments and accessories

1) Waveguide calibration kits

2) 2 straight waveguides

c) Test steps

1) Connect the system as shown in Figure 9-5, and preheat for more than 30 minutes.

2) Select [system] → [settings] [millimeter wave module settings], set vector network analyzer as CEYEAR 364X series vector network spread spectrum state, measurement parameters as S22, intermediate frequency bandwidth as 10 Hz.

3) According to the instrument prompt, as shown in Figure 9-5 and Figure 9-6, connect and complete the SOLT calibration between Port 1 and Port 2. Conduct the reflected calibration first, and then the direct connection calibration.



Figure 9-5. Block diagram 1 for payload matching and transmission tracking test



Figure 9-6. Block diagram 2 for payload matching and transmission tracking test

Test the payload matching of Port 1

4) Maintain the connection after completion of direct connection calibration, set the reference value of the spread spectrum system of CEYEAR 364X series vector network analyzer to -50dB, and the trigger mode as single trigger.

5) After the scan is completed, open the cursor search dialog box, and use cursor search function to search for the maximum value in the range of CEYEAR 364X series. Fill the corresponding value in Appendix A: Test Record - Payload Matching. After the measurement is completed, close the cursor search dialog box.

Test the payload matching of Port 2

6) Set the measurement parameter of the vector network spread spectrum system composed of CEYEAR 364X series to S11, and re-trigger measuring track for a single time.

7) After the scan is completed, open the cursor search dialog box, and use cursor search function to search for the maximum value in the frequency range of CEYEAR 364X series. Fill the corresponding positive value in Appendix A: Test Record - Payload Matching. After the measurement is completed, close the cursor search dialog box.

Test the transmission tracking of Port 1

- 8) Set the measurement parameter of the vector network spread spectrum system composed of CEYEAR 364X series to S12, reference value to 0dB, and re trigger measuring track for a single time.
- 9) After the scan is completed, open the cursor search dialog box, and use cursor search function to search for the maximum and minimum values in the frequency range of CEYEAR 364X series. Fill the cursor value corresponding to the absolute maximum value in Appendix A: Test Record - Transmission Tracking. After the measurement is completed, close the cursor search dialog box.

Test the transmission tracking of Port 2

- 10) Set the measurement parameter of the vector network spread spectrum system composed of CEYEAR 364X series to S21, reference value to 0dB, and re trigger measuring track for a single time.
- 11) After the scan is completed, open the cursor search dialog box, and use cursor search function to search for the maximum and minimum values in the frequency range of CEYEAR 364X series. Fill the cursor value corresponding to the absolute maximum value in Appendix A: Test Record - Transmission Tracking. After the measurement is completed, close the cursor search dialog box.

Section III Record of Performance Feature Test

Instrument No.: Tester:

Test conditions: Test date:

| SN | Inspection Item | Unit | Standard Requirements | Test Result | Conclusion |
|----|---------------------------|------|---|-------------|------------|
| 1 | Appearance | / | The spread spectrum module of CEYEAR 364X series vector network analyzer should be clean and tidy in appearance, without any rust, mildew, stain, coating peeling and obvious scratch and burr on the surface. Plastic parts should be without blister, crack and deformation. The characters, symbols, signs and various displays should be clear and firm, and the structural parts and control parts should be intact and without any mechanical damage. | | |
| 2 | Functional normality | / | After connecting the spread spectrum module of CEYEAR 364X series vector network analyzer with the network analyzer AV3672B and the spread spectrum controller AV3640, set the vector network analyzer program to enter the spread spectrum mode, select the corresponding model of vector network analyzer spread spectrum module, change the frequency range to the frequency range corresponding to the spread spectrum module of the vector network analyzer, and the programmable indicator shall light. Switch the test port, spread spectrum controller source indicator shall be switched with the port switch, the yellow indicator of the receiver shall always light. Under the normal condition of the direct current power indicator, the yellow light is on, which indicates that the spread spectrum module of the vector network analyzer works normally. | | |
| 3 | Dynamic range (@10Hz) | dB | Port 1 | | |
| | | | Port 2 | | |
| 4 | Reflection tracking | dB | Port 1 | | |
| | | | Port 2 | | |
| 5 | Effective directivity | dB | Port 1 | | |
| | | | Port 2 | | |
| 6 | Effective source matching | dB | Port 1 | | |
| | | | Port 2 | | |
| 7 | Transmission tracking | dB | Port 1 | | |
| | | | Port 2 | | |
| 8 | Payload matching | dB | Port 1 | | |
| | | | Port 2 | | |

Part III Maintenance Instructions

Chapter X Fault Information Description and Methods for Obtaining Repair Services

This chapter will show you how to identify problems and accept after-sales service. It also includes the interpretation of the error information inside the signal source.

If you bought Ceyear 364X series millimeter-wave VNA extender, encountered some problems in operation, or you need to purchase some related parts or accessories of millimeter-wave VNA extender, we will provide perfect after-sales service.

Usually, the cause of the problem comes from the hardware, software, or improper use, if there are any problems, please contact us in time. If the millimeter-wave VNA extender you purchased is still under warranty, we will maintain your test module free of charge as promised in the warranty; if it exceeds the warranty period, we will only charge for the cost.

Section I Fault Information Description



Note:

This section is to guide users to make simple judgment and handling when the Ceyear 364X series Millimeter-wave VNA Extender fails. If necessary, please as accurately as possible to feedback the problem to us, so that we can solve it as soon as possible.

1 Failure to be started of the test module

If the test module curve is completely abnormal, please check the test module as follows:

- a) Check whether the power socket is electrified, and whether the power supply meets the working requirements of the millimeter-wave VNA extender.
- b) Check whether the input cable of RF and local oscillator is connected correctly.
- c) Check the operation status of the fan.

If the power supply is normal and the fan does not turn, it may be a failure in the power conversion module of the millimeter-wave VNA extender.

If the above conditions are eliminated, contact the manufacturer for repair.

2 Failure of a single curve

If a single curve of the test module is abnormal, it may be a failure in the mixer under the millimeter-wave VNA extender.

If this is the case, contact the manufacturer for repair.

Section II Methods for Obtaining Repair Services

If the instrument needs to be returned to our institute for repair, please contact our service consultation center according to the contact information provided in the foreword. Please send us the detailed information of instrument failure and error or the copy of instrument test report. Please pack it in the original equipment packing box for transporting.

If you don't have the original package, you can repack the instrument with some common commercial steps listed below:

- 1) Attach complete service mark to the instrument.
- 2) Install the protective cover on the panel of the instrument. If there is no protective cover, use thick cardboard to protect the control panel.
- 3) To prevent static damage, pack the instrument in an antistatic bag.
- 4) Use a secure transport box. For example, double layers cardboard box with strength of 159 kg. The box must be large enough and secure enough. At least 3~4 inches of space should be left on each side of the carton and instrument to fill up the packaging material.
- 5) Reinforce the transport box with strong nylon tape. Mark the box as follows: "fragile! Don't touch it! Handle with care. "
- 6) Keep copies of all transport documents.