

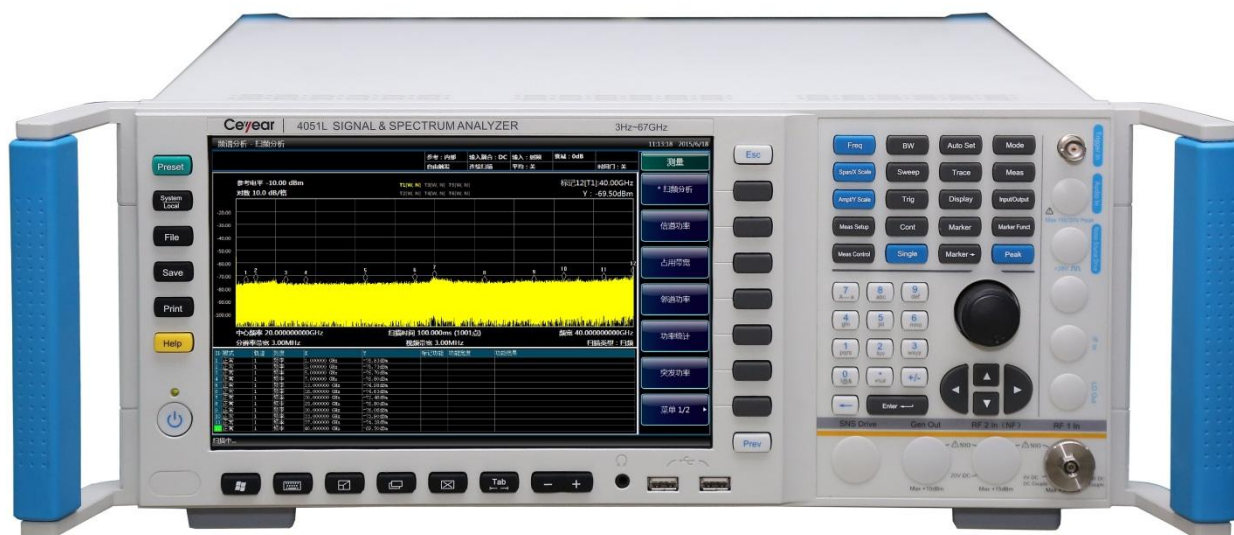

4051 Series Signal/Spectrum Analyzer User Manual



China Electronics Technology Instruments Co., Ltd

The manual applies to the Series Signal Analyzers of the following models:

- 4051A Series Signal/Spectrum Analyzer (3Hz-4GHz).
- 4051B Series Signal/Spectrum Analyzer (3Hz-9GHz).
- 4051C Series Signal/Spectrum Analyzer (3Hz-13.2GHz).
- 4051D Series Signal/Spectrum Analyzer (3Hz-18GHz).
- 4051E Series Signal/Spectrum Analyzer (3Hz-26.5GHz).
- 4051F Series Signal/Spectrum Analyzer (3Hz-40GHz).
- 4051G Series Signal/Spectrum Analyzer (3Hz-45GHz).
- 4051H Series Signal/Spectrum Analyzer (3Hz-50GHz).
- 4051L Series Signal/Spectrum Analyzer (3Hz-67GHz).
- 4051A-S Series Signal/Spectrum Analyzer (3Hz-4GHz).
- 4051B-S Series Signal/Spectrum Analyzer (3Hz-9GHz).
- 4051C-S Series Signal/Spectrum Analyzer (3Hz-13.2GHz).
- 4051D-S Series Signal/Spectrum Analyzer (3Hz-18GHz).
- 4051E-S Series Signal/Spectrum Analyzer (3Hz-26.5GHz).

Options of the 4051 Series Signal/Spectrum analyzer in addition to standard accessories:

- 4051-H01, Back RF input: To post position the RF signal input interface.
- 4051-H02, High IF Output : Output frequency range is 275MHz ~ 475MHz. Provide 30dB gain, 1dB step.
- 4051-H03, IF output: Output third IF signal, output frequency range is 10MHz ~ 160MHz, steps resolution is 1Hz. Provide 4 automatic gain positions to control level.
- 4051-H04A, Reconstruct IF/Video Signal Output: To realize arbitrary IF, AM/FM or I/Q signal output in form of digital reconstruction, the bandwidth upper limit is 40MHz.
- 4051-H04B, Wide band Reconstruct IF/Video Signal Output: To realize arbitrary IF, AM/FM or I/Q signal output in form of digital reconstruction, bandwidth range is 50MHz~100MHz.
- 4051-H08, Wide Log Detect Output: To output the logarithm wave-detection signal which can reflect the input signal level characteristics.
- 4051-H12A, 40MHz bandwidth digital interface: To output real-time broadband collecting data through optical fiber, support max. 40MHz bandwidth signal data output.
- 4051-H12B, 200MHz bandwidth digital interface: To output real-time broadband collecting data through optical fiber, support max. 200MHz bandwidth signal data output.
- 4051-H15, +24V DC power supply: +24V DC power supply.
- 4051-H22A, 4711 Data Recorder: Configured with SSD Data Recorder (have same interface characteristics) to realize real-time large-capacity recording of signal data.
- 4051-H22B, 4712 Data Recorder: Configured with HDD Data Recorder (have same interface characteristics) to realize real-time large-capacity recording of signal data.
- 4051-H33, Electronic Attenuator: The upper limit of frequency is 4GHz, attenuation range: 0~30dB, 1dB steps.
- 4051-H34-04/4051-H34-09/4051-H34-13/4051-H34-18/4051-H34-26/4051-H34-40/4051-H34-45/4051-H34-50, Low-noise Preamplifier: Optional low-band PreAmplifier or all-band amplifier. The maximum frequency of all-band amplifier is up to 50GHz (4051L exception). If an all-band PreAmplifier is adopted, a noise optimization path of at least 4GHz frequency band should be provided.

- 4051-H36, Preselector Bypass: The tracking preselector in the bypass receiving channel.
- 4051-H38A, 40MHz Analysis Bandwidth: Support 10Hz-40 MHz analysis bandwidth.
- 4051-H38B, 200 MHz Analysis Bandwidth: Support 10Hz-200 MHz analysis bandwidth.
- 4051-H38C, 550 MHz Analysis Bandwidth: Support 10Hz-550 MHz analysis bandwidth.
- 4051-H39, Audio Analyzer: Realize audio frequency signal parameter measurement, distortion measurement and waveform analysis
- 4051-H40, External Mixer: To extend the frequency range using external frequency mixing method. This option provides LO output and IF input, as well as signal recognition ability.
- 4051-H41, Real-time Spectrum Analyzer: Provide digital phosphor spectrum and seamless waterfall, including frequency template trigger, which can support real-time spectrum analysis of 200MHz bandwidth.
- 4051-H48, Noise Figure: Noise source drive and noise figure measurement function (4051L exception).
- 4051-S04, Phase Noise Measurement: Provide SSB phase noise curve and single point phase noise measurement.
- 4051-S09, Analog Demodulation Analyzer: Provide modulation characteristics and distortion characteristics analysis of AM, FM, Φ M signals.
- 4051-S10, Transient Analyzer: To realize the measurement & analysis of transient parameters, spectrum, and time-varying characteristics of signals, support playback of the recorded data.
- 4051-S12, Vector Signal Analyzer: This option provides flexible demodulation functions of multiple single-carrier digital modulation signals. It can provide vector charts, constellation diagrams, eye diagrams, spectrum diagrams, etc., to analyze the characteristics of the modulation signal. The modulation error of the signal can be obtained by demodulation, which helps to judge the cause of the signal error.
- 4051-S13, Pulse Signal Analyzer: Automatic measurement on time, level and modulation parameters of pulse waveform and statistical analysis of pulse sequence.
- 4051-H97, Mounting suit: Handles and accessories for 4051 mounting on standard racks.
- 4051-H98, English options: English panels, user manual, operation interface, and operation system. Power supply: AC 100~240V: 50~60Hz.
- 4051-H99, Aluminum transportation case: High-strength lightweight aluminum transportation case, with handle and roller, convenient for transportation.

Options of the 4051-S Series Signal/Spectrum analyzer in addition to standard accessories:

- 4051-H03, IF output: Output third IF signal, output frequency range is 10MHz ~ 160MHz, steps resolution is 1Hz. Provide 4 automatic gain positions to control level.
- 4051-H08, Wide Log Detect Output: To output the logarithm wave-detection signal which can reflect the input signal level characteristics.
- 4051-H34-04/4051-H34-09/4051-H34-13/4051-H34-18/4051-H34-26/4051-H34-40/4051-H34-45/4051-H34-50, Low-noise Preamplifier: Optional low-band PreAmplifier or all-band amplifier. The maximum frequency of all-band amplifier is up to 50GHz (4051L exception). If an all-band PreAmplifier is adopted, a noise optimization path of at least 4GHz frequency band should be provided.
- 4051-S04, Phase Noise Measurement: Provide SSB phase noise curve and single point phase noise measurement.
- 4051-H97, Mounting suit: Handles and accessories for 4051 mounting on standard racks.
- 4051-H98, English options: English panels, user manual, operation interface, and operation system. Power supply: AC 100~240V: 50~60Hz.
- 4051-H99, Aluminum transportation case: High-strength lightweight aluminum transportation case, with handle and roller, convenient for transportation.

Version: D.1 February 2017 China Electronics Technology Instruments Co. Ltd

Address: No.98 Xiangjiang Road, Qingdao City, China

Tel: +86-0532-86896691

Web: www.ceyear.com

E-mail: sales@ceyear.com

Postcode: 266555

Declaration of Conformity

Certificate No. : CTL1608153120-EC
Applicant : The 41st Institute of China Electronics Technology Group Corporation
Address : No.98 Xiangjiang Rd. QingDao Economy and Technology Development Zone, QingDao city, China
Product : SIGNAL & SPECTRUM ANALYZER
Trademark : EI
Model(s) : AV4051A, AV4051B, AV4051C, AV4051D, AV4051E, AV4051F, AV4051G, AV4051H, AV4051A-S, AV4051B-S, AV4051C-S, AV4051D-S, AV4051E-S
Manufacturer : The 41st Institute of China Electronics Technology Group Corporation
Address : No.98 Xiangjiang Rd. QingDao Economy and Technology Development Zone, QingDao city, China
Test Report : CTL1608153120-E

Complies with the requirements of the
EC EMC directive 2014/30/EU with amendments.

Test Standards:

EN 61326-1: 2013
EN 61000-3-2: 2014
EN 61000-3-3: 2013

Remarks:

The **CE** markings as shown below can be affixed on the product after preparation of necessary conformity documentation, as stipulated in article 10 of the Council Directive **93/68/EEC**.



For Chief Executive
Aug. 18, 2016



Shenzhen CTL Testing Technology Co., Ltd.

Add: Floor 1-A, Baisha Technology Park, No.3011, Shahexi Road, Nanshan District, Shenzhen, China 518055
Tel: (86)0755-89486194 Fax: (86)0755-26636041 Web: www.ctl-lab.com E-mail: ctl@ctl-lab.com

Preface

Thanks for choosing the 4051 Series Signal/Spectrum Analyzer developed and produced by China Electronics Technology Instruments Co. Ltd.

We devote ourselves to meeting your demands, providing you high-quality measuring instrument and the best after-sales service. We persist with "superior quality and considerate service", and are committed to offering satisfactory products and service for our clients.

Manual No.

AV2.732.1000SS

Version

D.2 2017.02

China Electronics Technology Instruments Co. Ltd

Manual Authorization

The information contained in this User Manual is subject to change without notice. The power to interpret the contents of and terms used in this Manual rests with China Electronics Technology Instruments Co. Ltd.

China Electronics Technology Instruments Co. Ltd owns the copyright of this User Manual which should not be modified or tampered by any organization or individual, or reproduced or transmitted for the purpose of making profit without its prior permission, otherwise China Electronics Technology Instruments Co. Ltd will reserve the right to investigate and affix legal liability of infringement.

Product Quality Assurance

The warranty period of the product is 18 months from the date of delivery. The instrument manufacturer will repair or replace damaged parts according to the actual situation within the warranty period. The user should return the product to the manufacturer and prepay mailing costs. The manufacturer will return the product and such costs to the user after maintenance.

Product Quality Certificate

The product meets the indicator requirements of the manual at the time of delivery. Calibration and measurement are completed by the measuring organization with qualifications specified by the state, and relevant data are provided for reference.

Quality/Environment Management

Research, development, manufacturing and testing of the product comply with the requirements of the quality and environmental management system. China Electronics Technology Instruments Co. Ltd has obtained the appropriate qualifications and passed the certification of ISO9001 and ISO14001 management system.

Precautions



“Warning” indicates danger. It reminds the user to pay attention to a certain operation process, operation method or similar situations. Noncompliance with the rules or improper operation may result in personal injuries. You must fully understand the warning and all the conditions in it shall be met before the next step.



“Attention” indicates important prompts and no danger. It reminds the user to pay attention to a certain operation process, operation method or similar situations. Noncompliance with the rules or improper operation may result in damage to the instrument or loss of important data. You must fully understand and meet the caution conditions before continuing next step.

Contents

1. Manual Guide	1
1.1 ABOUT THE MANUAL	1
1.2 RELATED DOCUMENTS.....	2
2 General	5
2.1 PRODUCT OVERVIEW	5
2.2 SAFE OPERATING MANUAL.....	5
2.2.1 Safety Signs	5
2.2.2 Operation Status and Location.....	7
2.2.3 Power Safety.....	7
2.2.4 Operation Precautions	8
2.2.5 Maintenance	9
2.2.6 Battery and Power Supply Module.....	9
2.2.7 Transportation.....	9
2.2.8 Waste Disposal/Environmental Protection	10
3 Introduction to Use	11
3.1 PREPARATIONS BEFORE OPERATION	11
3.1.1 Pre-operation Preparation.....	11
3.1.2 Configuration of operating system	20
3.1.3 Routine Maintenance.....	26
3.2 FRONT PANEL & REAR PANEL	28
3.2.1 Front Panel	28
3.2.2 Rear Panel.....	33
3.3 BASIC MEASUREMENT METHODS	36
3.3.1 Basic operation instructions.....	36
3.3.2 Basic operation examples.....	41
3.4 DATA MANAGEMENT.....	46
3.4.1 Working state saving/calling	46
3.4.2 Data saving/calling	48
3.4.3 Screenshot printing/saving	51
4. Operating Instruction	55
4.1 FUNCTION OPERATION GUIDE.....	55
4.1.1 Introduction of measurement modes and functions	55
4.1.2 Operation guidance for parameter setting of common measurement	56
4.1.3 Operation guidance on general analysis and display function	81
4.2 ADVANCED OPERATION GUIDE.....	88
4.2.1 Multi-signal measurement	89
4.2.2 Distortion measurement	98
4.2.3 Measure small signals.....	107
4.2.4 Increase frequency resolution and accuracy by using frequency count function.....	112
4.2.5 Noise signal measurement.....	114
4.2.6 AM signal demodulation	117
4.2.7 Drift signal measurement	123
4.2.8 Improvement of amplitude measurement accuracy by amplitude correction function.....	126
4.2.9 Time gate measurement.....	128
4.2.10 Channel power	142

Contents

4.2.11 Occupied Bandwidth	144
4.2.12 Adjacent Channel Power.....	146
4.2.13 Power Statistic.....	150
4.2.14 Burst Power.....	154
4.2.15 Harmonic Distortion	156
4.2.16 Three-order intermodulation (TOI).....	158
4.2.17 Spurious emission.....	160
4.2.18 Spectral emission mask	162
4.2.19 Display and limit lines.....	164
5 Menu.....	167
5.1 MENU STRUCTURE	167
5.1.1 General.....	168
5.1.2 Spectrum Analysis	173
5.1.3 Channel power	198
5.1.4 Occupied Bandwidth	214
5.1.5 Adjacent Channel Power.....	230
5.1.6 Power Statistic.....	248
5.1.7 Burst Power.....	264
5.1.8 Harmonic Distortion	280
5.1.9 Three-order intermodulation (TOI).....	296
5.1.10 Spurious emission.....	312
5.1.11 Spectral emission mask	329
5.2. DESCRIPTION OF MENU	346
5.2.1 General.....	346
5.2.2 Spectrum Analysis	355
5.2.3 Channel power	441
5.2.4 Occupied Bandwidth	462
5.2.5 Adjacent Channel Power.....	482
5.2.6 Power Statistic.....	510
5.2.7 Burst Power.....	519
5.2.8 Harmonic Distortion	538
5.2.9 Three-order intermodulation (TOI).....	551
5.2.10 Spurious emission.....	570
5.2.11 Spectral emission mask	588
6 Remote control.....	611
6.1 BASIS OF REMOTE CONTROL	611
6.1.1 Remote Control Interface	611
6.1.2 Message.....	613
6.1.3 SCPI Command.....	614
6.1.4 Command Sequence and Synchronization.....	621
6.1.5 Status Report System	622
6.1.6 Programming Precautions	625
6.2 PROGRAMMED PORT AND CONFIGURATION OF INSTRUMENT	625
6.2.1 LAN.....	625
6.2.2 GPIB.....	626
6.3 BASIC PROGRAMMING METHOD OF VISA INTERFACE	627
6.3.1 Install VISA library	627

6.3.2 Initialization of Controller	627
6.3.3 Instrument Initialization	628
6.3.4 Sending of Setting Command.....	628
6.3.5 Reading of Measurement Instrument Status.....	628
6.3.6 Reading of frequency marker (signal/spectrum analyzers).....	629
6.3.7 Command Synchronization.....	629
6.4 I/O LIBRARY	631
6.4.1 Overview of I/O Library	631
6.4.2 I/O Library Installation and Configuration.....	632
7 Fault Diagnosis and Repair	633
7.1 OPERATING PRINCIPLE	633
7.1.1 Operating principles and hardware functional block diagram.....	633
7.2 FAULT DIAGNOSIS AND TROUBLESHOOTING	635
7.2.1 Basic procedure of fault diagnose.....	635
7.2.2 Common faults and solutions	636
7.3 ERROR INFORMATION	639
7.3.1 Error message files.....	639
7.3.2 Description of Error Information.....	639
7.4 REPAIR	641
7.4.1 Contact Us.....	641
7.4.2 Packing and Mailing	641
8. Specifications and test methods	643
8.1 STATEMENT.....	643
8.2 PRODUCT FEATURES.....	643
8.3 TECHNICAL INDICATORS.....	644
8.3.1 Frequency and time	644
8.3.2 Amplitude accuracy and range.....	647
8.3.3 Dynamic range	648
8.4 ADDITIONAL INFORMATION	650
8.4.1 Front panel interfaces	650
8.4.2 Rear panel interfaces.....	651
8.5 PERFORMANCE CHARACTERISTICS TEST	651
8.5.1 Recommended test method	651
8.5.2 Record sheet of performance characteristics of signal/spectrum analyzer.....	689
8.5.3 Auxiliary form of performance characteristics of 4051 signal/spectrum analyzer	698
8.5.4 Instruments recommended for performance characteristics	709
Appendix	711
APPENDIX A TERMINOLOGY	711
LO.....	711
LO feedthrough	711
Waveform factor.....	711
Spurious response	711
Measuring Unit	712
Menu.....	712
Reference level	712
Measuring range	712
Marker Delta.....	712

Contents

<i>Impact bandwidth</i>	712
<i>Bandwidth selectivity</i>	712
<i>Dynamic range</i>	712
<i>Logarithm scale display</i>	713
<i>Spurious response</i>	713
<i>[FFT]</i>	713
<i>Resolution</i>	713
<i>Amplitude accuracy:</i>	714
<i>Negative peak value detection</i>	714
<i>Track</i>	714
<i>Intermodulation</i>	714
<i>Activity function area</i>	714
<i>Detection mode</i>	715
<i>Speed factor</i>	715
<i>Zero Span</i>	715
<i>Drift</i>	715
<i>Frequency response</i>	715
<i>Marker</i>	715
<i>Span</i>	715
<i>Frequency range</i>	715
<i>frequency accuracy</i>	715
<i>Frequency stability</i>	715
<i>Signal/spectrum analyzer</i>	716
<i>flatness</i>	716
<i>Sampling detection</i>	716
<i>[Scanning time</i>	716
<i>RF attenuator</i>	716
<i>Residual frequency modulation</i>	716
<i>Video</i>	716
<i>[Video bandwidth</i>	716
<i>Video amplifier</i>	716
<i>Video filter and video average</i>	716
<i>Input amplitude range</i>	717
<i>Input impedance</i>	717
<i>Refresh mode</i>	717
<i>Display range</i>	717
<i>Average noise level display</i>	717
<i>Linear display</i>	717
<i>Relative amplitude accuracy</i>	717
<i>Preselector</i>	718
<i>Sensitivity</i>	718
<i>Noise Marker</i>	718
<i>Phase noise (noise sideband)</i>	718
<i>Harmonic mixing</i>	718
<i>Gain compression</i>	718
<i>Normal detection</i>	718
<i>Negative peak value detection</i>	719

Contents

IF gain/attenuation..... 719

APPENDIX B SCPI COMMAND INDEX 720

APPENDIX C ERROR MESSAGE INDEX 733

1. Manual Guide

This chapter describes the functions, chapter composition and main contents of the User Manual of 4051 Series Signal/Spectrum analyzer, and the instrument-related documents for the user.

- [About manual](#).....1
- [Related documents](#).....2

1.1 About the Manual

In the Manual, basic functions and operating methods of the 4051 Series Signal/Spectrum Analyzer are introduced. Including instrument characteristics, basic operating methods, measurement configuration operating manual, menus, remote control, maintenance, specifications and test methods to help you rapidly get familiar with and understand key points of the instrument operation method and use. For the convenience of operation, please carefully read the manual before operating the instrument, and properly operating it according to the guidance in the manual.

The user manual includes the following chapters.

- **Overview**

It provides an overview of main performance features and typical application of the 4051 Series Signal Analyzer and safety guidelines for instrument operations. It helps users get to know main performance features of the instrument and guide them to operate it.

- **Introduction to Use**

In this chapter, inspections before use, instrument navigation, basic measurement methods and data management of the 4051 Series Signal/Spectrum Analyzer are explained to help users get to understand the instrument itself and measurement procedure and lay foundation for subsequent detailed introduction of the instrument measurement operating manual. Contents in this chapter are consistent with chapters in the Quick Start Guide.

- **Operation Manual**

It introduces in details operations of measurement functions of the instrument, including instrument configuration, measurement process initiation and obtaining measurement results. It mainly includes two parts: function operation manual and advanced operation manual. The functions operation manual introduce and exemplify each setting in a systematic and detail manner for users not familiar w

ith operating methods of the analyzer to help them understand and grasp basic usages of the Series Signal Analyzer, including setting of frequency, span and marker. The advanced operation guidance introduces complicated test procedures, advanced using technI/Ques and guidelines of measurement implementation with users having the basic knowledge of the use of 4051 Series Series Signal Analyzer but unfamiliar with some special operations as target readers. Including multi-signal measurement, distortion measurement, noise measurement, modulation signal measurement and power kit measurement.

- **Menu**

This chapter describes the menu structure and items according to functional categories to facilitate query and reference.

- **Remote control**

This section outlines the remote control of the instrument, so that the user can rapidly get to know how to remotely control the instrument. It is divided into four sections: the program control basics describe the concepts related to program control, software configuration, program-controlled port, SCPI commands, etc.; instrument port configuration describes the connection and software configuration of the program-controlled port of 4051 Series Signal Analyzer; basic programming of VISA interface provides an example of basic programming with text illustration and example codes, so that the user can rapidly get to know the

1.2 Related Documents

programming method; and I/O function library describes the basic concepts of the instrument drive and the basic installation and configuration requirements of the IVI-COM/IVI-C drive.

- **Fault diagnosis and repair**

This section describes the overall operating theory, fault diagnosis and troubleshooting, and errors and repair.

- **Specifications and test methods**

This section describes characteristics and main specifications of the 4051 Series Signal Analyzer and recommended test instructions for users.

- **Appendix**

This section provides necessary reference information for 4051 Series Signal/Spectrum Analyzer, including terminology, remote control commands index, menu index and error messages index.

1.2 Related Documents

The documents related to 4051 Series Signal/Spectrum Analyzer include:

- User Manual
- Remote Control Manual
- Quick Start Guide
- Online help

User Manual

This manual introduces the functions and operation methods of the instrument in details, including configuration, measurement, program control, maintenance, etc. It aims to guide the user to comprehensively understand the functional characteristics and common test methods of the instrument. It mainly includes the following chapters:

- Manual Guide
- Overview
- Introduction to Use
- Operation Instruction
- Menu
- Remote control
- Fault diagnosis and repair
- Specifications and test methods
- Appendix

Remote Control Manual

This manual introduces the remote programming basis, SCPI basis, SCPI commands, programming examples, I/O drive function library, etc. It aims to guide the user to rapidly and comprehensively know the program control commands and methods of the instrument. It mainly includes the following chapters:

- Manual Guide
- Remote control
- Remote Command
- Programming examples
- Error illustration

- Appendix

Quick Start Guide

This manual introduces the basic operations of configuration, start-up and measurement of the instrument, aiming to help users rapidly know the characteristics of the instrument and understand basic local and remote control operations. It mainly includes the following chapters:

- Manual Guide
- Preparation for use
- Typical application
- Help

Online help

Online help is integrated in the instrument to provide rapid text navigation help and facilitate local and remote operation. Hard keys on the front panel of the instrument and tool bars of the user interface can be activated with corresponding shortcut keys. Main chapters are the same as those in the user manual.

2 General

In addition to main performance features and main applications of the 4051 Series Signal/Spectrum Analyzer, it also describes precautions for proper operation, electrical safety, etc.

- [Product overview](#).....5
- [Safe operating manual](#).....5

2.1 Product Overview

The 4051 Series Signal/Spectrum Analyzer can cover a frequency range of 3Hz ~ 50 GHz at most and feature excellent test dynamic range, phase noise, amplitude accuracy and test speed as well as high-sensitivity spectrum analysis, standard power measurement unit, I/Q analysis, transient analysis, pulse parameter analysis, audio analysis, analog modulation measurement, phase noise test, providing reliable and high-performance test services for users. Moreover, the Series Signal Analyzer has good expansion capability for further improvement of test performance with flexible optional configuration and is capable of test system construction or secondary development with various digital and analog signal output interfaces. Such instrument can find wide application signals and equipment test in industries such as aviation, aerospace, radar detection, communications, electronic countermeasure and navigation.

2.2 Safe operating manual

Please carefully read and strictly follow the notes for attention below!

We will spare no effort to ensure that all production stages conform to the latest safety standards to guarantee the highest safety for users. The design and test of our product and ancillary equipment thereof have been up to relevant standards of security; quality assurance system has been established to monitor the product quality to ensure the consistency with such standards. Precautions proposed in this User Manual should be followed to keep equipment intact and operations safe. Please do not hesitate to consult us if you have any questions.

However, it is your responsibility to operate the product in a correct way. Please read and follow the safety instructions carefully before operating the instrument. The instrument is applicable to the industrial and laboratory environment or field measurement. Pay attention to the limitations for proper operation to avoid personal injury or property damage. We will not take any responsibility for any misuse or inconsistency as required, and you are liable for any risks incurred by. Therefore, please follow the safety instructions to prevent from personal injury or property damage. Please keep product documentation safe and deliver them to end users.

- [Safety signs](#).....5
- [Operation status and location](#).....7
- [Power safety](#).....7
- [Operation precautions](#).....8
- [Maintenance](#).....9
- [Battery and power supply module](#).....9
- [Transportation](#).....9
- [Waste disposal/environment protection](#).....10

















2.2.1 Safety Signs

2.2.1.1 Product-related Signs

The safety signs of the instrument are as follows (Table 2.1).

2.2 Safe operating manual

Table 2.1 Instrument Safety Signs

Symbol	Meaning	Symbol	Meaning
	Caution: the user should pay attention to the information. The user should pay attention to the operation information or instructions.		Power on/off
	Caution: handle heavy equipment.		Standby indication
	Danger! Be careful of electric shock!		Direct-current (DC) power
	Warning! Be careful of surface heat.		Alternating-current (AC) power
	Protect the conductive terminal.		Direct-current/alternating-current power (DC/AC)
	Grounding		Instrument reinforcement and insulation protection.
	Earthing Terminal		EU mark of battery and accumulator. For details, refer to 1 of “2.2.8 Waste disposal/environment protection”.
	Caution: electrostatic sensitive device. Be careful.		EU mark for electronic parts to be collected separately For details, refer to 2 of “2.2.8 Waste disposal/environment protection”.
	Warning! Radiation. For more details, refer to item 7 of “2.2.4 Operation precautions”.		

2.2.1.2 Manual-related Signs

The following safety warning signs are used in the product manual to remind the user to operate the instrument safely and pay attention to relevant information.



Danger sign: personal injury and equipment damage may be caused if no attention is paid.



Warning sign: personal injury and equipment damage may be caused if no attention is paid.



Caution sign: minor or moderate personal injury and equipment damage may be caused if no attention is paid.



Caution sign: it indicates important prompts but no danger.



Prompt sign: information of the instruction and operation.

2.2.2 Operation Status and Location

Pay attention to the following items before operation:

- 1) Unless otherwise stated, the 4051 Series Signal/Spectrum Analyzer should be placed steadily and operated indoor. The instrument should be operated and transported at places with an altitude no higher than 4,600 m. The actual power supply voltage may be the indicated voltage $\pm 10\%$, and the power supply frequency may be the indicated frequency $\pm 5\%$.
- 2) Unless otherwise stated, the instrument is not allowed to be placed on a wet surface, vehicle, cabinet, table and other objects which are not fixed and do not conform to the load conditions since it has not gone through waterproof treatment. Place the instrument steadily and fix it on the solid object surface (such as the anti-static workbench).
- 3) The instrument must not be placed in misty environment. For example, if the instrument is handled in an environment with temperature fluctuation, hazards such as electric shock may be caused by water drops produced on the instrument.
- 4) Do not place the instrument on a heat dissipating surface (such as a radiator). The operating temperature must not exceed the specified range of relevant indicators of the instrument. Overheating may result in electric shock, fire, etc.
- 5) It is prohibited to tuck any article from the opening on the housing into the instrument or cover openings or notches on the instrument for they are used for ventilation of the instrument and preventing overheating.

2.2.3 Power Safety

Precautions for the power supply of the instrument:

- 1) Ensure that the actual power supply voltage is the same as that marked on the instrument before powering-on.
- 2) Refer to the power supply requirements on the rear panel of the instrument. Use three-core power cords. Ensure that the power cord is grounded reliably. Floating or improper grounding may result in damage to the instrument and even operator injuries.
- 3) Do not damage the power cord; otherwise, electrical leakage may be caused, resulting in instrument damage and even operator injuries. If any, check the external power cord or terminal block before operation to ensure the power safety.

2.2 Safe operating manual

- 4) If the power socket is not equipped with any ON/OFF switch, the power plug can be directly pulled off to power off the instrument. In this case, ensure it is easy to plug and unplug the power line.
- 5) Do not use any damaged power cord. Before connecting the power cord to the instrument, check the power cord for integrity and safety. Reasonably place the power cord to avoid the impact from human activities. For example, the operator may fall over if the power cord extends over long distance.
- 6) Keep the socket clean and the plug and the socket in good and firm contact.
- 7) The socket and power cord must not be overloaded; otherwise, fire or electric shock may be caused.
- 8) Unless specially permitted, the instrument shell must not be opened; otherwise, internal circuits and parts may be exposed, resulting in unnecessary damage.
- 9) If the instrument needs to be fixed in a test place, the protective ground wire should be installed between the test place and instrument by the electrician with qualifications.
- 10) Take appropriate overload protection measures to avoid instrument damages or personal injuries caused by overload voltage (arising from lightning, etc.).
- 11) It is notable that when the instrument is in fire, toxic gas or II/Quid harmful to human being may be released

2.2.4 Operation Precautions

- 1) The instrument operator must have certain professional and technological knowledge, good psychological quality and emergency response capability.
- 2) Refer to relevant requirements in “2.2.7 Transportation” before handling or transporting the instrument.
- 3) Allergic substances (such as nickel) are produced inevitably during instrument production. If the operator shows any allergic symptom (such as rash, frequent sneezing, red eye, breathing difficulty, etc.), immediately seek medical help to eliminate the symptoms.
- 4) Refer to relevant requirements in “2.2.8 Waste disposal/environmental protection” of this section before removing and disposal of the instrument.
- 5) RF instruments may result in high-intensity electromagnetic radiation. The pregnant women and operators with heart pacemaker must be protected particularly. If the degree of radiation is high, take appropriate measures to remove the radiation source so as to prevent personal injury.
- 6) To avoid the damage to the instrument caused by static electricity, anti-static treatment such as the use of anti-static table pad, foot pad and wrist pad should be provide, and the anti-static voltage should not be over 500V.
- 7) You should choose connectors and cables meeting testing conditions and check connectors and cables before operation.
- 8) During measurement, DC or AC coupling can be selected for the RF input interface. When DC coupling is selected, input of DC signals is prohibited since it will result in damage of internal parts; when AC coupling is selected, the maximum DC signals to be input is 50 V.
- 9) It should be ensured that the input signal power at radio frequency input interface is lower than the maximum safety input level +30dBm to avoid the burning of the instrument.
- 10) Hotplug should not be used for GPIB and monitor interface which do not support hot plug.
- 11) It is prohibited to remove all connector protectors and matching units accompanying the instrument to avoid damage to connectors and measuring error.
- 12) Turn off the power at front panel in a normal way instead of forcing a power off, or it will result in abnormalities to the operating system;
- 13) The instrument should be preheated for 30 min before testing in order to ensure measurement accuracy.

2.2 Safe operating manual

- 14) To ensure the best measurement effect, the instrument should be working at associated state as much as possible.
- 15) When the tested signal is overloaded, the attenuator or the reference level should be adjusted to display the signal peak under the top division of the screen.
- 16) Users are prohibited to delete ex-factory data of the instrument.
- 17) Open Windows environment is adopted in the analyzer; and the user is prohibited to modify BIOS setup, or it will result in abnormal startup and work of the analyzer;
- 18) Users can only delete the files they store rather than the system file.
- 19) Before transmitting files with USB interface and Internet port, you should ensure the security and reliability of the carrier to avoid virus infection of the instrument.
- 20) Addresses of GPIB and Internet access should be correctly set when GPIB or Internet access is used to form the testing system.
- 21) In case of instrument failure, it is prohibited to disassemble the instrument, and instead, you should send it to the manufacturer for repair.

2.2.5 Maintenance

- 1) The instrument chassis must be opened by an authorized operator who has received special technical training. The power cord should be disconnected before operation, so as to avoid instrument damages and even personal injuries.
- 2) The instrument should be repaired, replaced and maintained by special electronic engineers of the manufacturer, and the replaced or maintained parts must be subject to safety tests to ensure the safety of subsequent operation.

2.2.6 Battery and Power Supply Module

Carefully read relevant information before using the battery and power supply module, so as to avoid explosion, fire and even personal injuries. Precautions for battery use:

- 1) Do not damage the battery.
- 2) The battery and power supply module must not be exposed to flame and other heat sources. They must be prevented from direct sunlight and should be kept clean and dry in storage. Clean the connection port of the battery or power supply module with clean and dry soft cloth.
- 3) Do not make the battery or power supply module short-circuited. As the short circuit may be easily caused by mutual contact or contact with other conductors, several batteries or power supply modules must not be stored in the same carton or drawer. Do not remove the original package until the battery and power supply module are required.
- 4) The battery and power supply module must be prevented from mechanical impact.
- 5) The leaky battery must not contact with the skin or eyes. In case of contact, rinse with plenty of clean water and immediately seek medical help.
- 6) Use the standard battery and power supply module provided by the manufacturer. Any improper replacement or charging of alkaline batteries (such as lithium batteries) may easily result in explosion.
- 7) The waste battery and power supply module should be recovered and disposed separately with other wastes. The battery contains toxic substances. It must be discarded or recycled according to the local provisions.

2.2.7 Transportation

- 1) The heavy instrument must be handled carefully. If necessary, use tools (such as the crane) to move the instrument to prevent damage to the body.

2.2 Safe operating manual

- 2) The instrument handle is applicable to handling by individuals. The instrument must not be fixed on the transport equipment during transportation. In order to prevent damage to the property and body, observe the manufacturer's safety provisions on instrument transportation.
- 3) If the instrument is operated on the transport vehicle, the driver should drive carefully to ensure the transportation safety. The manufacturer will not be responsible for emergencies in transportation. Do not operate the machine during transportation. Take reinforcement and protection measures to ensure the safety of transportation.

2.2.8 Waste Disposal/Environmental Protection

- 1) Do not dispose the equipment with the battery or accumulator mark along with other unclassified wastes. Instead, such equipment should be collected separately and discarded or disposed in the appropriate collection place or by the customer service center of the manufacturer.
- 2) Do not dispose the discarded electronic equipment with other unclassified wastes. Such electronic equipment should be collected separately. The manufacturer has the right and responsibility to help end users to dispose waste products. If necessary, contact the customer service center of the manufacturer for corresponding disposal to avoid damage to the environment.
- 3) Toxic substances (heavy dust such as lead, beryllium, nickel, etc.) May be released in machining or thermal reprocessing of the instrument or internal parts. In this case, the instrument or internal parts must be removed by technical personnel who have received special training and relevant experience, so as to avoid personal injuries.
- 4) Toxic substances or fuel released by the instrument in reprocessing should be disposed in the specified method, with reference to the safety operation rules put forward by the manufacturer, so as to avoid personal injuries.

3 Introduction to Use

This chapter introduces the operation precautions, description of front and rear panel, basic measurement methods, data file management, etc. Of the 4051 Series Signal/Spectrum Analyzer to help users get a preliminary understanding of the instrument and measurement process. To help users get to understand the instrument itself and measurement procedure. Contents in this chapter are consistent with chapters in the Quick Start Guide.

- Preparation before operation.....11
- Front panel and rear panel28
- Basic measurement methods.....36
- Data management.....46

3.1 Preparations before Operation

- Pre-operation preparation.....11
- Configuration of Operating system20
- Routine maintenance.....26

3.1.1 Pre-operation Preparation

This chapter introduces the precautions for initial setting and operation of the 4051 Series Signal/Spectrum Analyzer.



Warning

Prevent damages to persons and the instrument

In order to avoid electric shock, fire and personal injury:

- Do not open the casing without permission.
- Do not disassemble or modify any part which is not described in this manual. Disassembly may result in declining of the electromagnetic shielding performance, damage to parts in the instrument, etc., thus affecting the product reliability. In this case, we will not provide free maintenance services even within the warranty period.
- Please carefully read “2.2 Safe Operating Manual” of this Manual, and the safety precautions listed below and pay attention to the specific operating environment requirements in specifications.

Caution

Electrostatic protection

Pay attention to anti-static measures in the workplace to prevent damage to the instrument. For more details, refer to “2.2 Safe Operating Manual” of this Manual.

3.1 Preparations before Operation

Caution

Pay attention to the following requirements before operation:

The improper operation location or measurement setting may result in damage to the instrument or the connected instrument. Pay attention to the following requirements before powering on the instrument:

- The instrument should be kept at least 15 cm from the wall to ensure the fan blades and the louvers are not blocked. All ventilation holes should be smooth and unobstructed.
➤ Keep the instrument dry.
➤ Horizontally and reasonably arrange the instrument.
➤ The ambient temperature should meet the requirement in the technical specifications;
➤ The input signal power of the port is within the specified range.
➤ The signal input interface should be properly connected to avoid overload.

Prompt

Influence of electromagnetic interference (EMI):

Electromagnetic interference will affect measurement results, therefore:

- Select the appropriate shielded cable. Example: use the dual-shielded radio-frequency/network connection cable.
➤ Always open and close the cable connection port which is not used temporarily.
➤ Please refer to the EMC grade indicated in the technical specifications.

• Unpacking.....12
• Environmental requirement.....13
• Power-on/off.....14
• Proper use of connector.....17
• User inspection.....19

3.1.1.1 Unpacking

1) Appearance inspection

Step 1. check whether the outer packing box and shockproof package are damaged. In case of any damage, keep the outer package for future use. Continue inspection according to the following steps.

Step 2. unpack the box and check whether the host and accompanying articles are damaged.

Step 3. carefully check the above articles according to Table 3.1.

Step 4. Do not turn on the power supply of the instrument if the outer package, instrument and accompanying article is damaged or any error exists. Contact our service consultation center at the service consultation hotline in the Manual. We will rapidly repair or replace the instrument, depending on the actual situation.

Caution

Handling: the heavy instrument and packing box must be handled by two persons and placed carefully.

3.1 Preparations before Operation

2) Model confirmation

Accompanying items of the 4051 analyzer are as shown in Table 3.1.

Table 3.1 List of Accompanying Articles of 4051

Name	Quantity	Function
Host		
4051	1	—
Standard		
Power cord	1	—
USB mouse	1	—
User Manual	1	—
Remote Control Manual	1	—
Packing list	1	—
Certificate	1	—
Options		
Depend on users' options	—	—

3.1.1.2 Environmental Requirements

The 4051 Series Signal/Spectrum Analyzer should be operated at places conforming to the following environmental requirements:

1) Operating environment

The operating environment should meet the requirements in Table 3.2:

Table 3.2 Operating Environment Requirements of 4051

Operating temperature	0°C ~ 50°C
Relative humidity:	When the temperature is > +10°C, the humidity is (95% ± 5%) RH When the temperature is > +30°C, the humidity is (75% ± 5%) RH When the temperature is > +40°C, the humidity is (45% ± 5%) RH
Altitude	0 ~ 4,600 m

Caution

The above requirements are for the operating environment of the instrument and not the range of technical specifications.

2) Heat dissipation requirements

In order to keep the operating temperature of the instrument within the specified temperature range, the heat dissipation space of the instrument should conform to the following requirements in Table 3.3.

Table 3.3 Heat Dissipation Requirements of 4051

Instrument Part	Heat Dissipation Distance
Rear side	≥ 150 mm
Left and right side	≥ 60 mm

3) Electrostatic protection

Static electricity is destructive to electronic components and devices. Generally, two anti-static measures can be taken: combination of conductive table mat and wrist strap; and combination of conductive floor mat and

3.1 Preparations before Operation

ankle strap. Anti-static effect will be better when two measures are used at the same time. If used independently, only the former can make sure the safety. In order to ensure the user safety, the ground isolation resistance of anti-static components must be 1MΩ at least.

The follow anti-static measures should be taken to reduce static damage:

- All instruments must be properly grounded to prevent static electricity.
- The internal and external conductor of the cable should respectively contact with the ground temporarily before the coaxial cable and instrument are connected.
- Workers must wear the anti-static wrist strap or take other anti-static measures before contact with the connector or wire or any assembly.



Voltage range

The above anti-static measures are not suitable for the places with the voltage higher than 500V.

3.1.1.3 Power on/off

1) Precautions before powering-on

Check the following items before powering on the instrument.

a) Confirm the power supply parameters.

The 4051 Series Signal/Spectrum Analyzer is internally equipped with 220V AC power module (using 220V AC power supply) or 110V/220V self-adaptive AC power module (option, using 110V or 220V AC power supply working in self adaptive way, which means to automatically switch operating mode based on external AC power supply voltage). Therefore, please carefully read power requirements on the rear panel before using the instrument. Table 3.4 lists the requirements of the external power supply for normal operation of the Series Signal Analyzer.

Table 3.4 Parameters of Working Power Supply of 4051

Power supply parameter	Applicable range	
Voltage, frequency	220V±10%, 50 ~ 60Hz	110V±10%, 50 ~ 60Hz
Power consumption (startup)	<400W	<400W
Power consumption (standby)	<20W	<20W



Prevent mutual interference of various power supplies.

In order to prevent mutual interference of power supplies of various devices, especially the instrument hardware damage caused by peak pulse interference of high-power equipment, it is recommended to use the 220 V or 110 VAC voltage-regulated power supply to power on the Series Signal Analyzer.

b) Confirm and connect the power line.

The 4051 Series Signal/Spectrum Analyzer adopts three-core power line interface and conforms to national safety standards. Before the Series Signal Analyzer is energized, it should be ensured that the ground wire in its power line is reliably grounded. Floating or improper grounding may result in damage to the instrument and even operator injuries. Do not use the power line with no protective ground wire. When the appropriate

3.1 Preparations before Operation

power socket is connected, the instrument shell will be grounded through the power line. The rated voltage of the power line should be no less than 250V, and the rated current should be no less than 6A.

Connection of the power line to the instrument:

Step 1: confirm that the power line is not damaged.

Step 2: connect the power socket on the rear panel of the instrument to the well grounded three-core power socket through the power line.



Warning

Grounding

Improper/wrong ground might lead to instrument destroy or even personal injury. It should be ensured that the protective ground wire of the instrument and that of the power supply are in good contact before energizing to start the Series Signal Analyzer.

Use the power socket with protective ground wire. Do not use the external cable, power line or autotransformer subject to no grounding protection instead of the protective ground wire. If autotransformer is used, its common terminal must be connected with the ground protection of the power connection.

2) Initial power-on

The method and precautions of initial power-on are as follows.

a) Connection of power supply

Check the power supply parameters and the power cord before initial energizing. For details, refer to “Precautions before energizing” in 3.1.1.3 of the Manual.

Step 1. Connect power line: Connect one end of the supporting power line of the Series Signal Analyzer or the three-core power line conforming to the requirements in the packing box to the power socket (as shown in Fig. 3.1) on the rear panel of the Series Signal Analyzer. The voltage indicator of the Series Signal Analyzer is marked beside the power socket to remind the user that the applied voltage should conform to the requirements. Connect the other end of the power cord to the required AC power supply.

Step 2. turn on the power switch on the rear panel. As shown in Fig. 3.2, check whether the standby indicator above the power switch on the front panel (as shown in Fig. 3.3) is ON and yellow.

Step 3. Turn on the power switch on the front panel: as shown in Fig. 3.3, do not connect any device to the Series Signal Analyzer before start-up. Start the instrument under normal conditions. After start-up, the indicator above the power switch on the front panel will turn green.



110 V/220 V self-adaptive AC power module



220 V AC power module

Fig. 3.1 Power outlet on the rear panel of the 4051 analyzer

3.1 Preparations before Operation



Fig. 3.2 Power Switch of Rear Panel of 4051



Fig. 3.3 Power Switch on Front Panel of 4051

b) Start-up/shutdown

I. Start-up

- Step 1.** Turn the power switch on the rear panel to “I”. At such time, the power indicator above the power switch on the front panel turns yellow and the instrument is in standby mode;
- Step 2.** Turn on the power switch in the lower left corner of the front panel. The power indicator above the power switch turns from yellow to green;
- Step 3.** The user interface on the front panel of the instrument will gradually display the information of instrument startup: first with the manufacturer information and logo, followed by operating system options. There are two options available for selection, but users do not need to choose during normal operation. Windows 7 automatically starts after the timer hits 0;
- Step 4.** After Window 7 is successfully started, the system will automatically initiate the Series Signal Analyzer and display its main operation interface.

Then the instrument can be operated.

Prompt

10 MHz time base and warm-up

In case of cold start of the 4051 Series Signal/Spectrum Analyzer (the instrument starts from complete shutdown), the instrument should be preheated for a while to reach the operating temperature at 10 MHz. If the instrument is started from standby, no preheating is required. When testing specifications, the instrument should be preheated for 0.5 h (refer to instructions in the technical specifications for more details).

Prompt

Attenuator initializing

When entering the host program, there will be noise from attenuator gear setting due to attenuator initialization. Do not mistake it for a fault in the Series Signal Analyzer.

Caution

System startup

Windows + x86 computer control platform is used in this analyzer, therefore no interference by the user is

needed during BIOS self inspection and Windows loading. Do not cut the power or modify the setup options in BIOS.

Ii. Shutdown

Step 1. Turn off the power switch at the lower left corner of the front panel. In this case, the shutdown process is started (the power supply must not be turned off until certain processing of software and hardware is completed). The instrument will be shut down after seconds. In this case, the color of the power indicator above the power switch will change from green to yellow.

Step 2. Turn the power switch on the rear panel to “O”, or connect the power supply of the instrument.

Then the instrument is turned off.

Caution

Shutdown of Instrument

The instrument in normal operation must be shut down by operating the power switch of the front panel. Do not directly operate the power switch of the rear panel or directly cut off the power supply of the instrument; otherwise, the instrument cannot be shut down normally and may be damaged, or the current status/measurement data may be lost. **Shut down the instrument properly.**

c) Cutoff of power supply

In order to prevent personal injury under abnormal conditions, the power supply of the Series Signal Analyzer requires emergency cutoff. In this case, pull off the power cord (from the AC power socket or the power socket of the rear panel of the instrument). Therefore, sufficient operating space should be reserved for direct cutoff of the power supply if necessary.

3.1.1.4 Proper Use of Connector

Connectors are commonly used in various tests of the Series Signal Analyzer and the following items should be checked when using connectors:

1) Inspection of connector

Wear the anti-static wristband in connector inspection. It is recommended to use the magnifying lens to check the following items.

- Check whether the plating surface is worn or deeply scratched.
- Check whether threads are deformed;
- Check whether there are metal particles on the connector threads and joint surfaces.
- Check whether the internal conductor is bent or cracking;
- Check whether the connector screw can rotate properly.



Caution

Prevent damage to the instrument port in connector inspection.

Any damaged connector may result in damage to the connector in good conditions even in the first measurement connection. In order to protect each interface of the Series Signal Analyzer, the connector must be checked before connection.

2) Connection method

Check and clean the connector before measurement connection. Ensure that the connector is clean and intact. Wear the anti-static wristband in connection. The correct connection method and steps are as follows.

3.1 Preparations before Operation

Step 1. as shown in Fig. 3.4, align the axes of two connectors to be interconnected, and ensure that the pin of the male connector can concentrically slide into the jack of the female connector.



Fig. 3.4 Diagram of connector connection

Step 2. as shown in Fig. 3.5, horizontally move two connectors to make them connected smoothly. Tighten the connector nut by means of rotation (do not rotate the connector). Avoid relative rotation of connectors during connection.

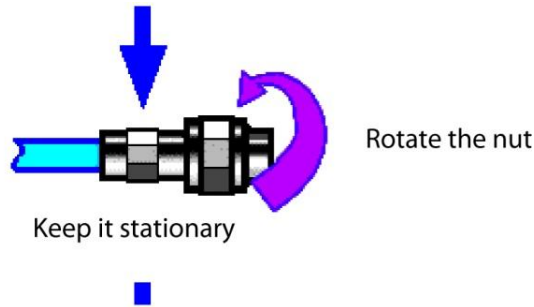

Fig. 3.5 Diagram of connector rotation

Step 3. as shown in Fig. 3.6, complete the final connection by tightening with the torque wrench. Note that the torque wrench must not be beyond the initial break point. Use the auxiliary wrench to prevent the connectors from rotation.

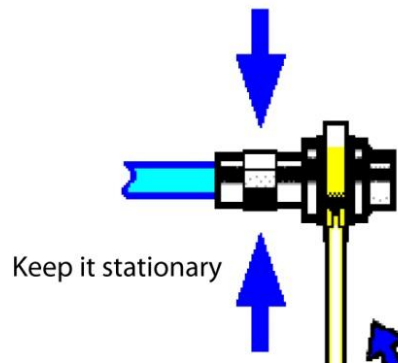

Fig. 3.6 Diagram of wrench operation

3) Disconnection method

Step 1. support the connectors to prevent any kind of force which may result in distortion, shaking or bending.

Step 2. use the open-end wrench to prevent the connector body from rotation.

Step 3. use another wrench to loosen the connector nut.

Step 4. rotate the connector nut by hand to complete final disconnection.

Step 5. horizontally separate two connectors.

4) Use of torque wrench

The use of the torque wrench is shown in Fig. 3.7. Pay attention to the following items.

- Check whether the torque of the torque wrench is set properly before use.
- Ensure that the angle between the torque wrench and the other wrench (used to support the connector or cable) is less than 90° before applying force.

3.1 Preparations before Operation

- Carefully grip the handle end of the torque wrench, and apply force in the direction vertical to the handle to reach the break point of the wrench.

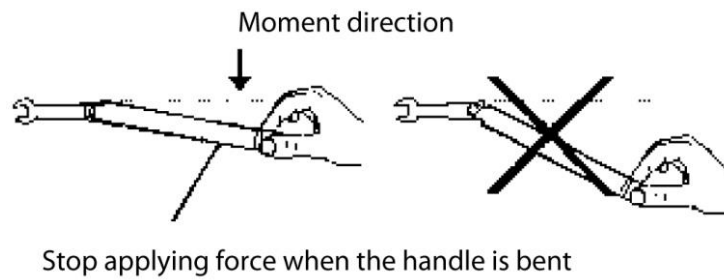

Fig. 3.7 Use of Torque Wrench

3.1.1.5 User inspection

After the 4051 Series Signal/Spectrum Analyzer is energized for the first time, the instrument should be checked for normal operation to prepare for subsequent measurement operations.

Prompt

Description of hard/soft keys on the front panel

Hard/soft keys on the front panel are described in the following forms:

- Description form of hard key: **【XXX】**, in which XXX is the name of the hard key;
- Description form of soft key: [XXX], in which XXX is the name of the soft key.

If soft keys correspond to more than one state and their selected values have blue background color, it means relevant keys are enabled. For example, [Sweep Time Auto **Man**] indicates the sweep time auto on option is available.

1) Self-calibration

When the instrument is used for the first time, or there is obvious change in its temperature, self-calibration is required and the instrument should be calibrated according to the calibration signal. Power the instrument up and check that the power indicator above the power switch at the lower left corner of the front panel turns yellow, which means the standby power is working properly. Press the power switch on the front panel, check that the power indicator on the front panel turns green and the display backlight is on. It takes about 40 s to start the display and show the starting status interface.

The Series Signal Analyzer should be set as follows:

Step 1. Press the **【System】** key on the front panel to enter the system menu; press [Align] and [Align All] for the instrument to begin whole-machine calibration. At such time, a yellow dialog box will appear on the screen, saying “Calibration is underway”;

Step 2. Wait for the calibration to complete:

The calibration completes when the dialog box disappears. If no error message is prompted at the lower right corner of the screen, it means the instrument is working properly; if there is error message, it means the instrument is not working properly. In this case, please contact our service consultation center at the service consultation hotline in the Manual. We will rapidly repair or replace the instrument, depending on the actual situation.

2) Self-Test

Self-Test is not necessarily required for every startup of the instrument. It is only required when the instrument is suspected to develop faults.

3.1 Preparations before Operation

Step 1. Press **【System】** key on the front panel to enter the system menu;

Step 2. Press [Self-Test] key in the soft menu of the front panel to enter Self-Test interface;

Step 3. Select the item to be tested and press [Start] soft menu to start the test. Check the test result. If all items are passed, it means the instrument is working properly; if certain item fails the test, it means the instrument is not working properly in someway. In this case, please contact our service consultation center at the service consultation hotline in the Manual. We will rapidly repair or replace the instrument, depending on the actual situation.

After the above two steps are done, the instrument will be ready for operation.

3) Functional verification

After self-calibration, the instrument should be set as follows:

Step 1. Press **【Input/Output】** key on the front panel to pop up the input/output setting soft menu, press [Cal Port] and [500 MHz] to select 500 MHz calibration signal and press [Input Port **RF**CAL] soft key to select the input interface for calibration. At such time, the internal calibration signal of the instrument is connected to the RF input interface;

Step 2. Observe the test result on the screen. If 500 MHz calibration signal can be observed, it means the instrument is working properly; if not, it means the instrument is not working properly in someway. In this case, please contact our service consultation center at the service consultation hotline in the Manual. We will rapidly repair or replace the instrument, depending on the actual situation;

Step 3. Press [Cal Port], [4800 MHz] to select 4800 MHz calibration signal;

Step 4. Observe the test result on the screen. If 4800 MHz calibration signal can be observed, it means the instrument is working properly; if not, it means the instrument is not working properly in someway. In this case, please contact our service consultation center at the service consultation hotline in the Manual. We will rapidly repair or replace the instrument, depending on the actual situation;

3.1.2 Configuration of operating system

In this chapter, operating system and its configuration and maintenance methods of the 4051 Series Signal/Spectrum Analyzer are explained Please refer to the following precautions for the operating system of the Series Signal Analyzer to ensure normal operation of software functions of the instrument.

- Description of instrument software.....20
- Windows 7 usage.....20
- Windows 7 configuration.....21
- Windows 7 system security and maintenance.....25
- System backup and recovery.....26

3.1.2.1 Description of instrument software

The 4051 Series Signal/Spectrum Analyzer uses Window 7 operating system as its host software and such operating system has been installed and configured according to performance requirements of the Series Signal Analyzer.

3.1.2.2 Windows 7 usage

The following operations will be available with the administrator account:

- Installation of third-part software;
- Configuration of network and printer;
- Reading and writing of any files on the hard disk;

3.1 Preparations before Operation

- Adding and deleting user accounts and passwords;
- Reconfiguration of Windows settings;
- Running of other application program.

Caution**The third-part software may affect the instrument performance.**

The 4051 Series Signal/Spectrum Analyzer is equipped with the open Windows system, and the third-party software may affect the performance of the Series Signal Analyzer. The applied software must be tested by the manufacturer and compatible with the host software.

3.1.2.3 Windows 7 configuration

Before the instrument is delivered from the factory, the operating system of the instrument has been set to the best configuration and any change in such setting will result in reduction in measurement performance of the instrument. Generally, no change in Window operating system settings is required.

Caution**Problems caused by changes in system configuration**

In case of problems in instrument usage or system crash due to changes in system configuration, the system recovery tool can be used to restore the operating system and application software, or users may contact our service consultation center at the service consultation hotline in the Manual. We will resolve the problems as soon as possible.

However, users may be free to modify the following items to facilitate measurement reporting and system integration.

1) Configure USB device

The 4051 Series Signal/Spectrum Analyzer has USB interfaces on the front and rear panel for direct connection with USD devices. If USB interfaces are not enough, a USB hub can be connected to the USB interface to meet relevant requirement. The USB devices that can be connected to the Series Signal Analyzer include:

- USB memory that can be directly plugged in or out of the computer to facilitate data updating;
- CD-ROM drive, to help install firmware programs;
- Keyboard and mouse, to facilitate data editing and instrument operation;
- Printer, to help output measurement results.

The Windows 7 operating system supports plug-and-play devices and therefore is easy for USB devices installation. When devices are connected to USB interfaces, Windows 7 will automatically search for device drivers for matching. If no relevant drivers are found, the system will automatically search for driver program directories to complete installation.

If USB devices are removed from the USB interfaces, Windows 7 will automatically detect such changes in hardware configuration and uninstall relevant driver programs. Plugging of the USB devices does not affect operation of the Series Signal Analyzer.

USB devices should be connected as follows:

a) Connect USB memory or CD-ROM drive

If the USB memory or CD-ROM is successfully installed, Windows 7 will prompt “device successfully installed and available for use” and automatically display relevant path name and prompt (e.g.: “D:”).

b) Connect keyboard

3.1 Preparations before Operation

Windows 7 system will automatically detect the USB keyboard connected to the instrument with default language as “Chinese (China)- Simplified Chinese - US Keyboard” and set keyboard properties via “Start > Control Panel > Clock, Language and Region > Keyboard and Language”.

c) Connect mouse

Windows 7 system will automatically detect the mouse connected to the instrument and set mouse properties via “Start > Control Panel > Hardware and Sound > Equipment and Printer > Mouse”.

d) Connect printer

Windows control panel can be used to configure the printer. Externally connected USB mouse and keyboard can be used to make printer configuration easier. If a new printer is required, only the drive program for such printer is needed. The manufacturer of the printer will provide such drive installer. The installer can be installed via externally connected USB CD-ROM.

2) Configure GPIB

The user may need to modify the GPIB address in system building. The default GPIB address of the Series Signal Analyzer is 18. Change the GPIB address as follows:

Press **【System】** [Interface Config>>] [GPIB Address] to enter the interface shown in Fig. 3.9. Modify the GPIB address in the [Local GPIB address] input box through the number keys on the front panel.

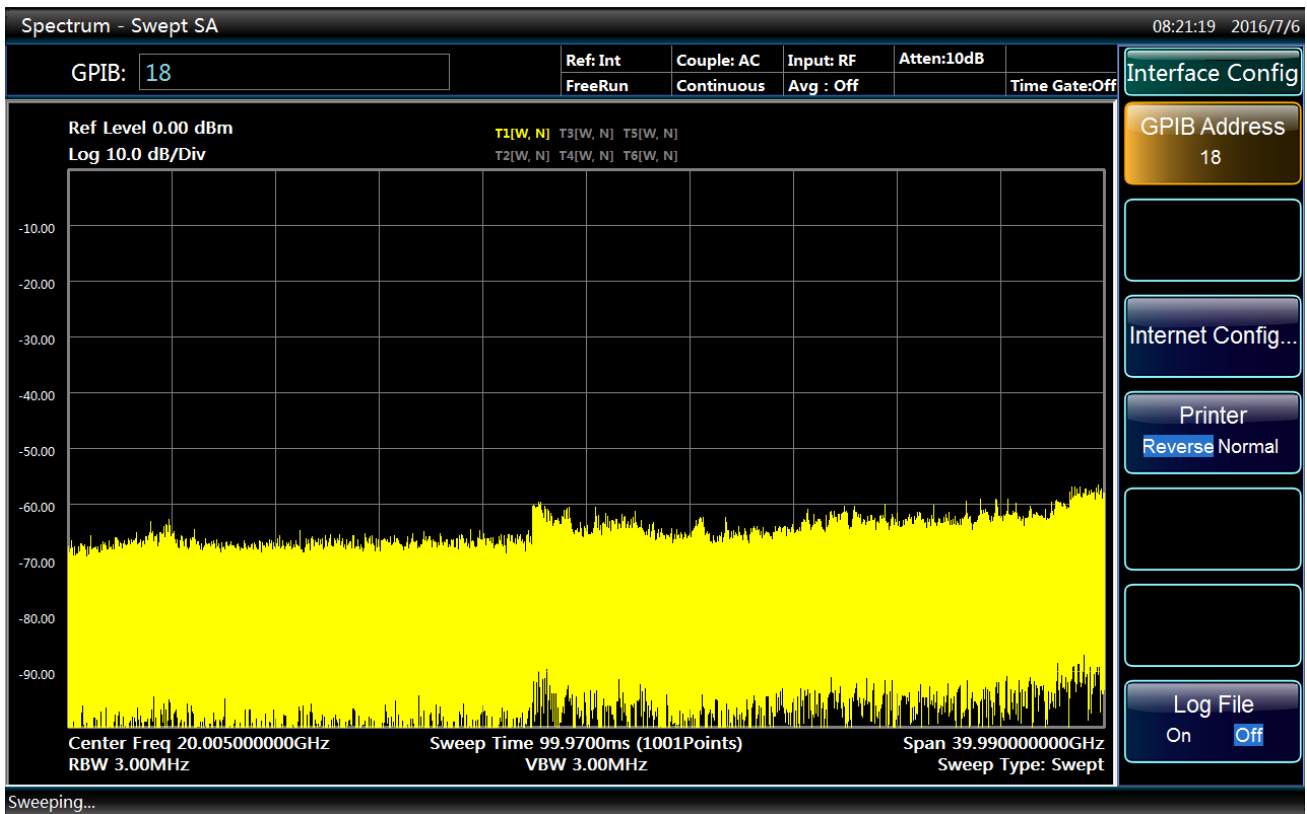

Fig. 3.9 Change GPIB Address

3) Configure network

a) Change host name

The host name (computer name) of the 4051 Series Signal/Spectrum Analyzer has been preset as “4051-PC” before delivery from the factory. To avoid repetition of network name, if one network is connected to more than one analyzer, users may be free to change the host name. The host name should be changed as follows: (refer to Microsoft Windows 7 help documents.)

3.1 Preparations before Operation

Step 1. Press Start menu, select Computer and right click Properties, click Change Settings at the right of Computer Name, Domain and Working Group and again click the Computer Name column to change. As shown in Fig. 3.10.

Step 2. Edit to enter a new host name and click Confirm to restart.

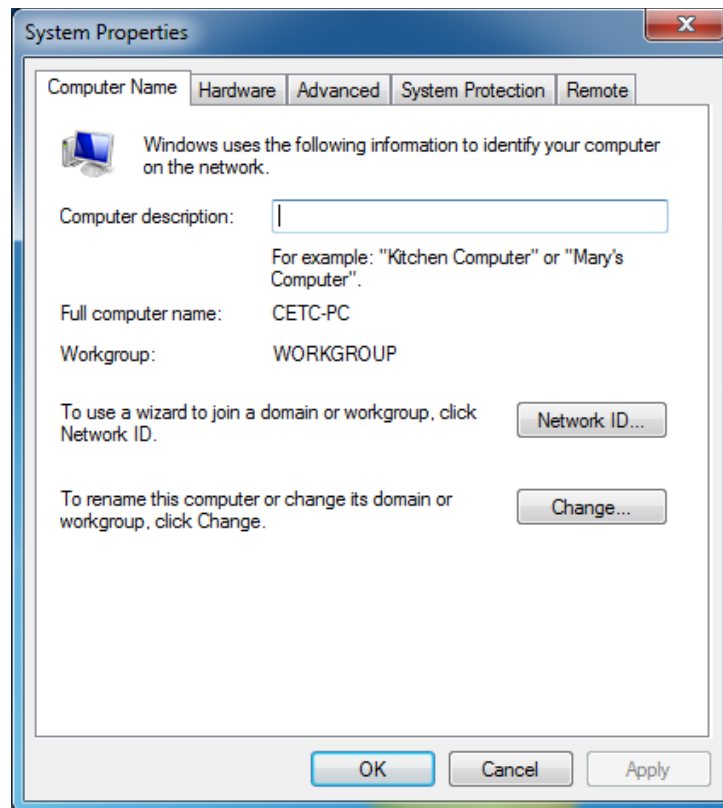

Fig. 3.10 Change host name

b) Configure IP address, subnet mask and default gateway

Press **【System】**, [Interface Config▶] and [Internet Config] to pop up the network connection setting interface, click Local Connection and right click Properties, double click “Internet Protocol Version 4 (TCP/IP)” as shown in Fig. 3.11 to change IP address, subnet mask and default gateway.

3.1 Preparations before Operation

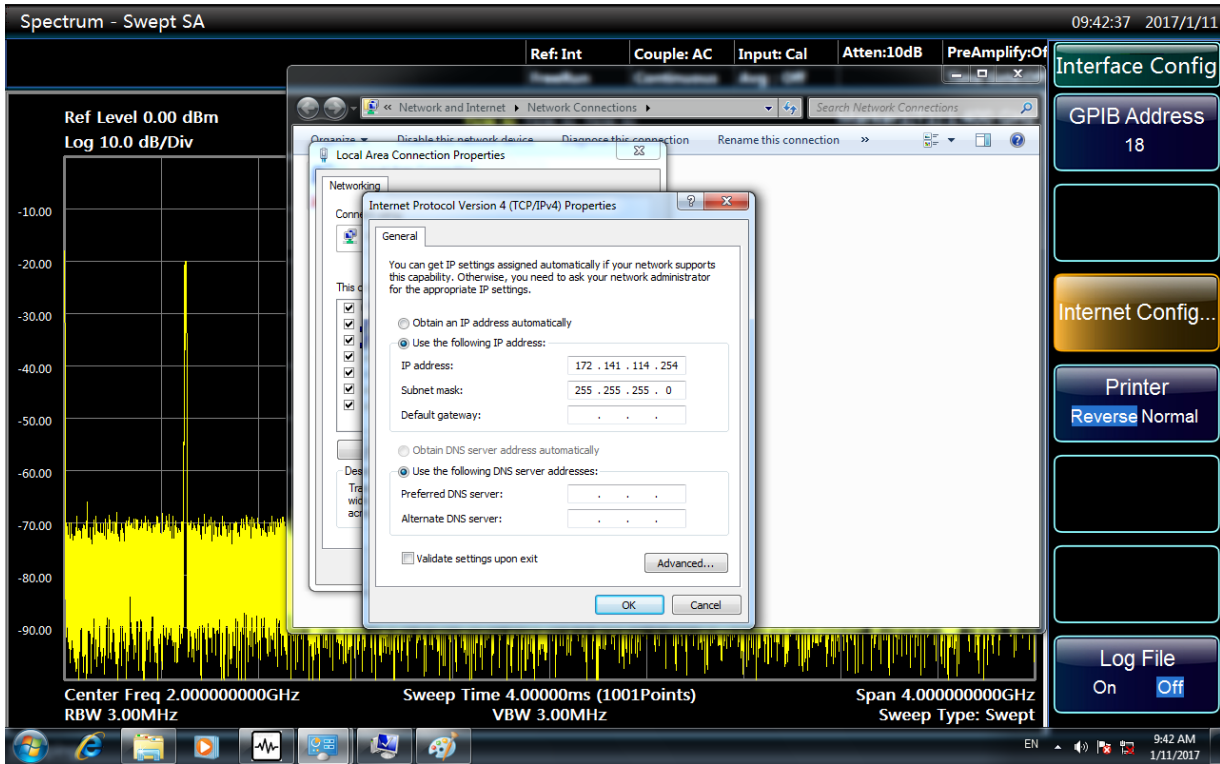

Fig. 3.11 Configure IP address, subnet mask and default gateway

c) Change system firewall settings

The firewall is used to prevent unauthorized users to remotely operate the instrument. Therefore, it is the manufacturer’s recommendation to turn on the firewall for protection. Firewall protection has been enabled for the system and all interfaces for remote operations when the Series Signal Analyzer is delivered from the factory. The administrator is the only person authorized to change firewall settings.

4) Configure BIOS

Targeted setup has been made for the Series Signal Analyzer in BIOS.

Caution

Such BIOS setting cannot be changed.

Targeted setup has been made for the Series Signal Analyzer in BIOS. Users should not change such setting; otherwise the instrument may not start or operate properly.

5) Connect monitor

External monitor (or projector) can be connected to “Display Interface” connector at the rear panel of the instrument according to the following steps:

Step 1. Connect the external monitor to the connector at the rear panel of the instrument.

Step 2. Usually double screen will be displayed automatically. If other options are required, the video card at the lower right corner of the system can be used for setting.

Step 3. Select the instrument to be displayed:

- “Display 1”: only internal monitor;
- “Display 2”: only external monitor;
- “Double display”: internal and external monitors.

Step 4. When necessary, the screen resolution to be used can be changed.

3.1 Preparations before Operation

Step 5. Before the setting is to take effect permanently, press “Apply” to test it to help to restore the previous setting when necessary.

Step 6. If such setting is suitable, press “OK”.

6) Configure initial state

This section explains how to initially set the 4051 Series Signal/Spectrum Analyzer.

a) Set date & time

Date & time is displayed in the status bar at the top right corner of the operation interface of the instrument. When a file is saved, relevant time information will be saved synchronously. Users can set date/time in the Windows 7 system.

3.1.2.4 Windows 7 system security and maintenance

1) Anti-virus software

Installation of anti-virus software may have some negative effect on performance of the instrument. It is highly recommended that users do not use the instrument as common computer for browsing the Internet or transmitting files to avoid infection of viruses.

Before using any USB mobile memory devices, they should go through anti-virus treatment with a computer installed with latest anti-virus software to ensure that such devices will not carry any virus.

Infection of the Series Signal Analyzer system by viruses will bring adverse effect on system operation and usage by users. In such case, it is recommended that users restore the system. Refer to “2) System maintenance” for more details.

2) System maintenance

a) Windows 7 backup

It is recommended that users regularly back up the system with the “system recovery tool” of the instrument to completely back up instrument data and the system. See “System backup and recovery” for more details.

It is recommended that before the instrument is used for purposes other than common purposes, such as long-term access to Internet and installation of third-party software, system backup of the instrument should be made to avoid accidental infection of viruses and other damages to operations of the instrument system.

The Windows 7 operating system has similar data backup function and is capable of copying all data in the instrument and creating a system disk to recover Windows system in case of serious failure. Refer to helps and references of Windows 7 system for more information. At the same time, third-party backup software that is compatible with the system software of the instrument can be used. It is recommended to use external devices for backup of the system data, such as network hard disk or USB hard disk.

b) Windows 7 system recovery

The Windows 7 system is capable of system recovery to restore the system to its previous state at certain point. However, Windows built-in system backup and recovery function does not always succeed. Therefore, such backup method is not recommended.

3) Hard disk partition and usage

The hard disk has been divided into three parts: “C:”, “D:” and “E:”.

Disk C contains Windows 7 operating system and instrument application programs. Third-part software can also be installed to Disk C. Disk C is the only disk for program backup and recovery.

Disk D mainly contain the response program for keys: keymap.

Disk E is mainly used for data storage. It contains software data saved by users and Disk C system backup data. Users can copy the backup data on Disk E to external memory devices. In this case, all that is needed is to restore backup data to the new disk if the hard disk is to be replaced.

3.1 Preparations before Operation

3.1.2.5 System backup and recovery

1) Disk operating system or data recovery

The disk recovery system of the Series Signal Analyzer is used to restore in case of software error of Disk C (caused by loss of system files or data) or restore original manufacturer defaults.

Restoring of manufacturer defaults will affect the following:

- User-defined Windows 7 settings. Such as adding new user accounts. After the system is restored, new settings are required.
- After the system is restored, other third-party software installed by users should be reinstalled.

Using data recovery to repair disk error may result in loss of data or files. Therefore, data generated during measurement should be saved in Disk E. Furthermore, it is recommended that users regularly transmit such data via LAN to other computers or other storage media for storage.

2) How to use instrument recovery program

Step 1. Confirm that the instrument is turned off.

Step 2. Connect standard keyboard from PS/2 interface on the rear panel of the instrument;

Step 3. Turn on the instrument. After display of the system information, an operating system menu with a timer will appear:

Windows 7

System Recovery Tool

Before the timer hits 0, use the up/down arrow on the standard keyboard to select “System Recovery Tool” and click Enter.

Step 4. After entering the system recovery program interface, proceed as follows:

- a) Select the first item “GHOST, DISKGEN, PQMAGIC, MHDD, DOS” and wait to enter the next operation prompt interface;
- b) Select the third item to start “GHOST11.2”, wait to enter GHOST11.2 operating interface and click Enter when a dialog with OK button appears;
- c) Select Local→Partition→From Image; use Tab key to enable “File name” input box in the opened file dialogue and enter 1.4: \systemghost.GHO;
- d) Use Tab key to switch to OK in the Select Source Partition dialog popped up and click Enter; then again use Tab key to switch to OK in Select Target Device” dialog popped up and click Enter; select Partition 1 in Select Target Partition dialog popped up, use Tab key to switch to OK and click Enter;
- e) Select Yes in Alert and Confirmation dialog and click Enter;
- f) Wait until the system is completely recovered and select Reboot by following the prompts.

Step 5. After the instrument is restarted, the system will restore to the previous state when backup was made.

Step 6. After the system is restored, it is recommended that users execute all IF calibrations when the instrument is working stably after startup.

3.1.3 Routine Maintenance

This section describes the routine maintenance of the 4051 Series Signal/Spectrum Analyzer.

- Cleaning.....27
- Test interface maintenance.....27

3.1.3.1 Cleaning**1) Clean the instrument surface according to the following steps:**

Step 1. turn off the instrument by disconnecting the power line connected to the instrument.

Step 2. carefully wipe the surface with dry or slightly wet soft cloth. Do not wipe the inside of the instrument.

Step 3. do not use any chemical cleaner, such as alcohol, acetone or any cleaner which may be diluted.

2) Clean LCD display

The LCD display should be cleaned after using for a while. Follow the steps below:

Step 1. turn off the instrument by disconnecting the power line connected to the instrument.

Step 2. soak clean soft cloth with cleaner, and carefully wipe the display panel.

Step 3. Dry the display panel with clean and soft cotton cloth;

Step 4. Connect the power line after the cleaner is thoroughly dry.

Caution**Clean the display.**

There is anti-static coating on display surface, do not use fluoride-bearing detergent or acidic/alkaline detergent. Do not spray detergent on display panel directly, otherwise it may penetrate into and damage the instrument.

3.1.3.2 Test interface maintenance

The 4051 Series Signal/Spectrum Analyzer has a RF input interface. If such interface is damaged or there is dust inside it, RF band test result may be affect. Therefore, such interface should be maintained as follows:

- Keep the interface far away from dust and keep it clean.
- Do not expose the interface surface to prevent ESD.
- Do not use damaged interfaces.

Please use the air blower to clean the interface and new allow tools such as sandpaper to get in contact with the interface surface.

Caution**Interface impedance matching**

The 4051 Series Signal/Spectrum Analyzer has a RF input interface of 50 Ω . If the impedance connector is not matched, the test result will be affected.

3.2 Front Panel & Rear Panel

3.2 Front Panel & Rear Panel

This chapter introduces the elements and functions of the front panel, the rear panel and the operation interface of the 4051 Series Signal/Spectrum Analyzer.

- Front panel.....28
- Rear panel.....33

3.2.1 Front Panel

This section describes the structure and functions of the front panel of 4051 Series Signal/Spectrum Analyzer. The front panel is as shown in Fig. 3.12.

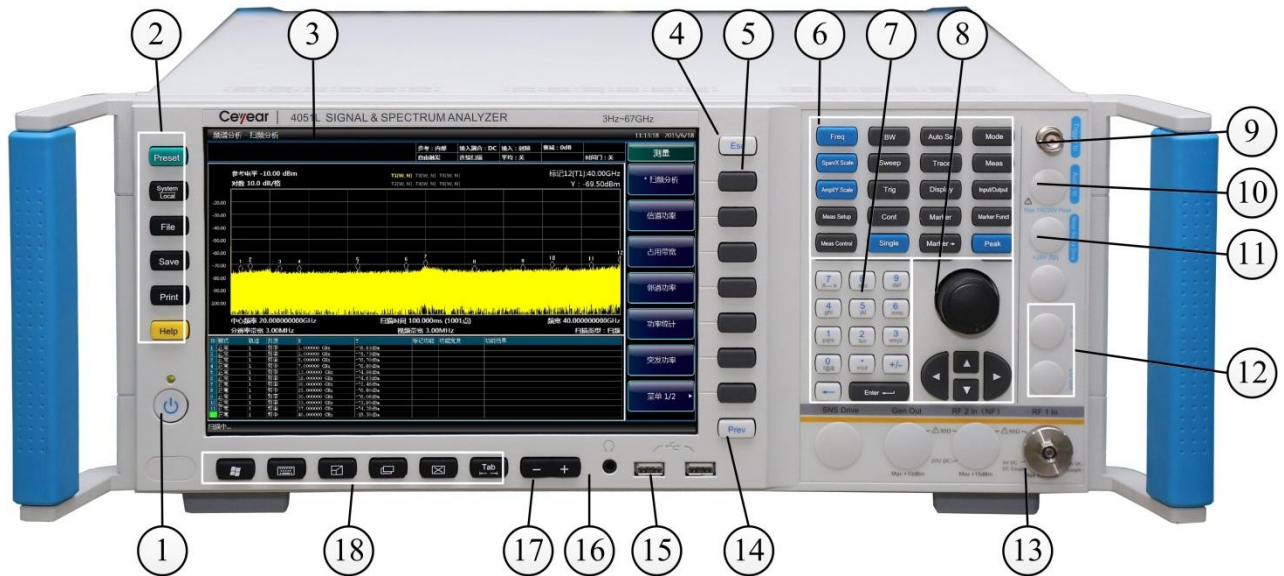

Fig. 3.12 Front Panel of 4051

- | | | |
|---------------------------------|-------------------------------|-------------------|
| 1. Power button | 7. Numeric keypad | 13. RF input |
| 2. System function area | 8. Knob and arrow keys | 14. Back |
| 3. Display zone | 9. Trigger input | 15. USB interface |
| 4. Cancel key | 10. Audioinput | 16. Headset jack |
| 5. Soft key | 11. Noise source drive | 17. Volume key |
| 6. Measurement setting key area | 12. External mixing interface | 18. Window keys |

3.2.1.1. Power button

The power button, located lower left corner of the front panel, is used for turning on and off the instrument.

3.2.1.2 System control key area

The function key area is used to set system-level functions as shown in Table 3.5.

Table 3.5 Description of system control key area

Button name	Function description
Reset	To restore the instrument to default settings.
System	To provide functions related to system setting: error list, start-up reset, calibration, time & date, input/output and configuration.
File	To manage, save and call files.
Save	To store instrument settings.

Print	To define printer output, select and configure printer.
Help	To display online help.

3.2.1.3 Display Zone

To display all measurement results on the screen on the front panel. Besides, the screen display also provides status and setting information and allows users to switch among different measurement tasks. Refer to “3.3.1.1 Display area information” of the Manual for more details.

3.2.1.4 Cancel key

It is used to exit any functional operation without changing current parameters, including cancel trigger, exit numeric keypad and exit file dialog.

3.2.1.5 Soft keys

The display screen on the front panel of the analyzer has 7 unidentified black buttons, known as “soft keys”. Such keys have different instructions depending on currently selected mode and measurement and are closely related to keys recently used. Corresponding functions of such keys will be highlighted when they are pressed. Fig. 3.13 shows the soft key menu of 【Frequency】.



Fig. 3.13 Soft key menu

1) Select soft keys

- Directly press the corresponding soft key at the right of the menu;
- Use the mouse pointer or other pointer device to press the key on the screen.

2) Navigation in the soft key menu

- “Menu 1/2” indicates that such menu has more soft keys than can be showed at a time. Press the menu to display a set of soft keys;

3.2 Front Panel & Rear Panel

- If the soft key tab has ► symbol, it means a submenu of more soft keys is contained. Press such soft key to display the submenu;
- Return key is used to return to the previous menu.

3) Soft keys operation

Press the soft key to execute one of the following actions:

- Open a dialog box to enter data;
- Enable or disable a function;
- Open a submenu (only for soft keys with ► symbol).

4) Identify status of soft keys by colors

The selected soft key will be displayed in highlight. If it is a switch soft key, it is currently highlighted as black. If some instrument function cannot be used due to specific setting, relevant soft key will be disabled and grayed out. Some soft key belongs to specific (fixed) option and will not be displayed if such option is not installed.

3.2.1.6 Measurement setting key area

The measurement setting key area provides most commonly used measurement settings and functions as shown in Table 3.6. Refer to “5.2 Menu desperation” of the Manual for detailed description of functions.

Table 3.6-1 Description of measurement setting key area

Button name	Function description
Frequency	To set center frequency, start and stop frequency and frequency step of frequency range of current measurement. This key is also used to set frequency offset, auto tuning and signal tracking.
Span/X Axis	To set the frequency span to be analyzed or return to previous frequency span.
Amplitude/Y Axis	To set reference level, attenuator, scale type, scale size, unit, reference level offset and amplitude correction.
Measurement setting	To set measurement average count, average type, limit line, phase noise optimization, preselector, RF gain and ADC dither status.
Measurement control	To set measurement stop or restart.
Bandwidth	To set resolution bandwidth, video bandwidth, VBW/RBW, frequency span/RBW, filter type and filter bandwidth.
Scanning	To set sweep time, sweep count and to select continuous measurement OFF or ON.
Trigger	To select trigger mode, trigger threshold, trigger delay and trigger holdoff time.
Continuous	To select continuous measurement.
Singular	To select continuous measurement off.
Automatic setting	To enable auto setting of mechanical attenuator, resolution bandwidth, video bandwidth, VBW/RBW, frequency span/RBW, sweep time and frequency step.
Track	To obtain and analyze trace configuration of measurement data.
Display	To set display line, language, graticule, status area and frequency information status.
Marker	To set absolute and relative positioning measurement marker (marker and delta marker).
Mrk→	To give marker frequency to center frequency, marker to frequency step, marker to start frequency, marker to stop frequency and marker level to reference level.
Mode	To set measurement mode of the Series Signal Analyzer.
Measurement	To set measurement functions in current mode.

3.2 Front Panel & Rear Panel

Input Output	To set frequency reference, coupling mode, input interface, calibration interface, High IF output switch, logarithm detector output switch and input impedance.
--------------	---

Table 3.6-2 Description of measurement setting key area (continue)

Button name	Function description
Marker function	To provide additional analysis function for measurement marker: <ul style="list-style-type: none"> – Marker Count – Audio Demulation – Noise Marker – N dB measurement – Bandwidth Power – Bandwidth Density
Peak search	To execute peak search, delta marker, give marker frequency to center frequency and give marker level to reference level functions for active markers. If no marker is active, enable normal marker 1 and execute peak search.

3.2.1.7 Keyboard



To enter alphanumeric parameters. Including the following keys:

1) **Alphanumeric keys**

To enter numbers and (special) characters in the edit dialog. See “3.3.1.4 Input data” in the Manual for more details.

2) **Decimal point**

To inset one “.” At cursor position.

3) **Symbolic keys**

To change symbols of numeric parameters. When inserting an alphanumeric parameter, a “-” will show at the cursor position.

4) **Backspace key** 

- When alphanumeric character has been entered, this key will delete the character at the left of the cursor;
- If no input field is active, this key will cancel recently entered value and restore the previous value. Therefore, users can switch between two values (such as frequency span).

5) **Enter key**

- To terminate the input of a dimensionless number and set it as a new value;
- For other inputs, this key may be used as unit key including “Hz/dB”;
- Press Default or Focus button in the dialog.

3.2 Front Panel & Rear Panel

3.2.1.8 Knob and arrow keys

1) Knob function:

	<ul style="list-style-type: none">➤ When entering numbers, step up (clockwise) or down (anticlockwise) the instrument parameters as specified;➤ To move the selection bar in the Focus area (such as list);➤ To move markers or limit lines on the screen;➤ If a scroll bar is selected, to vertically move such scroll bar;➤ When pressed, it has the same function with Enter key.
---	--

2) Up/down key function

	<ul style="list-style-type: none">➤ To increase or decrease instrument parameters in the number edit dialog;➤ To roll up and down the items in the list;➤ To vertically move the selection bar in the table;➤ To move the scroll bar in windows or dialogs with the vertical scroll bar.
---	---

3) Left/right key function

- To move the cursor in the alphanumeric character edit dialog;
- To roll up and down the items in the list;
- To horizontally move the selection bar in the table;
- To move the scroll bar in windows or dialogs with the horizontal scroll bar.

3.2.1.9 Trigger input

BNC female, for external trigger signal input on the front panel with input voltage range of [-5V, +5V].

3.2.1.10 Audio input

BNC female, for test and analysis of audio signal input with input frequency range of [-5V, +5V].

3.2.1.11 Noise source drive

Reserved for function extension.

3.2.1.12 External mixing interface

Available when relevant option is selected.

LO output interface: 2.4 mm connector;

IF input interface: 3.5 mm SMA female connector.

3.2.1.13 RF input

For subsequent analysis by connecting the tested device via the cable to RF input interface.

Caution

The input interface should not be overloaded. Refer to the specification manual for maximum permissible value. DC input voltage of no more than 50 V is allowed for AC coupling. No DC voltage is allowed at the input interface for DC coupling. The internal mixer of the instrument will be damaged if the above conditions are not met.

3.2.1.14 ESC key

Press Esc to return the soft menu to the previous level.

3.2.1.15 USB Interface

Standard USB2.0 interface, A type. For connecting peripherals of the same interface, such as keyboard, mouse, drive and hard disk.

3.2.1.16 Headset jack

To connect the headset. If it is connected, the internal loudspeaker will be turned off automatically.



Caution

Be careful! Too high volume may damage hearing.

Headset volume should be checked to be moderate before putting on the headset in order to protect users' hearing.

3.2.1.17 Volume key





To set headset or loudspeaker volume.

3.2.1.18 Window key

See Table 3.7 for icons and function description of the window key area.

Table 3.7 Description of measurement setting key area

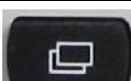
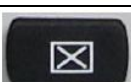
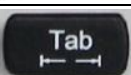
Icon of window key	Name of window key	Function description of window key
	Windows system Start menu key	To display Windows "Start" menu
	Virtual keyboard key	To switch between screen keyboard display interface
	Windows zoom in/out key	Zoom in/out current window
	Window switching key	To switch between several windows
	Window close key	To close currently selected window
	Tab	To move in different areas of Windows dialogs

3.2.2 Rear Panel

This section describes the structure and functions of the rear panel of 4051 Series Signal/Spectrum Analyzer. The rear panel is as shown in Fig. 3.14.

3.2 Front Panel & Rear Panel

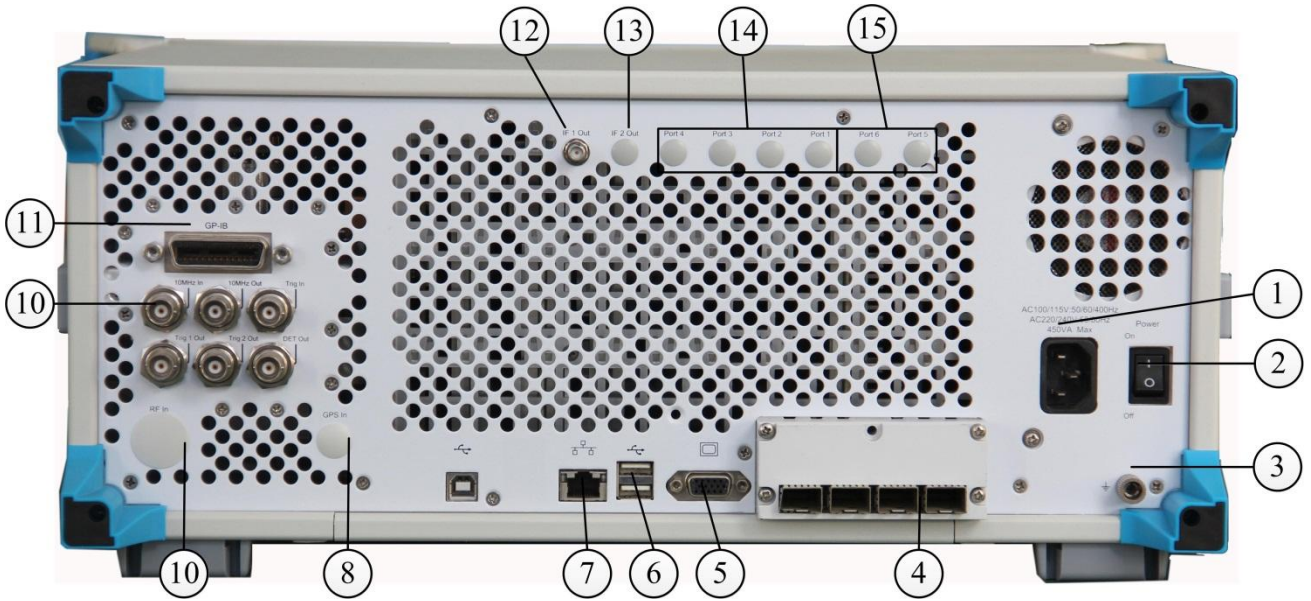

Fig. 3.14 Rear Panel of the 4051 Analyzer

- | | | |
|---|--|--|
| 1. Input interface of power supply | 6. USB interface | 11. GPIB interface |
| 2. Power switch | 7. LAN interface | 12. IF output 1 |
| 3. Earthing Terminal | 8. Positioning antenna input | 13. IF output 2 |
| 4. 40MHz/200MHz bandwidth digital interface | 9. RF input on the rear panel | 14. Broadband reconstructed IF/video signal output |
| 5. Monitor | 10. BNC input/output on the rear panel | 15. Reconstructed IF/video signal output |

3.2.2.1 Input interface of power supply

AC power input of the instrument.

3.2.2.2 Power switch

Main power control switch of the instrument.

3.2.2.3 Grounding terminal

To reliably ground the instrument.

3.2.2.4 40MHz/200MHz bandwidth digital interface

Use the photoelectric conversion module to realize IQ data stream output and input at 40MHz/200MHz.

3.2.2.5 Monitor

VGA interface, for external connection with VGA display device.

3.2.2.6 USB Interface

Standard USB2.0 interface, A type. For connecting peripherals of the same interface, such as keyboard, mouse, drive and hard disk.

3.2.2.7 LAN Interface

RJ45 interface, TCP/IP interface, 10/100/1000M self-adaptive, for remote operation of the analyzer.

3.2.2.8 Positioning antenna input

SMA female, GPS / Beidou positioning module antenna input interface (reserved for extension).

3.2.2.9 RF input on the rear panel

Option with interface type subject to the frequency range of the instrument for signal connection during test system building.

3.2.2.10 BNC input/output on the rear panel

See Table 3.8 and Figure 3.15 for BNC interface on the rear panel and relevant description.

Table 3.8 Description of measurement setting key area

Interface name	Interface description
10 MHz input	BNC female for 10 MHz reference signal input with required amplitude over 0dBm.
10 MHz output	BNC female for 10 MHz reference signal output of the analyzer. To lock the frequency of other test devices to the frequency reference of the analyzer.
Trigger input	BNC female for external trigger signal input on the rear panel with input voltage range of [-5V, +5V].
Trigger Output 1	BNC female, TTL level, trigger signal output for synchronizing with other test devices. Output signal type configured by the output/input menu.
Trigger Output 2	BNC female, TTL level, trigger signal output for synchronizing with other test devices. Output signal type configured by the output/input menu.
Detector output	BNC female for video detector signal output.

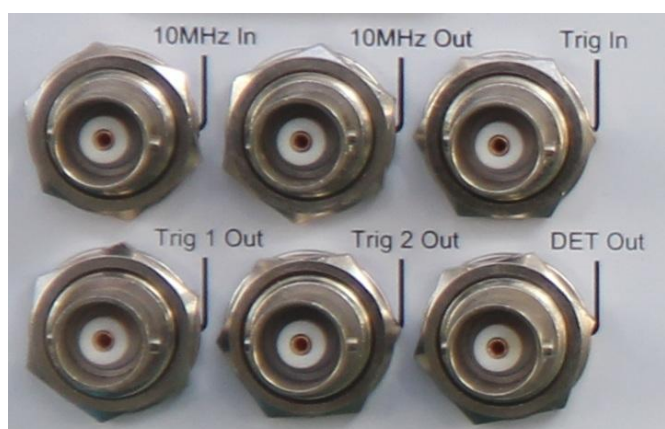

Fig. 3.15 BNC interface input/output on the rear panel

3.2.2.11 GPIB Interface

Standard IEEE488 interface, SCPI language supported. For remote control.

3.2.2.12 IF output 1

Option, to output the second IF signal with output frequency range of 275MHz-475MHz and step resolution of 1Hz.

3.2.2.13 IF output 2

Option, to output the third IF signal with output frequency range of 10MHz-160MHz and step resolution of 1Hz.

3.3 Basic measurement methods

3.2.2.14 Broadband reconstructed IF/video signal output

Option, to realize any IF, AM/FM or I/Q signal output through digital reconstruction with bandwidth limit of 50 MHz-100MHz.

3.2.2.15 Reconstructed IF/video signal output

Option, to realize any IF, AM/FM or I/Q signal output through digital reconstruction with bandwidth upper limit of 40 MHz.

3.3 Basic measurement methods

This section describes basic settings and measurement methods of the 4051 Series Signal/Spectrum Analyzer, including:

- Basic operation instructions.....36
- Basic operation examples.....41

3.3.1 Basic operation instructions

This section gives an overall introduction of how to use the 4051 Series Signal/Spectrum Analyzer (including graphic area display information type), how to use the 4051 Series Signal/Spectrum Analyzer via keys on the front panel and other interactive operations and how to use online help.

3.3.1.1 Display area information

Fig. 3.16 shows a measurement interface of the instrument in spectrum analysis mode. Each information zone is marked with description of the operating interface as shown in Table 3.9. A detailed description will be given below. Display interfaces of other application modes or functions may vary slightly.

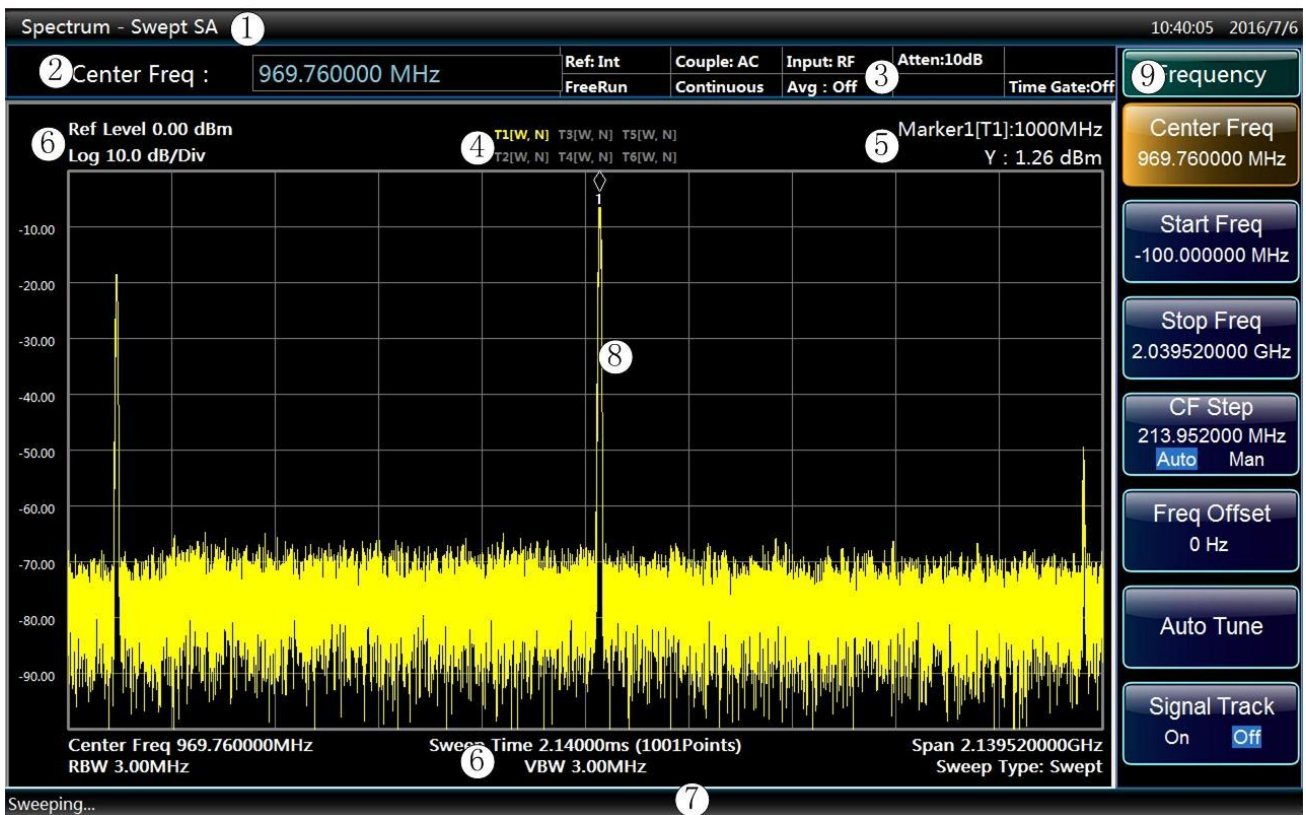

Fig. 3.16 Display interface of the 4051 analyzer

Table 3.9 Description of operating interface

3.3 Basic measurement methods

Graphic No.	Function description
1	Title bar to display currently active measurement mode/function.
2	Parameter input area as the input field of the measurement setting.
3	Instrument setting information panel for displaying current setting information of the instrument, such as reference clock, internal/external, input source, trigger mode; sweep mode, attenuator decrement; trace average type and average count, time gate on/off, etc.
4	To display trace information.
5	To display active marker information.
6	To display measurement setting of graticule area data. This legend includes reference level, scale type, scale/division, center frequency, sweep time (sweep count), frequency span, resolution bandwidth, video bandwidth and sweep type.
7	Instrument and status information for displaying measurement progress and prompting error messages.
8	To display test table.
9	To display the sot key menu of the last key pressed.

1) Title bar

To display currently active measurement mode/function.

2) Parameter input zone

Center frequency: 1.000000000GHz

Number input area of currently active function.

3) Instrument setting information panel

To display information related to the instrument and its settings for view by users as shown in Fig. 3.10.

Reference: internal Input coupling: AC Input: RF Attenuation: 10 dB
Free Trigger Continuous scanning Average: OFF Time gate: off

Table 3.10 Description of setting information panel

Message content	Symbol
Frequency reference	Reference: Int
	Reference: Ext
Coupling method selection	Input coupling: AC
	Input coupling: DC
Input interface selection	Input: RF
	Input: Cal
Attenuator	Attenuation: 10 dB
Marker count selection	Marker count: off
	Marker count: on

Table 3.10 Description of setting information panel (Continued)

Message content	Symbol
Trigger Slope	Free Run
	Video
	Line Trig

3.3 Basic measurement methods

	External 1
	External 2
	RF Burst
	Periodic Timer
Sweep status	Continuous
	Single
Average type	Log-Pwr
	Pwr
	Voltage
Average count/total count	25/25
Time gate status	On
	Off

4) Trace information

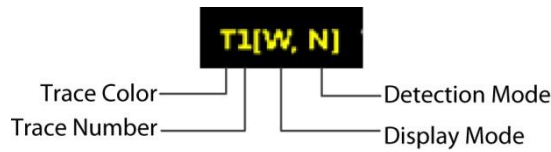

Details of trace information are listed in Table 3.11.

Table 3.11 Description of trace information

Message content	Symbol	Meaning			
Trace color	Highlighted / Grey	Trace display color and its opening status in the table			
Trace No.	T1—T6	Trace No. Indicated			
Display mode	W	Refresh			
	A	Average			
	M	Max. Hold			
	M	Min. Hold			
Detection mode	N	Normal detection			
	P	Positive peak detection			
	S	Sample detection			
	P	Negative peak detection			
	A	Average detection	<table border="1"> <tr> <td>Video Average</td> </tr> <tr> <td>Power Average</td> </tr> <tr> <td>Average Voltage</td> </tr> </table>	Video Average	Power Average
Video Average					
Power Average					
Average Voltage					

5) Marker information

Marker information is shown at the top right corner of the table. See “5.2.2.15 Marker” of the Manual for more details.

3.3 Basic measurement methods



6) To display measurement setting of graticule area data.

Center frequency: 1.000000000GHz	Sweep time: 5.50000 ms (1001 points)	Frequency bandwidth: 2.200000000GHz	bandwidth:
Resolution bandwidth: 3.00 MHz	Video bandwidth: 3.00 MHz	Sweep type: sweep	

Description of settings of general purpose hardware is as shown in Table 3.12.

Table 3.12 Description of settings of general purpose hardware.

Message content	Symbol	Meaning
Reference level	Reference level 0.00dBm	Reference level value currently set for the instrument
Scale Type	Logarithm/linear	Scale type set
Scale/Division	10.0dB/grid	Scale value of each graticule on Y axis
Center frequency:	Center Freq: 1.000000GHz	To display the center frequency of the screen
Span	Span: 2.200000GHz	To display the frequency range of the screen
[Scanning time	Sweep time: 4.400 ms (1001 points)	Sweep time/display count set
Resolution bandwidth	RBW: 3.00 MHz	Resolution bandwidth set
[Video bandwidth	VBW: 3.00 MHz	Video bandwidth set
Sweep mode	Sweep Type: "Auto" "Swept" "FFT"	To display the spectrum sweep mode currently selected.

7) Instrument and status information

The instrument status and error messages (if any) are shown in the status bar at the bottom right of the table.

a) Measurement progress

Sweeping...

To display current operation progress in the status bar at the bottom left of the table.

b) Error messages

Err:116 LO2 FAIL

If any error or abnormality is detected, corresponding error code and error message will be displayed at the right of the status bar. See Schedule 3 Local Error Message Table of Appendix C Error Message Index for meanings of error codes.

c) Date/time

09:56:42 2015/6/18

3.3 Basic measurement methods

To display date and time information at the top right of the screen.

8) Test table

To display the test table in current measurement mode.

9) Soft key menu

To display the soft key menu of the last key pressed.

3.3.1.2 User interaction

The following interactions can be used for the instrument with no need for user operating interface of the external keyboard.

- Screen keyboard;
- Knob;
- Arrow keys;
- Soft keys.

All tasks to be completed during operation of the instrument can be done via this user interface. All keys correspond to external keyboard operations (such as arrow keys and Enter key) and comply with Microsoft standards except for special keys for the instrument.

1) Keyboard

See 3.2.1.7 for details.

2) Knob

See 3.2.1.8 for details.

3) Arrow keys

See 3.2.1.8 for details.

4) Soft keys

See 3.2.1.5 for details.

3.3.1.3 Current window switch key



When users need to switch between several display windows, press the current window switch key at the bottom of the front panel.

3.3.1.4. Input data

The following methods can be used to enter the data into relevant dialog:

- Use keys on the front panel, such as the keyboard, the knob or the navigation key;
- Use keys on the virtual keyboard on the front panel;
- Use external keyboard connected.

Characteristics of Windows dialogs: In some cases, for example, when you want to install a printer, you need to use Windows built-in dialogs. The knob and the function keys do not work in such dialogs.

When entering numeric parameters into certain field, the keyboard can only be used to input numbers:

- Use the keyboard to enter parameters, or use the knob (small step) or up/down keys (large step) to change parameter values currently used;
- After inputting numeric values with the keyboard, press the unit key corresponding to the soft key menu to add relevant unit to the entered values;

3.3 Basic measurement methods

- If no unit is required, press “Enter” or any one of the unit keys to confirm values entered. Highlight the edited row to confirm the value entered.

3.3.1.5 Get help

The 4051 Series Signal/Spectrum Analyzer features online help: press the yellow **【Help】** key to call the online help file.

3.3.2 Basic operation examples

This section introduces detailed steps of common and important basic settings and functions of the 4051 Series Signal/Spectrum Analyzer with examples to help the user rapidly know the characteristics of the instrument and understand basic measurement methods.

Firstly, complete preparations before operation according to the following steps:

Step 1. energize and start the instrument;

Step 2. enter the system and initialize settings;

Step 3. proceed to the next operation if there is no prompt error message in the main operating interface of the front panel.

3.3.2.1 Measure sine signal

The most common measurement task of the Series Signal Analyzer is to determine level and frequency of signals. When measuring an unknown signal, users can use **【Preset】** key to switch the instrument to preset status and start measurement. In this section, the internal calibration signal of the instrument is used as an input to introduce how to measure a simple sine signal.

Caution

If the signal level may be higher than +30dBm (= 1 W), a power attenuator should be provided at the RF input interface of the Series Signal Analyzer, otherwise the signal level over 30dBm will damage the RF attenuator or the input mixer. At the same time, the total power of all current signals should be taken into consideration.

1) Display the internal 500 MHz calibration signal

Step 1. reset the instrument:

- Press **【Preset】** key to restore the instrument to a predefined configuration status.

Step 2. turn on the internal 500 MHz calibration signal:

- Press **【Input/Output】** key to pop up Input/Output setting soft menu.
- Press [Cal Port>>] and [500 MHz] to select the internal 500 MHz calibration signal.
- Press **【Input/Output】** , [Input Port **RF** Cal] to select calibration port.

At such time, the internal calibration signal of the instrument is connected to the RF input interface and the 500 MHz calibration signal can be observed on the instrument screen as shown in Fig. 3.17.

3.3 Basic measurement methods

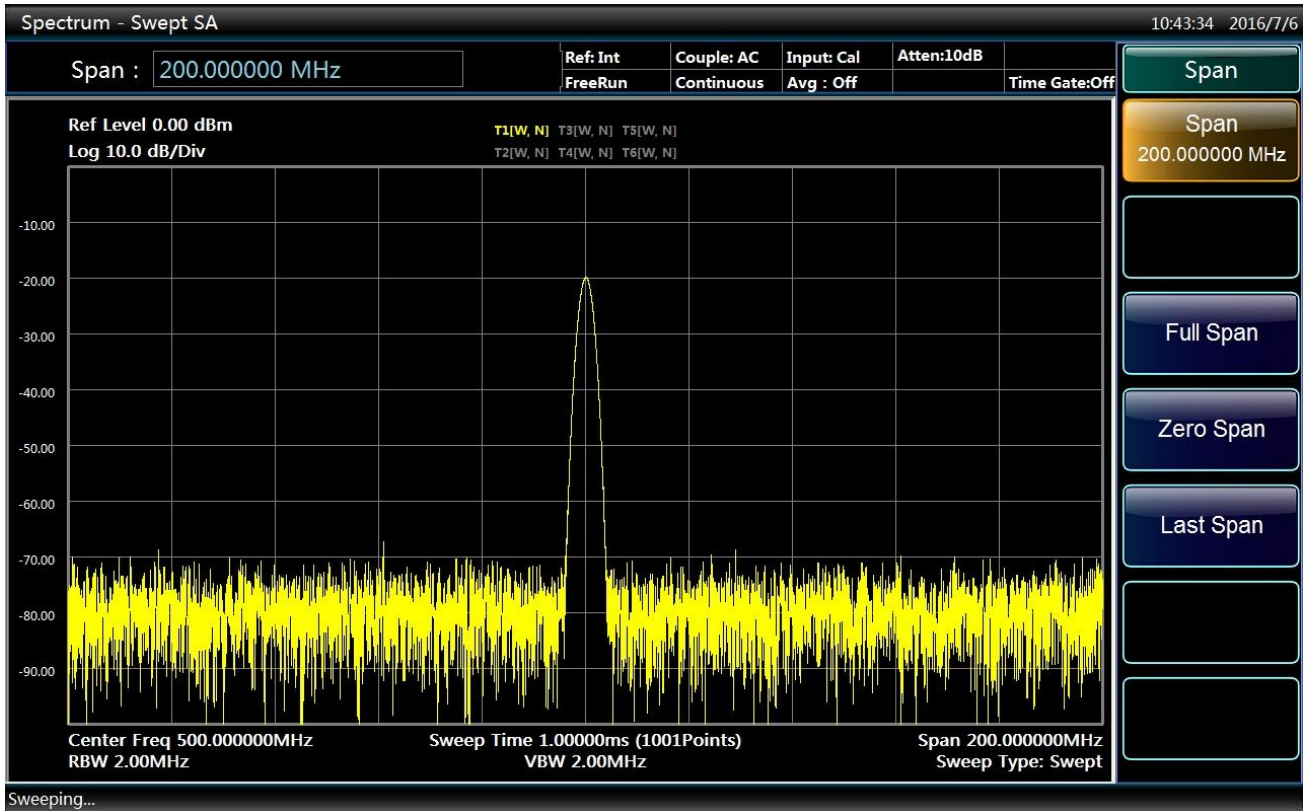

Fig. 3.17 500 MHz calibration signal as RF input

2) Optimize signal display

Adjust the main measurement settings to observe the calibration signal in a better way.

Step 1. set the center frequency as the calibration signal frequency (500 MHz):

- Press **【Frequency】** key.
- Press [Center Freq] soft key and input 500 MHz via the numeric keys on the instrument panel.

Step 2. reduce the frequency span to 20 MHz:

- Press **【Span/X Axis】** key.
- Input 20 MHz via the numeric keys on the instrument panel.

Step 3. set the reference level as -10dBm:

- Press **【Amplitude/Y Axis】** key.
- Input -10dBm via the numeric keys on the instrument panel.

At such time, the calibration signal spectrum is displayed in the middle of the trace and the calibration signal can be observed more directly and clearly as shown in Fig. 3.18.

3.3 Basic measurement methods

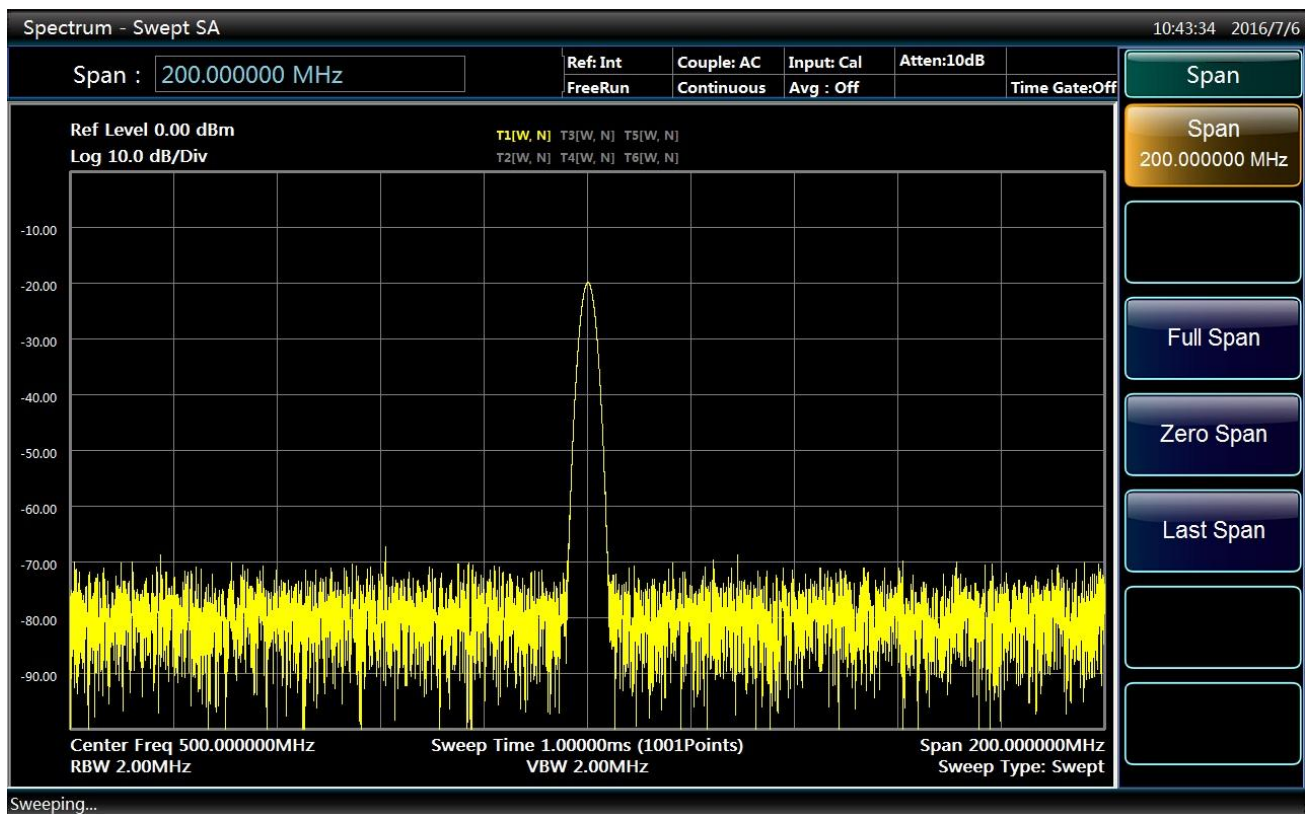

Fig. 3.18 Calibration signal spectrum after optimizing settings

3.3.2.2 Set and move markers

The marker is used to determine the position of specific function in the trace. Its most common purpose is to determine certain peak. When a marker is enabled, the default settings will be applied. Here we are going to set a peak marker on the spectrum trace.

Step 1. reset the instrument:

- Press **【Preset】** key to restore the instrument to a predefined configuration status.

Step 2. execute Continuous Sweep Off:

- Press **【Single】** key on the front panel.

Execute Continuous Sweep Off for once to generate a trace to help set a marker on it.

Step 3. enable Marker:

- Press **【Marker】** key on the front panel to display Marker soft menu.

At such time, Marker 1 is activated default as on Trace 1 and automatically set as the center frequency of Trace 1 as shown in Fig. 3.19. Such marker is indicated at the top right corner of the table as "Marker 1 [T1]". See "3.3.1.1 Display area information" of the Manual for more details the marker.

3.3 Basic measurement methods

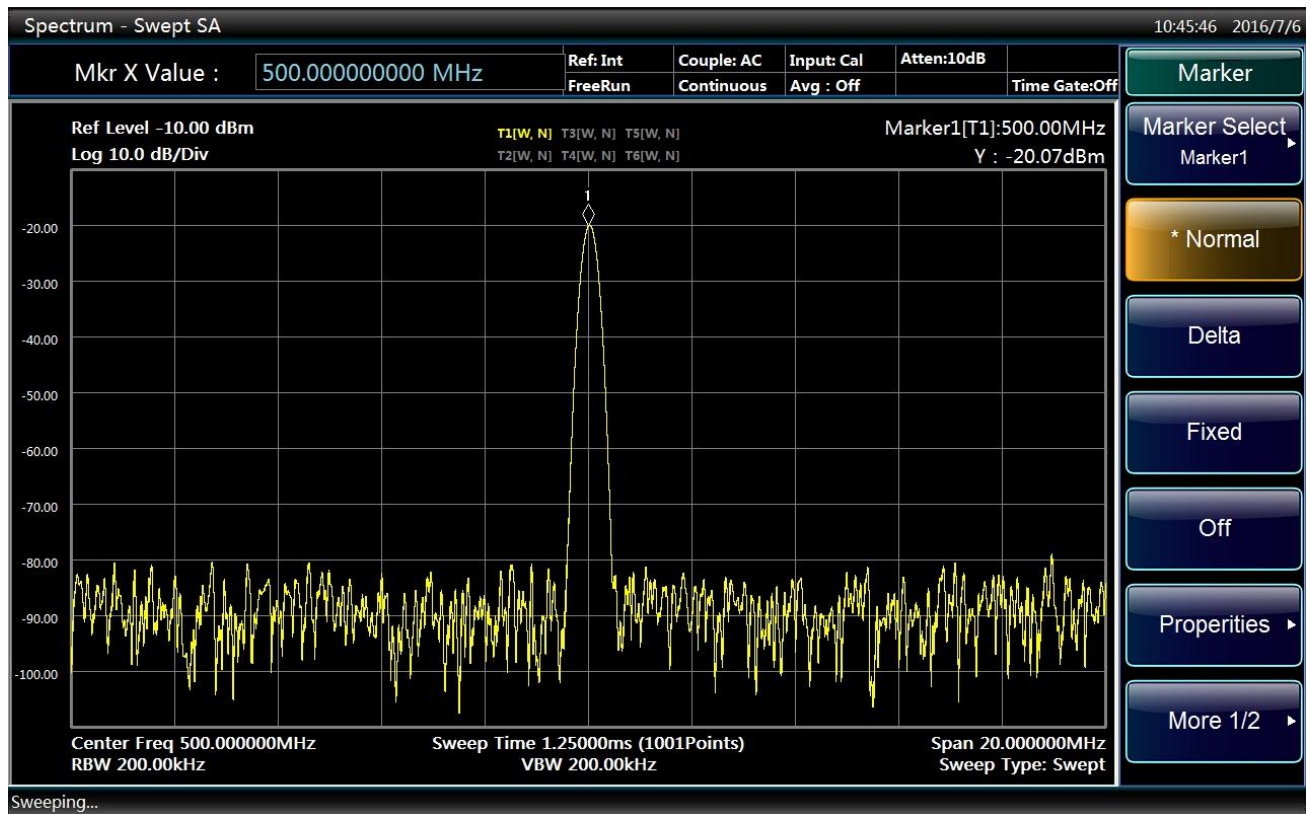

Fig. 3.19 Marker 1 activation interface

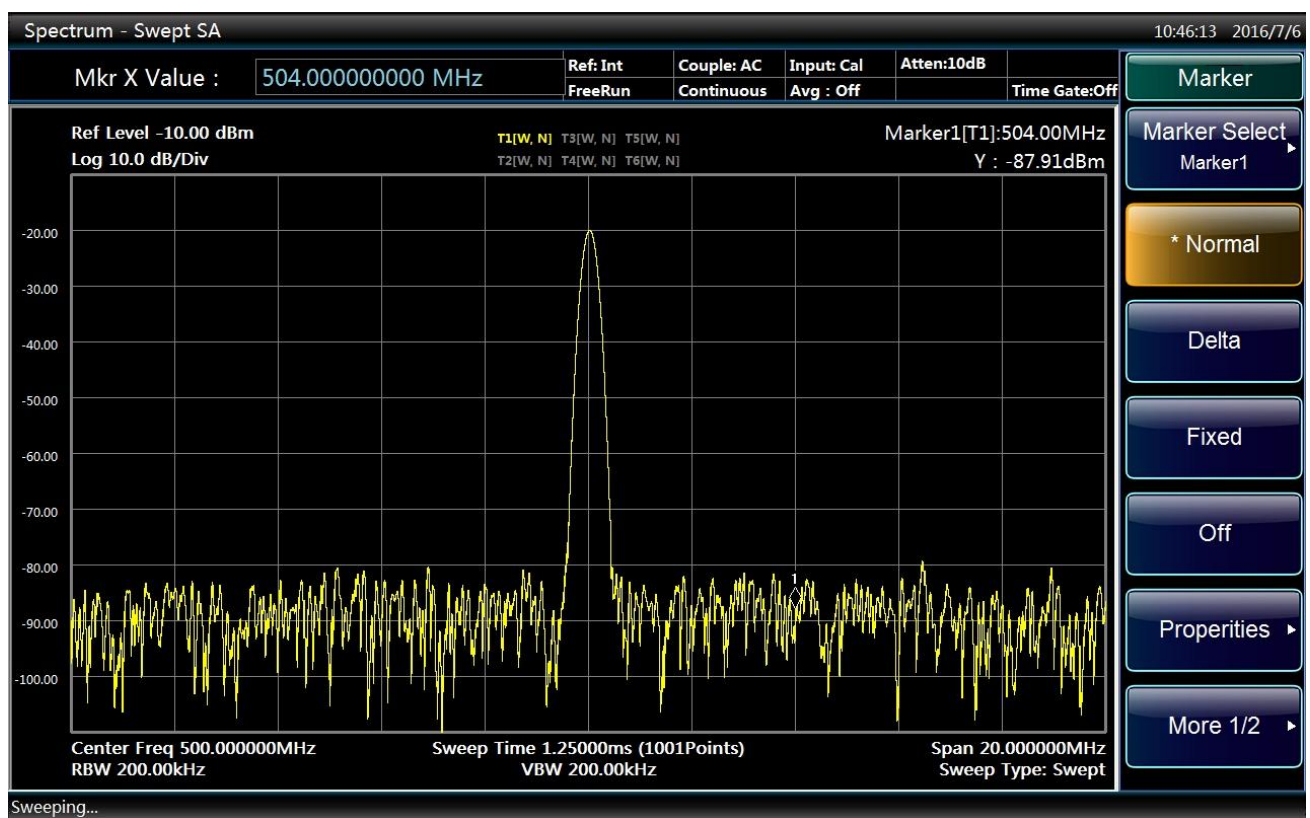

Fig. 3.20 Marker moving interface

3.3 Basic measurement methods

Step 4. move the marker:

- Click and drag the marker with the mouse or use the knob or the arrow keys to move the marker to other places. Current position of the marker is indicated with a white diamond box as shown in Fig. 3.20.

3.3.2.3 Peak list

The marker peak list can automatically determine frequency and level in the spectrum.

Step 1. execute Continuous Sweep Off:

- Press **【Single】** on the front panel for the instrument to sweep once.

Step 2. open Peak List window:

- Press **【Peak Search】** to open the peak search soft menu.
- Press [More1/2], [Peak Table>>] and [Peak Table On/Off] to open a new window of marker peak list as shown in Fig. 3.21.

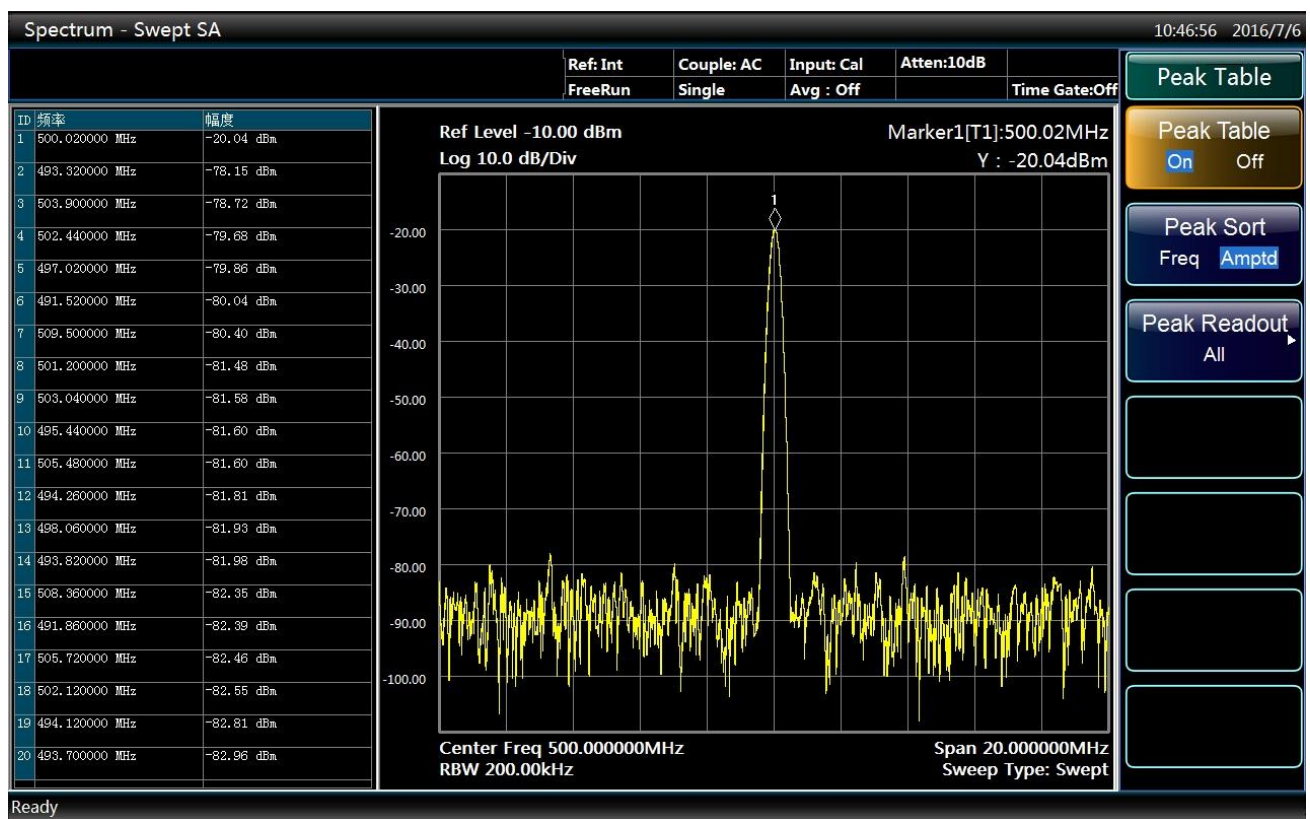

Fig. 3.21 The interface of opening peak table

Step 3. enable Peak Search:

- Press **【Peak Search】** to open the peak search soft menu; press [More 1/2], [Peak Criteria▶] and [Peak Threshold On/Off] to set the peak threshold as -68dBm as shown in Fig. 3.22.

In order to obtain the noise-free peak and meet users' peak requirement, parameter such as the peak offset and the peak threshold in the peak criteria menu can be set to screen the peak list. For example, to set a threshold higher than the noise floor.

In the peak list, only a peak over -68dBm is included. The marker peak list displays determined peaks higher than the set threshold.

3.4 Data management

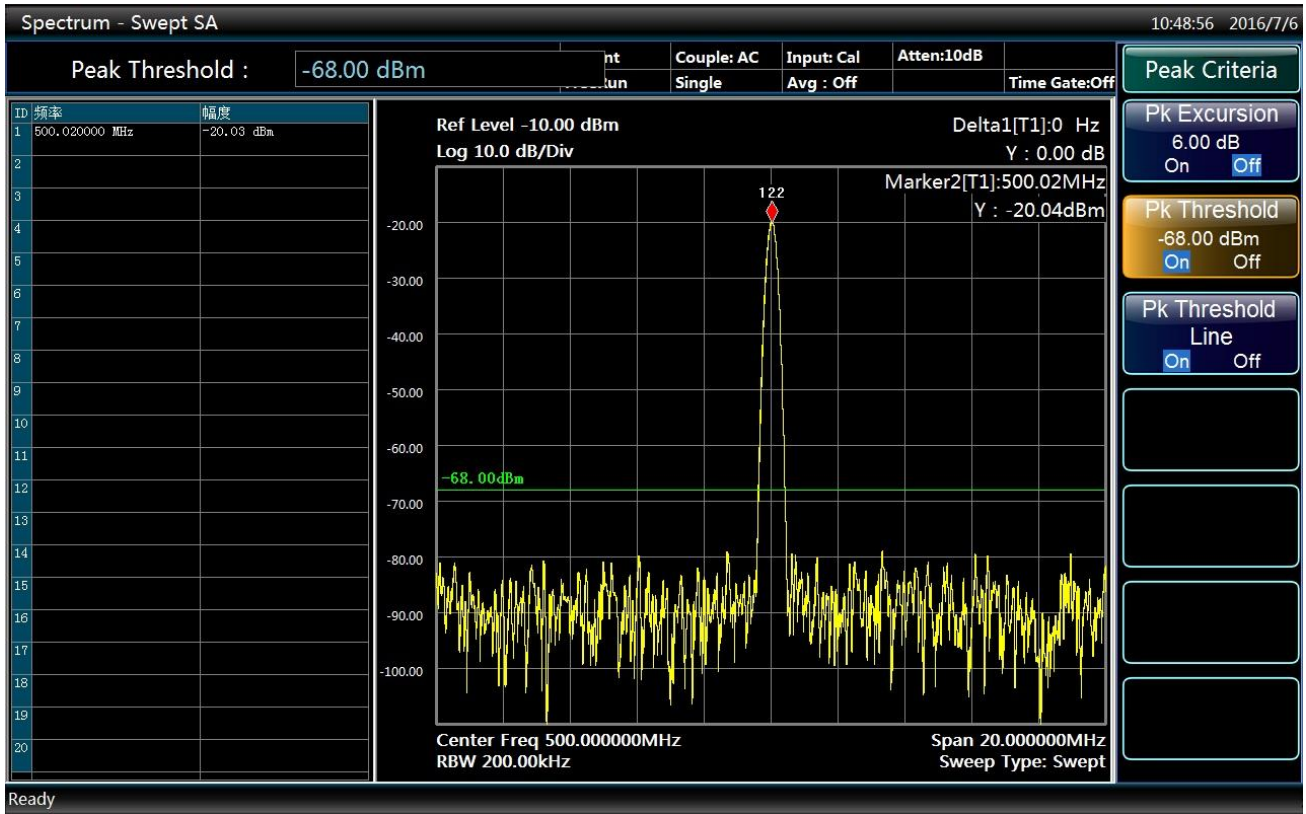

Fig. 3.22 The interface of opening peak threshold

3.4 Data management

This section describes working state saving/calling, measurement result data input/output methods and screenshot printing/saving method of the 4051 Series Signal/Spectrum Analyzer.

- Working state saving/calling.....46
- Data saving/calling.....48
- Screenshot printing/saving.....51

3.4.1 Working state saving/calling

- Instrument reset state.....46
- User state saving/calling.....47

3.4.1.1 Instrument reset state

The 4051 Series Signal/Spectrum Analyzer uses the startup state previously saved by users as the initial state of startup measurement. If there is no such startup state, the factory default startup state will be called. Usually when the measurement state of the instrument goes wrong, the initial state when the instrument works properly can be restored by resetting the instrument state.

The reset state of the Series Signal Analyzer is saved and called as follows:

Step 1. save reset state:

- Press 【System】 key on the front panel.
- Press [PowerOn/Preset] soft menu.
- Press \[Save User Preset] soft menu.

Step 2. call reset state:

- Firstly, press **【System】** key on the front panel.
- Press [PowerOn/Preset] soft menu.
- Press \[Reset **Fac**/User] to select reset switch.

If the factory state is required, set the reset switch as Factory; if the measurement state previously saved by users is required, set the reset switch as User.

- Press **【Preset】** key on the front panel to call the reset state.

3.4.1.2 User state saving/calling

The 4051 Series Signal/Spectrum Analyzer provides instrument measurement state (data) saving and calling functions to help users restore required measurement state for repeated observation and analysis as well as saving of required measurement data for further analysis.

1) Save instrument state**Step 1. set file save type:**

- Press **【File】** key on the front panel.
- Press [Save Type] soft menu.
- Press [State] soft menu to change current save type as “State”.

Step 2. save file:

- Press [Save...] Soft menu. As shown in Fig. 3.23.

Pop up Save As dialog to select the path and the file name to be saved and then click Save.

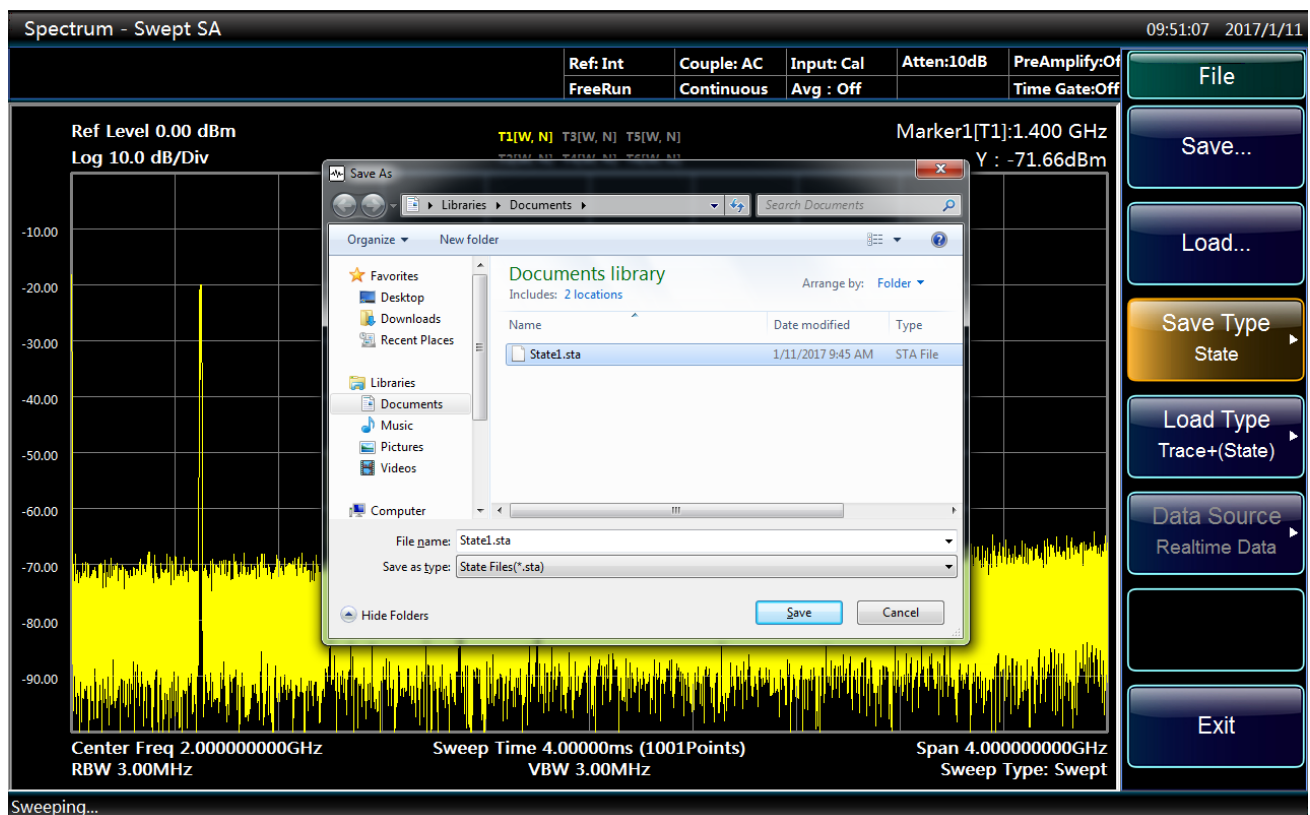

Fig. 3.23 File saving interface

3.4 Data management

2) Call instrument state

Step 1. set file call type:

- Press **【File】** key on the front panel.
- Press [Load Type] soft menu.
- Press [State] soft menu to change current call type as “State”.

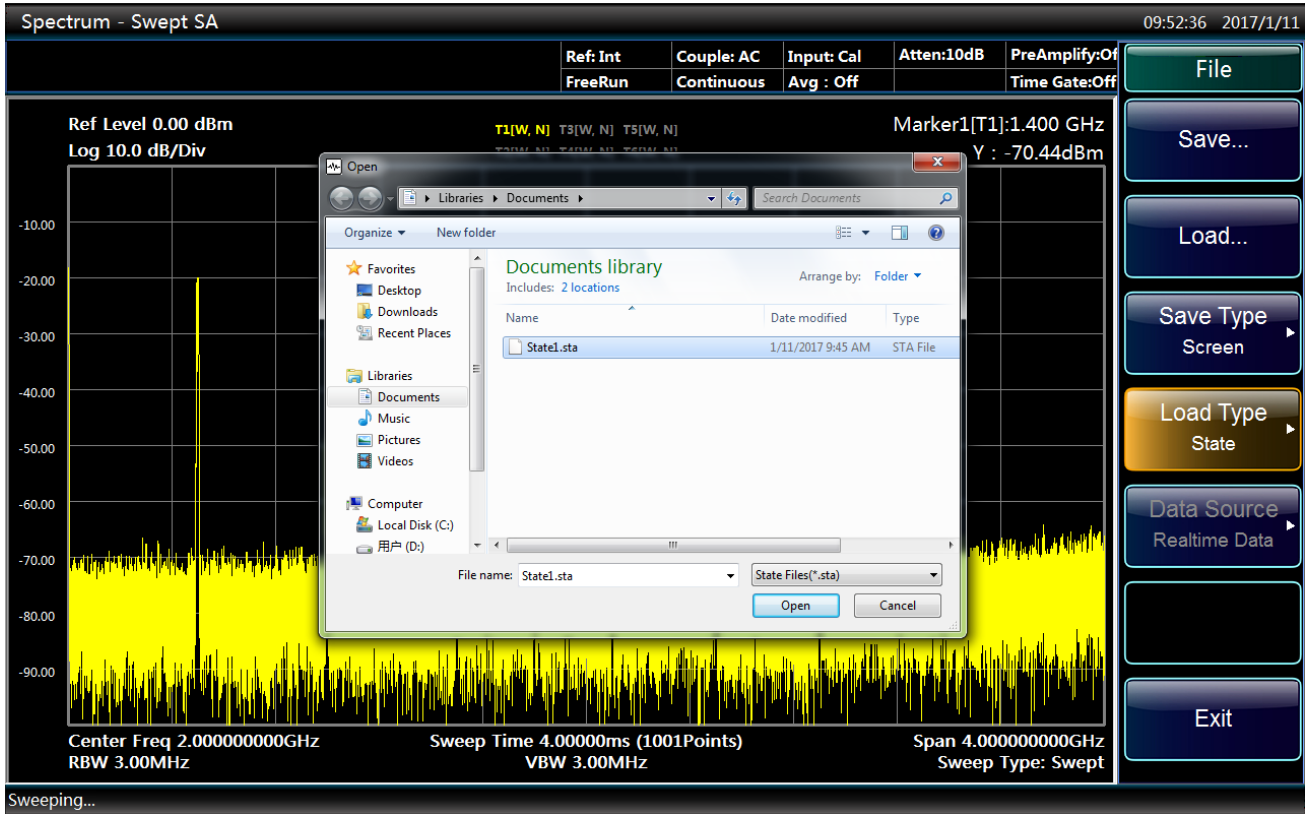

Fig. 3.24 File calling interface

Step 2. Load file:

- Press \[Load...] Soft menu.
- Pop up Open File dialog to select the file to be called and click Open as shown in Fig. 3.24.

3.4.2 Data saving/calling

The 4051 Series Signal/Spectrum Analyzer features file management and provides functions including file saving/calling, file browsing and copying, cutting, pasting and deleting of directory (file). Data files can be accessed via keys on the front panel, the mouse or remote operation (refer to the remote control manual of the 4051 Series Signal/Spectrum Analyzer for more details).

3.4.2.1 Measurement data file type

Data file types of file management are as shown in Table 3.13.

Table 3.13 Table of data file types

File type	Description of saved data
Startup state file	To save current measurement state of the instrument for calling during startup
Reset state file	To save current measurement state of the instrument for calling during reset by users

3.4 Data management

User saved state file	To save current measurement state of the instrument (such as center frequency and span)
User saved trace + state file	To save current trace data and current measurement state
User saved image file	To save the bitmap of current operation screen as bmp format
User saved I/Q data file	To save I/Q modulation data
Limit line file	To save the information of the limit lined edited by users
Amplitude correction file	To save the information of amplitude correction edited by users

3.4.2.2 File saving/calling method

The 4051 Series Signal/Spectrum Analyzer features data file saving/calling function, in which file saving means saving the measurement data into relevant file according to agreed format (such as: ASCII, *.dat) and file calling means opening selected data file, refreshing such display information as measurement parameters and list parameters to facilitate observation and assessment by users.

The Series Signal Analyzer provides four types of saving functions and two types of calling functions based on information types and its management methods. Four types of files that can be saved include state file, trace (+ state) file, image file and I/Q data file. Two types of files that can be called include state file and trace (+ state) file. Users only need to enter corresponding menu to pop up relevant dialog and designate the file name to be saved or select relevant file to complete file saving and calling. Details are as follows:

1) File saving method**Operating procedures:****Step 1. set file save type:**

- Press **【File】** key on the front panel.
- Press [Save Type] soft menu to select file type.

If it is required to save current measurement state, press [State] soft menu to change current save type as “State”; if it is required to save trace data, change the save type to “Trace (+ state)”; if it is required to save current screen image, change the save type to “Image”; if it is required to save I/Q data in I/Q analysis mode, change current save type as “I/Q Data”. The state of saving I/Q data can be set in “I/Q Data” menu, including auto on/off. In auto mode, saved I/Q data is consistent with that used for analysis with no need to set I/Q data time and length; in auto off mode, I/Q data time and length can be set manually and re-collection of I/Q data is required when saving.

Step 2. save file:

- Press [Save...] Soft menu.

Pop up File Save As dialog to select the path and file name to be saved and click Save as shown in Fig. 3.25.

3.4 Data management

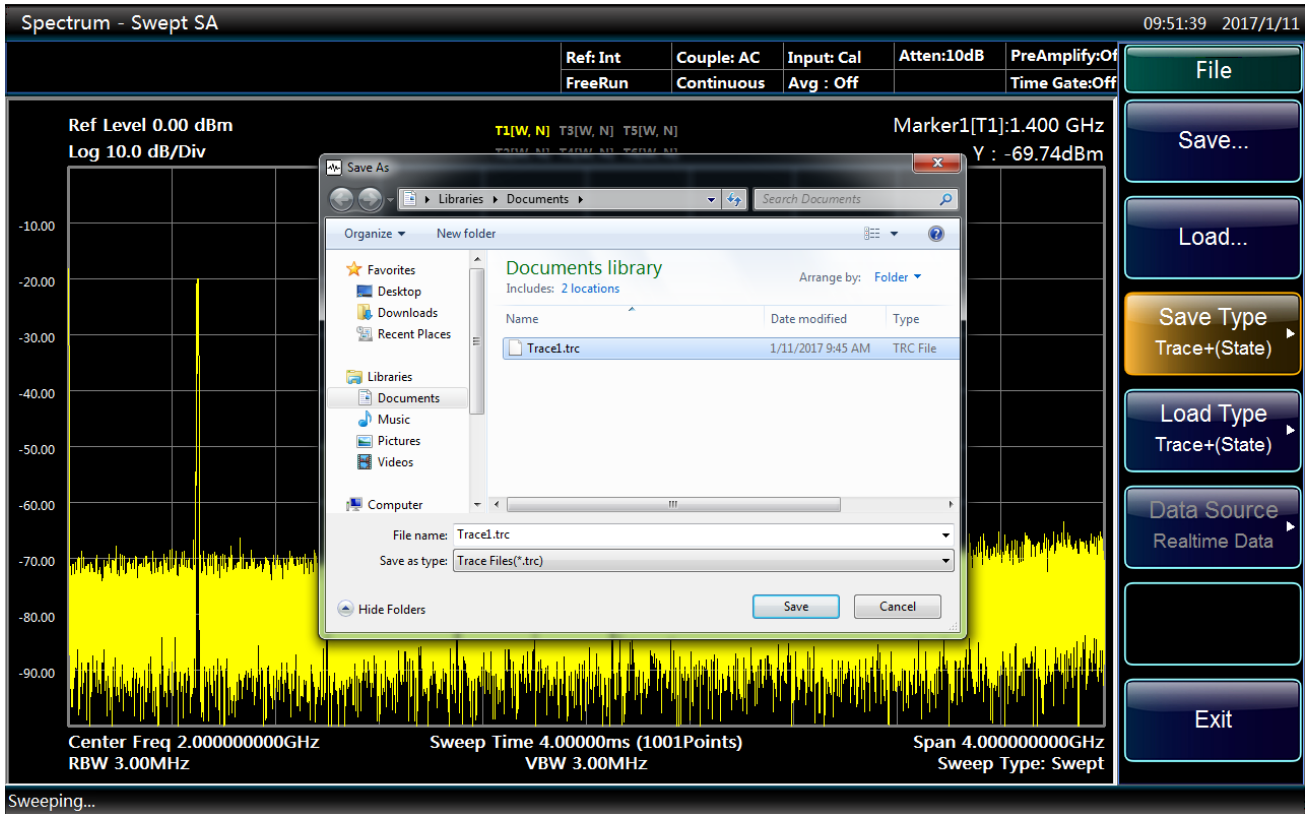

Fig. 3.25 File saving interface

2) File calling method

Operating procedures:

Step 1. set file call type:

- Press **【File】** key on the front panel.
- Press [Load Type] soft menu to select file type.

If it is required to call measurement state file, press [State] soft menu to change current call type as “State”. If it is required to call trace data, change the call type to “Trace (+ state)”; at such time, call the trace data in the file to current trace and change current trace display mode to “Static Status Display”.

Step 2. Load file:

- Press [Load...] Key to pop up Open File dialog, select the file named to be called and click Call as shown in Fig. 3.26.

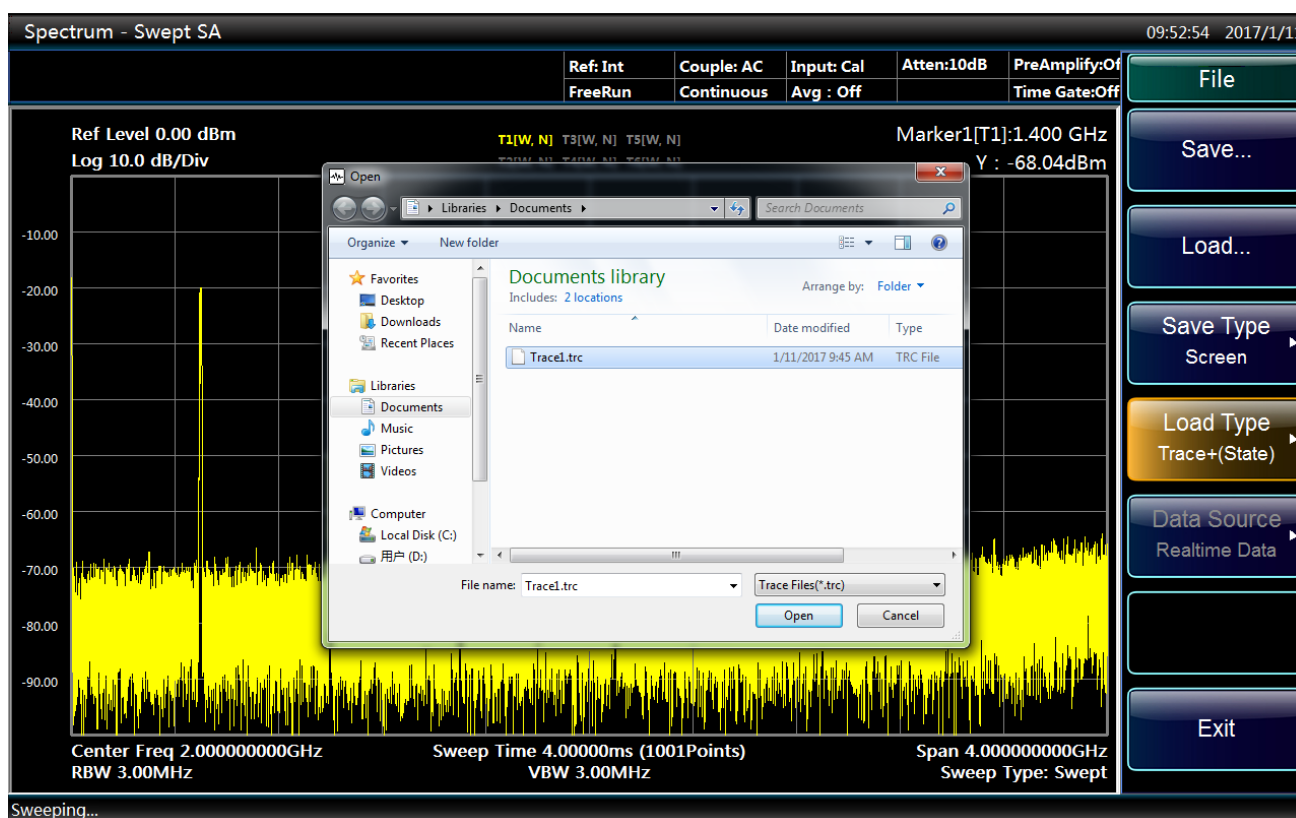

Fig. 3.26 File calling interface

3.4.2.3 File directory management

The 4051 Series Signal/Spectrum Analyzer does not provide separate file directory management function. Such operations as file browsing, assigning, copying, pasting and deleting should be done in Windows system after exiting the Series Signal Analyzer.

3.4.2.4 Description file format

All files of the Series Signal Analyzer are saved directly. All files except I/Q data files adopt the binary format and their suffixes are determined by specific file types.

3.4.3 Screenshot printing/saving

The 4051 Series Signal/Spectrum Analyzer is capable of saving screenshots to graphic files (bmp format) and printing screenshots.

- [Save screen \(to files\)](#)51
- [Print screen](#).....52

3.4.3.1 Save screen (to files)

Operating procedures:

Step 1. set file save type:

- Press **【File】** key on the front panel.
- Press [Save Type] soft menu.
- Press [Bitmap] soft menu to use image as the type of the currently saved file.

Step 2. save screen:

3.4 Data management

- Press [Save...] Soft menu to pop up File Save As dialog to select the path and file name to be saved and click Save as shown in Fig. 3.27.

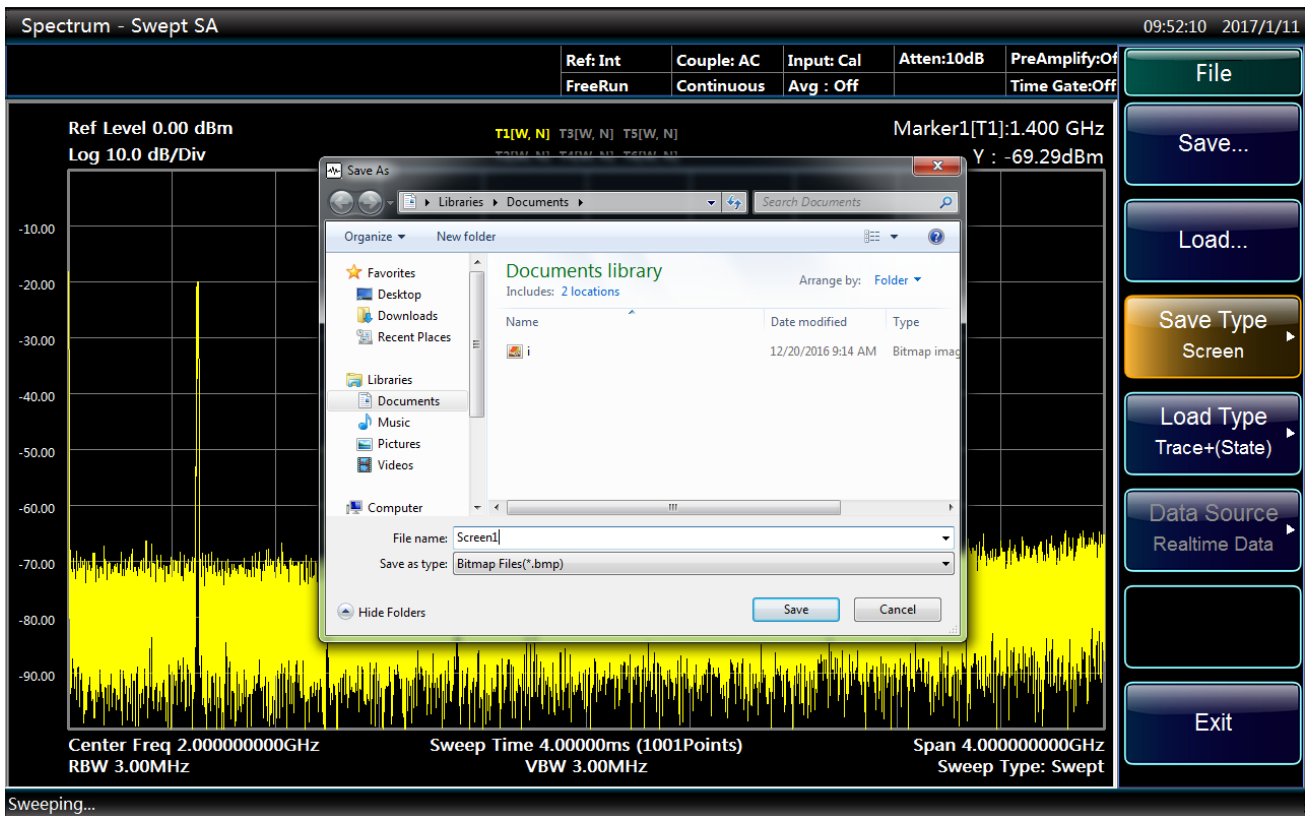

Fig. 3.27 File saving interface

3.4.3.2 Print screen

Prompt

Install printer drive program

Before printing, a matching printer drive program should be installed firstly for the 4051 Series Signal/Spectrum Analyzer.

Step 1. open Print Setting dialog:

- Press **【Print】** on the front panel to pop up Print Setting dialog as shown in Fig. 3.28.

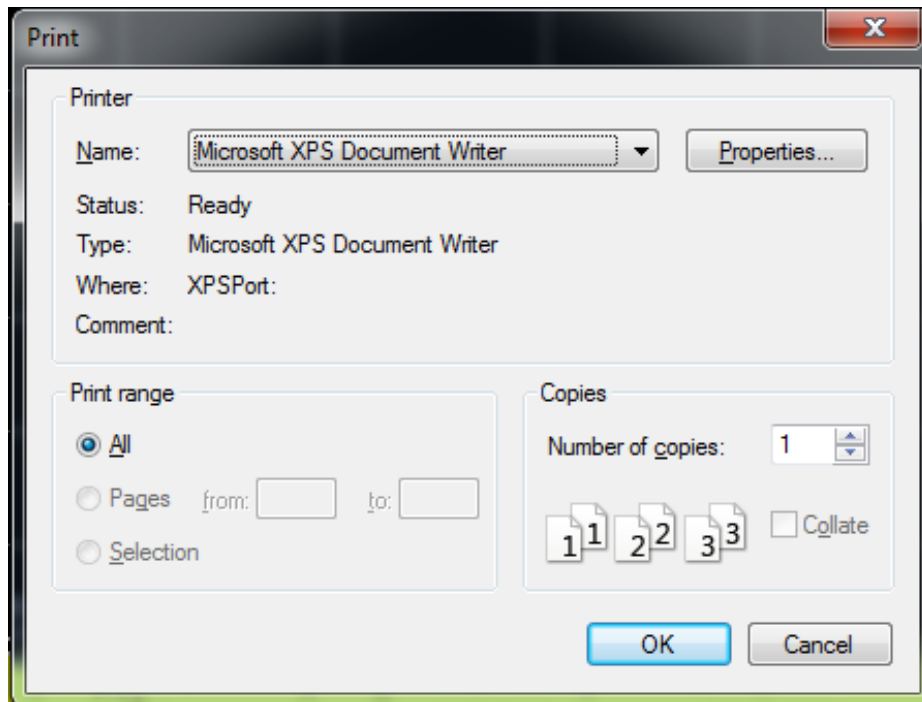

Fig. 3.28 Print dialog

Step 2. configure the printer:

- Select the printer and click Properties to configure the printer if special configurations are required.

Step 3. click OK to print current screen image.

4. Operating Instruction

In this chapter, operating methods of different measurement functions of the 4051 Series Signal/Spectrum Analyzer are introduced and measurement procedures are explained in detail.

- [Function operation guide](#).....55
- [Advanced operation guide](#).....88

4.1 Function operation guide

This section mainly introduces operating methods related to measurement modes, setting of common measurement parameters and analysis display of the 4051 Series Signal/Spectrum Analyzer.

4.1.1 Introduction of measurement modes and functions

This section mainly introduces major measurement modes and their main purposes of the 4051 Series Signal/Spectrum Analyzer. The Series Signal Analyzer has two measurement modes with standard configuration: spectrum analysis mode and I/Q analysis mode (I/Q analysis mode is not available for 4051-S series). Users may select measurement mode via **【Mode】** key on the front panel. Please refer to relevant software option user manual for more information of measurement mode options. Each measurement mode of the 4051 Series Signal/Spectrum Analyzer may contain several measurement functions and in the selected mode, specific measurement functions can be selected via **【Measure】** key on the front panel.

4.1.1.1 Spectrum analysis mode

The spectrum analysis mode is one regular general spectrum analysis and measurement environment and has very flexible spectrum analysis ability, which includes the traditional swept spectrum analysis and FFT spectrum analysis; in addition, the spectrum analysis has the signal spectrum peak search, marker function and various trace detectors and trace processing abilities, which enables the user to search and measure different types of signals conveniently.

The spectrum analysis mode can be accessed by activating the [Spectrum] menu through the **【Mode】** key on the front panel.

Moreover, the spectrum analysis mode also provides the one-key measurement function for the some special types of signals and common measurement applications. For these measurement functions, the 4051 Series Signal/Spectrum Analyzer pre-configure the measurement parameters of analyzer, which significantly reduces the complicated and trivial measurement setting operations for the user, thus enabling the user to carry out measurement conveniently. For the features of analyzer, the one-key measurement function integrates many measuring algorithms to optimize the measurement results.

Under the spectrum analysis mode, the measurement function can be selected by pressing the **【Measure】** key on the front panel. The one-key measurement functions of 4051 Series Signal/Spectrum Analyzer include:

- Swept Analysis
- Channel Power
- Occupied Bandwidth
- Adjacent Channel Power
- Power Statistic
- Burst Power
- Harmonic Distortion
- Three-order Intermodulation
- Spurious Emission

4.1 Function operation guide

➤ Spectrum Emission Mask

4.1.1.2 I/Q analysis mode (4051-S series is not provided with the IO analysis mode)

The I/Q analysis mode can help the user capture the complex number time domain data from the RF input port signal, which retains the vector relation of time, frequency, phase and amplitude of signal. By setting center frequency and analysis bandwidth, the broadband VDC and digital IF processing in the Series Signal Analyzer can resolve the signal to I/Q data. Those I/Q data can be analyzed through the I/Q analysis function under this mode or inputted to other analysis tools through GPIB, LAN and USB interface for analysis and processing. The I/Q analysis tool inside the 4051 Series Signal/Spectrum Analyzer can execute such basis analysis and measurement as FFT spectrum, time domain and I/Q waveform.

Under standard configuration, the 4051 Series Signal/Spectrum Analyzer can execute I/Q analysis of 10 MHz bandwidth signal and extend the bandwidth signal to 40 MHz or 200 MHz through configuration of options. The I/Q analysis mode can be accessed by activating the [I/Q Analyzer] menu through the **【Mode】** key on the front panel.

4.1.2 Operation guidance for parameter setting of common measurement

This section mainly describes the concept of basic measurement setting commonly used in the spectrum analysis mode and its effect on the measurement results, as well as its setting methods. Regardless of measurement mode or measurement task, those concept and setting methods are of great help to familiarize you with the 4051 Series Signal/Spectrum Analyzer and its use. Some setting methods of measurement may vary slightly should other measurement modes be used, please refer to the corresponding user manual relating to the measurement mode.

- Settings of reset state and powon.....56
- Settings of frequency and span/X Axis.....58
- Settings of bandwidth, filter and sweep.....60
- Settings parameters of amplitude/Y Axis.....66
- Trigger parameter settings.....70
- Parameter settings.....74
- Parameters settings of coupling and auto.....76
- Input and output settings.....77

4.1.2.1 Settings of reset state and PowOn

Reset state means the Series Signal Analyzer is restored to one known and definite measurement state. The reset state is classified into two types: factory reset state and user reset state. Whether the analyzer is restored to factory preset state or user preset state can be set by pressing **【Preset】** key through the [PowerOn/Preset] soft menu in the **【System】** key on the front panel.

PowOn refers to one known and definite working state that the analyzer enters automatically when the Series Signal Analyzer is powered on and started or the software program of Series Signal Analyzer is started through the Windows operating system.

1) Save user reset state

Step 1. First set the analyzer to the reset working state desired by you;

Step 2. Press **【System】** key on the front panel, then [PowerOn/Preset] soft menu and [Preset Fact User], set the preset state to user state;

Step 3. Finish the saving of user reset state by pressing the soft menu of [Save User Preset].

2) Execute user reset

4.1 Function operation guide

Step 1. Press **【System】** key on the front panel and then [PowerOn/Preset] soft menu, the settings menu displays the state of [Preset Fact User];

Step 2. The user Preset is completed by pressing **【Preset】** key on the front panel.

Caution**Reset Condition**

If the user has never saved the user powon, the Series Signal Analyzer will automatically return to the factory reset state during execution of user reset operation.

3) Execute factory reset

Step 1. Press **【System】** key on the front panel and then [PowerOn/Preset] soft menu, the settings menu displays the state of [Preset Fact User];

Step 2. The factory Preset is completed by pressing **【Preset】** key on the front panel.

Caution**【Preset】 key**

If the signal analysis is under program control mode, the **【Preset】** key on the front panel is inactive.

4) Save User powon

Step 1. First set the analyzer to the working state of powon desired by you.

Step 2. Press **【System】** key on the front panel and then press [PowerOn/Preset] soft menu many times to guarantee that the settings menu display state of [Preset Fact User];

Step 3. Finish the saving of user powon by pressing the soft menu of [Save User UserPreset].

Caution**Power-on State**

If the user has never saved the user powon, the Series Signal Analyzer will automatically enter the factory reset state when the Series Signal Analyzer is powered on and started or the software program of Series Signal Analyzer is started through the Windows operating system.

Prompt**Reset state under different measurement modes and functions**

The 4051 Series Signal/Spectrum Analyzer has multiple measurement modes (menu corresponding to [Mode] key), while different measurement functions may be provided under one measurement mode (menu corresponding to **【Measure】** key). Each measurement mode or function in the 4051 Series Signal/Spectrum Analyzer is equipped with separate factory Preset and user Preset state. Therefore, the reset operation is executed only for the current active measurement mode and function.

5) Factory reset state under different measurement modes and functions

For factory preset value of each measurement parameter of 4051 Series Signal/Spectrum Analyzer, please refer to the menu description of relevant parameter and for relevant details, please refer to chapter [“5.2 Menu description”](#) herein.

4.1 Function operation guide

4.1.2.2 Settings of frequency and span/X Axis

The **【Frequency】** key and **【Span/X Axis】** key can be used to set the range displayed by X Axis in the current active window of Series Signal Analyzer. Under non-zero span (greater than zero), the active window of spectrum analysis mode usually displays the signal spectrum trace with X Axis as frequency axis; the frequency measurement range can be set through the **【Frequency】** key and **【Span/X Axis】** on the front panel; under zero span (equals to zero), it displays the trace of signal frequency changing over time with X Axis as time axis. Only the span can be changed should corresponding soft menu of **【Span/X Axis】** be operated.

1) Parameter description of **【Frequency】** key

Frequency range (frequency measurement range) refers to the display range of frequency axis of Series Signal Analyzer. The frequency range is displayed in the information display area under screen with two ways including center frequency value and span value or start frequency value and stop frequency value. The parameters corresponding to **【Frequency】** key include [Center Freq], [Start Freq],[Stop Freq],[CF Step],[Freq Offset], [Auto Tune] and [Signal Track].

- [Center Freq] is used to set and indicate the frequency value in the center of measurement display window of Series Signal Analyzer;
- [Freq Freq] is used to set and indicate the frequency value in the leftmost position of measurement display window of Series Signal Analyzer;
- [Stop Freq] is used to set and indicate the frequency value in the rightmost position of measurement display window of Series Signal Analyzer;
- [CF Step] is used to set and indicate the frequency step size when the center frequency, start frequency and stop frequency are changed through Up/Down key on the front panel;
- [Freq Offset] is used to set and indicate the correction value of frequency range of information display area;
- After the [Auto Tune] is pressed, the Series Signal Analyzer will automatically optimize and set the frequency measurement range and display range of Y Axis based on the signal characteristics. For the specific setting methods and operation guidance of auto optimization, please refer to chapter “4.1.2.7 Parameter setting of coupling and auto” herein;
- [Signal Track] is used to track and measure the drift signal, by which the center frequency of Series Signal Analyzer can be automatically tuned for the maximum peak frequency of input port signal. For measurement methods of drift signal, please refer to chapter “4.2.8 Drift signal measurement” herein.

2) Parameter description of **【Span/X Axis】** key

Span refers to difference between start frequency and stop frequency measured by Series Signal Analyzer. Under spectrum analysis mode, the parameters corresponding to **【Span/X Axis】** key on the front panel include [Span], [Full Span], [Zero Span] and [Last Span], which are used to set the frequency range measured by Series Signal Analyzer, provided that the center frequency remains unchanged. Differences may exist in other modes, please refer to relevant manual for specific operations.

[Full Span] is used to set the frequency measurement range as maximum frequency range. It should be noted that the center frequency will automatically change to 1/2 of nominal maximum upper limit frequency of analyzer. This setting is of great use for observing the signals in the entire frequency measurement range.

[Zero Span] is used to set the span as 0 Hz, then the X Axis will change to time axis and the length of time will automatically become the sweep time of current Series Signal Analyzer.

[Last Span] is used to set the span as the value set last time. This function can help the user quickly switch the detail measurement under full span measurement and narrower span.

3) How to set frequency measurement range

4.1 Function operation guide

The following methods are commonly used to set the frequency measurement range of Series Signal Analyzer through **【Frequency】** key, **【Span/X Axis】** key and corresponding soft menus; for programming methods under program control mode, please refer to program control manual:

Method 1. Set frequency measurement range through [Center Freq] and [Span].

Method 2. Set frequency measurement range through [Start Freq] and [Stop Freq].

Method 3. Frequency measurement range can be set through [Center Freq] and [Zero Span] should time domain power be measured.

Method 4. Frequency measurement range can be set through [Full Span] should the measurement of entire frequency range be executed.

Caution
Zero span

When the span manually input is 0 Hz, the Series Signal Analyzer will automatically enter the zero span state and execute the measurement of time domain power.

Method 5. Frequency measurement range can be set quickly through [Last Span] should the frequency range set last time be measured.

Method 6. Frequency measurement range can be set quickly through [Auto Tune] should RF input signal be barely understood.

The center frequency, start frequency and stop frequency can be set manually with number keys and adjusted through the Up/Down key and knob on the front panel.

4) How to adjust frequency measurement range

When the measurement is being executed in the current frequency range, the following methods can help the user quickly adjust the frequency measurement range:

Method 1. The center frequency, start frequency and stop frequency can be adjusted through the Up/Down key and knob on the front panel.

Step 1. Set frequency step.

The frequency step value desired by you can be inputted manually through the number keys on the front panel by pressing **【Frequency】** key on the front panel and then [CF Step].

Caution
Frequency step

When the frequency step is set to auto, the Up/Down key on the front panel is corresponding to frequency step 1, 2, 5 and 10; during zero span, the frequency step corresponding to the knob is 1/20 of current resolution bandwidth; during non-zero span, the frequency step corresponding to the knob is 1/200 of current resolution bandwidth.

Step 2. Press the soft menu of [Center Freq], [Start Freq] or [Stop Freq] to be adjusted.

Step 3. The adjustment can be realized by pressing the Up/Down key or knob on the front panel.

If the center frequency needs to be adjusted, press the Up key on the front panel once, then center frequency will automatically change to current center frequency value plus frequency step size; while press the Down key on the front panel once, then center frequency will automatically change to current center frequency value minus frequency step size. The start frequency and stop frequency are adjusted in the same way provided above.

4.1 Function operation guide

Method 2. Adjust the measurement span through the Up/Down key and knob on the front panel. The span step corresponding to the Up/Down key on the front panel of 4051 Series Signal/Spectrum Analyzer is based on way of 1-2-5-10, while the step size corresponding to the knob is 1/10 of maximum order of current span.

Method 3. If the frequency of display signal is drifting, you can enable the signal track function, then the Series Signal Analyzer will automatically adjust the center frequency based on the signal peak.

Prompt

The span is likely to change automatically when the center frequency is changed.

For 4051 Series Signal/Spectrum Analyzer, the minimum value of frequency display range is -100 MHz, while the maximum value is related to the maximum nominal value of analyzer:

➤ 4051A	4.1 GHz;
➤ 4051B	9.1 GHz;
➤ 4051C	13.5GHz;
➤ 4051D	18.3GHz;
➤ 4051E	27GHz;
➤ 4051F	40.4GHz;
➤ 4051G	45.5GHz;
➤ 4051H	50.2GHz.
➤ 4051L	70GHz.

When the center frequency is adjusted to approach the lowest frequency limit, if current span is $> 2 \times (\text{center frequency} + 100 \text{ MHz})$, the current span will automatically change to $= 2 \times (\text{center frequency value} + 100 \text{ MHz})$. When the center frequency is adjusted to approach the nominal highest frequency limit of Series Signal Analyzer, if current span is $> 2 \times (\text{maximum value of display range} - \text{center frequency value})$, the current span will automatically change to $= 2 \times (\text{maximum value of display range} - \text{center frequency value})$.

Prompt

Rules of signal track

When the signal track function is enabled, the Series Signal Analyzer, with the current marker frequency value as center and 1/10 of current measurement span as search span, will set the frequency value corresponding to the signal peak searched to the center frequency of next measurement.

Method 4. Adjust the center frequency, start frequency and stop frequency through **【Marker →】**.

For the use and operation of **【Marker →】** key, please refer to the “4.1.3 Operation guidance on general analysis and display function” herein.

5) How to change frequency offset

If you hope that the frequency measurement range displayed on screen is to be corrected within the frequency measurement range of Series Signal Analyzer during actual work, the correction value of frequency offset can be set with number keys on the front panel by pressing **【Frequency】** key on the front panel and activating [Freq Offset] menu. The step size set for frequency offset corresponding to the Up/Down key and knob on the front panel is same as frequency step size.

4.1.2.3 Settings of bandwidth, filter and sweep

The section mainly describes the meaning of the parameters corresponding to **【BW】** key and **【Sweep】** key and provides the operation guidance. When the Series Signal Analyzer is executing the spectrum measurement, the **【BW】** key and **【Sweep】** key can be used to set the parameters including resolution

4.1 Function operation guide

bandwidth, video bandwidth, sweep time, sweep type, etc., which are used to determine the access way of spectrum data of Series Signal Analyzer and filter type. Differences may exist in other modes, please refer to relevant user manual

1) Parameter description of 【BW】 key

The setting menus corresponding to the 【BW】 key on the front panel include [Res BW], [Video BW], [VBW/RBW], [Span/RBW], [Filter Type] and [Filter BW].

[Res BW] is used to set and indicate the frequency resolution capability when the Series Signal Analyzer executes the spectrum measurement. The parameters of Resolution Bandwidth (RBW) determines the minimum frequency interval that the spectrum distinguish two signals. The smaller the resolution bandwidth is, the higher the resolution capability is.

For a simple-frequency signal, the trace displayed by swept spectrum analysis is the frequency response shape of checked IF filter. When the filter bandwidth is changed, the trace width displayed by analyzer will change at the same time. For two signals with equal amplitude and very close frequency, the spectrum traces of two signals display as one signal if the broader filter is selected; if filter narrow enough is used, these two input signals can be distinguished and display as two separate spectrum peaks. Therefore, the signal resolution capability is determined by the IF filter of analyzer.

When the settings of resolution bandwidth are changed, the IF filter inside the analyzer will change at the same time. Usually, the resolution bandwidth is defined as 3 dB bandwidth of filter or as 6 dB bandwidth of filter sometimes. To distinguish two signals with equal amplitude, the resolution bandwidth has to be less than or equal to signal frequency interval. If the resolution bandwidth is equal to the signal interval and video bandwidth is less than resolution bandwidth, a 3 dB dip will appear between two signals on the spectrum trace. The smaller the resolution bandwidth is, the deeper the dip goes. Therefore, distinction between two adjacent signals will be clearer.

The desired resolution bandwidth can be realized with IF filter by 4051 Series Signal/Spectrum Analyzer under swept spectrum measurement mode or with FFT filter under FFT spectrum measurement mode. FFT filter can be understood as the window function operation before executing FFT spectrum operation.

The Video Bandwidth Filter is the low-pass filter operation or average operation executed on spectrum trace, which can smoothen the spectrum trace displayed. Under swept spectrum measurement mode, [Video BW] (VBW) refers to the bandwidth of low-pass filter executed on spectrum trace. Under FFT spectrum measurement mode, video bandwidth (VBW) refers to the equivalent low-pass filter bandwidth after the FFT spectrum trace is averaged many times.

[VBW/RBW] is used to set and indicate the specific value of resolution bandwidth and video bandwidth used by current spectrum measurement. This parameter can be set automatically or manually. The Series Signal Analyzer is set as 1 automatically, namely the resolution bandwidth is same as video bandwidth. This parameter only has influence on the settings of video bandwidth. When the video bandwidth is set to auto, the VBW value of Series Signal Analyzer will be determined based on the current RBW and [VBW/RBW].

[Span/RBW] is used to set and indicate the specific value of current span and resolution bandwidth. This parameter can be set automatically or manually. The Series Signal Analyzer is set as 106 automatically, namely the resolution bandwidth is approximately equal to 1/106 of current span. This parameter only has influence on the settings of resolution bandwidth. When the resolution bandwidth is set to auto, the resolution bandwidth of Series Signal Analyzer will be determined based on the current span and [Span/RBW].

[Filter Type] is used to set whether the resolution bandwidth of Series Signal Analyzer is realized with Gaussian filter or flat top filter.

[Filter BW] is used to set whether the resolution bandwidth is selected as 3dB, 6dB, noise bandwidth or pulse bandwidth when the Series Signal Analyzer uses the Gaussian filter. When this parameter is changed, the resolution bandwidth filter is fixed, and the bandwidth value in the information display zone changes.

2) Parameter description of 【Sweep】 key

4.1 Function operation guide

The parameters corresponding to the **【Sweep】** on the front panel include [Sweep Time], [Sweep Single Cont], [Sweep Setup▶] and [Sweep Points].

[Sweep Time] is used to set and indicate the time that is used by the Series Signal Analyzer to execute one measurement. The information of this parameter is displayed in the lower middle position of screen trace display area. When the sweep time is set as auto, the Series Signal Analyzer will automatically execute the sweep based on the sweep type and rules set.

[Sweep Single Cont] is used to control whether the next measurement manually started by the user or auto start of re-measurement is required for the Series Signal Analyzer after finishing one measurement. The **【Single】** key and **【Cont】** key on the front panel also can be used to set this parameter.

Prompt

Continuous measurement and sweep OFF

When the “Average Num” (**【Meas Setup】** menu) is set as 1, or trace average and hold are not opened, the continuous sweep and measurement OFF are equivalent. By pressing **【Single】** key, the Series Signal Analyzer will stop the measurement after executing one sweep and measurement and enter idle state.

When the “Average Num (**【Meas Setup】** menu) is set as greater than 1, average or hold is opened for any trace, the Series Signal Analyzer will execute multi-measurement or data capture operations and stop the measurement after reaching the specified average count and enter idle state by pressing [Continuous OFF] key.

The operation corresponding to the **【Single】** key on the front panel is to execute the single measurement.

[Sweep Setup ▶] is used to determine whether Swept or FFT is adopted for the Series Signal Analyzer. Also set the FFT step bandwidth for FFT sweep.

[Sweep Points] is used to set the number of trace data that is required to be captured by the Series Signal Analyzer during one measurement.

3) Interactions of bandwidth, filter and sweep time

The bandwidth and filter are closely related to and correlate with the sweep time. The values of resolution bandwidth and video bandwidth depend on the type of filter selected, and, meanwhile, these settings have an influence on other measured parameters to a certain degree. As the analog or digital filter is used, the sweep speed will be limited by the transient response of IF and video filter.

If $VBW > RBW$ during sweep, the transient time of video filter is not affected. In such case, the transient response time required is inversely proportional to the square of RBW, as shown below:

$$T_{sweep} = k \times Span / RBW^2$$

Wherein: T_{sweep} is the minimum sweep time required under the given span and resolution bandwidth with unit of s;

RBW is resolution Bandwidth with unit of Hz;

Span is the display span with unit of Hz;

K refers to the filter constant, depending on the type of filter and permissible error of transient response. Gaussian filter is used for the Series Signal Analyzer by default.

If $VBW < RBW$, the minimum sweep time required will be affected by the transient time of video filter. Similar to the IF filter, the reducing bandwidth will increase the transient time. If the analog technology is used, the video filter is in general first-order low pass or simple RC circuit; there is one linear relation between VBW and sweep time. Decrease the video bandwidth by factor n and extend the sweep time by n-fold.

During FFT, the sweep also interacts with the resolution bandwidth and video bandwidth. The sweep time is about the sum of data acquisition time and the time of executing FFT spectrum operations. During FFT

4.1 Function operation guide

measurement, the sweep time cannot be set randomly, while the Series Signal Analyzer provides one approximate value based on the current resolution bandwidth, video bandwidth and FFT step configuration.

4) How to set parameters of solution bandwidth

Usually, the 4051 Series Signal/Spectrum Analyzer sets the resolution bandwidth automatically based on the specific value of [Bandwidth/RBW] and current span. There are over 160 scales of settings for the resolution bandwidth of 4051 Series Signal/Spectrum Analyzer, with 25 per 10 octave within 1 Hz - 1 MHz, changing by 10% step between 1Hz and 3 MHz and taking 4 MHz, 5 MHz, 6 MHz, 8 MHz, 10 MHz and 20 MHz above 3 MHz. Changing the resolution bandwidth if it is expected to can be realized in the following two methods:

Method 1. When the specific value of span and resolution bandwidth is changed manually by pressing [Span/RBW] after pressing the **【BW】** key on the front panel, the resolution bandwidth will automatically select based on the specific value.

Method 2. The expected resolution bandwidth can be entered with the number keys or the resolution bandwidth can be set with Up/Down key or knob on the front panel by pressing [Res BW] after pressing **【BW】** key on the front panel. When the number of resolution bandwidth is entered with number keys, the Series Signal Analyzer will automatically set the resolution bandwidth to the scale closet to the number entered. When the resolution bandwidth is set with Up/Down key, the resolution bandwidth of Series Signal Analyzer will change in the step way of 1-2-3-5-10. When the resolution bandwidth is set with knob, all scales of resolution bandwidth can be selected.

5) How to set parameters of video bandwidth

Usually, the 4051 Series Signal/Spectrum Analyzer selects the video bandwidth automatically based on the specific value of [VBW/RBW] and according to the current resolution bandwidth. The video bandwidth and resolution bandwidth of 4051 Series Signal/Spectrum Analyzer vary in scale. Changing the video bandwidth if it is expected to can be realized in the following two methods:

Method 1. When the specific value of RBW and VBW is changed manually by pressing [VBW/RBW] after pressing the **【BW】** key on the front panel, the video bandwidth will automatically select based on the specific value.

Method 2. The expected video bandwidth can be entered with the number keys or the video bandwidth can be set with Up/Down key or knob on the front panel by pressing [Video BW] after pressing **【BW】** key on the front panel. When the number of video bandwidth is entered with number keys, the Series Signal Analyzer will automatically set the video bandwidth to the scale closet to the number entered. When the video bandwidth is set with Up/Down key, the video bandwidth of Series Signal Analyzer will change in the step way of 1-2-3-5-10. When the video bandwidth is set with knob, all scales of resolution bandwidth can be selected.

6) Set sweep parameters manually

Setting the suitable sweep parameters manually is of great help for executing measurement task.

➤ Set sweep time manually

When the sweep time of 4051 Series Signal/Spectrum Analyzer is set as auto, it usually selects the fastest sweep time to execute measurement and the maximum error of measurement is less than 0.1 dB in comparison with the sweep measurement with relative longer time.

The sweep time can be set with the number keys, Up/Down key or knob on the front panel in the [Sweep Time Auto **Man**] by pressing the **【Sweep】** key on the front panel.

Prompt

Limitations on the setting of sweep time

When the sweep type is sweep frequency (and span > 0 Hz), the Series Signal Analyzer will automatically

4.1 Function operation guide

work out the minimum sweep time based on such parameters as resolution bandwidth, video bandwidth and type of filter. When the sweep time set manually is less than the minimum sweep time, the Series Signal Analyzer will automatically execute the measurement based on the minimum sweep time. When the sweep time set manually is greater than 6,000 s, the Series Signal Analyzer will automatically execute the measurement based on the sweep time of 6,000 s.

When the sweep type is zero span, the sweep time of Series Signal Analyzer is not related to the parameters including resolution bandwidth, video bandwidth and type of filter. When the sweep time set manually is less than the minimum sweep time (1 μ s), the Series Signal Analyzer will automatically execute the measurement based on the minimum sweep time. When the sweep time set manually is greater than 6,000 s, the Series Signal Analyzer will automatically execute the measurement based on the sweep time of 6,000 s.

When the sweep type is FFT, the sweep time cannot be set manually.

➤ How to switch continuous sweep ON and OFF

The continuous sweep ON indicates that the Series Signal Analyzer automatically executes the measurement based on the trigger event set. The continuous sweep ON is the default state of the Series Signal Analyzer.

The continuous sweep OFF indicates that the Series Signal Analyzer is manually controlled by the user to execute the measurement based on the trigger event set. When the trace average function is opened, the Series Signal Analyzer will not stop the measurement until the designated trace average count is reached. For more details, please refer to “4.1.2.6 Parameter settings of **【Meas Setup】** and **【Meas Control】**” herein.

Many methods in the 4051 Series Signal/Spectrum Analyzer are available for switching the continuous sweep ON and OFF directly.

Method 1. switch can be realized with [Sweep Single **Cont**] soft menu by pressing **【Sweep】** key on the front panel.

Method 2. switch can be realized by pressing **【Single】** and **【Cont】** key on the front panel

➤ Configure sweep type rules manually

For the 4051 Series Signal/Spectrum Analyzer, the sweep type includes sweep frequency and FFT, while the sweep type rules include “Best Dynamic Range” and “Best Speed”.

“Best Dynamic Range” rules: when RBW is or larger than 300Hz, the sweep type is Swept; when RBW is less than 300Hz, the sweep type is FFT.

“Best Speed” rules: when RBW is or larger than 3kHz, the sweep type is Swept; when RBW is less than 3kHz, the sweep type is FFT.

The user can set the sweep type rules manually by pressing **【Sweep】** key on the front panel and entering sweep setting menu. In the reset state, the 4051 usually select the sweep type automatically based on the “Best Dynamic Range”.

➤ Configure sweep type manually

By setting the [Sweep Setup ▶] as manual by entering sweep setting menu through **【Sweep】** and [Sweep Type ▶] key, the user can manually set the sweep type of the current Series Signal Analyzer as sweep frequency or FFT.

Prompt

Judge the parasitic or residual response of Series Signal Analyzer by changing sweep time

The 4051 Series Signal/Spectrum Analyzer can carry out the spectrum measurement by using sweep and FFT. When you find the lesser parasitic or residual response on the measured data, you can try to judge that the response is generated by Series Signal Analyzer itself or brought into by the input signal by changing the sweep type. If the response signal disappears or gets smaller in different sweep type, it can be considered that the signal distortion to a certain degree is caused by the hardware measurement channel of Series Signal Analyzer.

➤ Configure FFT width manually

The FFT width can be set by activating the [Sweep Type ▶] and [FFT Width▶] though **【Sweep】** key on the front panel.

Before the FFT width is set manually, the working principle and process that 4051 Series Signal/Spectrum Analyzer executes the FFT spectrum measurement should be understood first. When the FFT is used to measure the signal spectrum within one frequency range, the Series Signal Analyzer is tuned to center frequency of measured frequency range, then the FFT spectrum calculation is carried out for the time domain data obtained. As the limitation of resolution bandwidth, the maximum frequency range of this way of measurement is also limited with limit value of FFT width. For the spectrum measurement of frequency range exceeding the FFT width, the Series Signal Analyzer will measure one section of frequency range at a time by tuning the center frequency of RF reception circuit by step and joint the measured spectrum.

FFT width is only active when the FFT sweep type is selected. When the sweep type is set as auto, the 4051 Series Signal/Spectrum Analyzer will execute FFT spectrum measurement, the maximum resolution bandwidth is 1 MHz. The larger is the FFT width, the faster is FFT spectrum measurement, but the dynamic range performance will be affected.

Under FFT sweep, the FFT width setup limits the maximum value for center frequency step of each tune. For example, if [$<100\text{Hz}$] is selected, the maximum value for center freq step of each tune is 100Hz. As the FFT width gets larger, the count of instrument center frequencies get smaller when performing measurement of same frequency scope, and the response measurement gets faster. Therefore, to improve measurement speed, you can manually change the FFT width.

Caution

The maximum FFT

If the FFT width is set as [\leq Maximum Value], the maximum FFT is 10 MHz under standard configuration.

7) Select the filter bandwidth and type reasonably

➤ Configure filter type manually

The filter type can be selected manually by activating the [Filter Type] through **【BW】** key on the front panel.

In general, the 4051 Series Signal/Spectrum Analyzer uses Gaussian filter, i.e., use filter approximate to the Gaussian shape to complete filtering of resolution bandwidth. If the flat top filter is used, the Series Signal Analyzer adopts filter approximate to the rectangular shape to complete filtering of resolution bandwidth. The response time of flat top filter of 4051 Series Signal/Spectrum Analyzer is about 3 times of that of the Gaussian filter, as the sweep speed of the flat top filter is smaller than that of the Gaussian filter. The flat top

4.1 Function operation guide

filter has better selectivity than the Gaussian filter and therefore is more capable of distinguishing two signals with unequal amplitude.

➤ Configure filter bandwidth manually

The filter bandwidth can be selected manually by activating the [Filter BW] through **【BW】** key on the front panel.

The 4051 Series Signal/Spectrum Analyzer has four ways to describe the Gaussian filter bandwidth: 3 dB and 6 dB bandwidth of filter, pulse bandwidth and noise bandwidth. Wherein: the noise bandwidth refers to the bandwidth when the rectangular filter is used to pass through the noise signal power with same peak gains. The pulse bandwidth refers to the bandwidth when the rectangular filter passes through the pulse signal power with same peak gains.

When the electromagnetic interference test is executed, the 6 dB bandwidth or pulse bandwidth is applicable to describe the filter bandwidth; when the noise-like signal or channel power is measured, the noise bandwidth is applicable to describe the bandwidth.

When the parameters of [Filter BW] are changed, the filter bandwidth actually used will not be affected, and the Series Signal Analyzer only uses another way to describe the filter bandwidth and display it on the screen information area. E.g., the 3 dB (1 kHz) bandwidth and 6 dB (1.41 kHz) bandwidth, equivalent noise bandwidth filter of 1.06 kHz and equivalent pulse width filter of 1.48 kHz.

Caution

The filter type and the filter bandwidth

When the 4051 Series Signal/Spectrum Analyzer selects the “flat top” for the filter type, the filter bandwidth cannot be selected and the [Filter BW] turns grey.

4.1.2.4 Set parameters of amplitude/Y Axis

The section mainly describes the meaning of the parameters corresponding to **【Amplitude/Y Axis】** and provides the operation guidance. The **【Amplitude/Y Axis】** key and the corresponding setting soft menu are used to set the amplitude reference and display range of active window of Series Signal Analyzer, which is available in multiple measurement modes and functions. In the spectrum analysis mode, they are mainly used to set the reference level, attenuator, display range of level and unit of amplitude of the Series Signal Analyzer. The functions may vary in other measurement modes or functions, please refer to the corresponding manual.

1) Parameter description of **【Amplitude/Y Axis】**

The menus corresponding to the **【Amplitude/Y Axis】** key on the front panel include [RefLevel], [Attenuation], [Scale Type **Log** Line], [Scale/Div], [Auto Scale], [Y Axis Unit ▶], [Ref Level Offset], [Ampl Cor ▶].

[RefLevel] refers to the maximum signal acceptable by the measurement hardware on the premise that the measured results are guaranteed. The input level exceeding the above the maximum signal may distort. In such case, the information bar of 4051 Series Signal/Spectrum Analyzer will display the prompt information of “IF Overload”.

[Attenuation ▶] submenu is mainly used to control the gain distribution of the RF reception hardware of the Series Signal Analyzer and includes such parameters to be set as mechanical attenuator, Elec Attenuator, step of mechanical attenuator and maximum mixer level. Only the options of Elec Attenuator are configured properly will the settings of relevant Elec Attenuator become effective.

[Scale Type **Log Linear]** is used to select the trace data in display area to be linear or logarithm. When the “Logarithm” is selected as the type scale, the graticule of Y Axis is segmented in way of logarithm and the top graticule is corresponding to the reference level (when the reference level offset is set as zero), while the numbers corresponding to other Y axes can be set through amplitude scale. When the “Linear” is selected as the type scale, the graticule of Y Axis is segmented in linear and the top graticule is corresponding to the

4.1 Function operation guide

reference level (when the reference level offset is set as zero), the bottom graticule 0 V and middle graticule of Y Axis 1/10 of reference level.

[Scale/Div] is used to set the gain between graticules of Y Axis in the trace display area. This parameter is effective only when the [Scale Type] is logarithm. When the scale type is linear, the menu turns grey automatically and is in the idle state.

[Auto Scale] is used to automatically set the amplitude scale for the current measured data and the reference value corresponding to the top graticule of Y Axis.

[Y Axis Unit] is used to change the scale unit displayed by the Y-axis in the trace display area. By default, when the scale type is set as “Logarithm”, the scale unit of Y Axis is dBm; by default, when the scale type is set as “Linear”, the scale unit of Y Axis is V. Regardless of logarithm or linear scale type, the scale unit of Y Axis can be set as any one of dBm, dBmv, dBma, W, V, A, dBuv and dBua.

[Ref Level Offset] is used to increase the reference level display by one offset. Reference level indicates the absolute amplitude value represented by the top graticule of Y Axis in the trace display area.

[Ampl Cor ▶] is used to correct the correction value edited by the user on the measured trace data.

2) Set reference level properly

Reference level indicates the absolute amplitude value represented by the top graticule of Y Axis in the trace display area and is closely related to the maximum signal level receivable by the RF input port and internal mixer of the Series Signal Analyzer. If the reference level is set improperly, the serious signal distortion may occur, directing affecting the measured results.

Caution

The total power of all input signals of RF input port should be considered and known and the reference level set should be greater than the total power of all input signals when the reference level is set.

The reference level can be set by activating the [RefLevel] soft menu through the **【Amplitude/Y Axis】** key, on the front panel. If you are to set the reference level manually, the Series Signal Analyzer will just correct the data offset on the measured trace instead of stopping the current measurement in most cases. Only when the change of reference level brings about the change of associated attenuator will the Series Signal Analyzer top the current measurement and restart measurement.

Generally, that measured by the 4051 Series Signal/Spectrum Analyzer is the level value of input signal, while that displayed by the measured result is the effective value of the unadjusted sine signal level calibrated and corrected. By default, assuming that the input impedance is 50 Ω, the reference level is the converted power = 1 mw (0 dBm). For more information about “assuming that the input impedance is 50 Ω”, please refer to “4.1.2.8 Input and output settings” herein.

3) Optimize the measured results by setting attenuator properly

The attenuator of 4051 Series Signal/Spectrum Analyzer is located at the back-end of RF input port and directly connected to the RF input port, which is mainly used to guarantee that the mixer at the back end of attenuator will not be damaged by inputting high power RF signal. Therefore, The 4051 Series Signal/Spectrum Analyzer, by default, will automatically set the attenuator based on the reference level set. The input level of mixer can be calculated in the following formula:

Input level of mixer = input level of signal - attenuator value



Warning

The maximum input level of mixer

The maximum input level of mixer is -10 dBm. If the signal level inputted into the mixer exceeds -10 dBm, the wrong measured result may occur, even the mixer may be damaged.

4.1 Function operation guide

The measuring sensitivity of Series Signal Analyzer is closely related to the attenuator, so the higher the attenuator is, the greater the inherent noise inside the Series Signal Analyzer is; and the measuring sensitivity of Series Signal Analyzer will decrease with the increase of noise floor in the trace display area. The attenuator is usually set as 0 dB to obtain higher measuring sensitivity. The measuring sensitivity will decrease by 10 dB and the corresponding average noise level displayed increases by 10 dB as the decrement increases by every 10 dB. Therefore, the decrement of attenuator should be decreased usually to improve the SNR of measuring signal. However, the greater decrement set can prevent the Series Signal Analyzer from intermodulation or harmonic distortion, and, in such case, the RF amplification circuit at the back of mixer can re-amplify the signal.

Accordingly, the attenuator can be set as distortion measurement or high sensitivity measurement to complete the complicated measurement. If you have not understood the functions of attenuator thoroughly, it is suggested that the attenuator should be set as auto coupling.

Prompt

Benefits of setting attenuator manually

When you are executing the distortion measurement, such as harmonic distortion or intermodulation distortion, the greater decrement set is of great help and helps to determine whether the distortion is caused by Series Signal Analyzer.

When you are executing the weak signal measurement, the attenuator is set as 0 dB, which is an effective method for increasing the measuring sensitivity of Series Signal Analyzer.

Two types of attenuators including mechanical attenuator and Elec Attenuator are provided for the 4051 Series Signal/Spectrum Analyzer. Wherein the mechanical attenuator includes one mechanical attenuator with step of 2 dB, maximum decrement of 6 dB and AC/DC switch function and one mechanical attenuator with step of 6 dB and maximum decrement of 66 dB, which jointly form the attenuator component with minimum step of 2 dB and maximum decrement of 72 dB. The connection relation is shown in Fig. 4.1.

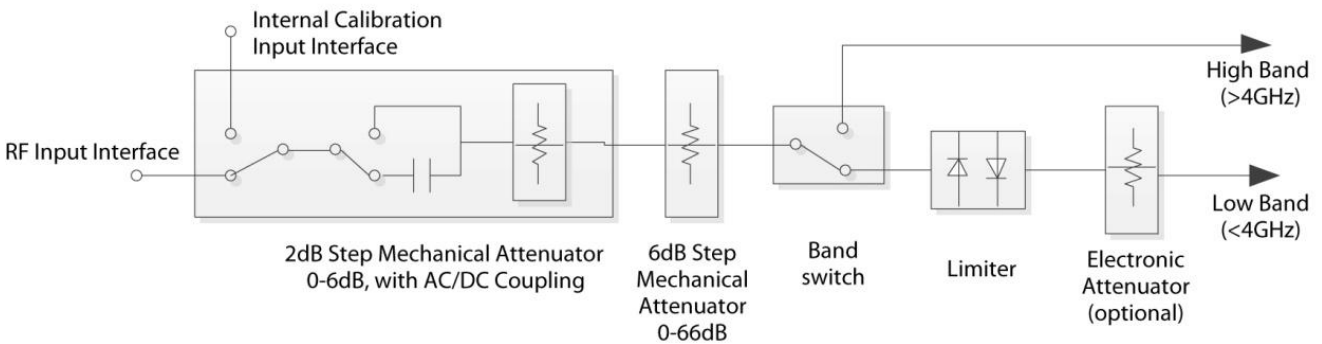

Fig. 4.1 Connection Relation of Attenuators of 4051 Series Signal/Spectrum Analyzer

➤ **Set mechanical attenuator manually**

Generally, the mechanical attenuator is set automatically based on the reference level set with step of 2 dB. The Series Signal Analyzer will automatically set the attenuator based on the following formula:

$$\text{Decrement of attenuator} = \text{reference level} + \text{gain of PreAmplifier} + \text{external gain} - \text{reference level offset} - \text{maximum mixer level} + \text{IF gain}$$

Wherein: if the options of PreAmplifier are not set, its gain is 0 dB; IF gain is the variable gain amplifier at the back end of the circuit of mixer, invisible for the user, which is set automatically by the Series Signal Analyzer based on the reference level.

In addition, the attenuator values automatically set are greater than or equal to 6 dB. The decrement of attenuator calculated based on the formula above is rounded up to an integer and parameters are set based on the step of mechanical attenuator, automatically selecting the closest decrement. E.g., if the decrement of

4.1 Function operation guide

attenuator calculated is 40.1 dB, the attenuator will automatically select 50 dB (the step of mechanical attenuator is 10 dB) or 42 dB (the step of mechanical attenuator is 2 dB).

If you hope to set the mechanical attenuator manually, the decrement of mechanical attenuator can be modified with number keys, Up/Down key or knob on the front panel by pressing **【Amplitude/Y Axis】** key on the front panel, entering [Attenuation ▶] menu and modifying the mechanical attenuator to [Mech Atten Auto **Man**].

In addition, you can set the step of mechanical attenuator as 2 dB or 10 dB manually. When the step menu of mechanical attenuator is set as 10 dB, namely [Mech Atten Step 2dB **10dB**], the decrement scope of mechanical attenuator can only be set within 0 dB - 70 dB with a minimum step of 10 dB. Then the minimum step size corresponding to the Up/Down key and knob on the front panel is also set as 10 dB automatically. When the step menu of mechanical attenuator is set as 2 dB, namely [Mech Atten Step **2dB** 10dB], the decrement scope of mechanical attenuator can only be set within 0 dB - 70 dB with a minimum step of 2 dB. Then the minimum step size corresponding to the Up/Down key and knob on the front panel is also set as 2 dB automatically.

➤ **Set maximum mixer level**

The [Max Mixer Level] in the [Attenuation ▶] menu only has an influence on the auto setting algorithm of attenuator. The maximum mixer level of 4051 Series Signal/Spectrum Analyzer is -10 dBm by default. Unless you have a thorough understanding of the principle of measurement of Series Signal Analyzer, do not change the maximum mixer level.

4) How to set display range of Amplitude/Y Axis

➤ **Set scale type**

The scale type can be selected by activating the [Scale Type **Log** Line] menu after pressing **【Amplitude/Y Axis】** key on the front panel. Usually, the Series Signal Analyzer is set as logarithm scale type.

When the [Scale Type **Log** Line] is selected to be linear, the measured values are always linear distribution in the display check. The linear scale is of great use for exactly displaying the signal level of small range. However, if the maximum and minimum values of signal are displayed on the screen at the same time, it is very difficult to display each value exactly or distinguish two approximate signal levels. The linear scale type is commonly applied to the demodulation waveform display of AM signal.

When the [Scale Type] is selected to be logarithm, the smaller measured value display will occupy most area of screen display area, so it is very effective for distinguishing the signals of low level. If you hope to display the greater measured data of signal level range on one screen, selecting the logarithm scale type is very useful. The unit commonly selected for the logarithm scale type is the data of logarithm (such as dBm or dB).

➤ **Set display range of Y Axis through amplitude scale and reference level**

When the scale type is selected to be logarithm, the amplitude value represented by each division of Y Axis can be set with number keys, Up/Down key or knob on the front panel by pressing **【Amplitude/Y Axis】** key on the front panel and activating the [Scale/Div] menu. Usually, the Series Signal Analyzer is set as 10 dB.

When the reference level is changed with number keys, Up/Down key or knob on the front panel by pressing **【Amplitude/Y Axis】** key on the front panel and activating the [Scale/Div] menu, the display range of Y Axis will change, then the measured value represented by the top division of screen is: reference level + reference level offset, while measured value represented by the bottom division is: reference level + reference level offset - $10 \times$ amplitude scale value.

Prompt

The influence of changing display range of Y Axis by changing reference level

As the attenuator and IF gain in the RF reception circuit of corresponding Series Signal Analyzer may change when the reference level is changed, the corresponding measurement performance, such as dynamic range or sensitivity, will change as well. If you want to avoid this situation, set the display range of Y Axis through the

4.1 Function operation guide

amplitude scale and reference level offset.

➤ Set display range of Y Axis through amplitude scale and reference level offset

Changing the reference level offset through [More1/2] soft menu is of help for you to change the logarithmic amplitude value represented by the top division in the screen display area.

➤ Set display range of Y Axis through auto scale

When the **【Amplitude/Y Axis】** key on the front panel is pressed and the [Auto Scale] soft menu is then clicked, the Series Signal Analyzer will set the [Scale/Div] (logarithm scale type) and reference level offset based on the maximum and minimum value of latest measured data, optimize the display range of Y Axis and reflect all the latest measured data on the screen. The auto scale menu corresponding to the active window may vary slightly in other measurement modes or functions, please refer to the corresponding manual or menu description of corresponding function for more details.

Prompt

Auto Scale

When you click the [Auto Scale] once, the Series Signal Analyzer will set [Scale/Div] (logarithm scale type) and reference level offset once only based on the current measured data and will not reset even in case of change of the measured data.

5) Open PreAmplifier (optional)

If the Series Signal Analyzer purchased by you is equipped with the option of PreAmplifier, it can be seen that the [PreAmplifier ON **OFF**] menu is in active state by pressing **【Amplitude/Y Axis】** key on the front panel and [More 1/2▶] soft menu, or the menu turns grey, indicating idle state. The built-in PreAmplifier of Series Signal Analyzer can be opened by setting the menu.

By opening the PreAmplifier, the Series Signal Analyzer can obtain better noise factor, improving the measuring sensitivity, and the dynamic range performance (such as TOI indicator) of Series Signal Analyzer will be deteriorated.

The 4051 Series Signal/Spectrum Analyzer can be equipped with multiple options of PreAmplifiers, including the low-band PreAmplifier (with frequency range from 10 MHz to 4 GHz) and full-band PreAmplifier (10 MHz to upper limit of maximum measured frequency), but only one type of PreAmplifier can be equipped.

During sweep, the measured result of Series Signal Analyzer will automatically take into account the gain of PreAmplifier. Even though the measured frequency range set by you exceeds the operating frequency range of built-in PreAmplifier, the Series Signal Analyzer will reflect the corrected gain in the measured result.

4.1.2.5 Trigger parameter setting

Under the default settings of spectrum measurement mode, the Series Signal Analyzer executes the measurement immediately when you start measurement through the **【Single】** and **【Cont】**, which is called free trigger normally. However, the measurement will not be executed sometimes until some measurement conditions are met. E.g., the measurement will be executed or not executed based on certain time period when the signal level exceeds one certain value. In such case, the trigger measurement will be used.

The trigger measurement refers to the measurement executed or capture of certain piece of data in the signal of interest when certain measurement conditions are met (also called trigger event). Setting different trigger modes and proper trigger parameters is of help for detecting different signal events. Parameter description of **【Trig】** key

Choosing different trigger modes (also called trigger source) by pressing **【Trig】** key on the front panel can enable the Series Signal Analyzer to execute different trigger measurement tasks. Under the spectrum analysis mode, the 4051 Series Signal/Spectrum Analyzer has many trigger modes, including free trigger, video trigger, power trigger, external trigger 1, external trigger 2, burst signal trigger and timer trigger.

4.1 Function operation guide

[Video] refers to the trigger measurement based on the video signal level; [Line] refers to the trigger measurement based on the power frequency signal of AC power supply; [External 1] refers to the trigger measurement based on the trigger input port signal of front panel; [External 2] refers to the trigger measurement based on the trigger input port signal of rear panel; [RF Burst] refers to the trigger measurement based on the signal power of RF input port; [Periodic Timer] refers to the predefined time period.

Except the timer trigger and free trigger, other trigger modes have the settings of [Trig Slope]. The 4051 Series Signal/Spectrum Analyzer can set the trigger polarity for these trigger modes respectively and the [Trig Slope Pos Neg] menu is located in the submenu of each trigger mode. Negative polarity indicates that the trigger event occurs when the trigger input signal level increases to the trigger level, while negative polarity indicates that the trigger event occurs when the trigger input signal level decreases to the trigger level.

Except the free trigger, other trigger modes have the settings of trigger delay. The 4051 Series Signal/Spectrum Analyzer can set the trigger delay for these trigger modes respectively and the [Trig Delay ON OFF] menu is located in the submenu of each trigger mode. When the trigger delay is set as “OFF” state, the corresponding menu displays [Trig Delay ON OFF]; the Series Signal Analyzer will execute the measurement immediately after the trigger event occurs. When the trigger delay is set as “ON” state, the corresponding menu displays [Trig Delay On Off], the Series Signal Analyzer will not execute the measurement until a period of time after the trigger event occurs. The trigger delay time can be set with number keys, Up/Down key or knob after the [Trig Delay ON OFF] is activated.

[Trig Holdoff] can set one time parameter, which limits the minimum time interval of occurrence of effective trigger event. When the trigger holdoff is opened, the trigger event that occurs within the trigger holdoff time will be neglected after one trigger event.

1) Execute video trigger measurement

The trigger input signal corresponding to the video trigger is the IF signal envelope displayed on the screen. The external trigger level can be set in such steps of pressing the **【Trig】** key on the front panel, entering [Video ▶], pressing soft menu of [Trigger Level] and then using the number keys, Up/Down key or knob. After entering [Video] menu, the Series Signal Analyzer will automatically execute the video trigger measurement. By default, the video trigger level is -25 dBm, and the display line (red) of trigger level and trigger level value will be displayed on the screen and the “Video Trigger” will be displayed in corresponding state bar, as shown in Fig. 4.2.

4.1 Function operation guide

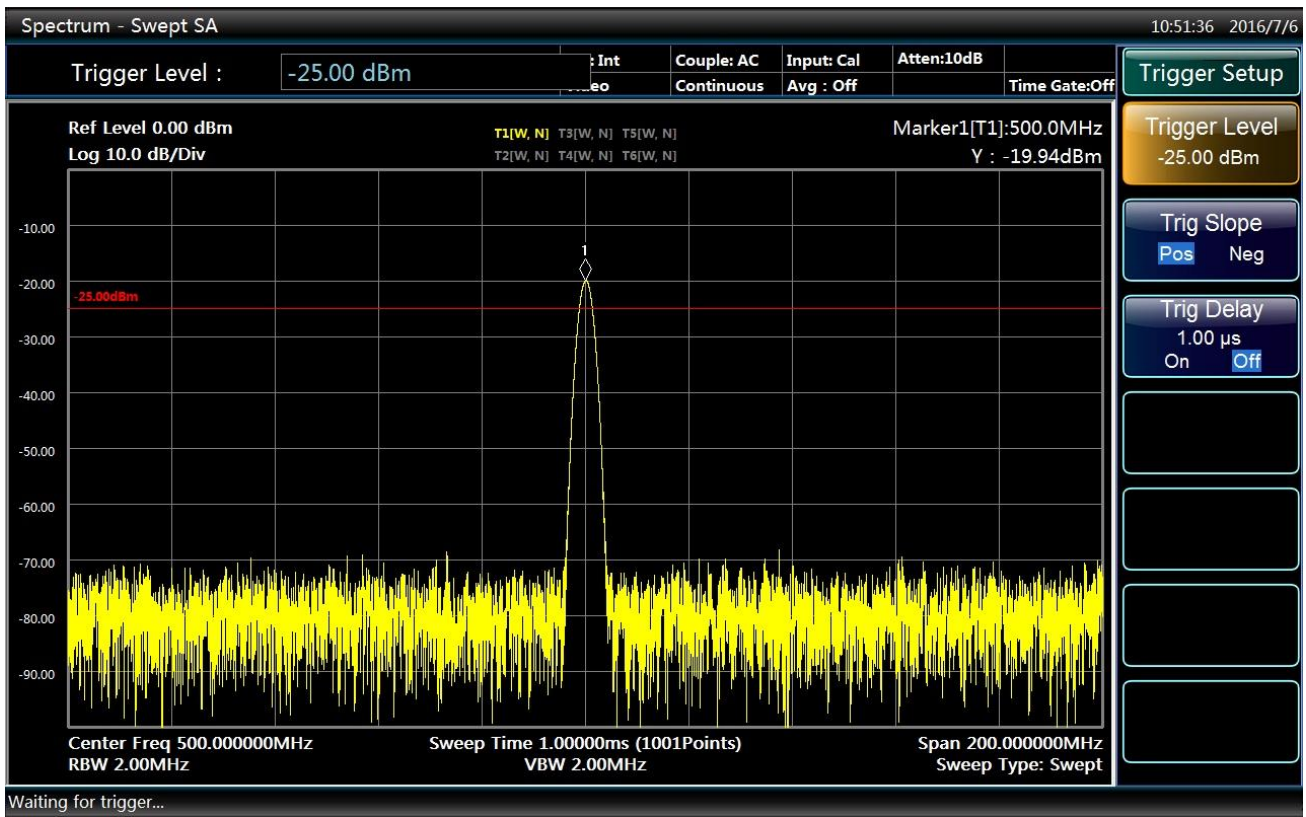

Fig. 4.2 Setting Interface of Video Trigger

Prompt

Applicable conditions of video trigger

Usually, the video trigger is applied to the time domain power measurement under zero span, while, under non-zero span (span > 0 Hz), the correct spectrum measurement may not be executed if the video trigger is set, then the burst signal trigger mode will be used instead of video trigger.

2) Execute external trigger measurement

The trigger input signal corresponding to the external trigger is the trigger input on the front panel (external trigger 1) or the trigger input on the rear panel (trigger input 2). The trigger input port on the front and rear panel is BNC. The input port can receive the signal provided by the external device with level ranging from -5 V - +5 V. The trigger input signal can be sine AC signal or TTL level signal. When the sine AC signal is input, the comparator circuit inside the Series Signal Analyzer will compare with the trigger level set and then convert it into TTL level signal.

The external trigger level can be set in such steps of pressing the **【Trig】** key on the front panel, entering [External 1 ▶] or [External 2 ▶], pressing soft menu of [Trigger Level] and then using the number keys, Up/Down key or knob. If the External Trigger 1 is activated, the Series Signal Analyzer will automatically select the trigger input signal on the front panel; if the External Trigger 2 is activated, the Series Signal Analyzer will automatically select the trigger input signal on the rear panel.

Prompt

In the state of external trigger measurement, please carefully inspect whether the analyzer is properly connected with the external device or not and ensure that the correct external trigger input signal is provided if the Series Signal Analyzer cannot execute the measurement properly.

3) Execute power trigger measurement

The trigger input signal corresponding to the power trigger is the power frequency signal of AC power supply provided for Series Signal Analyzer. The circuit inside the Series Signal Analyzer will automatically extract the signal and convert it into trigger input signal. The trigger polarity and parameters of trigger delay can be set in such steps of pressing the **【Trig】** key on the front panel and then entering [Line] menu. The trigger level is inactive during power trigger and the corresponding Power Trigger Menu is not available.

4) Execute burst signal trigger measurement

The trigger input signal corresponding to the burst signal trigger is the IF (intermediate frequency) signal envelope outputted by the Series Signal Analyzer at the second IF. Some Series Signal Analyzers are also known as IF power trigger, then the IF bandwidth is also known as trigger bandwidth. When the burst signal of the 4051 Series Signal/Spectrum Analyzer is triggering, the trigger bandwidth is about 200 MHz. When the non-zero bandwidth is being measured, the second IF signal approximately represents the signal of start frequency relating to the measurement of analyzer; when the zero bandwidth is being measured, the second IF signal approximately represents the signal of center frequency relating to the measurement of analyzer. As the Series Signal Analyzer has the IF bandwidth of 200 MHz, the noise limits the setting range of the trigger level, please refer to the Data Manual of 4051 Series Signal/Spectrum Analyzer for details.

The external trigger level can be set in such steps of pressing the **【Trig】** key on the front panel, entering [RF Burst ▶], pressing soft menu of [Trigger Level] and then using the number keys, Up/Down key or knob.

Prompt

The trigger level of the burst signal of the 4051 Series Signal/Spectrum Analyzer is set without considering the amplitude correction and reference level offset, so a larger difference may exist between the trigger level set by you and the signal level displayed by measurement, which can be eliminated by closing amplitude correction and modifying reference level offset.

Caution

When the start frequency in the state of nonzero bandwidth measurement or the center frequency in the state of zero bandwidth measurement is close to 0 Hz and less than 120 MHz, the LO feedthrough will cause the decrease of the trigger function or failure of trigger of the burst signal.

5) Execute timer trigger measurement

The trigger input signal corresponding to the timer trigger is the signal outputted periodically and regularly inside the Series Signal Analyzer.

In most cases, it is very complicated and difficult to measure the burst RF signal. Although the burst signal trigger is helpful for executing some routine measurement work of burst RF signal, measurement cannot be carried out sometimes due to many limiting conditions, e.g., the power of the burst RF signal to be measured is too small to form effective trigger signal or the power is less than 100 MHz. If you have already known the generation period of the signal, the measurement can be carried out by using timer. When the generation period of the burst RF signal is slow and drifting, or there is difference between the internal time base of Series Signal Analyzer and that of the device being measured, the measurement can also be carried out in such way as the 4051 Series Signal/Spectrum Analyzer adjusts the timer trigger offset and open the sync function of the timer trigger.

For the purpose of better understanding and using the timer trigger function, the sequence diagram relating to the measurement of the timer trigger is shown in Fig. 4.3. The synchronizing signal of timer trigger in the figure is selected as the signal from the port of trigger input 1 on the front panel. The waveform at the top of the figure is the signal waveform of the port of trigger input 1 on the front panel, whose rising edge will cause the timer to execute sync, then the timer will generate the timing pulse based on the time base provided by the Series Signal Analyzer until the end of sync source holdoff of timer, then the sync will proceed based on the

4.1 Function operation guide

rising edge of the trigger input. As the internal time base of the Series Signal Analyzer is different from that of the signal being measured, the input of timer will drift during the sync holdoff of timer. The timer offset determines the actual time of occurrence of the trigger event, when the timer trigger has occurred, the Series Signal Analyzer will not carry out the measurement until the trigger delay time if the trigger delay is on-state.

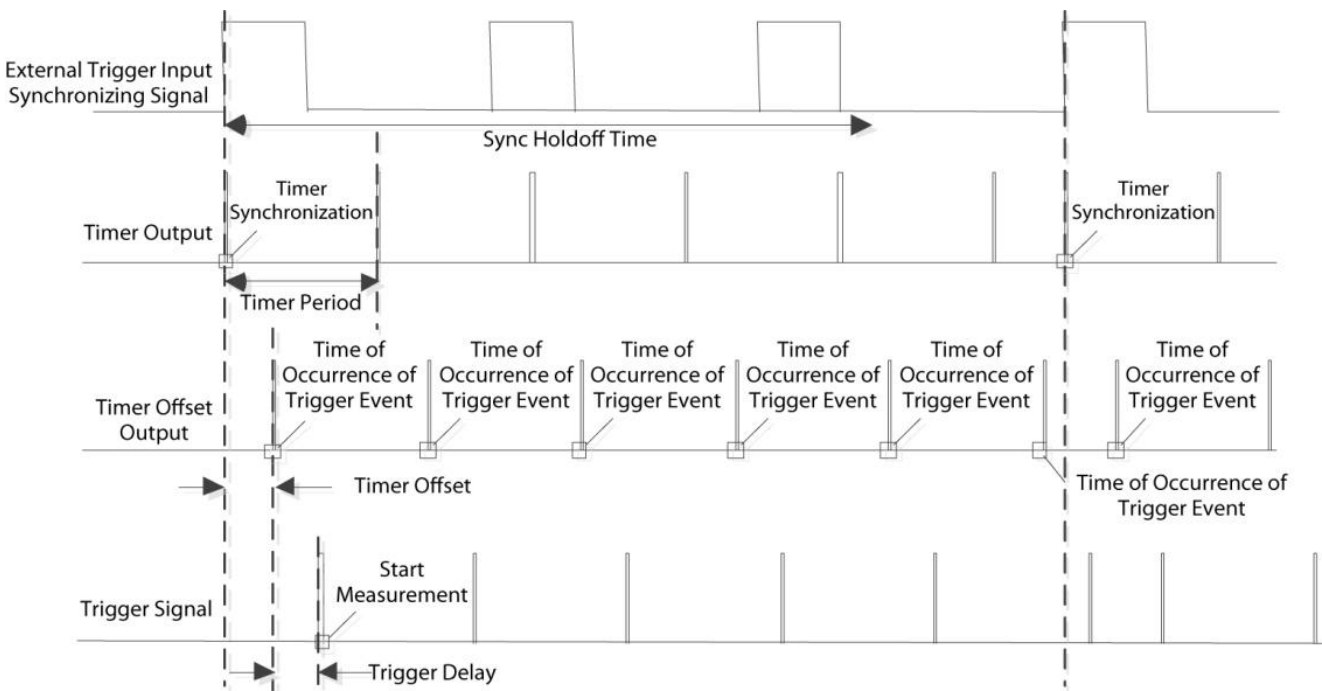

Fig. 4.3 Sequence Relation of Timer Trigger and Timing Sync

The parameters of timer trigger including [Sync Source], [Period], [Offset], [TrigHoldoff], [Trig Delay], etc. Can be set in such steps of pressing the **【Trig】** key on the front panel, entering [Periodic Timer ▶] and then using the number keys, Up/Down key or knob.

The sync source can be selected as external trigger 1, external trigger 2 or burst signal trigger. With the menu of [Sync Source], the trigger level and sync source polarity can be set through the [External 1], [External 2] and [RF Burst]. If the sync source is set as “Positive”, namely [Trig Slope Pos Neg], it means the sync of the rising edge of the timer output and sync source signal. If the sync source is set as “Negative”, namely [Trig Slope Pos Neg], it means the sync of the falling edge of the timer output and sync source signal. When the trigger level of the sync source is set, the trigger level in the corresponding trigger mode menu will change at the same time.

Caution

The timer offset

When the Series Signal Analyzer sets the parameters of timer trigger, it will first reset the internal timer to configure the timing parameters, default the timer offset as 0 s and then start the timer. When you modify [Offset] with the menu, the Series Signal Analyzer just modifies the time of occurrence of the trigger event instead of resetting or restarting the timer.

4.1.2.6 Parameter settings of **【Meas Setup】** and **【Meas Control】**

The section mainly describes the parameters corresponding to the **【Meas Setup】** key and **【Meas Control】** key on the front panel. The parameters corresponding to the **【Meas Setup】** key vary greatly with different measurement modes and measurement functions.

1) Description of parameters of **【Meas Control】** key

4.1 Function operation guide

The measurement state of the Series Signal Analyzer can be controlled with soft menus of [Restart] and [Pause] by pressing the **【Meas Control】** key. The menus of [Pause] and [Restart Measurement] cannot work at the same time. Menu description: when the Series Signal Analyzer is in operation, this menu is used for pausing current measurement; when in Paused status, this menu is used for continuing measurement. If the average or hold function is enabled, the average count will be frozen, then the measurement will stop accordingly.

When the Series Signal Analyzer stops measuring, the [Restart] is enabled; the Series Signal Analyzer will restart measuring by pressing [Restart] menu.

[Restart] is used to restart the current swiping or measurement; when the average/hold function of trace is enabled, the Series Signal Analyzer will reset the current average count and clear the previous hold results by pressing [Restart] menu.

Caution

If the Series Signal Analyzer is the in process of calibration or LO auto adjustment, it will not execute the corresponding operations until the end of the process of calibration or LO auto adjustment by pressing [Pause] or [Restart]

2) Parameter description of **【Meas Setup】 key**

Under the mode of spectrum analysis, the parameters set corresponding to the **【Meas Setup】** key on the front panel include [Average Num], [Average Type], [Limit Line], [PhNoise Opt] and [ADC Dither].

➤ Set trace average

The count of trace average and average type can be set by pressing **【Meas Setup】** key on the front panel. Starting the trace average needs to press the **【Trace】** key on the front panel, select the trace requiring average and enable the [Trace Average] menu.

[Average Num] is used to control the average count when the trace average (**【Trace】** key on the front panel) is enabled.

[Average Type] is used to control the averaging algorithm of trace data, including video average, voltage average or power average.

Video average (also called logarithm power average) refers to the average based on the signal level of the log unit being measured.

Power average (also called root mean square (RMS) average) refers to the process during which average results are again converted into the measured values displaying scale requirements after all measured values are converted into power values and averaged.

Voltage average refers to the process during which average results are again converted into the measured values displaying scale requirements after all measured values are converted into voltage values and averaged.

For more details relating to the trace average, please refer to the corresponding menu description.

If the trace average type is set as auto, the Series Signal Analyzer will automatically select the average type based on the detector type, marker function, amplitude scale, etc. Of the corresponding trace. Rules on auto selection of average type: if trace detector (for detector, please refer to relevant information stated in the section of 4.1.3) is power average, the average type is selected as power average; if the trace detector (for detector, please refer to relevant information stated in the section of 4.1.3) is voltage average, the average type is selected as voltage average; if the noise marker, bandwidth power or bandwidth density of the marker function (for marker function, please refer to relevant information stated in the section of 4.1.3) is opened, the average type is selected as power average; if the amplitude scale (for amplitude scale, please refer to relevant information stated in the section of 4.1.2.4) is selected as linear scale, the average type is selected as voltage average or video average.

4.1 Function operation guide

Prompt

Average operation in the 4051 Series Signal/Spectrum Analyzer

The trace average is to average the signal levels of multiple traces generated from swiping for many times.

The video average detector, power average detector and voltage average detector are to average the period of time or the frequency interval data reflected by the data of a certain point on one trace.

Noise marker is to average the data of multiple measurement points on the same trace to decrease the amplitude fluctuation.

The video filter is also considered to average the same trace being measured in a similar way.

Caution

The average operation carried out to the logarithm power data and the data conversion carried out to the data averaged will generate totally different measurement results.

➤ Limit line measurement

The function of limit line measurement can help you execute some specified conformance measurements quickly. The limit line can be edited and the limit line measurement can be started with [Limit Line Measurement] menu by pressing **【Meas Setup】** on the front panel.

➤ Control ADC dither

The ADC dither circuit of the Series Signal Analyzer can be opened and closed manually with [ADC Dither] menu corresponding to the **【Meas Setup】** key. The ADC dither function is helpful for improving the linearity low level signal measurement at the cost of compromising part of measurement SNR (signal to noise ratio) performance.

With ADC dither opened, the Series Signal Analyzer can provide better measurement linearity, so as to improve the fidelity of scale, which works effectively particularly during small-signal measurement. With ADC dither closed, the lower noise floor can be obtained.

Under default state, the ADC dither is under auto state; the Series Signal Analyzer sets the auto control of ADC dither to be open or close based on different measurements.

4.1.2.7 Parameter settings of coupling and auto

Many parameters of 4051 Series Signal/Spectrum Analyzer can be set automatically based on the current measurement state, so as to enable you to carry out measurement in a more convenient way.

If you hope to restore the measurement parameters from manual state to auto state quickly, all the measurement parameters will be restored to auto state by pressing **【Couple】** and enabling the [Couple All] menu. The menus corresponding to the **【Couple】** key also include the common [Mech Atten **AutoMan**], [Res BW **Auto** OFF], [Video BW **AutoMan**], [VBW/RBW], [Span/RBW], [Sweep Time **AutoMan**] and [CF Step **AutoMan**].

Caution

The corresponding menus

The parameters of corresponding menus will be modified accordingly after the auto parameter settings in the **【Couple】** menu are modified.

4.1.2.8 Input and output settings

The input and output settings are effective under all measurement modes and measurement functions of Series Signal Analyzer. The **【Input/Output】** key on the front panel is used to control the input and output parameters of Series Signal Analyzer. The input and output interfaces on the front and rear panel of Series Signal Analyzer may be involved generally when the input and output parameters are modified, which remain unmodified normally, so most input and output parameter settings are not modified when reset is carried out.

Caution

Input and output parameters

While input and output parameters are global parameters relative to the measurement mode and measurement function of Series Signal Analyzer, all measurement modes and measurement functions can be affected by modifying those parameters, some parameters are invalid under some measurement modes or measurement functions.

1) Set frequency reference

The frequency reference signal used by the Series Signal Analyzer can be selected from internal or external with [Freq Ref **Int** Ext] menu by pressing **【Input/Output】** key on the front panel.

Caution

The frequency reference

When the frequency reference is set as “Internal”, the reference output of the rear panel is the 10 MHz signal inside the analyzer; if the frequency reference is set as “External”, the reference output of the rear panel is the reference input signal of rear panel.

When the frequency reference of the Series Signal Analyzer is set as “Internal”, it still uses the internal reference signal of 10 MHz even the reference input port of the rear panel is connected with the external device.

When the frequency reference is set as “External”, the Series Signal Analyzer will use the reference signal provided by the external reference input port of rear panel, the screen message display area will display “Reference: External”. If incorrect external reference input signal is sensed, e.g., reference input not available, the signal power fails to reach the required power range, the error message prompt area will display “Invalid External Reference”. Once the external reference reaches those required by the Series Signal Analyzer, the error message will be cleared.

2) Set input port

➤ Settings of input port selection

The signal measured by the Series Signal Analyzer can be selected as the RG signal inputted from front panel or the internal calibration signal with [Input Port **RF** CAL] menu by pressing **【Input/Output】** key on the front panel.

The screen message display area on the front panel will display the RF input state. If the calibration signal is selected, the “Input: Calibration” will display; if the RF input signal of front or rear panel is selected, the “Input: RF” will display.

➤ Settings of calibration port selection

4.1 Function operation guide

If the RF input is selected as calibration, namely [Input Port RF **CAL**], any one of three calibration signals including 500 MHz sine signal, comb wave signal and 4.8 GHz sine signal inside the analyzer can be selected through [Cal Port].

The internal calibration signals of the Series Signal Analyzer are mainly used to calibration of analyzer. When the calibration operation is running (the calibration can be carried out to the analyzer with soft menu of [Align ▶] by pressing **【System】** key on the front panel), the analyzer will automatically select those calibration signals without concern of users.

Setting the RF input to calibration can help you learn to use the analyzer or judge whether fault exists in the analyzer.

➤ Settings of coupling method

The coupling method can be switched with [Input Couple AC **DC**] menu by pressing **【Input/Output】** key on the front panel and then entering [More 1/2 ▶]. AC represents AC coupling, while DC represents DC coupling. Signal/spectrum analyzer uses DC coupling by default.

When the input coupling is selected as AC coupling, the blocking capacitor will insert into the back end of the RF input to prevent the DC signal from entering the internal circuit of the Series Signal Analyzer, so as to effectively protect the Series Signal Analyzer from being damaged due to the DC voltage existing in the RF input port. However, the AC coupling will limit the frequency measurement range of the Series Signal Analyzer, mainly the measurement of lower frequency signal, e.g., the input signal less than 10 MHz.

For the signal less than 10 MHz, the measurement performance of the 4051 Series Signal/Spectrum Analyzer is guaranteed under DC coupling.

If the input coupling is selected as DC coupling, it should be noted that the range of the DC voltage existing in the RF input port must be ensured between 0 V - 200 mv.

Regardless of DC coupling or AC coupling, the power of the signal of the RF input port cannot exceed + 30 dBm (1 W).

➤ Settings of input impedance

The unit correction value can be modified with [Input Impedance 50 Ω **75 Ω**] menu by pressing **【Input/Output】** key on the front panel and then entering [More 1/2 ▶]. The actual impedance of the hardware circuit of the Series Signal Analyzer is 50 Ω . The input impedance is only used for the purpose of calculation, only affecting the measurement results. When the scale of Y Axis uses the voltage or current (dBmv, dB μ V, dB μ A, V, A) as the unit, the input impedance only affect the measurement results; while it uses the power (dBm, W) as the unit, the measurement results are not affected.

When users measure the device with impedance of 75 Ω by using the 75 Ω -50 Ω adapter, it is very meaningful to set the input impedance as 75 Ω .

3) Set reconstructed signal output (optional)

Multiple auxiliary output ports on the rear panel of the Series Signal Analyzer can be set with [Reconstructed Signal Output ▶] menu by pressing **【Input/Output】** key on the front panel. The auxiliary output ports can help you use the Series Signal Analyzer to construct the measurement system or output to other external devices to test, while the output port is not applicable to all measurement modes and measurement functions.

➤ Set reconstructed any IF output (option H04A + H04B)

The 4051 Series Signal/Spectrum Analyzer is to realize the any IF output function with two technological approaches: the first one is to reconstruct the internal fixed IF signal to any IF signal with the digital processing technology and output through the ports including narrowband I, narrowband Q and broadband I (differential) on the rear panel with SMA female connector; the second one is to convert the second IF signal into the any IF signal through the analog mixer and output, and the corresponding output interface on the rear panel is IF 2.

4.1 Function operation guide

The settings and use methods of the reconstructed any IF output will be described below. The function of the reconstructed any IF output is only applicable to the transient analysis in the I/Q analysis mode and signal analysis mode. The different signal types can be selected for the output ports of narrowband I, narrowband Q, broadband I (differential output port) and broadband Q (differential output port) on the rear panel by setting reconstructed signal output. The corresponding relation is shown as Table 4.1. From the above table, it can be seen that the reconstructed any IF output, AM/FM demodulation output, I/Q demodulation output and detector cannot remain valid at the same time.

Table 4.1 Signal Type of Narrowband and Broadband Output Interface of Rear Panel

Parameter setting	Narrowband I	Narrowband Q	Broadband I (Differential)	Broadband Q (Differential)
Any IF Output (Bandwidth \leq 40 MHz)	IF signal	Invalid	Invalid	Invalid
Any IF Output (Bandwidth $>$ 40 MHz)	Invalid	Invalid	IF signal	Invalid
AM/FM Demodulation Output (Bandwidth \leq 40 MHz)	AM Demodulation Signal	FM Demodulation Signal	Invalid	Invalid
AM/FM Demodulation Output (Bandwidth $>$ 40 MHz)	Invalid	Invalid	AM Demodulation Output	FM Demodulation Output
I/Q Demodulation Output (Bandwidth \leq 40 MHz)	I channel signal	Q channel signal	Invalid	Invalid
I/Q Demodulation Output (Bandwidth $>$ 40 MHz)	Invalid	Invalid	I channel signal	Q channel signal
Detector output (Bandwidth \leq 40 MHz)	Detector output	Invalid	Invalid	Invalid
Detector output (Bandwidth $>$ 40 MHz)	Invalid	Invalid	Detector output	Invalid

The step configuration is carried out for the reconstructed IF output bandwidth within 100 Hz - 200 MHz on the basis of 1-2-5. Only when the 40 MHz broadband digital IF (option H38A) or 200 MHz broadband digital IF (option H38B) is configured is the function of reconstructed IF output enabled, while the any IF output (option H04A) is being configured. The output range of IF and bandwidth vary with different options selected, the specific mapping relation is shown in Table 4.2.

Table 4.2 Function of Reconstructed Any IF Output and Option Configuration Relation Table

Configuration Combination of Options	Output Range and Bandwidth of Any IF (Narrowband I Port)	Output Range and Bandwidth of Any IF (Broadband I Port)
Option H04A	IF Range: 10 MHz - 75 MHz Band width: 10 MHz	Invalid
Option H04A + Option H38A	IF Range: 10 MHz - 75 MHz Bandwidth: \leq 40 MHz	Invalid
Option H04A + H04B + Option H38A + H38B	IF Range: 10 MHz - 75 MHz Bandwidth: \leq 40 MHz	IF Range: 10 MHz - 140MHz Bandwidth: 50 MHz/100 MHz/200 MHz

The IF can be set with number keys, Up/Down stepping keys and knob in the [Reconstructed IF ►] menu in the [Reconstructed Signal Output ►] menu by pressing 【Input/Output】 key on the front panel.

The Series Signal Analyzer applies different frequency conversion plans for different wavebands, so the IF output signal spectrum may invert in comparison with the RF input signal spectrum, that is, the left and right

4.1 Function operation guide

signal spectrum exchange with each other centering around center frequency, then the inversion can be switched with the [Spectrum Inversion Switch] soft menu.

The IF output frequency can also be adjusted with the menu of [Reconstructed IF ▶] and [Digital Gains]. The gain of the 4051 Series Signal/Spectrum Analyzer is 0 dB by default, then the IF output power is 8 dB - 12 dB less than the RF output power, e.g., if the RF input power is -10 dBm, the IF output power is -18 dBm to -22 dBm. If you set the digital gain as 6 dB, the IF output power will amplify by 6 dB.

Caution

To change the output SNR

The adjustment function of digital gain in the [Reconstructed IF ▶] menu is realized through the digital processing technology, so the parameters are only used to adjust the IF output power instead of changing the output SNR.

If you hope to change the output SNR, the parameters including reference level, attenuator, PreAmplifier, etc. Can be set with [Amplitude/Axis] key.

➤ **Set AM/FM demodulation output (option H04A + H04B)**

The 4051 Series Signal/Spectrum Analyzer demodulates the AM/FM signal with digital technology and outputs through the ports including narrowband I, narrowband Q, broadband I (differential) and broadband Q (differential) on the rear panel with SMA female connector. The step configuration is carried out for the demodulation bandwidth within 100 Hz - 200 MHz on the basis of 1-2-5. Only when the 40 MHz broadband digital IF (option H38A) or 200 MHz broadband digital IF (option H38B) is configured is the function of AM/FM demodulation output enabled, while the AM/FM demodulation output (option H04A) is being configured. The demodulation bandwidth range varies with different options selected, the specific mapping relation is shown in Table 4.3.

Table 4.3 AM/FM Demodulation Output Function and Option Configuration Relation Table

Configuration Combination of Options	Demodulation Bandwidth (Narrowband I and Narrowband Q Port)	Demodulation Bandwidth (Broadband I and Broadband Q Port)
Option H04A	Demodulation bandwidth: ≤ 10 MHz	Invalid
Option H04A + Option H38A	Demodulation bandwidth: ≤ 40 MHz	Invalid
Option H04A + H04B + Option H38A + H38B	Demodulation bandwidth: ≤ 40 MHz	Demodulation bandwidth: 50 MHz/100 MHz/200 MHz

When the reconstructed signal output is selected as the AM/FM demodulation output, the narrowband I or broadband I port outputs AM demodulation signal, while narrowband Q or broadband Q port outputs FM demodulation signal.

The [AM Digital Gain] and the [FM Digital Gain] in the [AM/FM Demodulation ▶] menu is available for the adjustment of output voltage. The gain of the 4051 Series Signal/Spectrum Analyzer is 0 dB by default, so the output voltage of the demodulation signal will double if you set the output gain as 6 dB.

➤ **Set detector output**

The 4051 Series Signal/Spectrum Analyzer carries out the envelope detector and logarithmic detector for the RF signal with digital processing technology and outputs through the narrowband I port on the rear panel with SMA female connector. The step configuration is carried out for the detector bandwidth within 100 Hz - 10 MHz on the basis of 1-2-5. When the 40 MHz broadband digital IF (option H38A) is being configured, the detector bandwidth can be extended to 40 MHz.

You can set the output as logarithm or linearity with the [Output Options] in the [Detector Output ▶] menu, while the default setting of the 4051 Series Signal/Spectrum Analyzer is logarithm. The [FM Digital Gain] in

4.1 Function operation guide

the [Detector Output ▶] menu is also available for the adjustment of the voltage of detector output signal. The 4051 Series Signal/Spectrum Analyzer is 0 dB by default.

Caution

The [Bandwidth] menu in the function settings menu of [Reconstructed Signal Output ▶] in the 4051 Series Signal/Spectrum Analyzer is only used to indicate the value of the current IF bandwidth (reconstructed IF output), demodulation bandwidth (AM/FM demodulation output or I/Q demodulation output) or the detector bandwidth (detector output). If those parameters are required to be changed, the settings can be carried out by selecting relevant menu through the **【Meas Setup】** key of measurement functions.

Caution

The functions including reconstructed IF output, AM/FM demodulation output, I/Q demodulation output and detector output of the 4051 Series Signal/Spectrum Analyzer are only applicable to the I/Q analysis mode and transient analysis mode.

➤ Set broadband logarithmic detector output (option H08)

The second IF signal inside the 4051 Series Signal/Spectrum Analyzer will go through one fast log amplification and detector module, and it will output the detector signal to the detector output port (BNC) of the rear panel. For every 1 dB change in RF input signal, the open-circuit output level of the detector output port varies about 25 mv. When the power of the RF input signal is 0 dBm, the voltage of the detector output port is 1 V (Different Series Signal Analyzers may vary slightly on this). In comparison with the digital detector output, the detector output features faster rise time and shorter delayed response time), which can be used for the test of pulse signal.

The function can be opened or closed with [Detector Output] menu in the [Reconstructed Signal Output ▶] menu by pressing **【Input/Output】** key on the front panel.

4) Set High IF output

The 4051 Series Signal/Spectrum Analyzer connects the internal High IF of analyzer to the IF 1 output port on the rear panel (SMA female) The function can be opened or closed with [High IF Output] menu by pressing **【Input/Output】** key on the front panel.

Caution

4051 Series Signal/Spectrum Analyzer uses the electronic switch to control whether the second IF signal is used for the internal service or outputted to external ports, so the analysis function cannot execute properly when the second IF output is selected as “On”.

4.1.3 Operation guidance on general analysis and display function

The section mainly describes the operation guidance on the general analysis and display that are carried out by the 4051 Series Signal/Spectrum Analyzer using trace and marker under the spectrum analysis mode. Regardless of measurement mode or measurement task, those operations are of great help to familiarize you with the 4051 Series Signal/Spectrum Analyzer and its use. The measurement and analysis method may vary if you are using other measurement modes, please refer to the user manual of corresponding measurement mode.

- Trace detector and trace operation.....82
- Marker.....87

4.1 Function operation guide

4.1.3.1 Trace detector and trace operation

The trace refers to a set of sampling points of data, each of which (x, y) has one x value generally representing frequency or time and y value generally representing amplitude. Each data point is also called trace point. In any trace, the first data point is called trace 0, while the last one is called trace (sweep point -1). The trace points are also called sweep points. For the spectrum trace, one trace point is generally corresponding to one frequency interval, also called Bucket sometimes, and the measured value Y represents a measured data corresponding to one Bucket. The menu corresponding to the **【Trace】** key on the front panel can help you configure the measured trace and complete the trace operation.

Each trace can be considered to be one analysis implemented to the measured data. Each trace window of the 4051 Series Signal/Spectrum Analyzer can display 6 traces. The trace configurations determine how the measured data analyzes and displays. The section mainly describes how to configure the trace and execute trace operation.

1) Concept of trace detector

When the sweep type is sweep under the spectrum analysis mode, the Series Signal Analyzer control the LO by digital mode to carry out step sweep in smallest frequency. During the entire sweep period, the sampling points captured by ADC in the digital IF circuit are much larger than the sweep points that used by the Series Signal Analyzer for display. When the sweep type is FFT, the Series Signal Analyzer tunes the LO to fixed frequency point. During the entire measurement period, after the FFT is carried out, the sampling points captured by ADC in the digital IF circuit may be larger than the sweep points that used by the Series Signal Analyzer for display.

E.g., we assume that the sampling frequency of ADC is 100 msa/s, sweep points are 1000, sweep time is 100 ms and the span is 1 GHz. For each sweep, the Series Signal Analyzer captures 100×10^5 sampling points, which are needed to be turned into 1001 trace data. Equivalently, every 100,000 sampling data is corresponding to the trace data at one point, while each trace datum represents the signals appeared with frequency range of 1 MHz. If the sweep points are added, the span corresponding to each trace datum is narrower, the measured results are more stable and the frequency readout accuracy is higher.

From the above analysis, it can be seen that the trace display needs to turn the more sampling data points into the less sweep trace points, which is what the trace detector needs to do.

There are many types for the trace detector modes. The 4051 Series Signal/Spectrum Analyzer has 7 trace detector modes:

➤ Normal detection

Take the maximum value and minimum value from the sampling data assigned to each trace point and display them at the same time.

➤ Positive peak detection

Take and display the maximum value from the sampling data assigned to each trace point.

➤ Negative peak detection

Take and display the minimum value from the sampling data assigned to each trace point.

➤ Sampling Value Detector

Take and display the last value from the sampling data assigned to each trace point.

➤ Power Average Detector

Also called root mean square (RMS) detector. Calculate the root mean square of all sampling data assigned to each trace point; the 4051 Series Signal Analyzer envelopes the detector for the RF input signal and obtains linear voltage. After square these voltage values, take sum and divide the count of sampling data points corresponding to each trace point. Finally, take square root. When the scale is logarithm, take 20 times of logarithm transformation for these RMS values (with 10 as base) and obtain the trace data. When the scale is linear, those RMS values are trace data.

➤ **Voltage Average Detector**

Also called average (AVG) detector. Take linear average for all sampling data assigned to each trace point; the 4051 Series Signal Analyzer envelopes the detector for the RF input signal and obtains linear voltage. After summing those voltage values, divide the number of sampling data points corresponding to each trace point. When the scale is logarithm, take 20 times of logarithm transformation for these RMS values (with 10 as base) and obtain the trace data. When the scale type is linear, those average values are trace data.

➤ **Video Average Detector**

Also called Logarithm Power Average Detector, i.e., take the logarithm power average value for all data assigned to each trace point; earlier Series Signal Analyzer generally displays the measurement trace of logarithm scale, and all filtering and averaging are based on the logarithm power data; the trace is generally called as video signal. After digital IF processing is adopted, to make measurement results same as the earlier Series Signal Analyzer, the video average detector function is added.

The trace detector mode of 4051 Series Signal/Spectrum Analyzer can be manually set or set as auto selection. When the detector mode is set as auto selection, the Series Signal Analyzer will automatically select the suitable detector mode based on the current trace processing mode, marker function and trace average type.

2) **Concept of trace processing**

When the Series Signal Analyzer is in the continuous sweep mode or has carried out the sweep measurement continuously for many times, the trace processing mode determines how the current measured trace deals with the previous measured traces to obtain new trace.

The 4051 Series Signal/Spectrum Analyzer has four trace processing modes:

➤ **Refresh**

New trace is directly assigned with the current measured trace, irrelevant with the previous measured traces.

➤ **Average**

Based on the average count N set in the **【Meas Setup】**, update trace is obtained after averaging the performance index of the measurement trace.

Detailed algorithm:

New trace = ((K-1) previous trace + current measurement trace)/K

Where, K is accumulated average count.

Under continuous measurement, when K is accumulated to the average count N set in the **【Meas Setup】**, the K will always equal to N. Under single measurement status, when K is accumulated to the average count N set in the **【Meas Setup】**, the measurement will stop.

➤ **Max. Hold**

The new trace data is assigned with maximum value of previous measured trace data.

➤ **Min. Hold**

The new trace data is assigned with minimum value of previous measured trace data.

For each trace activated, the trace processing mode is defaulted to refresh in the 4051 Series Signal/Spectrum Analyzer.

3) **Trace display ON/OFF**

The trace display ON/OFF indicates whether the trace will execute and be displayed on the display area of the front panel. There are four types of the 4051 Series Signal/Spectrum Analyzers:

➤ **Refresh Display(Trace on)**

New trace will execute refresh in the internal part of application (backstage) and will be displayed on the display area of the front panel.

4.1 Function operation guide

➤ **Static Display (View)**

When the trace [View/Blank] is set as “View”, the signal/spectrum will keep the most recent trace and do not go through trace processing. The latest trace will be displayed in the display area of the front panel.

➤ **Backstage Refresh (Background)**

New trace will execute refresh in the internal part of application (backstage), but not be displayed on the display area of the front panel. This type is commonly applied in remote control.

➤ **Display OFF(Blank)**

“Display OFF” indicates that the Series Signal Analyzer neither goes through backstage trace processing nor display. That means, the trace is not activated and is OFF.

For each trace activated, the Trace on is defaulted to refresh display in the 4051 Series Signal/Spectrum Analyzer.

4) **How to activate and configure trace**

The 4051 Series Signal/Spectrum Analyzer can activate up to 6 traces at the same time including Trace 1, Trace 2, Trace 3, Trace 4, Trace 5 and Trace 6. The Series Signal Analyzer only activates Trace 1, the processing mode of Trace 1 is “Refresh”, Display ON/OFF of Trace 1 is set as “Refresh Display”, the detector of Trace defaults to auto and other 5 traces are in Display OFF (OFF) state by default.

The prompt area of screen trace message displays:

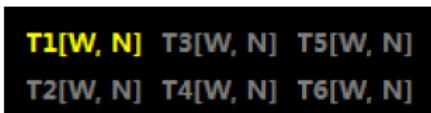

Multiple traces can be selected, activated and configured with [Select Trace] submenu by pressing **【Trace】** key on the front panel. For the purpose of better understanding and reasonably configuring the trace, we assume that the Series Signal Analyzer is in the default state and the Trace 1 is activated with processing mode of “Refresh”, Display ON/OFF set as “Refresh Display” and Detector Mode automatically selected as Normal. Please activate and configure Trace 2 based on the following steps:

Step 1. Select Trace 2:

Select the Trace 2 in the [Select Trace] submenu by pressing **【Trace】** key on the front panel. After it is selected, the Series Signal Analyzer returns to the previous menu automatically. Then the [Select Trace] soft key menu displays [Select Trace 2], which indicates that the subsequent trace processing mode settings and trace Display ON/OFF operation are only applicable to the Trace 2.

Step 2. Select the processing mode of Trace 2 and activate Trace 2:

When you press the [Clear Write] soft menu, the Series Signal Analyzer will automatically activate the Trace 2 and set its processing mode as Refresh, [View/Blank] menu as [Trace On] and detector mode as Auto.

If you directly enter the [View/Blank] menu instead of pressing [Clear Write] soft menu and select [Trace On], the Series Signal Analyzer will also activate the Trace 2 and set its processing mode as Refresh, [View/Blank] as [Trace On] and detector mode as Auto. It can be seen that the [Trace On] soft menu appears light blue representing active.

Step 3. Select Max. Hold for the processing mode and sample detector for the detector mode of Trace 2:

By pressing [Max Hold] menu, the Trace 2 will be set as Max. Hold, the character “*” will pop up in the [* Max Hold] menu and the detector mode of Trace 2 will be automatically set as Auto same as Trace 1. The detector of Trace 2 will be changed to manual sample detector by selecting [Sample] for the detector in the [Detector] submenu.

Caution

Traces and the type of detector

As the 4051 Series Signal/Spectrum Analyzer can only use one type of detector at the same time, other active traces will change to use the same type of detector when the detector mode of any trace is changed.

5) Rules on auto trace average and auto trace detector

If the trace average type is set as auto, the Series Signal Analyzer will automatically select the average type based on the detector type, marker function, amplitude scale, etc. Of the corresponding trace. Rules on auto selection of average type: if trace detector (for detector, please refer to relevant information stated in the section of 4.1.3) is power average, the average type is selected as power average; if the trace detector (for detector, please refer to relevant information stated in the section of 4.1.3) is voltage average, the average type is selected as voltage average; if the noise marker, bandwidth power or bandwidth density of the marker function (for marker function, please refer to relevant information stated in the section of 4.1.3) is opened, the average type is selected as power average; if the amplitude scale (for amplitude scale, please refer to relevant information stated in the section of 4.1.2.4) is selected as linear scale, the average type is selected as voltage average or video average.

If the trace detector is set as auto, the Series Signal Analyzer will automatically select the detector type based on the processing mode, average type, marker function, amplitude scale, etc. Of the corresponding trace. Rules on auto selection of detector type: if the noise marker, bandwidth power in the marker function of the current trace or any function of bandwidth density function is enabled, the detector mode is automatically selected as power detector; if the trace average type is power average, the detector mode is automatically selected as power detector, if the trace processing mode is Max. Hold, the detector mode is automatically selected as Max. Value; if the trace average is voltage average, the trace detector is automatically selected as voltage average; if the amplitude scale is linear scale, the detector mode is selected as voltage average detector; if the trace average type is selected as video average, the detector mode is automatically selected as video average; if the trace processing is Min. Value Hold, the detector mode is automatically selected as Min. Value or normal.

If the trace average type and trace detector type are auto, the auto rules are based on the last settings. E.g., if the last operation is trace average type settings, the auto rules of detector type are followed; if the last operation is detector type settings, the auto rules of average type are followed.

6) Clear trace and clear all traces

Clearing trace is to restore the trace data currently selected in the Series Signal Analyzer to defaults. If the current trace processing mode is not Min. Hold, clearing trace will reset the trace data to the minimum value state; if the current trace processing mode is Min. Hold, clearing trace will reset the trace data to maximum value state.

Clearing all traces is to restore all trace data currently selected in the Series Signal Analyzer to defaults. If the current trace processing mode is not Min. Hold, clearing trace will reset the trace data to the minimum value state; if the trace with processing of Min. Hold exists, clearing trace will reset the trace data to maximum value state.

Clearing trace and clearing all traces will not change any variable and parameter of analyzer.

7) Open and use trace operation

Trace operation refers to the mathematical operation carried out to the data of two traces. The Series Signal Analyzer can take mathematical operation for any two traces from the active 6 ones, and save the results to the update data of the second trace. The trace operation in the 4051 Series Signal/Spectrum Analyzer includes addition and subtraction.

The math rule is used for specifying the data type of two traces under processing, including logarithmic power, linear voltage (current) or linear power.

4.1 Function operation guide

The trace operation will be executed with [Math] submenu in the [More1/2 ▶] menu by pressing **【Trace】** key on the front panel. Specific steps are as follows.

Step 1. Select the trace corresponding to the Operand through [Operand1 ▶] Select menu:

Select any trace among Trace 1 to Trace 6 by pressing [Operand 2 ▶] menu; if the trace selected is not active, the Series Signal Analyzer will automatically activate this trace.

Step 2. Select the trace corresponding to the Operand through [Operand2 ▶] menu:

Select any trace among Trace 1 to Trace 6 by pressing [Operand 2 ▶] menu; if the trace selected is not active, the Series Signal Analyzer will automatically activate this trace.

Step 3. Execute trace addition:

When the [Op1+Op2->Op2] menu is pressed, the Series Signal Analyzer will automatically activate the trace operation and carry out addition operation to the trace corresponding to Operator 1 and the trace corresponding to Operator 2 and then save the results to the trace corresponding to Operator 2.

Step 4. Execute trace subtraction:

When the [Op1-Op2->Op2] menu is pressed, the Series Signal Analyzer will automatically activate the trace operation and carry out the subtraction operation to the trace corresponding to Operator 1 and the trace corresponding to Operator 2 and then save the results to the trace corresponding to Operator 2.

Step 5. Change operational rules:

When the [Mode▶] menu is pressed, the data type of two traces in the operation will be changed. Operational rules are logarithmic by default.

Step 6. Close trace operation:

When the [OFF] menu is pressed, the Series Signal Analyzer will close the trace operation.

Caution

The operation results can only be obtained by executing sweep measurement. During process of trace operation, clearing trace, uploading trace and copying trace from file will affect the results of trace operation, so those operations should be avoid.

8) Understand the relation of trace processing and trace operation

The trace operation is the mathematical operation carried out to the current active traces (any two traces from 6 ones) during one sweep, while the trace processing is to average or hold the traces obtained during many sweeps. Whenever the trace operation function is enabled, operational rules are changed or operator selected is changed, the trace data saving operation results will be cleared and the sweep measurement will be re-executed.

After the trace is obtained, execute trace operation, then trace processing and save the processing results to new trace for display or that transferred to the users through programmable interface. The specific relation is shown in Fig. 4.4.

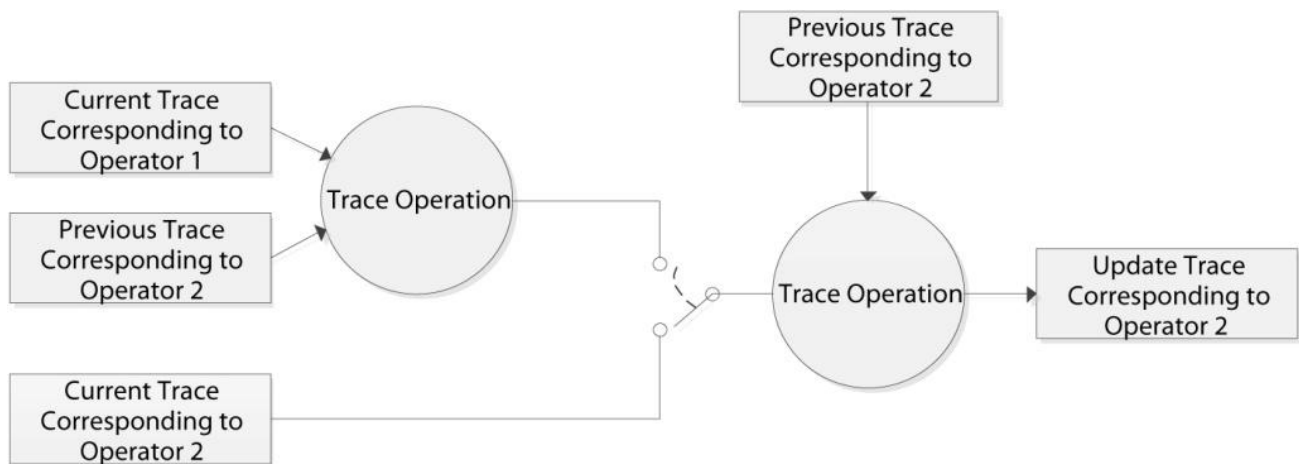

Fig. 4.4 Relation of Trace Processing and Trace Operation

Fig. 4.4 provides the relation figure of trace operation and trace processing corresponding to Operator 2. When the trace operation function is enabled, the current trace data of trace processing comes from the results of trace operation, while the trace operation function is disabled, the current trace data of trace processing comes from the traces obtained currently, then update the trace after trace processing including averaging or holding with previous trace. The trace updated is used for display or transferred to the users through programmable interface.

The Series Signal Analyzer will always execute trace operation and trace processing to all active traces based on the sequence of Trace 1, Trace 2, Trace 3, Trace 4, Trace 5 and Trace 6, which is very important. E.g., if the Operator 1 set by you is corresponding to the Trace 1, while the Operator 2 is corresponding to the Trace 2, the current trace corresponding to the Operator 1 is the trace data that has already gone through detector and trace average/hold when the Trace 2 is executed.

9) Copy trace

Copying trace is used to help you select the data of one trace (e.g., Trace 1) and copy them to any trace selected (e.g., Trace 2). Note that Copy Trace is only an operation rather than parameter setting; therefore, it is only performed once and not for every sweep and measurement.

The Copy Trace will be executed with [Copy] submenu in the [More 1/2 ▶] menu by pressing **【Trace】** key on the front panel. Assuming that we hope to copy the data of Trace 2 to Trace 3, the execution steps are as follows:

Step 1. Select Trace 2 as the one corresponding to the Operand 1 through [Operator 1 ▶] menu:

Select Trace 2 by pressing [Operand 1▶] menu after entering [Copy] submenu.

Step 2. Select Trace 3 as the one corresponding to the Operand 2 through [Operator 2 ▶] menu:

Select Trace 3 by pressing [Operand 2▶] menu after entering [Copy] submenu.

Step 3. Execute Copy Trace

The Series Signal Analyzer will execute single Copy Trace by pressing [Op1 -> Op2] menu after entering [Copy] submenu.

4.1.3.2 Marker

Marker can help you quickly select and read specific trace data and accurately locate the position of one measured data in the trace, obtain its information and indicate its position. Each active window of the 4051 Series Signal/Spectrum Analyzer can activate up to 12 markers.

The marker function is to execute the more complicated measurement process and calculation function on the basis of marker measurement, which can help you execute noise measurement, signal demodulation, high-accuracy frequency measurement, etc.

4.2 Advanced operation guide

The section mainly describes the basic concept and operation methods of marker and marker function. The marker function is not available for all measurement modes and measurement functions. The corresponding menu will not display in the measurement function without marker or marker function.

1) Type of marker

The 4051 Series Signal/Spectrum Analyzer has three types of markers:

➤ [Normal Marker]

Indicating that the marker is position marker. The normal marker can move on the trace points by assigning X Axis value, and the corresponding trace value is the absolute value of Y Axis.

➤ Delta Marker

Indicating that the marker is numeric marker. The delta marker refers to the relative value between the selected marker and its reference marker. The delta marker can move on the trace data by assigning the relative value of X Axis between itself and its reference marker.

➤ Fixed Marker

Indicating that the marker is position marker. As the name suggests, the fixed marker means that it remains stationary in the designated position. The fixed marker can move by assigning X Axis and Y Axis or peak-peak search. Once the move of fixed marker is finished, it will remain stationary. If the normal marker or delta marker is to be changed to fixed marker, the X Axis position and Y Axis value corresponding to the marker will remain unchanged.

2) Active marker

One marker is corresponding to one trace, so the marker will be activated only when it is displayed on the active window. If the trace display in the current active window is closed, the corresponding trace marker and marker function will automatically close accordingly. The active marker appears white diamond in the corresponding screen position.

By default, when the **【Marker】** key on the front panel is pressed, the 4051 Series Signal/Spectrum Analyzer will automatically activate Marker 1 with type of normal marker, which is corresponding to the trace selected currently, and place the position of marker in the center of display area, namely the center of x Axis.

The Series Signal Analyzer will automatically activate the markers and set them as normal marker after being selected through soft keys after entering [Select Marker ▶].

4.2 Advanced operation guide

This section introduces the relatively complex measurement procedures of 4051 Series Signal/Spectrum Analyzer.

● Multi-signal measurement.....	89
● Distortion measurement.....	98
● Measurement small signals.....	107
● Increase frequency resolution by using frequency count function.....	112
● Noise signal measurement.....	114
● AM signal demodulation.....	117
● Drift signal measurement.....	123
● Improvement of amplitude measurement accuracy by applying amplitude correction function.....	126
● Time gate measurement.....	128
● Channel Power.....	142

● Occupied Bandwidth.....	144
● Adjacent Channel Power.....	146
● Power Statistic.....	150
● Burst Power.....	154
● Harmonic Distortion.....	156
● Three-order Intermodulation.....	158
● Spurious Emission.....	160
● Spectral emission mask.....	162
● Display and limit lines.....	164

4.2.1 Multi-signal measurement

4.2.1.1 Use delta marker to compare signals on the same screen

Users may find it easy to compare frequency difference and amplitude difference between signals with 4051. When two signals are shown on the screen at the same time, the Series Signal Analyzer can calculate their difference in frequency and amplitude with the delta marker function.

In this section, we take the reference signal output of 10 MHz of the analyzer as input to demonstrate how to measure the difference in frequency and amplitude of two signals on the same screen.

Step 1: connect reference signal output of 10 MHz on the rear panel of the analyzer to the RF input port on the front panel.

Step 2: set the analyzer at spectrum analysis mode and then reset it:

- Press **【Mode】** and [Spectrum].
- Press **【Preset】** .

Step 3: set center frequency, frequency span and reference level of the analyzer in order to observe 10 MHz reference signal and its 20 MHz harmonic at the same time:

- Press **【Frequency】** , [Center Freq] and enter 25 MHz.
- Press **【Span/X Axis】** , [Span] and enter 40 MHz.
- Press **【Amplitude/Y Axis】** , [RefLevel] and enter 0 dBm.

Step 5: open a marker and search for the maximum peak on the trace:

- Press **【Peak Search】** to ensure the marker is on 10 MHz reference signal.
[Next Pk Left] and [Next Pk Right] soft keys in the peak menu can enable shift of the marker from one peak to another.

Step 6: retain the first marker and trigger a second delta marker:

- Press **【Marker】** and [Delta Marker].

The diamond symbol of the first marker changes from hollow to red solid, indicating the first fixed marker (reference point) and the marker No. Changes to 2. The second marker has a diamond symbol with a number of 1R2, representing the delta marker. When [Delta Marker] is pressed for the first time, two markers overlap at the same frequency point.

Step 7: use the knob or peak search key on the front panel to move the delta marker to another signal peak:

- Press **【Amplitude/Y Axis】**, [RefLevel] and enter 10 dBm.

Step 4: open a marker, set it to the peak of 10 MHz reference signal and then set center frequency as marker frequency (10 MHz):

- Press **【Peak Search】**.
- Press **【Marker →】** and [Marker → Center Freq].

Step 5: trigger a second delta marker:

- Press **【Marker】** and [Delta].

Step 6. increase center frequency to 10 MHz in order to observe 20 MHz harmonic of 10 MHz reference signal:

- Press **【Frequency】**, [Center Freq] and **【↑】**.

Move the first marker and the delta marker to the left of the screen at the peak of 10 MHz reference signal.

Step 7. move delta marker to peak frequency of 20 MHz harmonic signal:

- Press **【Peak Search】**.

“←2” shown on the left of the screen in Fig. 4.6 indicates that 10 MHz reference signal has a lower frequency than the scope displayed on the screen. Delta marker 1R2 appears on the 20 MHz harmonic frequency point. Delta marker result shows difference in frequency and amplitude between 10 MHz reference signal and 20 MHz harmonic signal.

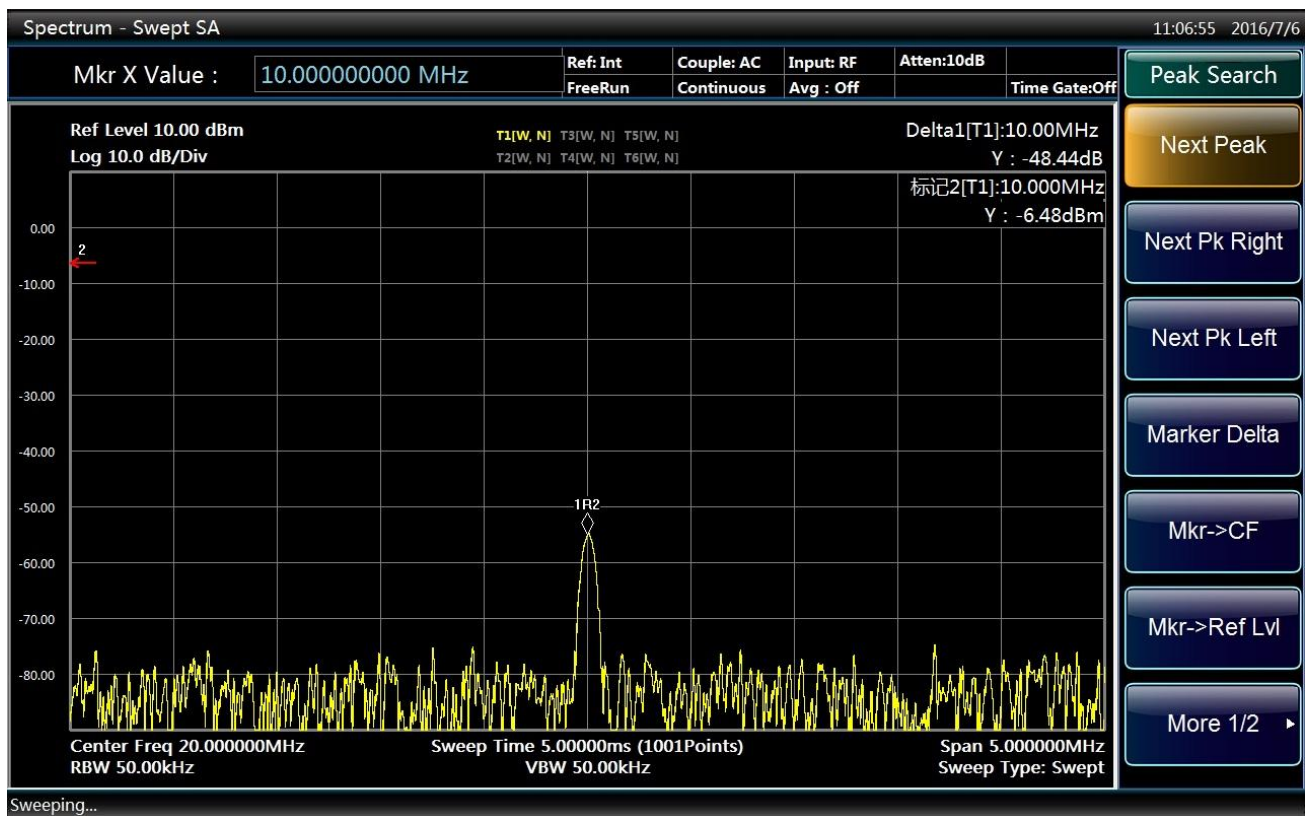

Fig. 4.6 Delta marker of two signals on different screens

Step 8. close all markers:

- Press **【Marker】** and [OFF].

4.2 Advanced operation guide

4.2.1.3 Distinguish measurements of two signals with constant amplitude

1) Basic Concepts

For frequency response of a simple-frequency signal, the Series Signal Analyzer has a trace of the shape of the selected IF filter (usually referred as resolution bandwidth (RBW) filter). When the filter bandwidth is changed, trace width shown by the analyzer will change accordingly. The resolution bandwidth is usually defined as 3 dB bandwidth of the filter. Or sometimes, 6 dB bandwidth of the filter.

A basic characteristic of the Series Signal Analyzer is that it can separate each spectrum component from a composite signal. While separation of such component depends upon the resolution bandwidth used. If the resolution bandwidth is too large, it may be impossible to distinguish each spectrum component, thus displaying only one signal.

To distinguish two signal of constant amplitude, the resolution bandwidth has to be less than or equal to signal frequency interval. If the resolution bandwidth is equal to the frequency interval, a 3 dB dip will appear in the spectral view between two signals. The smaller the resolution bandwidth is, the deeper the dip goes. Therefore, distinction between signals will be clearer.

For Series Signal Analyzer in sweep mode, the sweep time is automatically set as $1/\text{RBW}^2$ to ensure measurement accuracy. With frequency span remaining unchanged, if the bandwidth is narrow, higher frequency resolution should be obtained at the cost of higher sweep time. If the resolution reduces by 10 times, the sweep time will increase by 100 times. In 4051, RBW can be set to as large as 20 MHz.

To optimize sweep time and maintain standard measurement of the analyzer, the sweep time (**【Sweep】** , [Sweep Time]) and sweep type (**【Sweep】** , [Sweep Setup] and [Sweep Type]) can be set as auto.

2) Measure two signals with frequency interval of 100 kHz

In this section, two signals of constant amplitude with frequency interval of 100 kHz are analyzed by reducing their resolution bandwidth and video bandwidth. Attention should be paid to ensure that the resolution bandwidth selected should be equal to signal frequency interval and that the video bandwidth should be slightly smaller than the resolution bandwidth.

Step 1. connect two signal sources to the RF input port of the analyzer as shown in Fig. 4.7.

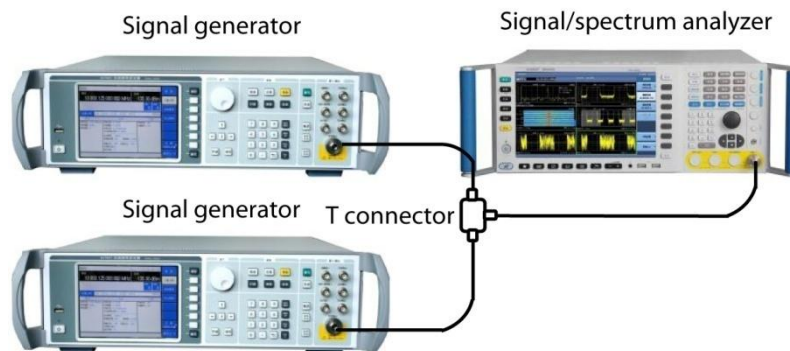

Fig. 4.7 Test instrument connection diagram of two input signals

Step 2. set frequency of one signal generator at 300 MHz and the other at 300.1 MHz and them set output amplitude of both generators at -20 dBm.

Step 3. set the Series Signal Analyzer in spectrum analysis mode and reset:

- Press **【Mode】** and [Spectrum];
- Press **【Preset】** .

Step 4. set parameters of the analyzer:

- Press **【Frequency】** , [Center Freq] and enter 300 MHz.

4.2 Advanced operation guide

- Press **【BW】** , [Res BW **AutoMan**] and enter 300 kHz;
- Press **【Span/X Axis】** , [Span] and enter 2 MHz.
- Press **【Trace】** , [More 1/2▶], [Detector▶] and [Peak] to switch the detector mode to positive peak. Then you can see there is only one signal peak on the screen of the analyzer as shown in Fig. 4.8.

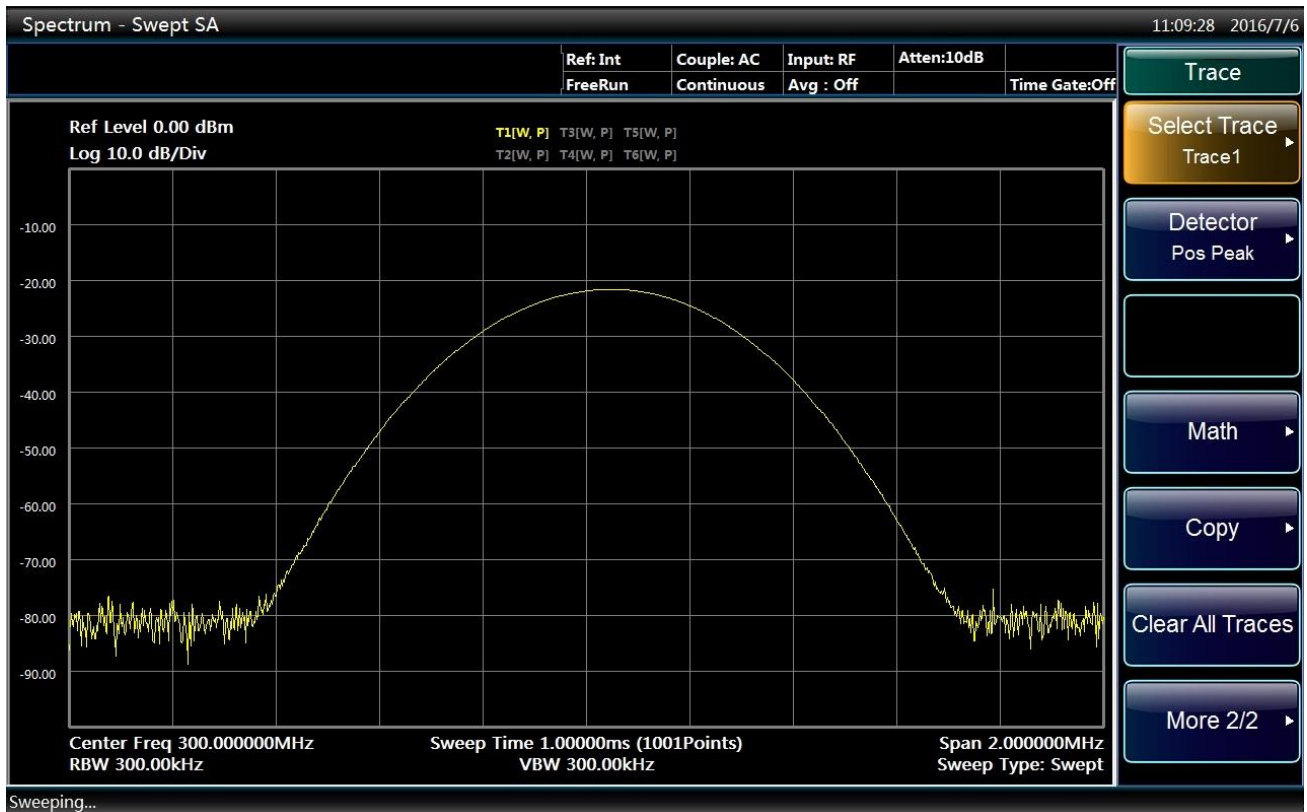

Fig. 4.8 Spectrogram when resolution bandwidth (300 kHz) is larger than signal frequency bandwidth

Step 5. change resolution bandwidth to 100 kHz to make it equal to frequency interval of two signals and reduce video bandwidth to 10 kHz:

- Press **【BW】** , [Res BW **AutoMan**] and enter 100kHz;
- Press **【BW】** , [Video BW **AutoMan**] and enter 10kHz.

You can clearly distinguish two signals with two independent peaks on top of them, as shown in Fig. 4.9.

Caution

Video bandwidth setting

The video bandwidth is set as 10 kHz in order to show level reduction between two signals in the center of the screen. For large video bandwidth, video voltage generated by the envelope detector cannot be fully suppressed. Therefore, additional voltage will be generated in the transition area of two and displayed on the trace.

4.2 Advanced operation guide

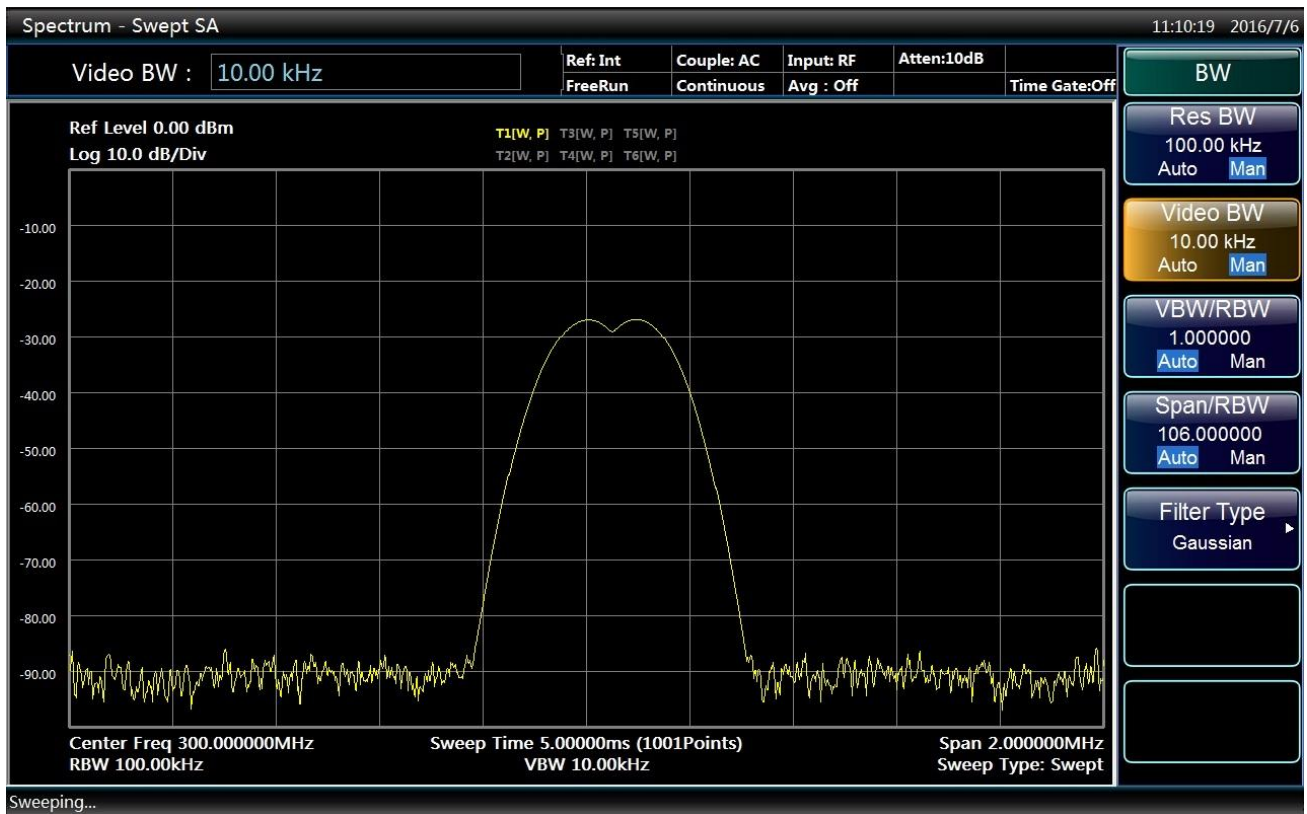

Fig. 4.9 Spectrogram when resolution bandwidth (100 kHz) is equal to signal frequency bandwidth

Step 6. reduce resolution bandwidth to 10 kHz:

- Press **【BW】**, [Res BW **Auto**Man] and enter 10kHz;

Two signals are completely separated as shown in Fig. 4.10. The knob or up and down arrow keys may also be used to further reduce resolution bandwidth to obtain higher frequency resolution and thus better resolution signals. However, the sweep time will get longer. 4051 Series Series Signal Analyzer can be finely tuned in 10% increment to optimize resolution bandwidth and sweep speed.

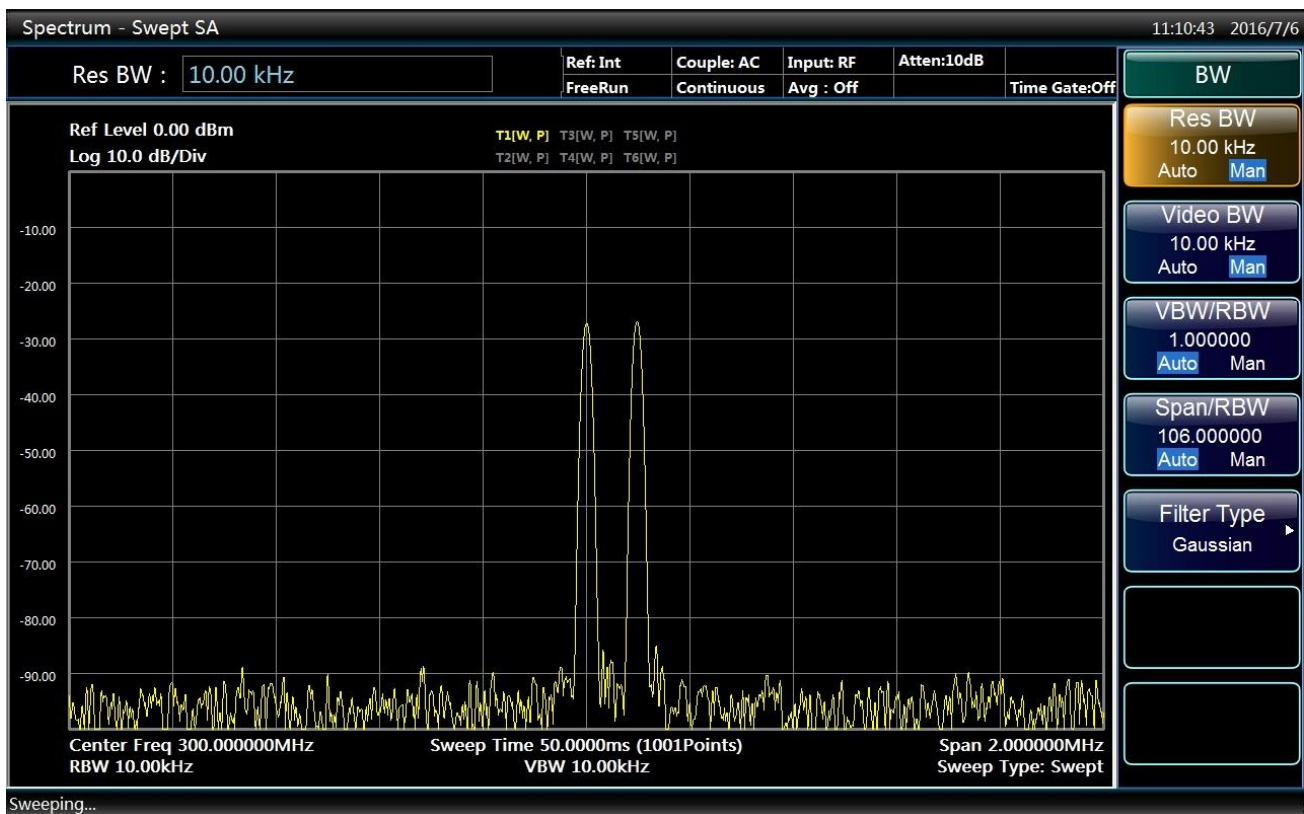

Fig. 4.10 Spectrogram when resolution bandwidth (10 kHz) is smaller than signal frequency bandwidth

4.2.1.4 Distinguish two signals with unequal amplitude

1) Basic concepts of filter selectivity

When distinguishing two signals with unequal amplitude but similar frequency, the filter shape in the Series Signal Analyzer, i.e. 3 dB bandwidth should be taken in to account. The filter shape is defined by filter selectivity, which the ratio of 60 dB bandwidth against 3 dB bandwidth. Filter bandwidth and selectivity are shown in Fig. 4.11. If one small signal is located very close to a large signal, then such small signal may be overwhelmed by the large signal.

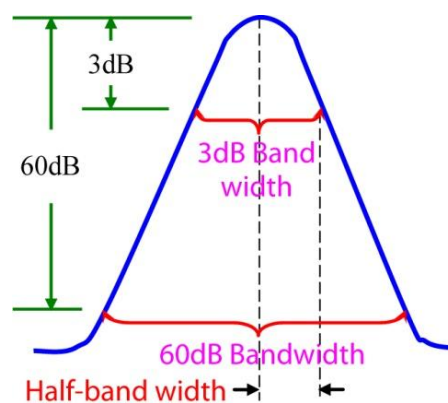

Fig. 4.11 Diagram of filter bandwidth and selectivity

Fig. 4.12 shows the diagram of relationship between two close signals, in which a indicates frequency interval of two signals and k indicates half of the filter bandwidth of the large signal. a should be larger than k in order to measure level of the small signal.

Digital filter bandwidth of the analyzer is about 1/3 of typical analog resolution bandwidth filter, which means when distinguishing a nearby signal, a wider resolution bandwidth can be used to cut sweep time.

4.2 Advanced operation guide

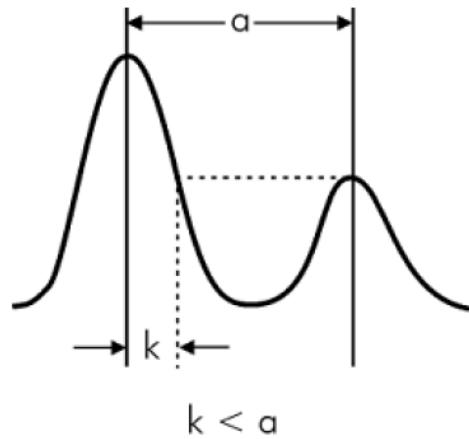

Fig. 4.12 Resolution bandwidth requirement when distinguishing small signals

2) Distinguish two signals with frequency difference of 50 kHz and amplitude difference of 60 dB

In this section, a narrow resolution bandwidth is adopted to distinguish two signals with frequency interval of 50 kHz and amplitude difference of 60 dB. Output ports of two signal generators should be connected to the input port of the analyzer as shown in Fig. 4.7.

Step 1. set frequency of one signal generator at 300 MHz and its amplitude at -10 dBm; set frequency of the other signal generator at 300.05 MHz and its signal output amplitude at -70 dBm. Turn on RF output of two signal generators.

Step 2. set the Series Signal Analyzer in spectrum analysis mode and reset:

- Press **【Mode】** and [Spectrum].
- Press **【Preset】** .

Step 3. set parameters of the analyzer:

- Press **【Frequency】** , [Center Freq] and enter 300 MHz.
- Press **【BW】** , [Res BW **AutoMan**] and enter 30kHz;
- Press **【Span/X Axis】** , [Span] and enter 500kHz.

Step 4. Set 300 MHz signal peak to reference level:

- Press **【Peak Search】** , [Marker→] and [Marker → Ref Level].

Caution

Rectangle coefficient of the resolution bandwidth filter of the analyzer is about 4.1:1. When resolution bandwidth is 30 kHz, 60 dB bandwidth is 123 kHz and half-band width is 61.5 kHz, larger than the frequency interval of 50 kHz. Therefore, it is impossible to distinguish two input signals as shown in Fig. 4.13.

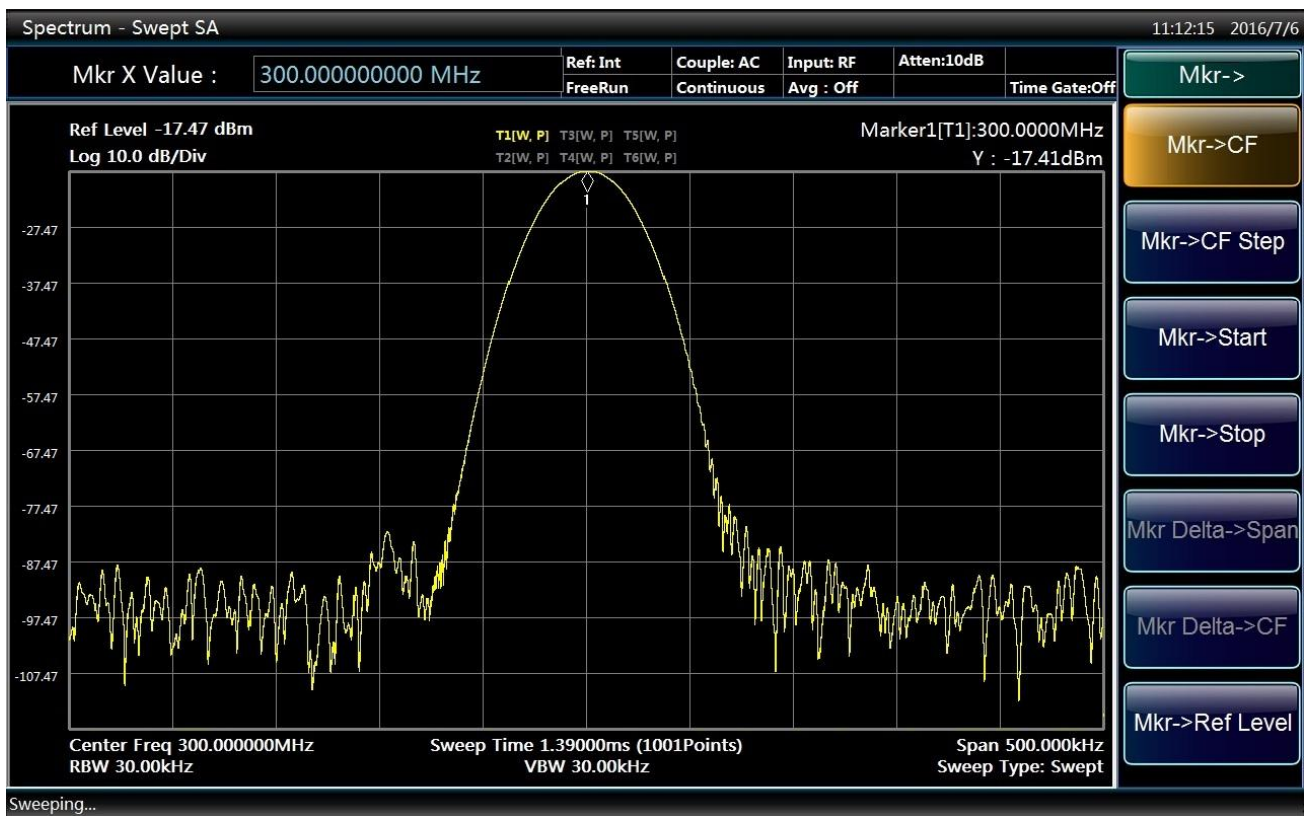

Fig. 4.13 Test interface with resolution bandwidth of 30 kHz

Step 5. reduce resolution bandwidth to observe the hidden small signal:

- Press **【BW】**, [Res BW AutoMan] and enter 1kHz;

As shown in Fig. 4.14, half-band width is 2.05 kHz, smaller than the frequency interval of 50 kHz, therefore, two input signals can be distinguished.

4.2 Advanced operation guide

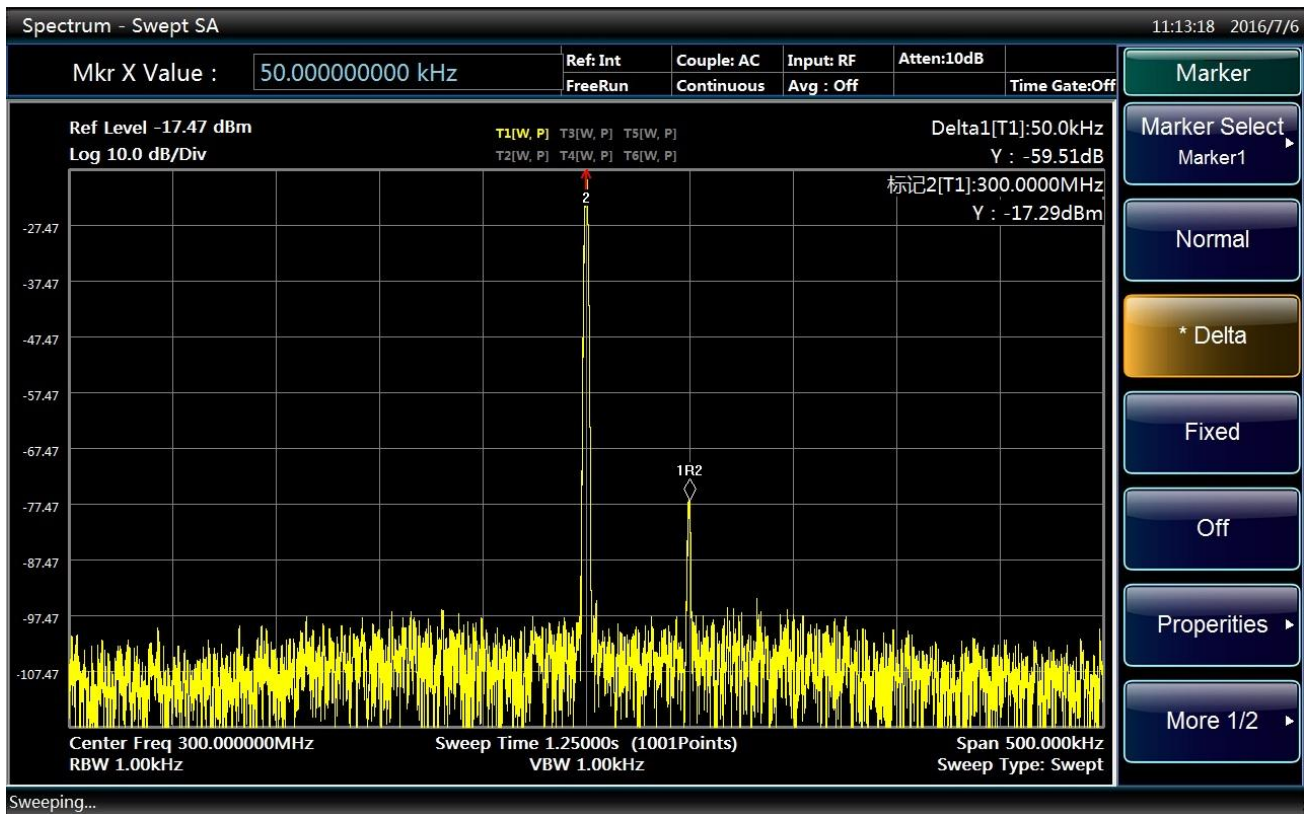

Fig. 4.14 Test interface with resolution bandwidth of 1kHz

Step 6. measure frequency and amplitude difference of two signals with delta marker:

- Press **【Peak Search】** .
- Press **【Marker】** and [Delta Marker].
- Press **【Peak Search】** and [Next Peak] and read difference in frequency and amplitude of two signals of unequal amplitude.

Caution

The average function may also be used to distinguish two signals in clearer manner.

Press **【Trace】** and [Average] to turn on average function; press **【Meas Setup】** and [Average Num] and enter 10 to set average count as 10 times.

4.2.2 Distortion measurement

Mutual interference between equipment in common in crowd operating environment of the communications system. For example, second-order and third-order intermodulation distortion is common in narrowband systems. When there are two signals (F1 and F2) in one system, they and second harmonic distortion signals generated by them (2F1 and 2F2) mix and become third-order intermodulation products 2F2-F1 and 2F1-F2 very close to original signals, thus resulting in high-order intermodulation distortion. Such distortion products are mostly generated by devices such as amplifiers and mixers in the system. Most transmission units and signal generators have harmonics and their components need to be measured.

4.2.2.1 Identify distortion generated by the Series Signal Analyzer

When a large signal is input, it will cause distortion of the Series Signal Analyzer and thus affect distortion measurement result of the actual signal. In this case, an attenuator can be used to determine which one is the

4.2 Advanced operation guide

distortion signal generated in the analyzer. In this section, the input signal generated by the signal generator is used to explain whether the analyzer produces harmonic distortion.

Step 1. connect RF output of the signal generator to the input port of the analyzer.

Step 2. set an output dot frequency signal of the signal generator with frequency of 200 MHz and amplitude of 0 dBm.

Step 3. set the analyzer as spectrum analysis mode:

- Press **【Mode】** and [Spectrum].

Step 4. set center frequency and frequency span of the analyzer:

- Press **【Preset】** .
- Press **【Frequency】** , [Center Freq] and enter 400 MHz.
- Press **【Span/X Axis】** , [Span] and enter 500 MHz.

It can be seen from the trace of the analyzer that the harmonic distortion generated by the signal has 200 MHz frequency offset from the original signal of 200 MHz, as shown in Fig. 4.15.

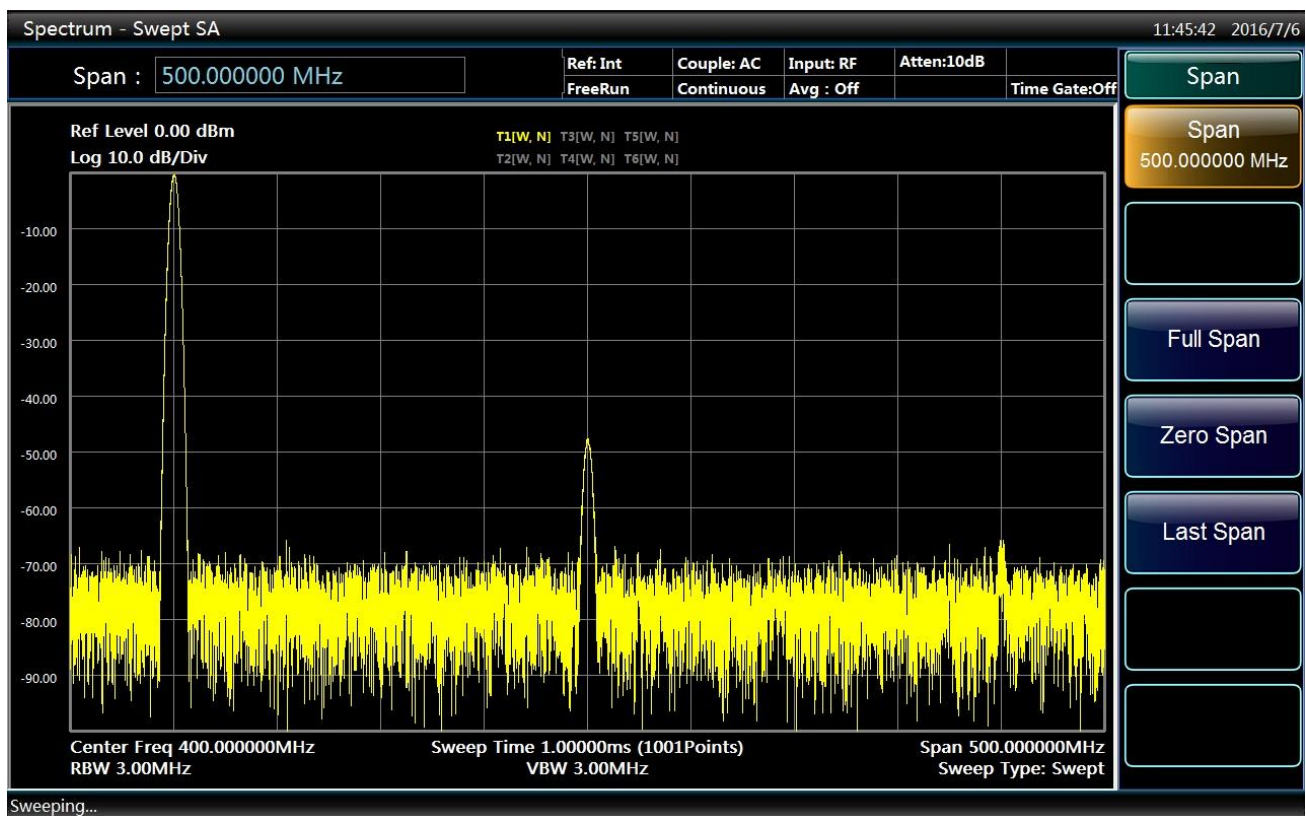

Fig. 4.15 Observe harmonic distortion

Step 5. set center frequency of the analyzer to the position of the first harmonic distortion:

- Press **【Peak Search】** and [Next Peak].
- Press **【Marker →】** and [Marker → Center Freq].

Step 6. set frequency span as 50 MHz and reset center frequency:

- Press **【Span/X Axis】** , [Span] and enter 50 MHz.
- Press **【Marker →】** and [Marker → Center Freq].

4.2 Advanced operation guide

Step 7. set attenuator as 0 dB and open interpolation marker:

- Press **【Amplitude/Y Axis】** , Press **【Amplitude/Y Axis】** , [Attenuation▶], [Mech Atten **AutoMan**] and enter 0 dB.
- Press **【Peak Search】** and [MarkerDelt].

Step 8. increase attenuator setting to 10 dB:

- Press **【Amplitude/Y Axis】** , [Attenuation▶], [Mech Atten **AutoMan**] and enter 10 dB.

Attention should be paid to the reading of delta marker as shown in Fig. 4.16, which is the difference in distortion when the attenuator setting is 0 and 10 dB. When the attenuator setting is changed, if delta marker reading is larger than 1 dB, it means certain distortion has been generated by the analyzer. When delta marker reading is not obvious, the attenuator setting may also be increased.

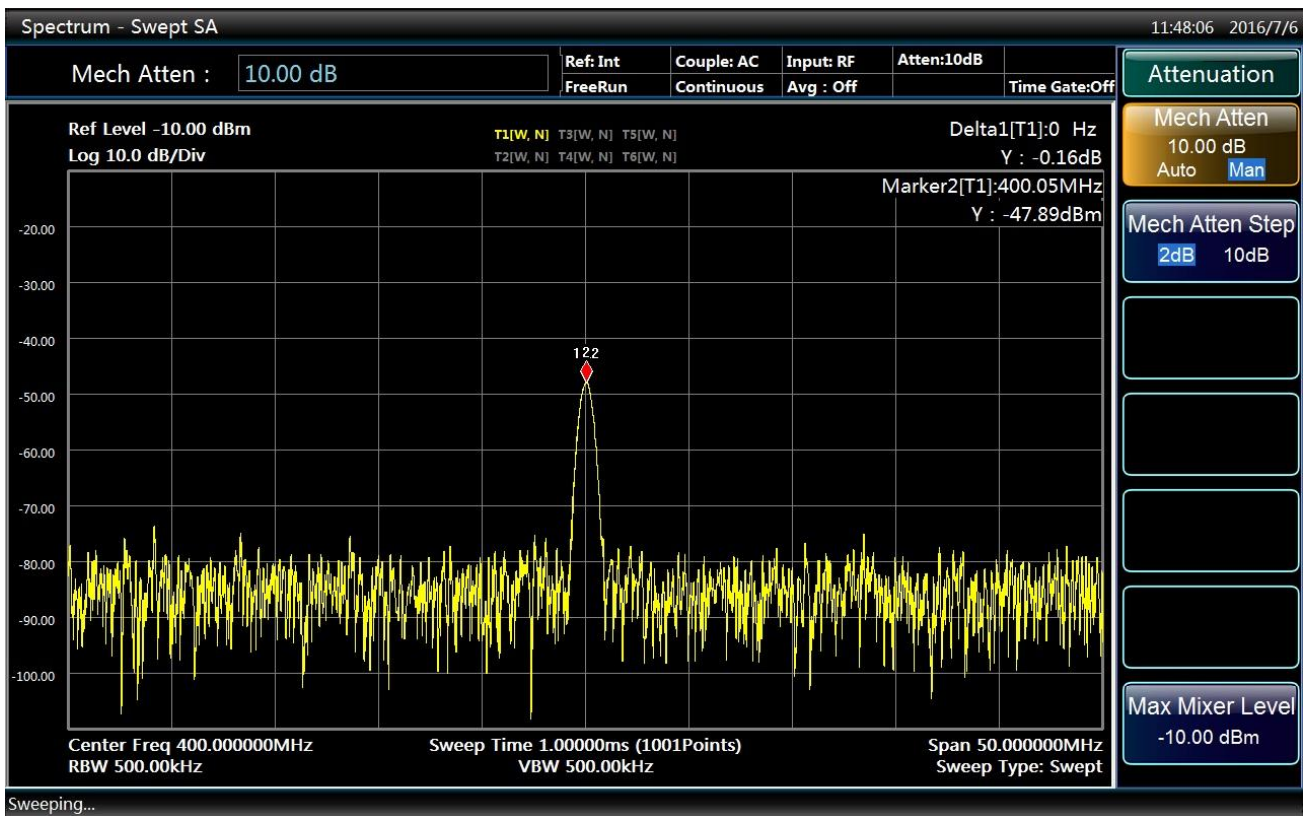

Fig. 4.16 Set attenuator as 10 dB

The amplitude reading of the delta marker comes from two sources: firstly, positive reading will be displayed when signal-to-noise ratio is reduced due to increase in RF attenuation; secondly, negative reading will be shown when the harmonic distortion generated by the analyzer circuit reduces. The larger the reading, the bigger the error of measurement. In such case, the attenuator setting may be changed to reduce absolute amplitude of such delta marker reading.

4.2.2.2 Quick harmonic measurement

In this section, harmonic components are measured of a signal with frequency of 1 GHz and power of -10 dBm generated by the signal generator. The 500 MHz calibration signal of the analyzer may also be used, but the start and stop frequency of the analyzer should be adjusted to match with the signal frequency and its harmonic.

Step 1. connect output of the signal generator to the RF input port of the analyzer.

Step 2. set the analyzer as spectrum analysis mode and reset:

- Press **【Mode】** and [Spectrum].
- Press **【Preset】** .

Step 3. set start and stop frequency of the analyzer:

- Press **【Frequency】** , [Start Freq] and enter 800 MHz.
- Press [Stop Freq] and enter 2.5 GHz.

As shown in Fig. 4.17, the fundamental wave and the second harmonic are displayed on the screen at the same time.

Step 4. smooth the noise with video frequency to increase resolution:

- Press **【BW】** , [Video BW Auto **Man**] to enable auto off.

Use **【↓】** key to reduce video bandwidth.

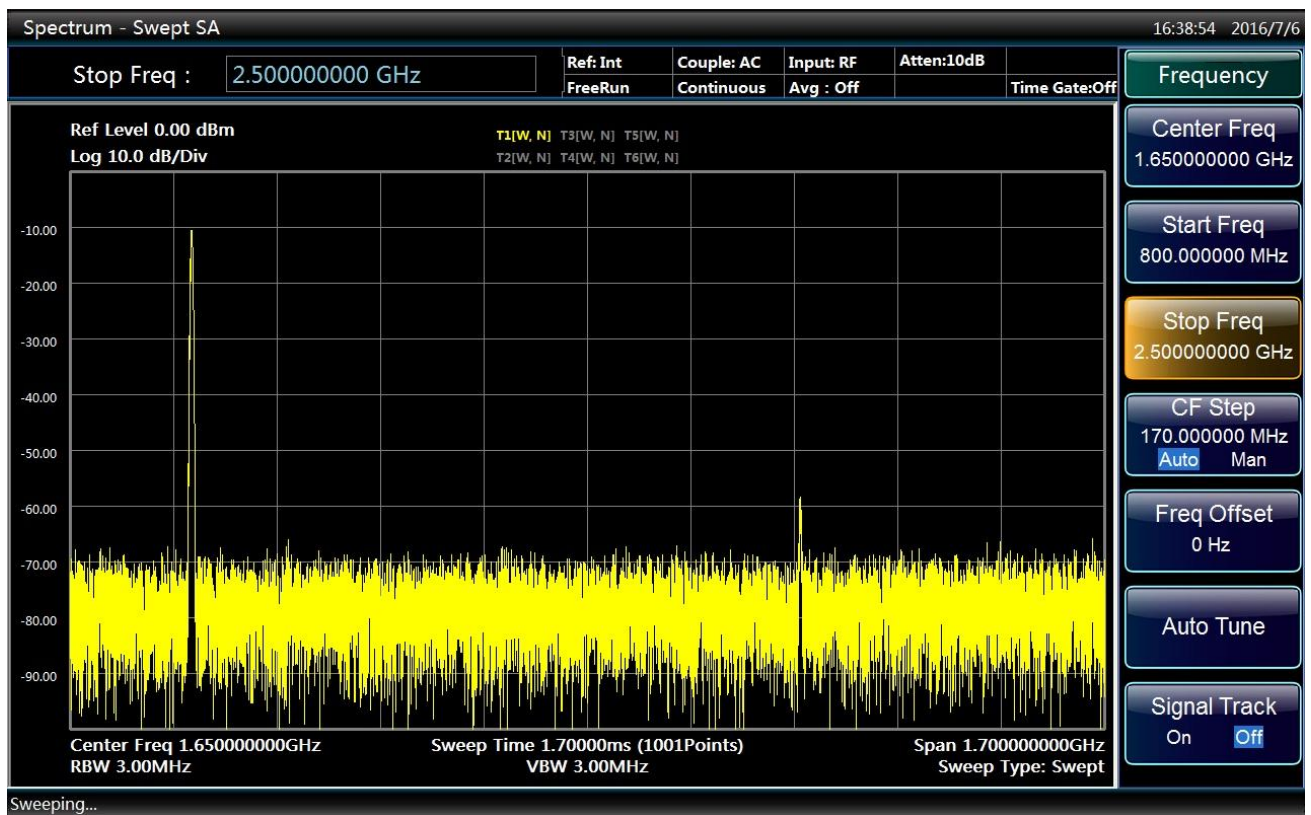

Fig. 4.17 Display interface of input signal and harmonic

Step 5. set fundamental wave peak level as reference level in order to improve measurement accuracy:

- Press **【Peak Search】** and [Marker → Ref Level] to obtain an interface as shown in Fig. 4.18.

4.2 Advanced operation guide

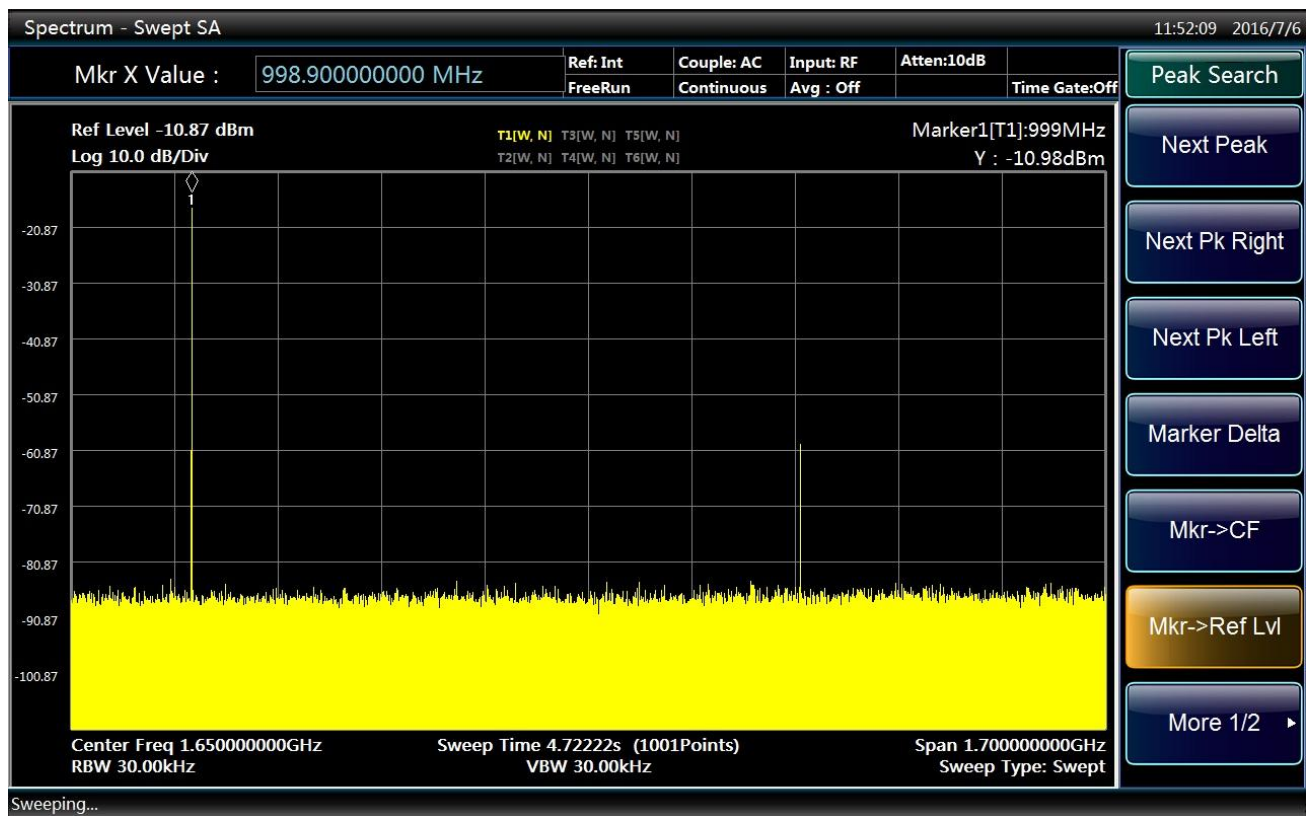

Fig. 4.18 Display interface of signal peak at reference level

Step 6. trigger second marker:

- Press **【Peak Search】** and [MarkerDelta].
- Press **【Peak Search】** and [Next Peak]. At this time, the fixed marker is indicated on the fundamental wave and the active marker is at the peak of the second harmonic as shown in Fig. 4.19.

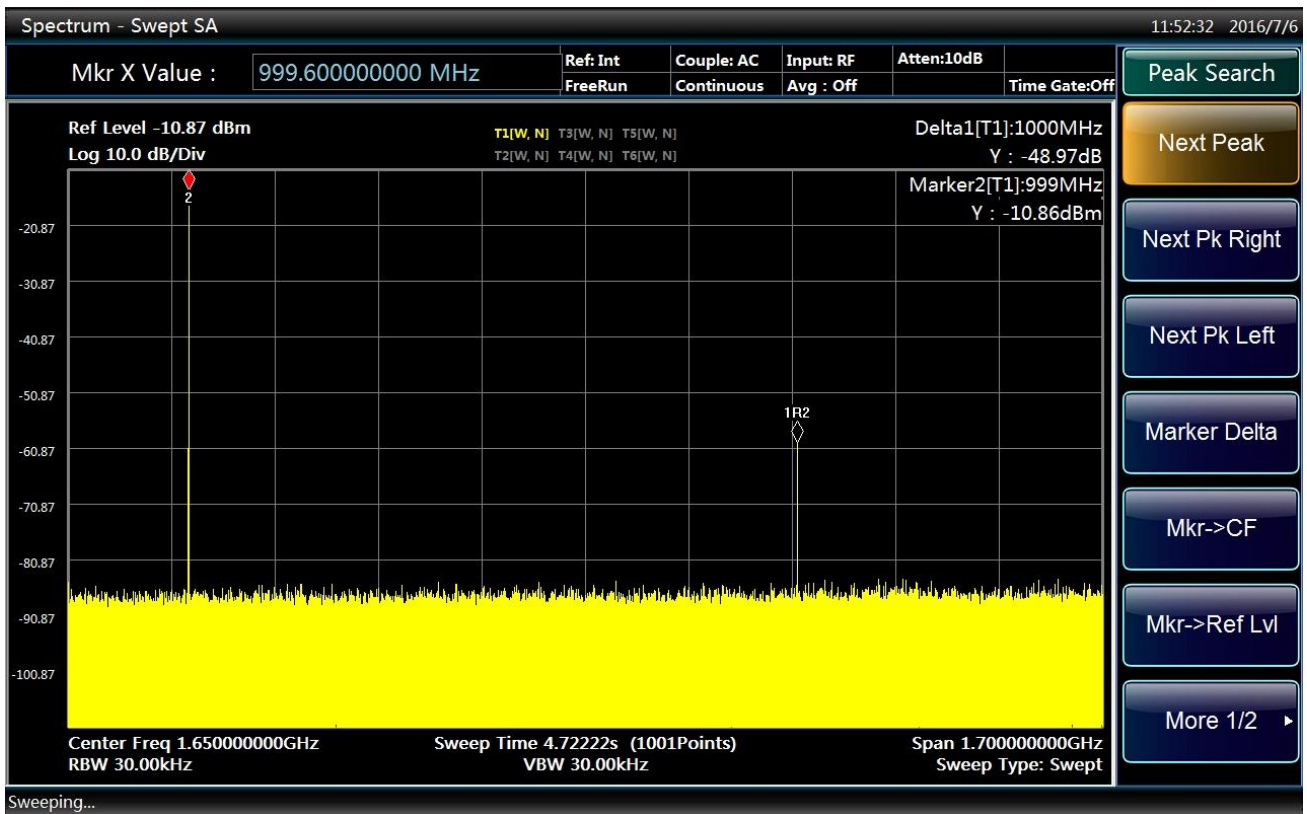

Fig. 4.19 Display interface of second harmonic measurement with delta marker

Step 7. measure harmonic distortion (method 1):

The fundamental wave and the second harmonic as shown in the figure has an amplitude difference of about -60 dB, or a harmonic distortion of 0.1% (see Fig. 4.20).

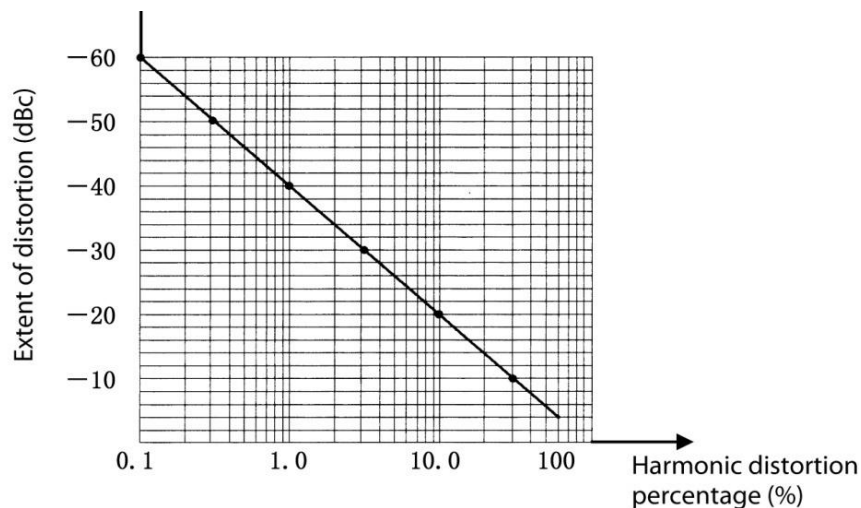

Fig. 4.20 Harmonic distortion amplitude percentage transformation diagram

Before reading amplitude ratio of other harmonics and the fundamental wave, the harmonic should be measured for three times and **【Peak Search】** and **[Next Pk Right]** should be pressed.

Step 8. measure harmonic distortion (method 2):

- Press **【Amplitude/Y Axis】**, **[MORE 1/2▶]**, **[Y Axis Unit▶]** and **[V]**.

4.2 Advanced operation guide

By this time, the delta marker changes automatically to volt (V) and move the decimal point of the ratio shown two places to the right to get the distortion percentage. An easy way to determine distortion percentage is to change the unit to volt. The minimum ratio that can be displayed is 0.01 or 1%.

4.2.2.3 Accurate harmonic measurement

It will be explained below how to measure the harmonic of 1 GHz signals. It takes more steps to measure in this method, but since measurement is done with smaller frequency span and resolution bandwidth for each signal, the signal-to-noise ratio is increased and more accurate measurement result will be obtained.

Step 1. connect output of the signal generator to the RF input port of the analyzer.

Step 2. reset the Series Signal Analyzer:

- Press **【Preset】** key.

Step 3. set start and stop frequency of the analyzer:

- Press **【Frequency】**, [Start Freq] and enter 800 MHz.
- Press [Stop Freq] and enter 2.5 GHz.

As shown in Fig. 4.17, the fundamental wave and the second harmonic are displayed on the screen.

Step 4. set the video frequency to smooth the noise and increase resolution:

- Press **【BW】**, [Video BW **AutoMan**] to enable auto off.

Use **【↓】** key to reduce video bandwidth.

Step 5. use signal tracking to reduce frequency span:

- Press **【Peak Search】** to trigger marker and search signal peak.
- Press **【Frequency】** and [Signal Track On **Off**].
- Press **【Span/X Axis】**, [Span] and enter 1 MHz.

Step 6. turn off signal tracking:

- Press **【Frequency】** and [Signal Track **On** Off].

Step 7. Move signal peak to top grid line to get the best amplitude measurement accuracy:

- Press **【Marker →】** and [Marker → Ref Level] to obtain an interface as shown in Fig. 4.21.

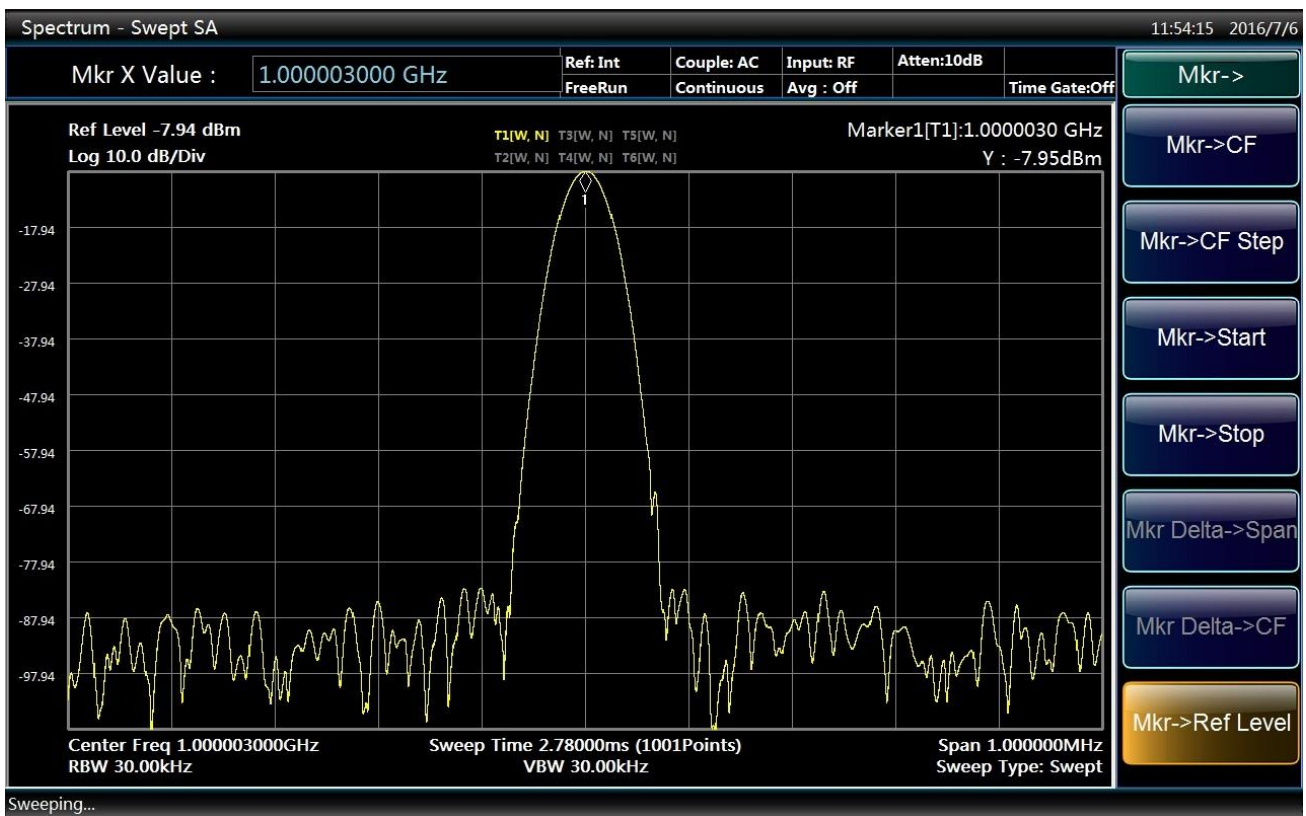

Fig. 4.21 Display interface of input signal with 1 MHz frequency span

Step 8. set center frequency increment as fundamental wave signal frequency:

- Press **【Frequency】** and [CF Step Auto **Man**] and enter 1 GHz.
- Press **【Frequency】**, [Center Freq] and **【↑】** to increase center frequency.

Step 9. measure second harmonic:

- Press **【Peak Search】**, [Next Peak] and [Marker → Center Freq].

Move the center frequency of the analyzer to the second harmonic.

- Press [Marker → Ref Level] to adjust harmonic peak to the reference level with second harmonic amplitude as shown in Fig. 4.22.

4.2 Advanced operation guide



Fig. 4.22 Display interface of second harmonic amplitude

Step 10. calculate harmonic distortion:

- Use the relation shown in Fig. 4.20 to convert distortion percentage between the second harmonic and the fundamental wave. The unit can be changed again to volt in order to read the voltage ratio of two signals.

Repeat step 9 - 10 for other harmonics to be measured to get their distortion percentage. Total signal harmonic distortion percentage is also subject to frequent test. In order to test such parameter, amplitude of each harmonic should be tested with linear unit (such as volt) rather than relative unit dBc.

Step 11. measure total harmonic:

- Press **【Amplitude/Y Axis】**, **[More 1/2>>]**, **[Y Axis Unit▶]** and **[V]** and set amplitude unit as volt. Measured signal amplitude may be used in the following equation to calculate total harmonic distortion:

$$\text{Total harmonic distortion} = \frac{100 \times \sqrt{(A_2)^2 + (A_3)^2 + \dots + (A_n)^2}}{A_1} \%$$

Where:

A₁ refers to fundamental wave amplitude (V)

A₂ refers to second harmonic amplitude (V)

A₃ refers to fundamental wave amplitude (V)

A_n refers to nth harmonic amplitude (V)

If the signal amplitude is measured carefully as indicated above, measured harmonic distortion percentage will be very accurate.

4.2.3 Measure small signals

Noise produced inside the Series Signal Analyzer determines the ability of the analyzer to measure small signals and the following methods can be used to change measurement settings in order to increase measurement sensitivity of the analyzer.

4.2.3.1 Reduce RF attenuator decrement to measure small signals

The input attenuator affects input signal level. If the input signal is very close to the noise floor, reduction in attenuator decrement may help to extract the signal from the noise.

Caution

Total power of all signals of the analyzer should be kept under +30 dBm (1 W)!

Step 1. reset the Series Signal Analyzer:

- Press **【Preset】**.

Step 2. Set the signal generator and connect the Series Signal Analyzer:

- Set the signal generator frequency as 300 MHz and amplitude as -80 dBm; connect RF output of the signal generator to the input port of the analyzer.

Step 3. set center frequency, frequency span and reference level of the analyzer:

- Press **【Frequency】**, [Center Freq] and enter 300 MHz.
- Press **【Span/X Axis】**, [Span] and enter 5 MHz.
- Press **【Amplitude/Y Axis】**, [RefLevel] and enter -40 dBm.

Step 4. move the signal peak to the center frequency (300 MHz in this case):

- Press **【Peak Search】** and [Marker → Center Freq].

Step 5. reduce frequency span to 1 MHz and if necessary, repeat step 4 to ensure the signal peak in at the center frequency of the analyzer:

- Press **【Span/X Axis】**, [Span] and enter 1 MHz.

Display as shown in Fig. 4.23.

4.2 Advanced operation guide

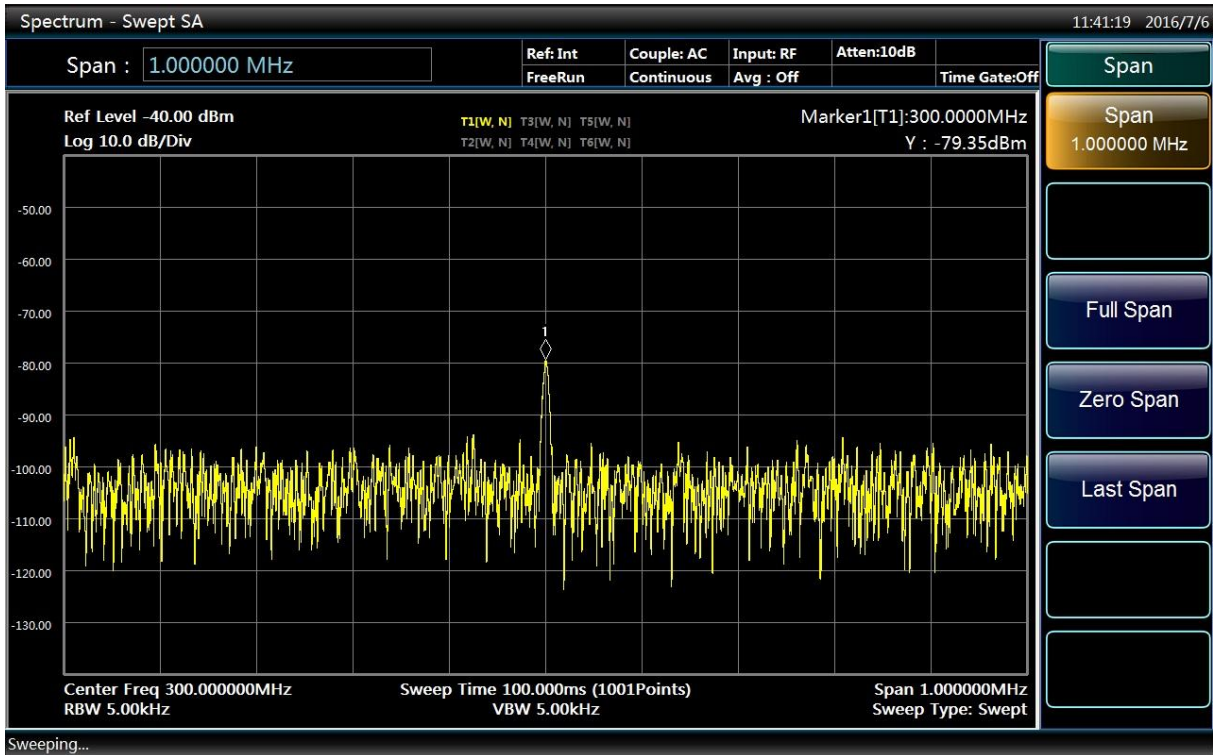

Fig. 4.23 Small signal when the attenuator is default as 10 dB

Step 6. set attenuation decrement as 20 dB:

- Press **【Amplitude/Y Axis】**, Press **【Amplitude/Y Axis】**, [Attenuation▶], [Mech Atten **AutoMan**] and enter 20 dB.

As shown in Fig. 4.24, when attenuator decrement is increased, the noise floor gets more closer to the signal level.

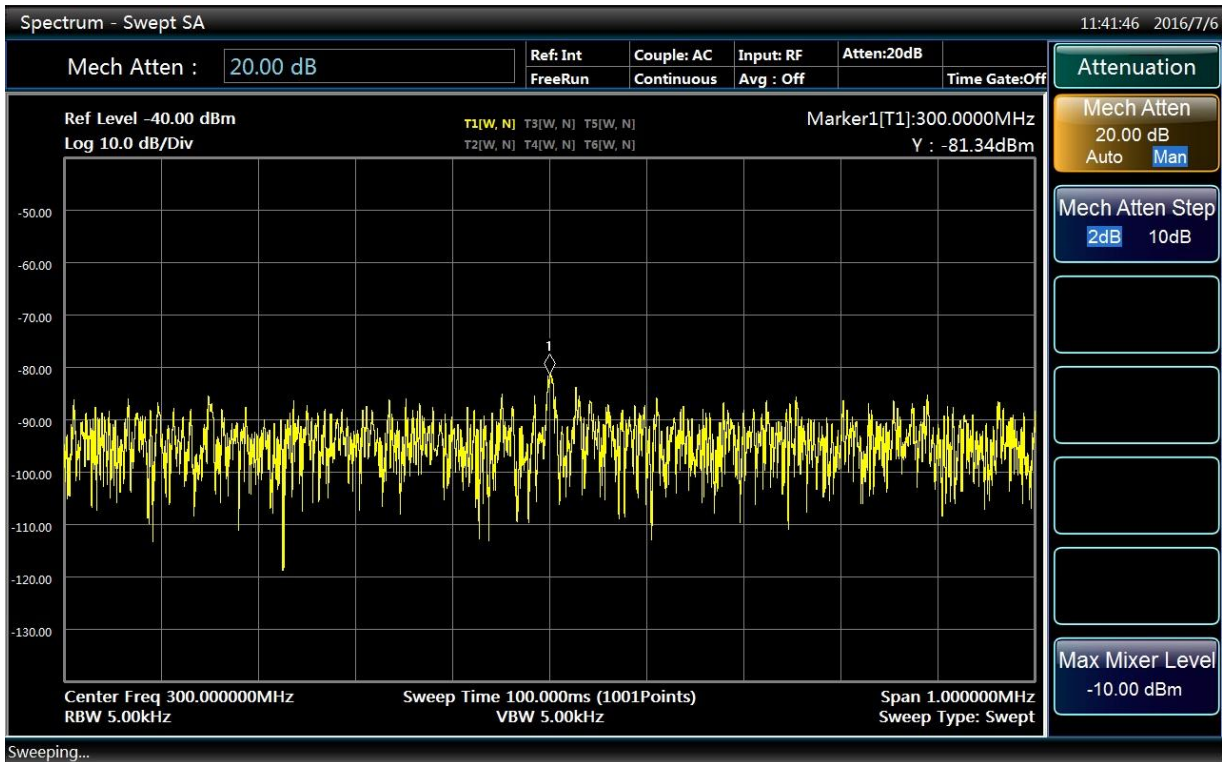

Fig. 4.24 Small signal when attenuator is set as 20 dB

Step 7. set attenuator as 0 dB in order to observe the measured signal more clearly:

- Press **【Amplitude/Y Axis】**, **[Attenuation▶]**, **[Mech Atten AutoMan]** and enter 0 dB.

Fig. 4.25 shows the measured signal displayed by the analyzer when the attenuator decrement is 0 dB.

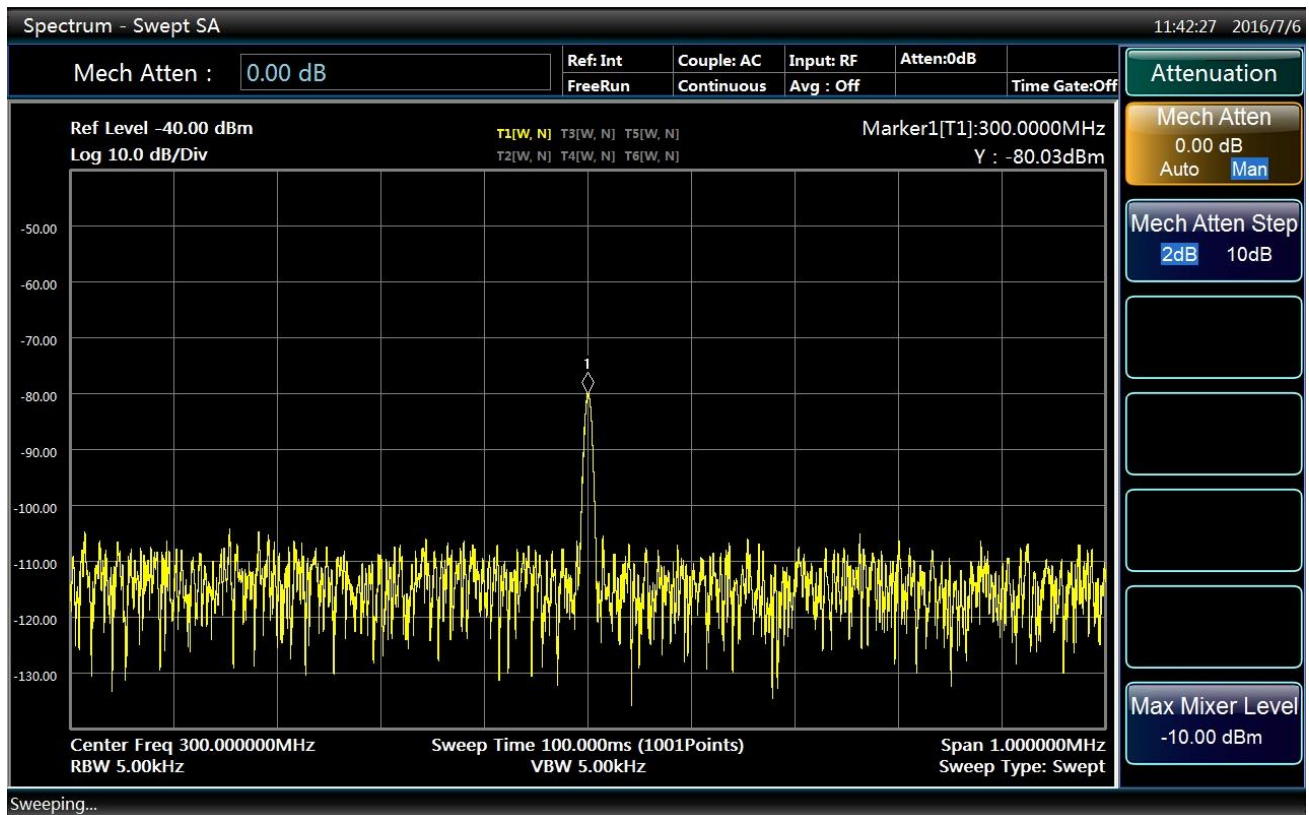

Fig. 4.25 Small signal when attenuator is set as 0 dB

Caution

Please remember to restore attenuation value of the analyzer after test in order to protect the RF input port.

Press **【Amplitude/Y Axis】**, **[Attenuation▶]**, **[Mech Atten Auto Man]** or press **【Couple】** and **[Couple All]**.

4.2.3.2 Reduce resolution bandwidth to measure small signals

The resolution bandwidth affects the noise floor inside the analyzer but has no effect on measurement of the level of continuous-wave signals. The relation between noise reduction and resolution bandwidth can be expressed with the following formula:

$$\Delta L = 10 \log \frac{BW_1}{BW_2}$$

Where, ΔL refers to change in the noise amplitude (dB).

BW1 and BW2 refer to different resolution bandwidths (hz).

Therefore, when the frequency bandwidth is reduced by 10 times, the noise floor will be reduced by 10 dB.

Step 1. reset the Series Signal Analyzer:

- Press **【Preset】**.

Step 2. Set the signal generator and connect the Series Signal Analyzer:

4.2 Advanced operation guide

- Set the signal generator frequency as 300 MHz and amplitude as -80 dBm; connect RF output of the signal generator to the input port of the analyzer.

Step 3. set center frequency, frequency span and reference level of the analyzer:

- Press **【Frequency】** , [Center Freq] and enter 300 MHz.
- Press **【Span/X Axis】** , [Span] and enter 1 MHz.
- Press **【Amplitude/Y Axis】** , [RefLevel] and enter -40 dBm.

Step 4. use **【↓】 to reduce resolution bandwidth:**

- Press **【BW】** , [Res BW] and **【↓】** .

As shown in Fig. 4.26, the noise floor reduces and therefore we can see the signal more clearly. Since reduced resolution bandwidth will result in increase in sweep time, in 4051 Series Signal/Spectrum Analyzer, the resolution bandwidth is increased or decreased in 10% within the range of 1 Hz - 3 MHz. By choosing a proper resolution bandwidth, a more delicate balance can be achieved between the sweep time and the resolution bandwidth.

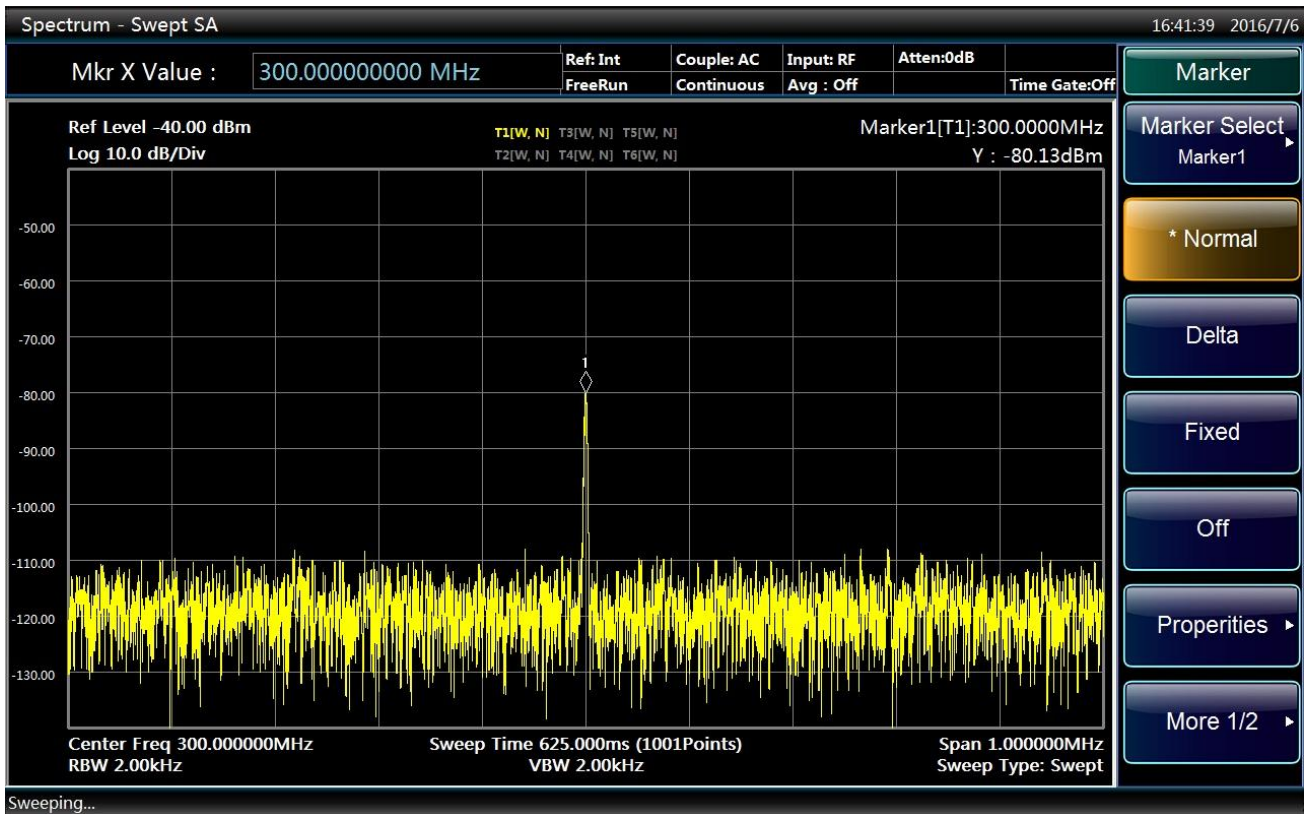

Fig. 4.26 Reduce resolution bandwidth to measure small signals

4.2.3.3 Measure small signals with average detector and increase in sweep time

When the noise floor of the analyzer covers small signals, average detector can be used and the sweep time can be increased to smooth the noise so as to increase signal visibility. Longer sweep time will result in better average noise variance.

Step 1. reset the Series Signal Analyzer:

- Press **【Preset】** .

Step 2. Set the signal generator and connect the Series Signal Analyzer:

4.2 Advanced operation guide

- Set the signal generator frequency as 300 MHz and amplitude as -80 dBm; connect RF output of the signal generator to the input port of the analyzer.

Step 3. set center frequency, frequency span and reference level of the analyzer:

- Press **【Frequency】** , [Center Freq] and enter 300 MHz.
- Press **【Span/X Axis】** , [Span] and enter 5 MHz.
- Press **【Amplitude/Y Axis】** , [RefLevel] and enter -40 dBm.

Step 4. Select detector mode of the analyzer as average detector:

- Press **【Trace】** , [More 1/2▶], [Detector▶], [Average▶] and [Log-Pwr Avg].

Step 5. increase sweep time of the analyzer:

- Press **【Sweep】** , [Sweep Time AutoMan] and **【↑】** to increase the sweep time.

When the sweep time is increased, more data will be obtained to get average of each trace pixel as shown in Fig. 4.27.

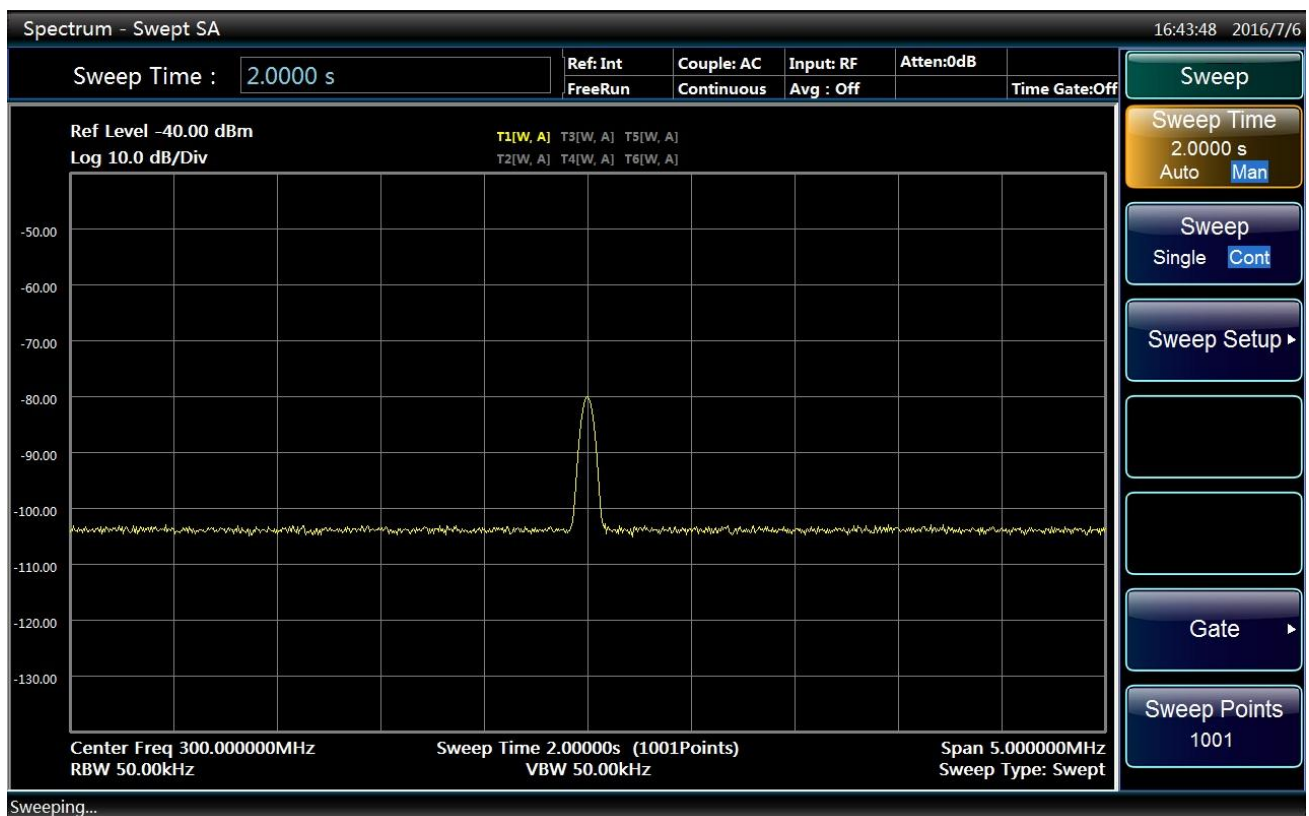

Fig. 4.27 Small signals after increasing sweep time

4.2.3.4 Measure small signals with video average

In video average function, digital method is used to average mean values of current trace point for sweeping and previous same trace position. After the video average is turned on, the analyzer will automatically set the detector mode as sample detector. Measurement of the signal peak by the sample detector is less accurate than that by the normal detector; therefore, it is common that the sample detector is unable to find out the real signal peak. The video average gets different result from the average detector.

Step 1. reset the Series Signal Analyzer:

- Press **【Preset】** .

Step 2. Set the signal generator and connect the Series Signal Analyzer:

4.2 Advanced operation guide

- Set the signal generator frequency as 300 MHz and amplitude as -80 dBm; connect RF output of the signal generator to the input port of the analyzer.

Step 3. set center frequency, frequency span and reference level of the analyzer:

- Press **【Frequency】** , [Center Freq] and enter 300 MHz.
- Press **【Span/X Axis】** , [Span] and enter 5 MHz.
- Press **【Amplitude/Y Axis】** , [RefLevel] and enter -40 dBm.

Step 4. turn on video average function:

- Press **【Trace】** and [Average] to prompt “Average type: video” at top right corner of the screen and display average count.

As averaging of the trace continues, small signals get more and more clear. The default average count is 100.

Step 5. set average count as 25:

Press **【Meas Setup】** and [Average Num].

Enter 25 from the number input area on the front panel and press **【←】** or press [Confirm] in the soft menu as shown in Fig. 4.28.

At the moment, average count displayed in the annotation window on the top of the screen will change to 25. Once the average count is set, the analyzer will continue to average operation on the basis of such count.

If you wish to stop the measurement after the average count is reached, you may use single sweep function. Press **【Sweep】** and [Sweep **Single Cont**].

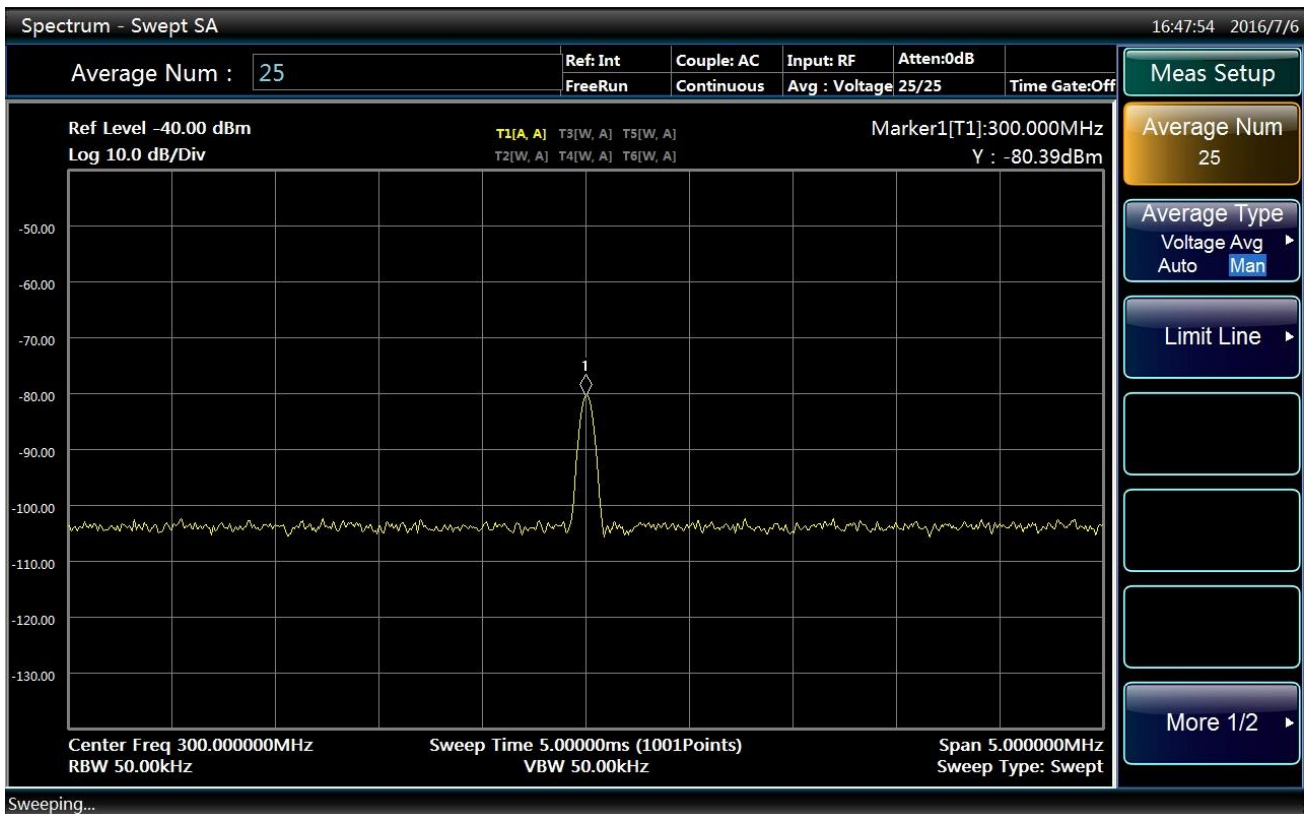

Fig. 4.28 Measure small signals with trace average

4.2.4 Increase frequency resolution and accuracy by using frequency count function

In this section, 500 MHz calibration signal of the analyzer will be taken as an example to explain how to use the frequency count to increase measured frequency read-out accuracy.

Step 1. set the analyzer as spectrum analysis mode and reset the analyzer:

- Press **【Mode】** and [Spectrum].
- Press **【Preset】** .

Step 2. enable 500 MHz calibration signal of the analyzer:

- Press **【Input/Output】** , [Input Port **RF** Cal] to select calibration port.
- Press [Cal Port] and [500 MHz] to select 500 MHz Calibration signal.

Step 3. set center frequency of the analyzer as 500 MHz and frequency span as 80 MHz:

- Press **【Frequency】** , [Center Freq] and enter 500 MHz.
- Press **【Span/X Axis】** , [Span] and enter 80 MHz.

Step 4. Turn off marker count function:

- Press **【Peak Search】** to enable the marker.
- Press **【Marker Func】** , [Marker Count▶] and [Marker Count On **Off**].

Observe the marker reading with frequency resolution capable of reaching 0.001 Hz. As shown in Fig. 4.29.

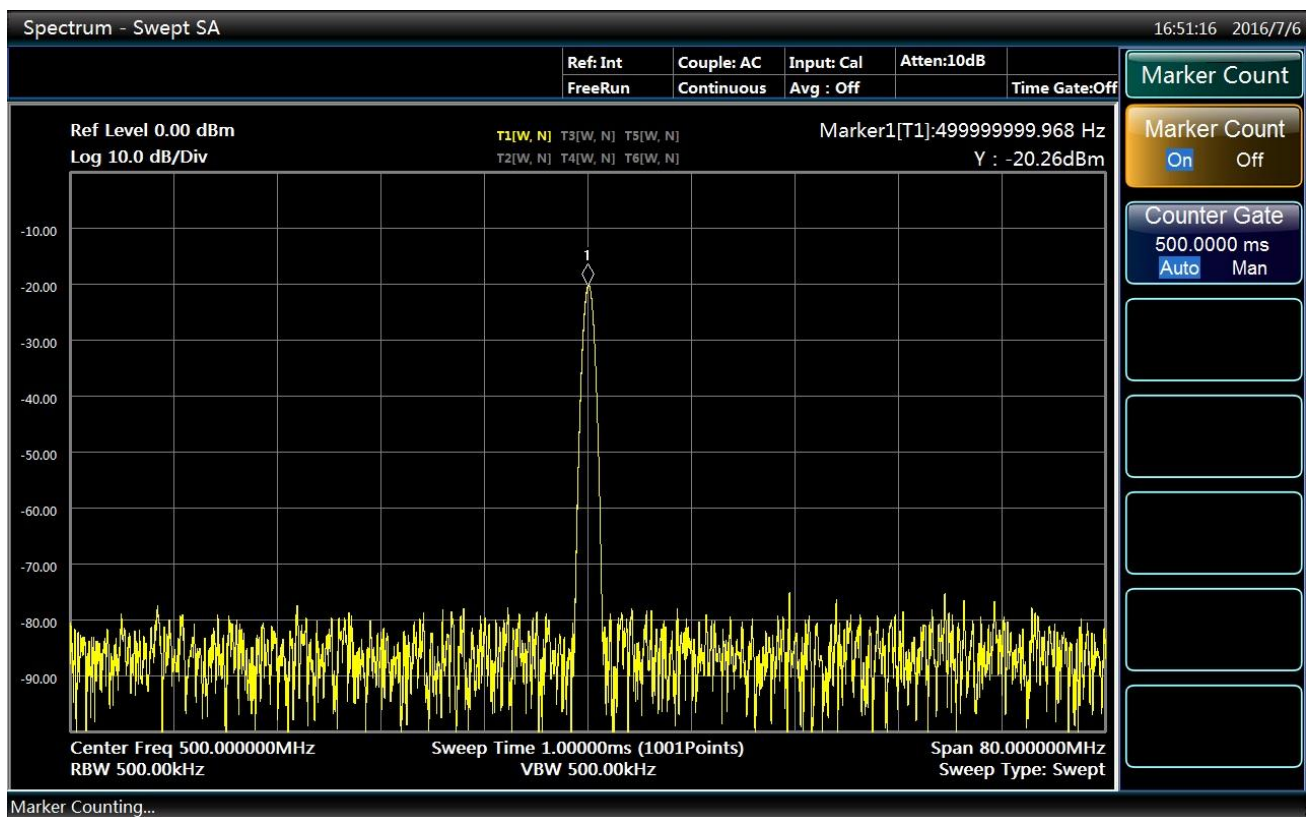

Fig. 4.29 Increase frequency measurement accuracy with marker function

The marker count function can only measure continuous wave signal or discrete spectrum component with signal amplitude over -50 dBm and above the noise level of 30 dB.

Step 5. change marker count gate time:

- Press **【Marker Func】** , [Marker Count▶] and [Counter Gate **Auto**Man].

When the value of the gate time is changed, the count accuracy can also be changed. The longer the gate time, the higher the count accuracy, as shown in Fig. 4.30. When the gate time is longer than or equal to 2 s, a count accuracy of 0.1 Hz can be ensured.

4.2 Advanced operation guide

Step 6. Turn off marker count function:

- Press **【Marker Func】** , [Marker Count▶] and [Marker Count On **Off**].

Caution

When using the frequency count function, if users find that sweep speed of the analyzer is dropping, it is normal because it takes longer for the analyzer to execute accurate signal locating and IF counting in the background.

Caution

When using the frequency count function, the signal generator to be measured and the analyzer should share the same time base in order to accurately measure the frequency.

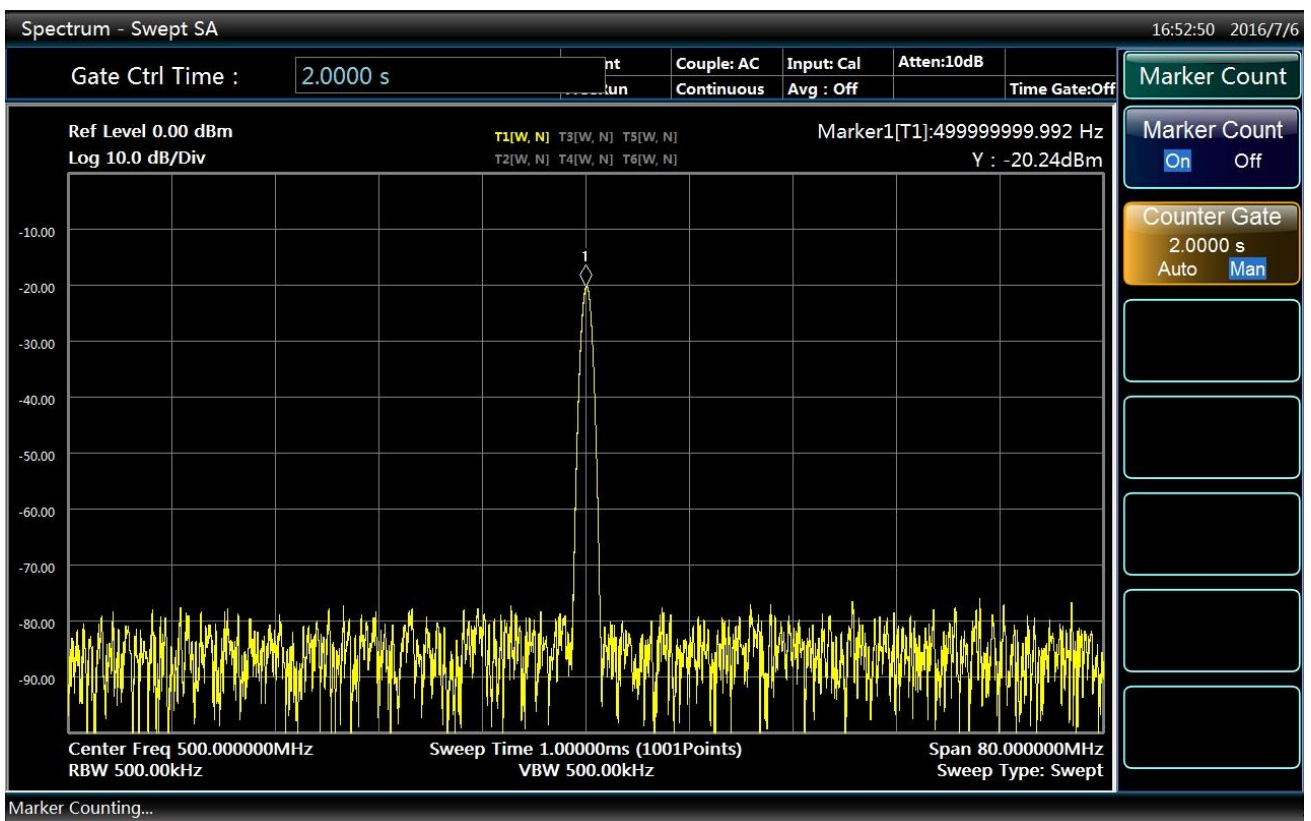

Fig. 4.30 Improve count accuracy by changing the gate time

4.2.5 Noise signal measurement

4.2.5.1 Concept of noise measurement

In communications systems, signal-to-noise ratio (SNR) is usually used to express noise amplitude. When the noise level in the system increases, SNR decreases and it will be harder to demodulate modulated signals. SNR measurement is also used to indicate measurement of ratio of carrier against noise in communications systems.

In the following example, the way to measure SNR and noise with marker function of 4051 Series Signal/Spectrum Analyzer will be introduced. In the example, SNR is measured with the signal (carrier) having only single frequency point. If the system to be measured has modulated signal, testing procedures have to be modified to correct the level of such modulated signal.

4.2.5.2 Measure SNR

Step 1. set the analyzer as spectrum analysis mode and reset the analyzer:

- Press **【Mode】** and [Spectrum].
- Press **【Preset】** .

Step 2. Input 500 MHz internal calibration signal into the analyzer:

- Press **【Input/Output】** , [Input Port **RF** Cal] to select calibration port.
- Press [Cal Port], [500 MHz] to select 500 MHz calibration signal.

Step 3. set center frequency, frequency span, reference level and attenuator:

- Press **【Frequency】** , [Center Freq] and enter 500 MHz.
- Press **【Span/X Axis】** , [Span] and enter 1 MHz.
- Press **【Amplitude/Y Axis】** , [RefLevel] and enter -10 dBm.
- Press **【Amplitude/Y Axis】** , Press **【Amplitude/Y Axis】** , [Attenuation▶], [Mech Atten **AutoMan**] and enter 40 dB.

Step 4. place the marker at the signal peak and then put the delta marker to the noise with 200 kHz frequency offset:

- Press **【Peak Search】** , [Delta Marker] and enter 200 kHz.

Step 5. turn on the delta marker function to check SNR:

- Press [Marker Func], [Noise Marker ON **OFF**] to open noise marker. As shown in Fig. 4.31.

SNR reading is expressed in the unit of dBc/Hz because such noise level is the value of noise bandwidth under 1 Hz which is reduced at a rate of $10 \times \log(BW)$. If you wish to obtain noise values under different channel bandwidth, the measurement result needs to be corrected based on current bandwidth. For example, if the analyzer reading is -86.07 dBc/Hz and the current channel bandwidth is 30 kHz, SNR will be $S/N = 86.07 \text{ dBc} / \text{Hz} - 10 \times \log(30 \text{ kHz}) = 41.3 \text{ dBc} / (30 \text{ kHz})$. If the delta maker is smaller than 1/4 of the distance from the signal peak to response edge, there will be potential error in noise measurement.

4.2 Advanced operation guide

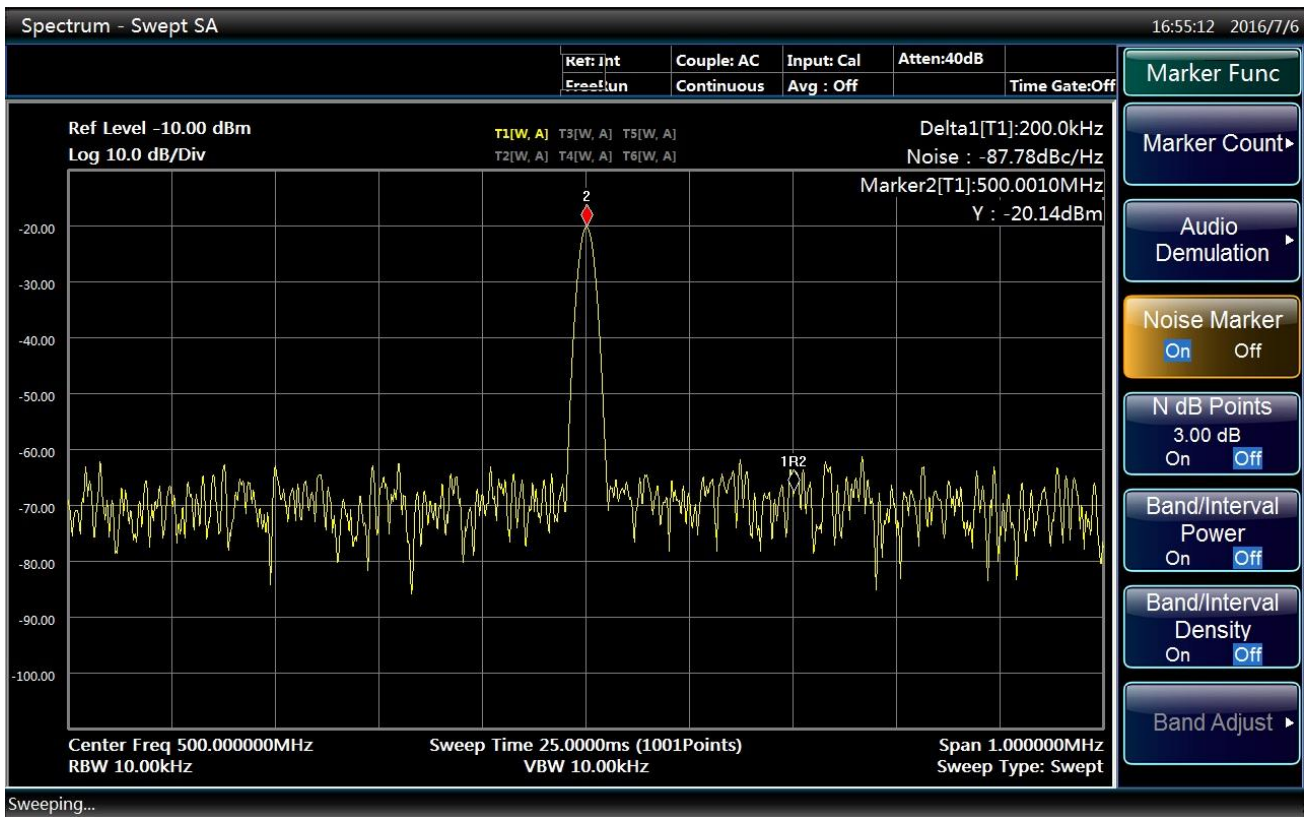

Fig. 4.31 Measure SNR

4.2.5.3 Measure noise with noise marker function

In this example, the noise marker function will be used to measure the noise of 1 Hz bandwidth with 500 MHz internal calibration signal.

Step 1. Input 500 MHz internal calibration signal into the analyzer:

- Press **【Input/Output】** , [Input Port **RF** Cal] to select calibration port.
- Press [Cal Port] and [500 MHz] to select 500 MHz Calibration signal.

Step 2. set center frequency, frequency span, reference level and attenuator:

- Press **【Frequency】** , [Center Freq] and enter 499.98 MHz.
- Press **【Span/X Axis】** , [Span] and enter 100kHz.
- Press **【Amplitude/Y Axis】** , [RefLevel] and enter -10 dBm.
- Press **【Amplitude/Y Axis】** , Press **【Amplitude/Y Axis】** , [Attenuation▶], [Mech Atten **AutoMan**] and enter 40 dB.

Step 3. enable the noise marker:

- Press [Marker Func], [Noise Marker ON **OFF**]

At such moment the detector mode will be automatically set as power average. If you wish to obtain noise power under different channel bandwidth, current bandwidth needs to be corrected based on $10 \times \log(BW)$. For example, if the noise power within 1 kHz bandwidth is to be obtained, $10 \times \log(1000)$ or 30 dB has to be added to the reading.

Step 4. Reduce measurement error by increasing sweep time:

- Press **【Sweep】** , [Sweep Time] and enter 3 s.

Step 5. move the marker to 500 MHz:

- Press **【Marker】** and turn the knob on the front panel to set noise marker reading as 500 MHz.

The noise marker value is derived by multiplying the number of sweep trace points with 5% and the marker position is the center of such trace points. The noise marker will not be at the signal peak since such position has no enough trace points for calculation. Therefore, when the resolution bandwidth is narrow, the noise level will average trace points below the signal peak. As shown in Fig. 4.32.

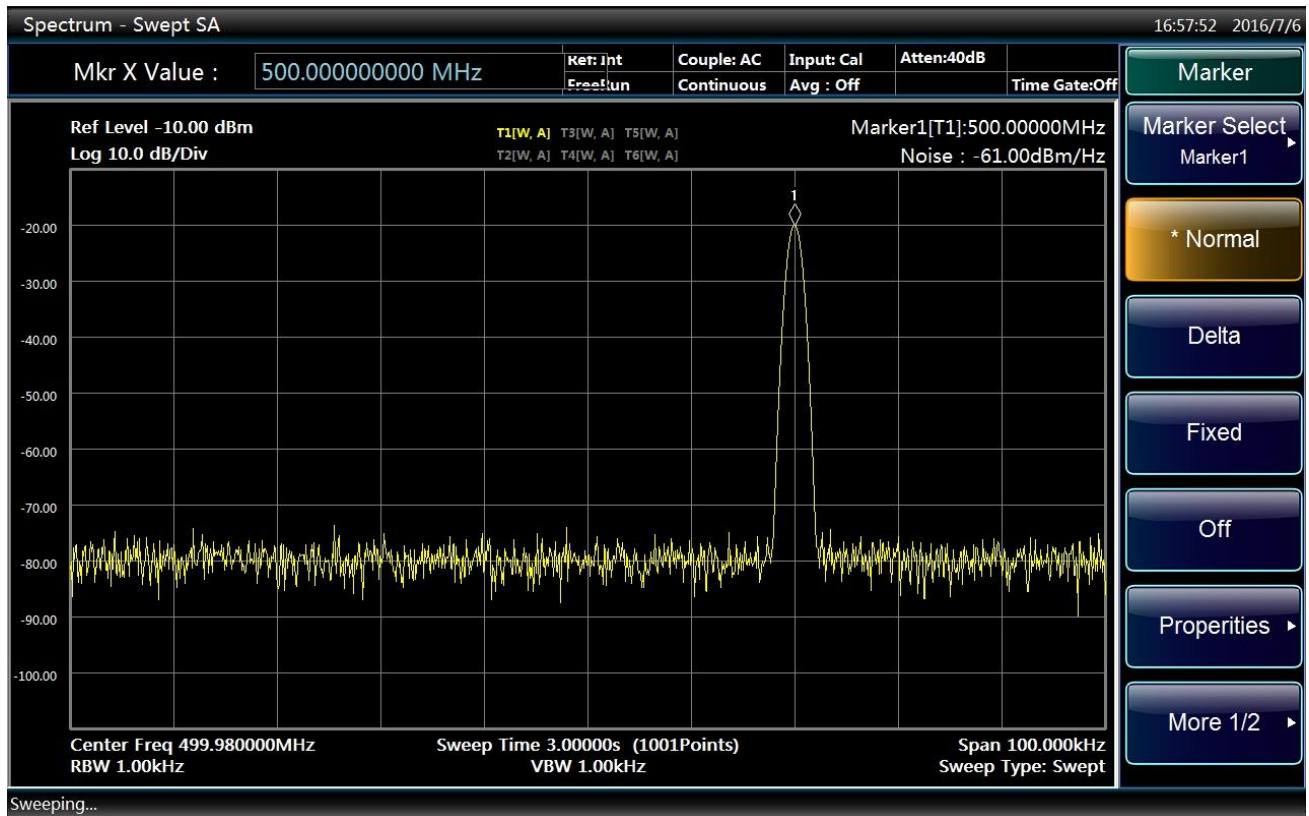

Fig. 4.32 Measure noise with the noise marker function

Step 6. set the analyzer as zero frequency span with the marker as the center:

- Press **【Marker →】** and [Marker → Center Freq].
- Press Span/X Axis] and [Zero Span].
- Press **【Marker】** .

The amplitude reading of the noise level is correct at the moment since all points are averaged under the same frequency without being affected by the shape of the resolution bandwidth filter. The noise marker is derived by averaging frequency points of interest. When measuring the power of discrete frequency points, the analyzer should be tuned to the frequency points of interest and then the measurement should be made under zero frequency span.

4.2.6 AM signal demodulation**4.2.6.1 Definition of modulation**

Modulation refers to the process of transforming low frequency or base band signals (sound, music and data) to high frequency signals. During modulation, some characteristics of carrier signals (usually frequency or amplitude) will change in proportion to transient change of base band signal amplitude. When demodulating AM signals, the analyzer can serve as a fixed-tuned receiver (time domain), which means to use zero frequency span mode to restore amplitude-modulated carrier signals.

4.2 Advanced operation guide

4051 Series Series Signal Analyzer can clearly display AM signal signal waveform via following operations:

- Obtain stable trace by setting trigger conditions on the modulation envelope and sweep demodulated waveform synchronously with video trigger if signal modulation is stable;
- Apply linear display in AM measurement to avoid distortion of logarithmic display caused during signal demodulation;
- Observe AM signal modulation speed via sweep time;
- Set resolution bandwidth and video bandwidth based on measured signal bandwidth.

In the following section, it will be explained how to measure AM and FM signals, how to display signals on the analyzer and how to monitor AM and FM broadcasting signals.

4.2.6.2 Measure modulation speed and depth of AM signals with RF spectrum

AM signals can be generated by one signal generator and demodulated by connecting one antenna to RF input port of the analyzer. The AM signal in this example is produced with a signal generator.

Step 1. connect output of the signal generator to the RF input port of the analyzer:

- Set the signal generator with an AM signal with output carrier of 100 MHz, amplitude of -10 dBm, modulation depth of 5% and modulation speed of 34 kHz.

Step 2. set center frequency of the analyzer as 100 MHz and frequency span as 500 MHz:

- Press **【Mode】** and [Spectrum].
- Press **【Preset】** .
- Press **【Frequency】** , [Center Freq] and enter 100MHz.
- Press **【Span/X Axis】** , [Span] and enter 500kHz.

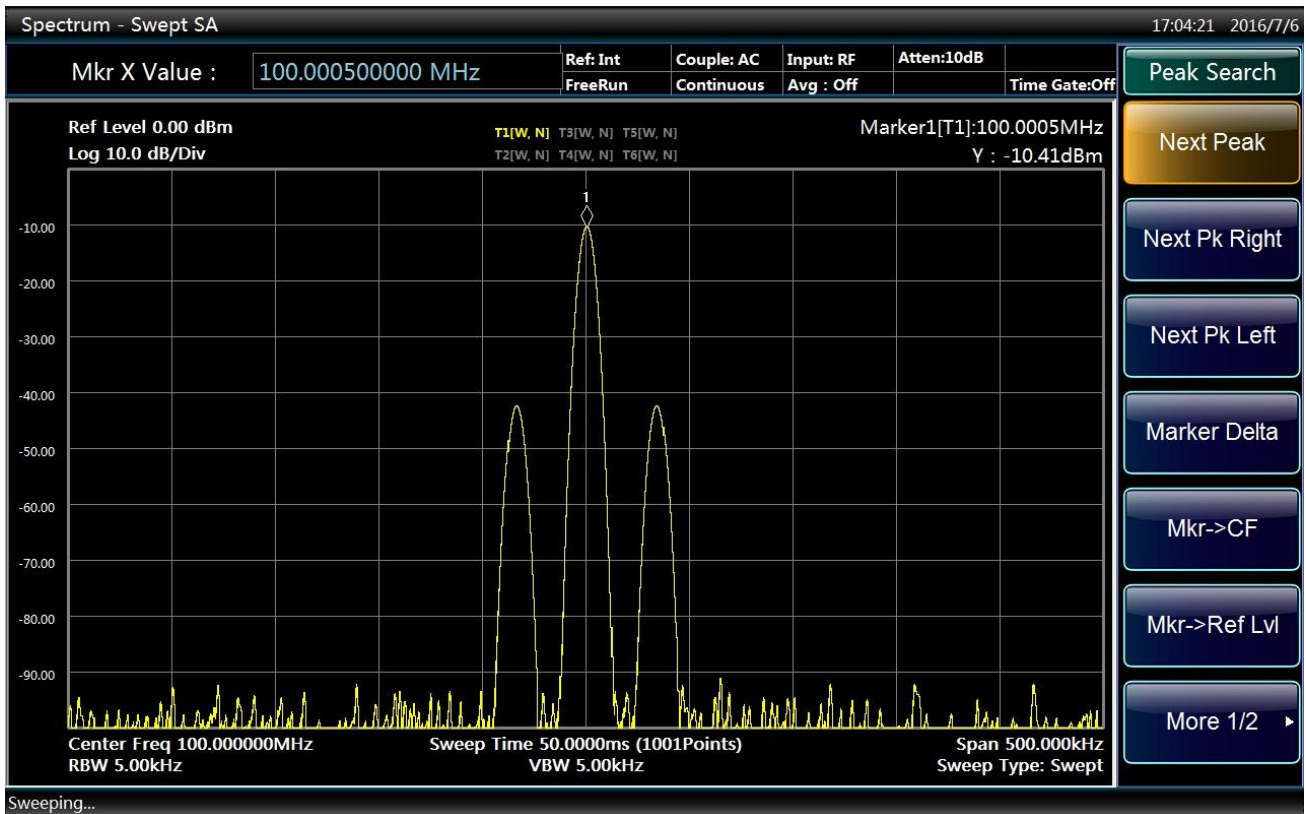

Fig. 4.33 AM signal

4.2 Advanced operation guide

Fig. 4.33 shows the AM signal displayed on the screen of the analyzer. Press **【Peak Search】** to define carrier signal frequency.

Caution

Amplitude different between upper and lower sideband indicates that there is residential frequency modulation on the input signal. Residential frequency modulation will reduce modulation depth and measurement accuracy.

Step 3. define parameters of modulated signals easily with carrier and sideband via following operations:

- Press **【Peak Search】**, [Delta Marker] and [Next Peak] to get the difference between the carrier and the sideband signal. The frequency difference of two signals can be read via the delta marker, which is the modulation speed of the measured AM signal and used to determine modulation depth as shown in Fig. 4.34.

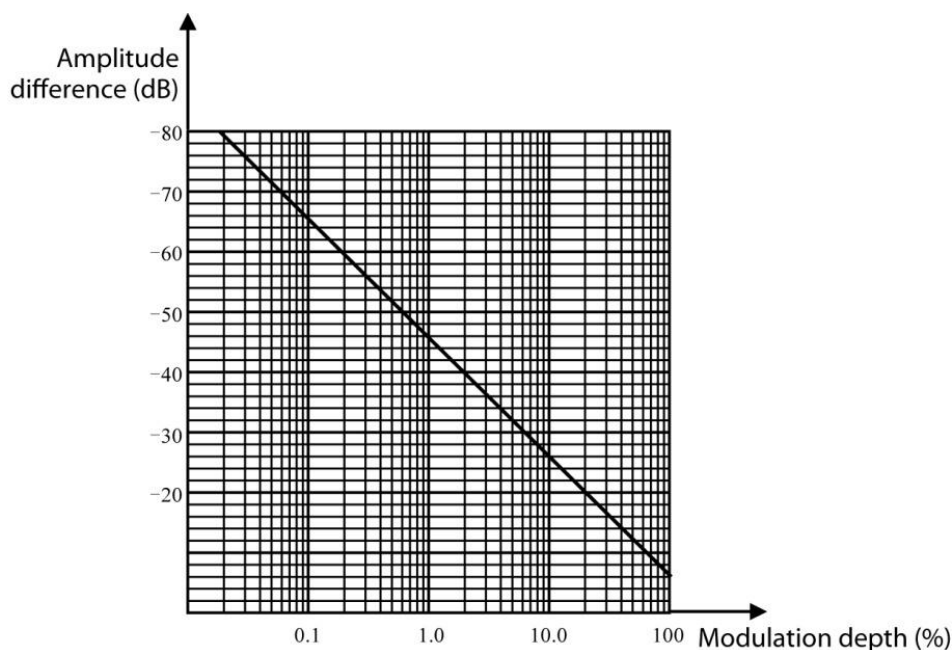

Fig. 4.34 Relation graph of modulation depth and amplitude difference

When the amplitude difference in dB is obtained, the following formula can be used to calculate modulation depth:

$$AM\% = 200 \times 10^{-(\Delta dB/20)}\%$$

Where:

ΔdB refers to the amplitude difference of the carrier and the sideband.

4.2.6.3 Measure amplitude modulation speed with demodulation waveform

Step 1. connect output of the signal generator to the input port of the analyzer:

- Set the signal generator with an AM signal with output carrier of 300 MHz, amplitude of -10 dBm, modulation signal of 1 kHz and AM depth of 80%.

Step 2. reset the analyzer and set center frequency, frequency span and sweep time:

- Press **【Preset】**.
- Press **【Frequency】**, [Center Freq] and enter 300MHz.

4.2 Advanced operation guide

- Press **【Span/X Axis】** , [Span] and enter 500kHz.
- Press **【BW】** , [Res BW **AutoMan**] and enter 30kHz;
- Press **【Sweep】** , [Sweep Time **AutoMan**] and enter 20 ms.

Step 3. set Y axis scale unit as volt:

- Press **【Amplitude/Y Axis】** , [MORE 1/2▶], [Y Axis Unit▶] and [V].

Step 4. place the signal peak near the reference level:

- Press **【Amplitude/Y Axis】** , [RefLevel] and turn the knob to adjust the reference level.

Step 5. change Y axis display scale to linear scale:

- Press **【Amplitude/Y Axis】** and [Scale Type **Log** Line].

Step 6. set the analyzer as zero frequency span for time domain measurement:

- Press Span/X Axis] and [Zero Span].
- Press **【Sweep】** , [Sweep Time] and enter 5 ms.

Step 7. use video trigger function to stabilize display trace:

- Press **【Trig】** and [Video ▶].

Since the modulation is stable, sweep operation can be triggered on the waveform via video trigger to stabilize trace, which process is similar to the oscilloscope, as shown in Fig. 4.35. If the video trigger level is set too high or too low in video trigger mode, the sweep will stop. In this case, the knob on the front panel can be used to adjust the video trigger level until the sweep resumes.

Step 8. measure amplitude modulation speed with delta maker:

- Press **【Peak Search】** and [Delta Marker].
- Press **【Peak Search】** , [Next Pk Left] or [Next Pk Right], place the marker at the peak and then use the delta marker to measure the time difference between peaks.

During measurement, it should be ensured that the delta marker is on the nearby peak as shown in Fig. 4.35. The modulation speed of the FM or AM signal can be derived by dividing 1 with the time difference between adjacent peaks.

In this example, AM signal speed is obtained by calculating the time difference between AM signal time domain peaks. In order to measure more accurately, the center frequency can be placed on the steep point at the edge of the AM signal and set the analyzer as zero frequency span and sweep time two times of the modulation speed so as to increase sweep points for the purpose of improving measurement accuracy.

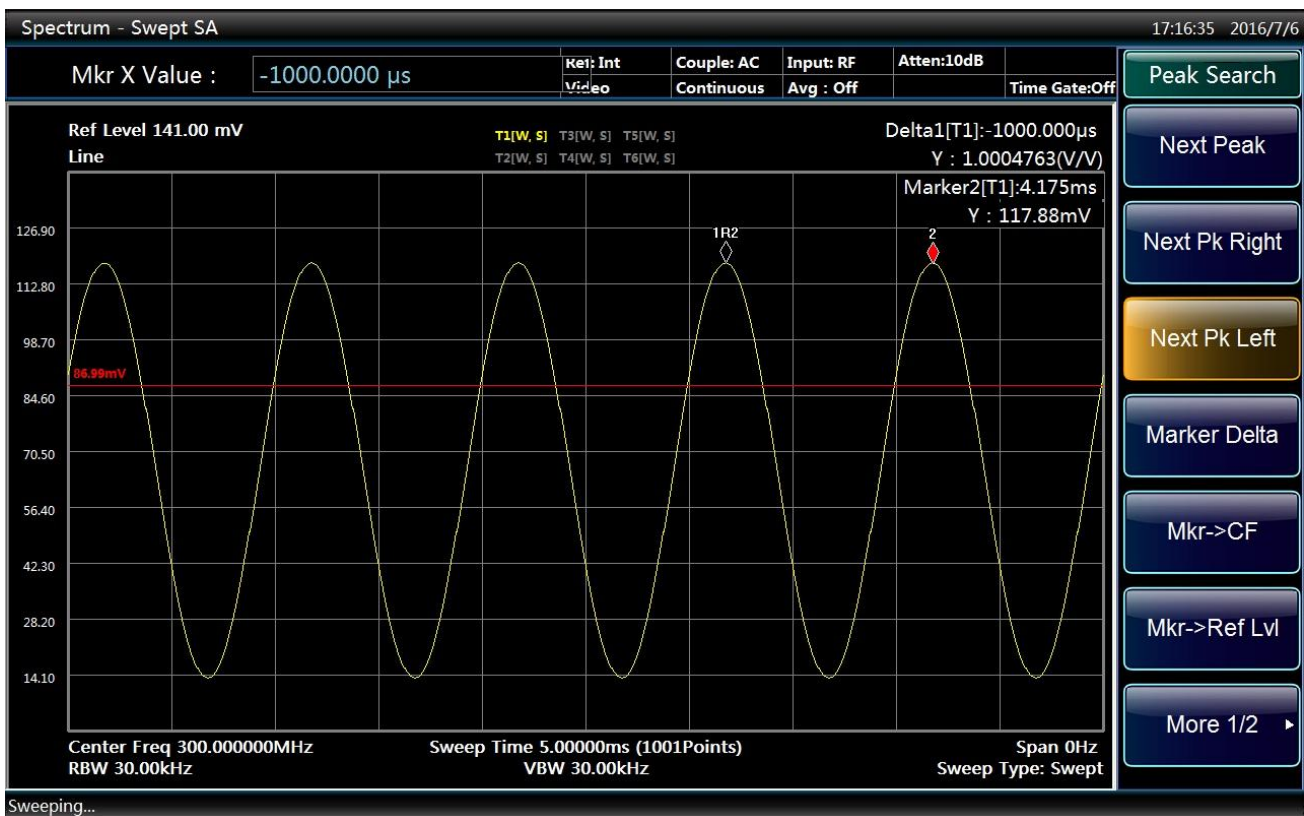

Fig. 4.35 Measure AM signal modulation speed with demodulation waveform

4.2.6.4 Measure AM modulation depth with demodulation waveform

In this section, we explain how to use the analyzer as a fixed-tuned (time domain) receiver to measure AM signal modulation depth with the measurement result expressed in percentage.

Step 1. connect output of the signal generator to the RF input port of the analyzer:

- Set the signal generator with an AM signal with output carrier of 300 MHz, amplitude of -10 dBm, modulation signal of 1 kHz and AM depth of 80%.

Step 2. reset the analyzer and set center frequency, frequency span and sweep time:

- Press **【Preset】**.
- Press **【Frequency】**, [Center Freq] and enter 300MHz.
- Press **【Span/X Axis】**, [Span] and enter 500kHz.
- Press **【BW】**, [Res BW **AutoMan**] and enter 30kHz;
- Press **【Sweep】**, [Sweep Time **AutoMan**] and enter 20 ms.

Step 3. set Y axis scale unit as volt:

- Press **【Amplitude/Y Axis】**, [MORE 1/2▶], [Y Axis Unit▶] and [V].

Step 4. place the signal peak near the reference level:

- Press **【Amplitude/Y Axis】**, [RefLevel] and turn the knob to adjust the reference level.

Step 5. change Y axis display scale to linear scale:

- Press **【Amplitude/Y Axis】** and [Scale Type **Log** Line].

Step 6. set the analyzer as zero frequency span for time domain measurement:

4.2 Advanced operation guide

- Press Span/X Axis] and [Zero Span].
- Press **【Sweep】** , [Sweep Time] and enter 5 ms.

Step 7. use video trigger function to stabilize display trace:

- Press **【Trig】** and [Video ▶].

Since the modulation is stable, sweep operation can be triggered on the waveform via video trigger to stabilize trace, which process is similar to the oscilloscope, as shown in Fig. 4.35. If the video trigger level is set too high or too low in video trigger mode, the sweep will stop. In this case, the knob on the front panel can be used to adjust the video trigger level until the sweep resumes.

Step 8. close all markers and set the analyzer as free trigger mode:

- Press **【Marker】** and [OFF].
- Press **【Trig】** and [Free Run].

Step 9. increase sweep time and reduce video bandwidth to display the waveform as a horizontal signal:

- Press **【Sweep】** , [Sweep Time] and enter 5 s.
- Press **【BW】** , [Video BW **AutoMan**] and enter 30 Hz.

Step 10. place the horizontal signal at the center of Y axis, increase video bandwidth and reduce sweep time to display the waveform in a sine wave:

- Press **【Amplitude/Y Axis】** and [RefLevel], turn the knob to adjust the reference level and place the horizontal signal at the center of Y Axis.
- Press **【BW】** , [Video BW **AutoMan**] and enter 100kHz.
- Press **【Sweep】** , [Sweep Time **AutoMan**] and enter 5 ms.

Step 11. measure AM signal modulation depth:

- To obtain a modulation depth in percentage, the following method can be used to read the trace: 100% AM modulation depth takes up all the grids from top to bottom, while 80% AM (as shown in this example) takes up grids from second from the top to second from the bottom. The number of grids taken up by Y axis can be counted to determine signal modulation depth percentage, as shown in Fig. 4.36.

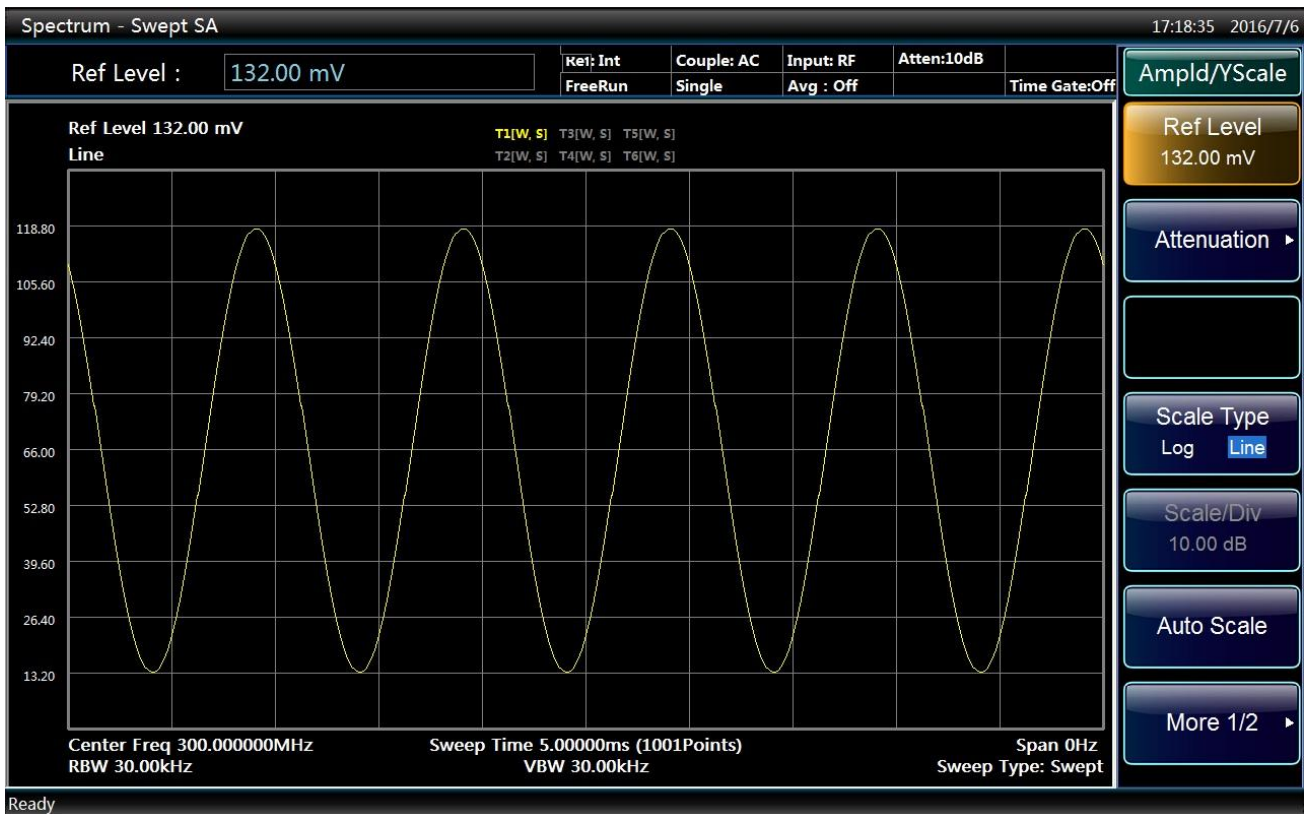

Fig. 4.36 Measure AM signal modulation depth with demodulation waveform

4.2.7 Drift signal measurement

4.2.7.1 Definition of drift signal

The signal to be measured is a drift signal, the center frequency should be frequently changed at different time when measuring with the analyzer in order to observe properly. If the signal tracking function of the analyzer is used, the marker peak will always be displayed at the center frequency of the analyzer to facilitate measurement.

4.2.7.2 Available functions of Series Signal Analyzer

The Section describes how to measure the drift signal, where the amplitude track and occupied bandwidth will be observed by the use of signal/ spectrum analyzer tracking, tracking and max hold functions for the signal drift.

4.2.7.3 Measurement of frequency drift for signal generator

The Series Signal Analyzer can measure the short-term and long-term stability of the signal generator, and display the max peak amplitude and frequency drift of the input signal via the max hold function signal of track/ spectrum analyzer. The max hold function of track may be used to measure the occupied bandwidth of signal.

This example will maintain the drift signal to display in the center position by the signal tracking of Series Signal Analyzer, and capture the drift signal via the max hold of the analyzer.

Step 1. connect RF output of the signal generator to the input port of the analyzer.

Step 2. set the signal of the signal generator with output frequency of 300 MHz and amplitude of -20dBm, and open its RF output.

Step 3. set the analyzer as spectrum analysis mode:

4.2 Advanced operation guide

- Press **【Mode】** and [Spectrum].

Step 4. set the center frequency, frequency span and reference level of the analyzer:

- Press **【Preset】** .
- Press **【Frequency】** , [Center Freq] and enter 300 MHz.
- Press **【Span/X Axis】** , [Span] and enter 10 MHz.
- Press **【Amplitude/Y Axis】** , [RefLevel] and enter -10 dBm.

Step 5. place the marker on the signal peak position and open the signal tracking:

- Press **【Peak Search】** .
- Press **【Frequency】** and [Signal Track On **Off**].

Step 6. reduce the bandwidth to 500kHz:

- Press the [Span] and input 500kHz to remain the signal at the center.

Step 7. Close the signal tracking:

- Press **【Frequency】** and [Signal Track On **Off**].

Step 8. measure the signal drift through the function of max hold:

- Press the [Track] and [Max Hold].

When the signal changes, the max hold will maintain the maximum response to the input signal. Note the track mode indication at the top of the screen, e.g. The yellow T1 [M, P] means Track 1 is in the status of max hold.

Step 9. activate Track 2 and set it for continuous update mode:

- Press the **【Trace】** , [Select Trace▶], [Trace 2] and [Clear Write].

Note that the track mode indication at the top of the screen, e.g. T2 is highlighted to be blue, T2[W, P] indicating the Track 2 in continuous update mode and the detection mode is positive peak.

Step 10. slowly change the output frequency of signal generator, to make it change at 1kHz step and range from ± 50 kHz. What displays on the Series Signal Analyzer is shown in Fig. 4.37.

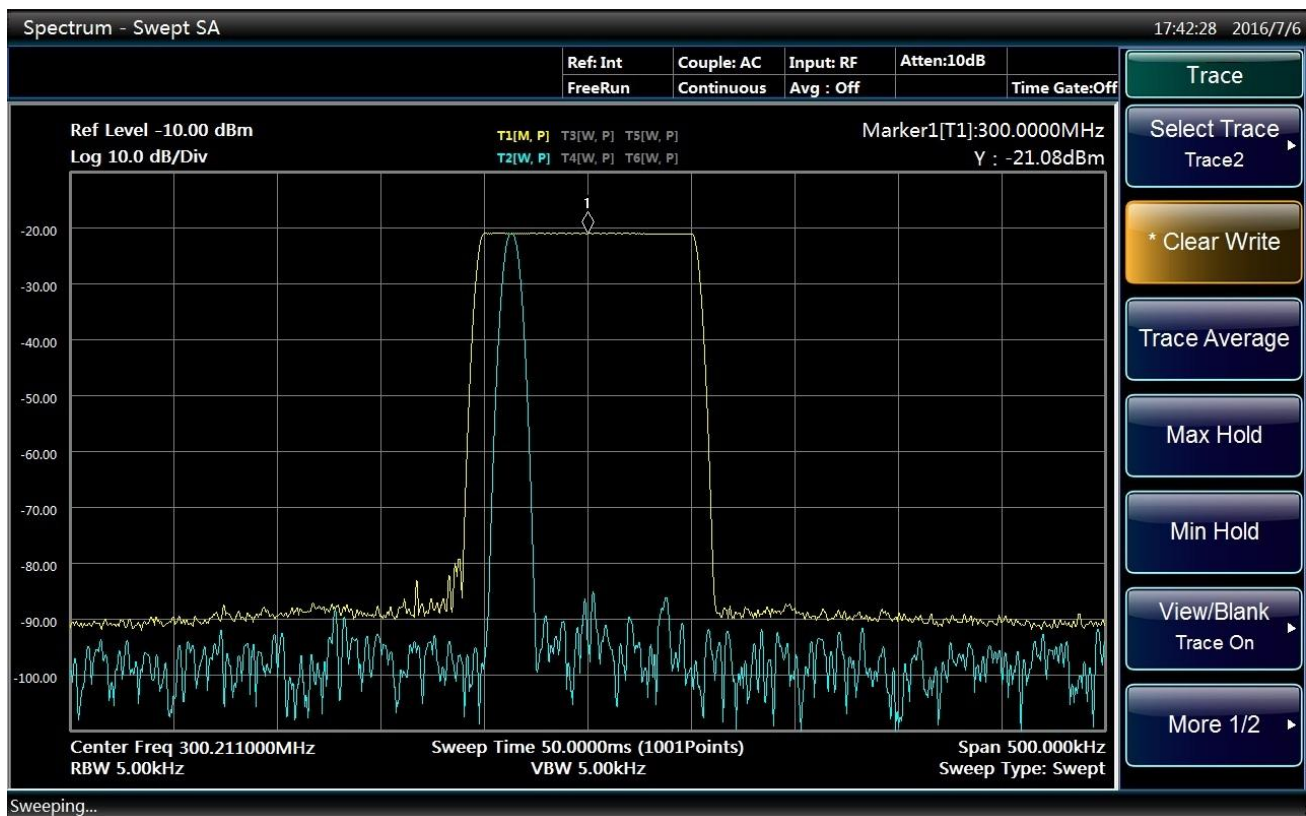

Fig. 4.37 Signal drift observation by the max hold

4.2.7.4 Tracking signal

The signal tracking function is very useful for the slow drift signal, which enables the drift signal to be the center of the display screen.

It should be noted that the signal tracking is to track the unstable signals, rather than track the signals until the center frequency of the Series Signal Analyzer is changed. Make sure the tracked signal is correct when the center frequency of the analyzer is changed.

Step 1. set the output signal of the signal generator with frequency of 300 MHz, amplitude of -20dBm, and stepped frequency of 100kHz, and open its RF output.

Step 2. set the analyzer as spectrum analysis mode:

- Press **【Mode】** and [Spectrum].

Step 3. set center frequency to be 1 MHz of frequency offset for the Series Signal Analyzer:

- Press **【Preset】** .
- Press **【Frequency】** , [Center Freq] and enter 301 MHz.
- Press **【Span/X Axis】** , [Span] and enter 10 MHz.

Step 4. open the signal tracking:

- Press **【Frequency】** and [Signal Track On **Off**].

It should be noted that the marker will be placed in the max peak amplitude, and then the signal is displayed in the center of the analyzer, and the center frequency will be automatically adjusted for each scanning.

Step 5. open the Delta Marker function:

- Press **【Marker】** and [Delta Marker].

4.2 Advanced operation guide

Step 6. Adjust the output frequency of the signal generator by 100kHz step: the observable center frequency of the Series Signal Analyzer also changes by the stepped frequency of 100kHz, where the step signal is always in the center of the screen display. As shown in Fig. 4.38.

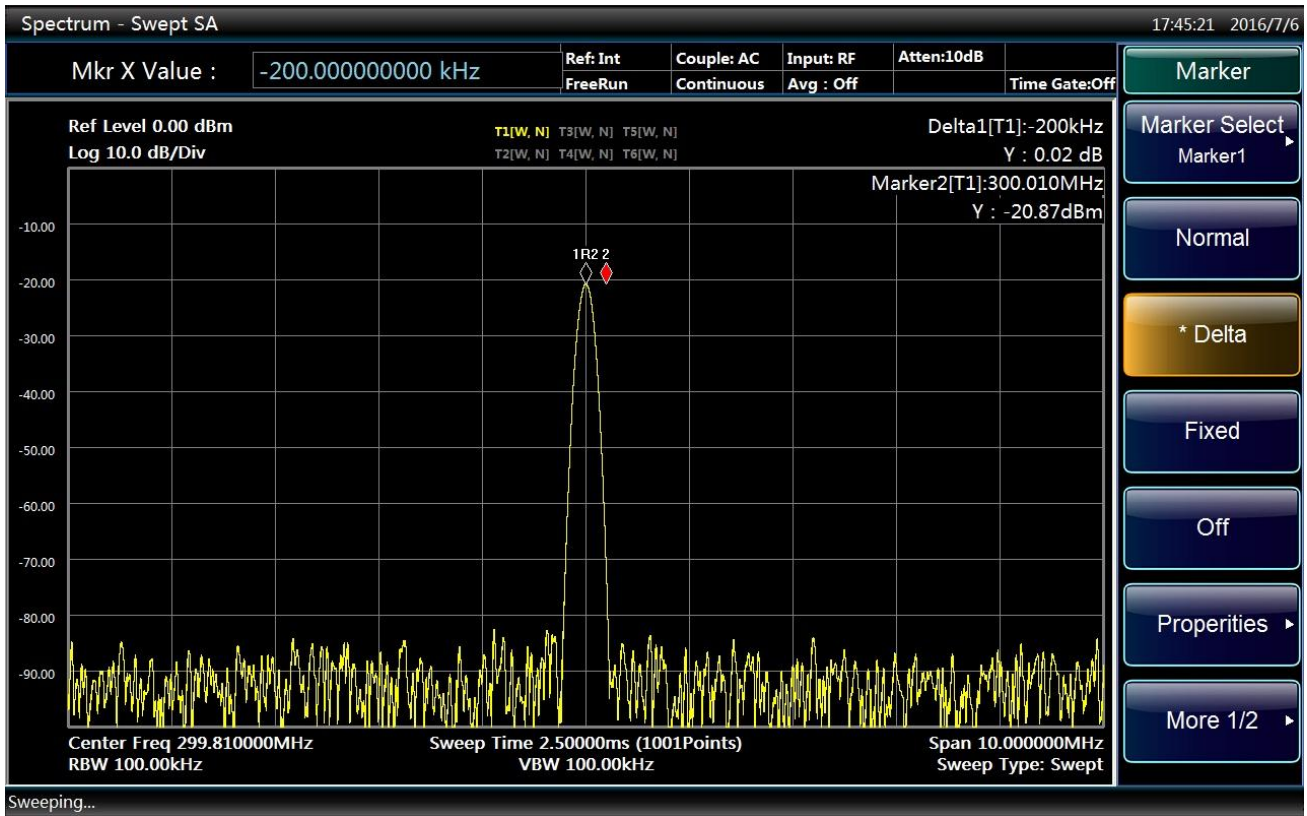

Fig. 4.38 Measurement of drift signal by signal tracking

4.2.8 Improvement of amplitude measurement accuracy by amplitude correction function

4.2.8.1 Definition of amplitude correction

The amplitude correction function aims to improve the accuracy of amplitude measurement. Due to many factors including the losses of adapter and cables, the flatness of the system is often impacted. Therefore, the amplitude correction is used for the unified disposal for the system, so as to eliminate the influence on the measurement results. Run the amplitude correction function after the paired frequency/amplitude correction data are input into the Series Signal Analyzer, and the analyzer will conduct the real-time correction for the measurement results via the revised data. The amplitude correction functions of 4051 Series Signal/Spectrum Analyzer include: user correction, antenna gain correction and cable correction, and the user can select the correction menu in need.

4.2.8.2 Available functions of Series Signal Analyzer

The Section will describe the function of amplitude correction where the application method of input and editing functions regarding the amplitude correction data is given for the convenience of inputting the frequency and amplitude correction data pair. A pair of data can be stored and reused once input.

4.2.8.3 Measuring steps for amplitude correction

The amplitude correction function is used to measure and calibrate the flatness changes of the system. Providing that the Series Signal Analyzer is applied for the measurement of one device, and the output signal frequency ranges from 1GHz to 3GHz. It is necessary to use cables and connector to connect the device and the analyzer. So the amplitude correction function can correct the measuring errors arising from the losses of

4.2 Advanced operation guide

cables and adapters, even the potential fluctuation of frequency response of the analyzer within the measured frequency range.

The measuring system is comprised of a signal generator used to simulate the device, plus the cables, connector and Series Signal Analyzer. After determining the amplitude correction values, input and save them. The correction values should be applied to the same measuring device.

Step 1. Connect a signal generator ranging from 1GHz to 3GHz to the Series Signal Analyzer by the cables and connector as shown in Fig. 4.39.

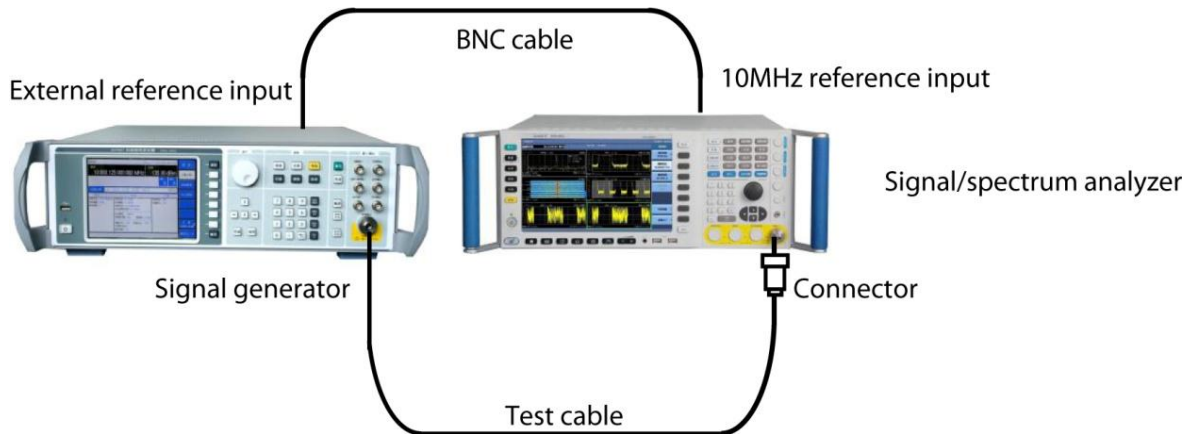

Fig. 4.39 Connection of measurement system for amplitude correction

Step 2. set the signal of the signal generator with output frequency of 1GHz and amplitude of -10 dBm, and open its RF output.

Step 3. set the analyzer as per the following parameters:

- Press **【Mode】** and [Spectrum].
- Press **【Preset】** key.
- Press **【Frequency】** and input 1GHz.
- Press **【BW】** , [Res BW **AutoMan**] and enter 1 MHz;
- Press **【BW】** , [Video BW **AutoMan**] and enter 1 MHz.
- Press **【Amplitude/Y Axis】** , [RefLevel] and enter -6 dBm.
- Press **【Amplitude/Y Axis】** , [Scale/Div] and input 1dB.
- Press **【Sweep】** , [Sweep Time **AutoMan**] and enter 50 ms.

Step 4. Adjust the signal generator to make the amplitude reading on the analyzer be -10dBm:

- The amplitude value to be corrected is obtained by the value on the signal generator subtracting -10dBm, which should be recorded as the amplitude correction value at the frequency point.

Step 5. Set the frequency on the signal generator to the next point which needs to be modified, and the set the frequency of the analyzer to the corrected frequency as well. Repeat the steps 3 4 until all correction values are recorded.

Step 6. To input the corrected value:

- Press **【Amplitude/Y Axis】** , [More 1/2▶], [Ampl Cor▶] and [Edit▶]. If the system has been loaded with the correction data, remove it (or clear the data prior to save it, and see below for details).

Step 7. Input the corrected value:

4.2 Advanced operation guide

- Press the soft key [Insert Point]. Edit the frequency points and amplitude values that need to be corrected. Input the amplitude correction value corresponding to each point recorded in Step 4 and press the soft key of [Insert Point] to add the next correction point. 100 independent correction points can be input to the Series Signal/Spectrum Analyzer. Every serial number corresponds to a frequency point and the amplitude value to be corrected.
- In case of any error of input data, press the [Delete Point] to remove the input data, and press [Insert Point] to continue the input process of correction points.
- Press **【Return】** and [Save Cor...]. The corrected data can be saved in the hard disk by cor as the file extension.

Step 8. Application of amplitude correction data:

- Press **【Amplitude/Y Axis】**, [More 1/2▶], [Ampl Cor▶] and [Cur Correction On **Off**] to close the amplitude correction data. The amplitude correction data is invalid.
- Press **【Amplitude/Y Axis】**, [More 1/2▶], [Ampl Cor▶] and [Delete] to clear the amplitude correction data.
- After the amplitude correction value is entered, disconnect the Series Signal Analyzer and signal generator, and connect the measurement signals by the same cables. Press **【Amplitude/Y Axis】**, [More 1/2▶], [Ampl Cor▶] and [Load Correction], and select the correct amplitude correction file to press OK on file dialog box, and then select [Cur Correction On **Off**] to call the saved amplitude correction data, for the track amplitude correction in the frequency range defined by the data correction.

Step 9. Application condition of amplitude correction

Errors may be caused in the following circumstances in the process of amplitude correction:

- Track data is above or below the values of grid coordinates.

If there is any point of track data not corrected above or below the grid line of the Series Signal Analyzer, the amplitude correction function will not be able to correct the values at the point. The amplitude accuracy of the analyzer is uncertain if the track data are above or below the values of grid coordinates. In order to avoid such mistake, make sure the track data are in the grid area of the analyzer prior to the application of amplitude correction data.

- Correction measurement near the bottom of the display grid lines;

If the coordinate scale of 10dB/grid, and the measurement signals are at the bottom of the grid are, the logarithmic distortion of the Series Signal Analyzer will result in the errors of amplitude correction.

- Flatness correction and temperature drift.

If the temperature plays a decisive role in the flatness changes, the correction is invalid.

4.2.9 Time gate measurement

4.2.9.1 Definition of time gate

This section will introduce some basic concepts related to the time gate, to help you to more reasonably set relevant parameters of Series Signal Analyzer during the measurement of time gate.

Under some circumstances, it is hardly to analyze the pulse RF signal, time-division multiplexing signal, time division multiple access (TDMA) signal or intermittent signal without the Series Signal Analyzer of time gate function. For example, there are two wireless communication signals #1 and #2 as shown in Fig. 4.40, where the same channel is used for the time division, and it takes 1 ms for each communication channel. How to separately analyze the frequency spectrum for each transmitter?

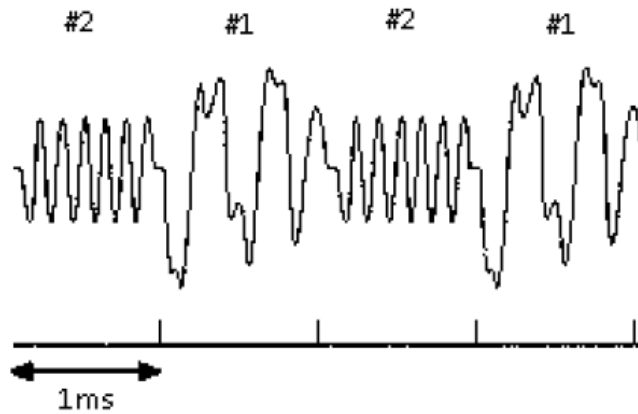

Fig. 4.40 Time domain waveform of simple digital communication signals

Although the scanning speed of analyzer becomes faster, the radio transmitter has switched back and forth for dozens of times when the analyzer has scanned once (the scanning time is tens of milliseconds). Because the two radio signals are transmitted with the same frequency, their spectrum will overlap, as shown in Fig. 4.41. The Series Signal Analyzer displays the spectrum of composite signal, so you cannot tell the signal corresponding to which spectrum. Therefore, the measurement cannot be achieved without the signal/spectrum analyzer of time gate function.

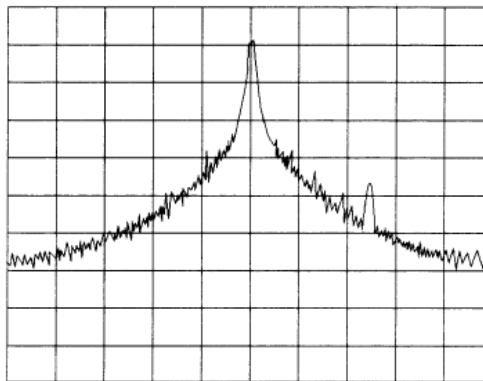

Fig. 4.41 Mixed spectrum of the two communication signals

The time gate refers to the time window for measurement defined by users. It means that users can specify the signal required to be measured, and eliminate or shield the interference signals. With the time gate function and external trigger signal, you can see the separate spectrum of Signal 1 (or Signal 2). The time gate spectrum of Signal 1 is shown in Fig. 4.42 and Fig.4.43 for Signal 2. There is false signal in Signal 1 of Fig. 4.42.

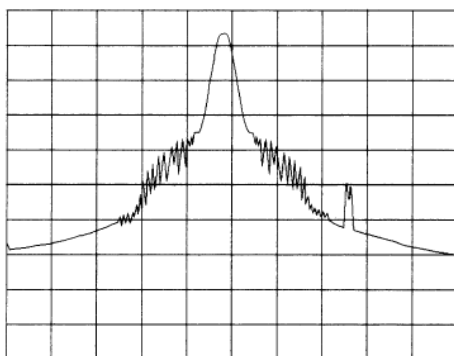

Fig. 4.42 Time gate spectrum of Signal 1

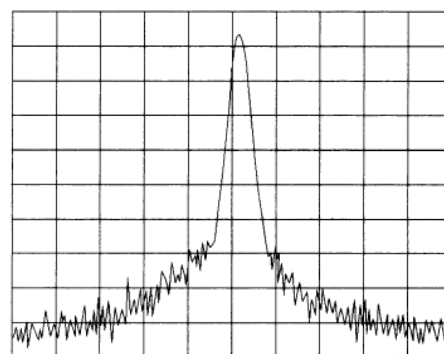

Fig. 4.43 Time gate spectrum of Signal 2

4.2 Advanced operation guide

4.2.9.2 Measurement principle of time gate

The measurement of time gate refers to the Series Signal Analyzer uses the trigger signals to carry out the alternative measurement, see Fig. 4.44. The gate width determines the capture time of measurement data (the signal pass through if gated, and the signal fails to pass through if closed). In proper conditions, the signal measured by the analyzer merely refers to the input signal during the gating, and other signals will be shielded if the setting is correct.

The gating conditions are determined by the trigger mechanism of the Series Signal Analyzer, including edge triggering and level triggering, which are described as follows:

Edge triggering: when the selected edge (positive or negative edge) of the trigger signal arrives, whether the Gate is ON is determined by the subsequent gate delay and gate length (both can be set by the menu). The Gate is ON whenever the trigger event arrives and the gate delay time is passed. During the gate length, the signal passes through; when the gate length ends, the signal is blocked, as shown in Fig. 4.44. In general, for edge triggering, the trigger signal is an TTL periodic signal, whose positive and negative edges are synchronous with those of the measured pulse signal. Gate delay time refers to the time during which the Series Signal Analyzer needs to wait from the trigger event to Gate ON.

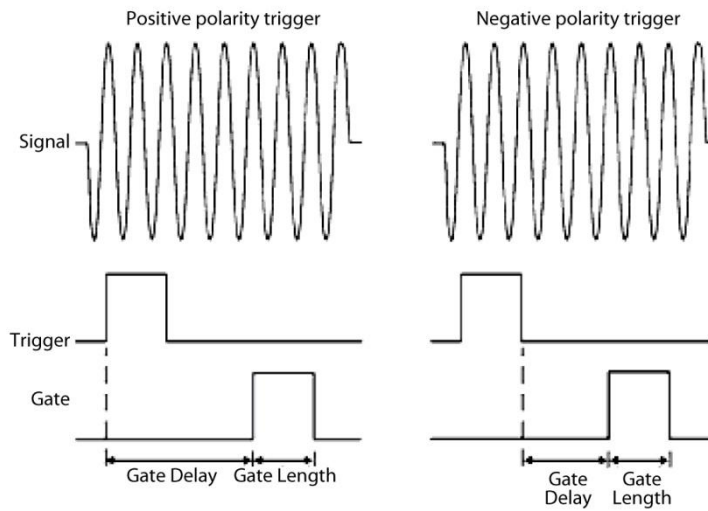

Fig. 4.44 Sequence diagram of edge triggering

Level triggering: when the gate signal has achieved a certain level (high level or low level. In Series Signal Analyzer, positive polarity indicates high level; and negative polarity indicates low level), the signal passes through; and when the gate signal fails to achieve specified level, the signal is blocked, as shown in Fig. 4.45. In Level triggering, the Gate Delay and Gate Length parameters are void.

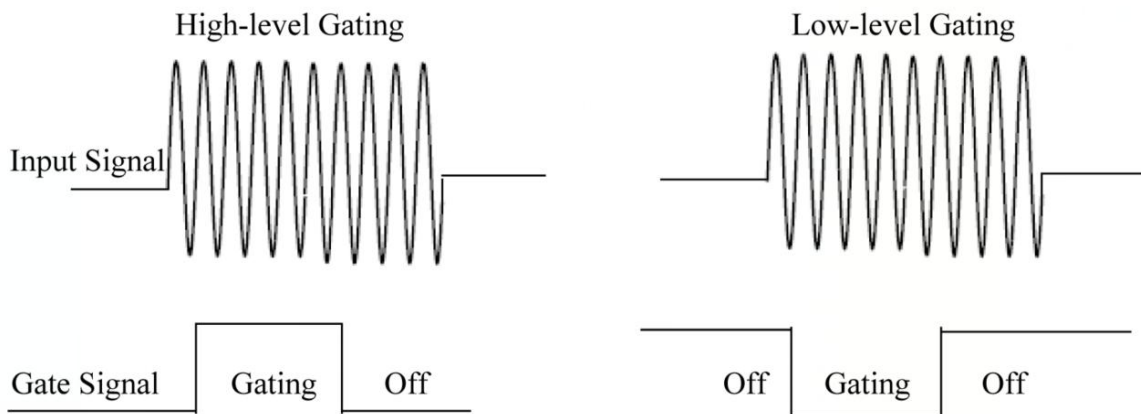

Fig. 4.45 Sequence diagram of level triggering

4.2 Advanced operation guide

The following three parameters are required to be considered when the time gate judges the signal passed or shielded:

- Triggering conditions: in general, for edge triggering, the trigger signal is a TTL periodic signal, while the level triggering refer to the high/low electrical level.
- Gate delay: the gate delay time refers to the duration from the time that triggering conditions are satisfied to gating signal (for the edge triggering).
- Gate width: the gate width determines the time duration of gating signal (for the edge triggering).

Research on the spectrum measurement of double pulse RF signal can better help users to understand the time gate, where the time allocation of three key signals is required to be considered during the measurement. The three signals include:

- Measured pulse RF signal
- The time gate trigger signal provided by the signal generator.
- Gate output signal from the BNC connector of the back panel of the Series Signal Analyzer. The signal is the TTL low electric level when the Gate is “Off” (shielding), and TTL high electric level when “On” (measurement).

Observing the three signals with an oscilloscope, you can be fully aware of the impact of the time allocation among them. The three signals on the oscilloscope are shown in Fig. 4.46.

The main purpose is to measure the spectrum of pulse sequence 1 and determine whether there is low-level modulation or false signal. The carrier frequencies of pulse sequence for Signal 1 and Signal 2 are similar, so both frequency domain spectra are overlapped. But the amplitude of Signal 2 is wider; therefore, its spectrum of the pulse sequence is stronger. If there is no time gate, it is impossible to observe the pulse sequence of Signal 1.

The pulse sequence of spectrum is covered by that of Signal 2.

To measure the pulse sequence 1, the time gate must opened in the pulse sequence 1. The time gate should be closed in other time periods so that other signals are blocked. The gate delay and width should be set to have the gate opened only in a certain area of the central pulse as shown in Fig. 4.46. Never position the gate at the positive or negative edge of the pulse. For the grid line marked “Gate” in the figure, the output signal indicates the actual position of gate on the time axis if the gate is activated.

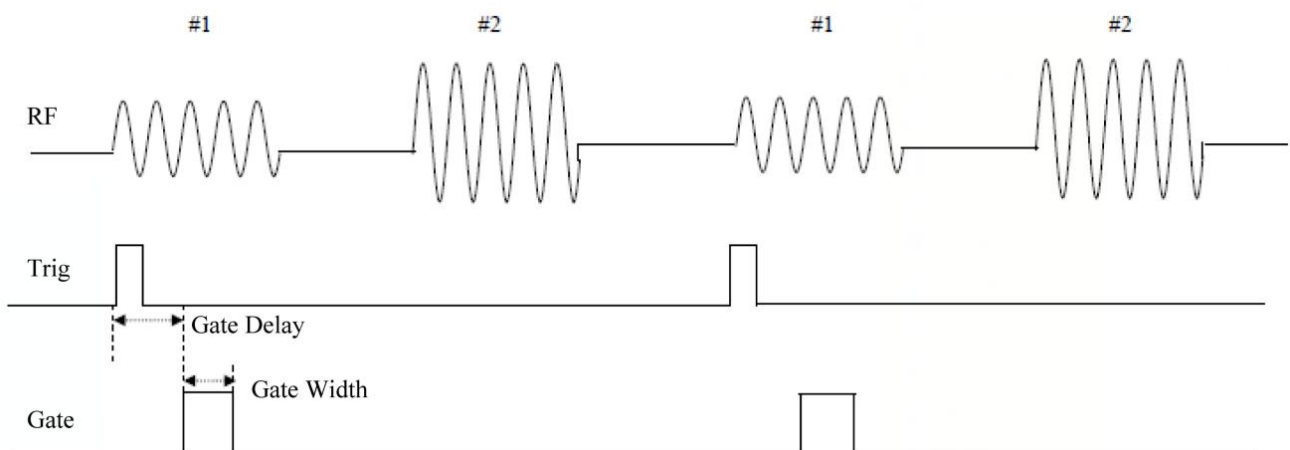

Fig. 4.46 Temporal relation between signal and gate

If you complete the gate measurement of Series Signal Analyzer, you will merely observe the spectrum of pulse train 1 as shown in Fig. 4.47; that of the pulse train 2 has been shielded. Additionally, you have to eliminate the spectrum generated at the pulse edge during the observation of pulse train 1, that is, the gate should be placed in the middle position of the pulse.

4.2 Advanced operation guide

The time gate should be moved in the center of pulse train 2, and the results are shown in Fig. 4.48. By this time, only the spectrum of Signal 2 can be observed; the edge pulse spectrum of Signal 2 and Signal 1 are removed.

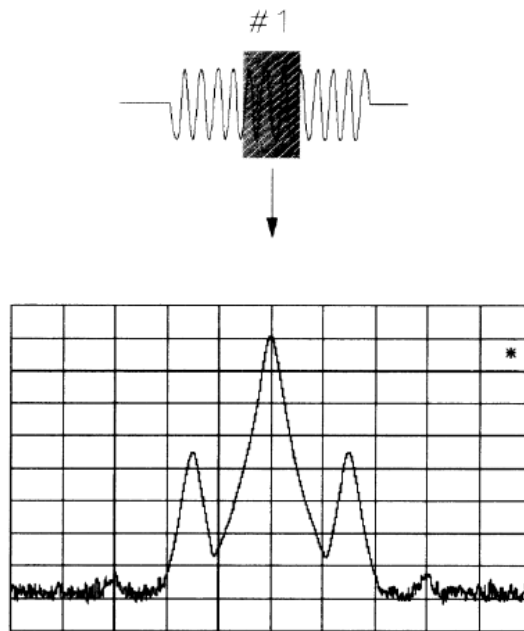

Fig. 4.47 Observation of Signal 1 by time gate

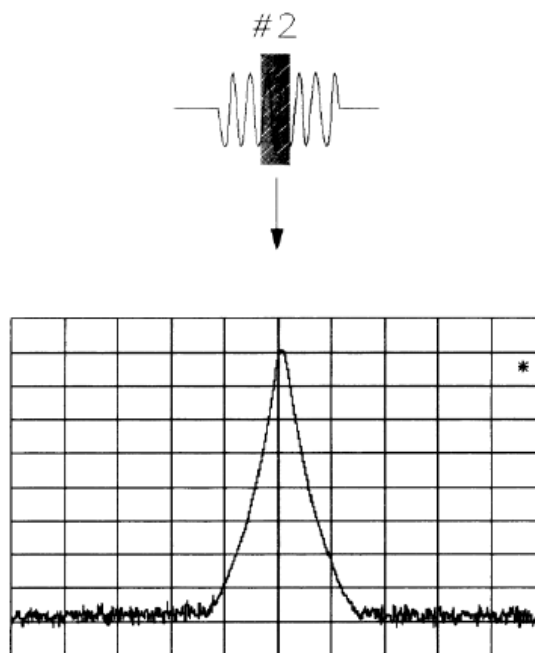

Fig. 4.48 Observation of Signal 2 by time gate

Prompt

Applicable conditions for measurement of time gate

The time gate is a useful tool for the measurement and analysis of various signals. However, the signals repeatedly occur, and contain the trigger signal of TTL synchronous with the time gate.

There are three ways to realize the measurement of the time gate of 4051 Series Signal/Spectrum Analyzer: gating LO, video and FFT which are introduced as follows:

4.2 Advanced operation guide

Local oscillator: LO is a smart way for gating. It only sweeps LO when Gate is ON and passes through signal. See Fig. 4.49 for the simple diagram of gating LO. It is observed that the Gate signal controls when the sweep generator scans and when it passes through or shields signal. This enables that the Series Signal Analyzer only sweeps when Gate is ON, that means, the Gate LO only sweeps LO and passes through signal when Gate is ON.

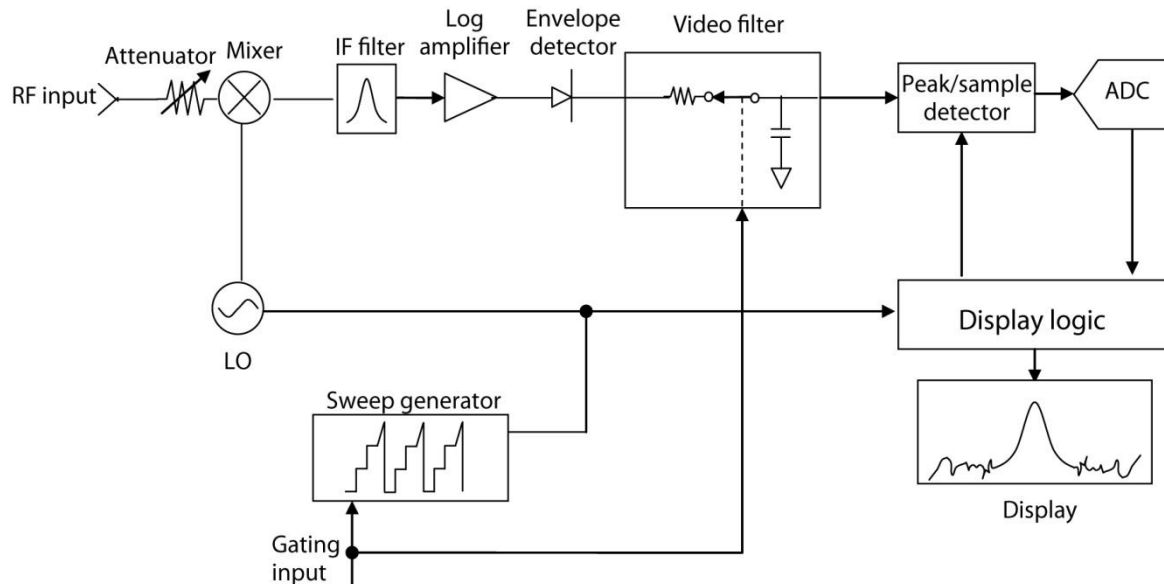

Fig. 4.49 Working principle of gating LO

Gating Video: this form of gating may be thought of as a simple switch, which connects the input signal to the Series Signal Analyzer. When the switch is ON (Gate ON), the video signal is allowed to pass through; and the switch is off (Gate OFF), the signal is blocked. Under Gated Video, whether the gate is ON or OFF, the Series Signal Analyzer measures signals and never stops sweeping. The working principle diagram of gating video of 4051 Series Signal/Spectrum Analyzer is shown as Fig. 4.50. The Gate Switch is between the signal pathway envelope detector and video filter, therefore is called as Gating Video. Since the Gate Switch is behind the envelope detector, whether the Gate is on or off, the Series Signal Analyzer measurement path will respond to the input signal; therefore, it is necessary to reduce the sweep speed to the extent that the Series Signal Analyzer can measure input signal during Gate ON period, which results in certain limits for applying Gated Video measurements. For this reason, in general, Video method results in slower measurement compared with Gated LO and FFT.

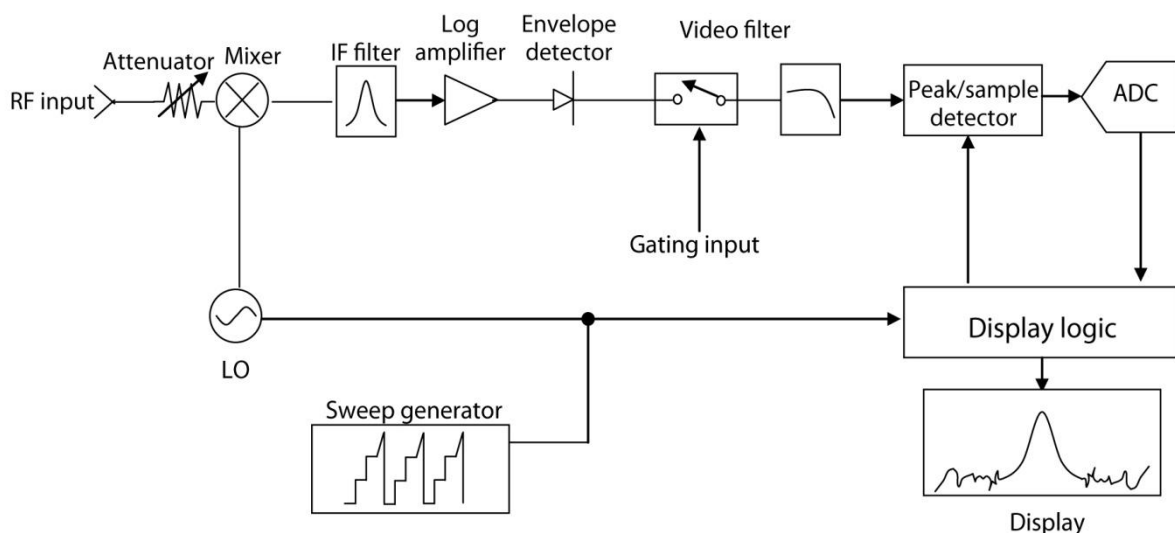

Fig. 4.50 Working principle of gating video

4.2 Advanced operation guide

Gated FFT: the way of FFT spectrum measurement if the trigger conditions are satisfied, which is called as the gated FFT. The FFT spectrum is the input signal spectrum through FFT calculation from a time domain waveform during collection. The time for collecting the domain waveform is similar to the gate length. The time for collecting the domain waveform is similar to the gate length. Different from the Sweep Time Gate, under Gated FFT, the gate length is determined by the currently set resolution bandwidth and cannot be set and modified through menu. When the Span is less than 10 MHz, in particular for small resolution bandwidth, the FFT measurement is faster than the Sweep measurement; therefore, for a given signal period, compared with Gated LO, the Gated FFT gets higher frequency resolution.

4.2.9.3 More about time gate measurement

The example demonstrates how to measure a specific signal by the use of time gate. Most signals which are required to be measured via the time gate are relatively complex, sometimes even some additional steps are needed for the measurement.

1) Be aware of the signals to be measured in time domain and how to synchronize with the trigger signals

Adjust the gate position by setting the gate delay parameters related to the trigger signals. In order to set the gate delay parameters, you need to know the temporal relation between the trigger signal and the signal to be measured. If not, the following parameters of the signal are required to be determined by the oscilloscope:

- Trigger polarity (positive or negative).
- Pulse repetition interval (PRI) refers to the time interval between two trigger events.
- Pulse width (τ).
- The signal delay (SD) refers to the time interval between the trigger event and stable signal, and the SD will be 0 if the trigger event and signal appear simultaneously.

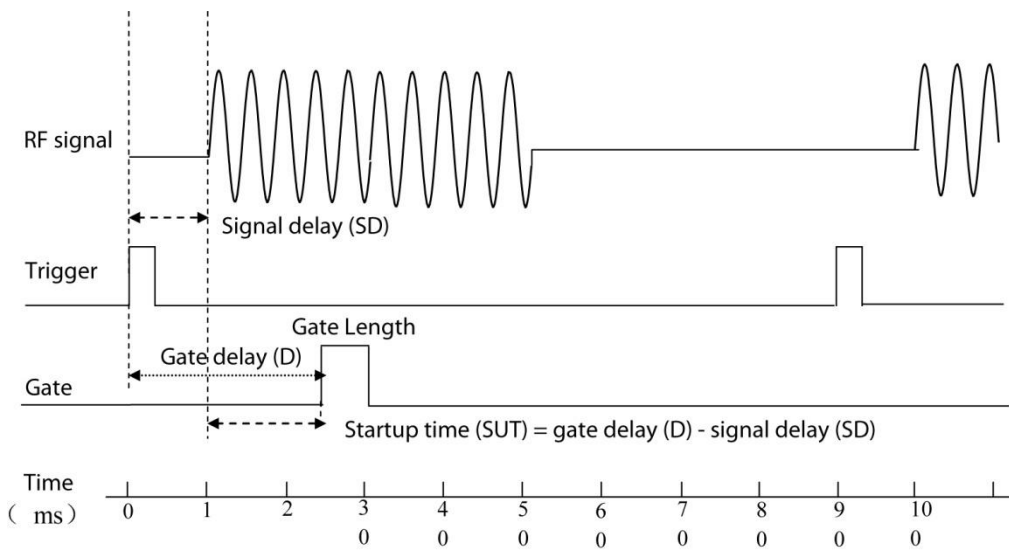

Fig. 4.51 Relation of time-domain parameters

In Fig. 4.51, relevant parameters are listed as follows:

- Pulse repetition interval (PRI) is 9ms.
- Pulse width (τ) is 3ms.
- For the trigger of positive edge, the time of signal delay (SD) is 1ms, while for the trigger of negative edge, the SD is 0.8ms.
- Gate delay time (D) is 2.5ms.

➤ Startup time (SUT) is 1.5ms.

2) Impact of scanning time

Although the scanning time does not affect the measurement results of gating LO, there may be noncontinuous tracks for two LO intervals on the screen if the scan time is set too short, resulting in increasing the scan time.

The scanning time has significant impact on the measurement results of gating video, so it is required to set the parameters related to the scanning time corresponding to the measurement of time gate. It is recommended that the scanning time should be set to be $PRI \times (\text{track points} - 1)$ at minimum, and $(PRI - \tau) \times (\text{track points} - 1)$ for the actual scanning time.

3) Optimized bandwidth parameter

For the measurement of time gate, it is important to set proper bandwidth to observe the signal spectrum. To better understand the signal characteristics, the max amplitude of the frequency point can be determined via the max hold before opening the time gate. In order to optimize the measuring speed, the bandwidth can be properly set to short to show the characteristics of the measured signal. For example, it is necessary to set the bandwidth above 200kHz for the observation of the false signal within the frequency range of 200kHz.

4) Set the gate signal by the SUT and SD

Generally, the gate is required to be placed in the area of stable signal, instead of pulse edge or transition zone; otherwise, it will interfere with the spectrum. The gate signal comes from the center of the pulse, and the SUT is calculated after the width of about half a pulse. The setup time (SUT) refers to the duration prior to the arrival of gate and after the signal stability. The SUT is required to set to be long enough for the resolution bandwidth filter of transient burst. The signal delay (SD) refers to the time interval between the trigger event and stable signal. If the trigger event and signal appear simultaneously, the SD will be 0 and the setup time (SUT) is equal to the delay time, otherwise the SUT is equal to the value of gate delay time subtracting the SD, as shown in Fig. 4.52.

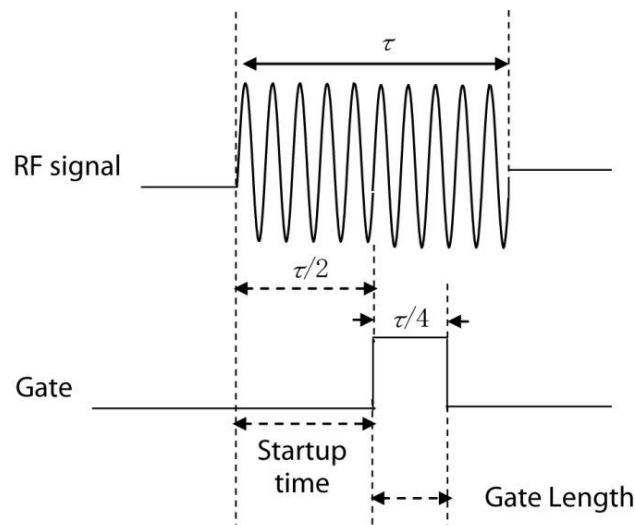

Fig. 4.52 Positioning of time gate

The gate can be set at random, but some positions may provide more selections for the resolution bandwidth, as shown in Fig. 4.53, the time Gate 1 and Gate 2 are extended to the pulse edge or signal transition zone, resulting in some inaccurate measurements. Therefore, it is better to place the gate at 20%~80% of the pulse. For Gate 3 and Gate 4, the best position is in the middle of the pulse, which makes a good match between the SUT and gate width.

4.2 Advanced operation guide

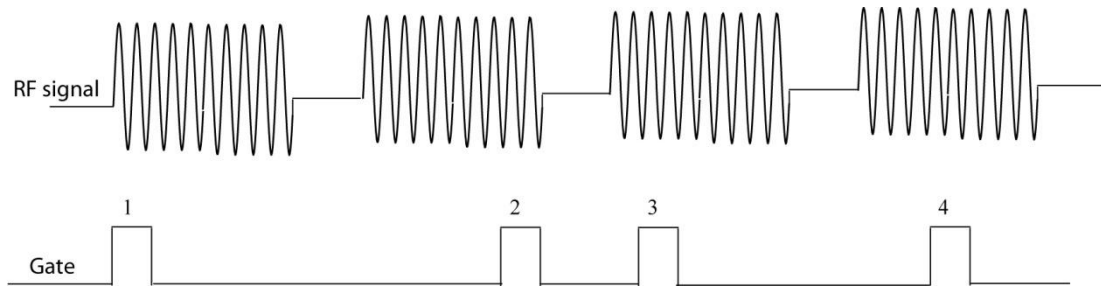

Fig. 4.53 Best position for time gate

The best measurement results are able to be obtained if the gate is generally set in the slight delay position of the signal of interest, namely, within the interior area of signal of interest, but not extending to the pulse edge or signal transition zone. Before the measurement of gate time, the SUT is set to the max value to provide enough time for the resolution bandwidth filter of the analyzer to reach the stable status. In such case, the slight delay position of signal of interest means the allowed $SUT = 4/\text{resolution bandwidth}$. For instance, if the filter of 1kHz is used for the measurement, the minimum SUT will be 4ms.

It should be noted that the signal is not the RF pulse but a specific periodic modulating signal, which continuously effects on the full power or works when the pulse is low. For specific applications, adjusting the gate position ensures enough SUT (not for the alternating process of other signals, e.g. The pulse edge or transition zone). Proper selection of gate delay and gate width may achieve the best signal-to-noise ratio.

For the spectrum measurement between two pulses, there shall be enough SUT after the pulse ends and before the Gate On so that the resolution bandwidth filter can fully discharge for the pulse high level to measure the low level signals between pulses.

5) Effect of resolution bandwidth and video bandwidth

The resolution bandwidth value is determined by the gate position. It takes a long setup time for the small resolution bandwidth, because the resolution bandwidth filter needs enough time to charge prior to the arrival of the gate, where the SUT refers to the period between the gate arrival and the signal stability. As shown in Fig. 4.54.

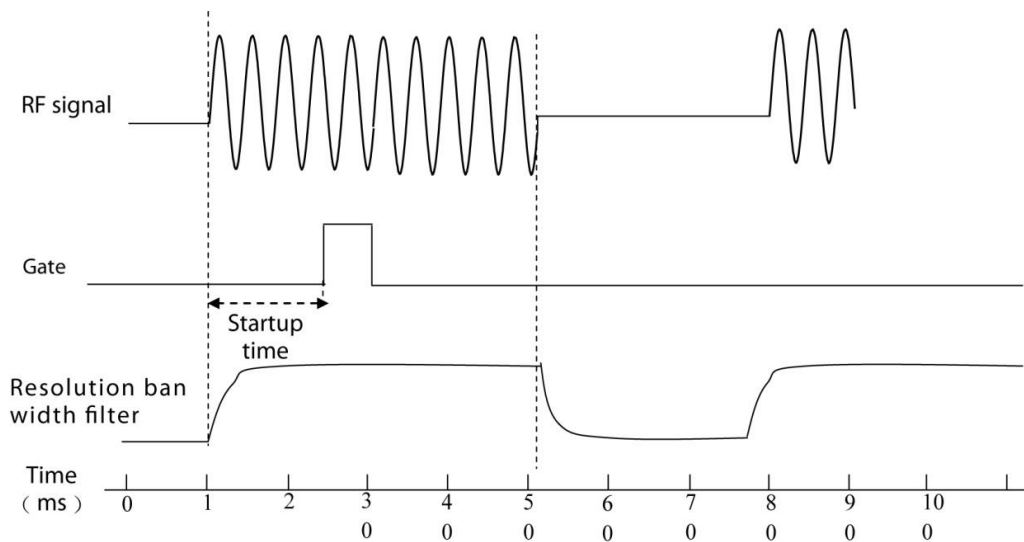

Fig. 4.54 Charging effect of resolution bandwidth filter

The resolution bandwidth filter is a band-limited device, so it will take a certain time for response and condition change. When the Series Signal Analyzer measure the pulse signal, the filter needs a certain time to fully charge.

- The SUT must be over the charging time of the filter.
- Setup time (SUT) > (4/Resolution Bandwidth).

➤ Gate length $< \tau$ -SUT.

In this example, providing that the SD is 0, the SUT will be equal to the gate delay time; otherwise, the gate delay time is equal to the SUT plus SD. See Fig. 4.55 for the positioning parameters of the time gate.

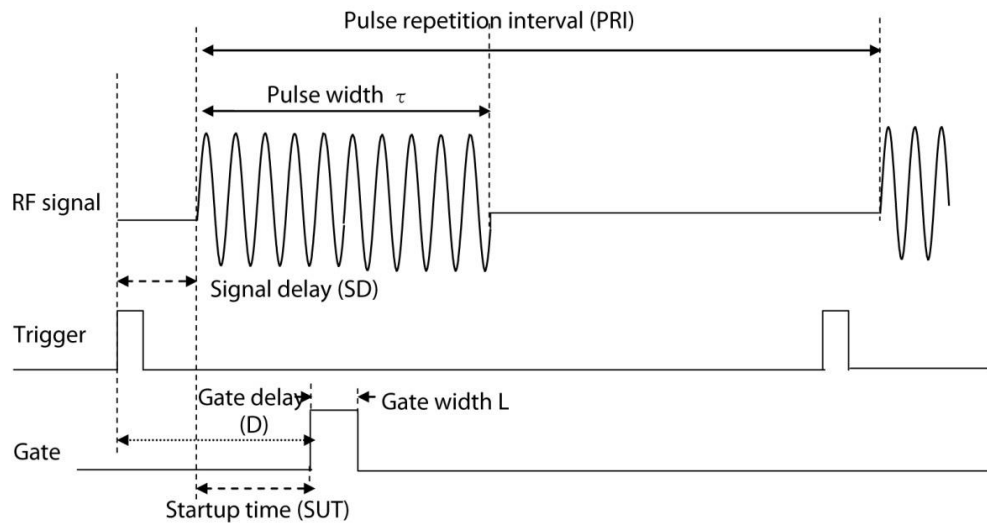

Fig. 4.55 Positioning parameters of the time gate

Similar to the resolution bandwidth filter, the video filter also needs a certain time for charging and discharging. As a post detector, it is used to smooth the track. No matter how long the actual pulse is, seen from the video filter, the pulse length will not exceed the gate width, and it will take some time to charge. If the video bandwidth value is reduced too fast, the amplitude on the screen will decline. For the value selection of video filter, the value can be set to the max, and then decreased until the signal level drops slightly, where the video bandwidth value is set for that before the signal level begins to have a slight decrease. The values of resolution bandwidth and video bandwidth are set to the manual mode so that the values are constant even though the bandwidth changes.

6) General principles for measurement of time gate

For most control setup, the signals are determined by two key parameters, pulse repetition interval (PRI) and pulse width τ . If both parameters are known, the standard setup may be applied. The setting principle of the Series Signal Analyzer is given in Table 4.4 during the observation of pulse RF signal.

Table 4.4 Setup of Series Signal Analyzer during the observation of pulse RF

Parameters of Series Signal Analyzer	Setting principle of Series Signal Analyzer	Note
Scanning time	Unlimited	Although the scanning time does not affect the measurement results of gating LO, the scanning time is required to be increased if it is set too short.
Gate delay	Gate delay = SD + 4/resolution bandwidth	The setup of gate delay should assure the pulse can be captured upon the Gate On. If the gate delay is too short or long, the pulse will be lost or the response of resolution bandwidth filter in transition zone will be included.
Gate width	Gate length = τ -SUT	If the gate is too wide, the response of resolution bandwidth filter in transition zone will be contained. The gate is recommended to set at the position of 25% of the pulse
Resolution bandwidth	Resolution Bandwidth $>$ (4/SUT)	The resolution bandwidth value must be large enough to ensure the charging time of the filter is less than the signal pulse width.

4.2 Advanced operation guide

Video bandwidth	Video Bandwidth Resolution Bandwidth >	The video bandwidth value should be large enough to make sure the video bandwidth filter does not weaken the signal during the rising time.
-----------------	--	---

The parameters are listed in Table 4.5 for the signal trigger events and the simultaneous arrival of pulses, namely the SD is 0. If the signal is a non-zero delay, it will be added to the recommended value of gate delay.

Table 4.5 Recommended value for measured parameters of the Gate

Pulse width	Gate delay	Minimum Resolution	Gate width
20μs	8μs	1MHz	8μs
50μs	40μs	100kHz	8μs
100μs	40μs	100kHz	48μs
500μs	400μs	10kHz	80μs
1ms	600μs	10kHz	200μs
5ms	4ms	1kHz	0.8ms
10ms	6ms	1kHz	2.4ms
50ms	30ms	1kHz	12ms
100ms	50ms	1kHz	24ms

4.2.9.4 Measuring example: to measure the RF pulse signal of FM modulation by the use of gating LO

The example of time gate measurement is a simple pulse signal of frequency modulation, aiming to eliminate the pulse spectrum to observe the spectrum of FM carrier, which seems to be a continuous signal instead of a pulse signal. It is possible to reveal the simple modulation behind the pulse spectrum.

Step 1. Generate the FM signal modulated by RF pulse via the signal generator:

There are many ways to generate FM signal modulated by RF pulse. The internal modulation of 1464 series signal generator is applied to this example, with the parameter shown in Table 4.6.

Table 4.6 Parameters of 1464 series signal generator

Frequency	400 MHz
Amplitude	-10dBm
Modulation	Pulse modulation On and FM modulation On
Pulse period	5ms (or pulse repetition frequency 200Hz)
Pulse width	4ms
Pulse input	Internal auto
FM modulation rate	50kHz
FM frequency offset	1kHz
FMinput	For internal
Waveform	Sine wave

Step 2. Connect the signal generator and Series Signal Analyzer:

As shown in Fig. 4.56, connect the Series Signal Analyzer and signal generator, where the RF output of signal generator is connected to the RF input of the analyzer, and the monitoring output port of the signal generator to the input port of external trigger on the front panel of 4051 Series Signal Analyzer.

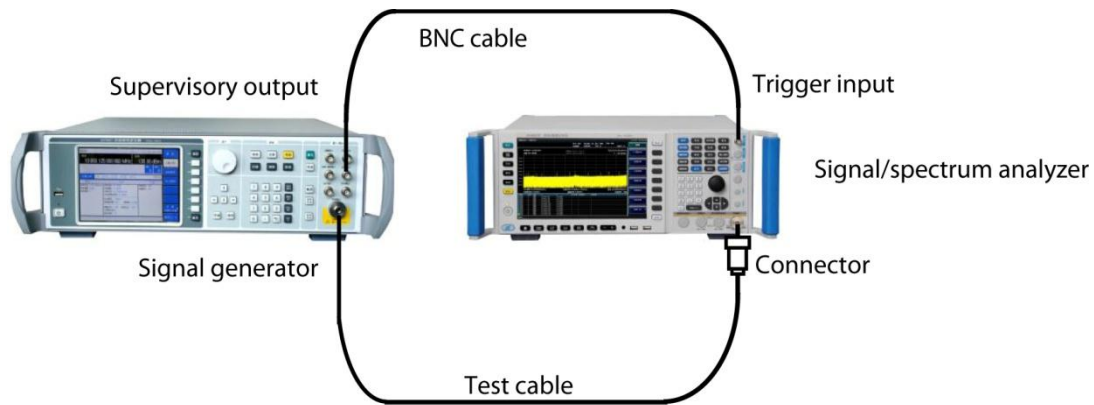

Fig. 4.56 Test connection diagram of signal generator and Series Signal Analyzer

Step 3. set the center frequency, frequency span and reference level of the analyzer:

- Press **【Preset】** .
- Press **【Frequency】** , [Center Freq] and enter 400 MHz.
- Press **【Span/X Axis】** , [Span] and enter 500 kHz.
- Press [Amplitude], [reflevel] and input 0 dBm;
- Press **【Sweep】** , [Sweep Time **Auto** Manual] and enter 100 ms;
- Mobile signal refers to pulse signal, which can be shielded by the Gate, and the original FM signal will be generated. The spiked period is 5ms (it is the same as the period of the pulse signal) by the judgment of the difference frequency scale, as shown in Fig. 4.57.

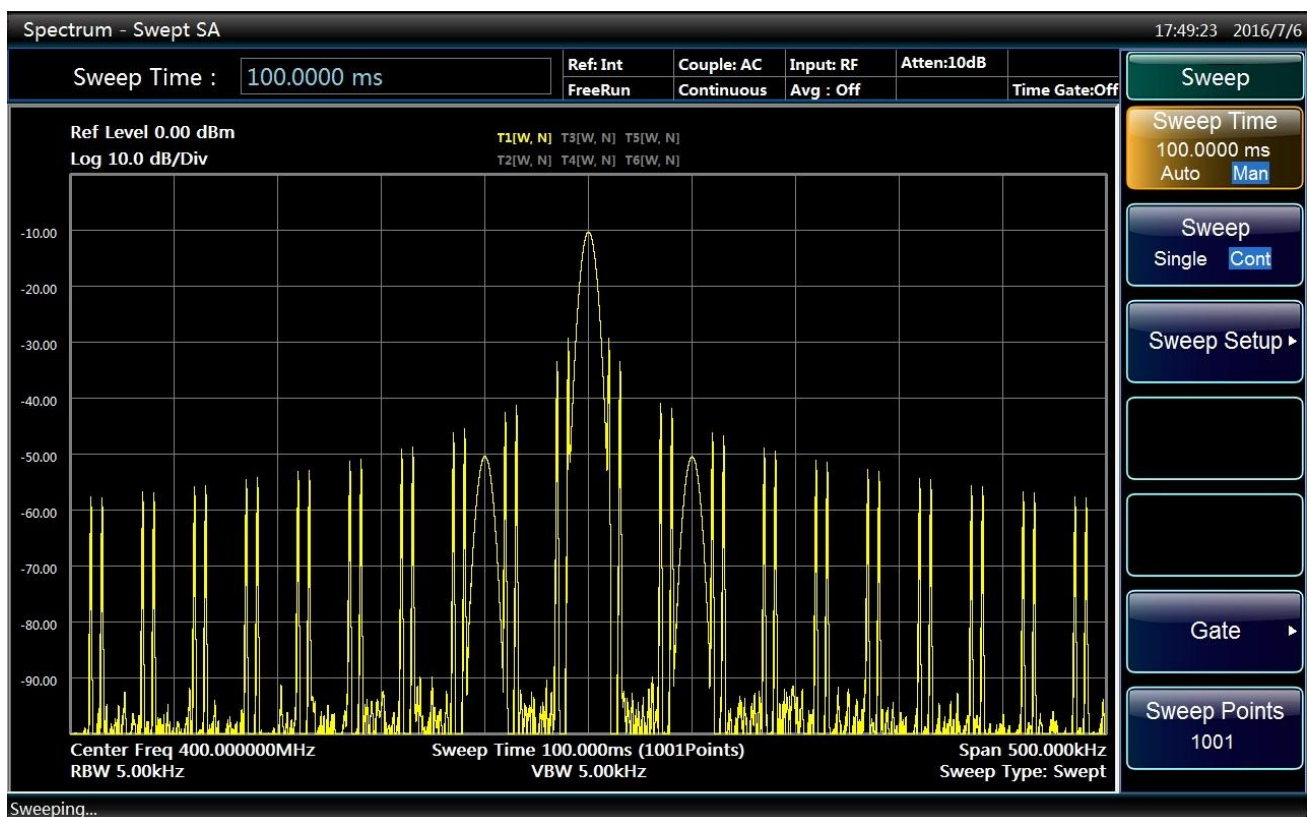

Fig. 4.57 Observed signal spectrum without the Gate

4.2 Advanced operation guide

Step 4. Opened the Gate Preview Window, and set the gate delay and gate width, etc.:

- Press **【Sweep】** , [Gate], [Gate Setup], [Gate Method] and [LO];
- Press [Gate Delay] and input 2ms;
- Press [Gate Length] and enter 1ms;
- Press [Gate View Sweep Time] and input 5ms;
- Press [Gate Source] and select [External Signal 1], [Trigger Level] 1.2V and [Pos] for [Gate Slope].
- Press [Gate View On **Off**] and select [On].

The interface of Gate Preview Window is shown in Fig. 4.58, stating the temporal relations of the gate trigger, gate delay, width and the measured signal pulse envelope. The time on the left of the figure is the Zero Hour, indicating the time when the gate trigger event occurs, which also refer to the initial time of the Gate On when the gate delay is zero. The green line on the left represents the initial time of Gate On, as well as the gate delay time. The time between the two green lines refers to the gate width, namely the gating time. The yellow path line represents the temporal envelope of the input RF pulse signal.

Adjust the gate delay time to make the gating time between 20% and 80% of the pulse envelope. If there are changes in the measuring conditions, such as the resolution bandwidth and bandwidth, etc., the Gate Preview should be reopened to reset the gate trigger polarity, gate delay and gate width, etc.

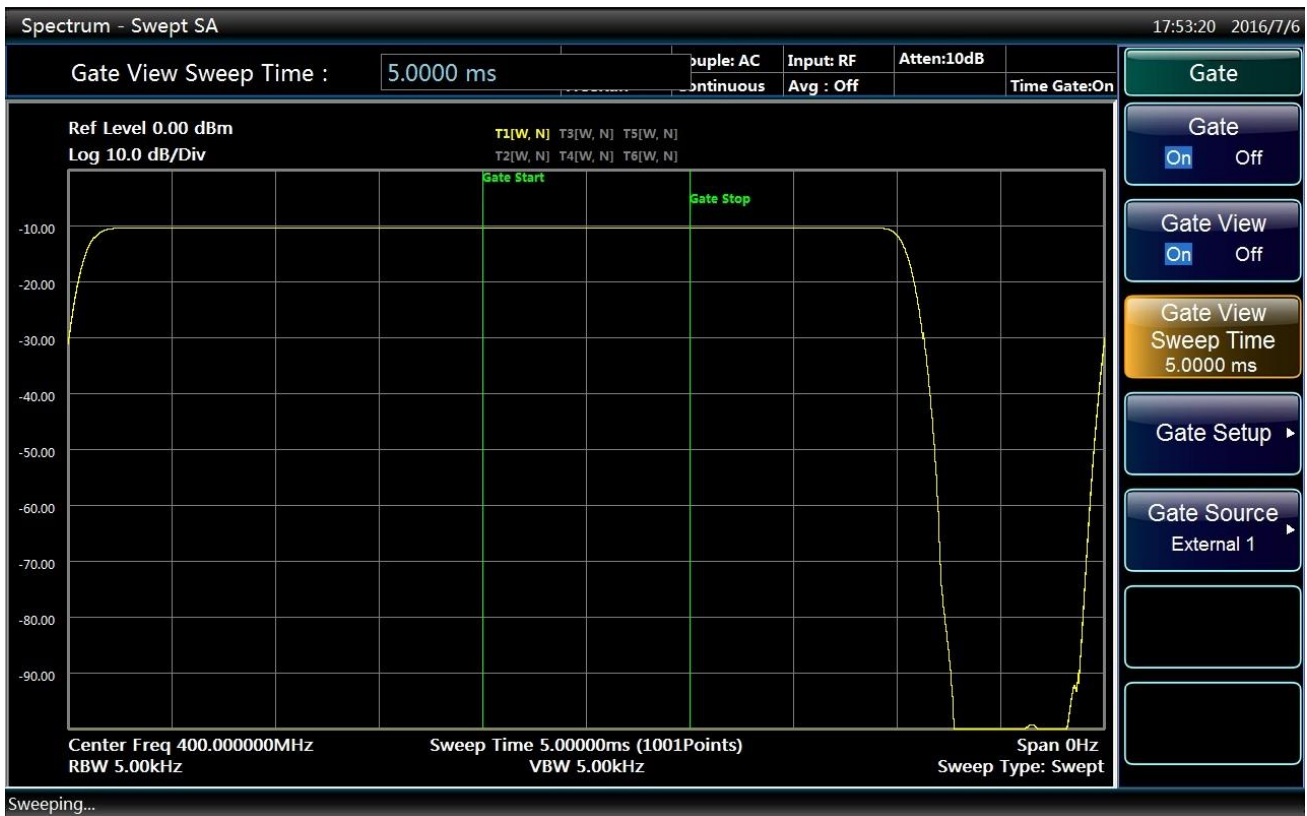

Fig. 4.58 Gate Preview Interface of LO Status

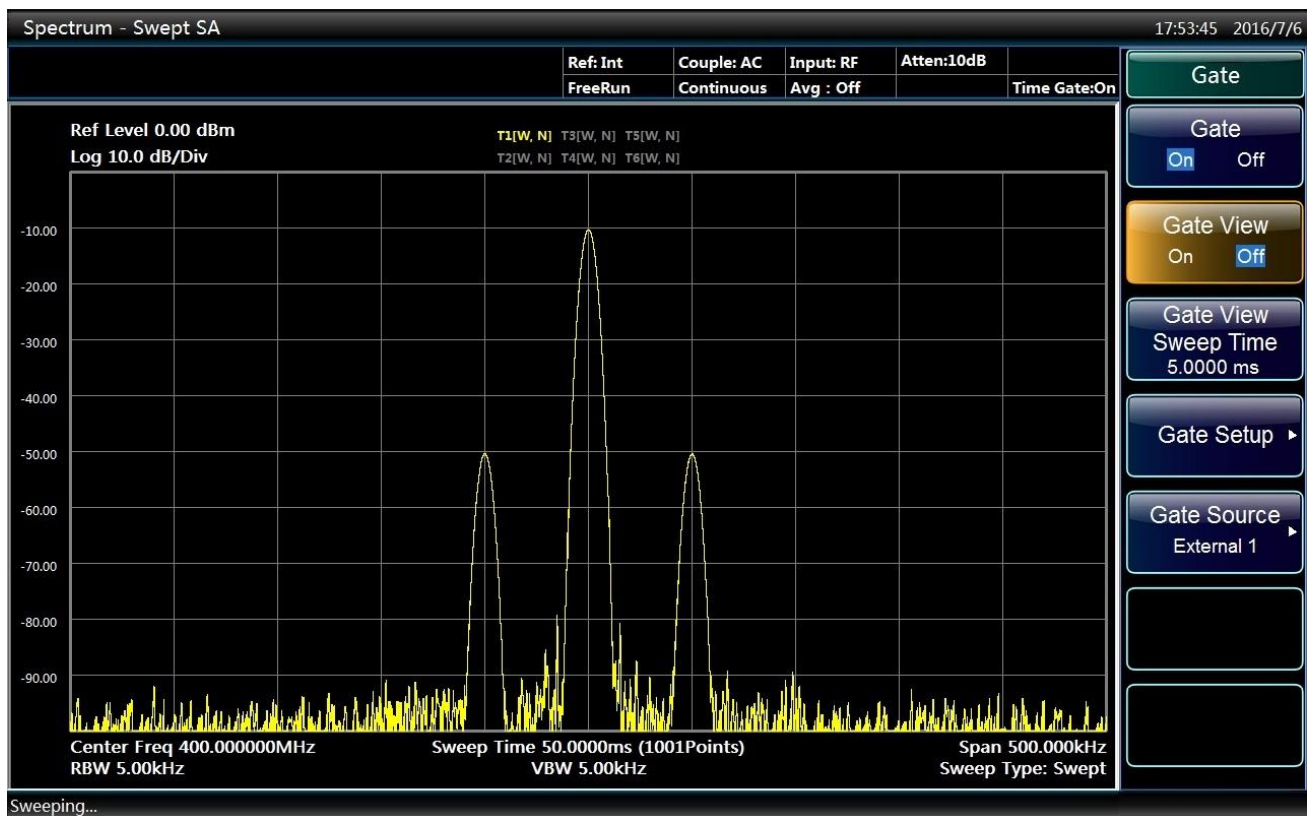

Fig. 4.59 Observed FM signal spectrum with the Gate

Step 5. Close the Gate Preview and open the Time Gate to observe the FM signal spectrum

It is obvious that the spectrum observed with the Time Gate is clearer than that without the Time Gate (see Fig. 4.59).

Select the Pulse Modulation Off on the signal generator and stop the pulse modulation. Press **【Sweep】**, **[Gate]** and **[Gate On Off]** on the Series Signal Analyzer to close the time gate. In such case, the spectrum is shown in Fig. 4.60, indicating the spectrum with time gate is consistent with that of FM signal without pulse modulation. There is no change of spectra under two cases.

4.2 Advanced operation guide

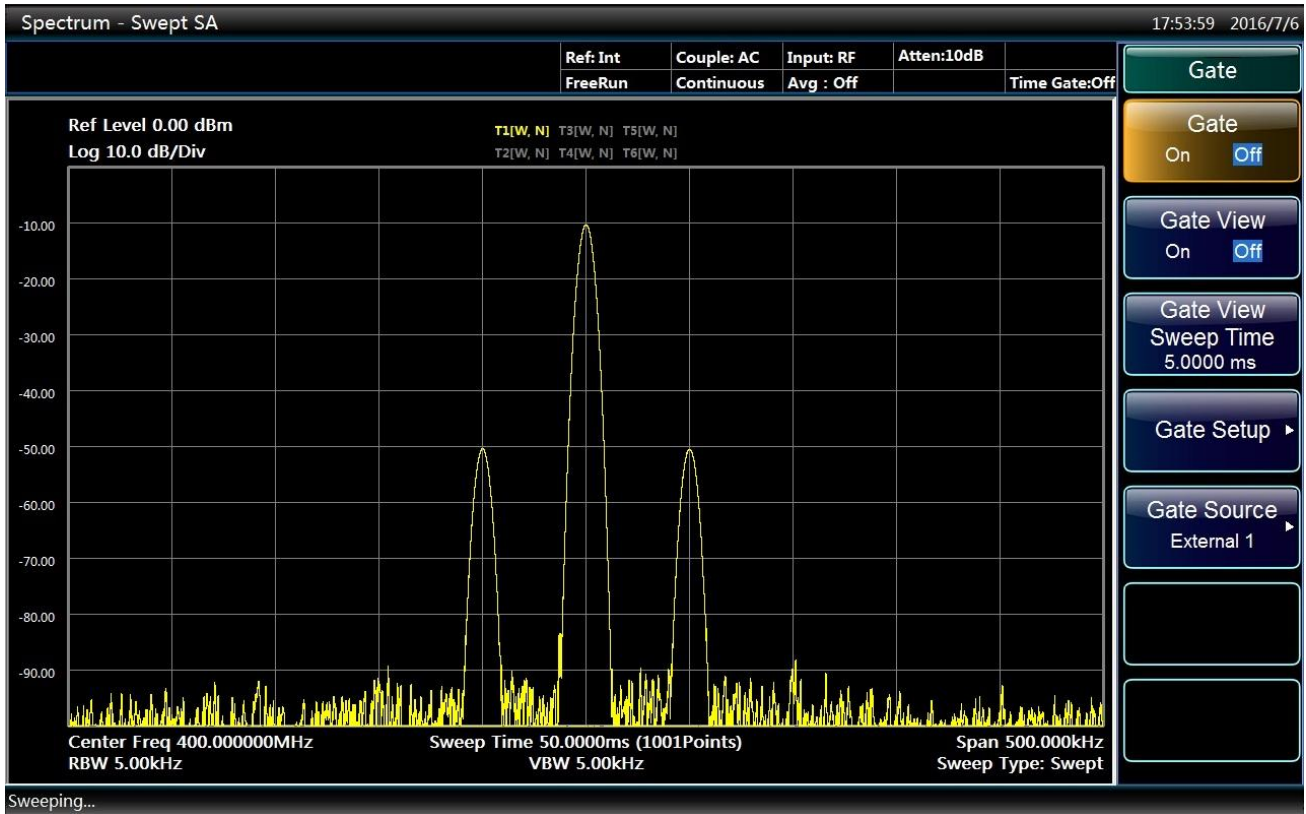

Fig. 4.60 Observed FM signal spectrum without the Gate

4.2.10 Channel power

4.2.10.1 Basic concept

Measure the power and power spectral density under specified channel bandwidth. A pair of markers displayed indicates the edges of the channel. The user can self-define the center frequency, reference level, channel bandwidth and other parameters.

Having press **【Measure】** and [Channel Power], user can set relevant measurement parameters through **【Meas Setup】**. Suspend and restart measurement by pressing **【Meas Control】** or switching continuous measurement and singular measurement.

Resolution bandwidth shall be set as 1% - 4% of channel bandwidth during the measurement of channel power. Meanwhile, video bandwidth shall be set as over 10 times of resolution bandwidth for noise-like of signal measured.

4.2.10.2 Measurement Example

This section mainly introduces the channel power measurements of W-CDMA(3GPP)(simulate a W-CDMA signal by signal generator) to measure the total radio-frequency power in the channel. Measurement results show total power (dBm) and power spectral density (dBm/Hz).

Step 1. Set signal source as below:

- Set the mode as W-CDMA.
- Set frequency on signal source to 1.960GHz.
- Set signal amplitude to -10dBm.

Step 2. Connect the radio frequency output port of the signal source to that of the analyzer. As shown in Fig. 4.61:

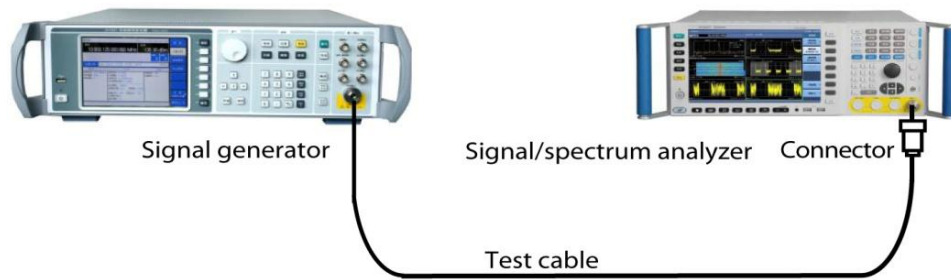

Fig 4.61 Connection Settings of Channel Power Measurement

Step 3. set the analyzer as spectrum analysis mode and activate swept analysis mode:

- Press **【Mode】** and [Spectrum].

Step 4. Resetting of analyzer

- Press **【Preset】** key.

Step 5. Initialize channel power measurement:

- Press **【Measure】** , [Channel Power].

Set the measurement function as channel power measurement.

Step 6. Set up a wireless standard and switch the wireless devices for base station:

- Press **【Measure】** , [More 1 / 2▶], [Radio StdRadio Std▶], [W-CDMA 3GPP].

Set the wireless standard as W-CDMA.

- Press [Radio Device▶], [BTS].

Switch the wireless devices as BTS.

Step 7. Set the frequency of the analyzer as 1.960 GHz:

- Press **【Frequency】** , [Center Freq].

Set the center frequency of the analyzer and input 1.960 GHz.

- Results of channel power measurements are shown in Fig. 4.62. Graphics window and text window display the absolute power value and average power spectral density in channel bandwidth.

4.2 Advanced operation guide



Fig 4.62 Results of channel power measurement

Step 8. Change the measurement parameters:

- Press **【Meas Setup】** .

Users can modify measurement parameters like integration bandwidth and other as needed.

4.2.11 Occupied Bandwidth

4.2.11.1 Basic concept

Occupied Bandwidth Integration display of spectrum power, including marker setting at frequency containing certain power part. The measurement accounts for 99% of the total measurement by default. Firstly calculate the joint power responded by all signals in track. As for power occupying the bandwidth, 99% of power distributed between two vertical line marker, and the rest 1% distributed out of the markers. The difference value between the two markers is the bandwidth occupying 99% power.

Meanwhile, occupied bandwidth measurement can display the center frequency of analyzer and difference value of center frequency in channel, which is called carrier frequency offset.

User can set measurement parameters by himself by pressing **【Measure】** key and selecting [Occupied BW] menu, pressing **【Meas Setup】** key and enter measurement parameters setup menu, and then selecting single or continuous measurement by pressing **【Meas Control】** keys.

4.2.11.2 Measurement Example

This section mainly introduces the occupied bandwidth measurements of W-CDMA(3GPP) (simulate a W-CDMA signal by signal generator) to measure the total power in the bandwidth and calculate the bandwidth occupied by 99% of total power.

Step 1. Set signal source as below:

- Set the mode as W-CDMA.

- Set frequency on signal source to 1.960GHz.
- Set signal amplitude to -10dBm.

Step 2. Connect the radio frequency output port of the signal source to that of the analyzer. As shown in Fig. 4.63:

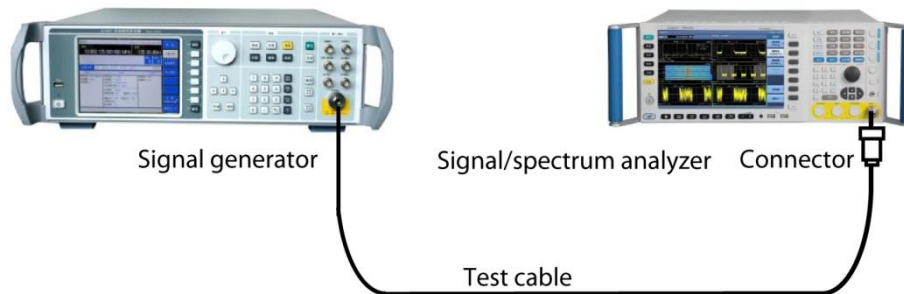

Fig. 4.63 Connection settings of occupied bandwidth measurements

Step 3. set the analyzer as spectrum analysis mode and activate swept analysis mode:

- Press **【Mode】** and [Spectrum].

Step 4. Resetting of analyzer

- Press **【Preset】** key.

Step 5. Initialize occupied bandwidth measurements:

- Press **【Measure】** , [Occupied BW].

Set the measurement function as occupied bandwidth measurement.

Step 6. Set up a wireless standard and switch the wireless devices for base station:

- Press **【Measure】** , [More 1 / 2▶], [Radio StdRadio Std▶], [W-CDMA 3GPP].

Set the wireless standard as W-CDMA.

- Press [Radio Device▶], [BTS].

Switch the wireless devices as BTS.

Step 7. Set the frequency of the analyzer as 1.960 GHz:

- Press **【Frequency】** , [Center Freq].

Set the center frequency of the analyzer and input 1.960 GHz.

- Results of occupied bandwidth measurements are shown in Fig. 4.64.

4.2 Advanced operation guide



Fig. 4.64 Results of occupied bandwidth measurements

Step 8. Change the measurement parameters:

- Press **【Meas Setup】**.

Users can modify measurement parameters like Occupied Power %, xdB and other as needed.

4.2.12 Adjacent Channel Power

4.2.12.1 Basic concept

Adjacent Channel Power (ACP) indicates the power leaked to the adjacent channels. Adjacent channel power can be used to measure different types of signals by selecting different wireless communication standards.

Calculate the power in bandwidth relative to each offset by selecting integration bandwidth method to execute track scanning. Measurement results show the corresponding total power or power spectral density according to reference type selected. User can observe the measurement results by selecting spectrum display or cylindrical diagram display.

Having pressed **【Measure】** key and selected [ACP], press **【Meas Setup】** key to enter detailed setup menu of measurement parameters. Press **【Meas Control】** key to switch continuous measurement and singular measurement.

4.2.12.2 Measurement Example

Designate the total power and 6 groups of power offsetting channel to measure adjacent channel power. The measurement results show ratio of power offsetting channel and the power of main channel. This section mainly introduces the adjacent channel power measurements of W-CDMA(3GPP) (simulate a W-CDMA signal by signal generator).

Step 1. Set signal source as below:

- Set the mode as W-CDMA.

- Set frequency on signal source to 1.960GHz.
- Set signal amplitude to -10dBm.

Step 2. Connect the radio frequency output port of the signal source to that of the analyzer. As shown in Fig. 4.65:

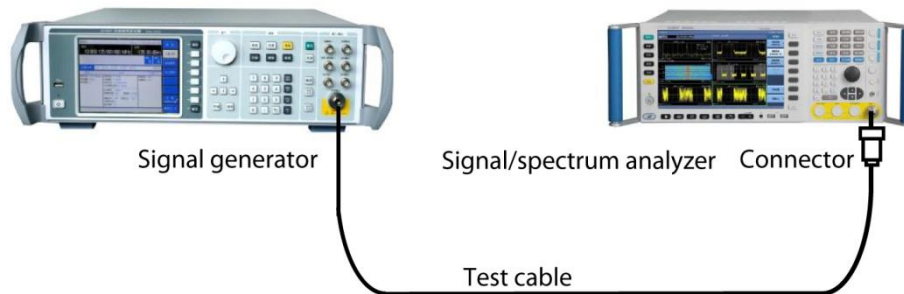

Fig 4.65 Connection settings of adjacent channel power measurement

Step 3. set the analyzer as spectrum analysis mode and activate swept analysis mode:

- Press **【Mode】** and [Spectrum].

Step 4. Resetting of analyzer

- Press **【Preset】** key.

Step 5. Initialize Adjacent Channel Power Measurement:

- Press **【Measure】** , [ACP].

Set the measurement function as adjacent channel power measurement.

Step 6: Set up a wireless standard and switch the wireless devices for base station:

- Press **【Measure】** , [More 1/2▶], [Radio Std▶], [W-CDMA 3GPP].

Set the wireless standard as W-CDMA.

- Press [Radio Device▶], [BTS].

Switch the wireless devices as BTS.

Step 7. Set the frequency of the analyzer as 1.960 GHz:

- Press **【Frequency】** , [Center Freq].

Set the center frequency of the analyzer and input 1.960 GHz.

- Results of adjacent channel power measurements are shown in Fig. 4.66. Measurement parameters, including offset frequency, integration bandwidth, bandwidth setting and others are all adopted with default setting referred to wireless standard.

4.2 Advanced operation guide



Fig 4.66 Results of Adjacent Channel Power Measurement

Step 8. Define a new third offset:

- Press **【Meas Setup】** , [Offset/Limit▶], [Offset▶], [C].

Select a new offset channel C.

- Press [Offset Freq **ON** OFF]

Set offset frequency as ON state and input 15 MHz.

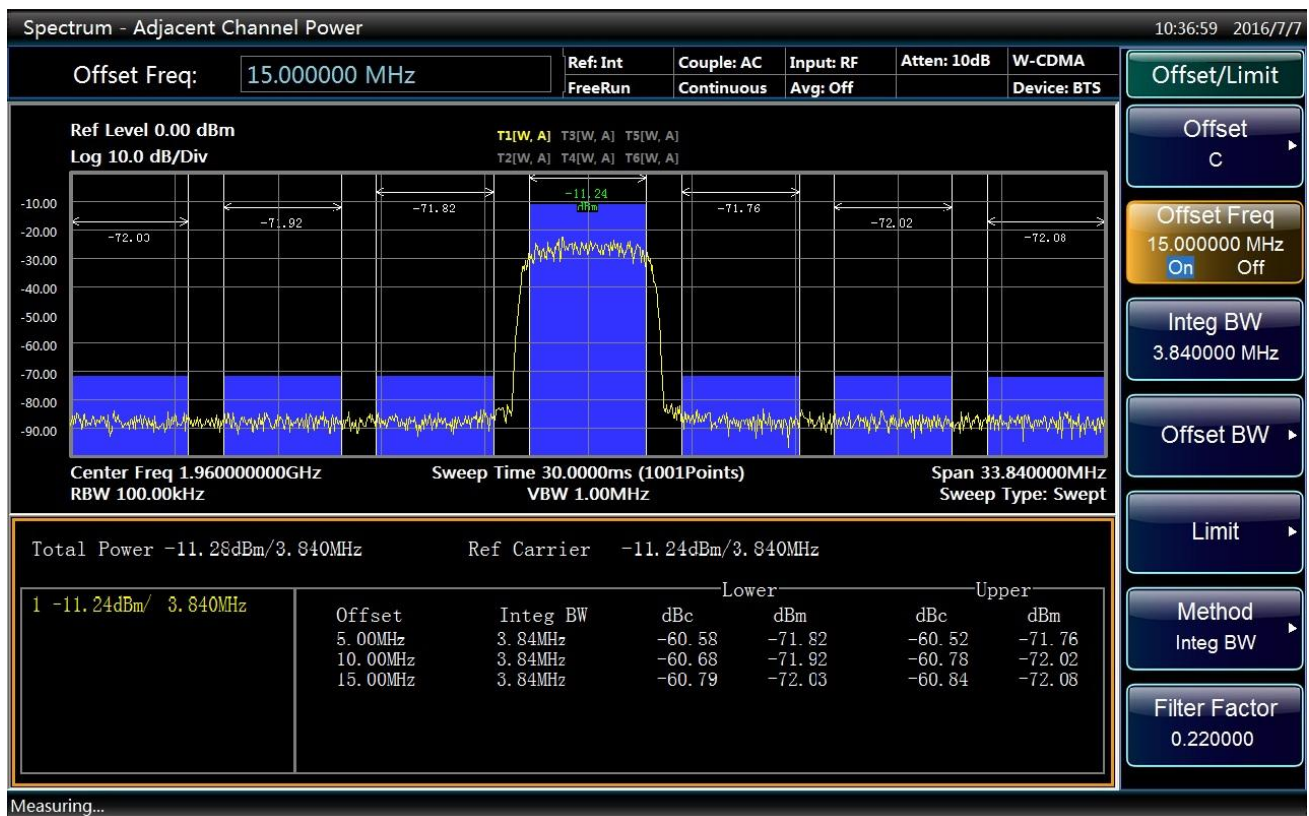

Fig.4.67 Measuring third adjacent channel

Step 9. Set every offset limit of pass/fail:

- Press **【Meas Setup】** , [Offset/Limit▶], [Offset▶], [A], [Limit▶], [Rel Limit (Car)]. Set the limit value of offset A and input -55dB.
- Press **【Meas Setup】** , [Offset/Limit▶], [Offset▶], [B], [Limit▶], [Rel Limit (Car)].
- Set the limit value of offset B and input -75dB.
- Press **【Meas Setup】** , [Offset/Limit▶], [Offset▶], [C], [Limit▶], [Rel Limit (Car)]. Set the limit value of offset C and input -55dB.

Step 10. Start limit test:

- Press **【Meas Setup】** , [More 1/3▶], [Limit Test ON **OFF**].

Set limit test as ON state.

- In Fig. 4.68, offset A and C passed, and offset B failed. Offset B failed because of its power level exceeding standard of -75dB designated by us. Bar graph and power marker of channel failed will be shown in red.

4.2 Advanced operation guide



Fig. 4.68 Limit test

4.2.13 Power Statistic

4.2.13.1 Basic concept

CCDF measurement is a statistic measurement for high level signal power or peak power. It reflects, with figures and tables, percentage of time and value which the signal exceeds its average power.

Curve of complementary cumulative distribution function (CCDF) of power indicates high level of power on signal. It shows the scatter diagram to peak-to-average power ratio and corresponding probability. The CCDF curve stands for the time quantum spent on power level whose waveform is equal to or greater than that of given power level. The percentage of time spent by signal on power level which is equal to or greater than given power level is defined as the probability of given power level.

4.2.13.2 Measurement Example

This section mainly introduces power statistics CCDF measurement of W-CDMA(3GPP) (simulate a W-CDMA signal by signal generator).

Step 1. Set signal source as below:

- Set the mode as W-CDMA.
- Set frequency on signal source to 1.960GHz.
- Set signal amplitude to -10dBm.

Step 2. Connect the radio frequency output port of the signal source to that of the analyzer. As shown in Fig. 4.69:

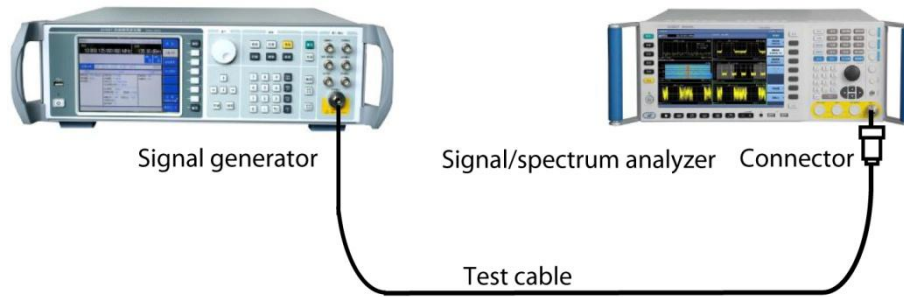

Fig. 4.69 Connection Settings of Power Statistical Measurement

Step 3. set the analyzer as spectrum analysis mode and activate swept analysis mode:

- Press **【Mode】** and [Spectrum].

Step 4. Resetting of analyzer

- Press **【Preset】** key.

Step 5. Initialize power statistical measurement:

- Press **【Measure】** , [Power Stat CCDF].

Set the measurement function to power statistical measurement.

Step 6. Set up a wireless standard and switch the wireless devices for base station:

- Press **【Measure】** , [More 1 / 2▶], [Radio Std▶], [W-CDMA 3GPP].

Set the wireless standard as W-CDMA.

- Press [Wireless Devices▶], [BTS].

Switch the wireless devices as BTS.

Step 7. Set the frequency of the analyzer as 1.960 GHz:

- Press **【Frequency】** , [Center Freq].

Set the center frequency of the analyzer and input 1.960 GHz.

- Power statistical measurement results as shown in Fig. 4.70.

4.2 Advanced operation guide

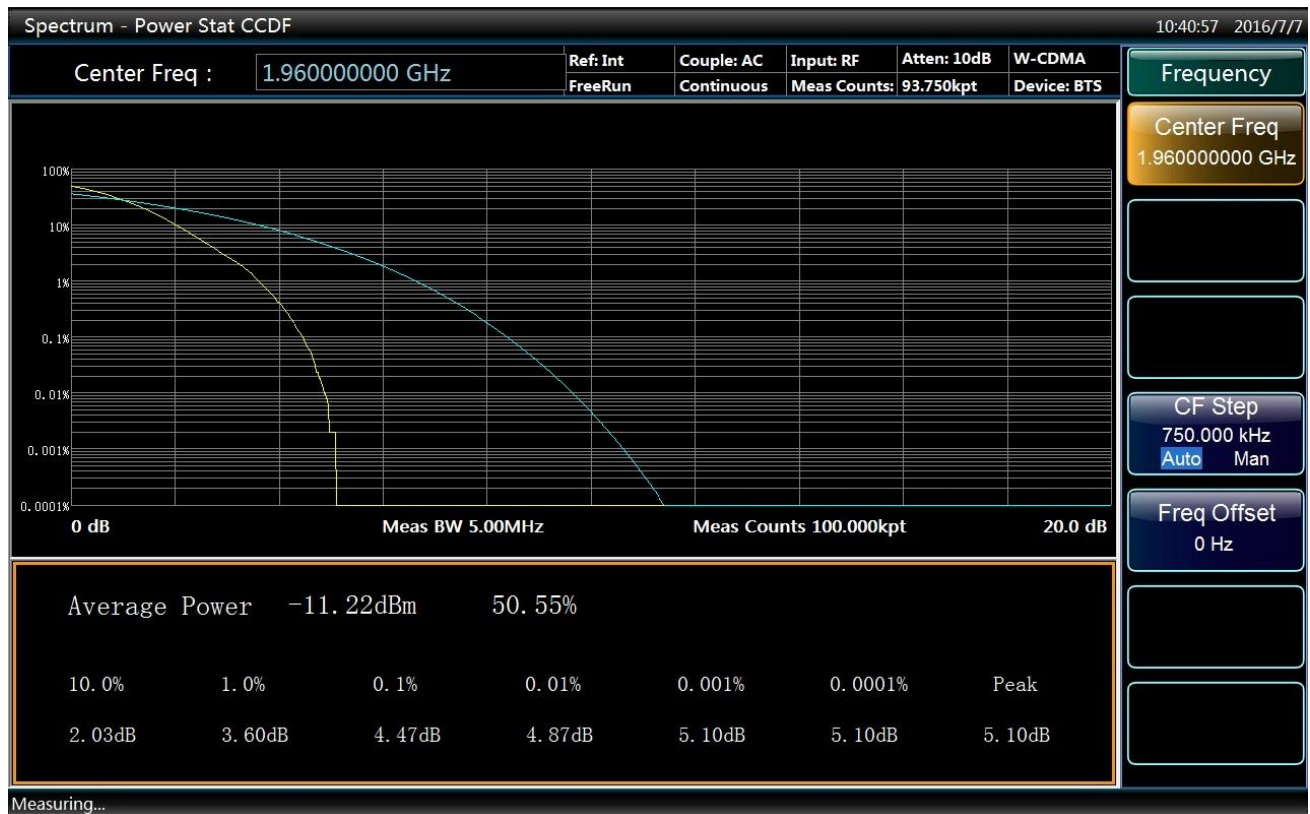

Fig. 4.70. Power Statistical Measurement

Step 8. Save the current measured trace for reference:

- Press **【Trace】**, [Save Reference Trace].

Save the current measured trace as the Reference Trace. During the first CCDF measurement of power statistic, graphic shown is a typical pure noise signal, marked as Gaussian curve and color in blue. CCDF curve currently measured appears as yellow, while the Reference Trace saved for comparison appears as pink.

Step 9. Show the reference trace saved.

- Press **【Trace】**, [Reference Trace On/Off].

Set the Reference Trace to be open, and turn on the reference trace saved.

Step 10. Change the measurement bandwidth to 1 MHz:

- Press **【BW】**.

Set the frequency of instrument measurement to 1.0 MHz, as shown in Fig. 4.71.

4.2 Advanced operation guide

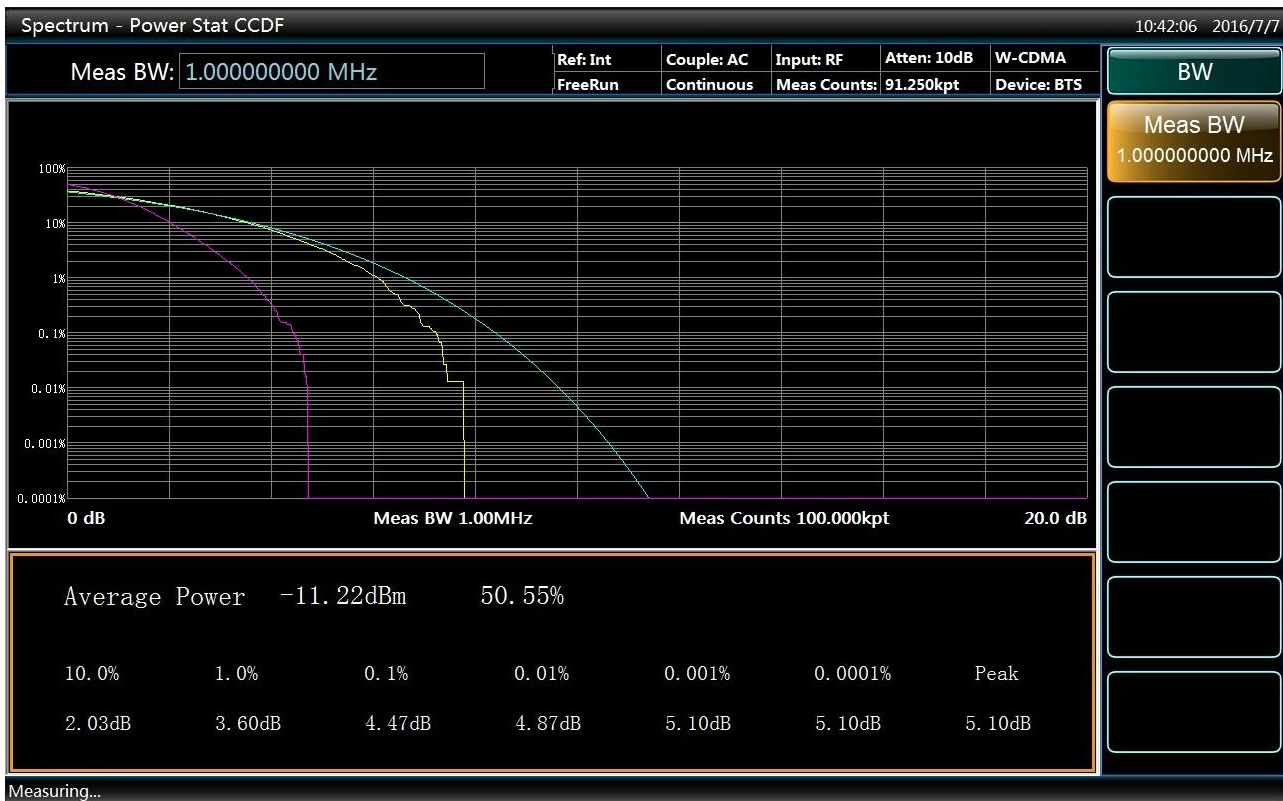

Fig. 4.71 Save and Display CCDF Measurement

Step 11. Amend measurement points to 1 kpt:

- Press **【Meas Setup】**, [Meas Counts].

Set accumulated points to 1 kpt, as shown in Fig. 4.72.



Fig. 4.72 Modify Measurement Points

4.2 Advanced operation guide

Step 12. Modify the X-axis scale to 1 dB to optimize special measurement:

- Press [Span/X-Axis], [Scale/Div].

Set the X-axis scale to 1 dB, as shown in Fig. 4.73.



Fig. 4.73 Modify the X-axis Scale

4.2.14 Burst Power

4.2.14.1 Basic concept

Burst power is an accurate method to measure specific burst average power. It is the average power of the pulse captured by measurement under zero bandwidth. The measurement is mainly used to measure the pulse modulated signal and burst signal in the time domain. If there is no user-defined, pulse width can be obtained in this way: identify peaks in the captured data, and then find the first position above the threshold on the trace as the starting point of the pulse, while the terminal point of the pulse is the first point below the threshold on the trace. The average carrier power can be calculated by pulse width and threshold.

4.2.14.2 Measurement Example

This section mainly describes how to carry out burst power measurement of a pulse modulated signal of 1.0 GHz frequency.

Step 1. Set signal source as below:

- Set up a pulse modulated signal.
- Set frequency on signal source to 1.960GHz.
- Set up the period of pulse modulation signal as 100 us.
- Set signal amplitude to -10dBm.

Step 2. Connect the radio frequency output port of the signal source to that of the analyzer. As shown in Fig. 4.74:

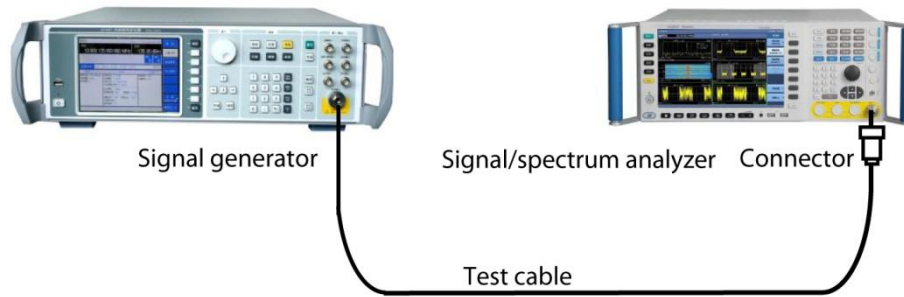

Fig. 4.74 Connection Settings of Burst Power Measurements

Step 3. set the analyzer as spectrum analysis mode and activate swept analysis mode:

- Press **【Mode】** and [Spectrum].

Step 4. Resetting of analyzer

- Press **【Preset】** key.

Step 5. Initialize burst power measurements:

- Press **【Measure】** , [Burst Power].

Set up the measurement function as burst power measurements.

Step 6. Set the frequency of the analyzer as 1.960 GHz:

- Press **【Frequency】** , [Center Freq].

Set the center frequency of the analyzer and input 1.960 GHz.

Step 7. Set the sweep time of the analyzer as 200.0 us:

- Press **【Sweep】** , [Sweep Time].

Set up the sweep time of the instrument, enter 200.0 us.

Step 8. Set analyzer trigger mode to burst power trigger:

- Press, **【Trig】** , [RF Burst].

Set up the instrument trigger mode, select burst power trigger.

- Results of burst power measurements are shown in Fig. 4.75.

4.2 Advanced operation guide

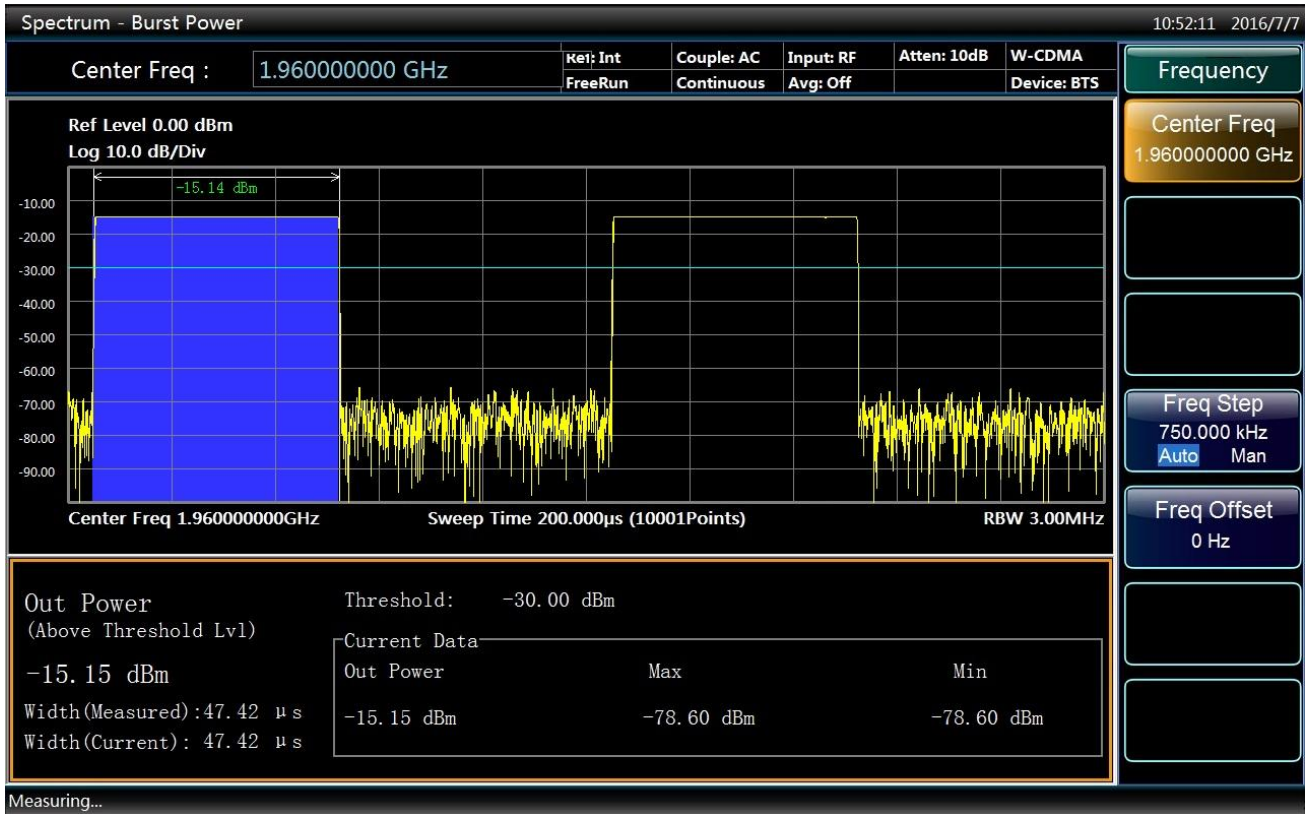

Fig. 4.75 Results of Burst Power Measurements

Step 9. Change the measurement parameters:

- Press **【Meas Setup】**.

Users can change measurement parameters like the threshold level, measuring method as required.

4.2.15 Harmonic Distortion

4.2.15.1 Basic concept

There are two ways adopted for harmonic distortion measurements of signals.

Auto search carrier: at this time range list is closed, the instrument automatically search base-band signal, and measure its harmonics. Specifically, center frequency for each harmonic measured will be set as integer multiples of the fundamental frequency, and perform a scan. Amplitude can be obtained by taking the average of the trace power and displays in the results list of the window. Each harmonic resolution bandwidth can be obtained by fundamental frequency resolution bandwidth multiplied by the number of harmonics. Each harmonic resolution bandwidth value is resolution bandwidth of fundamental frequency multiplied by the number of harmonics. In the minimum resolution bandwidth available, this result is greater than or equal to the calculated value.

Means of range list: open range list, set the required parameter list status, and measure according to the current known list parameters. After the fundamental wave, for each valid range table, set up the center frequency as the frequency of range table. If the current bandwidth is set to 0, the amplitude can be obtained by averagely calculating the trace power, and displays in the list of results window.

After measurement of a specified number of harmonics and amplitude, general harmonic distortion results (Harmonics & THD) will display in the left part of the window. If the measurement is carried out in single sweep mode, the display will remain at the last harmonic setting, and the instrument stop scanning. If the measurement is carried out in a continuous scan mode, it will continuously measure the fundamental wave and harmonic amplitude.

4.2.15.2 Measurement Example

This section mainly describes how to carry out harmonic distortion measurements of signals.

Step 1. Set signal source as below:

- Set frequency on signal source to 1.960GHz.
- Set signal amplitude to -10dBm.

Step 2. Connect the radio frequency output port of the signal source to that of the analyzer. As shown in Fig. 4.76:

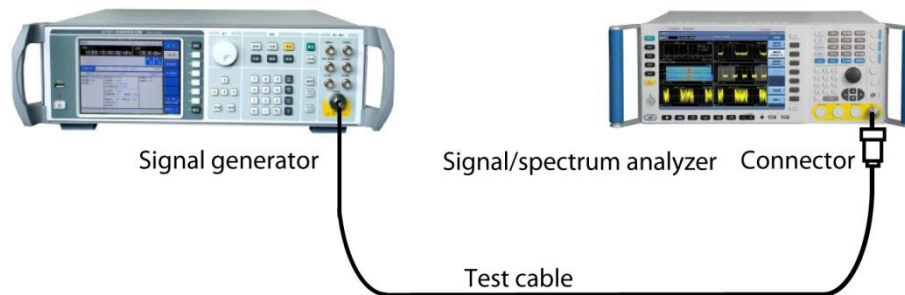

Fig. 4.76 Connection Settings of Harmonic Distortion Measurements

Step 3. set the analyzer as spectrum analysis mode and activate swept analysis mode:

- Press **【Mode】** and [Spectrum].

Step 4. Resetting of analyzer

- Press **【Preset】** key.

Step 5. Set the frequency of the analyzer as 1.960 GHz:

- Press **【Frequency】** , [Center Freq].

Set the center frequency of the analyzer and input 1.960 GHz.

Step 6. Initialize harmonic distortion measurements, by default, automatically search for the fundamental wave and measure harmonics.

- Press **【Measure】** [More 1/2▶], [Harmonics].

Set the measurement function as harmonic distortion measurements.

- The results of harmonic distortion measurements are shown in Fig. 4.77. Text window displays the absolute power value of the fundamental wave and the relative value of harmonic to fundamental frequency, and gives the total harmonic distortion value.

Step 7. Set harmonic parameters manually, the user can edit the list to:

- Press **【Meas Setup】** , [Harmonics Table ON OFF].

Set up harmonic edit list to be open, turn on harmonics edit list.

- Press [Harmonics Table Config▶].

Users can select and set measurement parameters like the frequency, resolution bandwidth as required.

4.2 Advanced operation guide

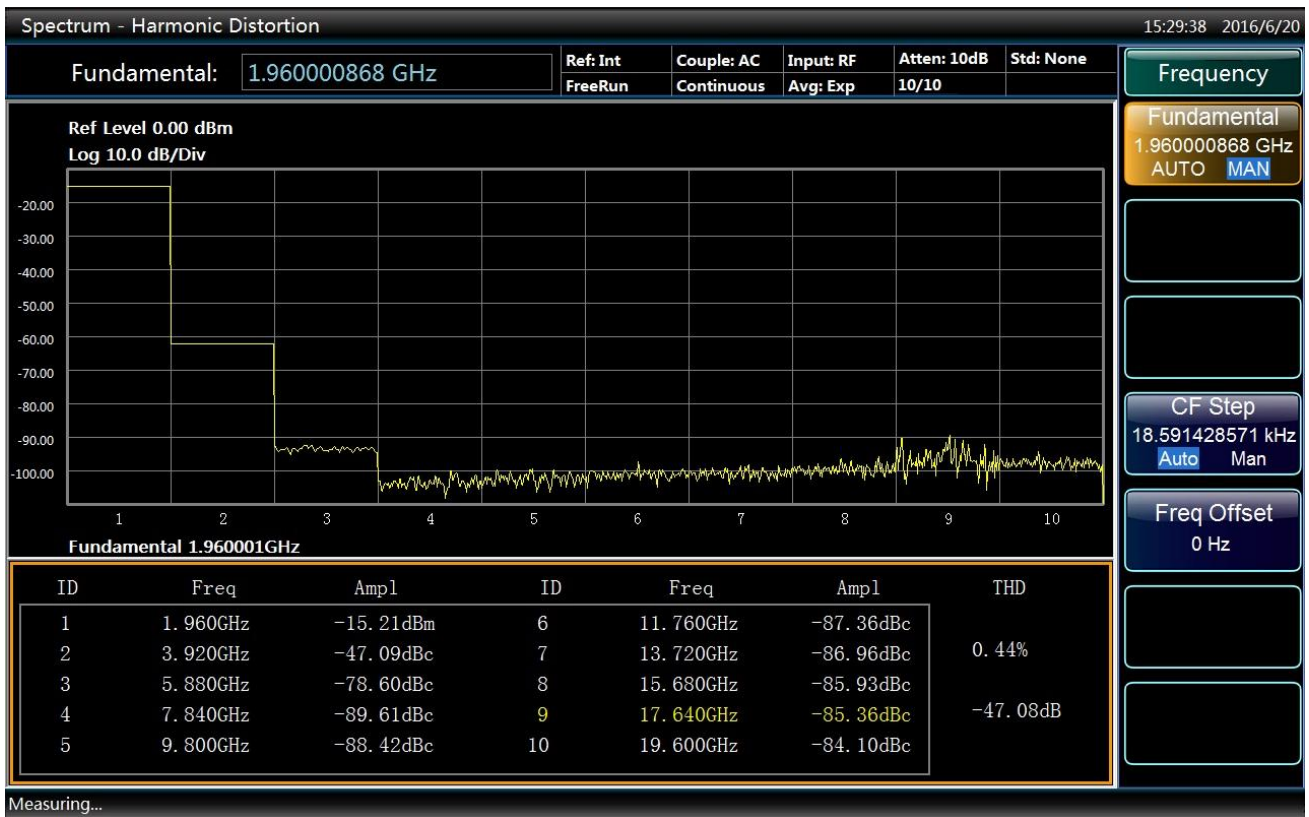

Fig. 4.77 Results of Harmonic Distortion Measurements

4.2.16 Three-order intermodulation (TOI)

4.2.16.1 Basic concept

Three-order intermodulation, also known as TOI for short, is a means for analysis and measurement of intermodulation product of communication system equipment. Mutual interference between equipment is very common in communication systems, which is usually caused by distortion products from equipment such as amplifiers and frequency mixer. TOI can measure, calculate and display output intercept points (IP3) and signs on the curve show measured signals and three-order products.

After selecting [TOL], press **【Meas Setup】** key to enter the parameter settings menu of third-order intermodulation measurement, press **【Meas Control】** key for remeasuring, continuous switch and single sweep.

4.2.16.2 Measurement Example

This section mainly describes how to measure third-order intermodulation for signals (use a signal generator to simulate an intermodulation signal).

Step 1. Connect the RF output ports of two signal sources with a directional coupler, and place the device under test (e.g. an amplifier) in between the output port of the directional coupler and input port of the analyzer, as shown in Fig.4.78.

Step 2. Set signal source as below:

- Set the frequency on one signal source at 500 MHz.
- Set the frequency on the other signal source at 510 MHz to make a frequency space of 10 MHz between the two signal sources.
- Set the power of the two signal sources to achieve same measured amplitude of spectrum analyzer. The power is set at -2.0dBm in this example.

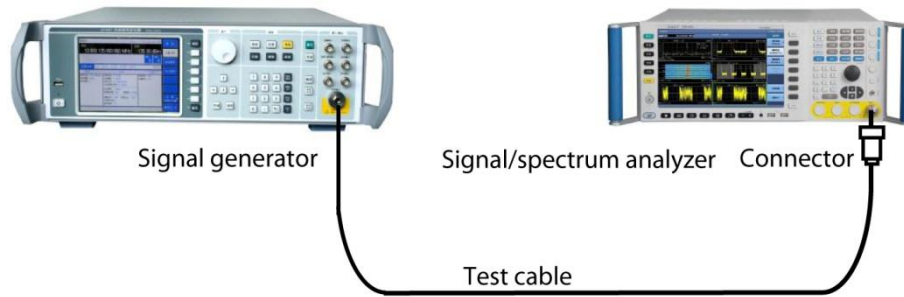

Fig. 4.78 Connection Settings of Third-order Intermodulation Measurements

Step 3. set the analyzer as spectrum analysis mode and activate swept analysis mode:

- Press **【Mode】** and [Spectrum].

Step 4: Resetting of analyzer

- Press **【Preset】** key.

Step 5. Initialize the third-order intermodulation measurements:

- Press **【Measure】**, [More1/2 >>], [TOI].

Set the measurement function as third-order intermodulation measurements.

Step 6. Set center frequency of the analyzer as 505.0 MHz:

- Press **【Frequency】**, [Center Freq].

Set the center frequency of the analyzer and input 505.0 MHz.

Step 7. Set the analyzer bandwidth as 50.0 MHz:

- Press **【Span/X Axis】**, [Span].

Set up the instrument bandwidth, input 50.0 MHz.

- Results of third-order intermodulation measurement are shown in Fig. 4.79. Text window shows the fundamental frequency and power, and third-order inter-modulation frequencies and power, and gives third-order intercept values.

Step 8. The user can apply zero bandwidth mode:

- Press **【Meas Setup】**, [Zero-Span Mode▶], [Zero-Span Meas On Off].

Users can set up measurement parameters like the resolution bandwidth, dwell time and other as needed.

4.2 Advanced operation guide

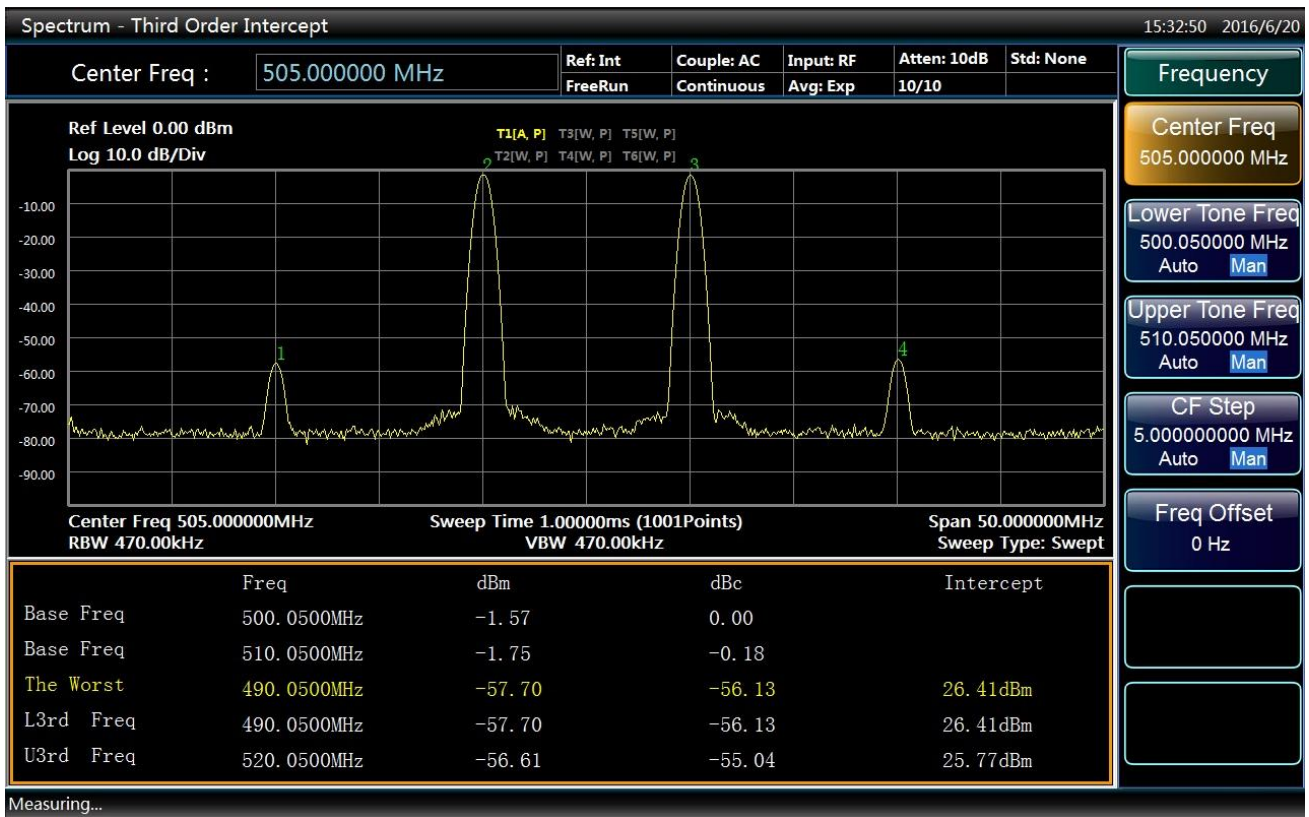

Fig. 4.79 Results of Three-order Intermodulation Measurement

4.2.17 Spurious emission

4.2.17.1 Basic concept

Spurious emission measurement identifies and defines the power level of spurious emission within certain bandwidth and is mainly used to measure spurious signals, harmonic and intermodulation. In practice, spurious emissions should ensure to be under a lower power level, preferably close to the background noise to avoid interfering with communication of other frequency bands.

4.2.17.2 Measurement Example

This section mainly introduces how to measure the spurious emission of signals, by using spurious signals on frequency spectrum of pulse signal simulation measurement.

Step 1. Set signal source as below:

- Set up the repetition frequency as 1 kHz pulse signal.
- Set frequency on signal source to 1.920GHz.
- Set signal amplitude to -10dBm.

Step 2. Connect the radio frequency output port of the signal source to that of the analyzer. As shown in Fig. 4.80:

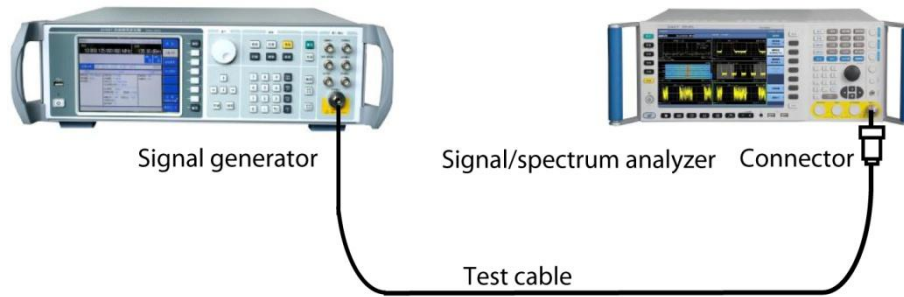

Fig. 4.80 Connection Settings of Spurious Emission Measurements

Step 3. set the analyzer as spectrum analysis mode and activate swept analysis mode:

- Press **【Mode】** and [Spectrum].

Step 4. Resetting of analyzer

- Press **【Preset】** key.

Step 5. Set the frequency of the analyzer as 1.920GHz:

- Press **【Frequency】** , [Center Freq] and enter 1.920 GHz.

Step 6. Initialize spurious emission measurement:

- Press **【Measure】** , [More 1/2▶], [Spurious Emission], set up the measurement mode as spurious emissions.

Step 7. Check the specified spurious signals:

- Press **【Meas Setup】** , [Spur].

Input checked stray figures.

- Results of spurious emission measurement are shown in Fig. 4.81.

What shows in the text window is the detected stray. Each message includes a spurious frequency range, a stray power and a limited value.

Step 8. The user can change the measurement parameters, and customize measuring range list as needed:

- Press **【Meas Setup】** , [Range Table▶].

Users can select and edit measurement parameters for multiple lists.

4.2 Advanced operation guide

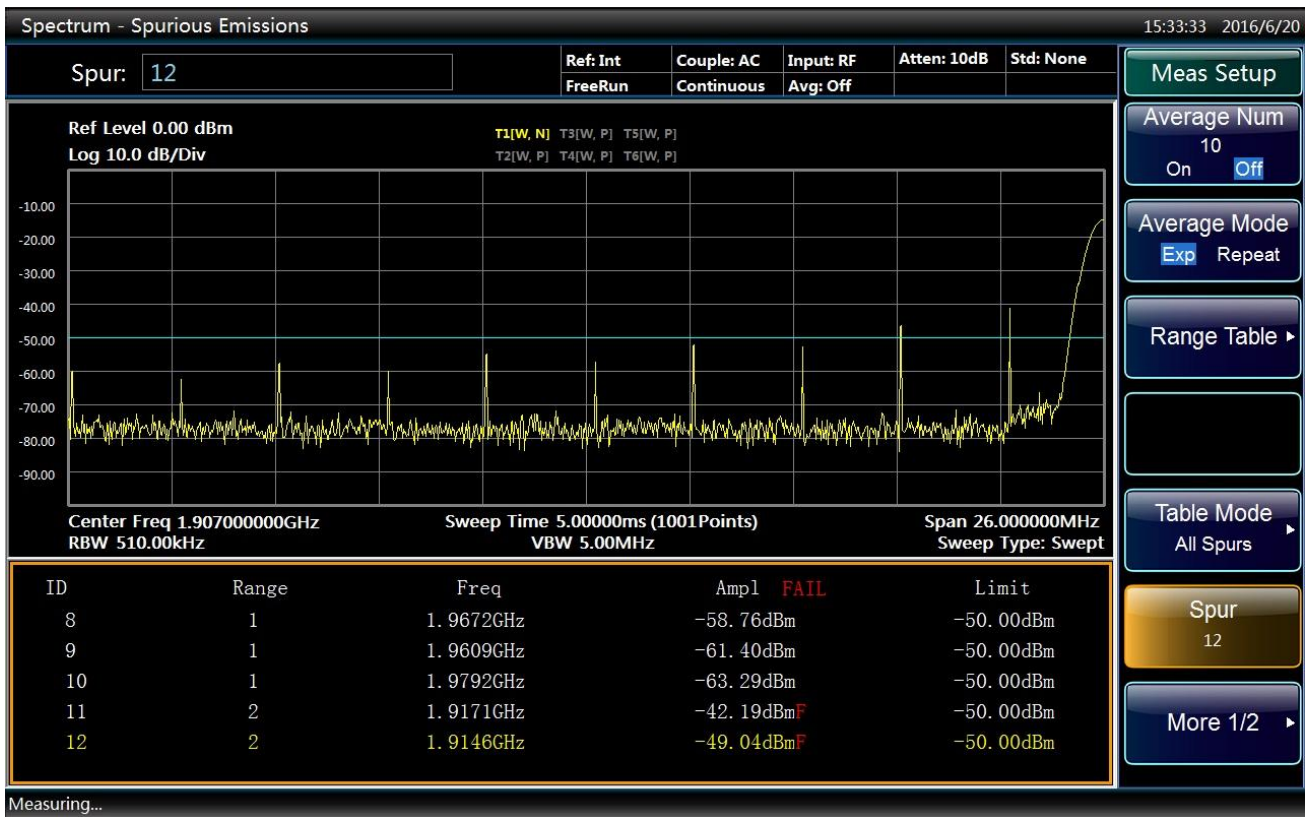

Fig. 4.81 Results of Spurious Emission Measurement

4.2.18 Spectral emission mask

4.2.18.1 Basic concept

Spectral emission mask (SEM) measurement includes spurious emission inside and outside the band and is targeted at spurious signals inside the frequency range close to carrier signals. Analysis bandwidth for spurious measurement may differ for varied frequency range of carrier shift. To facilitate observation and judgment, spurious threshold level is given for each frequency range starting right from the carrier signal according to relevant standards, which is connected to form the spectral mask. Only spurious signals located within such spectral mask can be measured. Therefore, the spectral mask can be used as a direct indicator of whether spurious component of one signal exceeds the standard.

Measurement setup key is for detailed setting of relevant parameters of multicarrier measurement, while measurement control key is for single or continuous measurement switch.

4.2.18.2 Measurement Example

This section mainly introduces how to carry out spectrum emission mask measurement of W-CDMA (3GPP) signal (use a signal generator to simulate a W-CDMA signal). SEM will assign power within carrier bandwidth and power within offset channel to compare with power level specified in the Standard.

Step 1. Set signal source as below:

- Set up W-CDMA signals.
- Set frequency on signal source to 1.960GHz.
- Set signal amplitude to -10dBm.

Step 2. Connect the radio frequency output port of the signal source to that of the analyzer. As shown in Fig. 4.82:

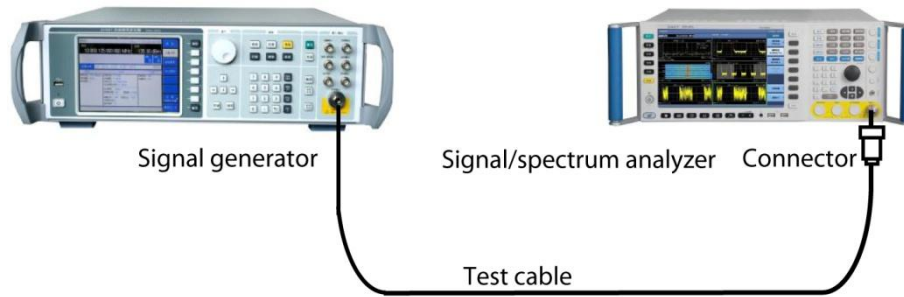

Fig. 4.82 Connection Settings of Spectral Emission Mask Measurements

Step 3. set the analyzer as spectrum analysis mode and activate swept analysis mode:

- Press **【Mode】** and [Spectrum].

Step 4. Resetting of analyzer

- Press **【Preset】** key.

Step 5. Initialize the spectral emission mask measurements:

- Press **【Measure】**, [More 1 / 2▶], [Spectral Emission Mask].

Set the measurement function as spectral emission mask measurements.

Step 6. Set up a wireless standard and switch the wireless devices for base station:

- Press **【Measure】**, [More 1 / 2▶], [Radio Std▶], [W-CDMA 3GPP].

Set the wireless standard as W-CDMA.

- Press [Wireless Devices▶], [BTS].

Switch the wireless devices as BTS.

Step 7. Set the frequency of the analyzer as 1.960 GHz:

- Press **【Frequency】**, [Center Freq].

Set up the center frequency of the instrument, input 1.960 GHz.

- Results of spectrum emission mask measurements are shown in Fig. 4.83. Text window shows the reference carrier power and the absolute peak power level within offset band in both sides of the reference channel.

4.2 Advanced operation guide



Fig. 4.83 Results of Spectrum Emission Mask Measurements

Step 8. The user can change the measurement parameters:

- Press **【Meas Setup】**, [Ref Channel▶].

Users can select and edit measurement parameters of the reference channel as needed.

- Press **【Meas Setup】**, [Offset/Limit▶].

Users can select and edit measurement and qualifying parameters of offset channel as required.

4.2.19 Display and limit lines

Capability of display and limit lines contribute to further analysis of the measurement trace.

4.2.19.1 Display line

Display line is similar to mark, which can help analyze the measurement trace.

4.2.19.2 Function set of display and limit lines

1) Display line setup

Step 1. Press the key **【Display】** on the front panel surface.

Step 2. Press soft menu [Display line On / **Off**], and turn on display line, and the screen will show a green line.

Step 3. Use the numeric keypad, arrow keys or knob to modify the amplitude value of the display line.

2) Settings and functions of the limit line.

Signal / spectrum analyzer can display 6 limit lines simultaneously.

Step 1. Turn on the limit line function:

- Press key **【Meas Setup】** on the front panel.

- Press the soft menu [Limit Line▶], pop up setup sub-menu of limit line function.
- Press [More 1/2 ▶], [Test Limit Line On / Off], turn on limit line test switch.

Step 2. To edit limit line:

- Press **【Meas Setup】**, [Limit Line▶], [Edit▶], pop up sub-menu of limit line editing, in this case, edit window of the limit line appear, as shown in Fig. 4.84.

ID	Freq	Ampl
1	400.000000 MHz	-147.68 dBm
2	800.000000 MHz	-146.64 dBm
3	1.200000 GHz	-145.90 dBm
4	1.600000 GHz	-145.01 dBm
5	2.040000 GHz	-146.04 dBm

Fig. 4.84 Edit Window of Limit Line

- Press the soft menu [Insert Point], and it will automatically generate a new limit line point. The default frequency of the first point is current start frequency, with amplitude of 0 dBm. After the first point, each new point inserted will be created with 1/100 of current span increased each time based on the above (if the unit on X-axis of limit line is time, then the points inserted will be created with 1/100 of current sweep time increased each time based on the above), with default amplitude always as 0 dBm.
- Arrow keys can be used to further edit the generated point of limit line list. Press the soft menu **【Frequency】** or [Amplitude], and it will modify the frequency or amplitude value of the current edit point.
- Limit line point can be deleted by soft menu [Delete Point].
- [Copy From Limit ▶] function can copy the selected limit line to the current limit line. Such as, pressing soft menu [Copy From Limit ▶], [Limit Line 2] can copy all points information of limit line 2 to the current limit line.

Note: This will overwrite the currently edited data of limit line, please be careful!

- [Build From Trace▶] function will generates a default limit lines based on the currently selected trace data, the default test results of the limit line generated is pass.

Step 3. Save and call limit lines:

- Press [Save Limit Line...] Soft menu, pop up Save As dialog box, select save path and save file name, click to save, and it will save the edit data of the current limit line, file name suffixed with “.lim”, as shown in Fig. 4.85.

4.2 Advanced operation guide

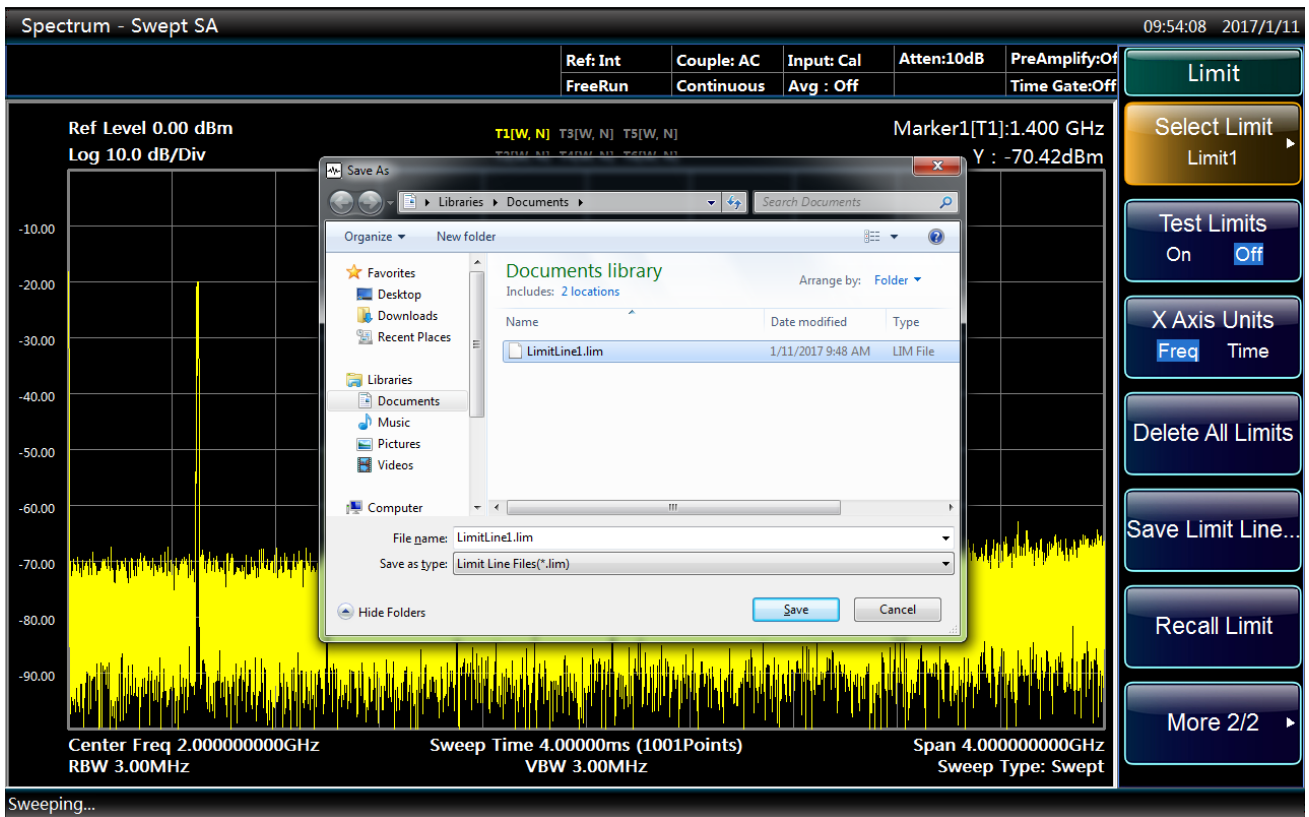

Fig. 4.85 Save Limit Line Window

- Press [Load Limit Line...] Soft menu, pop up file open dialog box, select limit line file which its name suffixed with “.lim”, click to open, and reflect the limit line data in the current limit line, as shown in Fig. 4.86.

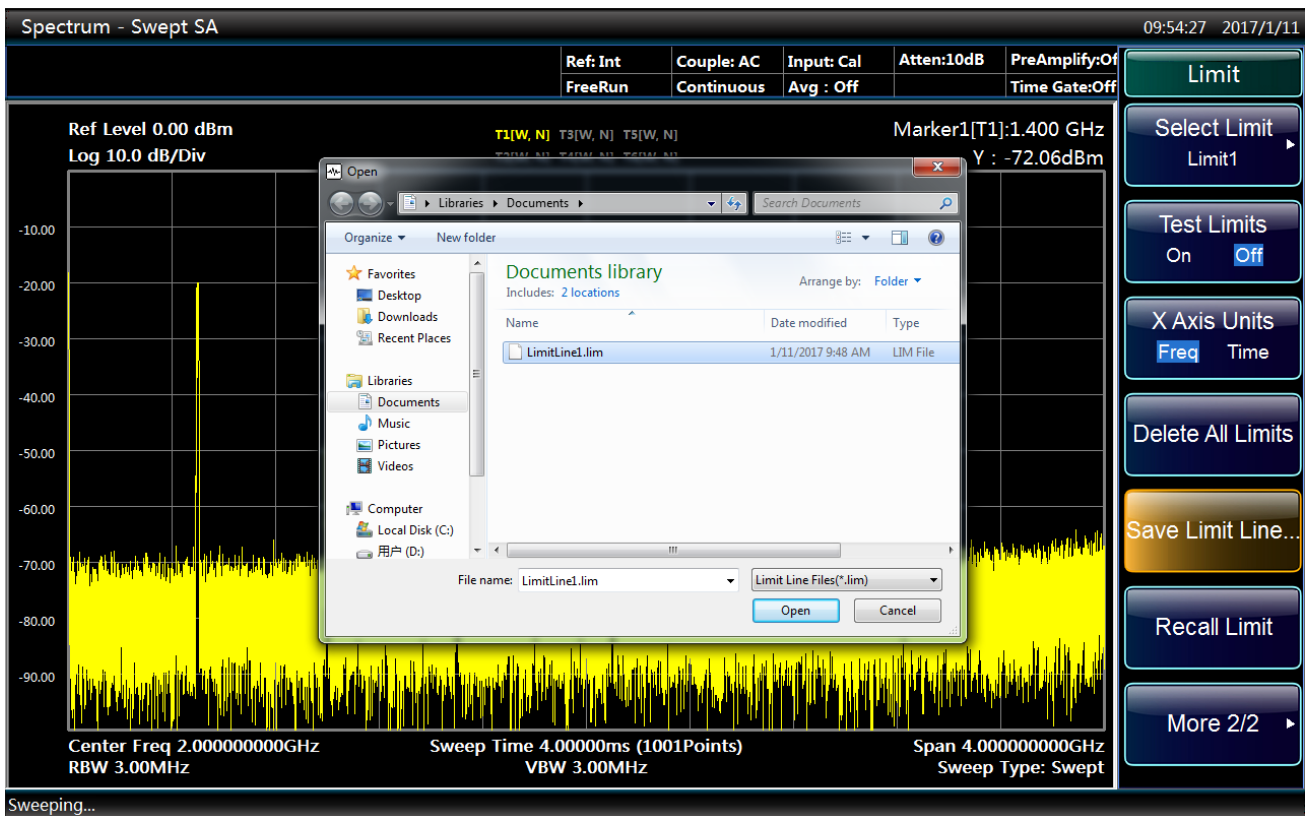

Fig. 4.86 Load Limit Line Window

5 Menu

The 4051 Series Series Signal Analyzer menus comprise: Mode, Measurement, Measurement Setting, Measurement Control, Frequency, Amplitude, Span, Sweep, Bandwidth, Trigger, Marker, Marker->, Marker Function, Peak Search, Trace, Display, Input/Output, Couple, System, File, Print, Save and Help. Detailed menu structure and description will be listed below.

- Menu structure.....167
- Description of menu346

5.1 Menu structure

- General.....168
- Spectrum Analysis.....173
- Channel Power.....198
- Occupied Bandwidth.....214
- Adjacent Channel Power.....230
- Power Statistic.....248
- Burst Power.....264
- Harmonic Distortion.....280
- Three-order Intermodulation.....296
- Spurious Emission.....312
- Spectral Emission Mask.....329

5.1 Menu structure

5.1.1 General

5.1.1.1 System

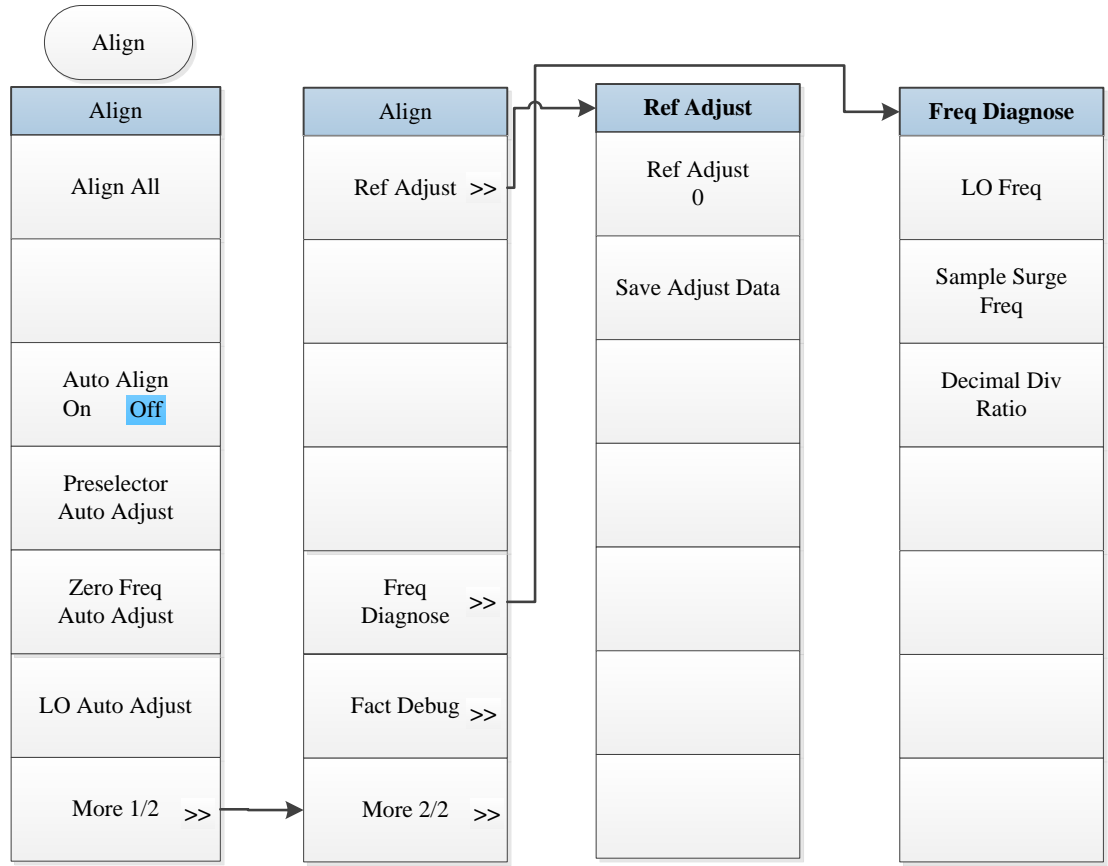
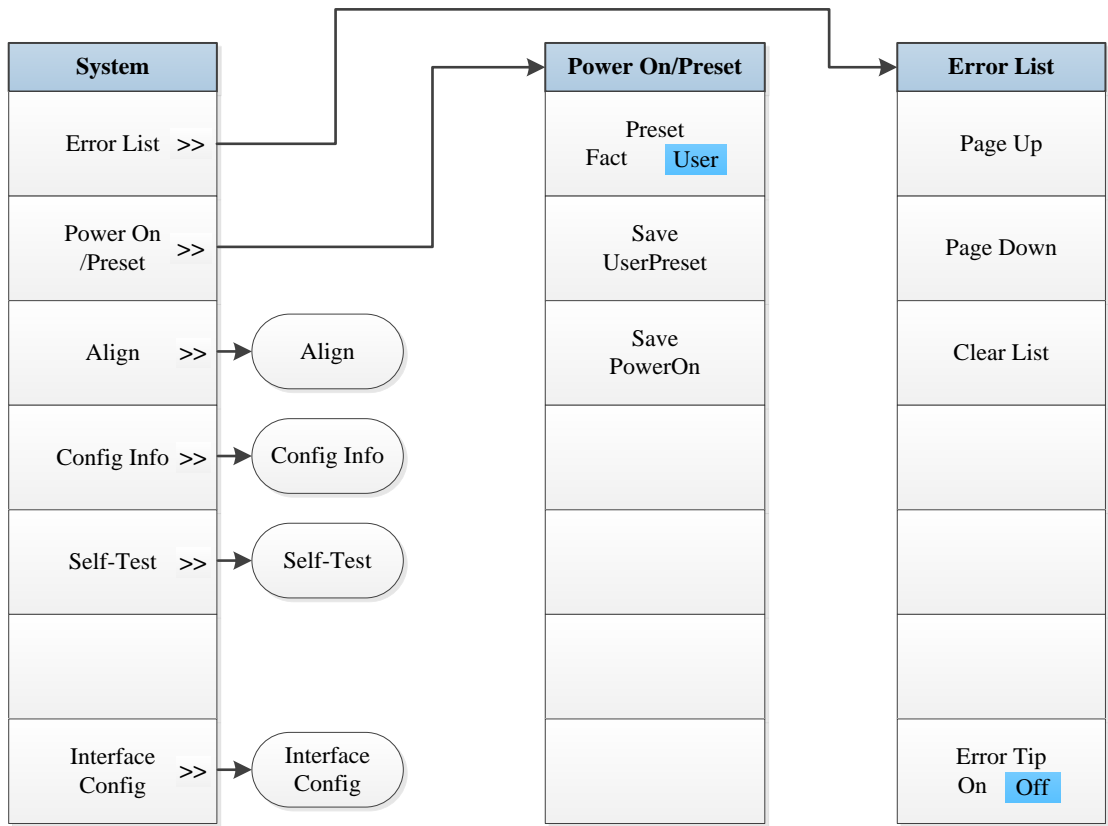

5.1 Menu structure

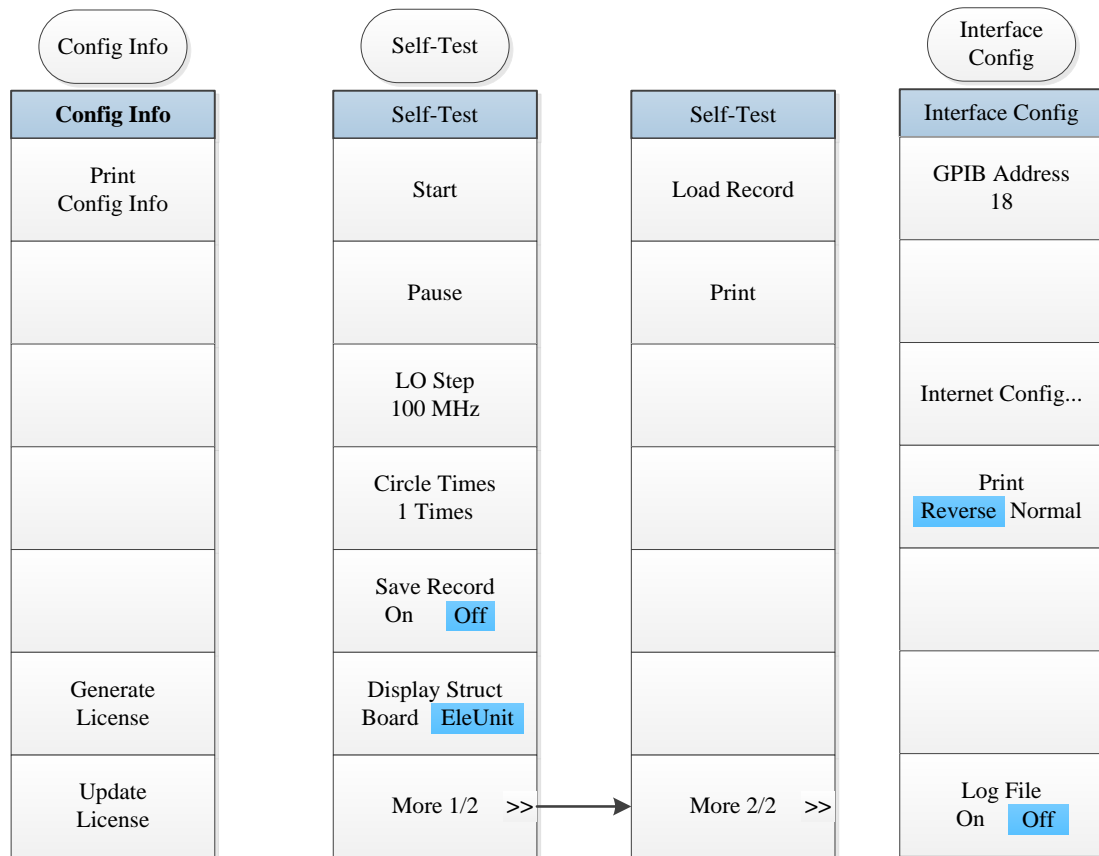
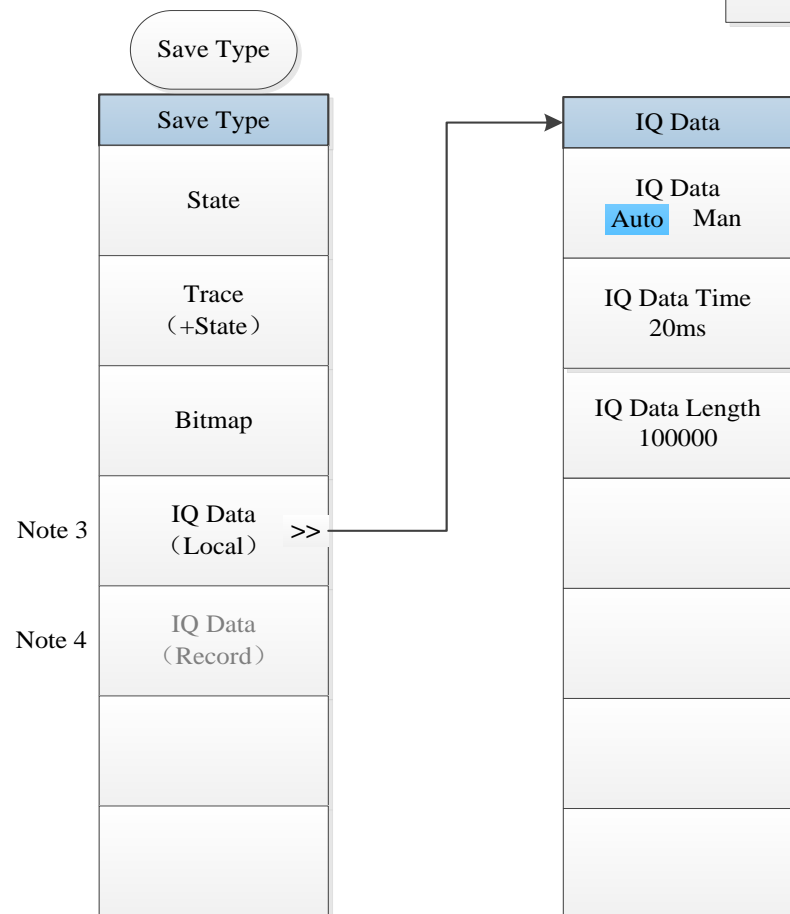
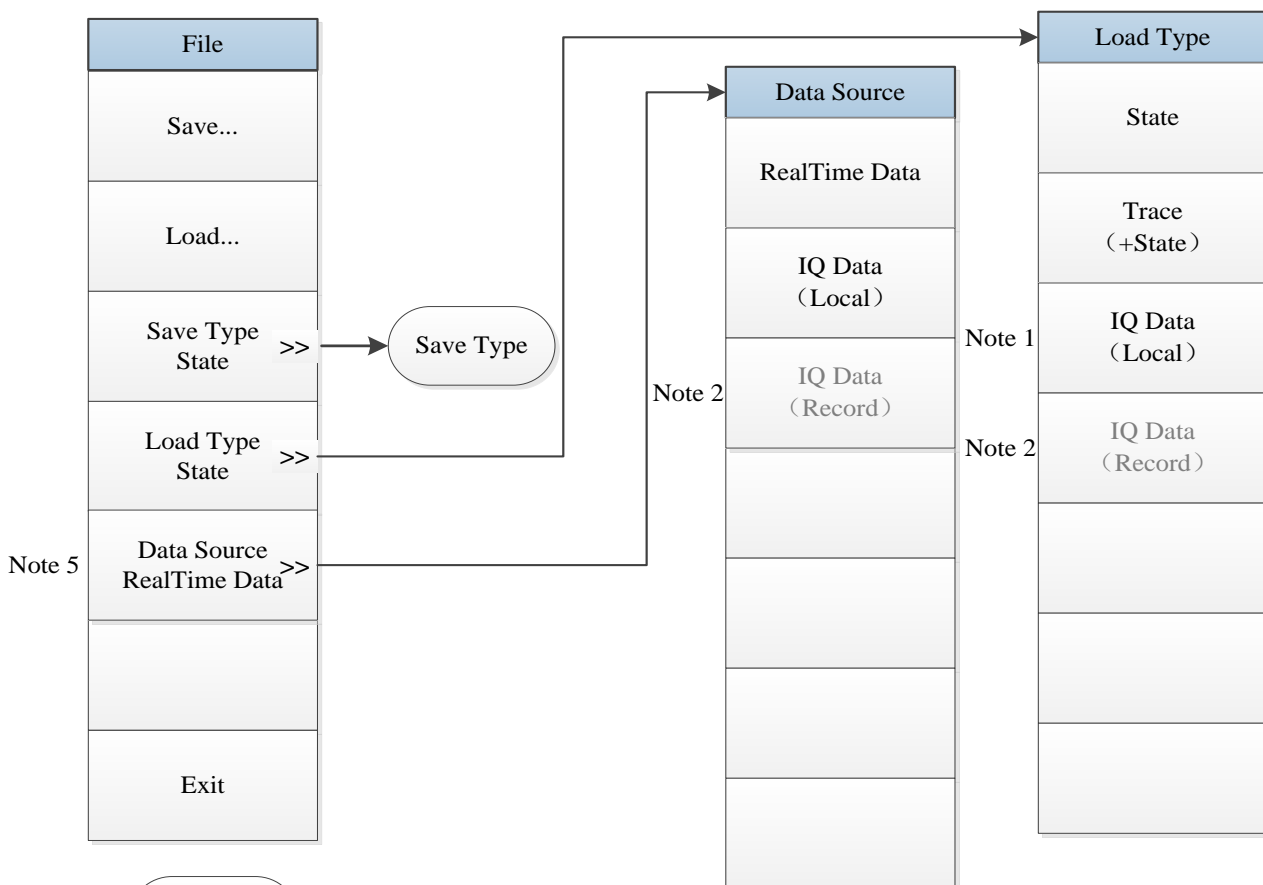

Fig. 5.1-1 System Menu

5.1 Menu structure

5.1.1.2 File



5.1 Menu structure

- Note 1.* This menu is only enabled under Vector Analysis, Transient Analysis and Pulse Analysis.
- Note 2.* This menu only appears after Option H22A or H22B (Data Recorder) is purchased and is only enabled under Transient Analysis and Pulse Analysis.
- Note 3.* This menu is only enabled under Vector Analysis, Transient Analysis, Pulse Analysis and I/Q Analysis.
- Note 4.* This menu only appears after Option H22A or H22B (Data Recorder) is purchased and is only enabled under Transient Analysis and Pulse Analysis.
- Note 5.* This menu is only enabled under Vector Analysis, Transient Analysis and Pulse Analysis.

Fig. 5.1-2 File Menu

5.1 Menu structure

5.1.1.3 Mode

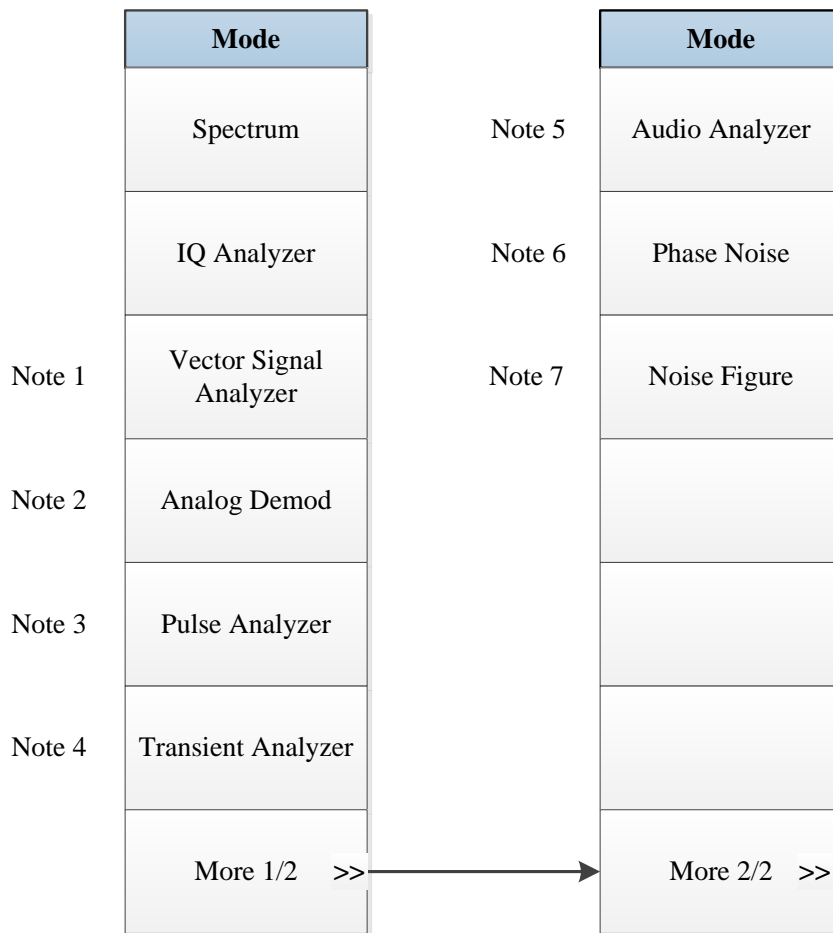

Note 1. this menu is only available when the S12 option (Digital Modulation Signal Analysis) is purchased.

Note 2. this menu is only available when the S09 option (Analog Demodulation Analysis) is purchased.

Note 3. this menu is only available when the S13 option (Pulse Signal Analysis) is purchased.

Note 4. this menu is only available when the S10 option (Transient Analysis) is purchased.

Note 5. this menu is only available when the S08 option (Audio Analysis) is purchased.

Note 6. this menu is only available when the S04 option (Phase Noise Test) is purchased.

Note 7. this menu is only available when the S05 option (Noise Factor Test) is purchased.

Fig. 5.1-3 Mode Menu

5.1.1.4 Reset

5.1.1.5 Print

5.1.1.6 Help

5.1.2 Spectrum Analysis

5.1.2.1 Frequency

Frequency
Center Freq 13.250000 GHz
Start Freq 0.000000 GHz
Stop Freq 26.500000 GHz
CF Step 10.0000MHz <input checked="" type="radio"/> Auto <input type="radio"/> Man
Freq Offset 0.000000 GHz
Auto Tune
Signal Track On <input checked="" type="radio"/> Off

Fig. 5.2-1 Frequency Menu

5.1 Menu structure

5.1.2.2 Amplitude/Y Axis

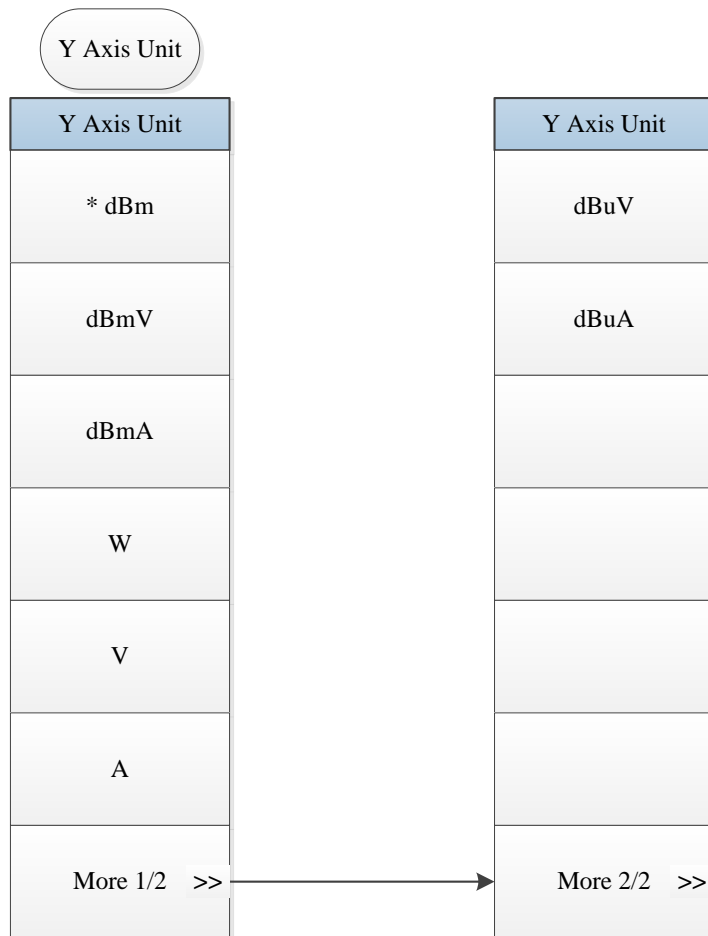
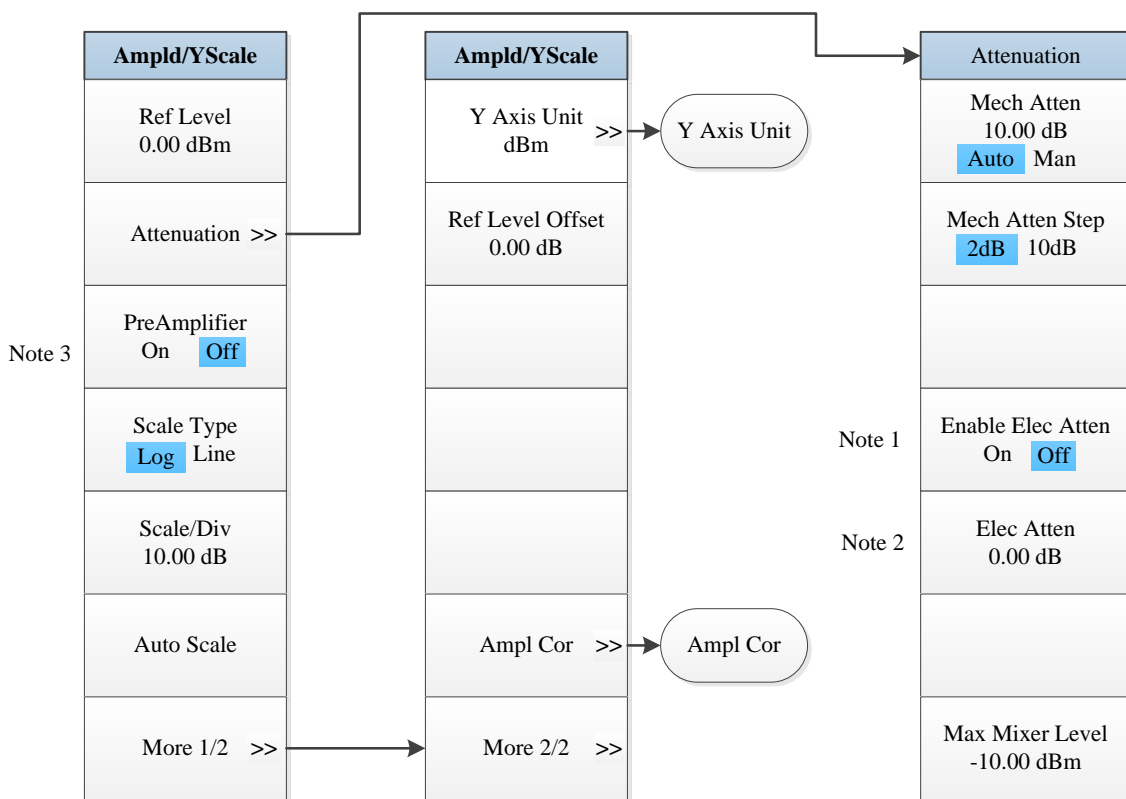

5.1 Menu structure

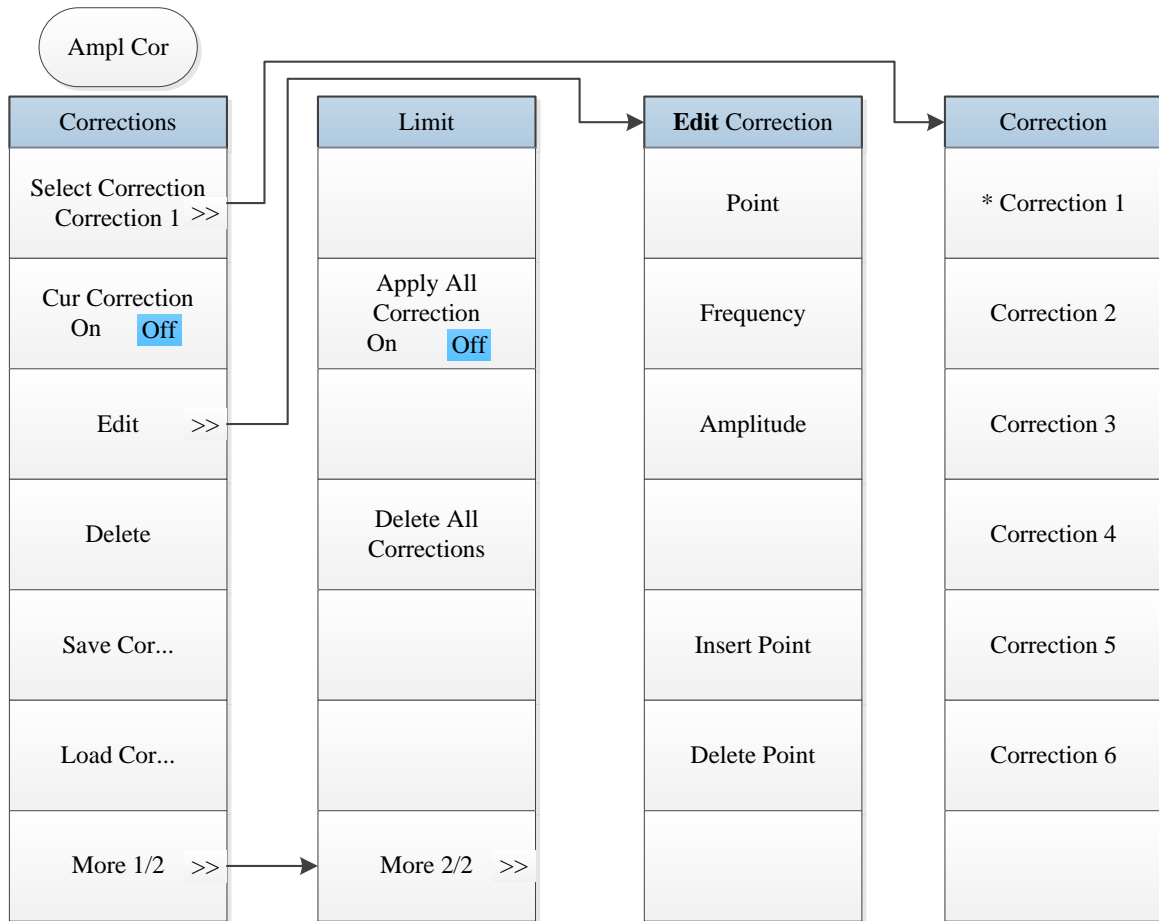

Note 1. this menu is only available when the H33 option (Elec Attenuator) is purchased.

Note 2. this menu is only available when the H33 option (Elec Attenuator) is purchased.

Note 3. this menu is only available when the H34 option (Low Noise PreAmplifier) is purchased.

Fig. 5.2-2 Amplitude/Y Axis Menu

5.1 Menu structure

5.1.2.3 Span/X Axis

Span
Span 40.000000 GHz
Full Span
Zero Span
Last Span

Fig. 5.2-3 Span Menu

5.1.2.4 Bandwidth

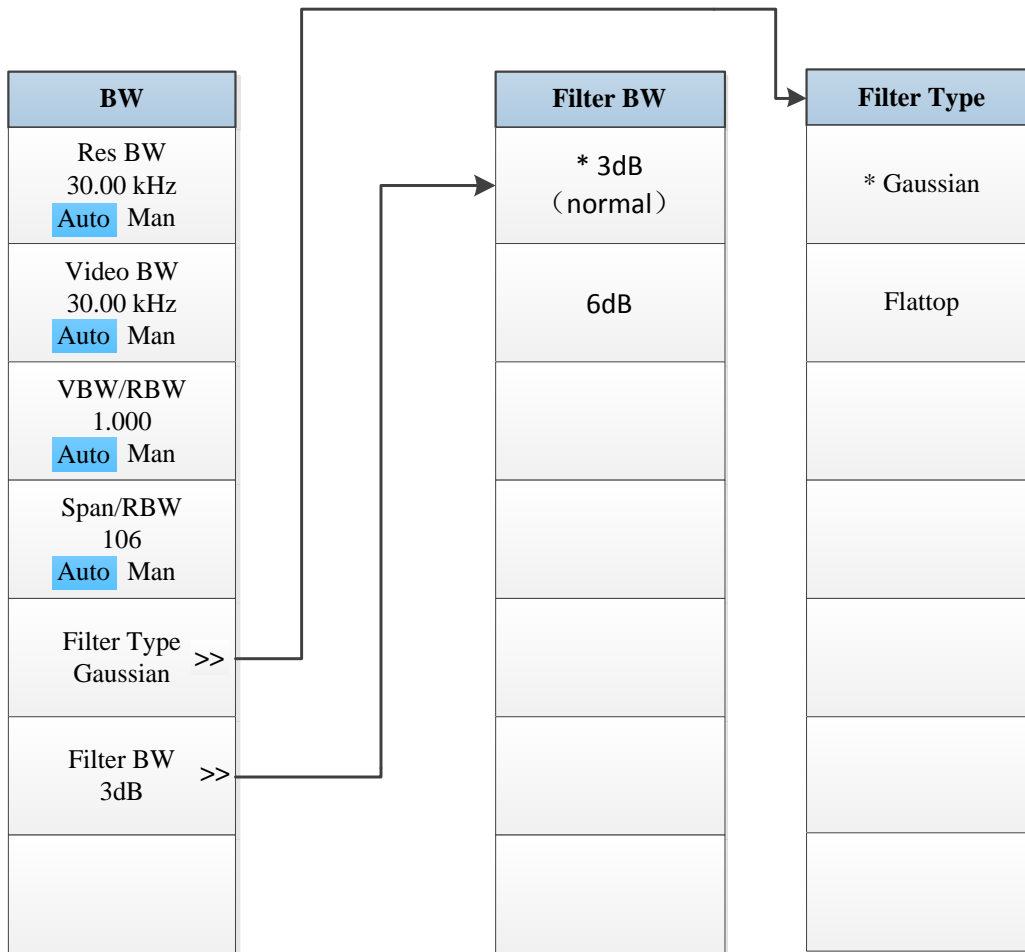
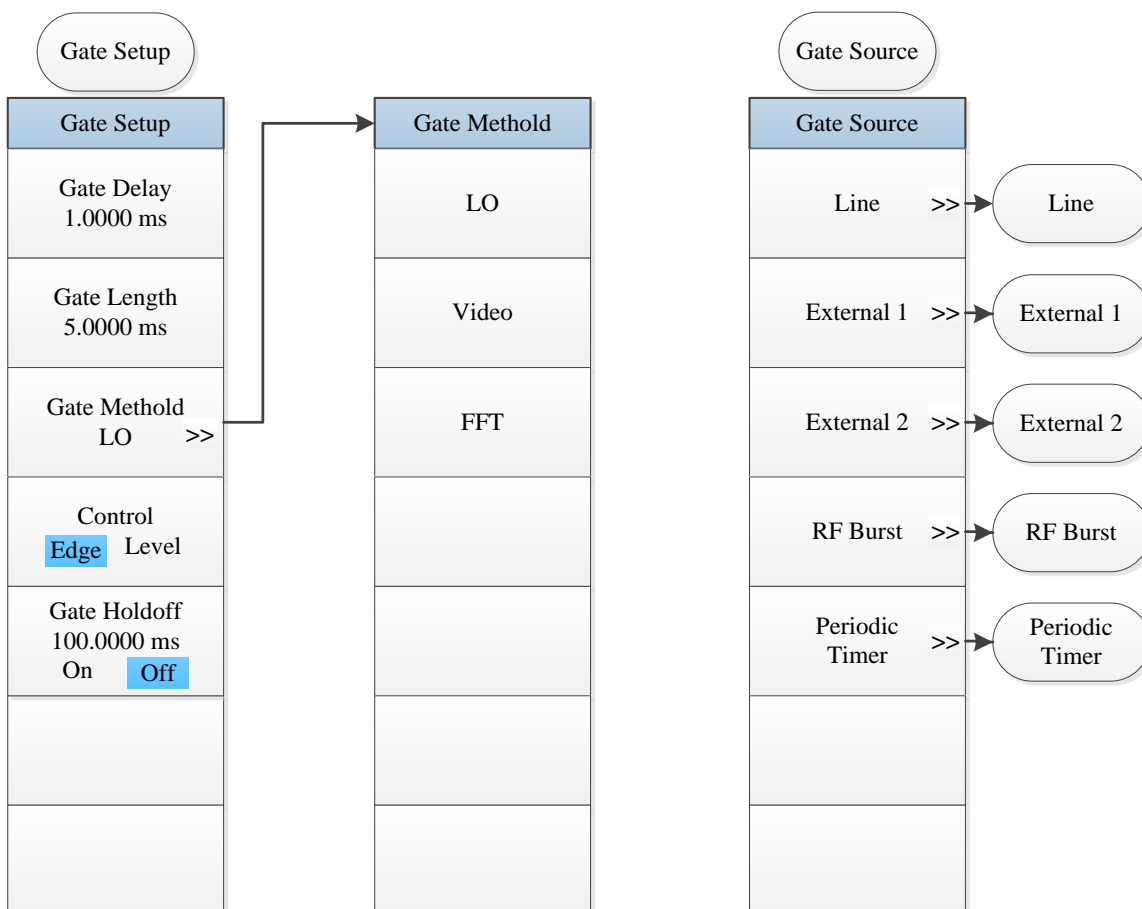
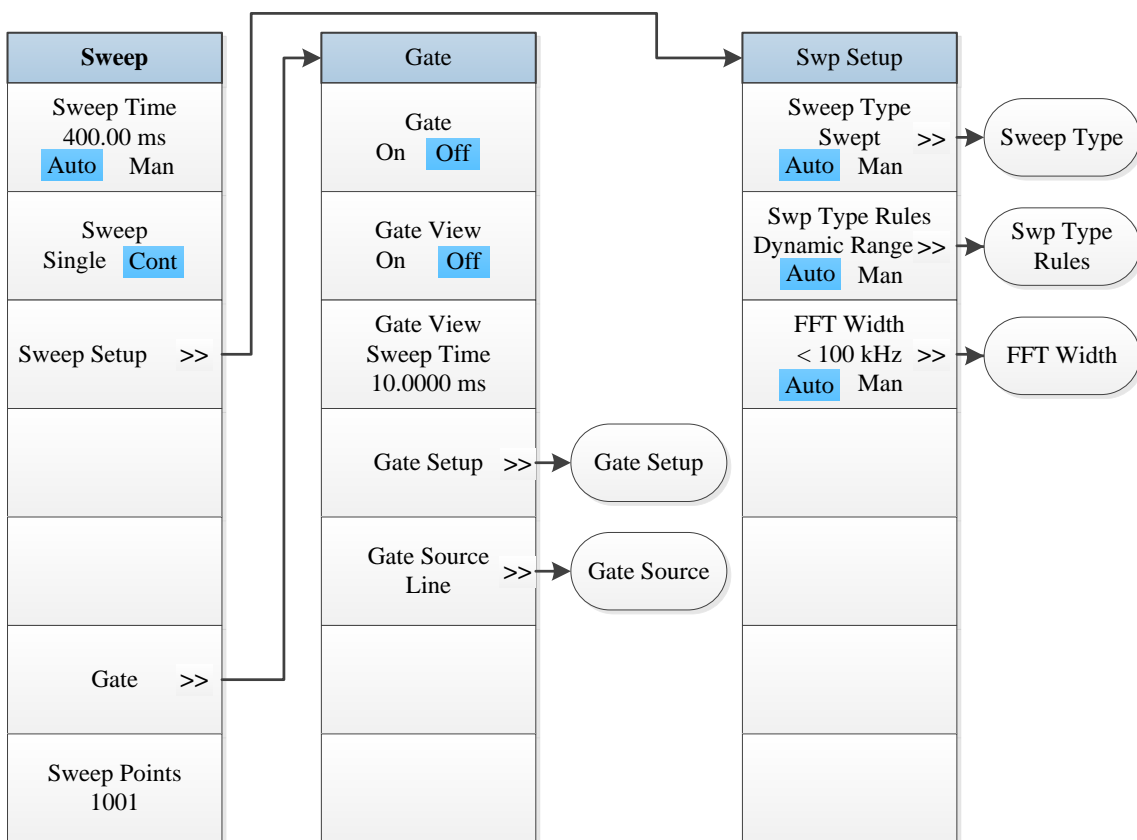

Fig. 5.2-4 Bandwidth Menu

5.1 Menu structure

5.1.2.5 Sweep



5.1 Menu structure

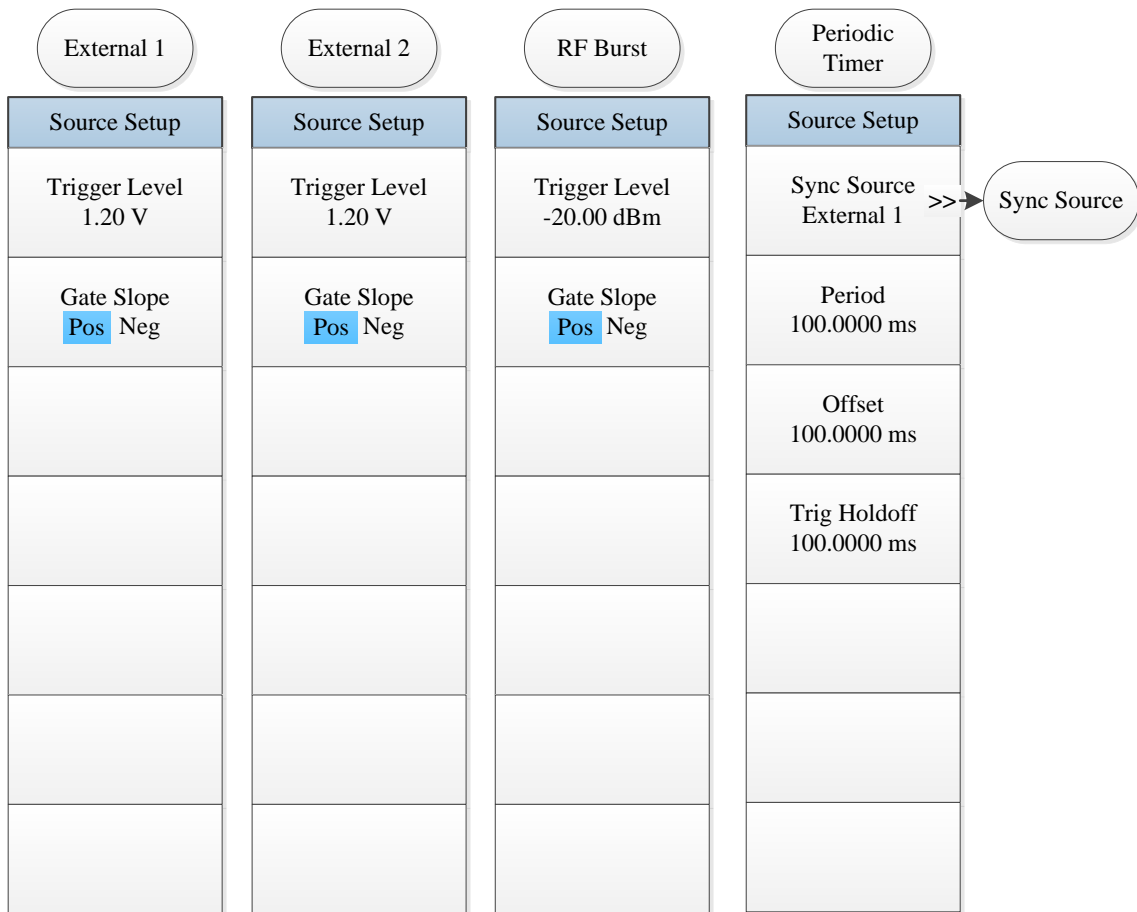

5.1 Menu structure

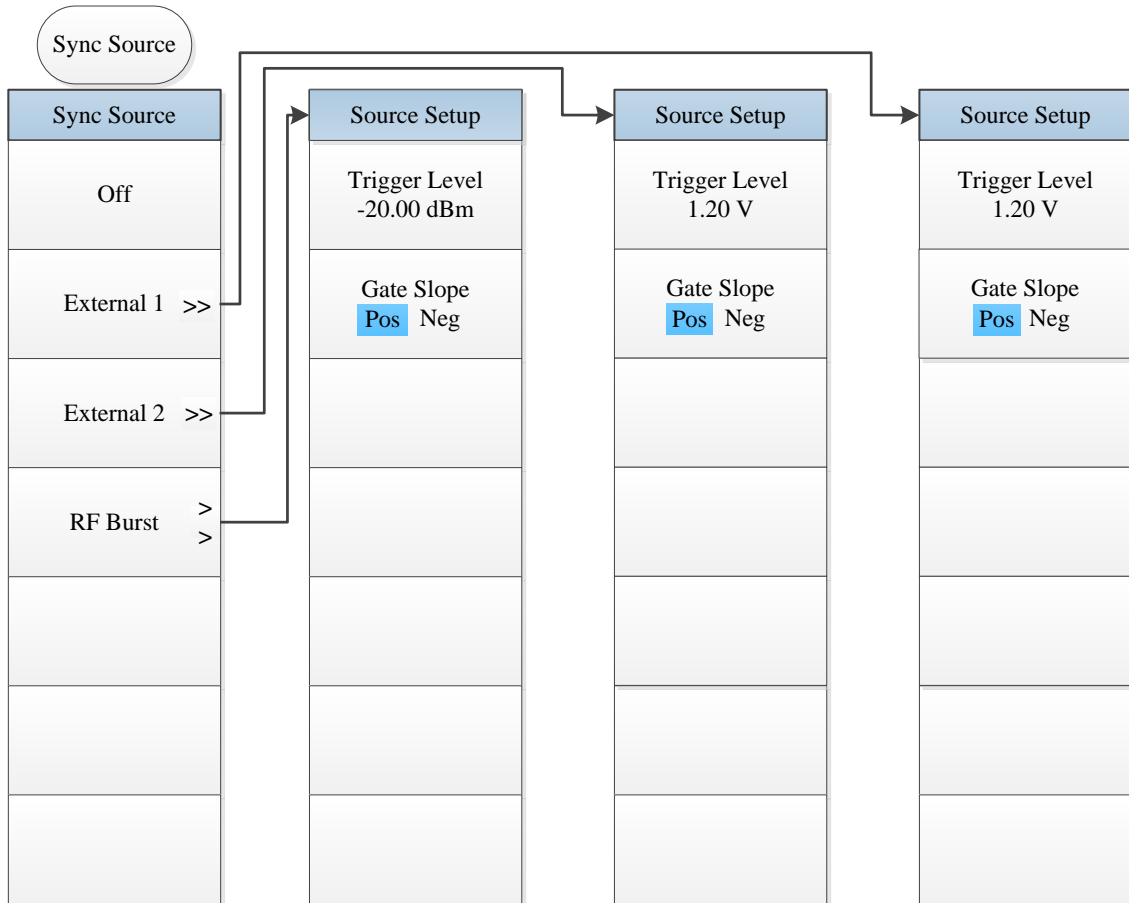
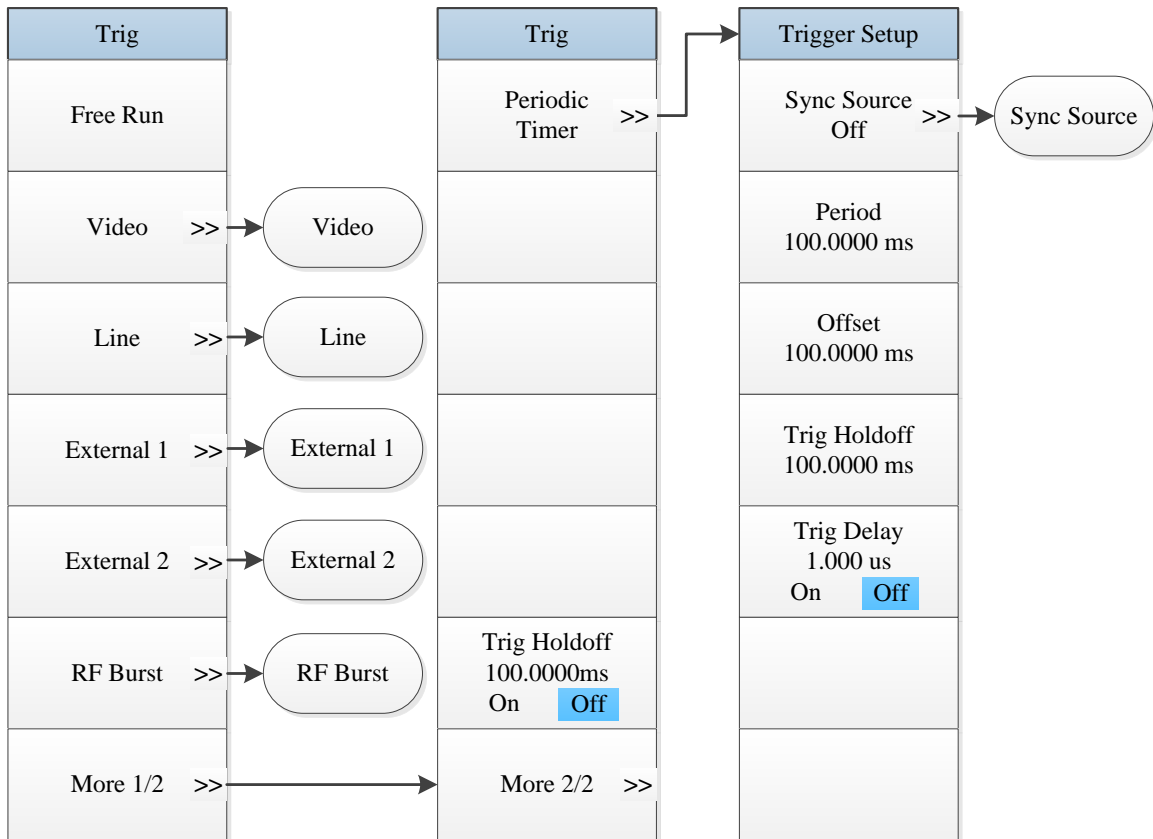

Fig. 5.2-5 Sweep Menu

5.1.2.6 Trigger



	RF Burst	External 2	External 1	Line	Video
	Trigger Setup	Trigger Setup	Trigger Setup	Trigger Setup	Trigger Setup
	Trigger Level -25.00 dBm	Trigger Level 1.2 V	Trigger Level 1.2 V		Trigger Level -25.00 dBm
	Trig Slope <input checked="" type="checkbox"/> Pos <input type="checkbox"/> Neg	Trig Slope <input checked="" type="checkbox"/> Pos <input type="checkbox"/> Neg	Trig Slope <input checked="" type="checkbox"/> Pos <input type="checkbox"/> Neg	Trig Slope <input checked="" type="checkbox"/> Pos <input type="checkbox"/> Neg	Trig Slope <input checked="" type="checkbox"/> Pos <input type="checkbox"/> Neg
	Trig Delay 100.00 ms <input type="checkbox"/> On <input checked="" type="checkbox"/> Off	Trig Delay 100.00 ms <input type="checkbox"/> On <input checked="" type="checkbox"/> Off	Trig Delay 100.00 ms <input type="checkbox"/> On <input checked="" type="checkbox"/> Off	Trig Delay 100.00 ms <input type="checkbox"/> On <input checked="" type="checkbox"/> Off	Trig Delay 100.00 ms <input type="checkbox"/> On <input checked="" type="checkbox"/> Off

5.1 Menu structure

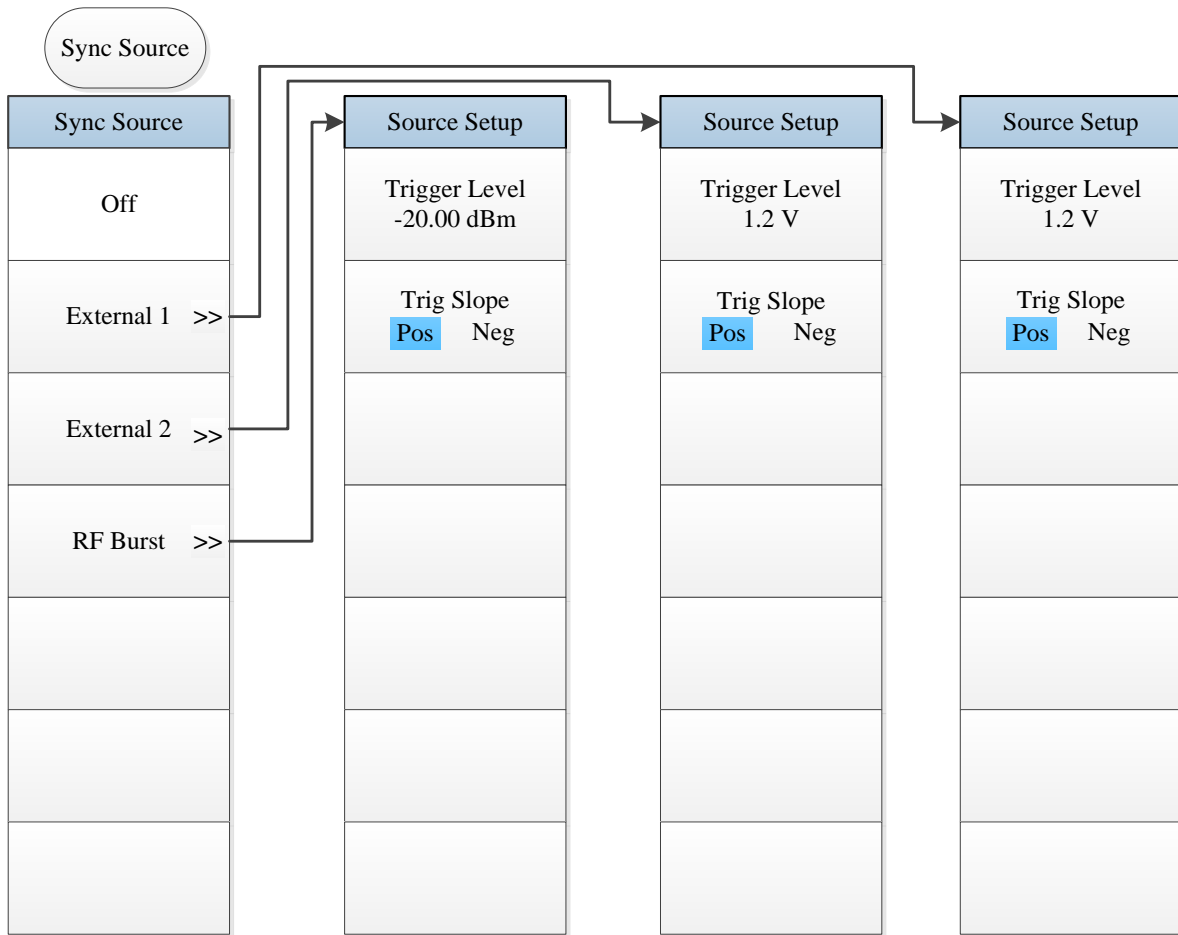

Fig. 5.2-6 Trigger Menu

5.1.2.7 Measurement

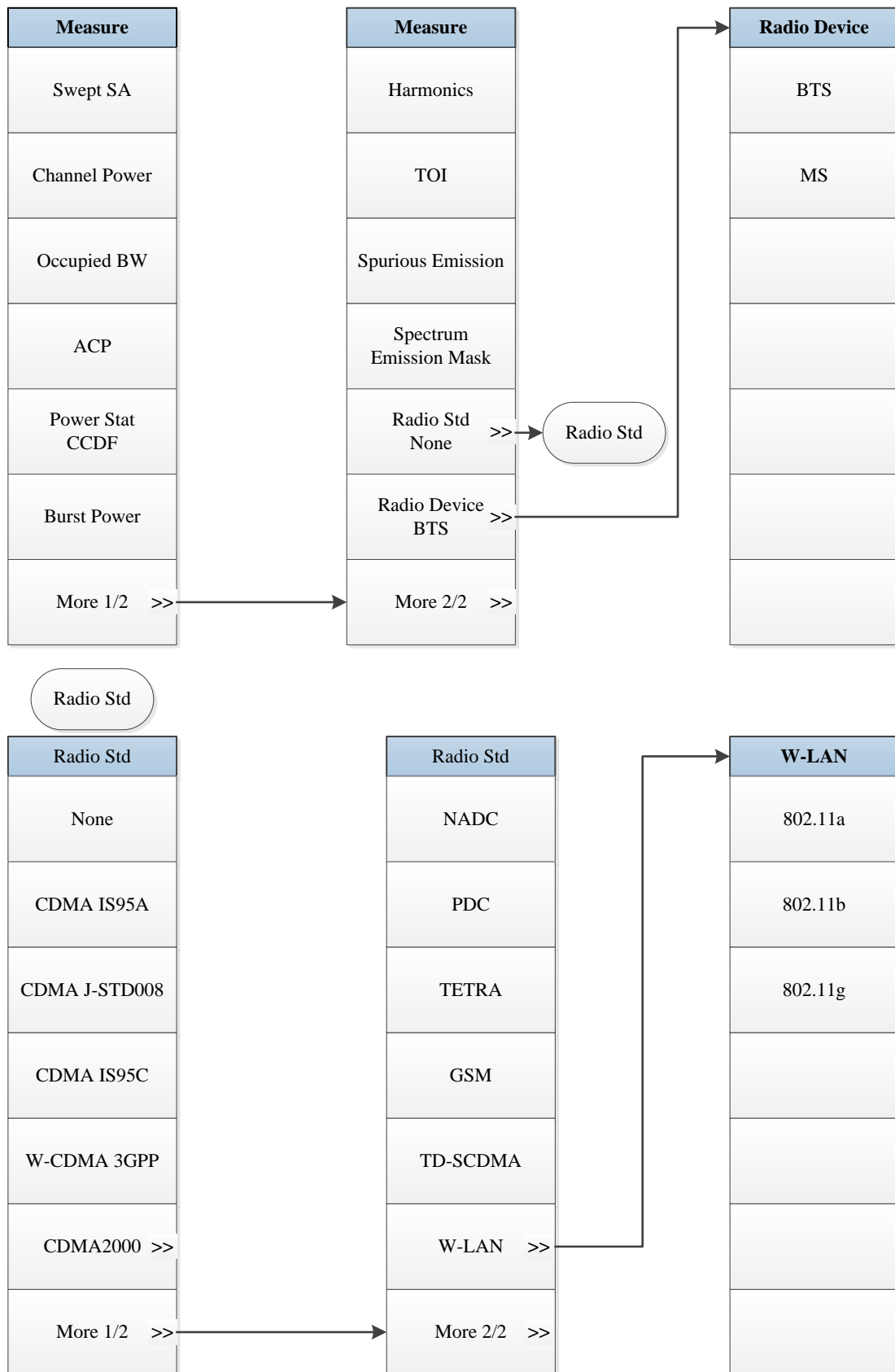
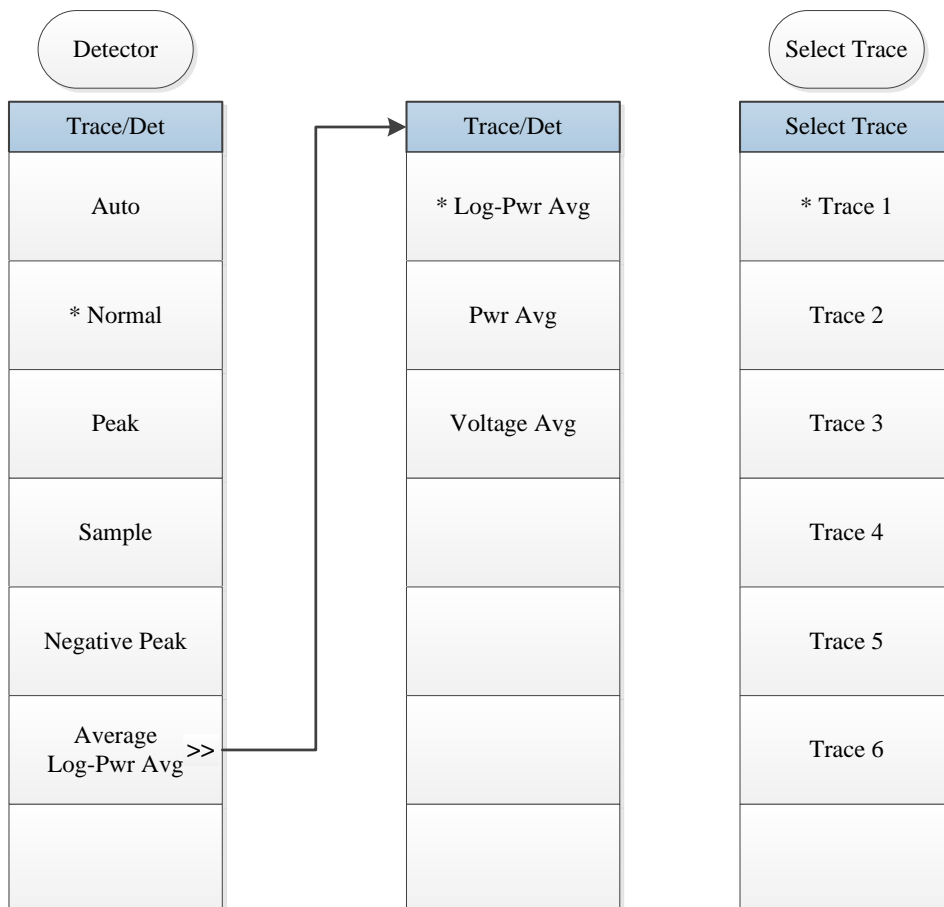
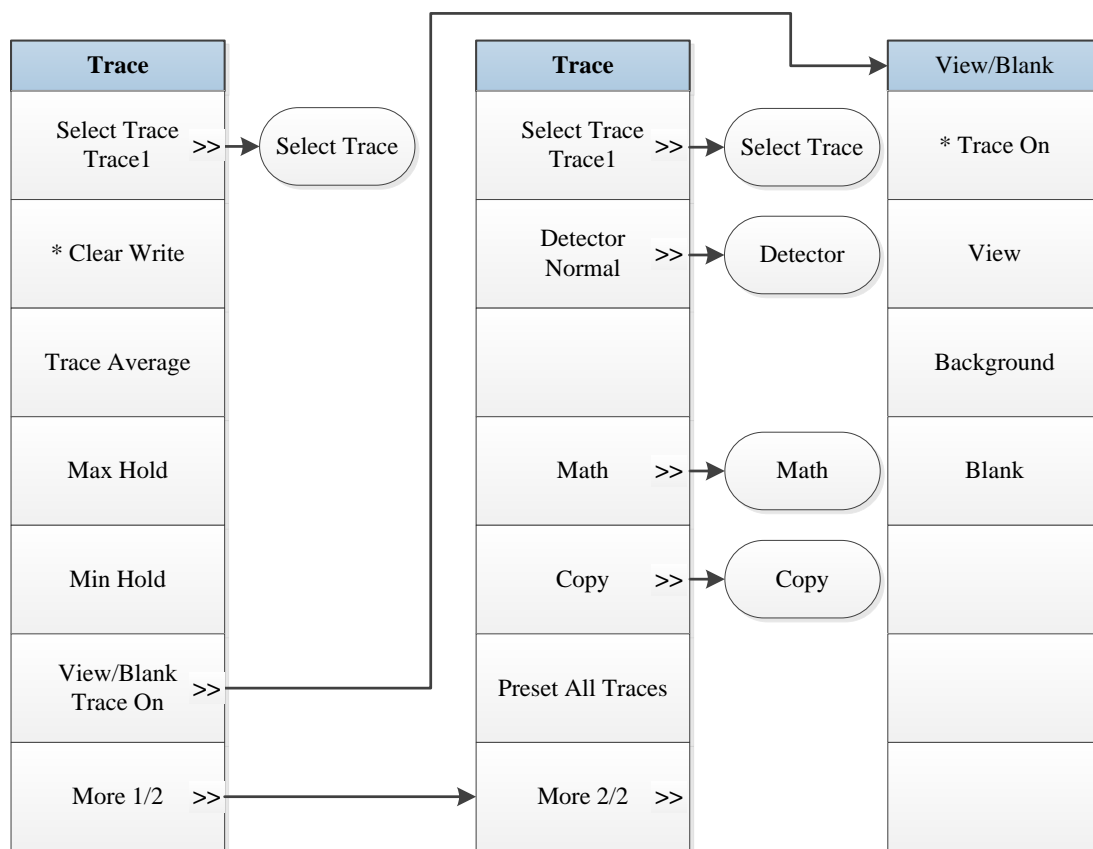

Fig. 5 2-7 Measurement Menu

5.1 Menu structure

5.1.2.8 Trace



5.1 Menu structure

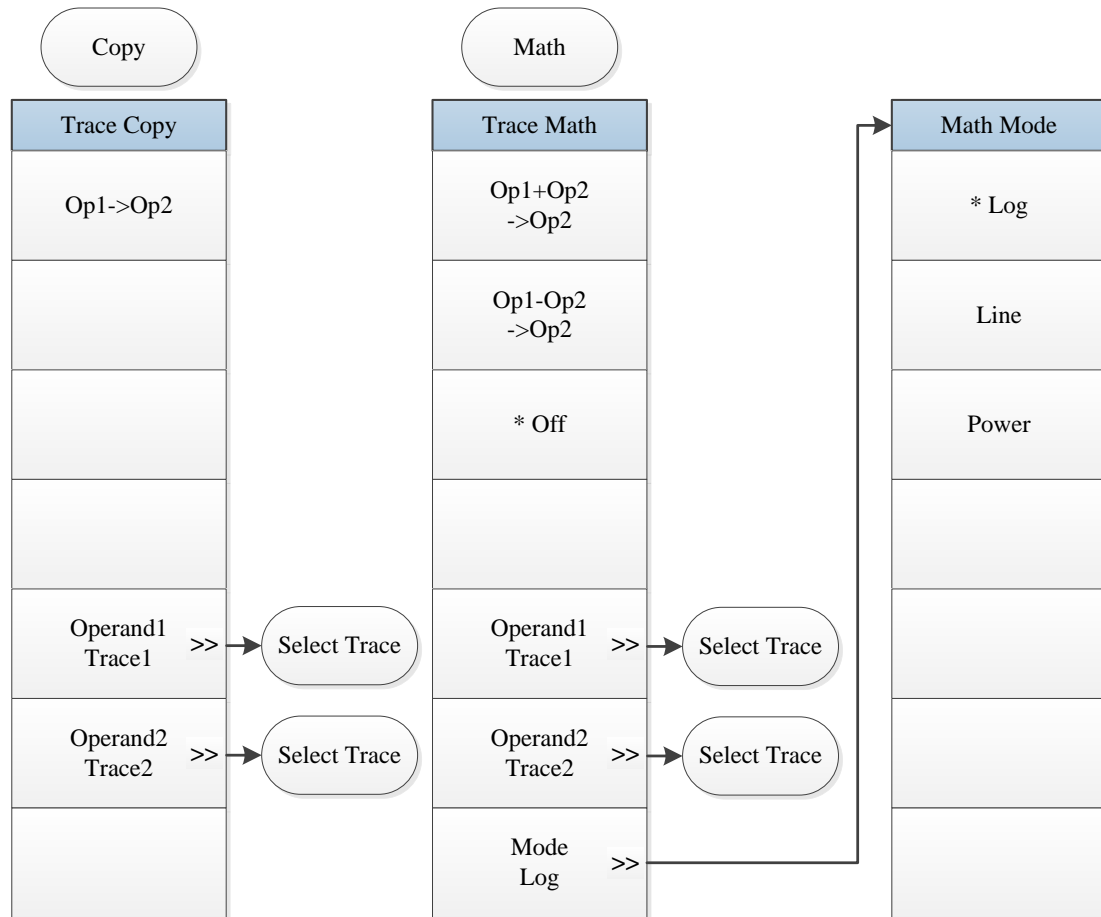
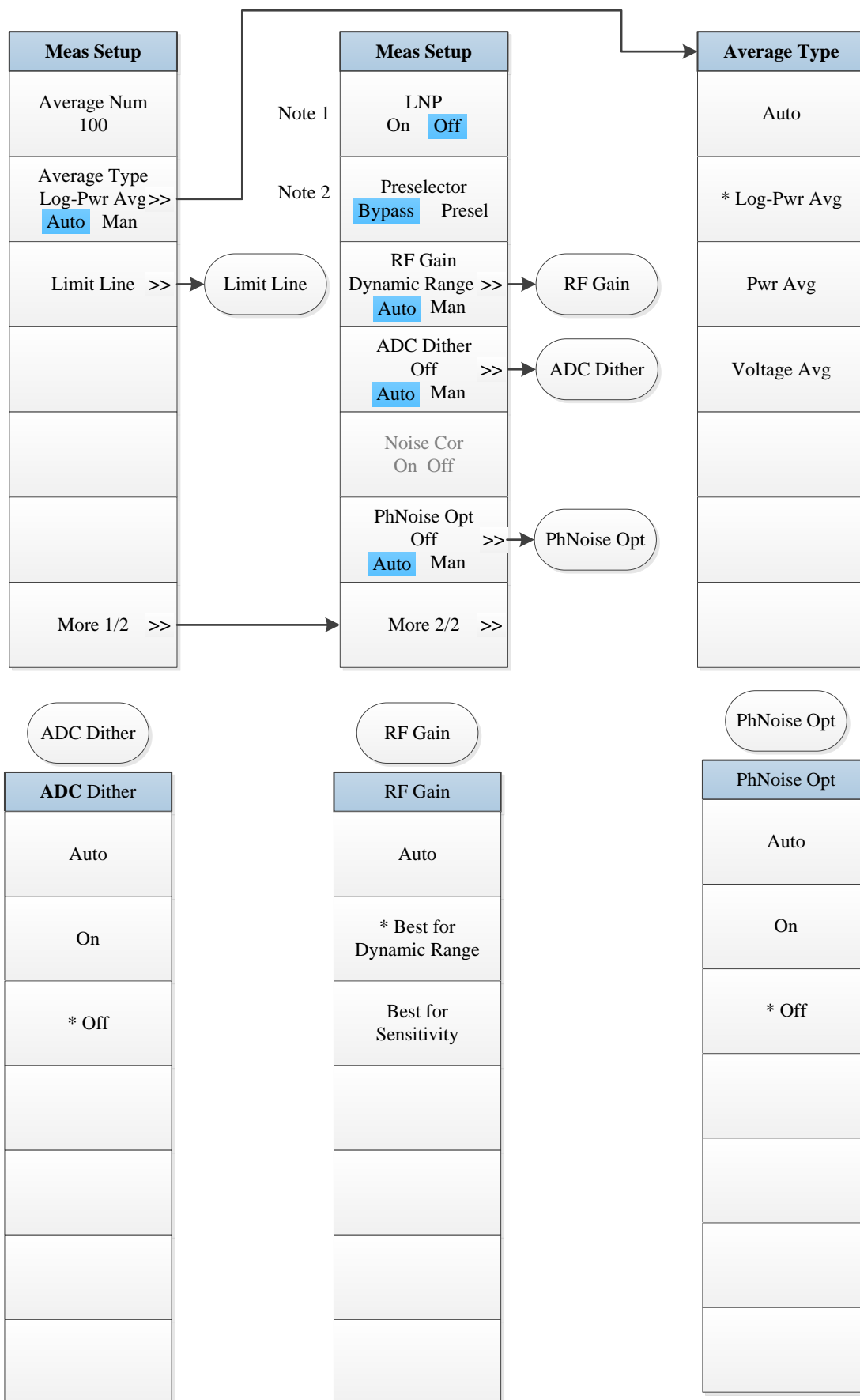

Fig. 5.2-8 Trace Menu

5.1 Menu structure

5.1.2.9 Measurement Setting



5.1 Menu structure

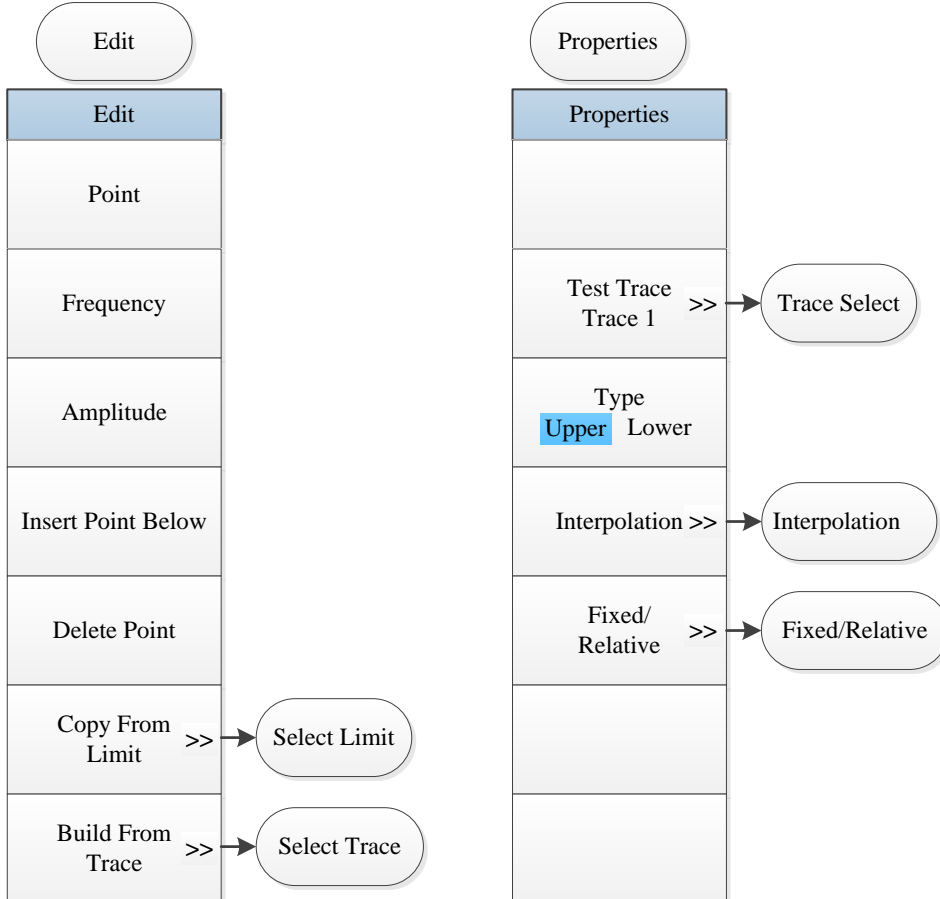
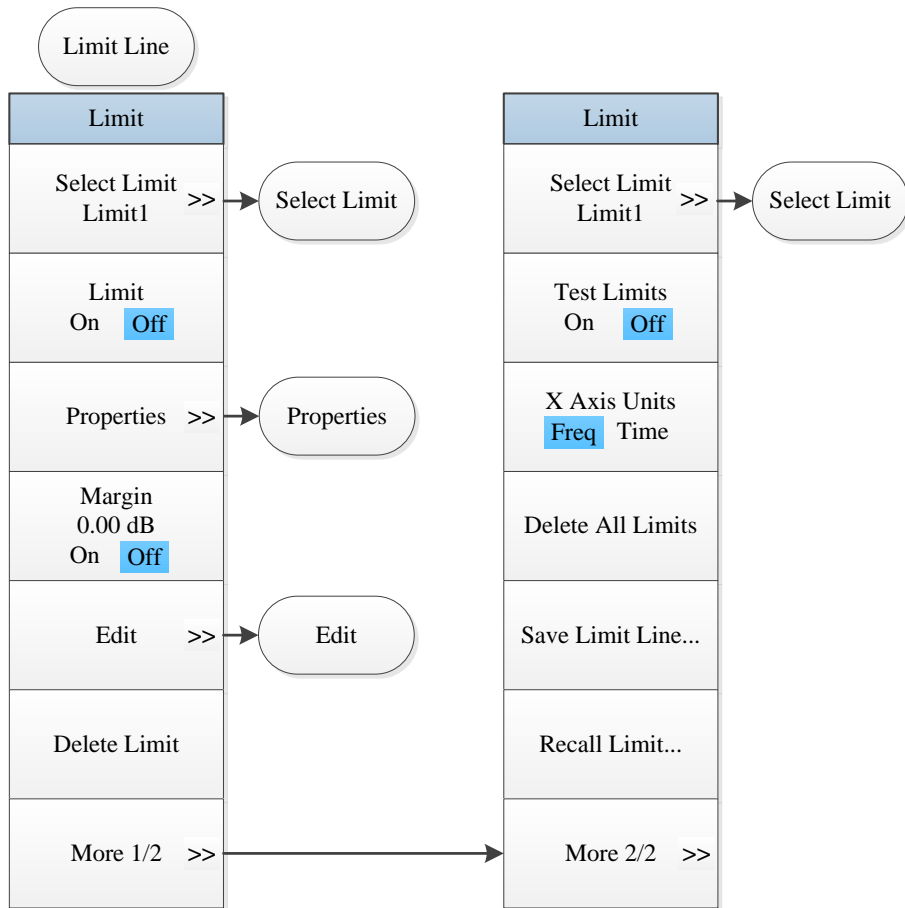

5.1 Menu structure

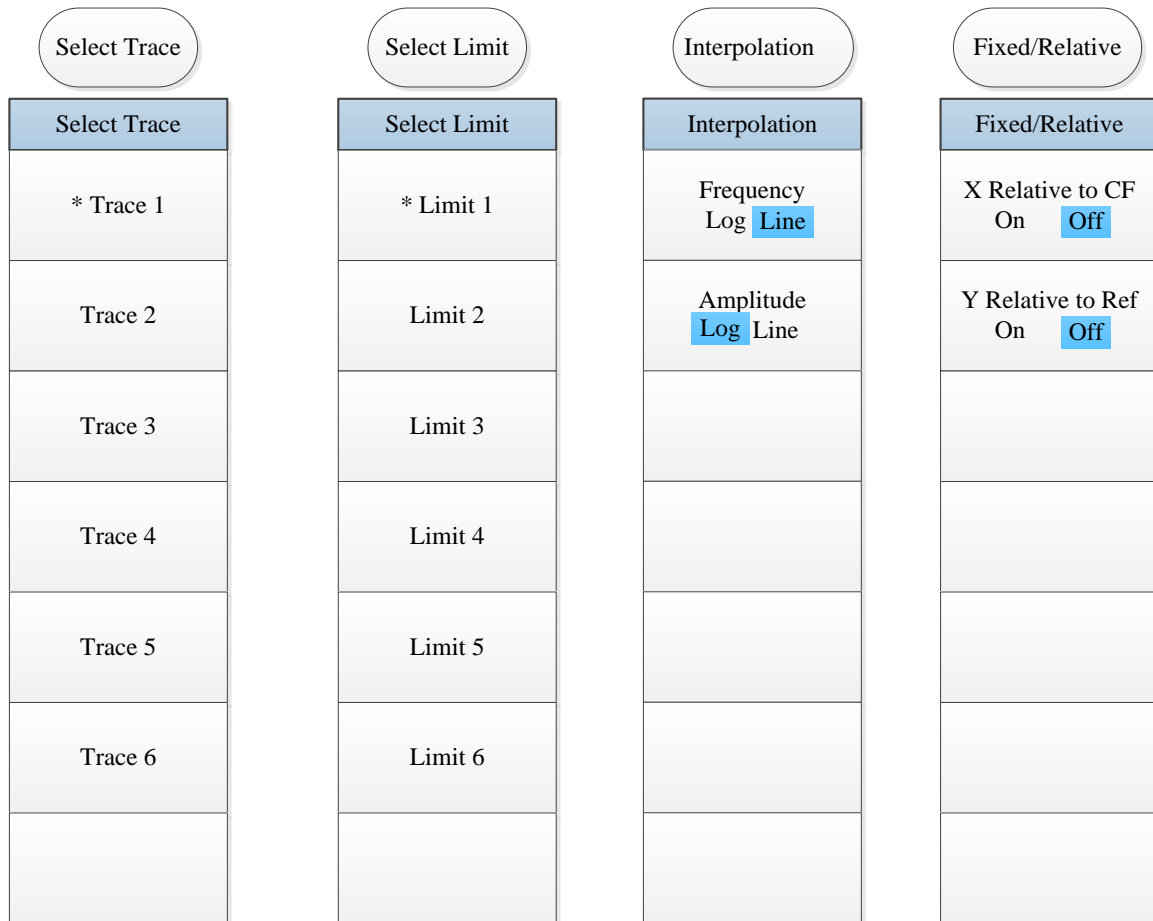

Note 1. this menu is only available when the H34 option (Low Noise PreAmplifier) is purchased. When the PreAmplifier is ON, the Low Noise Path is OFF and this menu is grayed out; when the PreAmplifier is OFF, this menu lights on and is switchable.

Note 2. this menu is only available when the H36 option (Preselector Bypass) is purchased.

Fig. 5.2-9 Measurement Setting Menu

5.1.2.10 Measurement Control

Fig. 5.2-10 Measurement Control Menu

5.1 Menu structure

5.1.2.11 Auto Setting

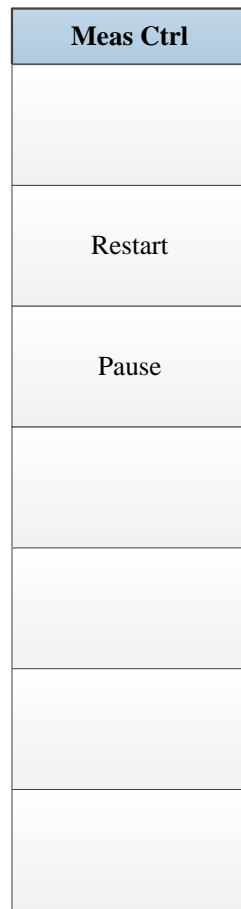

Fig. 5.2-11 Auto Setting Menu

5.1.2.12 Display

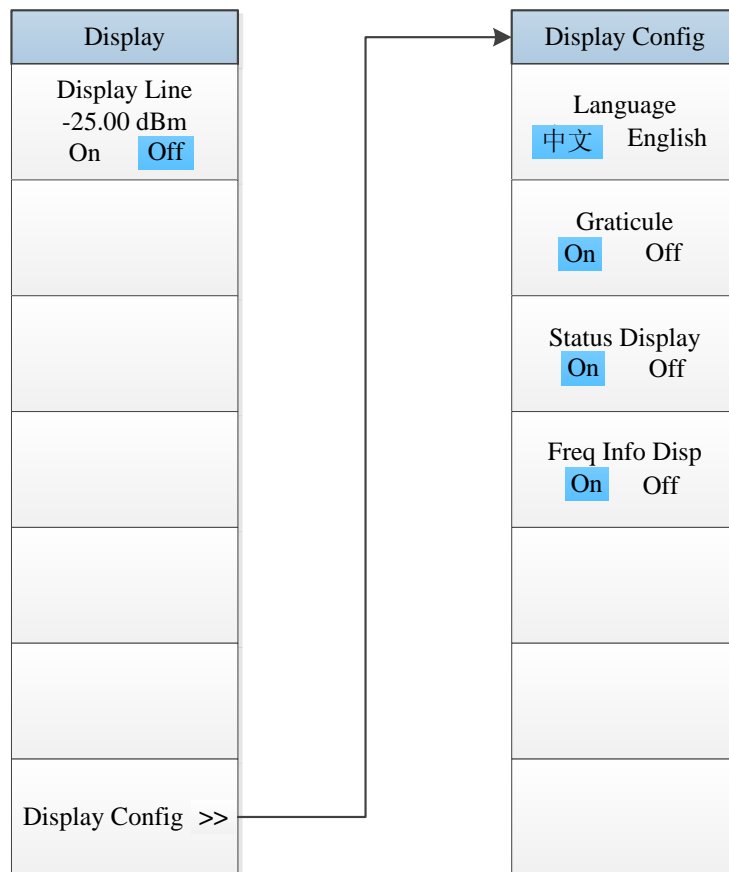
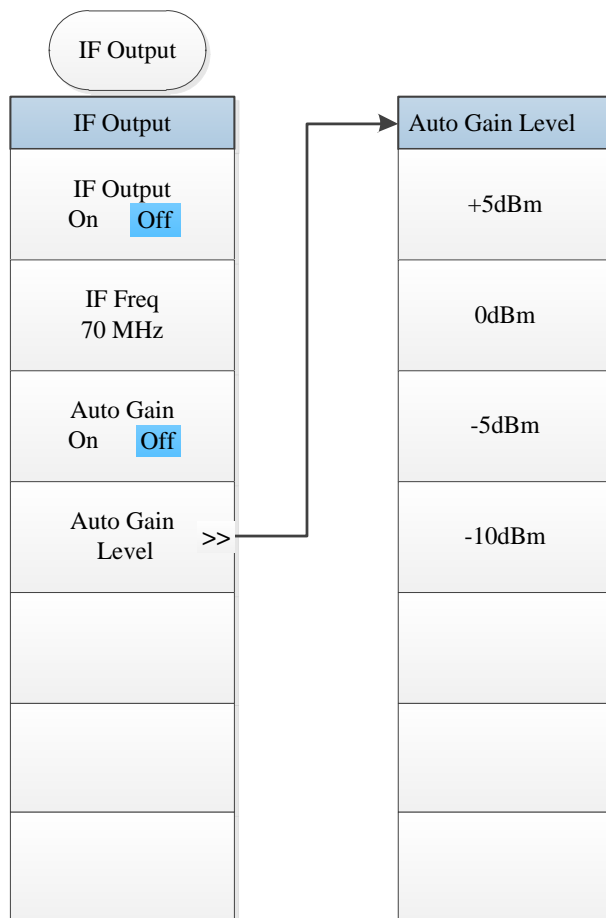
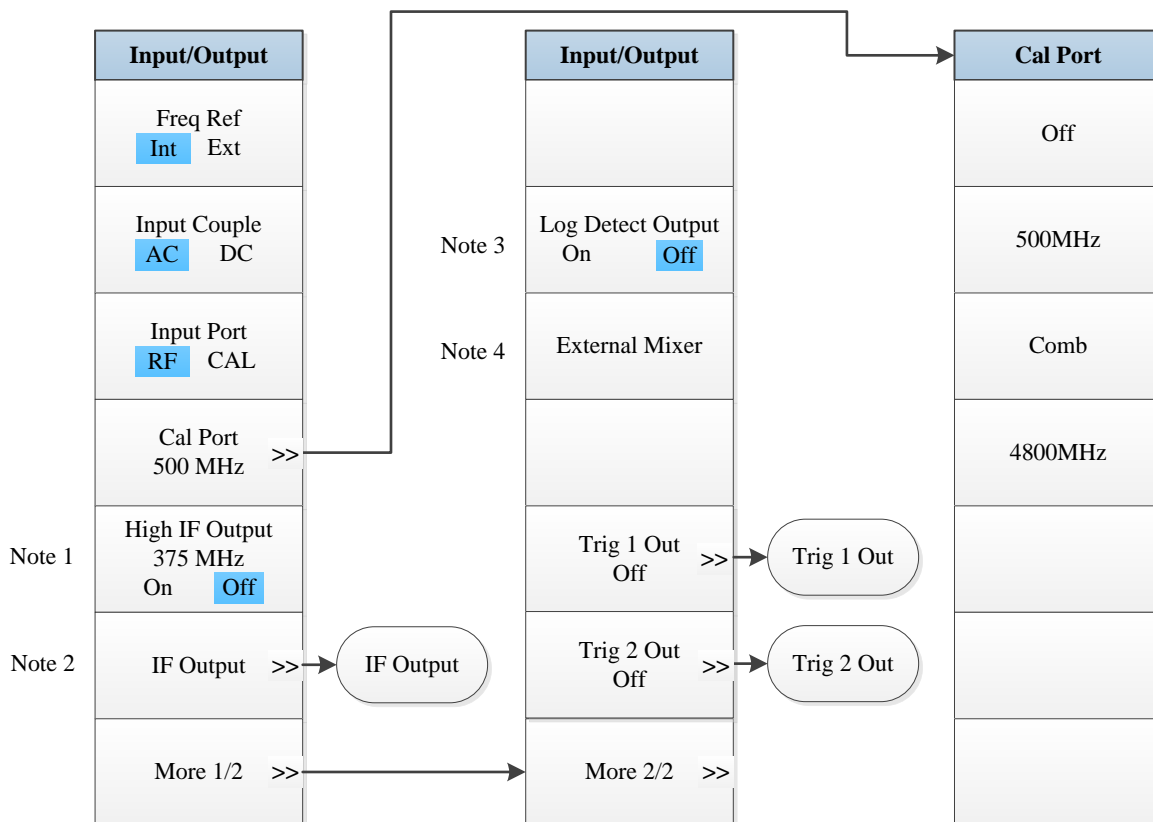

Fig. 5.2-12 Display Menu

5.1 Menu structure

5.1.2.13 Input/Output



5.1 Menu structure

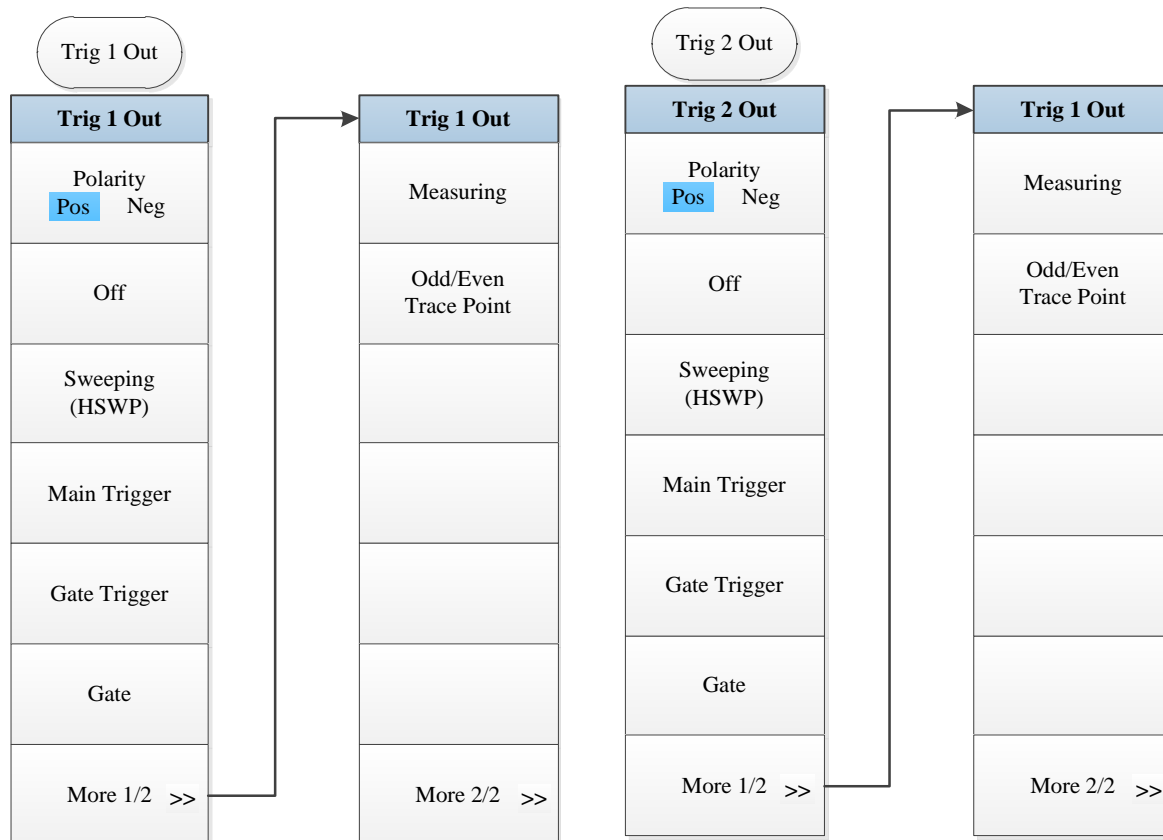

Note 1. this menu is only available when the H02 option (High IF Output) is purchased.

Note 2. this menu is only available when the H03 option (IF Output) is purchased.

Note 3. this menu is only available when the H08 option (Logarithmic Detector Output) is purchased.

Note 4. this menu is only available when the H40 option (MMV Spread Spectrum) is purchased.

Fig. 5.2-13 Input/Output Menu

5.1 Menu structure

5.1.2.14 Marker

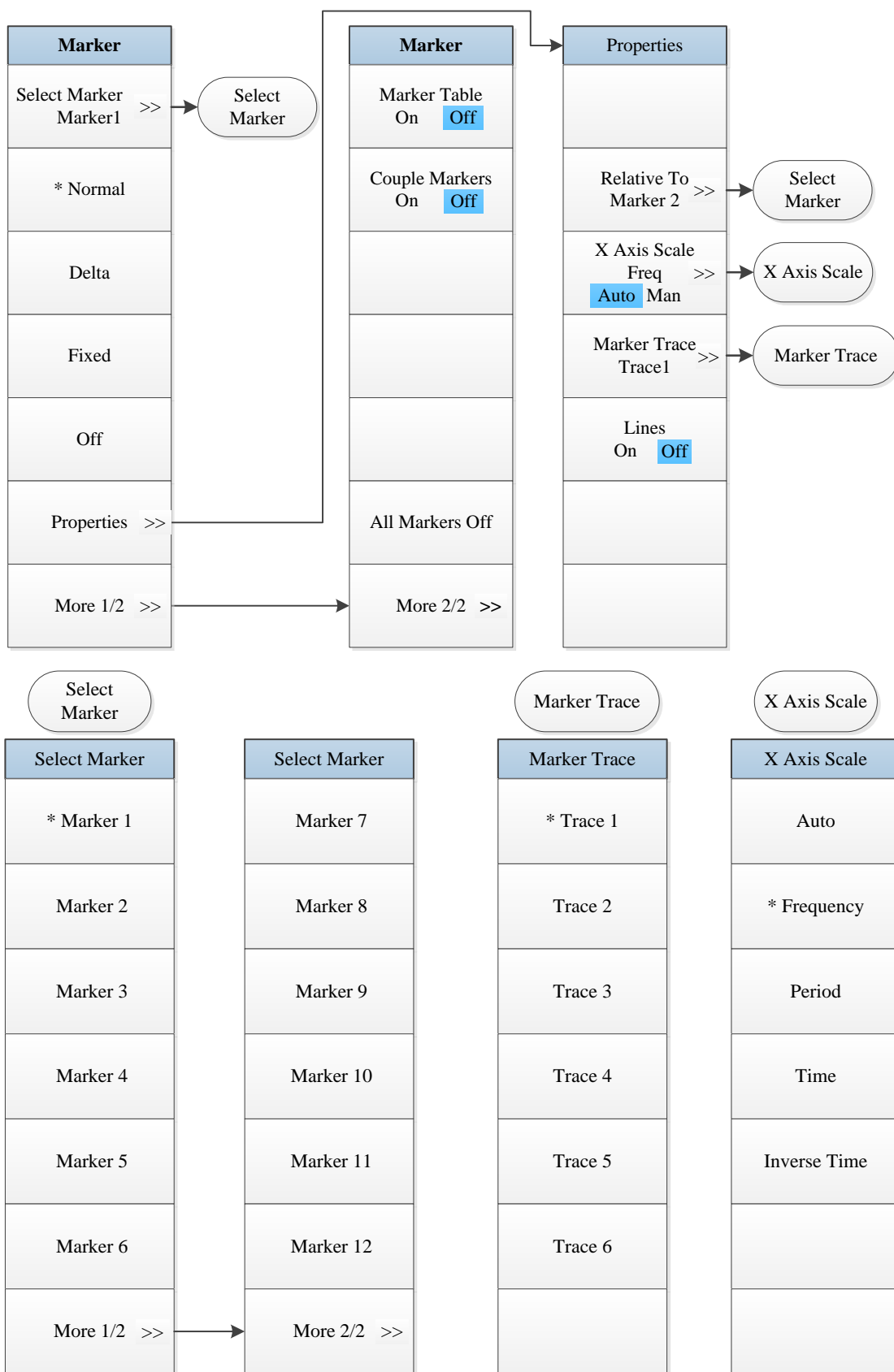

Fig. 5.2-14 Marker Menu

5.1.2.15 Marker->

Mkr->
Mkr->CF
Mkr->CF Step
Mkr->Start
Mkr->Stop
Mkr Delta->Span
Mkr Delta->CF
Mkr->Ref Level

Fig. 5.2-15 Marker->Menu

5.1 Menu structure

5.1.2.16 Marker Function

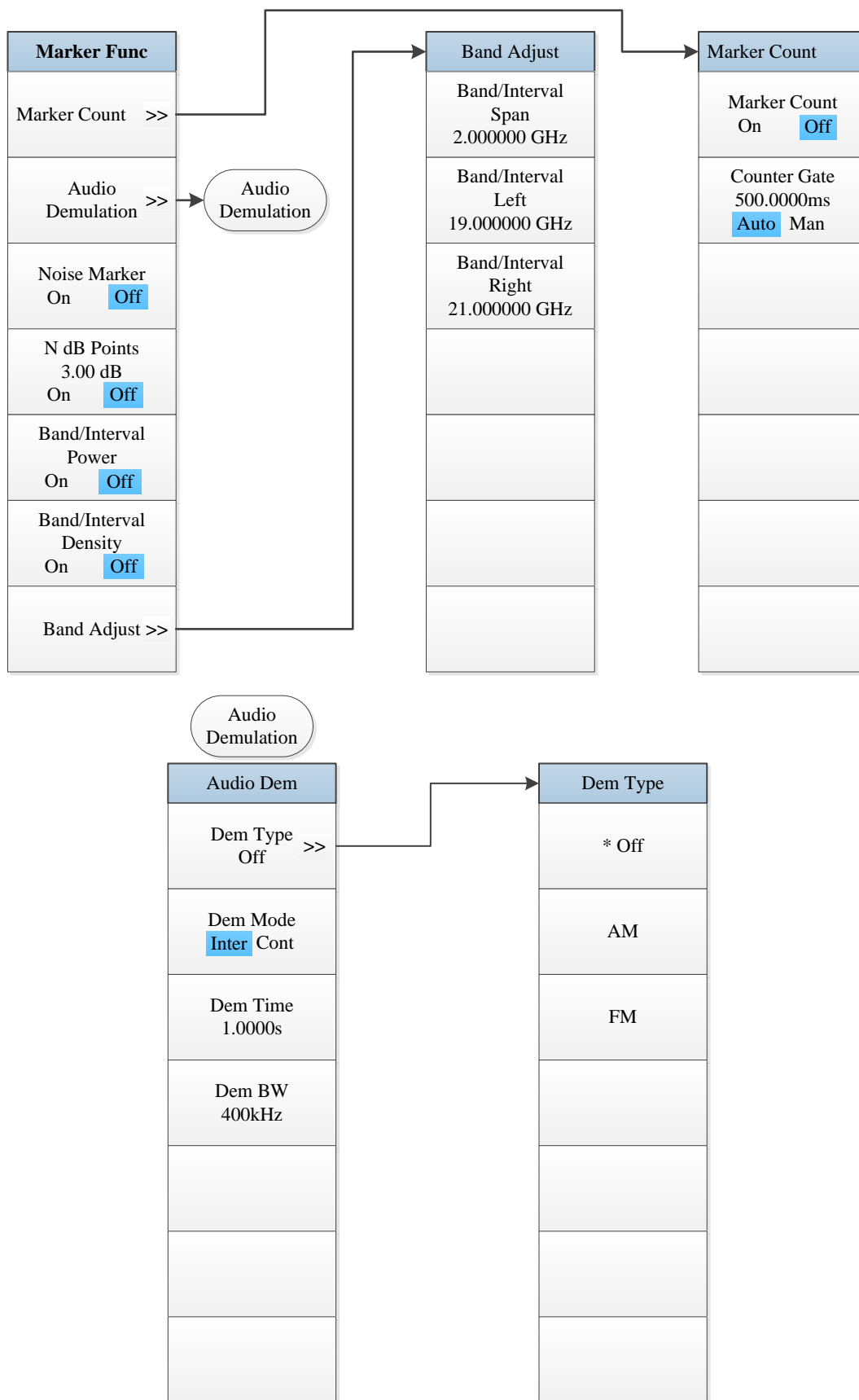

Fig. 5.2-16 Marker Function Menu

5.1.2.17 Peak Search

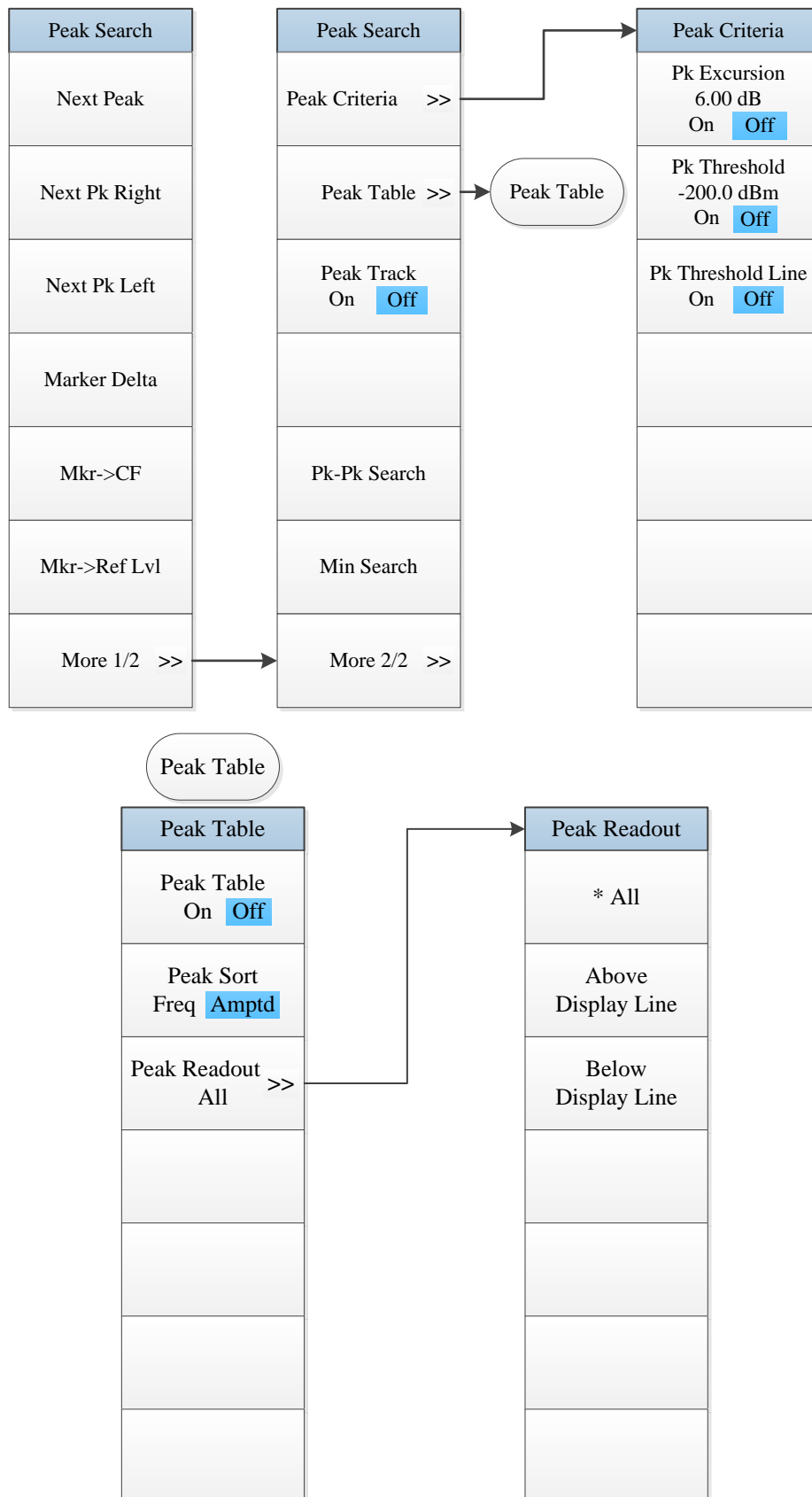

Fig. 5.2-17 Peak Search Menu

5.1 Menu structure

5.1.3 Channel power

5.1.3.1 Frequency

Frequency
Center Freq 13.250000 GHz
CF Step 10.0000MHz Auto Man
Freq Offset 0.000000 GHz

Fig. 5.3-1 Frequency Menu

5.1.3.2 Amplitude/Y Axis

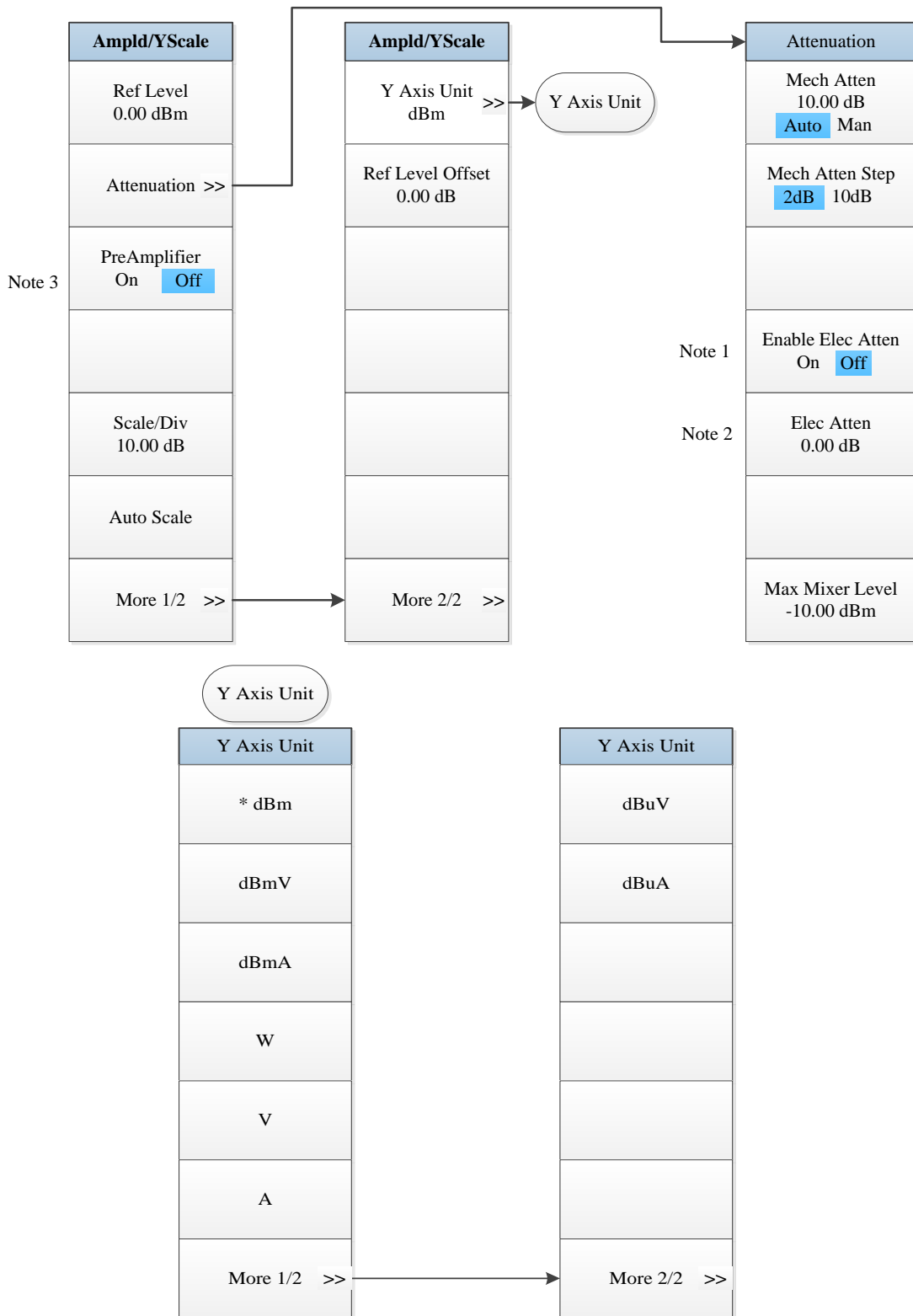

Note 1. this menu is only available when the H33 option (Elec Attenuator) is purchased.

Note 2. this menu is only available when the H33 option (Elec Attenuator) is purchased.

Note 3. this menu is only available when the H34 option (Low Noise PreAmplifier) is purchased.

Fig. 5.3-2 Amplitude/Y Axis Menu

5.1 Menu structure

5.1.3.3 Span/X Axis

Span
Span 3.000000 GHz
Full Span
Last Span

Fig. 5.3-3 Span Menu

5.1.3.4 Bandwidth

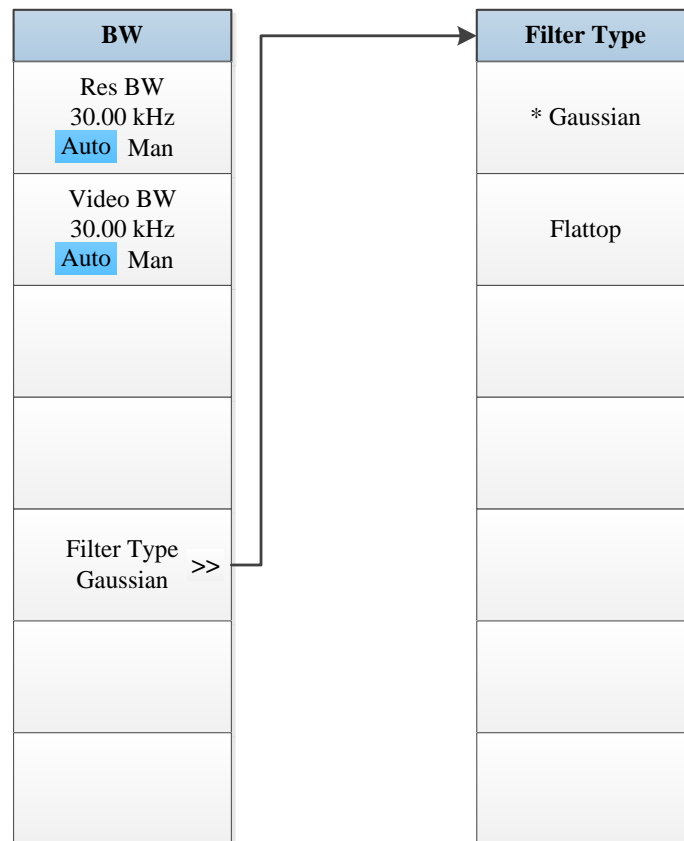

Fig. 5.3-4 Bandwidth Menu

5.1 Menu structure

5.1.3.5 Sweep

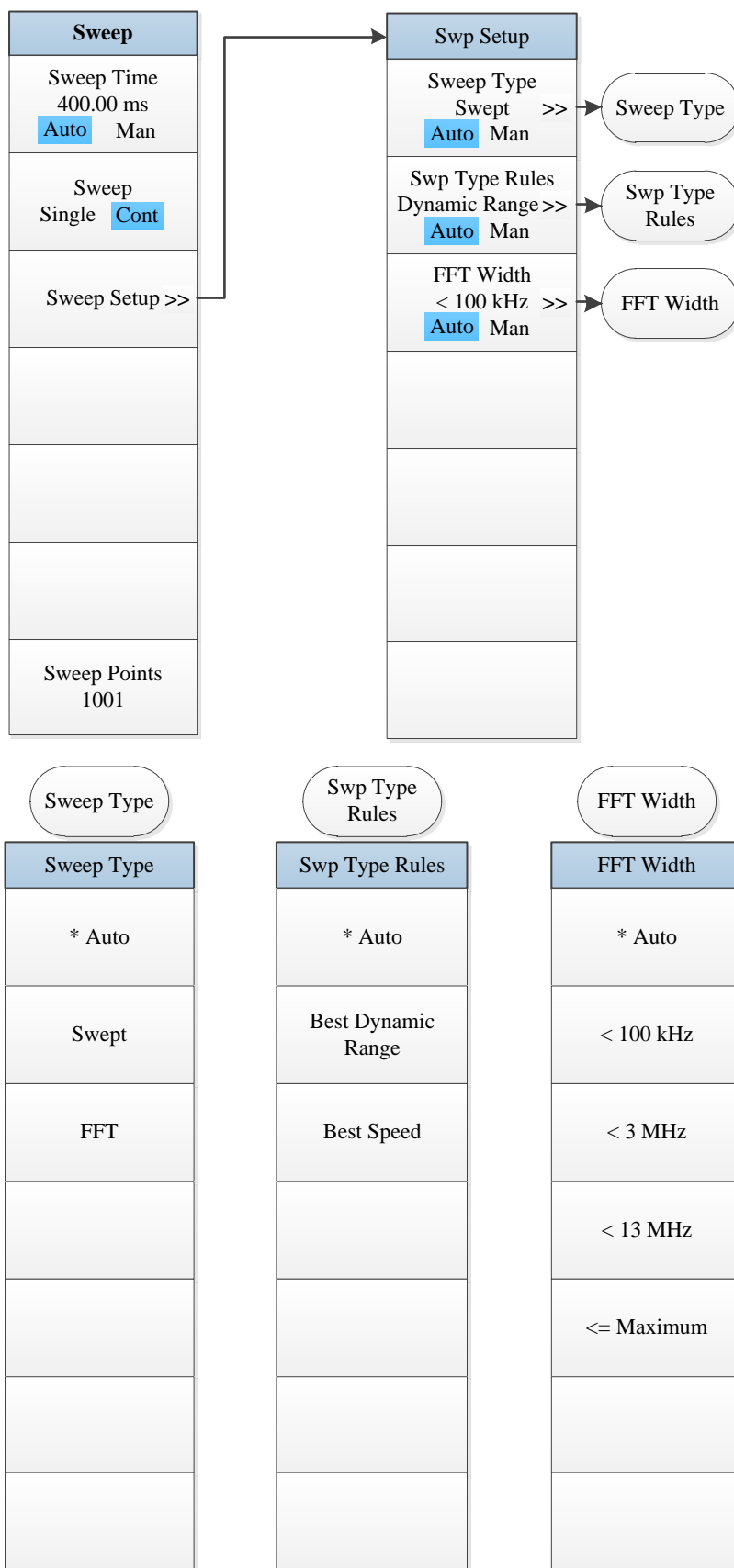
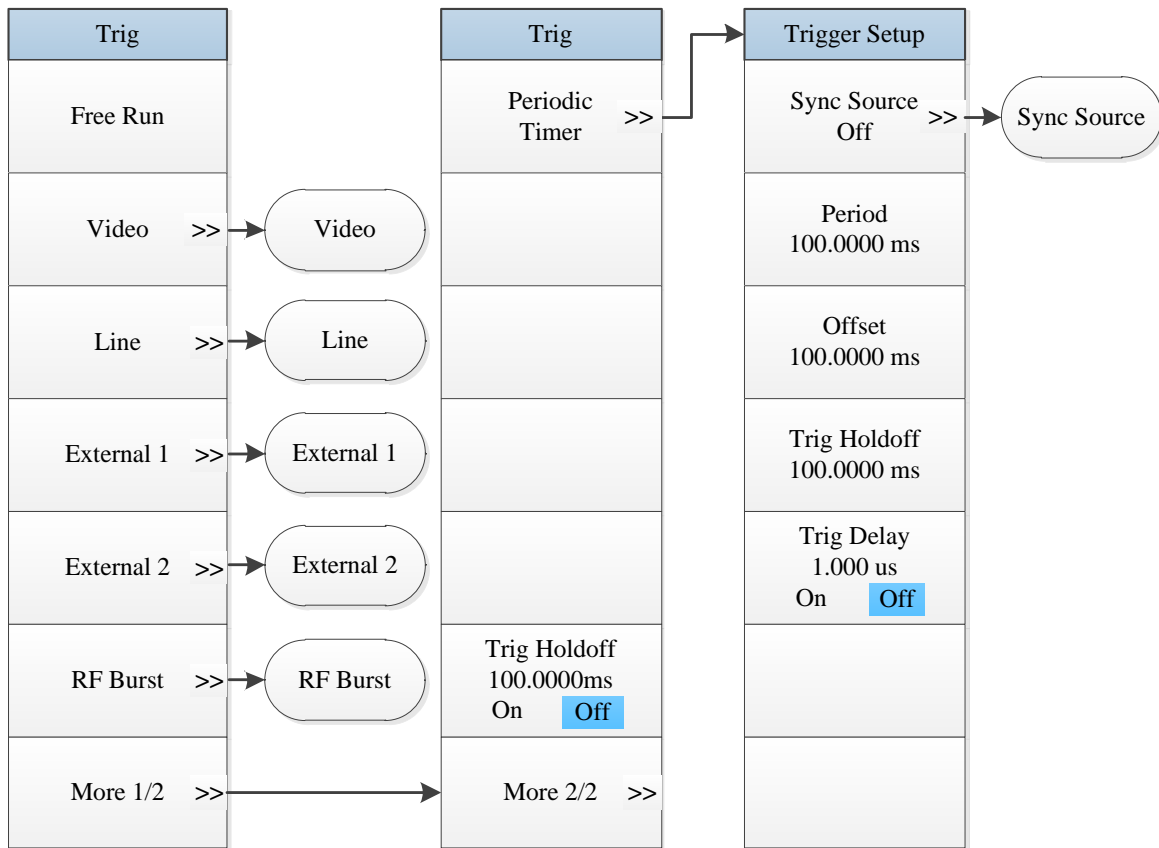

Fig. 5.3-5 Sweep Menu

5.1.3.6 Trigger



RF Burst	External 2	External 1	Line	Video
Trigger Setup	Trigger Setup	Trigger Setup	Trigger Setup	Trigger Setup
Trigger Level -25.00 dBm	Trigger Level 1.2 V	Trigger Level 1.2 V		Trigger Level -25.00 dBm
Trig Slope Pos Neg	Trig Slope Pos Neg	Trig Slope Pos Neg	Trig Slope Pos Neg	Trig Slope Pos Neg
Trig Delay 100.00 ms On Off	Trig Delay 100.00 ms On Off	Trig Delay 100.00 ms On Off	Trig Delay 100.00 ms On Off	Trig Delay 100.00 ms On Off

5.1 Menu structure

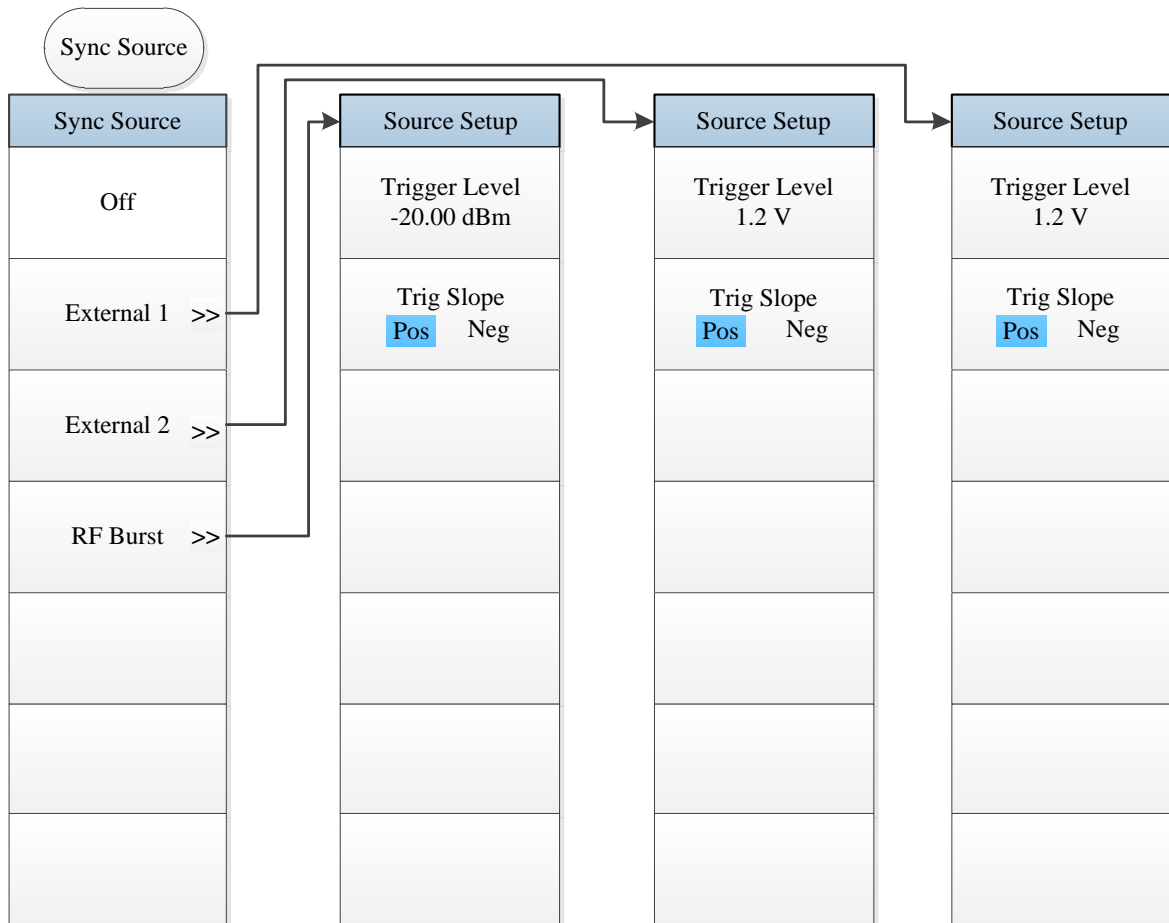

Fig. 5 3-6 Trigger Menu

5.1.3.7 Trace

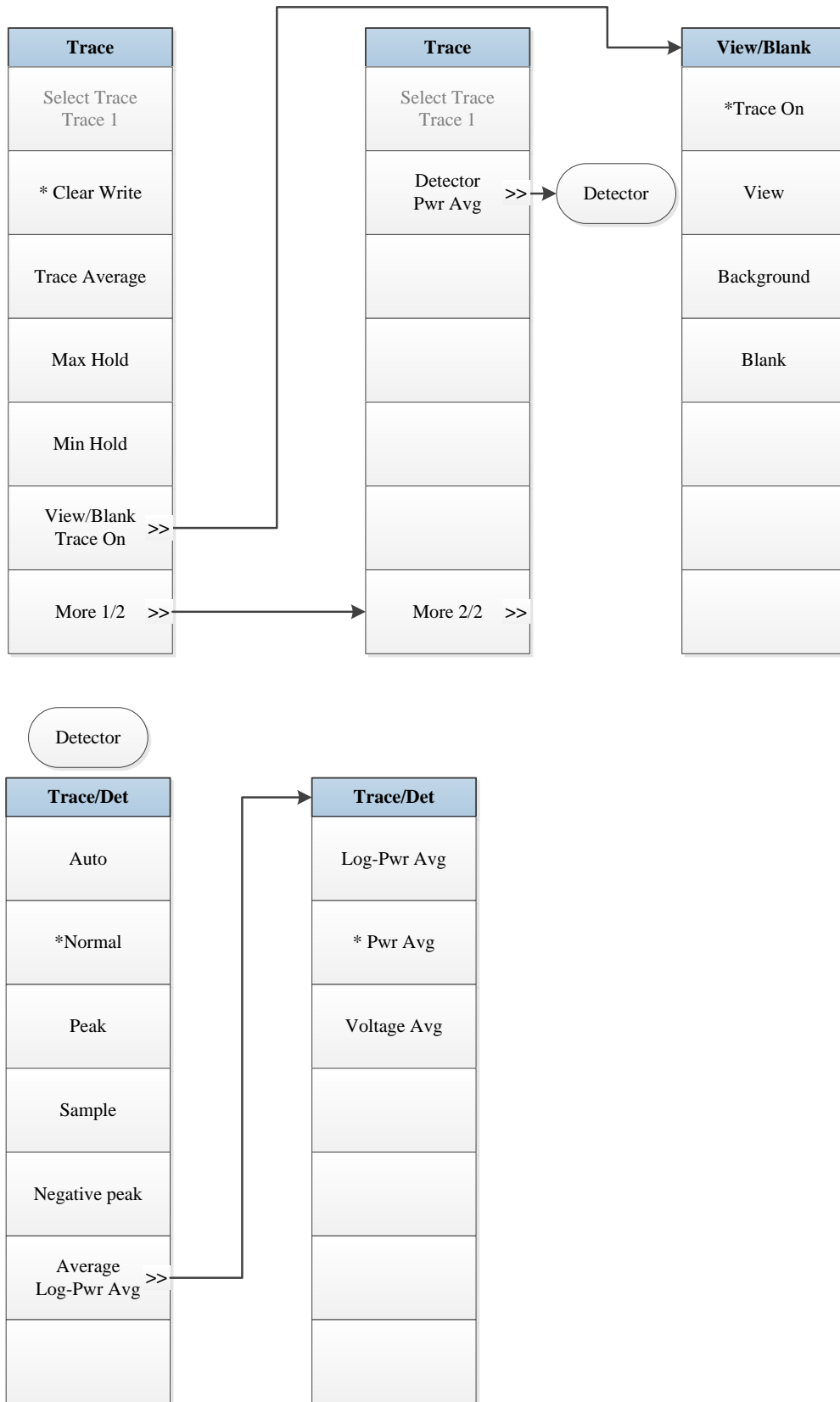
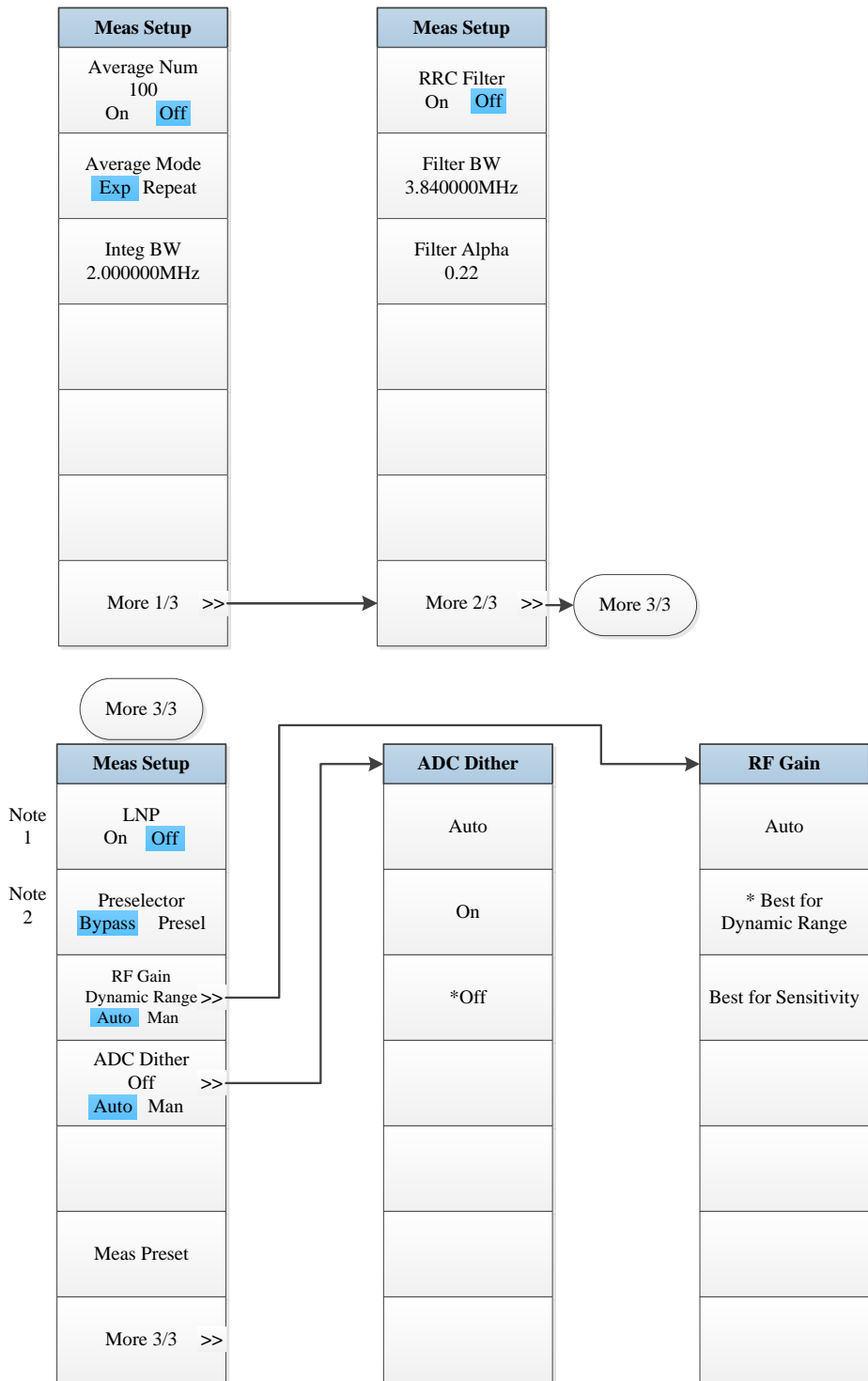

Fig. 5.3-7 Trace Menu

5.1 Menu structure

5.1.3.8 Measurement Setting



Note 1. this menu is only available when the H34 option (Low Noise PreAmplifier) is purchased. When the PreAmplifier is ON, the Low Noise Path is OFF and this menu is grayed out; when the PreAmplifier is OFF, this menu lights on and is switchable.

Note 2. this menu is only available when the H36 option (Preselector Bypass) is purchased.

Fig. 5.3-8 Measurement Setting Menu

5.1.3.9 Measurement Control

Meas Control
Measure Single Cont
Restart
Pause/Resume

Fig. 5.3-9 Measurement Control Menu

5.1 Menu structure

5.1.3.10 Auto Setting

Auto Set
Couple All
Mech Atten 10.00 dB Auto Man
Res BW 30.000kHz Auto Man
Video BW 30.000KHz Auto Man
Sweep time 80.0000 ms Auto Man
CF Step 10.000MHz Auto Man

Fig. 5 3-10 Auto Setting Menu

5.1.3.11 Display

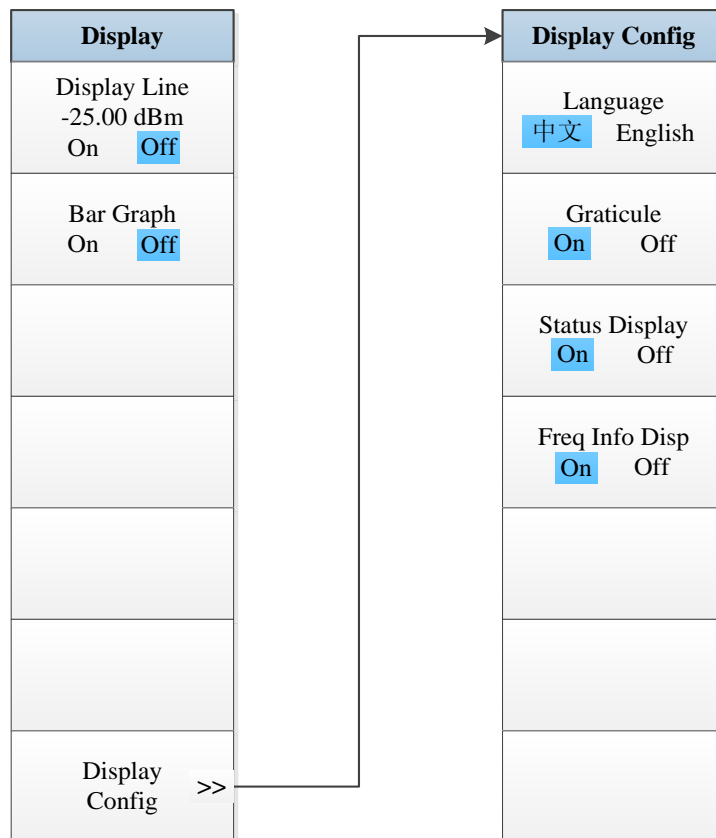

Fig. 5.3-11 Display Menu

5.1 Menu structure

5.1.3.12 Marker

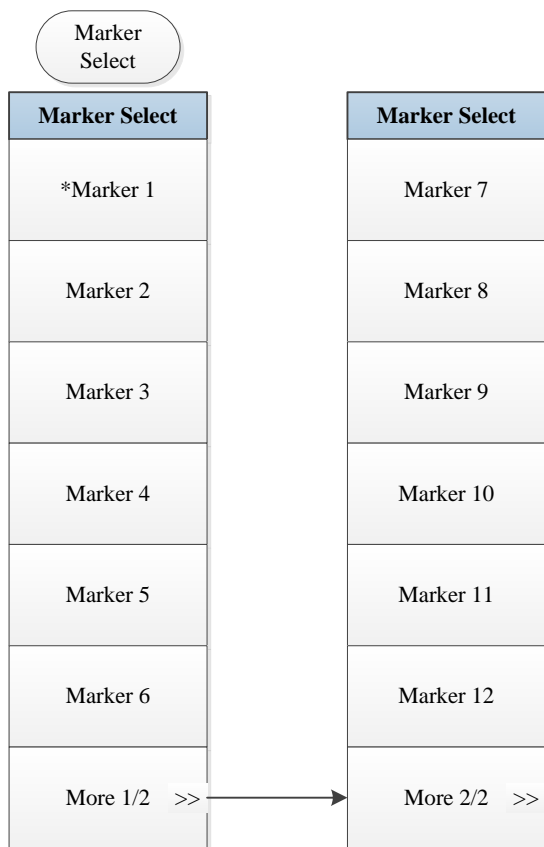
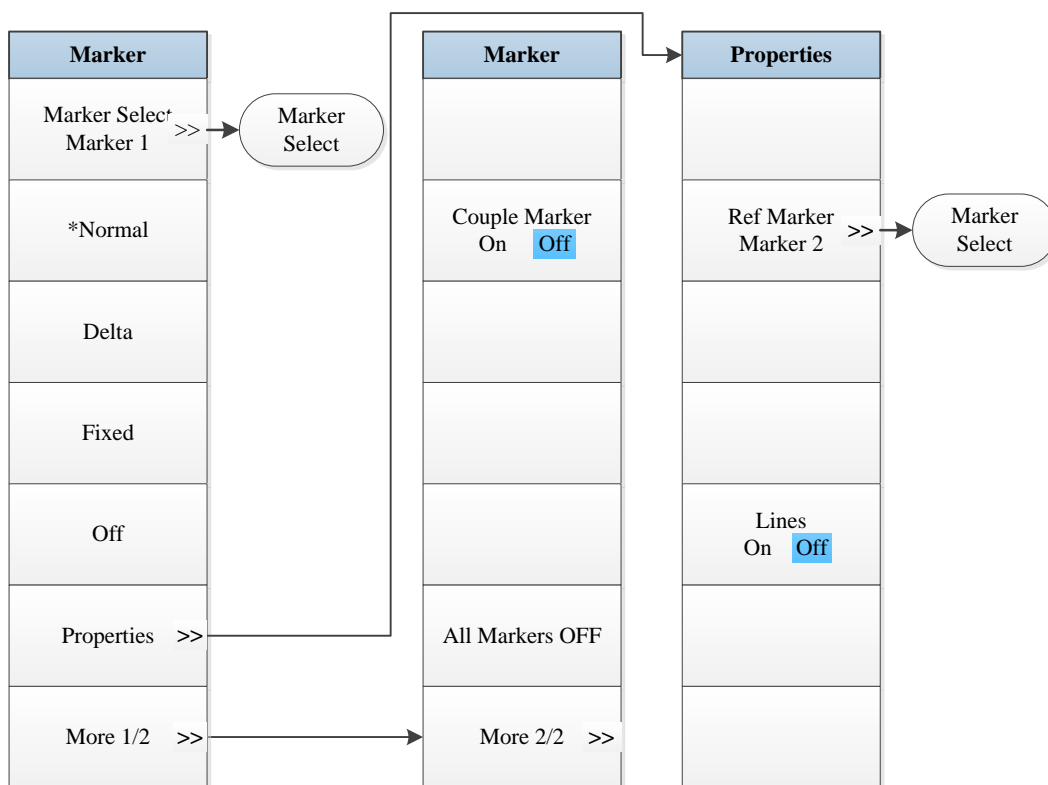

Fig. 5.3-12 Marker Menu

5.1.3.13 Maker->



Fig. 5.3-13 Marker->Menu

5.1 Menu structure

5.1.3.14 Marker Function

Marker Func

Fig. 5.3-14 Marker Function Menu

5.1.3.15 Peak Search

Peak Search
Next peak
Next pk Right
Next Pk Left

Fig. 5.3-15 Peak Search Menu

5.1 Menu structure

5.1.4 Occupied Bandwidth

5.1.4.1 Frequency

Frequency
Center Freq 13.250000 GHz
CF step 10.0000MHz <input checked="" type="radio"/> Auto <input type="radio"/> Man
Freq Offset 0.000000 GHz

Fig. 5.4-1 Frequency Menu

5.1.4.2 Amplitude/Y Axis

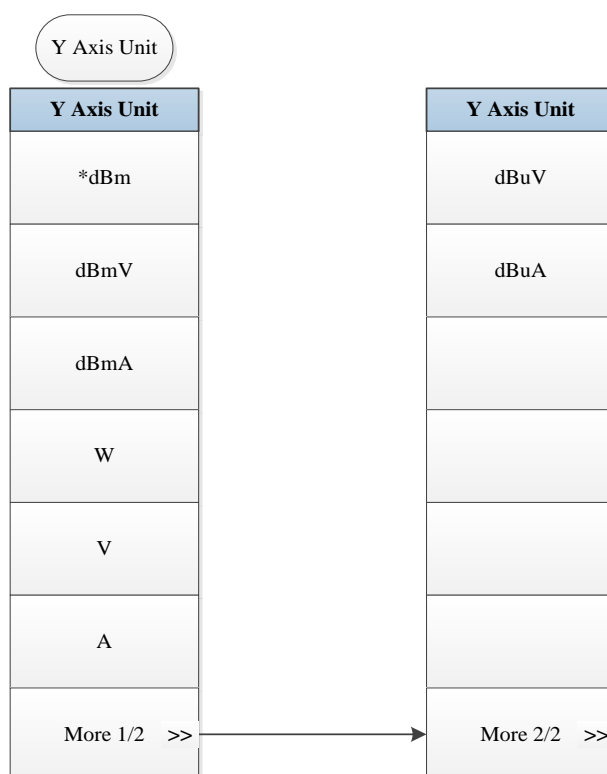
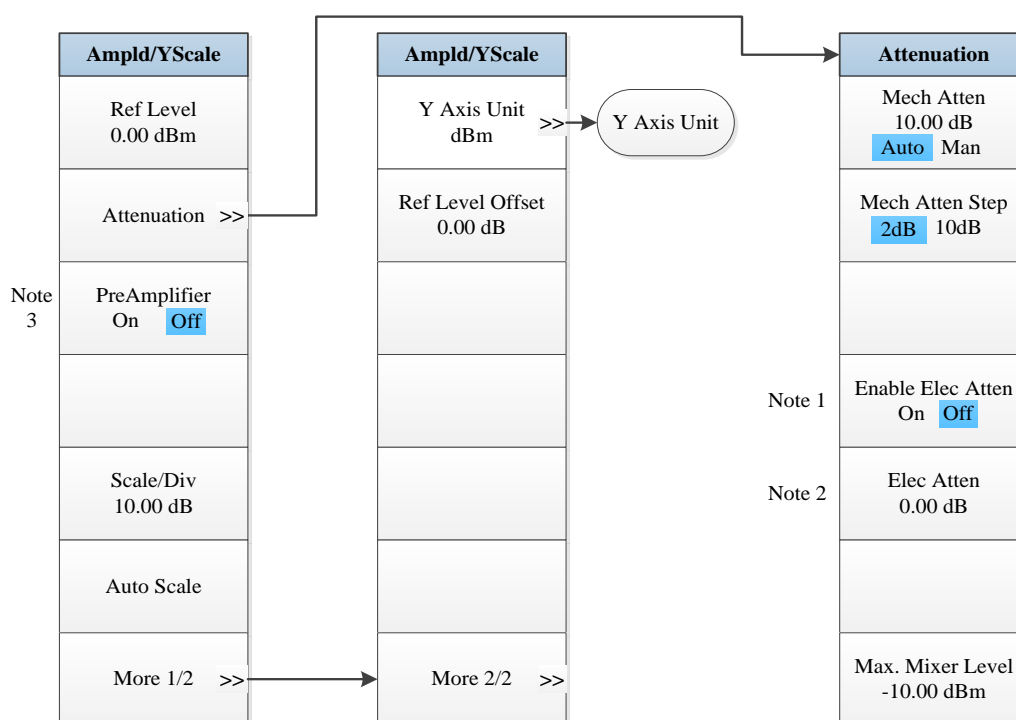

Note 1. this menu is only available when the H33 option (Elec Attenuator) is purchased.

Note 2. this menu is only available when the H33 option (Elec Attenuator) is purchased.

Note 3. this menu is only available when the H34 option (Low Noise PreAmplifier) is purchased.

Fig. 5.4-2 Amplitude/Y Axis Menu

5.1 Menu structure

5.1.4.3 Span/X Axis

Span
Span 3.000000 MHz
Full Span
Last Span

Fig. 5.4-3 Span Menu

5.1.4.4 Bandwidth

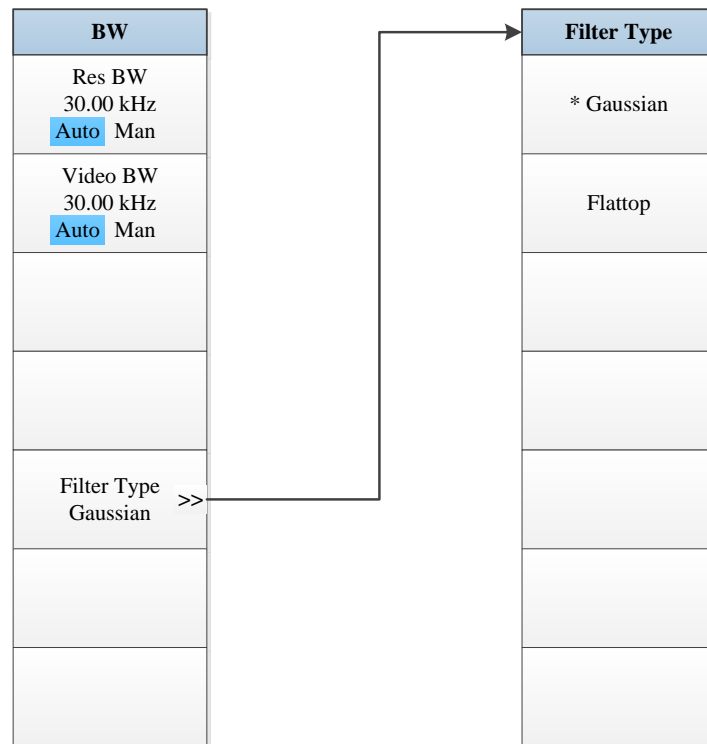

Fig. 5.4-4 Bandwidth Menu

5.1 Menu structure

5.1.4.5 Sweep

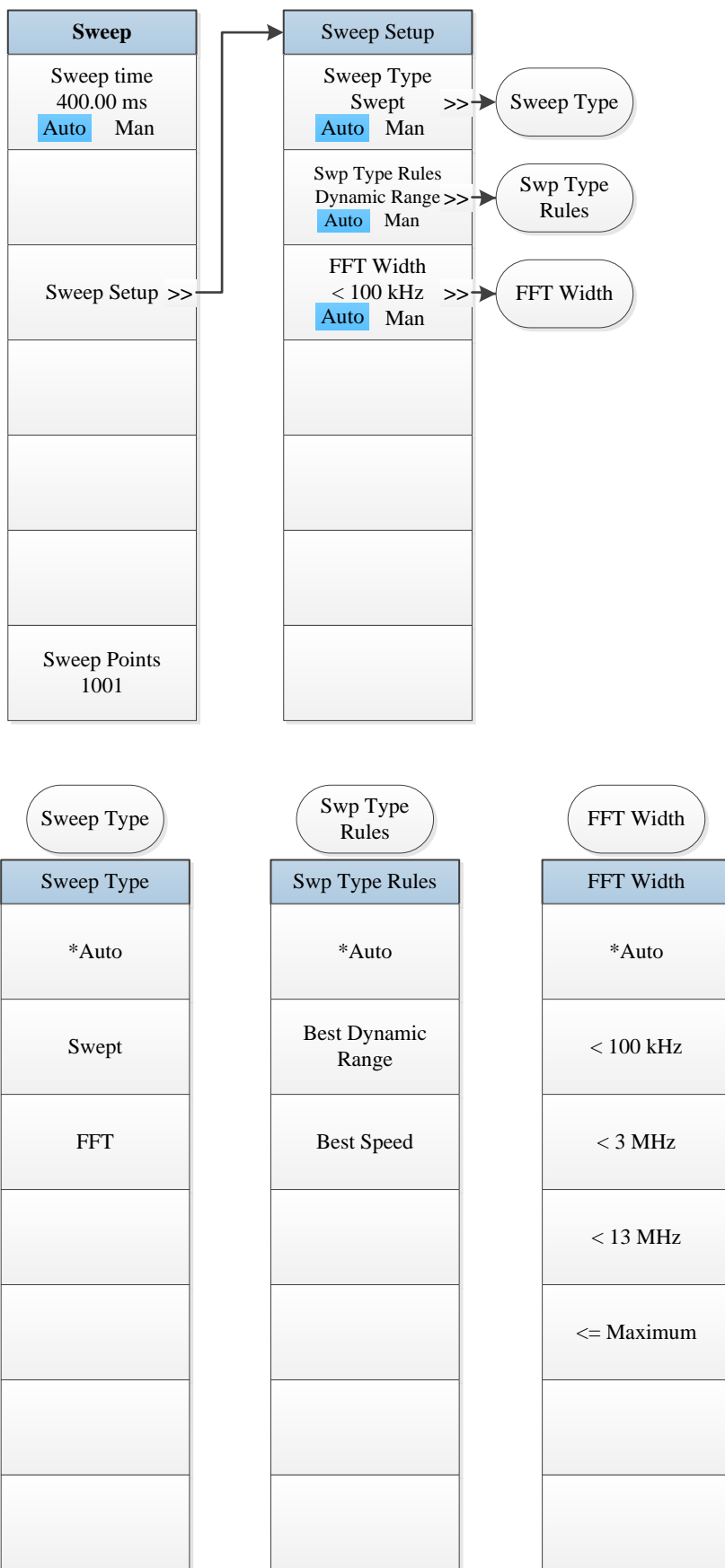
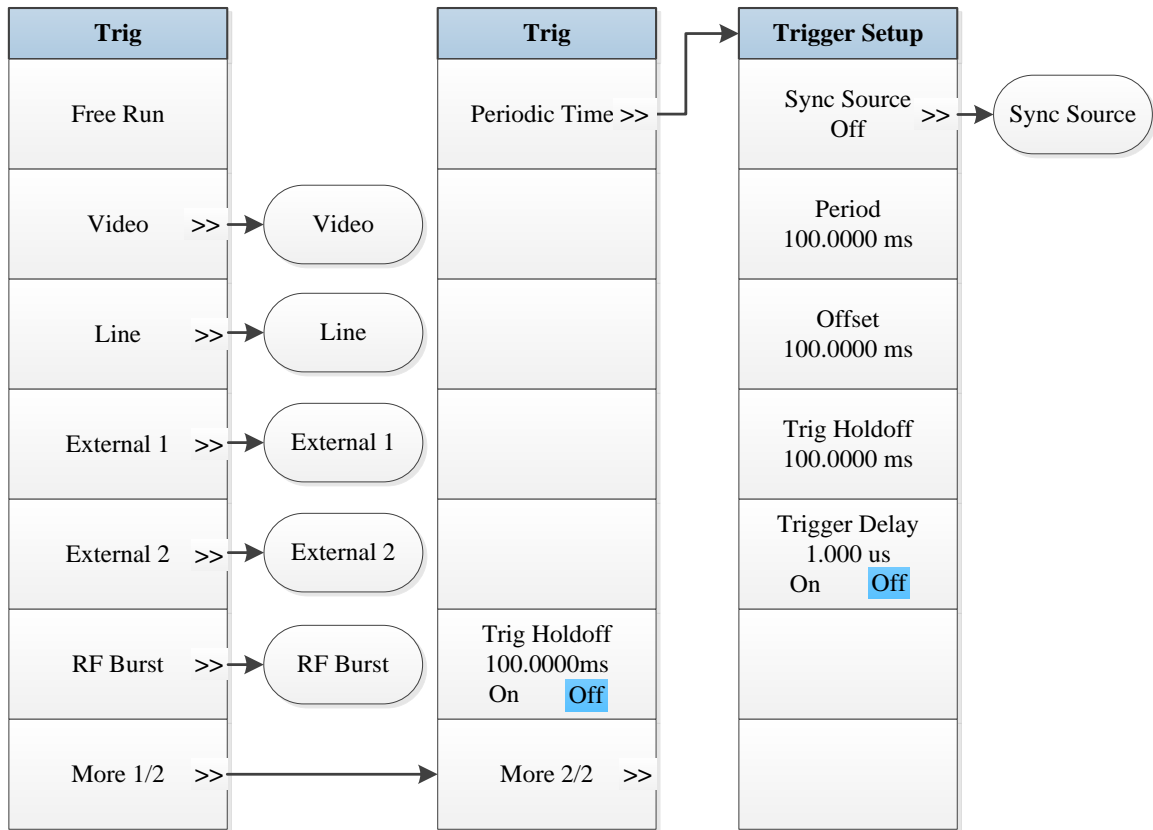

Fig. 5.4-5 Sweep Menu

5.1.4.6 Trigger



RF Burst	External 2	External 1	Line	Video
Trigger Setup	Trigger Setup	Trigger Setup	Trigger Setup	Trigger Setup
Trigger level -25.00 dBm	Trigger level 1.2 V	Trigger level 1.2 V		Trigger level -25.00 dBm
Trig Slope Pos Neg	Trig Slope Pos Neg	Trig Slope Pos Neg	Trig Slope Pos Neg	Trig Slope Pos Neg
Trig Delay 100.00 ms On Off	Trig Delay 100.00 ms On Off	Trig Delay 100.00 ms On Off	Trig Delay 100.00 ms On Off	Trig Delay 100.00 ms On Off

5.1 Menu structure

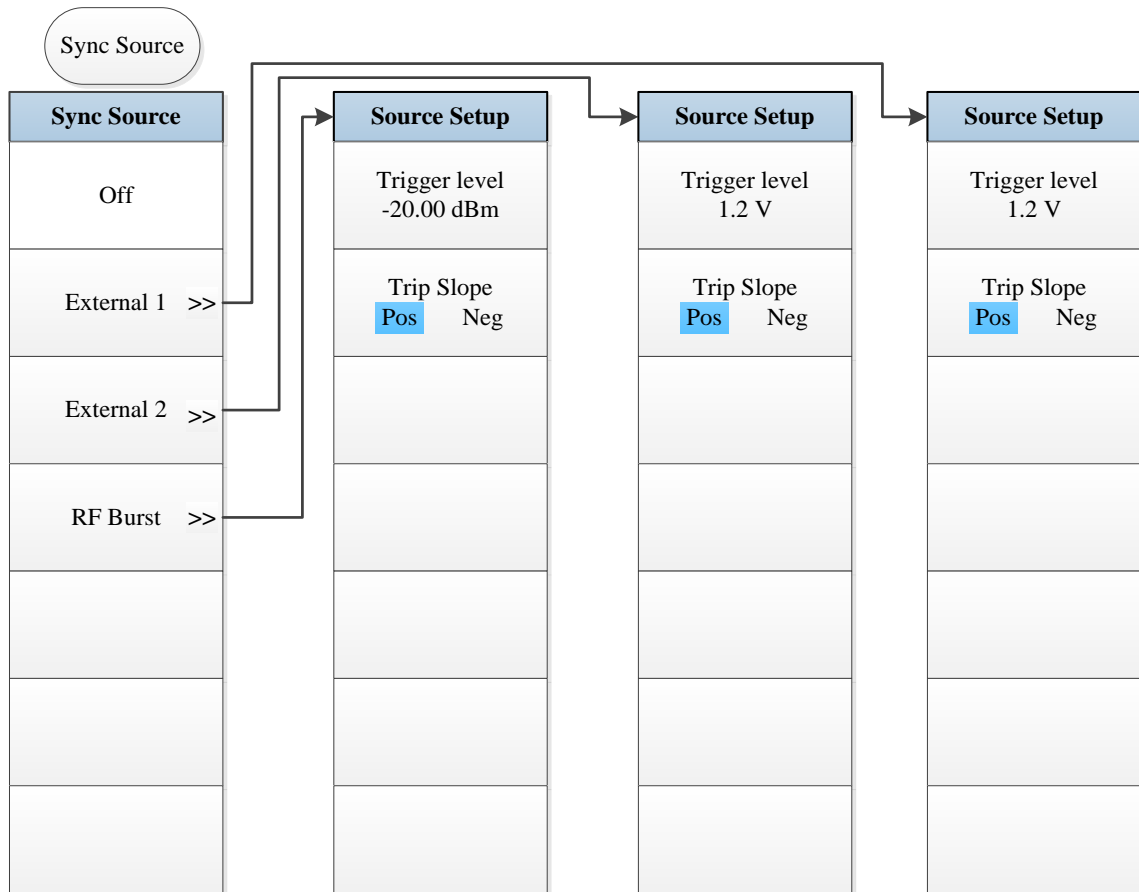

Fig. 5.4-6 Trigger Menu

5.1.4.7 Trace

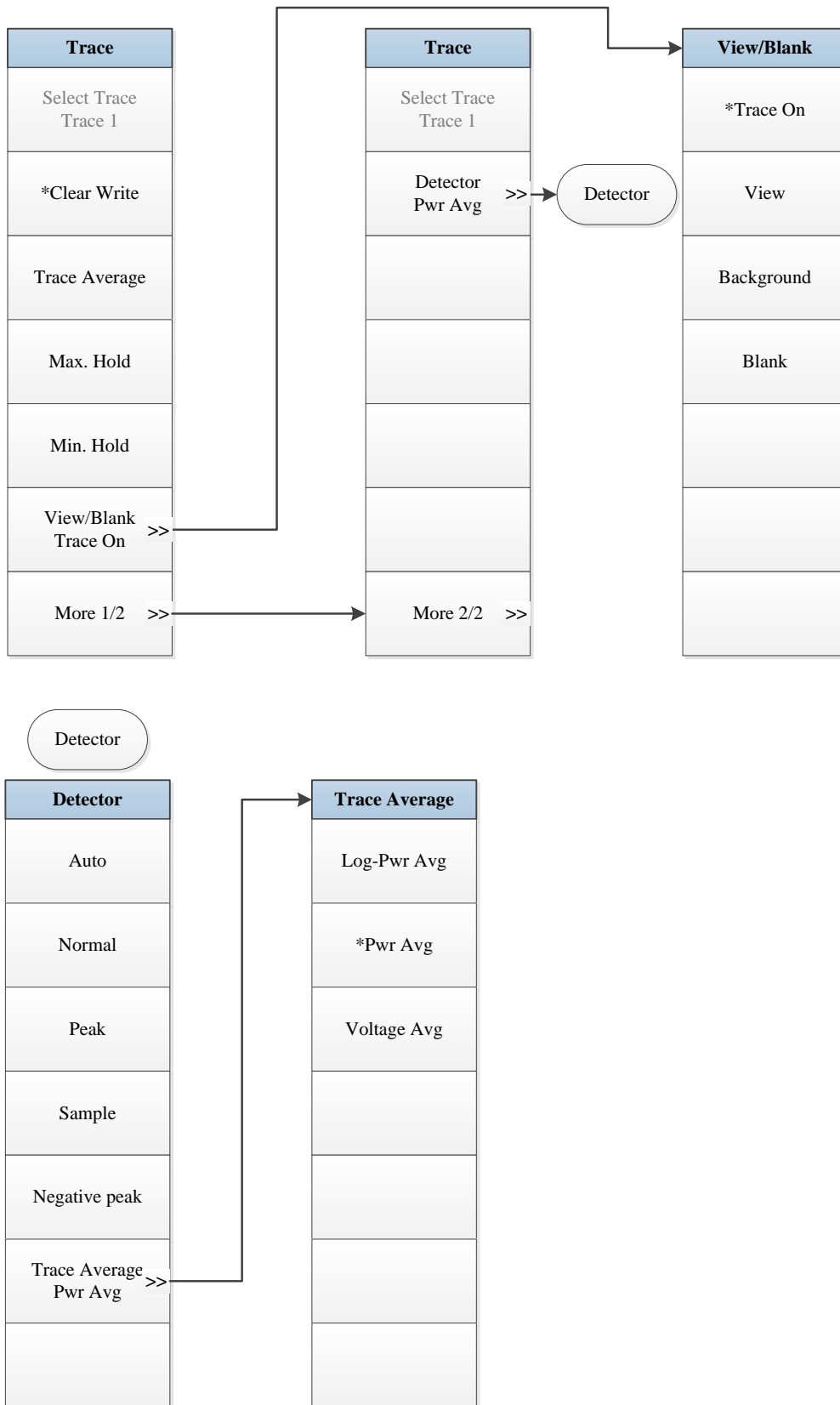
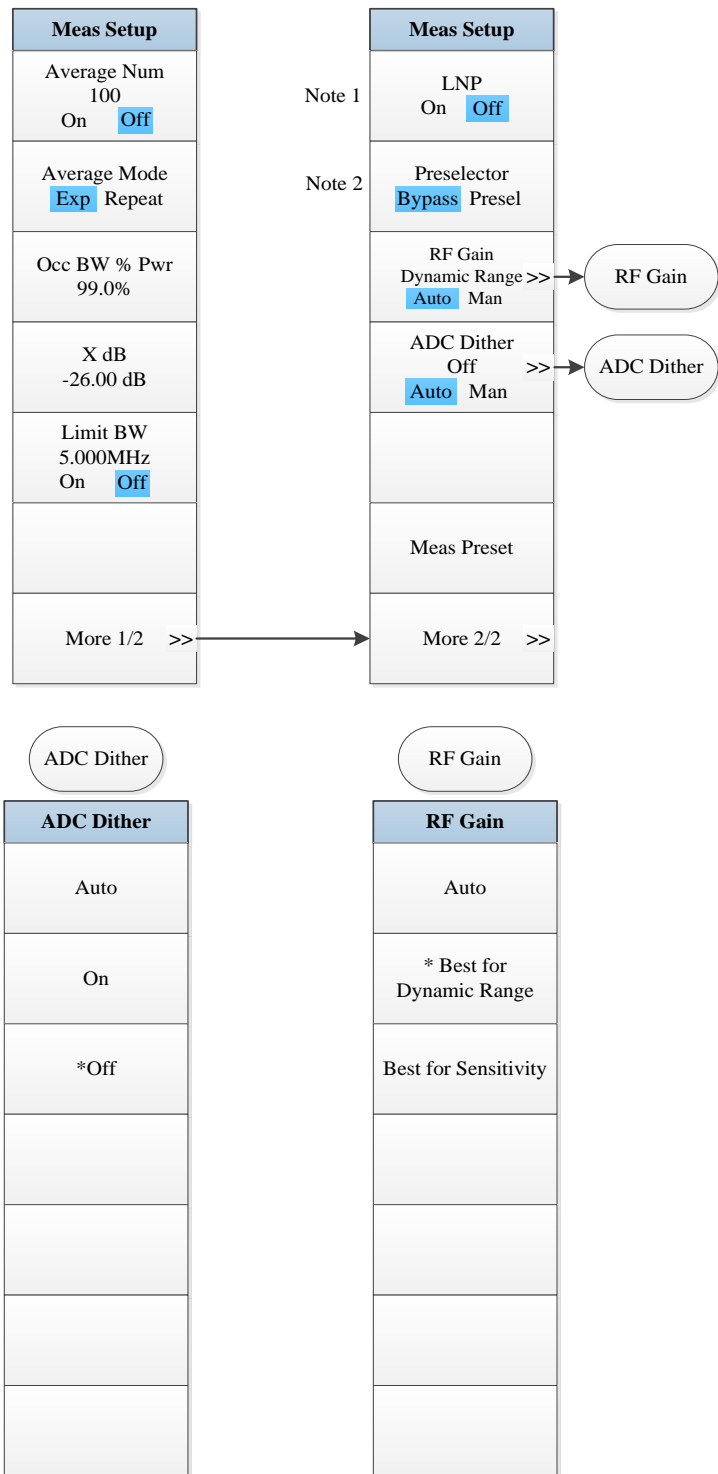

Fig. 5.4-7 Trace Menu

5.1 Menu structure

5.1.4.8 Measurement Setting



Note 1. this menu is only available when the H34 option (Low Noise PreAmplifier) is purchased. When the PreAmplifier is ON, the Low Noise Path is OFF and this menu is grayed out; when the PreAmplifier is OFF, this menu lights on and is switchable.

Note 2. this menu is only available when the H36 option (Preselector Bypass) is purchased.

Fig. 5.4-8 Measurement Setting Menu

5.1.4.9 Measurement Control

Meas Control
Measure Single Cont
Restart
Pause/Resume

Fig. 5.4-9 Measurement Control Menu

5.1 Menu structure

5.1.4.10 Auto Setting

Auto set
Couple All
Mech Atten 10.00 dB Auto Man
Res BW 30.000kHz Auto Man
Video BW 30.000KHz Auto Man
Sweep time 80.0000 ms Auto Man
CF Step 10.000MHz Auto Man

Fig. 5.4-10 Auto Setting Menu

5.1.4.11 Display

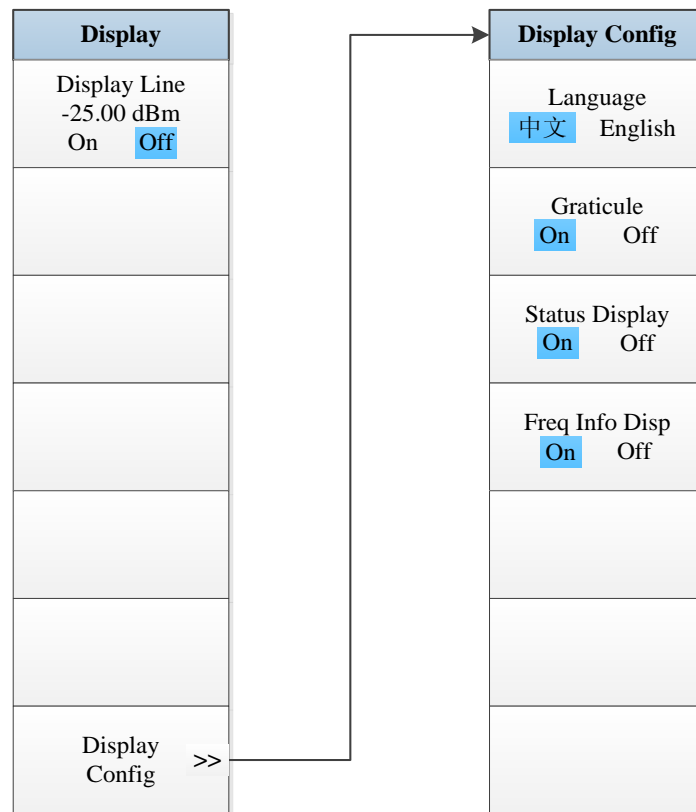

Fig. 5.4-11 Display Menu

5.1 Menu structure

5.1.4.12 Marker

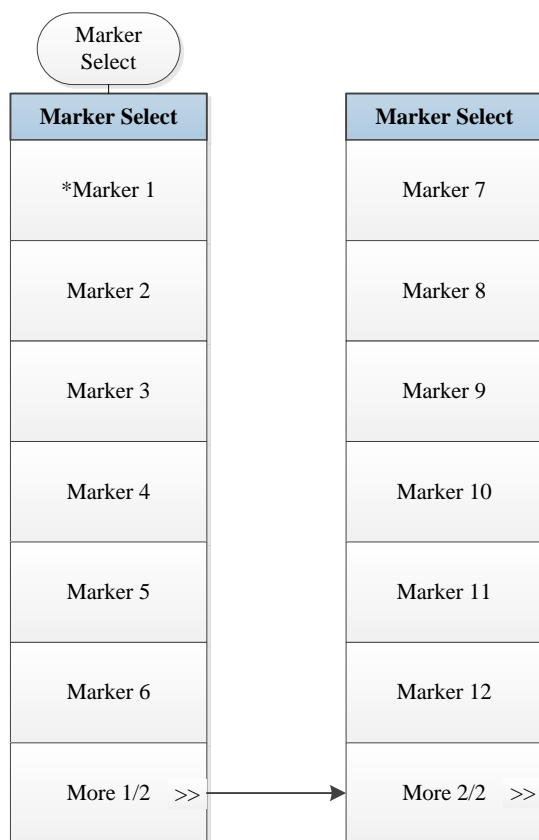
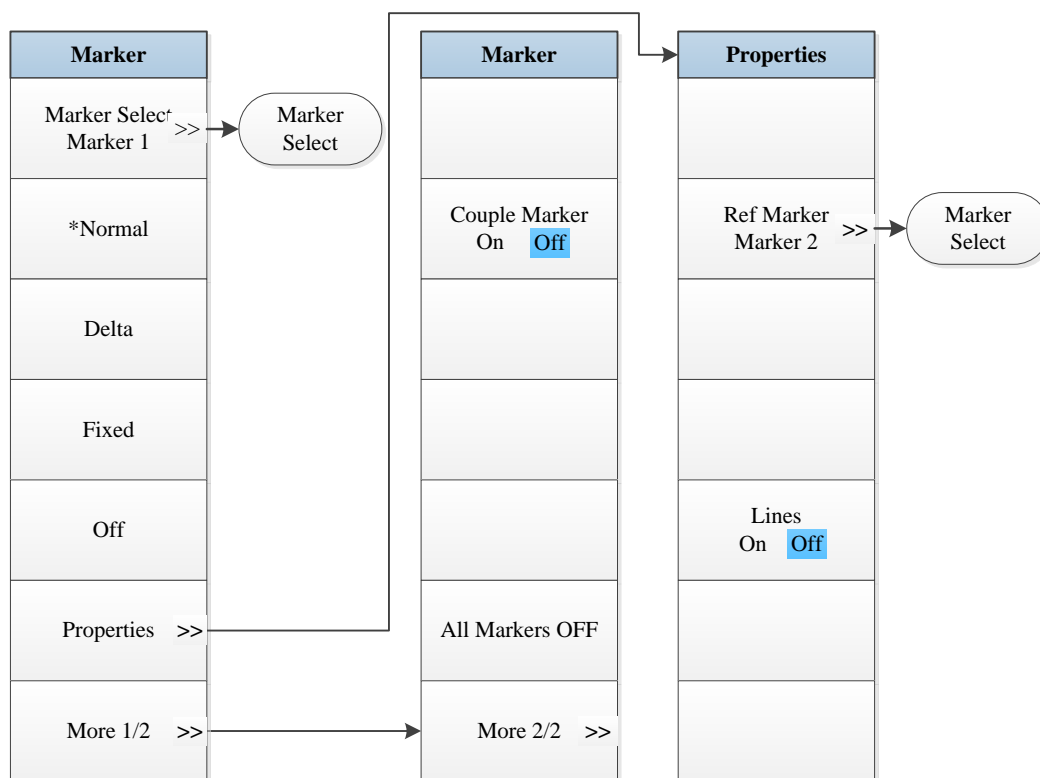

Fig. 5.4-12 Marker Menu

5.1.4.13 Maker->

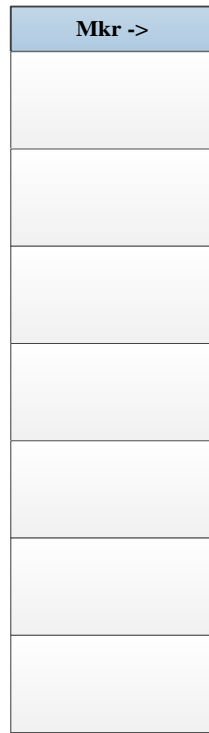

Fig. 5.4-13 Marker->Menu

5.1 Menu structure

5.1.4.14 Marker Function

Marker Func

Fig. 5.4-14 Marker Function Menu

5.1.4.15 Peak Search

Peak Search
Next peak
Next pk Right
Next Pk Left

Fig. 5.4-15 Peak Search Menu

5.1 Menu structure

5.1.5 Adjacent Channel Power

5.1.5.1 Frequency

Frequency
Center Freq 13.25000 GHz
CF step 10.0000MHz <input checked="" type="radio"/> Auto <input type="radio"/> Man
Freq Offset 0.000000 GHz

Fig. 5.5-1 Frequency Menu

5.1.5.2 Amplitude/Y Axis

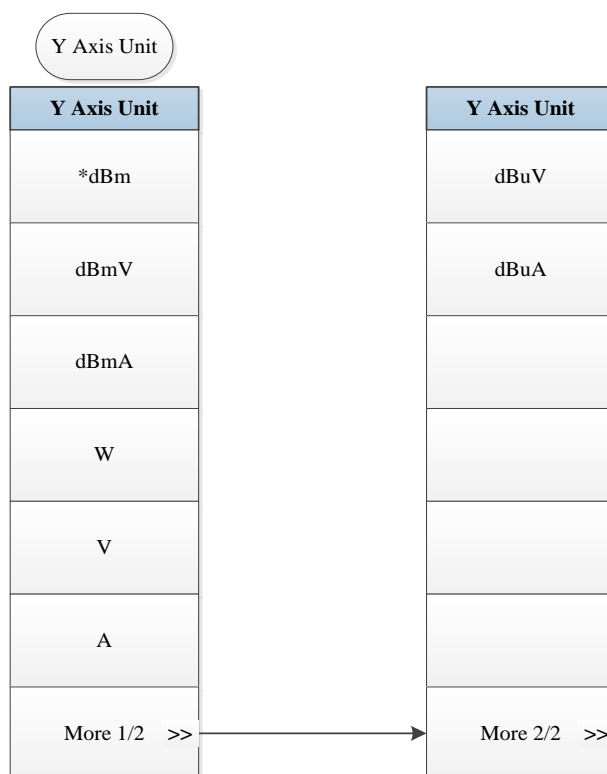
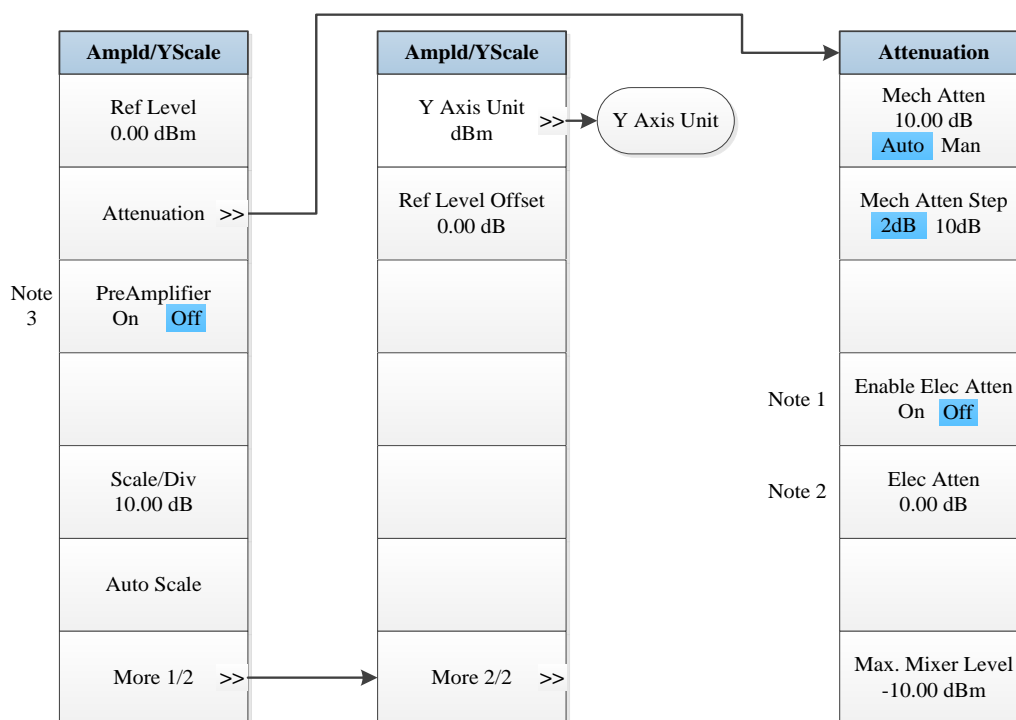

Note 1. this menu is only available when the H33 option (Elec Attenuator) is purchased.

Note 2. this menu is only available when the H33 option (Elec Attenuator) is purchased. **Note 3:** this menu is only available when the H34 option (Low Noise PreAmplifier) is purchased.

Fig. 5.5-2 Amplitude/Y Axis Menu

5.1 Menu structure

5.1.5.3 Span/X Axis

Span
Span 8.000000 MHz
Full Span
Last Span

Fig. 5.5-3 Span Menu

5.1.5.4 Bandwidth

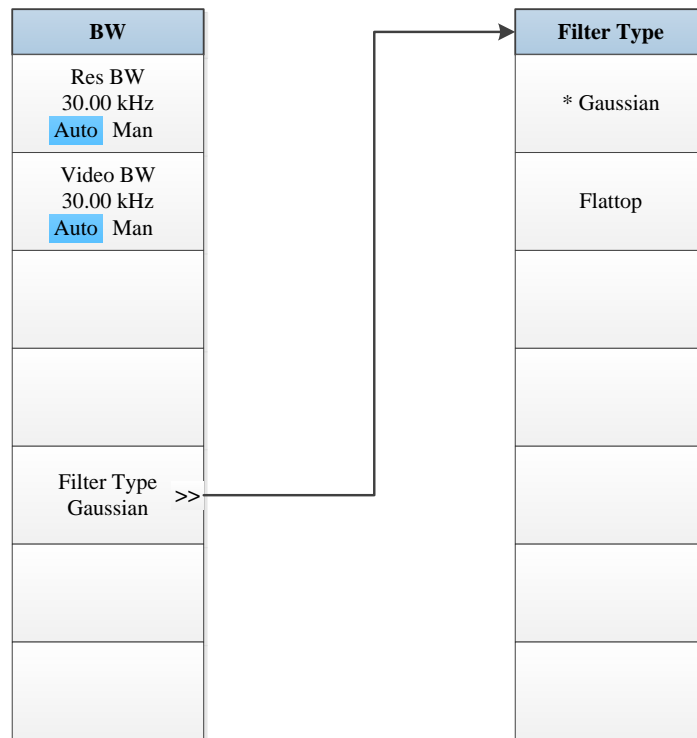

Fig. 5.5-4 Bandwidth Menu

5.1 Menu structure

5.1.5.5 Sweep

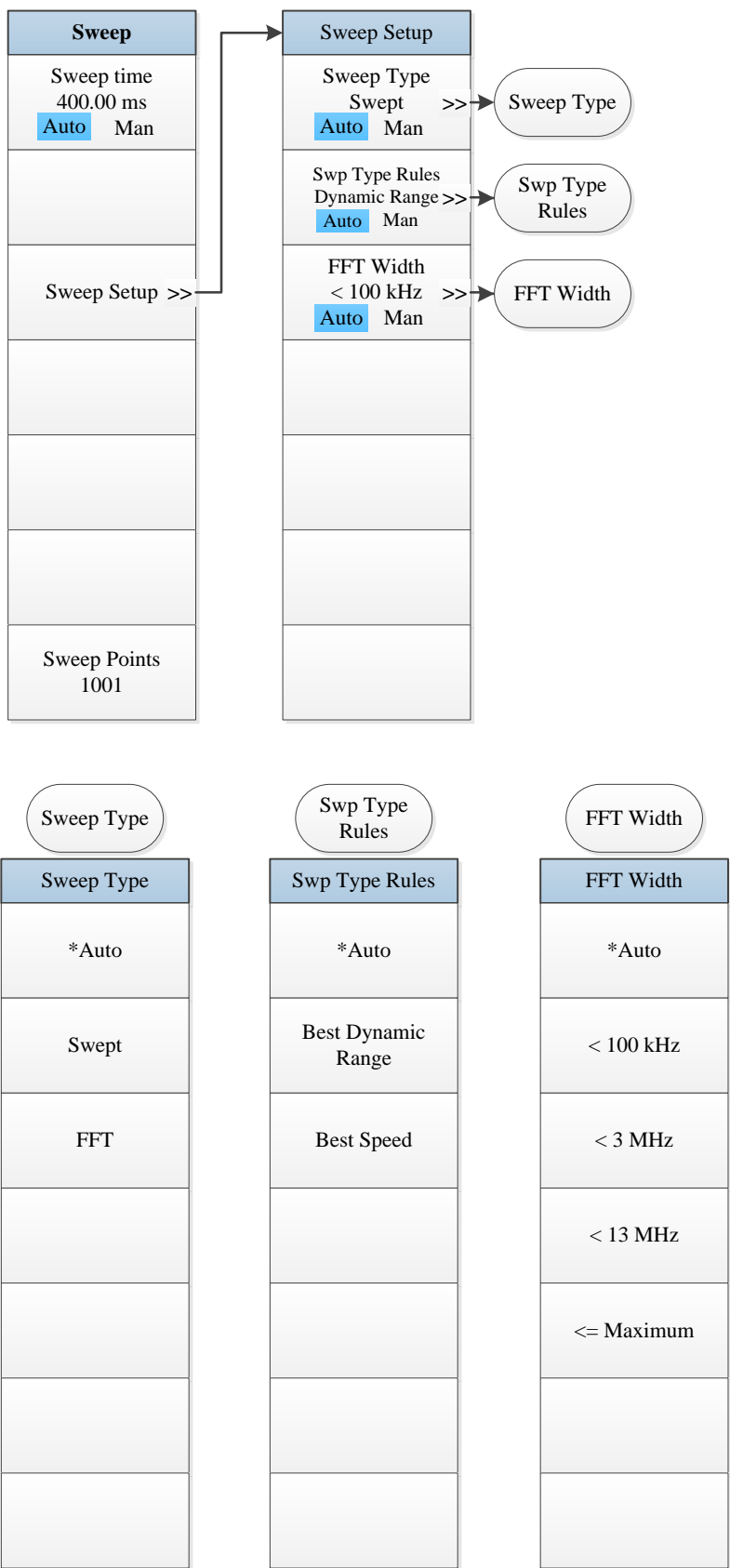
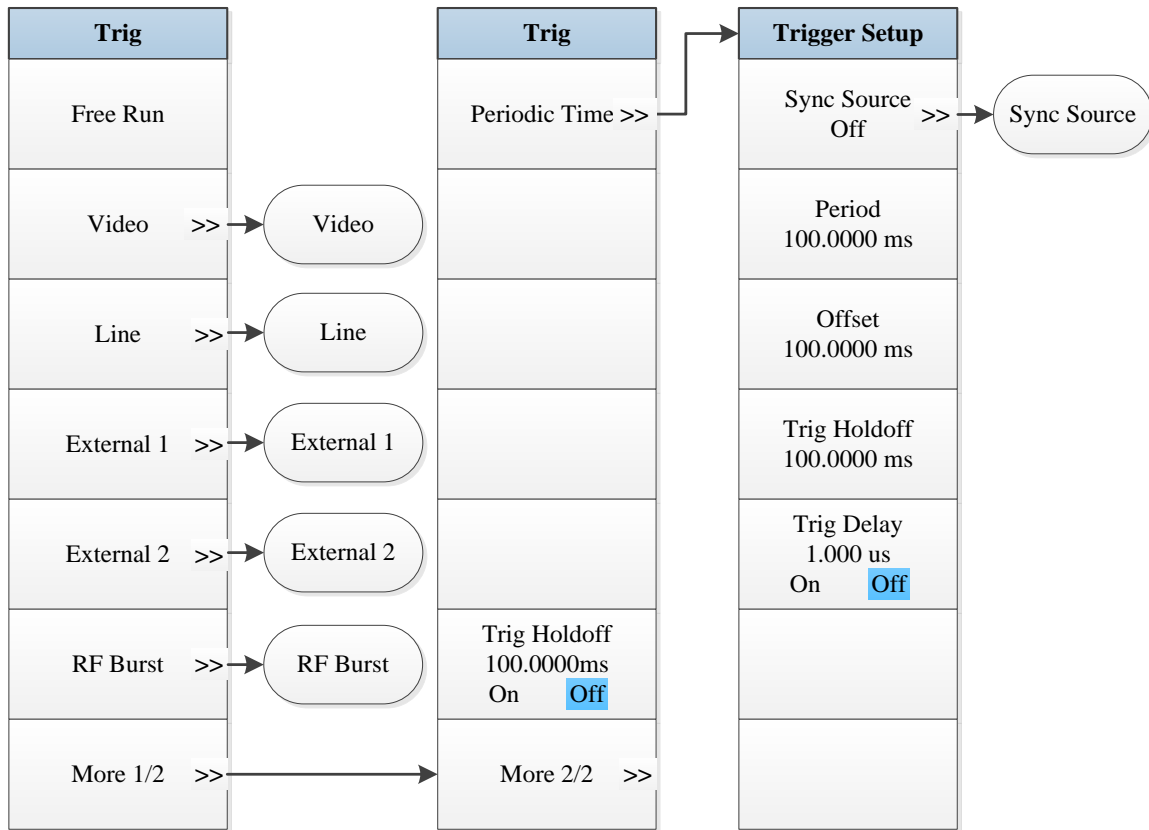

Fig. 5.5-5 Sweep Menu

5.1.5.6 Trigger



RF Burst	External 2	External 1	Line	Video
Trigger Setup	Trigger Setup	Trigger Setup	Trigger Setup	Trigger Setup
Trigger level -25.00 dBm	Trigger level 1.2 V	Trigger level 1.2 V		Trigger level -25.00 dBm
Trig Slope Pos Neg	Trig Slope Pos Neg	Trig Slope Pos Neg	Trig Slope Pos Neg	Trig Slope Pos Neg
Trig Delay 100.00 ms On Off	Trig Delay 100.00 ms On Off	Trig Delay 100.00 ms On Off	Trig Delay 100.00 ms On Off	Trig Delay 100.00 ms On Off

5.1 Menu structure

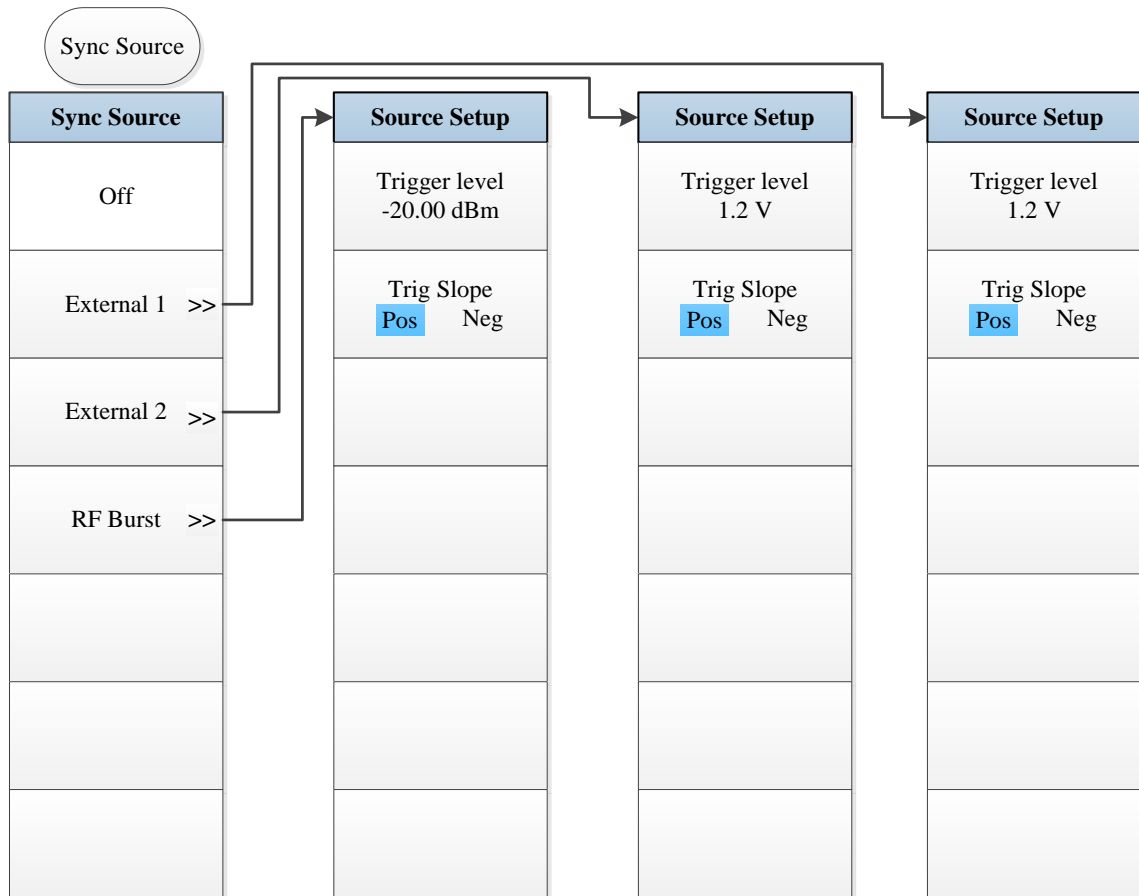

Fig. 5.5-6 Trigger Menu

5.1.5.7 Trace

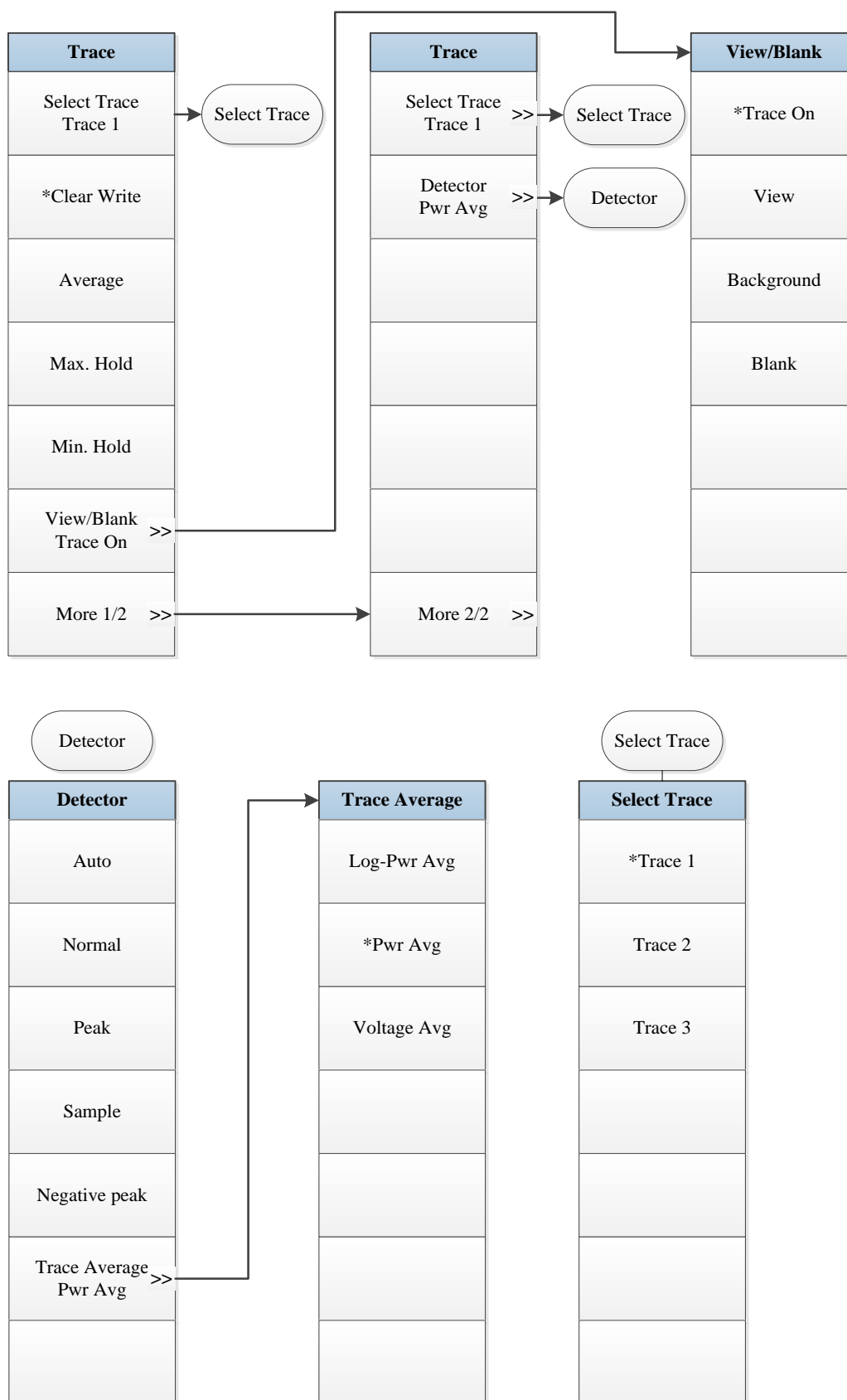
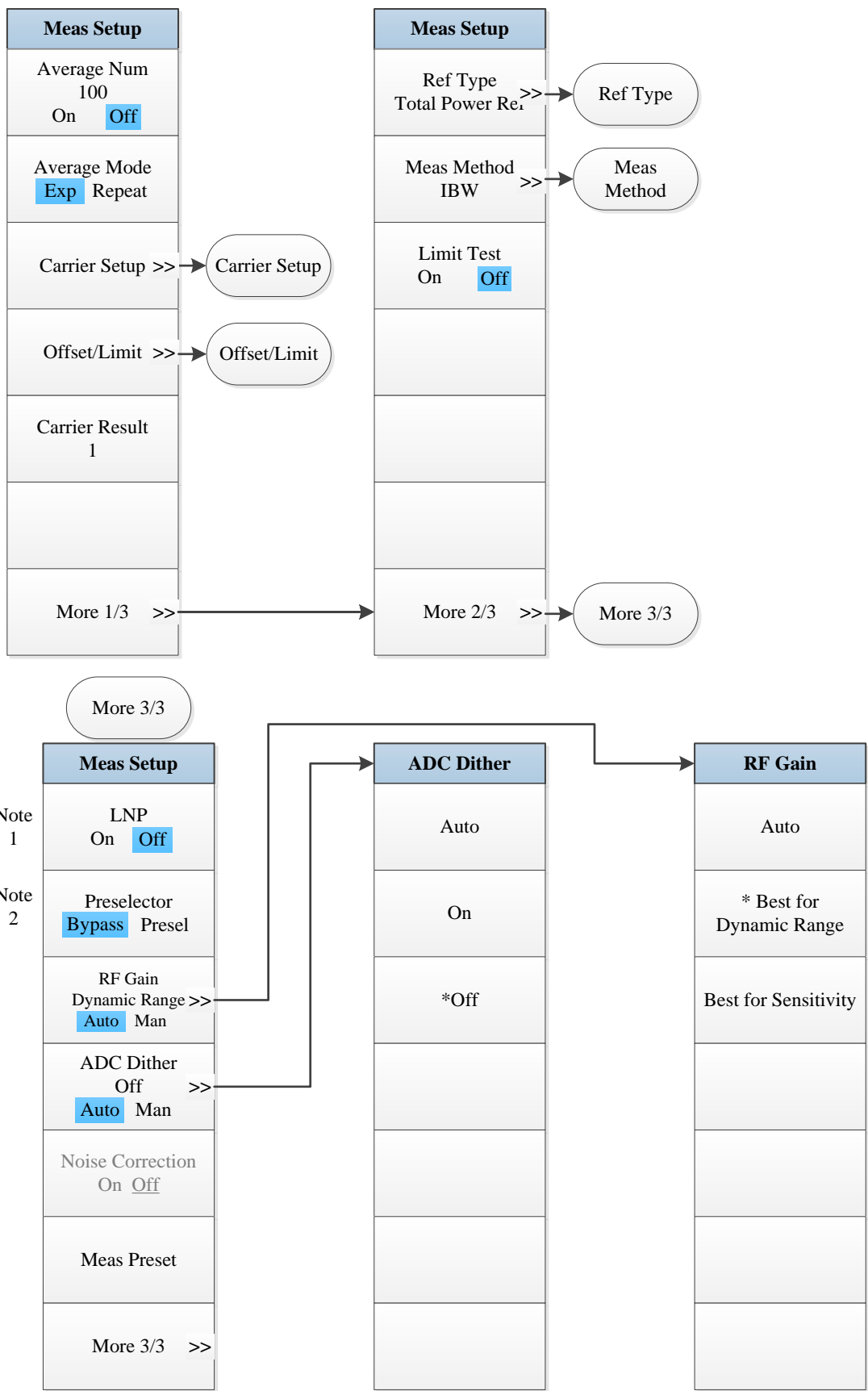

Fig. 5.5-7 Trace Menu

5.1 Menu structure

5.1.5.8 Measurement Setting



5.1 Menu structure

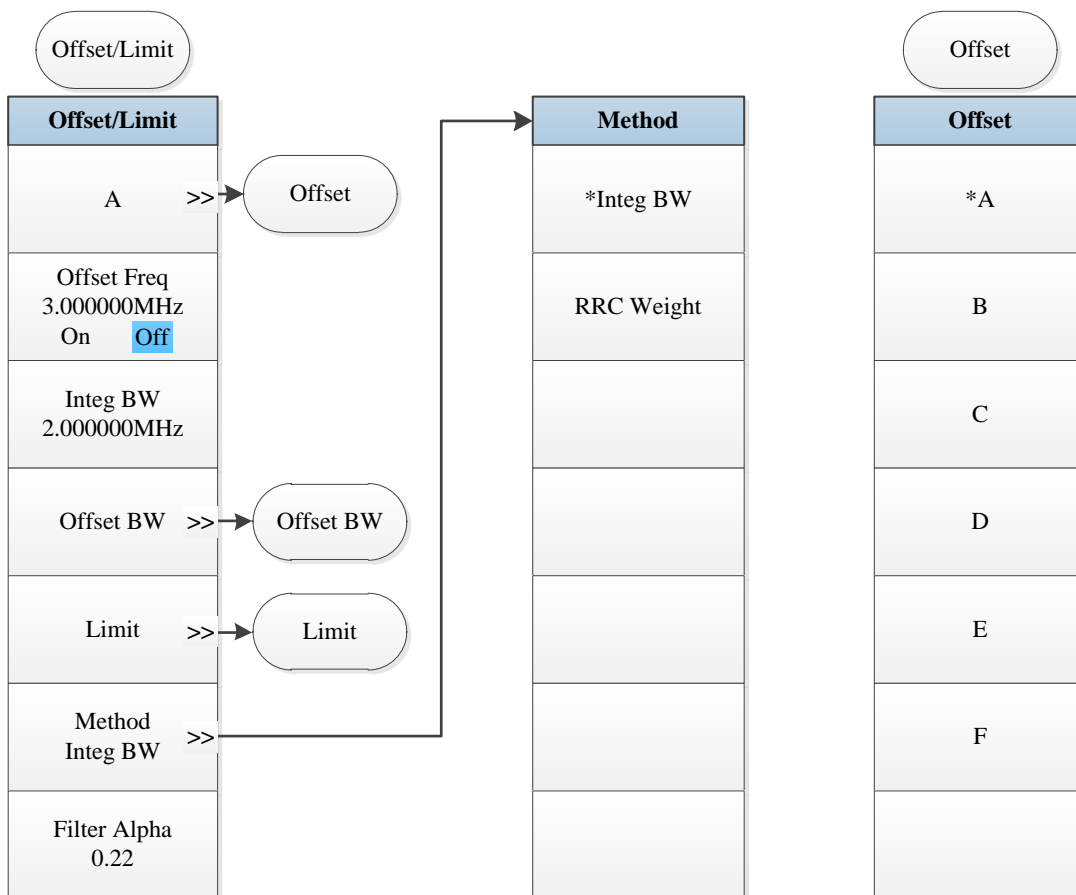
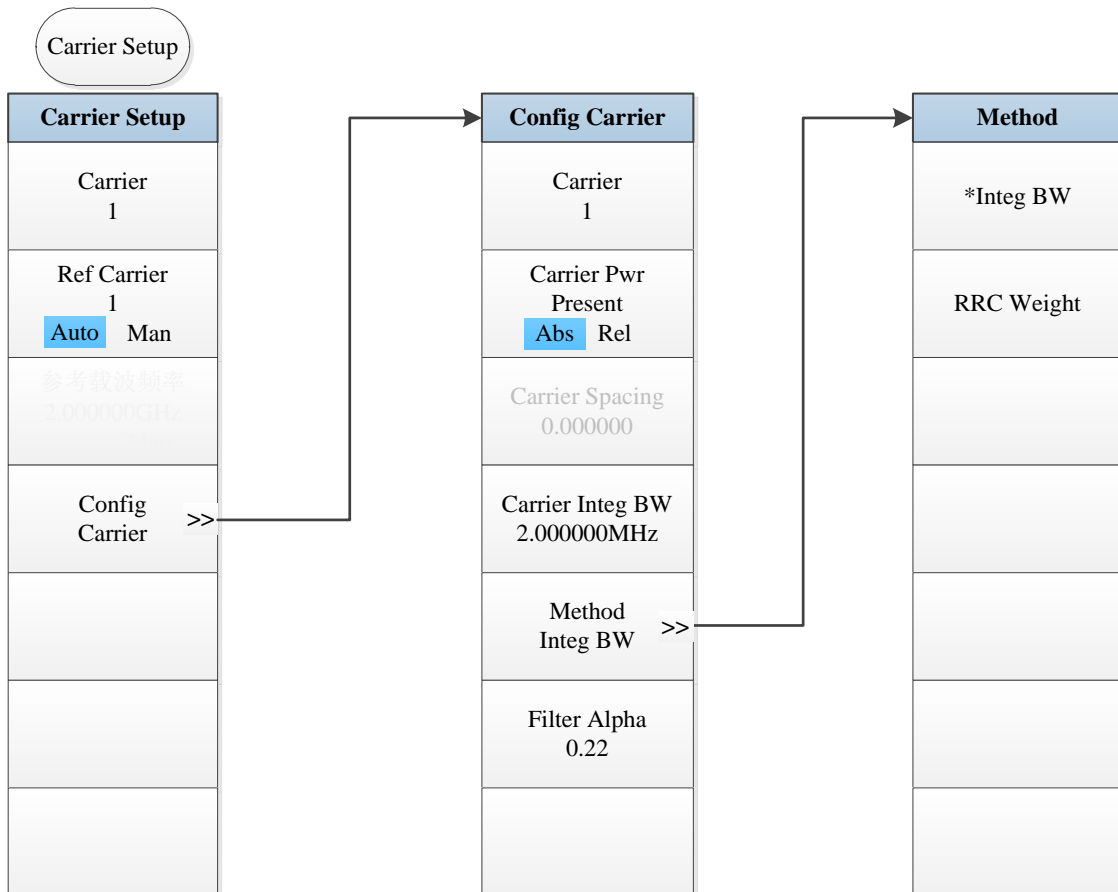

5.1 Menu structure

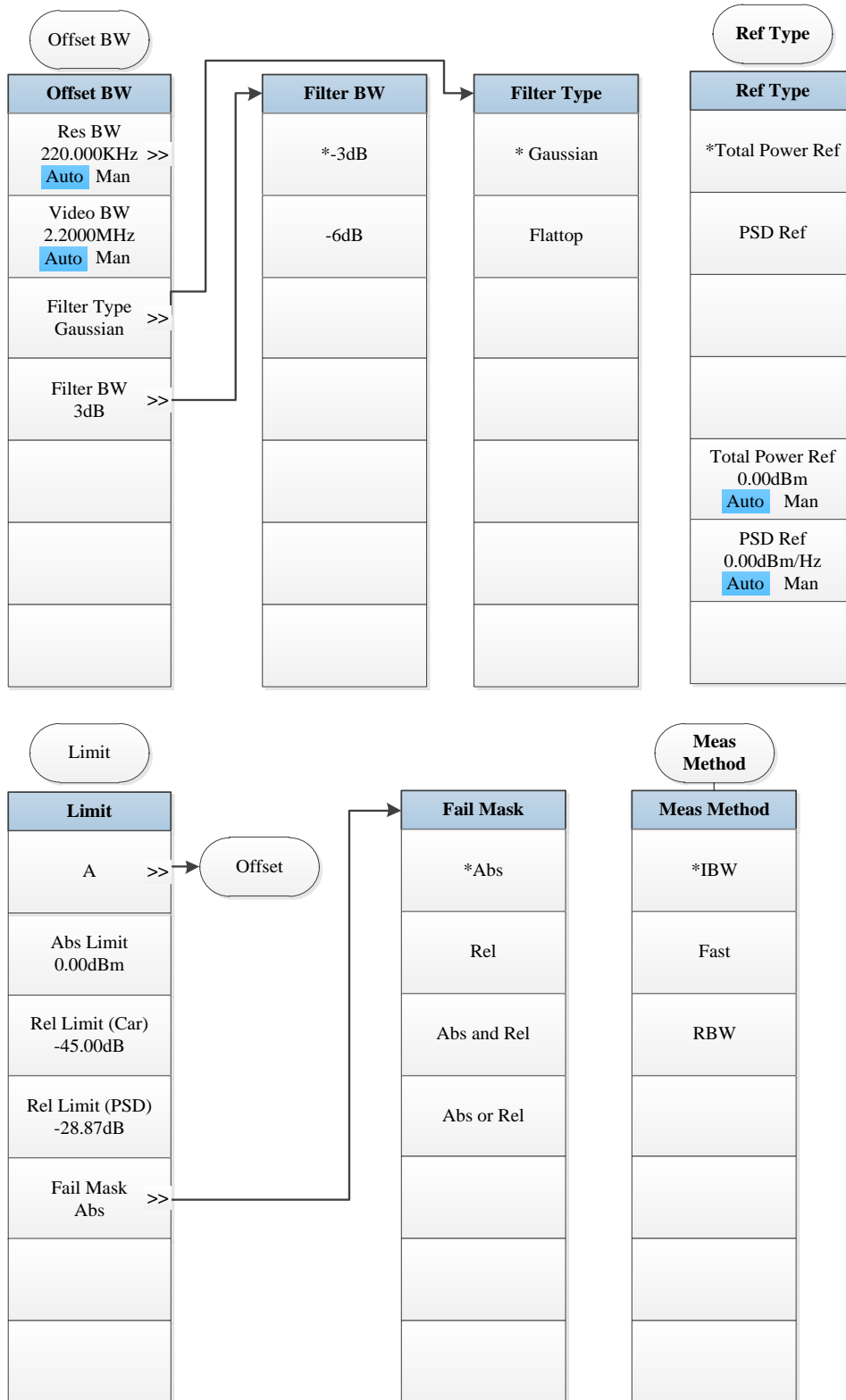

Note 1. this menu is only available when the H34 option (Low Noise PreAmplifier) is purchased. When the PreAmplifier is ON, the Low Noise Path is OFF and this menu is grayed out; when the PreAmplifier is OFF, this menu lights on and is switchable.

Note 2. this menu is only available when the H36 option (Preselector Bypass) is purchased.

Fig. 5. 5-8 Measurement Setting Menu

5.1.5.9 Measurement Control

Meas Control
Measure Single Cont
Restart
Pause/Resume

Fig. 5.5-9 Measurement Control Menu

5.1 Menu structure

5.1.5.10 Auto Setting

Auto set
Couple All
Mech Atten 10.00 dB Auto Man
Res BW 20.00 MHz Auto Man
Video BW 20.00 MHz Auto Man
Sweep time 80.0000 ms Auto Man
CF step 4.000000 GHz Auto Man

Fig. 5.5-10 Auto Setting Menu

5.1.5.11 Display

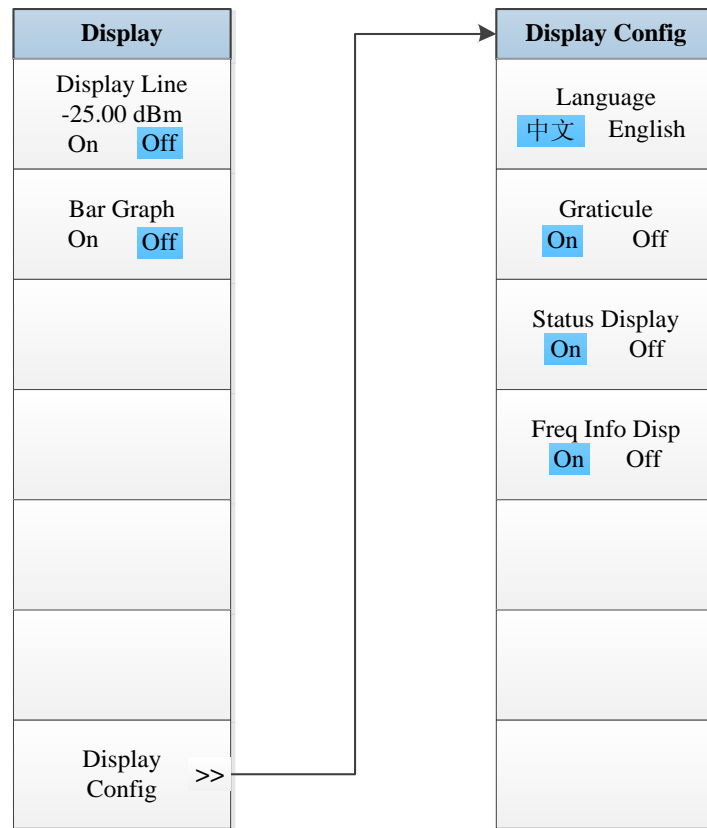

Fig. 5.5-11 Display Menu

5.1 Menu structure

5.1.5.12 Marker

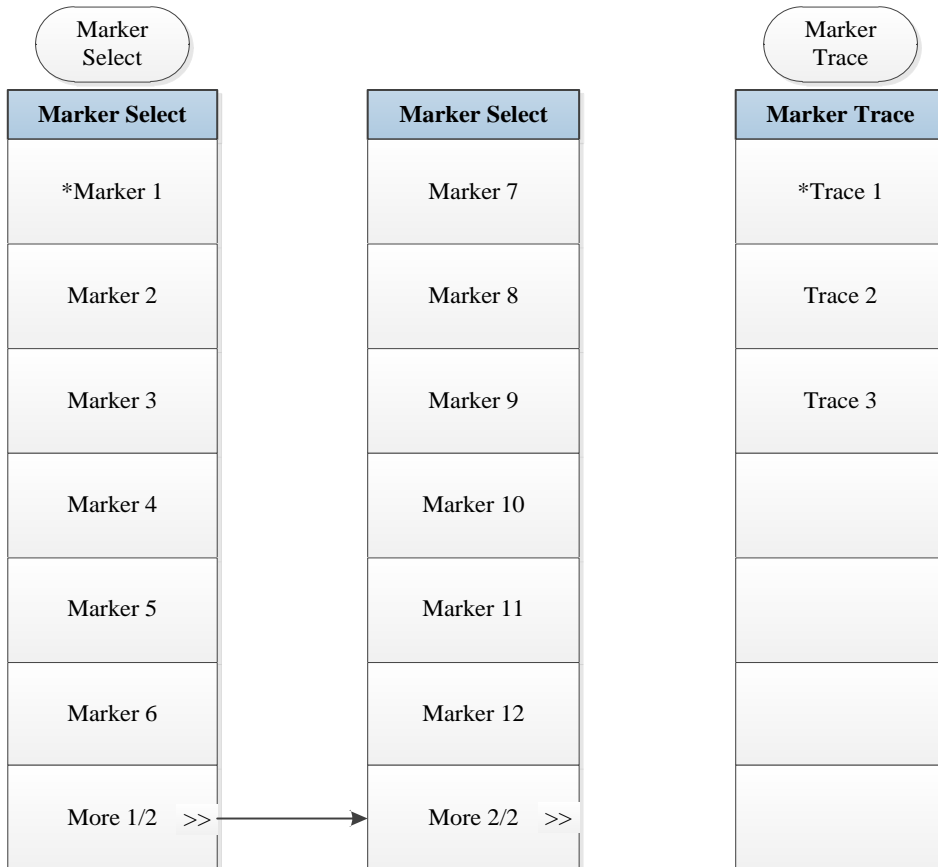
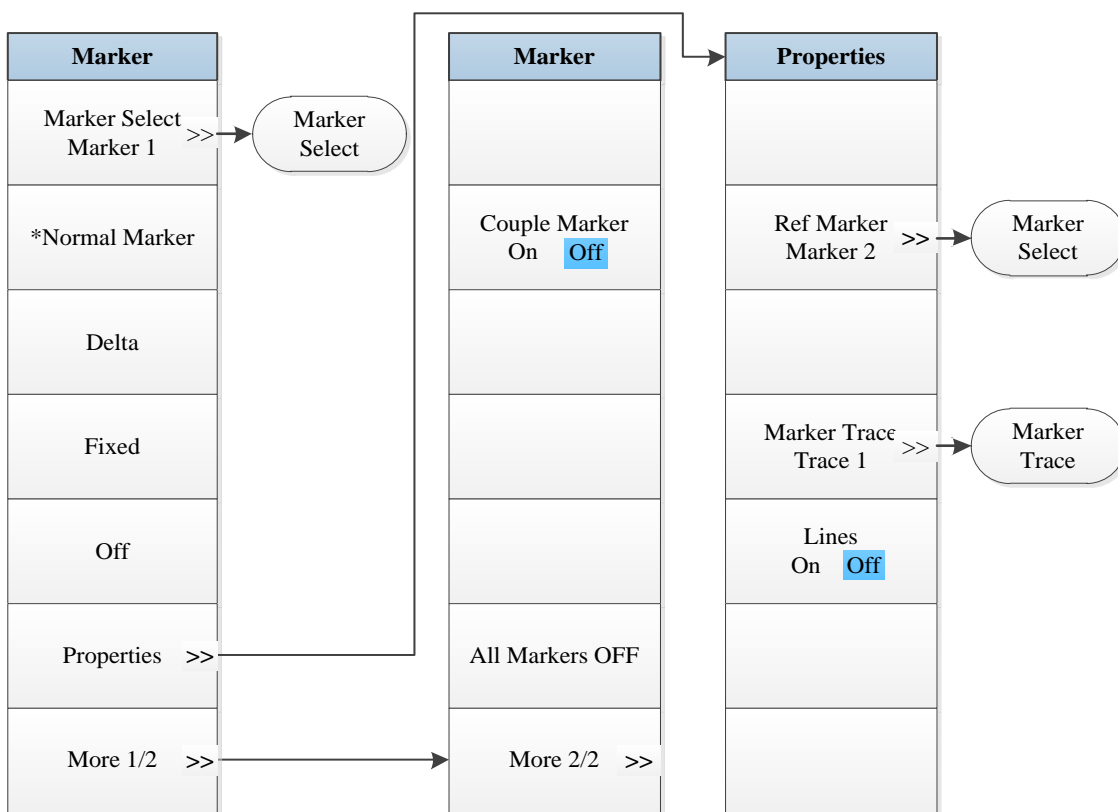

Fig. 5.5-12 Marker Menu

5.1.5.13 Maker->

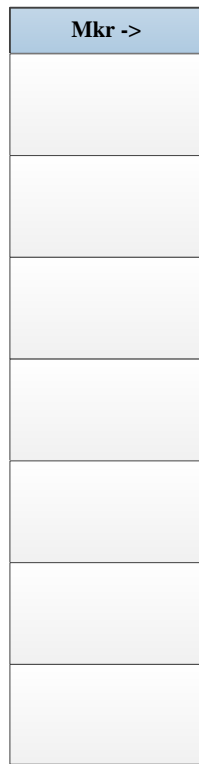

Fig. 5.5-13 Marker->Menu

5.1 Menu structure

5.1.5.14 Marker Function

Marker Func

Fig. 5.5-14 Marker Function Menu

5.1.5.15 Peak Search

Peak Search
Next peak
Next pk Right
Next pk Left

Fig. 5.5-15 Peak Search Menu

5.1 Menu structure

5.1.6 Power Statistic

5.1.6.1 Frequency

Frequency
Center Freq 13.250000 GHz
CF step 10.0000MHz Auto Man
Freq Offset 0.000000 GHz

Fig. 5.6-1 Frequency Menu

5.1.6.2 Ampld/Y Scale

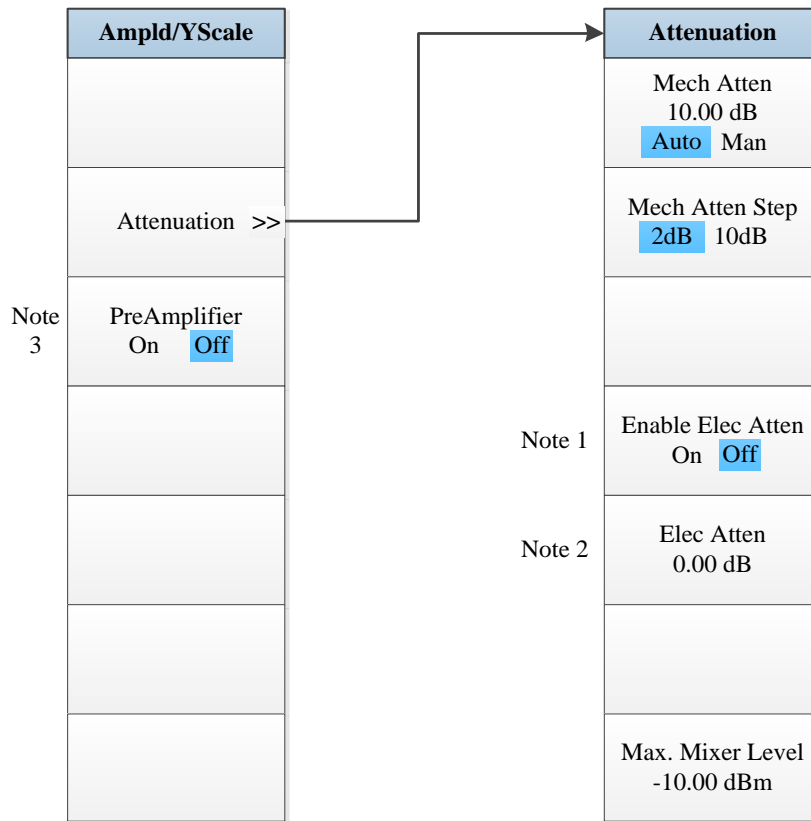

Note 1. this menu is only available when the H33 option (Elec Attenuator) is purchased.

Note 2. this menu is only available when the H33 option (Elec Attenuator) is purchased.

Note 3. this menu is only available when the H34 option (Low Noise PreAmplifier) is purchased.

Fig. 5.6-2 Ampld/Y Scale Menu

5.1 Menu structure

5.1.6.3 Span/X Scale

Span/X Scale
Scale/Div 2.00dB

Fig. 5.6-3 Span Menu

5.1.6.4 Bandwidth

BW
Measure BW 1.000000MHz

Fig. 5.6-4 Bandwidth Menu

5.1 Menu structure

5.1.6.5 Sweep

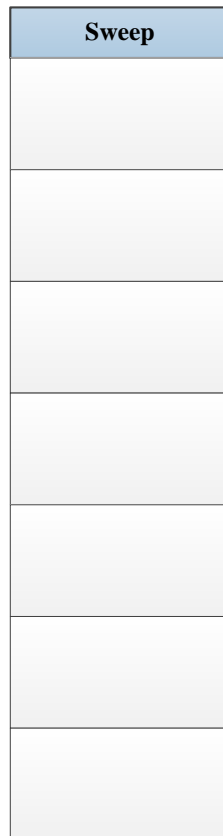
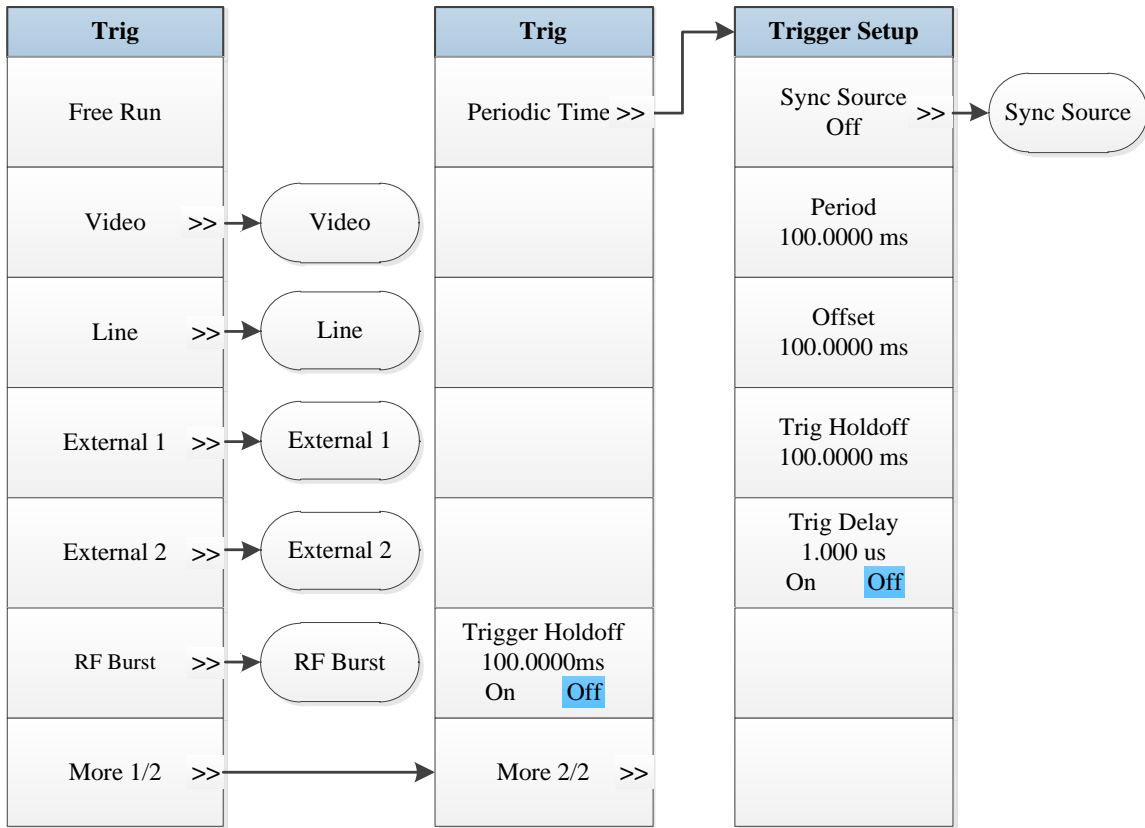

Fig. 5.6-5 Sweep Menu

5.1.6.6 Trigger



RF Burst	External 2	External 1	Line	Video
Trigger Setup	Trigger Setup	Trigger Setup	Trigger Setup	Trigger Setup
Trigger level -25.00 dBm	Trigger level 1.2 V	Trigger level 1.2 V		Trigger level -25.00 dBm
Trig Slope Pos Neg	Trig Slope Pos Neg	Trig Slope Pos Neg	Trig Slope Pos Neg	Trig Slope Pos Neg
Trig Delay 100.00 ms On Off	Trig Delay 100.00 ms On Off	Trig Delay 100.00 ms On Off	Trig Delay 100.00 ms On Off	Trig Delay 100.00 ms On Off

5.1 Menu structure

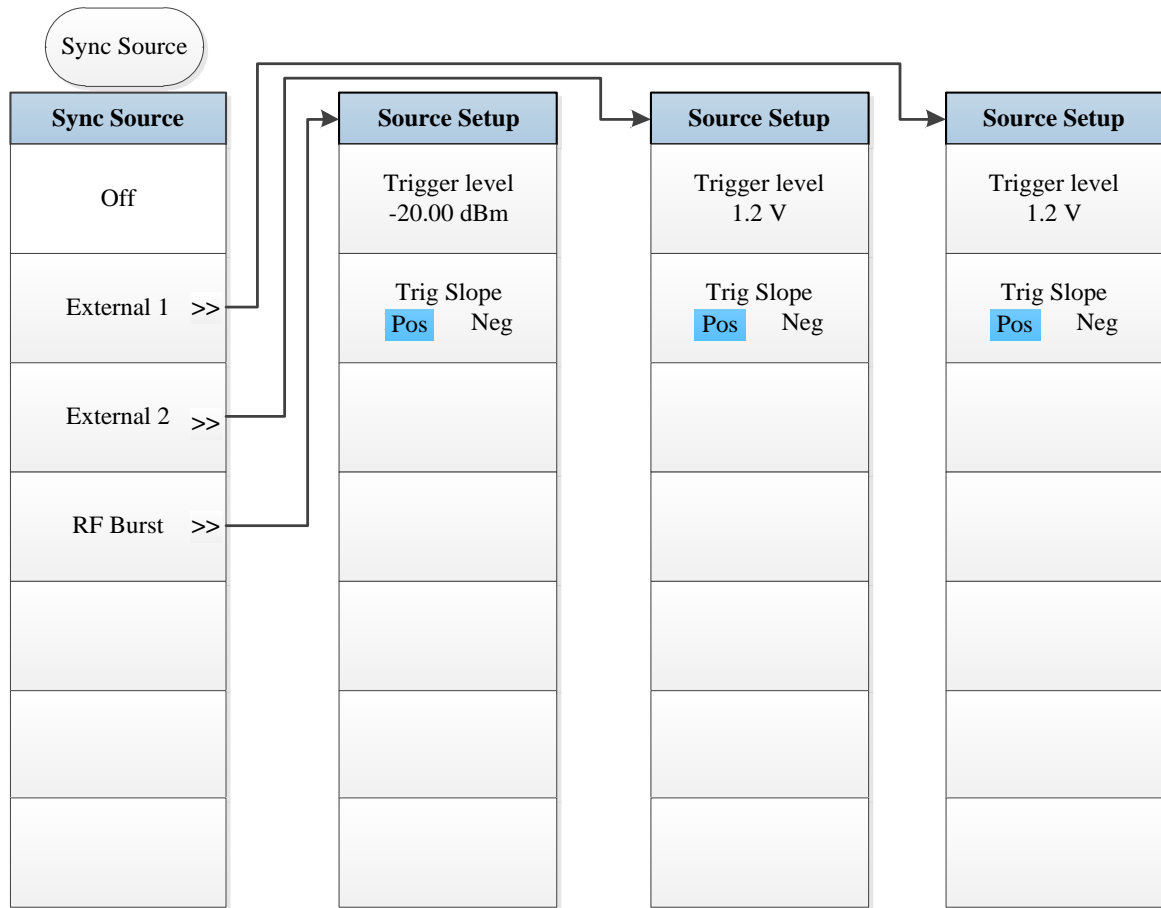

Fig. 5.6-6 Trigger Menu

5.1.6.7 Trace

Trace
Store Ref Trace
Reference Trace On <input type="checkbox"/> Off <input checked="" type="checkbox"/>
Gaussian Line On <input type="checkbox"/> Off <input checked="" type="checkbox"/>

Fig. 5.6-7 Trace Menu

5.1 Menu structure

5.1.6.8 Meas Setup

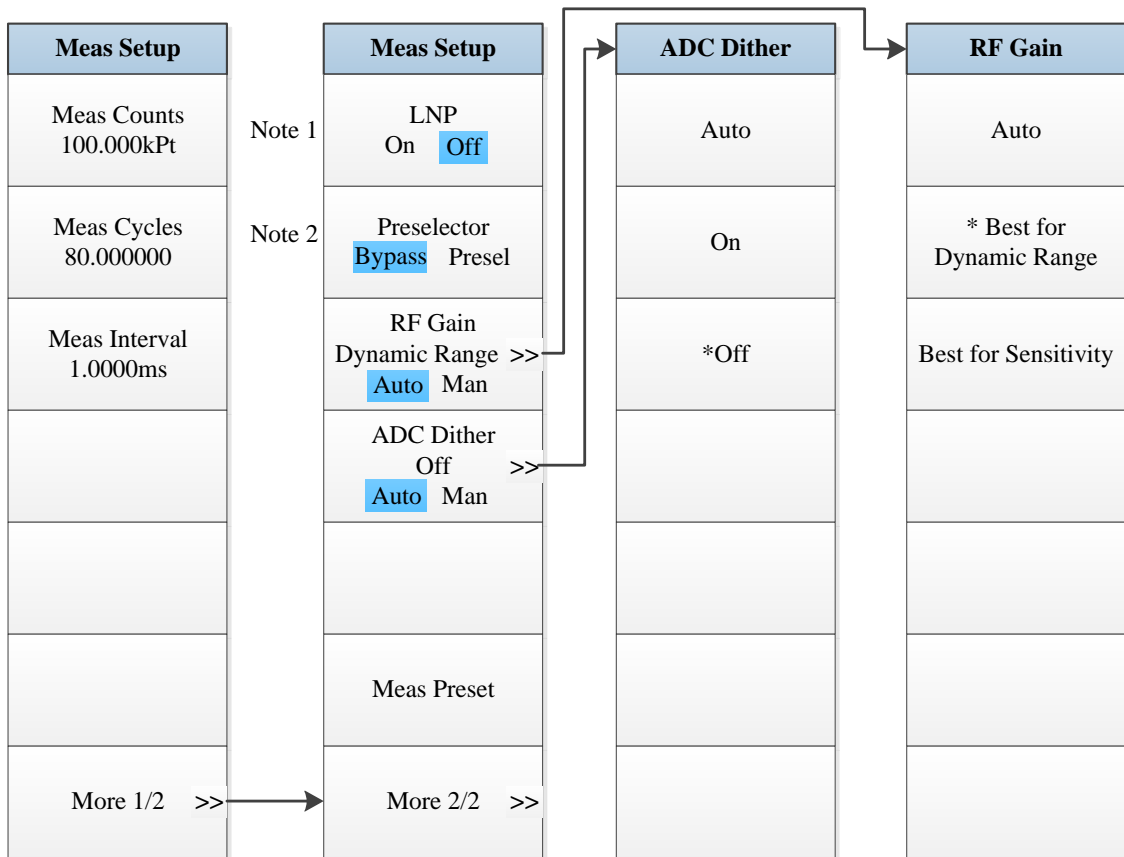

Note 1. this menu is only available when the H34 option (Low Noise PreAmplifier) is purchased. When the PreAmplifier is ON, the Low Noise Path is OFF and this menu is grayed out; when the PreAmplifier is OFF, this menu lights on and is switchable.

Note 2. this menu is only available when the H36 option (Preselector Bypass) is purchased.

Fig. 5.6-8 Measurement Setting Menu

5.1.6.9 Measurement Control

Meas Control
Measure Single Cont
Restart
Pause/Resume

Fig. 5.6-9 Measurement Control Menu

5.1 Menu structure

5.1.6.10 Auto Setting

Auto Set
Couple All

Fig. 5.6-10 Auto Setting Menu

5.1.6.11 Display

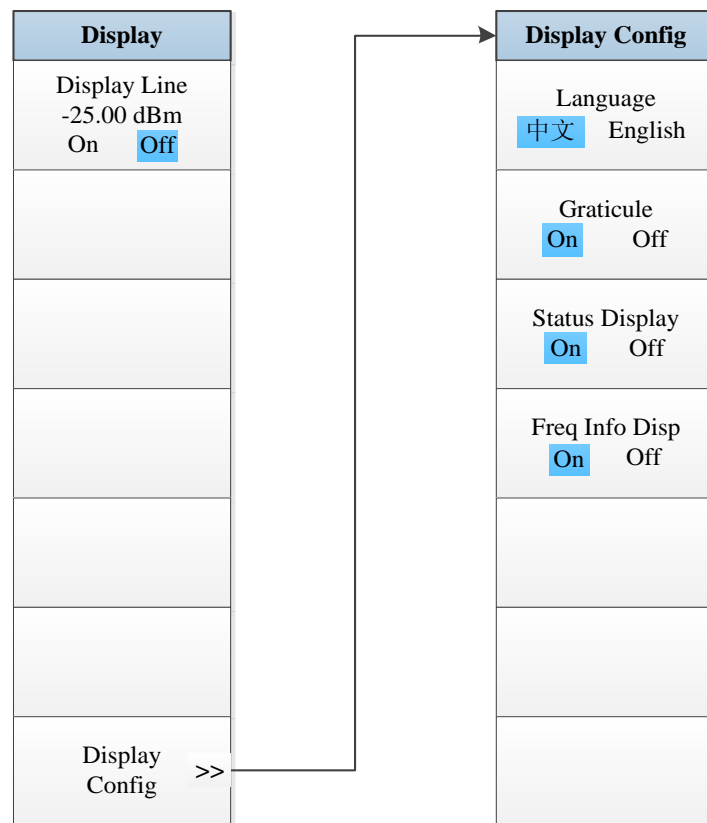

Fig. 5.6-11 Display Menu

5.1 Menu structure

5.1.6.12 Marker

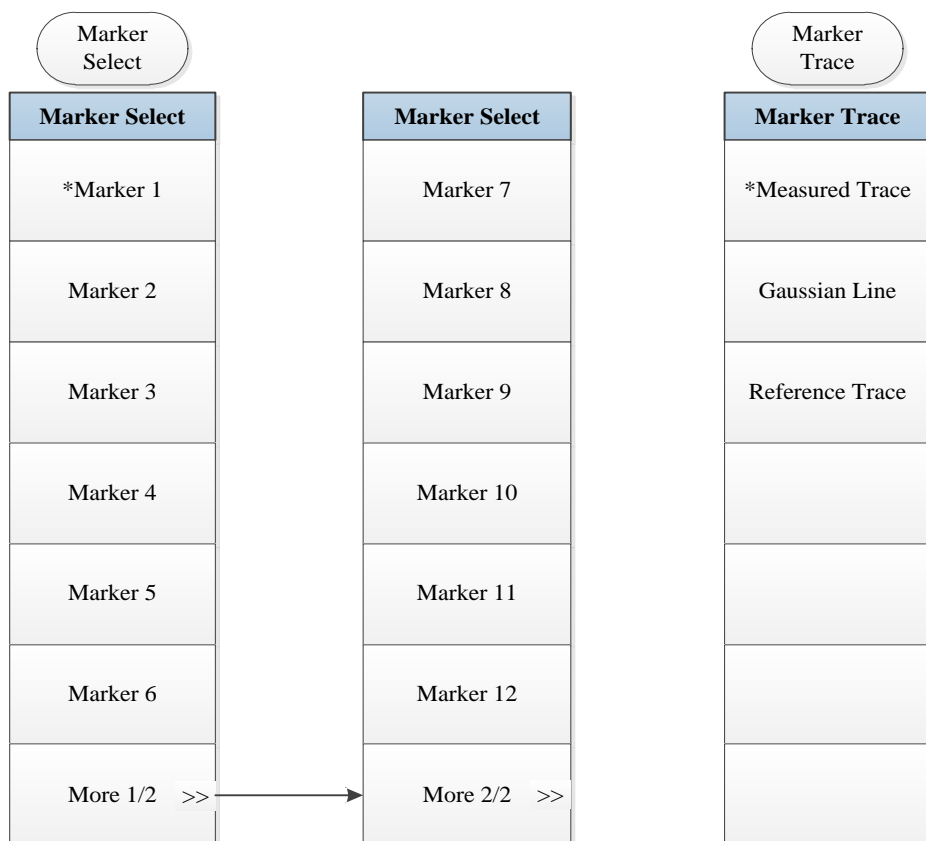
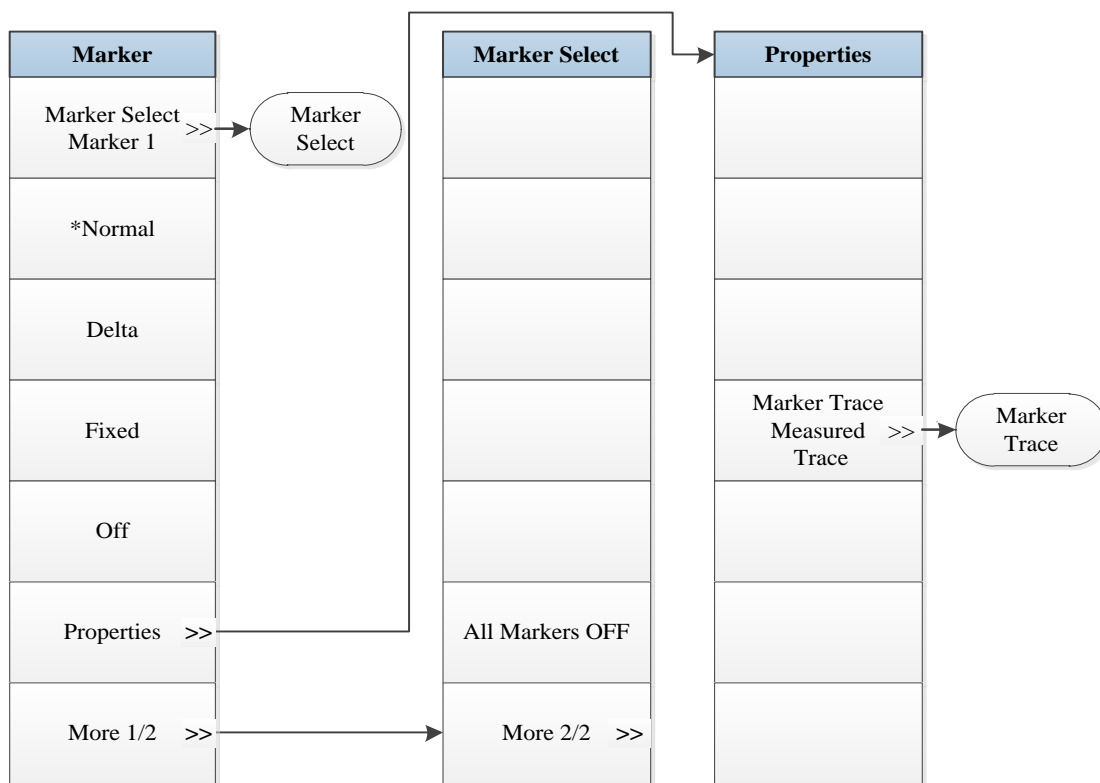

Fig. 5.6-12 Marker Menu

5.1.6.13 Maker->



Fig. 5.6-13 Marker->Menu

5.1 Menu structure

5.1.6.14 Marker Function

Marker Func

Fig. 5.6-14 Marker Function Menu

5.1.6.15 Peak Search

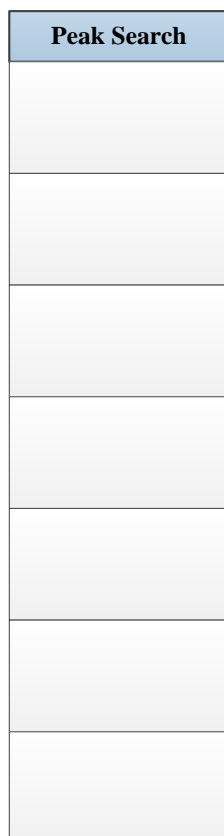

Fig. 5.6-15 Peak Search Menu

5.1 Menu structure

5.1.7 Burst Power

5.1.7.1 Frequency

Frequency
Center Freq 13.250000 GHz
CF Step 10.0000MHz <input checked="" type="radio"/> Auto <input type="radio"/> Man
Freq Offset 0.000000 GHz

Fig. 5.7-1 Frequency Menu

5.1.7.2 Ampld/Y Scale

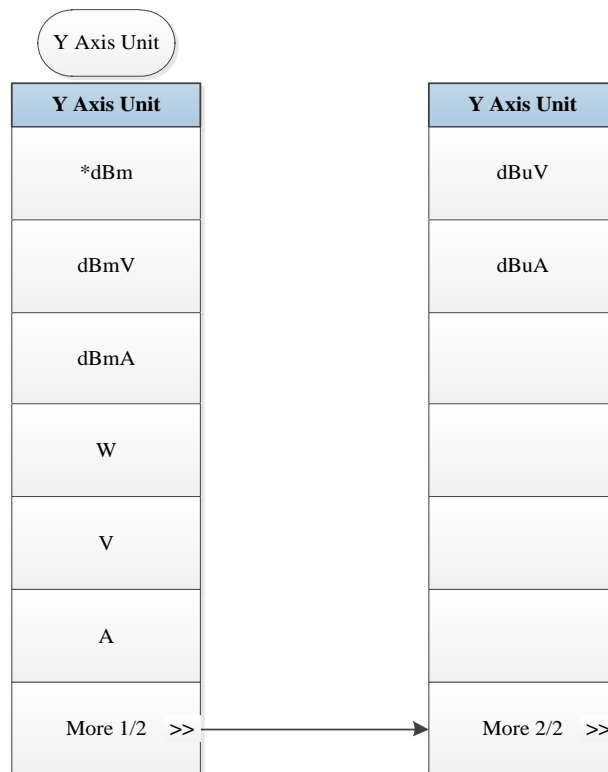
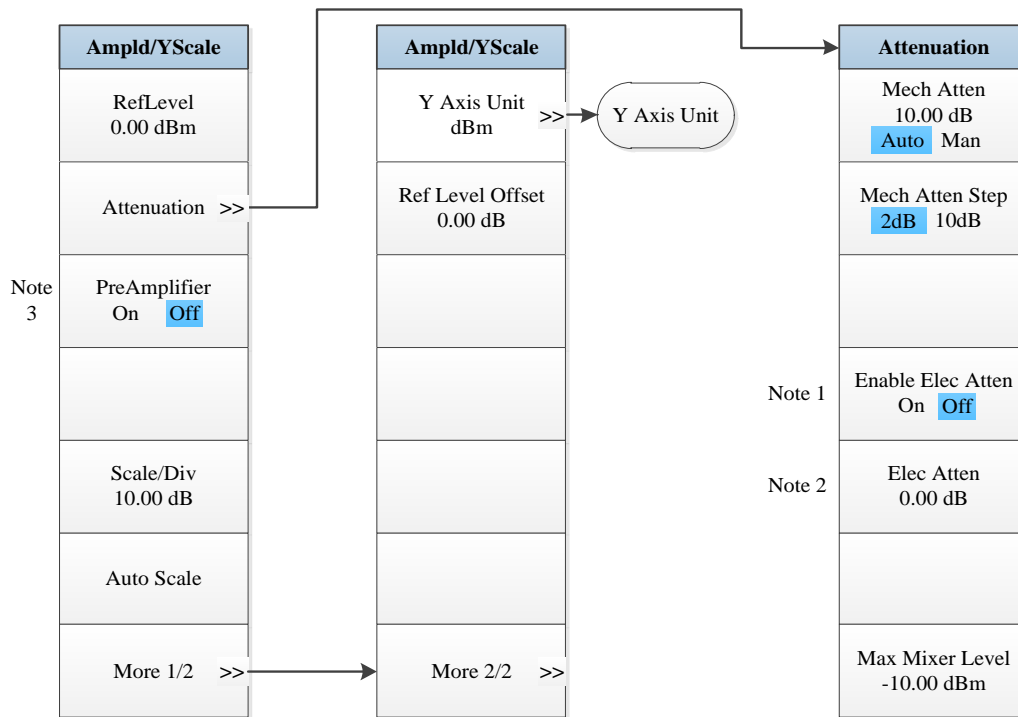

Note 1. this menu is only available when the H33 option (Elec Attenuator) is purchased.

Note 2. this menu is only available when the H33 option (Elec Attenuator) is purchased. **Note 3:** this menu is only available when the H34 option (Low Noise PreAmplifier) is purchased.

Fig. 5.7-2 Ampld/Y Scale Menu

5.1 Menu structure

5.1.7.3 Span/X Scale

Span

Fig. 5.7-3 Span Menu

5.1.7.4 Bandwidth

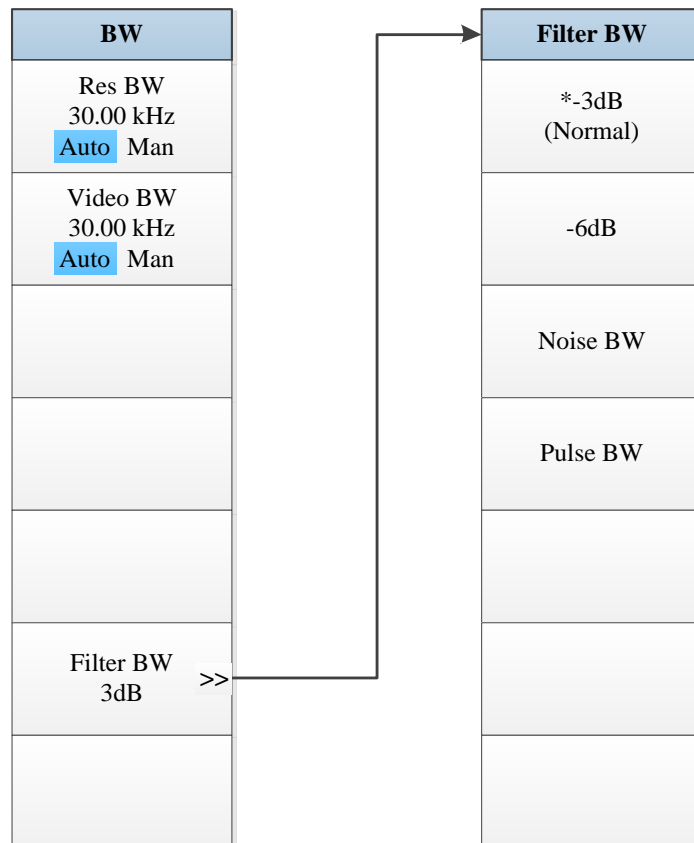

Fig. 5.7-4 Bandwidth Menu

5.1 Menu structure

5.1.7.5 Sweep

Sweep
Sweep Time 400.00 ms
<input checked="" type="radio"/> Auto <input type="radio"/> Man
Sweep Points 1001

Fig. 5.7-5 Sweep Menu

5.1.7.6 Trigger

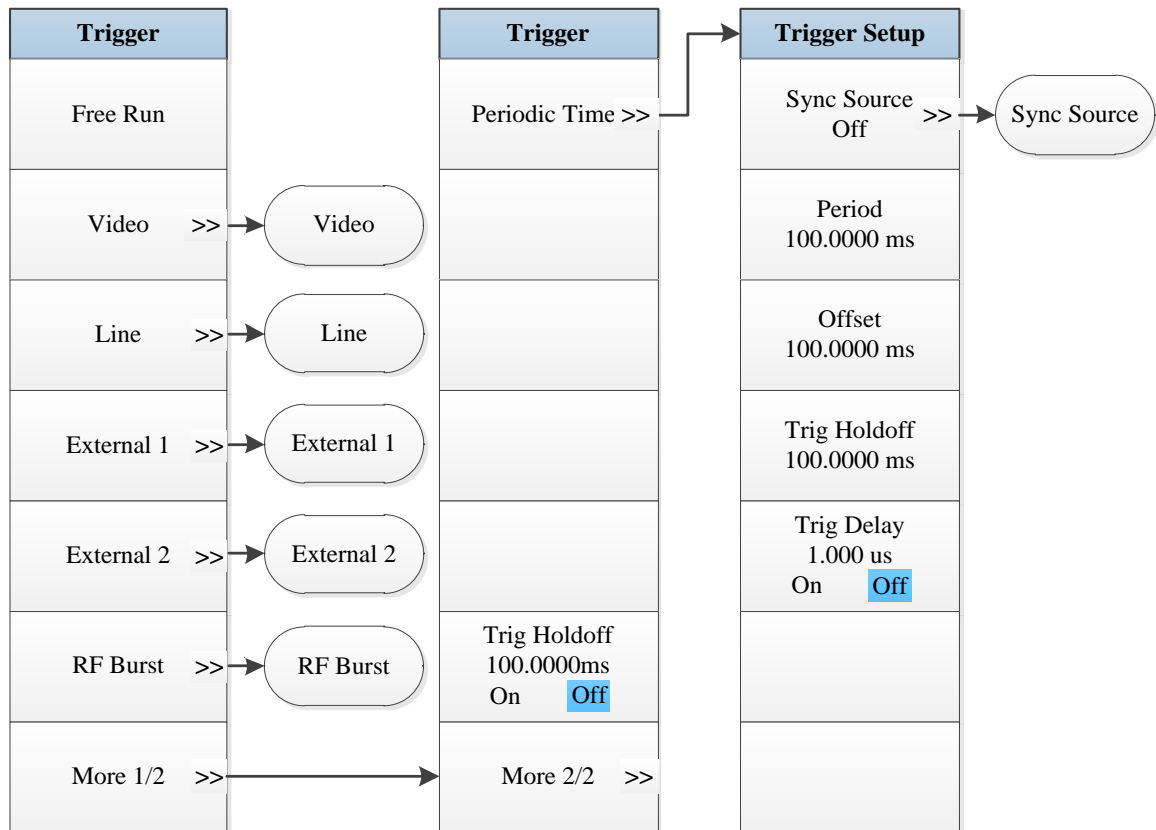

	RF Burst	External 2	External 1	Line	Video
Trigger Setup	Trigger Setup	Trigger Setup	Trigger Setup	Trigger Setup	Trigger Setup
Trigger level -25.00 dBm	Trigger level 1.2 V	Trigger level 1.2 V			Trigger level -25.00 dBm
Trig Slope Pos Neg	Trig Slope Pos Neg	Trig Slope Pos Neg			Trig Slope Pos Neg
Trig Delay 100.00 ms On Off	Trig Delay 100.00 ms On Off	Trig Delay 100.00 ms On Off			Trig Delay 100.00 ms On Off

5.1 Menu structure

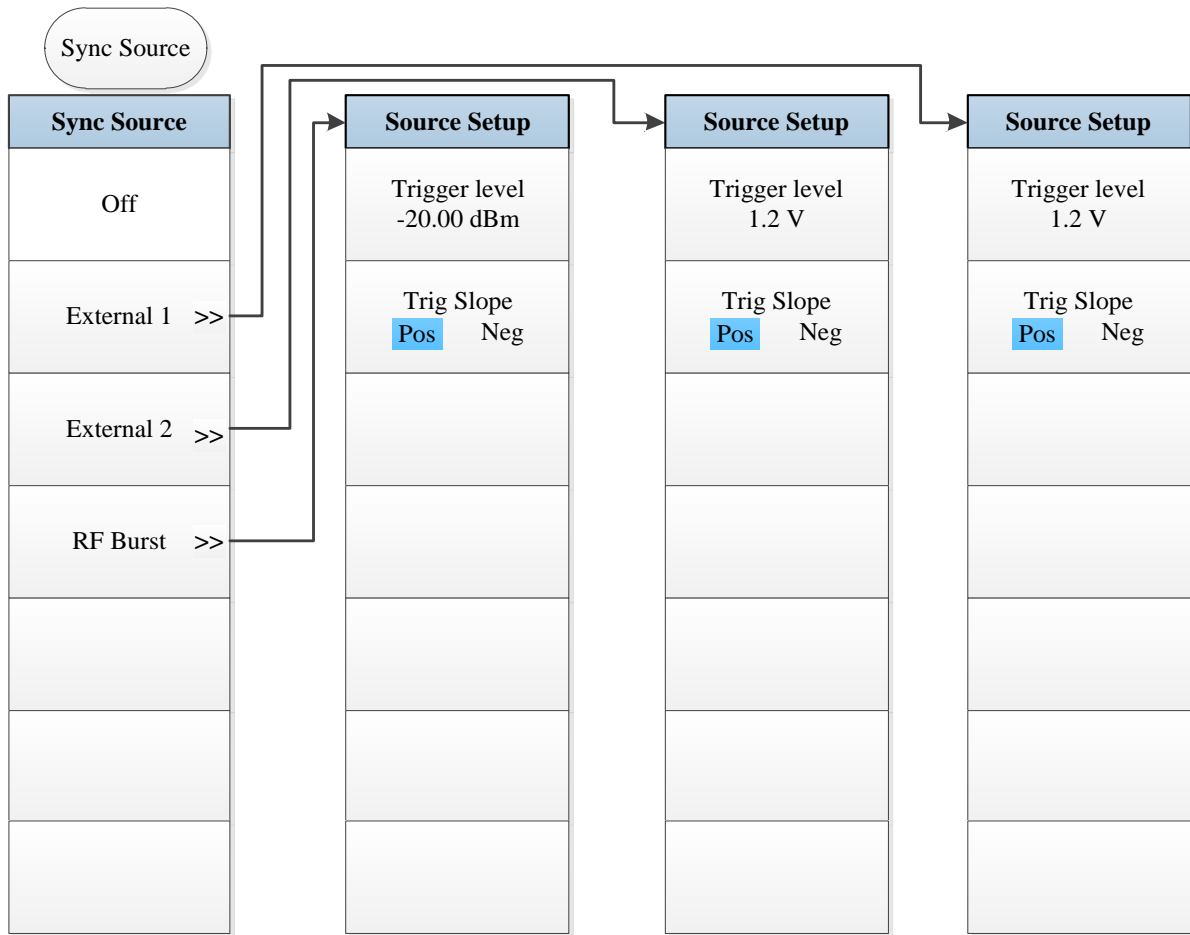

Fig. 5.7-6 Trigger Menu

5.1.7.7 Trace

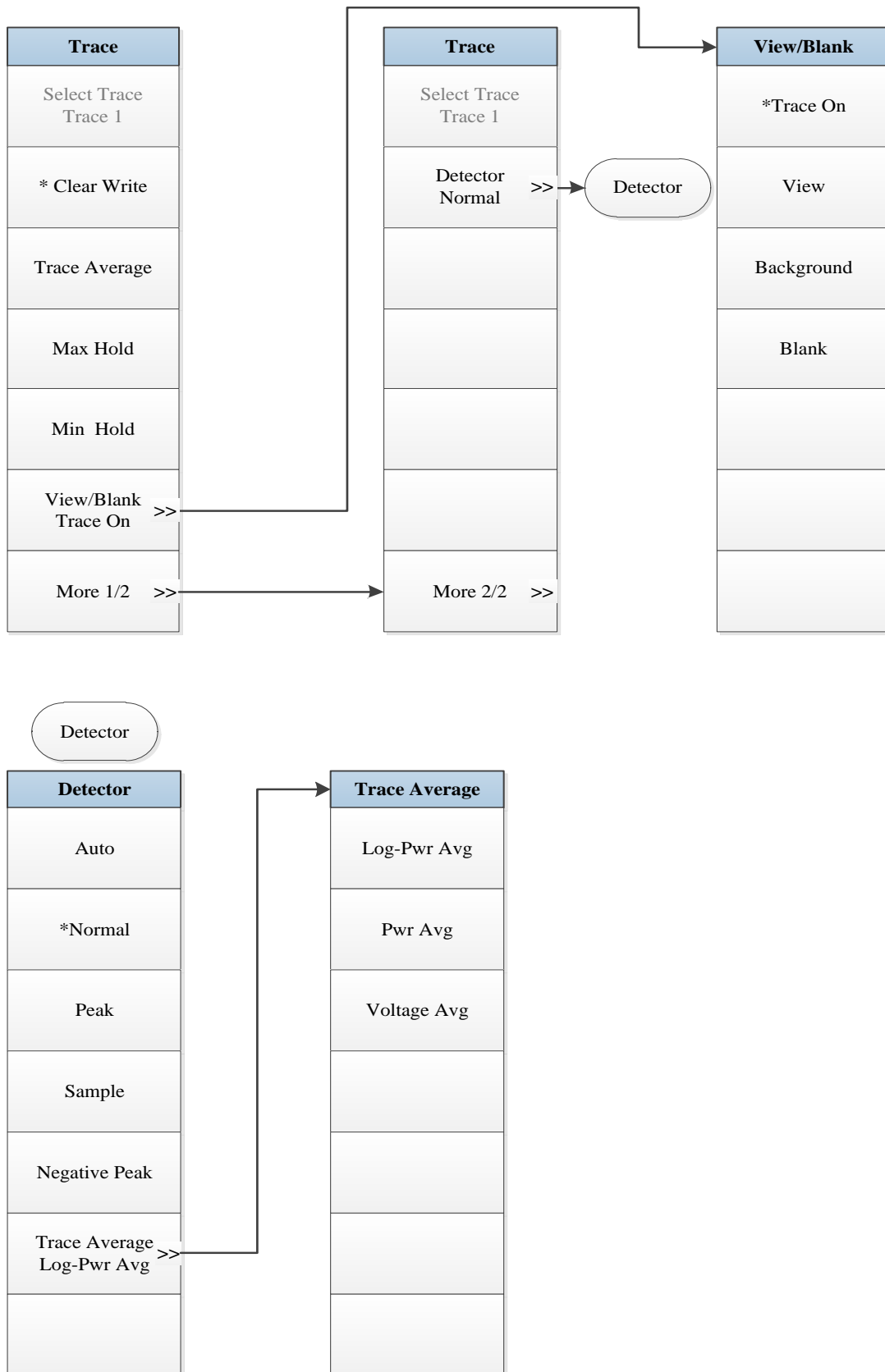
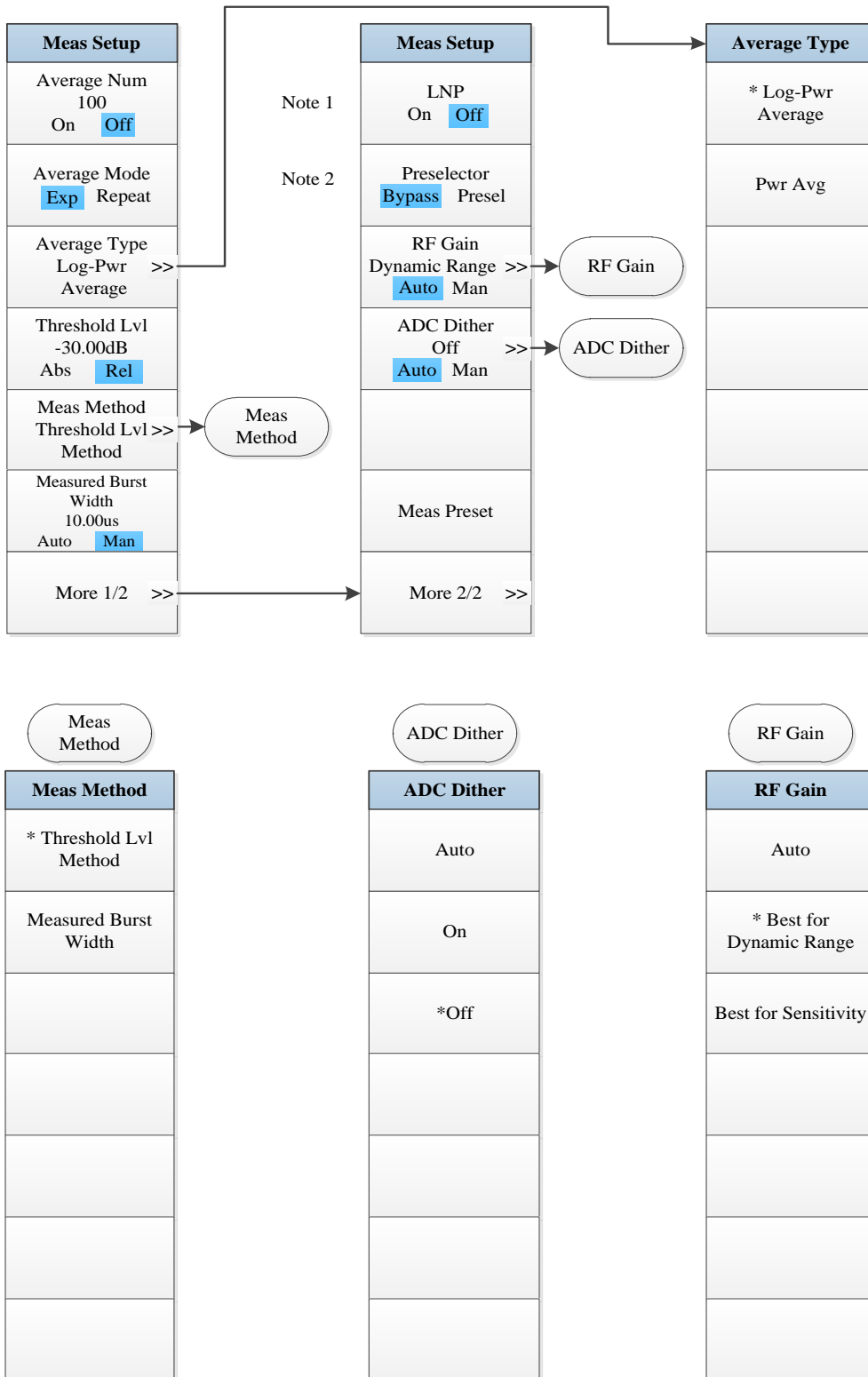

Fig. 5.7-7 Trace Menu

5.1 Menu structure

5.1.7.8 Measurement Setting



Note 1. this menu is only available when the H34 option (Low Noise PreAmplifier) is purchased. When the PreAmplifier is ON, the Low Noise Path is OFF and this menu is grayed out; when the PreAmplifier is OFF, this menu lights on and is switchable.

Note 2. this menu is only available when the H36 option (Preselector Bypass) is purchased.

Fig. 5.7-8 Measurement Setting Menu

5.1.7.9 Measurement Control

Meas Control
Measure Single Cont
Restart
Pause/Resume

Fig. 5.7-9 Measurement Control Menu

5.1 Menu structure

5.1.7.10 Auto Setting

Auto Set
Couple All
Mech Atten 10.00 dB Auto Man
Res BW 30.000kHz Auto Man
Video BW 30.000KHz Auto Man
Sweep Time 80.0000 ms Auto Man
CF Step 10.000MHz Auto Man

Fig. 5.7-10 Auto Setting Menu

5.1.7.11 Display

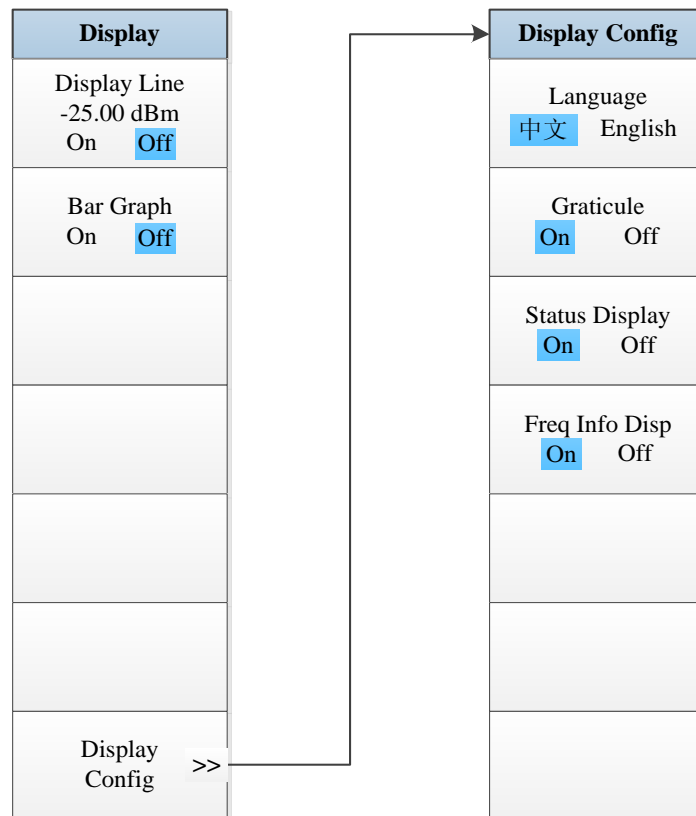

Fig. 5.7-11 Display Menu

5.1 Menu structure

5.1.7.12 Marker

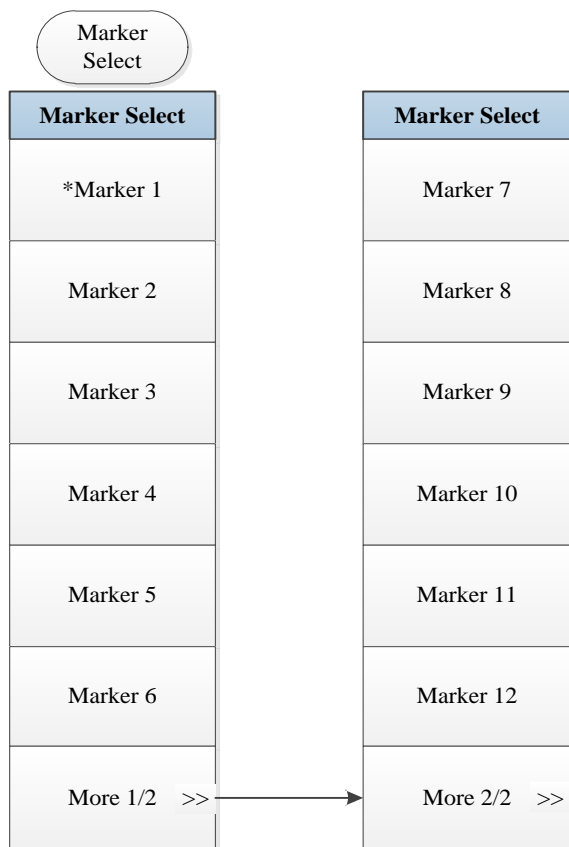
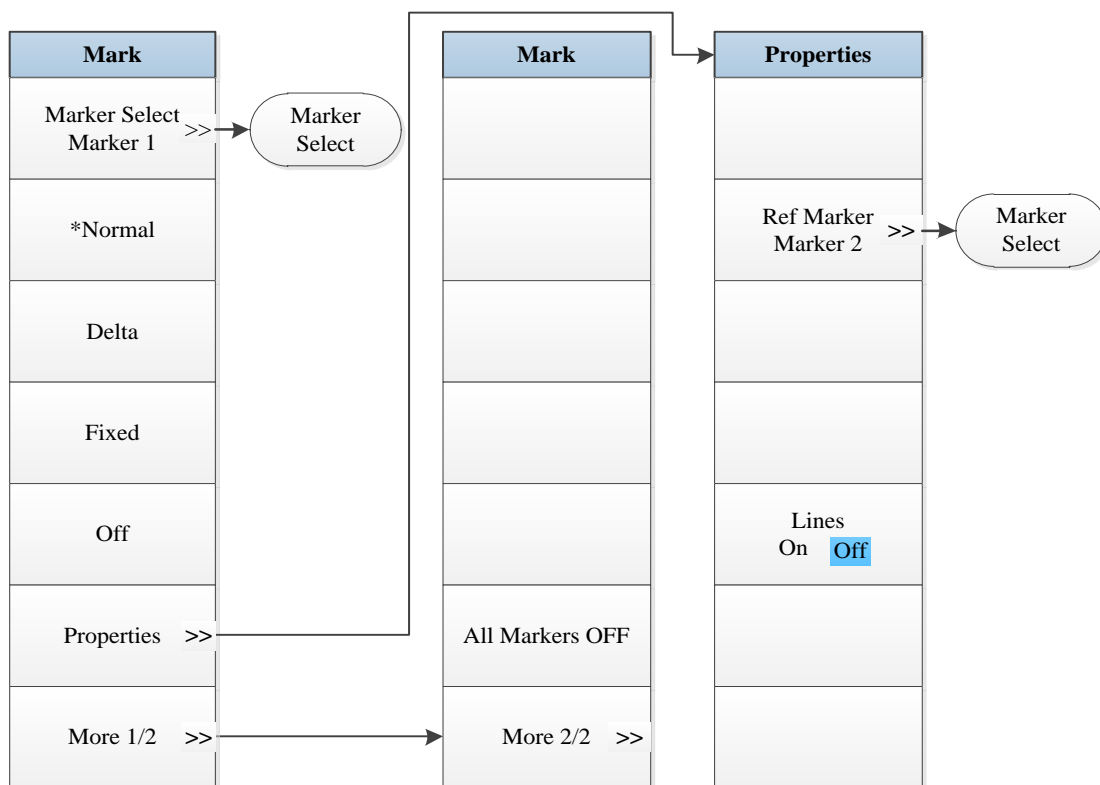

Fig. 5.7-12 Marker Menu

5.1.7.13 Maker->

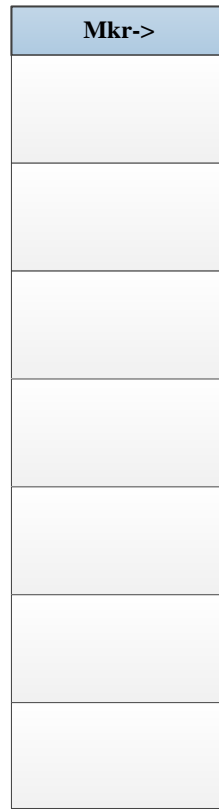

Fig. 5.7-13 Marker->Menu

5.1 Menu structure

5.1.7.14 Marker Function

Marker Func

Fig. 5.7-14 Marker Function Menu

5.1.7.15 Peak Search

Peak Search
Next Peak
Next Pk Right
Next Pk Left

Fig. 5.7-15 Peak Search Menu

5.1 Menu structure

5.1.8 Harmonic Distortion

5.1.8.1 Frequency

Frequency
Fundamental 13.250000 GHz <input checked="" type="radio"/> Auto <input type="radio"/> Man
CF Step 10.0000MHz <input checked="" type="radio"/> Auto <input type="radio"/> Man
Freq Offset 0.000000 GHz

Fig. 5.8-1 Frequency Menu

5.1.8.2 Ampld/Y Scale

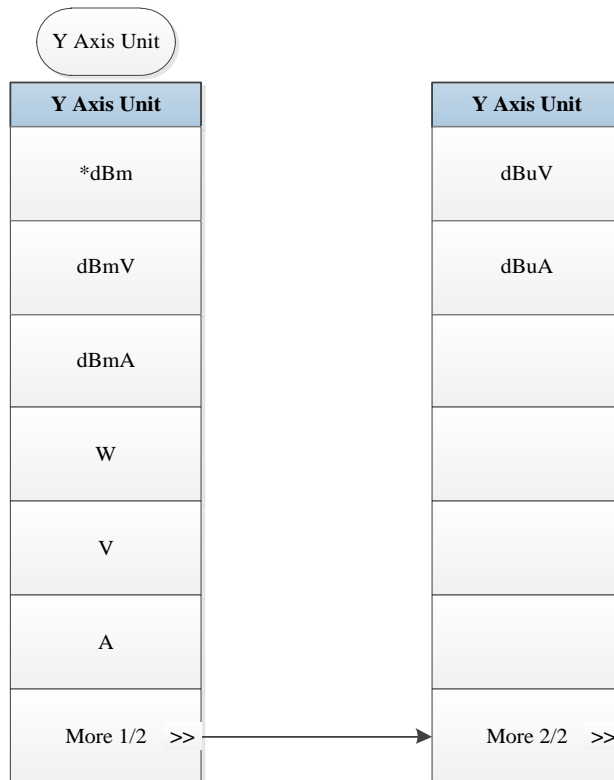
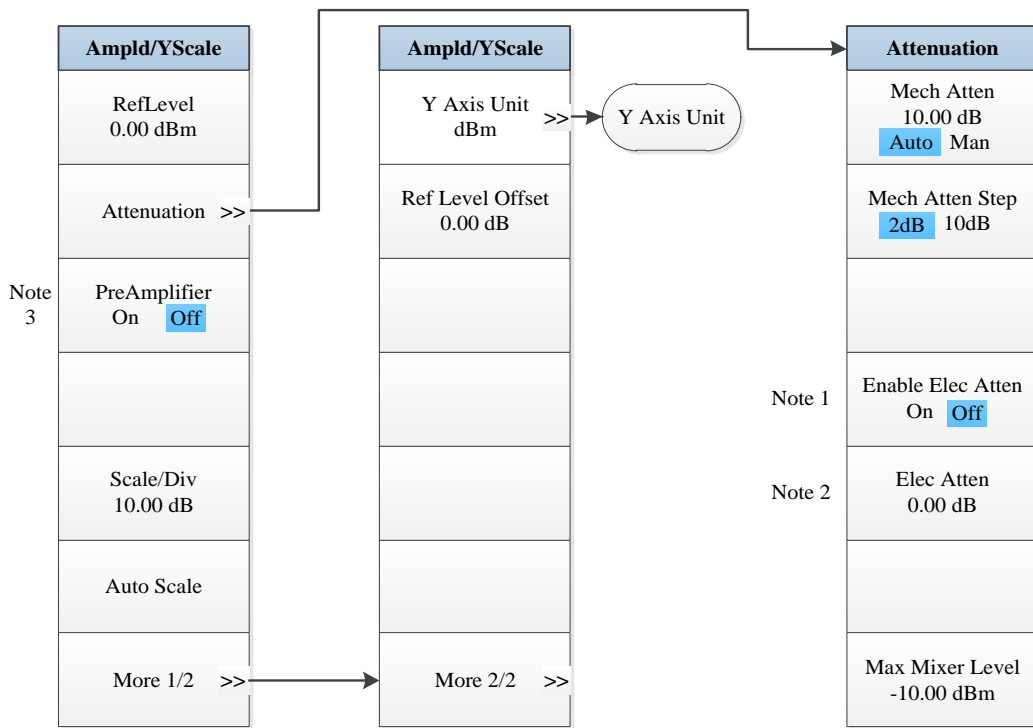

Note 1. this menu is only available when the H33 option (Elec Attenuator) is purchased.

Note 2. this menu is only available when the H33 option (Elec Attenuator) is purchased.

Note 3. this menu is only available when the H34 option (Low Noise PreAmplifier) is purchased.

Fig. 5.8-2 Ampld/Y Scale Menu

5.1 Menu structure

5.1.8.3 Span/X Scale

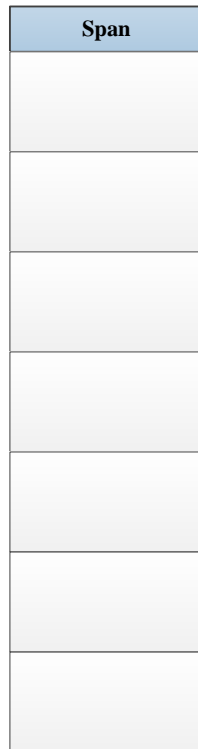

Fig. 5.8-3 Span Menu

5.1.8.4 Bandwidth

BW
Res BW 30.00 kHz Auto Man

Fig. 5.8-4 Bandwidth Menu

5.1 Menu structure

5.1.8.5 Sweep

Sweep
Sweep Time 400.00 ms Auto Man

Fig. 5.8-5 Sweep Menu

5.1.8.6 Trigger

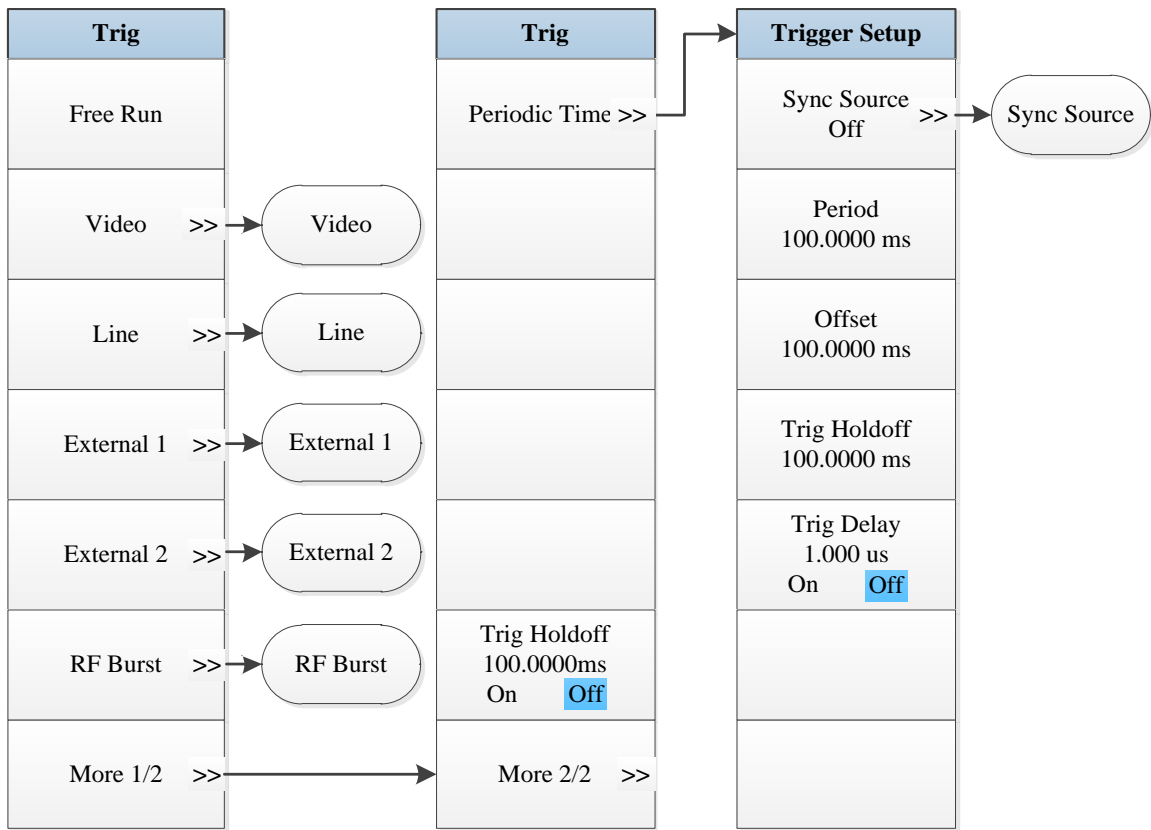

RF Burst	External 2	External 1	Line	Video
Trigger Setup	Trigger Setup	Trigger Setup	Trigger Setup	Trigger Setup
Trigger level -25.00 dBm	Trigger level 1.2 V	Trigger level 1.2 V		Trigger level -25.00 dBm
Trig Slope Pos Neg	Trig Slope Pos Neg	Trig Slope Pos Neg	Trig Slope Pos Neg	Trig Slope Pos Neg
Trig Delay 100.00 ms On Off	Trig Delay 100.00 ms On Off	Trig Delay 100.00 ms On Off	Trig Delay 100.00 ms On Off	Trig Delay 100.00 ms On Off

5.1 Menu structure

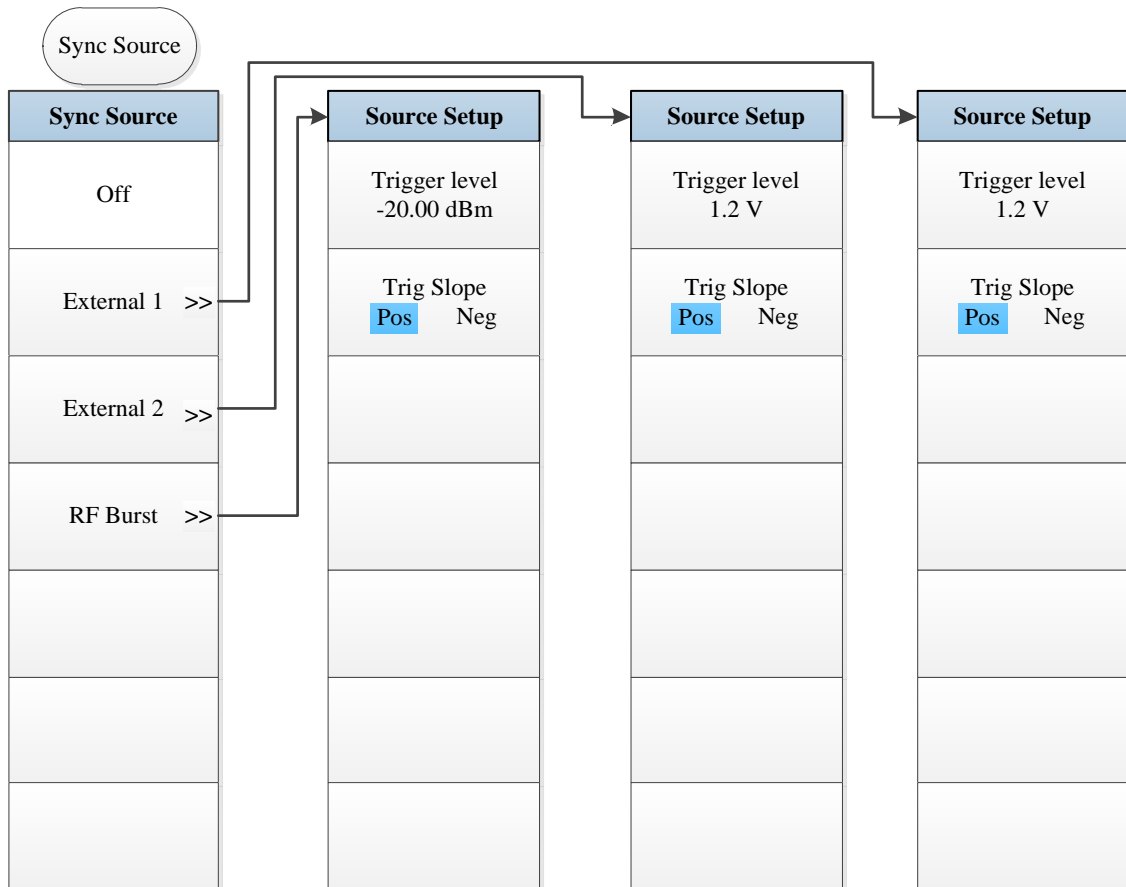

Fig. 5.8-6 Trigger Menu

5.1.8.7 Trace

Trace
Select Trace >> Trace 1
* Clear Write
Trace Average

Fig. 5.8-7 Trace Menu

5.1 Menu structure

5.1.8.8 Measurement Setting

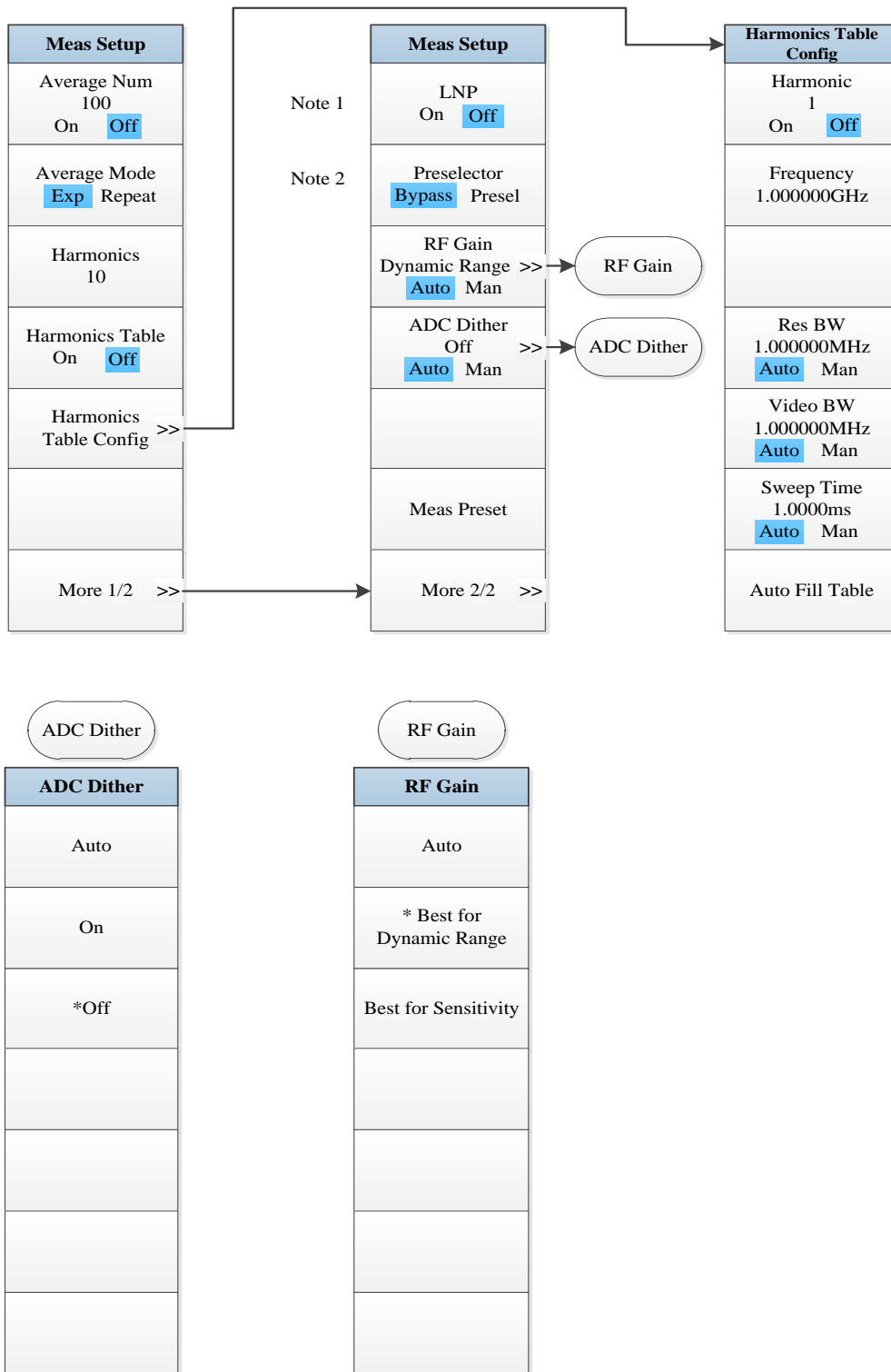

Note 1. this menu is only available when the H34 option (Low Noise PreAmplifier) is purchased. When the PreAmplifier is ON, the Low Noise Path is OFF and this menu is grayed out; when the PreAmplifier is OFF, this menu lights on and is switchable.

Note 2. this menu is only available when the H36 option (Preselector Bypass) is purchased.

Fig. 5.8-8 Measurement Setting Menu

5.1.8.9 Measurement Control

Meas Control
Measure Single Cont
Restart
Pause/Resume

Fig. 5.8-9 Measurement Control Menu

5.1 Menu structure

5.1.8.10 Auto Setting

Auto Set
Couple All
Mech Atten 10.00 dB Auto Man
Res BW 20.00 MHz Auto Man
Sweep Time 80.0000 ms Auto Man
Fundamental 13.250000 GHz Auto Man
CF Step 10.000 MHz Auto Man

Fig. 5.8-10 Auto Setting Menu

5.1.8.11 Display

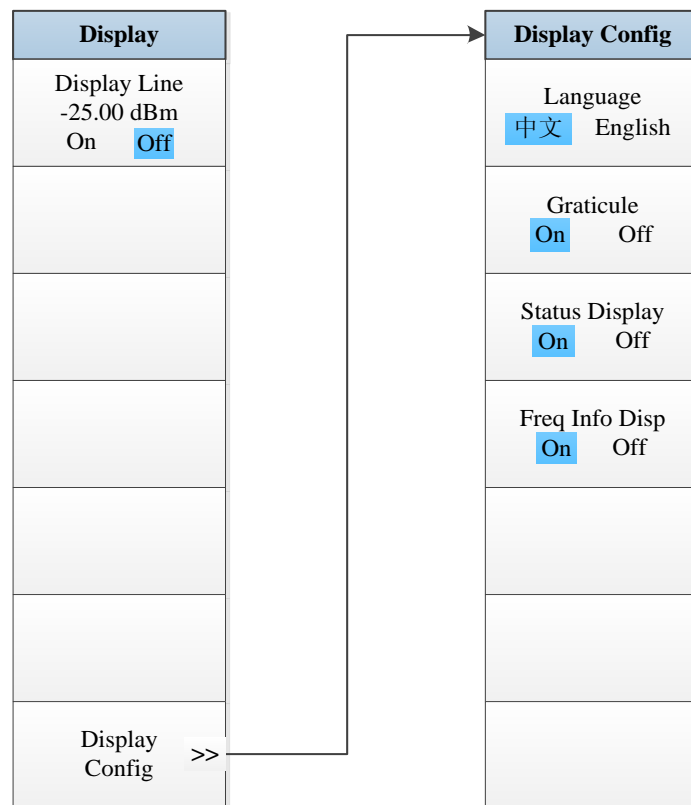

Fig. 5.8-11 Display Menu

5.1 Menu structure

5.1.8.12 Marker

Marker

Fig. 5.8-12 Marker Menu

5.1.8.13 Maker->

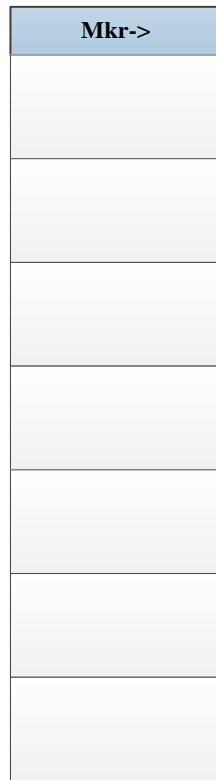

Fig. 5 8-13 Marker->Menu

5.1 Menu structure

5.1.8.14 Marker Function

Marker Func

Fig. 5.8-14 Marker Function Menu

5.1.8.15 Peak Search

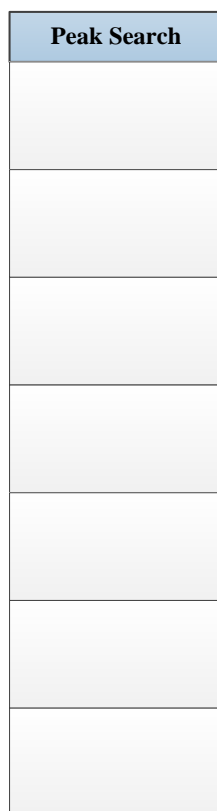

Fig. 5.8-15 Peak Search Menu

5.1 Menu structure

5.1.9 Three-order intermodulation (TOI)

5.1.9.1 Frequency

Frequency
Center Freq 13.25000 GHz
Lower Tone Freq 1.00000GHz Auto Man
Upper Tone Freq 1.25000GHz Auto Man
CF Step 10.0000MHz Auto Man
Freq Offset 0.00000 GHz

Fig. 5.9-1 Frequency Menu

5.1.9.2 Ampld/Y Scale

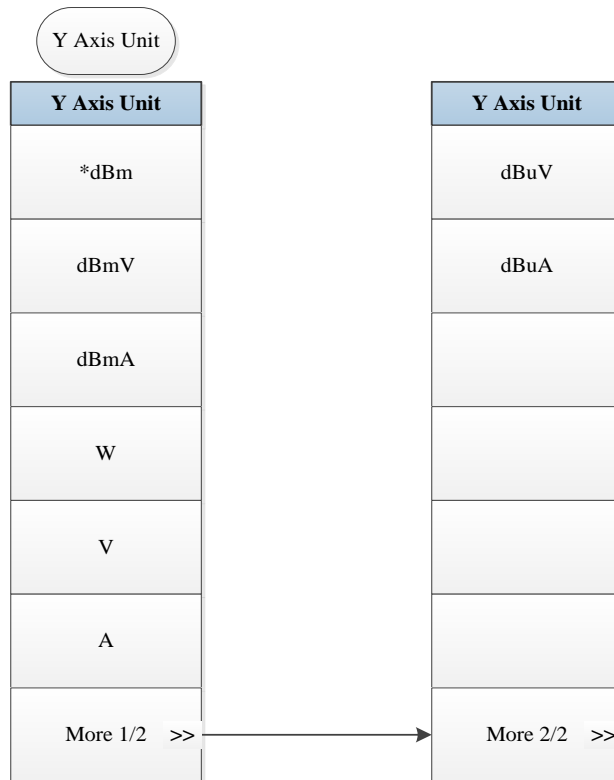
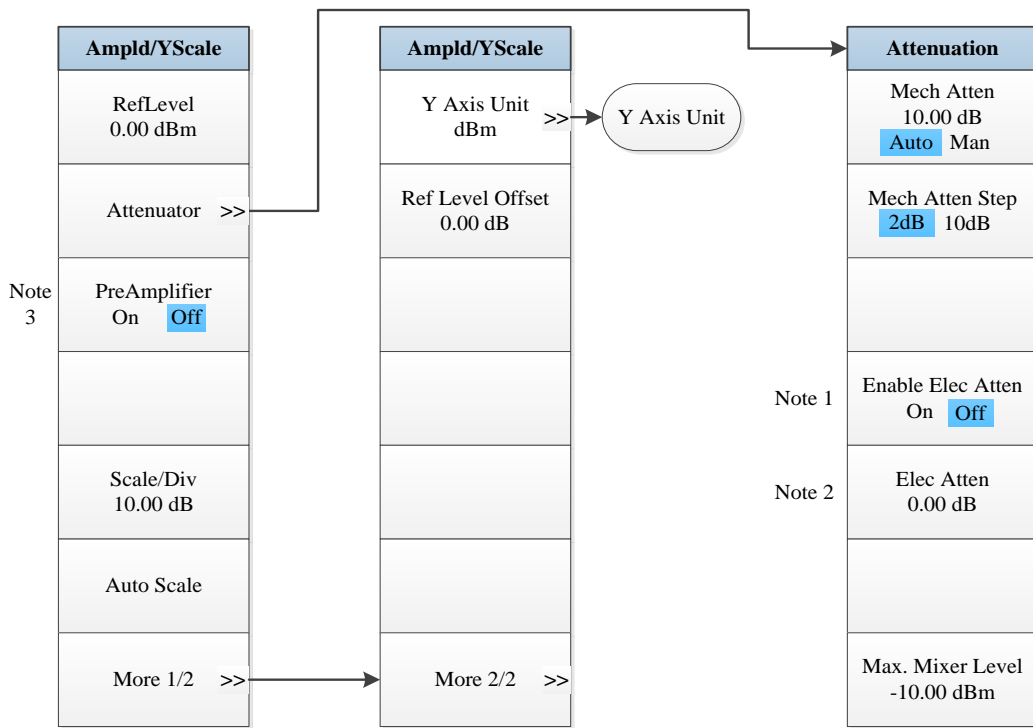

Note 1. this menu is only available when the H33 option (Elec Attenuator) is purchased.

Note 2. this menu is only available when the H33 option (Elec Attenuator) is purchased.

Note 3. this menu is only available when the H34 option (Low Noise PreAmplifier) is purchased.

Fig. 5.9-2 Ampld/Y Scale Menu

5.1 Menu structure

5.1.9.3 Span/X Scale

Span
Span 4.000000 GHz

Fig. 5.9-3 Span Menu

5.1.9.4 Bandwidth

BW
Res BW 30.00 kHz Auto Man
Video BW 30.00 kHz Auto Man
VBW/RBW 1.000 Auto Man
Span/RBW 106 Auto Man

Fig. 5.9-4 Bandwidth Menu

5.1 Menu structure

5.1.9.5 Sweep

Sweep
Sweep Time 400.00 ms Auto Man
Sweep Points 1001

Fig. 5.9-5 Sweep Menu

5.1.9.6 Trigger

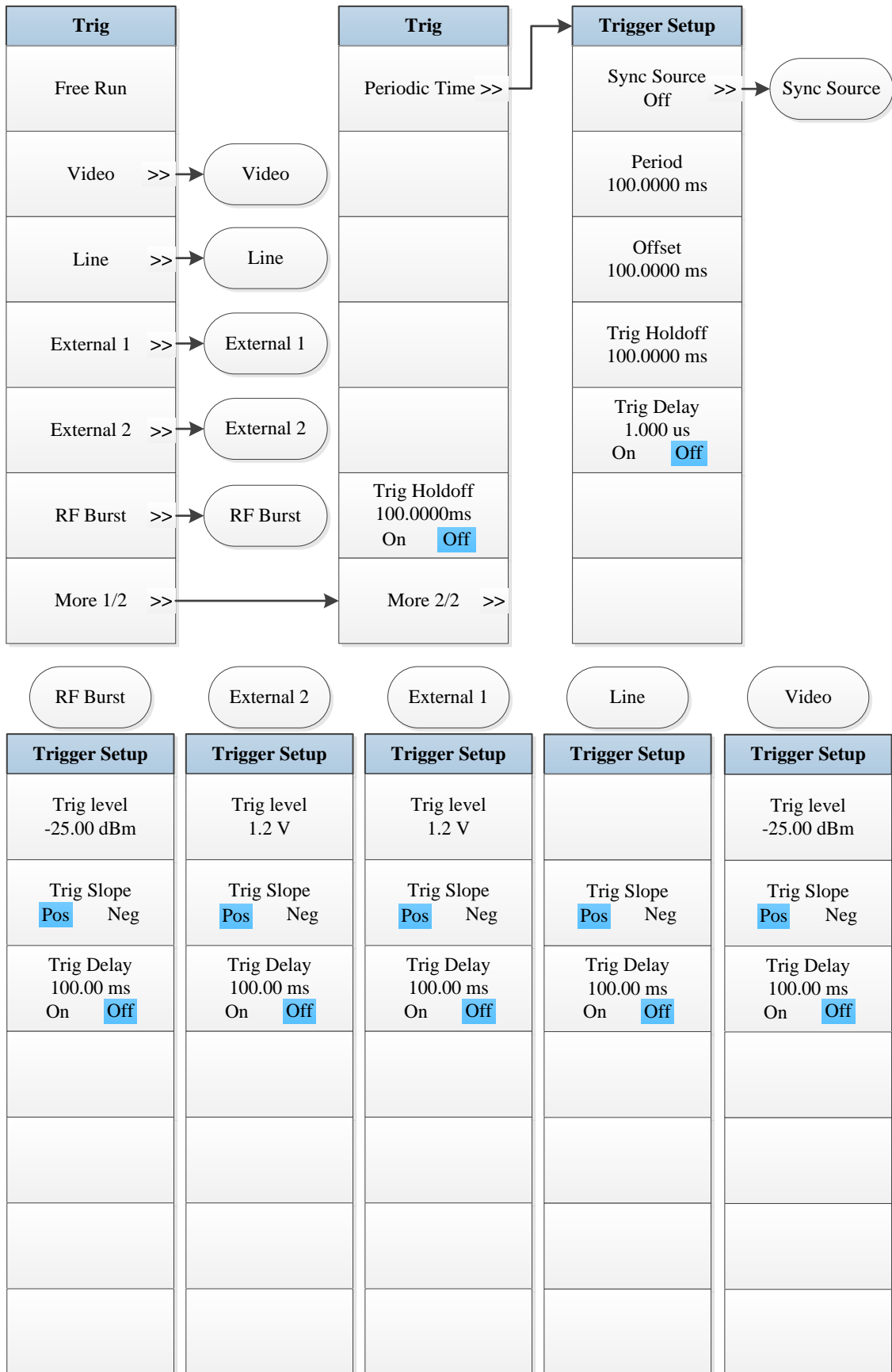

5.1 Menu structure

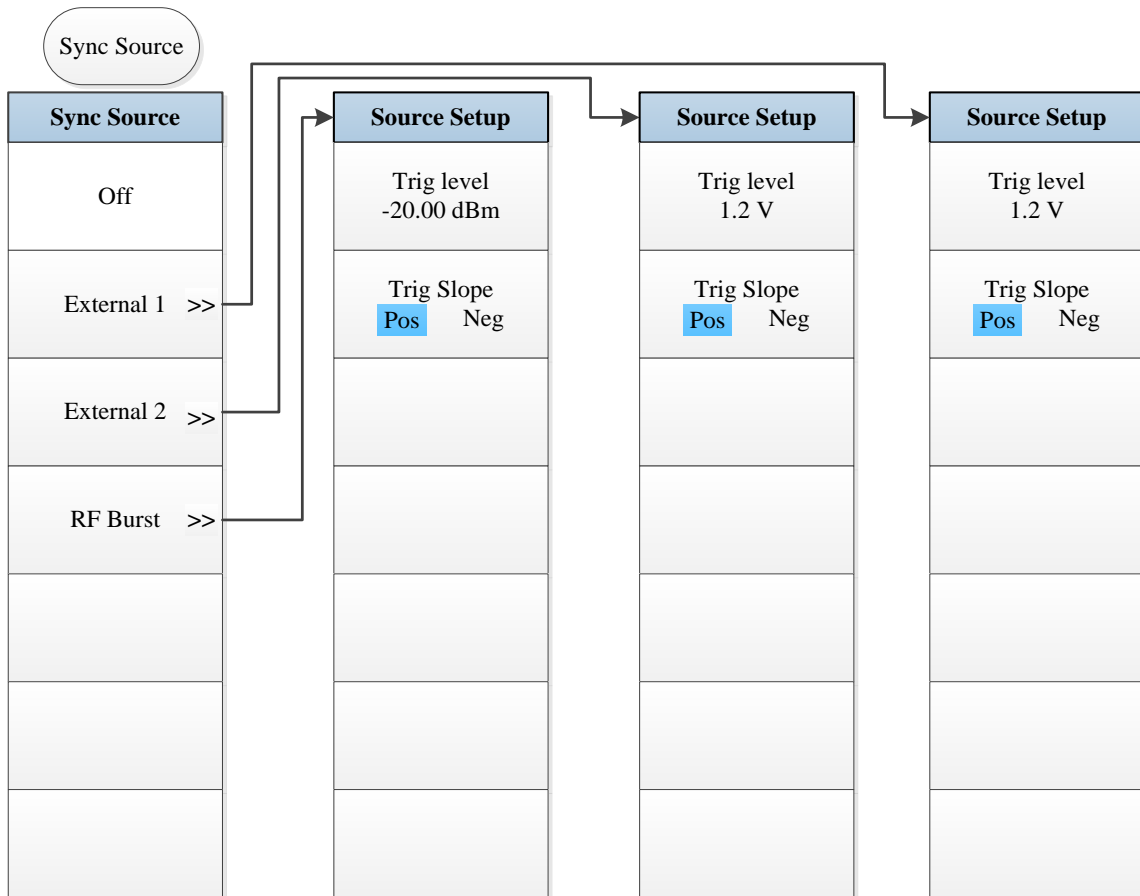

Fig. 5.9-6 Trigger Menu

5.1.9.7 Trace

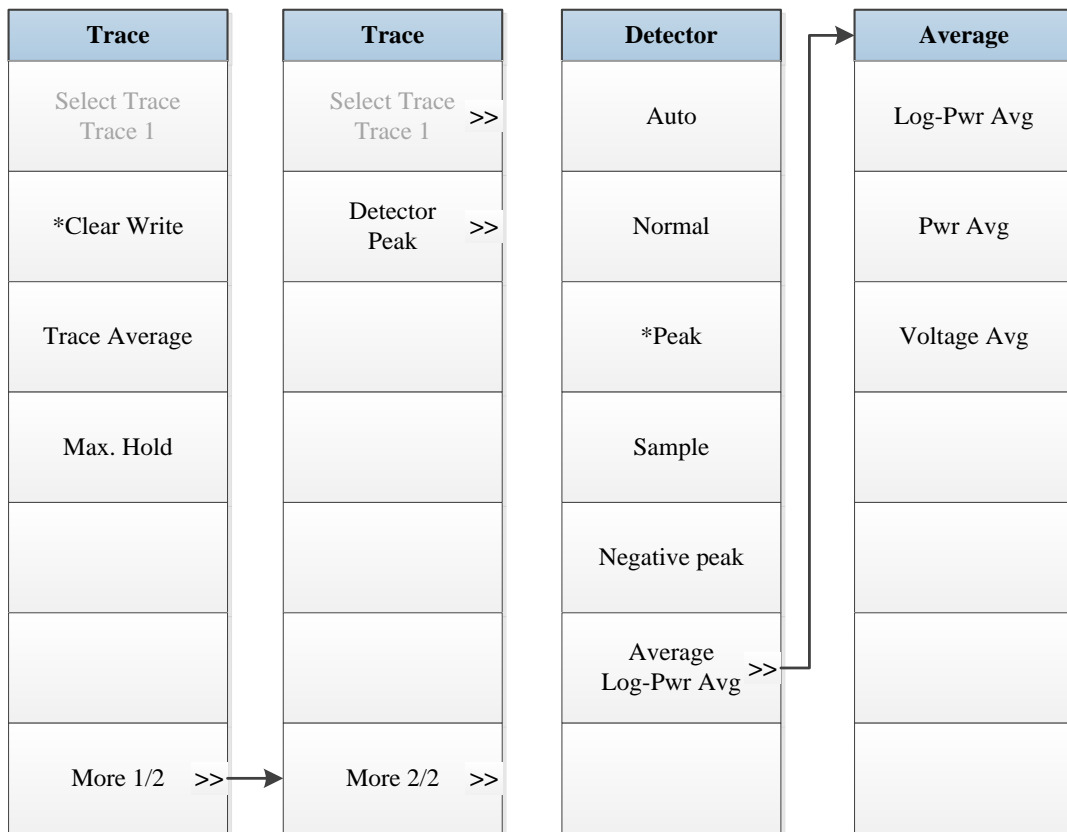
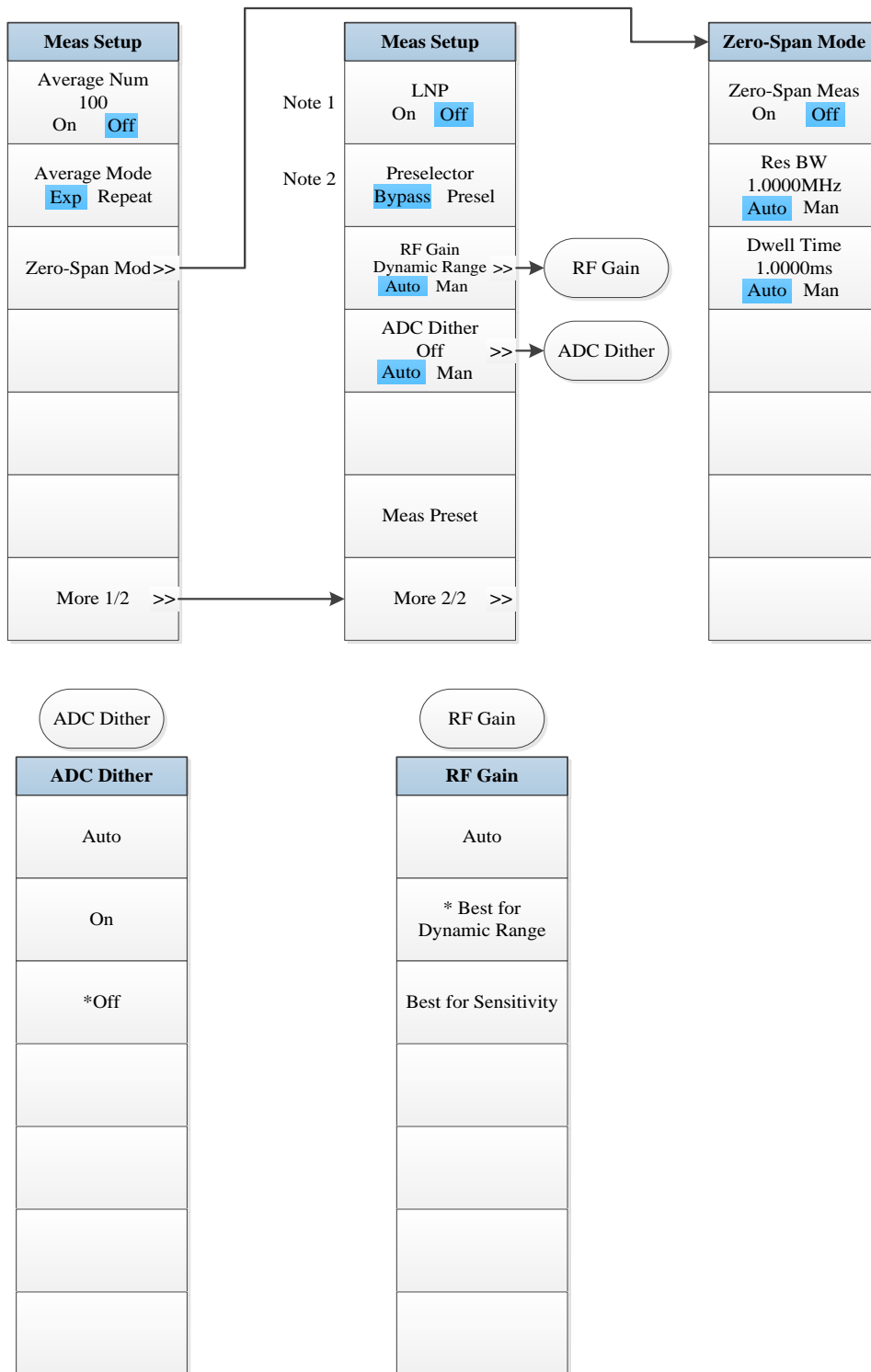

Fig. 5.9-7 Trace Menu

5.1 Menu structure

5.1.9.8 Measurement Setting



Note 1. this menu is only available when the H34 option (Low Noise PreAmplifier) is purchased. When the PreAmplifier is ON, the Low Noise Path is OFF and this menu is grayed out; when the PreAmplifier is OFF, this menu lights on and is switchable.

Note 2. this menu is only available when the H36 option (Preselector Bypass) is purchased.

Fig. 5.9-8 Measurement Setting Menu

5.1.9.9 Measurement Control

Meas Control
Measure Single Cont
Restart
Pause/Resume

Fig. 5.9-9 Measurement Control Menu

5.1 Menu structure

5.1.9.10 Auto Setting

Auto Set	Auto Set
Couple All	Sweep Time 80.0000 ms Auto Man
Mech Atten 10.00 dB Auto Man	Lower Tone Freq 1.000000GHz Auto Man
Res BW 20.00 MHz Auto Man	Upper Tone Freq 1.05000 0GHz Auto Man
Video BW 20.00 MHz Auto Man	CF Step 10.0000 MHz Auto Man
VBW/RBW 1.000000 Auto Man	
Span/RBW 106.000000 Auto Man	
More 1/2 >>	More 2/2 >>

Fig. 5.9-10 Auto Setting Menu

5.1.9.11 Display

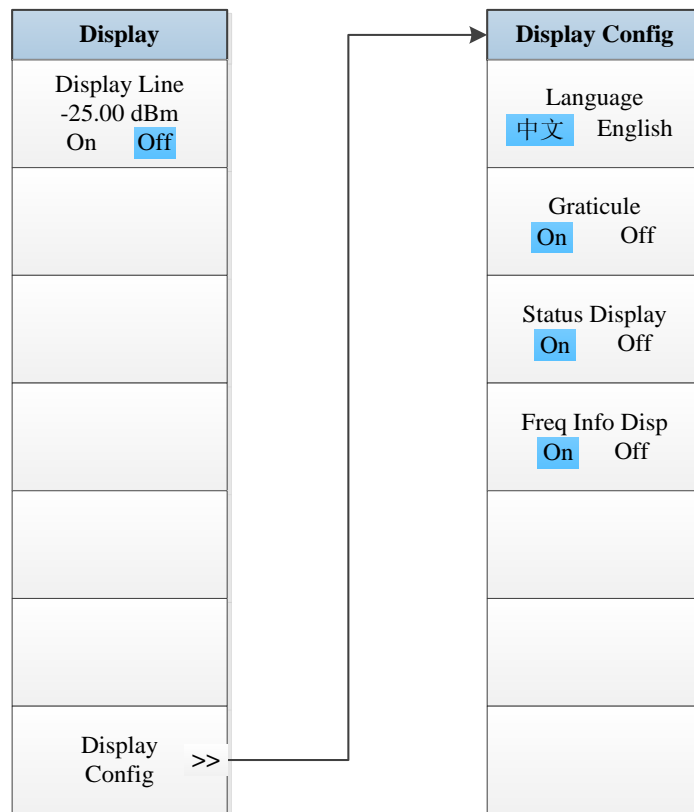

Fig. 5.9-11 Display Menu

5.1 Menu structure

5.1.9.12 Marker

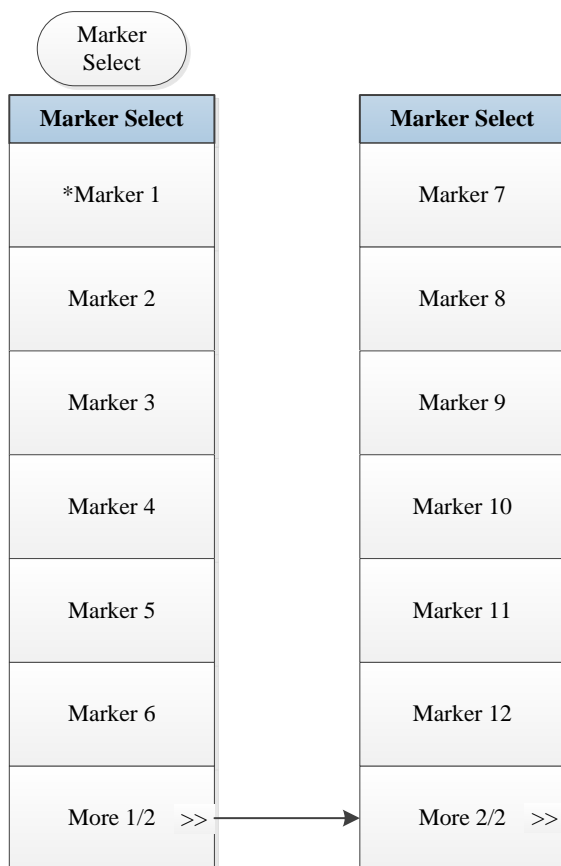
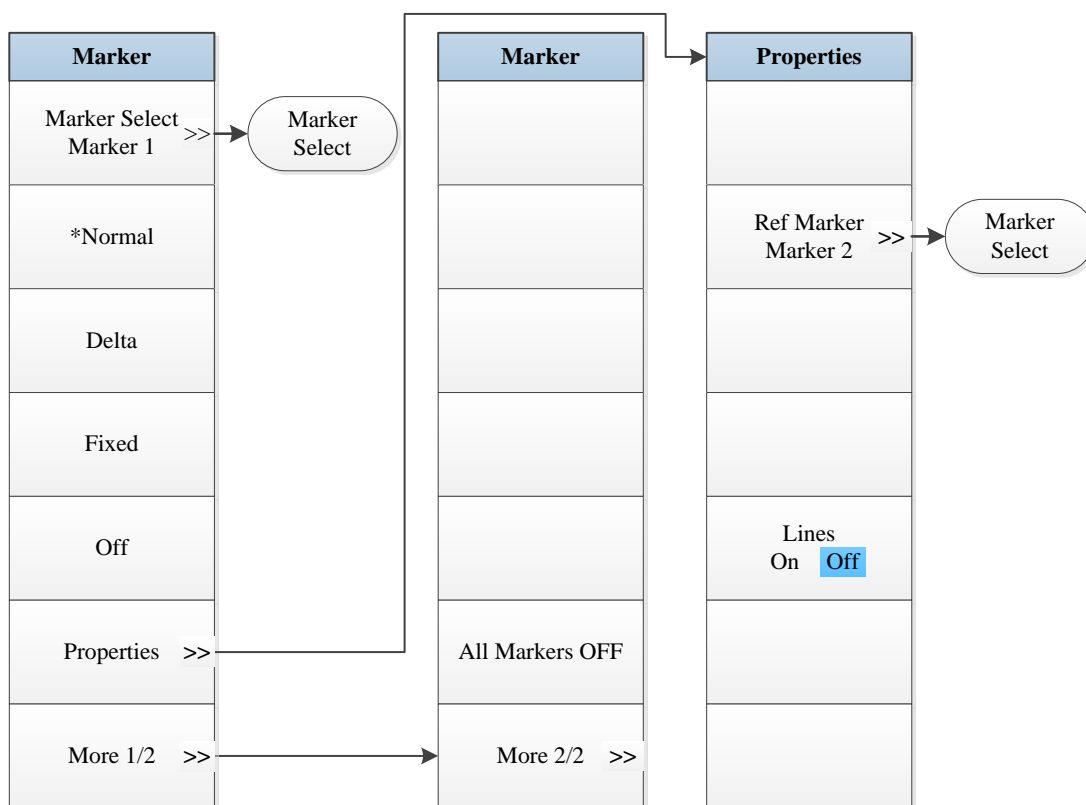

Fig. 5.9-12 Marker Menu

5.1.9.13 Maker->

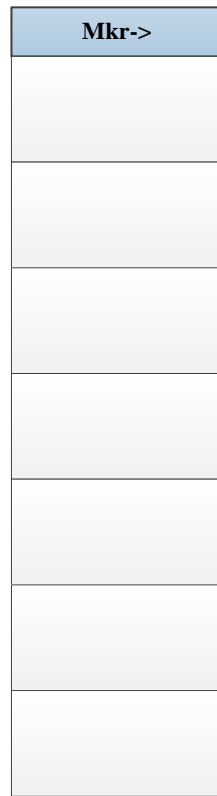

Fig. 5.9-13 Marker->Menu

5.1 Menu structure

5.1.9.14 Marker Function

Marker Func

Fig. 5.9-14 Marker Function Menu

5.1.9.15 Peak Search

Peak Search
Next Peak
Next Pk Right
Next Pk Left

Fig. 5.9-15 Peak Search Menu

5.1 Menu structure

5.1.10 Spurious emission

5.1.10.1 Frequency

Frequency

Fig. 5.10-1 Frequency Menu

5.1.10.2 AmpI/Y Scale

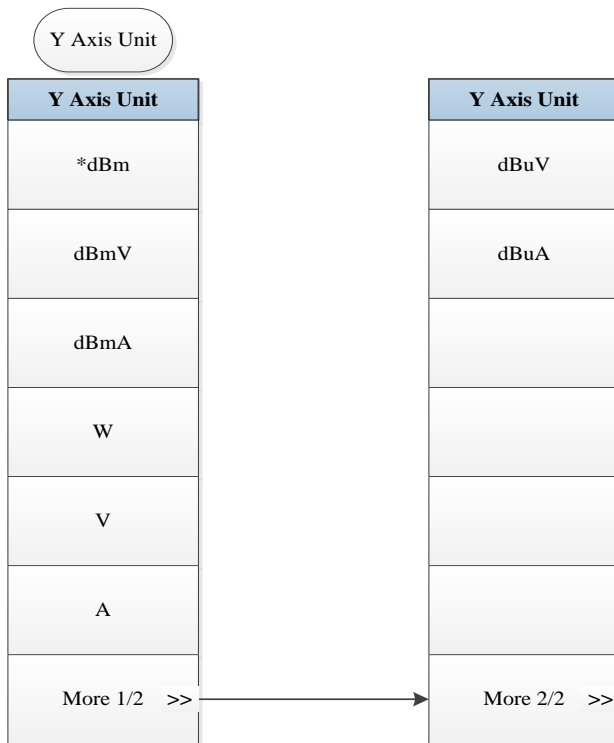
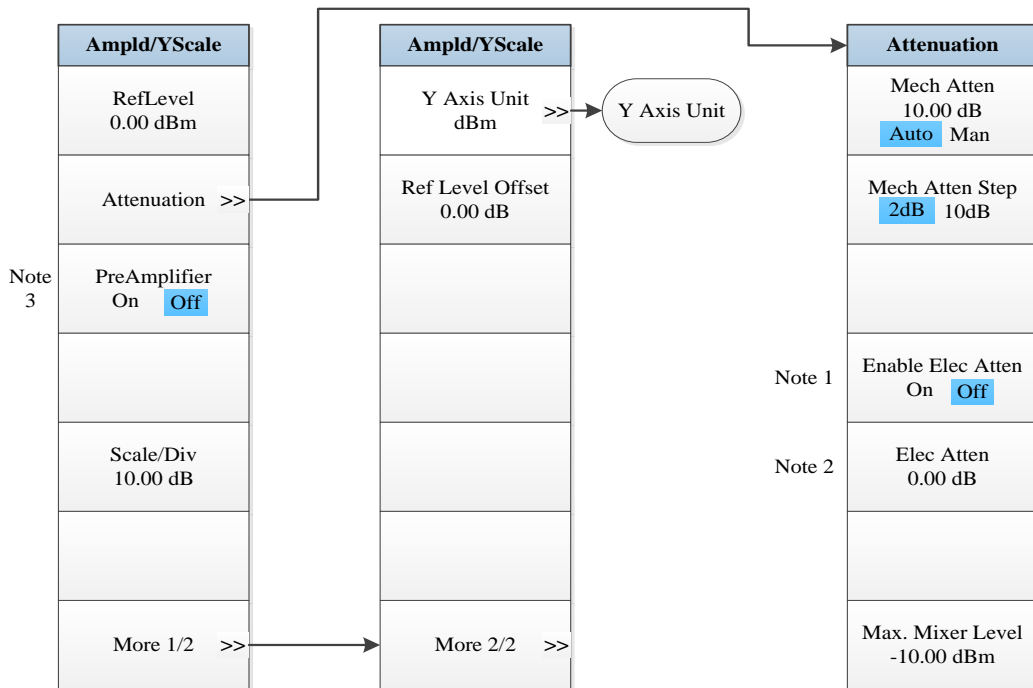

Note 1. this menu is only available when the H33 option (Elec Attenuator) is purchased.

Note 2. this menu is only available when the H33 option (Elec Attenuator) is purchased.

Note 3. this menu is only available when the H34 option (Low Noise PreAmplifier) is purchased.

Fig. 5.10-2 AmpI/Y Scale Menu

5.1 Menu structure

5.1.10.3 Span/X Scale

Span

Fig. 5.10-3 Span Menu

5.1.10.4 Bandwidth

BW

Fig. 5.10-4 Bandwidth Menu

5.1 Menu structure

5.1.10.5 Sweep

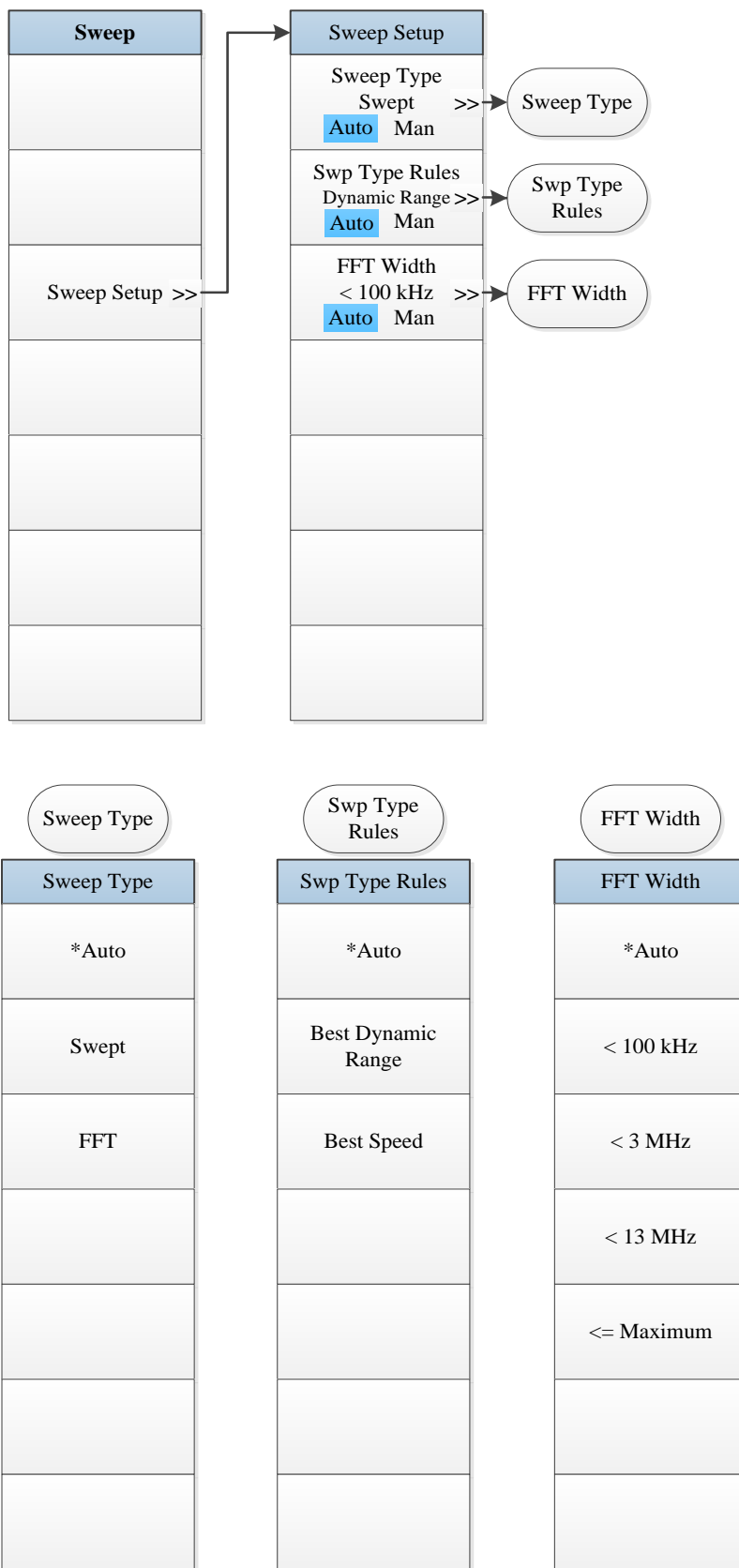
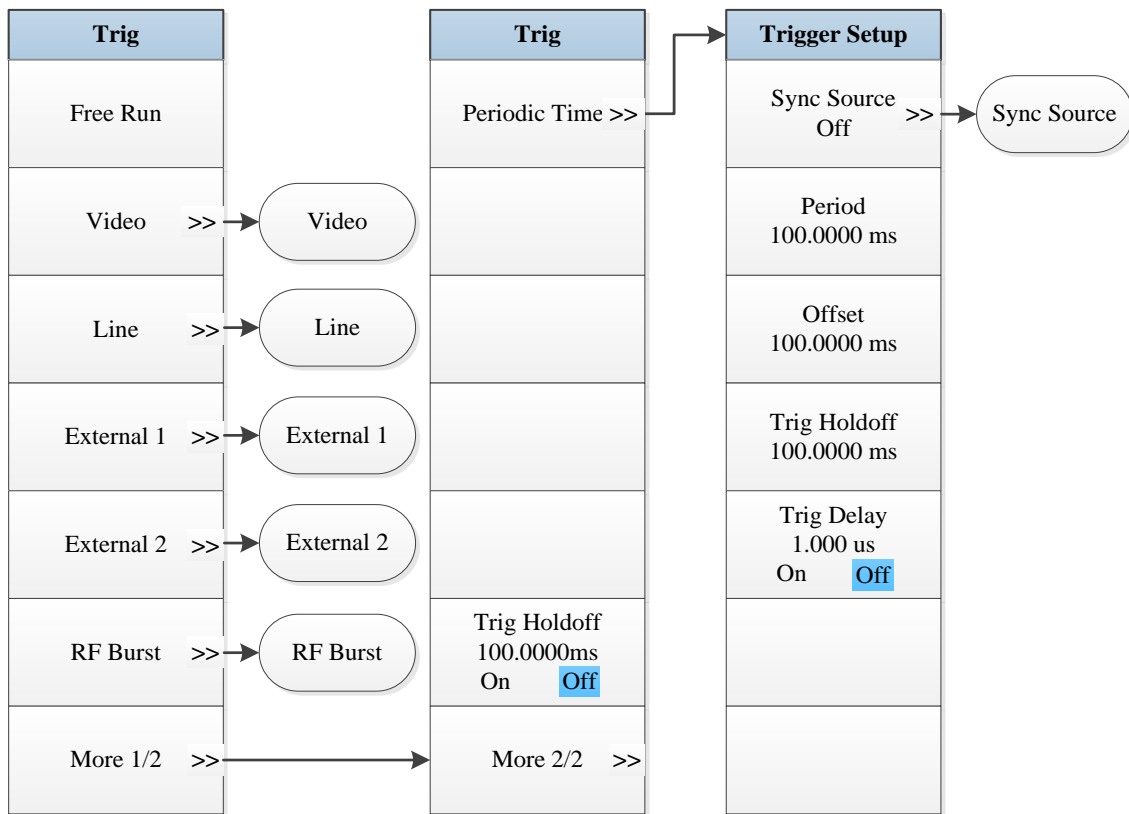

Fig. 5.10-5 Sweep Menu

5.1.10.6 Trigger



RF Burst	External 2	External 1	Line	Video
Trigger Setup	Trigger Setup	Trigger Setup	Trigger Setup	Trigger Setup
Trigger Level -25.00 dBm	Trigger Level 1.2 V	Trigger Level 1.2 V		Trigger Level -25.00 dBm
Trig Slope Pos Neg	Trig Slope Pos Neg	Trig Slope Pos Neg	Trig Slope Pos Neg	Trig Slope Pos Neg
Trig Delay 100.00 ms On Off	Trig Delay 100.00 ms On Off	Trig Delay 100.00 ms On Off	Trig Delay 100.00 ms On Off	Trig Delay 100.00 ms On Off

5.1 Menu structure

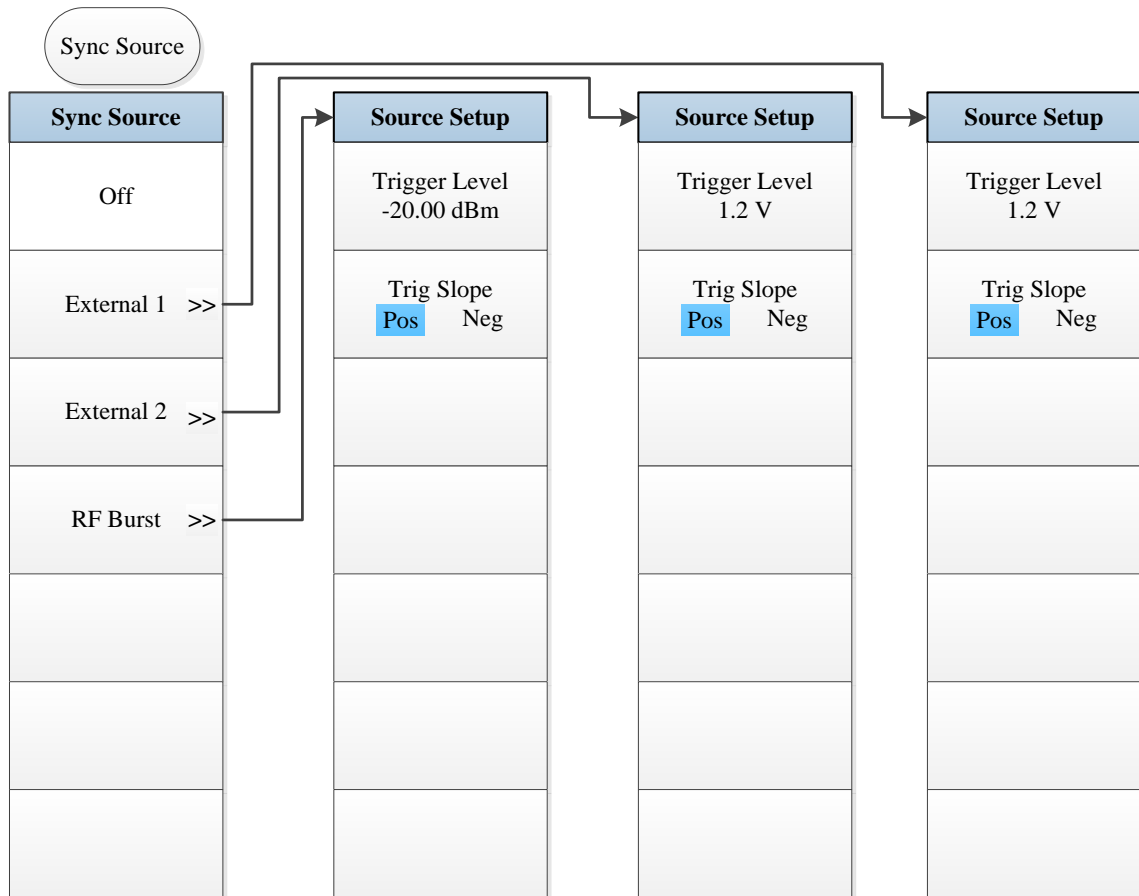

Fig. 5.10-6 Trigger Menu

5.1.10.7 Trace

Trace

Fig. 5.10-7 Trace Menu

5.1 Menu structure

5.1.10.8 Measurement Setting

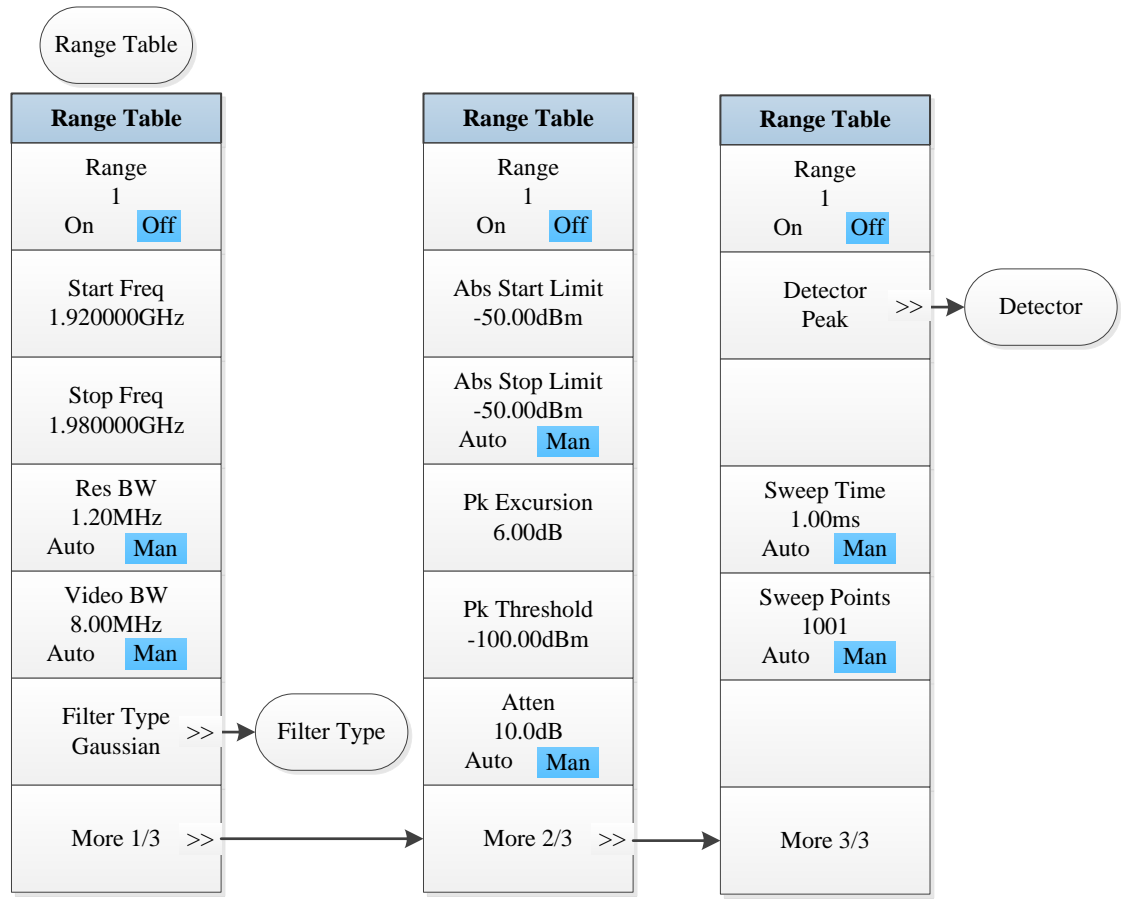
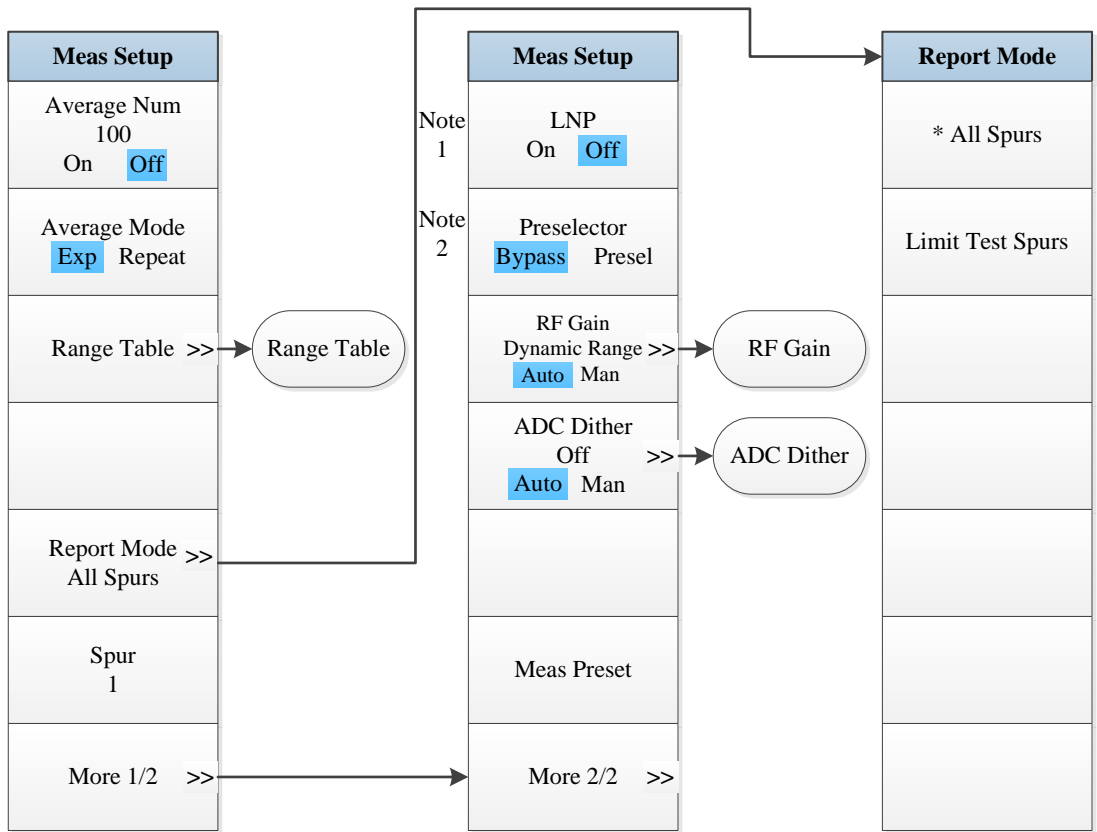

5.1 Menu structure

ADC Dither	RF Gain	Detector	Filter Type
Auto	Auto	Normal	* Gaussian
On	* Best for Dynamic Range	Average	Flattop
*Off	Best for Sensitivity	* Peak	
		Sample	
		Negative peak	

Note 1. this menu is only available when the H34 option (Low Noise PreAmplifier) is purchased. When the PreAmplifier is ON, the Low Noise Path is OFF and this menu is grayed out; when the PreAmplifier is OFF, this menu lights on and is switchable.

Note 2. this menu is only available when the H36 option (Preselector Bypass) is purchased.

Fig. 5.10-8 Measurement Setting Menu

5.1 Menu structure

5.1.10.9 Measurement Control

Meas Control
Measure Single Cont
Restart
Pause/Resume

Fig. 5.10-9 Measurement Control Menu

5.1.10.10 Auto Setting

Auto Set
Couple All

Fig. 5.10-10 Auto Setting Menu

5.1 Menu structure

5.1.10.11 Display

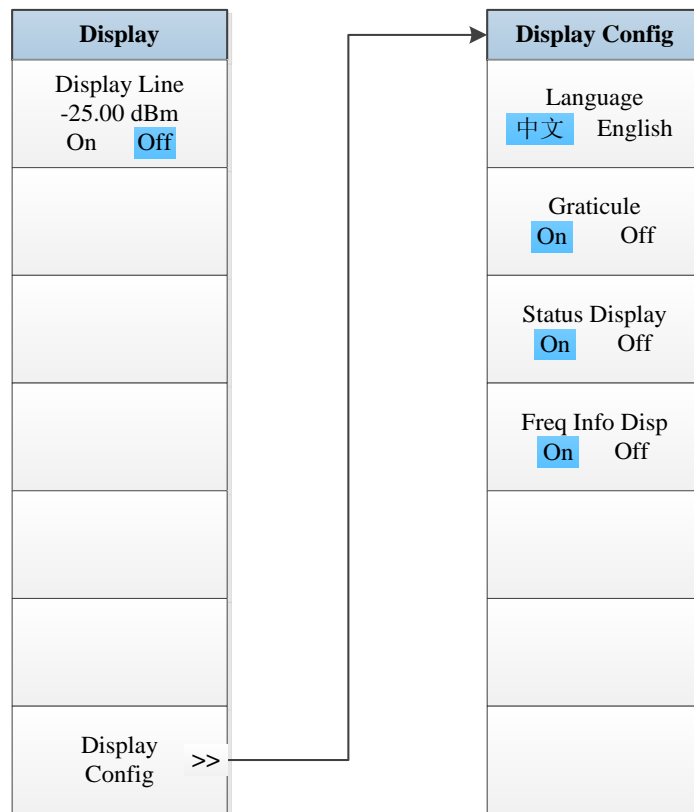

Fig. 5.10-11 Display Menu

5.1.10.12 Marker

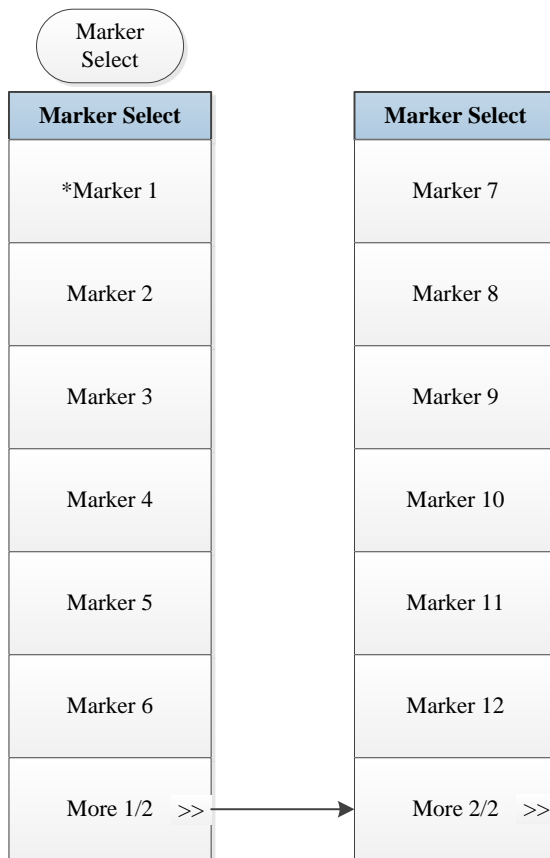
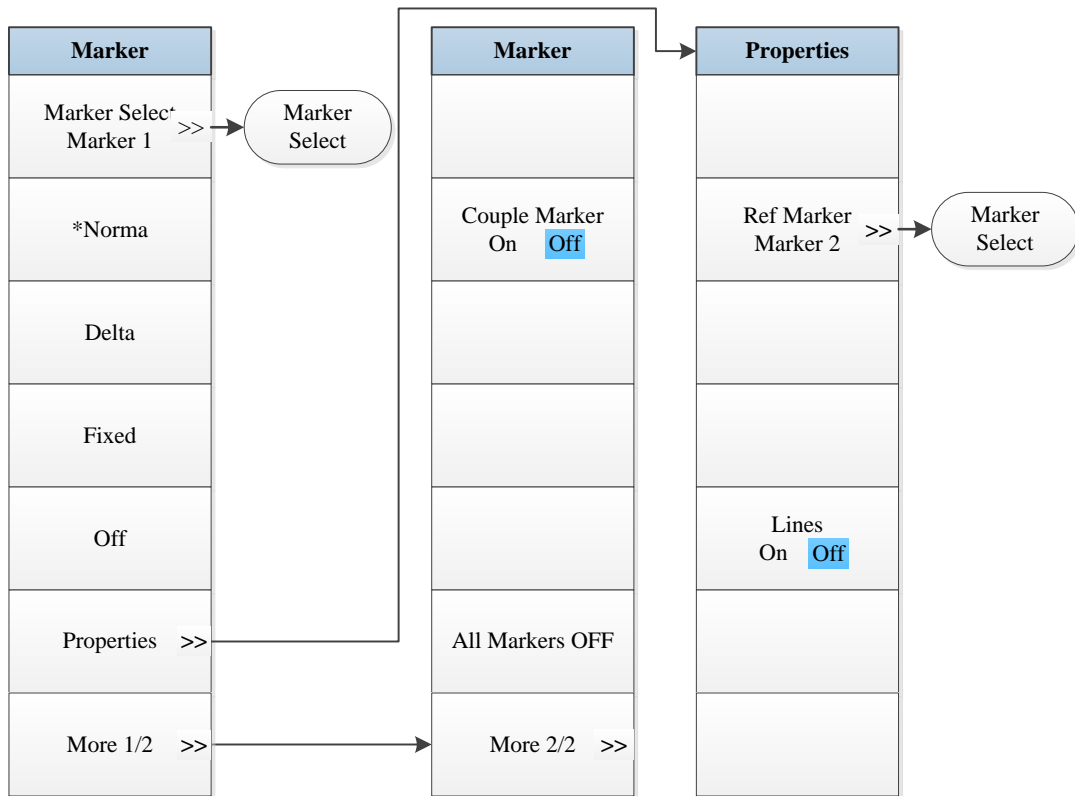

Fig. 5.10-12 Marker Menu

5.1 Menu structure

5.1.10.13 Maker->



Fig. 5.10-13 Marker->Menu

5.1.10.14 Marker Function

Marker Func

Fig. 5.10-14 Marker Function Menu

5.1 Menu structure

5.1.10.15 Peak Search



Fig. 5.10-15 Peak Search Menu

5.1.11 Spectral emission mask

5.1.11.1 Frequency

Frequency
Center Freq 13.25000 GHz
CF Step 10.0000MHz <input checked="" type="radio"/> Auto <input type="radio"/> Man
Freq Offset 0.000000 GHz

Fig. 5.11-1 Frequency Menu

5.1 Menu structure

5.1.11.2 Ampld/Y Scale

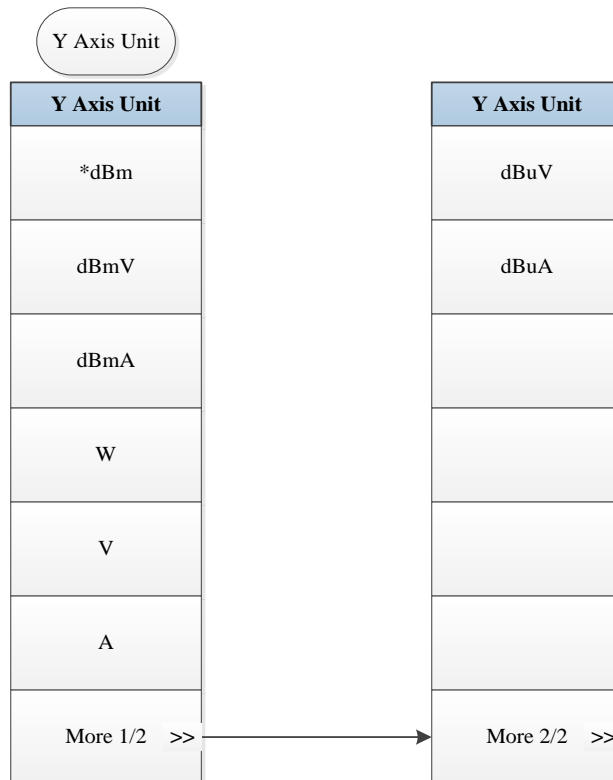
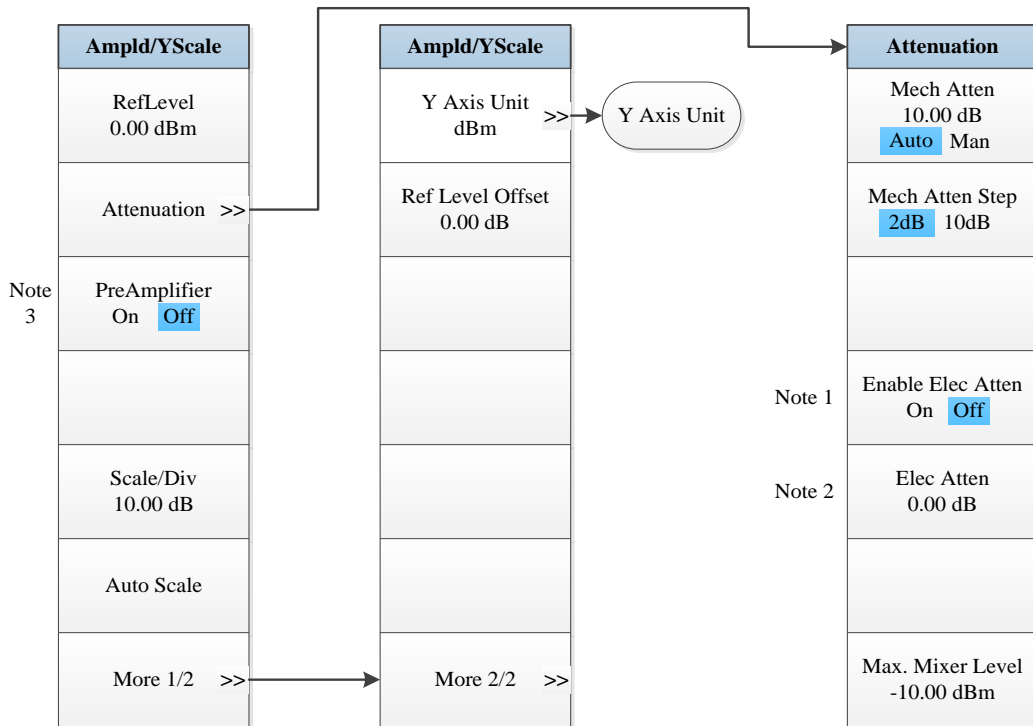

Note 1. this menu is only available when the H33 option (Elec Attenuator) is purchased.

Note 2. this menu is only available when the H33 option (Elec Attenuator) is purchased.

Note 3. this menu is only available when the H34 option (Low Noise PreAmplifier) is purchased.

Fig. 5.11-2 Ampld/Y Scale Menu

5.1.11.3 Span/X Scale

Span

Fig. 5.11-3 Span Menu

5.1 Menu structure

5.1.11.4 Bandwidth

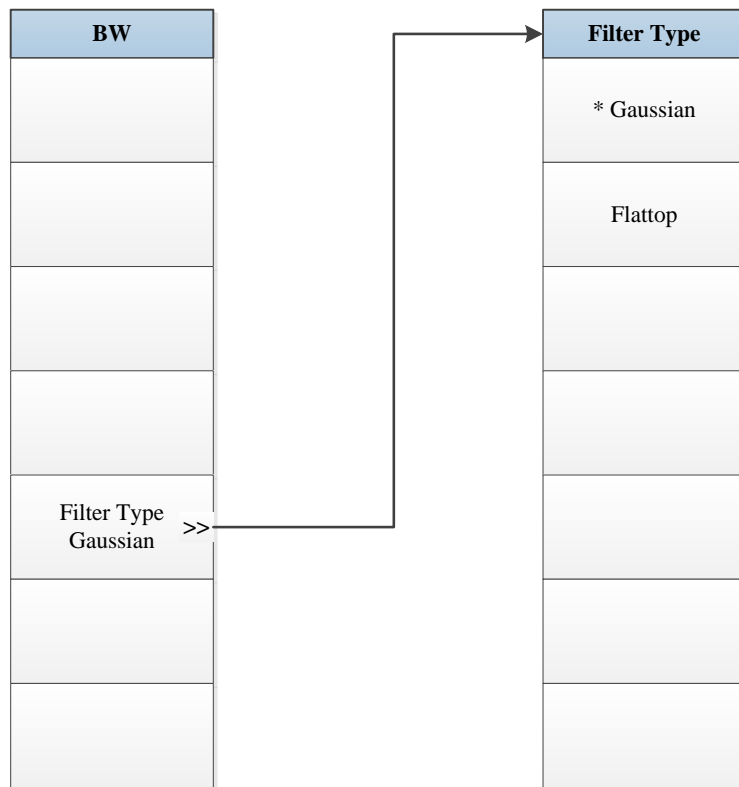

Fig. 5.11-4 Bandwidth Menu

5.1.11.5 Sweep

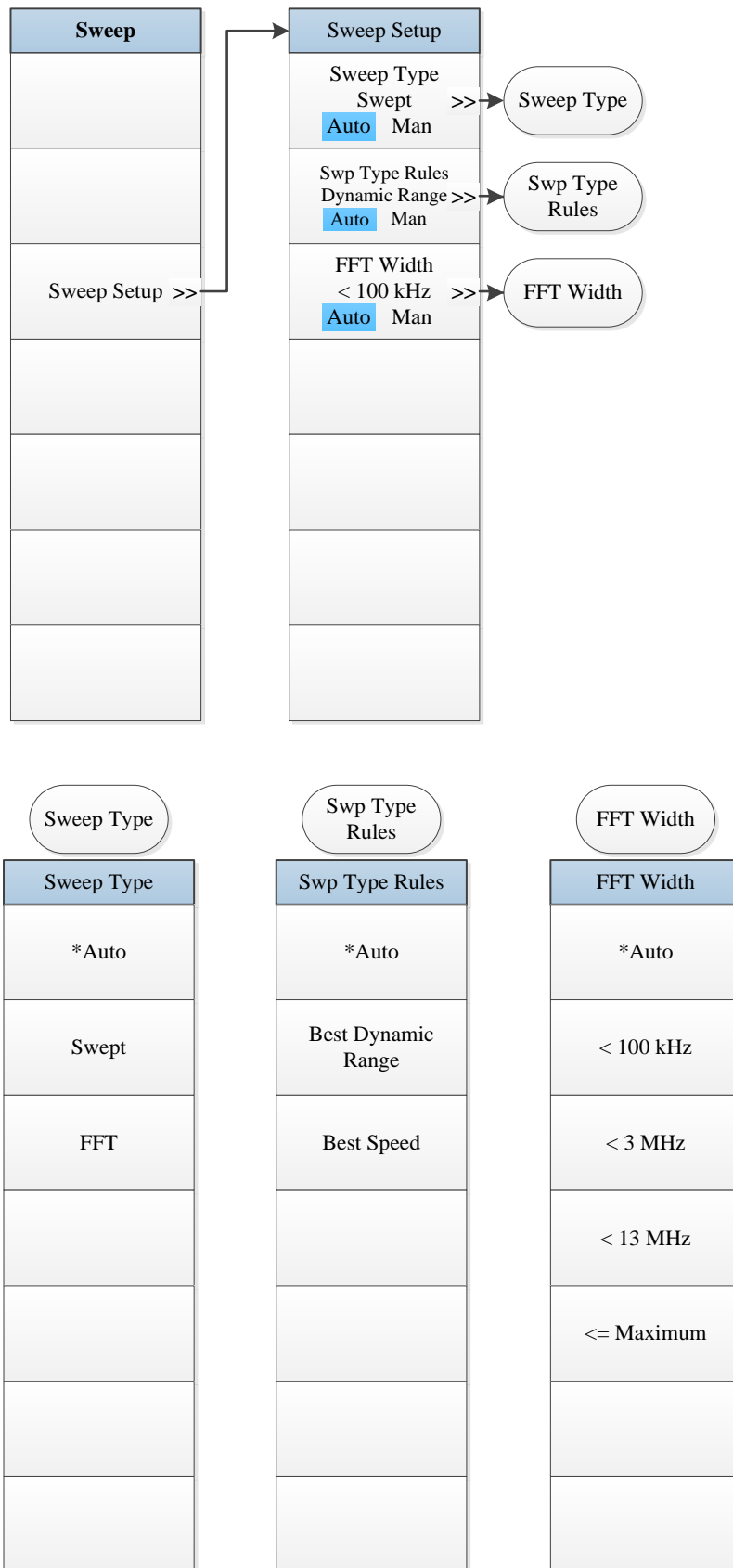
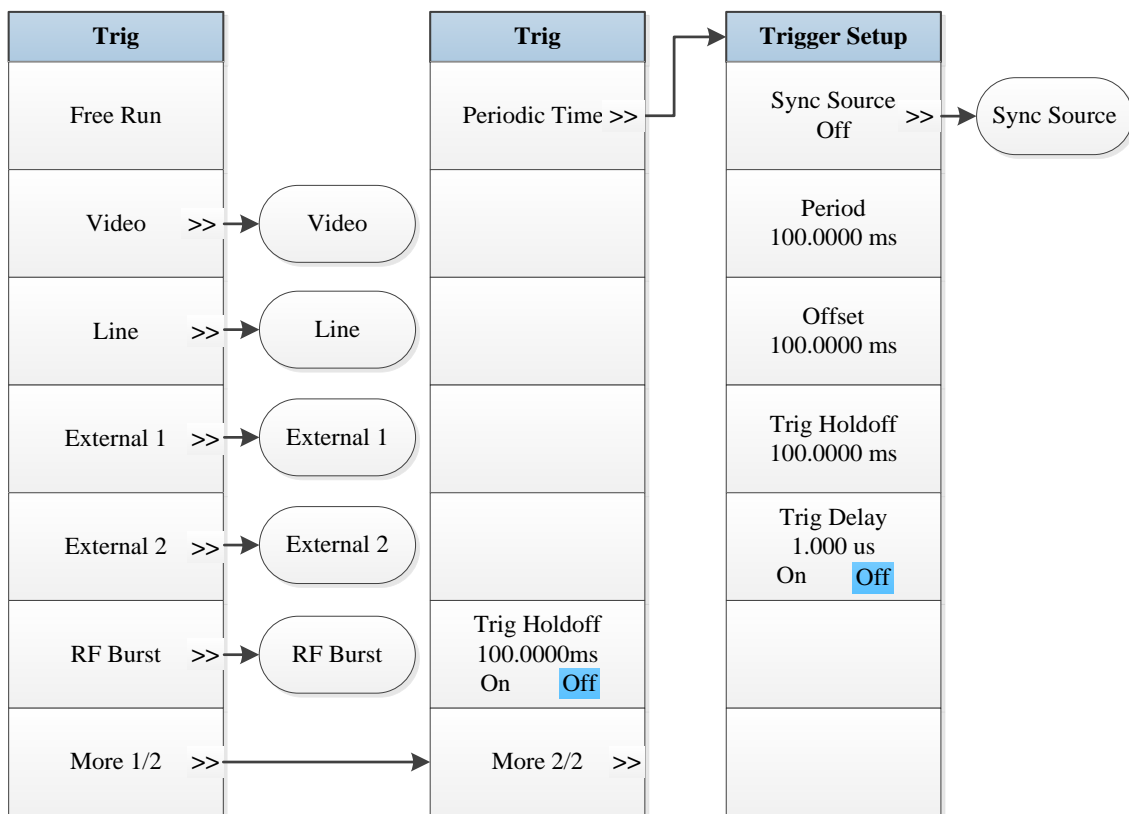

Fig. 5.11-5 Sweep Menu

5.1 Menu structure

5.1.11.6 Trigger



RF Burst	External 2	External 1	Line	Video
Trigger Setup	Trigger Setup	Trigger Setup	Trigger Setup	Trigger Setup
Trigger Level -25.00 dBm	Trigger Level 1.2 V	Trigger Level 1.2 V		Trigger Level -25.00 dBm
Trig Slope Pos Neg	Trig Slope Pos Neg	Trig Slope Pos Neg	Trig Slope Pos Neg	Trig Slope Pos Neg
Trig Delay 100.00 ms On Off	Trig Delay 100.00 ms On Off	Trig Delay 100.00 ms On Off	Trig Delay 100.00 ms On Off	Trig Delay 100.00 ms On Off

5.1 Menu structure

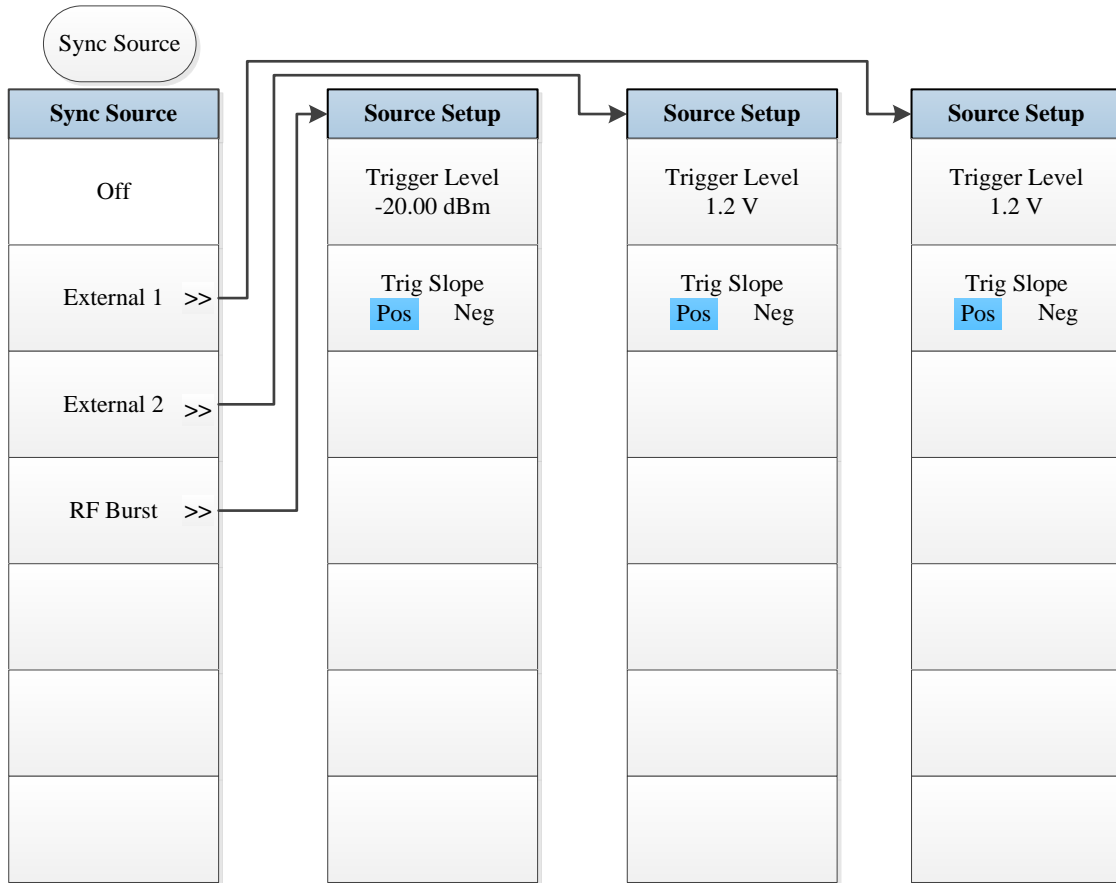

Fig. 5.11-6 Trigger Menu

5.1 Menu structure

5.1.11.7 Trace

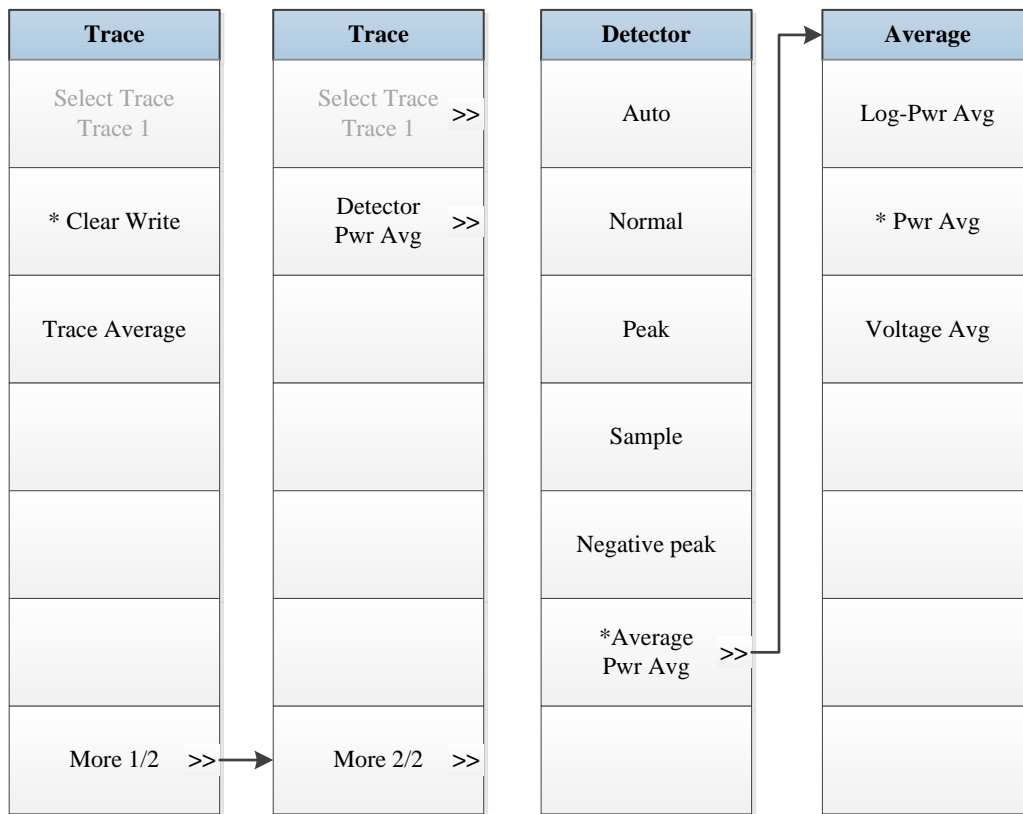
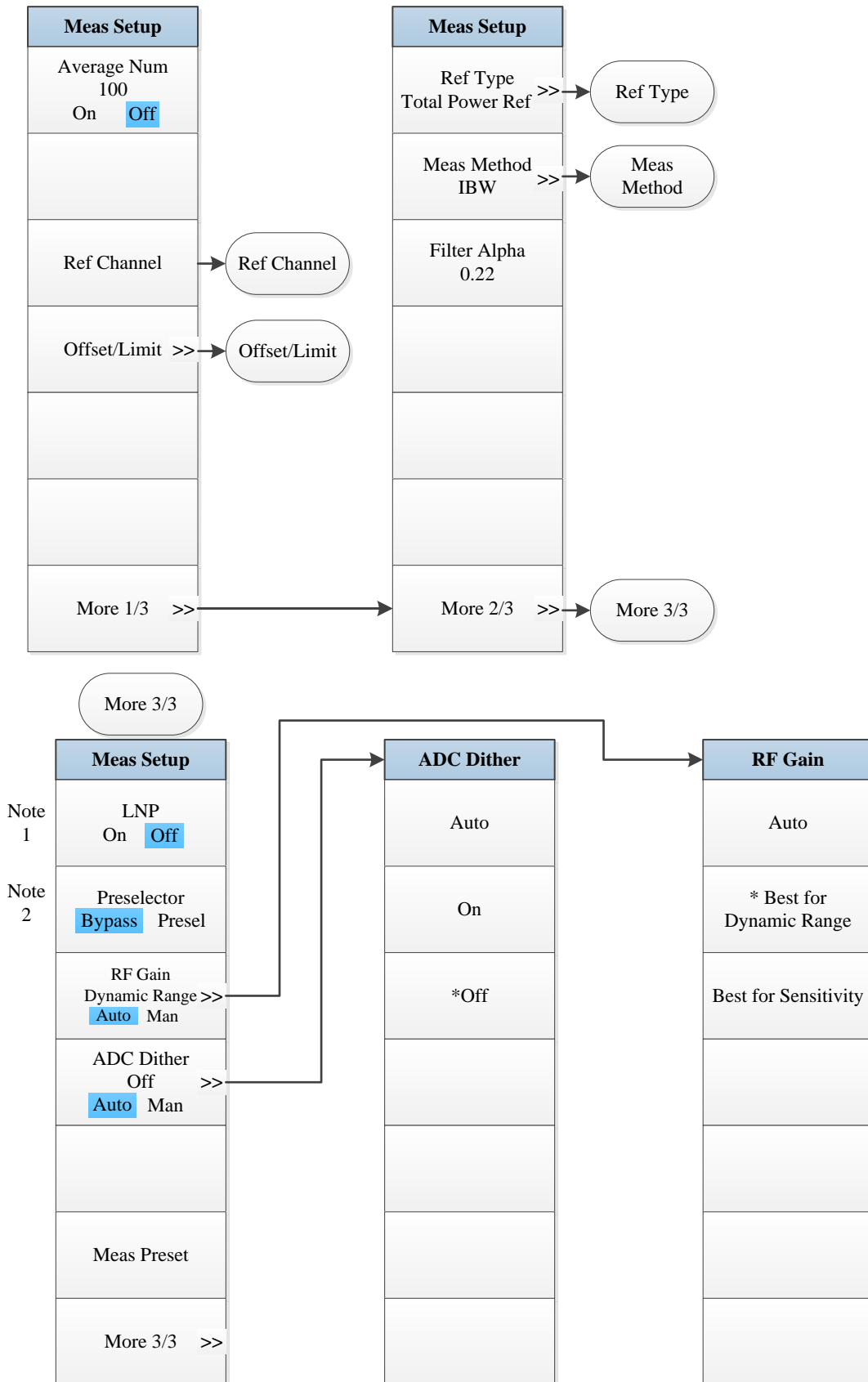
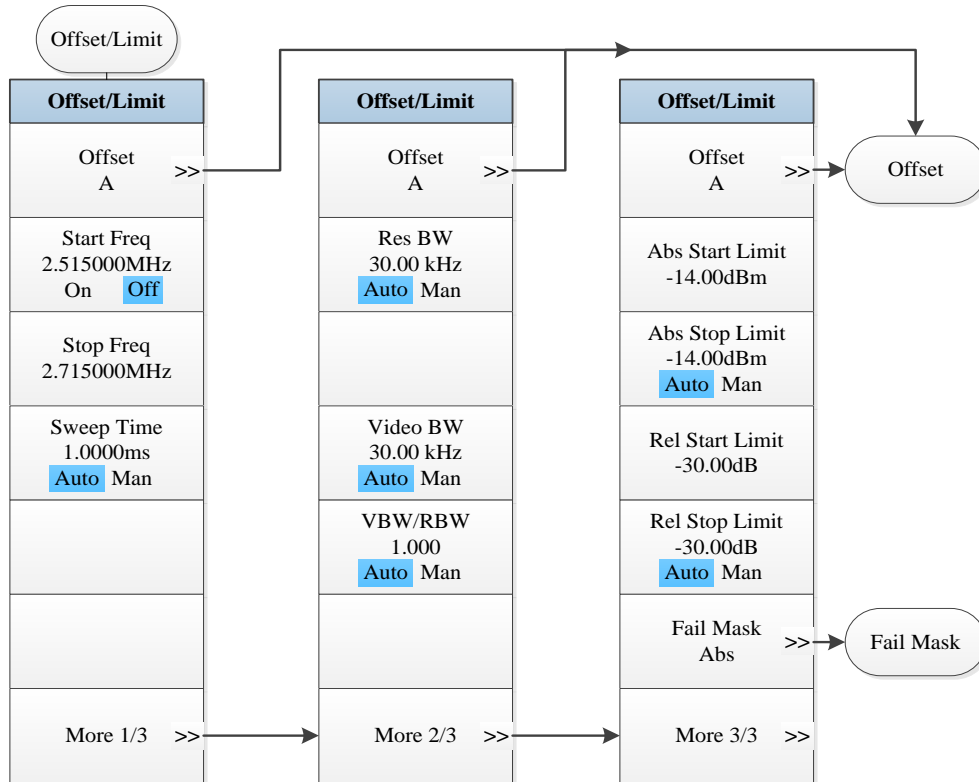

Fig. 5.11-7 Trace Menu

5.1.11.8 Measurement Setting



5.1 Menu structure



Ref Channel	Ref Type	Offset	Fail Mask	Meas Method
Integ BW 3.840000MHz	* Total Power Ref	*A	*Abs	*Integ BW
Channel Span 5.000000MHz	PSD Ref	B	Rel	RRC Weigh
Sweep Time 1.0000ms Auto Man	Spectrum Pk Ref	C	Abs And Rel	
Res BW 30.00 kHz Auto Man		D	Abs Or Rel	
Video BW 30.00 kHz Auto Man	Total Power Ref 0.00dBm Auto Man	E		
VBW/RBW 1.000 Auto Man	PSD Ref 0.00dBm/Hz Auto Man	F		
	Spectrum Pk Ref 0.00dBm Auto Man			

Note 1. this menu is only available when the H34 option (Low Noise PreAmplifier) is purchased. When the PreAmplifier is ON, the Low Noise Path is OFF and this menu is grayed out; when the PreAmplifier is OFF, this menu lights on and is switchable.

Note 2. this menu is only available when the H36 option (Preselector Bypass) is purchased.

Fig. 5.11-8 Measurement Setting Menu

5.1.11.9 Measurement Control

Meas Control
Measure Single Cont
Restart
Pause/Resume

Fig. 5.11-9 Measurement Control Menu

5.1 Menu structure

5.1.11.10 Auto Setting

Auto Set
Couple All

Fig. 5.11-10 Auto Setting Menu

5.1.11.11 Display

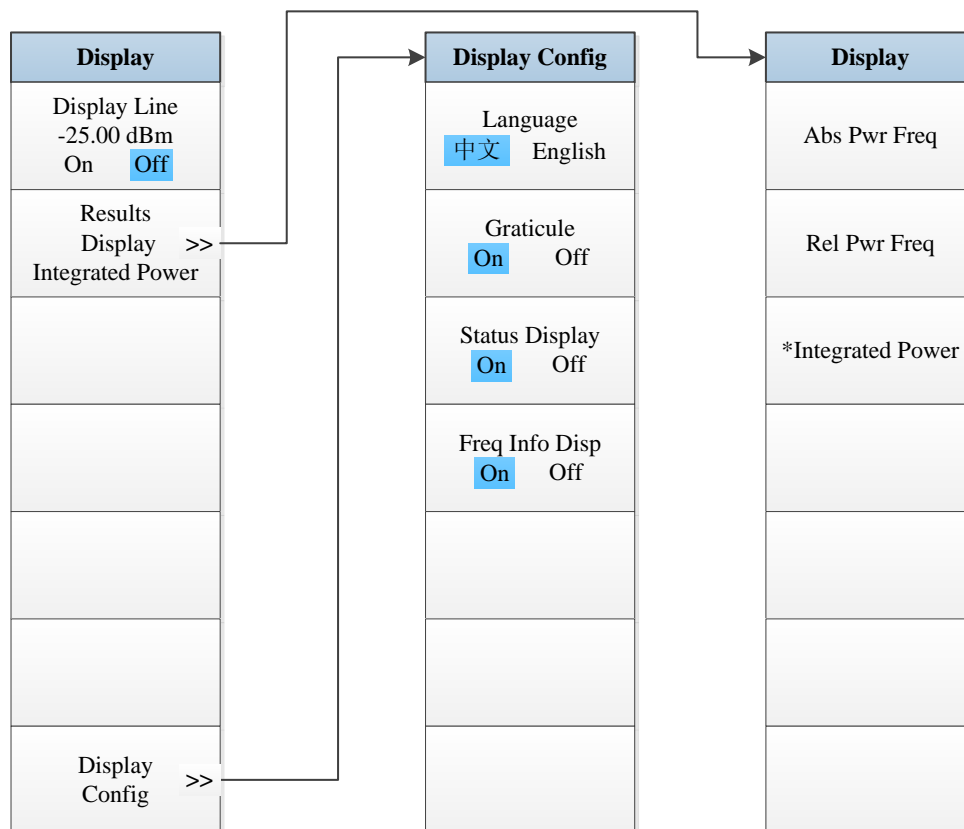

Fig. 5.11-11 Display Menu

5.1 Menu structure

5.1.11.12 Marker

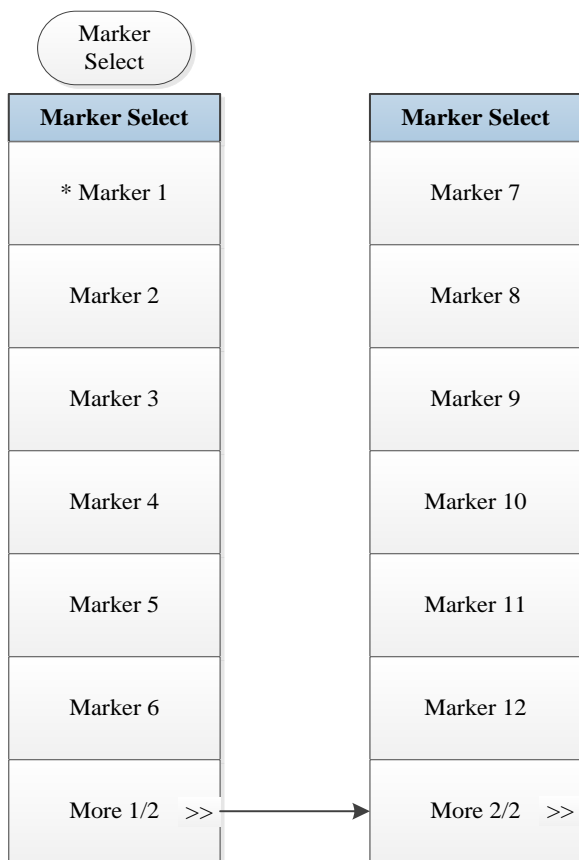
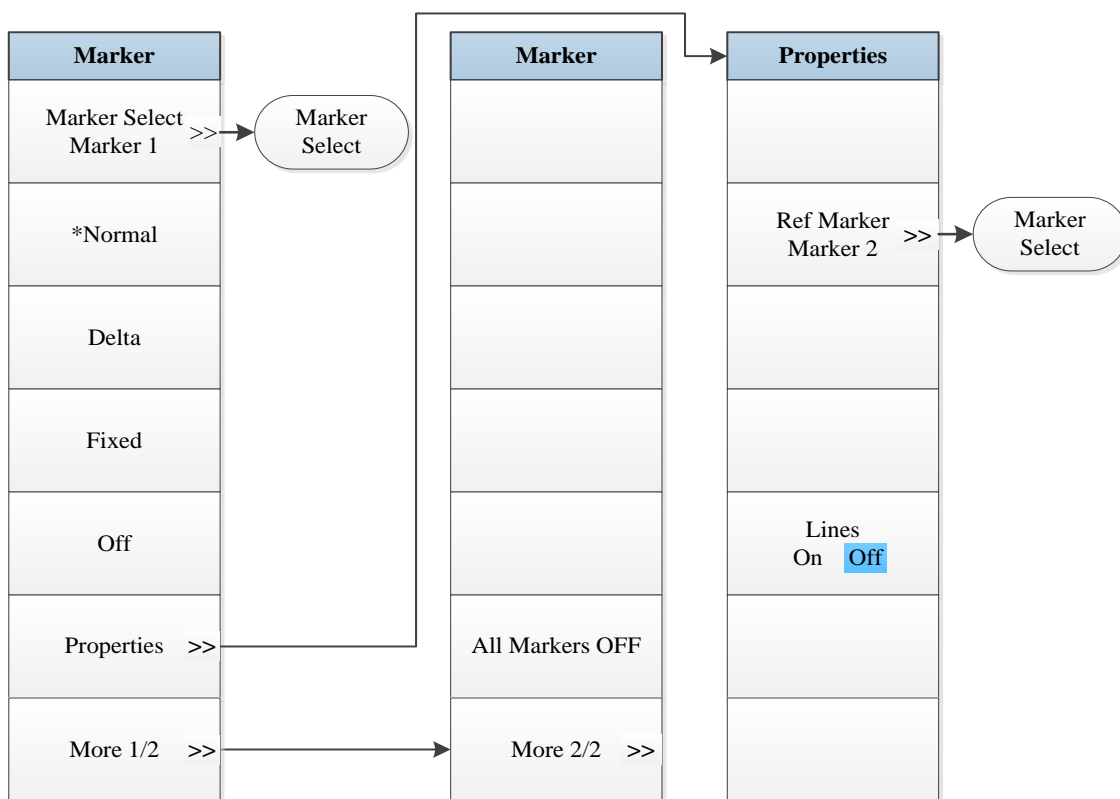

Fig. 5.11-12 Marker Menu

5.1.11.13 Maker->



Fig. 5.11-13 Marker -> Menu

5.1 Menu structure

5.1.11.14 Marker Function

Marker Func

Fig. 5.11-14 Marker Function Menu

5.1.11.15 Peak Search

Peak Search

Fig. 5.11-15 Peak Search Menu

5.2. Description of menu

5.2. Description of menu

This section introduces the details of the functions, parameters, etc. Of menu items.

- General.....346
- Spectrum Analysis.....355
- Channel Power441
- Occupied Bandwidth.....462
- Adjacent Channel Power.....482
- Power Statistic510
- Burst Power.....519
- Harmonic Distortion538
- Three-order Intermodulation.....551
- Spurious Emission570
- Spectral Emission Mask.....588

5.2.1 General

5.2.1.1 System

Press the **【System】** to pop up soft menus related to system configuration, including [Error List ▶], [Power On/Prese▶], [Align▶], [Config Info▶], [Self-Test ▶], [Interface Config ▶].

[Error List▶]

Pop up a list displaying current errors of the instrument. When the instrument has any error, the error information prompt column at the screen bottom will provide error prompt.

Remote Command:

:SYSTem:ERRor[:NEXT]?

Examples:

:SYST:ERR?

[Page Up]

When the error list is displayed in several pages, through this menu, you can display previous page. If current page is first page, this menu is unresponsive.

[Page Down]

When the error list is displayed in several pages, through this menu, you can display next page. If current page is last page, this menu is unresponsive.

[Clear List]

Clear all information of current error list.

[Error Tip **Man**]

5.2. Description of menu

With this menu, you can enable or disable the error information prompt column information at the screen bottom. Under default setting, the Error Prompt is ON.

[Power On/Preset ▶]

Pop up three soft menus including [Preset Fac **User**], [Save User Preset], [Save PowerOn].

[Preset Fac **User]**

With the menu, you can select whether the instrument executes Factory Preset or User Preset when the **【Preset】** key on the front panel is selected for reset. Under default setting, the instrument executes User Reset. If the user fails to save the User Reset Status, the instrument will keep current status.

Remote Command:

:SYSTem:PRESet:USER

Examples:

:SYST:PRES:USER

[Save User Preset]

With this menu, you can save the current working status of instrument as User Reset Status. If the [Preset Fact **User**] is selected as User, when the **【Preset】** key on the front panel is selected for reset, the instrument working status will automatically recover to the User Preset Status.

Remote Command:

:SYSTem:PRESet:USER:SAVE

Examples:

:SYST:PRES:USER:SAVE

[Save PowerOn]

With this menu, you can save the current working status of instrument as User Start-up Status. If the user has saved the User Start-up Status, at every start-up, the instrument working status will automatically be User Start-up Status; if not, the instrument working status will automatically be Factory Start-up Status.

[Align▶]

Pop up sub-menus related to calibration, including [Align All], [Auto Align Man], [Freq Diagnosis ▶], [LO Auto Adjust].

[Align All]

With this menu, you can calibrate all parameters of the signal/spectrum analyzer. Every calibration takes several minutes in general.

Remote Command:

:calibration[:ALL]

Examples:

:CAL

5.2. Description of menu

[Auto Align On Off]

Control ON and OFF of the Auto Calibration. Under default setting, this function is ON. The signal/spectrum analyzer will automatically judge whether to calibrate any parameters based on start-up time and internal temperature change. When [Auto Align Man] is set as ON, automatic calibration will be taken 15 minutes after start-up. If within 15 minutes, the instrument detects that the internal temperature change exceeds 10 °C, the instrument will automatically stop current test and conduct auto calibration. After calibration, the instrument will proceed measurement. For every change of 10 °C for the internal temperature, the instrument takes one auto calibration. You can set the Auto Calibration as OFF to avoid interruption of normal measurement by Auto Calibration. However, the measurement results may be affected if there is large internal temperature change or the auto calibration fails to be taken for a long time.

Remote Command:

:calibration:AUTO OFF|ON

:calibration:AUTO?

Examples:

:CAL:AUTO OFF

[Freq Diagnose▶]

Display soft menus related to frequency diagnosis, including [LO Frequency], [Sample Oscillation Frequency] and [Decimal Div Ratio].

Note: in multi-band sweep, the displayed frequency corresponds to the start frequency of the corresponding band for which the oscillator sweeps.

This menu has no corresponding remote commands, and is mainly for local usage.

[LO Freq]

Display the start frequency of the first LO of the current band. This menu has no corresponding remote commands, and is mainly for local usage.

[Sample Surge Freq]

Display the sample oscillator frequency to which the current band start frequency corresponds and the compensation value of the sample loop bandwidth. This menu has no corresponding remote commands, and is mainly for local usage.

[Decimal Div Ratio]

Display the Decimal Div Ratio to which the current band start frequency corresponds. This menu has no corresponding remote commands, and is mainly for usage by local debugger.

[Preselector Auto Adjust]

With this menu, you can take auto calibration of the preselector center frequency to ensure accuracy and consistency of instrument measurement. This menu has no corresponding remote commands, and is mainly for local usage.

5.2. Description of menu**[Zero Freq Auto Adjust]**

Realize auto amplitude adjustment for zero span signal to meet test requirements on low frequency signal. This menu has no corresponding remote commands, and is mainly for local usage.

[LO Auto Adjust]

With this menu, you can control the instrument optimized setting of LO control parameters. In case of sharp change of working environment or internal temperature, the control parameters of internal LO circuit module may in need of change to guarantee normal and stable operation of the LO circuit. The signal/spectrum analyzer will automatically optimize the setting of LO control parameters based on start-up time and internal temperature change. With this menu, you can manually control the instrument optimized setting of LO control parameters.

This menu has no corresponding remote commands, and is mainly for local usage.

[Ref Adjust▶]

Pop up soft menus related to reference adjustment. The Soft More include [Ref Adjust] and [Save Adjust Data]. This menu has no corresponding remote commands, and is mainly for local usage.

[Ref Adjust]

When the frequency test accuracy is reduced due to crystal oscillator aging, you can use this menu to calibrate crystal oscillator to improve instrument frequency test accuracy.

This menu has no corresponding remote commands, and is mainly for local usage.

[Save Adjust Data]

With this menu, you can save the adjusted reference data into file.

This menu has no corresponding remote commands, and is mainly for local usage.

Note: be careful about reference adjustment as it may influence test accuracy.

[Config Info▶]

Control and display software/hardware information and option configurations of the instrument. The Soft More include [Print Config Info], [Generate License] and [Update Licence].

[Print Config Info]

Display software/hardware information and option configurations of the current instrument.

[Generate Licence]

Configure software/hardware and options of the instrument and generate license files.

[Update Licence]

Update the software/hardware of the instrument through updating license files.

5.2. Description of menu

[Self-Test ▶]

Control instrument Self-Test. The soft more include [Start], [Pause], [LO Step], [Circle Times], [Save Record On and Off], [Display Struct Board EleUnit], [More 1/2▶], [Load Record], [Print].

[Start]

Control the instrument to start[Self-Test] at initial access to [Self-Test ▶] More or Pause Self-Test.

[Pause]

Pause Self-Test of the instrument.

[LO Step]

Set LO step frequency (default: 1 MHz) during instrument Self-Test.

[Circle Times]

Set cycle test count. When executing this function, the instrument will automatically stop Self-Test.

[Save Record On Off]

Set whether to save Self-Test records after test. Under default setting, the Save Record is ON.

[Display Struct BoardEleUnit]

Control the display method of instrument Self-Test results. When setting to Board Level, the Self-Test results of internal electric circuits will be displayed; when setting to Unit, the Self-Test results of instrument unit-level modules will be displayed.

[Load Record]

Call the Self-Test results saved in previous time.

[Print]

Control the printing of current instrument Self-Test results.

[Interface Config▶]

Pop up soft More related to interface config of the signal/spectrum analyzer, including [GPIB Address], [Internet Config...], [Printer Reverse Normal], [Log File Man].

[GPIB Address]

Set GPIB address. That is 18 by default.

Remote Command:

:system:communicate:GPIB[:SELF]:address <integer>

:system:communicate:GPIB[:SELF]:address?

Examples:

:SYST:COMM:GPIB:ADDR 20

[Internet Config...]

Pop up Windows dialogues for setting IP address and gateway.

IP address and gateway are set as “Automatically Obtain an IP Address” before factory leaving. Both IP address and gateway can be manually changed. For specific operations, refer to Help File of Microsoft Windows7.

[Printer Reverse Normal]

Set the print output color as Normal or Invert. The trace display area background of the instrument screen is black. To facilitate usage, the print output is defaulted as Invert Color.

[Log File On Off]

Write some operation instrument information into files, mainly including input remote command information, etc. The log files will be automatically generated under the Factdir/Log of the program run directory at every start-up. This function is defaulted as OFF under factory status.

Remote Command:

:system:clogging ON|OFF

:system:clogging?

Examples:

:SYST:CLOG ON

:SYST:CLOG?

5.2.1.2 Files

Pop up soft More related to files, including: [Save...], [Load...], [Save Type ►], [Load Type ►] and [Exit].

This menu tree has no corresponding remote commands, and is mainly for local usage.

[Save...]

Files can be saved through the two steps below:

A) Firstly, select the file type to be saved and press **【File】**, [Save Type ►]. Select Save Type. The Save Type is defaulted as “Status”, i.e., current working status of instrument.

B) Press the [Save...] More to pop up a “Save As” dialog of Windows Standard File. Select file save directory and input file name and press Save. Press Cancel to stop File Save. For details, refer to “[3.4 Data Management](#)” of this manual.

Remote Command:

:MMEMory:STORe:STATe <filename>

:MMEMory:STORe:SCReen <filename>

Examples:

5.2. Description of menu

:MMEM:STOR:STAT 1.sta

:MMEM:STOR:SCR 1.bmp

[Load...]

Files can be called through the two steps below:

A) Firstly, select the file type to be called and press **【File】**, [Load Type ▶]. Select Call Type. The Call Type is defaulted as “Status”, i.e., saved working status of instrument.

B) Press the [Load...] More to pop up an “Open” dialog for Windows Standard File. Select file call directory and file name and press Open. Press Cancel to stop File Call.

For details, refer to “[3.4 Data Management](#)” of this manual.

Remote Command:

:MMEMory:LOAD:STATe <filename>

Examples:

:MMEM:LOAD:STAT 1.sta

[Save Type ▶]

Select the Save Type of instrument files, including Status, Trace (+ Status), Image, I/Q Data (Local) and I/Q Data (Record). “Status” indicates that the Save Type is the current working status of the instrument; “Trace (+ Status)” indicates that the Save Type is the current measured trace data, including current working status of instrument; “Image” indicates that the Save Type is current displayed image on the screen; “I/Q Data (Local)” indicates that the I/Q data will be saved under local files; and “I/Q Data (Record)” indicates that the I/Q data will be saved in recorder. The Save Type is defaulted as “Status”.

Attention:

1. “I/Q Data (Local)” is only enabled in I/Q Analysis, Transient Analysis and Pulse Analysis.
2. “I/Q Data (Record)” is only enabled in Transient Analysis and Pulse Analysis.

[Load Type ▶]

Select the Call Type of instrument files, including Status, Trace (+ Status), I/Q Data (Local) and I/Q Data (Record). “Status” indicates that the Call Type is the current saved working status of the instrument; “Trace (+ Status)” indicates that the Call Type is the saved trace data and the working status; “I/Q Data (Local)” indicates that the I/Q data will be called from local folder; and “I/Q Data (Record)” indicates that the I/Q data will be called from the recorder. The Call Type is defaulted as “Status”.

Note: “I/Q Data (Local)” and “I/Q Data (Record)” is only enabled in Transient Analysis and Pulse Analysis.

[Exit]

Exit the software program of the signal/spectrum analyzer and get access to the Windows operation system interface.

5.2.1.3 Mode

Select the measurement mode of signal/spectrum analyzer. Spectrum Analysis and I/Q Analysis are supported under standard configuration. After purchase of options and updating license documents, menu item entry will be provided in this menu.

[Spectrum]

Control the signal/spectrum analyzer to get access to the Spectrum Analysis mode.

Remote Command:

:instrument[:select] SA

:instrument[:select] ?

Examples:

:instrument SA

:instrument?

[I/Q Analyzer]

Control the signal/spectrum analyzer to get access to the I/Q Analysis mode.

Remote Command:

:instrument[:select] BASIC

:instrument[:select] ?

Examples:

:instrument BASIC

:instrument?

[Vector Analyzer]

Control the signal/spectrum analyzer to get access to the Vector Analysis mode.

Remote Command:

:instrument[:select] VSA

:instrument[:select] ?

Examples:

:instrument VSA

:instrument?

[Analog Demod]

Control the signal/spectrum analyzer to get access to the analog demodulation mode.

Remote Command:

:instrument[:select] ADEMOD

:instrument[:select] ?

Examples:

:instrument ADEMOD

:instrument?

[Pulse Analyzers]

5.2. Description of menu

Control the signal/spectrum analyzer to get access to the Pulse Analysis mode.

[Transient Analysis]

Control the signal/spectrum analyzer to get access to the Transient Analysis mode.

[Audio Analyzer]

Control the signal/spectrum analyzer to get access to the Audio Analysis mode.

[Phase Noise]

Control the signal/spectrum analyzer to get access to the phase noise mode.

Remote Command:

:instrument[:select] PNOISE

:instrument[:select] ?

Examples:

:instrument PNOISE

:instrument?

[Noise Factor]

Control the signal/spectrum analyzer to get access to the noise factor mode.

5.2.1.4 Reset

The **【Preset】** key on the front panel has no corresponding soft menu. Press the **【Preset】** key on the front panel to control the reset operation of the signal/spectrum analyzer. Press the **【System】** Key on the front panel to enter the [PowerOn/Preset ▶], [Preset Fact **User**] menu to set whether Factory Preset or User Preset is executed when the reset operation is selected.

5.2.1.5 Printing

The **【Print】** key on the front panel has no corresponding menu. Press the **【Print】** key on the front panel to control the screen shot print of the signal/spectrum analyzer. For details, refer to “[3.4 Data Management](#)” of this manual.

Remote Command:

:HCOPy[:IMMEDIATE]

Examples:

:HCOP

5.2.1.6 Help

The **【Help】** key on the front panel has no corresponding menu. Press the **【Help】** key on the front panel to display the electronic user manual contents to which the current instrument menu correspond. For details, refer to [3.3.1.5 Help of the manual](#).

5.2.2 Spectrum Analysis

5.2.2.1 Frequency

The **【Frequency】** key on the front panel is used to set parameters related to the signal/spectrum analyzer frequency, including [Center Freq], [Start Freq], [Stop Freq], [CF Step Auto Man], [Freq Offset], [Auto Tune], [Signal Track ON OFF].

The User can configure the frequency measure scope through the [Start Freq] and [Stop Freq], or through the [Center Freq] and [Span]. Press the **【Frequency】** key to enable any soft menu from [Center Freq], [Start Freq] and [Stop Freq], and corresponding parameter input area will display current parameters.

[Center Freq]

- **Menu description:** to enable the center frequency and set the signal/spectrum analyzer into the center frequency/span mode. Use number keys, stepping keys or knob to change the center frequency. If the set center frequency is inconsistent with the current span, the latter will automatically change to the value best suitable for desired frequency.
- **Key path:** **【Frequency】** , [Center Freq] on the front panel.
- **Status saved:** saved in the instrument status.
- **Factory preset:** depend on maximum frequency limit of signal/spectrum analyzer.
- **Setting range:** Min.: 0Hz; Max.: maximum frequency limit of signal/spectrum analyzer
- **Default unit:** Hz
- **Remote Command:**

[:sense]:frequency:center <frequency>

[:sense]:frequency:center?

- **Examples:**

:FREQ:CENT 5 GHz

[Start freq]

- **Menu description:** to enable the start frequency and set the signal/spectrum analyzer into the start frequency/stop frequency mode. Use number keys, stepping keys or knob to change the start frequency. In changing the start frequency, if the selected start frequency is larger than the stop frequency, the latter one will automatically increase till equaling to the sum of start frequency plus minimum span (100Hz multiply N, where, N is the harmonic order of local oscillator).
- **Key Entry:** **【Frequency】** , [Start Freq] on the front panel.
- **Status saved:** saved in the instrument status.
- **Factory preset:** depend on maximum frequency limit of signal/spectrum analyzer.
- **Setting range:** Min.: -100 MHz; Max.: maximum frequency limit of signal/spectrum analyzer
- **Default unit:** Hz
- **Remote Command:** [:sense]:frequency:start <freq> [:sense]:frequency:start?
- **Examples:**

: FREQ:STAR 200 MHz

[Stop Freq]

5.2. Description of menu

- **Menu description:** to enable the stop frequency and set the signal/spectrum analyzer into the start frequency/stop frequency mode. Use number keys, stepping keys or knob to change the stop frequency. In changing stop frequency, if the selected stop frequency is less than the start frequency, the latter one will automatically decrease till equaling to the difference of stop frequency minus minimum span (100Hz multiply N, where, N is the harmonic order of local oscillator).
- **Key path:** **【Frequency】** , [Stop Freq] on the front panel.
- **Status saved:** saved in the instrument status.
- **Factory preset:** depend on maximum frequency limit of signal/spectrum analyzer.
- **Setting range:** Min.: 0Hz; Max.: maximum frequency limit of signal/spectrum analyzer
- **Default unit:** Hz
- **Remote Command:**

```
[[:sense]:frequency:STOP <frequency>
```

```
[[:sense]:frequency:STOP?
```

- **Examples:**

```
:FREQ:STOP 1600 MHz
```

[CF Step **Auto** Man]

- **Menu description:** to change the steps of center frequency, start frequency or stop frequency. When it is under [Auto Mode], and when the center frequency is active, press the step key, the [CF Step] changes by 1, 2, 5 and 10. When it is under Auto Off mode, use the number keys, stepping keys or knob for change. At this time, reactivate the [Center Freq], and press the step key, the center freq will change by set step size. This function is extremely useful to quickly change the center frequency to the input signal harmonic. For example, observe the harmonic of 300 MHz input signal, and set the [CF Step Auto Man] as Auto OFF, and input 300 MHz. If the current center frequency is 300 MHz, press the stepping key to increase the center frequency to 600 MHz. Press the stepping key again to increase the center frequency by 300 MHz to 900 MHz. The shaded status of [CF Step **Auto** Man] More indicates whether the step is set as Auto On or Off. When the step is under Auto Off, select the Auto On from [CF Step **Auto** Man] to return to Auto On status.
- **Key path:** **【Frequency】** , [CF Step **Auto** Man] on the front panel.
- **Status saved:** saved in the instrument status.
- **Factory preset:** depend on maximum frequency limit of signal/spectrum analyzer.
- **Setting range:** Min.: 1Hz; Max.: maximum frequency limit of signal/spectrum analyzer
- **Default unit:** Hz
- **Remote Command:**

```
[[:sense]:frequency:center:STEP[:increment] <freq>
```

```
[[:sense]:frequency:center:STEP[:increment]?
```

```
[[:sense]:frequency:center:STEP:AUTO OFF|ON|0|1
```

```
[[:sense]:frequency:center:STEP:AUTO?
```

- **Examples:**

```
:FREQ:CENT:STEP 100 MHz
```

```
:FREQ:CENT:STEP:AUTO ON
```

5.2. Description of menu

[Freq Offset]

- **Menu description:** to add the set frequency offset to the displayed frequency value, including marker frequency value, but this does not affect the signal display position. Use number keys, stepping keys or knob to change the offset.
- **Key path:** **【Frequency】** , [Freq Offset] on the front panel.
- **Status saved:** saved in the instrument status.
- **Factory preset:** depend on maximum frequency limit of signal/spectrum analyzer and current measurement mode.
- **Setting range:** Min.: -500GHz, Max.: +500GHz.
- **Default unit:** Hz
- **Remote Command:** [:sense]:frequency:offset <freq> [:sense]:frequency:offset?
- **Examples:**
:FREQ:OFFS 10 MHz

[Auto Tune]

- **Menu description:** the instrument automatically sets parameters like center frequency, span and reference level based on input signal characteristics. The instrument takes one auto tune when this soft menu key is pressed.
- **Key path:** **【Frequency】** , [Auto Tune] on the front panel.
- **Status saved:** not saved in instrument status.
- **Remote Command:**
[:sense]:frequency:TUNE:immediate
- **Examples:**
:FREQ:TUNE:IMM

[Signal Track On Off]

- **Menu description:** to turn on or off Signal Track. The enabling marker is on the signal peak point, and the peak frequency is set as the center frequency. In each sweep, perform this function and place the marker at the center frequency. Use [Signal Track **Man**] to keep the slowly-drifted signal on the center of the display.
- **Key path:** **【Frequency】** , [Signal Trace On **Off**] on the front panel.
- **Status saved:** saved in the instrument status.
- **Factory preset:** OFF
- **Remote Command:**
Calculate:marker:trcking[:state] OFF|ON|0|1
Calculate:marker:trcking[:state]?
- **Examples:**
CALC:MARK:TRCK OFF CALC:MARK:TRCK?

5.2.2.2 Ampld/YScale

5.2. Description of menu

Pop up More related to parameter setting of Amplitude/YScale, including [RefLevel], [Attenuation ▶], [PreAmplifier On Off], [Scale Type Log Line], [Scale/Div], [Auto Scale], [More 1/2▶], [Y Axis Unit], [Ref Level Offset], [Ampl Cor▶].

[RefLevel]

- **Menu description:** to enable the Reference Level function. The reference level can be adjusted with the number keys, step keys or knob. The reference level corresponds to the top of the coordinate top. Measure signal at reference level position to get highest accuracy. The input attenuator of the signal/spectrum analyzer is coupled to the reference level, which can be automatically changed to avoid compression of input signal.
- **Key path:** **【Amplitude/YScale】** , [RefLevel] on the front panel.
- **Status saved:** saved in the instrument status.
- **Factory preset:** 0dBm
- **Setting range:** Min.: -170dBm, Max.: 30dBm.
- **Default unit:** set based on Y Axis scale unit.
- **Remote Command:**

```
:display>window[1]:trace:Y[:scale]:rlevel <real>
```

```
:display>window[1]:trace:Y[:scale]:rlevel?
```

- **Examples:**

```
:DISP:WIND:TRAC:Y:RLEV 20 dBm
```

[Attenuation▶]

Adjust the mechanical attenuator, mechanical attenuator step, maximum mixer level. When the Elec Attenuator options are configured correctly, it can be used for switching on or off the Elec Attenuator and setting its attenuation, Soft menu

Include [Mech Atten Auto Man], [Mech Atten Step 2dB 10dB], [Elec Atten Man], [Elec Atten 0.00dB] and [Max Mixer Level].

[Mech Atten Auto Man]

- **Menu description:** In Auto ON mode, the mechanical attenuator is coupled to the reference level. Under Auto OFF Mode, use number keys, stepping keys or knob to change the attenuation of the attenuator. The atten scope of mechanical attenuator is 0dB-70dB. You can set a decrease by 10dB or 2dB through the [Mech Atten Step 2dB 10dB].
- **Key path:** **【Amplitude/YScale】** , [Attenuation▶], [Mech Atten Auto Man] on the front panel.
- **Status saved:** saved in the instrument status.
- **Factory preset:** Auto.
- **Setting range:** Min.:0dB, Max.: 70dB.
- **Default unit:** dB.
- **Remote Command:**

```
[[:sense]:power[:RF]:attenuation <rel_power>
```

5.2. Description of menu

[[:sense]:power[:RF]:attenuation?

[[:sense]:power[:RF]:attenuation:AUTO OFF|ON|0|1

[[:sense]:power[:RF]:attenuation:AUTO?

- **Examples:**

:POW:ATT 30 dB

:POW:ATT:AUTO ON

- **Other instructions:**

The mechanical attenuator, in general, is set as Auto ON mode. When the reference level changes, the attenuation will automatically change, but this does not change the reference level. This change aims to ensure that the maximum signal amplitude of the input mixer is less than or equals to -10dBm. For example, if the reference level is +23dBm and the mixer input level is -17dBm, the mixer is 40dB (23- 40= -17). The final purpose is to prevent signal compression. When the mechanical atten is under Auto Off mode, press the [Mech Atten Auto **Man**], couple the attenuation to the refllevel again.

Note: the maximum input signal amplitude of the input attenuator (at least 10dB input attenuation) is +30dBm, otherwise, this power signal will damage the mechanical attenuator or the input mixer.

[Mech Atten Step **2dB 10dB**]

- **Menu description:** to control the step of the mechanical attenuator. The step size can only be increased or decreased by 10dB or 2dB. For 2dB step, the input mixer level can be set based on input signal optimization to improve measurement dynamic scope.
- **Key path:** **[Ampld/YScale]** , [Attenuation ▶], [Mech Atten Step **2 dB 10 dB**] on the front panel.
- **Status saved:** saved in the instrument status.
- **Factory preset:** 2 dB.
- **Remote Command:**

Frequency step auto on/off

[[:sense]:power[:RF]:attenuation?

[[:sense]:power[:RF]:attenuation:AUTO OFF|ON|0|1

[[:sense]:power[:RF]:attenuation:AUTO?

[Max Mixer Level]

- **Menu description:** to set the input maximum mixer level. This level is used as the maximum level limit of the input mixer for assignment of reference level. The level is equivalent to reference level value minus the attenuator decrement. When the reference level changes, the mechanical attenuator also changes to ensure that the signal display on the reference level will not be larger than the maximum mixer level. If the maximum mixer level decreases, the instrument will automatically optimize the distortion performance under default measurement mode. If the maximum mixer level increases, the mixer may be damaged by excessive input signal. This parameter cannot be changed unless the user has a good knowledge of the signal analyzer.
- **Key path:** **[Ampld/YScale]** , [Attenuation▶], [Max Mixer Level] on the front panel.
- **Status saved:** saved in the instrument status.
- **Factory preset:** -10dBm.
- **Setting range:** Min.: -50dBm, Max.: -10dBm.

5.2. Description of menu

- **Default unit:** dBm.
- **Remote Command:**

```
[[:sense]:power[:RF]:mixer:range[:upper] <power>
```

```
[[:sense]:power[:RF]:mixer:range[:upper]?
```

- **Examples:**

```
:POW:MIX:RANG -15 dBm
```

[Elec Atten On **Off**]

- **Menu description:** this menu is only available when Elec Attenuator option is purchased. It is used to switch on or off the Elec Attenuator. The Elec Attenuator is only active when measuring signal with frequency between 3Hz and 4GHz. When the measurement frequency scope set by the signal/spectrum analyzer is beyond 3Hz-4GHz, this menu will be void and grayed out.
- **Key path:** **【Ampld/YScale】** , [Attenuation ►], [Elec Atten ON OFF] on the front panel.
- **Status saved:** saved in the instrument status.
- **Factory preset:** OFF
- **Remote Command:**

```
[[:sense]:power[:RF]:eattenuation:state OFF|ON|0|1
```

```
[[:sense]:power[:RF]:eattenuation:state?
```

[Elec Atten **0.00dB**]

- **Menu description:** this menu is only available when Elec Attenuator option is purchased. It is used to manually set the attenuation of Elec Attenuator. The Elec Attenuator is only active when measuring signal with frequency between 3Hz and 4GHz. When the measurement frequency scope set by the signal/spectrum analyzer is beyond 3Hz-4GHz, this menu will be void and grayed out.
- **Key path:** **【Ampld/YScale】** , [Attenuation ►], [Elec Atten **0.00 dB**] on the front panel.
- **Status saved:** saved in the instrument status.
- **Factory preset:** 0.00 dB.
- **Setting range:** Min.:0dB, Max.:30dB.
- **Remote Command:**

```
[[:sense]:power[:RF]:eattenuation <rel_ampl>
```

```
[[:sense]:power[:RF]:eattenuation?
```

- **Examples:**

```
:power:EATT 10dB
```

```
:power:EATT?
```

[PreAmplifier On **Off**]

- **Menu description:** to control the ON OFF status of the PreAmplifier. This menu is only active when the PreAmplifier options are configured.
- **Key path:** **【Ampld/YScale】** , [PreAmplifier ON OFF] on the front panel.

5.2. Description of menu

- **Status saved:** saved in the instrument status.
- **Factory preset:** OFF
- **Remote Command:**

```
[sense]:power[:RF]:GAIN[:state] OFF|ON|0|1
```

```
[sense]:power[:RF]:GAIN[:state]?
```

- **Examples:**

```
:power:GAIN OFF
```

```
:power:GAIN?
```

[Scale Type **Log/Line**]

- **Menu description:** to select the Y Axis Scale Type as Logarithm or Linear. In general, the logarithm scale unit is dBm and the linear scale unit is mv. Other unit types will be manually selected through the Y axis scale.
- **Key path:** **【Ampld/YScale】** Ampld/Y Scale, [Scale Type **Log Line**] on the front panel.
- **Status saved:** saved in the instrument status.
- **Factory preset:** Logarithm
- **Remote Command:**

```
:display>window[1]:trace:Y [:scale]:spacing linear|logarithmic
```

```
:display>window[1]:trace:Y[:scale]:spacing?
```

- **Examples:**

```
:DISP:WIND:TRAC:Y:SPAC LOG
```

[Scale/Div]

- **Menu description:** to select the scale/division from 0.1dB/division to 20dB/division. This menu is only valid when the scale type is logarithm.
- **Key path:** **【Ampld/YScale】** , [Scale/Div] on the front panel.
- **Status saved:** saved in the instrument status.
- **Factory preset:** 10.00 dB.
- **Setting range:** Min.: 0.1dB, Max.: 20dB.
- **Remote Command:**

```
:display>window[1]:trace:Y[:scale]:pdivision <rel_amp>
```

```
:display>window[1]:trace:Y[:scale]:pdivision?
```

- **Examples:**

```
:DISP:WIND:TRAC:Y:PDIV 5
```

```
:DISP:WIND:TRAC:Y:PDIV?
```

[Auto Scale]

5.2. Description of menu

- **Menu description:** the instrument automatically sets parameters like reference level and scale/division based on input signal sizes.

When this [soft menu] key is pressed, the instrument performs one auto scaling. Setting rule for auto scaling: firstly obtain the maximum value and the minimum value based on current measurement trace data. Based on the maximum value, place on the 80% graticule of the screen trace Y axis for auto setting of reference level and scale/division.

- **Key path:** **【Ampld/YScale】** , [Auto Scale] on the front panel.
- **Status saved:** not saved in instrument status.
- **Remote Command:**

[sense]:adjust:level

- **Examples:**

:ADJ:LEV

[Y Axis Unit ▶]

- **More description:** to select the Y Axis unit from [dBm], [dBmv], [dBma], [W], [V], [A], [dB μ V] and [dB μ A]. The instrument will automatically calculate the trace data and marker readout based on the Y axis unit.
- **Key path:** **【Ampld/YScale】** , [More 1/2▶], [Y Axis Unit ▶] on the front panel.
- **Status saved:** saved in the instrument status.
- **Factory preset:** dBm
- **Remote Command:**

:UNIT:power DBM|DBMV|DBMA|V|W|A|DBUV|DBUA|DBUVM|DBUAM|DBPT|DBG

:UNIT:power?

:UNIT:power?

:UNIT:power?

- **Examples:**

:UNIT:POW DBMV

:UNIT:POW?

[Ref Level Offset]

- **Menu description:** to introduce offset for all amplitude readout (e.g, reference level and marker amplitude). It will not change the trace position on the screen. This offset unit is dB and is not affected by the scale and unit. Use number keys, stepping keys or knob to input the offset value.
- **Key path:** **【Ampld/YScale】** , [More 1/2▶],[Ref Level Offset] on the front panel.
- **Status saved:** saved in the instrument status.
- **Factory preset:**0 dB.
- **Setting range:** Min.: -1000dB, Max.:1000dB.
- **Remote Command:**

:display>window[1]:trace:Y[:scale]:rlevel:offset <rel_power>

:display>window[1]:trace:Y[:scale]:rlevel:offset?

- **Examples:**

:DISP:WIND1:TRAC:Y:RLEV:OFFS 12.7

[Ampl Cor▶]

Pop up soft menus related to amplitude correction functions to improve measurement system accuracy. The soft More include: [Select Correction], [Cur Correction On Off], [Edit▶], [Delete], [Save Correction ...], [Load Correction ...], [Apply All Corrections On Off], [Delete All Corrections].

[Select Correction▶]

Pop up corrections to be edited or applied by the user, including [Correction 1], [Correction 2], [Correction 3], [Correction 4], [Correction 5], [Correction 6].

[Cur Correction On Off]

When the user has not selected or edited correction data, this menu shall not be set as ON. When this menu is set as OFF, the currently edited correction data fails to act. When this menu is set as ON, the currently edited correction data will be reflected on trace.

- **Remote Command:**

[[:sense]:correction:CSET[1]|2|3|4|5|6[:state] ON|OFF|1|0

[[:sense]:correction:CSET[1]|2|3|4|5|6[:state]?

- **Examples:**

:CORR:CSET1 ON

:CORR:CSET1?

[Edit▶]

Pop up sub More for selected or edited correction, including [Point], [Freq], [Ampld], [Insert Point], [Delete Point].

- **Remote Command:**

[[:sense]:correction:CSET[1]|2|3|4|5|6:DATA <freq>, <ampl>, ...

[[:sense]:correction:CSET[1]|2|3|4|5|6:DATA?

[[:sense]:correction:CSET[1]|2|3|4|5|6:DATA:merge <freq>, <ampl>, ...

- **Examples:**

:CORR:CSET1:DATA 10000000, -10, 50000000, -30

:CORR:CSET1:DATA?

:CORR:CSET1:DATA:MERG 30000000, -20

[Delet]

Erase all correction values under editing.

- **Remote Command:**

[[:sense]:correction:CSET[1]|2|3|4|5|6:delete

- **Examples:**

5.2. Description of menu

:CORR:CSET1:DEL

[Save Cor...]

- **Menu description:** to pop up Windows dialogue for saving the currently edited correction data into a file.

- **Remote Command:**

:mmemory:store:correction 1|2|3|4|5|6,<filename>

- **Examples:**

:MMEM:STOR:CORR 1,"amplcor.cor"

[Load Cor...]

- **Menu description:** to pop up Windows dialogue for calling the currently edited correction data into currently selected correction.

- **Remote Command:**

:mmemory:LOAD:correction 1|2|3|4|5|6,<filename>

- **Examples:**

:MMEM:LOAD:CORR 1,"amplcor.cor"

[Apply All Corrections On Off]

Apply all edited or called correction data on current measurement trace.

- **Remote Command:**

[[:sense]:correction:CSET:ALL[:state] ON|OFF]1|0 [[:sense]:correction:CSET:ALL[:state]]?

- **Examples:**

:CORR:CSET:ALL ON

:CORR:CSET:ALL?

[Delete All Corrections]

Erase all edited correction values.

- **Remote Command:**

[[:sense]:correction:CSET:ALL:delete

- **Examples:**

:CORR:CSET:ALL:DEL

5.2.2.3 Span/X Scale

Press the **【Span/X Scale】** on the front panel to enable the span function and set the signal/spectrum analyzer into center frequency/span mode. Press the **【Span】** key to pop up [Span], [Full Span], [Zero Span] and [Last Span] at the same time.

[BW]

- **Menu description:** the span can be set by number keys, stepping keys or knob. Use number keys or select [Zero Span] to set the span as zero.

5.2. Description of menu

- **Key path:** **【Span/X Scale】** , [Span] on the front panel.
- **Status saved:** saved in the instrument status.
- **Factory preset:** maximum frequency limit - start frequency.
- **Setting range:** Min.:0Hz (for non-zero span, Min.:10Hz); Max.: related to the maximum working frequency limit of the instrument.

- **Remote Command:**

```
[::sense]:frequency:SPAN <frequency>
```

```
[::sense]:frequency:SPAN?
```

- **Examples:**

```
:FREQ:SPAN 22 GHz
```

[Full Span]

- **Menu description:** to set the signal/spectrum analyzer into the center frequency/span mode. Set the span as maximum value.

- **Remote Command:**

```
[::sense]:frequency:SPAN:FULL
```

- **Examples:**

```
:FREQ:SPAN:FULL
```

[Zero Span]

- **Menu description:** to set span as 0Hz. It is good for observing signal at time domain, in particular, good for observation of modulating signal.

- **Remote Command:**

```
[::sense]:FREQ:SPAN 0 Hz
```

- **Examples:**

```
:FREQ:SPAN 0 Hz
```

[Last Span]

- **Menu description:** to set the signal/spectrum analyzer back to the previous span.

- **Remote Command:**

```
[::sense]:frequency:SPAN:previous
```

- **Examples:**

```
:FREQ:SPAN:PREV
```

5.2.2.4 Bandwidth

Pop up the soft More for setting Res BW and Video BW, including [Res BW Auto Man], [Video BW Auto Man], [VBW/RBW Auto Man], [Span/RBW Auto Man], [Filter Type▶].

[Res BW**Auto Man]**

5.2. Description of menu

- **Menu description:** to change the resolution bandwidth of spectrum analysis, ranging from 1Hz to 20 MHz, which is stepped by 1, 2, 3, 5 and 10. The resolution bandwidth can be changed with the number keys, step keys and knob. The shaded character indicates the currently selected mode.
- **Key path:** [BW], [Res BW Auto Man] on the front panel.
- **Status saved:** saved in the instrument status.
- **Factory preset:** Auto
- **Setting range:** Min.: 1Hz, Max.: 20 MHz.
- **Default unit:** Hz.
- **Remote Command:**

```
[[:sense]:bandwidth|bwidth[:resolution] <freq>
```

```
[[:sense]:bandwidth|bwidth[:resolution]?
```

```
[[:sense]:bandwidth|bwidth[:resolution]:AUTO OFF|ON|0|1
```

```
[[:sense]:bandwidth|bwidth[:resolution]:AUTO?
```

- **Examples:**

```
BAND 1 kHz
```

```
BWID:AUTO On
```

[Video BW

Auto Man]

- **Menu description:** to change the video bandwidth within the active function area, ranging from 1Hz to 20 MHz, which is stepped by 1, 2, 3, 5 and 10. Use number keys, stepping keys or knob to change. The current mode is shaded. When set as Auto Off, press [Video BW Auto On/Off] to select Auto On and return to auto mode.
- **Key path:** [BW], [Video BW Auto Man] on the front panel.
- **Status saved:** saved in the instrument status.
- **Factory preset:** Auto, same as the Resolution Bandwidth setting.
- **Setting range:** Min.: 1Hz, Max.: 20 MHz.
- **Default unit:** Hz.
- **Remote Command:**

```
[[:sense]:bandwidth|bwidth:video <freq>
```

```
[[:sense]:bandwidth|bwidth:video?
```

```
[[:sense]:bandwidth|bwidth:video:AUTO OFF|ON|0|1
```

```
[[:sense]:bandwidth|bwidth:video:AUTO?
```

- **Examples:**

```
:BAND:VID 1 kHz
```

```
:BWID:VID:AUTO ON
```

[VBW/RBW

5.2. Description of menu

Auto Man]

- **Menu description:** to set the ratio between the current video bandwidth and resolution bandwidth with the default value as 1. As the resolution bandwidth changes, the video bandwidth changes to maintain this ratio. The ratio should be displayed on the input area and used for the coupling mode of those two kinds of bandwidth. When a new ratio is selected, change the video bandwidth to meet this new ratio and the resolution bandwidth should remain unchanged.
- **Key path:** **【BW】** , [VBW/RBW Auto Man] on the front panel.
- **Status saved:** saved in the instrument status.
- **Factory preset:** auto with VBW/RBW as 1.
- **Setting range:** Min.:0.0001, Max.: 300000.
- **Remote Command:**

```
[[:sense]:bandwidth|bwidth:video:ratio <number>
```

```
[[:sense]:bandwidth|bwidth:video:ratio?
```

```
[[:sense]:bandwidth|bwidth:video:ratio:AUTO OFF|ON|0|1
```

```
[[:sense]:bandwidth|bwidth:video:ratio:AUTO?
```

- **Examples:**

```
:BAND:VID:RAT 2
```

[Span/RBW Auto Man]

- **Menu description:** to set the ratio between the current span and resolution bandwidth and display it in the input area. This ratio is used in coupling mode of the resolution bandwidth.
- **Key path:** **【BW】** , [Span/RBW Auto Man] on the front panel.
- **Status saved:** saved in the instrument status.
- **Factory preset:** auto with span/RBW as 106.
- **Setting range:** Min.:2, Max.: 10000.
- **Remote Command:**

```
[[:sense]:frequency:SPAN:bandwidth[:resolution]:ratio <integer>
```

```
[[:sense]:frequency:SPAN:bandwidth[:resolution]:ratio?
```

```
[[:sense]:frequency:SPAN:bandwidth[:resolution]:ratio:AUTO OFF|ON|0|1
```

```
[[:sense]:frequency:SPAN:bandwidth[:resolution]:ratio:AUTO?
```

- **Examples:**

```
:SPAN:BAND:RAT 20
```

[Filter Type▶]

- **Menu description:** comprising [Gaussian] and [Flattop]. In general, the signal/spectrum uses Gaussian filter, i.e., use filter approximates to the Gaussian shape to complete filtering of Res BW. If the flat top filter is used, the signal/spectrum analyzer adopts filter approximate to the rectangular shape to complete filtering of resolution bandwidth. The response time of flat top filter is about 3 times of that of the Gaussian filter. The sweep speed of the flat top filter is smaller than that of the Gaussian filter. The flat top filter has better selectivity than the Gaussian filter and therefore is more capable of distinguishing two signals with unequal amplitude.

5.2. Description of menu

- **Key path:** **【BW】** , [Filter Type▶] on the front panel.
- **Status saved:** saved in the instrument status.
- **Factory preset:** Gaussian.
- **Remote Command:**

```
[::SENSe]:BANDwidth|BWIDth:SHAPE GAUSSian|FLATtop
```

```
[::SENSe]:BANDwidth|BWIDth:SHAPE?
```

- **Examples:**

```
:BAND:SHAP GAUS
```

```
:BAND:SHAP?
```

[Filter BW▶]

- **Menu description:** set the signal/spectrum analyzer. In case of Gaussian filter, select the resolution bandwidth as 3dB or 6dB. When this parameter changes, the resolution bandwidth filter is fixed and the bandwidth in information display area changes only.
- **Key path:** front panel **【Bandwidth】** 、 [Filter BW ▶].
- **Status saved:** saved in the instrument status.
- **Factory preset:**3dB.
- **Remote Command:**

```
[::SENSe]:BANDwidth|BWIDth:TYPE DB3|DB6
```

```
[::SENSe]:BANDwidth|BWIDth:TYPE?
```

- **Examples:**

```
:BAND:TYPE DB6
```

```
:BAND:TYPE?
```

5.2.2.5 Sweep

Enable sweep-related parameter setup function to pop up corresponding soft More, including [Sweep Time Auto Man], [Sweep Single Cont], [Sweep Setup ▶], [Gate ▶], [Sweep Points].

[Sweep Time Auto Man]

- **Menu description:** to change the sweep time of signal/spectrum analyzer. Use the number keys, step keys or knob to adjust the sweep time. When it is under Auto OFF mode (shaded), it indicates that sweep time can be set manually. When it is under Auto ON status, the sweep time will be automatically coupled based on resolution bandwidth, span and video bandwidth

Under Swept type, when the swept time is limited within the minimum sweep time, it can be set from 1ms to 6000s. Under zero span, the sweep time can be 1μs at minimum. When the sweep type is FFT, the sweep time is mainly used to meet the requirements of FFT sampling and processing time.

The sweep time is coupled with the sweep type, resolution bandwidth, video bandwidth and span. Changing those parameters will result in change of the sweep time or triggering of the limit setting of sweep time.

- **Key path:** **【Sweep】** , [Sweep Time Auto Man] on the front panel.

5.2. Description of menu

- **Status saved:** saved in the instrument status.
- **Factory preset:** sweep time Auto.
- **Setting range:** Min.: 1ms and Max.: 6000s (for non-zero span); and Min.: 1us, Max.: 6000s (for zero span).
- **Default unit:** s.

- **Remote Command:**

```
[[:sense]:sweep:TIME <seconds>
```

```
[[:sense]:sweep:TIME?
```

```
[[:sense]:sweep:TIME:AUTO OFF|ON|0|1
```

```
[[:sense]:sweep:TIME:AUTO?
```

- **Examples:**

```
:SWE:TIME 500 ms
```

```
:SWE:TIME:AUTO OFF
```

[Sweep **Cont** Single]

- **Menu description:** to set continuous sweep OFF or ON. When the [Sweep **Cont** Single] is set as Cont On, Continuous On will be triggered and continuous sweep will be the default measurement control method; when the [Sweep Cont **Single**] is set as Conti Off, single sweep will be triggered. Press **【Sweep Single】** to restart sweep when the next trigger signal arrives. When single sweep mode is triggered, the information prompt column at the screen top will display: Sweep Continuous OFF.
- **Key path:** **【Sweep】** , [Sweep Single **Cont**] on the front panel.
- **Status saved:** saved in the instrument status.
- **Factory preset:** Sweep Continuous ON.
- **Remote Command:**

```
:initiate:continuous OFF|ON|0|1
```

```
:initiate:continuous?
```

- **Examples:**

```
:INIT:CONT OFF
```

[Sweep Setup▶]

Pop up the soft More related to Sweep type, including [Sweep Type Auto Man], [Sweep Type Rules Auto Man] and [FFT Width Auto Man].

[Sweep Type **Auto** Man]

- **Menu description:** to set sweep type. To determine whether Swept or FFT is adopted for frequency spectrum measurement. Also set the FFT step bandwidth for FFT sweep The soft More include [Auto], [Swept] and [FFT]. When under Auto ON mode, the signal/spectrum analyzer will automatically select the sweep type based on sweep type rules.
- **Key path:** **【Sweep】** , [Sweep Setup ▶], [Sweep Type Auto Man] on the front panel.
- **Status saved:** saved in the instrument status.

5.2. Description of menu

- **Factory preset:** sweep type: Auto.
- **Remote Command:**

```
[[:sense]:sweep:TYPE FFT|sweep
```

```
[[:sense]:sweep:TYPE?
```

```
[[:sense]:sweep:TYPE:AUTO OFF|ON|0|1
```

```
[[:sense]:sweep:TYPE:AUTO?
```

- **Examples:**

```
:SWE:TYPE FFT
```

```
:SWE:TYPE?
```

```
:SWE:TYPE:AUTO OFF
```

```
:SWE:TYPE:AUTO?
```

[Sweep Type Rules **Auto Man**]

- **Menu description:** to set rules for auto sweep type. While the sweep type rules include “Best Dynamic Range” and “Best Speed”.

“Best Dynamic Range” rules: when RBW is or larger than 1kHz, the sweep type is Swept; when RBW is less than 1kHz, the sweep type is FFT.

“Best Speed” rules: when RBW is or larger than 30kHz, the sweep type is Swept; when RBW is less than 30kHz, the sweep type is FFT.

- **Key path:** **[Sweep]** , [Sweep Setup ►], [Sweep Type Rules Auto Man] on the front panel.
- **Status saved:** saved in the instrument status.
- **Factory preset:** the sweep type rules are automatically set as “Best Dynamic Range”.
- **Remote Command:**

```
[[:sense]:sweep:TYPE:AUTO:rules speed|drange
```

```
[[:sense]:sweep:TYPE:AUTO:rules?
```

```
[[:sense]:sweep:TYPE:AUTO:rules:AUTO[:state] OFF|ON|0|1
```

```
[[:sense]:sweep:TYPE:AUTO:rules:AUTO[:state]?
```

- **Examples:**

```
:SWE:TYPE:AUTO:RUL SPE
```

```
:SWE:TYPE:AUTO:RUL?
```

```
:SWE:TYPE:AUTO:RUL:AUTO OFF
```

```
:SWE:TYPE:AUTO:RUL:AUTO?
```

[FFT Width

Auto Man]

- **Menu description:** to set FFT Width. The FFT width includes [Auto], [<100kHz], [<3 MHz], [<13 MHz], [<=Max.]. FFT width is only active when the FFT sweep type is selected. Under Auto type, when the signal/spectrum analyzer performs FFT spectrum measurement, the maximum resolution bandwidth is 30kHz. To guarantee best dynamic measurement range, the signal/spectrum analyzer automatically

5.2. Description of menu

optimizes the FFT width within 100kHz. The larger is the FFT width, the faster is FFT spectrum measurement, but the dynamic range performance will be affected.

Under FFT sweep, the FFT width setup limits the maximum value for center frequency step of each tune. For example, if [$<100\text{Hz}$] is selected, the maximum value for center freq step of each tune is 100Hz. As the FFT width gets larger, the count of instrument center frequencies get smaller when performing measurement of same frequency scope, and the response measurement gets faster. Therefore, to improve measurement speed, you can manually change the FFT width.

- **Key path:** **【Sweep】** , [Sweep Setup▶], [FFT Width▶] on the front panel.
- **Status saved:** saved in the instrument status.
- **Factory preset:** FFT Width is set as Auto.
- **Remote Command:**

```
[[:sense]:sweep:FFT:width <real>
```

```
[[:sense]:sweep:FFT:width?
```

```
[[:sense]:sweep:FFT:width:AUTO OFF|ON|0|1
```

```
[[:sense]:sweep:FFT:width:AUTO?
```

- **Examples:**

```
:SWE:FFT:WIDT 100kHz
```

```
:SWE:FFT:WIDT?
```

```
:SWE:FFT:WIDT:AUTO OFF
```

```
:SWE:FFT:WIDT:AUTO?
```

[Gate▶]

Pop up soft More related to gate, including [Gate On Off], [Gate View On Off], [Gate View Sweep Time], [Gate Setup▶] and [Gate Source▶] items.

[Gate On **Off**]

- **Menu description:** to turn on or off Gate. When the Gate function is on, the signal/spectrum analyzer will sweep and refresh traces based on the set Gate Method in combination with related gate parameters and Gate Source signals. Not all types of gating are available for all measurements.

The Gate function is unavailable (grayed out) when: the FFT Sweep Type is manually selected; the Gate Method is LO or Video; Sweep is manually selected; and the Marker Count is ON.

The Gate ON/OFF status is displayed on the status zone at top right corner of the window.

- **Key path:** **【Sweep】** , [Gate▶], [Gate ON OFF] on the front panel.
- **Status saved:** saved in the instrument status.
- **Factory preset:** OFF.
- **Remote Command:**

```
[[:sense]:sweep:egate[:state] OFF|ON|0|1
```

```
[[:sense]:sweep:egate[:state]?
```

- **Examples:**

```
:SWE:EGAT OFF
```

5.2. Description of menu

:SWE:EGAT OFF

[Gate View On Off]

- **Menu description:** to turn on or off Gate View. It is realized by Swept Analysis under Zero Span. At this time, the trigger source is the Gate Source.

When the Gate View is on, the Sweep Setting and the Sweep Time menus are unavailable (grayed out). The analyzer automatically switches to the sweep frequency under Zero Span. At this time, the current span is Zero Span. When the Sweep Time is selected as the Gate View time, the Gate ON OFF function is unavailable; when the Gate View is OFF, the Sweep Time menu, Sweep Setting menu and Span recover to the status before the View is ON. The Gate ON or OFF is determined by the current menu status.

When the Gate View is ON, if the Span is as non-zero, the Gate View will turn off.

- **Key path:** **【Sweep】**, [Gate▶], [Gate View ON OFF] on the front panel.
- **Status saved:** saved in the instrument status.
- **Factory preset:** OFF.
- **Remote Command:**

```
[::sense]:sweep:egate:VIEW ON|OFF|1|0
```

```
[::sense]:sweep:egate:VIEW?
```

- **Examples:**

```
:SWE:EGAT:VIEW ON
```

```
:SWE:EGAT:VIEW?
```

[Gate View Sweep Time]

- **Menu description:** to set the sweep time in the Gate View.
- **Key path:** **【Sweep】**, [Gate▶], [Gate View Sweep Time] on the front panel.
- **Status saved:** saved in the instrument status.
- **Factory preset:** 10ms
- **Setting range:** 1us-6000s.
- **Remote Command:**

```
[::sense]:sweep:egate:TIME <time>
```

```
[::sense]:sweep:egate:TIME?
```

- **Examples:**

```
:SWE:EGAT:TIME 10ms
```

```
:SWE:EGAT:TIME?
```

[Gate setup▶]

Pop up soft More related to gate setup, including [Gate Delay], [Gate Length], [Gate Method ▶], [Control Edge Level] and [Gate Holdoff On Off] items.

[Gate Delay]

5.2. Description of menu

- **Menu description:** to set gate delay time. And control the length of time from the time when the gate signal is TRUE until the gate is turned on.
- **Key path:** **[Sweep]** , [Gate▶], [Gate Setup▶], [Gate Delay] on the front panel.
- **Status saved:** saved in the instrument status.
- **Factory preset:** 1ms.
- **Setting range:** 0s-40s.
- **Remote Command:**

```
[[:sense]:sweep:egate:delay <time>
```

```
[[:sense]:sweep:egate:delay?
```

- **Examples:**

```
:SWE:EGAT:DEL 1ms
```

```
:SWE:EGAT:DEL?
```

[Gate length]

- **Menu description:** to set the gate length. And control the length of time that the gate is on after it opens.
- **Key path:** **[Sweep]** , [Gate▶], [Gate Setup▶], [Gate Length] on the front panel.
- **Status saved:** saved in the instrument status.
- **Factory preset:** 5ms.
- **Setting range:** 100us-5s
- **Remote Command:**

```
[[:sense]:sweep:egate:length <time>
```

```
[[:sense]:sweep:egate:length?
```

- **Examples:**

```
:SWE:EGAT:length 5ms
```

```
:SWE:EGAT:length?
```

[Gate Method▶]

Pop up soft More for selecting gate methods, including [LO], [Video], [FFT] items. Not all types of gating are available for all measurements.

[LO]

- **Menu description:** to set the gate method as LO.

LO is a smart way for gating. It only sweeps LO when Gate is ON and passes through signal. The Gate signal controls when the sweep generator scans and when it passes through or shields signal. This enables that the signal/spectrum analyzer only sweeps when Gate is ON, that means, the Gate LO only sweeps LO and passes through signal when Gate is ON.

When set to Gate ON, the LO sweeps whenever the specified gate parameters are satisfied. This form of gating is more sophisticated, and results in faster measurements. With Gated LO, the analyzer only sweeps while the specified gate parameters are satisfied. This means that a sweep could take place over several gate events. It would start when the gate signal goes TRUE and stop when it goes FALSE, then continue when it

5.2. Description of menu

goes TRUE again. But since the LO is sweeping as long as the gate conditions are satisfied, the sweep typically finishes much more quickly than with Gated Video.

When in zero span, there is no actual sweep performed. But data is only taken while the gate conditions are satisfied. So even though there is no sweep, the gate settings will still function when data is acquired.

- **Key path:** **【Sweep】** , [Gate▶], [Gate Setup▶], [Gate Method▶], [LO] on the front panel.
- **Remote Command:**

```
[::sense]:sweep:egate:method LO
```

```
[::sense]:sweep:egate:method?
```

- **Examples:**

```
:SWE:EGAT:METH LO
```

```
:SWE:EGAT:METH?
```

[Video]

- **Menu description:** to set the gate method as Video.

This form of gating may be thought of as a simple switch, which connects the input signal to the signal/spectrum analyzer. When the switch is ON (Gate ON), the video signal is allowed to pass through; and the switch is off (Gate OFF), the signal is blocked. Under Gated Video, whether the gate is ON or OFF, the signal/spectrum analyzer measures signals and never stops sweeping. The Gate Switch is between the signal pathway envelope detector and video filter, therefore is called as Gated Video. Since the Gate Switch is behind the envelope detector, whether the Gate is on or off, the signal/spectrum analyzer measurement path will respond to the input signal; therefore, it is necessary to reduce the sweep speed to the extent that the signal/spectrum analyzer can measure input signal during Gate ON period, which results in certain limits for applying Gated Video measurements. For this reason, in general, Video method results in slower measurement compared with Gated LO and FFT.

- **Key path:** **【Sweep】** , [Gate▶], [Gate Setup▶], [Gate Method▶], [Video] on the front panel.
- **Remote Command:**

```
[::sense]:sweep:egate:method video
```

```
[::sense]:sweep:egate:method?
```

- **Examples:**

```
:SWE:EGAT:METH VID
```

```
:SWE:EGAT:METH?
```

[FFT]

- **Menu description:** to the gate method as Gated FFT.

The way of FFT spectrum measurement if the trigger conditions are satisfied, which is called as the gated FFT. The FFT spectrum is the input signal spectrum through FFT calculation from a time domain waveform during collection. The time for collecting the domain waveform is similar to the gate length. The time for collecting the domain waveform is similar to the gate length. Different from the Sweep Time Gate, under Gated FFT, the gate length is determined by the currently set resolution bandwidth and cannot be set and modified through menu. When the Span is less than 10 MHz, in particular for small resolution bandwidth, the FFT measurement is faster than the Sweep measurement; therefore, for a given signal period, compared with Gated LO, the Gated FFT gets higher frequency resolution.

5.2. Description of menu

When set to Gate ON, an FFT is performed whenever the specified gate conditions are satisfied. This is an FFT measurement which begins when the predefined conditions are satisfied. Since the time period of an FFT is approximately $2.57/\text{RBW}$, you get a measurement which starts under predefined conditions and takes place over a predefined period. So, in essence, this is a gated measurement.

Gated FFT cannot be done in zero span. So in zero span, the Gated LO and Video methods are used. Data is still only taken while the specified gate parameters are satisfied, so the gate settings do impact when data is acquired.

- **Key path:** **【Sweep】**, [Gate▶], [Gate Setup▶], [Gate Method▶], [FFT] on the front panel.

- **Remote Command:**

```
[sense]:sweep:egate:method FFT
```

```
[sense]:sweep:egate:method?
```

- **Examples:**

```
:SWE:EGAT:METH FFT
```

```
:SWE:EGAT:METH?
```

[Control **Edge** Level]

- **Menu description:** set the method of controlling the gating function.

— Edge

When the selected edge (positive or negative edge) of the trigger signal arrives, whether the Gate is ON is determined by the subsequent gate delay and gate length (both can be set by the menu). The Gate is ON whenever the trigger event arrives and the gate delay time has passed. During the gate length, the signal passes through; when the gate length ends, the signal is blocked. In general, for edge triggering, the trigger signal is an TTL periodic signal, whose positive and negative edges are synchronous with those of the measured pulse signal. Gate delay time refers to the time during which the signal/spectrum analyzer needs to wait from the trigger event to Gate ON.

— Level

When the gate signal has achieved a certain level (high level or low level. In signal/spectrum analyzer, positive polarity indicates high level; and negative polarity indicates low level), the signal passes through; and when the gate signal fails to achieve specified level, the signal is blocked. In Level triggering, the Gate Delay and Gate Length parameters are void.

- **Key path:** **【Sweep】**, [Gate▶], [Gate Setup▶], [Control Edge Level] on the front panel.

- **Status saved:** saved in the instrument status.

- **Factory preset:** Edge.

- **Remote Command:**

```
[sense]:sweep:egate:control EDGE|level
```

```
[sense]:sweep:egate:control?
```

- **Examples:**

```
:SWE:EGAT:CONT EDGE
```

```
:SWE:EGAT:CONT?
```

[Gate Holdoff On **Off**]

5.2. Description of menu

- **Menu description:** to increase or decrease the wait time after a gate event ends before the signal/spectrum analyzer will respond to the next gate signal.

When Method is set to LO, after any gate event finishes, the signal/spectrum analyzer must wait for the sweep status reset before it can respond to another gate signal. When the Gate Holdoff is ON, the user can adjust the wait time; shortening holdoff period can improve speed, but it may reduce measurement accuracy; if accuracy is insufficient, the user may consider extending holdoff period.

When Method is set to Video or FFT, the Gate Holdoff function still functions and has no effect on measurement accuracy.

- **Key path:** **[Sweep]** , [Gate▶], [Gate Setup▶], [Gate Holdoff ON OFF] on the front panel.
- **Status saved:** saved in the instrument status.
- **Factory preset:** gate time: 100ms; status: OFF.
- **Remote Command:**

```
[sense]:sweep:egate:holdoff <time>
```

```
[sense]:sweep:egate:holdoff?
```

```
[sense]:sweep:egate:holdoff:AUTO OFF|ON|0|1
```

```
[sense]:sweep:egate:holdoff:AUTO?
```

- **Examples:**

```
:SWE:EGAT:HOLD 100ms
```

```
:SWE:EGAT:HOLD?
```

```
:SWE:EGAT:HOLD:AUTO OFF
```

```
:SWE:EGAT:HOLD:AUTO?
```

[Gate Source▶]

Pop up soft More related to gate source setting, including [Power Trig▶], [External Trig 1▶], [External Trig 2▶],

[RF Burst ▶] and [Periodic Timer ▶].

[RF Burst▶]

- **Menu description:** to set the Gate Source as Power Trigger. The soft More is [Gate Slope Pos Neg].
- **Key path:** **[Sweep]** , [Gate▶], [Gate Source▶], [RF Burst▶] on the front panel.
- **Status saved:** saved in the instrument status.
- **Remote Command:**

```
[sense]:sweep:egate:source LINE
```

```
[sense]:sweep:egate:source?
```

- **Examples:**

```
:SWE:EGAT:SOUR LINE
```

```
:SWE:EGAT:SOUR?
```

[Gate Slope Pos Neg]

5.2. Description of menu

- **Menu description:** to set the Gate Source Polarity Man of Power Trigger.
- **Key path:** **【Sweep】** , [Gate▶], [Gate Source▶], [RF Burst▶] [Gate Slope Pos Neg] on the front panel.
- **Status saved:** saved in the instrument status.
- **Factory preset:** Positive.
- **Remote Command:**

```
:trigger[:sequence]:LINE:slope positive|negative
```

```
:trigger[:sequence]:LINE:slope?
```

- **Examples:**

```
:TRIG:LINE:SLOP POS
```

```
:TRIG:LINE:SLOP?
```

[External 1▶]

- **Menu description:** to set the Gate Source as External Trigger Signal 1. The soft More are [Trigger Level], [Gate Slope Pos Neg].
- **Remote Command:**

```
[:sense]:sweep:egate:source external1
```

```
[:sense]:sweep:egate:source?
```

- **Examples:**

```
:SWE:EGAT:SOUR EXT1
```

```
:SWE:EGAT:SOUR?
```

[Trigger level]

- **Menu description:** to set the Trigger Level Threshold of the External Trigger Signal 1.
- **Key path:** **【Sweep】** , [Gate▶], [Gate Source▶], [External 1▶], [Trigger Level] on the front panel.
- **Status saved:** saved in the instrument status.
- **Factory preset:** 1.2V
- **Setting range:** -5V-5V.
- **Default unit:** V
- **Remote Command:**

```
:trigger[:sequence]:external1:level <level>
```

```
:trigger[:sequence]:external1:level?
```

- **Examples:**

```
:TRIG:EXT1:LEV 1.2V
```

```
:TRIG:EXT1:LEV?
```

[Gate Slope Pos Neg]

- **Menu description:** to set the Gate Source Polarity of the External Trigger Signal 1.

5.2. Description of menu

- **Key path:** **【Sweep】** , [Gate▶], [Gate Source▶], [External 1▶], [Gate Slope Pos Neg] on the front panel.
- **Status saved:** saved in the instrument status.
- **Factory preset:** Positive.
- **Remote Command:**
- :TRIGger[:SEquence]:EXTernal1:SLOPe POSitive|NEGative
- :TRIGger[:SEquence]:EXTernal1:SLOPe?

- **Examples:**

:TRIG:EXT1:SLOP POS

:TRIG:EXT1:SLOP?

[External 2▶]

- **Menu description:** to set the Gate Source as External Trigger Signal 2. The soft More are [Trigger Level], [Gate Slope Pos Neg].

- **Remote Command:**

[:sense]:sweep:egate:source external2

[:sense]:sweep:egate:source?

- **Examples:**

:SWE:EGAT:SOUR EXT2

:SWE:EGAT:SOUR?

[Trigger level]

- **Menu description:** to set the Trigger Level Threshold of the External Trigger Signal 2.
- **Key path:** **【Sweep】** , [Gate▶], [Gate Source▶], [External 2▶], [Trigger Level] on the front panel.
- **Status saved:** saved in the instrument status.
- **Factory preset:** 1.2V
- **Setting range:** -5V-5V.
- **Default unit:** V
- **Remote Command:**

:trigger[:sequence]:external2:level <level>

:trigger[:sequence]:external2:level?

- **Examples:**

:TRIG:EXT2:LEV 1.2V

:TRIG:EXT2:LEV?

[Gate Slope Pos Neg]

- **Menu description:** to set the Gate Source Polarity of the External Trigger Signal 2.
- **Key path:** **【Sweep】** , [Gate▶], [Gate Source▶], [External 2▶], [Gate Slope Pos Neg] on the front panel.

5.2. Description of menu

- **Status saved:** saved in the instrument status.
- **Factory preset:** Positive.
- **Remote Command:**

:trigger[:sequence]:external2:slope positive|negative

:trigger[:sequence]:external2:slope?

- **Examples:**

:TRIG:EXT2:SLOP POS

:TRIG:EXT2:SLOP?

[RF Burst▶]

- **Menu description:** to set the Gate Source as Burst Signal Trigger. The soft More are [Trigger Level], [Gate Source Polarity Pos Neg].

- **Remote Command:**

[:sense]:sweep:egate:source rfburst

[:sense]:sweep:egate:source?

- **Examples:**

:SWE:EGAT:SOUR RFB

:SWE:EGAT:SOUR?

[Trigger level]

- **Menu description:** to set the Trigger Level Threshold of the burst signal.
- **Key path:** **【Sweep】**, [Gate▶], [Gate Source▶], [RF Burst▶], [Trigger Level] on the front panel.
- **Status saved:** saved in the instrument status.
- **Factory preset:** -20dBm.
- **Setting range:** max.: -270dBm-30dBm. The current settable range is coupled with the current reference level and scale/division. The maximum is the level represented by the top graticule, and the minimum value is the level represented by the bottom graticule.
- **Default unit:** dBm.
- **Remote Command:**

:trigger[:sequence]:rfburst:level:absolute <amp;gt;

:trigger[:sequence]:rfburst:level:absolute?

- **Examples:**

:TRIG:RFB:LEV:ABS -20dBm

:TRIG:RFB:LEV:ABS?

[Gate Slope Pos Neg]

- **Menu description:** to set the trigger polarity of the Burst Signal Trigger.
- **Key path:** **【Sweep】**, [Gate▶], [Gate Source▶], [RF Burst▶], [Gate Slope Pos Neg] on the front panel.

5.2. Description of menu

- **Status saved:** saved in the instrument status.
- **Factory preset:** Positive.
- **Remote Command:**

:trigger[:sequence]:rfburst:slope positive|negative

:trigger[:sequence]:rfburst:slope?

- **Examples:**

:TRIG:RFB:SLOP POS

:TRIG:RFB:SLOP?

[Periodic Timer▶]

- **Menu description:** to set the Gate Source as Timer Trigger. The soft More include [Sync Source ▶], [Period], [Offset], [Trig Holdoff].
- **Remote Command:**

:TRIG:SOUR FRAM

[Sync Source▶]

- **Menu description:** to select and set the Timer Sync Source parameters. The soft More include [Off], [External 1▶], [External 2▶], [RF Burst▶]. OFF means that the timer is not synchronous.
- **Remote Command:**

:trigger[:sequence]:frame:SYNC external1|external2|rfburst|OFF

:trigger[:sequence]:frame:SYNC?

[External 1▶]

- **Menu description:** to set the Timer Sync Source as External Trigger Signal 1. The soft More are [Trigger Level], [Trig Slope Pos Neg].
- **Remote Command:**

:trigger[:sequence]:frame:SYNC external1

- **Examples:**

:TRIG:FRAM:SYNC EXT1

:TRIG:FRAM:SYNC?

[Trigger level]

- **Menu description:** to set the Trigger Level Threshold of the External Trigger Signal 1.
- **Key path:** **【Sweep】**, [Gate▶], [Gate Source▶], [Periodic Timer▶], [Sync Source▶], [External 1▶], [Trigger Level] on the front panel.
- **Status saved:** saved in the instrument status.
- **Factory preset:** 1.2V
- **Setting range:** -5V-5V.

- **Default unit:** V

- **Remote Command:**

:trigger[:sequence]:external1:level <level>

:trigger[:sequence]:external1:level?

- **Examples:**

:TRIG:EXT1:LEV 1.2V

:TRIG:EXT1:LEV?

[Trig Slope **Pos** Neg]

- **Menu description:** to set the trigger polarity of the External Trigger Signal 1.
- **Key path:** **【Sweep】** , [Gate▶], [Gate Source▶], [Periodic Timer▶], [Sync Source▶], [External 1▶], [Trig Slope **Pos** Neg] on the front panel.
- **Status saved:** saved in the instrument status.
- **Factory preset:** Positive.
- **Remote Command:**

:trigger[:sequence]:external1:slope positive|negative

:trigger[:sequence]:external1:slope?

- **Examples:**

:TRIG:EXT1:SLOP

:TRIG:EXT1:SLOP?

[External 2▶]

Set the Sync Source as External Trigger Signal 2. The soft More are [Trigger Level], [Trig Slope Pos Neg].

- **Remote Command:**

:trigger[:sequence]:frame:SYNC external2

- **Examples:**

:TRIG:FRAM:SYNC EXT2

[Trigger level]

- **Menu description:** to set the Trigger Level Threshold of the External Trigger Signal 2.
- **Key path:** **【Sweep】** , [Gate▶], [Gate Source▶], [Periodic Timer▶], [Sync Source▶], [External 2▶], [Trigger Level] on the front panel.
- **Status saved:** saved in the instrument status.
- **Factory preset:** 1.2V
- **Setting range:** -5V-5V.
- **Default unit:** V
- **Remote Command:**

:trigger[:sequence]:external2:level <level>

5.2. Description of menu

:trigger[:sequence]:external2:level?

- **Examples:**

:TRIG:EXT2:LEV 1.2V

:TRIG:EXT2:LEV?

[Trig Slope Pos Neg]

- **Menu description:** to set the trigger polarity of the External Trigger Signal 2.
- **Key path:** **【Sweep】**, [Gate▶], [Gate Source▶], [Periodic Timer▶], [Sync Source▶], [External 2▶], [Trig Slope Pos Neg] on the front panel.
- **Status saved:** saved in the instrument status.
- **Factory preset:** Positive.
- **Remote Command:**

:trigger[:sequence]:external2:slope positive|negative

:trigger[:sequence]:external2:slope?

- **Examples:**

:TRIG:EXT2:SLOP POS

:TRIG:EXT2:SLOP?

[RF Burst▶]

Set the Timer Sync Source as Burst Signal. The soft More are [Trigger Level], [Trig Slope Pos Neg].

- **Remote Command:**

:trigger[:sequence]:frame:SYNC rfburst

- **Examples:**

:TRIG:FRAM:SYNC RFB

[Trigger level]

- **Menu description:** to set the Trigger Level Threshold of the burst signal.
- **Key path:** **【Sweep】**, [Gate▶], [Gate Source▶], [Periodic Timer▶], [Sync Source▶], [RF Burst▶], [Trigger Level] on the front panel.
- **Status saved:** saved in the instrument status.
- **Factory preset:** -20dBm.
- **Setting range:** max.: -270dBm-30dBm. The current settable range is coupled with the current reference level and scale/division. The maximum is the level represented by the top graticule, and the minimum value is the level represented by the bottom graticule.
- **Default unit:** dBm.
- **Remote Command:**

:trigger[:sequence]:rfburst:level:absolute <amp|>

:trigger[:sequence]:rfburst:level:absolute?

- **Examples:**

:TRIG:RFB:LEV:ABS -20dBm

:TRIG:RFB:LEV:ABS?

[Trig Slope Pos Neg]

- **Menu description:** to set the trigger polarity of the Burst Signal.
- **Key path:** **【Sweep】**, [Gate▶], [Gate Source▶], [Periodic Timer▶], [Sync Source▶], [RF Burst▶], [Trig Slope Pos Neg] on the front panel.
- **Status saved:** saved in the instrument status.
- **Factory preset:** Positive.
- **Remote Command:**

:trigger[:sequence]:rfburst:slope positive|negative

:trigger[:sequence]:rfburst:slope?

- **Examples:**

:TRIG:rfburst:SLOP POS

:TRIG:rfburst:SLOP?

[Period]

- **Menu description:** to set the Trigger Mode as Timer Period.
- **Key path:** **【Sweep】**, [Gate▶], [Gate Source▶], [Periodic Timer▶], [Period] on the front panel.
- **Status saved:** saved in the instrument status.
- **Factory preset:** 100ms.
- **Setting range:** 100ns-20s.
- **Default unit:** s.
- **Remote Command:**

:trigger[:sequence]:frame:period <time>

:trigger[:sequence]:frame:period?

- **Examples:**

:TRIG:FRAM:PER 100ms

:TRIG:FRAM:PER?

[Offset]

- **Menu description:** to set the Trigger Mode as Timer Offset, which is not more than the Timer Period.
- **Key path:** **【Sweep】**, [Gate▶], [Gate Source▶], [Periodic Timer▶], [Offset] on the front panel.
- **Status saved:** saved in the instrument status.
- **Factory preset:** 100ms.
- **Setting range:** 10ns-20s.

5.2. Description of menu

- **Default unit:** s

- **Remote Command:**

:trigger[:sequence]:frame:offset <time>

:trigger[:sequence]:frame:offset?

- **Examples:**

:TRIG:FRAM:OFFS 100ms

:TRIG:FRAM:OFFS?

[Trig Holdoff]

- **Menu description:** to set the Trigger Mode as Sync Holdoff.
- **Key path:** **【Sweep】**, [Gate▶], [Gate Source▶], [Periodic Timer▶], [Trig Holdoff] on the front panel.
- **Status saved:** saved in the instrument status.
- **Factory preset:** 100ms.
- **Setting range:** 100ns-20s.
- **Default unit:** s
- **Remote Command:**

:trigger[:sequence]:frame:SYNC:holdoff <time>

:trigger[:sequence]:frame:SYNC:holdoff?

- **Examples:**

:TRIG:FRAM:SYNC:HOLD 100ms

:TRIG:FRAM:SYNC:HOLD?

[Sweep Points]

- **Menu description:** to set the trace points.
- **Key path:** **【Sweep】**, [Sweep Points] on the front panel.
- **Status saved:** saved in the instrument status.
- **Factory preset:** 1001.
- **Setting range:** 101-30001.
- **Remote Command:**

[:sense]:sweep:points <integer>

[:sense]:sweep:points?

- **Examples:**

:SWE:POIN 1001

:SWE:POIN?

5.2.2.6 Trigger

Select the trigger method of sweep or measurement, including [Free Run], [Video ▶], [Line▶], [External 1▶], [External 2▶], [RF Burst ▶], [Periodic Timer▶], [Trig Holdoff On off]. Different triggers will be expressed in different ways on the parameter zone of the screen.

[Free Run]

- **Menu description:** when the previous single or continuous sweep finishes, the next sweep or measurement is automatically triggered.

- **Remote Command:**

:TRIG:SOUR IMM

[Video ►]

- **Menu description:** to set the Trigger Mode as Video Trigger. When the positive slope part of input trigger signal passes through the video trigger level determined by [Trig Slope Pos Neg], the sweep will be triggered. The trigger level value can be set by the number keys, stepping keys or knob. The red line on the screen indicates the selected trigger level. The soft More include [Trigger Level], [Trig Slope Pos Neg], [Trig Delay On Off].

- **Remote Command:**

:TRIG:SOUR VID

[Trigger level]

- **Menu description:** to set the Trigger Level Threshold of the Video Trigger.
- **Key path:** **【Trig】** , [Video►], [Trigger Level] on the front panel.
- **Status saved:** saved in the instrument status.
- **Factory preset:** -25dBm.
- **Setting range:** max.: -270dBm-30dBm. The current settable range is coupled with the current reference level and scale/division. The maximum is the level represented by the top graticule, and the minimum value is the level represented by the bottom graticule.
- **Default unit:** dBm.
- **Remote Command:**

:trigger[:sequence]:video:level <ampl>

:trigger[:sequence]:video:level?

- **Examples:**

:TRIG:VID:LEV -25dBm

:TRIG:VID:LEV?

[Trig Slope Pos Neg]

- **Menu description:** to set the trigger polarity of the Video Trigger, where Positive means positive edge trigger, and Negative means negative edge trigger.
- **Key path:** **【Trig】** , [Video►], [Trig Slope Pos Neg] on the front panel.
- **Status saved:** saved in the instrument status.
- **Factory preset:** Positive.
- **Remote Command:**

:trigger[:sequence]:video:slope positive|negative

5.2. Description of menu

:trigger[:sequence]:video:slope?

- **Examples:**

:TRIG:VID:SLOP POS

:TRIG:VID:SLOP?

[Trig Delay

On Off]

- **Menu description:** to set the Video Trigger Delay ON OFF and delay time.
- **Key path:** **【Trig】** , [Video▶], [Trig Delay ON OFF] on the front panel.
- **Status saved:** saved in the instrument status.
- **Factory preset:** OFF.
- **Setting range:** 20ns-60s.
- **Default unit:** s.
- **Remote Command:**

:trigger[:sequence]:video:delay <time>

:trigger[:sequence]:video:delay?

:trigger[:sequence]:video:delay:state OFF|ON|0|1

:trigger[:sequence]:video:delay:state?

- **Examples:**

:TRIG:VID:DEL 1ms

:TRIG:VID:DEL?

:TRIG:VID:DEL:STAT OFF

:TRIG:VID:DEL:STAT?

[Line▶]

- **Menu description:** to set the Trigger Mode as Power Trigger. The soft More include [Trig Slope Pos Neg], [Trig Delay On Off].
- **Key path:** **【Trig】** , [Line▶] on the front panel.
- **Status saved:** saved in the instrument status.
- **Remote Command:**

:TRIG:SOUR LINE

[

Trig Slope

Pos Neg]

- **Menu description:** to set the trigger polarity ON OFF of the Power Trigger.
- **Key path:** **【Trig】** , [Line▶], [Trig Slope Pos Neg] on the front panel.

5.2. Description of menu

- **Status saved:** saved in the instrument status.
- **Factory preset:** Positive.
- **Remote Command:**
- :TRIGger[:SEQuence]:LINE:SLOPe POSitive|NEGative
- :TRIGger[:SEQuence]:LINE:SLOPe?

- **Examples:**

:TRIG:LINE:SLOP POS

:TRIG:LINE:SLOP?

[Trig Delay

On Off]

- **Menu description:** to set the trigger delay ON OFF of the Power Trigger and trigger delay time.
- **Key path:** **【Trig】** , [Line▶], [Trig Delay ON OFF] on the front panel.
- **Status saved:** saved in the instrument status.
- **Factory preset:** OFF.
- **Setting range:** 20ns-60s.
- **Default unit:** s.
- **Remote Command:**
- :TRIGger[:SEQuence]:LINE:DELay <time>
- :TRIGger[:SEQuence]:LINE:DELay?
- :TRIGger[:SEQuence]:LINE:DELay:STATe OFF|ON|0|1
- :TRIGger[:SEQuence]:LINE:DELay:STATe?

- **Examples:**

:TRIG:LINE:DEL 1ms

:TRIG:LINE:DEL?

:TRIG:LINE:DEL:STAT OFF

:TRIG:LINE:DEL:STAT?

[External 1▶]

- **Menu description:** to set the Trigger Mode as External Trigger Signal 1. The soft menus include [Trigger Level], [Trig Slope Pos Neg], [Trig Delay ON OFF].

- **Remote Command:**

:TRIG:SOUR EXT1

[Trigger level]

- **Menu description:** to set the Trigger Level Threshold of the External Trigger Signal 1.
- **Key path:** **【Trig】** , [External 1 ▶], [Trigger Level] on the front panel.

5.2. Description of menu

- **Status saved:** saved in the instrument status.
- **Factory preset:** 1.2V
- **Setting range:** -5V-5V.
- **Default unit:** V
- **Remote Command:**

:trigger[:sequence]:external1:level <level>

:trigger[:sequence]:external1:level?

- **Examples:**

:TRIG:EXT1:LEV 1.2V

:TRIG:EXT1:LEV?

[

Trig Slope

Pos Neg]

- **Menu description:** to set the trigger polarity of the External Trigger Signal 1.
- **Key path:** **【Trig】** , [External 1 ►], [Trig Slope **Pos** Neg] on the front panel.
- **Status saved:** saved in the instrument status.
- **Factory preset:** Positive.
- **Remote Command:**

:trigger[:sequence]:external1:slope positive|negative

:trigger[:sequence]:external1:slope?

- **Examples:**

:TRIG:EXT1:SLOP POS

:TRIG:EXT1:SLOP?

[Delay

On Off]

- **Menu description:** to set the trigger delay ON OFF of the External Trigger 1 and trigger delay time.
- **Key path:** **【Trig】** , [External 1 ►], [Trig Delay ON OFF] on the front panel.
- **Status saved:** saved in the instrument status.
- **Factory preset:** OFF.
- **Setting range:** 20ns-60s.
- **Default unit:** s.
- **Remote Command:**

:trigger[:sequence]:external1:delay <time>

:trigger[:sequence]:external1:delay?

:trigger[:sequence]:external1:delay:state OFF|ON|0|1

:trigger[:sequence]:external1:delay:state?

- **Examples:**

:TRIG:EXT1:DEL 1ms

:TRIG:EXT1:DEL?

:TRIG:EXT1:DEL:STAT OFF

:TRIG:EXT1:DEL:STAT?

[External 2▶]

- **Menu description:** to set the Trigger Mode as External Trigger Signal 2. The soft menus include [Trigger Level], [Trig Slope Pos Neg], [Trig Delay ON OFF].

- **Remote Command:**

:TRIG:SOUR EXT2

[Trigger level]

- **Menu description:** to set the Trigger Level Threshold of the External Trigger Signal 2.
- **Key path:** **【Trig】** , [External 2 ▶], [Trigger Level] on the front panel.
- **Status saved:** saved in the instrument status.
- **Factory preset:** 1.2V
- **Setting range:** -5V-5V.
- **Default unit:** V
- **Remote Command:**

:trigger[:sequence]:external2:level <level>

:trigger[:sequence]:external2:level?

- **Examples:**

:TRIG:EXT2:LEV 1.2V

:TRIG:EXT2:LEV?

[Trig Slope Pos Neg]

- **Menu description:** to set the trigger polarity of the External Trigger Signal 2.
- **Key path:** **【Trig】** , [External 2 ▶], [Trig Slope Pos Neg] on the front panel.
- **Status saved:** saved in the instrument status.
- **Factory preset:** Positive.
- **Remote Command:**

:trigger[:sequence]:external2:slope positive|negative

:trigger[:sequence]:external2:slope?

- **Examples:**

5.2. Description of menu

:TRIG:EXT2:SLOP POS

:TRIG:EXT2:SLOP?

[Trig Delay On **Off**]

- **Menu description:** to set the trigger delay ON OFF of the External Trigger 2 and trigger delay time.
- **Key path:** **【Trig】** , [External 2 ►], [Trig Delay ON OFF] on the front panel.
- **Status saved:** saved in the instrument status.
- **Factory preset:** OFF.
- **Setting range:** 20ns-60s.
- **Default unit:** s.
- **Remote Command:**

:trigger[:sequence]:external2:delay <time>

:trigger[:sequence]:external2:delay?

:trigger[:sequence]:external2:delay:state OFF|ON|0|1

:trigger[:sequence]:external2:delay:state?

- **Examples:**

:TRIG:EXT2:DEL 1ms

:TRIG:EXT2:DEL?

:TRIG:EXT2:DEL:STAT OFF

:TRIG:EXT2:DEL:STAT?

[RF Burst►]

- **Menu description:** to set the Trigger Mode as Burst Signal. The soft menus include [Trigger Level], [Trig Slope **Pos** Neg], [Trig Delay ON **OFF**].
- **Remote Command:**

:TRIG:SOUR RFB

[Trigger level]

- **Menu description:** to set the Trigger Level Threshold of the burst signal.
- **Key path:** **【Trig】** , [RF Burst►], [Trigger Level] on the front panel.
- **Status saved:** saved in the instrument status.
- **Factory preset:** -20dBm.
- **Setting range:** max.: -270dBm-30dBm. The current settable range is coupled with the current reference level and scale/division. The maximum is the level represented by the top graticule, and the minimum value is the level represented by the bottom graticule.
- **Default unit:** dBm.
- **Remote Command:**

:trigger[:sequence]:rfburst:level:absolute <amp;gt;

5.2. Description of menu

:trigger[:sequence]:rburst:level:absolute?

- **Examples:**

:TRIG:RFB:LEV:ABS -20dBm

:TRIG:RFB:LEV:ABS?

[Trigger Slope Pos Neg]

- **Menu description:** to set the trigger polarity of the Burst Signal Trigger.
- **Key path:** **【Trig】** , [RF Burst ▶], [Trigger Slope Pos Neg] on the front panel.
- **Status saved:** saved in the instrument status.
- **Factory preset:** Positive.
- **Remote Command:**

:trigger[:sequence]:rburst:slope positive|negative

:trigger[:sequence]:rburst:slope?

- **Examples:**

:TRIG:RFB:SLOP POS

:TRIG:RFB:SLOP?

[Trig Delay On Off]

- **Menu description:** to set the trigger delay ON OFF of Burst Signal Trigger and the trigger delay time.
- **Key path:** **【Trig】** , [RF Burst ▶], [Trig Delay ON OFF] on the front panel.
- **Status saved:** saved in the instrument status.
- **Factory preset:** OFF.
- **Setting range:** 20ns-60s.
- **Default unit:** s.
- **Remote Command:**

:trigger[:sequence]:rburst:delay <time>

:trigger[:sequence]:rburst:delay?

:trigger[:sequence]:rburst:delay:state OFF|ON|0|1

:trigger[:sequence]:rburst:delay:state?

- **Examples:**

:TRIG:RFB:DEL 1ms

:TRIG:RFB:DEL?

:TRIG:RFB:DEL:STAT OFF|ON|0|1

:TRIG:RFB:DEL:STAT?

[Periodic Timer▶]

5.2. Description of menu

- **Menu description:** to set the Trigger Mode as Timer Trigger. The soft More include [Sync Source ▶], [Period], [Offset], [Trig Holdoff], [Trig Delay On Off].

- **Remote Command:**

:TRIG:SOUR FRAM

[Sync Source▶]

- **Menu description:** to select and set the Timer Sync Source parameters. The soft More include [Off], [External 1▶], [External 2▶], [RF Burst▶]. OFF means that the timer is not synchronous.

- **Remote Command:**

:trigger[:sequence]:frame:SYNC external1|external2|rfburst|OFF

:trigger[:sequence]:frame:SYNC?

[External 1▶]

- **Menu description:** to set the Timer Sync Source as External Trigger Signal 1. The soft More are [Trigger Level], [Trig Slope Pos Neg].

- **Remote Command:**

:trigger[:sequence]:frame:SYNC external1

- **Examples:**

:TRIG:FRAM:SYNC EXT1

:TRIG:FRAM:SYNC?

[Trigger level]

- **Menu description:** to set the Trigger Level Threshold of the External Trigger Signal 1.
- **Key path:** **【Trig】**, [More 1/2▶], [Periodic Timer▶], [Sync Source ▶], [External 1▶], [Trigger Level] on the front panel.
- **Status saved:** saved in the instrument status.
- **Factory preset:** 1.2V
- **Setting range:** -5V-5V.
- **Default unit:** V
- **Remote Command:**

:trigger[:sequence]:external1:level <level>

:trigger[:sequence]:external1:level?

- **Examples:**

:TRIG:EXT1:LEV 1.2V

:TRIG:EXT1:LEV?

[Trig Slope **Pos** Neg]

- **Menu description:** to set the trigger polarity of the External Trigger Signal 1.

5.2. Description of menu

- **Key path:** **【Trig】** , [More 1/2▶], [Periodic Timer▶], [Sync Source ▶], [External 1▶], [Trig Slope Pos Neg] on the front panel.
- **Status saved:** saved in the instrument status.
- **Factory preset:** Positive.
- **Remote Command:**

```
:trigger[:sequence]:external1:slope positive|negative
```

```
:trigger[:sequence]:external1:slope?
```

- **Examples:**

```
:TRIG:EXT1:SLOP POS
```

```
:TRIG:EXT1:SLOP?
```

[External 2▶]

Set the Sync Source as External Trigger Signal 2. The soft More are [Trigger Level], [Trig Slope Pos Neg].

- **Remote Command:**

```
:trigger[:sequence]:frame:SYNC external2
```

- **Examples:**

```
:TRIG:FRAM:SYNC EXT2
```

```
:TRIG:FRAM:SYNC?
```

[Trigger level]

- **Menu description:** to set the Trigger Level Threshold of the External Trigger Signal 2.
- **Key path:** **【Trig】** , [More 1/2▶], [Periodic Timer▶], [Sync Source ▶], [External 2▶], [Trigger Level] on the front panel.
- **Status saved:** saved in the instrument status.
- **Factory preset:** 1.2V
- **Setting range:** -5V-5V.
- **Default unit:** V
- **Remote Command:**

```
:trigger[:sequence]:external2:level <level>
```

```
:trigger[:sequence]:external2:level?
```

- **Examples:**

```
:TRIG:EXT2:LEV 1.2V
```

```
:TRIG:EXT2:LEV?
```

[Trig Slope Pos Neg]

- **Menu description:** to set the trigger polarity of the External Trigger Signal 2.
- **Key path:** **【Trig】** , [More 1/2▶], [Periodic Timer▶], [Sync Source ▶], [External 2▶], [Trig Slope Pos Neg] on the front panel.

5.2. Description of menu

- **Status saved:** saved in the instrument status.
- **Factory preset:** Positive.
- **Remote Command:**

```
:trigger[:sequence]:external2:slope positive|negative
```

```
:trigger[:sequence]:external2:slope?
```

- **Examples:**

```
:TRIG:EXT2:SLOP POS
```

```
:TRIG:EXT2:SLOP?
```

[RF Burst▶]

Set the Timer Sync Source as Burst Signal. The soft More are [Trigger Level], [Trig Slope Pos Neg].

- **Remote Command:**

```
:trigger[:sequence]:frame:SYNC rfburst
```

- **Examples:**

```
:TRIG:FRAM:SYNC RFB
```

[Trigger level]

- **Menu description:** to set the Trigger Level Threshold of the burst signal.
- **Key path:** **【Trig】** , [More 1/2▶], [Periodic Timer▶], [Sync Source ▶], [RF Burst▶], [Trigger Level] on the front panel.
- **Status saved:** saved in the instrument status.
- **Factory preset:** -20dBm.
- **Setting range:** max.: -270dBm-30dBm. The current settable range is coupled with the current reference level and scale/division. The maximum is the level represented by the top graticule, and the minimum value is the level represented by the bottom graticule.
- **Default unit:** dBm.
- **Remote Command:**

```
:trigger[:sequence]:rfburst:level:absolute <ampl>
```

```
:trigger[:sequence]:rfburst:level:absolute?
```

- **Examples:**

```
:TRIG:RFB:LEV:ABS -20dBm
```

```
:TRIG:RFB:LEV:ABS?
```

[Trig Slope **Pos** Neg]

- **Menu description:** to set the trigger polarity of the Burst Signal.
- **Key path:** **【Trig】** , [More 1/2▶], [Periodic Timer▶], [Sync Source ▶], [RF Burst▶], [Trig Slope **Pos** Neg] on the front panel.
- **Status saved:** saved in the instrument status.

- **Factory preset:** Positive.
- **Remote Command:**
:trigger[:sequence]:rburst:slope positive|negative
:trigger[:sequence]:rburst:slope?

- **Examples:**
:TRIG:RFB:SLOP POS
:TRIG:RFB:SLOP?

[Period]

- **Menu description:** to set the Trigger Mode as Timer Period.
- **Key path:** **【Trig】** , [More 1/2▶], [Periodic Timer▶], [Period] on the front panel.
- **Status saved:** saved in the instrument status.
- **Factory preset:** 100ms.
- **Setting range:** 100ns-20s.
- **Default unit:** s.
- **Remote Command:**

:trigger[:sequence]:frame:period <time>
:trigger[:sequence]:frame:period?

- **Examples:**
:TRIG:FRAM:PER 100ms
:TRIG:FRAM:PER?

[Offset]

- **Menu description:** to set the Trigger Mode as Timer Offset, which is not more than the Timer Period.
- **Key path:** **【Trig】** , [More 1/2▶], [Periodic Timer▶], [Offset] on the front panel.
- **Status saved:** saved in the instrument status.
- **Factory preset:** 100ms.
- **Setting range:** 10ns-20s.
- **Default unit:** s
- **Remote Command:**

:trigger[:sequence]:frame:offset <time>
:trigger[:sequence]:frame:offset?

- **Examples:**
:TRIG:FRAM:OFFS 100ms
:TRIG:FRAM:OFFS?

[Trig Holdoff]

5.2. Description of menu

- **Menu description:** to set the Trigger Mode as Sync Holdoff.
- **Key path:** **【Trig】** , [More 1/2▶], [Periodic Timer▶], [Trig Holdoff] on the front panel.
- **Status saved:** saved in the instrument status.
- **Factory preset:** 100ms.
- **Setting range:** 100ns-20s.
- **Default unit:** s
- **Remote Command:**

```
:trigger[:sequence]:frame:SYNC:holdoff <time>
```

```
:trigger[:sequence]:frame:SYNC:holdoff?
```

- **Examples:**

```
:TRIG:FRAM:SYNC:HOLD 100ms
```

```
:TRIG:FRAM:SYNC:HOLD?
```

[Trig Delay

On Off]

- **Menu description:** to set the trigger delay ON OFF of the Timer Trigger and trigger delay time.
- **Key path:** **【Trig】** , [More 1/2▶], [Periodic Timer▶], [Trig Delay ON OFF] on the front panel.
- **Status saved:** saved in the instrument status.
- **Factory preset:** OFF.
- **Setting range:** 20ns-60s.
- **Default unit:** s.
- **Remote Command:**

```
:trigger[:sequence]:frame:delay <time>
```

```
:trigger[:sequence]:frame:delay?
```

```
:trigger[:sequence]:frame:delay:state OFF|ON|0|1
```

```
:trigger[:sequence]:frame:delay:state?
```

- **Examples:**

```
:TRIG:FRAM:DEL 1
```

```
:TRIG:FRAM:DEL?
```

```
:TRIG:FRAM:DEL:STAT OFF
```

```
:TRIG:FRAM:DEL:STAT?
```

[Trig Holdoff

On Off]

- **Menu description:** to set the trigger holdoff time.
- **Key path:** **【Trig】** , [More 1/2▶], [Trig Holdoff ON OFF] on the front panel.
- **Status saved:** saved in the instrument status.

5.2. Description of menu

- **Factory preset:** 100ms.
- **Setting range:** 100ns-20s.
- **Default unit:** s.
- **Remote Command:**

```
[[:sense]:sweep:egate:holdoff <time>
```

```
[[:sense]:sweep:egate:holdoff?
```

```
[[:sense]:sweep:egate:holdoff:AUTO OFF|ON|0|1
```

```
[[:sense]:sweep:egate:holdoff:AUTO?
```

- **Examples:**

```
:SWE:EGAT:HOLD 100ms
```

```
:SWE:EGAT:HOLD?
```

```
:SWE:EGAT:HOLD:AUTO OFF
```

```
:SWE:EGAT:HOLD:AUTO?
```

5.2.2.7 Trace

Press **【Trace】** key on the front panel to pop up corresponding soft menu Including: [Select Trace▶], [Clear Write], [Trace Average], [Max Hold], [Min Hold], [View/Blank ▶], [More 1/2▶], [Detector ▶], [[Math ▶], [Copy ▶], [Clear All Traces].

[Select Trace▶

Trace 1]

- **Menu description:** to select trace. The signal/spectrum analyzer provides six trace lines including Trace 1, Trace 2, Trace 3, Trace 4, Trace 5 and Trace 6. The selected trace number will be marked in the menu, and the trace processing method, display method and detector will be displayed on the graticule top. After one trace is selected, the corresponding menu trace processing, display method and detector type setting are only active for the selected trace.
- **Key path:** **【Trace】** , [Select Trace ▶] on the front panel.
- **Status saved:** saved in the instrument status.
- **Factory preset:** to activate Trace 1 with processing method as Refresh, display method as Refresh Display and detector mode as Normal.

[Clear Write]

- **Command description:** to set the current trace processing as Refresh, i.e., clear all data of displayed trace and continue the signal trace receipt under sweep status.
- **Key path:** **【Trace】** , [Clear Write] on the front panel.
- **Status saved:** saved in the instrument status.
- **Factory preset:** after all traces are selected, the trace mode is defaulted as Refresh.
- **Remote Command:**

```
:trace<1|2|3|4|5|6>:TYPE write
```

```
:trace<1|2|3|4|5|6>:TYPE?
```

- **Examples:**

5.2. Description of menu

:TRAC1:TYPE WRIT

:TRAC1:TYPE?

[Trace Average]

- **Command description:** to set the current trace processing method as Average, i.e., based on the average count N set in the **【Meas Setup】**, update trace after averaging the performance index of the measurement trace.

Detailed algorithm:

New trace = ((K-1) previous trace + current measurement trace)/K

Where, K is accumulated average count.

Under continuous measurement, when K is accumulated to the average count N set in the **【Meas Setup】**, the K will always equal to N. Under single measurement status, when K is accumulated to the average count N set in the **【Meas Setup】**, the measurement will stop.

- **Key path:** **【Trace】**, [Trace Average] on the front panel.
- **Status saved:** saved in the instrument status.
- **Factory preset:** after all traces are selected, the trace mode is defaulted as Refresh.
- **Remote Command:**

:trace<1|2|3|4|5|6>:TYPE average

:trace<1|2|3|4|5|6>:TYPE?

- **Examples:**

:TRAC1:TYPE AVER

:TRAC1:TYPE?

[Max Hold]

- **Menu description:** to set the current trace processing method as maximum hold, i.e., the new trace data will be assigned with maximum value of previous measured trace data.
- **Key path:** **【Trace】**, [Max Hold] on the front panel.
- **Status saved:** saved in the instrument status.
- **Factory preset:** after all traces are selected, the trace mode is defaulted as Refresh.
- **Remote Command:**

:trace<1|2|3|4|5|6>:TYPE maxhold

:trace<1|2|3|4|5|6>:TYPE?

- **Examples:**

:TRAC1:TYPE MAX

:TRAC1:TYPE?

[Min Hold]

- **Menu description:** to set the current trace processing method as minimum hold, i.e., the new trace data will be assigned with minimum value of previous measured trace data.

5.2. Description of menu

- **Key path:** **【Trace】** , [Min Hold] on the front panel.
- **Status saved:** saved in the instrument status.
- **Factory preset:** after all traces are selected, the trace mode is defaulted as Refresh.
- **Remote Command:**

```
:trace<1|2|3|4|5|6>:TYPE minhold
```

```
:trace<1|2|3|4|5|6>:TYPE?
```

- **Examples:**

```
:TRAC1:TYPE MIN
```

```
:TRAC1:TYPE?
```

[View/Blank▶]**Refresh Display**

- **More description:** to set the display method for the selected trace from [Trace On], [View], [Background] and [Blank].
- **Key path:** **【Trace】** , [View/Blank▶] on the front panel.
- **Status saved:** saved in the instrument status.
- **Factory preset:** Except Trace 1, after selection of other traces, the trace display is defaulted as Display OFF.
- **Remote Command:**

```
:trace<1|2|3|4|5|6>:display[:state] ON|OFF|0|1
```

```
:trace<1|2|3|4|5|6>:display[:state]?
```

- **Examples:**

```
:TRAC1:DISP ON
```

```
:TRAC1:DISP?
```

- Other descriptions: “Refresh Display” indicates that a new trace will execute refresh in the internal part of application (backstage) and will be displayed on the display area of the front panel. When the trace [View/Blank] is set as “View”, the signal/spectrum will keep the most recent trace and do not go through trace processing. The latest trace will be displayed in the display area of the front panel. “Backstage Refresh” indicates that a new trace will execute refresh in the internal part of application (backstage) and but will not be displayed on the display area of the front panel. This type is commonly applied in remote control. “Display OFF” indicates that the signal/spectrum analyzer neither goes through backstage trace processing nor display. That means, the trace is not activated and is OFF.

[Detector ▶]

Pop up soft More related to setting the detector type for the currently selected trace, including [Auto], [Normal], [Peak], [Sample], [Negative Peak], [Trace Average▶], where, the average detector type includes Log-Pwr Avg, Log-Pwr Avg and Voltage Avg.

[Auto]

- **Menu description:** to set the detector command for the currently selected trace as Auto. That means, the signal/spectrum analyzer will automatically select most suitable detector based on the parameter setting

5.2. Description of menu

of currently selected trace, including trace processing method, trace average type, noise marker function, etc.

- **Key path:** **【Trace】** , [More 1/2▶], [Detector ▶], [Auto] on the front panel
- **Status saved:** saved in the instrument status.
- **Factory preset:** after trace selection, all Trace Detector Types are selected as Auto.
- **Remote Command:**

```
[ :sense]:detector:AUTO ON|OFF|1|0
```

```
[ :sense]:detector:AUTO?
```

- **Examples:**

```
:DET:AUTO ON
```

```
:DET:AUTO?
```

[Normal]

- **Menu description:** to set the detector command for the currently selected trace as Normal. I.e., display the measurement results of positive peak and negative peak at the same time to achieve display effect similar to the analog instrument.
- **Key path:** **【Trace】** , [More 1/2▶], [Detector ▶], [Normal] on the front panel.
- **Status saved:** saved in the instrument status.
- **Remote Command:**

```
[ :sense]:detector[:function] normal
```

```
[ :sense]:detector[:function]?
```

- **Examples:**

```
:DET NORM
```

```
:DET?
```

[Peak]

- **Menu description:** to set the detector command for the currently selected trace as Positive Peak. I.e., take the maximum value from sampling data assigned to each trace point.
- **Key path:** **【Trace】** , [More 1/2▶], [Detector▶], [Peak] on the front panel.
- **Status saved:** saved in the instrument status.
- **Remote Command:**

```
[ :sense]:detector[:function] positive
```

```
[ :sense]:detector[:function]?
```

- **Examples:**

```
:DET POS
```

```
:DET?
```

[Sample]

5.2. Description of menu

- **Menu description:** to set the detector command for the currently selected trace as Sample. I.e., take the last value from sampling data assigned to each trace point.
- **Key path:** **【Trace】** , [More 1/2▶], [Detector▶], [Sample] on the front panel.
- **Status saved:** saved in the instrument status.
- **Remote Command:**

```
[::sense]:detector[:function] sample
```

```
[::sense]:detector[:function]?
```

- **Examples:**

```
:DET SAMP
```

```
:DET?
```

[Negative Peak]

- **Menu description:** to set the detector command for the currently selected trace as Negative Peak. I.e., take the minimum value from sampling data assigned to each trace point.
- **Key path:** **【Trace】** , [More 1/2▶], [Detector▶], [Negative Peak] on the front panel.
- **Status saved:** saved in the instrument status.
- **Remote Command:**

```
[::sense]:detector[:function] negative
```

```
[::sense]:detector[:function]?
```

- **Examples:**

```
:DET NEG
```

```
:DET?
```

[Average ▶]**Video Average]**

- **Menu description:** to set the detector command for the currently selected trace as Video Average. Also called Logarithm Power Average Detector, i.e., take the logarithm power average value for all data assigned to each trace point; earlier signal/spectrum analyzer generally displays the measurement trace of logarithm scale, and all filtering and averaging are based on the logarithm power data; the trace is generally called as video signal. After digital IF processing is adopted,

After digital IF processing is adopted, to make measurement results same as the earlier signal/spectrum analyzer, the video average detector function is added.

- **Key path:** **【Trace】** , [More 1/2▶], [Detector▶], [Trace Average▶], [Log-Pwr Avg] on the front panel.
- **Status saved:** saved in the instrument status.
- **Remote Command:** [::sense]:detector[:function] average [::sense]:detector[:function]?
- **Examples:**

```
:DET AVER
```

```
:DET?
```

5.2. Description of menu

[Average ▶]

Pwr Avg]

- **Menu description:** to set the detector command for the currently selected trace as Power Average. Also called root mean square (RMS) detector. Calculate the root mean square of all sampling data assigned to each trace point; the 4051 signal/spectrum analyzer envelopes the detector for the RF input signal and obtains linear voltage. After square these voltage values, take sum and divide the count of sampling data points corresponding to each trace point. Finally, take square root. When the scale is logarithm, take 20 times of logarithm transformation for these RMS values (with 10 as base) and obtain the trace data. When the scale type is linear, those RMS values are trace data.

- **Key path:** **【Trace】** , [More 1/2▶], [Detector▶], [Trace Average▶], [Pwr Avg] on the front panel.

- **Status saved:** saved in the instrument status.

- **Remote Command:**

[:sense]:detector[:function] RMS

[:sense]:detector[:function]?

- **Examples:**

:DET RMS

:DET?

[Average ▶]

Voltage Avg]

- **Menu description:** to set the detector command for the currently selected trace as Voltage Average. Also called average (AVG) detector. Take linear average for all sampling data assigned to each trace point; the 4051 signal/spectrum analyzer envelopes the detector for the RF input signal and obtains linear voltage. After summing those voltage values, divide the number of sampling data points corresponding to each trace point. When the scale is logarithm, take 20 times of logarithm transformation for these RMS values (with 10 as base) and obtain the trace data. When the scale type is linear, those average values are trace data.

- **Key path:** **【Trace】** , [Menu 1/2▶], [Detector▶], [Trace Average▶], [Voltage Avg] on the front panel.

- **Status saved:** saved in the instrument status.

- **Remote Command:**

[:sense]:detector[:function] scalar

[:sense]:detector[:function]?

- **Examples:**

:DET SCAL

:DET?

[Math▶]

- **Menu description:** to start up trace mathematical operation and set the methods and rules. The soft More include [Op1+Op2->Op2], [Op1-Op2->Op2], [Off], [Operand1 ▶], [Operand2▶], [Math Rule▶].

The signal/spectrum analyzer can take mathematical operation for any two traces from the active 6 ones, and save the results to the update data of the second trace. The mathematical operation includes addition and subtraction.

5.2. Description of menu

The math rule is used for specifying the data type of two traces under processing, including logarithmic power, linear voltage (current) or linear power. For details, refer to “4.1.3.1 Trace Detector and Trace Math”.

- **Key path:** **【Trace】** , [More 1/2▶], [Math▶] on the front panel.
- **Status saved:** saved in the instrument status.
- **Factory preset:** Trace Operation Off.
- **Remote Command:**

```
:calculate:MATH:MODE <linear|logarithmic|power>
```

```
:calculate:MATH
```

```
TRACE1|TRACE2|TRACE3|TRACE4|TRACE5|TRACE6,pdifference|PSUM|loffset|ldifference|OFF,TRACE1|TRACE2|TRACE3|TRACE4|TRACE5|TRACE6,TRACE1|TRACE2|TRACE3|TRACE4|TRACE5|TRACE6,<real>,<real>
```

```
:calculate:MATH? TRACE1|TRACE2|TRACE3|TRACE4|TRACE5|TRACE6
```

- **Examples:**

```
:CALC:MATH:MODE LIN
```

```
:CALC:MATH TRACE1,PDIF,TRACE2,TRACE1,0.0,0.0
```

```
:CALC:MATH? TRACE1
```

[Copy ▶]

- **Menu description:** to copy the data for the selected trace to the other trace. The soft More include: [Operator 1->Operator 2], [Operand1 ▶], [Operand2 ▶].

Note that Copy Trace is only an operation rather than parameter setting; therefore, it is only performed once and not for every sweep and measurement. For details, refer to “4.1.3.1 Trace Detector and Trace Math”.

- **Key path:** **【Trace】** , [More 1/2▶], [Copy▶] on the front panel.
- **Status saved:** not saved in instrument status.
- **Remote Command:**

```
:trace:COPY
```

```
TRACE1|TRACE2|TRACE3|TRACE4|TRACE5|TRACE6,TRACE1|TRACE2|TRACE3|TRACE4|TRACE5|TRACE6
```

```
:trace:COPY?
```

- **Examples:**

```
:TRAC:COPY TRACE1,TRACE2
```

```
:TRAC:COPY?
```

[Clear All Traces]

- **Menu description:** to recover all current traces back to the default status, including trace processing method, display method and detector type.

Note that Reset All Traces is only an operation rather than parameter setting; therefore, it is only performed once and not for every sweep and measurement.

- **Key path:** **【Trace】** , [More 1/2▶], [Clear All Traces] on the front panel.
- **Status saved:** not saved in instrument status.

5.2. Description of menu

- **Remote Command:**

:trace:preset:ALL

- **Examples:**

:TRAC:PRES:ALL

5.2.2.8 Measurement Setting

Pop up the soft menu related to measurement setting, Include [Average Num], [Average Type Auto Man], [Limit▶],[PhNoise Opt], [Low Noise Path On Off], [Preselector Presel Bypass], [RF Gain▶], [ADC Dither Auto Man].

[Average Num]

- **Menu description:** to define the average count for trace averaging. This function is only active when the Average is selected in the **【Trace】** menu.
- **Key path:** **【Meas Setup】** [Average Num] on the front panel.
- **Status saved:** saved in the instrument status.
- **Factory preset:** 10.
- **Setting range:** 1-10000.
- **Remote Command:**

[:sense]:average:count <integer> [:sense]:average:count? [:sense]:average:clear

- **Examples:**

:AVER:COUN 100

:AVER:COUN?

:AVER:CL

[Average Type ▶

Auto Man]

- **Menu description:** to set the trace average type. The soft More include [Auto], [Log-Pwr Avg], [Pwr Avg], [Voltage Avg].
- **Key path:** **【Meas Setup】** , [Average Type Auto Man] on the front panel.
- **Status saved:** saved in the instrument status.
- **Factory preset:** Auto.
- **Remote Command:**

[:sense]:average:TYPE RMS|LOG|scalar

[:sense]:average:TYPE?

- **Examples:**

:AVER:TYPE RMS

:AVER:TYPE?

[Log-Pwr Avg]

- **Menu description:** to set the trace average type as Video Average.

5.2. Description of menu

- **Key path:** **【Meas Setup】** , [Average Type Auto Man], [Log-Pwr Avg] on the front panel.
- **Status saved:** saved in the instrument status.
- **Factory preset:** Auto.
- **Remote Command:**

[sense]:average:TYPE LOG

- **Examples:**

:AVER:TYPE LOG

[Pwr Avg]

- **Menu description:** to set the trace average type as Power Average.
- **Key path:** **【Meas Setup】** , [Average Type Auto Man], [Pwr Avg] on the front panel.
- **Status saved:** saved in the instrument status.
- **Factory preset:** Auto.
- **Remote Command:**

[sense]:average:TYPE RMS

- **Examples:**

:AVER:TYPE RMS

[Voltage Avg]

- **Menu description:** to set the trace average type as Voltage Average.
- **Key path:** **【Meas Setup】** , [Average Type Auto Man], [Voltage Avg] on the front panel.
- **Status saved:** saved in the instrument status.
- **Factory preset:** Auto.
- **Remote Command:**

[sense]:average:TYPE scalar

- **Examples:**

:AVER:TYPE SCAL

[Limit▶]

Pop up soft More related to limit line editing and application, including [Select Limit▶], [Limit Line On Off], [Properties▶], [Margin On Off], [Edit ▶], [Delete Limit], [Test Limit On Off], [X Axis unit **Frequency** Time], [Delete All Limit], [Save Limit...], [Load Limit...].

[Select Limit▶]

- **Menu description:** to select and apply Limit Line. The signal/signal/spectrum analyzer has 6 limit lines for selection and application.
- **Key path:** **【Meas Setup】** , [Limit▶], [Select Limit▶]

5.2. Description of menu

- **Status saved:** saved in the instrument status.
- **Factory preset:** Limit Line 1.

[Limit On Off]

- **Menu description:** to turn on or off Limit Line Display.
- **Key path:** **【Meas Setup】** , [Limit▶], [Limit On Off]
- **Status saved:** saved in the instrument status.
- **Factory preset:** OFF.
- **Remote Command:**

```
:calculate:lline<1|2|3|4|5|6>:display OFF|ON|0|1
```

```
:calculate:lline<1|2|3|4|5|6>:display?
```

```
:calculate:limit<1|2|3|4|5|6>:FAIL?
```

- **Examples:**

```
:CALC:LLIN1:DISP OFF
```

```
:CALC:LLIN1:DISP?
```

```
:CALC:LIM1:FAIL?
```

[Properties▶]

Set the properties for currently selected limit line, including [Test Trace], [Type **Upper** Lower], [Interpolation ▶], [Ab/Rel▶].

[Test Trace]

- **Menu description:** to designate the trace which currently selected limit line will be applied. There are 6 traces for selection, including [Trace 1], [Trace 2],[Trace 3],[Trace 4],[Trace 5], [Trace 6].
- **Key path:** **【Meas Setup】** , [Limit▶], [Properties▶], [Test Trace] on the front panel.
- **Status saved:** saved in the instrument status.
- **Factory preset:** the trace active in current trace menu.
- **Remote Command:**

```
:calculate:lline<1|2|3|4|5|6>:trace 1|2|3|4|5|6
```

```
:calculate:lline<1|2|3|4|5|6>:trace?
```

- **Examples:**

```
:CALC:LLIN1:TRAC 1
```

```
:CALC:LLIN1:TRAC?
```

[Type Upper Lower]

- **Menu description:** to specify when the test trace data, higher or lower than the limit line, will FAIL. Upper means that the limit line fails as long as one data in the test trace is higher than the limit; and Lower means that the limit line fails as long as one data in the test trace is lower than the limit.
- **Key path:** **【Meas Setup】** , [Limit▶], [Properties▶], [Type Upper/Lower] on the front panel.

5.2. Description of menu

- **Status saved:** saved in the instrument status.
- **Factory preset:** upper.
- **Remote Command:**

```
:calculate:lline<1|2|3|4|5|6>:TYPE upper|lower
```

```
:calculate:lline<1|2|3|4|5|6>:TYPE?
```

- **Examples:**

```
:CALC:LLIN1:TYPE UPP
```

```
:CALC:LLIN1:TYPE?
```

[Interpolation▶]

- **Menu description:** to select the interpolation rules on which the data are based during edit of the currently selected limit line. Including [Log Line Frequency], [Log Line Amplitude]
- **Key path:** **【Meas Setup】** , [Limit▶], [Properties▶], [Interpolation▶] on the front panel.
- **Status saved:** saved in the instrument status.
- **Remote Command:**

```
:calculate:lline<1|2|3|4|5|6>:amplitude:interpolate:TYPE logarithmic|linear
```

```
:calculate:lline<1|2|3|4|5|6>:amplitude:interpolate:TYPE?
```

```
:calculate:lline<1|2|3|4|5|6>:control:interpolate:TYPE logarithmic|linear
```

```
:calculate:lline<1|2|3|4|5|6>:control:interpolate:TYPE?
```

- **Examples:**

```
:CALC:LLIN1:AMPL:INT:TYPE LOG
```

```
:CALC:LLIN1:AMPL:INT:TYPE?
```

```
:CALC:LLIN1:CONT:INT:TYPE LOG
```

```
:CALC:LLIN1:CONT:INT:TYPE?
```

[Log Line Frequency]

- **Menu description:** to select the interpolation rules on which data interpolation by the frequency axis is based during edit of the currently selected limit line. Logarithmic rules or linear rules can be used.
- **Key path:** **【Meas Setup】** , [Limit▶], [Properties▶], [Interpolation▶] on the front panel.
- **Status saved:** saved in the instrument status.
- **Factory preset:** linear.
- **Remote Command:**

```
:calculate:lline<1|2|3|4|5|6>:control:interpolate:TYPE logarithmic|linear
```

```
:calculate:lline<1|2|3|4|5|6>:control:interpolate:TYPE?
```

- **Examples:**

```
:CALC:LLIN1:CONT:INT:TYPE LOG
```

```
:CALC:LLIN1:CONT:INT:TYPE?
```

5.2. Description of menu

[Log Line Amplitude]

- **Menu description:** to select the interpolation rules on which data interpolation by the amplitude axis is based during edit of the currently selected limit line. Logarithmic rules or linear rules can be used.
- **Key path:** **【Meas Setup】** , [Limit▶], [Properties▶], [Interpolation▶], [Log Line Amplitude] on the front panel.
- **Status saved:** saved in the instrument status.
- **Factory preset:** Logarithm
- **Remote Command:**

```
:calculate:lline<1|2|3|4|5|6>:amplitude:interpolate:TYPE logarithmic|linear
```

```
:calculate:lline<1|2|3|4|5|6>:amplitude:interpolate:TYPE?
```

- **Examples:**

```
:CALC:LLIN1:AMPL:INT:TYPE LOG
```

```
:CALC:LLIN1:AMPL:INT:TYPE?
```

[Abs/Rel▶]

- **Menu description:** to specify whether the X and Y axis data are absolute or relative during edit of the currently selected limit line. The soft More includes [X Axis Relative to CF On/Off], [Y Axis Relative to reflvel On/Off].
- **Key path:** **【Meas Setup】** , [Limit▶], [Properties▶], [Abs/Rel▶] on the front panel.
- **Status saved:** saved in the instrument status.

[X Axis Relative to Center Freq

On Off]

- **Menu description:** to specify whether the X axis data are absolute or relative during edit of the currently selected limit line.
- **Key path:** **【Meas Setup】** , [Limit▶], [Properties▶], [Abs/Rel▶], [X Axis Relative to CF ON/OFF] on the front panel.
- **Status saved:** saved in the instrument status.
- **Factory preset:** OFF.
- **Remote Command:**

```
:calculate:lline<1|2|3|4|5|6>:frequency:cmode:relative ON|OFF|1|0
```

```
:calculate:lline<1|2|3|4|5|6>:frequency:cmode:relative?
```

- **Examples:**

```
:CALC:LLIN1:FREQ:CMOD:REL ON
```

```
:CALC:LLIN1:FREQ:CMOD:REL?
```

[Y Axis Relative to reflvel

On Off]

5.2. Description of menu

- **Menu description:** to specify whether the Y axis data are absolute or relative during edit of the currently selected limit line.
- **Key path:** **【Meas Setup】** , [Limit▶], [Properties▶], [Abs/Rel▶], [Y Axis Relative to RL ON/OFF] on the front panel.
- **Status saved:** saved in the instrument status.
- **Factory preset:** OFF.
- **Remote Command:**

```
:calculate:lline<1|2|3|4|5|6>:amplitude:cmode:relative ON|OFF|1|0
```

```
:calculate:lline<1|2|3|4|5|6>:amplitude:cmode:relative?
```

- **Examples:**

```
:CALC:LLIN1:AMPL:CMOD:REL ON
```

```
:CALC:LLIN1:AMPL:CMOD:REL?
```

[Margin On Off]

- **Menu description:** to specify a limit line margin dB which will cause the amplitude data exceeds the limit during test of the currently selected limit line.
- **Key path:** **【Meas Setup】** , [Limit▶], [Margin ON/OFF] on the front panel.
- **Status saved:** saved in the instrument status.
- **Factory preset:** OFF.
- **Setting range:** -40 dB ~ 40 dB.
- **Default unit:** dB.
- **Remote Command:**

```
:calculate:lline<1|2|3|4|5|6>:margin <rel_amp>
```

```
:calculate:lline<1|2|3|4|5|6>:margin?
```

```
:calculate:lline<1|2|3|4|5|6>:margin:state OFF|ON|0|1
```

```
:calculate:lline<1|2|3|4|5|6>:margin:state?
```

- **Examples:**

```
:CALC:LLIN1:MARG -10dB
```

```
:CALC:LLIN1:MARG?
```

```
:CALC:LLIN1:MARG:STAT OFF|ON|0|1
```

```
:CALC:LLIN1:MARG:STAT?
```

[Edit▶]

- **Menu description:** to pop up the menu for limit line editing. Including [Point], [Frequency], [Ampld], [Insert Point],[Delete Point], [Copy Limit▶], [Trace Generation].
- **Key path:** **【Meas Setup】** , [Limit▶], [Edit▶] on the front panel.
- **Status saved:** not saved in instrument status.

5.2. Description of menu

[Test Limit

On Off]

- **Menu description:** to specify whether the limit line test is ON or OFF.
- **Key path:** **【Meas Setup】** , [Limit▶], [More 1/2], [Test Limit ON/OFF] on the front panel.
- **Status saved:** not saved in instrument status.
- **Factory preset:** OFF.
- **Remote Command:**

```
:calculate:lline:TEST OFF|ON|0|1
```

```
:calculate:lline:TEST?
```

- **Examples:**

```
:CALC:LLIN:TEST OFF
```

```
:CALC:LLIN:TEST?
```

[X Axis Unit

Frequency Time]

- **Menu description:** to specify that the X Axis unit of the Limit Line is set to Frequency or Time.
- **Key path:** **【Meas Setup】** , [Limit▶], [More 1/2], [X Axis Unit Frequency Time] on the front panel.
- **Status saved:** saved in the instrument status.
- **Factory preset:** frequency.
- **Remote Command:**

```
:calculate:lline:control:domain frequency|TIME
```

```
:calculate:lline:control:domain?
```

- **Examples:**

```
:CALC:LLIN:CONT:domain FREQ
```

```
:CALC:LLIN:CONT:DOM?
```

[Delete All Limit]

- **Menu description:** to clear all limit line data.
- **Key path:** **【Meas Setup】** , [Limit Line], [More 1/2▶], [Delete All Limit] on the front panel.
- **Status saved:** not saved in instrument status.
- **Remote Command:**

```
:calculate:lline:ALL:delete
```

- **Examples:**

```
:CALC:LLIN:ALL:DEL
```

[Save Limit Line...]

- **Menu description:** to pop up a dialog box for saving currently edited limit line data into a file.

5.2. Description of menu

- **Key path:** **【Meas Setup】** , [Limit▶], [More 1/2], [Save Limit Line...] On the front panel.
- **Status saved:** not saved in instrument status.
- **Remote Command:**

```
:memory:store:limit LLINE1|LLINE2,<filename>
```

- **Examples:**

```
:MMEM:STOR:LIM LLINE1,"D:\limitline.lim"
```

[Load Limit Line...]

- **Menu description:** to pop up a dialog box for applying currently saved limit line file data to currently selected limit line.
- **Key path:** **【Meas Setup】** , [Limit▶], [Menu 1/2], [Load Limit Line...] On the front panel.
- **Status saved:** not saved in instrument status.
- **Remote Command:**

```
:memory:LOAD:limit LLINE1|LLINE2,<filename>
```

- **Examples:**

```
:MMEM:LOAD:LIM LLINE1,"D:\limitline.lim"
```

[Low Noise Path**On Off]**

- **Menu description:** this menu is only available when the H34 option (Low Noise PreAmplifier) is purchased. When the PreAmplifier is ON, the Low Noise Path is OFF and this menu is grayed out; when the PreAmplifier is OFF, this menu lights on and is switchable.
- **Key path:** **【Meas Setup】** , [More 1/2▶], [Low Noise Path Man] on the front panel.
- **Status saved:** saved in the instrument status.
- **Remote Command:**

```
[:sense]:power[:RF]:MW:PATH STD|Inpath
```

```
[:sense]:power[:RF]:MW:PATH?
```

- **Examples:**

```
:POW:MW:PATH STD
```

```
:POW:MW:PATH?
```

[Preselector**Bypass Presel]**

- **Menu description:** this menu is only available when the H36 option is purchased. It is used for setting whether to bypass the front-end preselector of the signal/spectrum analyzer. In analyzing bandwidth signal, bypass is usually required.
- **Key path:** **【Meas Setup】** , [More 1/2▶], [Preselector Presel Bypass] on the front panel.
- **Status saved:** saved in the instrument status.

5.2. Description of menu

- **Remote Command:**

Input:filter:YIG[:state] OFF|ON|0|1

Input:filter:YIG[:state]?

- **Examples:** INP:FILT:YIG OFF INP:FILT:YIG?

[RF Gain▶]

- **More description:** to set the Auto ON/OFF of the RF Gain and best allocation algorithm for RF Gain. The soft More includes [Auto], [Best for Dynamic Range] and [Best for Sensitivity].
- **Key path:** **【Meas Setup】** , [More 1/2▶], [RF Gain▶] on the front panel.
- **Status saved:** saved in the instrument status.

[Auto]

- **Menu description:** to set the RF Gain distribution algorithm to Auto. In this case, the RF Gain distribution is “Best Dynamic Range”.
- **Key path:** **【Meas Setup】** , [More 1/2▶], [RF Gain▶], [Auto] on the front panel.
- **Status saved:** saved in the instrument status.
- **Remote Command:**

[:sense]:RF:GAIN:AUTO[:state] OFF|ON|0|1 [:sense]:RF:GAIN:AUTO[:state]?

- **Examples:**

:RF:GAIN:AUTO OFF

:RF:GAIN:AUTO?

[Best for Dynamic Range]

- **Menu description:** to set the RF Gain distribution algorithm to Best Dynamic Range. In this case, the RF Gain is switched to “Auto OFF”
- **Key path:** **【Meas Setup】** , [More 1/2▶], [RF Gain▶], [Best for Dynamic Range] on the front panel.
- **Status saved:** saved in the instrument status.
- **Remote Command:**

[:sense]:RF:GAIN:AUTO:rules RANGE

[:sense]:RF:GAIN:AUTO:rules?

- **Examples:**

:RF:GAIN:AUTO:RUL RANGE

:RF:GAIN:AUTO:RUL?

[Best for Sensitivity]

- **Menu description:** to set the RF Gain distribution algorithm to Best Sensitivity. In this case, the RF Gain is switched to “Auto OFF”
- **Key path:** **【Meas Setup】** , [More 1/2▶], [RF Gain▶], [Best for Sensitivity] on the front panel.

5.2. Description of menu

- **Status saved:** saved in the instrument status.
- **Remote Command:**

```
[[:sense]:RF:GAIN:AUTO:rules SENSITIVITY
```

```
[[:sense]:RF:GAIN:AUTO:rules?
```

- **Examples:**

```
:RF:GAIN:AUTO:RUL SENSITIVITY
```

```
:RF:GAIN:AUTO:RUL?
```

[ADC Dither

Auto Man]

- **Menu description:** to control opening/closing of ADC dither of the frequency acquisition circuit in the analyzer. Under default mode, the signal/spectrum analyzer will automatically control whether the ADC Dither is ON based on current working condition. When the ADC Dither is under Auto mode, the ON or OFF status depends on the span, resolution bandwidth and sweep type (continuous swept or step sweep); when it is continuous swept, the ADC Dither status will force to switch to Auto and turns off; when it is step sweep, under Auto mode, if the span is 2 MHz or below, the ADC Dither is ON; if the span is below 2 MHz, the ADC Dither is OFF. Under Auto OFF mode, if the span is above 2 MHz, turning on the ADC Dither may affect the measurement results based on selected dither status.

You can access the submenu for manual control You can access the submenu for manual control.

- **Key path:** **【Meas Setup】** , [More 1/2▶], [ADC Dither Auto Man] on the front panel.
- **Status saved:** saved in the instrument status.
- **Factory preset:** Auto.
- **Remote Command:**

```
[[:sense]:ADC:dither[:state] OFF|ON|HIGH
```

```
[[:sense]:ADC:dither[:state]?
```

```
[[:sense]:ADC:dither:AUTO[:state] OFF|ON|0|1
```

```
[[:sense]:ADC:dither:AUTO[:state]?
```

- **Examples:**

```
:ADC:DITH OFF
```

```
:ADC:DITH?
```

```
:ADC:DITH:AUTO OFF
```

```
:ADC:DITH:AUTO?
```

[Noise Correction

On Off]

- **Menu description:** activate or deactivate the noise correction function. When the noise correction function is activated, 4051 first implements the noise correction under the current apparatus state to obtain the correction data and then deletes the apparatus background noise from measuring result so as to improve the measuring flexibility and dynamic range. When the measuring state of apparatus changes, such as resolution bandwidth, frequency width, center frequency and so on, 4051 will implement the noise correction under the new measuring state.

5.2. Description of menu

It should be noted that the implementation of noise correction will often change the mechanical attenuator in apparatus to reduce the service life of attenuator. It is not recommended to keep the noise correction switch at the position On for long.

- **Key path:** **【Meas Setup】** , [More 1/2▶], [Noise Correction On Off]
- **Status saved:** saved in the instrument status.
- **Factory preset:** off.
- **Remote Command:**

```
[.SENSe]:CORRection:NOISe:FLOor ON|OFF|1|0
```

```
[.SENSe]:CORRection:NOISe:FLOor?
```

- **Examples:**

```
:CORR:NOIS:FLO ON
```

```
:CORR:NOIS:FLO?
```

[Phnoise Opt>>

Auto Man]

Pop up the soft menu related to phase noise optimization, including [Auto], [ON] and [OFF]. If Auto is selected, the signal/spectrum analyzer will automatically control the LO circuit parameters and phase noise optimization based on current span, center frequency, RF Gain Man. In principle, Phase Noise Optimization is defaulted as Auto mode.

- **Remote Command:**

```
[.sense]:frequency:synthesis:AUTO[:state] OFF|ON|0|1
```

```
[.sense]:frequency:synthesis:AUTO[:state]?
```

```
[.sense]:frequency:synthesis:[.state] OFF|ON|0|1
```

```
[.sense]:frequency:synthesis:[.state]?
```

- **Examples:**

```
:FREQ:SYNT:AUTO OFF|ON|0|1
```

```
:FREQ:SYNT:AUTO?
```

```
:FREQ:SYNT: OFF|ON|0|1
```

```
:FREQ:SYNT:?
```

5.2.2.9 Measurement Control

Pop up the More of meas control, including [Restart] and [Pause].

[Restart]

- **Menu description:** to stop current measurement and restart measurement for the signal/spectrum analyzer.
- **Key path:** **【Meas Control】** , [Restart] on the front panel
- **Status saved:** not saved in instrument status.
- **Remote Command:**

```
:initiate:REST
```

- **Examples:**

:INIT:REST

[Pause]

- **Menu description:** when the signal/spectrum analyzer is in operation, this menu is used for pausing current measurement; when in Paused status, this menu is used for continuing measurement.
- **Key path:** **【Meas Control】** , [Pause] on the front panel.
- **Status saved:** not saved in instrument status.
- **Remote Command:**

:initiate:PAUS

:initiate:RES

- **Examples:**

:INIT:PAUS

:INIT:RES

5.2.2.10 Auto Setting

Pop up the soft menu related to auto setting including [Couple All], [Mech Atten Auto Man], [Res BW Auto Man], [Video BW Auto Man], [VBW/RBW Auto Man], [Span/RBW Auto Man], [Sweep Time Auto Man] and [CF Step Auto Man].

[Couple All]

- **Menu description:** to set the sweep mode, resolution bandwidth, video bandwidth, sweep time, mechanical attenuator and frequency step as auto coupling mode. The signal/spectrum analyzer will select most suitable values for those functions based on set frequency and bandwidth (or start frequency and stop frequency). These values will be set based on span and coupling ratio saved under [VBW/RBW] or the [Span/RBW]. If no ratio is pre-saved, use default ratio.
- **Key path:** **【Auto Set】** , [Couple All] on the front panel.
- **Status saved:** not saved in instrument status.
- **Factory preset:** Couple All.
- **Remote Command:**

:couple ALL|NONE

- **Examples:**

:COUP ALL

[Mech Atten **Auto** Man]

- **Menu description:** In Auto ON mode, the mechanical attenuator is coupled to the reference level. Under Auto OFF Mode, use number keys, stepping keys or knob to change the attenuation of the attenuator. Such menu is used for another port of the mechanical attenuator and the setting can also be made via [Ampld/Y Scale], [Attenuation▶], [Mech Atten Auto ON/OFF] on the front panel.
- **Key path:** **【Auto Set】** , [Mech Atten Auto ON/OFF] on the front panel.
- **Status saved:** saved in the instrument status.
- **Factory preset:** Auto.

5.2. Description of menu

- **Setting range:** Min.:0dB, Max.: 70dB.
- **Default unit:** dB.
- **Remote Command:**

```
[[:sense]:power[:RF]:attenuation <rel_power>
```

```
[[:sense]:power[:RF]:attenuation?
```

```
[[:sense]:power[:RF]:attenuation:AUTO OFF|ON|0|1
```

```
[[:sense]:power[:RF]:attenuation:AUTO?
```

- **Examples:**

```
:POW:ATT 30 dB
```

```
:POW:ATT:AUTO ON
```

[Res BW **Auto Man**]

- **Menu description:** to change the resolution bandwidth of spectrum analysis, ranging from 1Hz to 20 MHz, which is stepped by 1, 2, 3, 5 and 10. The resolution bandwidth can be changed with the number keys, step keys and knob. The shaded character indicates the currently selected mode.
- **Key path:** **【Auto Set】** , [Res BW Auto ON/OFF] on the front panel.
- **Status saved:** saved in the instrument status.
- **Factory preset:** Auto
- **Setting range:** Min.:1Hz, Max.: 20 MHz.
- **Default unit:** Hz
- **Remote Command:**

```
[[:sense]:bandwidth|bwidth[:resolution] <freq>
```

```
[[:sense]:bandwidth|bwidth[:resolution]?
```

```
[[:sense]:bandwidth|bwidth[:resolution]:AUTO OFF|ON|0|1
```

```
[[:sense]:bandwidth|bwidth[:resolution]:AUTO?
```

- **Examples:**

```
BAND 1 kHz
```

```
BWID:AUTO On
```

[Video BW **Auto Man**]

- **Menu description:** to change the video bandwidth within the active function area, ranging from 1Hz to 20 MHz, which is stepped by 1, 2, 3, 5 and 10. Use number keys, stepping keys or knob to change The current mode is shaded. When set as Auto Off, press [Video BW Auto Man] to select Auto On and return to auto mode.
- **Key path:** **【Auto Set】** , [Video BW Auto ON/OFF] on the front panel.
- **Status saved:** saved in the instrument status.
- **Factory preset:** Auto, same as the Resolution Bandwidth setting.
- **Setting range:** Min.:1Hz, Max.: 20 MHz.
- **Default unit:** Hz

- **Remote Command:**

```
[[:sense]:bandwidth|bwidth:video <freq>
```

```
[[:sense]:bandwidth|bwidth:video?
```

```
[[:sense]:bandwidth|bwidth:video:AUTO OFF|ON|0|1
```

```
[[:sense]:bandwidth|bwidth:video:AUTO?
```

- **Examples:**

```
:BAND:VID 1 kHz
```

```
:BWID:VID:AUTO ON
```

[VBW/RBW **Auto Man**]

- **Menu description:** to set the ratio between the current video bandwidth and resolution bandwidth with the default value as 1. As the resolution bandwidth changes, the video bandwidth changes to maintain this ratio. The ratio should be displayed on the input area and used for the coupling mode of those two kinds of bandwidth. When a new ratio is selected, change the video bandwidth to meet this new ratio and the resolution bandwidth should remain unchanged.

- **Key path:** **【Auto Set】** , [VBW/RBW Auto ON/OFF] on the front panel.

- **Status saved:** saved in the instrument status.

- **Factory preset:** auto with VBW/RBW as 1.

- **Setting range:** Min.:0.0001, Max.: 300000.

- **Remote Command:**

```
[[:sense]:bandwidth|bwidth:video:ratio <number>
```

```
[[:sense]:bandwidth|bwidth:video:ratio?
```

- **Examples:**

```
:BAND:VID:RAT 2
```

[Span/RBW **Auto Man**]

- **Menu description:** to set the ratio between the current span and resolution bandwidth and display it in the input area. This ratio is used in coupling mode of the resolution bandwidth.

- **Key path:** **【Auto Set】** , [Span/RBW Auto ON/OFF] on the front panel.

- **Status saved:** saved in the instrument status.

- **Factory preset:** auto with span/RBW as 106.

- **Setting range:** Min.:2, Max.: 10000.

- **Remote Command:**

```
[[:sense]:frequency:SPAN:bandwidth[:resolution]:ratio <integer>
```

```
[[:sense]:frequency:SPAN:bandwidth[:resolution]:ratio?
```

```
[[:sense]:frequency:SPAN:bandwidth[:resolution]:ratio:AUTO OFF|ON|0|1
```

```
[[:sense]:frequency:SPAN:bandwidth[:resolution]:ratio:AUTO?
```

- **Examples:**

```
:SPAN:BAND:RAT 20
```

5.2. Description of menu

[CF Step **Auto Man**]

- **Menu description:** to change the steps of center frequency, start frequency or stop frequency. When it is under [Auto Mode], and when the center frequency is active, press the step key, the [CF Step] changes by 1, 2, 5 and 10. When it is under Auto Off mode, use the number keys, stepping keys or knob for change. At this time, reactivate the [Center Freq], and press the step key, the center freq will change by set step size. This function is extremely useful to quickly change the center frequency to the input signal harmonic. For example, observe the harmonic of 300 MHz input signal, and set the [CF Step Auto Man] as Auto OFF, and input 300 MHz. If the current center frequency is 300 MHz, press the stepping key to increase the center frequency to 600 MHz. Press the stepping key again to increase the center frequency by 300 MHz to 900 MHz. The shaded status of [CF Step Auto Man] More indicates whether the step is set as Auto On or Off. When the step is under Auto Off, select the Auto On from [CF Step Auto Man] to return to Auto On status.
- **Key path:** **【Auto Set】** , [More 1/2▶], [CF Step Auto ON/OFF] on the front panel.
- **Status saved:** saved in the instrument status.
- **Factory preset:** depend on maximum frequency limit of signal/spectrum analyzer and current measurement mode.
- **Setting range:** Min.: 1 Hz, Max.: maximum center frequency.
- **Default unit:** Hz
- **Remote Command:**

```
[[:sense]:frequency:center:STEP[:increment] <freq>
```

```
[[:sense]:frequency:center:STEP[:increment]?
```

```
[[:sense]:frequency:center:STEP:AUTO OFF|ON|0|1
```

```
[[:sense]:frequency:center:STEP:AUTO?
```

- **Examples:**

```
:FREQ:CENT:STEP 100 MHz
```

```
:FREQ:CENT:STEP:AUTO ON
```

5.2.2.11 Display

Pop up the soft More related to display, including [Display Line On Off], [Display Config ▶].

[Display Line ON **OFF**]

- **Menu description:** when this menu is ON, it activates an adjustable horizontal reference line Which indicates an amplitude value corresponding to the reference level. The value of the display line can be adjusted using the stepping keys, knob or number keys. The display line unit depends on [Y Axis Unit] under [Ampld] menu.
- **Key path:** **【Display】** , [Display Line ON OFF] on the front panel.
- **Status saved:** saved in the instrument status.
- **Factory preset:** -25dBm.
- **Setting range:** -200 dBm ~ 30 dBm.
- **Default unit:** dBm.
- **Remote Command:**

```
:display>window[1]:trace:Y:dline <ampl>
```

5.2. Description of menu

```
:display:window[1]:trace:Y:dline?
:display:window[1]:trace:Y:dline:state OFF|ON|0|1
:display:window[1]:trace:Y:dline:state?
```

- **Examples:**

```
:DISP:WIND:TRAC:Y:DLIN -20dBm
:DISP:WIND:TRAC:Y:DLIN?
:DISP:WIND:TRAC:Y:DLIN:STAT ON
:DISP:WIND:TRAC:Y:DLIN:STAT?
```

[Display Config▶]

It is used for configurations of interface language, status area display ON OFF related to interface display, The soft More include [Input/Output], [Graticule On Off], [Status Display On Off], [Freq Info Disp On Off].

[Language 中文 English]

- **Menu description:** to set the display language to Chinese or English.
- **Key path:** 【Display】 , [Display Config▶], [Language 中文 English] on the front panel.
- **Remote command:** this menu has no corresponding remote commands, and is mainly for local usage.

[Graticule ON OFF]

- **Menu description:** to select whether to display the graticule in the screen trace area.
- **Key path:** 【Display】 , [Display Config▶], [Graticule ON/OFF] on the front panel.
- **Remote Command:**

```
:display:window[1]:trace:graticule:GRID[:state] OFF|ON|0|1
:display:window[1]:trace:graticule:GRID[:state]?
```

- **Examples:**

```
:DISP:WIND:TRAC:GRAT:GRID OFF
:DISP:WIND:TRAC:GRAT:GRID?
```

[Status Display ON OFF]

- **Menu description:** to select whether to display the status area information.
- **Key path:** 【Display】 , [Display Config▶], [Status Display ON/OFF] on the front panel.
- **Remote Command:**

```
:display:window[1]:annotation[:ALL] OFF|ON|0|1
:display:window[1]:annotation[:ALL]?
```

- **Examples:**

```
:DISP:WIND:ANN OFF
:DISP:WIND:ANN?
```

5.2. Description of menu

[Freq Info Disp **ON** OFF]

- **Menu description:** to select whether to display the status area frequency information.
- **Key path:** **【Display】** , [Display Config ▶], [Freq Info Disp ON OFF] on the front panel.
- **Remote Command:**

:display:annotation:frequency OFF|ON|0|1

:display:annotation:frequency?

- **Examples:**

:DISP:ANN:FREQ OFF

:DISP:ANN:FREQ?

5.2.2.12 Input Output

This More pops up the More related to external input and output interfaces of the signal/spectrum and the soft More includes [Freq Ref Int Ext], [Input Couple AC DC], [Input Port RF CAL], [Cal Port▶], [HF IF Output ON/OFF], [IF Output▶], [Log Detector Output ON/OFF], [Ext Mixer...], [Input Impedance 50Ω/75Ω].

[Freq Ref **In** Ext]

- **Menu description:** to select internal or external frequency reference. The external frequency reference should be 10 MHz±100Hz and amplitude 0dBm (Limit range: -2dBm~+10dBm). The external frequency reference should be input through the “10 MHz Reference Input” interface on the rear panel. In selecting external reference, the information prompt area will display “Reference: External”.
- **Key path:** **【Input/Output】** , [Freq Ref Int Ext] on the front panel.
- **Status saved:** saved in the instrument status.
- **Factory preset:** internal.
- **Remote Command:**

[[:sense]:roscillator:source internal|external

[[:sense]:roscillator:source?

- **Examples:**

:ROSC:SOUR INT

:ROSC:SOUR?

[Input Couple AC **DC**]

- **Menu description:** to select the coupling method of the input interface of the signal/spectrum analyzer as DC or AC coupling. The DC coupling is useful for measuring input signal less than 10 MHz. However, the external input DC signal may damage the instrument. AC coupling prevents external DC signal from entering the instrument, and is suitable for measuring RF signal larger than 10 MHz.
- **Key path:** **【Input/Output】** , [Input Couple AC DC] on the front panel.
- **Status saved:** saved in the instrument status.
- **Factory preset:** DC.
- **Remote Command:**

:input:coupling AC|DC

:input:coupling?

- **Examples:**

:INP:COUP AC

:INP:COUP?

[Input Port **RF CAL**]

- **Menu description:** to select the input interface type as RF input signal or internal calibration signal.
- **Key path:** **【Input/Output】** , [Input Port **RF CAL**] on the front panel.
- **Status saved:** saved in the instrument status.
- **Factory preset:** RF.
- **Remote Command:**

[[:sense]:FEED RF|areference

[[:sense]:FEED?

- **Examples:**

:FEED RF

:FEED?

[Cal Port▶]

The menu is used to select internal calibration signal for the signal/spectrum analyzer. When setting the input interface to Calibration, you can measure those calibration signals through screen measurement. The soft More includes [Off], [500 MHz], [Comb], [4800 MHz].

- **Remote Command:**

[[:sense]:FEED:areference REF500|REFCOMB|REF4800|OFF

[[:sense]:FEED:areference?

- **Examples:**

:FEED:AREF REF500

:FEED:AREF?

[Off]

- **Menu description:** to turn off the internal calibration signal.
- **Key path:** **【Input/Output】** , [Cal Port▶], [Off] on the front panel.
- **Status saved:** saved in the instrument status.

[500 MHz]

- **Menu description:** to select 500 MHz internal sine wave calibration signal with a power of -20 dBm.
- **Key path:** **【Input/Output】** , [Cal Port▶], [500 MHz] on the front panel.
- **Status saved:** saved in the instrument status.

5.2. Description of menu

[Comb]

- **Menu description:** to select internal comb wave calibration signal with a frequency interval of 500 MHz.
- **Key path:** **【Input/Output】** , [Cal Port▶], [Comb] on the front panel.
- **Status saved:** saved in the instrument status.

[4800 MHz]

- **Menu description:** to select 4800 MHz internal sine wave calibration signal with a power of -20 dBm.
- **Key path:** **【Input/Output】** , [Cal Port▶], [4800 MHz] on the front panel.
- **Status saved:** saved in the instrument status.

[High IF Output ON **OFF**]

- **Menu description:** the High IF Output menu is only available when H02 option is purchased. This function can output IF signal between 275 MHz and 475 MHz, Which can be set by the knob, number keys or stepping keys on the front panel.
- **Key path:** **【Input/Output】** , [High IF Output ON/OFF] on the front panel.
- **Status saved:** saved in the instrument status.
- **Factory preset:** OFF.
- **Setting range:** 275 MHz ~ 475 MHz.
- **Default unit:** Hz.
- **Remote Command:**

```
:output:AUX SIF|AIF| OFF
```

```
:output:AUX?
```

```
:output:AUX:SIF <value>
```

```
:output:AUX:SIF?
```

- **Examples:**

```
:OUTP:AUX SIF
```

```
:OUTP:AUX?
```

```
:OUTP:AUX:SIF 275 MHz
```

```
:OUTP:AUX:SIF?
```

[IF Output▶]

The IF Output menu is only available when H03 option is purchased. It is used for controlling the IF output frequency and gain. The soft More includes [IF Output On/Off], [IF Frequency], [Auto Gain On/Off], [Auto Gain Level▶].

[IF Output ON **OFF**]

- **Menu description:** to turn on or off IF Output. When the IF Output is on, the front panel may display no or incorrect trace.

5.2. Description of menu

- **Key path:** **【Input/Output】** , [IF Output▶], [IF Output ON/OFF] on the front panel.
- **Status saved:** saved in the instrument status.
- **Factory preset:** OFF.
- **Remote Command:**

```
:output:AUX SIF|AIF| OFF
```

```
:output:AUX?
```

- **Examples:**

```
:OUTP:AUX AIF
```

```
:OUTP:AUX?
```

[IF Frequency]

- **Menu description:** to set frequency of IF output. Which can be set by the knob, number keys or stepping keys on the front panel.
- **Key path:** **【Input/Output】** , [IF Output▶], [IF Freq] on the front panel.
- **Status saved:** saved in the instrument status.
- **Factory preset:** 70 MHz
- **Setting range:** 10 MHz-160 MHz.
- **Default unit:** MHz.
- **Remote Command:**

```
:output:AUX:AIF <value>
```

```
:output:AUX:AIF?
```

- **Examples:**

```
:OUTP:AUX:AIF 70 MHz
```

```
:OUTP:AUX:AIF?
```

[Auto Gain ON OFF]

- **Menu description:** to turn on or off IF Output Auto Gain.
- **Key path:** **【Input/Output】** , [IF Output▶], [Auto Gain ON/OFF] on the front panel.
- **Status saved:** saved in the instrument status.
- **Factory preset:** OFF.
- **Remote Command:**

```
[[:sense]:IF:GAIN:AUTO OFF|ON|0|1
```

```
[[:sense]:IF:GAIN:AUTO?
```

- **Examples:**

```
:IF:GAIN:AUTO OFF
```

```
:IF:GAIN:AUTO?
```

5.2. Description of menu

[Auto Gain Level▶]

- **Menu description:** to set the Auto Gain Level. Including +5dBm, 0dBm, -5dBm and -10dBm.
- **Key path:** **【Input/Output】** , [IF Output▶], [Auto Gain Level▶] on the front panel.
- **Status saved:** saved in the instrument status.
- **Factory preset:** 0dBm.
- **Remote Command:**

```
[::sense]:IF:GAIN:AUTO:LEVEL 5|0|-5|-10
```

```
[::sense]:IF:GAIN:AUTO:LEVEL?
```

- **Examples:**

```
:IF:GAIN:AUTO:LEVEL 5
```

```
:IF:GAIN:AUTO:LEVEL?
```

[Log Detector Output ON **OFF**]

- **Menu description:** the logarithmic detector output menu is only available when H08 option is purchased. The analyzer can be used as a wideband detector for logarithmic detector output to output logarithmic detector envelop signal of the RF signal to the rear panel.
- **Key path:** **【Input/Output】** , [More 1/2], [Log Detector Output ON/OFF] on the front panel.
- **Status saved:** saved in the instrument status.
- **Factory preset:** OFF.
- **Remote Command:**

```
:output:AUX:logvideo OFF|ON|0|1
```

```
:output:AUX:logvideo?
```

- **Examples:**

```
:OUTP:AUX:LOGV OFF
```

```
:OUTP:AUX:LOGV?
```

[Ext Mixer...]

- **Menu description:** the Ext Mixer menu is only available when H40 option is purchased. Press this menu to pop up the parameter setting dialogs for external mixer test. For details, refer to other related manuals.
- **Key path:** **【Input/Output】** , [More 1/2], [Ext Mixer...] On the front panel.
- **Status saved:** not saved in instrument status.

5.2.2.13 Marker

Pop up the soft More related to markers, including [Select Marker ▶], [Normal], [Delta], [Fixed], [Off], [Properties ▶], [Marker Table On/Off], [Marker Couple Markers On/Off], and [All Markers Off].

[Select Marker▶]

Marker 1]

- **Command description:** to select among 12 different markers of the analyzer. When a certain marker is selected, the marker will be indicated in the menu where its type and attribute can be set. Select and

5.2. Description of menu

trigger another marker and place it at the center of the current trace. Users can read amplitude and frequency information (when the frequency span is 0 Hz, time information will be displayed) at the marker display area at the top right corner of the screen.

- **Key path:** **【Marker】** , [Select Marker ►] on the front panel.
- **Status saved:** saved in the instrument status.
- **Factory preset:** Marker 1.

[Normal]

- **Menu description:** to set the selected marker as the Normal Marker.
- **Key path:** **【Marker】** , [Normal] on the front panel.
- **Status saved:** saved in the instrument status.
- **Remote Command:**

```
:calculate:marker[1|2|3|4|5|6|7|8|9|10|11|12]:MODE position
```

```
:calculate:marker[1|2|3|4|5|6|7|8|9|10|11|12]:MODE?
```

- **Examples:**

```
:CALC:MARK1:MODE POS
```

```
:CALC:marker1:MODE?
```

[Delta]

- **Menu description:** to set the selected marker as the Delta Marker. Display the amplitude difference and frequency difference (or time difference, when span is zero) between two markers at the marker display area at the top right corner of the screen. If there exists a single marker, a [Marker Delta] operation will generate a Ref marker in the active marker position. Move the active marker through the knob, stepping keys or number keys. The display amplitude difference unit is dB.
- **Key path:** **【Marker】** , [Delta] on the front panel.
- **Status saved:** saved in the instrument status.
- **Remote Command:**

```
:calculate:marker[1|2|3|4|5|6|7|8|9|10|11|12]:MODE delta
```

```
:calculate:marker[1|2|3|4|5|6|7|8|9|10|11|12]:MODE?
```

- **Examples:**

```
:CALC:MARK1:MODE DELT
```

```
:CALC:MARK1:MODE?
```

[Fixed]

- **Menu description:** to set the selected marker as the Fixed Marker. The X Axis and Y Axis positions of the fixed marker are fixed. The Fixed Marker can be used as reference marker.
- **Key path:** **【Marker】** , [Fixed] on the front panel.
- **Status saved:** saved in the instrument status.
- **Remote Command:**

5.2. Description of menu

:calculate:marker[1|2|3|4|5|6|7|8|9|10|11|12]:MODE fixed

:calculate:marker[1|2|3|4|5|6|7|8|9|10|11|12]:MODE?

- **Examples:**

:CALC:MARK1:MODE FIX

:CALC:MARK1:MODE?

[Off]

- **Menu description:** to turn off the selected marker.
- **Key path:** **【Marker】**], [Off] on the front panel.
- **Status saved:** saved in the instrument status.
- **Remote Command:**

:calculate:marker[1|2|3|4|5|6|7|8|9|10|11|12]:MODE OFF

:calculate:marker[1|2|3|4|5|6|7|8|9|10|11|12]:MODE?

- **Examples:**

:CALC:MARK1:MODE OFF

:CALC:MARK1:MODE?

[Properties▶]

Pop up the corresponding More of currently selected marker attribute setup, including [Relative to▶], [X Axis Auto Man], [Marker Trace ▶] and [Lines On Off].

[Ref Marker▶]

- **Menu description:** to select reference marker for current marker. It can be any one from 11 markers except the currently selected marker.
- **Key path:** **【Marker】**], [Properties▶], [Ref Marker▶] on the front panel.
- **Status saved:** saved in the instrument status.
- **Remote Command:**

:calculate:marker[1|2|3|4|5|6|7|8|9|10|11|12]:reference <integer>

:calculate:marker[1|2|3|4|5|6|7|8|9|10|11|12]:reference?

- **Examples:**

:CALC:MARK1:REF 2

:CALC:MARK1:REF?

[X Axis Scale **Auto Man**]

- **Menu description:** to set X Axis (horizontal axis) data type of current marker. The soft More includes [Auto], [Frequency], [Period], [Time], [Inverse Time].
- **Key path:** **【Marker】**], [Properties▶], [X Axis Scale Auto Man] on the front panel.
- **Status saved:** saved in the instrument status.

5.2. Description of menu

- **Factory preset:** Auto.

[Auto]

- **Menu description:** to set X Axis (horizontal axis) data type of current marker as Auto Select. When the current marker trace is time waveform data, the X Axis scale automatically sets as Time; when spectrum data, the marker X axis scale automatically sets as Frequency.
- **Key path:** **【Marker】** , [Properties▶], [X Axis Scale Auto Man], [Auto] on the front panel.
- **Status saved:** saved in the instrument status.
- **Remote Command:**

```
:calculate:marker[1|2|3|4|5|6|7|8|9|10|11|12]:X:readout:AUTO ON|OFF|1|0
```

```
:calculate:marker[1|2|3|4|5|6|7|8|9|10|11|12]:X:readout:AUTO?
```

- **Examples:**

```
:CALC:MARK1:X:READ:AUTO ON
```

```
:CALC:MARK1:X:READ:AUTO?
```

[Frequency]

- **Menu description:** to set X Axis (horizontal axis) data type of current marker as frequency.
- **Key path:** **【Marker】** , [Properties▶], [X Axis Scale Auto Man], [Frequency] on the front panel.
- **Status saved:** saved in the instrument status.
- **Remote Command:**

```
:calculate:marker[1|2|3|4|5|6|7|8|9|10|11|12]:X:readout frequency
```

```
:calculate:marker[1|2|3|4|5|6|7|8|9|10|11|12]:X:readout?
```

- **Examples:**

```
:CALC:MARK1:X:READ:FREQ
```

```
:CALC:MARK1:X:READ?
```

[Period]

- **Menu description:** to set X Axis (horizontal axis) data type of current marker as period.
- **Key path:** **【Marker】** , [Properties▶], [X Axis Scale Auto Man], [Period] on the front panel.
- **Status saved:** saved in the instrument status.
- **Remote Command:**

```
:calculate:marker[1|2|3|4|5|6|7|8|9|10|11|12]:X:readout period
```

```
:calculate:marker[1|2|3|4|5|6|7|8|9|10|11|12]:X:readout?
```

- **Examples:**

```
:CALC:MARK1:X:READ:PER
```

```
:CALC:MARK1:X:READ?
```

[Time]

5.2. Description of menu

- **Menu description:** to set X Axis (horizontal axis) data type of current marker as Time.
- **Key path:** **【Marker】** , [Properties▶], [X Axis Scale Auto Man], [Time] on the front panel.
- **Status saved:** saved in the instrument status.
- **Remote Command:**

```
:calculate:marker[1|2|3|4|5|6|7|8|9|10|11|12]:X:readout TIME
```

```
:calculate:marker[1|2|3|4|5|6|7|8|9|10|11|12]:X:readout?
```

- **Examples:**

```
:CALC:MARK1:X:READ TIME
```

```
:CALC:MARK1:X:READ?
```

[Inverse Time]

- **Menu description:** to set X Axis (horizontal axis) data type of current marker as Inverse Time.
- **Key path:** **【Marker】** , [Properties▶], [X Axis Scale Auto Man], [Inverse Time] on the front panel.
- **Status saved:** saved in the instrument status.
- **Remote Command:**

```
:calculate:marker[1|2|3|4|5|6|7|8|9|10|11|12]:X:readout itime
```

```
:calculate:marker[1|2|3|4|5|6|7|8|9|10|11|12]:X:readout?
```

- **Examples:**

```
:CALC:MARK1:X:READ ITIM
```

```
:CALC:MARK1:X:READ?
```

[Marker Trace▶]

- **Menu description:** to select trace data for current marker. The marker trace can be any active trace.
- **Key path:** **【Marker】** , [Properties▶], [Marker Trace▶] on the front panel.
- **Status saved:** saved in the instrument status.
- **Remote Command:**

```
:calculate:marker[1|2|3|4|5|6|7|8|9|10|11|12]:trace 1|2|3|4|5|6
```

```
:calculate:marker[1|2|3|4|5|6|7|8|9|10|11|12]:trace?
```

- **Examples:**

```
:CALC:MARK1:TRAC 1
```

```
:CALC:MARK1:TRAC?
```

[Lines ON OFF]

- **Menu description:** to set whether the current marker is displayed as a line on the screen, which is easy to observe.
- **Key path:** **【Marker】** , [Properties▶] and [Lines ON/OFF] on the front panel.
- **Status saved:** saved in the instrument status.

5.2. Description of menu

- **Factory preset:** OFF.

- **Remote Command:**

:calculate:marker[1|2|3|4|5|6|7|8|9|10|11|12]:lines[:state] OFF|ON|0|1

:calculate:marker[1|2|3|4|5|6|7|8|9|10|11|12]:lines[:state]?

- **Examples:**

:CALC:MARK1:LIN OFF

:CALC:MARK1:LIN?

[Marker Table ON **OFF**]

- **Menu description:** to turn on the marker table display. Where there are many markers, it is convenient for data measurement.

- **Key path:** **【Marker】** , [More 1/2▶], [Marker Table ON/OFF] on the front panel.

- **Status saved:** saved in the instrument status.

- **Factory preset:** OFF.

- **Remote Command:**

:calculate:marker:table[:state] OFF|ON|0|1

:calculate:marker:table[:state]?

- **Examples:**

:CALC:MARK:TABL OFF

:CALC:MARK:TABL?

[Marker Couple ON **OFF**]

- **Menu description:** to turn on or off Marker Couple. When it is ON, moving any marker horizontal axis position will cause an equal movement of horizontal axis position of every other marker which is ON. When the marker is moved to less than Start Frequency or larger than Stop Frequency, the marker is limited to the value of the Start Frequency or the Stop Frequency; when the span is zero, the minimum value is limited as 0, and the maximum value is limited as the Sweep Time.

- **Key path:** **【Marker】** , [More 1/2▶], [Marker Couple On/Off] on the front panel.

- **Status saved:** saved in the instrument status.

- **Factory preset:** OFF.

- **Remote Command:**

:calculate:marker:couple[:state] OFF|ON|0|1

:calculate:marker:couple[:state]?

- **Examples:**

:CALC:MARK:COUP OFF

:CALC:MARK:COUP?

[All Markers OFF]

- **More description:** to turn off all current markers which are On and related soft keys, e.g. [Noise Marker].

5.2. Description of menu

- **Key path:** **【Marker】** , [More 1/2▶], [All Markers OFF] on the front panel.
- **Status saved:** not saved in instrument status.
- **Remote Command:**

:calculate:marker:AOFF

- **Examples:**

:CALC:MARK:AOFF

5.2.2.14 Mrk ->

Pop up soft menus related to Marker->Function. Such menus are related to the frequency, span and marker type (Normal or Delta Marker):

Table 5.1 Relationship between Span and Marker->Function

Span >0Hz	Span =0Hz
[Mrk → CF] [Mrk → CF Step] [Mrk→ Start] [Mrk → Stop] [Delta Mrk →Span] [Delta Mrk → CF] [Mrk →Ref Level]	[Mrk →Ref Level]

Those marker functions allow the user to change the signal/spectrum analyzer positions using markers as reference.

[Mrk → CF]

- **Menu description:** to set the Center Frequency equal to the Marker Frequency. It can quickly move the signal to the center position of the screen.
- **Key path:** **【Mrk->】** , [Mrk→ CF] on the front panel.
- **Remote Command:**

:calculate:marker[1|2|3|4|5|6|7|8|9|10|11|12][:SET]:center

- **Examples:**

:CALC:MARK1:CENT

[Mrk → CF Step]

- **Menu description:** to set the Frequency Step equal to the Marker Frequency. The menu changes the value of frequency step.
- **Key path:** **【Mrk->】** , [Mrk → CF Step] on the front panel.
- **Remote Command:**

:calculate:marker[1|2|3|4|5|6|7|8|9|10|11|12][:SET]:STEP

- **Examples:**

:CALC:MARK1:STEP

[Mrk → Start]

- **Menu description:** to set the Start Frequency equal to the Marker Frequency. The menu changes the value of start frequency.
- **Key path:** **【Mrk->】** , [Mrk →Start] on the front panel.
- **Remote Command:**

```
:calculate:marker[1|2|3|4|5|6|7|8|9|10|11|12][:SET]:start
```

- **Examples:**

```
:CALC:MARK1:STAR
```

[Mrk → Stop]

- **Menu description:** to set the Stop Frequency equal to the Marker Frequency. The menu changes the value of stop frequency.
- **Key path:** **【Mrk->】** , [Mrk →Stop] on the front panel.
- **Remote Command:**

```
:calculate:marker[1|2|3|4|5|6|7|8|9|10|11|12][:SET]:STOP
```

- **Examples:**

```
:CALC:MARK1:STOP
```

[Delta Mrk →Span]

- **Menu description:** to set the Span equaling to frequency difference of the Delta Marker. The menu changes the value of frequency span.
- **Key path:** **【Mrk->】** , [Mkr Delta->Span] on the front panel.
- **Remote Command:**

```
:calculate:marker[1|2|3|4|5|6|7|8|9|10|11|12][:SET]:delta:SPAN
```

- **Examples:**

```
:CALC:MARK1:DELT:SPAN
```

[Delta Mrk → CF]

- **Menu description:** to set the Center Frequency equal to frequency difference of the Delta Marker. The menu changes the value of center frequency.
- **Key path:** **【Mrk->】** , [Mkr Delta->CF] on the front panel.
- **Remote Command:**

```
:calculate:marker[1|2|3|4|5|6|7|8|9|10|11|12][:SET]:delta:center
```

- **Examples:**

```
:CALC:MARK1:DELT:CENT
```

[Mrk →Ref Level]

5.2. Description of menu

- **Menu description:** to set the Reference Level equal to the Marker Amplitude. The menu changes the value of reference level.
- **Key path:** **【Mrk->】** , [Mrk →Ref Level] on the front panel.

- **Remote Command:**

```
:calculate:marker[1|2|3|4|5|6|7|8|9|10|11|12][:SET]:rlevel
```

- **Examples:**

```
:CALC:MARK1:RLEV
```

5.2.2.15 Marker Function

The **【Marker Func】** key on the front panel, is used for turning on the control instrument marker functions. The Marker Function performs post-processing on the marker data. Its soft More includes [Marker Count▶], [Audio Demulation], [Noise Marker On/Off], [N dB Points On/Off], [Band/Interval Power On/Off], [Band/Interval Density On/Off], [Band Adjust ▶].

[Marker Count▶]

- **Menu description:** to open Marker Count menu. Its soft More includes [Marker Count On/Off], [Counter Gate].

[Marker Count ON OFF]

- **Menu description:** to turn on or off Marker Count. If there is no active marker, enabling this function will activate an active marker at the center of screen. The Marker Count readout is not affected by the Frequency Offset. To facilitate normal function of Marker Count, the SPAN/RBW should be less than 500.

In Zero Span, the Marker Count continues operation and counts the signals close to the Center Frequency of the signal/spectrum analyzer.

- **Key path:** **【Marker Func】** , [Marker Count], [Marker Count ON OFF] on the front panel.
- **Status saved:** saved in the instrument status.
- **Factory preset:** OFF.
- **Remote Command:**

```
:calculate:marker[1|2|3|4|5|6|7|8|9|10|11|12]:fcount[:state] OFF|ON|0|1
```

```
:calculate:marker[1|2|3|4|5|6|7|8|9|10|11|12]:fcount[:state]?
```

- **Examples:**

```
:CALC:MARK1:FCO OFF
```

```
:CALC:MARK1:FCO?
```

[Counter Gate Auto Man]

- **Menu description:** to control the length of time during which the Marker Count measures the signal frequency. Gate time of 500ms or longer allows for less than 0.1Hz count accuracy. However, the longer is the gate time, the slower is the key response.
- **Key path:** **【Marker Func】** , [Marker Count], [Marker Count ON OFF] on the front panel.
- **Status saved:** saved in the instrument status.
- **Factory preset:** 0.5s.

5.2. Description of menu

- **Setting range:** Min.:1.0E-3s, Max.: 8s.
- **Value resolution:** 100 ns.
- **Default unit:** s.
- **Remote Command:**

:calculate:marker[1|2|3|4|5|6|7|8|9|10|11|12]:fcount:gatetime <time>

:calculate:marker[1|2|3|4|5|6|7|8|9|10|11|12]:fcount:gatetime?

:calculate:marker[1|2|3|4|5|6|7|8|9|10|11|12]:fcount:gatetime:AUTO OFF|ON|0|1

:calculate:marker[1|2|3|4|5|6|7|8|9|10|11|12]:fcount:gatetime:AUTO?

- **Examples:**

CALC:MARK:FCO:GAT:AUTO On

CALC:MARK:FCO:GAT 1e-2

[Audio Demulation]

- **Menu description:** to open Audio Demulation menu. Its soft More includes [Dem Type▶], [Dem Mode Inter/Cont], [Dem Time].

[Dem Type▶]

OFF]

- **Menu description:** to open Demodulation Mode menu. You can turn off demodulation or select AM Demodulation or FM Demodulation.
- **Key path:** **【Marker Func】** , [Audio Demulation▶], [OFF], [AM], [FM] on the front panel.
- **Status saved:** saved in the instrument status.
- **Factory preset:** OFF.
- **Remote Command:**

:demod AM|FM|OFF

:demod?

:demod:state OFF|ON|0|1

:demod:state?

- **Examples:**

:DEM AM

:DEM?

:DEM:STAT OFF

:DEM:STAT?

[Dem Mode **Inter** Cont]

- **Menu description:** to select the Demodulation Mode as Inter or Cont.
- **Key path:** **【Marker Func】** , [Audio Demulation▶], [Dem Mode Inter Cont] on the front panel.
- **Status saved:** saved in the instrument status.

5.2. Description of menu

- **Remote Command:**

```
[[:sense]:demod:state:MODE INTER|CONT
```

```
[[:sense]:demod:state:MODE?
```

- **Examples:**

```
:DEM:STAT:MODE INTER
```

```
:DEM:STAT:MODE?
```

[Dem Time 1.0000s]

- **Menu description:** to control the length of time of the Audio Demulation.
- **Key path:** **【Marker Func】** , [Audio Demulation▶], [Dem Time] on the front panel.
- **Status saved:** saved in the instrument status.
- **Factory preset:** 1s.
- **Setting range:** Min.:0.01s, Max.: 100s.
- **Value resolution:** 0.01 s.
- **Default unit:** s.
- **Remote Command:**

```
:demod:TIME <time>
```

```
:demod:TIME?
```

- **Examples:**

```
:DEM:TIME 1s
```

```
:DEM:TIME?
```

[Noise Marker ON **OFF**]

- **Menu description:** when this menu is ON, it activates the noise maker. Read out the noise power that normalizes the noise into 1Hz bandwidth near the active marker. At that time, the detector is under Sample Detector mode. The Noise Marker averages the values of the 32 data points (including 16 at the left side and 15 on and at the right of marker) near the frequency axis or time axis. In measuring the ratio between the signal and noise, place the marker on the signal peak and select the Delta Marker mode. Place the active marker to the noise to be measured with number keys or knob. Then select the [Noise Marker Man]. At that time, the display value unit at the marker display area is dBc/Hz.
- **Key path:** **【Marker Func】** , [Noise Marker ON/OFF] on the front panel.
- **Status saved:** saved in the instrument status.
- **Factory preset:** OFF.
- **Remote Command:**

```
:calculate:marker[1|2|3|4|5|6|7|8|9|10|11|12]:function
```

```
Noise|bpower|bdensity|OFF
```

```
:calculate:marker[1|2|3|4|5|6|7|8|9|10|11|12]:function?
```

- **Examples:**

```
:CALC:MARK1:FUNC NOIS
```

:CALC:MARK:FUNC?

[N dB Points ON OFF]

- **Menu description:** to turn on or off the ndB measurement of bandwidth values descending from signal peak point. You can input the ndB value to be measured from the front panel.
- **Key path:** **【Marker Func】** , [N dB Points 3.00dB ON/OFF] on the front panel.
- **Status saved:** saved in the instrument status.
- **Factory preset:** 3.0.
- **Setting range:** Min.:1.0, Max.: 60.0.
- **Value resolution:** 1.
- **Remote Command:**

:calculate:bwid|bandwidth:NDB <rel_amp>

:calculate:bwid|bandwidth:NDB?

:calculate:bwid|bandwidth[:state] OFF|ON|0|1

:calculate:bwid|bandwidth[:state]?

:calculate:bwid|bandwidth:result?

- **Examples:**

:CALC:BWID:NDB 6dB

:CALC:BWID:NDB?

:CALC:BWID OFF

:CALC:BWID?

:CALC:BWID:RES?

[Band/Interval Power ON OFF]

- **Menu description:** to turn on or off Bandwidth Power. Initialize the Bandwidth Power width as 5% of the total span.
- **Key path:** **【Marker Func】** , [Band/Interval Power ON/OFF] on the front panel.
- **Status saved:** saved in the instrument status.
- **Factory preset:** OFF.
- **Remote Command:**

:calculate:marker[1|2|3|4|5|6|7|8|9|10|11|12]:function bpower

:calculate:marker[1|2|3|4|5|6|7|8|9|10|11|12]:function?

- **Examples:**

:CALC:MARK1:FUNC BPOW

:CALC:MARK1:FUNC?

[Band/Interval Density ON OFF]

5.2. Description of menu

- **Menu description:** to turn on or off Bandwidth Density. Initialize the Bandwidth Density width as 5% of the total span.
- **Key path:** **【Marker Func】** , [Band/Interval Density ON/OFF] on the front panel.
- **Status saved:** saved in the instrument status.
- **Factory preset:** OFF.
- **Remote Command:**

```
:calculate:marker[1|2|3|4|5|6|7|8|9|10|11|12]:function bdensity
```

```
:calculate:marker[1|2|3|4|5|6|7|8|9|10|11|12]:function?
```

- **Examples:**

```
:CALC:MARK1:FUNC BDEN
```

```
:CALC:MARK1:FUNC?
```

5.2.2.16 Peak Search

The **【Peak Search】** key on the front panel. Is used to turn on the peak search for traces by the control instrument and turn on marker for display, including [Next Peak], [Next Pk Right], [Next Pk Left], [Marker Delta], [Mkr->CF], [Mkr->Ref Lvl], [Peak Criteria▶] , [Peak Table▶],[Peak Track ON OFF], [Pk-pk Search], [Min Search].

- **Remote Command:**

```
:calculate:marker[1|2|3|4|5|6|7|8|9|10|11|12]:maximum
```

- **Examples:**

```
:CALC:MARK1:MAX
```

[Next Peak]

- **Menu description:** Taking the Amplitude of the point where the current marker is located, search for the next peak of current test trace.
- **Key path:** **【Peak Search】** , [Next Peak] on the front panel.
- **Status saved:** not saved in instrument status.
- **Remote Command:**

```
:calculate:marker[1|2|3|4|5|6|7|8|9|10|11|12]:maximum:NEXT
```

- **Examples:**

```
:CALC:MARK1:MAX:NEXT
```

[Next Pk Right]

- **Menu description:** to search for the peak to the right of the current test trace marker position.
- **Key path:** **【Peak Search】** , [Next Pk Right] on the front panel.
- **Status saved:** not saved in instrument status.
- **Remote Command:**

```
:calculate:marker[1|2|3|4|5|6|7|8|9|10|11|12]:maximum:right
```

- **Examples:**

5.2. Description of menu

:CALC:MARK1:MAX:RIGH

[Next Pk Left]

- **Menu description:** to search for the peak to the left of the current test trace marker position.
- **Key path:** **【Peak Search】** , [Next Pk Left] on the front panel.
- **Status saved:** not saved in instrument status.
- **Remote Command:**

:calculate:marker[1|2|3|4|5|6|7|8|9|10|11|12]:maximum:LEFT

- **Examples:**

:CALC:MARK1:MAX:LEFT

[Marker Delta]

- **Menu description:** to set the selected marker as the Delta Marker. Display the amplitude difference and frequency difference (or time difference, when span is zero) between two markers at the marker display area at the top right corner of the screen. If there exists a single marker, a [Marker Delta] operation will generate a Ref marker in the active marker position. Move the active marker through the knob, stepping keys or number keys. The display amplitude difference unit is dB.
- **Key path:** **【Peak Search】** , [Marker Delta] on the front panel.
- **Status saved:** not saved in instrument status.
- **Remote Command:**

:calculate:marker[1|2|3|4|5|6|7|8|9|10|11|12]:MODE delta

:calculate:marker[1|2|3|4|5|6|7|8|9|10|11|12]:MODE?

- **Examples:**

:CALC:MARK1:MODE DELT

:CALC:MARK1:MODE?

[Mkr → CF]

- **Menu description:** to set the Center Frequency equal to the Marker Frequency. It can quickly move the signal to the center position of the screen.
- **Key path:** **【Peak Search】** , [Mkr->CF] on the front panel.
- **Remote Command:**

:calculate:marker[1|2|3|4|5|6|7|8|9|10|11|12][:SET]:center

- **Examples:**

:CALC:MARK1:CENT

[Mkr → Ref Lvl]

- **Menu description:** to set the Reference Level equal to the Marker Amplitude. The menu changes the value of reference level.
- **Key path:** **【Peak Search】** , [Mkr->Ref Lvl] on the front panel.

5.2. Description of menu

- **Remote Command:**

```
:calculate:marker[1|2|3|4|5|6|7|8|9|10|11|12][:SET]:rlevel
```

- **Examples:**

```
:CALC:MARK1:RLEV
```

[Peak Criteria▶]

Pop up rules for peak search. The soft More includes [Peak Excursion On/Off], [Peak Threshold On/Off], [Peak Threshold Line On/Off].

[Pk Excursion ON OFF]

- **Menu description:** to define the value (dB) than which the rise or fall edge time is larger required for a peak point identified as signal peak in defining of the peak search.
- **Key path:** **【Peak Search】** , [Peak Criteria▶], [Pk Excursion ON/OFF] on the front panel.
- **Status saved:** saved in the instrument status.
- **Factory preset:** off, with peak defined value of 6 dB.
- **Setting range:** Min.:0dB, Max.: 100dB.
- **Remote Command:**

```
:calculate:marker:PEAK:excursion <rel_ampl>
```

```
:calculate:marker:PEAK:excursion?
```

```
:calculate:marker:PEAK:excursion:state OFF|ON|0|1
```

```
:calculate:marker:PEAK:excursion:state?
```

- **Examples:**

```
:CALC:MARK:PEAK:EXC 10
```

```
:CALC:MARK:PEAK:EXC?
```

```
:CALC:MARK:PEAK:EXC:STAT OFF
```

```
:CALC:MARK:PEAK:EXC:STAT?
```

[Pk Threshold ON OFF]

- **Menu description:** to define the value than which the signal peak value is larger (dBm) required a peak to be identified.
- **Key path:** **【Peak Search】** , [Peak Criteria▶], [Pk Threshold ON/OFF] on the front panel.
- **Status saved:** saved in the instrument status.
- **Factory preset:** default OFF, with all peak values valid.
- **Setting range:** Min.: -200dBm, Max.: Reference Level.
- **Remote Command:**

```
:calculate:marker:PEAK:threshold <ampl>
```

```
:calculate:marker:PEAK:threshold?
```

```
:calculate:marker:PEAK:threshold:state OFF|ON|0|1
```

5.2. Description of menu

:calculate:marker:PEAK:threshold:state?

- **Examples:**

:CALC:MARK:PEAK:THR -100

:CALC:MARK:PEAK:THR?

:CALC:MARK:PEAK:THR:STAT OFF

:CALC:MARK:PEAK:THR:STAT?

[Pk Threshold Line ON **OFF**]

- **Menu description:** to turn on or off Peak Threshold Line.
- **Key path:** **【Peak Search】** , [Peak Criteria▶], [Pk Threshold Line ON/OFF] on the front panel.
- **Status saved:** saved in the instrument status.
- **Factory preset:** off.

[Peak Table▶]

Pop up commands related to peak table, including [Peak Table On/Off], [Peak Sort Frequency/Amplitude], [Peak Readout▶].

[Peak Table ON **OFF**]

- **Menu description:** to turn on or off Peak Table.
- **Key path:** **【Peak Search】** , [Peak Table▶], [Peak Table ON/OFF] on the front panel.
- **Status saved:** saved in the instrument status.
- **Factory preset:** off.
- **Remote Command:**

:calculate:marker:PEAK:table:state OFF|ON|0|1

:calculate:marker:PEAK:table:state?

- **Examples:**

:CALC:MARK:PEAK:TABL:STAT OFF

:CALC:MARK:PEAK:TABL:STAT?

[Peak Sort Freq **Amptd**]

- **Menu description:** to set the peak lists in the Peak Table in order of ascending frequency or descending amplitude.
- **Key path:** **【Peak Search】** , [Peak Table▶], [Peak Sort Freq Amptd] on the front panel.
- **Status saved:** saved in the instrument status.
- **Factory preset:** in descending order of amplitude.
- **Remote Command:**

:calculate:marker:PEAK:SORT frequency|amplitude

5.2. Description of menu

:calculate:marker:PEAK:SORT?

- **Examples:**

:CALC:MARK:PEAK:SORT FREQ

:CALC:MARK:PEAK:SORT?

[Peak Readout▶]

All]

- **Command description:** to show up the peak lists in the Peak Table by Above Display Line or Below Display Line or All.
- **Key path:** **【Peak Search】** , [Peak Table▶], [Peak Readout▶] on the front panel.
- **Status saved:** saved in the instrument status.
- **Factory preset:** default ALL.
- **Remote Command:**

:calculate:marker:PEAK:table:readout ALL|gtddline|ltdline

:calculate:marker:PEAK:table:readout?

- **Examples:**

:CALC:MARK:PEAK:TABL:READ ALL

:CALC:MARK:PEAK:TABL:READ?

[Peak Track ON **OFF**]

- **Menu description:** when Continuous Peak Search is ON, the current marker will perform one Peak Search after each sweep. If the Continuous Peak Search is OFF, no operation is made.
- **Key path:** **【Peak Search】**], [More 1/2▶], [Peak Track ON/OFF] on the front panel.
- **Status saved:** saved in the instrument status.
- **Factory preset:** off.
- **Remote Command:**

:calculate:marker[1|2|3|4|5|6|7|8|9|10|11|12]:cpsearch[:state] ON|OFF|1|0

:calculate:marker[1|2|3|4|5|6|7|8|9|10|11|12]:cpsearch[:state]?

- **Examples:**

:CALC:MARK1:CPS ON

:CALC:MARK1:CPS?

[Pk-Pk Search]

- **Menu description:** to turn on the Peak-to-peak Search.
- **Key path:** **【Peak Search】** , [Pk-pk Search] on the front panel.
- **Remote Command:**

:calculate:marker[1|2|3|4|5|6|7|8|9|10|11|12]:ptpeak

- **Examples:**

:CALC:MARK1:ptpeak

[Min Search]

- **Menu description:** to turn on the Min Search.
- **Key path:** **【Peak Search】** , [Min Search] on the front panel.
- **Remote Command:**

:calculate:marker[1|2|3|4|5|6|7|8|9|10|11|12]:minimum

- **Examples:**

:CALC:MARK1:MIN

5.2.2.17 Single

- **Menu description:** the **【Single】** key on the front panel has no corresponding soft menu. This function is mainly used for manual trigger of a sweep. When the Video Average is ON, this function performs the sweeps at the count specified by the video average count.

In remote control programming and system establishment, this function combined with *WAI can effectively synchronize the sweep process and enable the trace data obtained after the *WAI finishes directly correspond to the sweep process one by one.

- **Remote Command:**

:initiate

- **Examples:**

:INIT

5.2.2.18 Continuous ON

The **【Cont】** key on the front panel has no corresponding soft menu. This function is mainly used for changing the Continuous OFF into Continuous ON; if the current sweep is Continuous ON, the instrument performs no operation.

5.2.3 Channel power

5.2.3.1 Frequency

The **【Frequency】** key on the front panel is used to set parameters related to the signal/spectrum analyzer frequency, including [Center Freq], [CF Step Auto ON/OFF], [Freq Offset]. See the **【Frequency】** menu of the sweep analysis function for more details.

[Center Freq]

See the [Center Freq] under **【Frequency】** of the sweep analysis function for more details.

[CF Step **Auto Man**]

See the [CF Step Auto ON/OFF] under **【Frequency】** of the sweep analysis function for more details.

[Freq Offset]

See the [Freq Offset] under **【Frequency】** of the sweep analysis function for more details.

5.2. Description of menu

5.2.3.2 Ampld/Y Scale

Pop up More related to parameter setting of Ampld/YScale, including [Ref Level], [Attenuation ▶], [PreAmplifier On/Off], [[Scale/Div], [Auto Scale], [More 1/2▶], [Y Axis Unit], [Ref Level Offset].

[RefLevel]

- **Menu description:** to enable the Reference Level function. The reference level can be adjusted with the number keys, step keys or knob. The reference level corresponds to the top of the coordinate top. Measure signal at reference level position to get highest accuracy. The input attenuator of the signal/spectrum analyzer is coupled to the reference level, which can be automatically changed to avoid compression of input signal.
- **Key path:** **【Ampld/YScale】** , [RefLevel] on the front panel.
- **Status saved:** saved in the instrument status.
- **Factory preset:** 0dBm.
- **Setting range:** Min.: -170dBm, Max.: 30dBm.
- **Default unit:** set based on Y Axis scale unit.
- **Remote Command:**

```
:display:chpower:VIEW>window:trace:Y:rlevel <real>
```

```
:display:chpower:VIEW>window:trace:Y:rlevel?
```

- **Examples:**

```
:display:chpower:VIEW>window:trace:Y:rlevel 20dBm
```

[Attenuation▶]

See [Attenuation▶] under **【Ampld/YScale】** of the sweep analysis function for more details.

[PreAmplifier ON **OFF**]

See [PreAmplifier ON/OFF] under **【Ampld/YScale】** of the sweep analysis function for more details.

[Scale/Div]

- **Menu description:** to select the scale/division from 0.1dB/division to 20dB/division. This menu is only valid when the scale type is logarithm.
- **Key path:** **【Ampld/YScale】** , [Scale/Div] on the front panel.
- **Status saved:** saved in the instrument status.
- **Factory preset:** 10.00 dB.
- **Setting range:** Min.: 0.1dB, Max.: 20dBm.
- **Remote Command:**

```
:display:chpower:VIEW>window:trace:Y:pdivision <rel_ampl>
```

```
:display:chpower:VIEW>window:trace:Y:pdivision?
```

5.2. Description of menu

[Auto Scale]

- **Menu description:** the instrument automatically sets parameters like reference level and scale/division based on input signal sizes. When this soft menu key is pressed, the instrument performs one auto scaling. Setting rule for auto scaling: firstly obtain the maximum value and the minimum value based on current measurement trace data. Based on the maximum value, place on the 80% graticule of the screen trace Y axis for auto setting of reference level and scale/division.
- **Key path:** **【Ampld/YScale】** , [Auto Scale] on the front panel.
- **Status saved:** not saved in instrument status.
- **Remote Command:**

```
:chpower:adjust:level
```

[Y Axis Unit ▶]

- **More description:** to select the Y Axis unit from [dBm], [dBmv], [dBma], [W], [V], [A], [dBμV] and [dBμA]. The instrument will automatically calculate the trace data and marker readout based on the Y axis unit.
- **Key path:** **【Ampld/YScale】** , [More 1/2▶], [Y Axis Unit ▶] on the front panel.
- **Status saved:** saved in the instrument status.
- **Factory preset:** dBm.

```
:UNIT:chpower:power DBM|DBMV|DBMA|V|W|A|DBUV|DBUA
```

```
:UNIT:chpower:power?
```

[Ref Level Offset]

- **Menu description:** to introduce offset for all amplitude readout (e.g, reference level and marker amplitude). It will not change the trace position on the screen. This offset unit is dB and is not affected by the scale and unit. Use number keys, stepping keys or knob to input the offset value.
- **Key path:** **【Ampld/YScale】** , [More 1/2▶],[Ref Level Offset] on the front panel.
- **Status saved:** saved in the instrument status.
- **Factory preset:** 0 dB.
- **Setting range:** Min.: -1000dB, Max.:1000dB.
- **Remote Command:**

```
:display:chpower:window:trace:Y:rlevel:offset <rel_amp>
```

```
:display:chpower:window:trace:Y:rlevel:offset?
```

- **Examples:**

```
:display:chpower:window:trace:Y:rlevel:offset 12
```

5.2.3.3 Span/XScale

Press the **【Span/XScale】** on the front panel to enable the span function and set the signal/spectrum analyzer into center frequency/span mode. Press the **【Span】** key to pop up [Span], [Full Span] and [Last Span].

[BW]

5.2. Description of menu

- **Menu description:** the span can be set by number keys, stepping keys or knob. Use number keys or select [Zero Span] to set the span as zero.
- **Key path:** **【Span/X Scale】** , [Span] on the front panel.
- **Status saved:** saved in the instrument status.
- **Factory preset:** maximum frequency limit - start frequency.
- **Setting range:** Min.: 10Hz, Max.: related to the maximum working frequency limit of the instrument.
- **Remote Command:**

```
:chpower:frequency:SPAN <freq>
```

```
:chpower:frequency:SPAN?
```

- **Examples:**

```
:chpower:frequency:SPAN10 MHz
```

[Full Span]

- **Menu description:** to set the signal/spectrum analyzer into the center frequency/span mode. Set the span as maximum value.
- **Remote Command:**

```
:chpower:frequency:SPAN:FULL
```

[Last Span]

- **Menu description:** to set the signal/spectrum analyzer back to the previous span.
- **Remote Command:**

```
:chpower:frequency:SPAN:previous
```

5.2.3.4 Bandwidth

Pop up the soft More for setting Res BW and Video BW, including [Res BW Auto Man], [Video BW Auto Man] and [Filter Type].

[Res BW **Auto** Man]

- **Menu description:** to change the resolution bandwidth of spectrum analysis, ranging from 1Hz to 20 MHz, which is stepped by 1, 2, 3, 5 and 10. The resolution bandwidth can be changed with the number keys, step keys and knob. The shaded character indicates the currently selected mode.
- **Key path:** **【BW】** , [Res BW Auto Man] on the front panel.
- **Status saved:** saved in the instrument status.
- **Factory preset:** Auto.
- **Setting range:** Min.: 1Hz, Max.: 20 MHz.
- **Default unit:** Hz.
- **Remote Command:**

```
:chpower:bandwidth <bandwidth>
```

```
:chpower:bandwidth?
```

5.2. Description of menu

```
:chpower:bandwidth:AUTO ON|OFF|1|0
```

```
:chpower:bandwidth:AUTO?
```

- **Examples:**

```
:chpower:bandwidth 1kHz
```

```
:chpower:bandwidth:AUTO ON On
```

[Video BW **Auto** Man]

- **Menu description:** to change the video bandwidth within the active function area, ranging from 1Hz to 20 MHz, which is stepped by 1, 2, 3, 5 and 10. The resolution bandwidth can be changed with the number keys, step keys and knob. The shaded character indicates the currently selected mode. When set as Auto Off, press [Video BW Auto Man] to select Auto On and return to auto mode.
- **Key path:** **[BW]** , [Video BW Auto Man] on the front panel.
- **Status saved:** saved in the instrument status.
- **Factory preset:** Auto, same as the Resolution Bandwidth setting.
- **Setting range:** Min.: 1Hz, Max.: 20 MHz.
- **Default unit:** Hz
- **Remote Command:**

```
:chpower:bandwidth:video <bandwidth>
```

```
:chpower:bandwidth:video?
```

```
:chpower:bandwidth:video:AUTO ON|OFF|1|0
```

```
:chpower:bandwidth:video:AUTO?
```

- **Examples:**

```
:chpower:bandwidth:video 1 kHz
```

```
:chpower:bandwidth:video:AUTO ON
```

[Filter Type▶]

- **More description:** comprising [Gaussian] and [Flattop]. In general, the signal/spectrum uses Gaussian filter, i.e., use filter approximate to the Gaussian shape to complete filtering of Res BW. If the flat top filter is used, the signal/spectrum analyzer adopts filter approximate to the rectangular shape to complete filtering of resolution bandwidth. The response time of flat top filter is about 3 times of that of the Gaussian filter. The sweep speed of the flat top filter is smaller than that of the Gaussian filter. The flat top filter has better selectivity than the Gaussian filter and therefore is more capable of distinguishing two signals with unequal amplitude.
- **Key path:** **[BW]** , [Filter Type▶] on the front panel.
- **Status saved:** saved in the instrument status.
- **Factory preset:** Gaussian.
- **Remote Command:**

```
:chpower:bandwidth:shape gaussian|flattop
```

```
:chpower:bandwidth:shape?
```

5.2.3.5 Auto Setting

5.2. Description of menu

Pop up the soft menu related to auto setting Which includes [Couple All], [Mech Atten Auto Man], [Res BW Auto Man], [Video BW Auto Man], [Sweep Time Auto Man] and [CF Step Auto Man].

[Couple All]

- **Menu description:** to set the resolution bandwidth, video bandwidth, sweep time, mechanical attenuator and frequency step as auto coupling mode. The signal/spectrum analyzer will select most suitable values for those functions based on set frequency and bandwidth (or start frequency and stop frequency). If no ratio is pre-saved, use default ratio.
- **Key path:** **【Auto Set】** , [Couple All] on the front panel.
- **Status saved:** not saved in instrument status.
- **Factory preset:** Couple All.
- **Remote Command:**
:couple ALL
- **Examples:**
:COUP ALL

[Mech Atten **Auto** Man]

See [Attenuation▶] under **【Ampld/YScale】** for more details.

[Res BW **Auto** Man]

See [Res BW Auto ON/OFF] under **【BW】** for more details.

[Video BW **Auto** Man]

See [Video BW Auto ON/OFF] under **【BW】** for more details.

[Sweep Time **Auto** Man]

See [Sweep Time Auto ON/OFF] under **【Sweep】** for more details.

[CF Step **Auto** Man]

See [CF Step Auto ON/OFF] under **【Frequency】** for more details.

5.2.3.6 Trace

Press **【Trace】** key on the front panel to pop up corresponding soft menu Including [Clear Write], [Trace Average], [Max Hold], [Min Hold], [View/Blank ▶] [More 1/2▶] and [Detector▶].

[Clear Write]

- **Command description:** to set the current trace processing as Refresh, i.e., clear all data of displayed trace and continue the signal trace receipt under sweep status.
- **Key path:** **【Trace】** , [Clear Write] on the front panel.
- **Status saved:** saved in the instrument status.

5.2. Description of menu

- **Factory preset:** after all traces are selected, the trace mode is defaulted as Refresh.
- **Remote Command:**

```
:trace:chpower:TYPE write|average|maxhold|minhold
```

```
:trace:chpower:TYPE?
```

[Trace Average]

- **Command description:** to set the current trace processing method as Average, i.e., based on the average count N set in the **【 Meas Setup 】** , update trace after averaging the performance index of the measurement trace.
- **Key path:** **【 Trace 】** , [Trace Average] on the front panel.
- **Status saved:** saved in the instrument status.
- **Factory preset:** all trace modes are defaulted as Refresh.
- **Remote Command:**

```
:trace:chpower:TYPE average
```

```
:trace:chpower:TYPE?
```

[Max Hold]

- **Menu description:** to set the current trace processing method as maximum hold, i.e., the new trace data will be assigned with maximum value of previous measured trace data.
- **Key path:** **【 Trace 】** , [Max Hold] on the front panel.
- **Status saved:** saved in the instrument status.
- **Factory preset:** all trace modes are defaulted as Refresh.
- **Remote Command:**

```
:trace:chpower:TYPE maxhold
```

```
:trace:chpower:TYPE?
```

[Min Hold]

- **Menu description:** to set the current trace processing method as minimum hold, i.e., the new trace data will be assigned with minimum value of previous measured trace data.
- **Key path:** **【 Trace 】** , [Min Hold] on the front panel.
- **Status saved:** saved in the instrument status.
- **Factory preset:** all trace modes are defaulted as Refresh.
- **Remote Command:**

```
:trace:chpower:TYPE minhold
```

```
:trace:chpower:TYPE?
```

[View/Blank▶**Trace On]**

5.2. Description of menu

- **More description:** to set the display method for the selected trace from [Trace On], [View], [Background] and [Blank].
- **Key path:** **【Trace】** , [View/Blank▶] on the front panel.
- **Status saved:** saved in the instrument status.
- **Factory preset:** all trace display modes are defaulted as Refresh.

- **Remote Command:**

```
:trace:chpower:display[:state] ON|OFF|0|1
```

```
:trace:chpower:display[:state]?
```

```
:trace:chpower:update[:state] ON|OFF|0|1
```

```
:trace:chpower:update[:state]?
```

[Detector ▶]

Pop up soft More related to setting the detector type for the currently selected trace, including [Auto], [Normal], [Peak], [Sample], [Negative Peak], [Average▶], where, the average detector type includes Log-Pwr Avg, Log-Pwr Avg and Voltage Avg.

[Auto]

- **Menu description:** to set the detector command for the currently selected trace as Auto. That means, the signal/spectrum analyzer will perform based on the parameter setting of currently selected trace.
- **Key path:** **【Trace】** , [More 1/2▶], [Detector ▶], [Auto] on the front panel
- **Status saved:** saved in the instrument status.
- **Factory preset:** the trace detector type is Power Average.
- **Remote Command:**

```
:chpower:detector:AUTO ON|OFF|1|0
```

```
:chpower:detector:AUTO?
```

[Normal]

- **Menu description:** to set the detector command for the currently selected trace as Normal. I.e., display the measurement results of positive peak and negative peak at the same time to achieve display effect similar to the analog instrument.
- **Key path:** **【Trace】** , [More 1/2▶], [Detector ▶], [Normal] on the front panel.
- **Status saved:** saved in the instrument status.
- **Remote Command:**

```
:chpower:detector normal
```

```
:chpower:detector?
```

[Peak]

- **Menu description:** to set the detector command for the currently selected trace as Positive Peak. I.e., take the maximum value from sampling data assigned to each trace point.

5.2. Description of menu

- **Key path:** **【Trace】** , [More 1/2▶], [Detector▶], [Peak] on the front panel.
- **Status saved:** saved in the instrument status.
- **Remote Command:**

:chpower:detector positive

:chpower:detector?

[Sample]

- **Menu description:** to set the detector command for the currently selected trace as Sample. I.e., take the last value from sampling data assigned to each trace point.
- **Key path:** **【Trace】** , [More 1/2▶], [Detector▶], [Sample] on the front panel.
- **Status saved:** saved in the instrument status.
- **Remote Command:**

:chpower:detector sample

:chpower:detector?

[Negative Peak]

- **Menu description:** to set the detector command for the currently selected trace as Negative Peak. I.e., take the minimum value from sampling data assigned to each trace point.
- **Key path:** **【Trace】** , [More 1/2▶], [Detector▶], [Negative Peak] on the front panel.
- **Status saved:** saved in the instrument status.
- **Remote Command:**

:chpower:detector negative

:chpower:detector?

[Average ▶**Log-Pwr Avg]**

- **Menu description:** to set the detector command for the currently selected trace as Video Average. Also called Logarithm Power Average Detector, i.e., take the logarithm power average value for all data assigned to each trace point; earlier signal/spectrum analyzer generally displays the measurement trace of logarithm scale, and all filtering and averaging are based on the logarithm power data; the trace is generally called as video signal. After digital IF processing is adopted, to make measurement results same as the earlier signal/spectrum analyzer, the video average detector function is added.
- **Key path:** **【Trace】** , [More 1/2▶], [Detector▶], [Average▶], [Log-Pwr Avg] on the front panel.
- **Status saved:** saved in the instrument status.
- **Remote Command:**

[:sense]:chpower:detector[:function] LOG [:sense]:chpower:detector[:function]?

[Average ▶**Pwr Avg]**

5.2. Description of menu

- **Menu description:** to set the detector command for the currently selected trace as Power Average. Also called root mean square (RMS) detector. Calculate the root mean square of all sampling data assigned to each trace point; the 4051 signal/spectrum analyzer envelopes the detector for the RF input signal and obtains linear voltage. After square these voltage values, take sum and divide the count of sampling data points corresponding to each trace point. Finally, take square root. When the scale is logarithm, take 20 times of logarithm transformation for these RMS values (with 10 as base) and obtain the trace data. When the scale type is linear, those RMS values are trace data.
- **Key path:** **【Trace】** , [More 1/2▶], [Detector▶], [Trace Average▶], [Pwr Avg] on the front panel.
- **Status saved:** saved in the instrument status.
- **Remote Command:**

[[:sense]:chpower:detector[:function] average or

[[:sense]:chpower:detector[:function] RMS [:sense]:chpower:detector[:function]?

[Average ▶

Voltage Avg]

- **Menu description:** to set the detector command for the currently selected trace as Voltage Average. Also called average (AVG) detector. Take linear average for all sampling data assigned to each trace point; the 4051 signal/spectrum analyzer envelopes the detector for the RF input signal and obtains linear voltage. After summing those voltage values, divide the number of sampling data points corresponding to each trace point. When the scale is logarithm, take 20 times of logarithm transformation for these RMS values (with 10 as base) and obtain the trace data. When the scale type is linear, those average values are trace data.
- **Key path:** **【Trace】** , [Menu 1/2▶], [Detector▶], [Trace Average▶], [Voltage Avg] on the front panel.
- **Status saved:** saved in the instrument status.
- **Remote Command:**
- **Remote Command:**

[[:sense]:chpower:detector[:function] scalar

[[:sense]:chpower:detector[:function]?

5.2.3.7 Sweep

Enable sweep-related parameter setup function to pop up corresponding soft More, including [Sweep Time Auto Man], [Sweep Setup▶] and [Sweep Points].

[Sweep Time **Auto Man**]

- **Menu description:** to change the sweep time of signal/spectrum analyzer. Use the number keys, step keys or knob to adjust the sweep time. When it is under Auto OFF mode (shaded), it indicates that sweep time can be set manually. When it is under Auto ON status, the sweep time will be automatically coupled based on resolution bandwidth, span and video bandwidth
- **Key path:** **【Sweep】** , [Sweep Time Auto Man] on the front panel.
- **Status saved:** saved in the instrument status.
- **Factory preset:** sweep time Auto.
- **Setting range:** Min.: 1ms, Max.: 6000s.
- **Default unit:** s.

- **Remote Command:**

:chpower:sweep:TIME <time>

:chpower:sweep:TIME?

:chpower:sweep:TIME:AUTO OFF|ON|0|1

:chpower:sweep:TIME:AUTO?

- **Examples:**

:chpower:sweep:TIME 500 ms

:chpower:sweep:TIME:AUTO OFF

[Sweep Setup▶]

Pop up the soft More related to Sweep type, including [Sweep Type Auto Man], [Sweep Type Rules Auto Man] and [FFT Width Auto Man].

[Sweep Type **Auto** Man]

- **Menu description:** to set sweep type. To determine whether Swept or FFT is adopted for frequency spectrum measurement. Also set the FFT step bandwidth for FFT sweep The soft More include [Auto], [Swept] and [FFT]. When under Auto ON mode, the signal/spectrum analyzer will automatically select the sweep type based on sweep type rules.
- **Key path:** **[Sweep]** , [Sweep Setup ▶], [Sweep Type Auto Man] on the front panel.
- **Status saved:** saved in the instrument status.
- **Factory preset:** sweep type: Auto.
- **Remote Command:**

:chpower:sweep:TYPE FFT|sweep

:chpower:sweep:TYPE?

:chpower:sweep:TYPE:AUTO OFF|ON|0|1

:chpower:sweep:TYPE:AUTO?

[Swp Type Rules **Auto** Man]

- **Menu description:** to set rules for auto sweep type. While the sweep type rules include “Best Dynamic Range” and “ Best Speed”.
 “Best Dynamic Range” rules: when RBW is or larger than 1kHz, the sweep type is Swept; when RBW is less than 1kHz, the sweep type is FFT.
 “Best Speed” rules: when RBW is or larger than 30kHz, the sweep type is Swept; when RBW is less than 30kHz, the sweep type is FFT.
- **Key path:** **[Sweep]** , [Sweep Setup ▶], [Sweep Type Rules Auto Man] on the front panel.
- **Status saved:** saved in the instrument status.
- **Factory preset:** the sweep type rules are automatically set as “Best Dynamic Range”.
- **Remote Command:**

:chpower:sweep:TYPE:AUTO:rules speed|drange

5.2. Description of menu

:chpower:sweep:TYPE:AUTO:rules?

:chpower:sweep:TYPE:AUTO:rules:AUTO OFF|ON|0|1

:chpower:sweep:TYPE:AUTO:rules:AUTO?

[FFT Width **Auto** Man]

- **Menu description:** to set FFT Width. The FFT width includes [Auto], [<100kHz], [<3 MHz], [<13 MHz], [<=Max.]. FFT width is only active when the FFT sweep type is selected. Under Auto type, when the signal/spectrum analyzer performs FFT spectrum measurement, the maximum resolution bandwidth is 30kHz. To guarantee best dynamic measurement range, the signal/spectrum analyzer automatically optimizes the FFT width within 100kHz. The larger is the FFT width, the faster is FFT spectrum measurement, but the dynamic range performance will be affected.

Under FFT sweep, the FFT width setup limits the maximum value for center frequency step of each tune. For example, if [<100Hz] is selected, the maximum value for center freq step of each tune is 100Hz. As the FFT width gets larger, the count of instrument center frequencies get smaller when performing measurement of same frequency scope, and the response measurement gets faster. Therefore, to improve measurement speed, you can manually change the FFT width.

- **Key path:** **【Sweep】** , [Sweep Setup▶], [FFT Width▶] on the front panel.
- **Status saved:** saved in the instrument status.
- **Factory preset:** FFT Width is set as Auto.
- **Remote Command:**

:chpower:sweep:FFT:width <real>

:chpower:sweep:FFT:width?

:chpower:sweep:FFT:width:AUTO OFF|ON|0|1

:chpower:sweep:FFT:width:AUTO?

[Sweep points]

- **Menu description:** to set the trace points.
- **Key path:** **【Sweep】** , [Sweep Points] on the front panel.
- **Status saved:** saved in the instrument status.
- Factory preset: 1001.
- Setting range: 101-30001.
- **Remote Command:**

:chpower:sweep:points <integer>

:chpower:sweep:points?

5.2.3.8 Single

- **Menu description:** the **【Single】** key on the front panel has no corresponding soft menu. This function is mainly used for manual trigger of a sweep. When the Average is ON, this function performs the sweeps at the count specified by the Average Count.

In remote control programming and system establishment, this function combined with *WAI can effectively synchronize the sweep process and enable the trace data obtained after the *WAI finishes directly correspond to the sweep process one by one.

- **Remote Command:**

:initiate:chpower

5.2.3.9 Continuous

The **【Cont】** key on the front panel has no corresponding soft menu. This function is mainly used for changing the Continuous OFF into Continuous ON; if the current sweep is Continuous ON, the instrument performs no operation.

- **Remote Command:**

:initiate:continuous ON

5.2.3.10 Trigger

See **【Trig】** menu of the sweep analysis function for more details.

5.2.3.11 Display

Pop up soft More related to display, including [Display Line On Off], [Bar Graph On Off], [Display Config ▶].

[Display Line ON OFF]

See [Display Line On/off] under **【Display】** of the sweep analysis function for more details.

[Display Config▶]

It is used for configurations of interface language, status area display ON OFF related to interface display, The soft More include [Input/Output], [Graticule On Off], Status Area Display On Off], [Freq Info Disp On Off]. See [Display Config▶] under **【Display】** of the sweep analysis function for more details.

[Bar Graph ON OFF]

- **Menu description:** to turn on or off Bar Graph Display.
- **Key path:** **【Display】** on the front panel.
- **Status saved:** saved in the instrument status.
- **Factory preset:** ON.
- **Remote Command:**

:display:chpower:VIEW>window:bgraph ON|OFF|1|0

:display:chpower:VIEW>window:bgraph?

5.2.3.12 Input Output

See the **【Input/Output】** menu of the sweep analysis function for more details.

5.2.3.13 Marker

Pop up the soft More related to markers, including [Select Marker▶], [Normal], [Marker Delta], [Fixed], [Off], [Properties▶], [Marker Couple On Off], and [All Markers Off].

[Select Marker▶]

5.2. Description of menu

Marker 1]

- **Command description:** to select among 12 different markers of the analyzer. When a certain marker is selected, the marker will be indicated in the menu where its type and attribute can be set. Select and trigger another marker and place it at the center of the current trace. Users can read amplitude and frequency information (when the frequency span is 0 Hz, time information will be displayed) at the marker display area at the top right corner of the screen.
- **Key path:** **【Marker】** , [Select Marker▶] on the front panel.
- **Status saved:** saved in the instrument status.
- **Factory preset:** Marker 1.

[Normal]

- **Menu description:** to set the selected marker as the Normal Marker.
- **Key path:** **【Marker】** , [Normal] on the front panel.
- **Status saved:** saved in the instrument status.
- **Remote Command:**

```
:calculate:chpower:marker[1|2|3|4|5|6|7|8|9|10|11|12]:MODE position
```

```
:calculate:chpower:marker[1|2|3|4|5|6|7|8|9|10|11|12]:MODE?
```

[Marker Delta]

- **Menu description:** to set the selected marker as the Delta Marker. Display the amplitude difference and frequency difference (or time difference, when span is zero) between two markers at the marker display area at the top right corner of the screen. If there exists a single marker, a [Marker Delta] operation will generate a Ref marker in the active marker position. Move the active marker through the knob, stepping keys or number keys. The display amplitude difference unit is dB.
- **Key path:** **【Marker】** , [Marker Delta] on the front panel.
- **Status saved:** saved in the instrument status.
- **Remote Command:**

```
:calculate:chpower:marker[1|2|3|4|5|6|7|8|9|10|11|12]:MODE delta
```

```
:calculate:chpower:marker[1|2|3|4|5|6|7|8|9|10|11|12]:MODE?
```

[Fixed]

- **Menu description:** to set the selected marker as the Fixed Marker. The X Axis and Y Axis positions of the fixed marker are fixed. The Fixed Marker can be used as reference marker.
- **Key path:** **【Marker】** , [Fixed] on the front panel.
- **Status saved:** saved in the instrument status.
- **Remote Command:**

```
:calculate:chpower:marker[1|2|3|4|5|6|7|8|9|10|11|12]:MODE fixed
```

```
:calculate:chpower:marker[1|2|3|4|5|6|7|8|9|10|11|12]:MODE?
```

[Off]

5.2. Description of menu

- **Menu description:** to turn off the selected marker.
- **Key path:** **【Marker】** , [Off] on the front panel.
- **Status saved:** saved in the instrument status.
- **Remote Command:**

```
:calculate:chpower:marker[1|2|3|4|5|6|7|8|9|10|11|12]:MODE OFF
```

```
:calculate:chpower:marker[1|2|3|4|5|6|7|8|9|10|11|12]:MODE?
```

[Properties▶]

Pop up the corresponding More of currently selected marker attribute setup, including [Select Marker ▶], [Reference Marker▶], [Marker Display Line On/Off].

[Ref Marker▶]

- **Menu description:** to select reference marker for current marker. It can be any one from 11 markers except the currently selected marker.
- **Key path:** **【Marker】** , [Properties▶], [Ref Marker▶] on the front panel.
- **Status saved:** saved in the instrument status.
- **Remote Command:**

```
:calculate:chpower:marker[1|2|3|4|5|6|7|8|9|10|11|12]:reference <integer>
```

```
:calculate:chpower:marker[1|2|3|4|5|6|7|8|9|10|11|12]:reference?
```

[Marker Display Line ON OFF]

- **Menu description:** to set whether the current marker is displayed as a line on the screen, which is easy to observe.
- **Key path:** **【Marker】** , [Properties▶] and [Marker Display Line On/Off] on the front panel.
- **Status saved:** saved in the instrument status.
- **Factory preset:** OFF.
- **Remote Command:**

```
:calculate: chpower:marker[1|2|3|4|5|6|7|8|9|10|11|12]:lines[:state] OFF|ON|0|1
```

```
:calculate: chpower:marker[1|2|3|4|5|6|7|8|9|10|11|12]:lines[:state]?
```

[Couple Markers ON OFF]

- **Menu description:** to turn on or off Marker Couple. When it is ON, moving any marker horizontal axis position will cause an equal movement of horizontal axis position of every other marker which is ON. When the marker is moved to less than Start Frequency or larger than Stop Frequency, the marker is limited to the value of the Start Frequency or the Stop Frequency; when the span is zero, the minimum value is limited as 0, and the maximum value is limited as the Sweep Time.
- **Key path:** **【Marker】** , [More 1/2▶], [Couple Markers On/Off] on the front panel.
- **Status saved:** saved in the instrument status.
- **Factory preset:** OFF.

5.2. Description of menu

- **Remote Command:**

```
:calculate:chpower:marker:couple[:state] ON|OFF|1|0
```

```
:calculate:chpower:marker:couple[:state]?
```

[All Markers OFF]

- **More description:** to turn off all current markers which are On and related soft keys, e.g. [Noise Marker].

- **Key path:** **【Marker】** , [More 1/2▶], [All Markers OFF] on the front panel.

- **Status saved:** not saved in instrument status.

- **Remote Command:**

```
:calculate:chpower:marker:AOFF
```

5.2.3.14 Maker->

This key has no soft menu.

5.2.3.15 Marker Function

This key has no soft menu.

5.2.3.16 Peak

The **【Peak Search】** key on the front panel is used for turning on the peak search for traces by the control instrument and turning on marker for display, including [Next Peak], [Next Pk Right], [Next Pk Left].

- **Remote Command:**

```
:calculate:chpower:marker[1|2|3|4|5|6|7|8|9|10|11|12]:maximum
```

[Next Peak]

- **Menu description:** Taking the Amplitude of the point where the current marker is located, search for the next peak of current test trace.

- **Key path:** **【Peak Search】** , [Next Peak] on the front panel.

- **Status saved:** not saved in instrument status.

- **Remote Command:**

```
:calculate:chpower:marker[1|2|3|4|5|6|7|8|9|10|11|12]:maximum:NEXT
```

[Next Pk Right]

- **Menu description:** to search for the peak to the right of the current test trace marker position.

- **Key path:** **【Peak Search】** , [Next Pk Right] on the front panel.

- **Status saved:** not saved in instrument status.

- **Remote Command:**

```
:calculate:chpower:marker[1|2|3|4|5|6|7|8|9|10|11|12]:maximum:right
```

[Next Pk Left]

- **Menu description:** to search for the peak to the left of the current test trace marker position.

5.2. Description of menu

- **Key path:** **【Peak Search】** , [Next Pk Left] on the front panel.
- **Status saved:** not saved in instrument status.
- **Remote Command:**

```
:calculate:chpower:marker[1|2|3|4|5|6|7|8|9|10|11|12]:maximum:LEFT
```

5.2.3.17 Measurement Setting

Pop up the soft menu related to measurement setting, including [Average Num On Off], [Average Mode Exponential Repeat], [Integration BW], [RRC Filter On Off], [Filter Bandwidth], [Filter Factor a], [PhNoise Opt], [Low Noise Path On Off], [Preselector Preselecting Bypass], [RF Gain>>], [ADC Dither Auto Man] and [Meas Reset].

[Average Num ON OFF]

- **Menu description:** to turn on or off Average. When Average Count is ON, the user can specify the average count required for measurement. The Average Count can be adjusted by number keys, stepping keys or knob.
- **Key path:** **【Meas Setup】** , [Average Num ON OFF] on the front panel.
- **Status saved:** saved in the instrument status.
- **Factory preset:** 100/OFF
- **Setting range:** 1~10000
- **Default unit:** none
- **Remote Command:**

```
[sense]:chpower:average:count <integer>
```

```
[sense]:chpower?average:count?
```

```
[sense]:chpower:average[:state] ON|OFF|1|0
```

```
[sense]:chpower:average[:state]?
```

[Average Mode Exponential Repeat]

- **Menu description:** when Average Count is ON, the user can select Average State required for measurement.

Exponential - Different from Linear Average, in Exponential State, the weight of new data is larger than that of old data. This is good for tracking data change in terms of time. In this case, the selected averaging count determines the weight of the old data on the new data. As the average count increases, the weight of new data gradually decreases. This is good for tracking data change in terms of time. In this case, the selected averaging count determines the weight of the old data on the new data. As the average count increases, the weight of new data gradually decreases.

Repeat - Similarly, it takes exponential averaging. However, when the average count is met, clear all previous results, restart average till the set average count and repeat this process.

- **Key path:** **【Meas Setup】** , [Average Mode Exponential Repeat] on the front panel.
- **Status saved:** saved in the instrument status.
- **Factory preset:** Exponential.
- **Remote Command:**

```
[sense]:chpower:average:tcontrol exponential|repeat
```

5.2. Description of menu

[[:sense]:chpower:average:tcontrol?

[Integration BW]

- **Menu description:** to designate the bandwidth integration range for calculating power within the channel. The integration bandwidth is displayed in the trace window and indicated with a pair of vertical lines connected with arrows. It ensures that the set instrument span is not less than the integral bandwidth. Such commands may be adjusted via number keys, stepping keys or the knob.
- **Key path:** **【Meas Setup】** , [Integration BW] on the front panel.
- **Status saved:** saved in the instrument status.
- **Factory preset:** 2.0 MHz
- **Setting range:** 100Hz - 1.0GHz.
- **Default unit:** Hz.
- **Remote Command:**

[[:sense]:chpower:bandwidth:integration <bandwidth>

[[:sense]:chpower:bandwidth:integration?

[RRC Filter ON **OFF**]

- **Menu description:** to turn on or off RRC Filter. When RRC Filter is ON, the influence factor of RRC Filter will be considered in calculating the measurement result.
- **Key path:** **【Meas Setup】** , [More 1/3▶] , [RRC Filter Man] on the front panel.
- **Status saved:** saved in the instrument status.
- **Factory preset:** OFF.
- **Remote Command:**

[[:sense]:chpower:filter[:RRC][:state] OFF|ON|0|1

[[:sense]:chpower:filter[:RRC][:state]?

[Filter BW]

- **Menu description:** to set bandwidth value for the RRC Filter. When RRC Filter is ON, the influence factor of RRC Filter will be considered in calculating the measurement result. Use number keys, stepping keys or knob to adjust occupied power percentage.
- **Key path:** **【Meas Setup】** , [More 1/3▶] , [Filter BW] on the front panel.
- **Status saved:** saved in the instrument status.
- **Factory preset:** 3.84 MHz
- **Setting range:** 100Hz - 100 MHz.
- **Default unit:** Hz.
- **Remote Command:**

[[:sense]:chpower:filter[:RRC]:bandwidth <real>

[[:sense]:chpower:filter[:RRC]:bandwidth?

5.2. Description of menu

[Filter Factor a]

- **Menu description:** to turn on or off RRC Filter. When RRC Filter is ON, the influence factor of RRC Filter will be considered in calculating the measurement result. Use number keys, stepping keys or knob to change the Filter Factor a.
- **Key path:** **【Meas Setup】** , [More 1/3▶] , [Filter Factor a] on the front panel.
- **Status saved:** saved in the instrument status.
- **Factory preset:** 0.22
- **Setting range:** 0.01~1.0
- **Default unit:** none
- **Remote Command:**

```
[sense]:chpower:filter[:RRC]:alpha <real>
```

```
[sense]:chpower:filter[:RRC]:alpha?
```

[Low Noise Path ON OFF]

- **Menu description:** this menu is only available when the H34 option (Low Noise PreAmplifier) is purchased. When the PreAmplifier is ON, the Low Noise Path is OFF and this menu is grayed out; when the PreAmplifier is OFF, this menu lights on and is switchable.
- **Key path:** **【Meas Setup】** , [More 1/3▶], [More 2/3▶], [Low Noise Path ON/OFF] on the front panel.
- **Status saved:** saved in the instrument status.
- **Remote Command:**

```
:chpower:power:MW:PATH STD|Inpath
```

```
:chpower:power:MW:PATH?
```

[Preselector Preselecting Bypass]

- **Menu description:** this menu is only available when the H36 option is purchased. It is used for setting whether to bypass the front-end preselector of the signal/spectrum analyzer. In analyzing bandwidth signal, bypass is usually required.
- **Key path:** **【Meas Setup】** , [More 1/3▶], [More 2/3▶], [Preselector Bypass Preselect] on the front panel.
- **Status saved:** saved in the instrument status.
- **Remote Command:**

```
:input:chpower:filter:YIG OFF|ON|0|1
```

```
:input:chpower:filter:YIG?
```

[RF Gain▶]

- **More description:** to set the Auto ON/OFF of the RF Gain and best allocation algorithm for RF Gain. The soft More includes [Auto], [Best for Dynamic Range] and [Best for Sensitivity].
- **Key path:** **【Meas Setup】** , [More 1/3▶], [More 2/3▶], [RF Gain] on the front panel.
- **Status saved:** saved in the instrument status.
- **Remote Command:**

5.2. Description of menu

```
:chpower:RF:GAIN:AUTO OFF|ON|0|1
```

```
:chpower:RF:GAIN:AUTO?
```

```
:chpower:RF:GAIN:AUTO:rules RANGE|SENSITIVITY
```

```
:chpower:RF:GAIN:AUTO:rules?
```

[Auto]

- **Menu description:** to set the RF Gain distribution algorithm to Auto. In this case, the RF Gain distribution is “Best Dynamic Range”.
- **Key path:** **【Meas Setup】** , [More 1/3▶], [More 2/3▶], [RF Gain], [Auto] on the front panel.
- **Status saved:** saved in the instrument status.

[Best for Dynamic Range]

- **Menu description:** to set the RF Gain distribution algorithm to Best Dynamic Range. In this case, the RF Gain is switched to “Auto OFF”
- **Key path:** **【Meas Setup】** , [More 1/3▶], [More 2/3▶], [RF Gain▶], [Best for Dynamic Range] on the front panel.
- **Status saved:** saved in the instrument status.

[Best for Sensitivity]

- **Menu description:** to set the RF Gain distribution algorithm to Best Sensitivity. In this case, the RF Gain is switched to “Auto OFF”
- **Key path:** **【Meas Setup】** , [More 1/3▶], [More 2/3▶], [RF Gain▶], [Best for Sensitivity] on the front panel.
- **Status saved:** saved in the instrument status.

[ADC Dither **Auto Man**]

- **Menu description:** to control opening/closing of ADC dither of the frequency acquisition circuit in the analyzer. Under default mode, the signal/spectrum analyzer will automatically control whether the ADC Dither is ON based on current working condition. When the ADC Dither is under Auto mode, the ON or OFF status depends on the span, resolution bandwidth and sweep type (continuous swept or step sweep); when it is continuous swept, the ADC Dither status will force to switch to Auto and turns off; when it is step sweep, under Auto mode, if the span is 2 MHz or below, the ADC Dither is ON; if the span is below 2 MHz, the ADC Dither is OFF. Under Auto OFF mode, if the span is above 2 MHz, turning on the ADC Dither may affect the measurement results based on selected dither status. You can access the submenu for manual control.
- **Key path:** **【Meas Setup】** , [More 1/3▶], [More 2/3▶], [ADC Dither Auto Man] on the front panel.
- **Status saved:** saved in the instrument status.
- **Factory preset:** Auto.
- **Remote Command:**

```
[[:sense]:]chpower:ADC:dither[:state] OFF|ON|HIGH
```

```
[[:sense]:]chpower:ADC:dither[:state]?
```

5.2. Description of menu

```
[[:sense]:chpower:ADC:dither:AUTO[:state] OFF|ON|0|1
```

```
[[:sense]:chpower:ADC:dither:AUTO[:state]?
```

[Meas Preset]

- **Menu description:** to reset the measurement parameters to the factory preset status or user saved parameter status
- **Key path:** **【Meas Setup】** , [More 1/3▶], [More 2/3▶], [Measurement Preset] on the front panel.
- **Factory preset:** factory reset.
- **Remote Command:**

```
:configure:chpower
```

5.2.3.18 Measurement Control

Pop up the More related to meas control, including [Measurement Single Cont On/Off], [Restart] and [Pause].

[Measure Continuous Man]

- **Menu description:** to set continuous measurement OFF or ON. When the [Measure Single Cont] is set as Cont mode, Cont On mode will be triggered and Cont sweep will be the default measure control method; when the [Measure Single Cont] is set as Single mode, single sweep will be triggered. Press **【Sweep Single】** to restart sweep when the next trigger signal arrives.
- **Key path:** **【Meas Ctrl】** , [Measure Cont Man] on the front panel.
- **Status saved:** saved in the instrument status.
- **Factory preset:** Continuous On.
- **Remote Command:**

```
:initiate:continuous OFF|ON|0|1
```

```
:initiate:continuous?
```

- **Examples:**

```
:INIT:CONT OFF
```

[Restart]

- **Menu description:** to stop current measurement and restart measurement for the signal/spectrum analyzer.
- **Key path:** **【Meas Ctrl】** , [Restart] on the front panel
- **Status saved:** not saved in instrument status.
- **Remote Command:**

```
:initiate:REST
```

[Pause]

- **Menu description:** when the signal/spectrum analyzer is in operation, this menu is used for pausing current measurement; when in Paused status, this menu is used for continuing measurement.
- **Key path:** **【Meas Ctrl】** , [Pause] on the front panel.
- **Status saved:** not saved in instrument status.

5.2. Description of menu

- **Remote Command:**

:initiate:PAUS

:initiate:RES

5.2.4 Occupied Bandwidth

5.2.4.1 Frequency

The **【Frequency】** key on the front panel is used to set parameters related to the signal/spectrum analyzer frequency, including [Center Freq], [CF Step Auto Man], [Freq Offset]. See the **【Frequency】** menu of the sweep analysis function for more details.

[Center Freq]

See the [Center Freq] under **【Frequency】** of the sweep analysis function for more details.

[CF Step **Auto Man**]

See the [CF Step Auto ON/OFF] under **【Frequency】** of the sweep analysis function for more details.

[Freq Offset]

See the [Freq Offset] under **【Frequency】** of the sweep analysis function for more details.

5.2.4.2 Ampld/Y Scale

Pop up More related to parameter setting of Ampld/Y Scale, including [Ref Level], [Attenuation ▶], [PreAmplifier On/Off], [[Scale/Div], [Auto Scale], [More 1/2▶], [Y Axis Unit], [Ref Level Offset].

[RefLevel]

- Menu description: to enable the Reference Level function. The reference level can be adjusted with the number keys, step keys or knob. The reference level corresponds to the top of the coordinate top. Measure signal at reference level position to get highest accuracy. The input attenuator of the signal/spectrum analyzer is coupled to the reference level, which can be automatically changed to avoid compression of input signal.
- Key path: **【Ampld/YScale】** Ampld/Y Scale, [Ref Level] on the front panel.
- Status saved: saved in the instrument status.
- Factory preset: 0dBm.
- Setting range: Min.: -170dBm, Max.: 30dBm.
- Default unit: set based on Y Axis scale unit.
- **Remote Command:**

:display:obwidth:VIEW>window:trace:Y:rlevel <real>

:display:obwidth:VIEW>window:trace:Y:rlevel?

- **Examples:**

:display:obwidth:VIEW>window:trace:Y:rlevel20dBm

[Attenuation▶]

See [Attenuation▶] under **【Ampld/Y Scale】** Ampld/Y Scale of the sweep analysis function for more details.

[Pre-amplifier ON OFF]

See [PreAmplifier ON/OFF] under **【Ampld/Y Scale】** Ampld/Y Scale of the sweep analysis function for more details.

[Scale/Div]

- Menu description: to select the scale/division from 0.1dB/division to 20dB/division. This menu is only valid when the scale type is logarithm.
- Key path: **【Ampld/Y Scale】** Ampld/Y Scale, [Scale/Div] on the front panel.
- Status saved: saved in the instrument status.
- **Factory preset:** 10.00 dB.
- Setting range: Min.: 0.1dB, Max.: 20dBm.
- **Remote Command:**

```
:display:obwidth:VIEW>window:trace:Y:pdivision <rel_ampl>
```

```
:display:obwidth:VIEW>window:trace:Y:pdivision?
```

[Auto Scale]

- Menu description: the instrument automatically sets parameters like reference level and scale/division based on input signal sizes. When this soft menu key is pressed, the instrument performs one auto scaling. Setting rule for auto scaling: firstly obtain the maximum value and the minimum value based on current measurement trace data. Based on the maximum value, place on the 80% graticule of the screen trace Y axis for auto setting of reference level and scale/division.
- Key path: **【Ampld/Y Scale】** Ampld/Y Scale, [Auto Scale] on the front panel.
- Status saved: not saved in instrument status.
- **Remote Command:**

```
:obwidth:adjust:level
```

[Y Axis Unit ▶]

- More description: to select the Y Axis unit from [dBm], [dBmv], [dBma], [W], [V], [A], [dBμV] and [dBμA]. The instrument will automatically calculate the trace data and marker readout based on the Y axis unit.
- Key path: **【Ampld/Y Scale】** Ampld/Y Scale, [More 1/2▶], [Y Axis Unit ▶] on the front panel.
- Status saved: saved in the instrument status.
- Factory preset: dBm.

```
:UNIT:obwidth:power DBM|DBMV|DBMA|V|W|A|DBUV|DBUA
```

```
:UNIT:obwidth:power?
```

5.2. Description of menu

[Ref Level Offset]

- Menu description: to introduce offset for all amplitude readout (e.g, reference level and marker amplitude). It will not change the trace position on the screen. This offset unit is dB and is not affected by the scale and unit. Use number keys, stepping keys or knob to input the offset value.
- Key path: **【Ampld/Y Scale】** Ampld/Y Scale, [More 1/2▶], [Ref Level Offset] on the front panel.
- Status saved: saved in the instrument status.
- **Factory preset:** 0 dB.
- Setting range: Min.: -1000dB, Max.:1000dB.
- **Remote Command:**

```
:display:obwidth>window:trace:Y:rlevel:offset <rel_ampl>
```

```
:display:obwidth>window:trace:Y:rlevel:offset?
```

- **Examples:**

```
:display:obwidth>window:trace:Y:rlevel:offset 12
```

5.2.4.3 Span/X Scale

Press the **【Span/X Scale】** on the front panel to enable the span function and set the signal/spectrum analyzer into center frequency/span mode. Press the [Span] key to pop up [Span], [Full Span] and [Last Span].

[Span]

- Menu description: the span can be set by number keys, stepping keys or knob. Use number keys or select [Zero Span] to set the span as zero.
- Key path: **【Span/X Scale】** , [Span] on the front panel.
- Status saved: saved in the instrument status.
- Factory preset: maximum frequency limit - start frequency.
- Setting range: Min.: 10Hz, Max.: related to the maximum working frequency limit of the instrument.
- **Remote Command:**

```
:obwidth:frequency:SPAN <freq>
```

```
:obwidth:frequency:SPAN?
```

- **Examples:**

```
:obwidth:frequency:SPAN 10 MHz
```

[Full Span]

- Menu description: to set the signal/spectrum analyzer into the center frequency/span mode. Set the span as maximum value.
- **Remote Command:**

```
:obwidth:frequency:SPAN:FULL
```

[Last Span]

- Menu description: to set the signal/spectrum analyzer back to the previous span.
- **Remote Command:**

:obwidth:frequency:SPAN:previous

5.2.4.4 Bandwidth

Pop up the soft More for setting Res BW and Video BW, including [Res BW Auto Man], [Video BW Auto Man] and [Filter Type].

[Res BW **A**uto Man]

- Menu description: to change the resolution bandwidth of spectrum analysis, ranging from 1Hz to 20 MHz, which is stepped by 1, 2, 3, 5 and 10. The resolution bandwidth can be changed with the number keys, step keys and knob. The shaded character indicates the currently selected mode.
- Key path: **[BW]** , [Res BW Auto Man] on the front panel.
- Status saved: saved in the instrument status.
- Factory preset: Auto.
- Setting range: Min.: 1Hz, Max.: 20 MHz.
- Default unit: Hz
- **Remote Command:**

:obwidth:bandwidth <bandwidth>

:obwidth:bandwidth?

:obwidth:bandwidth:AUTO ON|OFF|1|0

:obwidth:bandwidth:AUTO?

- **Examples:**

:obwidth:bandwidth 1kHz

:obwidth:bandwidth:AUTO ON On

[Video BW **A**uto Man]

- Menu description: to change the video bandwidth within the active function area, ranging from 1Hz to 20 MHz, which is stepped by 1, 2, 3, 5 and 10. The resolution bandwidth can be changed with the number keys, step keys and knob. The shaded character indicates the currently selected mode. When set as Auto Off, press [Video BW Auto Man] to select Auto On and return to auto mode.
- Key path: **[BW]** , [Video BW Auto Man] on the front panel.
- Status saved: saved in the instrument status.
- Factory preset: Auto, same as the Resolution Bandwidth setting.
- Setting range: Min.: 1Hz, Max.: 20 MHz.
- Default unit: Hz
- **Remote Command:**

:obwidth:bandwidth:video <bandwidth>

:obwidth:bandwidth:video?

:obwidth:bandwidth:video:AUTO ON|OFF|1|0

:obwidth:bandwidth:video:AUTO?

- **Examples:**

5.2. Description of menu

:obwidth:bandwidth:video 1 kHz

:obwidth:bandwidth:video:AUTO ON

[Filter Type▶]

- More description: comprising [Gaussian] and [Flattop]. In general, the signal/spectrum uses Gaussian filter, i.e., use filter approximate to the Gaussian shape to complete filtering of Res BW. If the flat top filter is used, the signal/spectrum analyzer adopts filter approximate to the rectangular shape to complete filtering of resolution bandwidth. The response time of flat top filter is about 3 times of that of the Gaussian filter. The sweep speed of the flat top filter is smaller than that of the Gaussian filter. The flat top filter has better selectivity than the Gaussian filter and therefore is more capable of distinguishing two signals with unequal amplitude.
- Key path: **【BW】** , [Filter Type▶] on the front panel.
- Status saved: saved in the instrument status.
- Factory preset: Gaussian.
- **Remote Command:**

: obwidth:bandwidth:shape gaussian|flattop

: obwidth:bandwidth:shape?

5.2.4.5 Auto Setting

Pop up the soft menu related to auto setting including [Couple All], [Mech Atten Auto Man], [Res BW Auto Man], [Video BW Auto Man], [VBW/RBW Auto Man], [Span/RBW Auto Man], [Sweep Time Auto Man] and [CF Step Auto Man].

[Couple All]

- Menu description: to set the resolution bandwidth, video bandwidth, sweep time, mechanical attenuator and frequency step as auto coupling mode. The signal/spectrum analyzer will select most suitable values for those functions based on set frequency and bandwidth (or start frequency and stop frequency). If no ratio is pre-saved, use default ratio.
- Key path: **【Auto Set】** , [Couple All] on the front panel.
- Status saved: not saved in instrument status.
- Factory preset: Couple All.
- **Remote Command:**

:couple ALL

- **Examples:**

:COUP ALL

[Mech Atten **Auto** Man]

See [Attenuation▶] under [Ampld/YScaleAmpld/Y Scale] for more details.

[Res BW **Auto** Man]

See [Res BW Auto Man] under **【BW】** for more details.

[Video BW Auto Man]

See [Video BW Auto Man] under **【BW】** for more details.

[Sweep Time Auto Man]

See [Sweep Time Auto ON/OFF] under **【Sweep】** for more details.

[CF Step Auto Man]

See [CF Step Auto ON/OFF] under **【Frequency】 Freq]** for more details.

5.2.4.6 Trace

Press **【Trace】** key on the front panel to pop up corresponding soft menu Including [Clear Write], [Average], [Max. Hold], [Min. Hold], [View/Blank On/Off▶] [More 1/2▶] and [Detector▶].

[Clear Write]

- Command description: to set the current trace processing as Refresh, i.e., clear all data of displayed trace and continue the signal trace receipt under sweep status.
- Key path: **【Trace】** , [Clear Write] on the front panel.
- Status saved: saved in the instrument status.
- Factory preset: after all traces are selected, the trace mode is defaulted as Refresh.
- **Remote Command:**

:trace:obwidth:TYPE write

:trace:obwidth:TYPE?

[Average]

- Command description: to set the current trace processing method as Average, i.e., based on the average count N set in the [Meas Setup], update trace after averaging the performance index of the measurement trace.
- Key path: **【Trace】** , [Average] on the front panel.
- Status saved: saved in the instrument status.
- Factory preset: all trace modes are defaulted as Refresh.
- **Remote Command:**

:trace:obwidth:TYPE average

:trace:obwidth:TYPE?

[Max Hold]

- Menu description: to set the current trace processing method as maximum hold, i.e., the new trace data will be assigned with maximum value of previous measured trace data.
- Key path: **【Trace】** , [Max. Hold] on the front panel.
- Status saved: saved in the instrument status.

5.2. Description of menu

- Factory preset: all trace modes are defaulted as Refresh.
- **Remote Command:**

:trace:obwidth:TYPE maxhold

:trace:obwidth:TYPE?

[Min Hold]

- Menu description: to set the current trace processing method as minimum hold, i.e., the new trace data will be assigned with minimum value of previous measured trace data.
- Key path: **【Trace】**], [Min. Hold] on the front panel.
- Status saved: saved in the instrument status.
- Factory preset: all trace modes are defaulted as Refresh.
- **Remote Command:**

:trace:obwidth:TYPE minhold

:trace:obwidth:TYPE?

[View/Blank▶]

Refresh Display

- More description: to set the display method for the selected trace from [Trace On], [View], [Background] and [Blank].
- Key path: **【Trace】** , [Display ON/OFF▶] on the front panel.
- Status saved: saved in the instrument status.
- Factory preset: all trace display modes are defaulted as Refresh.
- **Remote Command:**

:trace:obwidth:display[:state] ON|OFF|0|1

:trace:obwidth:display[:state]?

:trace:obwidth:update[:state] ON|OFF|0|1

:trace:obwidth:update[:state]?

[Detector ▶]

Pop up soft More related to setting the detector type for the currently selected trace, including [Auto], [Normal], [Peak], [Sample], [Negative Peak], [Average▶], where, the average detector type includes Log-Pwr Avg, Log-Pwr Avg and Voltage Avg.

[Auto]

- Menu description: to set the detector command for the currently selected trace as Auto. That means, the signal/spectrum analyzer will perform based on the parameter setting of currently selected trace.
- Key path: **【Trace】** , [More 1/2▶], [Detector ▶], [Auto] on the front panel
- Status saved: saved in the instrument status.

5.2. Description of menu

- Factory preset: the trace detector type is Power Average.

- **Remote Command:**

:obwidth:detector:AUTO ON|OFF|1|0

:obwidth:detector:AUTO?

[Normal]

- Menu description: to set the detector command for the currently selected trace as Normal. I.e., display the measurement results of positive peak and negative peak at the same time to achieve display effect similar to the analog instrument.
- Key path: **【Trace】** , [More 1/2▶], [Detector ▶], [Normal] on the front panel.
- Status saved: saved in the instrument status.

- **Remote Command:**

:obwidth:detector normal

:obwidth:detector?

[Peak]

- Menu description: to set the detector command for the currently selected trace as Positive Peak. I.e., take the maximum value from sampling data assigned to each trace point.
- Key path: **【Trace】** , [More 1/2▶], [Detector▶], [Peak] on the front panel.
- Status saved: saved in the instrument status.

- **Remote Command:**

:obwidth:detector positive

:obwidth:detector?

[Sample]

- Menu description: to set the detector command for the currently selected trace as Sample. I.e., take the last value from sampling data assigned to each trace point.
- Key path: **【Trace】** , [More 1/2▶], [Detector▶], [Sample] on the front panel.
- Status saved: saved in the instrument status.

- **Remote Command:**

:obwidth:detector sample

:obwidth:detector?

[Negative Peak]

- Menu description: to set the detector command for the currently selected trace as Negative Peak. I.e., take the minimum value from sampling data assigned to each trace point.
- Key path: **【Trace】** , [More 1/2▶], [Detector▶], [Negative Peak] on the front panel.
- Status saved: saved in the instrument status.

5.2. Description of menu

- **Remote Command:**

:obwidth:detector negative

:obwidth:detector?

[Average ▶

Video Average]

- Menu description: to set the detector command for the currently selected trace as Video Average. Also called Logarithm Power Average Detector, i.e., take the logarithm power average value for all data assigned to each trace point; earlier signal/spectrum analyzer generally displays the measurement trace of logarithm scale, and all filtering and averaging are based on the logarithm power data; the trace is generally called as video signal. After digital IF processing is adopted, to make measurement results same as the earlier signal/spectrum analyzer, the video average detector function is added.
- Key path: **【Trace】** , [More 1/2▶], [Detector▶], [Average▶], [Video Average] on the front panel.
- Status saved: saved in the instrument status.

- **Remote Command:**

:obwidth:detector LOG

:obwidth:detector?

[Average ▶

Power Average]

- Menu description: to set the detector command for the currently selected trace as Power Average. Also called root mean square (RMS) detector. Calculate the root mean square of all sampling data assigned to each trace point; the 4051 signal/spectrum analyzer envelopes the detector for the RF input signal and obtains linear voltage. After square these voltage values, take sum and divide the count of sampling data points corresponding to each trace point. Finally, take square root. When the scale is logarithm, take 20 times of logarithm transformation for these RMS values (with 10 as base) and obtain the trace data. When the scale type is linear, those RMS values are trace data.
- Key path: **【Trace】** , [More 1/2▶], [Detector▶], [Average▶], [Pwr Avg] on the front panel.
- Status saved: saved in the instrument status.

- **Remote Command:**

:obwidth:detector average Or

:obwidth:detector RMS

:obwidth:detector?

[Average ▶

Average Voltage]

- Menu description: to set the detector command for the currently selected trace as Voltage Average. Also called average (AVG) detector. Take linear average for all sampling data assigned to each trace point; the 4051 signal/spectrum analyzer envelopes the detector for the RF input signal and obtains linear voltage. After summing those voltage values, divide the number of sampling data points corresponding to each trace point. When the scale is logarithm, take 20 times of logarithm transformation for these RMS values

5.2. Description of menu

(with 10 as base) and obtain the trace data. When the scale type is linear, those average values are trace data.

- Key path: **【Trace】** , [More 1/2▶], [Detector▶], [Average▶], [Voltage Avg] on the front panel.
- Status saved: saved in the instrument status.
- **Remote Command:**

:obwidth:detector scalar

:obwidth:detector?

5.2.4.7 Sweep

Enable sweep-related parameter setup function to pop up corresponding soft More, including [Sweep Time Auto Man], [Sweep Setup▶] and [Sweep Points].

[Sweep Time **Auto Man**]

- Menu description: to change the sweep time of signal/spectrum analyzer. Use the number keys, step keys or knob to adjust the sweep time. When it is under Auto OFF mode (shaded), it indicates that sweep time can be set manually. When it is under Auto ON status, the sweep time will be automatically coupled based on resolution bandwidth, span and video bandwidth
- Key path: **【Sweep】** , [Sweep Time Auto Man] on the front panel.
- Status saved: saved in the instrument status.
- Factory preset: sweep time Auto.
- Setting range: Min.: 1ms, Max.: 6000s.
- Default unit: s
- **Remote Command:**

:obwidth:sweep:TIME <time>

:obwidth:sweep:TIME?

:obwidth:sweep:TIME:AUTO OFF|ON|0|1

:obwidth:sweep:TIME:AUTO?

- **Examples:**

:OBW:SWE:TIME 500 ms

:OBW:SWE:TIME:AUTO OFF

[Sweep Setup▶]

Pop up the soft More related to Sweep type, including [Sweep Type Auto Man], [Sweep Type Rules Auto Man] and [FFT Width Auto Man].

[Sweep Type▶

Auto Man]

- Menu description: to set sweep type. To determine whether Swept or FFT is adopted for frequency spectrum measurement. Also set the FFT step bandwidth for FFT sweep The soft More include [Auto], [Swept] and [FFT]. When under Auto ON mode, the signal/spectrum analyzer will automatically select the sweep type based on sweep type rules.

5.2. Description of menu

- Key path: **【Sweep】** , [Sweep Setup ▶], [Sweep Type Auto Man] on the front panel.
- Status saved: saved in the instrument status.
- Factory preset: sweep type: Auto.
- **Remote Command:**

:obwidth:sweep:TYPE FFT|sweep

:obwidth:sweep:TYPE?

:obwidth:sweep:TYPE:AUTO OFF|ON|0|1

:obwidth:sweep:TYPE:AUTO?

[Sweep Type Rules **Auto Man**]

- Menu description: to set rules for auto sweep type. While the sweep type rules include “Best Dynamic Range” and “Best Speed”.
 “Best Dynamic Range” rules: when RBW is or larger than 1kHz, the sweep type is Swept; when RBW is less than 1kHz, the sweep type is FFT.
 “Best Speed” rules: when RBW is or larger than 30kHz, the sweep type is Swept; when RBW is less than 30kHz, the sweep type is FFT.

- Key path: **【Sweep】** , [Sweep Setup ▶], [Sweep Type Rules Auto Man] on the front panel.
- Status saved: saved in the instrument status.
- Factory preset: the sweep type rules are automatically set as “Best Dynamic Range”.
- **Remote Command:**

:obwidth:sweep:TYPE:AUTO:rules speed|drange

:obwidth:sweep:TYPE:AUTO:rules?

:obwidth:sweep:TYPE:AUTO:rules:AUTO OFF|ON|0|1

:obwidth:sweep:TYPE:AUTO:rules:AUTO?

[FFT Width **Auto Man**]

- Menu description: to set FFT Width. The FFT width includes [Auto], [<100kHz], [<3 MHz], [<13 MHz], [<=Max.]. FFT width is only active when the FFT sweep type is selected. Under Auto type, when the signal/spectrum analyzer performs FFT spectrum measurement, the maximum resolution bandwidth is 30kHz. To guarantee best dynamic measurement range, the signal/spectrum analyzer automatically optimizes the FFT width within 100kHz. The larger is the FFT width, the faster is FFT spectrum measurement, but the dynamic range performance will be affected.

Under FFT sweep, the FFT width setup limits the maximum value for center frequency step of each tune. For example, if [<100Hz] is selected, the maximum value for center freq step of each tune is 100Hz. As the FFT width gets larger, the count of instrument center frequencies get smaller when performing measurement of same frequency scope, and the response measurement gets faster. Therefore, to improve measurement speed, you can manually change the FFT width.

- Key path: **【Sweep】** , [Sweep Setup▶], [FFT Width▶] on the front panel.
- Status saved: saved in the instrument status.
- Factory preset: FFT Width is set as Auto.
- **Remote Command:**

5.2. Description of menu

:obwidth:sweep:FFT:width <real>

:obwidth:sweep:FFT:width?

:obwidth:sweep:FFT:width:AUTO OFF|ON|0|1

:obwidth:sweep:FFT:width:AUTO?

[Sweep points]

- Menu description: to set the trace points.
- Key path: **【Sweep】** , [Sweep Points] on the front panel.
- Status saved: saved in the instrument status.
- Factory preset: 1001.
- Setting range: 101-30001.
- **Remote Command:**

:obwidth:sweep:points <integer>

:obwidth:sweep:points?

5.2.4.8 Single

- Menu description: the **【Single】** key on the front panel has no corresponding soft menu. This function is mainly used for manual trigger of a sweep. When the Average is ON, this function performs the sweeps at the count specified by the Average Count.

In remote control programming and system establishment, this function combined with *WAI can effectively synchronize the sweep process and enable the trace data obtained after the *WAI finishes directly correspond to the sweep process one by one.

- **Remote Command:**

:initiate:obwidth

5.2.4.9 Continuous

The **【Cont】** key on the front panel has no corresponding soft menu. This function is mainly used for changing the Continuous OFF into Continuous ON; if the current sweep is Continuous ON, the instrument performs no operation.

5.2.4.10 Trigger

See **【Trig】** menu of the sweep analysis function for more details.

5.2.4.11 Display

Pop up the soft More related to display, including [Display Line On Off], [Display Config ▶].

[Display Line ON OFF]

See [Display Line On/off] under **【Display】** of the sweep analysis function for more details.

[Display Config▶]

5.2. Description of menu

It is used for configurations of interface language, status area display ON OFF related to interface display, The soft More include [Select Language 中文 English], [Graticule Display On Off], Status Display On Off], [Freq Info Disp On Off]. See [Display Config▶] under **【Display】** of the sweep analysis function for more details.

5.2.4.12 Input Output

See the **【Input/Output】** menu of the sweep analysis function for more details.

5.2.4.13 Marker

Pop up the soft More related to markers, including [Select Marker ▶], [Normal], [Marker Delta], [Fixed], [Off], [Properties▶], [Marker Couple Man], and [All Markers Off].

[Select Marker ▶]

Marker 1]

- Command description: to select among 12 different markers of the analyzer. When a certain marker is selected, the marker will be indicated in the menu where its type and attribute can be set. Select and trigger another marker and place it at the center of the current trace. Users can read amplitude and frequency information (when the frequency span is 0 Hz, time information will be displayed) at the marker display area at the top right corner of the screen.
- Key path: **【Marker】** , [Select Marker ▶] on the front panel.
- Status saved: saved in the instrument status.
- Factory preset: Marker 1.

[Normal]

- Menu description: to set the selected marker as the Normal Marker.
- Key path: **【Marker】** , [Normal] on the front panel.
- Status saved: saved in the instrument status.
- **Remote Command:**

:calculate:obwidth:marker[1|2|3|4|5|6|7|8|9|10|11|12]:MODE position

:calculate:obwidth:marker[1|2|3|4|5|6|7|8|9|10|11|12]:MODE?

[Marker Delta]

- Menu description: to set the selected marker as the Delta Marker. Display the amplitude difference and frequency difference (or time difference, when span is zero) between two markers at the marker display area at the top right corner of the screen. If there exists a single marker, a [Marker Delta] operation will generate a Ref marker in the active marker position. Move the active marker through the knob, stepping keys or number keys. The display amplitude difference unit is dB.
- Key path: **【Marker】** , [Marker Delta] on the front panel.
- Status saved: saved in the instrument status.
- **Remote Command:**

:calculate:obwidth:marker[1|2|3|4|5|6|7|8|9|10|11|12]:MODE delta

:calculate:obwidth:marker[1|2|3|4|5|6|7|8|9|10|11|12]:MODE?

5.2. Description of menu

[Fixed]

- Menu description: to set the selected marker as the Fixed Marker. The X Axis and Y Axis positions of the fixed marker are fixed. The Fixed Marker can be used as reference marker.
- Key path: **【Marker】** , [Fixed] on the front panel.
- Status saved: saved in the instrument status.

- **Remote Command:**

```
:calculate:obwidth:marker[1|2|3|4|5|6|7|8|9|10|11|12]:MODE fixed
```

```
:calculate:obwidth:marker[1|2|3|4|5|6|7|8|9|10|11|12]:MODE?
```

[Off]

- Menu description: to turn off the selected marker.
- Key path: **【Marker】** , [Off] on the front panel.
- Status saved: saved in the instrument status.

- **Remote Command:**

```
:calculate:obwidth:marker[1|2|3|4|5|6|7|8|9|10|11|12]:MODE OFF
```

```
:calculate:obwidth:marker[1|2|3|4|5|6|7|8|9|10|11|12]:MODE?
```

[Properties▶]

Pop up the corresponding More of currently selected marker attribute setup, including [Select Marker ▶], [Ref Marker ▶], and [Marker Display Line On Off].

[Ref Marker▶]

- Menu description: to select reference marker for current marker. It can be any one from 11 markers except the currently selected marker.
- Key path: **【Marker】** , [Properties▶], [Ref Marker▶] on the front panel.
- Status saved: saved in the instrument status.

- **Remote Command:**

```
:calculate:obwidth:marker[1|2|3|4|5|6|7|8|9|10|11|12]:reference <integer>
```

```
:calculate:obwidth:marker[1|2|3|4|5|6|7|8|9|10|11|12]:reference?
```

[Marker Display Line▶]**ON OFF**

- Menu description: to set whether the current marker is displayed as a line on the screen, which is easy to observe.
- Key path: **【Marker】** , [Properties▶] and [Marker Display Line On/Off] on the front panel.
- Status saved: saved in the instrument status.
- Factory preset: OFF.
- **Remote Command:**

5.2. Description of menu

:calculate:obwidth:marker[1|2|3|4|5|6|7|8|9|10|11|12]:lines[:state] OFF|ON|0|1

:calculate:obwidth:marker[1|2|3|4|5|6|7|8|9|10|11|12]:lines[:state]?

[Marker Couple ON OFF]

- Menu description: to turn on or off Marker Couple. When it is ON, moving any marker horizontal axis position will cause an equal movement of horizontal axis position of every other marker which is ON. When the marker is moved to less than Start Frequency or larger than Stop Frequency, the marker is limited to the value of the Start Frequency or the Stop Frequency; when the span is zero, the minimum value is limited as 0, and the maximum value is limited as the Sweep Time.
- Key path: **【Marker】** , [More 1/2▶], [Marker Couple ON/OFF] on the front panel.
- Status saved: saved in the instrument status.
- Factory preset: OFF.
- **Remote Command:**

:calculate:obwidth:marker:couple[:state] ON|OFF|1|0

:calculate:obwidth:marker:couple[:state]?

[All Markers OFF]

- More description: to turn off all current markers which are On and related soft keys, e.g. [Noise Marker].
- Key path: **【Marker】** , [More 1/2▶], [All Markers OFF] on the front panel.
- Status saved: not saved in instrument status.
- **Remote Command:**

:calculate:obwidth:marker:AOFF

5.2.4.14 Maker->

This key has no soft menu.

5.2.4.15 Marker Function

This key has no soft menu.

5.2.4.16 Peak

The **【Peak Search】** key on the front panel is used for turning on the peak search for traces by the control instrument and turning on marker for display, including [Next Peak], [Next Pk Right], [Next Pk Left].

- **Remote Command:**

:calculate:obwidth:marker[1|2|3|4|5|6|7|8|9|10|11|12]:maximum

[Next Peak]

- Menu description: Taking the Amplitude of the point where the current marker is located, search for the next peak of current test trace.
- Key path: **【Peak Search】** , [Next Peak] on the front panel.
- Status saved: not saved in instrument status.
- **Remote Command:**

5.2. Description of menu

:calculate:obwidth:marker[1|2|3|4|5|6|7|8|9|10|11|12]:maximum:NEXT

[Next Pk Right]

- Menu description: to search for the peak to the right of the current test trace marker position.
- Key path: **【Peak Search】** , [Next Pk Right] on the front panel.
- Status saved: not saved in instrument status.
- **Remote Command:**

:calculate:obwidth:marker[1|2|3|4|5|6|7|8|9|10|11|12]:maximum:right

[Next Pk Left]

- Menu description: to search for the peak to the left of the current test trace marker position.
- Key path: **【Peak Search】** , [Next Pk Left] on the front panel.
- Status saved: not saved in instrument status.
- **Remote Command:**

:calculate:obwidth:marker[1|2|3|4|5|6|7|8|9|10|11|12]:maximum:LEFT

5.2.4.17 Measurement Setting

Pop up the soft menu related to measurement setting, Which includes [Average Num On Off], [Average Mode Exponential Repeat], [Occ BW% Pwr], [x dB], [Limit BW On Off], [phnoise Opt▶], [Low Noise Path On Off], [Preselector Preselecting Bypass], [RF Gain▶], [ADC Dither Auto Man▶] and [Meas Preset].

[Average Num ON OFF]

- Menu description: to turn on or off Average. When Average Count is ON, the user can specify the average count required for measurement. The Average Count can be adjusted by number keys, stepping keys or knob.
- Key path: **【Meas Setup】** , [Average Num Man] on the front panel.
- Status saved: saved in the instrument status.
- Factory preset: 100/off.
- Setting range: 1~10000
- Default unit: none
- **Remote Command:**

[[:sense]: obwidth:average:count <integer> [:sense]: obwidth:average:count?

[[:sense]: obwidth:average[:state] ON|OFF|1|0 [:sense]: obwidth:average[:state]?

[Average Mode Exponential Repeat]

- Menu description: when Average Count is ON, the user can select Average State required for measurement.

Exponential - Different from Linear Average, in Exponential State, the weight of new data is larger than that of old data. This is good for tracking data change in terms of time. In this case, the selected

5.2. Description of menu

averaging count determines the weight of the old data on the new data. As the average count increases, the weight of new data gradually decreases. This is good for tracking data change in terms of time. In this case, the selected averaging count determines the weight of the old data on the new data. As the average count increases, the weight of new data gradually decreases.

Repeat - Similarly, it takes exponential averaging. However, when the average count is met, clear all previous results, restart average till the set average count and repeat this process.

- Key path: **【Meas Setup】** , [Average Mode Exponential Repeat] on the front panel.
- Status saved: saved in the instrument status.
- Factory preset: Exponential.
- **Remote Command:**

```
[::sense]:obwidth:average:tcontrol exponential|repeat
```

```
[::sense]:obwidth:average:tcontrol?
```

[Occ BW% Pwr]

- Menu description: to set the signal power percentage that determines the occupied bandwidth. Use number keys, stepping keys or knob to adjust occupied power percentage.
- Key path: **【Meas Setup】** , [Occ BW% Pwr] on the front panel.
- Status saved: saved in the instrument status.
- Factory preset: 99.0%.
- Setting range: 10% - 99.99%.
- Default unit: %
- **Remote Command:**

```
[::sense]:obwidth:percent <real> [::sense]:obwidth:percent?
```

[x dB]

- Menu description: to designate the power level that determines the transmission bandwidth within the range of occupied bandwidth and frequency span. The value is the decreased dB value at the signal peak point P. This function is independent from the occupied bandwidth calculation. X dB bandwidth is also called as the transmission bandwidth, which sets the arrow marker pair based on specified decreased dB value at the maximum power point and calculates the total power between two markers. X dB bandwidth is also called as the transmission bandwidth, which sets the arrow marker pair based on specified decreased dB value at the maximum power point and calculates the total power between two markers. Use number keys, stepping keys or knob to adjust x dB value.
- Key path: **【Meas Setup】** , [x dB] on the front panel.
- Status saved: saved in the instrument status.
- **Factory preset:** -26.0 dB.
- Setting range: -100.0dB - -0.1dB.
- Default unit: dB.
- **Remote Command:**

```
[::sense]:obwidth:XDB <rel_amp|> [::sense]:obwidth:XDB?
```

5.2. Description of menu

[Limit BW ON OFF]

- Menu description: to turn on or off the limit test for occupied bandwidth. When it is ON, take the set limit bandwidth as reference, and judge whether the measured occupied bandwidth value exceeds the limit. If so, F indicates that the test fails. Use number keys, stepping keys or knob to change the Limit Bandwidth.
- Key path: **【Meas Setup】** , [Limit BW ON OFF] on the front panel.
- Status saved: saved in the instrument status.
- Factory preset: 5.0 MHz/off.
- **Setting range:** 1.0kHz - 100.0 MHz.
- Default unit: Hz.
- **Remote Command:**

```
:calculate:obwidth:limit:fblimit <freq>
```

```
:calculate:obwidth:limit:fblimit?
```

```
:calculate:obwidth:limit[:TEST] ON|OFF|1|0
```

```
:calculate:obwidth:limit[:TEST]?
```

[Low Noise Path ON OFF]

- Menu description: this menu is only available when the H34 option (Low Noise PreAmplifier) is purchased. When the PreAmplifier is ON, the Low Noise Path is OFF and this menu is grayed out; when the PreAmplifier is OFF, this menu lights on and is switchable.
- Key path: **【Meas Setup】** , [More 1/2▶], [Low Noise Path ON OFF] on the front panel.
- Status saved: saved in the instrument status.
- **Remote Command:**

```
:obwidth:power:MW:PATH STD|lnpath
```

```
:obwidth:power:MW:PATH?
```

[Preselector Bypass Preselect]

- Menu description: this menu is only available when the H36 option is purchased. It is used for setting whether to bypass the front-end preselector of the signal/spectrum analyzer. In analyzing bandwidth signal, bypass is usually required.
- Key path: **【Meas Setup】** , [More 1/2▶], [Preselector Preselecting Bypass] on the front panel.
- Status saved: saved in the instrument status.
- **Remote Command:**

```
Input:obwidth:filter:YIG[:state] OFF|ON|0|1
```

```
Input:obwidth:filter:YIG[:state]?
```

[RF Gain▶]

- More description: to set the Auto ON/OFF of the RF Gain and best allocation algorithm for RF Gain. The soft More includes [Auto], [Best for Dynamic Range] and [Best for Sensitivity].
- Key path: **【Meas Setup】** , [More 1/2▶], [RF Gain▶] on the front panel.

5.2. Description of menu

- Status saved: saved in the instrument status.
- **Remote Command:**

:obwidth:RF:GAIN:AUTO OFF|ON|0|1

:obwidth:RF:GAIN:AUTO?

:obwidth:RF:GAIN:AUTO:rules RANGE|SENSITIVITY

:obwidth:RF:GAIN:AUTO:rules?

[Auto]

- Menu description: to set the RF Gain distribution algorithm to Auto. In this case, the RF Gain distribution is “Best Dynamic Range”.
- Key path: **【Meas Setup】** , [More 1/2▶], [RF Gain▶], [Auto] on the front panel.
- Status saved: saved in the instrument status.

[Best for Dynamic Range]

- Menu description: to set the RF Gain distribution algorithm to Best Dynamic Range. In this case, the RF Gain is switched to “Auto OFF”
- Key path: **【Meas Setup】** , [More 1/2▶], [RF Gain▶], [Best for Dynamic Range] on the front panel.
- Status saved: saved in the instrument status.

[Best for Sensitivity]

- Menu description: to set the RF Gain distribution algorithm to Best Sensitivity. In this case, the RF Gain is switched to “Auto OFF”
- Key path: **【Meas Setup】** , [More 1/2▶], [RF Gain▶], [Best for Sensitivity] on the front panel.
- Status saved: saved in the instrument status.

[ADC Dither **Auto Man**]

- Menu description: to control opening/closing of ADC dither of the frequency acquisition circuit in the analyzer. Under default mode, the signal/spectrum analyzer will automatically control whether the ADC Dither is ON based on current working condition. When the ADC Dither is under Auto mode, the ON or OFF status depends on the span, resolution bandwidth and sweep type (continuous swept or step sweep); when it is continuous swept, the ADC Dither status will force to switch to Auto and turns off; when it is step sweep, under Auto mode, if the span is 2 MHz or below, the ADC Dither is ON; if the span is below 2 MHz, the ADC Dither is OFF. Under Auto OFF mode, if the span is above 2 MHz, turning on the ADC Dither may affect the measurement results based on selected dither status. You can access the submenu for manual control.
- Key path: **【Meas Setup】** , [More 1/2▶], [ADC Dither Auto Man] on the front panel.
- Status saved: saved in the instrument status.
- Factory preset: Auto.
- **Remote Command:**

[[:sense]:obwidth:ADC:dither[:state] OFF|ON|HIGH

5.2. Description of menu

[[:sense]:obwidth:ADC:dither[:state]]?

[[:sense]:obwidth:ADC:dither:AUTO[:state]] OFF|ON|0|1

[[:sense]:obwidth:ADC:dither:AUTO[:state]]?

[Meas Preset]

- Menu description: to reset the measurement parameters to the factory preset status or user saved parameter status

Key path: **【Meas Setup】** , [More 1/2], [Meas Preset] on the front panel.

- Factory preset: factory reset.

•Remote Command:

:configure:obwidth

5.2.4.18 Measurement Control

Pop up the More related to meas control, including [Measurement Single Cont On/Off], [Restart] and [Pause].

[Measure Single **Continuous**]

- Menu description: to set continuous measurement OFF or ON. When the [Measure Single Cont] is set as Cont mode, Cont On mode will be triggered and Cont sweep will be the default measure control method; when the [Measure Single Cont] is set as Single mode, single sweep will be triggered. Press **【Sweep Single】** to restart sweep when the next trigger signal arrives.
- Key path: Meas Control, [Meas Single Cont] on the front panel.
- Status saved: saved in the instrument status.
- Factory preset: Continuous On.
- **Remote Command:**

:initiate:continuous OFF|ON|0|1

:initiate:continuous?

- **Examples:**

:INIT:CONT OFF

[Restart]

- Menu description: to stop current measurement and restart measurement for the signal/spectrum analyzer.
- Key path: **【Meas Control】** , [Restart] on the front panel
- Status saved: not saved in instrument status.
- **Remote Command:**

:initiate:REST

[Pause]

- Menu description: when the signal/spectrum analyzer is in operation, this menu is used for pausing current measurement; when in Paused status, this menu is used for continuing measurement.
- Key path: **【Meas Control】** , [Pause] on the front panel.

5.2. Description of menu

- Status saved: not saved in instrument status.
- **Remote Command:**

:initiate:PAUS

:initiate:RES

5.2.5 Adjacent Channel Power

5.2.5.1 Frequency

The **【Frequency】** key on the front panel is used to set parameters related to the signal/spectrum analyzer frequency, including [Center Freq], [CF Step Auto ON/OFF], [Freq Offset]. See the **【Frequency】** menu of the sweep analysis function for more details.

[Center Freq]

See the [Center Freq] under **【Frequency】** of the sweep analysis function for more details.

[CF Step **Auto Man**]

See the [CF Step Auto ON/OFF] under **【Frequency】** of the sweep analysis function for more details.

[Frequency deviation]

See the [Freq Offset] under **【Frequency】** of the sweep analysis function for more details.

5.2.5.2 Ampld/Y Scale

Pop up More related to parameter setting of Ampld/Y Scale, including [Ref Level], [Attenuation ▶], [PreAmplifier On/Off], [Scale/Div], [Auto Scale], [More 1/2▶], [Y Axis Unit▶], [Ref Level Offset].

[RefLevel]

- Menu description: to enable the Reference Level function. The reference level can be adjusted with the number keys, step keys or knob. The reference level corresponds to the top of the coordinate top. Measure signal at reference level position to get highest accuracy. The input attenuator of the signal/spectrum analyzer is coupled to the reference level, which can be automatically changed to avoid compression of input signal.
- Key path: **【Amplitude/Y Scale】** , [RefLevel] on the front panel.
- Status saved: saved in the instrument status.
- Factory preset: 0dBm.
- Setting range: Min.: -170dBm, Max.: 30dBm.
- Default unit: set based on Y Axis scale unit.
- **Remote Command:**

:display:acpower:VIEW>window:trace:Y:rlevel <real>

:display:acpower:VIEW>window:trace:Y:rlevel?

- **Examples:**

:display:acpower:VIEW>window:trace:Y:rlevel20dBm

[Attenuation▶]

See [Attenuation▶] under **【Ampld/Y Scale】** Ampld/Y Scale of the sweep analysis function for more details.

[PreAmplifier ON OFF]

See [PreAmplifier ON/OFF] under **【Ampld/Y Scale】** Ampld/Y Scale of the sweep analysis function for more details.

[Scale/Div]

- Menu description: to select the scale/division from 0.1dB/division to 20dB/division. This menu is only valid when the scale type is logarithm.
- Key path: **【Ampld/Y Scale】** Ampld/Y Scale, [Scale/Div] on the front panel.
- Status saved: saved in the instrument status.
- **Factory preset:** 10.00 dB.
- Setting range: Min.: 0.1dB, Max.: 20dB.
- **Remote Command:**

```
:display:acpower:VIEW>window:trace:Y:pdivision <rel_ampl>
```

```
:display:acpower:VIEW>window:trace:Y:pdivision?
```

[Auto Scale]

- Menu description: the instrument automatically sets parameters like reference level and scale/division based on input signal sizes. When this soft menu key is pressed, the instrument performs one auto scaling. Setting rule for auto scaling: firstly obtain the maximum value and the minimum value based on current measurement trace data. Based on the maximum value, place on the 80% graticule of the screen trace Y axis for auto setting of reference level and scale/division.
- Key path: **【Ampld/Y Scale】** Ampld/Y Scale, [Auto Scale] on the front panel.
- Status saved: not saved in instrument status.
- **Remote Command:**

```
:acpower:adjust:level
```

[Y Axis Unit ▶]

- More description: to select the Y Axis unit from [dBm], [dBmv], [dBma], [W], [V], [A], [dBμV] and [dBμA]. The instrument will automatically calculate the trace data and marker readout based on the Y axis unit.
- Key path: **【Ampld/Y Scale】** Ampld/Y Scale, [More 1/2▶], [Y Axis Unit ▶] on the front panel.
- Status saved: saved in the instrument status.
- Factory preset: dBm.

```
:UNIT:acpower:power DBM|DBMV|DBMA|V|W|A|DBUV|DBUA
```

```
:UNIT:acpower:power?
```

5.2. Description of menu

[Ref Level Offset]

- Menu description: to introduce offset for all amplitude readout (e.g, reference level and marker amplitude). It will not change the trace position on the screen. This offset unit is dB and is not affected by the scale and unit. Use number keys, stepping keys or knob to input the offset value.
- Key path: **【Ampld/Y Scale】** , [More 1/2▶], [Ref Level Offset] on the front panel.
- Status saved: saved in the instrument status.
- **Factory preset:** 0 dB.
- Setting range: Min.: -1000dB, Max.:1000dB.
- **Remote Command:**

```
:display:acpower>window:trace:Y:rlevel:offset <rel_ampl>
```

```
:display:acpower>window:trace:Y:rlevel:offset?
```

- **Examples:**

```
:display:acpower>window:trace:Y:rlevel:offset 12
```

5.2.5.3 Span/X Scale

Press the **【Span/X Scale】** on the front panel to enable the span function and set the signal/spectrum analyzer into center frequency/span mode. Press the **【Span】** key to pop up [Span], [Full Span] and [Last Span].

[BW]

- Menu description: the span can be set by number keys, stepping keys or knob. Use number keys or select [Zero Span] to set the span as zero.
- Key path: **【Span/X Scale】** , [Span] on the front panel.
- Status saved: saved in the instrument status.
- Factory preset: maximum frequency limit - start frequency.
- Setting range: Min.: 10Hz, Max.: related to the maximum working frequency limit of the instrument.
- **Remote Command:**

```
:acpower:frequency:SPAN <freq>
```

```
:acpower:frequency:SPAN?
```

- **Examples:**

```
:acpower:frequency:SPAN10 MHz
```

[Full Span]

- Menu description: to set the signal/spectrum analyzer into the center frequency/span mode. Set the span as maximum value.
- **Remote Command:**

```
:acpower:frequency:SPAN:FULL
```

[Last Span]

- Menu description: to set the signal/spectrum analyzer back to the previous span.

- **Remote Command:**

:acpower:frequency:SPAN:previous

5.2.5.4 Bandwidth

Pop up the soft More for setting Res BW and Video BW, including [Res BW Auto Man], [Video BW Auto Man] and [Filter Type].

[Res BW **Auto** Man]

- Menu description: to change the resolution bandwidth of spectrum analysis, ranging from 1Hz to 20 MHz, which is stepped by 1, 2, 3, 5 and 10. The resolution bandwidth can be changed with the number keys, step keys and knob. The shaded character indicates the currently selected mode.
- Key path: **【BW】** , [Res BW Auto Man] on the front panel.
- Status saved: saved in the instrument status.
- Factory preset: Auto.
- Setting range: Min.: 1Hz, Max.: 20 MHz.
- Default unit: Hz.

- **Remote Command:**

:acpower:bandwidth <bandwidth>

:acpower:bandwidth?

:acpower:bandwidth:AUTO ON|OFF|1|0

:acpower:bandwidth:AUTO?

- **Examples:**

:acpower:bandwidth 1kHz

:acpower:bandwidth:AUTO ON On

[Video BW **Auto** Man]

- Menu description: to change the video bandwidth within the active function area, ranging from 1Hz to 20 MHz, which is stepped by 1, 2, 3, 5 and 10. The resolution bandwidth can be changed with the number keys, step keys and knob. The shaded character indicates the currently selected mode. When set as Auto Off, press [Video BW Auto Man] to select Auto On and return to auto mode.
- Key path: **【BW】** , [Video BW Auto Man] on the front panel.
- Status saved: saved in the instrument status.
- Factory preset: Auto, same as the Resolution Bandwidth setting.
- Setting range: Min.: 1Hz, Max.: 20 MHz.
- Default unit: Hz

- **Remote Command:**

:acpower:bandwidth:video <bandwidth>

:acpower:bandwidth:video?

:acpower:bandwidth:video:AUTO ON|OFF|1|0

:acpower:bandwidth:video:AUTO?

5.2. Description of menu

- **Examples:**

:acpower:bandwidth:video 1 kHz

:acpower:bandwidth:video:AUTO ON

[Filter Type▶]

- More description: comprising [Gaussian] and [Flattop]. In general, the signal/spectrum uses Gaussian filter, i.e., use filter approximate to the Gaussian shape to complete filtering of Res BW. If the flat top filter is used, the signal/spectrum analyzer adopts filter approximate to the rectangular shape to complete filtering of resolution bandwidth. The response time of flat top filter is about 3 times of that of the Gaussian filter. The sweep speed of the flat top filter is smaller than that of the Gaussian filter. The flat top filter has better selectivity than the Gaussian filter and therefore is more capable of distinguishing two signals with unequal amplitude.
- Key path: **【BW】** , [Filter Type▶] on the front panel.
- Status saved: saved in the instrument status.
- Factory preset: Gaussian.
- **Remote Command:**

:acpower:bandwidth:shape gaussian|flattop

:acpower:bandwidth:shape?

5.2.5.5 Auto Setting

Pop up the soft menu related to auto setting Which includes [Couple All], [Mech Atten Auto Man], [Res BW Auto Man], [Video BW Auto Man], [Sweep Time AutoMan] and [CF Step Auto Man].

[Couple All]

- Menu description: to set the resolution bandwidth, video bandwidth, sweep time, mechanical attenuator and frequency step as auto coupling mode. The signal/spectrum analyzer will select most suitable values for those functions based on set frequency and bandwidth (or start frequency and stop frequency). If no ratio is pre-saved, use default ratio.
- Key path: **【Auto Set】** , [Couple All] on the front panel.
- Status saved: not saved in instrument status.
- Factory preset: Couple All.
- **Remote Command:**

:COUPle ALL

- **Examples:**

:COUP ALL

[Mech Atten **AutoMan**]

See [Attenuation▶] under **【Ampld/Y Scale】** for more details.

[Res BW **Auto Man**]

See [Res BW Auto ON/OFF] under **【BW】** for more details.

[Video BW AutoMan]

See [Video BW AutoMan] under **【BW】** for more details.

[Sweep Time Auto Man]

See [Sweep Time Auto Man] under **【Sweep】** for more details.

[CF Step AutoMan]

See [CF Step Auto Man] under **【Frequency】** for more details.

5.2.5.6 Trace

Press **【Trace】** key on the front panel to pop up corresponding soft menu Including [Clear Write], [Trace Average], [Max Hold], [Min Hold], [View/Blank On/Off] [More 1/2▶] and [Detector▶].

[Clear Write]

- Command description: to set the current trace processing as Refresh, i.e., clear all data of displayed trace and continue the signal trace receipt under sweep status.
- Key path: **【Trace】** , [Clear Write] on the front panel.
- Status saved: saved in the instrument status.
- Factory preset: after all traces are selected, the trace mode is defaulted as Refresh.
- **Remote Command:**

```
:trace:acpower:TYPE write
```

```
:trace:acpower:TYPE?
```

[Trace Average]

- Command description: to set the current trace processing method as Average, i.e., based on the average count N set in the **【Meas Setup】** , update trace after averaging the performance index of the measurement trace.
- Key path: **【Trace】** , [Trace Average] on the front panel.
- Status saved: saved in the instrument status.
- Factory preset: all trace modes are defaulted as Refresh.
- **Remote Command:**

```
:trace:acpower:TYPE average
```

```
:trace:acpower:TYPE?
```

[Max Hold]

- Menu description: to set the current trace processing method as maximum hold, i.e., the new trace data will be assigned with maximum value of previous measured trace data.
- Key path: **【Trace】** , [Max Hold] on the front panel.

5.2. Description of menu

- Status saved: saved in the instrument status.
- Factory preset: all trace modes are defaulted as Refresh.
- **Remote Command:**

:trace:acpower:TYPE maxhold

:trace:acpower:TYPE?

[Min Hold]

- Menu description: to set the current trace processing method as minimum hold, i.e., the new trace data will be assigned with minimum value of previous measured trace data.
- Key path: **【Trace】** , [Min Hold] on the front panel.
- Status saved: saved in the instrument status.
- Factory preset: all trace modes are defaulted as Refresh.
- **Remote Command:**

:trace:acpower:TYPE minhold

:trace:acpower:TYPE?

[View/Blank▶]

Trace On]

- More description: to set the display method for the selected trace from [Trace On], [View], [Background] and [Blank].
- Key path: **【Trace】** , [View/Blank▶] on the front panel.
- Status saved: saved in the instrument status.
- Factory preset: all trace display modes are defaulted as Refresh.
- **Remote Command:**

:trace:acpower:display[:state] ON|OFF|0|1

:trace:acpower:display[:state]?

:trace:acpower:update[:state] ON|OFF|0|1

:trace:acpower:update[:state]?

[Detector ▶]

Pop up soft More related to setting the detector type for the currently selected trace, including [Auto], [Normal], [Peak], [Sample], [Negative Peak], [Trace Average▶], where, the average detector type includes Log-Pwr Avg, Log-Pwr Avg and Voltage Avg.

[Auto]

- Menu description: to set the detector command for the currently selected trace as Auto. That means, the signal/spectrum analyzer will perform based on the parameter setting of currently selected trace.
- Key path: **【Trace】** , [More 1/2▶], [Detector ▶], [Auto] on the front panel

5.2. Description of menu

- Status saved: saved in the instrument status.
- Factory preset: the trace detector type is Power Average.
- **Remote Command:**

:acpower:detector:AUTO ON|OFF|1|0

:acpower:detector:AUTO?

[Normal]

- Menu description: to set the detector command for the currently selected trace as Normal. I.e., display the measurement results of Peak and negative peak at the same time to achieve display effect similar to the analog instrument.
- Key path: **【Trace】** , [More 1/2▶], [Detector ▶], [Normal] on the front panel.
- Status saved: saved in the instrument status.
- **Remote Command:**

:acpower:detector normal

:acpower:detector?

[Peak]

- Menu description: to set the detector command for the currently selected trace as Peak. I.e., take the maximum value from sampling data assigned to each trace point.
- Key path: **【Trace】** , [More 1/2▶], [Detector▶], [Peak] on the front panel.
- Status saved: saved in the instrument status.
- **Remote Command:**

:acpower:detector positive

:acpower:detector?

[Sample]

- Menu description: to set the detector command for the currently selected trace as Sample. I.e., take the last value from sampling data assigned to each trace point.
- Key path: **【Trace】** , [More 1/2▶], [Detector▶], [Sample] on the front panel.
- Status saved: saved in the instrument status.
- **Remote Command:**

:acpower:detector sample

:acpower:detector?

[Negative Peak]

- Menu description: to set the detector command for the currently selected trace as Negative Peak. I.e., take the minimum value from sampling data assigned to each trace point.
- Key path: **【Trace】** , [More 1/2▶], [Detector▶], [Negative Peak] on the front panel.

5.2. Description of menu

- Status saved: saved in the instrument status.
- **Remote Command:**

:acpower:detector negative

:acpower:detector?

[Average ▶

Video Average]

- Menu description: to set the detector command for the currently selected trace as Video Average. Also called Logarithm Power Average Detector, i.e., take the logarithm power average value for all data assigned to each trace point; earlier signal/spectrum analyzer generally displays the measurement trace of logarithm scale, and all filtering and averaging are based on the logarithm power data; the trace is generally called as video signal. After digital IF processing is adopted, to make measurement results same as the earlier signal/spectrum analyzer, the video average detector function is added.
- Key path: **【Trace】** , [More 1/2▶], [Detector▶], [Trace Average▶], [Log-Pwr Avg] on the front panel.
- Status saved: saved in the instrument status.

- **Remote Command:**

:acpower:detector LOG

:acpower:detector?

[Average ▶

Power Average]

- Menu description: to set the detector command for the currently selected trace as Power Average. Also called root mean square (RMS) detector. Calculate the root mean square of all sampling data assigned to each trace point; the 4051 signal/spectrum analyzer envelopes the detector for the RF input signal and obtains linear voltage. After square these voltage values, take sum and divide the count of sampling data points corresponding to each trace point. Finally, take square root. When the scale is logarithm, take 20 times of logarithm transformation for these RMS values (with 10 as base) and obtain the trace data. When the scale type is linear, those RMS values are trace data.
- Key path: **【Trace】** , [More 1/2▶], [Detector▶], [Trace Average▶], [Pwr Avg] on the front panel.
- Status saved: saved in the instrument status.
- **Remote Command:**

:acpower:detector average or

:acpower:detector RMS

:acpower:detector?

[Average ▶

Average Voltage]

- Menu description: to set the detector command for the currently selected trace as Voltage Average. Also called average (AVG) detector. Take linear average for all sampling data assigned to each trace point; the 4051 signal/spectrum analyzer envelopes the detector for the RF input signal and obtains linear voltage. After summing those voltage values, divide the number of sampling data points corresponding to each trace point. When the scale is logarithm, take 20 times of logarithm transformation for these RMS values

5.2. Description of menu

(with 10 as base) and obtain the trace data. When the scale type is linear, those average values are trace data.

- Key path: **【Trace】** , [More 1/2▶], [Detector▶], [Trace Average▶], [Voltage Avg] on the front panel.
- Status saved: saved in the instrument status.
- **Remote Command:**

:acpower:detector scalar

:acpower:detector?

5.2.5.7 Sweep

Enable sweep-related parameter setup function to pop up corresponding soft More, including [Sweep Time AutoMan], [Sweep Setup▶] and [Sweep Points].

[Sweep Time Auto Man]

- Menu description: to change the sweep time of signal/spectrum analyzer. Use the number keys, step keys or knob to adjust the sweep time. When it is under Auto OFF mode (shaded), it indicates that sweep time can be set manually. When it is under Auto ON status, the sweep time will be automatically coupled based on resolution bandwidth, span and video bandwidth
- Key path: **【Sweep】** , [Sweep Time Auto Man] on the front panel.
- Status saved: saved in the instrument status.
- Factory preset: sweep time Auto.
- Setting range: Min.: 1ms, Max.: 6000s.
- Default unit: s
- **Remote Command:**

:acpower:sweep:TIME <time>

:acpower:sweep:TIME?

:acpower:sweep:TIME:AUTO OFF|ON|0|1

:acpower:sweep:TIME:AUTO?

- **Examples:**

:ACP:SWE:TIME 500 ms

:ACP:SWE:TIME:AUTO OFF

[Sweep Setup▶]

Pop up the soft More related to Sweep type, including [Sweep Type Auto Man], [Sweep Type Rules Auto Man] and [FFT Width Auto Man].

[Sweep Type▶

Auto Man]

- Menu description: to set sweep type. To determine whether Swept or FFT is adopted for frequency spectrum measurement. Also set the FFT step bandwidth for FFT sweep The soft More include [Auto], [Swept] and [FFT]. When under Auto ON mode, the signal/spectrum analyzer will automatically select the sweep type based on sweep type rules.

5.2. Description of menu

- Key path: **【Sweep】** , [Sweep Setup ▶], [Sweep Type **AutoMan**] on the front panel.
- Status saved: saved in the instrument status.
- Factory preset: sweep type: Auto.
- **Remote Command:**

```
:acpower:sweep:TYPE FFT|sweep
```

```
:acpower:sweep:TYPE?
```

```
:acpower:sweep:TYPE:AUTO OFF|ON|0|1
```

```
:acpower:sweep:TYPE:AUTO?
```

[Sweep Type Rules **Auto Man**]

- Menu description: to set rules for auto sweep type. While the sweep type rules include “Best Dynamic Range” and “Best Speed”.
 “Best Dynamic Range” rules: when RBW is or larger than 1kHz, the sweep type is Swept; when RBW is less than 1kHz, the sweep type is FFT.
 “Best Speed” rules: when RBW is or larger than 30kHz, the sweep type is Swept; when RBW is less than 30kHz, the sweep type is FFT.
- Key path: **【Sweep】** , [Sweep Setup ▶], [Sweep Type Rules **Auto Man**] on the front panel.
- Status saved: saved in the instrument status.
- Factory preset: the sweep type rules are automatically set as “Best Dynamic Range”.

- **Remote Command:**

```
:acpower:sweep:TYPE:AUTO:rules speed|drange
```

```
:acpower:sweep:TYPE:AUTO:rules?
```

```
:acpower:sweep:TYPE:AUTO:rules:AUTO OFF|ON|0|1
```

```
:acpower:sweep:TYPE:AUTO:rules:AUTO?
```

[FFT Width **Auto Man**]

- Menu description: to set FFT Width. The FFT width includes [Auto], [<100kHz], [<3 MHz], [<13 MHz], [<=Max.]. FFT width is only active when the FFT sweep type is selected. Under Auto type, when the signal/spectrum analyzer performs FFT spectrum measurement, the maximum resolution bandwidth is 30kHz. To guarantee best dynamic measurement range, the signal/spectrum analyzer automatically optimizes the FFT width within 100kHz. The larger is the FFT width, the faster is FFT spectrum measurement, but the dynamic range performance will be affected.

Under FFT sweep, the FFT width setup limits the maximum value for center frequency step of each tune. For example, if [<100Hz] is selected, the maximum value for center freq step of each tune is 100Hz. As the FFT width gets larger, the count of instrument center frequencies get smaller when performing measurement of same frequency scope, and the response measurement gets faster. Therefore, to improve measurement speed, you can manually change the FFT width.

- Key path: **【Sweep】** , [Sweep Setup▶], [FFT Width▶] on the front panel.
- Status saved: saved in the instrument status.
- Factory preset: FFT Width is set as Auto.
- **Remote Command:**

5.2. Description of menu

```
:acpower:sweep:FFT:width <real>
:acpower:sweep:FFT:width?
:acpower:sweep:FFT:width:AUTO OFF|ON|0|1
:acpower:sweep:FFT:width:AUTO?
```

[Sweep points]

- Menu description: to set the trace points.
- Key path: **【Sweep】** , [Sweep Points] on the front panel.
- Status saved: saved in the instrument status.
- Factory preset: 1001.
- Setting range: 101-30001.
- **Remote Command:**

```
:acpower:sweep:points <integer>
:acpower:sweep:points?
```

5.2.5.8 Single

- Menu description: the **【Single】** key on the front panel has no corresponding soft menu. This function is mainly used for manual trigger of a sweep. When the Average is ON, this function performs the sweeps at the count specified by the Average Count.

In remote control programming and system establishment, this function combined with *WAI can effectively synchronize the sweep process and enable the trace data obtained after the *WAI finishes directly correspond to the sweep process one by one.

- **Remote Command:**

```
:initiate:acpower
```

5.2.5.9 Continuous

The **【Cont】** key on the front panel has no corresponding soft menu. This function is mainly used for changing the Continuous OFF into Continuous ON; if the current sweep is Continuous ON, the instrument performs no operation.

- **Remote Command:**

```
:initiate:continuous ON
```

5.2.5.10 Trigger

See **【Trig】** menu of the sweep analysis function for more details.

5.2.5.11 Display

Pop up soft More related to display, including [Display Line On **Off**], [Bar Graph **On** Off], [Display Config ▶].

[Display Line ON **OFF]**

See [Display Line ON/**OFF**] under **【Display】** of the sweep analysis function for more details.

5.2. Description of menu

[Display Config▶]

It is used for configurations of interface language, status area display on interface. The soft menus include [Select Language 中文 English], [Graticule Display ON OFF], Status Area Display ON OFF], [Frequency Information Display ON OFF]. See [Display Config▶] under **【Display】** of the sweep analysis function for more details.

[Bar Graph ON OFF]

Menu description: to turn on or off Bar Graph Display.

•Key path: **【Display】** on the front panel.

Status saved: saved in the instrument status.

• Factory preset: ON

•Remote Command:

```
:display:acpower:VIEW>window:bgraph ON|OFF|1|0
```

```
:display:acpower:VIEW>window:bgraph?
```

5.2.5.12 Input Output

See the **【Input/Output】** menu of the sweep analysis function for more details.

5.2.5.13 Marker

Pop up the soft More related to markers, including [Select Marker▶], [Normal], [Marker Delta], [Fixed], [Off], [Properties▶], [Marker Couple On Off], and [All Markers Off].

[Select Marker▶]

Marker 1]

- Command description: to select among 12 different markers of the analyzer. When a certain marker is selected, the marker will be indicated in the menu where its type and attribute can be set. Select and trigger another marker and place it at the center of the current trace. Users can read amplitude and frequency information (when the frequency span is 0 Hz, time information will be displayed) at the marker display area at the top right corner of the screen.
- Key path: Marker], [Select Marker▶] on the front panel.
- Status saved: saved in the instrument status.
- Factory preset: Marker 1.

[Normal]

- Menu description: to set the selected marker as the Normal Marker.
- Key path: **【Marker】** , [Normal] on the front panel.
- Status saved: saved in the instrument status.
- **Remote Command:**

```
:calculate:acpower:marker[1|2|3|4|5|6|7|8|9|10|11|12]:MODE position
```

```
:calculate:acpower:marker[1|2|3|4|5|6|7|8|9|10|11|12]:MODE?
```

5.2. Description of menu

[Marker Delta]

- Menu description: to set the selected marker as the Marker Delta. Display the amplitude difference and frequency difference (or time difference, when span is zero) between two markers at the marker display area at the top right corner of the screen. If there exists a single marker, a [Marker Delta] operation will generate a Ref marker in the active marker position. Move the active marker through the knob, stepping keys or number keys. The display amplitude difference unit is dB.
- Key path: **【Marker】** , [Marker Delta] on the front panel.
- Status saved: saved in the instrument status.
- **Remote Command:**

```
:calculate:acpower:marker[1|2|3|4|5|6|7|8|9|10|11|12]:MODE delta
```

```
:calculate:acpower:marker[1|2|3|4|5|6|7|8|9|10|11|12]:MODE?
```

[Fixed]

- Menu description: to set the selected marker as the Fixed Marker. The X Axis and Y Axis positions of the fixed marker are fixed. The Fixed Marker can be used as reference marker.
- Key path: **【Marker】** , [Fixed] on the front panel.
- Status saved: saved in the instrument status.
- **Remote Command:**

```
:calculate:acpower:marker[1|2|3|4|5|6|7|8|9|10|11|12]:MODE fixed
```

```
:calculate:acpower:marker[1|2|3|4|5|6|7|8|9|10|11|12]:MODE?
```

[Off]

- Menu description: to turn off the selected marker.
- Key path: **【Marker】** , [Off] on the front panel.
- Status saved: saved in the instrument status.
- **Remote Command:**

```
:calculate:chpower:marker[1|2|3|4|5|6|7|8|9|10|11|12]:MODE OFF
```

```
:calculate:acpower:marker[1|2|3|4|5|6|7|8|9|10|11|12]:MODE?
```

[Properties▶]

Pop up the corresponding More of currently selected marker attribute setup, including [Select Marker▶], [Ref Marker▶], [Marker Display Line On/Off].

[Ref Marker▶]

- Menu description: to select reference marker for current marker. It can be any one from 11 markers except the currently selected marker.
- Key path: **【Marker】** , [Properties▶], [Ref Marker▶] on the front panel.
- Status saved: saved in the instrument status.
- **Remote Command:**

5.2. Description of menu

:calculate:acpower:marker[1|2|3|4|5|6|7|8|9|10|11|12]:reference <integer>

:calculate:acpower:marker[1|2|3|4|5|6|7|8|9|10|11|12]:reference?

[Marker Display Line ON OFF]

- Menu description: to set whether the current marker is displayed as a line on the screen, which is easy to observe.
- Key path: **【Marker】** , [Properties▶] and [Marker Display Line On/Off] on the front panel.
- Status saved: saved in the instrument status.
- Factory preset: OFF.
- **Remote Command:**

:calculate:acpower:marker[1|2|3|4|5|6|7|8|9|10|11|12]:lines[:state] OFF|ON|0|1

:calculate:acpower:marker[1|2|3|4|5|6|7|8|9|10|11|12]:lines[:state]?

[Marker Couple ON OFF]

- Menu description: to turn on or off Marker Couple. When it is ON, moving any marker horizontal axis position will cause an equal movement of horizontal axis position of every other marker which is ON. When the marker is moved to less than Start Frequency or larger than Stop Frequency, the marker is limited to the value of the Start Frequency or the Stop Frequency; when the span is zero, the minimum value is limited as 0, and the maximum value is limited as the Sweep Time.
- Key path: **【Marker】** , [More 1/2▶], [Marker Couple ON/OFF] on the front panel.
- Status saved: saved in the instrument status.
- Factory preset: OFF.
- **Remote Command:**

:calculate:acpower:marker:couple[:state] ON|OFF|1|0

:calculate:acpower:marker:couple[:state]?

[All Markers Off]

- More description: to turn off all current markers which are On and related soft keys, e.g. [Noise Marker].
- Key path: **【Marker】** , [More 1/2▶], [All Markers Off] on the front panel.
- Status saved: not saved in instrument status.
- **Remote Command:**

:calculate:acpower:marker:AOFF

5.2.5.14 Maker->

This key has no soft menu.

5.2.5.15 Marker Function

This key has no soft menu.

5.2.5.16 Peak

5.2. Description of menu

The **【Peak Search】** key on the front panel is used for turning on the peak search for traces by the control instrument and turning on marker for display, including [Next Peak], [Next Pk Right], [Next Pk Left].

- **Remote Command:**

:calculate:acpower:marker[1|2|3|4|5|6|7|8|9|10|11|12]:maximum

[Next Peak]

- Menu description: Taking the Amplitude of the point where the current marker is located, search for the next peak of current test trace.
- Key path: **【Peak Search】** , [Next Peak] on the front panel.
- Status saved: not saved in instrument status.
- **Remote Command:**

:calculate:acpower:marker[1|2|3|4|5|6|7|8|9|10|11|12]:maximum:NEXT

[Next Pk Right]

- Menu description: to search for the peak to the right of the current test trace marker position.
- Key path: **【Peak Search】** , [Next Pk Right] on the front panel.
- Status saved: not saved in instrument status.
- **Remote Command:**

:calculate:acpower:marker[1|2|3|4|5|6|7|8|9|10|11|12]:maximum:right

[Next Peak Left]

- Menu description: to search for the peak to the left of the current test trace marker position.
- Key path: **【Peak Search】** , [Next Pk Left] on the front panel.
- Status saved: not saved in instrument status.
- **Remote Command:**

:calculate:acpower:marker[1|2|3|4|5|6|7|8|9|10|11|12]:maximum:LEFT

5.2.5.17 Measurement Setting

Pop up the soft menu related to measurement setting, including [Average Num On/Off], [Average Mode Exponential Repeat], [Carrier Setup▶], [Offset Limit▶], [phnoise Opt▶], [Ref Type▶], [Meas Method▶], [Limit Test On/Off], [Low Noise Path On/Off], [Preselector Preselecting Bypass], [RF Gain▶], [ADC Dither Auto On/Off] and [Meas Preset].

[Average Num ON OFF]

- Menu description: to turn on or off Average. When Average Count is ON, the user can specify the average count required for measurement. The Average Count can be adjusted by number keys, stepping keys or knob.
- Key path: **【Meas Setup】** , [Average Num ON OFF] on the front panel.
- Status saved: saved in the instrument status.
- Factory preset: 100/off.
- Setting range: 1~10000
- Default unit: none

5.2. Description of menu

- **Remote Command:**

```
[sense]:acpower:average:count <integer>
```

```
[sense]:acpower:average:count?
```

```
[sense]:acpower:average[:state] ON|OFF|1|0
```

```
[sense]:acpower:average[:state]?
```

[Average Mode **Exponential Repeat**]

- Menu description: when Average Count is ON, the user can select Average State required for measurement.

Exponential - Different from Linear Average, in Exponential State, the weight of new data is larger than that of old data. This is good for tracking data change in terms of time. In this case, the selected averaging count determines the weight of the old data on the new data. As the average count increases, the weight of new data gradually decreases. This is good for tracking data change in terms of time. In this case, the selected averaging count determines the weight of the old data on the new data. As the average count increases, the weight of new data gradually decreases.

Repeat - Similarly, it takes exponential averaging. However, when the average count is met, clear all previous results, restart average till the set average count and repeat this process.

- Key path: **【Meas Setup】** , [Average Mode Exponential Repeat] on the front panel.
- Status saved: saved in the instrument status.
- Factory preset: Exponential.
- **Remote Command:**

```
[sense]:acpower:average:tcontrol exponential|repeat
```

```
[sense]:acpower:average:tcontrol?
```

[Carrier Setup▶]

- Menu description: to access the Carrier Setting menu to set the Carrier Count and Reference Carrier parameters.
- Key path: **【Meas Setup】** , [Filter Setup] on the front panel.

[Carriers]

- Menu description: to select the Carrier Count menu to specify the number of carriers to be measured. Use number keys, stepping keys or knob to change the Carrier Count.
- Key path: **【Meas Setup】** , [Carrier Setup▶], [Carriers] on the front panel.
- Status saved: saved in the instrument status.
- Factory preset: 1.
- Setting range: 1~12
- Default unit: none
- **Remote Command:**

```
[sense]:acpower:carrier:count <integer>
```

```
[sense]:acpower:carrier:count?
```

[Ref Carrier Auto Man]

- Command description: to select the Reference Carrier (Auto ON) menu to specify a carrier. Other related power measurements will be made according to this carrier. When the Reference Carrier is set to Auto ON, the instrument selects the one with largest power as reference; when set to Auto OFF, use number keys, stepping keys or knob to change the Reference Carrier.
- Key path: **【Meas Setup】** , [Carrier Setup▶], [Ref Carrier Auto Man] on the front panel.
- Status saved: saved in the instrument status.
- Factory preset: Auto.
- Setting range: 1 ~ current carrier count.
- Default unit: none
- **Remote Command:**

```
[sense]:acpower:carrier:rcarrier <integer>
```

```
[sense]:acpower:carrier:rcarrier?
```

```
[sense]:acpower:carrier:rcarrier:AUTO OFF|ON|0|1
```

```
[sense]:acpower:carrier:rcarrier:AUTO?
```

[Config Carriers▶]

- Menu description: to access the Carrier Configure menu to further define each carrier.
- Key path: **【Meas Setup】** , [Carrier Setup▶], [Config Carriers] on the front panel.

[Carrier]

- Menu description: to select the carrier index to be configured. Use number keys, stepping keys or knob to change the carrier.
- Key path: **【Meas Setup】** , [Carrier Setup▶], [Config Carriers▶], [Carrier] on the front panel.
- Status saved: saved in the instrument status.
- Factory preset: 1
- Setting range: 1 ~ current carrier count.
- Default unit: none

[Carrier Pwr Present Absolute Relative]

- Menu description: to specify the carrier with power display. Firstly, press the [Carrier] key and use stepping keys, knob or number keys to select the Carrier Count to be defined. Then switch the [Carrier Pwr Present] as Abs Or Rel. If a carrier is defined as non-power display, the displayed power is relative to the reference carrier; otherwise, an absolute power is displayed.
- Key path: **【Meas Setup】** , [Carrier Setup▶], [Config Carriers▶], [Carrier Pwr Present Abs/Rel] on the front panel.
- Status saved: saved in the instrument status.
- Factory preset: Absolute.

5.2. Description of menu

- **Remote Command:**

```
[[:sense]:acpower:carrier:LIST:ppresent YES|NO,..
```

```
[[:sense]:acpower:carrier:LIST:ppresent?
```

[Carrier Spacing]

- Menu description: to specify the width between adjacent carriers. Firstly, press the [Carrier] key and use stepping keys, knob or number keys to select the carrier to be defined. Then, press the [Carrier Width] key and use stepping keys, knob or number keys to set the Carrier Width.
- Key path: **【Meas Setup】** , [Carrier Setup▶], [Config Carriers▶], [Carrier Spacing] on the front panel.
- Status saved: saved in the instrument status.
- Factory preset: 0 MHz
- **Setting range:** 0Hz - 1.0GHz.
- Default unit: Hz.
- **Remote Command:**

```
[[:sense]:acpower:carrier:LIST:width <bandwidth>,...
```

```
[[:sense]:acpower:carrier:LIST:width?
```

[Integration BW]

- Menu description: to set the integration bandwidth for calculating carrier power. Firstly, press the [Carrier] key and use stepping keys, knob or number keys to select the carrier to be defined. Then, press the [Integration Bandwidth] key and use stepping keys, knob or number keys to set the Integration Bandwidth.
- Key path: **【Meas Setup】** , [Carrier Setup▶], [Config Carriers▶], [Integration BW] on the front panel.
- Status saved: saved in the instrument status.
- Factory preset: 2.0 MHz
- **Setting range:** 100Hz - 1.0GHz.
- Default unit: Hz.
- **Remote Command:**

```
[[:sense]:acpower:carrier:LIST:bandwidth[:integration] <freq>,...
```

```
[[:sense]:acpower:carrier:LIST:bandwidth[:integration]?
```

[Method▶]

- Menu description: to select the calculation method for measuring carrier power.
- Key path: **【Meas Setup】** , [Carrier Setup▶], [Config Carrier▶], [Method] on the front panel.
- Status saved: saved in the instrument status.
- Factory preset: Bandwidth Integration.
- **Remote Command:**

```
[[:sense]:acpower:carrier:LIST:filter[:RRC][:state] ON|OFF|1|0, ...
```

[[:sense]:acpower:carrier:LIST:filter[:RRC][:state] ?

[BW Integration]

- Menu description: to select the calculation method as Bandwidth Integration method.
- Key path: **【Meas Setup】** , [Carrier Setup▶], [Config Carriers▶], [Method▶], [BW Integration] on the front panel.

[RRC Weighting]

- Menu description: to select the calculation method as RRC Weighting.
- Key path: **【Meas Setup】** , [Carrier Setup▶], [Config Carriers▶], [Method▶], [RRC Weight] on the front panel.

[Filter Factor a]

- Menu description: to set the Filter Factor a if RRC Weighting method is used. The influence factors of RRC Filter will be considered in calculating the measurement results. Use number keys, stepping keys or knob to change the Filter Factor a.
- Key path: **【Meas Setup】** , [Carrier Setup▶], [Config Carriers▶], [Filter Alpha] on the front panel.
- Status saved: saved in the instrument status.
- Factory preset: 0.22
- **Setting range:** 0.01~1.0
- Default unit: none
- **Remote Command:**

[[:sense]:acpower:carrier:LIST:filter:alpha <real>,...

[[:sense]:acpower:carrier:LIST:filter:alpha?

[Offset/Limit▶]

- Menu description: to set the measurement offset and limit.
- Key path: **【Meas Setup】** , [Offset/Limit▶] on the front panel.

[Offset▶]

- Menu description: to select the offset to be set.
- Key path: **【Meas Setup】** , [Offset/Limit▶], [Offset▶] on the front panel.
- Status saved: saved in the instrument status.
- Factory preset: A.

[Offset Freq]

- Menu description: to set the center frequency difference between the offset channel and carrier channel. Upper channel offset is the frequency difference between the offset channel center and the highest carrier channel center, while lower channel offset is the frequency difference between the offset channel center

5.2. Description of menu

and the lowest carrier channel center. If set to 0Hz, the Offset Channel will close. Use stepping keys, knob or number keys to set the Offset Frequency.

- Key path: **【Meas Setup】** , [Offset/Limit▶], [Offset Freq] on the front panel.
- Status saved: saved in the instrument status.
- Factory preset: 3.0 MHz
- **Setting range:** 0Hz - 500.0 MHz.
- Default unit: Hz.
- **Remote Command:**

```
[[:sense]:acpower:offset:LIST[:frequency] <freq>,...
```

```
[[:sense]:acpower:offset:LIST[:frequency]?
```

```
[[:sense]:acpower:offset:LIST:state OFF|ON|0|1,...
```

```
[[:sense]:acpower:offset:LIST:state?
```

[Integration BW]

- Menu description: to set the Power Integration bandwidth under the selected offset. Use stepping keys, knob or number keys to set the Integration Bandwidth.
- Key path: **【Meas Setup】** , [Offset/Limit▶], [Integration BW] on the front panel.
- Status saved: saved in the instrument status.
- Factory preset: 2.0 MHz
- **Setting range:** 10Hz - 1.0GHz.
- Default unit: Hz.
- **Remote Command:**

```
[[:sense]:acpower:offset:LIST:bandwidth[:integration] <bandwidth>,...
```

```
[[:sense]:acpower:offset:LIST:bandwidth[:integration]?
```

[Offset BW▶]

- Menu description: to set the bandwidth parameters for measuring offset.
- Key path: **【Meas Setup】** , [Offset/Limit▶], [Offset BW▶] on the front panel.

[Res BW **Auto Man**]

- Menu description: to set the instrument Resolution Bandwidth for measuring offset. Use stepping keys, knob or number keys to set the Resolution Bandwidth.
- Key path: **【Meas Setup】** , [Offset/Limit▶], [Offset BW▶], [Res BW Auto Man] on the front panel.
- Status saved: saved in the instrument status.
- Factory preset: 220kHz
- **Setting range:** 1Hz - 20 MHz.
- Default unit: Hz.
- **Remote Command:**

5.2. Description of menu

[[:sense]:acpower:offset:LIST:bandwidth:resolution <bandwidth>, ...

[[:sense]:acpower:offset:LIST:bandwidth:resolution?

[[:sense]:acpower:offset:LIST:bandwidth:resolution? AUTO N|OFF|1|0,...

[[:sense]:acpower:offset:LIST:bandwidth:resolution? AUTO?

[Video BW **Auto Man]**

- Menu description: to set the instrument Video Bandwidth for measuring offset. Use stepping keys, knob or number keys to set the Video Bandwidth.
- Key path: **【Meas Setup】** , [Offset/Limit▶], [Offset BW▶], [Video BW Auto Man] on the front panel.
- Status saved: saved in the instrument status.
- Factory preset: 2.2 MHz
- **Setting range:** 1Hz - 20 MHz.
- Default unit: Hz.
- **Remote Command:**

[[:sense]:acpower:offset:LIST:bandwidth:video <freq>,...

[[:sense]:acpower:offset:LIST:bandwidth:video?

[[:sense]:acpower:offset:LIST:bandwidth:video:AUTO OFF|ON|0|1,...

[[:sense]:acpower:offset:LIST:bandwidth:video:AUTO?

[Filter Type▶]

- Menu description: to set the Bandwidth Filter Type for measuring offset.
- Key path: **【Meas Setup】** , [Offset/Limit▶], [Offset BW▶], [Filter Type▶] on the front panel.
- Status saved: saved in the instrument status.
- Factory preset: Gaussian.
- **Remote Command:**

[[:sense]:acpower:offset:LIST:bandwidth:shape gaussian|flattop,...

[[:sense]:acpower:offset:LIST:bandwidth:shape?

[Gaussian]

- Menu description: to select the Bandwidth Filter Type as Gaussian.
- Key path: **【Meas Setup】** , [Offset/Limit▶], [Offset BW▶], [Filter Type▶], [Gaussian] on the front panel.

[Flattop]

- Menu description: to select the Bandwidth Filter Type as Top Flat.
- Key path: **【Meas Setup】** , [Offset/Limit▶], [Offset BW▶], [Filter Type▶], [Flattop] on the front panel.

[Filter BW▶]

5.2. Description of menu

- Menu description: to set the Filter Bandwidth type.
- Key path: **【Meas Setup】** , [Offset/Limit▶], [Offset BW▶], [Filter BW▶] on the front panel.
- Status saved: saved in the instrument status.
- **Factory preset:** -3 dB.
- **Remote Command:**

```
[[:sense]:acpower:offset:LIST:bandwidth:TYPE DB3|DB6,...
```

```
[[:sense]:acpower:offset:LIST:bandwidth:TYPE?
```

[-3dB]

- Menu description: to set the Filter Bandwidth type as 3 dB bandwidth.
- Key path: **【Meas Setup】** , [Offset/Limit▶], [Offset BW▶], [Filter BW▶], [-3dB] on the front panel.

[-6dB]

- Menu description: to set the Filter Bandwidth type as 6 dB Bandwidth.
- Key path: **【Meas Setup】** , [Offset/Limit▶], [Offset BW▶], [Filter BW▶], [-6dB] on the front panel.

[Limit▶]

- Menu description: to set the offset limit and test template type.
- Key path: **【Meas Setup】** , [Offset/Limit▶], [Limit▶].

[Absolute Limit]

- Menu description: to set the limit absolute power value. Use stepping keys, knob or number keys to set the Absolute Limit.
- Key path: **【Meas Setup】** , [Offset/Limit▶], [Offset BW▶], [Limit▶], [Abs Limit] on the front panel.
- Status saved: saved in the instrument status.
- Factory preset: 0dBm
- Setting range:-200dBm ~50dBm
- Default unit: dBm.
- **Remote Command:**

```
[[:sense]:acpower:offset:LIST:absolute <real>,...
```

```
[[:sense]:acpower:offset:LIST:absolute?
```

[Relative Limit (Car)]

- Menu description: to set the limit power value relative to the carrier power. Use stepping keys, knob or number keys to set the Limit.
- Key path: **【Meas Setup】** , [Offset/Limit▶], [Offset BW▶], [Limit▶], [Rel Limit (Car)] on the front panel.
- Status saved: saved in the instrument status.

5.2. Description of menu

- Factory preset: -45 dB.
- Setting range: - 200.0dB ~50dB
- Default unit: dB.
- **Remote Command:**

`[[:sense]:acpower:offset:LIST:rcarrier <real>,...`

`[[:sense]:acpower:offset:LIST:rcarrier?`

[Relative Limit (PSD)]

- Menu description: to set the limit power value relative to the spectral density. Use stepping keys, knob or number keys to set the Limit.
- Key path: **【Meas Setup】**, [Offset/Limit▶], [Offset BW▶], [Limit▶], [Rel Limit (PSD)] on the front panel.
- Status saved: saved in the instrument status.
- Factory preset: -28.87 dB.
- Setting range: - 200.0dB ~50dB
- Default unit: dB.
- **Remote Command:**

`[[:sense]:acpower:offset:LIST:rpsdensity <rel_ampl>,...`

`[[:sense]:acpower:offset:LIST:rpsdensity?`

[Fail Mask▶]

- Menu description: to set the Limit Test Type for currently selected offset, including:
 Absolute: When measured absolute result exceeds the absolute limit value, the test failed.
 Relative: When measured relative result exceeds the relative limit value, the test failed.
 Absolute and relative: When measured absolute results exceeds the absolute limit value, and measured relative result exceeds the relative limit value, the test failed.
 Absolute or relative: When measured absolute results exceeds the absolute limit value, or measured relative result exceeds the relative limit value, the test failed.
- Key path: **【Meas Setup】**, [Offset/Limit▶], [Offset BW▶], [Limit▶], [Fail Mask▶] on the front panel.
- Status saved: saved in the instrument status.
- Factory preset: Absolute
- **Remote Command:**

`[[:sense]:acpower:offset:LIST:TEST absolute|AND|OR|relative,...`

`[[:sense]:acpower:offset:LIST:TEST?`

[Method▶]

- Menu description: to select the calculation method for measuring the offset channel power.
- Key path: **【Meas Setup】** [Offset/Limit▶], [Method▶] on the front panel.

5.2. Description of menu

- Status saved: saved in the instrument status.
- Factory preset: Bandwidth Integration.
- **Remote Command:**

`[[:sense]:acpower:offset:LIST:filter[:RRC][[:state] ON|OFF|1|0],...`

`[[:sense]:acpower:offset:LIST:filter[:RRC][[:state]]?`

[BW Integration]

- Menu description: to select the calculation method as Bandwidth Integration method.
- Key path: **【Meas Setup】** [Offset/Limit▶], [Method▶], [BW Integration] on the front panel.

[RRC Weighting]

- Menu description: to select the calculation method as RRC Weighting.
- Key path: **【Meas Setup】** [Offset/Limit▶], [Method▶], [RRC Weight] on the front panel.

[Filter Factor a]

- Menu description: to set the Filter Factor when using RRC method. The influence factor of RRC Filter will be considered in calculating the measurement result. Use number keys, stepping keys or knob to change the Filter Factor a.
- Key path: **【Meas Setup】** [Offset/Limit▶], [Filter Alpha] on the front panel.
- Status saved: saved in the instrument status.
- Factory preset: 0.22
- **Setting range:** 0.01~1.0
- Default unit: none
- **Remote Command:**

`[[:sense]:acpower:offset:LIST:filter:alpha <real>,...`

`[[:sense]:acpower:offset:LIST:filter:alpha?`

[Carrier Result]

- Menu description: to view the carrier power value. Input carrier index or use number keys, stepping keys or knob to select the viewed carrier.
- Key path: **【Meas Setup】** , [Carrier Result] on the front panel.
- Status saved: saved in the instrument status.
- Factory preset: 1
- Setting range: 1 - Carrier Count
- Default unit: none

[Meas Method▶]

- Menu description: to select the Measurement Method for usage.

5.2. Description of menu

- Key path: **【Meas Setup】** , [More 1/3▶], [Meas Method▶] on the front panel.
- Status saved: saved in the instrument status.
- Factory preset: Bandwidth Integration method
- **Remote Command:**

[:sense]:acpower:method IBW|FAST|RBW [:sense]:acpower:method?

[IBW]

- Menu description: to select the Measurement Method as Bandwidth Integration method.
- Key path: **【Meas Setup】** , [More 1/3▶], [Meas Method▶], [IBW] on the front panel.
- Status saved: saved in the instrument status.

[Fast Measurement Method]

- Method description: to select the Measurement Method as Fast Measurement Method.
- Key path: **【Meas Setup】** , [More 1/3▶], [Meas Method▶], [Quick Meas Method] on the front panel.

[Time Domain Measurement Method]

- Menu description: to select the Measurement Method as Time Domain Measurement Method.
- Key path: **【Meas Setup】** , [More 1/3▶], [Meas Method▶], [Time Domain Meas Method] on the front panel.

[Limit Test ON OFF]

- Menu description: to turn on or off the limit test. If the Limit Test is ON, each offset will be compared to its high-end and low-end limit values. When the power exceeds limit, the red F near the dBc result indicates Fail. All offsets that are OFF will not be measured and their results will not be displayed on the screen.
- Key path: **【Meas Setup】** , [More 1/3▶], [Limit Test ON/OFF] on the front panel.
- Status saved: saved in the instrument status.
- Factory preset: OFF.
- **Remote Command:**

:calculate:acpower:limit:state OFF|ON|0|1

:calculate:acpower:limit:state?

[Low Noise Path ON OFF]

- Menu description: this menu is only available when the H34 option (Low Noise PreAmplifier) is purchased. When the PreAmplifier is ON, the Low Noise Path is OFF and this menu is grayed out; when the PreAmplifier is OFF, this menu lights on and is switchable.
- Key path: **【Meas Setup】** , [More 1/3], [More 2/3], [Low Noise Path ON OFF] on the front panel.
- Status saved: saved in the instrument status.
- **Remote Command:**

5.2. Description of menu

:acpower:power:MW:PATH STD|Inpath

:acpower:power:MW:PATH?

[Preselector **Preselecting Bypass**]

- Menu description: this menu is only available when the H36 option is purchased. It is used for setting whether to bypass the front-end preselector of the signal/spectrum analyzer. In analyzing bandwidth signal, bypass is usually required.
- Key path: **【Meas Setup】** , [More 1/3], [More 2/3], [Preselector Preselecting **Bypass**] on the front panel.
- Status saved: saved in the instrument status.
- **Remote Command:**

Input:acpower:filter:YIG[:state] OFF|ON|0|1

Input:acpower:filter:YIG[:state]?

[RF Gain▶]

- Menu description: to set the Auto ON/OFF of the RF Gain and best allocation algorithm for RF Gain. The soft menus includes [Auto], [Best Dynamic Range] and [Best Sensitivity].

[Auto], [Best Dynamic Range], [Best for Sensitivity].

- Key path: **【Meas Setup】** , [More 1/3], [More 2/3], [RF Gain] on the front panel.
- Status saved: saved in the instrument status.
- **Remote Command:**

:acpower:RF:GAIN:AUTO OFF|ON|0|1

:acpower:RF:GAIN:AUTO?

:acpower:RF:GAIN:AUTO:rules RANGE|SENSITIVITY

:acpower:RF:GAIN:AUTO:rules?

[Auto]

- Menu description: to set the RF Gain distribution algorithm to Auto. In this case, the RF Gain distribution is “Best Dynamic Range”.
- Key path: **【Meas Setup】** , [More 1/3], [More 2/3], [RF Gain▶], [Auto] on the front panel.
- Status saved: saved in the instrument status.

[Best for Dynamic Range]

- Menu description: to set the RF Gain distribution algorithm to Best Dynamic Range. In this case, the RF Gain is switched to “Auto OFF”
- Key path: **【Meas Setup】** , [More 1/3], [More 2/3], [RF Gain▶], [Best Dynamic Range] on the front panel.
- Status saved: saved in the instrument status.

[Best for Sensitivity]

5.2. Description of menu

- Menu description: to set the RF Gain distribution algorithm to Best Sensitivity. In this case, the RF Gain is switched to “Auto OFF”
- Key path: **【Meas Setup】** , [More 1/3], [More 2/3], [RF Gain▶], [Best for Sensitivity] on the front panel.
- Status saved: saved in the instrument status.

[ADC Dither **Auto Man**]

- Menu description: to control opening/closing of ADC dither of the frequency acquisition circuit in the analyzer. Under default mode, the signal/spectrum analyzer will automatically control whether the ADC Dither is ON based on current working condition. When the ADC Dither is under Auto mode, the ON or OFF status depends on the span, resolution bandwidth and sweep type (continuous swept or step sweep); when it is continuous swept, the ADC Dither status will force to switch to Auto and turns off; when it is step sweep, under Auto mode, if the span is 2 MHz or below, the ADC Dither is ON; if the span is below 2 MHz, the ADC Dither is OFF. Under Auto OFF mode, if the span is above 2 MHz, turning on the ADC Dither may affect the measurement results based on selected dither status. You can access the submenu for manual control.
- Key path: **【Meas Setup】** , [More 1/3], [More 2/3], [ADC Dither Auto **Man**] on the front panel.
- Status saved: saved in the instrument status.
- Factory preset: Auto.
- **Remote Command:**

```
[[:sense]:acpower:ADC:dither[:state] OFF|ON|HIGH
```

```
[[:sense]:acpower:ADC:dither[:state]?
```

```
[[:sense]:acpower:ADC:dither:AUTO[:state] OFF|ON|0|1
```

```
[[:sense]:acpower:ADC:dither:AUTO[:state]?
```

[Meas Preset]

- Menu description: to reset the measurement parameters to the factory preset status or user saved parameter status
- Key path: **【Meas Setup】** , [More 1/3], [More 2/3], [Meas Preset] on the front panel.
- Factory preset: factory reset.
- **Remote Command:**

```
:configure:acpower
```

5.2.5.18 Measurement Control

Pop up the More related to Meas Control, including [Measure Single Cont], [Restart] and [Pause/Resume].

[Measure Continuous **ON OFF**]

- Menu description: to set continuous measurement OFF or ON. When the [Measure Single **Cont**] is set as Cont mode, Cont On mode will be triggered and Cont sweep will be the default measure control method; when the [Measure Single Cont] is set as Single mode, single sweep will be triggered. Press **【Sweep Single】** to restart sweep when the next trigger signal arrives.
- Key path: **【Meas Control】** , [Meas Single Cont **ON OFF**] on the front panel.
- Status saved: saved in the instrument status.

5.2. Description of menu

- Factory preset: Continuous On.
- **Remote Command:**

:initiate:continuous OFF|ON|0|1

:initiate:continuous?

- **Examples:**

:INIT:CONT OFF

[Restart]

- Menu description: to stop current measurement and restart measurement for the signal/spectrum analyzer.
- Key path: **【Meas Control】** , [Restart] on the front panel
- Status saved: not saved in instrument status.
- **Remote Command:**

:initiate:REST

[Pause/Resume]

- Menu description: when the signal/spectrum analyzer is in operation, this menu is used for pausing current measurement; when in Paused status, this menu is used for continuing measurement.
- Key path: **【Meas Control】** , [Pause/Resume] on the front panel.
- Status saved: not saved in instrument status.
- **Remote Command:**

:initiate:PAUS

:initiate:RES

5.2.6 Power Statistic

5.2.6.1 Frequency

The **【Frequency】** key on the front panel is used to set parameters related to the signal/spectrum analyzer frequency, including [Center Freq], [CF Step Auto Man], [Freq Offset]. See the **【Frequency】** menu of the sweep analysis function for more details.

[Center Freq]

See the [Center Freq] under **【Frequency】** of the sweep analysis function for more details.

[CF Step **Auto Man**]

See the [CF Step **Auto Man**] under **【Frequency】** of the sweep analysis function for more details.

[Freq Offset]

See the [Freq Offset] under **【Frequency】** of the sweep analysis function for more details.

5.2.6.2 Ampld/YScale

5.2. Description of menu

Pop up More for setting Ampld/YScale parameter, including [Attenuation▶], [PreAmplifier On/Off].

[Attenuation▶]

See [Attenuation▶] under **【Ampld/YScale】** of the sweep analysis function for more details.

[PreAmplifier ON OFF]

See [PreAmplifier ON/OFF] under **【Ampld/YScale】** of the sweep analysis function for more details.

5.2.6.3 Span/X Scale

Press the **【Span/X Scale】** key on the front panel to enable the X Axis scale setting function. Press the **【Span/X Scale】** key to pop up [Scale/Div].

[Scale/Div]

- Menu description: to set the scale value to which each division of X Axis corresponds. Use number keys, stepping keys or knob to set the scale value.
- Key path: **【Meas Setup】** on the front panel.
- Status saved: saved in the instrument status.
- Factory preset: 2.0 dB.
- Setting range: 0.1dB – 20dB
- Default unit: dB.
- **Remote Command:**

```
:display:pstatistic:VIEW>window:trace:X[:scale]:pdivision rel_amp]>
```

```
:display:pstatistic:VIEW>window:trace:X[:scale]:pdivision?
```

5.2.6.4 Bandwidth

Pop up the soft More for setting the measurement BW, [Measure BW].

[Measure BW]

- Menu description: to change the Measure Bandwidth for power statistic function, ranging from 100 Hz to 40 MHz. Use number keys, stepping keys and knob to change the Measure Bandwidth.
- Key path: **【BW】** on the front panel.
- Status saved: saved in the instrument status.
- Factory preset: 1.0 MHz
- Setting range: Min.: 100Hz, Max.: 40 MHz.
- Default unit: Hz
- **Remote Command:**

```
:pstatistic:bandwidth <bandwidth>
```

```
:pstatistic:bandwidth?
```

- **Examples:**

5.2. Description of menu

:pstatistic:bandwidth 2 MHz

5.2.6.5 Auto Setting

Pop up the soft menu related to auto setting including [Couple All], [Mech Atten **Auto** Man], [Res BW **Auto** Man], [Video BW **Auto** Man], [VBW/RBW **Auto** Man], [Span/RBW **Auto** Man], [Sweep Time **Auto** Man] and [CF Step **Auto** Man].

[Couple All]

- Setting range: Min.: 1ms, Max.: 6000s.
- Default unit: s
- **Remote Command:**

:TXPower:SWEep:TIME <time>

:TXPower:SWEep:TIME?

- :TXPower:SWEep:TIME:AUTO OFF|ON|0|1 Menu description: to set the Mechanical Attenuator and Frequency Step as Auto Couple.
- Key path: **【Auto Set】** , [Couple All] on the front panel.
- Status saved: not saved in instrument status.
- Factory preset: Couple All.
- **Remote Command:**

:COUPle ALL

- **Examples:**

:COUP ALL

5.2.6.6 Trace

Press **【Trace】** key on the front panel to pop up corresponding soft menu , including [Save Reference Traces], [Reference Trace ON **OFF**], [Gaussian Curve **ON** OFF].

[Save Reference Trace]

- Menu description: to save the current measured trace as the Reference Trace.
- Key path: **【Trace】** , [Save Reference Trace] on the front panel.
- **Remote Command:**

:CALCulate:PSTatistic:STORe:REFerence

[Reference Trace ON **OFF**]

- Menu description: to turn on or off display of Reference Trace.
- Key path: **【Trace】** , [Reference Trace On/Off] on the front panel.
- Status saved: saved in the instrument status.
- Factory preset: OFF.
- **Remote Command:**

:DISPlay:PSTatistic:RTRace[:STATe] OFF|ON|0|1

:DISPlay:PSTatistic:RTRace[:STATe]?

[Gaussian curve ON OFF]

- Menu description: to turn on or off display of the Gaussian Curve.
- Key path: **【Trace】** , [Gaussian Curve On/Off] on the front panel.
- Status saved: saved in the instrument status.
- Factory preset: ON
- **Remote Command:**

```
:DISPlay:PStatistic:GAUSSian[:STATe] OFF|ON|0|1
```

```
:DISPlay:PStatistic:GAUSSian[:STATe]?
```

5.2.6.7 Sweep

This key has no soft menu.

5.2.6.8 Single

- Menu description: The **【Single】** on the front panel has no corresponding soft menu. Singular

In remote control programming and system establishment, this function combined with *WAI can effectively synchronize the measurement process and enable the trace data obtained after the *WAI finishes directly correspond to the measurement process one by one.

- **Remote Command:**

```
:INITiate:PStatistic
```

5.2.6.9 Continuous

The **【Cont】** key on the front panel has no corresponding soft menu. This function is mainly used for changing the Measurement Continuous OFF to Measurement Continuous ON; if the current state is Measurement Continuous ON, the instrument performs no operation.

- **Remote Command:**

```
:INITiate:CONTinuous ON
```

5.2.6.10 Trigger

See **【Trig】** menu of the sweep analysis function for more details.

5.2.6.11 Display

Pop up the soft More related to display, including [Display Line On Off], [Display Config ▶].

[Display Line ON OFF]

See [Display Line On/off] under **【Display】** of the sweep analysis function for more details.

[Display Config▶]

It is used for configurations of interface language, status area display on interface. The soft menus include [Select Language 中文 English], [Graticule Display ON OFF], Status Area Display ON OFF], [Frequency Information Display ON OFF].

5.2. Description of menu

See [Display Config▶] under [Display] of the sweep analysis function for more details.

5.2.6.12 Input Output

See the **【Input/Output】** menu of the sweep analysis function for more details.

5.2.6.13 Marker

Pop up the soft More related to markers, including [Select Marker▶], [Normal], [Marker Delta], [Fixed], [Marker Off], [Properties▶], [Marker Couple On Off], and [All Markers Off].

[Select Marker▶]

Marker 1]

- Command description: to select among 12 different markers of the analyzer. When a certain marker is selected, the marker will be indicated in the menu where its type and attribute can be set. Select and trigger another marker and place it at the center of the current trace.
- Key path: **【Marker】** , [Select Marker▶] on the front panel.
- Status saved: saved in the instrument status.
- Factory preset: Marker 1.

[Normal]

- Menu description: to set the selected marker as the Normal Marker.
- Key path: **【Marker】** , [Normal] on the front panel.
- Status saved: saved in the instrument status.
- **Remote Command:**

```
:CALCulate:PStatistic:MARKer[1|2|3|4|5|6|7|8|9|10|11|12]:MODE POSition
```

```
:CALCulate:PStatistic:MARKer[1|2|3|4|5|6|7|8|9|10|11|12]:MODE?
```

[Marker Delta]

- Menu description: to set the selected marker as the Marker Delta. Display the probability difference and amplitude difference between two markers at the marker display area at the top right corner of the screen. If there exists a single marker, a [Marker Delta] operation will generate a Ref marker in the active marker position. Move the active marker through the knob, stepping keys or number keys. The display amplitude difference unit is dB and probability difference unit is %.
- Key path: **【Marker】** , [Delta] on the front panel.
- Status saved: saved in the instrument status.
- **Remote Command:**

```
:CALCulate:PStatistic:MARKer[1|2|3|4|5|6|7|8|9|10|11|12]:MODE DELTa
```

```
:CALCulate:PStatistic:MARKer[1|2|3|4|5|6|7|8|9|10|11|12]:MODE?
```

[Fixed]

- Menu description: to set the selected marker as the Fixed Marker. The X Axis and Y Axis positions of the fixed marker are fixed. The Fixed Marker can be used as reference marker.

5.2. Description of menu

- Key path: **【Marker】** , [Fixed] on the front panel.
- Status saved: saved in the instrument status.
- **Remote Command:**
:CALCulate:PStatistic:MARKer[1|2|3|4|5|6|7|8|9|10|11|12]:MODE FIXed
:CALCulate:PStatistic:MARKer[1|2|3|4|5|6|7|8|9|10|11|12]:MODE?

[Marker Off]

- Menu description: to turn off the selected marker.
- Key path: **【Marker】** , [Off] on the front panel.
- Status saved: saved in the instrument status.
- **Remote Command:**
:CALCulate:PStatistic:MARKer[1|2|3|4|5|6|7|8|9|10|11|12]:MODE OFF
:CALCulate:PStatistic:MARKer[1|2|3|4|5|6|7|8|9|10|11|12]:MODE?

[Properties▶]

Pop up the More related to the attribute setting of currently selected marker, including [Ref Marker▶], [Marker Trace▶].

[Ref Marker▶]

- Menu description: to select reference marker for current marker. It can be any one from 11 markers except the currently selected marker.
- Key path: **【Marker】** , [Properties▶], [Ref Marker▶] on the front panel.
- Status saved: saved in the instrument status.
- **Remote Command:**
:CALCulate:PStatistic:MARKer[1|2|3|4|5|6|7|8|9|10|11|12]:REFerence <integer>
:CALCulate:PStatistic:MARKer[1|2|3|4|5|6|7|8|9|10|11|12]:REFerence?

[All Markes Off]

- More description: to turn off all current markers which are On and related soft keys, e.g. [Noise Marker].
- Key path: **【Marker】** , [More 1/2▶], [All Markers Off] on the front panel.
- Status saved: not saved in instrument status.
- **Remote Command:**
:CALCulate:PStatistic:MARKer:AOff

5.2.6.14 Maker->

This key has no soft menu.

5.2.6.15 Marker Function

5.2. Description of menu

This key has no soft menu.

5.2.6.16 Peak

This key has no soft menu.

5.2.6.17 Measurement Setting

Pop up the soft menu related to measurement setting, including [Meas Counts], [Meas Cycle], [Meas Time], [Low Noise Path On Off], [Preselector Preselecting Bypass], [RF Gain▶], [ADC Dither Auto Man], [Meas Preset].

[Meas Counts]

- Menu description: to set the accumulated counts of sampling points of the data. Use number keys, stepping keys or knob to set the Measurement Count.
- Key path: **【Meas Setup】** , [Meas Counts] on the front panel.
- Status saved: saved in the instrument status.
- Factory preset: 100kpt
- Setting range: 1000 - 8.389E+6
- Default unit: pt
- **Remote Command:**

[::SENSE]:PStatistic:COUNTs <integer> [::SENSE]:PStatistic:COUNTs?

[Meas Cycle]

- Menu description: to set the number of measurement cycles corresponding to the accumulated point count. This value is dependent on settings of the Measure Bandwidth, Measurement Time and Measurement Count. Use number keys, stepping keys or knob to set the Measurement Cycle.
- Key path: **【Meas Setup】** , [Meas Cycles] on the front panel.
- Status saved: saved in the instrument status.
- Factory preset: 80
- Setting range: dependent on settings of the Measure Bandwidth, Measurement Time and Measurement Count.
- Default unit: none
- **Remote Command:**

[::SENSE]:PStatistic:SWEEp:CYCLes <integer> [::SENSE]:PStatistic:SWEEp:CYCLes?

[Meas time]

- Menu description: to specify the time for measurements. The minimum value is 1 us and the maximum value depends on Measure Bandwidth setting. Use number keys, stepping keys or knob to set the Measuring Time.
- Key path: **【Meas Setup】** , [Measure Time] on the front panel.
- Status saved: saved in the instrument status.
- Factory preset: 1.0ms

5.2. Description of menu

- Setting range: 1 us – 60s
- Default unit: s
- **Remote Command:**

```
[[:SENSE]:PSTatistic:SWEEP:TIME <time>
```

```
[[:SENSE]:PSTatistic:SWEEP:TIME?
```

[Low Noise Path**ON OFF]**

- Menu description: this menu is only available when the H34 option (Low Noise PreAmplifier) is purchased. When the PreAmplifier is ON, the Low Noise Path is OFF and this menu is grayed out; when the PreAmplifier is OFF, this menu lights on and is switchable.
- Key path: **【Meas Setup】** , [More 1/2], [Low Noise Path ON OFF] on the front panel.
- Status saved: saved in the instrument status.
- **Remote Command:**

```
:PSTatistic:POWer:MW:PATH STD|LNPath
```

```
:PSTatistic:POWer:MW:PATH?
```

[Preselector Preselecting Bypass]

- Menu description: this menu is only available when the H36 option is purchased. It is used for setting whether to bypass the front-end preselector of the signal/spectrum analyzer. In analyzing bandwidth signal, bypass is usually required.
- Key path: **【Meas Setup】** , [More 1/2], [Preselector Preselecting Bypass] on the front panel.
- Status saved: saved in the instrument status.
- **Remote Command:**

```
INPut:PSTatistic:FILTer:YIG[:STATe] OFF|ON|0|1
```

```
INPut:PSTatistic:FILTer:YIG[:STATe]?
```

[RF Gain▶]

- More description: to set the Auto ON/OFF of the RF Gain and best allocation algorithm for RF Gain. The soft More includes [Auto], [Best for Dynamic Range] and [Best Sensitivity].
- Key path: **【Meas Setup】** , [More 1/2], [RF Gain] on the front panel.
- Status saved: saved in the instrument status.
- **Remote Command:**

```
:PSTatistic:RF:GAIN:AUTO OFF|ON|0|1
```

```
:PSTatistic:RF:GAIN:AUTO?
```

```
:PSTatistic:RF:GAIN:AUTO:RULEs RANGE|SENSITIVITY
```

```
:PSTatistic:RF:GAIN:AUTO:RULEs?
```

5.2. Description of menu

[Auto]

- Menu description: to set the RF Gain distribution algorithm to Auto. In this case, the RF Gain distribution is “Best Dynamic Range”.
- Key path: **【Meas Setup】** , [More 1/2], [RF Gain▶], [Auto] on the front panel.
- Status saved: saved in the instrument status.

[Best for Dynamic Range]

- Menu description: to set the RF Gain distribution algorithm to Best Dynamic Range. In this case, the RF Gain is switched to “Auto OFF”
- Key path: **【Meas Setup】** , [More 1/2], [RF Gain▶], [Best Dynamic Range] on the front panel.
- Status saved: saved in the instrument status.

[Best for Sensitivity]

- Menu description: to set the RF Gain distribution algorithm to Best Sensitivity. In this case, the RF Gain is switched to “Auto OFF”
- Key path: **【Meas Setup】** , [More 1/2], [RF Gain▶], [Best for Sensitivity] on the front panel.
- Status saved: saved in the instrument status.

[ADC Dither

Auto Man]

- Menu description: to control opening/closing of ADC dither of the frequency acquisition circuit in the analyzer. Under default mode, the signal/spectrum analyzer will automatically control whether the ADC Dither is ON based on current working condition.
- Key path: **【Meas Setup】** , [More 1/2], [ADC Dither Auto **Man**] on the front panel.
- Status saved: saved in the instrument status.
- Factory preset: Auto OFF.
- **Remote Command:**

[[:SENSE]:PStatistic:ADC:DITHer[:STATe] OFF|ON|HIGH

[[:SENSE]:PStatistic:ADC:DITHer[:STATe]?

[[:SENSE]:PStatistic:ADC:DITHer:AUTO[:STATe] OFF|ON|0|1

[[:SENSE]:PStatistic:ADC:DITHer:AUTO[:STATe]?

[Meas Preset]

- Menu description: to reset the measurement parameters to the factory preset status or user saved parameter status
- Key path: **【Meas Setup】** , [Meas Preset] on the front panel.
- Factory preset: factory reset.
- **Remote Command:**

:CONFigure:PStatistic

5.2.6.18 Measurement Control

Pop up the More related to Meas Control, including [Measure Single Cont], [Restart] and [Pause/Resume].

[Measure Continuous **ON** OFF]

- Menu description: to set continuous measurement OFF or ON. When the [Measure Single **Cont**] is set as Cont mode, Cont On mode will be triggered and Cont sweep will be the default measure control method; when the [Measure Single **Cont**] is set as Single mode, single sweep will be triggered. Press **【Sweep Single】** to restart sweep when the next trigger signal arrives.
- Key path: **【Meas Control】** , [Meas Single Cont On Off] on the front panel.
- Status saved: saved in the instrument status.
- Factory preset: Continuous On.

- **Remote Command:**

:INITiate:CONTinuous OFF|ON|0|1

:INITiate:CONTinuous?

- **Examples:**

:INIT:CONT OFF

[Restart]

- Menu description: to stop current measurement and restart measurement for the signal/spectrum analyzer.
- Key path: **【Meas Control】** , [Restart] on the front panel
- Status saved: not saved in instrument status.
- **Remote Command:**

:INITiate:REST

[Pause/Resume]

- Menu description: when the signal/spectrum analyzer is in operation, this menu is used for pausing current measurement; when in Paused status, this menu is used for continuing measurement.
- Key path: **【Meas Control】** , [Pause/Resume] on the front panel.
- Status saved: not saved in instrument status.
- **Remote Command:**

:INITiate:PAUS

:INITiate:RES

5.2.7 Burst Power

5.2.7.1 Frequency

The **【Frequency】** key on the front panel is used to set parameters related to frequency of the signal/spectrum analyzer and its soft menu includes [Center Frequency],

[CF Step Auto Man], [Freq Offset]. See the **【Frequency】** menu of the sweep analysis function for more details.

5.2. Description of menu

[Center Freq]

See the [Center Freq] under **【Frequency】** of the sweep analysis function for more details.

[CF Step **Auto Man**]

See the [CF Step **Auto Man**] under **【Frequency】** of the sweep analysis function for more details.

[Freq Offset]

See the [Freq Offset] under **【Frequency】** of the sweep analysis function for more details.

5.2.7.2 Ampld/YScale

Pop up More related to parameter setting of Ampld/YScale, including [RefLevel], [Attenuation ▶], [PreAmplifier On/Off], [Scale/Div], [Auto Scale], [More 1/2▶], [Y Axis Unit], [Ref Level Offset].

[RefLevel]

- Menu description: to enable the Reference Level function. The reference level can be adjusted with the number keys, step keys or knob. The reference level corresponds to the top of the coordinate top. Measure signal at reference level position to get highest accuracy. The input attenuator of the signal/spectrum analyzer is coupled to the reference level, which can be automatically changed to avoid compression of input signal.
- Key path: **【Ampld/YScale】** , [RefLevel] on the front panel.
- Status saved: saved in the instrument status.
- Factory preset: 0dBm.
- Setting range: Min.: -170dBm, Max.: 30dBm.
- Default unit: set based on Y Axis scale unit.
- **Remote Command:**

```
:DISPlay:TXPower:VIEW:WINDow:TRACe:Y:RLEVel <real>
```

```
:DISPlay:TXPower:VIEW:WINDow:TRACe:Y:RLEVel?
```

- **Examples:**

```
:DISPlay:TXPower:VIEW:WINDow:TRACe:Y:RLEVel20dBm
```

[Attenuation▶]

See [Attenuation▶] under **【Ampld/YScale】** of the sweep analysis function for more details.

[PreAmplifier ON **OFF**]

See [PreAmplifier ON/**OFF**] under **【Ampld/YScale】** of the sweep analysis function for more details.

[Scale/Div]

- Menu description: to select the scale/division from 0.1dB/division to 20dB/division. This menu is only valid when the scale type is logarithm.
- Key path: **【Ampld/YScale】** , [Scale/Div] on the front panel.

5.2. Description of menu

- Status saved: saved in the instrument status.
- **Factory preset:** 10.00 dB.
- Setting range: Min.: 0.1dB, Max.: 20dBm.
- **Remote Command:**

:DISPlay:TXPower:VIEW:WINDow:TRACe:Y:PDIVision <rel_amp>

:DISPlay:TXPower:VIEW:WINDow:TRACe:Y:PDIVision?

[Auto Scale]

- Menu description: the instrument automatically sets parameters like reference level and scale/division based on input signal sizes. When this soft menu key is pressed, the instrument performs one auto scaling. Setting rule for auto scaling: firstly obtain the maximum value and the minimum value based on current measurement trace data. Based on the maximum value, place on the 80% graticule of the screen trace Y axis for auto setting of reference level and scale/division.
- Key path: **【Ampld/YScale】** , [Auto Scale] on the front panel.
- Status saved: not saved in instrument status.
- **Remote Command:**

:TXPower:ADJust:LEVel

[Y Axis Unit]

- More description: to select the Y Axis unit from [dBm], [dBmV], [dBmA], [W], [V], [A], [dB μ V] and [dB μ A]. The instrument will automatically calculate the trace data and marker readout based on the Y axis unit.
- Key path: **【Ampld/YScale】** , [More 1/2▶], [Y Axis Unit ▶] on the front panel.
- Status saved: saved in the instrument status.
- Factory preset: dBm.

:UNIT:TXPower:POWer DBM|DBMV|DBMA|V|W|A|DBUV|DBUA

:UNIT:TXPower:POWer?

[Ref Level Offset]

- Menu description: to introduce offset for all amplitude readout (e.g, reference level and marker amplitude). It will not change the trace position on the screen. This offset unit is dB and is not affected by the scale and unit. Use number keys, stepping keys or knob to input the offset value.
- Key path: **【Ampld/YScale】** , [More 1/2▶], [Ref Level Offset] on the front panel.
- Status saved: saved in the instrument status.
- **Factory preset:** 0 dB.
- Setting range: Min.: -1000dB, Max.:1000dB.
- **Remote Command:**

:DISPlay:TXPower:WINDow:TRACe:Y:RLEVel:OFFSet <rel_amp>

:DISPlay:TXPower:WINDow:TRACe:Y:RLEVel:OFFSet?

- **Examples:**

5.2. Description of menu

:DISPlay:TXPower:WINDow:TRACe:Y:RLEVel:OFFSet 12

5.2.7.3 Span/X Scale

This key has no soft menu.

5.2.7.4 Bandwidth

Pop up the soft More for setting Res BW and Video BW, including [Res BW **Auto** Man], [Video BW **Auto** Man] and [Filter BW].

[Res BW **Auto** Man]

- Menu description: to change the resolution bandwidth of spectrum analysis, ranging from 1Hz to 20MHz, which is stepped by 1, 2, 3, 5 and 10. The resolution bandwidth can be changed with the number keys, step keys and knob. The shaded character indicates the currently selected mode.
- Key path: **[BW]** , [Res BW Auto Man] on the front panel.
- Status saved: saved in the instrument status.
- Factory preset: Auto
- Setting range: Min.: 1Hz, Max.: 20MHz.
- Default unit: Hz
- **Remote Command:**

:TXPower:BANDwidth <bandwidth>

:TXPower:BANDwidth?

:TXPower:BANDwidth:AUTO ON|OFF|1|0

:TXPower:BANDwidth:AUTO?

- **Examples:**

:TXPower:BANDwidth 1kHz

:TXPower:BANDwidth:AUTO ON On

[Video BW **Auto** Man]

- Menu description: to change the video bandwidth within the active function area, ranging from 1Hz to 20MHz, which is stepped by 1, 2, 3, 5 and 10. The resolution bandwidth can be changed with the number keys, step keys and knob. The shaded character indicates the currently selected mode. When set as Auto Off, press [Video BW **Auto** Man] to select Auto On and return to auto mode.
- Key path: **[BW]** , [Video BW Auto Man] on the front panel.
- Status saved: saved in the instrument status.
- Factory preset: Auto, same as the Resolution Bandwidth setting.
- Setting range: Min.: 1Hz, Max.: 20MHz.
- Default unit: Hz
- **Remote Command:**

:TXPower:BANDwidth:VIDEo <bandwidth>

:TXPower:BANDwidth:VIDEo?

5.2. Description of menu

:TXPower:BANDwidth:VIDeo:AUTO ON|OFF|1|0

:TXPower:BANDwidth:VIDeo:AUTO?

- **Examples:**

:TXPower:BANDwidth:VIDeo 1 kHz

:TXPower:BANDwidth:VIDeo:AUTO ON

[Filter BW]

- Menu description: if Gaussian filter is used for the signal/spectrum analyzer, set the resolution bandwidth as 3dB, 6dB, pulse bandwidth or equivalent noise bandwidth. When this parameter is changed, the resolution bandwidth filter is fixed, and the bandwidth value in the information display zone changes.
- Key path: **【BW】** , [Filter BW] on the front panel.
- Status saved: saved in the instrument status.
- **Factory preset:** 3 dB.
- **Remote Command:**

[[:SENSE]:BANDwidth|BWIDth:TYPE DB3|DB6|IMPulse|NOISe

[[:SENSE]:BANDwidth|BWIDth:TYPE?

5.2.7.5 Auto Setting

Pop up the soft menu related to auto setting Which includes [Couple All], [Mech Atten **Auto Man**], [Res BW **Auto Man**], [Video BW **Auto Man**], [Sweep Time **Auto Man**] and [CF Step **Auto Man**].

[Couple All]

- **Menu description:** to set the resolution bandwidth, video bandwidth, sweep time, mechanical attenuator and frequency step as auto coupling mode. The signal/spectrum analyzer will select most suitable values for those functions based on set frequency and bandwidth (or start frequency and stop frequency). If no ratio is pre-saved, use default ratio.
- Key path: **【Auto Set】** , [Couple All] on the front panel.
- Status saved: not saved in instrument status.
- Factory preset: Couple All.
- **Remote Command:**

:COUPle ALL

- **Examples:**

:COUP ALL

[Mech Atten **Auto Man**]

See [Attenuation▶] under **【Ampld/YScale】** for more details.

[Res BW **Auto Man**]

See [Res BW **Auto Man**] under **【BW】** for more details.

5.2. Description of menu

[Video BW **Auto Man**]

See [Video BW **Auto Man**] under **【BW】** for more details.

[Sweep Time **Auto Man**]

See [Sweep Time **Auto Man**] under **【Sweep】** for more details.

[CF Step **Auto Man**]

See [CF Step **Auto Man**] under **【Frequency】** for more details.

5.2.7.6 Trace

Press **【Trace】** key on the front panel to pop up corresponding soft menu Including [Clear Write], [Average], [Max Hold], [Min. Hold], [View/Blank On/Off] [More 1/2▶] and [Detector▶].

[Clear Write]

- Command description: to set the current trace processing as Refresh, i.e., clear all data of displayed trace and continue the signal trace receipt under sweep status.
- Key path: **【Trace】** , [Clear Write] on the front panel.
- Status saved: saved in the instrument status.
- Factory preset: after all traces are selected, the trace mode is defaulted as Refresh.
- **Remote Command:**

:TRACe:TXPower:TYPE WRITe

:TRACe:TXPower:TYPE?

[Average]

- Command description: to set the current trace processing method as Average, i.e, based on the average count N set in the **【Meas Setup】** , update trace after averaging the performance index of the measurement trace.
- Key path: **【Trace】** , [Trace Average] on the front panel.
- Status saved: saved in the instrument status.
- Factory preset: all trace modes are defaulted as Refresh.
- **Remote Command:**

:TRACe:TXPower:TYPE AVERAge

:TRACe:TXPower:TYPE?

[Max Hold]

- Menu description: to set the current trace processing method as maximum hold, i.e., the new trace data will be assigned with maximum value of previous measured trace data.
- Key path: **【Trace】** , [Max Hold] on the front panel.
- Status saved: saved in the instrument status.

5.2. Description of menu

- Factory preset: all trace modes are defaulted as Refresh.
- **Remote Command:**

```
:TRACe:TXPower:TYPE |MAXHold
```

```
:TRACe:TXPower:TYPE?
```

[Min Hold]

- Menu description: to set the current trace processing method as minimum hold, i.e., the new trace data will be assigned with minimum value of previous measured trace data.
- Key path: **[Trace]** , [Min Hold] on the front panel.
- Status saved: saved in the instrument status.
- Factory preset: all trace modes are defaulted as Refresh.
- **Remote Command:**

```
:TRACe:TXPower:TYPE MINHold
```

```
:TRACe:TXPower:TYPE?
```

[View/Blank▶]**Trace On]**

- More description: to set the display method for the selected trace from [Trace On], [View], [Background] and [Blank].
- Key path: **[Trace]** , [Display ON/OFF▶] on the front panel.
- Status saved: saved in the instrument status.
- Factory preset: all trace display modes are defaulted as Refresh.
- **Remote Command:**

```
:TRACe:TXPower:DISPlay[:STATe] ON|OFF|0|1
```

```
:TRACe:TXPower:DISPlay[:STATe]?
```

```
:TRACe:TXPower:UPDate[:STATe] ON|OFF|0|1
```

```
:TRACe:TXPower:UPDate[:STATe]?
```

[Detector ▶]

Pop up soft More related to setting the detector type for the currently selected trace, including [Auto], [Normal], [Peak], [Sample], [Negative Peak], [Average▶], where, the average detector type includes Log-Pwr Avg, Log-Pwr Avg and Voltage Avg.

[Auto]

- Menu description: to set the detector command for the currently selected trace as Auto. That means, the signal/spectrum analyzer will perform based on the parameter setting of currently selected trace.
- Key path: **[Trace]** , [More 1/2▶], [Detector ▶], [Auto] on the front panel
- Status saved: saved in the instrument status.

5.2. Description of menu

- Factory preset: the trace detector type is Power Average.
- **Remote Command:**

:TXPower:DETECTOR:AUTO ON|OFF|1|0

:TXPower:DETECTOR:AUTO?

[Normal]

- Menu description: to set the detector command for the currently selected trace as Normal. i.e., display the measurement results of Peak and negative peak at the same time to achieve display effect similar to the analog instrument.
- Key path: **【Trace】** , [More 1/2▶], [Detector ▶], [Normal] on the front panel.
- Status saved: saved in the instrument status.
- **Remote Command:**

:TXPower:DETECTOR NORMAl

:TXPower:DETECTOR?

[Peak]

- Menu description: to set the detector command for the currently selected trace as Peak. i.e., take the maximum value from sampling data assigned to each trace point.
- Key path: **【Trace】** , [More 1/2▶], [Detector▶], [Peak] on the front panel.
- Status saved: saved in the instrument status.
- **Remote Command:**

:TXPower:DETECTOR POSitive

:TXPower:DETECTOR?

[Sample]

- Menu description: to set the detector command for the currently selected trace as Sample. i.e., take the last value from sampling data assigned to each trace point.
- Key path: **【Trace】** , [More 1/2▶], [Detector▶], [Sample] on the front panel.
- Status saved: saved in the instrument status.
- **Remote Command:**

:TXPower:DETECTOR SAMPlE

:TXPower:DETECTOR?

[Negative Peak]

- Menu description: to set the detector command for the currently selected trace as Negative Peak. i.e., take the minimum value from sampling data assigned to each trace point.
- Key path: **【Trace】** , [More 1/2▶], [Detector▶], [Negative Peak] on the front panel.
- Status saved: saved in the instrument status.

5.2. Description of menu

- **Remote Command:**

:TXPower:DETECTOR NEGative

:TXPower:DETECTOR?

[Average ▶

Video Average]

- Menu description: to set the detector command for the currently selected trace as Video Average. Also called Logarithm Power Average Detector, i.e., take the logarithm power average value for all data assigned to each trace point; earlier signal/spectrum analyzer generally displays the measurement trace of logarithm scale, and all filtering and averaging are based on the logarithm power data; the trace is generally called as video signal. After digital IF processing is adopted, to make measurement results same as the earlier signal/spectrum analyzer, the video average detector function is added.
- Key path: **【Trace】**, [More 1/2▶], [Detector▶], [Average▶], [Video Average] on the front panel.
- Status saved: saved in the instrument status.

- **Remote Command:**

:TXPower:DETECTOR LOG

:TXPower:DETECTOR?

[Average ▶

Power Average]

- Menu description: to set the detector command for the currently selected trace as Power Average. Also called root mean square (RMS) detector. Calculate the root mean square of all sampling data assigned to each trace point; the 4051 signal/spectrum analyzer envelopes the detector for the RF input signal and obtains linear voltage. After square these voltage values, take sum and divide the count of sampling data points corresponding to each trace point. Finally, take square root. When the scale is logarithm, take 20 times of logarithm transformation for these RMS values (with 10 as base) and obtain the trace data. When the scale type is linear, those RMS values are trace data.
- Key path: **【Trace】**, [More 1/2▶], [Detector▶], [Average▶], [Pwr Avg] on the front panel.
- Status saved: saved in the instrument status.

- **Remote Command:**

:TXPower:DETECTOR AVERage or

:TXPower:DETECTOR RMS

:TXPower:DETECTOR?

[Average ▶

Average Voltage]

- Menu description: to set the detector command for the currently selected trace as Voltage Average. Also called average (AVG) detector. Take linear average for all sampling data assigned to each trace point; the 4051 signal/spectrum analyzer envelopes the detector for the RF input signal and obtains linear voltage. After summing those voltage values, divide the number of sampling data points corresponding to each trace point. When the scale is logarithm, take 20 times of logarithm transformation for these RMS values

5.2. Description of menu

(with 10 as base) and obtain the trace data. When the scale type is linear, those average values are trace data.

- Key path: **【Trace】** , [More 1/2▶], [Detector▶], [Average▶], [Voltage Avg] on the front panel.
- Status saved: saved in the instrument status.
- **Remote Command:**

:TXPower:DETECTOR SCALAR

:TXPower:DETECTOR?

5.2.7.7 Sweep

Enable sweep-related parameter setup function to pop up corresponding soft More, including [Sweep Time Auto Man], [Sweep Setup▶] and [Sweep Points].

[Sweep Time Auto Man]

- Menu description: to change the sweep time of signal/spectrum analyzer. Use the number keys, step keys or knob to adjust the sweep time. When it is under Auto OFF mode (shaded), it indicates that sweep time can be set manually. When it is under Auto ON status, the sweep time will be automatically coupled based on resolution bandwidth, span and video bandwidth
- Key path: **【Sweep】** , [Sweep Time Auto Man] on the front panel.
- Status saved: saved in the instrument status.
- Factory preset: sweep time Auto.

:TXPower:SWEep:TIME:AUTO?

- **Examples:**

:TXP:SWE:TIME 500 ms

:TXP:SWE:TIME:AUTO OFF

[Sweep points]

- Menu description: to set the trace points.
- Key path: **【Sweep】** , [Sweep Points] on the front panel.
- Status saved: saved in the instrument status.
- Factory preset: 1001.
- Setting range: 101-30001.
- **Remote Command:**

:TXPower:SWEep:POINts <integer>

:TXPower:SWEep:POINts?

5.2.7.8 Single

- Menu description: the **【Single】** key on the front panel has no corresponding soft menu. This function is mainly used for manual trigger of a sweep. When the Average is ON, this function performs the sweeps at the count specified by the Average Count.

In remote control programming and system establishment, this function combined with *WAI can effectively synchronize the sweep process and enable the trace data obtained after the *WAI finishes directly correspond to the sweep process one by one.

- **Remote Command:**

:INITiate:TXPower

5.2.7.9 Continuous

The **【Cont】** key on the front panel has no corresponding soft menu. This function is mainly used for changing the Continuous OFF into Continuous ON; if the current sweep is Continuous ON, the instrument performs no operation.

- **Remote Command:**

:INITiate:CONTinuous ON

5.2.7.10 Trigger

See **【Trig】** menu of the sweep analysis function for more details.

5.2.7.11 Display

Pop up soft More related to display, including [Display Line On Off], [Bar Graph On Off], [Display Config ▶].

[Display Line ON OFF]

See [Display Line On/off] under **【Display】** of the sweep analysis function for more details.

[Display Config▶]

It is used for configurations of interface language, status area display ON OFF related to interface display, The soft More include [Select Language 中文 English], [Graticule Display On Off], [Status Display On Off], [Freq Info Disp On Off]. See [Display Config▶] under **【Display】** of the sweep analysis function for more details.

[Bar Graph ON OFF]

Menu description: to turn on or off Bar Graph Display.

- Key path: **【Display】** on the front panel.

Status saved: saved in the instrument status.

- Factory preset: OFF.

- Remote Command:

:DISPlay:TXPower:VIEW:WINDow:BGRaph ON|OFF|1|0

:DISPlay:TXPower:VIEW:WINDow:BGRaph?

5.2.7.12 Input Output

See the **【Input/Output】** menu of the sweep analysis function for more details.

5.2.7.13 Marker

Pop up the soft More related to markers, including [Select Marker▶], [Normal], [Marker Delta], [Fixed], [Off], [Properties▶], [Marker Couple On Off], and [All Markers Off].

[Select Marker▶]

Marker 1]

5.2. Description of menu

- Command description: to select among 12 different markers of the analyzer. When a certain marker is selected, the marker will be indicated in the menu where its type and attribute can be set. Select and trigger another marker and place it at the center of the current trace. Users can read amplitude and frequency information (when the frequency span is 0 Hz, time information will be displayed) at the marker display area at the top right corner of the screen.
- Key path: **【Marker】** , [Select Marker▶] on the front panel.
- Status saved: saved in the instrument status.
- Factory preset: Marker 1.

[Normal]

- Menu description: to set the selected marker as the Normal Marker.
- Key path: **【Marker】** , [Normal] on the front panel.
- Status saved: saved in the instrument status.
- **Remote Command:**

:CALCulate:TXPower:MARKer[1|2|3|4|5|6|7|8|9|10|11|12]:MODE POSition

:CALCulate:TXPower:MARKer[1|2|3|4|5|6|7|8|9|10|11|12]:MODE?

[Marker Delta]

- Menu description: to set the selected marker as the Marker Delta. Display the amplitude difference and frequency difference (or time difference, when span is zero) between two markers at the marker display area at the top right corner of the screen. If there exists a single marker, a [Marker Delta] operation will generate a Ref marker in the active marker position. Use the knob, number keys or stepping keys to move the active marker.

Cursor ◦. The display amplitude difference unit is dB.

- Key path: **【Marker】** , [Marker Delta] on the front panel.
- Status saved: saved in the instrument status.
- **Remote Command:**

:CALCulate:TXPower:MARKer[1|2|3|4|5|6|7|8|9|10|11|12]:MODE DELTa

:CALCulate:TXPower:MARKer[1|2|3|4|5|6|7|8|9|10|11|12]:MODE?

[Fixed]

- Menu description: to set the selected marker as the Fixed Marker. The X Axis and Y Axis positions of the fixed marker are fixed. The Fixed Marker can be used as reference marker.
- Key path: **【Marker】** , [Fixed] on the front panel.
- Status saved: saved in the instrument status.
- **Remote Command:**

:CALCulate:TXPower:MARKer[1|2|3|4|5|6|7|8|9|10|11|12]:MODE FIXed

:CALCulate:TXPower:MARKer[1|2|3|4|5|6|7|8|9|10|11|12]:MODE?

[Marker Off]

5.2. Description of menu

- Menu description: to turn off the selected marker.
- Key path: **【Marker】** , [Off] on the front panel.
- Status saved: saved in the instrument status.
- **Remote Command:**

:CALCulate:TXPower:MARKer[1|2|3|4|5|6|7|8|9|10|11|12]:MODE OFF

:CALCulate:TXPower:MARKer[1|2|3|4|5|6|7|8|9|10|11|12]:MODE?

[Properties▶]

Pop up the corresponding More of currently selected marker attribute setup, including [Ref Marker▶], [X Axis Auto Man],

[Marker Trace▶] and [Marker Display Line On/Off].

[Ref Marker▶]

- Menu description: to select reference marker for current marker. It can be any one from 11 markers except the currently selected marker.
- Key path: **【Marker】** , [Properties▶], [Ref Marker▶] on the front panel.
- Status saved: saved in the instrument status.
- **Remote Command:**

:CALCulate:TXPower:MARKer[1|2|3|4|5|6|7|8|9|10|11|12]:REFeRence <integer>

:CALCulate:TXPower:MARKer[1|2|3|4|5|6|7|8|9|10|11|12]:REFeRence?

[Marker Display Line▶]**ON OFF]**

- Menu description: to set whether the current marker is displayed as a line on the screen, which is easy to observe.
- Key path: **【Marker】** , [Properties▶] and [Marker Display Line On/Off] on the front panel.
- Status saved: saved in the instrument status.
- Factory preset: OFF.
- **Remote Command:**

:CALCulate: TXPower:MARKer[1|2|3|4|5|6|7|8|9|10|11|12]:LINES[:STATe] OFF|ON|0|1

:CALCulate: TXPower:MARKer[1|2|3|4|5|6|7|8|9|10|11|12]:LINES[:STATe]?

[Marker Couple**ON OFF]**

- Menu description: to turn on or off Marker Couple. When it is ON, moving any marker horizontal axis position will cause an equal movement of horizontal axis position of every other marker which is ON. When the marker is moved to less than Start Frequency or larger than Stop Frequency, the marker is limited to the value of the Start Frequency or the Stop Frequency; when the span is zero, the minimum value is limited as 0, and the maximum value is limited as the Sweep Time.

5.2. Description of menu

- Key path: **【Marker】** , [More 1/2▶], [Marker Couple ON/OFF] on the front panel.
- Status saved: saved in the instrument status.
- Factory preset: OFF.
- **Remote Command:**

:CALCulate:TXPower:MARKer:COUPlE[:STATe] ON|OFF|1|0

:CALCulate:TXPower:MARKer:COUPlE[:STATe]?

[Marker All Off]

- More description: to turn off all current markers which are On and related soft keys, e.g. [Noise Marker].
- Key path: **【Marker】** , [More 1/2▶], [All Markers Off] on the front panel.
- Status saved: not saved in instrument status.
- **Remote Command:**

:CALCulate:TXPower:MARKer:AOff

5.2.7.14 Maker->

This key has no soft menu.

5.2.7.15 Marker Function

This key has no soft menu.

5.2.7.16 Peak

The **【Peak Search】** key on the front panel is used for turning on the peak search for traces by the control instrument and turning on marker for display, including [Next Peak], [Next Pk Right], [Next Pk Left].

- **Remote Command:**

:CALCulate:TXPower:MARKer[1|2|3|4|5|6|7|8|9|10|11|12]:MAXimum

[Next Peak]

- Menu description: Taking the Amplitude of the point where the current marker is located, search for the next peak of current test trace.
- Key path: **【Peak Search】** , [Next Peak] on the front panel.
- Status saved: not saved in instrument status.
- **Remote Command:**

:CALCulate:TXPower:MARKer[1|2|3|4|5|6|7|8|9|10|11|12]:MAXimum:NEXT

[Next Pk Right]

- Menu description: to search for the peak to the right of the current test trace marker position.
- Key path: **【Peak Search】** , [Next Pk Right] on the front panel.
- Status saved: not saved in instrument status.
- **Remote Command:**

5.2. Description of menu

:CALCulate:TXPower:MARKer[1|2|3|4|5|6|7|8|9|10|11|12]:MAXimum:RIGHT

[Next Pk Left]

- Menu description: to search for the peak to the left of the current test trace marker position.
- Key path: **【Peak Search】** , [Next Pk Left] on the front panel.
- Status saved: not saved in instrument status.
- **Remote Command:**

:CALCulate:TXPower:MARKer[1|2|3|4|5|6|7|8|9|10|11|12]:MAXimum:LEFT

5.2.7.17 Measurement Setting

Pop up the soft menu related to measurement setting, including [Average Num On **Off**], [Average Mode **Exponential Repeat**], [Average Type▶], [Threshold Lvl Absolute **Relative**], [Meas Method▶], [Measured Burst Width **Auto Man**], [Low Noise Path On **Off**], [Preselector Preselecting **Bypass**], [RF Gain▶], [ADC Dither **AutoMan**] and [Meas Preset].

[Average Num ON **OFF**]

- Menu description: to turn on or off Average. When Average Count is ON, the user can specify the average count required for measurement. The Average Count can be adjusted by number keys, stepping keys or knob.
- Key path: **【Meas Setup】** , [Average Num ON OFF] on the front panel.
- Status saved: saved in the instrument status.
- Factory preset: 100/OFF
- **Setting range:** 1~10000
- Default unit: none
- **Remote Command:**

[:SENSe]:TXPower:AVERAge:COUNT <integer>

[:SENSe]:TXPower:AVERAge:COUNT?

[:SENSe]:TXPower:AVERAge[:STATe] ON|OFF|1|0

[:SENSe]:TXPower:AVERAge[:STATe]?

[Average Mode **Exponential Repeat**]

- Menu description: when Average Count is ON, the user can select Average State required for measurement.

Exponential - Different from Linear Average, in Exponential State, the weight of new data is larger than that of old data. This is good for tracking data change in terms of time. In this case, the selected averaging count determines the weight of the old data on the new data. As the average count increases, the weight of new data gradually decreases. This is good for tracking data change in terms of time. In this case, the selected averaging count determines the weight of the old data on the new data. As the average count increases, the weight of new data gradually decreases.

Repeat - Similarly, it takes exponential averaging. However, when the average count is met, clear all previous results, restart average till the set average count and repeat this process.

- Key path: **【Meas Setup】** , [Average Mode Exponential Repeat] on the front panel.

5.2. Description of menu

- Status saved: saved in the instrument status.
- Factory preset: Exponential
- **Remote Command:**

[[:SENSE]:TXPower:AVERage:TCONtrol EXPonential|REPeat

[[:SENSE]:TXPower:AVERage:TCONtrol?

[Average Type ▶]

- Menu description: to allow to specify Average Type of data results.
- Key path: **【Meas Setup】** , [Average Type▶] on the front panel.
- Status saved: saved in the instrument status.
- Factory preset: Video Average
- **Remote Command:**

[[:SENSE]:TXPower:AVERage:TYPE LOG|MAXimum|MINimum|RMS

[[:SENSE]:TXPower:AVERage:TYPE?

[Log-Pwr Avg]

- Menu description: in calculation, divide the trace data sum by data point number.
- Key path: **【Meas Setup】** , [Average Type▶], [Log-Pwr Avg] on the front panel.
- Status saved: saved in the instrument status.

[Pwr Avg]

- Menu description: firstly, change the trace data into power in dB, then average the trace data. This averaging may take a long time.
- Key path: **【Meas Setup】** , [Average Type▶], [Pwr Avg] on the front panel.
- Status saved: saved in the instrument status.

[Threshold Lvl]

Absolute **Relative**

- Menu description: to set the Threshold Level, which is used to calculate the average carrier power that is higher than this threshold. It can be relative power value in dB, or absolute power value in dBm. Use number keys, stepping keys or knob to change the Threshold Level center frequency.
- Key path: **【Meas Setup】** , [Threshold Lvl Abs Rel] on the front panel.
- Status saved: saved in the instrument status.
- Factory preset: -30dB/Relative
- **Setting range:** -100~100
- Default unit: dB(dBm)
- **Remote Command:**

[[:SENSE]:TXPower:THReshold <real>

[[:SENSe]:TXPower:THReshold?

[[:SENSe]:TXPower:THReshold:TYPE ABSolute|RELative

[[:SENSe]:TXPower:THReshold:TYPE?

[Meas Method▶]

- Menu description: to select the Measurement Method for usage.
- Key path: **【Meas Setup】** , [Meas Method▶] on the front panel.
- Status saved: saved in the instrument status.
- Factory preset: Threshold Level method
- **Remote Command:**

[[:SENSe]:TXPower:METHOD THReshold|BWIDth

[[:SENSe]:TXPower:METHOD?

[Threshold Lvl Method]

- Menu description: to select the Measurement Method as Threshold Level: select the user-defined threshold level or default level (-30.0dB) as the measurement standard.
- Key path: **【Meas Setup】** , [Meas Method▶], [Threshold Lvl Method] on the front panel.
- Status saved: saved in the instrument status.
- Factory preset: Threshold Level method

[Measured Burst Width Method]

- Menu description: to select the Measurement Method as Burst Width Method.
- Key path: **【Meas Setup】** , [Meas Method▶], [Measured Burst Width Method] on the front panel.
- Status saved: saved in the instrument status.

[Measured Burst Width **Auto Man**]

- Menu description: to set the Burst Width parameter as Auto On/Off. Under Auto ON mode, the pulse width is calculated automatically based on the threshold level. For example, if the threshold level is set to 3dB, the pulse width is the interval between 3dB points. Before all results are calculated, after each sweep, the pulse width will update. Since this measurement is only made above the pulse width, the measurement is between 3dB points. Under Auto OFF mode, the user can directly input the pulse width for calculating the pulse power, or the percentage for measured pulse width. In the latter case, the pulse width is only calculated once based on the latest measured pulse width. Otherwise, the pulse width is positioned at the center of each measured pulse.
- Key path: **【Meas Setup】** , [Measured Burst Width Auto Man] on the front panel.
- Status saved: saved in the instrument status.
- Factory preset: 10us/Auto
- **Setting range:** 0~50s
- Default unit: s

5.2. Description of menu

- **Remote Command:**

```
[[:SENSe]:TXPower:BURSt:WIDTh <time>
```

```
[[:SENSe]:TXPower:BURSt:WIDTh?
```

```
[[:SENSe]:TXPower:BURSt:AUTO ON|OFF|1|0
```

```
[[:SENSe]:TXPower:BURSt:AUTO?
```

[Low Noise Path ON OFF]

- Menu description: this menu is only available when the H34 option (Low Noise PreAmplifier) is purchased. When the PreAmplifier is ON, the Low Noise Path is OFF and this menu is grayed out; when the PreAmplifier is OFF, this menu lights on and is switchable.
- Key path: **【Meas Setup】** , [More 1/2], [Low Noise Path ON OFF] on the front panel.
- Status saved: saved in the instrument status.
- **Remote Command:**

```
:TXPower:POWer:MW:PATH STD|LNPath
```

```
:TXPower:POWer:MW:PATH?
```

[Preselector Preselecting Bypass]

- Menu description: this menu is only available when the H36 option is purchased. It is used for setting whether to bypass the front-end preselector of the signal/spectrum analyzer. In analyzing bandwidth signal, bypass is usually required.
- Key path: **【Meas Setup】** , [More 1/2], [Preselector Preselecting Bypass] on the front panel.
- Status saved: saved in the instrument status.
- **Remote Command:**

```
INPut:TXPower:FILTer:YIG[:STATe] OFF|ON|0|1
```

```
INPut:TXPower:FILTer:YIG[:STATe]?
```

[RF Gain▶]

- More description: to set the Auto ON/OFF of the RF Gain and best allocation algorithm for RF Gain. The soft More includes [Auto], [Best for Dynamic Range] and [Best Sensitivity].
- Key path: **【Meas Setup】** , [More 1/2], [RF Gain] on the front panel.
- Status saved: saved in the instrument status.
- **Remote Command:**

```
:TXPower:RF:GAIN:AUTO OFF|ON|0|1
```

```
:TXPower:RF:GAIN:AUTO?
```

```
:TXPower:RF:GAIN:AUTO:RULEs RANGE|SENSITIVITY
```

```
:TXPower:RF:GAIN:AUTO:RULEs?
```

[Auto]

5.2. Description of menu

- Menu description: to set the RF Gain distribution algorithm to Auto. In this case, the RF Gain distribution is “Best Dynamic Range”.
- Key path: **【Meas Setup】** , [More 1/2], [RF Gain▶], [Auto] on the front panel.
- Status saved: saved in the instrument status.

[Best for Dynamic Range]

- Menu description: to set the RF Gain distribution algorithm to Best Dynamic Range. In this case, the RF Gain is switched to “Auto OFF”
- Key path: **【Meas Setup】** , [More 1/2], [RF Gain▶], [Best Dynamic Range] on the front panel.
- Status saved: saved in the instrument status.

[Best for Sensitivity]

- Menu description: to set the RF Gain distribution algorithm to Best Sensitivity. In this case, the RF Gain is switched to “Auto OFF”
- Key path: **【Meas Setup】** , [More 1/2], [RF Gain▶], [Best for Sensitivity] on the front panel.
- Status saved: saved in the instrument status.

[ADC Dither **Auto Man**]

- Menu description: to control opening/closing of ADC dither of the frequency acquisition circuit in the analyzer. Under default mode, the signal/spectrum analyzer will automatically control whether the ADC Dither is ON based on current working condition. When the ADC Dither is under Auto mode, the ON or OFF status depends on the span, resolution bandwidth and sweep type (continuous swept or step sweep); when it is continuous swept, the ADC Dither status will force to switch to Auto and turns off; when it is step sweep, under Auto mode, if the span is 2MHz or below, the ADC Dither is ON; if the span is below 2MHz, the ADC Dither is OFF. Under Auto OFF mode, if the span is above 2MHz, turning on the ADC Dither may affect the measurement results based on selected dither status. You can access the submenu for manual control.
- Key path: **【Meas Setup】** , [More 1/2], [ADC Dither **Auto Man**] on the front panel.
- Status saved: saved in the instrument status.
- Factory preset: Auto.
- **Remote Command:**

```
[[:SENSe]:TXPower:ADC:DITHer[:STATe] OFF|ON|HIGH
```

```
[[:SENSe]:TXPower:ADC:DITHer[:STATe]? \n
```

```
[[:SENSe]:TXPower:ADC:DITHer:AUTO[:STATe] OFF|ON|0|1
```

```
[[:SENSe]:TXPower:ADC:DITHer:AUTO[:STATe]?
```

[Meas Preset]

- Menu description: to reset the measurement parameters to the factory preset status or user saved parameter status
- Key path: **【Meas Setup】** , [Meas Preset] on the front panel.
- Factory preset: factory reset.

5.2. Description of menu

- **Remote Command:**

:CONFigure:TXPower

5.2.7.18 Measurement Control

Pop up the More related to Meas Control, including [Measure Single Cont], [Restart] and [Pause/Resume].

[Measure Continuous **ON** OFF]

- Menu description: to set continuous measurement OFF or ON. When the [Measure Single **Cont**] is set as Cont mode, Cont On mode will be triggered and Cont sweep will be the default measure control method; when the [Measure Single **Cont**] is set as Single mode, single sweep will be triggered. Press **【Sweep Single】** to restart sweep when the next trigger signal arrives.
- Key path: **【Meas Control】** , [Measurement Single **Cont** On Off] on the front panel.
- Status saved: saved in the instrument status.
- Factory preset: Continuous On.
- **Remote Command:**

:INITiate:CONTinuous OFF|ON|0|1

:INITiate:CONTinuous?

- **Examples:**

:INIT:CONT OFF

[Restart]

- Menu description: to stop current measurement and restart measurement for the signal/spectrum analyzer.
- Key path: **【Meas Control】** , [Restart] on the front panel
- Status saved: not saved in instrument status.
- **Remote Command:**

:INITiate:REST

[Pause/Resume]

- Menu description: when the signal/spectrum analyzer is in operation, this menu is used for pausing current measurement; when in Paused status, this menu is used for continuing measurement.
- Key path: **【Meas Control】** , [Pause/Resume] on the front panel.
- Status saved: not saved in instrument status.
- **Remote Command:**

:INITiate:PAUS

:INITiate:RES

5.2.8 Harmonic Distortion

5.2.8.1 Frequency

The **【Frequency】** key on the front panel is used to set parameters related to frequency of the signal/spectrum analyzer. The soft menus include: [Fundamental Freq], [CF Step Auto Man], [Freq Offset].

5.2. Description of menu

[Fundamental Frequency Auto Man]

- Menu description: to set the fundamental frequency at auto measurement of harmonic distortion. In Auto On mode, the instrument searches fundamental frequency automatically; in Auto Off mode, users may use number keys, stepping keys or the knob to set.
- Key path: **【Frequency】** , [Fundamental Freq Auto Man] on the front panel.
- Status saved: saved in the instrument status.
- Factory preset: Auto
- **Setting range:** 1.0E+7 ~ maximum instrument frequency
- Default unit: Hz
- **Remote Command:**

```
[::SENSE]:HARMONics:FREQUency:FUNDamental <freq>
```

```
[::SENSE]:HARMONics:FREQUency:FUNDamental?
```

```
[::SENSE]:HARMONics:FREQUency:FUNDamental:AUTO OFF|ON|0|1
```

```
[::SENSE]:HARMONics:FREQUency:FUNDamental:AUTO?
```

[CF Step Auto Man]

See the [CF Step Auto Man] under **【Frequency】** of the sweep analysis function for more details.

[Freq Offset]

See the [Freq Offset] under **【Frequency】** of the sweep analysis function for more details.

5.2.8.2 Ampld/YScale

Pop up More related to parameter setting of Ampld/YScale, including [RefLevel], [Attenuation ▶], [PreAmplifier On/Off], [Scale/Div], [Auto Scale], [More 1/2▶], [Y Axis Unit], [Ref Level Offset].

[RefLevel]

- Menu description: to enable the Reference Level function. The reference level can be adjusted with the number keys, step keys or knob. The reference level corresponds to the top of the coordinate top. Measure signal at reference level position to get highest accuracy. The input attenuator of the signal/spectrum analyzer is coupled to the reference level, which can be automatically changed to avoid compression of input signal.
- Key path: **【Ampld/YScale】** , [RefLevel] on the front panel.
- Status saved: saved in the instrument status.
- Factory preset: 0dBm.
- Setting range: Min.: -170dBm, Max.: 30dBm.
- Default unit: set based on Y Axis scale unit.
- **Remote Command:**

```
::DISPlay:HARMONics:VIEW:WINDow:TRACe:Y:RLEVel <real>
```

```
::DISPlay:HARMONics:VIEW:WINDow:TRACe:Y:RLEVel?
```

- **Examples:**

5.2. Description of menu

:DISPlay:HARMonics:VIEW:WINDow:TRACe:Y:RLEVl20dBm

[Attenuation▶]

See [Attenuation▶] under **【Ampld/YScale】** of the sweep analysis function for more details.

[PreAmplifier ON OFF]

See [PreAmplifier ON/OFF] under **【Ampld/YScale】** of the sweep analysis function for more details.

[Scale/Div]

- Menu description: to select the scale/division from 0.1dB/division to 20dB/division. This menu is only valid when the scale type is logarithm.
- Key path: **【Ampld/YScale】** , [Scale/Div] on the front panel.
- Status saved: saved in the instrument status.
- **Factory preset:** 10.00 dB.
- Setting range: Min.: 0.1dB, Max.: 20dB.
- **Remote Command:**

:DISPlay:HARMonics:VIEW:WINDow:TRACe:Y:PDIVision <rel_amp>

:DISPlay:HARMonics:VIEW:WINDow:TRACe:Y:PDIVision?

[Auto Scale]

- Menu description: the instrument automatically sets parameters like reference level and scale/division based on input signal sizes. When this soft menu key is pressed, the instrument performs one auto scaling. Setting rule for auto scaling: firstly obtain the maximum value and the minimum value based on current measurement trace data. Based on the maximum value, place on the 80% graticule of the screen trace Y axis for auto setting of reference level and scale/division.
- Key path: **【Ampld/YScale】** , [Auto Scale] on the front panel.
- Status saved: not saved in instrument status.
- **Remote Command:**

:HARMonics:ADJust:LEVl

[Y Axis Unit]

- More description: to select the Y Axis unit from [dBm], [dBmV], [dBmA], [W], [V], [A], [dBμV] and [dBμA]. The instrument will automatically calculate the trace data and marker readout based on the Y axis unit.
- Key path: **【Ampld/YScale】** , [More 1/2▶], [Y Axis Unit ▶] on the front panel.
- Status saved: saved in the instrument status.
- Factory preset: dBm.

:UNIT:HARMonics:POWer DBM|DBMV|DBMA|V|W|A|DBUV|DBUA

:UNIT:HARMonics:POWer?

[Ref Level Offset]

- Menu description: to introduce offset for all amplitude readout (e.g, reference level and marker amplitude). It will not change the trace position on the screen. This offset unit is dB and is not affected by the scale and unit. Use number keys, stepping keys or knob to input the offset value.
- Key path: **【Ampld/YScale】** , [More 1/2▶], [Ref Level Offset] on the front panel.
- Status saved: saved in the instrument status.
- **Factory preset:** 0 dB.
- Setting range: Min.: -1000dB, Max.:1000dB.
- **Remote Command:**

:DISPlay:HARMonics:WINDow:TRACe:Y:RLEVel:OFFSet <rel_ampl>

:DISPlay:HARMonics:WINDow:TRACe:Y:RLEVel:OFFSet?

- **Examples:**

:DISPlay:HARMonics:WINDow:TRACe:Y:RLEVel:OFFSet 12

5.2.8.3 Span/X Scale

This key has no soft menu.

5.2.8.4 Bandwidth

Pop up the soft More for setting the Res BW, [Res BW **Auto** Man].

[Res BW **Auto Man]**

- Menu description: to change the resolution bandwidth of spectrum analysis, ranging from 1Hz to 20MHz, which is stepped by 1, 2, 3, 5 and 10. The resolution bandwidth can be changed with the number keys, step keys and knob. The shaded character indicates the currently selected mode.
- Key path: **【BW】** , [Res BW **Auto** Man] on the front panel.
- Status saved: saved in the instrument status.
- Factory preset: Auto
- Setting range: Min.:1Hz, Max.: 20MHz.
- Default unit: Hz
- **Remote Command:**

:HARMonics:BANDwidth <bandwidth>

:HARMonics:BANDwidth?

:HARMonics:BANDwidth:AUTO ON|OFF|1|0

:HARMonics:BANDwidth:AUTO?

- **Examples:**

:HARM:BAND 1kHz

:HARM:BAND:AUTO ON On

5.2.8.5 Auto Setting

5.2. Description of menu

Pop up the soft menu related to auto setting including [Couple All], [Mech Atten Auto Man], [Res BW Auto Man], [Sweep Time Auto Man], [Fundamental Frequency Auto Man] and [CF Step Auto Man].

[Couple All]

- Menu description: to set the resolution bandwidth, sweep time, mechanical attenuator and frequency step as auto coupling mode. The signal/spectrum analyzer will select most suitable values for those functions based on set frequency. If no ratio is pre-saved, use default ratio.
- Key path: **【Auto Set】** , [Couple All] on the front panel.
- Status saved: not saved in instrument status.
- Factory preset: Couple All.

- **Remote Command:**

:COUPle ALL

- **Examples:**

:COUP ALL

[Mech Atten Auto Man]

See [Attenuation▶] under **【Ampld/YScale】** for more details.

[Res BW Auto Man]

See [Res BW Auto Man] under **【BW】** for more details.

[Sweep Time Auto Man]

See [Sweep Time Auto Man] under **【Sweep】** for more details.

Fundamental Frequency Auto Man]

See [Fundamental Freq Auto Man] under [Frequency] for more details.

[CF Step Auto ON OFF]

See [CF Step Auto ON/OFF] under **【Frequency】** for more details.

5.2.8.6 Track

Press **【Trace】** key on the front panel to pop up corresponding soft menu Including [Clear Write], [Trace Average].

[Refresh]

- Command description: to set the current trace processing as Refresh, i.e., clear all data of displayed trace and continue the signal trace receipt under sweep status.
- Key path: **【Trace】** , [Clear Write] on the front panel.
- Status saved: saved in the instrument status.
- Factory preset: all trace modes are defaulted as Refresh.

5.2. Description of menu

- **Remote Command:**

```
:TRACe:HARMonics:TYPE WRITe
```

```
:TRACe:HARMonics:TYPE?
```

[Trace Average]

- Command description: to set the current trace processing method as Average, i.e, based on the average count N set in the **【Meas Setup】** , update trace after averaging the performance index of the measurement trace.
- Key path: **【Trace】** , [Trace Average] on the front panel.
- Status saved: saved in the instrument status.
- Factory preset: all trace modes are defaulted as Refresh.

- **Remote Command:**

```
:TRACe:HARMonics:TYPE AVERAge
```

```
:TRACe:HARMonics:TYPE?
```

5.2.8.7 Sweep

Enable sweep parameter setting function to pop up setting More for Sweep Time, [Sweep Time **Auto** On Off].

[Sweep Time **Auto** Man]

- Menu description: to change the sweep time of signal/spectrum analyzer. Use the number keys, step keys or knob to adjust the sweep time. When it is under Auto OFF mode (shaded), it indicates that sweep time can be set manually. When it is under Auto ON status, the sweep time will be automatically coupled based on resolution bandwidth, span and video bandwidth
- Key path: **【Sweep】** , [Sweep Time **Auto** Man] on the front panel.
- Status saved: saved in the instrument status.
- Factory preset: sweep time Auto.
- Setting range: Min.: 1ms, Max.: 6000s.
- Default unit: s

- **Remote Command:**

```
:HARMonics:SWEEp:TIME <time>
```

```
:HARMonics:SWEEp:TIME?
```

```
:HARMonics:SWEEp:TIME:AUTO OFF|ON|0|1
```

```
:HARMonics:SWEEp:TIME:AUTO?
```

- **Examples:**

```
:HARM:SWE:TIME 500 ms
```

```
:HARM:SWE:TIME:AUTO OFF
```

5.2.8.8 Single

- Menu description: the **【Single】** key on the front panel has no corresponding soft menu. This function is mainly used for manual trigger of one measurement. When the Average is ON, this function performs measurement at the count specified by the Average Count.

5.2. Description of menu

In remote control programming and system establishment, this function combined with *WAI can effectively synchronize the measurement process and enable the trace data obtained after the *WAI finishes directly correspond to the measurement process one by one.

- **Remote Command:**

:INITiate:HARMonics

5.2.8.9 Continuous

The **【Cont】** key on the front panel has no corresponding soft menu. This is mainly used for changing the Measurement Continuous OFF to Measurement Continuous ON; if the current state is Measurement Continuous ON, the instrument performs no operation.

5.2.8.10 Trigger

See **【Trig】** menu of the sweep analysis function for more details.

5.2.8.11 Display

Pop up soft More related to display, including [Display Line On **Off**], [Bar Graph **On** Off], [Display Config **►**].

[Display Line ON OFF]

See [Display Line On/off] under **【Display】** of the sweep analysis function for more details.

[Display Config►]

It is used for configurations of interface language, status area display ON OFF related to interface display, The soft More include [Select Language **中文** **English**], [Graticule Display **On** Off], Status Display **On** Off], [Freq Info Disp **On** Off]. See [Display Config►] under **【Display】** of the sweep analysis function for more details.

5.2.8.12 Input Output

See the **【Input/Output】** menu of the sweep analysis function for more details.

5.2.8.13 Marker

This key has no soft menu.

5.2.8.14 Maker->

This key has no soft menu.

5.2.8.15 Marker Function

This key has no soft menu.

5.2.8.16 Peak

This key has no soft menu.

5.2.8.17 Measurement Setting

5.2. Description of menu

Pop up the soft menu related to measurement setting, including [Average Num On Off], [Average Mode Exponential Repeat], [Harmonics], [Harmonics Table On Off], [Harmonics Table Config], [Low Noise Path On Off], [Preselector Preselecting Bypass], [RF Gain▶], [ADC Dither Auto Man], [Meas Preset].

[Average Num ON OFF]

- Menu description: to turn on or off Average. When Average Count is ON, the user can specify the average count required for measurement. The Average Count can be adjusted by number keys, stepping keys or knob.
- Key path: **【Meas Setup】** , [Average Num ON OFF] on the front panel.
- Status saved: saved in the instrument status.
- Factory preset: 100/OFF
- **Setting range:** 1~10000
- Default unit: none
- **Remote Command:**

[::SENSE]:HARMONics:AVERAge:COUNT <integer>

[::SENSE]:HARMONics:AVERAge:COUNT?

[::SENSE]:HARMONics:AVERAge[:STATe] ON|OFF|1|0

[::SENSE]:HARMONics:AVERAge[:STATe]?

[Average Mode Exponential Repeat]

- Menu description: when Average Count is ON, the user can select Average State required for measurement.

Exponential - Different from Linear Average, in Exponential State, the weight of new data is larger than that of old data. This is good for tracking data change in terms of time. In this case, the selected averaging count determines the weight of the old data on the new data. As the average count increases, the weight of new data gradually decreases. This is good for tracking data change in terms of time. In this case, the selected averaging count determines the weight of the old data on the new data. As the average count increases, the weight of new data gradually decreases.

Repeat - Similarly, it takes exponential averaging. However, when the average count is met, clear all previous results, restart average till the set average count and repeat this process.

- Key path: **【Meas Setup】** , [Average Mode Exponential Repeat] on the front panel.
- Status saved: saved in the instrument status.
- Factory preset: Exponential
- **Remote Command:**

[::SENSE]:HARMONics:AVERAge:TCONtrol EXPONential|REPeat

[::SENSE]:HARMONics:AVERAge:TCONtrol?

[Harmonics]

- Menu description: to set to calculate the total number of harmonics to be measured for harmonic distortion. The minimum value is 2 (fundamental harmonics and second harmonics). The maximum value is 10. Use number keys, stepping keys or knob to change the harmonics number.
- Key path: **【Meas Setup】** on the front panel.

5.2. Description of menu

- Status saved: saved in the instrument status.
- Factory preset: 100/OFF
- **Setting range:** 2~10
- Default unit: none
- **Remote Command:**

[[:SENSE]:HARMONics:NUMBer <integer> [:SENSe]:HARMONics:NUMBer?

[Harmonics Table ON OFF]

- Menu description: to turn on or off Range List. If it is ON, take harmonics measurement based on table. If it is OFF, the first active scope is fundamental harmonic and the self sequence active range is harmonics.
- Key path: **【Meas Setup】** , [Harmonics Table ON OFF] on the front panel.
- Status saved: saved in the instrument status.
- Factory preset: OFF.
- **Remote Command:**

[[:SENSE]:HARMONics:RTABLE:STATe OFF|ON|0|1

[[:SENSE]:HARMONics:RTABLE:STATe?

[Harmonics Table Config▶]

- Menu description: to enter the setting interface of the harmonics editing list. If it is OFF, use “----” to indicate that this harmonic range is void and no measurement is made.
- Key path: **【Meas Setup】** , [Harmonics Table Config▶] on the front panel.

[Harmonic ON OFF]

- Menu description: to set the parameter for each harmonics. If it is ON, measure the harmonics. If it is OFF, no measurement is made.
- Key path: **【Meas Setup】** , [Harmonics Table Config▶], [Harmonics ON/OFF] on the front panel.
- Status saved: saved in the instrument status.
- Factory preset: ON
- **Remote Command:**

[[:SENSE]:HARMONics:RANGe[:LIST]:STATe OFF|ON|0|1, ...

[[:SENSE]:HARMONics:RANGe[:LIST]:STATe?)

[Freq]

- Menu description: to set harmonics frequency. Users may use number keys, stepping keys and the knob to adjust it.
- Key path: **【Meas Setup】** , [Harmonics Table Config▶], [Freq] on the front panel.
- Status saved: saved in the instrument status.

5.2. Description of menu

- Factory preset: 1.0GHz
- Setting range: 1 - set the maximum frequency of the instrument
- Default unit: Hz
- **Remote Command:**

[[:SENSE]:HARMONICS:RANGE[:LIST]:FREQUENCY <frequency>,...

[[:SENSE]:HARMONICS:RANGE[:LIST]:FREQUENCY?

[Res BW **Auto Man**]

- Menu description: to set resolution bandwidth state of the instrument. If the resolution bandwidth is set to Auto ON, the optimal setting is determined by the instrument. When the resolution bandwidth is set as auto off, users may define the bandwidth and adjust it with number keys, stepping keys or the knob.
- Key path: **【Meas Setup】** , [Harmonics Table Config▶], [Res BW Auto Man] on the front panel.
- Status saved: saved in the instrument status.
- Factory preset: 3MHz/Auto
- **Setting range:** 1Hz – 20MHz.
- Default unit: Hz
- **Remote Command:**

[[:SENSE]:HARMONICS:RANGE[:LIST]:BANDWIDTH|BWIDTh[:RESOLUTION] <frequency>,...

[[:SENSE]:HARMONICS:RANGE[:LIST]:BANDWIDTH|BWIDTh[:RESOLUTION]?

[[:SENSE]:HARMONICS:RANGE[:LIST]:BANDWIDTH|BWIDTh[:RESOLUTION]:AUTO ON|OFF|1|0, ...

[[:SENSE]:HARMONICS:RANGE[:LIST]:BANDWIDTH|BWIDTh[:RESOLUTION]:AUTO?

[Video BW **Auto Man**]

- Menu description: to set video bandwidth state of the instrument. If the video bandwidth is set to Auto ON, the optimal setting is determined by the instrument. If the video bandwidth is set to Auto OFF, users may define the bandwidth and adjust it with number keys, stepping keys or the knob. and adjust it with number keys, stepping keys or the knob.
- Key path: **【Meas Setup】** , [Harmonics Table Config▶], [Video BW Auto Man] on the front panel.
- Status saved: saved in the instrument status.
- Factory preset: 3MHz/Auto
- **Setting range:** 1Hz – 20MHz.
- Default unit: Hz
- **Remote Command:**

[[:SENSE]:HARMONICS:RANGE[:LIST]:BANDWIDTH|BWIDTh:VIDEo <frequency>,...

[[:SENSE]:HARMONICS:RANGE[:LIST]:BANDWIDTH|BWIDTh:VIDEo?

[[:SENSE]:HARMONICS:RANGE[:LIST]:BANDWIDTH|BWIDTh:VIDEo:AUTO ON|OFF|1|0, ...

[[:SENSE]:HARMONICS:RANGE[:LIST]:BANDWIDTH|BWIDTh:VIDEo:AUTO?

[Sweep Time **Auto Man**]

5.2. Description of menu

- Menu description: to set the Sweep Time of the instrument as Auto ON or OFF. Use number keys, stepping keys or knob to change the time.
- Key path: **【Meas Setup】** , [Harmonics Table Config▶], [Sweep Time Auto Man] on the front panel.
- Status saved: saved in the instrument status.
- Factory preset: 5ms/Auto
- Setting range: 1us – 6000s
- Default unit: s
- **Remote Command:**

```
[::SENSE]:HARMONics:RANGe[:LIST]:SWEeptime <time>, ...
```

```
[::SENSE]:HARMONics:RANGe[:LIST]:SWEeptime?
```

```
[::SENSE]:HARMONics:RANGe[:LIST]:SWEeptime:AUTO ON|OFF|1|0, ...
```

```
[::SENSE]:HARMONics:RANGe[:LIST]:SWEeptime:AUTO?
```

[Auto Fill Table]

- Menu description: to automatically set the parameters of range table based on current center frequency and span.
- Key path: **【Meas Setup】** , [Harmonics Table Config▶], [Auto Fill Table] on the front panel.
- **Remote Command:**

```
[::SENSE]:HARMONics:RTABLE:FILL
```

[Low Noise Path ON OFF]

- Menu description: this menu is only available when the H34 option (Low Noise PreAmplifier) is purchased. When the PreAmplifier is ON, the Low Noise Path is OFF and this menu is grayed out; when the PreAmplifier is OFF, this menu lights on and is switchable.
- Key path: **【Meas Setup】** , [More 1/2], [Low Noise Path ON OFF] on the front panel.
- Status saved: saved in the instrument status.
- **Remote Command:**

```
:HARMONics:POWer:MW:PATH STD|LNPath
```

```
:HARMONics:POWer:MW:PATH?
```

[Preselector Preselecting Bypass]

- Menu description: this menu is only available when the H36 option is purchased. It is used for setting whether to bypass the front-end preselector of the signal/spectrum analyzer. In analyzing bandwidth signal, bypass is usually required.
- Key path: **【Meas Setup】** , [More 1/2], [Preselector Preselecting Bypass] on the front panel.
- Status saved: saved in the instrument status.
- **Remote Command:**

```
INPut:HARMONics:FILTer:YIG[:STATe] OFF|ON|0|1
```

```
INPut:HARMONics:FILTer:YIG[:STATe]?
```

[RF Gain▶]

- More description: to set the Auto ON/OFF of the RF Gain and best allocation algorithm for RF Gain. The soft More includes [Auto], [Best for Dynamic Range] and [Best Sensitivity].
- Key path: **【Meas Setup】** , [More 1/2], [RF Gain] on the front panel.
- Status saved: saved in the instrument status.
- **Remote Command:**

:HARMonics:RF:GAIN:AUTO OFF|ON|0|1

:HARMonics:RF:GAIN:AUTO?

:HARMonics:RF:GAIN:AUTO:RULEs RANGE|SENSITIVITY

:HARMonics:RF:GAIN:AUTO:RULEs?

[Auto]

- Menu description: to set the RF Gain distribution algorithm to Auto. In this case, the RF Gain distribution is “Best Dynamic Range”.
- Key path: **【Meas Setup】** , [More 1/2], [RF Gain▶], [Auto] on the front panel.
- Status saved: saved in the instrument status.

[Best for Dynamic Range]

- Menu description: to set the RF Gain distribution algorithm to Best Dynamic Range. In this case, the RF Gain is switched to “Auto OFF”
- Key path: **【Meas Setup】** , [More 1/2], [RF Gain▶], [Best Dynamic Range] on the front panel.
- Status saved: saved in the instrument status.

[Best for Sensitivity]

- Menu description: to set the RF Gain distribution algorithm to Best Sensitivity. In this case, the RF Gain is switched to “Auto OFF”
- Key path: **【Meas Setup】** , [More 1/2], [RF Gain▶], [Best for Sensitivity] on the front panel.
- Status saved: saved in the instrument status.

[ADC Dither **Auto ON OFF]**

- Menu description: to control opening/closing of ADC dither of the frequency acquisition circuit in the analyzer. Under default mode, the signal/spectrum analyzer will automatically control whether the ADC Dither is ON based on current working condition. When the ADC Dither is under Auto mode, the ON or OFF status depends on the span, resolution bandwidth and sweep type (continuous swept or step sweep); when it is continuous swept, the ADC Dither status will force to switch to Auto and turns off; when it is step sweep, under Auto mode, if the span is 2MHz or below, the ADC Dither is ON; if the span is below 2MHz, the ADC Dither is OFF. Under Auto OFF mode, if the span is above 2MHz, turning on the ADC Dither may affect the measurement results based on selected dither status. You can access the submenu for manual control.
- Key path: **【Meas Setup】** , [More 1/2], [ADC Dither Auto **Man**] on the front panel.

5.2. Description of menu

- Status saved: saved in the instrument status.
- Factory preset: Auto.
- **Remote Command:**

```
[::SENSe]:HARMonics:ADC:DITHer[:STATe] OFF|ON|HIGH
```

```
[::SENSe]:HARMonics:ADC:DITHer[:STATe]? \n
```

```
[::SENSe]:HARMonics:ADC:DITHer:AUTO[:STATe] OFF|ON|0|1
```

```
[::SENSe]:HARMonics:ADC:DITHer:AUTO[:STATe]?
```

[Meas Preset]

- Menu description: to reset the measurement parameters to the factory preset status or user saved parameter status
- Key path: **【Meas Setup】** , [More 1/2▶], [Meas Preset] on the front panel.
- Factory preset: factory reset.
- **Remote Command:**

```
:CONFigure:HARMonics
```

5.2.8.18 Measurement Control

Pop up the More related to Meas Control, including [Measure Single Cont], [Restart] and [Pause/Resume].

[Measure Continuous **ON OFF**]

- Menu description: to set continuous measurement OFF or ON. When the [Measure Single **Cont**] is set as Cont mode, Cont On mode will be triggered and Cont sweep will be the default measure control method; when the [Measure Single **Cont**] is set as Single mode, single sweep will be triggered. Press **【Sweep Single】** to restart sweep when the next trigger signal arrives.
- Key path: **【Meas Control】** , [Meas Single Cont On Off] on the front panel.
- Status saved: saved in the instrument status.
- Factory preset: Continuous On.
- **Remote Command:**

```
:INITiate:CONTinuous OFF|ON|0|1
```

```
:INITiate:CONTinuous?
```

- **Examples:**

```
:INIT:CONT OFF
```

[Restart]

- Menu description: to stop current measurement and restart measurement for the signal/spectrum analyzer.
- Key path: **【Meas Control】** , [Restart] on the front panel
- Status saved: not saved in instrument status.
- **Remote Command:**

```
:INITiate:REST
```

[Pause/Resume]

- Menu description: when the signal/spectrum analyzer is in operation, this menu is used for pausing current measurement; when in Paused status, this menu is used for continuing measurement.
- Key path: **【Meas Control】** , [Pause/Resume] on the front panel.
- Status saved: not saved in instrument status.
- **Remote Command:**

:INITiate:PAUS

:INITiate:RES

5.2.9 Three-order intermodulation (TOI)**5.2.9.1 Frequency**

The **【Frequency】** key on the front panel is used to set parameters related to the signal/spectrum analyzer frequency, including [Center Freq], [Low Freq Auto Man], [High Freq Auto Man], [CF Step Auto Man], [Freq Offset]. See the **【Frequency】** menu of the sweep analysis function for more details.

[Center Freq]

See the [Center Freq] under **【Frequency】** of the sweep analysis function for more details.

[Lower base frequency **Auto Man]**

- Menu description: to set the lower frequency of the base frequency for TOI measurement. In Auto On mode, the instrument searches lower frequency automatically; in Auto Off mode, users may use number keys, stepping keys or the knob to set.
- Key path: [Freq, [Low Base Freq Auto Man] on the front panel.
- Status saved: saved in the instrument status.
- Factory preset: Auto
- Setting range: $-1.0E+8\sim$, set the maximum frequency of the instrument.
- Default unit: Hz
- **Remote Command:**

[:SENSe]:TOI:FREQuency:BASE:LOWer <freq>

[:SENSe]:TOI:FREQuency:BASE:LOWer <freq>

[:SENSe]:TOI:FREQuency:BASE:LOWer:AUTO OFF|ON|0|1

[:SENSe]:TOI:FREQuency:BASE:LOWer:AUTO?

[Upper base frequency **Auto Man]**

- Menu description: to set the upper frequency of the base frequency for TOI measurement. In Auto On mode, the instrument searches upper frequency automatically; in Auto Off mode, users may use number keys, stepping keys or the knob to set.
- Key path: **【Frequency】** , [High Base Freq Auto Man] on the front panel.

5.2. Description of menu

- Status saved: saved in the instrument status.
- Factory preset: Auto
- Setting range: $-1.0E+8\sim$, set the maximum frequency of the instrument.
- Default unit: Hz
- **Remote Command:**

```
[[:SENSe]:TOI:FREQuency:BASE:UPPer <frequency>
```

```
[[:SENSe]:TOI:FREQuency:BASE:UPPer?
```

```
[[:SENSe]:TOI:FREQuency:BASE:UPPer:AUTO OFF|ON|0|1
```

```
[[:SENSe]:TOI:FREQuency:BASE:UPPer:AUTO?
```

[CF Step **Auto** Man]

See the [CF Step **Auto** Man] under **【Frequency】** of the sweep analysis function for more details.

[Freq Offset]

See the [Freq Offset] under **【Frequency】** of the sweep analysis function for more details.

5.2.9.2 Ampld/YScale

Pop up More related to parameter setting of Ampld/YScale, including [RefLevel], [Attenuation ▶], [PreAmplifier On/Off], [Scale/Div], [Auto Scale], [More 1/2▶], [Y Axis Unit], [Ref Level Offset].

[RefLevel]

- Menu description: to enable the Reference Level function. The reference level can be adjusted with the number keys, step keys or knob. The reference level corresponds to the top of the coordinate top. Measure signal at reference level position to get highest accuracy. The input attenuator of the signal/spectrum analyzer is coupled to the reference level, which can be automatically changed to avoid compression of input signal.
- Key path: **【Ampld/YScale】**, [RefLevel] on the front panel.
- Status saved: saved in the instrument status.
- Factory preset: 0dBm
- Setting range: Min.: -170dBm, Max.: 30dBm.
- Default unit: set based on Y Axis scale unit.
- **Remote Command:**

```
:DISPlay:TOI:VIEW:WINDow:TRACe:Y:RLEVel <real>
```

```
:DISPlay:TOI:VIEW:WINDow:TRACe:Y:RLEVel?
```

- **Examples:**

```
:DISPl:TOI:VIEW:WINDow:TRAC:Y:RLEVel 20dBm
```

[Attenuation▶]

See [Attenuation▶] under **【Ampld/YScale】** of the sweep analysis function for more details.

5.2. Description of menu

[PreAmplifier ON OFF]

See [PreAmplifier ON/OFF] under **【Ampld/YScale】** of the sweep analysis function for more details.

[Scale/Div]

- Menu description: to select the scale/division from 0.1dB/division to 20dB/division. This menu is only valid when the scale type is logarithm.
- Key path: **【Ampld/YScale】** , [Scale/Div] on the front panel.
- Status saved: saved in the instrument status.
- **Factory preset:** 10.00 dB.
- Setting range: Min.: 0.1dB, Max.: 20dBm.
- **Remote Command:**

:DISPlay:TOI:VIEW:WINDow:TRACe:Y:PDIVision <rel_ampl>

:DISPlay:TOI:VIEW:WINDow:TRACe:Y:PDIVision?

[Auto Scale]

- Menu description: the instrument automatically sets parameters like reference level and scale/division based on input signal sizes. When this soft menu key is pressed, the instrument performs one auto scaling. Setting rule for auto scaling: firstly obtain the maximum value and the minimum value based on current measurement trace data. Based on the maximum value, place on the 80% graticule of the screen trace Y axis for auto setting of reference level and scale/division.
- Key path: **【Ampld/YScale】** , [Auto Scale] on the front panel.
- Status saved: not saved in instrument status.
- **Remote Command:**

:TOI:ADJust:LEVel

[Y Axis Unit]

- More description: to select the Y Axis unit from [dBm], [dBmV], [dBmA], [W], [V], [A], [dBμV] and [dBμA]. The instrument will automatically calculate the trace data and marker readout based on the Y axis unit.
- Key path: **【Ampld/YScale】** , [More 1/2▶], [Y Axis Unit ▶] on the front panel.
- Status saved: saved in the instrument status.
- Factory preset: dBm.

:UNIT:TOI:POWer DBM|DBMV|DBMA|V|W|A|DBUV|DBUA

:UNIT:TOI:POWer?

[Ref Level Offset]

- Menu description: to introduce offset for all amplitude readout (e.g, reference level and marker amplitude). It will not change the trace position on the screen. This offset unit is dB and is not affected by the scale and unit. Use number keys, stepping keys or knob to input the offset value.
- Key path: **【Ampld/YScale】** , [More 1/2▶],[Ref Level Offset] on the front panel.

5.2. Description of menu

- Status saved: saved in the instrument status.
- Factory preset: 0 dB.
- Setting range: Min.: -1000dB, Max.: 1000dB.
- **Remote Command:**

:DISPlay:TOI:WINDow:TRACe:Y:RLEVel:OFFSet <rel_amp>

:DISPlay:TOI:WINDow:TRACe:Y:RLEVel:OFFSet?

- **Examples:**

:DISPl:TOI:WIND:TRAC:Y:RLEVel:OFFSet 12

5.2.9.3 Span/X Scale

Press the **【Span/X Scale】** on the front panel to enable the span function and set the signal/spectrum analyzer into center frequency/span mode. Press the **【Span】** key to pop up [Span], [Full Span] and [Last Span].

[BW]

- Menu description: the span can be set by number keys, stepping keys or knob. Use number keys or select [Zero Span] to set the span as zero.
- Key path: **【Span/X Scale】** , [Span] on the front panel.
- Status saved: saved in the instrument status.
- Factory preset: maximum frequency limit - start frequency.
- Setting range: Min.: 10Hz, Max.: related to the maximum working frequency limit of the instrument.
- **Remote Command:**

:TOI:FREQuency:SPAN <freq>

:TOI:FREQuency:SPAN?

- **Examples:**

:TOI:FREQy:SPAN 10MHz

[Full Span]

- Menu description: to set the signal/spectrum analyzer into the center frequency/span mode. Set the span as maximum value.
- **Remote Command:**

:TOI:FREQuency:SPAN:FULL

[Last Span]

- Menu description: to set the signal/spectrum analyzer back to the previous span.
- **Remote Command:**

:TOI:FREQuency:SPAN:PREVious

5.2.9.4 Bandwidth

5.2. Description of menu

Pop up the soft More for setting Res BW and Video BW, including [Res BW **Auto** Man], [Video BW **Auto** Man] and [Filter Type].

[Res BW **Auto** Man]

- Menu description: to change the resolution bandwidth of spectrum analysis, ranging from 1Hz to 20MHz, which is stepped by 1, 2, 3, 5 and 10. The resolution bandwidth can be changed with the number keys, step keys and knob. The shaded character indicates the currently selected mode.
- Key path: **[BW]** , [Res BW Auto Man] on the front panel.
- Status saved: saved in the instrument status.
- Factory preset: Auto
- Setting range: Min.: 1Hz, Max.: 20MHz.
- Default unit: Hz
- **Remote Command:**

:TOI:BANDwidth <bandwidth>

:TOI:BANDwidth?

:TOI:BANDwidth:AUTO ON|OFF|1|0

:TOI:BANDwidth:AUTO?

- **Examples:**

:TOI:BAND 1kHz

:TOI:BAND:AUTO ON

[Video BW **Auto** Man]

- Menu description: to change the video bandwidth within the active function area, ranging from 1Hz to 20MHz, which is stepped by 1, 2, 3, 5 and 10. The resolution bandwidth can be changed with the number keys, step keys and knob. The shaded character indicates the currently selected mode. When set as Auto Off, press [Video BW **Auto** Man] to select Auto On and return to auto mode.
- Key path: **[BW]** , [Video BW Auto Man] on the front panel.
- Status saved: saved in the instrument status.
- Factory preset: Auto, same as the Resolution Bandwidth setting.
- Setting range: Min.: 1Hz, Max.: 20MHz.
- Default unit: Hz
- **Remote Command:**

:TOI:BANDwidth:VIDeo <bandwidth>

:TOI:BANDwidth:VIDeo?

:TOI:BANDwidth:VIDeo:AUTO ON|OFF|1|0

:TOI:BANDwidth:VIDeo:AUTO?

- **Examples:**

:TOI:BAND:VID 1 kHz

:TOI:BAND:VID:AUTO ON

5.2. Description of menu

[VBW/RBW **Auto Man**]

- Menu description: to set the ratio between the current video bandwidth and resolution bandwidth with the default value as 1. As the resolution bandwidth changes, the video bandwidth changes to maintain this ratio. The ratio should be displayed on the input area and used for the coupling mode of those two kinds of bandwidth. When a new ratio is selected, change the video bandwidth to meet this new ratio and the resolution bandwidth should remain unchanged.
- Key path: **【BW】** , [VBW/RBW Auto Man] on the front panel.
- Status saved: saved in the instrument status.
- Factory preset: auto with VBW/RBW as 1.
- Setting range: Min.:0.0001, Max.: 300000.
- **Remote Command:**

[[:SENSe]:TOI:BANDwidth|BWIDth:VIDeo:RATio <number>

[[:SENSe]:TOI:BANDwidth|BWIDth:VIDeo:RATio?

- **Examples:**

:TOI:BAND:VID:RAT 2

[Span/RBW **Auto Man**]

- Menu description: to set the ratio between the current span and resolution bandwidth and display it in the input area. This ratio is used in coupling mode of the resolution bandwidth.
- Key path: **【BW】** , [Span RBW Auto Man] on the front panel.
- Status saved: saved in the instrument status.
- Factory preset: auto with span/RBW as 106.
- Setting range: Min.:2, Max.: 10000.
- **Remote Command:**

[[:SENSe]:TOI:FREQuency:SPAN:BANDwidth[:RESolution]:RATio <integer>

[[:SENSe]:TOI:FREQuency:SPAN:BANDwidth[:RESolution]:RATio?

[[:SENSe]:TOI:FREQuency:SPAN:BANDwidth[:RESolution]:RATio:AUTO OFF|ON|0|1

[[:SENSe]:TOI:FREQuency:SPAN:BANDwidth[:RESolution]:RATio:AUTO?

5.2.9.5 Auto Setting

Pop up the soft menu related to auto setting including [Couple All], [Mech Atten **Auto Man**], [Res BW **Auto Man**], [Video BW **Auto Man**], [VBW/RBW **Auto Man**], [Span/RBW **Auto Man**], [Sweep Time **Auto Man**] and [CF Step **Auto Man**].

[Couple All]

- Menu description: to set the resolution bandwidth, video bandwidth, sweep time, mechanical attenuator and frequency step as auto coupling mode. The signal/spectrum analyzer will select most suitable values for those functions based on set frequency and bandwidth (or start frequency and stop frequency). If no ratio is pre-saved, use default ratio.
- Key path: **【Auto Set】** , [Couple All] on the front panel.
- Status saved: not saved in instrument status.

- Factory preset: Couple All.
- **Remote Command:**

:COUPle ALL

- **Examples:**

:COUP ALL

[Mech Atten Auto Man]

See [Attenuation▶] under **【Ampld/YScale】** for more details.

[Res BW Auto Man]

See [Res BW Auto Man] under **【BW】** for more details.

[Video BW Auto Man]

See [Video BW Auto Man] under **【BW】** for more details.

[VBW/RBW Auto Man]

See [VBW/RBW Auto Man] under **【BW】** for more details.

[Span/RBW Auto Man]

See [Span/RBW Auto Man] under **【BW】** for more details.

[Sweep Time Auto Man]

See [Sweep Time Auto Man] under **【Sweep】** for more details.

[Lower frequency Auto Man]

See [Low Freq Auto Man] under **【Frequency】** for more details.

[Upper frequency Auto Man]

See [High Freq Auto Man] under **【Frequency】** for more details.

[CF Step Auto ON OFF]

See [CF Step Auto Man] under **【Frequency】** for more details.

5.2.9.6 Trace

Press **【Trace】** key on the front panel to pop up corresponding soft menu Including [Clear Write], [Trace Average], [Max. Hold], [Min. Hold], [View/Blank] [More 1/2▶] and [Detector▶].

[Clear Write]

5.2. Description of menu

- Command description: to set the current trace processing as Refresh, i.e., clear all data of displayed trace and continue the signal trace receipt under sweep status.
- Key path: **【Trace】** , [Clear Write] on the front panel.
- Status saved: saved in the instrument status.
- Factory preset: after all traces are selected, the trace mode is defaulted as Refresh.

- **Remote Command:**

```
:TRACe:TOI:TYPE WRITe|AVERAge|MAXHold|MINHold
```

```
:TRACe:TOI:TYPE?
```

[Trace Average]

- Command description: to set the current trace processing method as Average, i.e, based on the average count N set in the **【Meas Setup】** , update trace after averaging the performance index of the measurement trace.
- Key path: **【Trace】** , [Trace Average] on the front panel.
- Status saved: saved in the instrument status.
- Factory preset: all trace modes are defaulted as Refresh.

- **Remote Command:**

```
:TRACe:TOI:TYPE WRITe|AVERAge|MAXHold|MINHold
```

```
:TRACe:TOI:TYPE?
```

[Max Hold]

- Menu description: to set the current trace processing method as maximum hold, i.e., the new trace data will be assigned with maximum value of previous measured trace data.
- Key path: **【Trace】** , [Max Hold] on the front panel.
- Status saved: saved in the instrument status.
- Factory preset: all trace modes are defaulted as Refresh.

- **Remote Command:**

```
:TRACe:TOI:TYPE WRITe|AVERAge|MAXHold
```

```
:TRACe:TOI:TYPE?
```

[Detector ►]

Pop up soft More related to setting the detector type for the currently selected trace, including [Auto], [Normal], [Peak], [Sample], [Negative Peak], [Trace Average►], where, the average detector type includes Log-Pwr Avg, Log-Pwr Avg and Voltage Avg.

[Auto]

- Menu description: to set the detector command for the currently selected trace as Auto. That means, the signal/spectrum analyzer will perform based on the parameter setting of currently selected trace.
- Key path: **【Trace】** , [More 1/2►], [Detector ►], [Auto] on the front panel

5.2. Description of menu

- Status saved: saved in the instrument status.
- Factory preset: the trace detector type is Power Average.
- **Remote Command:**

```
:TOI:DETECTOR:AUTO ON|OFF|1|0
```

```
:TOI:DETECTOR:AUTO?
```

[Normal]

- Menu description: to set the detector command for the currently selected trace as Normal. i.e., display the measurement results of Peak and negative peak at the same time to achieve display effect similar to the analog instrument.
- Key path: **【Trace】** , [More 1/2▶], [Detector ▶], [Normal] on the front panel.
- Status saved: saved in the instrument status.
- **Remote Command:**

```
:TOI:DETECTOR NORMAl|AVERAge|POSitive|SAMPlE|NEGative?
```

```
:TOI:DETECTOR?
```

[Peak]

- Menu description: to set the detector command for the currently selected trace as Peak. i.e., take the maximum value from sampling data assigned to each trace point.
- Key path: **【Trace】** , [More 1/2▶], [Detector▶], [Peak] on the front panel.
- Status saved: saved in the instrument status.
- **Remote Command:**

```
:TOI:DETECTOR NORMAl|AVERAge|POSitive|SAMPlE|NEGative?
```

```
:TOI:DETECTOR?
```

[Sample]

- Menu description: to set the detector command for the currently selected trace as Sample. i.e., take the last value from sampling data assigned to each trace point.
- Key path: **【Trace】** , [More 1/2▶], [Detector▶], [Sample] on the front panel.
- Status saved: saved in the instrument status.
- **Remote Command:**

```
:TOI:DETECTOR NORMAl|AVERAge|POSitive|SAMPlE|NEGative?
```

```
:TOI:DETECTOR?
```

[Negative Peak]

- Menu description: to set the detector command for the currently selected trace as Negative Peak. i.e., take the minimum value from sampling data assigned to each trace point.
- Key path: **【Trace】** , [More 1/2▶], [Detector▶], [Negative Peak] on the front panel.

5.2. Description of menu

- Status saved: saved in the instrument status.
- **Remote Command:**

:TOI:DETECTOR NORMAl|AVERAge|POSitive|SAMPlE|NEGative?

:TOI:DETECTOR?

[Average ▶

Video Average]

- Menu description: to set the detector command for the currently selected trace as Video Average. Also called Logarithm Power Average Detector, i.e., take the logarithm power average value for all data assigned to each trace point; earlier signal/spectrum analyzer generally displays the measurement trace of logarithm scale, and all filtering and averaging are based on the logarithm power data; the trace is generally called as video signal. After digital IF processing is adopted, to make measurement results same as the earlier signal/spectrum analyzer, the video average detector function is added.
- Key path: **【Trace】**, [More 1/2▶], [Detector▶], [Trace Average▶], [Log-Pwr Avg] on the front panel.
- Status saved: saved in the instrument status.

- **Remote Command:**

:TOI:DETECTOR NORMAl|AVERAge|POSitive|SAMPlE|NEGative?

:TOI:DETECTOR?

[Average ▶

Power Average]

- Menu description: to set the detector command for the currently selected trace as Power Average. Also called root mean square (RMS) detector. Calculate the root mean square of all sampling data assigned to each trace point; the 4051 signal/spectrum analyzer envelopes the detector for the RF input signal and obtains linear voltage. After square these voltage values, take sum and divide the count of sampling data points corresponding to each trace point. Finally, take square root. When the scale is logarithm, take 20 times of logarithm transformation for these RMS values (with 10 as base) and obtain the trace data. When the scale type is linear, those RMS values are trace data.
- Key path: **【Trace】**, [More 1/2▶], [Detector▶], [Trace Average▶], [Pwr Avg] on the front panel.
- Status saved: saved in the instrument status.
- **Remote Command:**

:TOI:DETECTOR NORMAl|AVERAge|POSitive|SAMPlE|NEGative?

:TOI:DETECTOR?

[Average ▶

Average Voltage]

- Menu description: to set the detector command for the currently selected trace as Voltage Average. Also called average (AVG) detector. Take linear average for all sampling data assigned to each trace point; the 4051 signal/spectrum analyzer envelopes the detector for the RF input signal and obtains linear voltage. After summing those voltage values, divide the number of sampling data points corresponding to each trace point. When the scale is logarithm, take 20 times of logarithm transformation for these RMS values

5.2. Description of menu

(with 10 as base) and obtain the trace data. When the scale type is linear, those average values are trace data.

- Key path: **【Trace】** , [Menu 1/2▶], [Detector▶], [Trace Average▶], [Voltage Avg] on the front panel.
- Status saved: saved in the instrument status.
- **Remote Command:**

```
:TOI:DETEctor NORMal|AVERAge|POSitive|SAMPlE|NEGative?
```

```
:TOI:DETEctor?
```

5.2.9.7 Sweep

Enable sweep-related parameter setup function to pop up corresponding soft More, including [Sweep Time Auto Man] and [Sweep Points].

[Sweep Time Auto Man]

- Menu description: to change the sweep time of signal/spectrum analyzer. Use the number keys, step keys or knob to adjust the sweep time. When it is under Auto OFF mode (shaded), it indicates that sweep time can be set manually. When it is under Auto ON status, the sweep time will be automatically coupled based on resolution bandwidth, span and video bandwidth
- Key path: **【Sweep】** , [Sweep Time Auto Man] on the front panel.
- Status saved: saved in the instrument status.
- Factory preset: sweep time Auto.
- Setting range: Min.: 1ms, Max.: 6000s.
- Default unit: s
- **Remote Command:**

```
:TOI:SWEep:TIME <time>
```

```
:TOI:SWEep:TIME?
```

```
:TOI:SWEep:TIME:AUTO OFF|ON|0|1
```

```
:TOI:SWEep:TIME:AUTO?
```

- **Examples:**

```
:TOI:SWE:TIME 500 ms
```

```
:TOI:SWE:TIME:AUTO OFF
```

[Sweep points]

- Menu description: to set the trace points.
- Key path: **【Sweep】** , [Sweep Points] on the front panel.
- Status saved: saved in the instrument status.
- Factory preset: 1001.
- Setting range: 101-30001.
- **Remote Command:**

```
:TOI:SWEep:POINts <integer>
```

```
:TOI:SWEep:POINts?
```

5.2. Description of menu

5.2.9.8 Single

- Menu description: the **【Single】** key on the front panel has no corresponding soft menu. This function is mainly used for manual trigger of one measurement. When the Average is ON, this function performs measurement at the count specified by the Average Count.

In remote control programming and system establishment, this function combined with *WAI can effectively synchronize the measurement process and enable the trace data obtained after the *WAI finishes directly correspond to the measurement process one by one.

- **Remote Command:**

:INITiate:TOI

5.2.9.9 Continuous

The **【Cont】** key on the front panel has no corresponding soft menu. This is mainly used for changing the Measurement Continuous OFF to Measurement Continuous ON; if the current state is Measurement Continuous ON, the instrument performs no operation.

- **Remote Command:**

:INITiate:CONTinuous ON

5.2.9.10 Trigger

See **【Trig】** menu of the sweep analysis function for more details.

5.2.9.11 Display

Pop up soft More related to display, including [Display Line On **Off**], [Bar Graph **On** Off], [Display Config ▶].

[Display Line ON **OFF**]

See [Display Line On/off] under **【Display】** of the sweep analysis function for more details.

[Display Config▶]

It is used for configurations of interface language, status area display ON OFF related to interface display, The soft More include [Select Language 中文 **English**], [Graticule Display On Off], Status Display **On** Off], [Freq Info Disp **On** Off]. See [Display Config▶] under **【Display】** of the sweep analysis function for more details.

5.2.9.12 Input Output

See the **【Input/Output】** menu of the sweep analysis function for more details.

5.2.9.13 Marker

Pop up the soft More related to markers, including [Select Marker▶], [Normal], [Marker Delta], [Fixed], [**Off**], [Properties▶], [Marker Couple On Off], and [All Markers Off].

[Select Marker▶]

Marker 1]

- Command description: to select among 12 different markers of the analyzer. When a certain marker is selected, the marker will be indicated in the menu where its type and attribute can be set. Select and trigger another marker and place it at the center of the current trace. Users can read amplitude and

5.2. Description of menu

frequency information (when the frequency span is 0 Hz, time information will be displayed) at the marker display area at the top right corner of the screen.

- Key path: **【Marker】** , [Select Marker▶] on the front panel.
- Status saved: saved in the instrument status.
- Factory preset: Marker 1.

[Normal]

- Menu description: to set the selected marker as the Normal Marker.
- Key path: **【Marker】** , [Normal] on the front panel.
- Status saved: saved in the instrument status.
- **Remote Command:**
:CALCulate:TOI:MARKer[1|2|3|4|5|6|7|8|9|10|11|12]:MODE POSition
:CALCulate:TOI:MARKer[1|2|3|4|5|6|7|8|9|10|11|12]:MODE?

[Marker Delta]

- Menu description: to set the selected marker as the Marker Delta. Display the amplitude difference and frequency difference (or time difference, when span is zero) between two markers at the marker display area at the top right corner of the screen. If there exists a single marker, a [Marker Delta] operation will generate a Ref marker in the active marker position. Move the active marker through the knob, stepping keys or number keys. The display amplitude difference unit is dB.
- Key path: **【Marker】** , [Marker Delta] on the front panel.
- Status saved: saved in the instrument status.
- **Remote Command:**
:CALCulate:TOI:MARKer[1|2|3|4|5|6|7|8|9|10|11|12]:MODE DELTa
:CALCulate:TOI:MARKer[1|2|3|4|5|6|7|8|9|10|11|12]:MODE?

[Fixed]

- Menu description: to set the selected marker as the Fixed Marker. The X Axis and Y Axis positions of the fixed marker are fixed. The Fixed Marker can be used as reference marker.
- Key path: **【Marker】** , [Fixed] on the front panel.
- Status saved: saved in the instrument status.
- **Remote Command:**
:CALCulate:TOI:MARKer[1|2|3|4|5|6|7|8|9|10|11|12]:MODE FIXEd
:CALCulate:TOI:MARKer[1|2|3|4|5|6|7|8|9|10|11|12]:MODE?

[Off]

- Menu description: to turn off the selected marker.
- Key path: **【Marker】** , [Off] on the front panel.
- Status saved: saved in the instrument status.

5.2. Description of menu

- **Remote Command:**

:CALCulate:TOI:MARKer[1|2|3|4|5|6|7|8|9|10|11|12]:MODE OFF

:CALCulate:TOI:MARKer[1|2|3|4|5|6|7|8|9|10|11|12]:MODE?

[Properties▶]

Pop up the corresponding More of currently selected marker attribute setup, including [Ref Marker ▶], [X Axis **Auto Man**], [Marker Trace ▶] and [Marker Display Line On **Off**].

[Ref Marker▶]

- Menu description: to select reference marker for current marker. It can be any one from 11 markers except the currently selected marker.
- Key path: **【Marker】** , [Properties▶], [Ref Marker▶] on the front panel.
- Status saved: saved in the instrument status.

- **Remote Command:**

:CALCulate:TOI:MARKer[1|2|3|4|5|6|7|8|9|10|11|12]:REFErence <integer>

:CALCulate:TOI:MARKer[1|2|3|4|5|6|7|8|9|10|11|12]:REFErence?

[Marker Display Line▶]

ON OFF]

- Menu description: to set whether the current marker is displayed as a line on the screen, which is easy to observe.
- Key path: **【Marker】** , [Properties▶] and [Marker Display Line On/**Off**] on the front panel.
- Status saved: saved in the instrument status.
- Factory preset: OFF.

- **Remote Command:**

:CALCulate: TOI:MARKer[1|2|3|4|5|6|7|8|9|10|11|12]:LINES[:STATe] OFF|ON|0|1

:CALCulate: TOI:MARKer[1|2|3|4|5|6|7|8|9|10|11|12]:LINES[:STATe]?

[All Markers Off]

- More description: to turn off all current markers which are On and related soft keys, e.g. [Noise Marker].
- Key path: **【Marker】** , [More 1/2▶], [All Markers Off] on the front panel.
- Status saved: not saved in instrument status.

- **Remote Command:**

:CALCulate:TOI:MARKer:AOFF

5.2.9.14 Maker->

This key has no soft menu.

5.2.9.15 Marker Function

This key has no soft menu.

5.2.9.16 Peak

The **【Peak Search】** key on the front panel is used for turning on the peak search for traces by the control instrument and turning on marker for display, including [Next Peak], [Next Pk Right], [Next Pk Left].

- **Remote Command:**

:CALCulate:TOI:MARKer[1|2|3|4|5|6|7|8|9|10|11|12]:MAXimum

[Next Peak]

- Menu description: Taking the Amplitude of the point where the current marker is located, search for the next peak of current test trace.
- Key path: **【Peak Search】** , [Next Peak] on the front panel.
- Status saved: not saved in instrument status.

- **Remote Command:**

:CALCulate:TOI:MARKer[1|2|3|4|5|6|7|8|9|10|11|12]:MAXimum:NEXT

[Next Pk Right]

- Menu description: to search for the peak to the right of the current test trace marker position.
- Key path: **【Peak Search】** , [Next Pk Right] on the front panel.
- Status saved: not saved in instrument status.

- **Remote Command:**

:CALCulate:TOI:MARKer[1|2|3|4|5|6|7|8|9|10|11|12]:MAXimum:RIGHT

[Next Pk Left]

- Menu description: to search for the peak to the left of the current test trace marker position.
- Key path: [Peak], [Next Pk Left] on the front panel.
- Status saved: not saved in instrument status.

- **Remote Command:**

:CALCulate:TOI:MARKer[1|2|3|4|5|6|7|8|9|10|11|12]:MAXimum:LEFT

5.2.9.17 Measurement Setting

Pop up the soft menu related to measurement setting, including [Average Num On/Off], [Average Mode Exponential Repeat], [Zero-Span Mode▶], [Low Noise Path On/Off], [Preselector Bypass], [RF Gain▶], [ADC Dither Auto Man] and [Meas Preset].

[Average Num ON OFF]

- Menu description: to turn on or off Average. When Average Count is ON, the user can specify the average count required for measurement. The Average Count can be adjusted by number keys, stepping keys or knob.
- Key path: **【Meas Setup】** , [Average Num ON OFF] on the front panel.

5.2. Description of menu

- Status saved: saved in the instrument status.
- Factory preset: 100/OFF
- **Setting range:** 1~10000
- Default unit: none
- **Remote Command:**

[::SENSE]:TOI:AVERAge:COUNT <integer>

[::SENSE]:TOI:AVERAge:COUNT?

[::SENSE]:TOI:AVERAge[:STATe] ON|OFF|1|0

[::SENSE]:TOI:AVERAge[:STATe]?

[Average Mode **Exponential Repeat**]

- Menu description: when Average Count is ON, the user can select Average State required for measurement.

Exponential - Different from Linear Average, in Exponential State, the weight of new data is larger than that of old data. This is good for tracking data change in terms of time. In this case, the selected averaging count determines the weight of the old data on the new data. As the average count increases, the weight of new data gradually decreases. This is good for tracking data change in terms of time. In this case, the selected averaging count determines the weight of the old data on the new data. As the average count increases, the weight of new data gradually decreases.

Repeat - Similarly, it takes exponential averaging. However, when the average count is met, clear all previous results, restart average till the set average count and repeat this process.

- Key path: **【Meas Setup】** , [Average Mode Exponential Repeat] on the front panel.
- Status saved: saved in the instrument status.
- Factory preset: Exponential
- **Remote Command:**

[::SENSE]:TOI:AVERAge:TCONtrol EXPonential|REPeat

[::SENSE]:TOI:AVERAge:TCONtrol?

[Zero-Span Mode▶]

- Menu description: to select zero span measurement method and set parameters for measurement.
- Key path: **【Meas Setup】** and [Zero-Span Mode▶] on the front panel.
- **Remote Command:**

[::SENSE]:TOI:AVERAge:TCONtrol EXPonential|REPeat

[::SENSE]:TOI:AVERAge:TCONtrol?

[Zero-Span Meas ON **OFF**]

- Menu description: to turn on or off zero span measurement method and set parameters for measurement. Users may specify resolution bandwidth and residence time required for the measurement.
- Key path: **【Meas Setup】** , [Zero-Span Mode▶] and [Zero-Span Meas On/Off] on the front panel.

5.2. Description of menu

- Status saved: saved in the instrument status.
- Factory preset: OFF.
- **Remote Command:**

```
[[:SENSe]:TOI:ZSPan:STATe ON|OFF|1|0 ) [:SENSe]:TOI:ZSPan:STATe?
```

[Res BW Auto Man]

- Menu description: to set resolution bandwidth state of the instrument during zero span measurement. If the resolution bandwidth is set to Auto ON, the optimal setting is determined by the instrument. When the resolution bandwidth is set as auto off, users may define the bandwidth and adjust it with number keys, stepping keys or the knob.
- Key path: **【Meas Setup】** , [Zero-Span Mode▶], [Res BW Auto Man] on the front panel.
- Status saved: saved in the instrument status.
- Factory preset: 3MHz/Auto
- **Setting range:** 1Hz – 20MHz.
- Default unit: Hz
- **Remote Command:**

```
[[:SENSe]:TOI:ZSPan:BANDwidth|BWIDth <frequency>
```

```
[[:SENSe]:TOI:ZSPan:BANDwidth|BWIDth?
```

```
[[:SENSe]:TOI:ZSPan:BANDwidth|BWIDth:AUTO OFF|ON|0|1
```

```
[[:SENSe]:TOI:ZSPan:BANDwidth|BWIDth:AUTO?
```

[Dwell Time Auto Man]

- Menu description: to set residence time of signals during zero span measurement as auto on/off. Use number keys, stepping keys or knob to change the time.
- Key path: **【Meas Setup】** , [Zero-Span Mode▶] and [Dwell Time Auto Man] on the front panel.
- Status saved: saved in the instrument status.
- Factory preset: 100/OFF
- Setting range: 1us – 6000s
- Default unit: s
- **Remote Command:**

```
[[:SENSe]:TOI:ZSPan:SWEep:TIME <time>
```

```
[[:SENSe]:TOI:ZSPan:SWEep:TIME?
```

```
[[:SENSe]:TOI:ZSPan:SWEep:TIME:AUTO OFF|ON|0|1
```

```
[[:SENSe]:TOI:ZSPan:SWEep:TIME:AUTO?
```

[Low Noise Path ON OFF]

- Menu description: this menu is only available when the H34 option (Low Noise PreAmplifier) is purchased. When the PreAmplifier is ON, the Low Noise Path is OFF and this menu is grayed out; when the PreAmplifier is OFF, this menu lights on and is switchable.

5.2. Description of menu

- Key path: **【Meas Setup】** , [More 1/2], [Low Noise Path ON OFF] on the front panel.
- Status saved: saved in the instrument status.
- **Remote Command:**

:TOI:POWer:MW:PATH STD|LNPath

:TOI:POWer:MW:PATH?

[Preselector **Preselecting Bypass**]

- Menu description: this menu is only available when the H36 option is purchased. It is used for setting whether to bypass the front-end preselector of the signal/spectrum analyzer. In analyzing bandwidth signal, bypass is usually required.
- Key path: **【Meas Setup】** , [More 1/2], [Preselector **Preselecting Bypass**] on the front panel.
- Status saved: saved in the instrument status.
- **Remote Command:**

INPut:TOI:FILTer:YIG[:STATe] OFF|ON|0|1

INPut:TOI:FILTer:YIG[:STATe]?

[RF Gain▶]

- More description: to set the Auto ON/OFF of the RF Gain and best allocation algorithm for RF Gain. The soft More includes [Auto], [Best for Dynamic Range] and [Best for Sensitivity].
- Key path: **【Meas Setup】** , [More 1/2], [RF Gain▶] on the front panel.
- Status saved: saved in the instrument status.
- **Remote Command:**

:TOI:RF:GAIN:AUTO OFF|ON|0|1

:TOI:RF:GAIN:AUTO?

:TOI:RF:GAIN:AUTO:RULEs RANGE|SENSITIVITY

:TOI:RF:GAIN:AUTO:RULEs?

[Auto]

- Menu description: to set the RF Gain distribution algorithm to Auto. In this case, the RF Gain distribution is “Best Dynamic Range”.
- Key path: **【Meas Setup】** , [More 1/2], [RF Gain▶], [Auto] on the front panel.
- Status saved: saved in the instrument status.

[Best for Dynamic Range]

- Menu description: to set the RF Gain distribution algorithm to Best Dynamic Range. In this case, the RF Gain is switched to “Auto OFF”
- Key path: **【Meas Setup】** , [More 1/2], [RF Gain▶], [Best for Dynamic Range] on the front panel.
- Status saved: saved in the instrument status.

[Best for Sensitivity]

- Menu description: to set the RF Gain distribution algorithm to Best Sensitivity. In this case, the RF Gain is switched to “Auto OFF”
- Key path: **【Meas Setup】** , [More 1/2], [RF Gain▶], [Best for Sensitivity] on the front panel.
- Status saved: saved in the instrument status.

[ADC Dither **Auto Man]**

- Menu description: to control opening/closing of ADC dither of the frequency acquisition circuit in the analyzer. Under default mode, the signal/spectrum analyzer will automatically control whether the ADC Dither is ON based on current working condition. When the ADC Dither is under Auto mode, the ON or OFF status depends on the span, resolution bandwidth and sweep type (continuous swept or step sweep); when it is continuous swept, the ADC Dither status will force to switch to Auto and turns off; when it is step sweep, under Auto mode, if the span is 2MHz or below, the ADC Dither is ON; if the span is below 2MHz, the ADC Dither is OFF. Under Auto OFF mode, if the span is above 2MHz, turning on the ADC Dither may affect the measurement results based on selected dither status. You can access the submenu for manual control.
- Key path: **【Meas Setup】** , [More 1/2], [ADC Dither **Auto** Man] on the front panel.
- Status saved: saved in the instrument status.
- Factory preset: Auto.
- **Remote Command:**

```
[::SENSE]:TOI:ADC:DITHer[:STATe] OFF|ON|HIGH
```

```
[::SENSE]:TOI:ADC:DITHer[:STATe]?n
```

```
[::SENSE]:TOI:ADC:DITHer:AUTO[:STATe] OFF|ON|0|1
```

```
[::SENSE]:TOI:ADC:DITHer:AUTO[:STATe]?
```

[Meas Preset]

- Menu description: to reset the measurement parameters to the factory preset status or user saved parameter status

Key path: **【Meas Setup】** , [More 1/2▶], [Meas Preset] on the front panel.

- Factory preset: factory reset.

•Remote Command:

```
:CONFigure:TOI
```

5.2.9.18 Measurement Control

Pop up the More related to Meas Control, including [Measure Single Cont], [Restart] and [Pause/Resume].

[Measure Continuous **ON OFF]**

- Menu description: to set continuous measurement OFF or ON. When [Measurement Single **Cont** On/Off] is pressed, Continuous On will be triggered and continuous sweep will be the default meas control method; when Continuous Off is selected, single measurement will be triggered. Press **【Sweep Single】** to restart sweep when the next trigger signal arrives.

5.2. Description of menu

- Key path: **【Meas Control】** , [Measure Cont **On** Off] on the front panel.
- Status saved: saved in the instrument status.
- Factory preset: Continuous On.

- **Remote Command:**

:INITiate:CONTInuous OFF|ON|0|1

:INITiate:CONTInuous?

- **Examples:**

:INIT:CONT OFF

[Restart]

- Menu description: to stop current measurement and restart measurement for the signal/spectrum analyzer.
- Key path: **【Meas Control】** , [Restart] on the front panel
- Status saved: not saved in instrument status.

- **Remote Command:**

:INITiate:REST

[Pause/Resume]

- Menu description: when the signal/spectrum analyzer is in operation, this menu is used for pausing current measurement; when in Paused status, this menu is used for continuing measurement.

- Key path: **【Meas Control】** , [Pause/Resume] on the front panel.

- Status saved: not saved in instrument status.

- **Remote Command:**

:INITiate:PAUS

:INITiate:RES

5.2.10 Spurious emission

5.2.10.1 Frequency

This key has no soft menu.

5.2.10.2 Ampld/YScale

Pop up More related to parameter setting of Ampld/YScale, including [RefLevel], [Attenuation ▶], [PreAmplifier On/Off], [Scale/Div], [Auto Scale], [More 1/2▶], [Y Axis Unit], [Ref Level Offset].

[RefLevel]

- Menu description: to enable the Reference Level function. The reference level can be adjusted with the number keys, step keys or knob. The reference level corresponds to the top of the coordinate top. Measure signal at reference level position to get highest accuracy. The input attenuator of the signal/spectrum analyzer is coupled to the reference level, which can be automatically changed to avoid compression of input signal.

5.2. Description of menu

- Key path: **【Ampld/YScale】** , [RefLevel] on the front panel.
- Status saved: saved in the instrument status.
- Factory preset: 0dBm.
- Setting range: Min.: -170dBm, Max.: 30dBm.
- Default unit: set based on Y Axis scale unit.

- **Remote Command:**

```
:DISPlay:SPURious:VIEW:WINDow:TRACe:Y:RLEVel <real>
```

```
:DISPlay:SPURious:VIEW:WINDow:TRACe:Y:RLEVel?
```

- **Examples:**

```
:DISP:SPUR:VIEW:WIND:TRAC:Y:RLEV 20dBm
```

[Attenuation▶]

See [Attenuation▶] under **【Ampld/YScale】** of the sweep analysis function for more details.

[PreAmplifier ON OFF]

See [PreAmplifier ON/OFF] under **【Ampld/YScale】** of the sweep analysis function for more details.

[Scale/Div]

- Menu description: to select the scale/division from 0.1dB/division to 20dB/division. This menu is only valid when the scale type is logarithm.
- Key path: **【Ampld/YScale】** , [Scale/Div] on the front panel.
- Status saved: saved in the instrument status.
- **Factory preset:** 10.00 dB.
- Setting range: Min.: 0.1dB, Max.: 20dBm.
- **Remote Command:**

```
:DISPlay:SPURious:VIEW:WINDow:TRACe:Y:PDIVision <rel_amp>
```

```
:DISPlay:SPURious:VIEW:WINDow:TRACe:Y:PDIVision?
```

[Y Axis Unit]

- More description: to select the Y Axis unit from [dBm], [dBmV], [dBmA], [W], [V], [A], [dBμV] and [dBμA]. The instrument will automatically calculate the trace data and marker readout based on the Y axis unit.
- Key path: **【Ampld/YScale】** , [More 1/2▶], [Y Axis Unit ▶] on the front panel.
- Status saved: saved in the instrument status.
- Factory preset: dBm.

```
:UNIT:SPURious:POWEr DBM|DBMV|DBMA|V|W|A|DBUV|DBUA
```

```
:UNIT:SPURious:POWEr?
```

5.2. Description of menu

[Ref Level Offset]

- Menu description: to introduce offset for all amplitude readout (e.g, reference level and marker amplitude). It will not change the trace position on the screen. This offset unit is dB and is not affected by the scale and unit. Use number keys, stepping keys or knob to input the offset value.
- Key path: **【Ampld/YScale】** , [More 1/2▶],[Ref Level Offset] on the front panel.
- Status saved: saved in the instrument status.
- **Factory preset:** 0 dB.
- Setting range: Min.: -1000dB, Max.:1000dB.
- **Remote Command:**

:DISPlay:SPURious:WINDow:TRACe:Y:RLEVel:OFFSet <rel_ampl>

:DISPlay:SPURious:WINDow:TRACe:Y:RLEVel:OFFSet?

- **Examples:**

:DISP:SPUR:WIND:TRAC:Y:RLEV:OFFS 12

5.2.10.3 Span/X Scale

This key has no soft menu.

5.2.10.4 Bandwidth

This key has no soft menu.

5.2.10.5 Auto Setting

[Couple All]

- Menu description: to set the resolution bandwidth, video bandwidth, sweep time, mechanical attenuator and frequency step as auto coupling mode. The signal/spectrum analyzer will select most suitable values for those functions based on set frequency and bandwidth (or start frequency and stop frequency). If no ratio is pre-saved, use default ratio.
- Key path: **【Auto Set】** , [Couple All] on the front panel.
- Status saved: not saved in instrument status.
- Factory preset: Couple All.
- **Remote Command:**

:COUPle ALL|NONE

- **Examples:**

:COUP ALL

5.2.10.6 Trace

This key has no soft menu.

5.2.10.7 Sweep

Enable sweep-related parameter setup function to pop up [Sweep Setup▶].

[Sweep Setup▶]

5.2. Description of menu

Pop up the soft More related to Sweep type, including [Sweep Type **Auto** Man], [Sweep Type Rules **Auto** Man] and [FFT Width **Auto** Man].

[Sweep Type▶**Auto** Man]

- Menu description: to set sweep type. to determine whether Swept or FFT is adopted for frequency spectrum measurement. Also set the FFT step bandwidth for FFT sweep The soft More include [Auto], [Swept] and [FFT]. When under Auto ON mode, the signal/spectrum analyzer will automatically select the sweep type based on sweep type rules.
- Key path: **[Sweep]** , [Sweep Setup ▶], [Sweep Type **Auto** On Off] on the front panel.
- Status saved: saved in the instrument status.
- Factory preset: sweep type: Auto.

• **Remote Command:**

```
:SPURious:SWEep:TYPE FFT|SWEep
```

```
:SPURious:SWEep:TYPE?
```

```
:SPURious:SWEep:TYPE:AUTO OFF|ON|0|1
```

```
:SPURious:SWEep:TYPE:AUTO?
```

[Sweep Type Rules **Auto Man]**

- Menu description: to set rules for auto sweep type. While the sweep type rules include “Best Dynamic Range” and “ Best Speed”.

“Best Dynamic Range” rules: when RBW is or larger than 1kHz, the sweep type is Swept; when RBW is less than 1kHz, the sweep type is FFT.

“Best Speed” rules: when RBW is or larger than 30kHz, the sweep type is Swept; when RBW is less than 30kHz, the sweep type is FFT.

- Key path: **[Sweep]** , [Sweep Setup ▶], [Sweep Type Rules **Auto** Man] on the front panel.
- Status saved: saved in the instrument status.
- Factory preset: the sweep type rules are automatically set as “Best Dynamic Range”.

• **Remote Command:**

```
:SPURious:SWEep:TYPE:AUTO:RULEs SPEed|DRANge
```

```
:SPURious:SWEep:TYPE:AUTO:RULEs?
```

```
:SPURious:SWEep:TYPE:AUTO:RULEs:AUTO OFF|ON|0|1
```

```
:SPURious:SWEep:TYPE:AUTO:RULEs:AUTO?
```

[FFT Width **Auto Man]**

- Menu description: to set FFT Width. The FFT width includes [Auto], [<100kHz], [<3MHz], [<13MHz], [<=Max.]. FFT width is only active when the FFT sweep type is selected. Under Auto type, when the signal/spectrum analyzer performs FFT spectrum measurement, the maximum resolution bandwidth is 30kHz. To guarantee best dynamic measurement range, the signal/spectrum analyzer automatically optimizes the FFT width within 100kHz. The larger is the FFT width, the faster is FFT spectrum measurement, but the dynamic range performance will be affected.

5.2. Description of menu

Under FFT sweep, the FFT width setup limits the maximum value for center frequency step of each tune. For example, if [<100Hz] is selected, the maximum value for center freq step of each tune is 100Hz. As the FFT width gets larger, the count of instrument center frequencies get smaller when performing measurement of same frequency scope, and the response measurement gets faster. Therefore, to improve measurement speed, you can manually change the FFT width.

- Key path: **【Sweep】** , [Sweep Setup▶], [FFT Width▶] on the front panel.
- Status saved: saved in the instrument status.
- Factory preset: FFT Width is set as Auto.
- **Remote Command:**

```
:SPURious:SWEEp:FFT:WIDTh <real>
```

```
:SPURious:SWEEp:FFT:WIDTh?
```

```
:SPURious:SWEEp:FFT:WIDTh:AUTO OFF|ON|0|1
```

```
:SPURious:SWEEp:FFT:WIDTh:AUTO?
```

5.2.10.8 Single

- Menu description: the **【Single】** key on the front panel has no corresponding soft menu. This function is mainly used for manual trigger of a measurement. When the Average is ON, this function performs the measurements at the count specified by the average count. In remote control programming and system establishment, this function combined with *WAI can effectively synchronize the measurement process and enable the trace data obtained after the *WAI finishes directly correspond to the measurement process one by one.
- **Remote Command:**

```
:INITiate:SPURious
```

5.2.10.9 Continuous

The **【Cont】** key on the front panel has no corresponding soft menu. This is mainly used for changing the Measurement Continuous OFF to Measurement Continuous ON; if the current state is Measurement Continuous ON, the instrument performs no operation.

- **Remote Command:**

```
:INITiate:CONTinuous ON
```

5.2.10.10 Trigger

See **【Trig】** menu of the sweep analysis function for more details.

5.2.10.11 Display

Pop up soft More related to display, including [Display Line On **Off**], [Bar Graph **On** Off], [Display Config ▶].

[Display Line ON OFF]

See [Display Line On/**Off**] under **【Display】** of the sweep analysis function for more details.

[Display Config▶]

5.2. Description of menu

It is used for configurations of interface language, status area display ON OFF related to interface display, The soft More include [Select Language 中文 English], [Graticule Display On Off], Status Display On Off], [Freq Info Disp On Off]. See [Display Config▶] under **【Display】** of the sweep analysis function for more details.

5.2.10.12 Input Output

See the **【Input/Output】** menu of the sweep analysis function for more details.

5.2.10.13 Marker

Pop up the soft More related to markers, including [Select Marker▶], [Normal], [Marker Delta], [Fixed], [Off], [Properties▶], [Marker Couple On Off], and [All Markers Off].

[Select Marker▶]

Marker 1]

- Command description: to select among 12 different markers of the analyzer. When a certain marker is selected, the marker will be indicated in the menu where its type and attribute can be set. Select and trigger another marker and place it at the center of the current trace. Users can read amplitude and frequency information (when the frequency span is 0 Hz, time information will be displayed) at the marker display area at the top right corner of the screen.
- Key path: **【Marker】** , [Select Marker▶] on the front panel.
- Status saved: saved in the instrument status.
- Factory preset: Marker 1.

[Normal]

- Menu description: to set the selected marker as the Normal Marker.
- Key path: **【Marker】** , [Normal] on the front panel.
- Status saved: saved in the instrument status.
- **Remote Command:**
:CALCulate:SPURious:MARKer[1|2|3|4|5|6|7|8|9|10|11|12]:MODE POSition
:CALCulate:SPURious:MARKer[1|2|3|4|5|6|7|8|9|10|11|12]:MODE?

[Marker Delta]

- Menu description: to set the selected marker as the Marker Delta. Display the amplitude difference and frequency difference (or time difference, when span is zero) between two markers at the marker display area at the top right corner of the screen. If there exists a single marker, a [Marker Delta] operation will generate a Ref marker in the active marker position. Move the active marker through the knob, stepping keys or number keys. The display amplitude difference unit is dB.
- Key path: **【Marker】** , [Marker Delta] on the front panel.
- Status saved: saved in the instrument status.
- **Remote Command:**
:CALCulate:SPURious:MARKer[1|2|3|4|5|6|7|8|9|10|11|12]:MODE DELTa
:CALCulate:SPURious:MARKer[1|2|3|4|5|6|7|8|9|10|11|12]:MODE?

5.2. Description of menu

[Fixed]

- Menu description: to set the selected marker as the Fixed Marker. The X Axis and Y Axis positions of the fixed marker are fixed. The Fixed Marker can be used as reference marker.
- Key path: **【Marker】** , [Fixed] on the front panel.
- Status saved: saved in the instrument status.

- **Remote Command:**

```
:CALCulate:SPURious:MARKer[1|2|3|4|5|6|7|8|9|10|11|12]:MODE FIXed
```

```
:CALCulate:SPURious:MARKer[1|2|3|4|5|6|7|8|9|10|11|12]:MODE?
```

[Off]

- Menu description: to turn off the selected marker.
- Key path: **【Marker】** , [Off] on the front panel.
- Status saved: saved in the instrument status.

- **Remote Command:**

```
:CALCulate:SPURious:MARKer[1|2|3|4|5|6|7|8|9|10|11|12]:MODE OFF
```

```
:CALCulate:SPURious:MARKer[1|2|3|4|5|6|7|8|9|10|11|12]:MODE?
```

[Properties▶]

Pop up the corresponding More of currently selected marker attribute setup, including [Ref Marker ▶], [X Axis **Auto Man**], [Marker Trace ▶] and [Marker Display Line On **Off**].

[Ref Marker▶]

- Menu description: to select reference marker for current marker. It can be any one from 11 markers except the currently selected marker.
- Key path: **【Marker】** , [Properties▶], [Ref Marker▶] on the front panel.
- Status saved: saved in the instrument status.

- **Remote Command:**

```
:CALCulate:SPURious:MARKer[1|2|3|4|5|6|7|8|9|10|11|12]:REFerence <integer>
```

```
:CALCulate:SPURious:MARKer[1|2|3|4|5|6|7|8|9|10|11|12]:REFerence?
```

[Marker Display Line▶]

ON OFF

- Menu description: to set whether the current marker is displayed as a line on the screen, which is easy to observe.
- Key path: **【Marker】** , [Properties▶] and [Marker Display Line On/**Off**] on the front panel.
- Status saved: saved in the instrument status.

- Factory preset: OFF.

- **Remote Command:**

5.2. Description of menu

:CALCulate: SPURious:MARKer[1|2|3|4|5|6|7|8|9|10|11|12]:LINEs[:STATe] OFF|ON|0|1

:CALCulate: SPURious:MARKer[1|2|3|4|5|6|7|8|9|10|11|12]:LINEs[:STATe]?

[Marker Couple ON OFF]

- Menu description: to turn on or off Marker Couple. When it is ON, moving any marker horizontal axis position will cause an equal movement of horizontal axis position of every other marker which is ON. When the marker is moved to less than Start Frequency or larger than Stop Frequency, the marker is limited to the value of the Start Frequency or the Stop Frequency; when the span is zero, the minimum value is limited as 0, and the maximum value is limited as the Sweep Time.
- Key path: **【Marker】** , [More 1/2▶], [Marker Couple On/Off] on the front panel.
- Status saved: saved in the instrument status.
- Factory preset: OFF.
- **Remote Command:**

:CALCulate:SPURious:MARKer:COUPlE[:STATe] ON|OFF|1|0

:CALCulate:SPURious:MARKer:COUPlE[:STATe]?

[All Markers Off]

- More description: to turn off all current markers which are On and related soft keys, e.g. [Noise Marker].
- Key path: **【Marker】** , [More 1/2▶], [All Markers Off] on the front panel.
- Status saved: not saved in instrument status.
- **Remote Command:**

:CALCulate:SPURious:MARKer:AOff

5.2.10.14 Maker->

This key has no soft menu.

5.2.10.15 Marker Function

This key has no soft menu.

5.2.10.16 Peak

The **【Peak Search】** key on the front panel is used for turning on the peak search for traces by the control instrument and turning on marker for display, including [Next Peak], [Next Pk Right], [Next Pk Left].

- **Remote Command:**

:CALCulate:SPURious:MARKer[1|2|3|4|5|6|7|8|9|10|11|12]:MAXimum

[Next Peak]

- Menu description: Taking the Amplitude of the point where the current marker is located, search for the next peak of current test trace.
- Key path: **【Peak Search】** , [Next Peak] on the front panel.
- Status saved: not saved in instrument status.
- **Remote Command:**

5.2. Description of menu

:CALCulate:SPURious:MARKer[1|2|3|4|5|6|7|8|9|10|11|12]:MAXimum:NEXT

[Next Pk Right]

- Menu description: to search for the peak to the right of the current test trace marker position.
- Key path: **【Peak Search】** , [Next Pk Right] on the front panel.
- Status saved: not saved in instrument status.
- **Remote Command:**

:CALCulate:SPURious:MARKer[1|2|3|4|5|6|7|8|9|10|11|12]:MAXimum:RIGHT

[Next Pk Left]

- Menu description: to search for the peak to the left of the current test trace marker position.
- Key path: **【Peak Search】** , [Next Pk Left] on the front panel.
- Status saved: not saved in instrument status.
- **Remote Command:**

:CALCulate:SPURious:MARKer[1|2|3|4|5|6|7|8|9|10|11|12]:MAXimum:LEFT

[Min Search]

- Menu description: to turn on the Min Search.
- Key path: **【Peak Search】** , [Min Search] on the front panel.
- **Remote Command:**

:CALCulate:SPURious:MARKer[1|2|3|4|5|6|7|8|9|10|11|12]:MINimum

5.2.10.17 Meas Setup

Pop up the soft menu related to measurement setting, including [Average Num On/Off], [Average Mode Exponential Repeat], [Zero-Span Mode▶], [Report Mode], [Low Noise Path On/Off], [Preselector Bypass], [RF Gain▶], [ADC Dither Auto Man] and [Meas Preset].

[Average Num ON OFF]

- Menu description: to turn on or off Average. When Average Count is ON, the user can specify the average count required for measurement. The Average Count can be adjusted by number keys, stepping keys or knob.
- Key path: **【Meas Setup】** , [Average Num ON OFF] on the front panel.
- Status saved: saved in the instrument status.
- Factory preset: 100/OFF
- **Setting range:** 1~10000
- Default unit: none
- **Remote Command:**

[[:SENSE]:SPURious:AVERage:COUNT <integer>

[[:SENSE]:SPURious:AVERage:COUNT?

5.2. Description of menu

```
[[:SENSE]:SPURious:AVERage[:STATe] ON|OFF]1|0
```

```
[[:SENSE]:SPURious:AVERage[:STATe]?
```

[Average Mode **Exponential Repeat**]

- Menu description: when Average Count is ON, the user can select Average State required for measurement.

Exponential - Different from Linear Average, in Exponential State, the weight of new data is larger than that of old data. This is good for tracking data change in terms of time. In this case, the selected averaging count determines the weight of the old data on the new data. As the average count increases, the weight of new data gradually decreases. This is good for tracking data change in terms of time. In this case, the selected averaging count determines the weight of the old data on the new data. As the average count increases, the weight of new data gradually decreases.

Repeat - Similarly, it takes exponential averaging. However, when the average count is met, clear all previous results, restart average till the set average count and repeat this process.

- Key path: **【Meas Setup】** , [Average Mode Exponential Repeat] on the front panel.
- Status saved: saved in the instrument status.
- Factory preset: Exponential
- **Remote Command:**

```
[[:SENSE]:SPURious:AVERage:TCONtrol EXPonential|REPeat
```

```
[[:SENSE]:SPURious:AVERage:TCONtrol?
```

[Range **Table▶**]

- Menu description: to configure parameters for 20 rangelists and switch them to continuous sweep mode. The instrument will set current parameter state of Range 1 (on or off). If certain current range is off, parameters in such range list will be replaced with “----”, representing non-active state of the current range.
- Key path: **【Meas Setup】** , [Range Table▶] on the front panel.
- Status saved: saved in the instrument status.

[Range **ON OFF**]

- Menu description: to configure parameters of the Range List. When the range is off, it will be used as part of the measurement, otherwise such range will not be measured. The range can be adjusted via number keys, stepping keys or the knob.
- Key path: **【Meas Setup】** , [Range Table▶], [Range On/Off] on the front panel.
- Status saved: saved in the instrument status.
- Factory preset: 1/OFF
- **Setting range:** 1~20
- Default unit: none
- **Remote Command:**

```
[[:SENSE]:SPURious[:RANGe][:LIST]:STATe ON|OFF]1|0,...
```

```
[[:SENSE]:SPURious[:RANGe][:LIST]:STATe?
```

5.2. Description of menu

[Start Freq]

- Menu description: to set start frequency of the current range. Users may use number keys, stepping keys and the knob to set it.
- Key path: **【Meas Setup】** [Range Table▶], [Start Freq] on the front panel.
- Status saved: saved in the instrument status.
- Factory preset: 1.92GHz
- Setting range: $-1.0E+8\sim$, set the maximum frequency of the instrument.
- Default unit: Hz
- **Remote Command:**

```
[::SENSE]:SPURious[:RANGE][:LIST]:FREQuency:STARt
<freq>,...[:SENSE]:SPURious[:RANGE][:LIST]:FREQuency:STARt?
```

[Stop Freq]

- Menu description: to set stop frequency of the current range. Users may use number keys, stepping keys and the knob to set it.
- Key path: **【Meas Setup】** [Range Table▶], [Stop Freq] on the front panel.
- Status saved: saved in the instrument status.
- Factory preset: 1.98GHz
- Setting range: $-1.0E+8\sim$, set the maximum frequency of the instrument.
- Default unit: Hz
- **Remote Command:**

```
[::SENSE]:SPURious[:RANGE][:LIST]:FREQuency:STOP <freq>,...
[:SENSE]:SPURious[:RANGE][:LIST]:FREQuency:STOP?
```

[Res BW **Auto Man**]

- Menu description: to set resolution bandwidth state of the instrument during zero span measurement. If the resolution bandwidth is set to Auto ON, the optimal setting is determined by the instrument. When the resolution bandwidth is set as auto off, users may define the bandwidth and adjust it with number keys, stepping keys or the knob.
- Key path: **【Meas Setup】** , [Range Table▶], [Res BW Auto Man] on the front panel.
- Status saved: saved in the instrument status.
- Factory preset: 3MHz/Auto
- **Setting range:** 1Hz – 20MHz.
- Default unit: Hz
- **Remote Command:**

```
[::SENSE]:SPURious[:RANGE][:LIST]:BANDwidth[:RESolution] <freq>,...
[:SENSE]:SPURious[:RANGE][:LIST]:BANDwidth[:RESolution]?
[:SENSE]:SPURious[:RANGE][:LIST]:BANDwidth[:RESolution]:AUTO OFF|ON|0|1,...
```

5.2. Description of menu

[[:SENSe]:SPURious[:RANGe][:LIST]:BANDwidth[:RESolution]:AUTO?

[Video BW **Auto Man**]

- Menu description: to set video bandwidth state of the instrument during zero span measurement. If the video bandwidth is set to Auto ON, the optimal setting is determined by the instrument. If the video bandwidth is set to Auto OFF, users may define the bandwidth and adjust it with number keys, stepping keys or the knob. and adjust it with number keys, stepping keys or the knob.
- Key path: **【Meas Setup】** , [Range Table▶], [Video BW Auto Man] on the front panel.
- Status saved: saved in the instrument status.
- Factory preset: 3MHz/Auto
- **Setting range:** 1Hz – 20MHz.
- Default unit: Hz
- **Remote Command:**

[[:SENSe]:SPURious[:RANGe][:LIST]:BANDwidth:VIDeo <freq>,...

[[:SENSe]:SPURious[:RANGe][:LIST]:BANDwidth:VIDeo?

[[:SENSe]:SPURious[:RANGe][:LIST]:BANDwidth:VIDeo:AUTO OFF|ON|0|1,...

[Filter Type▶]

- Menu description: to set filter type of resolution bandwidth measurement.
- Key path: **【Meas Setup】** , [Range Table▶], [Filter Type▶] on the front panel.
- Status saved: saved in the instrument status.
- Factory preset: Gaussian
- **Remote Command:**

[[:SENSe]:SPURious[:RANGe][:LIST]:BANDwidth:SHAPE AUSSian|FLATtop,...

[[:SENSe]:SPURious[:RANGe][:LIST]:BANDwidth:SHAPE?

[Gaussian]

- Menu description: to select the Bandwidth Filter Type as Gaussian.
- Key path: **【Meas Setup】** , [Range Table▶], [Filter Type▶], [Gaussian] on the front panel.

[Flattop]

- Menu description: to select the Bandwidth Filter Type as Top Flat.
- Key path: **【Meas Setup】** , [Range Table▶], [Filter Type▶], [Flattop] on the front panel.

[Abs Start Limit]

- Menu description: to set limit start value and the same stop value. Spurious information above the limit value will be recorded in the result report based on currently set peak offset and peak threshold. If measured spurious amplitude is above the start limit value, such amplitude will be added with a red F in the end. Users may use number keys, stepping keys or the knob to set the limit.

5.2. Description of menu

- Key path: **【Meas Setup】** , [Range Table▶], [More 1/3▶], [Abs Start Limit] on the front panel.
- Status saved: saved in the instrument status.
- Factory preset: -50dBm
- Setting range: -200dBm – 50dBm
- Default unit: dBm.

- **Remote Command:**

:CALCulate:SPURious[:RANGe][:LIST]:LIMit:ABSolute[:UPPer]:DATA[:START] <ampl>,...

:CALCulate:SPURious[:RANGe][:LIST]:LIMit:ABSolute[:UPPer]:DATA[:START]?

[Abs Stop Limit **Auto** Man]

- Menu description: to set limit stop value. Spurious information above the limit value will be recorded in the result report based on currently set peak offset and peak threshold. If measured spurious amplitude is above the start limit value, such amplitude will be added with a red F in the end. Under auto mode, the instrument will automatically couple a value same with the set start value; while under auto off mode, users may use number keys, stepping keys or the knob to set the limit.
- Key path: **【Meas Setup】** , [Range Table▶], [More 1/3▶], [Abs Stop Limit] on the front panel.
- Status saved: saved in the instrument status.
- Factory preset: -50dBm
- Setting range: -200dBm – 50dBm
- Default unit: dBm.

- **Remote Command:**

:CALCulate:SPURious[:RANGe][:LIST]:LIMit:ABSolute[:UPPer]:DATA:STOP <ampl>,...

:CALCulate:SPURious[:RANGe][:LIST]:LIMit:ABSolute[:UPPer]:DATA:STOP?

:CALCulate:SPURious[:RANGe][:LIST]:LIMit:ABSolute[:UPPer]:DATA:STOP:AUTO OFF|ON|0|1,...

:CALCulate:SPURious[:RANGe][:LIST]:LIMit:ABSolute[:UPPer]:DATA:STOP:AUTO?

[Pk Excursion]

- Menu description: to set the minimum amplitude change of the signal at peak point. For example, if the peak excursion is 6 dB, it means that points more than 6 dB higher or lower than the peak threshold will be considered as peak points. Users may use number keys, stepping keys or the knob to set.
- Key path: **【Meas Setup】** , [Range Table▶], [More 1/3▶], [Pk Excursion] on the front panel.
- Status saved: saved in the instrument status.
- Factory preset: 6 dB.
- Setting range: 0.0dB - 100.0dB
- Default unit: dB.

- **Remote Command:**

[:SENSe]:SPURious[:RANGe][:LIST]:PEAK:EXCursion <rel_ampl>,...

[:SENSe]:SPURious[:RANGe][:LIST]:PEAK:EXCursion?

5.2. Description of menu

[Pk Threshold]

- Menu description: to set the minimum amplitude value of the signal at peak point. For example, if the peak threshold is -90 dBm, only points meeting the peak excursion and with an amplitude more than -90 dBm will be considered as peak points. Users may use number keys, stepping keys or the knob to set.
- Key path: **【Meas Setup】** , [Range Table▶], [More 1/3▶], [Pk Threshold] on the front panel.
- Status saved: saved in the instrument status.
- Factory preset: 6 dB.
- Setting range: -200.0 dBm ~ reference level
- Default unit: dBm.
- **Remote Command:**

```
[::SENSE]:SPURious[:RANGE][:LIST]:PEAK:THReshold <real>,...
```

```
[::SENSE]:SPURious[:RANGE][:LIST]:PEAK:THReshold?
```

[Attenuation Auto Man]

- Menu description: to adjust decrement of the input attenuator via number keys, stepping keys or the knob. The decrement ranges from 0~70 dB and increases and decreases at a rate of 10 dB (or 2 dB if set as 2 dB). Users may use number keys, stepping keys or the knob to set.
- Key path: **【Meas Setup】** , [Range Table▶], [More 1/3▶], [Attenuation Auto Man] on the front panel.
- Status saved: saved in the instrument status.
- Factory preset: 10 dB/auto
- Setting range: 0dB – 70dB
- Default unit: dB.
- **Remote Command:**

```
[::SENSE]:SPURious[:RANGE][:LIST]:ATTenuation <rel_amp>,...
```

```
[::SENSE]:SPURious[:RANGE][:LIST]:ATTenuation?
```

```
[::SENSE]:SPURious[:RANGE][:LIST]:ATTenuation:AUTO OFF|ON|0|1,...
```

```
[::SENSE]:SPURious[:RANGE][:LIST]:ATTenuation:AUTO?
```

[Detector]

- Menu description: to set detector mode, including standard, positive and negative peak, sample, average modes.
- Key path: **【Meas Setup】** , [Range Table▶], [More 1/3▶], [More 2/3▶], [Detector] on the front panel.
- Status saved: saved in the instrument status.
- Factory preset: Peak mode
- **Remote Command:**

```
[::SENSE]:SPURious[:RANGE][:LIST]:DETector[:FUNCTION]
```

```
AVERAge|NEGative|NORMal|POSitive|SAMple|RMS,...
```

```
[::SENSE]:SPURious[:RANGE][:LIST]:DETector[:FUNCTION]?
```

5.2. Description of menu

[Sweep Time **Auto Man**]

- Menu description: to set the Sweep Time of current sweep block as Auto ON or OFF. Use number keys, stepping keys or knob to change the time.
- Key path: **【Meas Setup】** , [Range Table▶], [More 1/3▶], [More 2/3▶], [Sweep Time] on the front panel.
- Status saved: saved in the instrument status.
- Factory preset: 5ms/Auto
- Setting range: 1 ms ~ 6000 s
- Default unit: s
- **Remote Command:**

[::SENSE]:SPURious[:RANGE][:LIST]:SWEep:TIME <time>,...

[::SENSE]:SPURious[:RANGE][:LIST]:SWEep:TIME?

[::SENSE]:SPURious[:RANGE][:LIST]:SWEep:TIME:AUTO OFF|ON|0|1,...

[::SENSE]:SPURious[:RANGE][:LIST]:SWEep:TIME:AUTO?

[Sweep points **Auto Man**]

- Menu description: to set points of one measurement and sweep of current sweep block as Auto ON or OFF and adjust it with number keys, stepping keys or the knob.
- Key path: **【Meas Setup】** , [Range Table▶], [More 1/3▶], [More 2/3▶], [Sweep Points] on the front panel.
- Status saved: saved in the instrument status.
- Factory preset: 1001/Auto
- **Setting range:** 101~30001
- Default unit: none
- **Remote Command:**

[::SENSE]:SPURious[:RANGE][:LIST]:SWEep:POINts <integer>,...

[::SENSE]:SPURious[:RANGE][:LIST]:SWEep:POINts?

[::SENSE]:SPURious[:RANGE][:LIST]:SWEep:POINts:AUTO OFF|ON|0|1,...

[::SENSE]:SPURious[:RANGE][:LIST]:SWEep:POINts:AUTO?

[Spur]

- Menu description: to view spurious signals searched. When selected spurious is changed, the instrument state is set as the parameter state within the range of relevant spurious signal. Number keys, stepping keys or the knob can be used to adjust it.
- Key path: **【Meas Setup】** , [Spur] on the front panel.
- Status saved: saved in the instrument status.
- Factory preset: 1
- **Setting range:** 1~200
- Default unit: none

- **Remote Command:**

[::SENSE]:SPURious:SPUR <integer> [::SENSE]:SPURious:SPUR?

[Report Mode▶]

- Menu description: to select the display mode of spurious information in measured data report, including display all and display spurious information beyond the set limit.
- Key path: **【Meas Setup】** , [Report Mode▶] on the front panel.
- Status saved: saved in the instrument status.
- Factory preset: display all
- **Remote Command:**

[::SENSE]:SPURious:REPT:MODE ALL|LIMTest

[::SENSE]:SPURious:REPT:MODE?

[All Spurs]

- Menu description: to select the display mode of spurious information of measured data report as display all.
- Key path: **【Meas Setup】** , [Report Mode▶], [All Spurs] on the front panel.

[Limit Test Spurs]

- Menu description: to select the display mode of spurious information of measured data report as display spurious information beyond the set limit.
- Key path: **【Meas Setup】** , [Report Mode▶], [Limit Test Spurs] on the front panel.

[Low Noise Path ON OFF]

- Menu description: this menu is only available when the H34 option (Low Noise PreAmplifier) is purchased. When the PreAmplifier is ON, the Low Noise Path is OFF and this menu is grayed out; when the PreAmplifier is OFF, this menu lights on and is switchable.
- Key path: **【Meas Setup】** , [More 1/2], [Low Noise Path ON OFF] on the front panel.
- Status saved: saved in the instrument status.
- **Remote Command:**

:SPURious:POWer:MW:PATH STD|LNPath

:SPURious:POWer:MW:PATH?

[Preselector Preselecting Bypass]

- Menu description: this menu is only available when the H36 option is purchased. It is used for setting whether to bypass the front-end preselector of the signal/spectrum analyzer. In analyzing bandwidth signal, bypass is usually required.
- Key path: **【Meas Setup】** , [More 1/2], [Preselector Preselecting Bypass] on the front panel.

5.2. Description of menu

- Status saved: saved in the instrument status.
- **Remote Command:**

INPut:SPURious:FILTer:YIG[:STATe] OFF|ON|0|1

INPut:SPURious:FILTer:YIG[:STATe]?

[RF Gain▶]

- More description: to set the Auto Man of the RF Gain and best allocation algorithm for RF Gain. The soft More includes [Auto], [Best for Dynamic Range] and [Best for Sensitivity].
- Key path: **【Meas Setup】** , [More 1/2], [RF Gain▶] on the front panel.
- Status saved: saved in the instrument status.
- **Remote Command:**

:SPURious:RF:GAIN:AUTO OFF|ON|0|1

:SPURious:RF:GAIN:AUTO?

:SPURious:RF:GAIN:AUTO:RULEs RANGE|SENSITIVITY

:SPURious:RF:GAIN:AUTO:RULEs?

[Auto]

- Menu description: to set the RF Gain distribution algorithm to Auto. In this case, the RF Gain distribution is “Best Dynamic Range”.
- Key path: **【Meas Setup】** , [More 1/2], [RF Gain▶], [Auto] on the front panel.
- Status saved: saved in the instrument status.

[Best for Dynamic Range]

- Menu description: to set the RF Gain distribution algorithm to Best Dynamic Range. In this case, the RF Gain is switched to “Auto OFF”
- Key path: **【Meas Setup】** , [More 1/2], [RF Gain▶], [Best for Dynamic Range] on the front panel.
- Status saved: saved in the instrument status.

[Best for Sensitivity]

- Menu description: to set the RF Gain distribution algorithm to Best Sensitivity. In this case, the RF Gain is switched to “Auto OFF”
- Key path: **【Meas Setup】** , [More 1/2], [RF Gain▶], [Best for Sensitivity] on the front panel.
- Status saved: saved in the instrument status.

[ADC Dither **Auto** Man]

- Menu description: to control opening/closing of ADC dither of the frequency acquisition circuit in the analyzer. Under default mode, the signal/spectrum analyzer will automatically control whether the ADC Dither is ON based on current working condition. When the ADC Dither is under Auto mode, the ON or OFF status depends on the span, resolution bandwidth and sweep type (continuous swept or step sweep);

5.2. Description of menu

when it is continuous swept, the ADC Dither status will force to switch to Auto and turns off; when it is step sweep, under Auto mode, if the span is 2MHz or below, the ADC Dither is ON; if the span is below 2MHz, the ADC Dither is OFF. Under Auto OFF mode, if the span is above 2MHz, turning on the ADC Dither may affect the measurement results based on selected dither status. You can access the submenu for manual control.

- Key path: **【Meas Setup】** , [More 1/2], [ADC Dither Auto **Man**] on the front panel.
- Status saved: saved in the instrument status.
- Factory preset: Auto
- **Remote Command:**

```
[::SENSe]:SPURious:ADC:DITHer[:STATe]
```

```
[::SENSe]:SPURious:ADC:DITHer[:STATe]?
```

```
[::SENSe]:SPURious:ADC:DITHer:AUTO[:STATe] OFF|ON|0|1
```

```
[::SENSe]:SPURious:ADC:DITHer:AUTO[:STATe]?
```

[Meas Preset]

- Menu description: to reset the measurement parameters to the factory preset status or user saved parameter status
- Key path: **【Meas Setup】** , [More 1/2▶], [Meas Preset] on the front panel.
- Factory preset: factory reset.
- **Remote Command:**

```
:CONFigure:SPURious
```

5.2.10.18 Measurement Control

Pop up the More related to Meas Control, including [Measure Single Cont], [Restart] and [Pause/Resume].

[Measure Continuous **ON** OFF]

- Menu description: to set continuous measurement OFF or ON. When [Measurement Single **Cont** On/Off] is pressed, Continuous On will be triggered and continuous sweep will be the default meas control method; when Continuous Off is selected, single measurement will be triggered. Press **【Sweep Single】** to restart sweep when the next trigger signal arrives.
- Key path: **【Meas Control】** , [Measure Cont **On** Off] on the front panel.
- Status saved: saved in the instrument status.
- Factory preset: Continuous On.
- **Remote Command:**

```
:INITiate:CONTinuous OFF|ON|0|1
```

```
:INITiate:CONTinuous?
```

- **Examples:**

```
:INIT:CONT OFF
```

[Restart]

- Menu description: to stop current measurement and restart measurement for the signal/spectrum analyzer.

5.2. Description of menu

- Key path: **【Meas Control】** , [Restart] on the front panel
- Status saved: not saved in instrument status.
- **Remote Command:**

:INITiate:REST

[Pause/Resume]

- Menu description: when the signal/spectrum analyzer is in operation, this menu is used for pausing current measurement; when in Paused status, this menu is used for continuing measurement.
- Key path: **【Meas Control】** , [Pause/Resume] on the front panel.
- Status saved: not saved in instrument status.
- **Remote Command:**

:INITiate:PAUS

:INITiate:RES

5.2.11 Spectral emission mask

5.2.11.1 Frequency

The **【Frequency】** key on the front panel is used to set parameters related to the signal/spectrum analyzer frequency, including [Center Freq], [CF Step Auto Man], [Freq Offset]. See the **【Frequency】** menu of the sweep analysis function for more details.

[Center Freq]

See the [Center Freq] under **【Frequency】** of the sweep analysis function for more details.

[CF Step **Auto** On Off]

See the [CF Step **Auto** Man] under **【Frequency】** of the sweep analysis function for more details.

[Freq Offset]

See the [Freq Offset] under **【Frequency】** of the sweep analysis function for more details.

5.2.11.2 Ampld/YScale

Pop up More related to parameter setting of Ampld/YScale, including [RefLevel], [Attenuation ▶], [PreAmplifier On/Off], [Scale/Div], [Auto Scale], [More 1/2▶], [Y Axis Unit], [Ref Level Offset].

[RefLevel]

- Menu description: to enable the Reference Level function. The reference level can be adjusted with the number keys, step keys or knob. The reference level corresponds to the top of the coordinate top. Measure signal at reference level position to get highest accuracy. The input attenuator of the signal/spectrum analyzer is coupled to the reference level, which can be automatically changed to avoid compression of input signal.
- Key path: **【Ampld/YScale】** , [RefLevel] on the front panel.
- Status saved: saved in the instrument status.

5.2. Description of menu

- Factory preset: 0dBm.
- Setting range: Min.: -170dBm, Max.: 30dBm.
- Default unit: set based on Y Axis scale unit.

- **Remote Command:**

```
:DISPlay:SEMask:VIEW:WINDow:TRACe:Y:RLEVel <real>
```

```
:DISPlay:SEMask:VIEW:WINDow:TRACe:Y:RLEVel?
```

- **Examples:**

```
:DISP:SEM:VIEW:WIND:TRAC:Y:RLEV 20dBm
```

[Attenuation▶]

See [Attenuation▶] under **【Ampld/YScale】** of the sweep analysis function for more details.

[PreAmplifier ON OFF]

See [PreAmplifier ON/OFF] under **【Ampld/YScale】** of the sweep analysis function for more details.

[Scale/Div]

- Menu description: to select the scale/division from 0.1dB/division to 20dB/division. This menu is only valid when the scale type is logarithm.
- Key path: **【Ampld/YScale】** , [Scale/Div] on the front panel.
- Status saved: saved in the instrument status.
- **Factory preset:** 10.00 dB.
- Setting range: Min.: 0.1dB, Max.: 20dBm.
- **Remote Command:**

```
:DISPlay:SEMask:VIEW:WINDow:TRACe:Y:PDIVision <rel_amp>
```

```
:DISPlay:SEMask:VIEW:WINDow:TRACe:Y:PDIVision?
```

[Auto Scale]

- Menu description: the instrument automatically sets parameters like reference level and scale/division based on input signal sizes. When this soft menu key is pressed, the instrument performs one auto scaling. Setting rule for auto scaling: when [Auto Scale] is pressed, firstly obtain the maximum value and the minimum value based on current measurement trace data. Based on the maximum value, place on the 80% graticule of the screen trace Y axis for auto setting of reference level and scale/division.
- Key path: **【Ampld/YScale】** , [Auto Scale] on the front panel.
- Status saved: not saved in instrument status.
- **Remote Command:**

```
:SEMask:ADJust:LEVel
```

[Y Axis Unit]

5.2. Description of menu

- More description: to select the Y Axis unit from [dBm], [dBmV], [dBmA], [W], [V], [A], [dB μ V] and [dB μ A]. The instrument will automatically calculate the trace data and marker readout based on the Y axis unit.
- Key path: **【Ampld/YScale】** , [More 1/2▶], [Y Axis Unit ▶] on the front panel.
- Status saved: saved in the instrument status.
- Factory preset: dBm.

:UNIT:SEMAsk:POWer DBM|DBMV|DBMA|V|W|A|DBUV|DBUA

:UNIT:SEMAsk:POWer?

[Ref Level Offset]

- Menu description: to introduce offset for all amplitude readout (e.g. reference level and marker amplitude). It will not change the trace position on the screen. This offset unit is dB and is not affected by the scale and unit. Use number keys, stepping keys or knob to input the offset value.
- Key path: **【Ampld/YScale】** , [More 1/2▶],[Reference Level Offset] on the front panel.
- Status saved: saved in the instrument status.
- **Factory preset:** 0 dB.
- Setting range: Min.: -1000dB, Max.:1000dB.
- **Remote Command:**

:DISPlay:SEMAsk:WINDow:TRACe:Y:RLEVel:OFFSet <rel_amp>

:DISPlay:SEMAsk:WINDow:TRACe:Y:RLEVel:OFFSet?

- **Examples:**

:DISP:SEM:WIND:TRAC:Y:RLEV:OFFS 12

5.2.11.3 Span/X Scale

This key has no soft menu.

5.2.11.4 Bandwidth

Pop up the [Filter Type] More for selecting filter type.

[Filter Type]

- More description: comprising [Gaussian] and [Flattop]. In general, the signal/spectrum uses Gaussian filter, i.e., use filter approximate to the Gaussian shape to complete filtering of Res BW. If the flat top filter is used, the signal/spectrum analyzer adopts filter approximate to the rectangular shape to complete filtering of resolution bandwidth. The response time of flat top filter is about 3 times of that of the Gaussian filter. The sweep speed of the flat top filter is smaller than that of the Gaussian filter. The flat top filter has better selectivity than the Gaussian filter and therefore is more capable of distinguishing two signals with unequal amplitude.
- Key path: **【BW】** , [Filter Type] on the front panel.
- Status saved: saved in the instrument status.
- Factory preset: Gaussian
- **Remote Command:**

:SEMAsk:BANDwidth:SHAPe GAUSSian|FLATtop

:SEMAsk:BANDwidth:SHAPE?

5.2.11.5 Auto Setting

[Couple All]

- Menu description: to set the resolution bandwidth, video bandwidth, sweep time, mechanical attenuator and frequency step as auto coupling mode. The signal/spectrum analyzer will select most suitable values for those functions based on set frequency and bandwidth (or start frequency and stop frequency). If no ratio is pre-saved, use default ratio.
- Key path: **【Auto Set】** , [Couple All] on the front panel.
- Status saved: not saved in instrument status.
- Factory preset: Couple All.
- **Remote Command:**

:COUPle ALL

- **Examples:**

:COUP ALL

5.2.11.6 Trace

Press **【Trace】** key on the front panel to pop up corresponding soft menu Including [Clear Write], [Trace Average], [View/Blank] [More 1/2▶] and [Detector▶].

[Clear Write]

- Command description: to set the current trace processing as Refresh, i.e., clear all data of displayed trace and continue the signal trace receipt under sweep status.
- Key path: **【Trace】** , [Clear Write] on the front panel.
- Status saved: saved in the instrument status.
- Factory preset: after all traces are selected, the trace mode is defaulted as Refresh.
- **Remote Command:**

:TRACe:SEMAsk:TYPE WRITe

:TRACe:SEMAsk:TYPE?

[Average]

- Command description: to set the current trace processing method as Average, i.e, based on the average count N set in the **【Meas Setup】** , update trace after averaging the performance index of the measurement trace.
- Key path: **【Trace】** , [Trace Average] on the front panel.
- Status saved: saved in the instrument status.
- Factory preset: all trace modes are defaulted as Refresh.
- **Remote Command:**

:TRACe:SEMAsk:TYPE AVERAge

:TRACe:SEMAsk:TYPE?

5.2. Description of menu

[Detector ►]

Pop up soft More related to setting the detector type for the currently selected trace, including [Auto], [Normal], [Peak], [Sample], [Negative Peak], [Trace Average►], where, the average detector type includes Log-Pwr Avg, Log-Pwr Avg and Voltage Avg.

[Auto]

- Menu description: to set the detector command for the currently selected trace as Auto. That means, the signal/spectrum analyzer will perform based on the parameter setting of currently selected trace.
- Key path: **【Trace】** , [More 1/2►], [Detector ►], [Auto] on the front panel
- Status saved: saved in the instrument status.
- Factory preset: the trace detector type is Power Average.

- **Remote Command:**

```
:SEMask:DETECTOR:AUTO ON|OFF|1|0
```

```
:SEMask:DETECTOR:AUTO?
```

[Normal]

- Menu description: to set the detector command for the currently selected trace as Normal. i.e., display the measurement results of Peak and negative peak at the same time to achieve display effect similar to the analog instrument.
- Key path: **【Trace】** , [More 1/2►], [Detector ►], [Normal] on the front panel.
- Status saved: saved in the instrument status.

- **Remote Command:**

```
:SEMask:DETECTOR:NORMAL
```

```
:SEMask:DETECTOR?
```

[Peak]

- Menu description: to set the detector command for the currently selected trace as Peak. i.e., take the maximum value from sampling data assigned to each trace point.
- Key path: **【Trace】** , [More 1/2►], [Detector►], [Peak] on the front panel.
- Status saved: saved in the instrument status.

- **Remote Command:**

```
:SEMask:DETECTOR:POSITIVE
```

```
:SEMask:DETECTOR?
```

[Sample]

- Menu description: to set the detector command for the currently selected trace as Sample. i.e., take the last value from sampling data assigned to each trace point.
- Key path: **【Trace】** , [More 1/2►], [Detector►], [Sample] on the front panel.
- Status saved: saved in the instrument status.

5.2. Description of menu

- **Remote Command:**

:SEMAsk:DETEctor SAMPlE

:SEMAsk:DETEctor?

[Negative Peak]

- Menu description: to set the detector command for the currently selected trace as Negative Peak. i.e., take the minimum value from sampling data assigned to each trace point.

- Key path: **【Trace】** , [More 1/2▶], [Detector▶], [Negative Peak] on the front panel.

- Status saved: saved in the instrument status.

- **Remote Command:**

:SEMAsk:DETEctor NEGative

:SEMAsk:DETEctor?

[Average ▶]

Video Average]

- Menu description: to set the detector command for the currently selected trace as Video Average. Also called Logarithm Power Average Detector, i.e., take the logarithm power average value for all data assigned to each trace point; earlier signal/spectrum analyzer generally displays the measurement trace of logarithm scale, and all filtering and averaging are based on the logarithm power data; the trace is generally called as video signal. After digital IF processing is adopted, to make measurement results same as the earlier signal/spectrum analyzer, the video average detector function is added.

- Key path: **【Trace】** , [More 1/2▶], [Detector▶], [Trace Average▶], [Log-Pwr Avg] on the front panel.

- Status saved: saved in the instrument status.

- **Remote Command:**

:SEMAsk:DETEctor LOG

:SEMAsk:DETEctor?

[Average ▶]

Power Average]

- Menu description: to set the detector command for the currently selected trace as Power Average. Also called root mean square (RMS) detector. Calculate the root mean square of all sampling data assigned to each trace point; the 4051signal/spectrum analyzer envelopes the detector for the RF input signal and obtains linear voltage. After square these voltage values, take sum and divide the count of sampling data points corresponding to each trace point. Finally, take square root. When the scale is logarithm, take 20 times of logarithm transformation for these RMS values (with 10 as base) and obtain the trace data. When the scale type is linear, those RMS values are trace data.

- Key path: **【Trace】** , [More 1/2▶], [Detector▶], [Trace Average▶], [Pwr Avg] on the front panel.

- Status saved: saved in the instrument status.

- **Remote Command:**

:SEMAsk:DETEctor AVERage or

:SEMAsk:DETEctor RMS

5.2. Description of menu

:SEMAsk:DETEctor?

[Average ▶]

Average Voltage]

- Menu description: to set the detector command for the currently selected trace as Voltage Average. Also called average (AVG) detector. Take linear average for all sampling data assigned to each trace point; the 4051 signal/spectrum analyzer envelopes the detector for the RF input signal and obtains linear voltage. After summing those voltage values, divide the number of sampling data points corresponding to each trace point. When the scale is logarithm, take 20 times of logarithm transformation for these RMS values (with 10 as base) and obtain the trace data. When the scale type is linear, those average values are trace data.
- Key path: **【Trace】** , [Menu 1/2▶], [Detector▶], [Average▶], [Voltage Avg] on the front panel.
- Status saved: saved in the instrument status.

- **Remote Command:**

:SEMAsk:DETEctor SCALAr

:SEMAsk:DETEctor?

5.2.11.7 Sweep

Enable sweep-related parameter setup function to pop up [Sweep Setup▶].

[Sweep Setup▶]

Pop up the soft More related to Sweep type, including [Sweep Type **Auto** Man], [Sweep Type Rules **Auto** Man] and [FFT Width **Auto** Man].

[Sweep Type▶]

Auto Man]

- Menu description: to set sweep type. to determine whether Swept or FFT is adopted for frequency spectrum measurement. Also set the FFT step bandwidth for FFT sweep The soft More include [Auto], [Swept] and [FFT]. When under Auto ON mode, the signal/spectrum analyzer will automatically select the sweep type based on sweep type rules.
- Key path: **【Sweep】** , [Sweep Setup ▶], [Sweep Type **Auto** Man] on the front panel.
- Status saved: saved in the instrument status.
- Factory preset: sweep type: Auto.

- **Remote Command:**

:SEMAsk:SWEep:TYPE FFT|SWEep

:SEMAsk:SWEep:TYPE?

:SEMAsk:SWEep:TYPE:AUTO OFF|ON|0|1

:SEMAsk:SWEep:TYPE:AUTO?

[Sweep Type Rules **Auto** Man]

- Menu description: to set rules for auto sweep type. While the sweep type rules include “Best Dynamic Range” and “ Best Speed”.

5.2. Description of menu

“Best Dynamic Range” rules: when RBW is or larger than 1kHz, the sweep type is Swept; when RBW is less than 1kHz, the sweep type is FFT.

“Best Speed” rules: when RBW is or larger than 30kHz, the sweep type is Swept; when RBW is less than 30kHz, the sweep type is FFT.

- Key path: **【Sweep】**, [Sweep Setup ▶], [Sweep Type Rules **Auto** Man] on the front panel.
- Status saved: saved in the instrument status.
- Factory preset: the sweep type rules are automatically set as “Best Dynamic Range”.
- **Remote Command:**

```
:SEMask:SWEep:TYPE:AUTO:RULEs SPEed|DRANge
```

```
:SEMask:SWEep:TYPE:AUTO:RULEs?
```

```
:SEMask:SWEep:TYPE:AUTO:RULEs:AUTO OFF|ON|0|1
```

```
:SEMask:SWEep:TYPE:AUTO:RULEs:AUTO?
```

[FFT Width **Auto** Man]

- Menu description: to set FFT Width. The FFT width includes [Auto], [<100kHz], [<3MHz], [<13MHz], [<=Max.]. FFT width is only active when the FFT sweep type is selected. Under Auto type, when the signal/spectrum analyzer performs FFT spectrum measurement, the maximum resolution bandwidth is 30kHz. To guarantee best dynamic measurement range, the signal/spectrum analyzer automatically optimizes the FFT width within 100kHz. The larger is the FFT width, the faster is FFT spectrum measurement, but the dynamic range performance will be affected.

Under FFT sweep, the FFT width setup limits the maximum value for center frequency step of each tune. For example, if [<100Hz] is selected, the maximum value for center freq step of each tune is 100Hz. As the FFT width gets larger, the count of instrument center frequencies get smaller when performing measurement of same frequency scope, and the response measurement gets faster. Therefore, to improve measurement speed, you can manually change the FFT width.

- Key path: **【Sweep】**, [Sweep Setup▶], [FFT Width▶] on the front panel.
- Status saved: saved in the instrument status.
- Factory preset: FFT Width is set as Auto.
- **Remote Command:**

```
:SEMask:SWEep:FFT:WIDTh <real>
```

```
:SEMask:SWEep:FFT:WIDTh?
```

```
:SEMask:SWEep:FFT:WIDTh:AUTO OFF|ON|0|1
```

```
:SEMask:SWEep:FFT:WIDTh:AUTO?
```

5.2.11.8 Single

- Menu description: the **【Single】** key on the front panel has no corresponding soft menu. This function is mainly used for manual trigger of a measurement. When the Average is ON, this function performs the measurements at the count specified by the average count.

In remote control programming and system establishment, this function combined with *WAI can effectively synchronize the measurement process and enable the trace data obtained after the *WAI finishes directly correspond to the measurement process one by one.

- **Remote Command:**

5.2. Description of menu

:INITiate:SEMAsk

5.2.11.9 Continuous

The **【Cont】** key on the front panel has no corresponding soft menu. This is mainly used for changing the Measurement Continuous OFF to Measurement Continuous ON; if the current state is Measurement Continuous ON, the instrument performs no operation.

- **Remote Command:**

:INITiate:CONTInuous ON

5.2.11.10 Trigger

See **【Trig】** menu of the sweep analysis function for more details.

5.2.11.11 Display

Pop up the soft More related to display, including [Display Line On/Off], [Report Display▶] and [Display Config▶].

[Display Line ON OFF]

See [Display Line On/Off] under **【Display】** of the sweep analysis function for more details.

[Display Config▶]

It is used for configurations of interface language, status area display on interface. The soft menus include [Select Language 中文 English], [Graticule Display ON OFF], [Status Area Display ON OFF], [Frequency Information Display ON OFF].

See [Display Config▶] under [Display] of the sweep analysis function for more details.

[Report Display▶]

- Menu description: to select content information displayed at the data report window.

The absolute power & frequency-data report is displayed with the absolute power and frequency corresponding to the offset.

The relative power & frequency-data report is displayed with the relative power and frequency corresponding to the offset.

The integral power-data report is displayed with the integral power corresponding to the offset.

- Key path: **【Display】**, [Table Display▶] on the front panel.
- Status saved: saved in the instrument status.
- Factory preset: integral power.

- **Remote Command:**

:DISPlay:SEMAsk:VIEW[:SELEct] APFReq|RPFReq|IPOWER

:DISPlay:SEMAsk:VIEW[:SELEct]?

5.2.11.12 Input Output

See the **【Input/Output】** menu of the sweep analysis function for more details.

5.2.11.13 Marker

5.2. Description of menu

Pop up the soft More related to markers, including [Select Marker▶], [Normal], [Marker Delta], [Fixed], [Off], [All Markers Off].

[Select Marker▶]**Marker 1]**

- Command description: to select among 12 different markers of the analyzer. When a certain marker is selected, the marker will be indicated in the menu where its type and attribute can be set. Select and trigger another marker and place it at the center of the current trace. Users can read amplitude and frequency information (when the frequency span is 0 Hz, time information will be displayed) at the marker display area at the top right corner of the screen.
- Key path: **【Marker】** , [Select Marker▶] on the front panel.
- Status saved: saved in the instrument status.
- Factory preset: Marker 1.

[Normal]

- Menu description: to set the selected marker as the Normal Marker.
- Key path: **【Marker】** , [Normal] on the front panel.
- Status saved: saved in the instrument status.

- **Remote Command:**

```
:CALCulate:SEMAsk:MARKer[1|2|3|4|5|6|7|8|9|10|11|12]:MODE POSition
```

```
:CALCulate:SEMAsk:MARKer[1|2|3|4|5|6|7|8|9|10|11|12]:MODE?
```

[Marker Delta]

- Menu description: to set the selected marker as the Marker Delta. Display the amplitude difference and frequency difference (or time difference, when span is zero) between two markers at the marker display area at the top right corner of the screen. If there exists a single marker, a [Marker Delta] operation will generate a Ref marker in the active marker position. Move the active marker through the knob, stepping keys or number keys. The display amplitude difference unit is dB.
- Key path: **【Marker】** , [Marker Delta] on the front panel.
- Status saved: saved in the instrument status.

- **Remote Command:**

```
:CALCulate:SEMAsk:MARKer[1|2|3|4|5|6|7|8|9|10|11|12]:MODE DELTA
```

```
:CALCulate:SEMAsk:MARKer[1|2|3|4|5|6|7|8|9|10|11|12]:MODE?
```

[Fixed]

- Menu description: to set the selected marker as the Fixed Marker. The X Axis and Y Axis positions of the fixed marker are fixed. The Fixed Marker can be used as reference marker.
- Key path: **【Marker】** , [Fixed] on the front panel.
- Status saved: saved in the instrument status.

- **Remote Command:**

```
:CALCulate:SEMAsk:MARKer[1|2|3|4|5|6|7|8|9|10|11|12]:MODE FIXEd
```

5.2. Description of menu

:CALCulate:SEMAsk:MARKer[1|2|3|4|5|6|7|8|9|10|11|12]:MODE?

[Off]

- Menu description: to turn off the selected marker.
- Key path: **【Marker】** , [Off] on the front panel.
- Status saved: saved in the instrument status.
- **Remote Command:**

:CALCulate:SEMAsk:MARKer[1|2|3|4|5|6|7|8|9|10|11|12]:MODE OFF

:CALCulate:SEMAsk:MARKer[1|2|3|4|5|6|7|8|9|10|11|12]:MODE?

[All Markers Off]

- More description: to turn off all current markers which are On and related soft keys, e.g. [Noise Marker].
- Key path: **【Marker】** , [More 1/2▶], [All Markers Off] on the front panel.
- Status saved: not saved in instrument status.
- **Remote Command:**

:CALCulate:SEMAsk:MARKer:AOff

5.2.11.14 Maker->

This key has no soft menu.

5.2.11.15 Marker Function

This key has no soft menu.

5.2.11.16 Peak

This key has no soft menu.

5.2.11.17 Measurement Setting

Pop up the soft menu related to measurement setting, including [Average Num On/Off], [Average Mode Exponential Repeat], [Ref Channel▶], [Offset/Limit▶], [Ref Type▶], [Meas Method▶], [PhNoise Opt], [Low Noise Path On/Off], [Preselector Preselecting Bypass], [RF Gain▶], [ADC Dither Auto Man] and [Meas Preset].

[Average Num On OFF]

- Menu description: to turn on or off Average. When Average Count is ON, the user can specify the average count required for measurement. The Average Count can be adjusted by number keys, stepping keys or knob.
- Key path: **【Meas Setup】** , [Average Num ON OFF] on the front panel.
- Status saved: saved in the instrument status.
- Factory preset: 100/OFF
- **Setting range:** 1~10000
- Default unit: none

- **Remote Command:**

[::SENSE]:SEMAsk:AVERAge:COUNt <integer>

[::SENSE]:SEMAsk:AVERAge:COUNt?

[::SENSE]:SEMAsk:AVERAge[:STATe] ON|OFF|1|0

[::SENSE]:SEMAsk:AVERAge[:STATe]?

[Ref Channel▶]

- Menu description: to set parameters of reference channel
- Key path: **【Meas Setup】** [Ref Channel] on the front panel.
- Status saved: saved in the instrument status.

[Integration BW]

- Menu description: to designate the bandwidth integration range for calculating power within the channel. The integration bandwidth is displayed in the trace window and indicated with a pair of vertical lines connected with arrows. Such commands may be adjusted via number keys, stepping keys or the knob.
- Key path: **【Meas Setup】** [Ref Channel], [Integration BW] on the front panel.
- Status saved: saved in the instrument status.
- Factory preset: 3.84MHz
- **Setting range:** 1kHz – 50MHz.
- Default unit: Hz
- **Remote Command:**

[::SENSE]:SEMAsk:BANDwidth:INTEgration <bandwidth> [::SENSE]:SEMAsk:BANDwidth:INTEgration?

[Channel Span]

- Menu description: to designate frequency span range of the main channel. Such commands may be adjusted via number keys, stepping keys or the knob.
- Key path: **【Meas Setup】** [Ref Channel], [Channel Span] on the front panel.
- Status saved: saved in the instrument status.
- Factory preset: 5.0MHz
- Setting range: 10 Hz ~ maximum instrument frequency span
- Default unit: Hz
- **Remote Command:**

[::SENSE]:SEMAsk:FREQUency:SPAN <freq> [::SENSE]:SEMAsk:FREQUency:SPAN?

[Sweep Time **Auto Man**]

- Menu description: to set the Sweep Time of the main channel as Auto ON or OFF. Use number keys, stepping keys or knob to change the time.
- Key path: **【Meas Setup】** [Ref Channel▶], [Sweep Time] on the front panel.

5.2. Description of menu

- Status saved: saved in the instrument status.
- Factory preset: 1.0ms/Auto
- Setting range: 1 ms ~ 6000 s
- Default unit: s
- **Remote Command:**

```
[[:SENSe]:SEMAsk:SWEep:TIME <time>
```

```
[[:SENSe]:SEMAsk:SWEep:TIME?
```

```
[[:SENSe]:SEMAsk:SWEep:TIME:AUTO OFF|0|ON|1
```

```
[[:SENSe]:SEMAsk:SWEep:TIME:AUTO?
```

[Res BW **Auto Man**]

- Menu description: to set resolution bandwidth of the instrument when measuring the main channel. If the resolution bandwidth is set to Auto ON, the optimal setting is determined by the instrument. When the resolution bandwidth is set as auto off, users may define the bandwidth and adjust it with number keys, stepping keys or the knob.
- Key path: **【Meas Setup】** , [Ref Channel▶], [Res BW Auto Man] on the front panel.
- Status saved: saved in the instrument status.
- Factory preset: 270dB/auto
- **Setting range:** 1Hz – 20MHz.
- Default unit: Hz
- **Remote Command:**

```
[[:SENSe]:SEMAsk:BANDwidth[:RESolution] <bandwidth>
```

```
[[:SENSe]:SEMAsk:BANDwidth[:RESolution]?
```

```
[[:SENSe]:SEMAsk:BANDwidth[:RESolution]:AUTO OFF|ON|1|0
```

```
[[:SENSe]:SEMAsk:BANDwidth[:RESolution]:AUTO?
```

[Video BW **Auto Man**]

- Menu description: to set video bandwidth of the instrument when measuring the main channel. If the video bandwidth is set to Auto ON, the optimal setting is determined by the instrument. If the video bandwidth is set to Auto OFF, users may define the bandwidth and adjust it with number keys, stepping keys or the knob. and adjust it with number keys, stepping keys or the knob.
- Key path: **【Meas Setup】** , [Ref Channel▶], [Video BW Auto Man] on the front panel.
- Status saved: saved in the instrument status.
- Factory preset: 3MHz/Auto
- **Setting range:** 1Hz – 20MHz.
- Default unit: Hz
- **Remote Command:**

```
[[:SENSe]:SEMAsk:BANDwidth:VIDeo <bandwidth>
```

```
[[:SENSe]:SEMAsk:BANDwidth:VIDeo?
```

5.2. Description of menu

[[:SENSe]:SEMAsk:BANDwidth:VIDeo:AUTO OFF|ON|1|0

[[:SENSe]:SEMAsk:BANDwidth:VIDeo:AUTO?

[VBW/RBW **Auto Man**]

- Menu description: to set ratio of BW/RBW during main channel measurement. When it is set as auto off, users may define the ratio and adjust it with number keys, stepping keys or the knob.
- Key path: **【Meas Setup】** , [Ref Channel▶], [VBW/RBW Auto Man] on the front panel.
- Status saved: saved in the instrument status.
- Factory preset: 1.0/Auto
- **Setting range:** 0.0001~300000
- Default unit: none
- **Remote Command:**

[[:SENSe]:SEMAsk:BANDwidth:VIDeo:RAtio <real>

[[:SENSe]:SEMAsk:BANDwidth:VIDeo:RAtio

[[:SENSe]:SEMAsk:BANDwidth:VIDeo:RAtio:AUTO OFF|ON|1|0

[[:SENSe]:SEMAsk:BANDwidth:VIDeo:RAtio:AUTO?

[Offset Limit▶]

- Menu description: to set parameters of offset and limit.
- Key path: **【Meas Setup】** , [Offset Limit▶] on the front panel.

[Offset]

- Menu description: to select the offset to be set.
- Key path: **【Meas Setup】** , [Offset Limit▶], [Offset] on the front panel.
- Status saved: saved in the instrument status.
- Factory preset: A

[Starting frequency **ON OFF**]

- Menu description: to set start frequency limit of each offset (the points closest to the carrier). If it is set as off, no measurement will be made for such offset. Users may use number keys, stepping keys and the knob to adjust it.
- Key path: **【Meas Setup】** , [Offset/Limit▶], [Start Freq On/Off] on the front panel.
- Status saved: saved in the instrument status.
- Factory preset: 2.515 MHz/on.
- Setting range: 0 Hz ~ stop frequency - 10 Hz
- Default unit: Hz
- **Remote Command:**

[[:SENSe]:SEMAsk:OFFSet:LIST:FREQuency:STARt <freq>,...

5.2. Description of menu

[[:SENSE]:SEMAsk:OFFSet:LIST:FREQuency:STARt?

[[:SENSE]:SEMAsk:OFFSet:LIST:STATe ON|OFF|1|0,...

[[:SENSE]:SEMAsk:OFFSet:LIST:STATe?

[Stop Freq]

- Menu description: to set stop frequency limit of each offset (the points farthest from the carrier). Users may use number keys, stepping keys and the knob to adjust it.
- Key path: **【Meas Setup】** , [Offset/Limit▶], [Stop Freq] on the front panel.
- Status saved: saved in the instrument status.
- Factory preset: 2.715MHz
- Setting range: start frequency + 10 Hz ~500 MHz
- Default unit: Hz
- **Remote Command:**

[[:SENSE]:SEMAsk:OFFSet:LIST:FREQuency:STOP <freq>,...

[[:SENSE]:SEMAsk:OFFSet:LIST:FREQuency:STOP?

[Sweep Time **Auto Man**]

- Menu description: to set offset Sweep Time as Auto ON or OFF. Use number keys, stepping keys or knob to change the time.
- Key path: **【Meas Setup】** , [Offset/Limit▶], [Sweep Time Auto Man] on the front panel.
- Status saved: saved in the instrument status.
- Factory preset: 5.0 ms/Auto Off.
- Setting range: 1 ms ~ 6000 s
- Default unit: s
- **Remote Command:**

[[:SENSE]:SEMAsk:OFFSet:LIST:SWEep:TIME <time>,...

[[:SENSE]:SEMAsk:OFFSet:LIST:SWEep:TIME?

[[:SENSE]:SEMAsk:OFFSet:LIST:SWEep:TIME:AUTO ON|OFF|1|0,...

[[:SENSE]:SEMAsk:OFFSet:LIST:SWEep:TIME:AUTO?

[Res BW **Auto Man**]

- Menu description: to set resolution bandwidth of the instrument during offset measurement. If the resolution bandwidth is set to Auto ON, the optimal setting is determined by the instrument. When the resolution bandwidth is set as auto off, users may define the bandwidth and adjust it with number keys, stepping keys or the knob.
- Key path: **【Meas Setup】** , [Offset/Limit▶], [More 1/3▶], [Res BW Auto Man] on the front panel.
- Status saved: saved in the instrument status.
- Factory preset: 30 kHz/Auto Off.
- **Setting range:** 1Hz – 20MHz.

5.2. Description of menu

- Default unit: Hz
- **Remote Command:**

```
[[:SENSE]:SEMAsk:OFFSet:LIST:BANDwidth[:RESolution] <bandwidth>,...
```

```
[[:SENSE]:SEMAsk:OFFSet:LIST:BANDwidth[:RESolution]?
```

```
[[:SENSE]:SEMAsk:OFFSet:LIST:BANDwidth[:RESolution]:AUTO OFF|ON|1|0,...
```

```
[[:SENSE]:SEMAsk:OFFSet:LIST:BANDwidth[:RESolution]:AUTO?
```

[Video BW Auto Man]

- Menu description: to set video bandwidth of the instrument when measuring the main channel. If the video bandwidth is set to Auto ON, the optimal setting is determined by the instrument. If the video bandwidth is set to Auto OFF, users may define the bandwidth and adjust it with number keys, stepping keys or the knob. and adjust it with number keys, stepping keys or the knob.
- Key path: **【Meas Setup】** , [Offset/Limit▶], [More 1/3▶], [Video BW Auto Man] on the front panel.
- Status saved: saved in the instrument status.
- Factory preset: 30 kHz/Auto Off.
- **Setting range:** 1Hz – 20MHz.
- Default unit: Hz

```
[[:SENSE]:SEMAsk:OFFSet:LIST:BANDwidth:VIDeo <freq>,...
```

```
[[:SENSE]:SEMAsk:OFFSet:LIST:BANDwidth:VIDeo?
```

```
[[:SENSE]:SEMAsk:OFFSet:LIST:BANDwidth:VIDeo:AUTO OFF|ON|0|1,...
```

```
[[:SENSE]:SEMAsk:OFFSet:LIST:BANDwidth:VIDeo:AUTO?
```

[VBW/RBW Auto Man]

- Menu description: to set the ratio of BW/RBW during offset measurement. When it is set as auto off, users may define the ratio to be set and adjust it with number keys, stepping keys or the knob.
- Key path: **【Meas Setup】** , [Offset/Limit▶], [More 1/3▶], [VBW/RBW Auto Man] on the front panel.
- Status saved: saved in the instrument status.
- Factory preset: 1.0/Auto
- **Setting range:** 0.0001~300000
- Default unit: none
- **Remote Command:**

```
[[:SENSE]:SEMAsk:OFFSet:LIST:BANDwidth:VIDeo:RATio <real>,...
```

```
[[:SENSE]:SEMAsk:OFFSet:LIST:BANDwidth:VIDeo:RATio?
```

```
[[:SENSE]:SEMAsk:OFFSet:LIST:BANDwidth:VIDeo:RATio:AUTO OFF|ON|0|1,...
```

```
[[:SENSE]:SEMAsk:OFFSet:LIST:BANDwidth:VIDeo:RATio:AUTO?
```

[Abs Start Limit]

- Menu description: to set absolute limit start value of the current offset and the same stop value. Users may use number keys, stepping keys or the knob to set the limit.

5.2. Description of menu

- Key path: **【Meas Setup】** , [Offset/Limit▶], [More 1/3▶], [More 2/3▶], [Abs Start Limit] on the front panel.
- Status saved: saved in the instrument status.
- Factory preset: -14dBm
- Setting range: -200dBm – 50dBm
- Default unit: dBm.

- **Remote Command:**

```
[::SENSE]:SEMAsk:OFFSet:LIST:STARt:ABSolute <real>,...
```

```
[::SENSE]:SEMAsk:OFFSet:LIST:STARt:ABSolute?
```

[Abs Stop Limit **Auto Man**]

- Menu description: to set absolute limit stop value of the current offset. Under auto mode, the instrument will automatically couple a value same with the set start value; while under auto off mode, users may use number keys, stepping keys or the knob to set the limit.
- Key path: **【Meas Setup】** , [Offset/Limit▶], [More 1/3▶], [More 2/3▶], [Abs Stop Limit Auto Man] on the front panel.
- Status saved: saved in the instrument status.
- Factory preset: -14dBm
- Setting range: -200dBm – 50dBm
- Default unit: dBm.

- **Remote Command:**

```
[::SENSE]:SEMAsk:OFFSet:LIST:STOP:ABSolute <real>,...
```

```
[::SENSE]:SEMAsk:OFFSet:LIST:STOP:ABSolute?
```

```
[::SENSE]:SEMAsk:OFFSet:LIST:STOP:ABSolute:COUple ON|OFF|1|0,...
```

```
[::SENSE]:SEMAsk:OFFSet:LIST:STOP:ABSolute:COUple?
```

[Rel Start Limit]

- Menu description: to set relative limit start value of the current offset and the same stop limit. Users may use number keys, stepping keys or the knob to set the limit.
- Key path: **【Meas Setup】** , [Offset/Limit▶], [More 1/3▶], [More 2/3▶], [Rel Start Limit] on the front panel.
- Status saved: saved in the instrument status.
- Factory preset: -30 dB.
- Setting range: - 200.0dB -50dB
- Default unit: dB.

- **Remote Command:**

```
[::SENSE]:SEMAsk:OFFSet:LIST:STARt:RCARrier <rel_amp>,...
```

```
[::SENSE]:SEMAsk:OFFSet:LIST:STARt:RCARrier?
```

5.2. Description of menu

[Rel stop limit Auto Man]

- Menu description: to set relative limit stop value of the current offset. Under auto mode, the instrument will automatically couple a value same with the set start value; while under auto off mode, users may use number keys, stepping keys or the knob to set the limit.
- Key path: **【Meas Setup】** , [Offset/Limit▶], [More 1/3▶], [More 2/3▶], [Rel Stop Limit Auto Man] on the front panel.
- Status saved: saved in the instrument status.
- Factory preset: -30 dB.
- Setting range: - 200.0dB -50dB
- Default unit: dB.
- **Remote Command:**

```
[::SENSE]:SEMAsk:OFFSet:LIST:STOP:RCARrier <rel_ampl>,...
```

```
[::SENSE]:SEMAsk:OFFSet:LIST:STOP:RCARrier?
```

```
[::SENSE]:SEMAsk:OFFSet:LIST:STOP:RCARrier:COUPlE ON|OFF|1|0,...
```

```
[::SENSE]:SEMAsk:OFFSet:LIST:STOP:RCARrier:COUPlE?
```

[Fail Mask▶]

- Menu description: to set limit test mark of the current offset, including four following mask tests:
 - Absolute: to serve as absolute limit line. When measured absolute result exceeds the absolute limit value, the test failed.
 - Relative: to serve as relative limit line. and measured relative result exceeds the relative limit value, the test failed.
 - Absolute and relative: to serve both as the absolute and relative limit lines. When measured absolute results exceeds the absolute limit value, and measured relative result exceeds the relative limit value, the test fails.
 - Absolute or relative: to serve as the absolute or the relative limit lines. When measured absolute results exceeds the absolute limit value, or measured relative result exceeds the relative limit value, the test failed.
- Key path: **【Meas Setup】** , [Offset/Limit▶], [More 1/3▶], [More 2/3▶], [Fail Mask▶] on the front panel.
- Save: saved in the instrument status.
- Factory preset: Absolute

```
[::SENSE]:SEMAsk:OFFSet:LIST:TESTABSolute|AND|OR|RELative,...
```

```
[::SENSE]:SEMAsk:OFFSet:LIST:TEST?
```

[Ref Type▶]

- Menu description: to set measurement reference type, total power reference, power spectral density reference and frequency spectrum peak reference.
- Key path: **【Meas Setup】** , [More 1/2▶], [Ref Type▶] on the front panel.
- Status saved: saved in the instrument status.
- Factory preset: total power reference

5.2. Description of menu

[Total Power Ref]

- Menu description: to use carrier power as reference for calculating relative power value of the offset when selecting total power reference.
- Key path: **【Meas Setup】** , [More 1/2▶], [Ref Type▶], [Total Power Ref] on the front panel.

[PSD Ref]

- Menu description: to use carrier power spectral density as reference for calculating relative power value of the offset when selecting power spectral density reference.
- Key path: **【Meas Setup】** , [More 1/2▶], [Ref Type▶], [PSD Ref] on the front panel.

[Frequency Spectrum Peak Reference]

- Menu description: to use frequency spectrum peak power as reference for calculating relative power value of the offset when selecting frequency spectrum peak reference.
- Key path: **【Meas Setup】** , [More 1/2▶], [Ref Type▶], [Freq Spectrum Peak Ref] on the front panel.

[Total Power Ref **Auto Man**]

- Menu description: to set a reference value corresponding to the reference type of the menu when selecting total power reference as measurement type. Under auto mode, the reference value will be the power spectral density of the current main channel; while under auto off mode, users may use number keys, stepping keys or the knob to set the reference value.
- Key path: **【Meas Setup】** , [More 1/2▶], [Ref Type▶], [Total Power Ref Auto Man] on the front panel.
- Status saved: saved in the instrument status.
- Factory preset: 0dBm
- Setting range: -200dBm – 200dBm
- Default unit: dBm.
- **Remote Command:**

[[:SENSE]:SEMAsk:CARRier[:POWer] <real> [:SENSE]:SEMAsk:CARRier[:POWer]?

[[:SENSE]:SEMAsk:CARRier:AUTO[:STATe] OFF|ON|1|0 [:SENSE]:SEMAsk:CARRier:AUTO[:STATe]?

[PSD Ref **Auto Man**]

- Menu description: to set a reference value corresponding to the reference type of the menu when selecting spectral density reference as measurement type. Under auto mode, the reference value will be the power spectral density of the current main channel; while under auto off mode, users may use number keys, stepping keys or the knob to set the reference value.
- Key path: **【Meas Setup】** , [More 1/2▶], [Ref Type▶], [PSD Ref Auto Man] on the front panel.
- Status saved: saved in the instrument status.
- Factory preset: 0 dBm/Hz.
- Setting range: -200 dBm/Hz ~200 dBm/Hz
- Default unit: dBm/Hz

- **Remote Command:**

[[:SENSe]:SEMAsk:CARRier:CPSD <real> [:SENSe]:SEMAsk:CARRier:CPSD?

[Frequency Spectrum Peak Reference **Auto Man**]

- Menu description: to set a reference value corresponding to the reference type of the menu when selecting frequency spectrum peak reference as measurement type. Under auto mode, the reference value will be the frequency spectrum peak power of the current main channel; while under auto off mode, users may use number keys, stepping keys or the knob to set the reference value.
- Key path: **【Meas Setup】** , [More 1/2▶], [Ref Type▶], [Freq Spectrum Peak Ref Auto On/Off] on the front panel.
- Status saved: saved in the instrument status.
- Factory preset: 0dBm
- Setting range: -200dBm – 200dBm
- Default unit: dBm.
- **Remote Command:**

[[:SENSe]:SEMAsk:CARRier:PEAK[:POWER] <real>

[[:SENSe]:SEMAsk:CARRier:PEAK[:POWER]?

[Meas Method▶]

- Menu description: to select the calculation method for measurement.
- Key path: **【Meas Setup】** , [More 1/2▶], [Meas Method▶] on the front panel.
- Status saved: saved in the instrument status.
- Factory preset: Bandwidth Integration.
- **Remote Command:**

[[:SENSe]:SEMAsk:FILTer[:RRC][:STATe] OFF|ON|0|1 [:SENSe]:SEMAsk:FILTer[:RRC][:STATe]?

[BW Integration]

- Menu description: to select the calculation method as Bandwidth Integration method.
- Key path: **【Meas Setup】** , [More 1/2▶], [Meas Method▶], [BW Integration] on the front panel.

[RRC Weighting]

- Menu description: to select the calculation method as RRC Weighting.
- Key path: **【Meas Setup】** , [More 1/2▶], [Meas Method▶], [RRC Weight] on the front panel.

[Filter Factor a]

- Menu description: to set the Filter Factor when using RRC method. The influence factor of RRC Filter will be considered in calculating the measurement result. Use number keys, stepping keys or knob to change the Filter Factor a.
- Key path: **【Meas Setup】** , [More 1/2▶], [Filter Alpha] on the front panel.

5.2. Description of menu

- Status saved: saved in the instrument status.
- Factory preset: 0.22
- **Setting range:** 0.01~1.0
- Default unit: none
- **Remote Command:**

```
[[:SENSe]:SEMAsk:FILTer[:RRC]:ALPHa <real> [:SENSe]:SEMAsk:FILTer[:RRC]:ALPHa?
```

[Low Noise Path ON OFF]

- Menu description: this menu is only available when the H34 option (Low Noise PreAmplifier) is purchased. When the PreAmplifier is ON, the Low Noise Path is OFF and this menu is grayed out; when the PreAmplifier is OFF, this menu lights on and is switchable.
- Key path: **【Meas Setup】** , [More 1/3], [More 2/3], [Low Noise Path ON OFF] on the front panel.
- Status saved: saved in the instrument status.
- **Remote Command:**

```
:SEMAsk:POWer:MW:PATH STD|LNPath
```

```
:SEMAsk:POWer:MW:PATH?
```

[Preselector Preselecting Bypass]

- Menu description: this menu is only available when the H36 option is purchased. It is used for setting whether to bypass the front-end preselector of the signal/spectrum analyzer. In analyzing bandwidth signal, bypass is usually required.
- Key path: **【Meas Setup】** , [More 1/3], [More 2/3], [Preselector Preselecting Bypass] on the front panel.
- Status saved: saved in the instrument status.
- **Remote Command:**

```
INPut:SEMAsk:FILTer:YIG[:STATe] OFF|ON|0|1
```

```
INPut:SEMAsk:FILTer:YIG[:STATe]?
```

[RF Gain▶]

- More description: to set the Auto ON/OFF of the RF Gain and best allocation algorithm for RF Gain. The soft More includes [Auto], [Best for Dynamic Range] and [Best for Sensitivity].
- Key path: **【Meas Setup】** , [More 1/3], [More 2/3], [RF Gain] on the front panel.
- Status saved: saved in the instrument status.
- **Remote Command:**

```
:SEMAsk:RF:GAIN:AUTO OFF|ON|0|1
```

```
:SEMAsk:RF:GAIN:AUTO?
```

```
:SEMAsk:RF:GAIN:AUTO:RULes RANGE|SENSITIVITY
```

```
:SEMAsk:RF:GAIN:AUTO:RULes?
```

5.2. Description of menu

[Best for Dynamic Range]

- Menu description: to set the RF Gain distribution algorithm to Best Dynamic Range. In this case, the RF Gain is switched to “Auto OFF”
- Key path: **【Meas Setup】** , [More 1/3], [More 2/3], [RF Gain▶], [Best for Dynamic Range] on the front panel.
- Status saved: saved in the instrument status.

[Best for Sensitivity]

- Menu description: to set the RF Gain distribution algorithm to Best Sensitivity. In this case, the RF Gain is switched to “Auto OFF”
- Key path: **【Meas Setup】** , [More 1/3], [More 2/3], [RF Gain▶], [Best for Sensitivity] on the front panel.
- Status saved: saved in the instrument status.

[ADC Dither **Auto Man**]

- Menu description: to control opening/closing of ADC dither of the frequency acquisition circuit in the analyzer. Under default mode, the signal/spectrum analyzer will automatically control whether the ADC Dither is ON based on current working condition. When the ADC Dither is under Auto mode, the ON or OFF status depends on the span, resolution bandwidth and sweep type (continuous swept or step sweep); when it is continuous swept, the ADC Dither status will force to switch to Auto and turns off; when it is step sweep, under Auto mode, if the span is 2MHz or below, the ADC Dither is ON; if the span is below 2MHz, the ADC Dither is OFF. Under Auto OFF mode, if the span is above 2MHz, turning on the ADC Dither may affect the measurement results based on selected dither status. You can access the submenu for manual control.
- Key path: **【Meas Setup】** , [More 1/3], [More 2/3], [ADC Dither Auto **Man**] on the front panel.
- Status saved: saved in the instrument status.
- Factory preset: Auto.
- **Remote Command:**

```
[[:SENSe]:SEMAsk:ADC:DITHer[:STATe] OFF|ON|HIGH
```

```
[[:SENSe]:SEMAsk:ADC:DITHer[:STATe]?\\n
```

```
[[:SENSe]:SEMAsk:ADC:DITHer:AUTO[:STATe] OFF|ON|0|1
```

```
[[:SENSe]:SEMAsk:ADC:DITHer:AUTO[:STATe]?
```

[Meas Preset]

- Menu description: to reset the measurement parameters to the factory preset status or user saved parameter status
- Key path: **【Meas Setup】** , [More 1/3], [More 2/3], [Meas Preset] on the front panel.
- Factory preset: factory reset.

•Remote Command:

```
:CONFigure:SEMAsk
```

5.2.11.18 Measurement Control

5.2. Description of menu

Pop up the More related to Meas Control, including [Measure Single Cont], [Restart] and [Pause/Resume].

[Measure Continuous ON OFF]

- Menu description: to set continuous measurement OFF or ON. When the [Measure Single Cont] is set as Cont mode, Cont On mode will be triggered and Cont sweep will be the default measure control method; when the [Measure Single Cont] is set as Single mode, single sweep will be triggered. Press **【Sweep Single】** to restart sweep when the next trigger signal arrives.
- Key path: **【Meas Control】** , [Meas Single Cont On Off] on the front panel.
- Status saved: saved in the instrument status.
- Factory preset: Continuous On.

- **Remote Command:**

:INITiate:CONTinuous OFF|ON|0|1

:INITiate:CONTinuous?

- **Examples:**

:INIT:CONT OFF

[Restart]

- Menu description: to stop current measurement and restart measurement for the signal/spectrum analyzer.
- Key path: **【Meas Control】** , [Restart] on the front panel
- Status saved: not saved in instrument status.

- **Remote Command:**

:INITiate:REST

[Pause/Resume]

- Menu description: when the signal/spectrum analyzer is in operation, this menu is used for pausing current measurement; when in Paused status, this menu is used for continuing measurement.
- Key path: **【Meas Control】** , [Pause/Resume] on the front panel.
- Status saved: not saved in instrument status.

- **Remote Command:**

:INITiate:PAUS

:INITiate:RES

6 Remote control

In this chapter, basic information of operating 4051 series signal/spectrum analyzer via remote control is introduced to help users remotely operate the analyzer. Specific contents include:

- [Basis of remote control](#).....611
- [Programmed Port and Configuration of Instrument](#).....625
- [Basic Programming Method of VISA Interface](#).....627
- [I/O library](#).....631

6.1 Basis of Remote Control

- [Remote Control Interface](#).....611
- [Messages](#).....613
- [SCPI Command](#).....614
- [Command Sequence and Synchronization](#).....621
- [Status Report System](#)622
- [Programming Precautions](#).....625

6.1.1 Remote Control Interface

4051 series signal/spectrum analyzer is compatible only to two remote control interfaces: LAN and GPIB. As shown in the following table:

Table 6.1 Types and VISA Addressing Character Strings of Remote Control Interfaces

Remote Control Interface	VISA address character string (note 1)	Description
LAN (Local Area Network)	Original socket protocol: TCPIP::host_address::port::SOCKET	Remote control can be realized by the connecting the instrument through the network port on the rear panel of the instrument. For details, refer to: “ 6.1.1.1 LAN Interface ”.
GPIB (IEC/IEEE Bus Interface)	GPIB::primary address[::INSTR]	Remote control can be realized by the connecting the instrument through the port on the rear panel of the instrument. Comply with the bus interface standards of IEC 625.1/IEEE418. For details, refer to: “ 6.1.1.2 GPIB Interface ”.

Note 1: VISA stands for Virtual Instrumentation Software Architecture, which is a standard software interface function library. Users may use the library to control the instrument via such interfaces as GPIB, LAN and USB. Users should firstly install VISA library on the control computer and use it to remotely control the instrument. See the User Manual of the VISA library to be installed for more details.

- [LAN Interface](#).....611
- [GPIB interface](#).....613

6.1.1.1 LAN Interface

The signal/spectrum analyzer may use RJ45 communication cables (shielded or unshielded Class 5 TP) to connect to 10Mbps/100Mbps/1000Mbps Ethernet for remote control via the control computer inside LAN. In

6.1 Basis of Remote Control

order to control the instrument remotely inside LAN, the analyzer has been installed with the interface adapter and TCP/IP protocol and configured with corresponding TCP protocol-based web service.

The network interface adapter installed in the analyzer has three operating modes, including:

- 10Mbit/s Ethernet IEEE802.3;
- 100Mbit/s Ethernet IEEE802.3u;
- 1 Gbit/s Ethernet IEEE802.3ab.

The interface adapter will automatically seek appropriate network speed for matching based on link condition. The cable for connecting the analyzer usually has a length no more than 100 m. Visit <http://www.ieee.org> for more information of Ethernet.

LAN interfaces are introduced below.

1) IP address

Ensure that the physical connection is smooth for remote control of the signal/spectrum analyzer by LAN. Through the “Local IP” menu of the signal/spectrum analyzer, set the address to the subnet where the controlling computer is located. Example: If the IP address of the master control computer is 192.168.12.0, the IP address of the signal/spectrum analyzer should be set as 192.168.12.XXX, in which, XXX is a value between 1 and 255.

Only the IP address is required to establish the network connector. The VISA addressing character string is as follows:

TCPIP::host address::port::SOCKET

Where:

- TCPIP refers to the applied network protocol.
- “Host address” refers to the IP address or host name of the instrument, used to identify and control the instrument to be controlled.
- “port” refers to the socket port number and the port of the 4051 signal/spectrum analyzer is 5000;
- SOCKET refers to the original network socket resource class.

Example:

Use the following string for original socket connection:

“TCPIP::192.1.2.3::5000::SOCKET” can be used for establishing the original socket connection.

Prompt

Identification of multiple instrument in remote control system

If multiple instruments are connected in the network, distinguish them with the separate IP address and associated resource string. The respective VISA resource string is used by the master control computer to identify the instrument.

2) Socket communication

TCP/IP protocol can be networked with the signal generator using LAN socket. Socket is a basic approach used in computer network programming, which enables network communication among applications employing different hardware and operating systems. In this method, the signal/spectrum analyzer is connected to the computer through the port for two-way communication.

Socket is a kind of software specially programmed and has defined the information necessary for network communication such as IP address and device port number and integrated some basic operations of network programming. Socket can be used as long as the packaged libraries are installed in the OS. Berkeley Socket

6.1 Basis of Remote Control

Library applied in UNIX and Winsock Library applied in Windows constitute the two common socket libraries.

The socket of the signal/spectrum analyzer is compatible with the Berkeley socket and Winsock through the application program interface (API). Besides, it is also compatible with other standard socket API. The command will be sent by the socket program to control the signal/spectrum analyzer through SCPI commands. The signal/spectrum analyzer has a fixed socket port number of 5000.

6.1.1.2 GPIB Interface

As the only bus dedicated to instrument control, GPIB is still widely applied in automatic test systems. The 4051 signal/spectrum analyzer integrated GPIB interface on the rear panel. In order to realize remote control, the master control computer should be configured with the GPIB bus card, drive program and VISA library in advance. During communication, the controlled instrument is addressed by the master control computer according to the GPIB bus address and users may change such GPIB address to prevent communication failure caused by address conflict in the entire system.

Refer to ANSI/IEEE 488.1-1987 and ANSI/IEEE 488.2-1992 for details of descriptions of GPIB and relevant interfaces. For details, visit the IEEE website <http://www.ieee.org>.

Pay attention to the following when connecting the GPIB interface:

- Only 15 pieces of equipment are allowed at most in the test system connected with GPIB bus;
- The total length of the transmission cable must not exceed 20m or twice of the number of instruments in the system.
- Generally, the maximum length of the transmission cable between devices must not exceed 2m.
- For parallel connection of instruments, use “or” connecting lines.
- Connect the terminal of the IEC bus cable to the instrument or controlling computer.

6.1.2 Message

Messages transmitted through the data lines are divided into the following two types.

1) Interface message

Interface messages are uni/Que to GPIB bus and only instruments with GPIB bus function are able to respond to such messages. When the master control computer sends interface messages to the instrument, the attention line should be lowered at first before interface messages can be transmitted to the instrument via the data line.

2) Instrument message

For the structure and grammar of instrument messages, refer to “5.1.4 SCPI Commands”. According to the transmission direction, instrument messages can be divided into the command and instrument response. Unless otherwise specified, the same method should be applied for use of instrument messages with the remote control interface.

a) Commands

The command (programming message) is a kind of message transmitted by the master control computer to the instrument, used for remote control of the instrument function and query of the status information. Commands are divided into the following two types:

- According to the influence on the instrument:
 - Setting command: change the instrument setting status, such as resetting, frequency setting, etc.
 - Query command: inquire and return data, such as instrument identification or parameter query. The query command ends with a suffix question mark.
- According to the definition in the standard:

6.1 Basis of Remote Control

- General command: the function and grammar are defined in the IEEE488.2 standard, and this kind of command is suitable for all kinds of instruments, and if possible, used for standard status register management, resetting, automatic testing, etc.
- Instrument control command: a kind of instrument characteristic command, used to realize the instrument functions. Example: frequency setting. The grammar should comply with the SCPI specifications.

b) Instrument response

The instrument response (response message and service request) is a kind of query result message transmitted by the instrument to the computer. This kind of message includes the measurement result, instrument status, etc.

6.1.3 SCPI Command

- [SCPI Command Introduction](#)614
- [SCPI Command Specifications](#).....615

6.1.3.1 SCPI Command Introduction

SCPI (Standard Commands for Programmable Instruments) is a command set, which is established based on the IEEE488.2 Standard and suitable for all instrument. It mainly aims to apply the same programmed commands for the same functions to realize the universality of programmed commands.

The SCPI command is composed of the command head and one or more parameter(s), which are separated by spaces. The command head includes one or more key field(s). The command with the suffix question mark is the query command. The command can be divided into general command and special command of different grammatical structures. The SCPI command has the following features:

- 1) Programmed commands are applicable to the test function, but not for instrument description.
- 2) Programmed commands can help to reduce the repetition of similar test functions and ensure the program compatibility.
- 3) Programmed messages are defined in the layer which is not related to the hardware of the physical layer in communication.
- 4) Programmed messages are not related to the programming method and language. The SCPI test program is easy to transplant.
- 5) Programmed commands are scalable to adapt to measurement control of various scales.
- 6) The extensibility of SCPI enables it to be “live” standard.

For more SCPI details, refer to:

- IEEE Standard 488.1-1987, IEEE Standard Digital Interface for Programmable Instrumentation. New York, NY, 1998.
- IEEE Standard 488.2-1987, IEEE Standard Codes, Formats, Protocols and Comment Commands for Use with ANSI/IEEE Std488.1-1987. NewYork, NY, 1998.
- Standard Commands for Programmable Instruments(SCPI) VERSION 1999.0.

For details of the remote command set, classification and specifications of 4051 series signal/spectrum analyzer, refer to:

- 1) “Appendix B SCPI Command Index” of this Manual.
- 2) “3 Remote Control Commands” of the Remote Control Manual.
- 3) “Appendix A SCPI Command Tree of Section 6.1” of the Remote Control Manual.
- 4) “Appendix B Table of Subsystem-based ASCPI Classification of Section 6.2” of the Remote Control Manual.

- 5) “Appendix C Table of menu-based ASCPI Classification of Section 6.3” of the Remote Control Manual.

6.1.3.2 SCPI Command Specifications

1) General terms

The following terms are applicable to this section. In order to better understand the contents, you should know the exact definitions of such terms.

a) Controller

Any computer used to communicate with SCPI devices. The PC, minicomputer or card in a card cage can be used as the controller. Also, some intelligent devices can be used as controller.

b) Equipment

Any device supporting SCPI. The majority of devices are electrical measurement or excitation devices for communication through the GPIB interface.

c) Remote control messages

A combination of one or more properly formatted SCPI commands. Programming messages instruct a device how to measure and output signals.

d) Response messages

A combination of data in specified SCPI formats. Response messages are always transmitted from a device to a controller or monitor. Response messages inform the controller of the internal status or measured values of a device.

e) Commands

Any command compliant with SCPI standard. Messages control the combination of device commands. Generally, the commands consist of keyword, parameter and punctuation.

f) Event commands

Some commands are events and cannot be queried. Generally, there is no front panel key corresponding to the event command. The event command is used to trigger an event at the specific time.

g) Query

A special type of command. For query of control equipment, return to the response message conforming to the controller grammar requirements. Query string always end with a question mark.

2) Command type

The SCPI command is divided into two types: general command and special instrument command. Common commands are used to manage macros, status registers, synchronization and data storage, and are defined by IEEE 488.2. It can be easily identified with the star mark in front of the command. For example, *IDN? , *OPC and *RST are common commands. The general command is not the special instrument command and can be explained in the same method, regardless of the current path setting.

The special instrument command is easy to identify with the colon (:). The colon is used at the beginning of a command statement and between keywords, as in FREQuency[:CW?]. Based on the internal functional modules of the instrument, special instrument commands are divided into corresponding subsystem command subsets. For example, the power subsystem (:POWer) includes relevant power commands, and the status subsystem (:STATus) includes the status control register commands.

6.1 Basis of Remote Control

3) Grammar of special instrument command

Table 6.2 Special Characters of Command Grammar

Symbol	Meaning	Examples
	The vertical line between the keyword and parameter means a variety of options.	[[:SOURce]:AM: SOURce EXTernal INTernal EXTernal and INTernal are optional.
[]	The square brackets means that the included keywords or parameters are optional in the command. Even if the included keywords or parameters are ignored, the command will be executed.	[[:SOURce]:AM[:DEPTTh]:EXPon ential? SOURce and DEPTTh are optional.
<>	The part in the angle brackets must not be used according to the literal meaning in the command. The angle brackets mean the necessary part.	[[:SOURce]:FREQ:STOP <val><unit> In this command, <val> and <unit> must be replaced with the actual frequency and unit. Example: “:FREQ:STOP 3.5GHz”
{ }	The braces mean that the parameter is optional.	[[:SOURce]:LIST:POWER <val>{,<val>} Example: “LIST:POWER 5”

Table 6.3 Command Grammar

Character, Keyword and Grammar	Examples
Upper-case lettering indicates the minimum set of characters required to execute the command.	[[:SOURce]:FREQuency[:CW]?, FREQ is the short part of the command.
The lowercase character part of the command is optional. This flexible format is known as “flexible listening”. For more information, refer to the “Command Parameter and Response” section.	:FREQuency :FREQ,:FREQuency or :FREQUENCY, is correct.
If a colon is applied between two command mnemonics, the current path in the command tree will be moved to next layer. Refer to “Command Tree” for more information on command paths.	:TRIGger:OUTPut:POLarity? TRIGger is the keyword of the top layer of the command.
Adjacent parameters in the command should be separated with commas. The parameters have no influence on the path layer and do not belong to the command path part.	[[:SOURce]:LIST:DWELl <val>{,<val>} :FREQ 2.5GHZ; :POW 10DBM
The semicolon is used to separate two adjacent commands, with no influence on the current command path.	:FREQ 2.5GHZ; :POW 10DBM
The blank character, such as <space> or <tab>, is generally ignored when not used between or in keywords. are generally ignored as long as they do not occur within or between keywords. However, you must use the blank character to separate the command and parameter, with no influence on the current path.	:FREQ uency or :POWer :LEVel6.2 is not allowed. Allowed 的。 “:LEVel” and “6.2” must be separated with the space. E.g. “:POWer:LEVel 6.2”

A typical command is made up of keywords prefixed with colons (:). The keywords are followed by parameters. The following is an example syntax statement:

```
[[:SOURce]:POWer[:LEVel] MAXimum|MINimum
```

In the above example, “:POWER” is followed by [:LEVEL], with no space. “MINimum|MAXimum” behind [:LEVEL] is the parameter part. A space is used between the command and parameter. For the other parts of the grammar expression, see Table 6.2 and 6.3.

4) Command tree

Special instrument commands are used in most of remote control programs. To analyze this kind of command, the SCPI structure should be similar to the file system, known as the command tree.

The top command is the root command, referred to as the “root”. Follow the specific path of the tree structure to next layer in command analysis. Example: :POWer:ALC:SOURce? Where, “:POWer” refers to AA, “:ALC” refers to BB, and “:SOURce” refers to GG. The whole command path is (:AA:BB:GG).

The command interpreter, a module of the instrument software, is dedicated to analysis of each received SCPI command. It is used to divide the command into separate command elements according to a series of rules to distinguish command tree paths. The current command should be kept unchanged after analysis, so as to analyze the subsequent command more rapidly and efficiently as the same command keyword may be used in various paths. The current command path should be set as the root after the instrument is started or reset (*RST).

5) Command parameter and response

Table 6.4 SCPI Command Parameters and Response Types

Parameter type	Response Data Types
Numeric	Real or integer
Extended Numeric	Integer
Discrete	Discrete
Boolean	Numeric Boolean
String	String
Block	Block with definite length
	Block of uncertain length
Non-decimal Numeric	Hexadecimal system
	Octal system
	Binary system

SCPI defines different data formats for use in program and response messages. It does this to accommodate the principle of forgiving listening and precise talking. Refer to IEEE488.2 for more information. Forgiving listening means the command and parameter formats are flexible. For example, the signal/spectrum analyzer is set with a frequency offset status command: FREQUency:OFFSet:STATe ON|OFF|1|0. The following command formats are to turn on the frequency offset mode:

:FREQUency:OFFSet:STATe ON, :FREQUency:OFFSet:STATe 1,

:FREQ:OFFS:STAT ON, :FREQ:OFFS:STAT 1.

Various parameter types correspond to one or more response data type(s). The numeric type of the parameter will change into the data type in query. Response data are accurate, strictly referred to as “accurate telling”.

For example, if you query the power status (:POWer:ALC:STATe?) when it is on, the response is always 1, regardless of whether you previously sent :POWer:ALC:STATe1 or :POWer:ALC:STATe ON.

a) Numerical parameter

Special instrument commands and general commands can be expressed as numeric parameters. All kinds of common decimal counting can be applied for reception of numeric parameters, including the plus or minus, decimal and scientific counting methods. If one device can only receive the specific numeric type, such as the integer, the received numeric parameter will be automatically rounded.

6.1 Basis of Remote Control

The following are examples of numeric parameters:

0	no decimal point required
100	fractional digits optional
1.23	leading signs allowed
4.56e<space>3	space allowed after the E in exponential
-7.89E-01	use either E or e in exponential
+256	leading + allowed
5	digits left of decimal point optional

b) Extended numeric parameters

The numeric parameter is extended to specify the physical quantity in the majority of measurements related to special instrument commands. Extended numeric parameters accept all numeric parameter values and other special values as well. The extended numeric parameters include the MAXimum and MINimum. Other special values, such as UP and DOWN, are received depending on the analysis capability of the instrument. All effective parameters are listed in the SCPI command table.

Note: The extended numeric parameters are not applicable to general commands or STATus subsystem commands.

The following are examples of extended numeric parameters:

101	Numeric parameter
1.2GHz	GHz can be used for exponential (E009)
200MHz	MHz can be used for exponential (E006)
-100mV	negative 100 millivolts
10DEG	10 degree
MAXimum	sets parameter to largest possible value
MINimum	sets parameter to smallest possible value
UP	a stepper up
DOWN	a stepper down

c) Discrete parameters

Discrete parameters are used to identify a limited number of parameters to be set. Discrete parameters use mnemonics to represent each valid setting. Similar to the programmed command mnemonics, discrete parameter mnemonics are divided into long type, short type and uppercase/lowercase mixed type.

Discrete parameters and commands are used together in the following examples.

:TRIGger[:SEQuence]:SOURce BUS|IMMediate|EXTernal

BUS GPIB,LAN, triggering

IMMediate immediate trigger

EXTernal external triggering

d) Boolean parameters

The Boolean parameter represents one true or false binary condition, and only four possible values can be applied. The following are examples of boolean parameters:

ON boolean true

OFF boolean false

1 boolean true

0 boolean false

e) String parameters

For the character string type, the ASCII character string is allowed to be transmitted as the parameter. Single and double quotes are used as delimiters.

The following are examples of string parameters:

‘This is Valid’“This is also Valid”‘SO IS THIS’

f) Real response data

Most test data are real data that represent decimal numbers in either fixed decimal or scientific notation. Most high-level programming languages support such two formats.

The following are examples of real response data:

1.23E+0

-1.0E+2

+1.0E+2

0.5E+0

0.23

-100.0

+100.0

0.5

g) Integer response data

Integer response data are decimal representations of integer values including signs. For status register query, integer response data will be returned in most cases.

The following are examples of integer response data:

0 Signs are optional

6.1 Basis of Remote Control

+100	leading + allowed
-100	leading - allowed
256	never any decimal point

h) Discrete response data

Discrete response data are similar to discrete parameters. The main difference is that discrete response data only returns the short form of a particular mnemonic in all upper case letters.

Example of discrete response data:

INTernal	power leveled internally
EXTernal	power leveled externally
MMHead	power leveled by millimeter wave source module

i) Numeric Boolean response data

Boolean response data returns a binary numeric value of 1 or 0.

j) String response data

String response data are similar to string parameters. The main difference is that the double quotation marks instead of single quotation marks must be used as the separator of the string response data. Double quotation marks are allowed to be embedded in the string response data, with no character. The following are examples of string response data:

“This is a string”

“one double quote inside brackets: (“”)”

6) Binary, decimal, hexadecimal, and octal formats

The command value can be entered in the binary, decimal, hexadecimal or octal format. An appropriate identifier should be applied in front of the value in the binary, hexadecimal or octal format. The identifier is not required in the decimal format (default). The entered value with no identifier will be saved in the decimal format. The following list shows the identifiers for the formats that require them:

- #B means that the figure is a binary value;
- #H means that the figure is a hexadecimal value;
- #Q means that the figure is an octal value.

The following are examples of SCPI command values and identifiers for the decimal value 45:

#B101101

#H2D

#Q55

In the following example, the hexadecimal value 00A is used to set the RF output power as 10dBm (or equivalent to the value in the selected unit, such as DBUV or DBUVEMF).

:POW #H00A

In the non-decimal format, the measurement unit such as DBM or mV is not used together with the value.

7) Command line structure

One command line may include multiple SCPI commands. The following methods can be applied to end the current command line:

- Enter;
- Enter key and EOI;
- EOI and the last byte.

Commands in the command line are separated by semicolons. Commands of different subsystems begin with the colon. For example:

```
MMEM:COPY "Test1", "MeasurementXY";:HCOP:ITEM ALL
```

This command line includes two commands, the first of which is the MMEM subsystem command and the second of which is the HCOP subsystem command. If adjacent commands belong to the same subsystem and the command paths are subject to partial overlapping, the commands can be abbreviated. For example:

```
HCOP:ITEM ALL;:HCOP:IMM
```

This command line includes two commands which belong to the same level of the HCOP subsystem. The second command is started at the level lower than the HCOP command, and the colon at the beginning of the command can be omitted. The command line can be abbreviated as follows:

```
HCOP:ITEM ALL;IMM
```

6.1.4 Command Sequence and Synchronization

IEEE488.2 defines the difference of the overlapping command and continuous command.

- The continuous command refers to the command sequence to be executed continuously. Generally, the speed of command execution is high.
- The overlapping command refers to the command which is not executed automatically before execution of next command. The processing time of the overlapping command is generally long. The program is allowed to process other events synchronously.

Even if one command line includes multiple setting commands, commands may not be executed according to the reception sequence. In order to execute each command according to a certain sequence, all the commands must be transmitted as a separate command line.

Example: command line including setting and query commands.

If one command line includes query commands, query results are unpredictable. The returned value will be fixed if the following command is entered:

```
:FREQ:STAR 1GHZ;SPAN 100;:FREQ:STAR?
```

Returned value: 1000000000 (1GHz)

The returned value will not be fixed if the following command is entered:

```
:FREQ:STAR 1GHZ;STAR?;SPAN 1000000
```

The returned result may be the current starting frequency of the instrument before command sending, as the commands will be executed one by one by the host program after command messages are received. The returned result may be 1GHz in the case of execution after the commands are received by the host program.

Prompt

Setting commands and query commands are sent separately.

General rules: setting commands and query commands should be sent in different program messages in order to ensure that the returned results of query commands are correct.

6.1 Basis of Remote Control

6.1.4.1 Prevention of Overlapping Execution of Commands

In order to prevent overlapping execution of commands, multiple threads or commands can be applied, including *OPC, *OPC? or *WAI. The three commands cannot be executed until the hardware is set. The computer may be forced to wait for a certain period to synchronize certain events in the programming process. The above methods are described below.

➤ **Use multiple threads in the control program.**

Multiple threads are used to complete waiting commands and synchronize the user interface and program, that is, the command “*OPC?” is executed in each single thread, with no blockage of GUI or program threads.

➤ **The use of three commands in synchronous execution is shown in the following table.**

Table 6.5 Command Grammar

Method	Execution Action	Programming Method
*OPC	After command execution, set the operation completion bit in the ESR register.	Set ESE BIT0; Set SRE BIT5; send the overlapping command and *OPC; Wait for the service request signal (SRQ). The service request signal means that the overlapping command has been executed.
*OPC?	Stop executing the current command and return to 1. Only when the operation completion bit in the ESR register is set, the command will be returned, indicating that the previous command has been processed.	End the current command processing before executing other commands. Directly send the command after processing of the current command.
*WAI	Before executing *WAI, wait for sending of all commands. Then process the uncompleted commands.	End the current command processing before executing other commands. Directly send the command after processing of the current command.

6.1.5 Status Report System

The status report system is used to save all operation status information and error information of the current instrument. The operation status information and error information are respectively saved in the status register and error queue and can be inquired through the programmed interface.

- [Structure of status register organization.....622](#)
- [Application of status report system.....624](#)

6.1.5.1 Structure of Status Register Organization

Register categories are as follows:

1) STB, SRE

The top register of the status report system is composed of the status byte (STB) and associated shielding register, i.e. service request enabling register (SRE). STB is used to collect the information of registers of the lower layers and save the general working conditions of the instrument.

2) ESR and SCPI status register

STB is used to receive the following register information:

- Relevant values of event status registers and event status enabling (ESE) shielding registers.
- SCPI status registers, such as STATus:OPERation and STATus:QUESTionable registers (defined by the SCPI standard), including specific operations of the instrument. All the SCPI status registers have the

6.1 Basis of Remote Control

same internal structure (refer to “2.1.5.2 Structure of SCPI Status Register” of the program control manual).

3) IST, PPE

The separate bit of SRQ and IST sign (“IndividualSTatus”) is composed of the combination of all statuses of the instrument. The STB data bit for the IST sign depends on the associated Parallel Poll Enable (PPE) Register.

4) Output buffer zone

The output buffer zone is used to save messages returned by the instrument to the controller. It does not belong to the status report system, but is decisive to the MAV bit of STB.

For details of the above registers, refer to “2.1.6 Status Report System” of the program control manual.

Please refer to Fig. 6.1 for the hierarchical structure of the status register.

Prompt**SRE and ESE**

The Service Request Enable (SRE) register is used as the enabling part of STB. Similarly, ESE can be used as the enabling part of ESR.

6.1 Basis of Remote Control

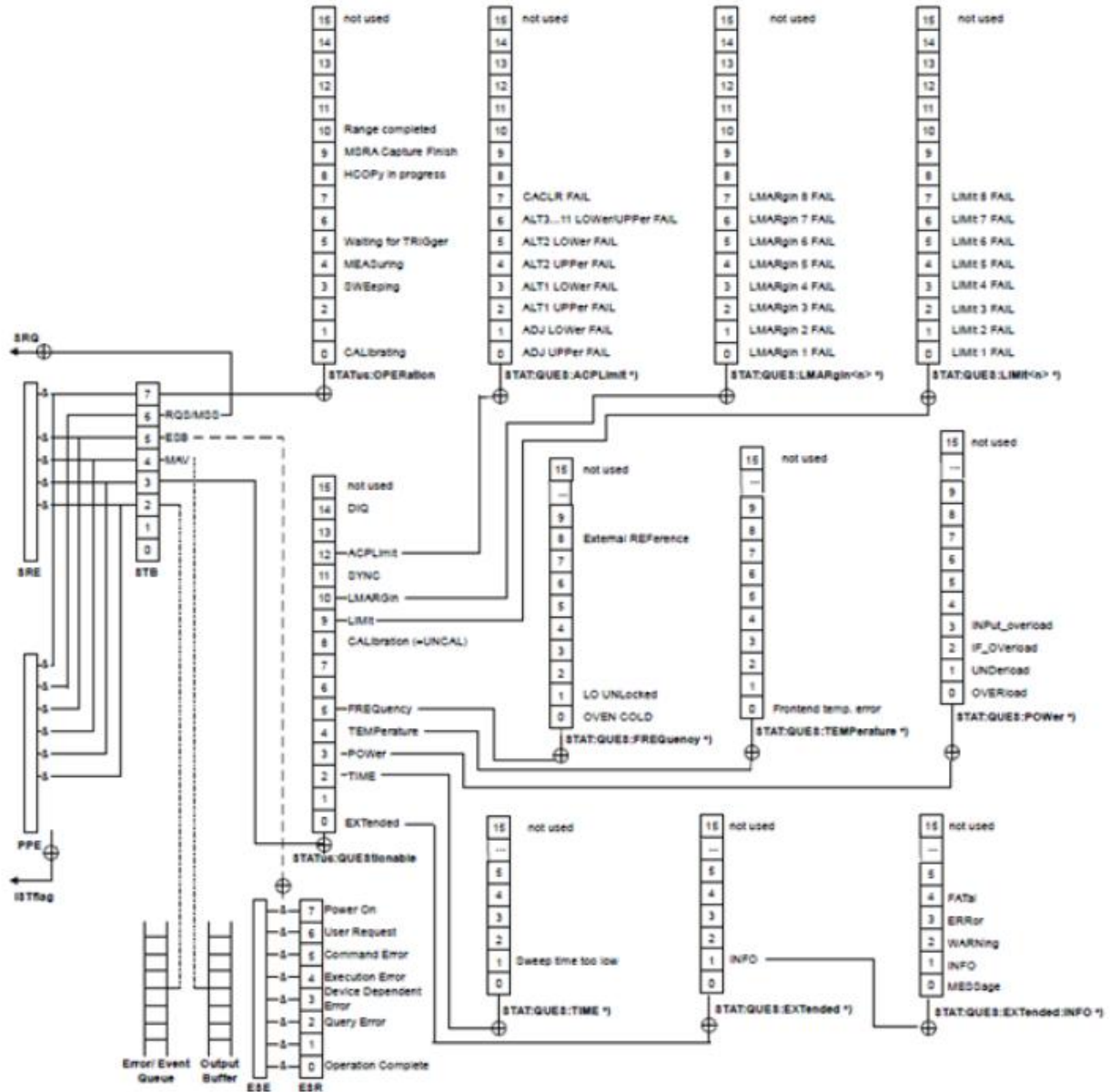

Fig. 6.1 Hierarchical Structure of Status Register

6.1.5.2 Application of Status Report System

The status report system is used to monitor the status of one or more instrument(s) in the test system. In order to properly realize the functions of the status report system, the controller in the test system must receive and evaluate the information of all instruments. Standard methods to be applied include:

- 1) Service request (SRQ) sent by the instrument.
- 2) Series query sent by the controlled to all instruments in the bus system, aiming to find the sender and causes of service request.
- 3) Parallel query of all instruments.
- 4) Query of specific instrument statuses with programmed commands.

For specific operations, refer to “2.1.5 Application Status Report System” of the programming manual.

6.2 Programmed Port and Configuration of Instrument

6.1.6 Programming Precautions

1) Initialize the instrument status before changing the setting.

For instrument setting of remote control, initialize the instrument status (sending “*RST”, etc.) and then set the required status.

2) Command sequence

Generally, the setting command and query command should be transmitted separately. Otherwise, the returned value of the query command will change according to the current instrument operation sequence.

3) Fault response

The service request must be sent by the instrument. The controller of the test system should be programmed to guide the instrument to actively send the service request if required, so as to enable the corresponding service interruption program.

4) Error queue

The error queue instead of the status register should be inquired once the service request is processed by the controller program, so as to find more accurate causes. The queue should be always inquired in the controller program test phase to obtain the commands sent by the controller to the instrument.

6.2 Programmed Port and Configuration of Instrument

- LAN.....625
- GPIB.....626

6.2.1 LAN

The programmed LAN (Local Area Network) system is configured with SOCKET to control 4051 signal/spectrum analyzer.

Caution

Use of USB master control port connector of the front panel:

The Type-A connector of the front panel is a USB master control port connector. In the 4051 signal/spectrum analyzer, this port is connected to the flash disc with USB1.1 interface to update the software in the instrument. It can also be connected to the USB keyboard and mouse to control the signal/spectrum analyzer. However, this port cannot be used for remotely control the instrument. However, this port cannot be used for remotely control the instrument.

- Establish connection.....625
- Interface Configuration.....625

6.2.1.1 Establish Connection

Connect the 4051 series signal/spectrum analyzer and external controller (computer) to LAN through cables. Pay special attention to the possibility of conflict caused by IP address setting and confirm with the network administrator before setting to prevent any conflict.

6.2.1.2 Interface Configuration

Ensure that the physical connection is smooth for remote control of the signal/spectrum analyzer by LAN. As the DHCP, domain name access and WAN are not supported, the network programming of the signal/spectrum analyzer is relatively simple. Users only need to press **【System】**, **[Interface Config▶]**, **[Internet Config▶]** and set the “IP address”, “Subnet mask” and “Default gateway” to be within the subnet with the master controller as shown in the menu of Fig. 6.2.

6.2 Programmed Port and Configuration of Instrument

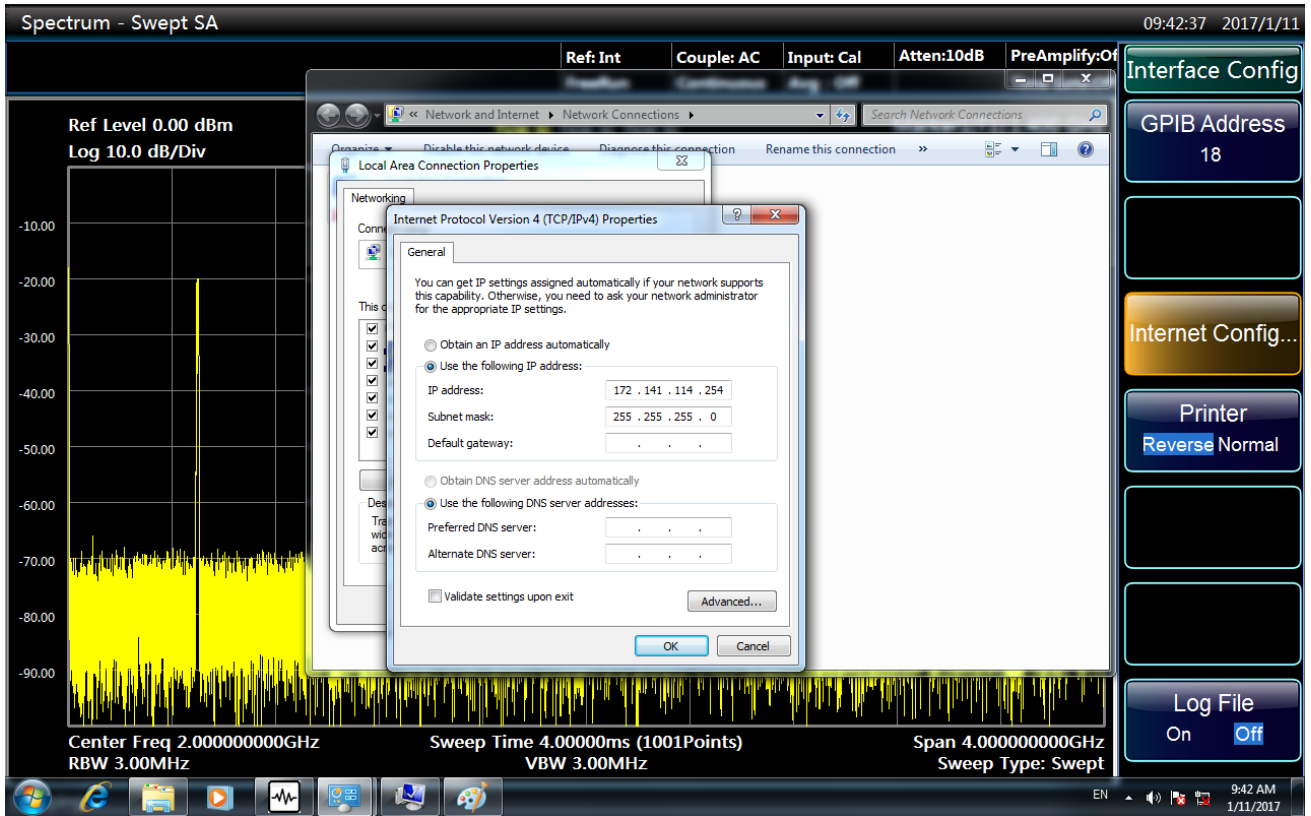

Fig. 6.2 LAN Interface Setting

Caution

Ensure that the signal/spectrum analyzer is in proper physical connection via RJ45 LAN cable.

The signal/spectrum analyzer only supports the establishment of one LAN control system and static IP address setting, and does not support DHCP or access to the host through the DNS and domain name server. Therefore, it is not required to modify the subnet mask. The subnet mask of the instrument should be set as the fixed value 255.255.255.0.

6.2.2 GPIB

- Establish connection.....626
- Interface Configuration.....626

6.2.2.1 Establish Connection

Connect the 4051 series signal/spectrum analyzer and external controller (computer) to LAN through GPIB cables.

6.2.2.2 Interface Configuration

To set the GPIB interface, press **【System】** [Interface Config▶] [GPIB Address] to enter the interface shown in Fig. 6.3; modify the GPIB address in the [Local GPIB address] input box through the number keys of the front panel.

6.3 Basic Programming Method of VISA Interface

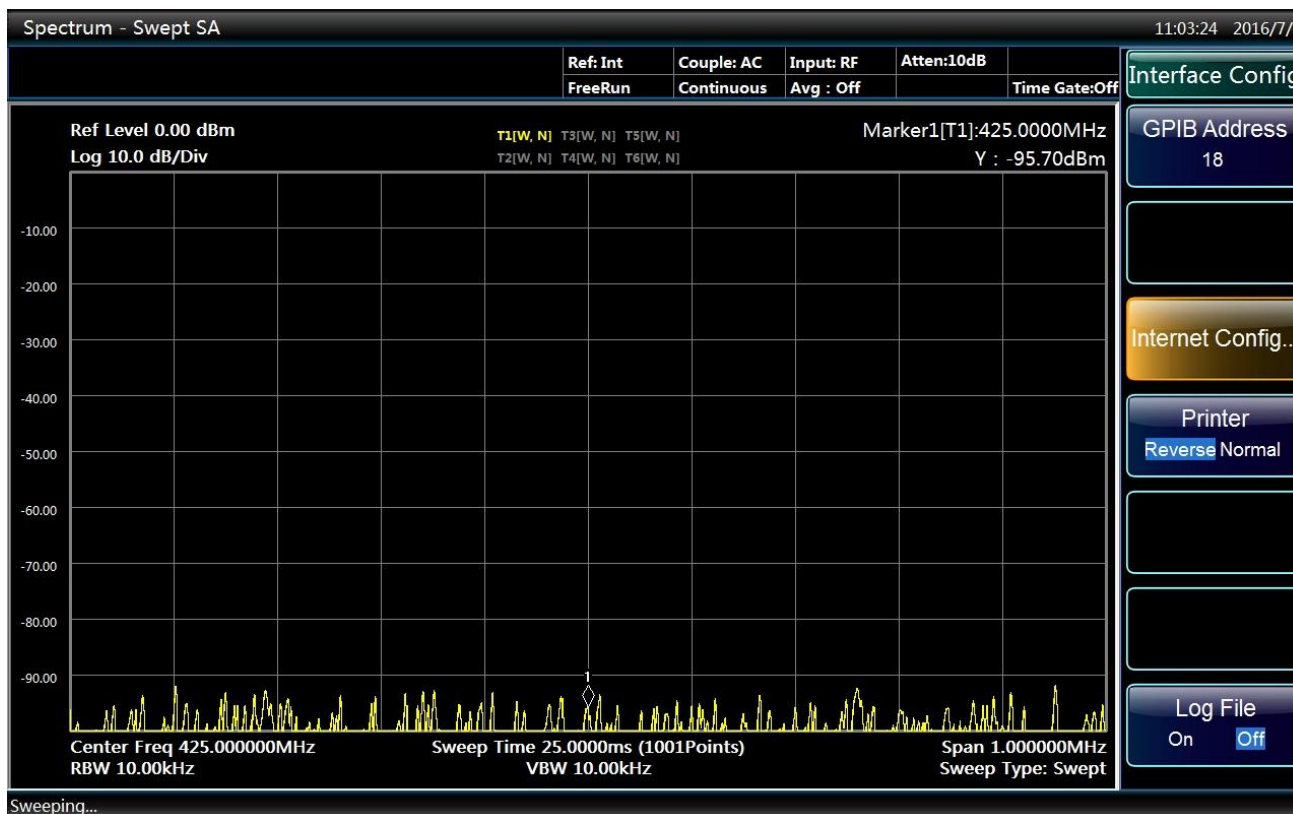

Fig. 6.3 GPIB Interface Setting

6.3 Basic Programming Method of VISA Interface

The following example shows the basic method of instrument programming with the VISA library. Take the C++ language as the example.

- Install VISA Library.....627
- Initialization of Controller.....627
- Instrument Initialization.....628
- Sending of setting command.....628
- Reading of measurement instrument state.....628
- Reading of frequency marker.....629
- Command synchronization.....629

6.3.1 Install VISA library

The VISA library must be installed at first for remote control. The VISA library includes the transmission functions of the bottom VXI, GPIB, LAN and USB interface to facilitate direct calling. This signal/spectrum analyzer is compatible with the programming interfaces of GPIB, LAN. Combination of such interfaces with the VISA library helps to remotely control the signal/spectrum analyzer.

6.3.2 Initialization of Controller

/*.....*/

The following example shows how to establish the communication connection between the VISA library and instrument (with the specified descriptor).

6.3 Basic Programming Method of VISA Interface

// initialize the controller: open the default resource manager and return the instrument handle to the analyzer.

```
/******
```

void InitController()

```
{
ViStatus status;
status = viOpenDefaultRM(&defaultRM);
status = viOpen(defaultRM, analyzerString, VI_NULL, VI_NULL, &analyzer);
}
```

6.3.3 Instrument Initialization

```
/******
```

The following example shows the initialization of the default instrument state and clearing of the status register.

```
/******
```

void InitDevice()

```
{
ViStatus status;
long retCnt;
status = viWrite(analyzer, "*CLS", 4, &retCnt); //reset status register
status = viWrite(analyzer, "*RST", 4, &retCnt); //Reset instrument
status = viWrite(analyzer, ":INST:SEL SA", 12, &retCnt); //Set instrument operating mode (with commands
of the signal/spectrum analyzer as an example)
}
```

6.3.4 Sending of Setting Command

```
/******
```

The following example shows how to set the center frequency of 4051 signal/spectrum analyzers.

```
/******
```

void SimpleSettings()

```
{
ViStatus status;
long retCnt;
// set the center frequency as 128MHz.
status = viWrite(analyzer, ":FREQUENCY:CENTER 128MHz", 22, &retCnt);
}
```

6.3.5 Reading of Measurement Instrument Status

```
/******
```

The following example shows how to read the setting status of the instrument.

```
/******
```

6.3 Basic Programming Method of VISA Interface

```

void ReadSettings()
{
ViStatus status;
long retCnt;
char rd_Buf_CW[VI_READ_BUFLEN]; // #define VI_READ_BUFLEN 40
//Query center frequency
status = viWrite(analyzer, ":FREQ:CENT?", 10, &retCnt);
status = viRead(analyzer, rd_Buf_CW, 20, &retCnt);
// printing of commissioning information
sprintf("Cw is %s", rd_Buf_CW);
}

```

6.3.6 Reading of frequency marker (signal/spectrum analyzers)

```

/*****

```

The following example shows how to read the frequency scale information.

```

/*****

```

```

void ReadMarker ()
{
ViStatus status;
long retCnt;
char rd_Buf_Marker[VI_READ_BUFLEN]; // #define VI_READ_BUFLEN 20
// opening of frequency marker 1 and query of frequency marker peak (frequency and amplitude)
status = viWrite(analyzer, ":CALC:MARKER:MAX", 25, &retCnt);
status = viWrite(analyzer, ":CALC:MARK:Y?", 15, &retCnt);
// printing of commissioning information
sprintf("Marker is %s", rd_Buf_Marker);
}

```

6.3.7 Command Synchronization

```

/*****

```

The method of command synchronization is introduced below, taking the scanning process as an example.

```

/*****

```

```

void SweepSync()
{
ViStatus status; long retCnt; ViEventType etype; ViEvent eevent;
int stat;
char OpcOk [2];
/*****

```

6.3 Basic Programming Method of VISA Interface

```

/* Command INITiate[:IMMediate] start single sweep ( closed in Cont SweepINIT:CONT OFF)*/
/* Execute next command of command buffer zone after single scanning */
/*****/
status = viWrite(analyzer, ":INIT:CONT OFF", 13, &retCnt);
// Method 1 of waiting for ending of scanning: use *WAI
status = viWrite(analyzer, ":INIT", 18, &retCnt);
status = viWrite(analyzer, "*WAI", 18, &retCnt);

// Method 2 of waiting for ending of scanning: use *OPC?
status = viWrite(analyzer, ":INIT", 20, &retCnt);
status = viWrite(analyzer, "*OPC?", 18, &retCnt);
status = viRead(analyzer, OpcOk, 2, &retCnt); //Wait for*OPC and return to “1”

// Method 3 of waiting for ending of scanning: use *OPC
//To use GPIB service request, set "Disable Auto Serial Poll"为"yes" status = viWrite(analyzer, "*SRE 32", 7,
&retCnt);
status = viWrite(analyzer, "*ESE 1", 6, &retCnt); // enable service request ESR
// set event enabling bit to complete operation
status = viEnableEvent(analyzer, VI_EVENT_SERVICE_REQ, VI_QUEUE, VI_NULL);
// enable SRQ event
status = viWrite(analyzer, ":INIT ", 18, &retCnt);
status = viWrite(analyzer, "*OPC?", 18, &retCnt);

// start scanning synchronously with OPC
status = viWaitOnEvent(analyzer, VI_EVENT_SERVICE_REQ, 10000, &etype,
&eevent)
// wait for service request
status = viReadSTB(analyzer, &stat);
status = viClose(eevent); // close event handle
// prohibit SRQ event
status = viDisableEvent(analyzer, VI_EVENT_SERVICE_REQ, VI_QUEUE);
// main program continues.....
}

```

6.4 I/O Library

- Overview of I/O Library631
- I/O Library Installation and Configuration632

6.4.1 Overview of I/O Library

The I/O library is a library of pre-written software programs for the instrument, known as the instrument drive program, i.e. instrument driver. It is an intermediate software layer between the computer and instrument hardware equipment. It is composed of the function library, utility program, tool kit, etc., and is a set of software code modules. This set corresponds to a series of planned operations, such as instrument configuration, reading, writing, triggering, etc. It is installed on the computer and used as a connecting bridge and link between the computer and instrument. With the easy-to-program high-level modular library, the user does not need to use the complex special low-level programming protocol for the specific instrument. It is key to use the instrument driver to rapidly develop the test measurement application.

From the functional perspective, one general instrument driver is composed of five parts: functional body, interactive developer interface, program developer interface, subprogram interface and I/O interface, as shown in Fig. 6.4.

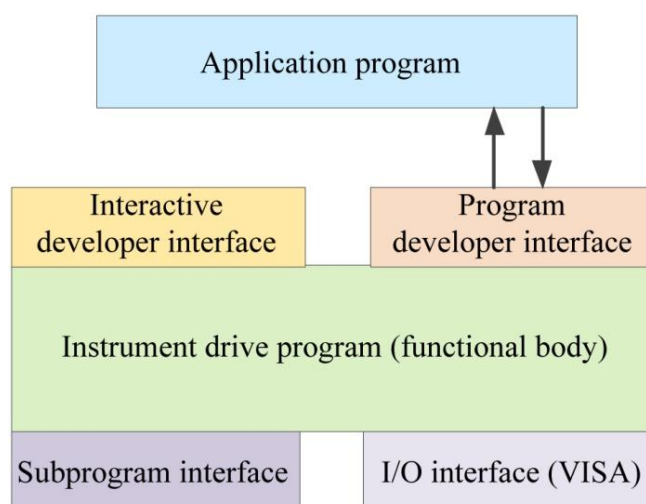

Fig. 6.4 Instrument Driver Structure Model

Details are as follows:

- 1) Functional body. This is the main functional part of the instrument driver and can be understood as the framework program of the instrument driver.
- 2) Interactive developer interface To facilitate use, the graphical interactive developer interface is generally set in the application environment supporting instrument driver development. For example, the function panel of Labwindows/CVI is a kind of interactive development interface. Each parameter of the instrument driver function in the function panel is expressed in the graphical control form.
- 3) Programming developer interface This is a software interface for the application program to call the instrument driver function, such as the dynamic link library file of instrument driver.dll in the Windows system.
- 4) I/O interface It is used for actual communication between the instrument driver and instrument. It is allowed to use the special bus I/O software, such as GPIB, or the general standard I/O software (VISA/I/O) to be used over multiple buses.
- 5) Subprogram interface It is a software interface for the instrument driver to visit other supporting libraries, such as the data library, FFT function, etc. It will be used when other software modules, operating systems,

6.4 I/O Library

program code libraries and analysis function libraries are called by the instrument driver after completion of tasks.

6.4.2 I/O Library Installation and Configuration

With applications in the test field, the I/O library has experienced various development phases from the traditional instrument to virtual instrument. In order ensure the instrument interchangeability in the automatic test system and the reusability of the test program, the instrument drive program has also experienced various development phases. At present, the popular universal driver is an IVI (Interchangeable Virtual Instruments) instrument driver. Based on the IVI specification, the new instrument programming interface, inserted drive program and VPP architecture on VISA are defined, so that the test application program is fully independent of the instrument hardware. In addition, the unI/Que functions of instrument simulation, range detection and status caching are added to improve the system operating efficiency and truly realize the instrument interchangeability.

IVI drives are divided into two types: IVI-C and IVI-COM. The IVI-COM drive is based on the Microsoft component object model (COM) technology and of COM API form. The IVI-C drive is based on the ANSI C technology and of C API form. The two types of drivers are designed in accordance with the instrument categories defined in the IVI specifications. The application development environments are the same, including Visual Studio, Visual Basic, Agilent VEE, LabVIEW, CVI/LabWindows, etc.

In order to meet user requirements in different development environments, two types of drivers are needed at present. The IVI drive of the signal/spectrum analyzer is developed with Nimbus Driver Studio, and the IVI-COM and IVI-C drive and program installation package is generated directly. For specific installation configuration, refer to the accompanying data of the control card and I/O library.

The installed IVI driver is divided into the IVI inherent function group and instrument function group (basic function group and extended function group). For specific functional classification, functions and attribute details, refer to the help file of the driver.

Prompt

Port configuration and I/O library installation:

Before controlling the signal/spectrum analyzer with a computer, check whether the necessary port and I/O library are properly installed and configured.

7 Fault Diagnosis and Repair

This chapter will introduce how to find out problems and receive the after-sale service. Indicate error messages of the signal/spectrum analyzer. In case of any problem in operation of the 4051 series signal/spectrum analyzer you purchased or when you need to purchase relevant components or accessories, please contact us as we provide complete after-sales services.

In general, the trouble is caused by failure of hardware/software or users' misuse. Please contact us immediately in case of any trouble. For the signal/spectrum analyzer within the warranty period, we will implement free repair according to the commitments in the warranty; otherwise, we will charge the costs.

- Operating principle.....633
- Fault diagnosis and troubleshooting.....635
- Error information.....639
- Repair.....641

7.1 Operating principle

To help users better understand functions of the 4051 series signal/spectrum analyzer and solve problems occurred during operation, basic operating principles and hardware schematic diagram of the signal/spectrum analyzer will be introduced in this section.

7.1.1 Operating principles and hardware functional block diagram

Controlled by a microprocessor and operated based on Windows 7 operating system, the instrument is a triple-conversion superheterodyne sweep type signal/spectrum analyzer. It consists of microwave receiver module, RF processor module, synthetic LO module, data collection & processing module, DSP processing module, control display module and power module. The functional block diagram of the instrument is as shown in Fig. 7.1.

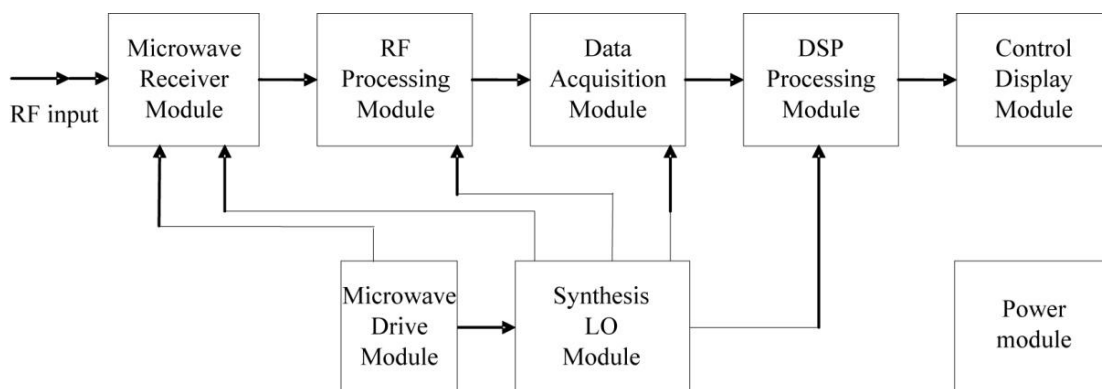

Fig. 7.1 Functional block diagram of 4051 series signal/spectrum analyzer

The block diagram of frequency conversion of the microwave and millimeter wave circuit is as shown in Fig. 7.2.

The 3HzGHz signal of zero wave band enters the low-band frequency converter module from the input terminal via the 14 dB switch DC block programmable step attenuator, the 58 dB programmable step attenuator and the duplexer, mixes with the signal from the first LO (YIG oscillator) to obtain 5.225 GHz IF signal. Such IF signal goes to the second frequency converter in the low-band frequency converter module via the 5.225 GHz band-pass filter and mixes with the 4.8 GHz beat frequency to get 425 MHz second IF signal. When the frequency is less than 1.1 GHz and the frequency span is less than 5 MHz, the instrument automatically enters phase noise optimization mode where the input signal mixes with the two divided-frequency signal (2.825 ~ 4.525 GHz) from the first LO (YIG oscillator) to obtain 2.825 GHz IF signal. Such IF signal goes to the second frequency converter in the low-band frequency converter module via the 5.225

7.1 Operating principle

GHz band-pass filter and mixes with the 2.4 GHz beat frequency to get 425 MHz second IF signal. The high band is divided into five bands: first, second, third, fourth and fifth bands.

The 40GHz signal enters the LO mixing module via the 14 dB switch DC block programmable step attenuator, the 58 dB programmable step attenuator, the duplexer, the millimeter-wave coaxial switch (optional preselector bypass), millimeter-wave YTF, millimeter-wave low-noise amplifier (or without YTF in wideband mode) and preselector bypass YTF to mix with the signal from the first LO in the built-in millimeter-wave mixer for fundamental wave frequency mixing in order to obtain second IF signal.

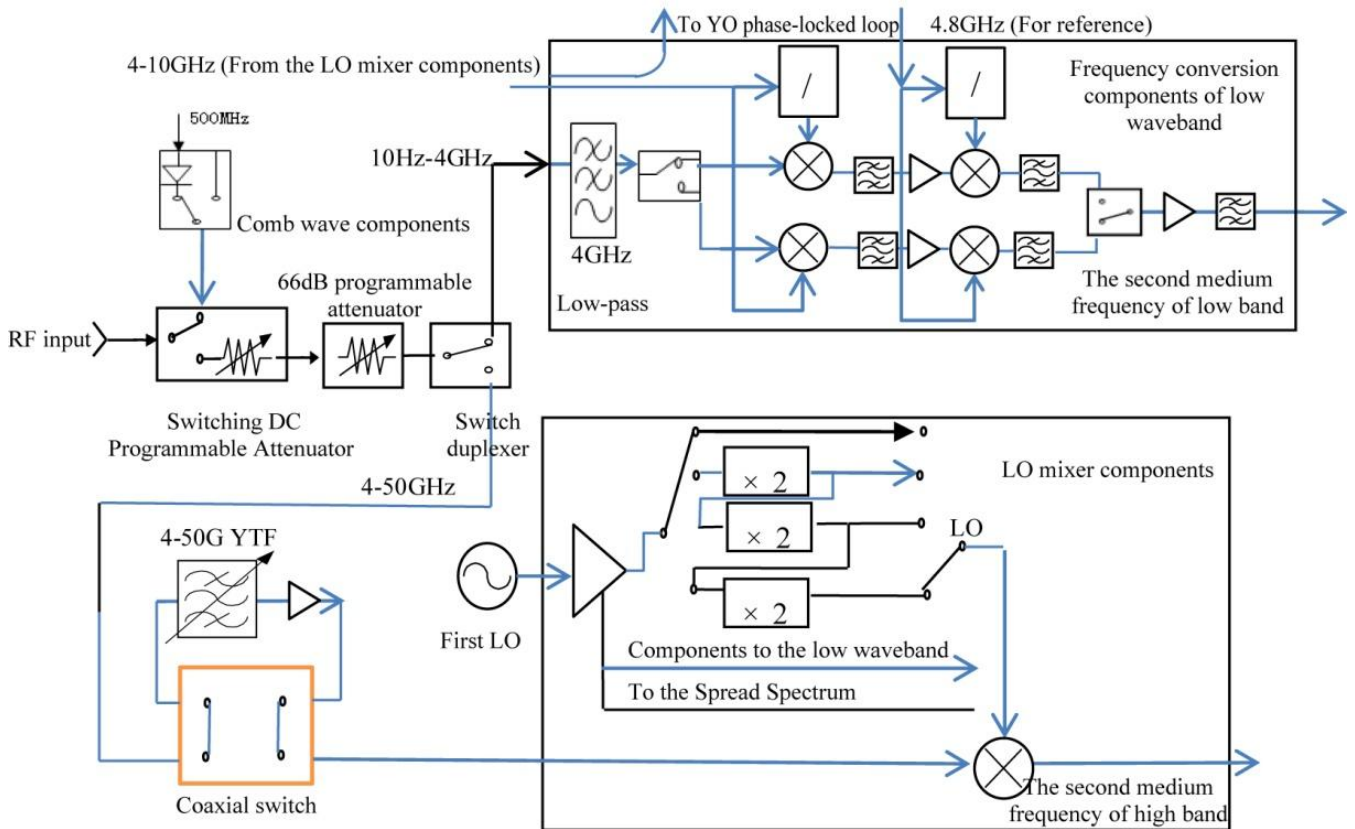

Fig. 7.2 Block diagram of frequency conversion of the microwave and millimeter wave circuit

The RF processor module combines low-band, high-band and external-mixing input signals from the switch selector into one signal for flatness compensation. The resulting 425 MHz signal is divided by a power divider into two, one for wideband IF output (375 MHz IF in wideband analysis mode) and the other for mixing with 500 MHz signal from the third LO to output 75 MHz IF signal.

The synthetic LO module mainly consists of 4 loops, including the reference loop, the sample loop, YTO loop and fractional loop. In single loop mode, the LO signal of 3 ~ 10 GHz enters the fractional loop module via the divide-by-2 divider to get a fixed IF of 50 MHz. Such fixed IF signal mixes with the 50 MHz signal from the reference loop for phase discrimination. The resulting error signal is sent to YTO drive coil for YTO frequency adjustment until the sample IF output is equal to 50 MHz. In four-loop mode, the LO signal of 4 ~ 9 GHz enters the sampler and the sample loop provides a signal of 618 ~ 905 MHz as the sample LO. The sample IF output of 30 ~ 64 MHz mixes with the 20-way frequency output from the fractional loop for phase discrimination. The resulting error signal is sent to YTO drive coil for YTO frequency adjustment until the sample IF output is equal to the fractional loop output. Phase lock synthesis greatly improves LO frequency stability and the microstep (mHz) from the fractional loop enables LO stepping by 1 (mHz) to increase the frequency resolution to 1 Hz.

The IF collection and processing module contains four circuit boards for narrowband collection, wideband collection, base band collection and DSP processing respectively. The narrowband collecting board quantifies 75 MHz IF signal with bandwidth of 40 MHz at a rate of 100 MHz. FPGA on the board is capable of digital down conversion, I/Q data separation and saving and transmits the data to DSP processing board or the host.

7.2 Fault Diagnosis and Troubleshooting

The wideband collecting board quantifies 425 MHz IF signal with bandwidth of 200 MHz at a rate of 500 MHz. FPGA on the board is capable of digital down conversion, I/Q data separation and saving and transmits the data to DSP processing board or the host.

The DSP processor module is mainly used for spectral analysis in sweep detection mode and wideband record and playback in wideband record mode. In sweep detection mode, the DSP processing board sends the data preprocessed by the narrowband or wideband collecting board to three DSPs for spectral analysis and transmits the processing result to the host for display processing; in wideband record and playback mode, the DSP processing board sends the data of the narrowband or wideband collecting board to the recorder for saving or return the data in the recorder back to the host for display processing.

The master controller controls internal operations of the signal/spectrum analyzer and receives various requests from the keyboard on the front pane l or the outer computer via the I/O port, while the control program in the flash memory card determines operations to be performed by the master controller. The master controller sends relevant control signals to such microwave components as YTO, YTF, programmable step attenuator and RF switch via the microwave drive board.

7.2 Fault Diagnosis and Troubleshooting

Generally, problems in the instrument are caused by hardware/software failure or improper use. In case of any problem, please check and save error message, analyze possible causes, and perform preliminary troubleshooting with reference to the methods indicated in “7.2.1 Basic procedure of fault diagnose” and “7.2.2 Common faults and solutions”. You can also contact our customer service center and provide the collected error information. We will assist you to solve the problem as soon as possible. For more details, refer to the contact information in the Manual or visit the website www.ei41.com to obtain the contact information of the nearest technical support center.

Prompt

Fault diagnosis and guidance

This section aims to guide simple judgment and disposal of faults of the 4051 series signal/spectrum analyzer. If necessary, you need to provide accurate feedbacks to the manufacturer for us to solve problems as soon as possible.

7.2.1 Basic procedure of fault diagnose

In case of any problem in the instrument, firstly check as follows:

- ✧ Check whether the power socket is connected to the power supply.
- ✧ Is the instrument turned on? Check whether the green LED beside the power switch is ON. Pay attention to the internal fan noise and check whether the cooling fan of the analyzer works.
- ✧ If any, check whether the other instruments, cables and connectors used together with the instrument are connected properly and work normally.
- ✧ If the communication of the instrument through LAN fails, check the yellow LED beside the LAN interface of the rear panel. If this indicator does not flash, check the LAN cable and connection.

If the operating system cannot be fully loaded or run or the application program of the instrument is not successfully started, the hard disc may be damaged. If the system recovery is run for a long time in the start-up process, refer to the “Windows 7 system restoration” in “2.2.2.2 System maintenance”.

- ✧ If the problem occurs again, check all measurement steps. Check whether all settings are correct.
- ✧ If the analyzer does not work normally, press **【Preset】** to go back to a known status of the analyzer.
- ✧ Check whether the measurement and results comply with the requirements of the performance indicators and features of the analyzer. Refer to the relevant performance indicators in “8 Specifications and test methods” of the user manual of the analyzer.

7.2 Fault Diagnosis and Troubleshooting

- ✧ The analyzer should be calibrated to meet above indicators. Select Auto Calibration (Of) (press **【System】** , [Align], [Auto Calibration **On/Off**]) or calibrate manually.
- ✧ Does the instrument display messages? Please refer to “7.3 Error messages” of the Manual for information of error messages.

7.2.2 Common faults and solutions

Common faults and solutions are classified by the following types of functions.

- [Startup problems.....636](#)
- [Instrument setup problems.....638](#)
- [Abnormal signal frequency reading.....638](#)
- [Abnormal signal amplitude reading.....638](#)
- [Instrument network connection failure.....639](#)

7.2.2.1 Startup problems

Problems occurred during startup of the 4051 series signal/spectrum analyzer may be caused by failures of the power, processor hardware, instrument setup, etc. In this section, faults during startup and possible causes will be analyzed according to the energizing and starting procedure of the analyzer. It takes about 3 min for the instrument to start and such time varies based on hardware configuration, installation options and the number of measurement applications.

1) Yellow standby indicator is not ON

Plug in the instrument outlet and turn on the switch on the rear panel to observe the power indicator at the bottom left corner of the front panel to turn yellow. If the yellow standby indicator is not on, firstly check whether the power switch on the rear panel is turned on and then whether the voltage and frequency of the power meet the operating power parameters requirement of the analyzer. See “3.1.1.3 Power ON/OFF” of the Manual. If power parameters meet the requirement, it is possible that the instrument power is at fault. Please contact our customer service center according to relevant information in the Manual and provide the error messages. We will help you solve the problem as quickly as possible.

2) Abnormal green start lamp

Press the power button at the bottom right of the front panel to turn on the instrument. At such time, the power indicator of the instrument will change from yellow to green. If the indicator has not turned green, it is possible that the instrument power is at fault. If the power indicator flashes in yellow and green alternatively, it is possibly caused by abnormal internal load of the instrument rather than the power failure. Please contact our customer service center according to relevant information in the Manual and provide the error messages. We will help you solve the problem as quickly as possible.

3) Abnormal fan operation

After energizing and starting up, all fans should start working. If none of them is working, it is possible that the power is at fault; if some fan does not work, then such fan has developed a fault. Please contact our customer service center according to relevant information in the Manual and provide the error messages. We will help you solve the problem as quickly as possible.

4) Black screen

A black screen can be caused by many a reason. If causes for three above failures are removed, follow the steps below:

- a) Connect from the monitor interface on the rear panel properly to a CRT display device, turn on its power and wait for 30 s. If the CRT displays normally, it is possible that the BIOS configuration parameters of the instrument have been altered. Users need to turn off the instrument, connect the standard keyboard of the PS/2 interface, turn on the analyzer again, long press “F2” to enter the BIOS setup interface, select

7.2 Fault Diagnosis and Troubleshooting

Load Setup Defaults under Exit tab, call and save factory configuration of display control, exit and reboot the instrument. If nothing is displayed, LED components may be at fault. Please contact our customer service center according to relevant information in the Manual and provide the error messages. We will help you solve the problem as quickly as possible.

- b) If nothing is displayed after CRT is connected, it is possible that the hardware fails. Please contact our customer service center according to relevant information in the Manual and provide the error messages. We will help you solve the problem as quickly as possible.

5) BIOS detection crash

If the analyzer stays at processor information display interface after energizing, it is caused by BIOS detection crash. Follow the steps below:

- a) Check if the standard keyboard is connected and BIOS detection is suspended; if not, proceed to the next step.
- b) Turn off the instrument, connect the standard keyboard of the PS/2 interface, turn on the instrument, long press “F2” to enter the BIOS setup interface, select Load Setup Defaults under Exit tab, call and save factory configuration of display control and reboot the instrument. If the problem remains, please contact our customer service center according to relevant information in the Manual and provide the error messages. We will help you solve the problem as quickly as possible.

6) Unable to find system disk

If the analyzer displays “unable to find system disk” after energizing, turn off the power at the back, wait for 1 ~ 2 min, turn on the instrument and press the power button on the front panel to see whether the system disk can be found properly. If not, connect the PS/2 keyboard to check whether the IDE is available. If not, the instrument hardware fails. Please contact our customer service center according to relevant information in the Manual and provide the error messages. We will help you solve the problem as quickly as possible.

7) Abnormal windows startup

After processor information is displayed, an operating system menu will be shown with a timer, including Windows 7 startup and system recovery tools. It is default to start Windows 7 system. If system recovery is required, use the up/down arrow on the standard keyboard to choose “OneKey Ghost V2011.07.01” before the timer hits 0 and click Enter.

In case of blue screen, startup crash, auto reboot during Windows system startup, check according to the following steps:

- a) Firstly confirm that no external USB storage is connected to the instrument.
- b) Reboot the analyzer and if the instrument can be used properly and no such failures occur frequently, then it is the occasional abnormal startup of the Windows system. Otherwise, proceed to the next step.
- c) Turn off the instrument and connect the standard keyboard of the PS/2 interface. Turn on the instrument again, long press “F2” to enter the BIOS setup interface, select Load Setup Defaults under Exit tab, call and save factory configuration of display control and reboot the instrument. If the failure is removed, it means the problem is caused by alternation of BIOS options. If the problem remains, proceed to the next step.
- d) Turn off the instrument and connect the standard keyboard of the PS/2 interface. Turn on the instrument again, select System Recovery option in the operating system menu (before starting system recovery, users need to follow instructions in the Manual and contact the manufacturer), follow system prompts to recover the system. Refer to “[3.1.2.5 System backup recovery](#)” in the Manual for detailed procedure.
- e) If it is unable to recover the system, it is possible that the hardware of the instrument fails. Please contact our customer service center according to relevant information in the Manual and provide the error messages. We will help you solve the problem as quickly as possible.

7.2 Fault Diagnosis and Troubleshooting

7.2.2.2 Instrument setup problems

When the signal/spectrum analyzer enters the test interface and successfully completed all starting calibrations, the instrument will enter normal sweep test status and continuously refreshed traces can be seen on the screen. However, if some parameters are not properly set, users may not be able to see traces or signals expected to be shown. IF trace refreshing or signal display fails, please firstly check the following settings.

1) No trace refreshing or abnormal refreshing

In case of no trace refreshing or abnormal refreshing on the interface, please follow the step below:

- a) Check if the instrument is set as auto trigger mode and continuous sweep mode. If the settings are correct, but there is still no refreshing, proceed to the next step.
- b) Open the marker and check if its reading changes. If the reading has changed, it may be caused by settings. For example, the trace will be shown below the screen by setting the instrument as linear mode or setting the reference level too high and thus is invisible. In this case, the instrument can be changed to log mode or the reference level can be lowered before observing the trace. If the marker reading remains unchanged, it indicates the error in sending back the trace. Please reboot the instrument. If the problem still remains, please contact our customer service center according to relevant information in the Manual and provide the error messages. We will help you solve the problem as quickly as possible.

2) No signal display

If no wave band has any signal display, please follow the steps: press **【Input/Output】**, [Input Port RF Align] to check whether RF signal is selected. If not, check the RF signal. If there is still no signal display, it is possible that the instrument hardware circuit fails. Please contact our customer service center according to relevant information in the Manual and provide the error messages. We will help you solve the problem as quickly as possible.

7.2.2.3 Abnormal signal frequency reading

If the signal is found jittering on the screen or the frequency reading is out of its error range during signal measurement, firstly check whether the frequency of the input signal of the instrument is stable. If the signal is stable, then check whether the instrument reference is correctly set and choose external or internal reference based on different test scenarios by pressing **【Input/Output】** and [Frequency Reference External/Internal]. If the frequency reading is still not accurate by this time, it is possible that internal LO of the instrument loses the lock. Please contact our customer service center according to relevant information in the Manual and provide the error messages. We will help you solve the problem as quickly as possible.

LO lock loss is usually classified into the following types: loss of lock when frequency span ≤ 180 kHz; loss of lock when $180 \text{ kHz} < \text{frequency span} \leq 2 \text{ MHz}$; loss of lock when $2 \text{ MHz} < \text{frequency span} \leq 20 \text{ MHz}$; loss of lock when frequency span $> 20 \text{ MHz}$; loss of lock under certain frequency points.

7.2.2.4 Abnormal signal amplitude reading

Abnormal amplitude includes abnormal low-band reading with normal high-band reading; abnormal high-band reading with normal low-band reading; abnormal amplitude reading of signals of all wave bands; huge in difference of amplitude reading between signals with different attenuator settings. If the signal amplitude reading is inaccurate, run all IF calibrations in the instrument. If the reading remains inaccurate, it is possible that the instrument internal circuit fails. In this case, follow the steps below:

- a) Press **【Input/Output】**, [Input Port RF Align], [Cal Port], [500MHz] to turn on the 500 MHz calibration signal of the instrument. Set the instrument center frequency as 500 MHz and frequency span as 1 MHz and turn on Peak Search to measure the level of the 500 MHz calibration signal. If the instrument operates normally, the amplitude of the calibration signal should fall in the range of $-20 \text{ dBm} \pm 2 \text{ dB}$. If such amplitude is not correct, it means that low-band (below 4 GHz) reading of the instrument is abnormal.
- b) Press **【Input/Output】**, [Input Port RF Align], [Cal Port], [4.8GHz] to turn on the 4.8 GHz calibration signal of the instrument. Set the instrument center frequency as 4.8GHz and frequency span as 1 MHz and turn on Peak Search to measure the level of the 4.8GHz calibration signal. If the instrument operates

7.3 Error Information

normally, the amplitude of the calibration signal should fall in the range of $-20 \text{ dBm} \pm 2 \text{ dB}$. If such amplitude is not correct, it means that high-band (above 4 GHz) reading of the instrument is abnormal.

The above two steps are used to determine abnormal reading in partial or entire wave band. Please contact our customer service center according to relevant information in the Manual and provide the error messages. We will help you solve the problem as quickly as possible.

Caution

Even if the calibration signal (500 MHz or 4.8 GHz) amplitude is normal, other frequency bands on the same wave band may have abnormal signal amplitude reading.

The amplitude test with internal calibration signal is only a quick way of path detection.

7.2.2.5 Instrument network connection failure

- 1) Firstly check that whether the network has web-surfing capability.
- 2) Ensure that proper IP settings have been obtained from the system administrator.
- 3) Check whether the cable connecting to the network interface of the instrument is intact.

Check whether the incoming network cable is connected to the LAN interface on the rear panel of the analyzer and whether the yellow indicator flashes at the interface. If the network connection still fails, please contact our customer service center according to relevant information in the Manual and provide the error messages. We will help you solve the problem as quickly as possible.

7.3 Error Information

The signal/spectrum analyzer records errors occurred during measurement in two ways: error message queue displayed in the operation interface of the front panel and SCPI (under remote control) error message queue. Such two queues are stored separately for management.

- [Error message files](#).....639
- [Description of error information](#).....639

7.3.1 Error message files

The file of “errormessage.pdf” stored in the random disc records a complete list of error messages. Such error list consists of error No. and error description. If several error messages have the same error No., they will be sorted in alphabetical order.

7.3.2 Description of Error Information

- [Local error information](#).....639
- [Program error information](#).....640

7.3.2.1 Local Error Information**1) Viewing of Error Information****By interface operation:**

Error messages prompted at the bottom right corner of the signal/spectrum analyzer during operation indicates software operation or hardware problems. Types of problems can be more or less determined based on error codes and measures can be taken for troubleshooting accordingly.

Only one error message will be display at a time in the error display area of the signal/spectrum analyzer. As the problems may occur at the same time, the following operations can help to view all the error prompt information:

7.3 Error Information

Step 1. press **【System】** > [Error List] to pop up the error list window.

Step 2. prompt information will be displayed in the window;

Step 3. browse the error information with the mouse and close the dialog window;

Step 4. click [Clear List] to clear historical error information.

2) If any error is detected during measurement of the analyzer, the warning or error message will be displayed at the right corner of the status indicator field (error code + error abbreviation) as shown in Fig. 7.4:

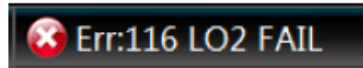

Fig. 7.4 Error message displayed in the status indicator field

See Schedule 3 Local Error Message Table of Appendix D: Error Message Index for more details of description of local error messages.

7.3.2.2 Program Error Information

1) Error information formats

In the remote control mode, error messages are recorded in the error/event queue in the status report system and can be inquired with “SYSTem:ERRor?” command with the format as follows:

“<error code>, “<error message in error queue>; <detailed description of error message>”

Example:

“-110, "Out-of-limit data; input parameter beyond lower bound.”

Program error information is divided into two types:

- Negative error codes defined in the SCPI standard, not detailed here;
- See Schedule 4 Remote Error Message Table of Appendix C: Error Message Zoom Table for positive-value error codes with instrument characteristics and more details of description of local error messages.

2) Error message type

Error event corresponds to only one type of error message. Error messages are classified into the following types (8257):

- System error (0 to 99): control platform, OS, file system, etc.
- Processing error (50 to 99): control platform, OS, file system, etc.
- LO RF (100 to 199): lock detect, status detect, etc.
- Wideband IF (200 to 299): bandwidth, gain, attenuation, compensation, etc.
- Narrowband IF (300 to 499): bandwidth, gain, attenuation, compensation, etc.
- Video & sample (500 to 599): Adc, dsp, platform interface, etc.
- Communication interface (600 to 699): network, gpib, print, etc.
- Measurement error (700 to 799): TBD.

7.4 Repair

- Contact Us.....641
- Packing and Mailing.....641

7.4.1 Contact Us

In case of any failure of the 4051 series signal/spectrum analyzer, first check and save error information, analysis possible causes and perform early screening and troubleshooting with reference to “7.2 Failure Diagnosis and Troubleshooting”. You also can contact with our customer service and provide the error information collected, we will provide assistance to solve the problem as quickly as possible. Query website: www.ei41.com, to query the contact information of the nearby technical support center.

Contact Information:

Service Consultation: 0532-86889847 800-868-7041

Technical support: 0532-86888026 0532-86880165

E-mail: eiqd@ei41.com

Zip code: 266555

Address: 98 Xiangjiang Road, Economic and Technological Development Zone, Qingdao, Shandong, China

7.4.2 Packing and Mailing

In case of problems hard to solve, contact us via telephone or fax. If it is confirmed that the analyzer needs to be returned for repair, pack the analyzer with the original package and case according to the following steps:

- 1) Place a detailed description of faults of the analyzer along with the instrument into the case.
- 2) Pack it with the original package to reduce possible damage.
- 3) Set pads in the four corners of the outer packing box, and place the instrument into the outer packing box.
- 4) Seal the opening of the packing box with a tape and strengthen the packing box with nylon straps.
- 5) Mark “Fragile!” on the box. No touch! Handle with care! on the box body.
- 6) Transport the network analyzer as a precision instrument.
- 7) Keep the copies of all transport documents.

Caution

Notes of packing

Packaging materials other than the original ones may damage the analyzer. Do not pack the instrument with the polystyrene sphere; otherwise, the instrument cannot be fully protected, and the generated static electricity may be sucked into the fan to cause damage to the instrument.

Prompt

Instrument packing and transportation

Strictly observe the precautions in “2.1.1 Unpacking” during transportation or handling of the instrument.

8. Specifications and test methods

In this chapter, specifications and major test methods of the 4051 series signal/spectrum analyzer is described.

- Statement.....643
- Product features.....643
- Technical specifications644
- Additional information.....650
- Performance characteristics test.....651

8.1 Statement

Unless otherwise stated, tests of all specifications should be conducted under the temperature of $23^{\circ}\text{C} \pm 5^{\circ}\text{C}$ and half an hour after startup. Supplementary information of the instrument aims to help users to get better understanding of its performance and is not related to any technical indicator. Key terms:

Specifications (spec): unless otherwise indicated, calibrated instrument should be left under the working temperature range of $0 \sim 40^{\circ}\text{C}$ for at least two hours and preheated for another 30 min to ensure its performance (measurement error included). If not otherwise noted, data in this Manual all refers to technical indicators.

Typical value (typ): indicates the typical performance 80% instruments can reach. This is not guaranteed data and does not include uncertainties in measurement process. It is only effective under room temperature (about 25°C).

Nominal value: indicates expected average performance or designed performance characteristics, such as 50Ω connector. It is not guaranteed data and is obtained under room temperature (about 25°C).

Measured value (meas): indicates the performance characteristics obtained in design stage and used to compare with the expected performance, such as change of amplitude shift along with time. This is not guaranteed data and is obtained under room temperature.

8.2 Product features

Table 8.1 Product features

General specifications	
Temp. range	Working hour: $0 \sim +50^{\circ}\text{C}$ Storage time: $-40 \sim +70^{\circ}\text{C}$
Altitude	4,600 m
Electromagnetic compatibility	Compliant with the following requirements of Section 3.9.2 in GJB 3947A-2009: a) CE102 10 kHz ~ 10 MHz power line conducted emission; b) CS101 25 Hz ~ 50 kHz power line conducted susceptibility; c) CS114 10 kHz ~ 400 MHz wire bundle injection conducted susceptibility; d) RE102 10 kHz ~ 18 GHz electric field radiation emission; e) RS103 10 kHz ~ 1 GHz electric field radiation susceptibility.
Security	Compliant with the safety certification requirements of Section 3.10 in GJB 3947A-2009: a) Resistance between the power input terminal and the enclosure of the instrument (power switch is on) should be no less than $100\text{ M}\Omega$ under standard atmospheric pressure for test and no less than $2\text{ M}\Omega$ in humid environment. b) When a AC voltage of 1,500 V is applied between the power input

8.3 Technical Specifications

		terminal and the enclosure, the instrument should be free from breakdown, flashover or flicker. c) During operation, the leakage current between the enclosure and the ground should be no more than 3.5 mA.
Power Requirements	Voltage and frequency (Nominal value)	220~240V, 50~60Hz; The allowable steady state voltage range is 10% of the nominal value, and the allowable steady state frequency range is $\pm 10\%$ of the nominal value.
	Power consumption	Maximum power consumption: 400 W Maximum standby: 20 W
Display screen		1280 x 800, XGA, 10.1"
Data storage		160G solid state disk Compatible with memory devices up to USB 2.0 standard
Weight		Net weight: less than 25 kg; Packed transportation weight: 34 kg nominal value
Dimension		W × H × D (mm) = 426 × 177 × 460 (not including the handle, the footing, the foot pad and the side belt) with allowable tolerance of ± 10 mm. W × H × D (mm) = 510 × 190 × 534 (including the handle, the footing, the foot pad and the side belt) with allowable tolerance of ± 10 mm.
Warranty		The 4051 signal/spectrum analyzer has a standard warranty period of 18 months.
Reliability		MTBF(θ_0) ≥ 5000 h
Calibration period		The recommended calibration period is one year by professional calibration bodies.

8.3 Technical Specifications

The table of specification is given based on function classification:

- Frequency and time.....644
- Amplitude accuracy and range.....647
- Dynamic range.....648

8.3.1 Frequency and time

1) Frequency range

Model	Frequency range (DC coupling)	Frequency range (AC coupling)
4051A	3Hz ~ 4GHz	10MHz ~ 4GHz
4051B	3Hz ~ 9GHz	10MHz ~ 9GHz
4051C	3Hz ~ 13.2GHz	10MHz ~ 13.2GHz
4051D	3Hz ~ 18GHz	10MHz ~ 18GHz
4051E	3Hz ~ 26.5GHz	10MHz ~ 26.5GHz
4051F	3Hz ~ 40GHz	10MHz ~ 40GHz
4051G	3Hz ~ 45GHz	10MHz ~ 45GHz
4051H	3Hz ~ 50GHz	10MHz ~ 50GHz
4051L	3Hz ~ 67GHz	/
4051A-S	3Hz ~ 4GHz	10MHz ~ 4GHz

8.3 Technical Specifications

4051B-S	3Hz ~ 9GHz	10MHz ~ 9GHz
4051C-S	3Hz ~ 13.2GHz	10MHz ~ 13.2GHz
4051D-S	3Hz ~ 18GHz	10MHz ~ 18GHz
4051E-S	3Hz ~ 26.5GHz	10MHz ~ 26.5GHz

2) Band division (nominal value)

N (LO harmonic order)	Band No.	Frequency range
0.5	Band 0	3Hz~1.2GHz(0Hz<frequency span \leq 5MHz)
1	Band 0	3Hz~4.1GHz(Zero span or frequency span> 5MHz)
1	Band 1	3.9GHz ~ 9GHz
2	Band 2	8.7GHz ~ 18.3GHz
4	Band 3	17.7GHz ~ 27GHz
4	Band 4	26.6GHz ~ 40.4GHz
8	Band 5	39.6GHz ~ 50GHz
1	Band6	49.5GHz~54.6GHz
2	Band 7	54.3GHz~63.9GHz
4	Band 8	63.3GHz~67GHz

3) Frequency reference

Frequency accuracy: \pm (time elapsed since the last calibration date \times aging rate + temperature stability + calibration accuracy)

Aging rate: $\pm 1 \times 10^{-7}$ /year

Temperature stability: $\pm 1.5 \times 10^{-8}$ (20°C ~ 30°C), $\pm 5 \times 10^{-8}$ (full temperature range)

To obtain the initial calibration accuracy: $\pm 4 \times 10^{-8}$

Note: The default time elapsed since the last calibration date is one year.

4) Residual frequency modulation

$\leq 0.25 \text{ Hz} \times N$ (10 Hz refers to the resolution bandwidth and the video bandwidth respectively, the nominal value within 20ms, and specific value of N depends on harmonic times of frequency band division)

5) Frequency readout accuracy:

\pm (frequency reading \times frequency reference accuracy + 0.10% \times frequency span + 5% \times resolution bandwidth + 2 Hz + 0.5 \times horizontal resolution *)

* Horizontal resolution=frequency span/ (points of sweep-1), the default points of sweep of 4051 is 1001.

6) Marker frequency count

Accuracy: \pm (marker frequency \times frequency reference accuracy + 0.100 Hz)

Counter resolution: 0.001Hz

7) Frequency span

Range: 0 Hz, 10 Hz ~ the maximum frequency range of the instrument

8. Specifications and test methods

8.3 Technical Specifications

Resolution: 2Hz
Accuracy: $\pm (0.1\% \times \text{frequency span} + \text{horizontal resolution})$

8) Sweep time and trigger

Range: 1 μ s ~ 6,000 s, frequency span = 0 Hz
1 ms ~ 6,000 s, frequency span \geq 10 Hz
Accuracy: $\pm 0.01\%$, frequency span = 0 Hz
Trigger mode: Free, video, power, external level (front panel), external level (rear panel), burst RF, timer
Trigger delay: 0 ~ + 500 ms
Trigger delay resolution: 0.1 μ s

9) Range of sweep points

101~30001

10) Resolution bandwidth

Bandwidth range: 1H ~ 3MHz (step by 1, 2, 3 and 5), 4、5、6、8、10、20MHz
Conversion uncertainty: 0.3dB 1Hz~10MHz
1.0 dB 20MHz
Bandwidth accuracy (3.01dB): $\pm 5\%$ (nominal) 1Hz ~ 2MHz (step by 1, 2, 3 and 5)
 $\pm 15\%$ (nominal) 3、4、5、6、8、10MHz
 $\pm 20\%$ (nominal) 20MHz
Selectivity (-60dB/-3dB): 5.0: 1 (nominal)

11) Maximum analysis bandwidth (nominal value)

10MHz Standard
40MHz Optional 4051-H38A
200MHz Optional 4051-H38B
550MHz Optional 4051-H38C

12) Video bandwidth (nominal value)

Range: 1 Hz ~ 3 MHz (step by 1, 2, 3 and 5) , 4, 5, 6, 8, 10 10、20MHz (nominal)

8.3.2 Amplitude accuracy and range

1) Amplitude range

Measuring range: Display average noise level (DANL) to the maximum safety input level

Input attenuator range: 0 ~ 70 dB, stepping by 2 dB

2) Maximum safety input level

Total average power: + 30 dBm (1 W)

3) Display range

Scale type: Logarithm/linear

Logarithm scale 0.1 ~ 20 dB/division with resolution of 0.01 dB

Scale unit: dBm, dBmV, dB μ V, dBmA, dB μ A, V, W, A

4) Frequency response (10 dB input attenuation, 20°C ~ 30°C)

Without pre-amplifier (dB)		With pre-amplifier (dB)		Frequency range
4051	4051-S	Pre-amplifier Off	Pre-amplifier On	
±0.70	±1.00	±1.20	±1.50	3Hz ~ 20MHz ^{2, 3} (nominal)
±0.50	±1.00	±1.00	±1.50	20MHz ~ 2GHz
±0.70	±1.00	±1.20	±1.50	2GHz ~ 3.6GHz
±1.00	±1.20	±1.50	±1.80	3.6GHz ~ 4GHz
±1.50	±1.50	±2.00	±2.50	4GHz ~ 9GHz
±2.00	±2.00	±2.50	±3.00	9GHz ~ 18GHz
±2.50	±3.00	±3.00	±3.50	18GHz~26.5GHz
±3.00	/	±3.50	±4.00	26.5GHz~40GHz
±3.00	/	±3.50	±4.00	40GHz ~ 50GHz
±4.00	/	/	/	50GHz~67GHz

Note 2: When the instrument is under AC coupling status or when the PreAmplifier is On, the start frequency is 10MHz-20MHz.

Note 3: When frequency <1.1GHz, the PhNoise Opt is Off.

5) Total resolute amplitude accuracy ((10 dB input attenuation, 20 ~ 30°C, 1 Hz ≤ RBW ≤ 1 MHz; input signal -10 ~ -50 dBm; all settings are automatically coupled with random reference level and random scale)

Technical index	Frequency range
±0.24dB	500 MHz (calibration frequency)
± (0.24dB+frequency response)	Above any frequency

6) Input voltage standing-wave ratio (VSWR) (10 dB input attenuation)

Technical index	Frequency range
-----------------	-----------------

8. Specifications and test methods

8.3 Technical Specifications

<1.40	50MHz ~ 4GHz
< 1.50	4GHz ~ 9GHz
< 1.80	9GHz ~ 18GHz
< 1.70	18GHz ~ 26.5GHz
< 1.80	26.5GHz ~ 40GHz
< 1.90	40GHz ~ 50GHz
< 3.00	50GHz ~ 67GHz

7) Reference level (RF gain coupling mode: best sensitivity)

Range: Logarithm scale: -170 ~ + 30 dBm, stepping by 0.01 dB.

Linear scale: 707 pV ~ 7.07 V, 0.11% (0.01dB) resolution

Switching error: 0.20dB

8) Display scale fidelity

±0.20dB Between -10 dBm ~ -80 dBm input mixer level

9) Trace detector mode

Normal, Peak, negative peak, sample, video average, power average, voltage average

8.3.3 Dynamic range

1) 1 dB gain compression

Input mixer level (4051)	Input mixer level (4051-S)	Frequency range
≥-3dBm	≥-3dBm	20MHz ~ 40MHz
≥+1dBm	≥0dBm	40MHz ~ 200MHz
≥+3dBm	≥+1dBm	200MHz ~ 4GHz
≥-1dBm	≥-1dBm	4GHz ~ 9GHz
≥+1dBm	≥0dBm	9GHz ~ 50GHz
≥-1dBm	/	50GHz ~ 67GHz

2) **Display average noise level** (The input end is connected with matched load for sampling or average detection, the average type is logarithm mode at 0dB input attenuation and the radio frequency gain is sensitivity priority and normalized to 1Hz RBW. 20 ~ 30°C)

8.3 Technical Specifications

Without pre-amplifier			With pre-amplifier (except 4051L)		Frequency range
4051L	4051A/B/C/ D/E/F/G/H	4051-S	Pre- amplifier Off	Pre- amplifier On	
≤-153dBm	≤-153dBm	≤-153dBm	≤-150dBm	≤-162dBm	10MHz~1GHz
≤-151dBm	≤-151dBm	≤-151dBm	≤-148dBm	≤-162dBm	1GHz~2GHz
≤-148dBm	≤-150dBm	≤-150dBm	≤-147dBm	≤-160dBm	2GHz~3GHz
≤-147dBm	≤-148dBm	≤-148dBm	≤-145dBm	≤-156dBm	3GHz~3.6GHz
≤-143dBm	≤-145dBm	≤-145dBm	≤-141dBm	≤-155dBm	3.6GHz~4GHz
≤-144dBm	≤-148dBm	≤-148dBm	≤-142dBm	≤-155dBm	4GHz~5GHz
≤-145dBm	≤-150dBm	≤-150dBm	≤-143dBm	≤-155dBm	5GHz~9GHz
≤-145dBm	≤-148dBm	≤-146dBm	≤-140dBm	≤-154dBm	9GHz~18GHz
≤-141dBm	≤-143dBm	≤-141dBm	≤-134dBm	≤-154dBm	18GHz~26.5GHz
≤-135dBm	≤-138dBm	/	≤-126dBm	≤-150dBm	26.5GHz~40GHz
≤-131dBm	≤-133dBm	/	≤-121dBm	≤-145dBm	40GHz~50GHz
≤-131dBm	/	/	/	/	50GHz~67GHz

3) Residual response (input port connected to 50 Ω load; 0 dB input attenuation)

Technical index	Frequency range
≤-100dBm	200kHz ~ 9GHz

4) Image response (-10 dBm mixer level)

Response(nominal value)	Tuning frequency (f)	Stimulusfrequency
≤ - 80dBc	10MHz ~ 1.2GHz	f+150MHz
≤ - 76dBc	1.2GHz ~ 4.0GHz	f-150MHz
≤ - 80dBc	4GHz ~ 26.5GHz	f-150MHz
≤ - 80dBc	26.5GHz ~ 40GHz	f+150MHz
≤ - 76dBc	40GHz ~ 50GHz	f-150MHz
≤ - 76dBc	50GHz ~ 67GHz	f-150MHz
≤ - 80dBc	10MHz ~ 1.2GHz	f-850MHz
≤ - 80dBc	1.2GHz ~ 18GHz	f+850MHz
≤ - 70dBc	18GHz ~ 26.5GHz	f+850MHz
≤ - 70dBc	26.5GHz ~ 40GHz	f-850MHz
≤ - 60dBc	40GHz ~ 50GHz	f+850MHz

8.4 Additional information

$\leq -47\text{dBc}$	50GHz ~ 67GHz	f+850MHz
$\leq -80\text{dBc}$	10MHz ~ 1.2GHz	f+3950MHz
$\leq -80\text{dBc}$	1.2GHz ~ 4.0GHz	f+10450MHz

5) Second harmonic distortion (SHI)

SHI	Distortion products	Mixer level	Input frequency range
+39dBm	-54dBc	-15dBm	10MHz ~ 0.6GHz
+39dBm	-54dBc	-15dBm	0.6GHz ~ 2GHz
+57dBm	-72dBc	-15dBm	2GHz ~ 4.5GHz
+55dBm	-70dBc	-15dBm	4.5GHz ~ 9GHz
+50dBm	-65dBc	-15dBm	9GHz ~ 25GHz
+50dBm	-65dBc	-15dBm	25GHz ~ 33.5GHz

6) Three-order intermodulation distortion (TOI) (test two input mixer signals of -10 dBm, with frequency interval of 50 kHz and 20°C ~ 30°C, nominal value)

TOI	TOI	Frequency range
(4051)	(4051-S)	
$\geq +13\text{dBm}$	$\geq +12\text{dBm}$	10MHz ~ 200MHz
$\geq +13\text{dBm}$	$\geq +12\text{dBm}$	200MHz ~ 4GHz
$\geq +11\text{dBm}$	$\geq +10\text{dBm}$	4GHz ~ 9GHz
$\geq +13\text{dBm}$	$\geq +12\text{dBm}$	9GHz ~ 18GHz
$\geq +13\text{dBm}$	$\geq +13\text{dBm}$	18GHz ~ 50GHz
$\geq +11\text{dBm}$	/	50GHz ~ 67GHz

7) Phase noise (carrier 1 GHz, 20°C ~ 30°C)

Technical index	Technical index	Frequency offset
(4051)	(4051-S)	
$\leq -96\text{ dBc/Hz}$	$\leq -92\text{ dBc/Hz}$	100Hz
$\leq -115\text{ dBc/Hz}$	$\leq -105\text{ dBc/Hz}$	1kHz
$\leq -125\text{ dBc/Hz}$	$\leq -118\text{ dBc/Hz}$	10kHz
$\leq -125\text{ dBc/Hz}$	$\leq -123\text{ dBc/Hz}$	100kHz

8.4 Additional information

8.4.1 Front panel interfaces

Table 8.2 Front panel interfaces

Front panel interfaces		
RF Input Interface	4051A/-S	N type (female)
	4051B/-S	N type (female)
	4051C/-S	N type (female)
	4051D/-S	N type (female)
	4051E/-S	3.5 mm (male)
	4051F	2.4mm (male)
	4051G	2.4mm (male)
	4051H	2.4mm (male)
	4051L	1.85mm (male)
USB2.0 interface	It is to connect mouse/keyboard, to externally upgrade system software and back up data, etc.	

Trigger input	BNC female adapter
----------------------	--------------------

8.4.2 Rear panel interfaces

Table 8.3 Rear panel interfaces

Rear panel interfaces	
Video interface	VGA interface (15-core D-SUB adapter) for external connection of display interface
LAN interface	Standard RJ-45 1000Base-T for software upgrading and remote control.
GP-IB interface	IEEE-488 bus connector with 24-pin plug (GP-IB code: SH1, AH1, T6, L4, SR1, RL1, PP0, DC1, C0) for remote control.
USB2.0 interface	It is to connect mouse/keyboard, to externally upgrade system software and back up data, etc.
Wideband output Q (optional)	50 Ω impedance, SMA female adapter
10MHz reference input	50 Ω impedance, BNC female adapter, amplitude range: -5 dBm ~ +10 dBm
10MHz reference output	50 Ω impedance, BNC female adapter, amplitude range ≥ 0 dBm
Trigger input	BNC female adapter
Trigger Output 1	BNC female adapter
Trigger Output 2	BNC female adapter

8.5 Performance characteristics test

- Recommended test method.....651
- Record sheet of performance characteristics of signal/spectrum analyzer.....689
- Auxiliary form of performance characteristics of 4051 signal/spectrum analyzer.....698
- Instruments recommended for performance characteristics.....709

8.5.1 Recommended test method

8.5.1.1 Frequency and time

8.5.1.1.1 Frequency Range

a) Test items

Frequency range refers to the range from the highest to the lowest frequency signal to be correctly measured by the signal/spectrum analyzer. Capability of the 4051 signal/spectrum analyzer to measure frequency according to relevant requirements is tested with signals from the signal generator with high frequency stability within the nominal upper and lower measurement frequency limits.

b) Test equipment

Synthesized signal generator (E8257D/1464 is recommended)

Frequency standard

c) Test steps

- 1) Connect the frequency standard output to the 10 MHz input of the signal generator according to Fig. 8.1 to provide reference frequency for the synthesized signal generator with the external frequency standard and connect the low frequency output of the synthesized signal generator to the input interface of the 4051

8.5 Performance characteristics test

signal/spectrum analyzer (if no frequency standard is available, optional signal generator with frequency of high stability can be used).

- 2) Connect the low frequency output of the synthesized signal generator to the RF input of the 4051 signal/spectrum analyzer as indicated by solid lines in Fig. 1.

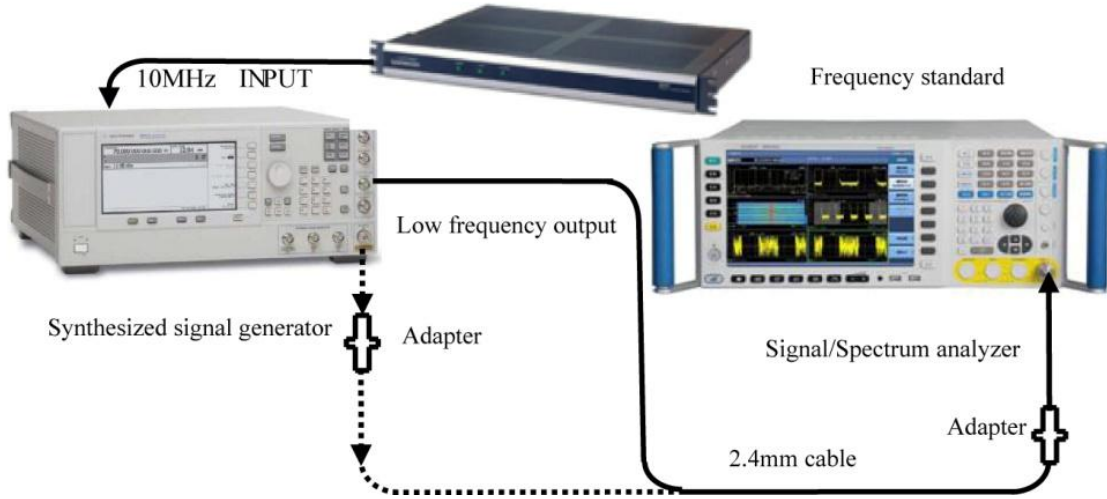

Fig. 8.1 Schematic diagram of frequency range test

- 3) Set the synthesized signal generator as follows: turn on AM modulation, set AM modulation amplitude as 80% and modulation rate as 3 Hz; turn on low frequency output amplitude and set it as 100 mVp.
- 4) Reset the analyzer and set as frequency analysis mode; set input/output coupling mode as DC, center frequency as the nominal lower frequency limit of 3 Hz, frequency span of 10 Hz; press Peak after completion of each test; when the marker correctly indicates the peak signal, there is no obvious dither in the marker amplitude value and the signal is clear distinguishable, record the center frequency as the lower measurement value. Records made at any other time will not meet relevant requirements (if the signal peak is at the zero frequency, zero frequency auto adjustment is required).
- 5) Change the connections in the test to connect the RF output of the synthesized signal generator to the RF input of the 4051 signal/spectrum analyzer as indicated by dotted lines in Fig. 1.
- 6) Set the output frequency of the synthesized signal generator as the nominal upper frequency limit of the analyzer to be tested, output power as -10 dBm, RF output on/off as on and modulation function as off.
- 7) Set the analyzer center frequency as the nominal upper frequency limit and frequency span as 20 kHz; press Peak Search and when the marker correctly indicates the peak signal, there is no obvious dither in the marker amplitude value and the signal is clear distinguishable, record the center frequency as the upper measurement value of the frequency range. Records made at any other time will not meet relevant requirements.
- 8) Record measurement results in the Record Sheet of Performance Characteristics of 4051 Series Signal/Spectrum Analyzer (hereinafter referred to as the “4051 Record Sheet”).
- 9) Set 4051 (except 4051L) input/output coupling mode as AC, repeat step 3 ~ 8, where the frequency lower limit test signal comes from the RF output of the signal generator.

d) Test records and data processing

- 10) Record measurement results in the 4051 Record Sheet.

8.5.1.1.2 Band division

a) Test items

Band division of 4051 depends on the combination of LO working scope (3 GHz ~ 10 GHz) and octave with reference to the principles of band division of ITU under IEE.

8.5 Performance characteristics test

4051 band division is ensured at the stage of design and manufacturing of the instrument.

b) Test procedure

- 1) Reset 4051 and set the center frequency as 1 GHz and the frequency span as 1 kHz.
- 2) Use the frequency diagnosis function in the analyzer system to display current first LO frequency LO₁ as 5.95 GHz. According to design regulations, N value of band 0 is 0.5, and IF₁ is 1.975 GHz, LO₂ is 2.4 GHz, IF₂ is 425MHz, LO₃ is 500MHz and IF₃ is 75MHz. Currently band 0 meets the frequency conversion formulae 1 ~ 3.

$$IF_1 = N * LO_1 - RF \dots\dots\dots (1)$$

$$IF_2 = LO_2 - IF_1 \dots\dots\dots (2)$$

$$IF_3 = LO_3 - IF_2 \dots\dots\dots (3)$$

- 3) Reset 4051 and set the center frequency as 1 GHz and the frequency span as zero.
- 4) Use the frequency diagnosis function in the analyzer system to display current first LO frequency LO₁ as 6.225 GHz. According to the design, N value of band 0 is 0.5, and IF₁ is 5.225 GHz, LO₂ is 4.8 GHz, IF₂ is 425MHz, LO₃ is 500MHz and IF₃ is 75MHz. Currently band 0 meets the frequency conversion formulae 4 ~ 6.

$$IF_1 = N * LO_1 - RF \dots\dots\dots (4)$$

$$IF_2 = IF_1 - LO_2 \dots\dots\dots (5)$$

$$IF_3 = LO_3 - IF_2 \dots\dots\dots (6)$$

- 5) Each band has a frequency point according to band division (not in the band cross-covered region). Since N value of band 2 is 1, that of band 3 and 4 is 5, and that of band 5 is 8, IF₂ is 425 MHz, LO₃ is 500 MHz and IF₃ is 75 MHz. Band 2, 3 and 5 meet the frequency conversion formulae 6 and 7; band 4 meets the frequency conversion formulae of 6 and 8.

$$IF_2 = N * LO_1 - RF \dots\dots\dots (7)$$

$$IF_2 = RF - N * LO_1 \dots\dots\dots (8)$$

c) Test records and data processing

- 6) If all LO frequencies meet the frequency conversion formulae, “compliant” should be noted in the 4051 Record Sheet, otherwise it should be considered as noncompliant.

8.5.1.1.3 Frequency reference**a) Test items**

Frequency reference is the basis of measurement by the spectrum analyzer. The frequency reference has a high requirements for frequency accuracy and stability and uses complicated test equipment of the aging rate and the temperature stability, featuring long test time and inapplicability in the production site test. During acceptance and identification of the signal analyzer and production inspection, the main test target is the reference frequency accuracy. The design nominal value of the frequency reference components can be used to obtain the initial calibration accuracy. The aging rate and the temperature stability can be obtained by sending sampled frequency reference components from production batches of each year to be tested by the measurement body with the surveyor's certificate. See “Regulation for Verification of Quartz Crystal Oscillator in Electronic Measuring Instruments (JJG180-2002)” or equivalent methods for more details of test methods.

b) Test equipment

Synthesized signal generator (E8257D/1464 is recommended)

Frequency standard

c) Test steps

8.5 Performance characteristics test

- 1) Connect the frequency standard output to the 10 MHz input of the signal generator according to Fig. 8.2 to provide reference frequency for the synthesized signal generator with the external frequency standard. Connect the low frequency output of the synthesized signal generator to the input interface of the 4051 signal/spectrum analyzer (if no frequency standard is available, optional signal generator with frequency of high stability can be used).
- 2) The 4051 analyzer to be tested, the synthesized generator and the frequency standard are preheated for predetermined time.
- 3) Set the output frequency of the synthesized signal generator as the upper frequency limit of the analyzer to be tested and the output power as -10 dBm.
- 4) Reset 4051, set the frequency span as 100 kHz, press Peak Search and turn on Delta Count.
- 5) Record marker count measurement results in B1 of the Auxiliary Form of Performance Characteristics of 4051 Series Signal/Spectrum Analyzer (hereinafter referred to as the “4051 Auxiliary Form”).

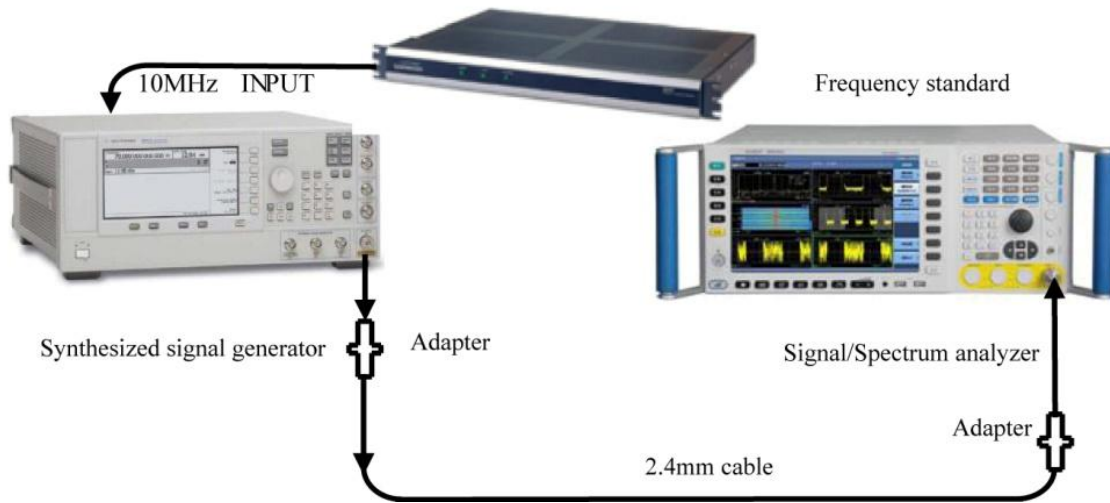

Fig. 8.2 Schematic diagram of frequency reference test

d) Test records and data processing

- 6) Calculate the frequency reference accuracy with formula (6).

$$S = \frac{f - f_0}{f_0} \dots\dots\dots (6)$$

Where f refers to the 4051 marker count measurement value (Hz);

f₀ refers to the nominal frequency value of the synthesized signal generator (Hz).

- 7) Record the frequency reference accuracy calculation results in the 4051 Record Sheet. The aging rate, the temperature stability and the standard accuracy will be obtained via measurement standards from batch spot checks.

8.5.1.1.4 Residual frequency modulation

a) Test items

The residual frequency modulation refers to the short-term frequency instability inherent to the local frequency signal without any modulation input. In general, it refers to the peak value or peak-to-peak value of frequency jitter during a set time interval of set test bandwidth.

For the analyzer, any instability of LO system is transferred to the IF by inputting a stable sinewave signal to the analyzer and setting the analyzer at zero frequency bandwidth. Measure the amplitude offset of the signal at the 10 Hz resolution frequency sideband. The frequency offset (also known as the residual frequency modulation) can be obtained by multiplying the amplitude offset with the slope of the 10 Hz filter slop.

8.5 Performance characteristics test

b) Test equipment

Synthesized signal generator (E8257D/1464 is recommended)

c) Test steps

- 1) Connect the test equipment as shown in Figure 8.3.
- 2) Set the synthesized signal generator frequency as 1 GHz and the amplitude as 0 dBm.
- 3) Reset 4051 and set as follows:

Center frequency as 1 GHz

Span: 1MHz

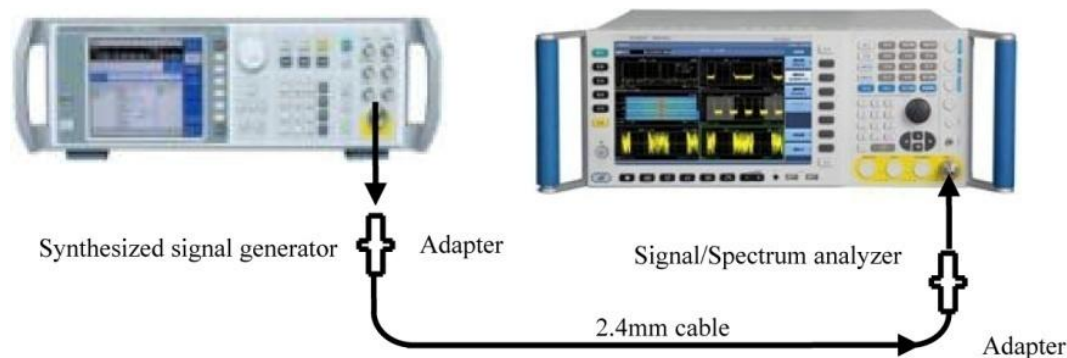

Fig. 8.3 Schematic diagram of residual frequency modulation

- 4) Gradually reduce the frequency span to 100 Hz and press Peak Search to move the signal to the center frequency.
- 5) Set 4051 amplitude scale as 2 dB/division and adjust the output amplitude of the signal generator to place the signal peak at the reference level.
- 6) Execute Peak Search to adjust the peak to the center and execute Marker Delta.
- 7) Turn the analyzer knob anticlockwise until the Marker Delta amplitude reading is closest to -5 dB. Execute Marker Delta.
- 8) Turn the knob anticlockwise until the Marker Delta amplitude reading is closest to -10 dB.
- 9) Record current frequency difference Δf and the amplitude different ΔL of the Marker Delta, calculate the demodulation sensitivity S according to the formula (7) and record the result in the 4051 Auxiliary Form.

$$S = \frac{\Delta f}{\Delta L} \dots\dots\dots (7)$$

- 10) Execute Peak Delta and Marker Delta. Turn the knob anticlockwise until the Marker Delta amplitude reading is closest to -10 dB. When the marker points step by 1 Hz at such time, select the marker point closest to -10 dB, execute marker-to-center and set the frequency span as 0.
- 11) Set the analyzer sweep time as 1 s, execute Single Sweep, press Peak Search, execute Marker Delta and turn the knob to move the marker to the lowest. Record the absolute value of the Marker Delta amplitude (amplitude offset) ΔA in B2 of the 4051 Auxiliary Form.
- 12) Change the output frequency of the signal generator and the center frequency of the 4051 analyzer and repeat step 2 ~ 11.

d) Test records and data processing

- 13) Calculate the residual frequency modulation RFM according to the formula (8) and record it in the 4051 Auxiliary Form.

8.5 Performance characteristics test

$$R_{FM} = \Delta A \times S \dots\dots\dots (8)$$

14) Determine errors in results of all test items in B2 of the 4051 Auxiliary Form. If all test data falls within the range of error, “compliant” should be noted in the 4051 Record Sheet, otherwise it should be considered as noncompliant.

8.5.1.1.5 Frequency readout accuracy

a) Test items

The frequency readout accuracy is used to reflect the closeness between the frequency measurement indicated value and the actual value. During sweeping of the analyzer, the frequency measurement indicated value is affected by the reference frequency, the sweep width, the frequency bandwidth and the LO residual frequency modulation. An input signal of a given frequency can be used to test the marker of the analyzer in order to read out the accuracy.

b) Test equipment

Synthesized signal generator (E8257D/1464 is recommended)

c) Test steps

- 1) Connect the test equipment according to Fig. 2 with the signal output interface of the signal generator connected to the signal input interface of the analyzer.
- 2) Reset the signal generator and set the output frequency as 1.5 GHz, the power level as -10 dBm and the RF output as on.
- 3) Reset 4051 and set the center frequency as 1.5 GHz and the frequency span as relevant value indicated in the 4051 Record Sheet.
- 4) Execute Marker until relevant marker value changes to the center frequency set value and then execute Marker Delta.
- 5) Execute Peak Search and record the frequency difference of the peak marker readout as measurement result in relevant test item of the 4051 Record Sheet.
- 6) Set the analyzer frequency span according to the frequency span value in the 4051 Record Sheet and repeat step 5.
- 7) Close all markers and repeat step 2 ~ 6 for all combinations of frequency and frequency span in relevant test items in the 4051 Record Sheet.

8.5.1.1.6 Marker count

a) Test items

A signal generator output of a given frequency is used as the standard and the error between the analyzer marker count value and the signal generator output as the marker count accuracy.

b) Test equipment

Synthesized signal generator (E8257D/1464 is recommended)

c) Test steps

- 1) Connect the test equipment according to Fig. 8.4 with the 10MHz output interface of the analyzer connected to the 10MHz input interface of the synthesized signal generator and the RF output of the synthesized signal generator connected to the signal input interface of the analyzer.
- 2) Reset 4051, set the frequency span as 1 MHz, turn on Marker Count and set the gate time as 5 s.
- 3) Check the resolution of the analyzer marker count and record as 0.001 Hz if the test data display meet the requirement of 0.001 Hz. otherwise consider it as incompliant.

8.5 Performance characteristics test

- 4) Set the output frequency of the synthesized signal generator and the center frequency of the analyzer as f_0 according to relevant test items in the 4051 Auxiliary Form.
- 5) Execute Peak Search and record the marker count frequency value f_s in relevant test item of the 4051 Auxiliary Form.
- 6) Repeat Step 4 to 5 for all frequency points in relevant test items of the 4051 Auxiliary Form.

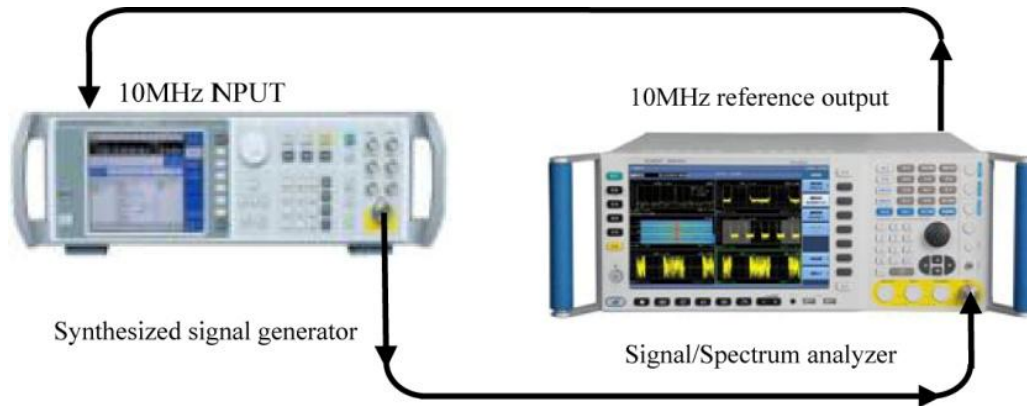

Fig. 8.4 Schematic diagram of marker count test

d) Test records and data processing

- 7) Calculate the marker count accuracy Δf according to the formula (9) and record it in B3 of the 4051 Auxiliary Form.

$$\Delta f = f_s - f_0 \dots\dots\dots (9)$$

- 8) Determine values in results of all test items in B3 of the 4051 Auxiliary Form. If all results fall within the range of error, records in the 4051 Record Sheet meet relevant requirements, otherwise not.

8.5.1.1.7 Frequency span accuracy**a) Test items**

Set frequency difference of two synthesized signal generator as $0.8 \times \text{SPAN}$ signal of the signal analyzer and the center frequency of the signal analyzer as the median of output frequencies of these two signal generators. Use the Marker function measure frequency difference of such two signals. Calculate and record the percentage error between the measured marker difference and the frequency span. Use the same frequency as reference for two signal generators and the signal analyzer.

Note: It is allowed to use only one signal generator for test. Firstly, set the center frequency and the frequency span of the signal analyzer; set the signal generator with the frequency value of #1 signal generator; set Marker Delta for the signal analyzer and set it as the frequency value of #2 signal generator; search for the peak and record current marker difference frequency value as the measurement value.

b) Test equipment

E8257D or 1464 is recommended for synthesized signal generator #1.

E8257D or 1464 power divider is recommended for synthesized signal generator #2.

c) Test steps

- 1) Connect the instrument as shown in Fig. 8.5, reset the 4051 analyzer and set it with the frequency reference provided by two synthesized signal generators.

8.5 Performance characteristics test

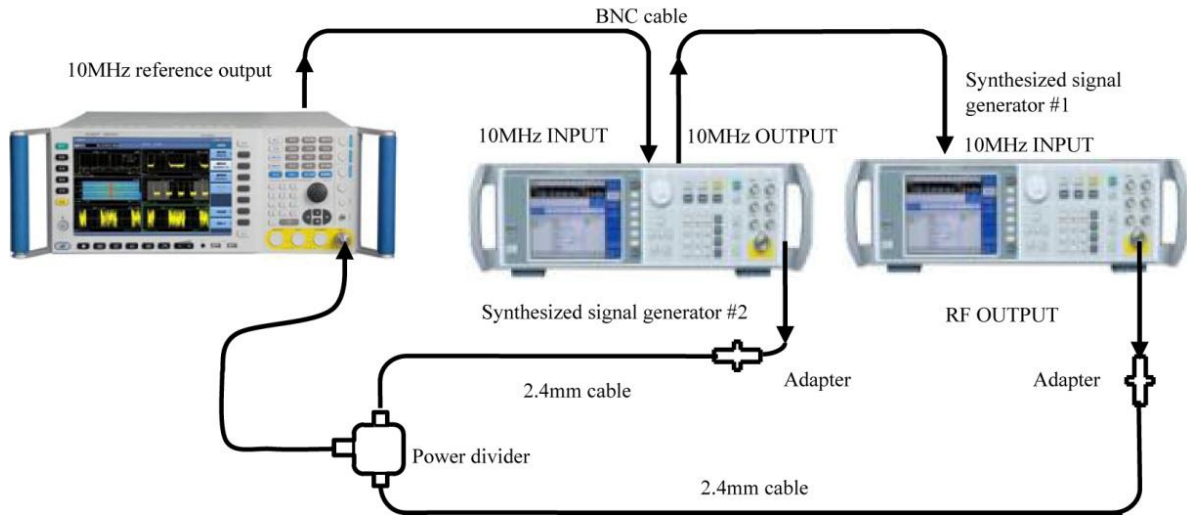

Fig. 8.5 Schematic diagram of frequency span accuracy test

- 2) Set the output power of synthesized signal generator #1 as 0 dBm and the frequency output as on.
- 3) Set the power of synthesized signal generator #2 as -10 dBm and the frequency output as on.
- 4) Set the 4051 analyzer according to the relations of frequency span and center frequency listed in B4 of the 4051 Auxiliary Form.
- 5) Set the synthesized signal generators according to the frequencies of synthesized signal generators #1 and #2 listed B4 of in the 4051 Auxiliary Form.
- 6) Execute Single Sweep and wait; execute Peak Search and Marker Delta and then Next Peak Search.
- 7) Record the Marker Delta frequency value Δf displayed in the 4051 analyzer.
- 8) Repeat Step 5 to 8 for all frequency span set values and frequencies of the signal generators in relevant test items in B4 of the 4051 Auxiliary Form.

d) Test records and data processing

- 9) Calculate the frequency span accuracy δ_{SPAN} according to the formula (10) and record it in the 4051 Auxiliary Form.

$$\delta_{SPAN} = \left(\frac{\Delta f - 0.8 * SPAN}{0.8 * SPAN} \right) \dots\dots\dots (10)$$

Where Δf refers to the Marker Delta frequency value Δf displayed in the 4051 analyzer (Hz);

SPAN refers to set frequency span value of the 4051 analyzer (Hz).

8.5.1.1.8 Sweep time and trigger

a) Test items

The amplitude modulation signals are demodulated into periodic amplitude change signals when the signal/spectrum analyzer is in the zero bandwidth state. When the modulation rate of the modulation signals reasonably correspond to the sweep time of the signal/spectrum analyzer, demodulation signals will be uniformly distributed on the screen. Calculate the peak value of demodulation signals to obtain the actual sweep time and then compare it with the designated time to obtain the sweep time accuracy. The sweep time accuracy is guaranteed in the design. In order to reduce the test time, the typical sweep time will be tested for verification.

The Trigger function of the analyzer is also guaranteed by the design.

8.5 Performance characteristics test

Note: The synthesized signal generator and the function generator can be replaced with the synthesized signal generator with built-in AM option.

b) Test equipment

E8257D is recommended for the synthesized signal generator.

Function generator

c) Test steps

- 1) Connect the test equipment as shown in Fig.8 4, reset 4051, and connect the output of the signal generator to the input of the tested 4051, and the 10MHz output interface of 4051 to the 10MHz INPUT port of the synthesized signal generator.
- 2) Set the output frequency of the signal generator as 1GHz, the output amplitude as -5dBm, the modulation mode as “Internal AM”, the modulation depth as 80% and the modulation wave as the triangular wave output.
- 3) Set the 4051 analyzer center frequency as 1 GHz, the frequency span as 100 MHz, the minimum settable sweep time as 1 ms and the maximum settable sweep time as 6,000 s. If above settings meet records in the 4051 Record Sheet, they will be considered as compliant, otherwise not.
- 4) Set the 4051 analyzer frequency span as 0 Hz and the range of sweep time as 1 μ s to 6,000 s.

If above settings meet records in the 4051 Record Sheet, they will be considered as compliant, otherwise not.

- 5) Set the 4051 analyzer with linear scale, Peak detection mode and the resolution bandwidth as 3 MHz.
- 6) Set the sweep time of 4051 and the AM frequency of the signal generator according to the test items listed in the 4051 Auxiliary Form.
- 7) Execute Single Sweep, read the time difference ΔT between the 2nd and 10th peak value from the left with the Marker Delta and record it in B5 of the 4051 Auxiliary Form.
- 8) Set different sweep time according to requirements in B5 of the 4051 Auxiliary Form and repeat step 6 to 7.
- 9) The 4051 analyzer has seven trigger modes, including free, video, power, external level (front panel), external level (rear panel), burst RF and timer. When set as free trigger, the spectrum trace can be refreshed normally.
- 10) Set the output frequency of the signal generator as 2 GHz, the output power as -20 dBm, the pulse modulation output width as 1 ms and the pulse period as 2 ms; connect the RF output interface to the RF input interface of the 4051 analyzer; set the 4051 analyzer frequency as 2 GHz and the trigger mode as video trigger; reduce the trigger level. If the signal spectrum trace can be refreshed, then the 4051 video trigger mode meets relevant technical requirements, otherwise not.
- 11) Set the output frequency of the signal generator as 2 GHz, the output power as -20 dBm, the pulse modulation output width as 0.1 ms and the pulse period as 0.2 ms; connect the RF output interface to the RF input interface of the 4051 analyzer; set the signal generator as low frequency output, the output frequency as 1 kHz and the output voltage as 1 V; connect the lower frequency output interface to the trigger input interface of the 4051; set the 4051 analyzer frequency as 2 GHz and the trigger mode as external trigger; reduce the trigger level. If the signal spectrum trace can be refreshed, then the 4051 external trigger mode meets relevant technical requirements, otherwise not.
- 12) Trigger delay of 0 ~ +500 ms and trigger delay resolution of 0.1 μ s are guaranteed by the design.
- 13) If steps 9 to 12 are completed, then the trigger mode of the 4051 analyzer meets relevant technical requirements and “Compliant” should be noted in relevant items in the 4051 Record Sheet. Otherwise, it will be considered as noncompliant.

d) Test records and data processing

- 14) Calculate the sweep time accuracy δ with the formula (11).

8.5 Performance characteristics test

$$\delta = \left(\frac{\Delta T - 0.8 \times T}{0.8 \times T} \right) \times 100\% \dots\dots\dots (11)$$

Where, ΔT refers to the time difference between the second peak and the tenth peak;

T refers to the set sweep time of 4051 analyzer.

15) Determine values in results of all test items in B5 of the 4051 Auxiliary Form. If all results fall within the range of error, the absolute maximum error in the result from step 9 should be recorded in the 4051 Record Sheet. Otherwise, the record will be considered not compliant with relevant requirements.

8.5.1.1.9 Range of sweep points

a) Test items

Sweep points are used to set the number of trace data that is required to be captured by the signal/spectrum analyzer during one measurement. If the sweep points are added, the span corresponding to each trace datum is narrower, the measured results are more stable and the frequency readout accuracy is higher.

Sweep points are guaranteed during design and production by the manufacturer of the analyzer and can be checked via the sweep points setting.

b) Test procedure

- 1) Reset the 4051 analyzer, enter the sweep menu and set the sweep points from 101 to 300001.
- 2) Determine measurement values according to the requirements in Section 3.12.1.9. If all results fall within the range of error, “compliant” should be noted in the 4051 Record Sheet, otherwise it should be considered as noncompliant.

8.5.1.1.10 Resolution bandwidth

a) Test items

The frequency resolution refers to the capacity of the signal/spectrum analyzer to distinguish the smallest constant amplitude signal.

The signal generator produces standard sine waves. The change of the signal generator frequency can be considered as equivalent to the change of the IF filter frequency; the measurement of the amplitude response of signals of different frequencies in fixed frequency points of the signal analyzer can be considered as equivalent to the measurement of the shape of IF filter (including 3 dB bandwidth and rectangle coefficient).

b) Test equipment

E8257D/1464 is recommended as the synthesized signal generator.

c) Test procedure

- 1) Connect the instrument as shown in Fig. 4. The 4051 analyzer provides the frequency reference for the synthesized signal generator.
- 2) Set the synthesized signal generator as follows: frequency as 500 MHz, power as -2 dBm, power step as 1 dBm and IF output on.
- 3) Reset the 4051 analyzer, complete all calibrations, turn on NdB bandwidth measurement function and change N value to 3.01.
- 4) Set the center frequency of 4051 as 500 MHz, the frequency span as 20 MHz, the amplitude scale as 1 dB, the resolution bandwidth as 10 MHz and VBW/RBW as 0.1.
- 5) Adjust the output amplitude of the synthesized signal generator to display the signal peak 2 ~ 3 divisions below the reference level (2 dB ~ 3 dB).
- 6) Execute Continuous Measurement On, Peak Search and Marker to Center to move the signal peak to the center of the screen.

8.5 Performance characteristics test

- 7) Execute Continuous Measurement Off, record current 3 dB bandwidth marker difference reading Δf -3 dB in the column “3 dB bandwidth measurement value” in B6 of the 4051 Auxiliary Form.
- 8) Set the 4051 analyzer according to the resolution bandwidth listed in B6 of the 4051 Auxiliary Form, set the frequency span as approximately 2 times of the resolution bandwidth and repeat step 6 ~ 7.
- 9) Reset the 4051 analyzer, set its center frequency as 500 MHz, the frequency span as 100 MHz, the reference level as 0 dBm, the amplitude scale as 10 dB, the resolution bandwidth as 10 MHz, VBW/RBW as 0.1 and the sweep type as sweep frequency and then execute Peak Search.
- 10) Adjust the output power of the synthesized signal generator until the 4051 signal peak amplitude reading is closest to 0 dBm. Turn on NdB bandwidth measurement function and change N value to 60.
- 11) Execute Continuous Measurement On, Peak Search and Marker to Center to move the signal peak to the center of the screen.
- 12) Execute Continuous Measurement Off, record current 60 dB bandwidth marker difference reading Δf -60 dB in the column “60 dB bandwidth measurement value” in B6 of the 4051 Auxiliary Form.
- 13) Set the 4051 analyzer according to the resolution bandwidth listed in B6 of the 4051 Auxiliary Form, set the frequency span as approximately 5 ~ 10 times of the resolution bandwidth and repeat step 11 ~ 12.

d) Test records and data processing

- 14) Calculate the resolution bandwidth accuracy δ according to the formula (12) and record it in the 4051 Record Sheet.

$$\delta = \left(\frac{\Delta f_{-3dB} - RBW}{RBW} \right) \times 100\% \dots\dots\dots (12)$$

Where Δf_{-3dB} refers to 3 dB bandwidth measurement value of the 4051 analyzer (Hz);

RBW refers to the nominal value of the 4051 analyzer resolution bandwidth (Hz).

- 15) Calculate the resolution bandwidth selectivity S according to the formula (13) and record it in the 4051 Record Sheet.

$$S = \frac{\Delta f_{-60dB}}{\Delta f_{-3dB}} \dots\dots\dots (13)$$

Where Δf_{-60dB} refers to 60 dB bandwidth measurement value of the 4051 analyzer (Hz);

Δf_{-3dB} refers to 3 dB bandwidth measurement value of the 4051 analyzer (Hz).

8.5.1.1.11 Maximum analysis bandwidth**a) Test items**

The nominal value of maximum analysis bandwidth of the 4051 analyzer is 10 MHz, option H38A is 40 MHz and option H38B is 200 MHz. Set the 4051 analyzer as I/Q analysis mode for two synthesized signal generators of stable frequency to provide constant amplitude signals for the 4051 analyzer at the same time; change frequencies of two signals within the demodulation bandwidth successively until amplitude difference of all signals does not exceed 3 dB, which means the maximum analysis bandwidth is met.

b) Testing block diagram and testing instrument and equipment

E8257D/1464 is recommended for synthesized signal generator #1.

E8257D/1464 is recommended as the synthesized signal generator#2.

c) Test procedure

- 1) Connect the tested instrument as shown in Fig. 8.6 and reset the 4051 analyzer.

8.5 Performance characteristics test

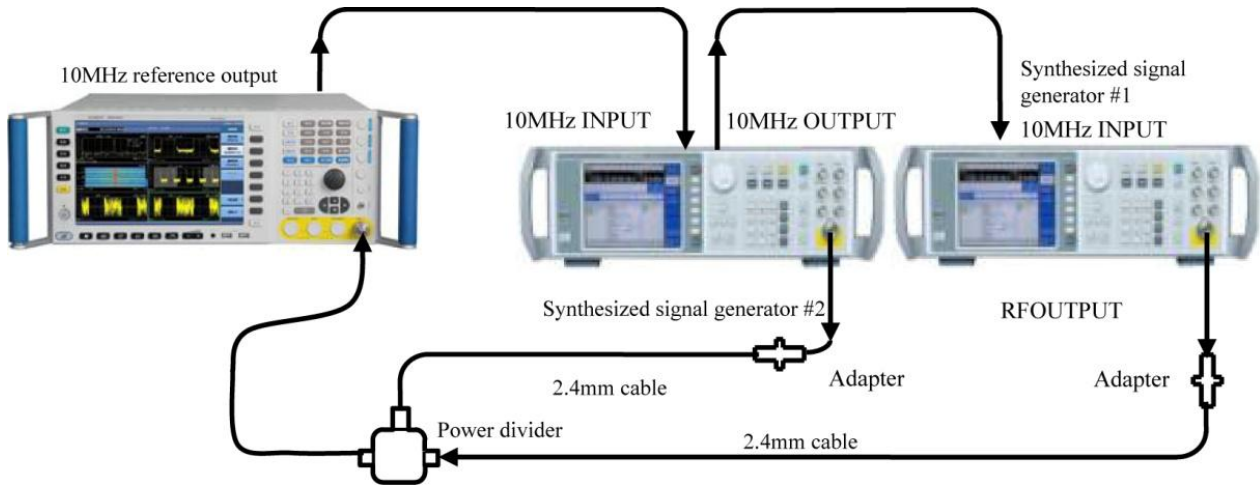

Fig. 8.6 Schematic diagram of maximum analysis bandwidth test

- 2) Set the 4051 analyzer as I/Q analysis mode and the frequency domain window as current window. Set the center frequency as 1 GHz and the analysis bandwidth as 10 MHz.
- 3) Set the frequency of synthesized signal generator#1 as 1 GHz and the amplitude as -10 dBm; execute Marker Delta and turn off the output of signal generator #1. Set the frequency of synthesized signal generator#2as 1 GHz and the amplitude as -10 dBm; adjust the output of signal generator#2 to ensure the Marker Delta reading is closest to 0 dB.
- 4) Gradually reduce the frequency of signal generator #2 and execute Peak Search. If the marker amplitude reading is less than -3 dB, note the current output frequency of the signal generator as left limit value, otherwise record the frequency value at the left-most graticule of the 4051 analyzer screen and record the result in the fL column in the 4051 Auxiliary Form.
- 5) Turn off the output of signal generator #2 and turn on the output of signal generator#1.
- 6) Turn on and gradually increase the frequency of signal generator #1 and execute Peak Search. If the marker amplitude reading is less than -3 dB, note the current output frequency of the signal generator as right limit value, otherwise record the frequency value at the right-most graticule of the 4051 analyzer screen and record the result in the fR column in the 4051 Auxiliary Form.
- 7) If bandwidth option H38A or H38B is available, repeat step 2 ~ 6 based on the set value of relevant analysis bandwidth in B7 of the 4051 Auxiliary Form.

d) Test records and data processing

- 8) Calculate the maximum analysis bandwidth measurement value BWMAX according to the formula (14) and record the result in the 4051 Record Sheet. Otherwise, the record will be considered not compliant with relevant requirements.

$$BW_{MAX} = f_R - f_L \dots\dots\dots (14)$$

Where, f R refers to the right limit value (MHz);

f_L refers to the left limit value (MHz).

8.5.1.1.12 Video bandwidth

a) Test items

The video bandwidth refers to the bandwidth of the tunable low-pass filter in the video circuit behind the detector of the signal/spectrum analyzer. The video filter is the low-pass filter located behind the detector for defining the bandwidth of the video amplifier. It can smooth the noise and is used to average or smooth traces. Besides, it can easily detect weak signals in noises. Change of the video bandwidth does not affect the frequency resolution of the 4051 analyzer, but too narrow video bandwidth may lead to increase in the sweep

8.5 Performance characteristics test

time. The video bandwidth is guaranteed during design and production by the manufacturer of the analyzer and can be checked via the video bandwidth setting.

b) Test procedure

- 1) Reset the 4051 analyzer, enter the bandwidth menu and set the video bandwidth from 1 Hz to 3 MHz or as 4, 5, 6, 8 and 10 MHz.
- 2) Determine measurement values according to the requirements in Section 8.3.1.12. If all results fall within the required range, "compliant" should be noted in the 4051 Record Sheet, otherwise it should be considered as noncompliant.

8.5.1.1.12 11. Other indicators

a) Test items

Other indicators mainly include the local measurement update rate, center frequency tuning and conversion rate, number of traces, to represent the fast measurement characteristics of 4051 signal analyzer.

b) Test block diagram and test apparatus and equipment

Synthesized signal generator..... 1463/E8254A is recommended

Oscilloscope..... 4445 is recommended

Real-time spectrum analyzer..... FSVR7 is recommended

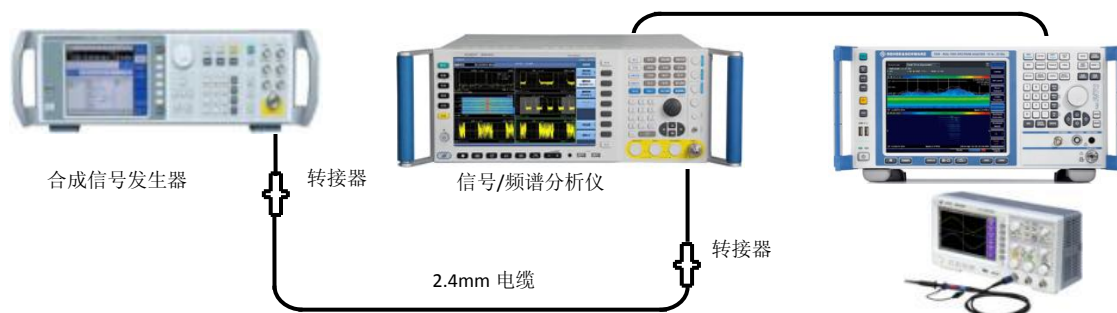

Fig .8.7 Testing device of other indicators

c) Test procedure

- 1) Local measurement update rate: connect apparatus as shown in Fig. 8.7. Set 4051 as spectrum analysis mode, analysis bandwidth as 3MHz, frequency width as 0Hz and scan time as 1us, use the oscilloscope to measure the pulse rising time of signal analyzer rear panel trigger output end, and measure the mean period as the local measurement update rate.
 - 2) Center frequency tuning and conversion rate: the center frequency tuning and conversion rate is the interval time between two 4051 scan processes. Set 4051 as spectrum analysis mode, scan width as 0Hz, scan time as 1ms and frequency step as 5MHz to respectively set the center frequency as 1GHz, 5GHz and 27GHz. For the step center frequency, adopt the real-time spectrum analyzer FSVR to capture the 4051 first local oscillation jump process, and read out the frequency jump interval time as center frequency tuning and conversion rate.
 - 3) Number of traces: press the key "Trace" and soft menu "Trace selection" to select 6 traces.
- d) Test record and data processing
- 4) Record the measuring result under the relevant test items in 《Record Form》 .

8.5 Performance characteristics test

8.5.1.2 Tests of amplitude accuracy and range

8.5.1.2.1 Amplitude range

a) Test items

It is used to check the range of amplitude from the maximum signal to the minimum signal of the 4051 analyzer. The maximum signal of the 4051 analyzer has the highest level.

For the safety input level, the minimum signal is the display average noise level.

b) Test procedure

- 1) The maximum signal LMAX (maximum safety input level) is tested based on Section 8.5.1.2.2.
- 2) The minimum signal LDNAL (display average noise level) is tested based on Section 8.5.1.3.2.
- 3) Calculate the amplitude measurement range according to the formula (15) with the measured display average noise level of each band of the signal/spectrum analyzer. If requirements in 1) and 2) are met, the amplitude range will be noted as “compliant”, otherwise it will be considered as noncompliant.

$$L_{range} = L_{MAX} - L_{DANL} \dots\dots\dots (15)$$

- 4) Reset the 4051 analyzer and select internal 500 MHz input interface. Set the center frequency as 500 MHz, the frequency span as 1 kHz, the resolution bandwidth as 100 Hz, the input attenuator as 10 dB and the reference level as -15 dBm.
- 5) Execute Peak Search and Marker Delta.
- 6) Set the input attenuator as 0dB, 2dB, 4dB, 6dB, 8dB, 20dB, 30dB, 40dB, 50dB, 60dB and 70dB respectively (The maximum setting of 4051L attenuator is 60dB) . If the instrument can properly indicate the decrement, note “compliant” in the 4051 Record Sheet, otherwise as “noncompliant”.

8.5.1.2.2 Maximum safety input level

a) Test items

The maximum safety input level refers to the maximum level allowed at the input interface of the signal/spectrum analyzer that will not damaged the instrument.

Damages of the signal/spectrum analyzer can be checked and the maximum safety input level can be determined whether to meet relevant requirements by producing a signal consistent to the maximum safety input level and inputting it into the signal/spectrum analyzer.

Since the test has high risk, several frequency points can be selected to test according to the following procedure if the purchase has such need.

b) Test equipment

Synthesized signal generator (E8257D/1464 is recommended)

38701D/80244 is recommended for the high power amplifier.

U2000B is recommended for the USB power meter.

c) Test steps

- 1) Set the signal output of the signal generator as off, the frequency as 3GHz, amplitude as -50 dB and power step as 0.1 dB.
- 2) Reset 4051 and set its center frequency as 3 GHz, the frequency span as 2 MHz and the reference level as +30 dBm.
- 3) Connect the test equipment according to solid lines of Fig. 8.8 with the output cable of the high power amplifier connected to the USB power meter sensor rather than the signal/spectrum analyzer.

8.5 Performance characteristics test

- 4) Turn on the signal generator RF output, press Amplitude Setting key and use the knob to change the amplitude and gradually increase the signal power to increase the test power value of the power meter to $+30 \pm 0.1$ dBm. At such time, the output cable interface power of the high power amplifier is +30 dBm.
- 5) Turn off the output of the signal generator and the power of the high power amplifier and connect the output cable of the high power amplifier to the input of the signal/spectrum analyzer.
- 6) Turn on the RF output of the signal generator and the power of the high power amplifier, keep the power on for 5 min and then set the output power of the signal generator as 65 dB.
- 7) Set Peak Search and Marker Delta of the signal/spectrum analyzer.
- 8) Change the decrement stepping of the attenuator of the signal/spectrum analyzer to 2 dB until all attenuation levels are set. There should be no obvious transition at such time. Turn off the output of the power of the high power amplifier.

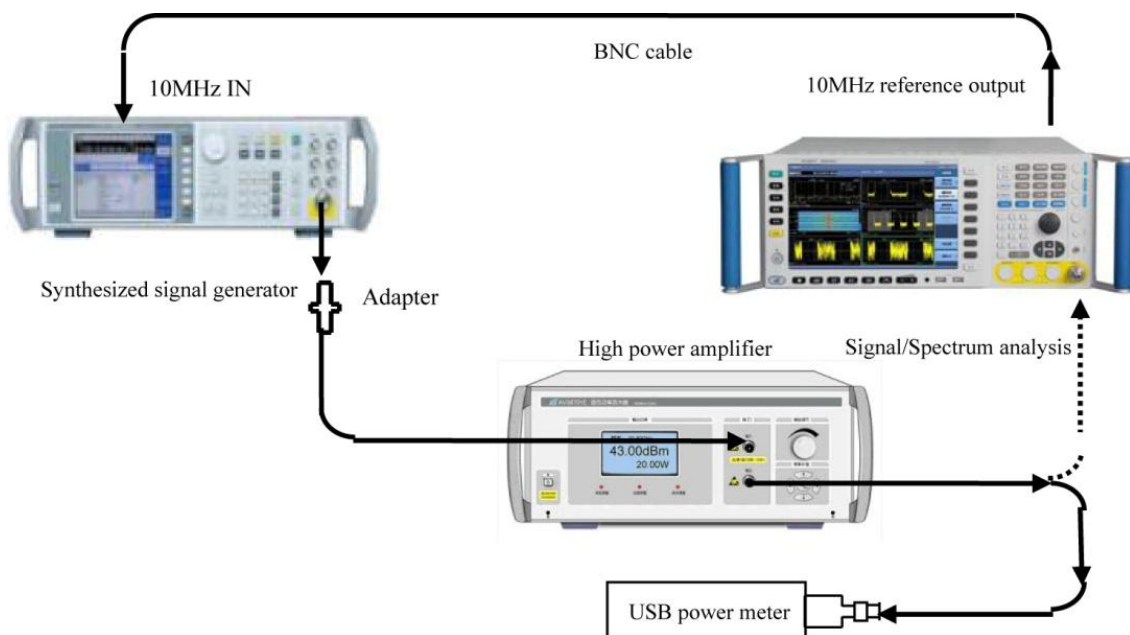

Fig. 8.8 Schematic diagram of maximum safety input level test

d) Records and data processing

- 9) If steps 1 ~ 8 can be properly completed, it means the maximum safety input level of +30 dBm meets relevant requirements and +30 dBm should be noted in the 4051 Record Sheet. If not, the relevant test item should be noted as noncompliant.

8.5.1.2.3 Frequency response**a) Test items**

The frequency response refers to the change of the amplitude along with that of the frequency within the specified frequency range, namely the dependency between the amplitude and the frequency.

The change of the amplitude along with that of the frequency within the specified frequency range is investigated by inputting a sine wave signal with known frequency and power (defined with the power meter) from the signal generator into the signal/spectrum analyzer.

Note: The overall frequency response is mainly affected by microwave frequency response from broadband radio frequency receiver front-end of the instrument, in which various compositions of AC/DC switch, PreAmplifier switch, low noise channel switch, preselector bypass switch and phase noise optimization switch will cause error of frequency response. It is estimated that a complete test cycle takes over 4 hours; therefore in this specification, only a representative composition of AC (with frequency band of over 50 MHz), DC (100 kHz ~ 50 MHz) and PreAmplifier switch has been tested.

8.5 Performance characteristics test

b) Testing block diagram and testing instrument and equipment

Synthesized signal generator (E8257D/1464 is recommended)

2434/E4418B is recommended for the power meter.

71712A/N8487A is recommended for the power sensor.

11667C is recommended for the power divider.

c) Test steps

Frequency response: (50MHz ~ 4GHz)

- 1) Connect the tested instrument as shown in Fig. 8.9.
- 2) Set the output frequency of the synthesized signal generator as 50 MHz, the frequency step as 200 MHz and the amplitude as -4 dBm.
- 3) Reset and set the 4051 analyzer:

Center frequency: 50MHz

Span:0Hz

Resolution bandwidth:300kHz

Video bandwidth:30kHz

Frequency step: 200 MHz

In case of frequency less than 1.1GHz, set the phase noise optimization Off (**【Measurement Setting】** 、
[More 1/2▶] [PhNoise Opt >>] [off]) 。

Set as Off when the pre-amplifier option is provided.

- 4) Set the power meter frequency as 50 MHz.
- 5) Record the 4051 marker reading L_2 and the power meter reading L_1 in the 4051 Auxiliary Form.
- 6) Execute Frequency Step Up for the synthesized signal generator and the 4051 analyzer.
- 7) Repeat the power meter frequency as the frequency value to be tested next in B8 of the 4051 Auxiliary Form and repeat step 5 to 6 for each frequency point in the 4051 Auxiliary Form.

Frequency response: (4GHz~9GHz)

- 8) Set the output frequency of the synthesized signal generator as 4.05 GHz and the center frequency of the 4051 analyzer as 4.05 GHz.
- 9) Set the power meter frequency as 4.05GHz.
- 10) Record the 4051 marker reading L_2 and the power meter reading L_1 in the 4051 Auxiliary Form.
- 11) Execute Frequency Step Up for the synthesized signal generator and the 4051 analyzer.
- 12) Repeat the power meter frequency as the frequency value to be tested next in B8 of the 4051 Auxiliary Form and repeat step 10 to 11 for each frequency point in the 4051 Auxiliary Form.

8.5 Performance characteristics test

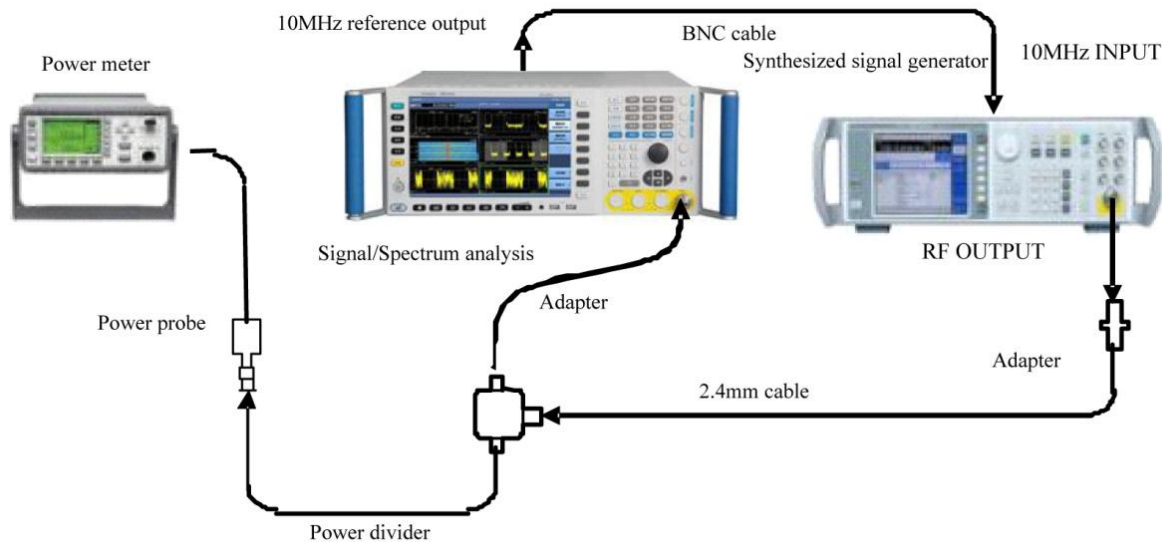

Fig. 8.9 Schematic diagram of frequency response test (50 MHz ~ 50 GHz)

Frequency response: (9GHz~18GHz)

- 13) Set the output frequency of the synthesized signal generator as 9.05 GHz. Set the center frequency of the 4051 analyzer as 9.05 GHz and the frequency step as 500 MHz.
- 14) Set the power meter frequency as 9.05GHz.
- 15) Record the 4051 marker reading L_2 and the power meter reading L_1 in the 4051 Auxiliary Form.
- 16) Execute Frequency Step Up for the synthesized signal generator and the 4051 analyzer.
- 17) Repeat the power meter frequency as the frequency value to be tested next in B8 of the 4051 Auxiliary Form and repeat step 15 to 16 for each frequency point in the 4051 Auxiliary Form.

Frequency response: (18GHz~26.5GHz)

- 18) Set the output frequency of the synthesized signal generator as 18.05GHz and the center frequency of the 4051 analyzer as 18.05GHz.
- 19) Set the power meter frequency as 18.05GHz.
- 20) Record the 4051 marker reading L_2 and the power meter reading L_1 in the 4051 Auxiliary Form.
- 21) Execute Frequency Step Up for the synthesized signal generator and the 4051 analyzer.
- 22) Repeat the power meter frequency as the frequency value to be tested next in B8 of the 4051 Auxiliary Form and repeat step 20 to 21 for each frequency point in the 4051 Auxiliary Form.

Frequency response: (26.5GHz~40GHz)

- 23) Set the output frequency of the synthesized signal generator as 26.55GHz and the center frequency of the 4051 analyzer as 26.55GHz.
- 24) Set the power meter frequency as 26.55GHz.
- 25) Record the 4051 marker reading L_2 and the power meter reading L_1 in the 4051 Auxiliary Form.
- 26) Execute Frequency Step Up for the synthesized signal generator and the 4051 analyzer.
- 27) Repeat the power meter frequency as the frequency value to be tested next in B8 of the 4051 Auxiliary Form and repeat step 25 to 26 for each frequency point in the 4051 Auxiliary Form.

Frequency response: (40GHz~50GHz)

- 28) Set the output frequency of the synthesized signal generator as 40.05GHz and the center frequency of the 4051 analyzer as 40.05GHz.

8.5 Performance characteristics test

- 29) Set the power meter frequency as 40.05GHz.
- 30) Record the 4051 marker reading L_2 and the power meter reading L_1 in the 4051 Auxiliary Form.
- 31) Execute Frequency Step Up for the synthesized signal generator and the 4051 analyzer.
- 32) Repeat the power meter frequency as the frequency value to be tested next in B8 of the 4051 Auxiliary Form and repeat step 30 to 31 for each frequency point in the 4051 Auxiliary Form.

Frequency response: (50GHz~67GHz)

- 33) Set the output frequency of the synthesized signal generator as 50.05GHz and the center frequency of the 4051 analyzer as 50.05GHz.
- 34) Set the power meter frequency as 50.05GHz.
- 35) Record the 4051 marker reading L_2 and the power meter reading L_1 in the 4051 Auxiliary Form.
- 36) Execute Frequency Step Up for the synthesized signal generator and the 4051 analyzer.
- 37) Repeat the power meter frequency as the frequency value to be tested next in B8 of the 4051 Auxiliary Form and repeat step 35 to 36 for each frequency point in the 4051 Auxiliary Form.

Frequency response: (3Hz~50MHz)

- 38) Set the 4051 analyzer as follows:

Center frequency as 50MHz

Span: 100Hz

Resolution bandwidth 10 Hz

Marker All Markers Off

- 39) Connect the test instrument as shown in Fig. 8.10 and then connect two output interfaces of the power divider to 50 Ω load and the signal/spectrum analyzer respectively.

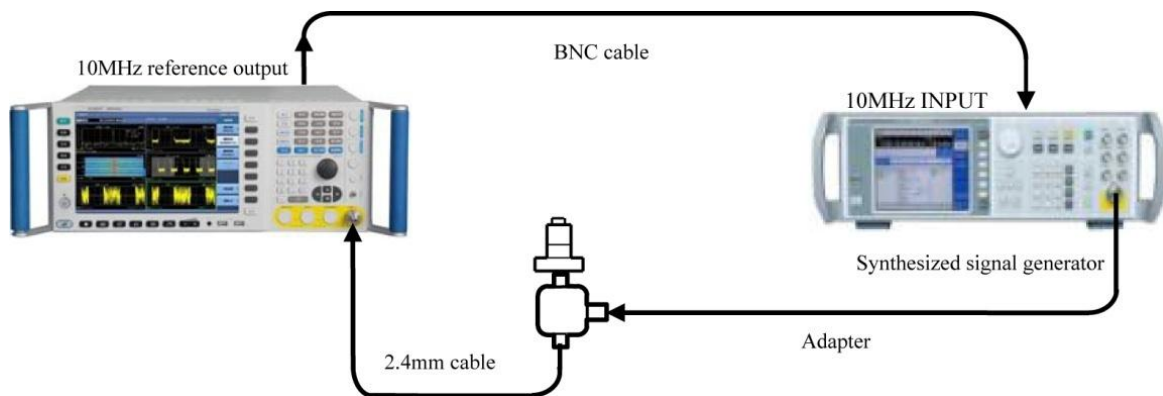

Fig. 8.10 Schematic diagram of frequency response test (3Hz ~ 50MHz)

- 40) Set Peak Search for the 4051 analyzer and adjust the amplitude of the synthesized signal generator until the 4051 amplitude reading is closest to the marker reading recorded in step 5.
- 41) Set Marker Delta for the 4051 analyzer.
- 42) Set the center frequency of the 4051 analyzer and the frequency of the synthesized signal generator as the frequencies listed in the form and record the Marker Delta reading at each frequency point in the “relative 50 MHz amplitude error” column in B8 of the 4051 Auxiliary Form.
- 43) Repeat step 37 for each frequency point in the form.
- 44) Record the 50 MHz amplitude error of the first point in “amplitude error (band 0, 50 MHz ~ 4 GHz)” in B8 of the 4051 Auxiliary Form in “50 MHz amplitude error” under “amplitude error (band 0, 0 MHz)”.

Frequency response (pre-amplifier on)

8.5 Performance characteristics test

45) Follow step 1 ~ 39 when the pre-amplifier option is provided and set the amplifier in step 3 as on.

d) Test records and data processing

46) Reduce “relative 50 MHz amplitude error” by “50 MHz amplitude error” in the table for each frequency point listed in “amplitude error (band 0, 50 MHz ~ 4 GHz)” in B8 of the 4051 Auxiliary Form and record the result as current frequency point amplitude error in the form.

47) Calculate and record the amplitude error ΔA of relevant frequency point according to the formula (16):

$$\Delta A = L_2 - L_1 \dots\dots\dots (16)$$

Where L_1 refers to the power meter reading (dBm);

L_2 refers to the marker reading of the 4051 analyzer (dBm).

48) Find the positive maximum amplitude error value ΔA_{\max} and the negative minimum amplitude error value ΔA_{\min} of each band and record them in “frequency response statistical results”. The absolute values of such two error values should fall within the frequency response range of the 4051 analyzer, otherwise it will be considered as noncompliant.

49) Calculate the frequency response ΔAP of each band according to the formula (17) and record it in the 4051 Record Sheet.

$$\Delta A_p = \pm \frac{\Delta A_{\max} - \Delta A_{\min}}{2} \dots\dots\dots (17)$$

8.5.1.2.4 Display range**a) Test items**

The display range defines the display scale type, the logarithm scale and the scale unit of the 4051 analyzer.

b) Test procedure

- 1) Connect the power of the 4051 analyzer and execute factory reset after normal startup.
- 2) Logarithm and linear scale types are displayed under the amplitude menu of the 4051.
- 3) Manually set the requirements of “0.1 ~ 20 dB/division, resolution 0.01 dB” in logarithm scale mode.
- 4) The 4051 analyzer has 8 scale units, including dBm, dBmV, dB μ V, dBmA, dB μ A, V, W, A.

c) Test records and data processing

5) If steps 1 ~ 4 can be properly completed, it means the display range meets relevant requirements and “compliant” should be noted in the 4051 Record Sheet, otherwise it should be considered as noncompliant.

8.5.1.2.5 Overall absolute amplitude accuracy**a) Test items**

The calibration signal frequency of the 4051 analyzer is 500 MHz and the amplitude is -20 dBm. The internal amplitude calibration of the 4051 analyzer will use them as the benchmark and the change in the calibration signal amplitude will be introduced to the absolute amplitude measurement accuracy error of the 4051 analyzer.

The signal produced from the signal generator with the same frequency and amplitude with the calibration signal is tested respectively by the signal/spectrum analyzer and the power meter and the reading difference between two test results is considered as the absolute amplitude accuracy of the calibration signal.

The absolute amplitude accuracy of the instrument can be obtained by adding the frequency response of each frequency point with the absolute amplitude accuracy of the 500 MHz calibration signal.

b) Testing block diagram and testing instrument and equipment

Synthesized signal generator (E8257D/1464 is recommended)

8.5 Performance characteristics test

2434/N1914A is recommended for the power meter.

N8487A/71712/R&sZ61 is recommended for the power sensor.

c) Test steps

- 1) Zero and calibrate the power meter. Connect the tested instrument according to solid lines in Fig. 8.11 and connect the output of the signal generator to the power meter. Reset the 4051 analyzer and complete all calibrations without prompted error messages.

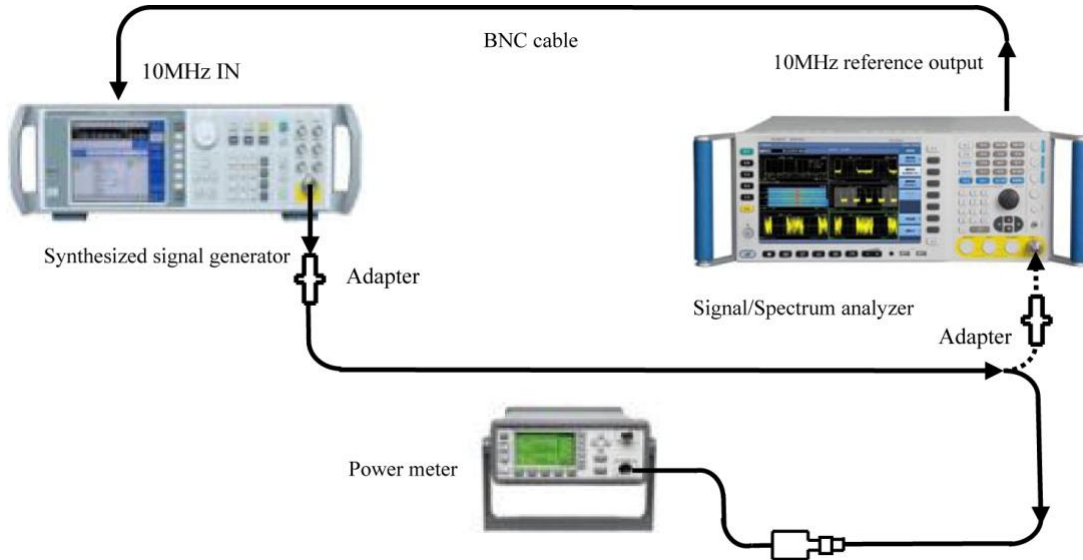

Fig. 8.11 Schematic diagram of overall absolute amplitude accuracy test

- 2) Set the output frequency of the synthesized signal generator as 500 MHz and the amplitude as -20 dBm.
- 3) Set the power meter frequency as 500 MHz and record the power meter reading in the column L1 of the 4051 Auxiliary Form.
- 4) Change the connections in the test according to dotted lines in Fig. 8.11 to connect the cable via the adapter to the 4051 analyzer.
- 5) Set the 4051 analyzer as follows:

Center frequency: 500MHz

Span: 0Hz

Resolution bandwidth: 300kHz

Video bandwidth: 30kHz

- 6) Execute Peak Search and record the 4051 marker reading L2 in B9 of the 4051 Auxiliary Form.

d) Test records and data processing

- 7) Calculate 500 MHz absolute amplitude accuracy ΔA_{500} of the frequency point according to the formula (18) and record the result in the 4051 Record Sheet:

$$\Delta A_{500} = L_2 - L_1 \dots\dots\dots (18)$$

Where L_1 refers to the power meter reading (dBm);

L_2 refers to the marker reading of the 4051 analyzer (dBm).

- 8) Calculate with the test result indicated in Section 8.5.1.2.3 for each band according to the formula (19) and record the calculation result as the overall absolute amplitude accuracy ΔALL in the 4051 Record Sheet:

8.5 Performance characteristics test

$$\Delta A_{ALL} = \pm \left(\left| \Delta A_{500} \right| + \left| \Delta A_p \right| \right) \dots \dots \dots (19)$$

Where, ΔA_{500} refers to the 500 MHz absolute amplitude accuracy (dB);

ΔA_p refers to the frequency response data obtained from the test in 4.6.12.2.3 (dB).

8.5.1.2.6 Input voltage standing-wave ratio**a) Test items**

Impedance mismatch will lead to production of reflected voltage. The incident voltage and the reflected voltage transmit in two opposite directions to produce certain interference pattern. The standing-wave ratio is the ratio of the maximum value against the minimum value of the voltage pattern envelop.

The standing-wave test function of the vector network analyzer can be directly used to test the input voltage standing-wave ratio at the input interface of the signal/spectrum analyzer.

b) Testing block diagram and testing instrument and equipment

N5247A is recommended for the network analyzer.

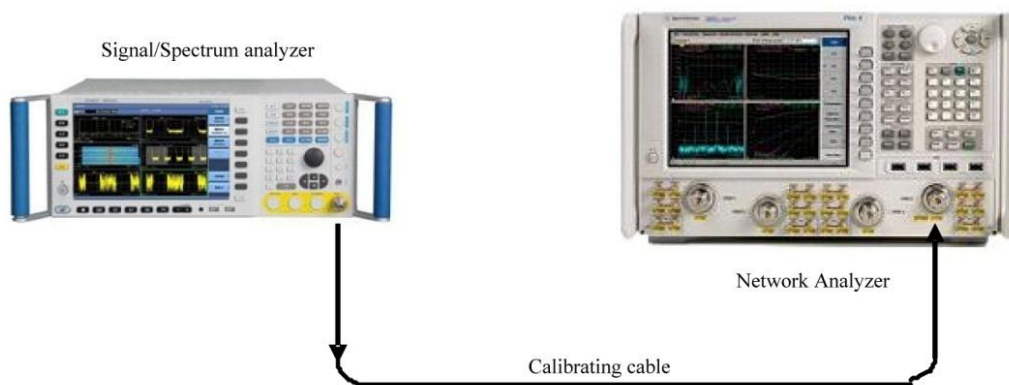

Fig. 8.12 Schematic diagram of input interface voltage standing-wave ratio test

c) Test steps

- 1) Reset the 4051 analyzer and check to confirm the input attenuator is set as 10 dB.
- 2) Set the frequency range and the source output power of the network analyzer properly and select VSWR display mode.
- 3) Select calibration cable for the network analyzer for single-interface measurement and calibration (including open circuit, short circuit and load calibration).
- 4) After calibration, take the calibrated part from the calibration cable and connect the test cable interface to the output interface of the 4051 analyzer as shown in Fig. 8.11.
- 5) Use the marker function to read out the VSWR of corresponding band of the 4051 analyzer in the network analyzer.

d) Test records and data processing

- 6) Record measurement results in the 4051 Record Sheet.

8.5.1.2.7 Resolution bandwidth switching error**a) Test items**

The resolution bandwidth is affected by configured parameters during switching, resulting in gain error. Such error has been modified during instrument design, however, certain amplitude error still exists due to calibration methods and environmental change.

8.5 Performance characteristics test

The signal peak amplitude offset displayed in the signal/spectrum analyzer will be the resolution bandwidth switching error only by inputting a stable signal and changing the resolution bandwidth of the 4051 analyzer.

b) Test procedure

- 1) Reset the 4051 analyzer and complete all calibrations.
- 2) Set the 4051 input as the calibration interface and the calibration source as 500 MHz and set the following parameters:
Center frequency: 500MHz
Span: 500kHz
Reference level-18 dBm
Logarithmic scale dB/division1 dB
Resolution bandwidth: 300kHz
VBW/RB: 0.1
- 3) Execute Peak Search and Marker Delta.
- 4) Set the 4051 analyzer according to the resolution bandwidth listed in the 4051 Auxiliary Form and set the ratio of the frequency span against the resolution bandwidth as approximately 2 times.
- 5) Execute Peak Search and record the marker difference reading as current resolution bandwidth switching error.
- 6) Repeat Step 4 to 5 for remaining resolution bandwidths in B12 of the 4051 Auxiliary Form.

c) Test records and data processing

- 7) Determine values in all test items in B12 of the 4051 Auxiliary Form and find the positive maximum error value ΔA_{max} and the negative minimum error value ΔA_{min} of each band. Such two values should fall within the resolution bandwidth switching error range of the 4051 analyzer, otherwise it will be considered as noncompliant.
- 8) Calculate the resolution bandwidth switching error ΔA according to the formula (20) and record it in the 4051 Record Sheet.

$$\Delta A = \pm \frac{\Delta A_{max} - \Delta A_{min}}{2} \dots\dots\dots (20)$$

8.5.1.2.8 Reference level

a) Test items

The calibrated vertical scale position on the screen of the signal/spectrum analyzer is used as the reference for amplitude measurement and the reference level usually refers to the top scale line. Switching of the reference level will cause the linkage of gain/attenuation. The reference level switching error is used to assess the error of the switch gain of the 4051 analyzer. By changing the set value of the standard attenuator, the error between the marker reading difference and the calibration value of the standard attenuator caused by switching of the reference level will be the reference level switching error.

b) Test equipment

Synthesized signal generator (E8257D/1464 is recommended)

84906L is recommended for the standard attenuator.

11713C is recommended for the attenuator drive.

c) Test steps

8.5 Performance characteristics test

- 1) Connect the instrument as shown in Fig. 8.13, reset the 4051 analyzer and set it to provide frequency reference for the signal generator. Set the frequency of the signal generator as 30.02 MHz and the output amplitude as -3 dBm.
- 2) Use 11713C to reduce the 84906L standard attenuator to 0 dB attenuation. Record the standard value of the standard attenuator at 30.02 MHz frequency point in the 4051 Auxiliary Form.
- 3) Reset the 4051 analyzer, execute all calibrations, wait until all calibrations are done and set the following parameter:

Center frequency: 30.02MHz

Logarithm scale 1dB/division

Resolution bandwidth: 1kHz

Video bandwidth: 30Hz

RF gain best sensitivity

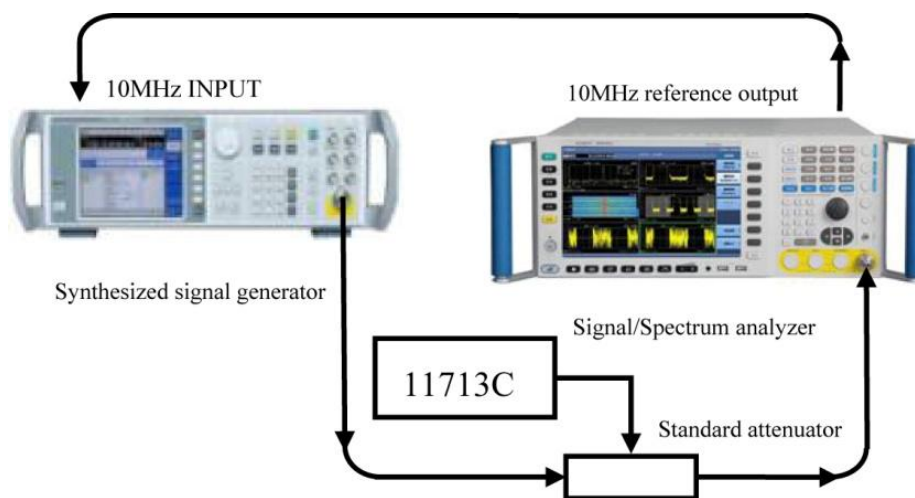

Fig. 8.13 Schematic diagram of reference level switching error

- 4) Execute Peak Search and adjust the output amplitude of the synthesized signal generator to display the signal 2 ~ 3 divisions below the reference level.
- 5) Execute Marker Delta.
- 6) Use 11713C to reduce the 84906L standard attenuator to 10 dB attenuation.
- 7) Set the reference level of the 4051 analyzer as -10 dBm, execute Continuous Measurement Off and wait for the sweep operation to complete.
- 8) Record the Marker Delta amplitude reading ΔL of the 4051 analyzer in B11 of the 4051 Auxiliary Form.
- 9) Repeat step 6 ~ 8 according to the reference level parameter and the set value of the standard attenuator in B11 of the 4051 Auxiliary Form.

Calculate the relevant reference level switching error ΔA_r according to the formula (21) and record it in the 4051 Record Sheet:

$$\Delta A_{ref} = \Delta L + A_{ATT} \dots\dots\dots (21)$$

Where ΔL refers to the Marker Delta amplitude reading of the 4051 analyzer (dB);

A_{ATT} refers to the calibration value of the standard attenuator (dB).

d) Test records and data processing

- 10) Determine values in results of all test items in B11 of the 4051 Auxiliary Form and find the positive maximum error value $\Delta A_{ref\ max}$ and the negative minimum error value $\Delta A_{ref\ min}$. The absolute values of

8.5 Performance characteristics test

such two errors should fall within the range of reference level switching error, otherwise, they will be considered as noncompliant.

- 11) Calculate the reference level switching error ΔA according to the formula (22) and record it in the 4051 Record Sheet.

$$\Delta A = \pm \frac{\Delta A_{ref \max} - \Delta A_{ref \min}}{2} \dots\dots\dots (22)$$

8.5.1.2.9 Display scale fidelity

a) Test items

The display scale fidelity is the error between the vertical scale on the screen of the signal/spectrum analyzer and its theoretical value. It is used to assess scale accuracy of the 4051 analyzer.

When testing fidelity with 10 dB/division, the resolution bandwidth of the schematic diagram is 1 kHz and the input signal start amplitude is set as 0 dBm reference level. When the signal amplitude is reduced, the displayed signal amplitude is compared with the reference level. The 4051 analyzer provides 10 MHz frequency reference for the signal generator.

b) Test equipment

Synthesized signal generator (E8257D/1464 is recommended)

84906L is recommended for the standard attenuator.

11713C is recommended for the attenuator drive.

c) Test steps

- 1) Connect the instrument as shown in Fig. 8.12, reset the 4051 analyzer and set it to provide frequency reference for the signal generator. Set the frequency of the signal generator as 30.02 MHz and the output amplitude as 0 dBm.
- 2) Use 11713C to reduce the 84906L standard attenuator to 0 dB attenuation. Record the standard value of the standard attenuator at 30.02 MHz frequency point in the 4051 Auxiliary Form.
- 3) Reset the 4051 analyzer, execute all calibrations, wait until all calibrations are done and set the following parameter:
Center frequency: 30.02MHz
Span: 10kHz
Resolution bandwidth: 1kHz
Video bandwidth: 30Hz
- 4) Adjust the output amplitude of the synthesized signal generator to display the signal peak at the reference level.
- 5) Execute Peak Search and Marker Delta.
- 6) Use 11713C to reduce the 84906L standard attenuator to 10 dB attenuation.
- 7) Set and execute Continuous Measurement Off and wait for the sweep operation to complete.
- 8) Record the Marker Delta amplitude reading ΔL of the 4051 analyzer in B12 of the 4051 Auxiliary Form.
- 9) Turn on Average when the reading fluctuation of the Marker Delta of the signal/spectrum analyzer exceeds relevant requirement.
- 10) Repeat step 6 ~ 9 according to the set value of the standard attenuator in B12 of the 4051 Auxiliary Form.
- 11) Calculate the relevant display scale error ΔAV according to the formula (23) and record it in the 4051 Record Sheet:

8.5 Performance characteristics test

$$\Delta A_V = \Delta L + A_{ATT} \dots\dots\dots (23)$$

Where ΔL refers to the Marker Delta amplitude reading of the 4051 analyzer (dB);

A_{ATT} refers to the calibration value of the standard attenuator (dB).

d) Test records and data processing

12) Determine values in results of all test items in B12 of the 4051 Auxiliary Form and find the positive maximum error value $\Delta A_{V_{max}}$ and the negative minimum error value $\Delta A_{V_{min}}$. The absolute values of such two errors should fall within the range of reference scale fidelity, otherwise, they will be considered as noncompliant.

13) Calculate the display fidelity ΔA according to the formula (24) and record it in the 4051 Record Sheet.

$$\Delta A = \pm \frac{\Delta A_{V_{max}} - \Delta A_{V_{min}}}{2} \dots\dots\dots (24)$$

8.5.1.2.10 Trace detector mode**a) Test items**

The detector mode refers to a way of displaying signal energy. The AV 4051 provides 7 detector modes including normal, Peak, negative peak, sample, video average, power average and voltage average.

b) Test procedure

- 1) Rest the 4051 analyzer and enter the second page of the trace menu to access 5 detector modes, including normal, Peak, sample, negative peak and average (the average detector mode is classified into three types: video, power and voltage), in which normal mode is the default detector mode.
- 2) Change the detector mode of the 4051 analyzer to change corresponding trace and display it based on the set detector mode.

c) Test records and data processing

3) If steps 1 ~ 3 can be properly completed, it means the trace detector mode is normal and meets relevant requirements. In this case, “compliant” should be noted in the 4051 Record Sheet, otherwise it should be considered as noncompliant.

8.5.1.3 Dynamic range test**8.5.1.3.1 1dB gain compression****a) Test items**

When the input signal level increases, unit circuits of the signal/spectrum analyzer, including the mixer and the amplifier are working close to the saturation point and the input signal component at such time will no longer change linearly with the input signal. Usually, the input level 1 dB lower than the input linear value offset is considered as 1 dB compression point.

Input a low power signal and then a high power signal with frequency interval of 3 MHz into the signal/spectrum analyzer. Change the power of the high power signal until it causes measured value of the low power signal to lower to the closest point to 1dB to obtain the power value of the high power signal, which is also the 1 dB gain compression value.

b) Test equipment

2434/E4418B is recommended for the power meter.

E8257D/1464 is recommended for synthesized signal generator #1.

E8257D/1464 is recommended for synthesized signal generator #2.

8.5 Performance characteristics test

N8487A/R&S Z61 is recommended for the power sensor.

RF directional coupler

MMW directional coupler

c) Test steps

Gain compression (10 MHz ~ 40 MHz)

- 1) The power meter is zeroed and calibrated.
- 2) Reset 4051 and set the center frequency as 30 MHz, the frequency span as 1 kHz, the reference level as -20 dBm, the display scale as 1 dB/division and the attenuator as 0 dB.
- 3) Set the frequency of synthesized signal generator#1 and #2 as 33 MHz and 30 MHz respectively, the power output as -10 dBm and the output of synthesized signal generator#2 as off.
- 4) Connect the instrument according to solid lines in Fig. 8.13 with the output of the RF direction couple connected via the adapter to the power sensor.
- 5) Set the test frequency of the power meter as the output frequency of synthesized signal generator#1. Adjust the output power level of signal generator#1 to change current power meter reading to the mixer level of current test section under 1 dB gain compression and turn off the output of signal generator#1.
- 6) Change the connections in the test according to dotted lines in Fig. 8.13, turn on the output of synthesized signal generator #2 and adjust the power level of synthesized signal generator #2 to display the signal peak 2 ~3 divisions under the 4051 reference level.
- 7) Execute Peak Search and turn on Marker Delta.
- 8) Turn on the output of synthesized signal generator#1. Read out the absolute value of current marker difference amplitude. If such value is lower than 1 dB, it should be recorded in the 4051 Record Sheet. Otherwise, it will be considered as noncompliant.
- 9) Turn off the output of synthesized signal generator#1.

Gain compression (40MHz ~ 200MHz)

- 10) Connect the instrument according to solid lines in Fig. 8.13. Set the center frequency of the 4051 analyzer as 100 MHz, the frequency of synthesized signal generator#1 as 103 MHz and the frequency of synthesized signal generator#2 as 100 MHz.
- 11) Repeat step 5 ~ 8.
- 12) Turn off the output of synthesized signal generator#1.

Gain compression (200MHz ~ 4GHz)

- 13) Connect the instrument according to solid lines in Fig. 8.13. Set the center frequency of the 4051 analyzer as 200 MHz, the frequency of synthesized signal generator#1 as 2.003 GHz and the frequency of synthesized signal generator#2 as 2 GHz.
- 14) Set the power meter frequency as 2GHz.
- 15) Repeat step 5 ~ 8.
- 16) Turn off the output of synthesized signal generator#1.

Gain compression (4GHz ~ 9GHz)

- 17) Connect the instrument according to solid lines in Fig. 8.13. Set the center frequency of the 4051 analyzer as 5 GHz, the frequency of synthesized signal generator#1 as 5.003 GHz and the frequency of synthesized signal generator#2 as 5 GHz.
- 18) Use the MMW directional coupler to replace the RF directional coupler.
- 19) Repeat step 5 ~ 8.

8.5 Performance characteristics test

20) Turn off the output of synthesized signal generator#1.

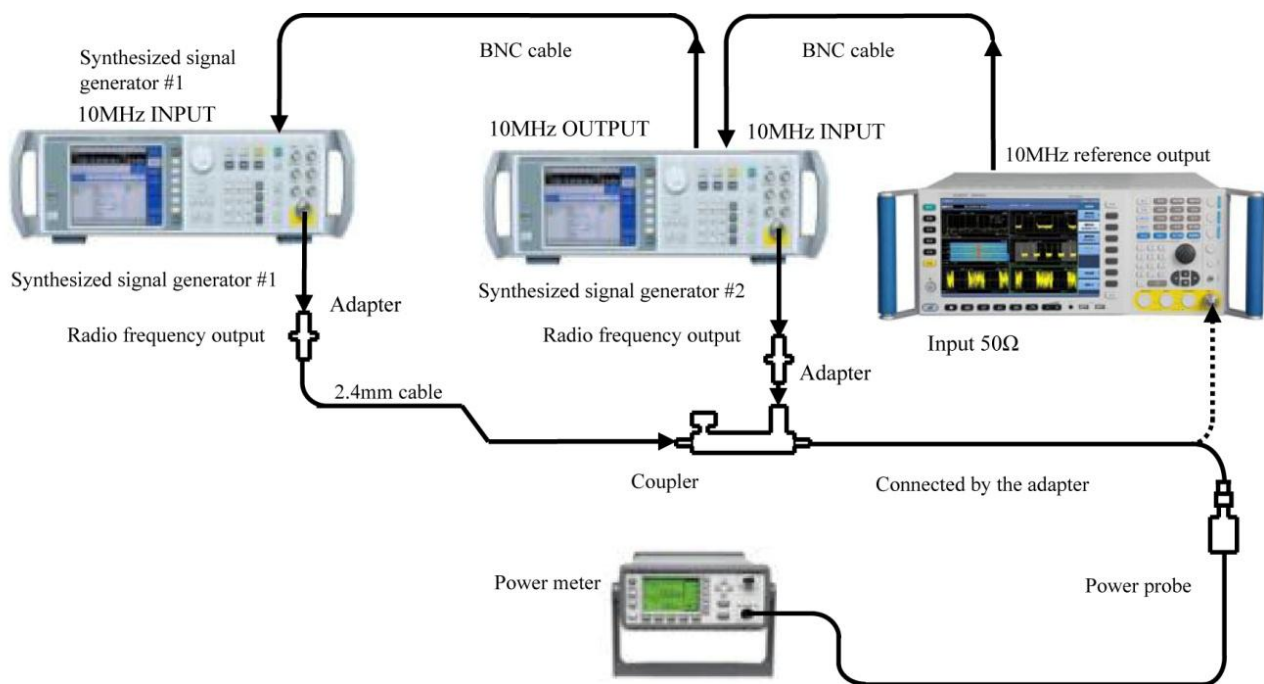

Fig. 8.13 Schematic diagram of 1 dB gain compression test

Gain compression (9GHz ~ 67GHz)

21) Connect the instrument according to solid lines in Fig. 8.13. Set the center frequency of the 4051 analyzer as 15 GHz, the frequency of synthesized signal generator#1 as 15.003 GHz and the frequency of synthesized signal generator#2 as 15 GHz.

22) Use the MMW directional coupler to replace the RF directional coupler.

23) Repeat step 5 ~ 8.

24) Turn off the output of synthesized signal generator#1.

8.5.1.3.2 Display average noise level

a) Test items

The display average noise level refers to the background noise detected by the signal/spectrum analyzer without any external noise or signal.

The normalized noise level detected without any external noise or signal as well as the minimum attenuation is the measured value of the display average noise level. When the peak test value is the residual response, relevant test frequency points should be avoided.

b) Test equipment

50 Ω loads

c) Test steps

Average noise display (10MHz to 1GHz)

1) Connect the 50 Ω load and the adapter to the input interface of the 4051 analyzer as shown in Fig. 8.14.

2) Reset 4051 and set as follows:

Start frequency: 10MHz

Stop Frequency: 1GHz

Reference level -40 dBm

8.5 Performance characteristics test

Average Num 10

Set as Off when the pre-amplifier option is provided.

- 3) Turn on Trace Average. Set Peak Search for the 4051 analyzer, set the peak value as the center frequency, turn on Noise Marker and set as follows:

Span: 100Hz

Reference level -80 dBm

Attenuation 0 dB

Single measurement

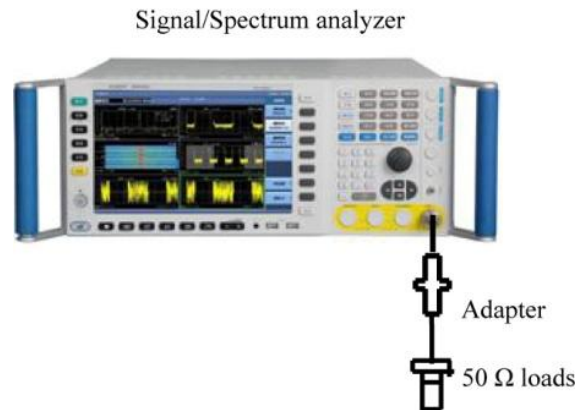

Fig. 8.14 Schematic diagram of display average noise level test

- 4) Read the mark amplitude. If this value is less than or equal to the requirement of the 4051 analyzer, record it as the display average noise level within the range from 10 MHz to 1GHz into the corresponding test item of the 4051 Record Sheet. Otherwise, it should be considered as noncompliant.

Average noise display (1GHz to 2GHz)

- 5) Reset 4051 and set as follows:

Reference level -40 dBm

Start frequency: 1GHz

Stop Frequency: 2GHz

Marker All Markers Off

- 6) Repeat step 3 ~ 4.
- 7) Read the mark amplitude. If this value is less than or equal to the requirement of the 4051 analyzer, record it as the display average noise level within the range from 1GHz ~ 2 GHz into the corresponding test item of the 4051 Record Sheet. Otherwise, it should be considered as noncompliant.

Average noise display (2GHz to 3GHz)

- 8) Reset 4051 and set as follows:

Reference level -50 dBm

Start frequency: 2GHz

Stop Frequency: 3GHz

Marker All Markers Off

- 9) Repeat step 3 ~ 4.

8.5 Performance characteristics test

- 10) Read the mark amplitude. If this value is less than or equal to the requirement of the 4051 analyzer, record it as the display average noise level within the range from 2GHz ~ 3GHz into the corresponding test item of the 4051 Record Sheet. Otherwise, it should be considered as noncompliant.

Average noise display (3GHz to 3.6GHz)

- 11) Reset 4051 and set as follows:

Reference level -50 dBm

Start frequency: 3GHz

Stop Frequency: 3.6GHz

Marker All Markers Off

- 12) Repeat step 3 ~ 4.

- 13) Read the mark amplitude. If this value is less than or equal to the requirement of the 4051 analyzer, record it as the display average noise level within the range from 3GHz ~ 3.6GHz into the corresponding test item of the 4051 Record Sheet. Otherwise, it should be considered as noncompliant.

Average noise display (3.6GHz to 4GHz)

- 14) Reset 4051 and set as follows:

Reference level -50 dBm

Starting frequency: 3.6GHz

Ending frequency: 4GHz

Marker All Markers Off

- 15) Repeat step 3 ~ 4.

- 16) Read the mark amplitude. If this value is less than or equal to the requirement of the 4051 analyzer, record it as the display average noise level within the range from 3.6GHz ~ 4GHz into the corresponding test item of the 4051 Record Sheet. Otherwise, it should be considered as noncompliant.

Average noise display (4GHz to 5GHz)

- 17) Reset 4051 and set as follows:

Reference level -30 dBm

Start frequency: 5GHz

Stop Frequency: 9GHz

Marker All Markers Off

- 18) Repeat step 3 ~ 4.

- 19) Read the mark amplitude. If this value is less than or equal to the indicator value of 4051, record it as the displayed average noise level within the range from 4GHz ~ 5GHz into the corresponding test item of “4051 Record Table”; otherwise, the value is unacceptable.

Average noise display (5GHz to 9GHz)

- 20) Reset 4051 and set as follows:

Reference level -30 dBm

Start frequency: 9GHz

Stop Frequency: 18GHz

Marker All Markers Off

8.5 Performance characteristics test

21) Repeat step 3 ~ 4.

22) Read the mark amplitude. If this value is less than or equal to the indicator value of 4051, record it as the displayed average noise level within the range from 5GHz to 9 GHz into the corresponding test item of “4051 Record Table”; otherwise, the value is unacceptable.

Average noise display (18GHz to 26.5GHz)

23) Reset 4051 and set as follows:

Reference level -30 dBm

Start frequency: 18GHz

Stop Frequency: 26.5GHz

Marker All Markers Off

24) Repeat step 3 ~ 4.

25) Read the mark amplitude. If this value is less than or equal to the indicator value of 4051, record it as the displayed average noise level within the range from 40GHz to 50GHz into the corresponding test item of “4051 Record Table”; otherwise, the value is unacceptable.

Average noise display (26.5GHz to 40GHz)

26) Reset 4051 and set as follows:

Reference level -30 dBm

Start frequency: 26.5GHz

Stop Frequency: 40GHz

Marker All Markers Off

27) Repeat step 3 ~ 4.

28) Read the mark amplitude. If this value is less than or equal to the indicator value of 4051, record it as the displayed average noise level within the range from 40GHz to 50GHz into the corresponding test item of “4051 Record Table”; otherwise, the value is unacceptable.

Average noise display (26.5GHz to 40GHz)

29) Reset 4051 and set as follows:

Reference level -30 dBm

Start frequency: 40GHz

Stop Frequency: 50GHz

Marker All Markers Off

30) Repeat step 3 ~ 4.

31) Read the mark amplitude. If this value is less than or equal to the indicator value of 4051, record it as the displayed average noise level within the range from 26.5GHz to 40GHz into the corresponding test item of “4051 Record Table”; otherwise, the value is unacceptable.

Average noise display (40GHz to 50GHz)

32) Reset 4051 and set as follows:

Reference level -30 dBm

Starting frequency: 40GHz

Ending frequency: 50GHz

Marker All Markers Off

8.5 Performance characteristics test

- 33) Repeat step 3 ~ 4.
- 34) Read the mark amplitude. If this value is less than or equal to the indicator value of 4051, record it as the displayed average noise level within the range from 40GHz to 50GHz into the corresponding test item of “4051 Record Table”; otherwise, the value is unacceptable.

Average noise display (50GHz~67GHz)

- 35) Reset 4051 and set as follows:

Reference level -30 dBm

Starting frequency: 50GHz

Ending frequency: 67GHz

MarkerAll Markers Off

- 36) Repeat step 3 ~ 4.
- 37) Read the mark amplitude. If this value is less than or equal to the indicator value of 4051, record it as the displayed average noise level within the range from 50GHz to 67GHz into the corresponding test item of “4051 Record Table”; otherwise, the value is unacceptable.

Display average noise (pre-amplifier on)

- 38) Follow step 1 ~ 34 when the pre-amplifier option is provided and set the amplifier in step 3 as on.

8.5.1.3.3 Residual response**a) Test items**

The residual response refers to the discrete response observed on the screen when no input signal enters the signal/spectrum analyzer.

b) Test procedure

- 1) Connect the instrument as shown in Fig. 8.14. Reset the 4051 analyzer and connect 50 matcher at the signal input 50 interface.
Set the 4051 analyzer as follows:
Center frequency: 15.2MHz
Frequency step 28.5MHz
Bandwidth=30MHz
Reference level -50 dBm
Attenuator 0 dB
Resolution bandwidth: 10kHz
RF gain best sensitivity
- 2) Turn on the display line and set the noise level at least 6 dB below such display line at -100 dBm. If not, reduce the frequency span and the resolution bandwidth to lower the noise level. If the frequency span is lowered, reduce the frequency step to no more than 95% of the frequency span. If the zero frequency signal leads to a starting signal amplitude higher than -106 dBm, use the knob to adjust the start frequency point to lower the noise level to under -106 dBm.
- 3) Record the maximum response frequency and the amplitude value of current trace in B13 of the 4051 Auxiliary Form.
- 4) If residual response is suspected, press Single Sweep. The residual response will continue to appear, while the noise peak will disappear. The noise should not be recorded as the residual response.

8.5 Performance characteristics test

- 5) Set the frequency step of the 4051 as once, compare the maximum response amplitude of current trace with the maximum value of the previous response after trace refreshing and save the higher value.
- 6) Check the residual response with the frequency up to 9 GHz following step 2 ~ 5 and record the measured maximum response value at the measurement value of “200 kHz ~ 9 GHz” in B13 of the 4051 Auxiliary Form.

c) Test records and data processing

- 7) Determine measurement values in B13 of the 4051 Auxiliary Form. If the maximum response value is smaller than or equal to the residual response requirement of the 4051 analyzer, it should be recorded in the 4051 Record Sheet, otherwise it should be considered as noncompliant.

8.5.1.3.4 Image response

a) Test items

During frequency mixing, if two signals can mix with the LO signal with the same frequency to generate IF signals of the same frequency and if one original signal has a frequency one IF lower than the LO signal and the other original signal has a frequency one IF higher than the LO signal, then such two original signals can be referred to as the image of each other. The input signal of each frequency of the LO signal has an image and the frequency of the original signal and the image differs by two times of IF.

Set the input signal frequency as the center frequency of the 4051 analyzer for reference amplitude measurement, then tune the synthesized signal generator to a frequency that will cause image, multiple or out-of-band response, measure and record the amplitude difference displayed as the image response.

b) Test equipment

Synthesized signal generator (E8257D/1464 is recommended)

c) Test steps

IF3 image response

- 1) Connect the test equipment as shown in Figure 8.8.
- 2) Set the frequency of the synthesized signal generator as 1 GHz, the power as -4 dBm, the center frequency of the 4051 analyzer as 1 GHz and the test frequency of the power meter as 1 GHz.
- 3) Reset 4051 and set as follows:
 - Span: 10kHz
 - Reference level -10 dBm
 - Attenuation 0 dB
 - Resolution bandwidth: 100Hz
 - Video bandwidth: 10Hz
- 4) Adjust the power level of the synthesized signal generator until the the power meter reading is closest to -10 dBm.
- 5) Execute Peak Search and Marker Delta.
- 6) Set the frequency of the synthesized signal generator and the power meter as the frequencies to enable IF3 image response as listed in the 4051 Record Sheet.
- 7) Adjust the output amplitude of the synthesized signal generator until the the power meter reading is closest to -10 dBm.
- 8) Record the Marker Delta amplitude value in the 4051 Record Sheet.
- 9) Set the 4051 analyzer, the synthesized signal generator and the power meter according to frequencies listed in the 4051 Record Sheet and repeat step 4 ~ 8.

8.5 Performance characteristics test**IF2 image response**

- 10) Set the frequency of the synthesized signal generator as 1 GHz, the power as -4 dBm, the center frequency of the 4051 analyzer as 1 GHz and the test frequency of the power meter as 1 GHz.
- 11) Execute Peak Search and Marker Delta.
- 12) Set the frequency of the synthesized signal generator and the power meter as the frequencies to enable IF2 image response as listed in the 4051 Record Sheet.
- 13) Adjust the output amplitude of the synthesized signal generator until the the power meter reading is closest to -10 dBm.
- 14) Record the Marker Delta amplitude value in the 4051 Record Sheet.
- 15) Set the 4051 analyzer, the synthesized signal generator and the power meter according to frequencies listed in the 4051 Record Sheet and repeat step 11 ~ 14.

IF1 image response

- 16) Set the frequency of the synthesized signal generator as 1 GHz, the power as -4 dBm, the center frequency of the 4051 analyzer as 1 GHz and the test frequency of the power meter as 1 GHz.
- 17) Execute Peak Search and Marker Delta.
- 18) Set the frequency of the synthesized signal generator and the power meter as the frequencies to enable IF1 image response as listed in the 4051 Record Sheet.
- 19) Adjust the output amplitude of the synthesized signal generator until the the power meter reading is closest to -10 dBm.
- 20) Record the Marker Delta amplitude value in the 4051 Record Sheet.
- 21) Set the 4051 analyzer, the synthesized signal generator and the power meter according to frequencies listed in the 4051 Record Sheet and repeat step 17 ~ 21.

8.5.1.3.5 Second harmonic distortion**a) Test items**

When a signal is input to nonlinear devices (such as mixer and amplifier), such nonlinear devices will generate subharmonic for such input signal. The unwanted second harmonic component added to the signal is called second harmonic distortion. The value of the second harmonic distortion can be obtained by inputting sine wave signals as pure as possible (by connecting the external filter) into the signal/spectrum analyzer and testing the second harmonic component caused after such signal passes the signal/spectrum analyzer.

b) Testing block diagram and testing instrument and equipment

Synthesized signal generator (E8257D/1464 is recommended)

500 MHz low-pass filter: 1

1.6GHz low-pass filter: 1

4GHz low-pass filter: 1

26.5GHz low-pass filter: 1

c) Test steps**Second harmonic distortion (10 MHz ~ 0.6 GHz)**

- 1) Connect the 500 MHz low-pass filter and the BNC cable to the instrument as shown in Fig. 8.15. Reset the 4051 analyzer to provide frequency reference for the synthesized signal generator.

8.5 Performance characteristics test

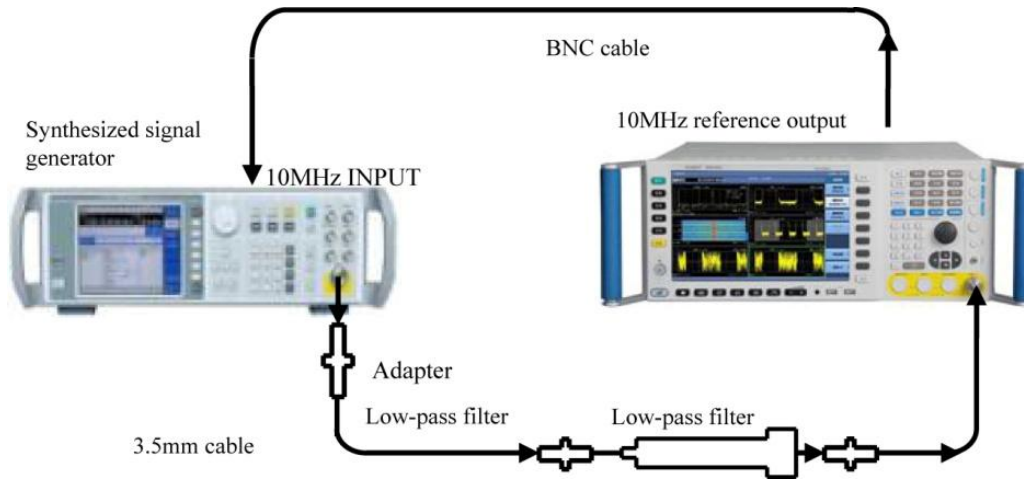

Fig. 8.15 Schematic diagram of second harmonic distortion test

- 2) Set the frequency of the synthesized signal generator as 500 MHz, the amplitude as -15 dBm and the RF output as on.
- 3) Reset 4051 and set as follows:
Center frequency: 500MHz
Span: 200Hz
Reference level -15 dBm
Attenuation 0 dB
- 4) Set Peak Search, adjust the power level of the synthesized signal generator until the 4051 analyzer reading is closest to -15 dBm.
- 5) Set the 4051 analyzer as Single Sweep and wait for the sweep operation to complete. Set Peak Search, Marker Step, Marker Delta and Frequency Step Once. Set the 4051 analyzer as Single Sweep.
- 6) Execute Peak Search after a new sweep is completed. Record the Marker Delta reading as in the 4051 Record Sheet as the second harmonic distortion product of current test band.

Second harmonic distortion (0.6 GHz ~ 2GHz)

- 7) Connect the instrument as shown in Fig. 8.15 and use 1.6 GHz low-pass filter.
- 8) Set the synthesized signal generator frequency as 1.6GHz and the amplitude as -15 dBm.
- 9) Set the 4051 analyzer as follows:
Center frequency: 1.6GHz
Marker All Markers Off
- 10) Repeat step 4 ~ 6.

Second harmonic distortion (2GHz ~ 4.5GHz)

- 11) Connect the instrument as shown in Fig. 8.15 and use 4GHz low-pass filter.
- 12) Set the synthesized signal generator frequency as 4GHz and the amplitude as -15 dBm.
- 13) Set the 4051 analyzer as follows:
Center frequency: 4GHz
Marker All Markers Off
- 14) Repeat step 4 ~ 6.

Second harmonic distortion (4.5 GHz ~ 9 GHz)

8.5 Performance characteristics test

- 15) Connect the instrument as shown in Fig. 8.15 and use 9GHz low-pass filter.
- 16) Set the synthesized signal generator frequency as 8GHz and the amplitude as -15 dBm.
- 17) Set the 4051 analyzer as follows:
 - Center frequency: 8GHz
 - Marker All Markers Off
- 18) Repeat step 4 ~ 6.

Second harmonic distortion (9GHz ~ 25GHz)

- 19) Connect the instrument as shown in Fig. 8.15 and use 26.5GHz low-pass filter.
- 20) Set the synthesized signal generator frequency as 20GHz and the amplitude as -15 dBm.
- 21) Set the 4051 analyzer as follows:
 - Center frequency: 20GHz
 - Marker All Markers Off
- 22) Repeat step 4 ~ 6.

Second harmonic distortion (25GHz~33.5GHz)

- 23) Connect the instrument as shown in Fig. 8.15 and use 40GHz low-pass filter.
- 24) Set the synthesized signal generator frequency as 30GHz and the amplitude as -15 dBm.
- 25) Set the 4051 analyzer as follows:
 - Center frequency: 30GHz
 - Marker All Markers Off
- 26) Repeat step 4 ~ 6.

8.5.1.3.6 Three-order intermodulation distortion**a) Test items**

TOI distortion refers to the unwanted frequency component generated via interactions of two or more input signal spectrum components caused by device nonlinearity.

It is produced by inputting at the same time two sine wave signals with frequency interval of 50 kHz and same power generated by two signal generators into the signal/spectrum analyzer. The Marker function of the signal/spectrum analyzer can be used directly to measure the TOI distortion product.

b) Testing block diagram and testing instrument and equipment

2434/E4418B is recommended for the power meter.

71712A/N8487A is recommended for the power sensor.

E8257D/1464 is recommended for synthesized signal generator #1.

E8257D/1464 is recommended for synthesized signal generator #2.

CTP-3060 is recommended for the isolator.

XTP-1218A is recommended for the isolator.

70603 is recommended for the MMW directional coupler.

RF directional coupler

50 MHz low-pass filter

1.6GHz low-pass filter

8.5 Performance characteristics test

c) Test steps

TOI distortion (10 MHz ~ 200 MHz)

- 1) Set the power meter frequency as 50 MHz after zeroing and calibration.
- 2) Connect the instrument according to solid lines in Fig. 8.16.

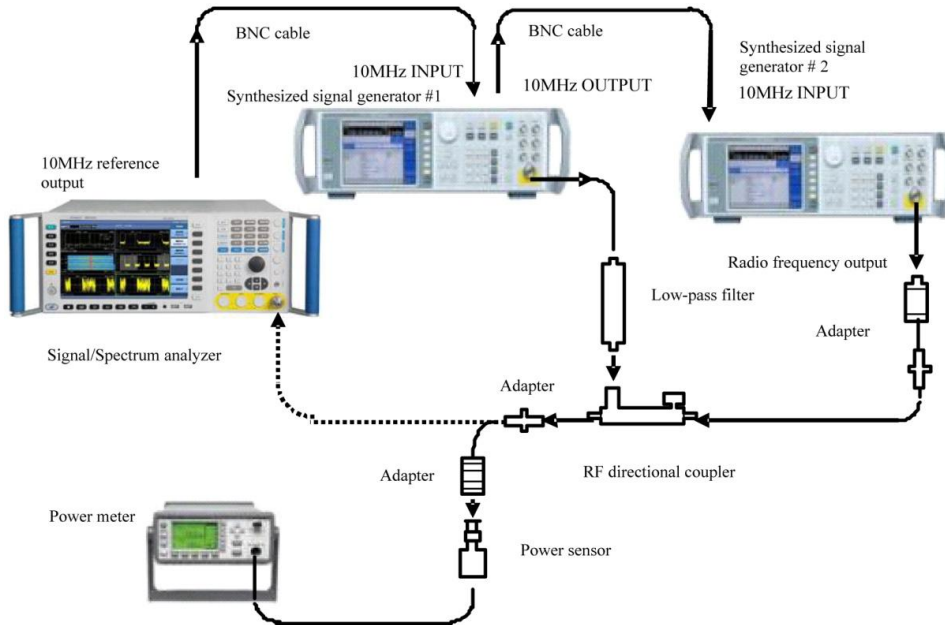

Fig. 8.16 Schematic diagram of TOI distortion test (10 MHz ~ 4 GHz)

- 3) Set the frequency of synthesized signal generator#1 as 50 MHz, the amplitude as +5 dBm and the amplitude step as 0.05 dB.
- 4) Reset synthesized signal generator#2 and set its frequency as 50.05 MHz, its power as -110 dBm and the RF output as off.
- 5) Reset 4051 and set as follows:
 - Center frequency: 50MHz
 - Frequency step: 50kHz
 - Span: 200Hz
 - Reference level -10 dBm
 - Attenuation 0 dB
- 6) Adjust the output amplitude of synthesized signal generator#1 until the the power meter reading is closest to -10 dBm.
- 7) Remove the power sensor from the RF directional coupler. Connect the RF directional coupler via the adapter directly to the input of the 4051 analyzer.
- 8) Set the 4051 analyzer as Peak Search and Marker Reference. Wait for the sweep operation to complete. Execute Marker Delta and Frequency Step Once.
- 9) Turn on the RF output of synthesized signal generator #2 and set the power as -10 dBm.
- 10) Set the 4051 analyzer as Peak Search.
- 11) Adjust the power level of synthesized signal generator#1 until the the Marker Delta reading of the 4051 analyzer is closest to 0 dBm.
- 12) Set the 4051 analyzer as Marker Delta and the center frequency as step down twice. Wait for the sweep operation to complete. Set Video Average as 5 times and execute Single Sweep. Wait until Video Average

8.5 Performance characteristics test

5 is displayed in the grid. Execute Peak Search and record obtained Marker Delta reading of the 4051 as the TOI distortion lower product in B14 of the 4051 Auxiliary Form.

- 13) Set the center frequency of the 4051 analyzer as step up for three times. Execute Peak Search after setting Single Sweep. The obtained Marker Delta reading of the 4051 is the TOI distortion upper product. in B14 of the 4051 Auxiliary Form.

TOI distortion (200MHz ~ 4GHz)

- 14) Set the frequency of synthesized signal generator#1 as 1.5 GHz, the power as +5 dBm and the RF output as on.
- 15) Set the frequency of synthesized signal generator#2 as 1.50005 GHz, the signal power as -110 dBm and the RF output as off.
- 16) Set the power meter frequency as 1.5GHz.
- 17) Reset the 4051 analyzer and set the center frequency as 1.5 GHz.
- 18) Repeat step 6 ~ 13.

TOI distortion (4GHz ~ 9GHz)

- 19) Connect the instrument as shown in Fig. 8.17 and use the MMW directional coupler to replace the RF directional coupler in Fig. 8.16.
- 20) Set the frequency of synthesized signal generator#1 as 5GHz, the power as +5 dBm and the RF output as on.
- 21) Set the frequency of synthesized signal generator#2 as 5.00005GHz, the signal power as -110 dBm and the RF output as off.
- 22) Set the power meter frequency as 5GHz.
- 23) Reset the 4051 analyzer and set the center frequency as 5 GHz.
- 24) Repeat step 6 ~ 13.

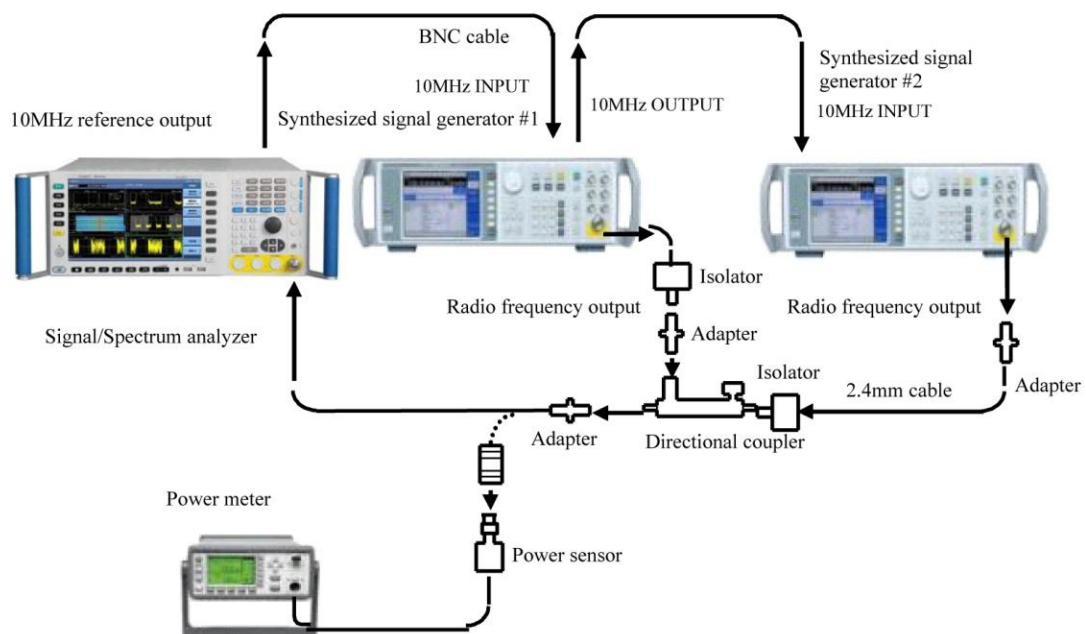

Fig. 8.17 Schematic diagram of TOI distortion test (4GHz ~ 50GHz)

TOI distortion (9GHz ~ 18GHz)

8.5 Performance characteristics test

- 25) Set the frequency of synthesized signal generator#1 as 15GHz, the power as+5 dBm and the RF output as on.
- 26) Set the frequency of synthesized signal generator#2 as 15.00005GHz, the signal power as -110 dBm and the RF output as off.
- 27) Set the power meter frequency as 5GHz.
- 28) Reset the 4051 analyzer and set the center frequency as 5GHz.
- 29) Repeat step 6 ~ 13.

TOI distortion (18GHz ~ 50GHz)

- 30) Set the frequency of synthesized signal generator#1 as 35GHz, the power as+5 dBm and the RF output as on.
- 31) Set the frequency of synthesized signal generator#2 as 35.00005GHz, the signal power as -110 dBm and the RF output as off.
- 32) Set the power meter frequency as 35GHz.
- 33) Reset the 4051 analyzer and set the center frequency as 35GHz.
- 34) Repeat step 6 ~ 13.

TOI distortion (50GHz~67GHz)

- 35) Set the frequency of synthesized signal generator#1 as 55GHz, the power as+5 dBm and the RF output as on.
- 36) Set the frequency of synthesized signal generator#2 as 55.00005GHz, the signal power as -110 dBm and the RF output as off.
- 37) Set the power meter frequency as 55GHz.
- 38) Reset the 4051 analyzer and set the center frequency as 55GHz.
- 39) Repeat step 6 ~ 13.

d) Test records and data processing

- 40) Select the maximum value in the lower and upper TOI distortion products of the same frequency as the TOI distortion product ΔA of the mixer level at L (0 ~ L0(-10 dBm). Calculate the TOI intercept point according to the formula (25) and record the result in the 4051 Record Sheet if it meets relevant requirement. Otherwise, the result will be considered as noncompliant.

$$TOI = L_0 - \frac{\Delta A}{2} \dots\dots\dots (25)$$

8.5.1.3.7 Phase noise

a) Test items

The phase noise is used to reflect the short-term stability of LO signal frequency of the signal/spectrum analyzer.

The reference sine signal of 1 GHz and 0 dBm can be measured at 100 Hz, 1 kHz, 10 kHz and 100 kHz offset carrier. The noise level at each frequency offset of the reference sine signal should be at least 6 dB higher than that of the signal/spectrum analyzer. If there is spurious response at set frequency offset during test, such spurious response should be eliminated and measurement should be made near relevant frequency offset.

b) Test equipment

E8257D is recommended for the synthesized signal generator.

c) Test steps

8.5 Performance characteristics test

- 1) Connect the test instrument as shown in Fig. 8.18 and connect the signal output interface of the synthesized signal generator to the signal input interface of the 4051 analyzer.

Set the signal generator as follows:

Frequency 1 GHz

Amplitude 0 dBm

- 2) Reset the 4051 analyzer and set the center frequency as 1 GHz and the frequency span as 100 kHz.
- 3) Reduce the frequency span of the 4051 analyzer to display the signal in the center of the screen and finally lower it to 200 Hz.
- 4) Adjust the amplitude of the synthesized signal generator to display the signal peak at the reference level.
- 5) Set the 4051 analyzer as Peak Search, turn on Nose Marker and Marker Delta functions and execute Video Average for 10 times and Single Sweep.
- 6) After single measurement, read the amplitude difference of the noise marker at 100 Hz and -100 Hz frequency offsets as the noise level at +100 Hz and -100 Hz frequency offset respectively and record them in the 4051 Record Sheet.

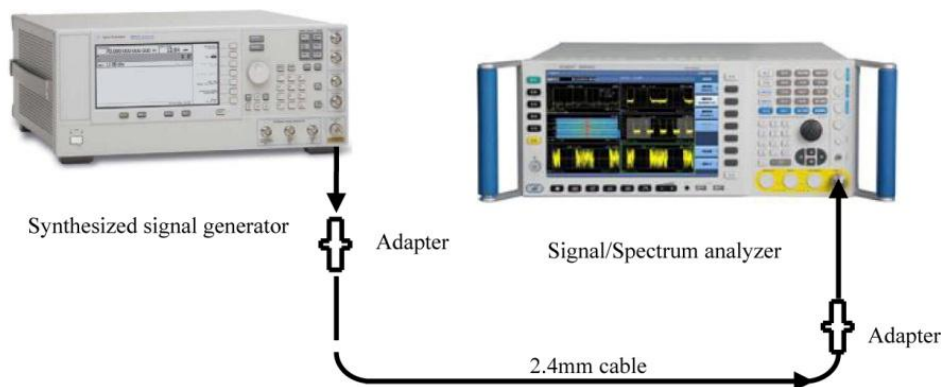

Fig. 8.18 Schematic diagram of phase noise test

- 7) Set the 4051 analyzer as Continuous Sweep.
- 8) Set the frequency span of the 4051 analyzer as 2 kHz, 20 kHz and 200 kHz, repeat step 5 ~ 7 and test the noise level at ± 1 kHz, ± 10 kHz and ± 100 kHz frequency offset.

8.5.2 Record sheet of performance characteristics of signal/spectrum analyzer

Table 8.4-1 Inspection Records of 4051 Signal/Spectrum Analyzer(Group A)

Instrument No.:

Tester:

Test conditions:

Testing date:

No.	Inspection item	Unit	Standard	Inspection result
1	Design and structure	/	The instrument is clean and neat; the panel signs are clear; keys are easy to use; each connector is convenient and properly in place.	
2	Function	/	Spectrum Analysis	
			Power Suite Measurement	
			I/Q Analysis	
			Analog Modulation Measurement (optional)	
			Phase Noise Test (optional)	
			Pulse Signal Analysis (optional)	

8.5 Performance characteristics test

			Transient Signal Analysis (optional)	
			Calibration	
			Self-test	
			Maximum Analysis Bandwidth (I/Q mode)	MHz
3	Frequency range	/	DC coupling: 3 Hz to the upper limit of the frequency range of relevant model	
			AC coupling: 10 MHz to the upper limit of the frequency range of relevant model	
4	Frequency reference	/	Frequency accuracy: $\pm 5.50E-008$	
5	Residual FM (N refers to LO harmonic orders)	Hz	3Hz ~ 1.2GHz (N=0.5) :	≤ 0.125
			3Hz ~ 4.0GHz (N=1) :	≤ 0.25
			4GHz ~ 9GHz (N=1) :	≤ 0.25
			9GHz ~ 18GHz (N=2) :	≤ 0.50
			18GHz ~ 26.5GHz (N=4) :	≤ 1.00
			26.5GHz ~ 40GHz (N=4) :	≤ 1.00
			40GHz ~ 50GHz (N=8) :	≤ 2.00
			50GHz ~ 67GHz (N=8) :	≤ 2.00
6	Frequency readout accuracy	kHz	1.5GHz(frequency span 200kHz):	± 0.39
		kHz	1.5GHz(frequency span 5MHz):	± 10.08
		kHz	1.5GHz(frequency span 50MHz):	± 100.06
		kHz	1.5GHz (frequency span 200MHz):	± 399.98
		kHz	1.5GHz (frequency span 500MHz):	± 899.83
		MHz	1.5GHz (frequency span 1GHz):	± 1.65
		kHz	3.0GHz(frequency span 200kHz):	± 0.48
		kHz	3.0GHz(frequency span 5MHz):	± 10.16
		kHz	3.0GHz(frequency span 50MHz):	± 100.14
		kHz	3.0GHz (frequency span 200MHz):	± 400.07
		kHz	3.0GHz (frequency span 500MHz):	± 899.92
		MHz	3.0GHz (frequency span 1GHz):	± 1.65
		kHz	5.0GHz(frequency span: 200kHz):	± 0.59
		kHz	5.0GHz(frequency span: 5MHz):	± 10.27
		kHz	5.0GHz(frequency span: 50MHz):	± 100.25
		kHz	5.0GHz (frequency span: 200MHz):	± 400.18
		kHz	5.0GHz (frequency span: 500MHz):	± 900.03
		MHz	5.0GHz (frequency span: 1GHz):	± 1.65
		kHz	15GHz(frequency span: 200kHz):	± 1.14
		kHz	15GHz(frequency span: 5MHz):	± 10.82
		kHz	15GHz(frequency span: 50MHz):	± 100.80
		kHz	15GHz (frequency span: 200MHz):	± 400.73
		kHz	15GHz (frequency span: 500MHz):	± 900.58
		MHz	15GHz (frequency span: 1GHz):	± 1.65
		kHz	25GHz(frequency span: 200kHz):	± 1.69
		kHz	25GHz(frequency span: 5MHz):	± 11.37
		kHz	25GHz(frequency span: 50MHz):	± 101.35
		kHz	25GHz (frequency span: 200MHz):	± 401.28
kHz	25GHz (frequency span: 500MHz):	± 901.13		

8.5 Performance characteristics test

		MHz	25GHz (frequency span: 1GHz):	±1.65	
		kHz	35GHz(frequency span: 200kHz):	±2.24	
		kHz	35GHz(frequency span: 5MHz):	±11.92	
		kHz	35GHz(frequency span: 50MHz):	±101.90	
		kHz	35GHz (frequency span: 200MHz):	±401.83	
		kHz	35GHz (frequency span: 500MHz):	±901.68	
		MHz	35GHz (frequency span: 1GHz):	±1.65	
		kHz	45GHz(frequency span: 200kHz):	±2.79	
		kHz	45GHz(frequency span: 5MHz):	±12.47	
		kHz	45GHz(frequency span: 50MHz):	±102.45	
		kHz	45GHz (frequency span: 200MHz):	±402.38	
		kHz	45GHz (frequency span: 500MHz):	±902.23	
		MHz	45GHz (frequency span: 1GHz):	±1.65	
		kHz	55GHz(frequency span: 200kHz):	±2.79	
		kHz	55GHz(frequency span: 5MHz):	±12.47	
		kHz	55GHz(frequency span: 50MHz):	±102.45	
		kHz	55GHz(frequency span: 200MHz):	±402.38	
		kHz	55GHz(frequency span: 500MHz):	±902.23	
		MHz	55GHz(frequency span: 1GHz):	±1.65	
		7	Marker Count	Hz	10MHz
1.7GHz	±0.100				
4GHz	±0.100				
9GHz	±0.100				
13.2GHz	±0.100				
18GHz	±0.100				
26.5GHz	±0.100				
40GHz	±0.100				
45GHz	±0.100				
50GHz	±0.100				
67GHz	±0.100				
8	Frequency span accuracy	/	Centerfrequency:300.000004MHz Frequency span:10Hz:	±0.20%	
			Center frequency: 300.00004MHz Frequency span: 100Hz :	±0.20%	
			Center frequency: 300.0004MHz Frequency span: 1kHz :	±0.20%	
			Center frequency: 300.004MHz Frequency span: 10kHz :	±0.20%	
			Center frequency: 300.04MHz Frequency span:100kHz :	±0.20%	
			Center frequency: 300.4MHz Frequency span: 1MHz :	±0.20%	
			Center frequency: 304MHz Frequency span: 10MHz :	±0.20%	
			Center frequency: 340MHz Frequency span: 100MHz :	±0.20%	
			Center frequency: 700MHz Frequency span: 1GHz :	±0.20%	

8.5 Performance characteristics test

			Center frequency: 2000MHz Frequency span: 4GHz :	$\pm 0.20\%$	
			Center frequency: 4500MHz Frequency span: 9GHz :	$\pm 0.20\%$	
			Center frequency: 6600MHz Frequency span: 13.2GHz :	$\pm 0.20\%$	
			Center frequency: 9000MHz Frequency span: 18GHz :	$\pm 0.20\%$	
			Center frequency: 13250MHz Frequency span: 26.5GHz :	$\pm 0.20\%$	
			Center frequency: 20000MHz Frequency span: 40GHz :	$\pm 0.20\%$	
			Center frequency: 22500MHz Frequency span: 45GHz :	$\pm 0.20\%$	
			Center frequency: 25000MHz Frequency span: 50GHz :	$\pm 0.20\%$	
			Center frequency: 33500MHz Frequency span: 67GHz :	$\pm 0.20\%$	
			9	Resolution bandwidth	Accuracy
8MHz:	$\pm 15\%$				
6MHz:	$\pm 15\%$				
5MHz:	$\pm 15\%$				
4MHz:	$\pm 15\%$				
3MHz:	$\pm 15\%$				
2MHz:	$\pm 5\%$				
1MHz:	$\pm 5\%$				
500kHz:	$\pm 5\%$				
300kHz:	$\pm 5\%$				
200kHz:	$\pm 5\%$				
100kHz:	$\pm 5\%$				
50kHz:	$\pm 5\%$				
30kHz:	$\pm 5\%$				
20kHz:	$\pm 5\%$				
10kHz:	$\pm 5\%$				
5kHz:	$\pm 5\%$				
3kHz:	$\pm 5\%$				
2kHz:	$\pm 5\%$				
1kHz:	$\pm 5\%$				
500Hz:	$\pm 5\%$				
300Hz:	$\pm 5\%$				
200Hz:	$\pm 5\%$				
100Hz:	$\pm 5\%$				
50Hz:	$\pm 5\%$				
30Hz:	$\pm 5\%$				
20Hz:	$\pm 5\%$				
10Hz:	$\pm 5\%$				
5Hz:	$\pm 5\%$				
3Hz:	$\pm 5\%$				
2Hz:	$\pm 5\%$				
1Hz:	$\pm 5\%$				
	Selec	/	10MHz:	5.0:1	

8.5 Performance characteristics test

9	Resolution bandwidth	tivity		8MHz:	5.0:1	
				6MHz:	5.0:1	
				5MHz:	5.0:1	
				4MHz:	5.0:1	
				3MHz:	5.0:1	
				2MHz:	5.0:1	
				1MHz:	5.0:1	
				500kHz:	5.0:1	
				300kHz:	5.0:1	
				200kHz:	5.0:1	
				100kHz:	5.0:1	
				50kHz:	5.0:1	
				30kHz:	5.0:1	
				20kHz:	5.0:1	
				10kHz:	5.0:1	
				5kHz:	5.0:1	
				3kHz:	5.0:1	
				2kHz:	5.0:1	
				1kHz:	5.0:1	
				500Hz:	5.0:1	
				300Hz:	5.0:1	
				200Hz:	5.0:1	
				100Hz:	5.0:1	
				50Hz:	5.0:1	
				30Hz:	5.0:1	
				20Hz:	5.0:1	
				10Hz:	5.0:1	
				5Hz:	5.0:1	
3Hz:	5.0:1					
2Hz:	5.0:1					
1Hz:	5.0:1					
10	Maximum analysis bandwidth		MHz			
11	Frequency response		dB	3Hz ~ 20MHz maximum positive response:	+0.70	
				3Hz ~ 20MHz maximum negative response:	-0.70	
				20MHz ~ 2GHz maximum positive response:	+0.50	
				20MHz ~ 2GHz maximum negative response:	-0.50	
				2GHz ~ 3.6GHz maximum positive response:	+0.70	
				2GHz ~ 3.6GHz maximum negative response:	-0.70	
				3.6GHz ~ 4GHz maximum positive response:	+1.00	
				3.6GHz ~ 4GHz maximum negative response:	-1.00	
				4GHz ~ 9GHz maximum positive response:	+1.50	
				4GHz ~ 9GHz maximum negative response:	-1.50	
				9GHz ~ 18GHz maximum positive response:	+2.00	
				9GHz ~ 18GHz maximum negative response:	-2.00	
				18GHz ~ 26.5GHz maximum positive response:	+2.50	
				18GHz ~ 26.5GHz maximum negative response:	-2.50	
				26.5GHz ~ 40GHz maximum positive response:	+3.00	
				26.5GHz ~ 40GHz maximum negative response:	-3.00	
40GHz ~ 50GHz maximum positive response:	+3.00					
40GHz ~ 50GHz maximum negative response:	-3.00					

8.5 Performance characteristics test

			50GHz ~67GHzmaximum negative response: +4.00		
			50GHz ~ 67GHzmaximum negative response: -4.00		
12	Overall absolute amplitude accuracy	dB	At 500MHz(calibration frequency)	±0.24	
13	Resolution bandwidth switching error	dB	10MHz:	±0.30	
			8MHz:	±0.30	
			6MHz:	±0.30	
			5MHz:	±0.30	
			4MHz:	±0.30	
			3MHz:	±0.30	
			2MHz:	±0.30	
			1MHz:	±0.30	
			500kHz:	±0.30	
			300kHz:	±0.30	0(REF)
			200kHz:	±0.30	
			100kHz:	±0.30	
			50kHz:	±0.30	
			30kHz:	±0.30	
			20kHz:	±0.30	
			10kHz:	±0.30	
			5kHz:	±0.30	
			3kHz:	±0.30	
			2kHz:	±0.30	
			1kHz:	±0.30	
			500Hz:	±0.30	
			300Hz:	±0.30	
			200Hz:	±0.30	
100Hz:	±0.30				
50Hz:	±0.30				
30Hz:	±0.30				
20Hz:	±0.30				
10Hz:	±0.30				
5Hz:	±0.30				
3Hz:	±0.30				
2Hz:	±0.30				
1Hz:	±0.30				
14	Reference level switching error	dB	-10dBm:	±0.20	
			-20dBm:	±0.20	
			-30dBm:	±0.20	
			-40dBm:	±0.20	
			-50dBm:	±0.20	
			-60dBm:	±0.20	
			-70dBm:	±0.20	
15	1dB gain compression	dB	20MHz~40MHz (Mixer level -3dBm)	≥-1.00	
			40MHz~200MHz (Mixer level +1dBm)	≥-1.00	
			200MHz~4GHz (Mixer level +3dBm)	≥-1.00	
			4GHz~9GHz (Mixer level -1dBm)	≥-1.00	
			9GHz~67GHz (Mixer level +1dBm)	≥-1.00	

8.5 Performance characteristics test

16	Displayed Average Noise Level		dBm/Hz	10MHz ~ 1GHz	≤ -153.00		
				1GHz ~ 2GHz	≤ -151.00		
				2GHz ~ 3GHz	≤ -150.00		
				3GHz ~ 3.6GHz	≤ -148.00		
				3.6GHz ~ 4GHz	≤ -145.00		
				4GHz ~ 5GHz	≤ -148.00		
				5GHz ~ 9GHz	≤ -150.00		
				9GHz ~ 18GHz	≤ -148.00		
				18GHz ~ 26.5GHz	≤ -143.00		
				26.5GHz ~ 40GHz	≤ -138.00		
				40GHz ~ 50GHz	≤ -133.00		
50GHz ~ 67GHz	≤ -131.00						
17	Residual response		dBm	200kHz ~ 9GHz	≤ -100.00		
18	Image response		IF3 image response	dBc	1GHz (input 1.15GHz)	≤ -80.0	
					3GHz (input 2.85GHz)	≤ -76.0	
					5GHz (input 4.85GHz)	≤ -80.0	
					15GHz (input 14.85GHz)	≤ -80.0	
					25GHz (input 24.85GHz)	≤ -80.0	
					35GHz (input 35.15GHz)	≤ -80.0	
					45GHz (input 44.85GHz)	≤ -76.0	
					55GHz (input 54.85GHz)	≤ -76.0	
			IF2 image response	dBc	1GHz (input 150MHz)	≤ -80.0	
					3GHz (input 3.85GHz)	≤ -80.0	
					5GHz (input 5.85GHz)	≤ -80.0	
					15GHz (input 15.85GHz)	≤ -80.0	
					25GHz (input 25.85GHz)	≤ -70.0	
					35GHz (input 34.15GHz)	≤ -70.0	
					45GHz (input 45.85GHz)	≤ -60.0	
IF1 image response	dBc	1GHz (input 4.95GHz)	≤ -80.0				
		3GHz (input 13.45GHz)	≤ -80.0				
19	Second harmonic distortion (dBc)		dBc	Input frequency range	Distortion products		
				10MHz ~ 0.6GHz	< -54.0		
				0.6GHz ~ 2GHz	< -54.0		
				2GHz ~ 4.5GHz	< -72.0		
				4.5GHz ~ 9GHz	< -70.0		
				9GHz ~ 25GHz	< -65.0		
				25GHz ~ 33.5GHz	< -65.0		
20	Three-order intermodulation (TOI)		dBc	10MHz ~ 200MHz ≤ -46.0 (Test frequency 50MHz)	Upper product		
					Lower product		
				200MHz ~ 4GHz ≤ -46.0 (Test frequency 200MHz)	Upper product		
					Lower product		

8.5 Performance characteristics test

			4GHz ~ 9GHz (Test frequency 5GHz)	Upper product				
				Lower product				
			9GHz ~ 18GHz (Test frequency 15GHz)	Upper product				
				Lower product				
			18GHz ~ 50GHz (Test frequency 35GHz)	Upper product				
				Lower product				
			50GHz ~ 67GHz (Test frequency 55GHz)	Upper product				
				Lower product				
			21	Phase noise	dBc/ Hz	Frequency offset 100Hz	≤ -96.0	
						Frequency offset 1kHz	≤ -115.0	
						Frequency offset 10kHz	≤ -125.0	
						Frequency offset 100kHz	≤ -125.0	
22	Interface	/	RF input interface	4051A/B/C/D: N type (female)				
				4051E : 3.5mm (male)				
				4051F/G/H : 2.4mm (male)				
				4051L : 1.8mm (male)				
			Communication interface	interface on the front panel: A type, two				
				interface on the rear panel: A type, two				
				interface: 15-core D-SUB cable adapter				
				LAN interface: RJ-45				
				Keyboard interface: PS/2				
				GP-IB interface: IEEE-488 connector				
			Trigger interface	Trigger input on the front panel (BNC female adapter)				
				Trigger input on the rear panel (BNC female adapter)				
				Trigger output 1 (BNC female adapter)				
				Trigger output 2 (BNC female adapter)				
			Frequency reference interface	10 MHz reference input (BNC female adapter) Output amplitude ≥ 0 dBm				
				10 MHz reference output (BNC female adapter)				
Sound	Loudspeaker							

8.5 Performance characteristics test

				Headphone	
23	Option	/	rear panel RF input		
			HF/IF output		
			IF output		
			reconstructed IF/video signal output		
			broadband reconstructed IF/video signal output		
			broadband logarithmic detector output		
			40 MHz bandwidth digital interface		
			200 MHz bandwidth digital interface		
			+24 V DC power supply		
			electronic attenuator		
			low-noise preamplifier		
			preselector bypass		
			40 MHz analysis bandwidth		
			200 MHz analysis bandwidth		
			audio analysis		
external frequency extension					
English suite					
24	Safety	Insulation resistance	MΩ	The insulation resistance between power input port and the case of the instrument should be not less than 100MΩ under standard atmospheric pressure used in experiment.	
			MΩ	The insulation resistance between power input port and the case of the instrument should be not less than 2MΩ under humid environment.	
		Dielectric strength	/	AC 1.5Kv/10mA/1min, there should be no breakdown, arcing and flicker.	
		Leakage current	mA	242V voltage, leakage current $\leq 3.5\text{mA}$, 1min.	

8.5 Performance characteristics test

Comprehensive judgment	
<p>Remarks: “√” indicates conformity, and “×” indicates non-conformity; “/” indicates no content in this cell or no such test item for the tested instrument.</p>	

8.5.3 Auxiliary form of performance characteristics of 4051 signal/spectrum analyzer

Auxiliary Form of Performance Characteristics of 4051 Signal/Spectrum Analyzer

Instrument No.:

Tester:

Test conditions:

Testing date:

8.5 Performance characteristics test

Table 8.5 frequency reference accuracy

Nominal output frequency value of signal generator	Marker count measurement value of signal/spectrum analyzer	Frequency reference accuracy

Table 8.6 Residual FM

Band No.	Test frequency (GHz)	Δf	ΔL	S	ΔA	R_{FM}
0	1					
1	5					
2	15					
3	25					
4	35					
5	45					
6	53					
7	60					
8	65					

Table 8.7 Marker count accuracy

Nominal frequency of input signal	4051 marker count frequency	Theoretical error range	Count accuracy
4GHz			
9GHz			
13.2GHz			
18GHz			
26.5GHz			
40GHz			
45GHz			
50GHz			
67GHz			

Table 8.8 Frequency span accuracy

4051 center frequency (MHz)	Signal generator #1 frequency (MHz)	Signal generator #2 frequency (MHz)	4051 frequency span	Marker difference frequency	Frequency span accuracy
300.000004	300	300.000008	10Hz		
300.00004	300	300.00008	100Hz		
300.0004	300	300.0008	1kHz		
300.004	300	300.008	10kHz		
300.04	300	300.08	100kHz		
300.4	300	300.8	1MHz		
304	300	308	10MHz		
340	300	38	100MHz		
700	300	1100	1GHz		

8.5 Performance characteristics test

2000	400	3600	4GHz		
4500	900	8100	9GHz		
6600	1320	11880	13.2GHz		
9000	1800	16200	18GHz		
13250	2650	23850	26.5GHz		
20000	4000	36000	40GHz		
22500	4500	40500	45GHz		
25000	5000	45000	50GHz		
33500	6700	60300	67GHz		

Table 8.9 Sweep time accuracy

Sweep time settings	Function generator frequency	Time difference ΔT	Sweep time accuracy
1ms	10kHz		
20ms	500Hz		
100ms	100Hz		
200ms	50Hz		
1s	10Hz		

Table 8.10 Resolution bandwidth

Resolution bandwidth	3 dB bandwidth measurement value	Resolution bandwidth accuracy	60 dB bandwidth measurement value	Resolution bandwidth selectivity
10MHz				
8MHz				
6MHz				
5MHz				
4MHz				
3MHz				
2MHz				
1MHz				
500kHz				
300kHz				
200kHz				
100kHz				
50kHz				
30kHz				
20kHz				
10kHz				
5kHz				
3kHz				
2kHz				
1kHz				
500Hz				

8.5 Performance characteristics test

300Hz				
200Hz				
100Hz				
50Hz				
30Hz				
20Hz				
10Hz				
5Hz				
3Hz				
2Hz				
1Hz				

Table 8.11 Maximum analysis bandwidth

Maximum analysis bandwidth set value	Left limit value fL	Right limit value fR	Maximum analysis bandwidth measurement value
10MHz			
40MHz			
200MHz			

Table 8.12 Frequency response

Table 8.12-1 Amplitude error (band 0, 50 MHz ~ 4 GHz)

Frequency (MHz)	4051 marker reading L2 (dBm)	Power meter reading L1 (dBm)	Amplitude error
50			
150			
250			
350			
450			
550			
750			
950			
1150			
1350			
1550			
1750			
1950			
2150			
2350			
2550			
2750			
2950			
3150			
3350			

8.5 Performance characteristics test

3550			
3750			
3950			

Table 8.12-2 Amplitude error (band 2, 4GHz ~ 9GHz)

Frequency (GHz)	4051 marker reading L2 (dBm)	Power meter reading L1 (dBm)	Amplitude error
4.05			
4.25			
4.45			
4.65			
4.85			
5.05			
5.25			
5.45			
5.65			
5.85			
6.05			
6.25			
6.45			
6.65			
6.85			
7.05			
7.25			
7.45			
7.65			
7.85			
8.05			
8.25			
8.45			
8.65			
8.85			

Table 8.12-3 Amplitude error (band 3, 9GHz ~ 18GHz)

Frequency (GHz)	4051 marker reading L2 (dBm)	Power meter reading L1 (dBm)	Amplitude error
9.05			
9.55			
10.05			
10.55			
11.05			
11.55			
12.05			
12.55			

8.5 Performance characteristics test

13.05			
13.55			
14.05			
14.55			
15.05			
15.55			
16.05			
16.55			
17.05			
17.55			

Table 8.12-4 Amplitude error (band 4, 18GHz ~ 26.5GHz)

Frequency (GHz)	4051 marker reading L2 (dBm)	Power meter reading L1 (dBm)	Amplitude error
18.05			
18.55			
19.05			
19.55			
20.05			
20.55			
21.05			
21.55			
22.05			
22.55			
23.05			
23.55			
24.05			
24.55			
25.05			
25.55			
26.05			

Table 8.12-5 Amplitude error (band 5, 26.5GHz ~ 40GHz)

Frequency (GHz)	4051 marker reading L2 (dBm)	Power meter reading L1 (dBm)	Amplitude error
26.55			
27.05			
27.55			
28.05			
28.55			
29.05			
29.55			
30.05			
30.55			

8.5 Performance characteristics test

31.05			
31.55			
32.05			
32.55			
33.05			
33.55			
34.05			
34.55			
35.05			
35.55			
36.05			
36.55			
37.05			
37.55			
38.05			
38.55			
39.05			
39.55			

Table 8.12-6 Amplitude error (band 6, 40GHz ~ 50GHz)

Frequency (GHz)	4051 marker reading L2 (dBm)	Power meter reading L1 (dBm)	Amplitude error
40.05			
40.55			
41.05			
41.55			
42.05			
42.55			
43.05			
43.55			
44.05			
44.55			
45.05			
45.55			
46.05			
46.55			
47.05			
47.55			
48.05			
48.55			
49.05			
49.55			

8.5 Performance characteristics test

Table 8.12-7 Amplitude error (band 7, 50GHz ~ 67GHz)

Frequency (GHz)	4051 marker reading L2 (dBm)	Power meter reading L1 (dBm)	Amplitude error
50.05			
50.55			
51.05			
51.55			
52.05			
52.55			
53.05			
53.55			
54.05			
54.55			
55.05			
55.55			
56.05			
56.55			
57.05			
57.55			
58.05			
58.55			
59.05			
59.55			
60.05			
60.55			
61.05			
61.55			
62.05			
62.55			
63.05			
63.55			
64.05			
64.55			
65.05			
65.55			
66.05			
66.55			

Table 8.12-8 Amplitude error (band 0, < 50 MHz)

Frequency	50 MHz amplitude error	Relative 50 MHz amplitude error	Amplitude error
50MHz		0 (ref)	
20MHz			
10MHz			
5MHz			
1MHz			
100kHz			

8.5 Performance characteristics test

Table 8.12-9 Frequency response statistical result

Frequency range	Maximum amplitude error value ΔA_{max}	Minimum amplitude error value ΔA_{min}	Frequency response
3Hz ~ 20MHz			
20MHz ~ 2GHz			
2GHz ~ 3.6GHz			
3.6GHz ~ 4GHz			
4GHz ~ 9GHz			
9GHz ~ 18GHz			
18GHz ~ 26.5GHz			
26.5GHz ~ 40GHz			
40GHz ~ 50GHz			
50GHz~67GHz			

Table 8.13 Absolute amplitude accuracy(500 MHz Absolute amplitude accuracy)

Frequency (MHz)	4051 marker reading (dBm)	Power meter reading (dBm)	Absolute amplitude accuracy
500			

Table 8.14 Resolution bandwidth switching error

Resolution bandwidth	Measured value
10MHz	
8MHz	
6MHz	
5MHz	
4MHz	
3MHz	
2MHz	
1MHz	
500kHz	
300kHz	0 (ref)
200kHz	
100kHz	
50kHz	
30kHz	
20kHz	
10kHz	
5kHz	
3kHz	
2kHz	
1kHz	
500Hz	
300Hz	

8.5 Performance characteristics test

200Hz	
100Hz	
50Hz	
30Hz	
20Hz	
10Hz	
5Hz	
3Hz	
2Hz	
1Hz	
Resolution bandwidth switching error	$\pm 0.30\text{dB}$ 1Hz ~ 2MHz
	$\pm 0.30\text{dB}$ 3, 4, 5, 6, 8, 10MHz

Table 8.15 Reference level switching error

Reference level	Standard attenuator		Marker difference reading L (dB)	Switching error (dB)
	Set value (dB)	Calibrated value AATT (dB)		
0dBm	0	0dB	0 (ref)	0 dB (ref)
-10dBm	10			
-20 dBm	20			
-30 dBm	30			
-40 dBm	40			
-50dBm	50			
-60dBm	60			
-70dBm	70			

Table 8.16 Scale fidelity

Standard attenuator		Marker difference reading L (dB)	Scale error (dB)
Set value (dB)	Calibrated value AATT (dB)		
0	0dB	0 (ref)	0 dB (ref)
10			
20			
30			
40			
50			
60			
70			

8.5 Performance characteristics test

Table 8.17 Residual response

Frequency range	Frequency value	Response value
200kHz ~ 9GHz		

8.5 Performance characteristics test

8.5.4 Instruments recommended for performance characteristics

Table 8.19 Instruments recommended for performance characteristics

No.	Instrument name	Main technical indexes	Recommended cable
1	Synthesized signal generator	Frequency range: 250kHz ~ 67GHz Power output: -100 dBm ~ +15 dBm Frequency accuracy: $\pm 0.02\%$ Power level capable of being calibrated and saved With internal and external AM modes	E8257D or 1464
2	Function generator	Waveform: sine, triangle, square, etc. Frequency range: 1 μ Hz ~ 80MHz Amplitude range: 1mV ~ 10V	33250A
3	Power meter	Power range: -70 dBm ~ +20 dBm Calibration source amplitude: 0 dBm	2434 or E4418B
4	Power probe	Frequency range: 50MHz ~ 67GHz Power range: -30 dBm ~ +20 dBm	N8487A or R&sZ61
5	Vector Network Analyzer	Frequency range: 50MHz ~ 67GHz	N5247 or 36587A
6	spectrum analyzer	Frequency range: 3Hz ~ 4GHz	4036A
7	Power divider	Frequency range: 50kHz ~ 67GHz Insertion loss: 6 dB Equivalent output VSWR: < 1.22:1	11667C
8	Arbitrary waveform generator	Featuring vertical resolution of 1.25 GS/s and 15 bits, instantaneous analog bandwidth of 500 MHz per channel and spurious free dynamic range of 65 dBc	N8241A
9	Calibration program control step attenuator	Stepping by 10 dB with 90 dB in total; provided with calibration certificate	84906L
10	Attenuator, switch controller	Voltage output: 5, 15 & 24 V, GPIB, USB, LAN (LXI Class C)	11713C
11	RF directional coupler	Frequency range: 300kHz ~ 4GHz Directivity: 35dB VSWR: < 1.45	Self-produced
12	Directional coupler	Frequency range: 2GHz ~ 67GHz coupling factor: 16dB Maximum coupling offset: ± 1 dB Directivity: 14dB Flatness: 0.75 dB Insertion loss: < 1.3 dB	70603
13	Low-pass filter	Cut-off frequency: 1.6GHz Insertion loss: < 0.9 dB Out-of-band rejection: > 65 dB	Self-produced
14	Low-pass filter	Cut-off frequency: 4GHz Insertion loss: < 1 dB Out-of-band rejection: > 65 dB	Self-produced
15	Low-pass filter	Cut-off frequency: 9GHz Insertion loss: < 1 dB Out-of-band rejection: > 65 dB	Self-produced
16	Low-pass filter	Cut-off frequency: 26.5GHz	Self-produced

8.5 Performance characteristics test

		Insertion loss: < 1 dB Out-of-band rejection: > 65 dB	
17	Isolator	Conducting frequency 3 GHz ~ 6.8 GHz Reverse isolation: 20 dB	CTP-3060
18	Load	Impedance: 50Ω	SMA-50JR
19	Adapter	2.4 (f) ~ 3.5 (f)	Self-produced
20	Isolator	Conducting frequency 10GHz ~ 18GHz Reverse isolation: 20 dB	XTP-1218A
21	Low-loss cable	2.4 mm cable (m-m) (two cables are required)	Self-produced
22	Cable	BNC cable (two cables are required)	Self-produced
23	Vernier calipers	0 ~ 1000mm	41-A-54
24	Platform scale	TGT-100	00000051
25	Computer	WinXP or Win7	
26	Leakage current withstand voltage tester	Leakage current: 0.5 mA ~ 20 mA; voltage: 242 V, 3 kV, 5 kV	CJ2673
27	Digital display megger	FLUKE1508	FLUKE1508
28	Variable-frequency power supply	Frequency: 47 Hz ~ 400 Hz; voltage: 0 ~ 3,000 V	AFC-1kW

Appendix

- Appendix A Terminology.....711
- Appendix B SCPI Command Index.....720
- Appendix C Error Message Index.....733

Appendix A Terminology

LO

short for local oscillator. the IF signal obtained by mixing the LO frequency in the signal/spectrum analyzer and the frequency of the received signal.

LO feedthrough

LO feedthrough is the obvious defect of the superheterodyne signal/spectrum analyzer. When the LO frequency is the same with (or very close to) the IF frequency, the LO signal appears in the measurement via the IF filter. Such LO frequency corresponds to 0 Hz (DC) input frequency and can be used as 0 Hz frequency marker. Therefore, LO feedthrough can also be called as DC response. For IF filters with limited bandwidth, LO feedthrough extends from 0 Hz to about $BWRES/2$ and its shape is similar to the filter curve of IF filters.

Waveform factor

It is the ratio of 60 dB (or 40 dB) bandwidth against 3 dB bandwidth of the filter, known also as the rectangle coefficient, indicating steepness and selectivity of the filter. The waveform factor affects the capability of the signal/spectrum analyzer to distinguish signals of unequal amplitude.

Spurious response

Spurious signal unwanted on the screen of the signal/spectrum analyzer. The spurious response is divided into spurious response and residual response, in which spurious response is the abnormal response caused on the screen of the signal/spectrum analyzer along with the input signal and can be divided into harmonic, image frequency, multiple and out-of-band response. The spurious response can also be divided into harmonic response and non-harmonic response, in which non-harmonic response should be intermodulation or residual response. Detailed description is as follows:

a) Harmonic distortion: When the input signal amplitude increases to enable the mixer to work in nonlinear state, the harmonic component of such input signal will be produced in the mixer, which is called harmonic distortion.

b) Image and multiple response

During frequency mixing, if two signals can mix with the LO signal with the same frequency to generate IF signals of the same frequency and if one original signal has a frequency one IF lower than the LO signal and the other original signal has a frequency one IF higher than the LO signal, then such two original signals can be referred to as the image of each other. The input signal of each frequency of the LO signal has an image and the frequency of the original signal and the image differs by two times of IF.

The multiple response refers to double or multiple response caused on the screen by one input signal of single frequency, which means the signal responds to two or more LO frequencies. The LO frequency capable of generating the multiple response has an interval of two times of IF. The multiple response can only occur when overlapping is selected as mixing mode and the LO sweeps a range wide enough to mix the input signal in more than one mixing mode. Difference signal/spectrum analyzers have different principle structures and cause the image and multiple response at different frequencies.

c) Residual response

The residual response refers to the discrete response observed on the screen when no input signal enters the signal/spectrum analyzer.

Appendix A Terminology

Measuring Unit

Measurement units commonly used in the signal/spectrum analyzer are as shown in Schedule 1:

Schedule A.1 Measuring Units

Measured parameters	Unit Name	Abbr.
Frequency	Hz	Hz
Power Level	dBm	dBm
Power ratio	Decibel	dB
Voltage	Volt (V)	V
Time	Second	s
Impedance (resistance)	Ohm (Ω)	

Menu

Press hard keys or soft keys on the front panel to trigger relevant functions according to the functional information of the signal/spectrum analyzer prompted on the right of the display area on the screen.

Reference level

The calibrated vertical scale position on the screen of the signal/spectrum analyzer is used as the reference for amplitude measurement and the top scale line is usually selected for the reference level.

Measuring range

The power ratio (dB) of the maximum signal (usually the maximum safety input level) and the minimum signal (display average noise level) measured at the input interface of the signal/spectrum analyzer. Such ratio is usually far larger the dynamic range to be realized in single measurement.

Marker Delta

One marker method, in which one is the fixed reference marker and the other is the active marker that can be placed at any position of the displayed trace. The displayed data can be the relative amplitude difference and the frequency difference (or time difference) between the active marker and the fixed reference marker.

Impact bandwidth

If the actual area formed by voltage response curve of the filter in the signal/spectrum analyzer is made equivalent to the voltage response curve of an ideal rectangular filter with the same area and the height of such two curves are made equal, then the width of such rectangular filter is called equivalent impact bandwidth. It is different from the signal bandwidth or the noise bandwidth. In signal/spectrum analyzer, the impact width is about 1.5 times of 3 dB bandwidth.

Bandwidth selectivity

Otherwise known as rectangle coefficient, the bandwidth selectivity is an index for assessing the capacity of the signal/spectrum analyzer to distinguish signals of unequal amplitude. It is usually defined as the ratio of the 60 dB bandwidth and the 3 dB bandwidth of the filter and it indicates steepness of the filter edge.

Dynamic range

The maximum power ratio of two or more signals at the input interface of the signal/spectrum analyzer measured with a given accuracy (unit: dB). It indicates the capability to measure the amplitude difference of two or more signals. The dynamic range is divided into multi-signal dynamic range, single-signal dynamic range, instantaneous dynamic range and safety dynamic range. It is different from the concept of display range or measurement range. Influence factors of the dynamic range include display average noise level, internal distortion, noise sideband, input attenuator, logarithmic amplifier, detector and AD converter.

The best dynamic range for two-order and three-order undistorted measurement can be calculated according to the following formula.

$$MDR_2 = \frac{1}{2} \times (SHI - DANL)$$

$$MDR_3 = \frac{2}{3} \times (TOI - DANL)$$

Where:

MDR₂: best dynamic range of two-order undistorted measurement

SHI: two-order distortion intercept point

DANL: display average noise level

MDR₃: best dynamic range of two-order undistorted measurement

TOI: three-order distortion intercept point

Logarithm scale display

The vertical scale on the screen is displayed in logarithm mode. The amplitude units of dBm, dBmV, dBμV, W and V can be used in logarithm mode.

Spurious response

Spurious signal unwanted on the screen of the signal/spectrum analyzer. The spurious response is divided into spurious response and residual response, in which spurious response is the abnormal response caused on the screen of the signal/spectrum analyzer along with the input signal and can be divided into harmonic, image frequency, multiple and out-of-band response. The spurious response can also be divided into harmonic response and non-harmonic response, in which non-harmonic response should be intermodulation or residual response. Detailed description is as follows:

a) Harmonic distortion

When the input signal amplitude increases to enable the mixer to work in nonlinear state, the harmonic component of such input signal will be produced in the mixer, which is called harmonic distortion.

b) Image and multiple response

During frequency mixing, if two signals can mix with the LO signal with the same frequency to generate IF signals of the same frequency and if one original signal has a frequency one IF lower than the LO signal and the other original signal has a frequency one IF higher than the LO signal, then such two original signals can be referred to as the image of each other. The input signal of each frequency of the LO signal has an image and the frequency of the original signal and the image differs by two times of IF.

The multiple response refers to double or multiple response caused on the screen by one input signal of single frequency, which means the signal responds to two or more LO frequencies. The LO frequency capable of generating the multiple response has an interval of two times of IF. The multiple response can only occur when overlapping is selected as mixing mode and the LO sweeps a range wide enough to mix the input signal in more than one mixing mode. Difference signal/spectrum analyzers have different principle structures and cause the image and multiple response at different frequencies.

c) Residual response

The residual response refers to the discrete response observed on the screen when no input signal enters the signal/spectrum analyzer.

[FFT]

short for fast fourier transform. It is used for specific mathematical analysis of time domain signals to provide frequency domain analysis result.

Resolution

Resolution indicates the capacity of the signal/spectrum analyzer to clearly distinguish two input signals. It is affected by IF filter bandwidth, rectangle coefficient, LO residual frequency modulation, phase noise and

Appendix A Terminology

sweep time. Most signal/spectrum analyzers use LC filter, crystal filter, active power filter and digital filter to enable different resolution bandwidths.

Amplitude accuracy:

A parameter, associated with the result of a measurement, that characterizes the dispersion of the values that could reasonably be attributed to the measurement. Influence factors of amplitude measurement accuracy include frequency response, display fidelity, input attenuator switching error, IF gain, scale factor and resolution bandwidth.

Negative peak value detection

It is a display detection method for signal energy. Each displayed point corresponds to multiple detection sampling data points of video signals in any part of the frequency span or the time interval indicated by such point. The method to extract the minimum value among such data points is the negative peak value detection.

Track

Traces comprise of a succession of data points containing frequency (time) and amplitude information. Such succession of data points is usually considered as an a set. Trace 1, 2 and 3 are commonly used in the signal/spectrum analyzer.

Intermodulation

When two or more signals are loaded at the input interfaces of active devices (such as mixer or amplifier) at the same time, multiple sum frequency or difference frequency of signal themselves will produce intermodulation products in addition to signal harmonics due to nonlinearity of such active devices. For the signal/spectrum analyzer, such intermodulation products are interference signal and their level should be as low as possible. The relation between the intermodulation product level and the input signal level: if the amplitude of two sine input signals changes by Δ dB, relevant intermodulation product level will change by $n \cdot \Delta$ dB, in which n refers to the order of the intermodulation product, which means the sum of the term of each frequency. For example, if the frequency is $2 \cdot f_1 + 1 \cdot f_2$, the order will be $2 + 1 = 3$. The point of intersection where the signal amplitude is equal to the intermodulation product amplitude is usually called the intercept point. Actually such point does not exist because when the input signal increases to a certain degree, there will be compression imposed on the output of active devices. The intercept point can be defined with the input or output level. Therefore, the nominal intercept point is divided into input and output intercept point and the default intercept point is the input intercept point. The intercept point is usually expressed with dBm. The greater the value of the intercept point, the better the linearity of the signal/spectrum analyzer, which is the precondition of obtaining larger dynamic range. In most cases, two-order and three-order products among such intermodulation products have great impact on measurements. The two-order intercept point is often defined as IP₂ or SOI (second order intercept) and the three-order intercept point defined as IP₃ or TOI (third order intercept). The value of the front input attenuator of the signal/spectrum analyzer (usually 0 dB) should be designated when calibrating the intercept point since the intercept point value will increase along with the increase in the decrement of the attenuator.

Linearity of the active devices changes with the increase in the current and the power. The larger the current provided by the amplifier, or the larger the LO power of the mixer, the better the linearity. Therefore, low power consumption of the signal/spectrum analyzer often indicates poor linearity. However, what should be noted is that this is contradictory to the noise requirement. The input attenuator of the signal/spectrum analyzer can control intermodulation products and has high IP₃ under high noise factor. Therefore, IP₃ and the noise factor should be analyzed and compared in the equivalent operation mode. IP₃ is an index for measuring the linearity of the signal/spectrum analyzer and reflects the size of intermodulation distortion when the signal/spectrum analyzer is affected by strong signal interference.

Activity function area

It is the area on the screen for the signal/spectrum analyzer to display active functions and their status. Active functions are those triggered by the last-pressed key or the last remote control command by the signal/spectrum analyzer.

Detection mode

It is a way of processing before analog information is digitalized and saved in the memory and serves mainly as a method of display detection for signal energy. It includes normal, Peak, negative peak, sample, and average modes.

Speed factor

It refers to the numeric unit represented by each grid on vertical axis scale of the screen.

Zero Span

The sweep LO of the signal/spectrum analyzer is kept fixed to certain frequency, which means there is no LO sweep operation (span = 0). When the span is set as zero, the signal/spectrum analyzer becomes a fixed-tuned receiver whose bandwidth is the resolution bandwidth.

Drift

The LO frequency changes when the sweep voltage changes, resulting in the signal position changing slowly on the screen. In case of drift, readjustment may be required, but the frequency resolution will not be compromised.

Frequency response

The frequency response refers to the change of the amplitude along with that of the frequency within the specified frequency range, namely the dependency between the amplitude and the frequency. The frequency response is divided into absolute and relative frequency response. The absolute frequency response refers to the amplitude offset of other frequency points when the signal amplitude of certain frequency point has been taken as the reference within a given frequency range. Also known as the frequency response flatness, the relative frequency response indicates the difference between the maximum signal amplitude and the minimum amplitude or $\pm 1/2$ of such difference within certain band or the entire frequency range.

Marker

It refers to the visible indicating cursor placed at any point of the screen trace and can use numbers to display absolute values of frequency and amplitude on traces on markers. Active markers refer to those on the traces that are capable of being directly moved via control keys or remote control commands on the front panel.

Span

The difference between the start frequency and the stop frequency of the signal/spectrum analyzer. The frequency span setting defines the scale of the horizontal axis of the screen of the signal/spectrum analyzer.

Frequency range

When the specified performance conditions are met, the signal/spectrum analyzer can measure the range between the lowest frequency and the highest frequency. The frequency range and relevant band division should be specified in the product specifications.

frequency accuracy

The degree of closeness between the measured frequency display value and the actual value. It is divided into absolute and relative accuracy, in which the absolute accuracy refers to the actual size of read-out frequency error and the relative accuracy refers to the ratio of the read-out frequency error against the ideal frequency value.

Frequency stability

It refers to the extent of the signal frequency remaining unchanged in short term or long term. The short-term frequency stability can be expressed with residual frequency modulation or phase noise. The long-term frequency stability can be expressed with aging rate.

Appendix A Terminology

Signal/spectrum analyzer

The instrument used to effectively display each single spectrum component (sine wave) composing the time-domain signal. Whether to retain phase information depends on the type of analyzer and relevant design principles.

flatness

It corresponds to the variation in display amplitude of the measurement frequency range of the signal/spectrum analyzer and indicates the corresponding relation between the signal amplitude variation and the frequency.

Sampling detection

It is a display detection method for signal energy. The value displayed for each point refers to the instantaneous value at certain time of the video signal at the frequency interval or time interval represented by such point.

[Scanning time

The time it takes for LO tuning to pass the selected frequency interval. The sweep time directly affects the time used to complete one test, excluding the dead time after previous sweep completes and the next sweep begins. When the span is zero, the horizontal axis only calibrates the time. When the span is not zero, the horizontal axis calibrates both the frequency and the time. The sweep time often changes with the span, the resolution bandwidth and the video bandwidth.

RF attenuator

The step attenuator between the input connector and the first mixer of the signal/spectrum analyzer. The RF attenuator is used to adjust the signal level of the first mixer.

Residual frequency modulation

The inherent short-term frequency instability of the LO signal when there is no frequency modulation input. It generally refers to the peak or its value with frequency dither in specified time interval within the test bandwidth. The residual frequency modulation causes spectral line jitter, reduces actual resolution and affects frequency readout accuracy of the signal/spectrum analyzer.

Video

The signal input from the detector of the signal/spectrum analyzer. Its frequency ranges from 0 Hz to far beyond the frequency of the widest resolution bandwidth provided by the signal/spectrum analyzer and video filter setting defines the final bandwidth of the video path.

[Video bandwidth

The bandwidth of the tunable low-pass filter in the video circuit of the signal/spectrum analyzer. The video filter is the low-pass filter located behind the detector for defining the bandwidth of the video amplifier. It can smooth the noise and is used to average or smooth traces. Besides, it can easily detect weak signals in noises. Change of the video bandwidth does not affect the frequency resolution of the signal/spectrum analyzer, but too narrow video bandwidth may lead to increase in the sweep time.

Video amplifier

The DC coupling amplifier located behind the detector of the signal/spectrum analyzer.

Video filter and video average

Since what the signal/spectrum analyzer displays is the measured signal plus its internal noise, video filter or video average is required for the displayed signals in order to reduce the impact of such noise of the small signals to be measured.

The video filter refers to the low-pass filter behind the envelop filter. When the video bandwidth is equal to or smaller than the resolution bandwidth, the video circuit is unable to adequately respond to the fast fluctuations

Appendix A Terminology

of the detector output and the displayed trace is smoothed. The degree of such average or smoothing is associated with the video bandwidth and the resolution bandwidth.

The video average is done point by point during several sweep operations. At each point, new measured data and previous data are averaged together and average values of several measurements will be centrally displayed. The video average function is only used in the signal/spectrum analyzers with digital display and the average values depend on the sweep times selected by users. In average algorithm, one weighting coefficient ($1/n$, n refers to current sweep times) is used as the amplitude value of the given point of current sweep and another weighting coefficient $[(n-1) / n]$ is used for previously saved average value. Such two values will then be combined as current average value. After the specified sweeps are completed, the weighting coefficients remain unchanged and dynamic average will be displayed.

In most measurement cases, the video filter is basically the same with the video average. However, they differ in that the video filter is a kind of real-time average function. When a signal drifting with the time is measured, their difference becomes significant, leading to totally different measurement results. When the video filter is used, each sweep may result in different average value; while the video average uses results of several sweeps to obtain adequately averaged value. Therefore, the result got via the video average is very close to the actual average value.

Input amplitude range

The power ratio (dB) of the maximum signal (usually the maximum safety input level) and the minimum signal (display average noise level) measured at the input interface of the signal/spectrum analyzer. Such ratio is always far larger than the dynamic range to be realized in single measurement.

Input impedance

The terminal impedance presented by the signal/spectrum analyzer with respect to the signal source. The impedance of the RF and microwave analyzer is usually $50\ \Omega$. The standard impedance of some systems (such as cable television) is $75\ \Omega$. The degree of mismatch between the nominal impedance and the actual impedance is expressed with VSWR.

Refresh mode

It is used to clear screen traces and sweep will be restarted when the trigger condition is met. When the trigger condition is met, new input signal data will be displayed.

Display range

The difference between the maximum signal and the minimum signal observed on the screen at the same time. For the signal/spectrum analyzer with 10 amplitude scale intervals, its display range is scale coefficient * 10.

Average noise level display

When reducing peak-to-peak fluctuation of noise by decreasing resolution bandwidth with minimum resolution bandwidth and input attenuation, the level observed on the screen of the signal/spectrum analyzer is the display average noise level expressed in dBm. The display average noise level of the signal/spectrum analyzer is equivalent to its sensitivity.

Linear display

The vertical scale on the screen is displayed in direct proportion to the input signal voltage. The graticule at the bottom of the screen stands for 0 V and the top graticule stands for the reference level (depending on some non-zero value of specific signal/spectrum analyzer). For most signal/spectrum analyzers, the scale factor equals to the product derived by dividing the reference level with the number of divisions. In linear display mode, the amplitude units of dBm, dBmV, dB μ V, W and V can be used for the signal/spectrum analyzer.

Relative amplitude accuracy

Error of amplitude measurement The amplitude of one signal is compared with that of the other without considering the absolute amplitude of either signal. Influence factors of amplitude accuracy include frequency response, display fidelity, change in input decrement, IF gain, scale factor and resolution bandwidth.

Appendix A Terminology

Preselector

The low-pass filter with tunable center frequency before the input mixer of the signal/spectrum analyzer. It is used to eliminate multiple and image responses of the superheterodyne signal/spectrum analyzer and improve its dynamic range. The preselector generally uses bands over 4 GHz.

Sensitivity

The capability of the signal/spectrum analyzer to measure signals with lowest level. The sensitivity is divided into input signal level sensitivity, which produces input signal level about two times of average noise, and equivalent input noise sensitivity, which the average level converted with externally generated noise to the input interface. The best sensitivity can be obtained under the narrowest resolution bandwidth and the minimum input attenuation and with adequate video filter. Influence factors of the sensitivity include input attenuator, pre-amplifier, insertion loss of front-end devices, bandwidth of IF filter and noise sideband. The video filter is unable to improve sensitivity, but it can enhance resolution capability and measurement repeatability under low signal-to-noise ratio. The best sensitivity may conflict with other measurement requirements. For example, when the resolution bandwidth is decreased, the sweep time increases; when attenuation is set as 0 dB, the VSWR increases and the measurement accuracy decreases; when pre-amplifier is increased, the dynamic range of the signal/spectrum analyzer is affected. Relation between the sensitivity and the resolution bandwidth is as follows:

$$\text{PdBm} = -174 \text{ dBm} + \text{FdB} + 10 \text{ LogB}$$

Where:

PdBm: sensitivity of the signal/spectrum analyzer

FdB: noise factor of the signal/spectrum analyzer

B: 3 dB bandwidth of the signal/spectrum analyzer (Hz)

Noise Marker

A marker whose value indicates the noise level within 1 Hz equivalent noise bandwidth. When the noise maker is selected, sample detector mode will be initiated and trace line points (the number of such points depends on the analyzer) surrounding the marker will be averaged; obtained average value will normalize the power within 1 Hz equivalent noise bandwidth.

Phase noise (noise sideband)

The oscillator of the signal/spectrum analyzer is used to convert input signals of different frequencies to IF. The phase noise refers to the relative value (dBc/Hz) of the noise power and the carrier power within 1 Hz equivalent noise bandwidth at certain frequency offset of the relative carrier. It indicates the level of short-term frequency stability of the oscillator, which is caused by phase or frequency change. It is displayed among signals of the oscillator as a bell-shaped noise characteristic. It affects the capability of the instrument to measure phase noise of the tested signal as well as the sensitivity and the dynamic range of the instrument.

Harmonic mixing

LO harmonic “generated” in the mixer is used in mixing to extend the tuning measurement range of the signal/spectrum analyzer.

Gain compression.

When the input signal level increases, unit circuits of the signal/spectrum analyzer, including mixer and the amplifier are working close to the saturation point. At such time, the input signal component will no longer change linearly with the input signal and the displayed signal level is low due to gain compression. Usually, the input level 1 dB (0.5 dB) lower than the output linear value offset is used to indicate 1 dB (0.5 dB) compression point.

Normal detection

It is a display detection method for signal energy. Each displayed point corresponds to multiple detection sampling data points of video signals in any part of the frequency span or the time interval indicated by such

point. The minimum value and the maximum value among such data points are extracted and connected with a vertical line during trace display. Such mode helps direct analysis of noise signal fluctuation range and increase in the sweep time will widen the displayed noise bandwidth.

Negative peak value detection

It is a display detection method for signal energy. Each displayed point corresponds to multiple detection sampling data points of video signals in any part of the frequency span or the time interval indicated by such point. The method to extract the maximum value among such data points is the Peak value detection.

IF gain/attenuation

IF gain/attenuation is used to adjust the vertical position of the signal on the screen without affecting the IF controller for the signal level on the mixer. When the IF gain/attenuation is changed, the reference level changes accordingly.

Appendix B SCPI Command Index

Appendix B SCPI Command Index

Schedule B SCPI Command Index

Command	Function
*CLS	Generic commands
*ESE	Generic commands
*ESE?	Generic commands
*ESR?	Generic commands
*IDN?	Generic commands
*OPC	Generic commands
*OPC?	Generic commands
*RST	Generic commands
*SRE	Generic commands
*SRE?	Generic commands
*STB?	Generic commands
*TST?	Generic commands
*TRG	Generic commands
*WAI	Generic commands
:ABORt	Cancel (only for remote control)
:CALCulate:BWIDth BANDwidth:NDB <rel_amp>	ndB setting
:CALCulate:BWIDth BANDwidth:NDB?	ndB setting query
:CALCulate:BWIDth BANDwidth[:STATe] OFF ON 0 1	ndB measurement switch
:CALCulate:BWIDth BANDwidth[:STATe]?	ndB measurement switch query
:CALCulate:BWIDth BANDwidth:RESult?	ndB result query
:CALCulate:MARKer:TRCKing[:STATe] OFF ON 0 1	Set signal track
:CALCulate:MARKer:TRCKing[:STATe]?	Query signal track
:CALCulate:MARKer[1] 2 3 4 5 6 7 8 9 10 11 12:MAXimum	Peak search
:CALCulate:MARKer[1] 2 3 4 5 6 7 8 9 10 11 12:MAXimum:NEX T	Next Peak
:CALCulate:MARKer[1] 2 3 4 5 6 7 8 9 10 11 12:MAXimum:RIG Ht	Next Peak Right
:CALCulate:MARKer[1] 2 3 4 5 6 7 8 9 10 11 12:MAXimum:LEF T	Next Peak Left
:CALCulate:MARKer:PEAK:EXCursion <rel_amp>	Set peak definition
:CALCulate:MARKer:PEAK:EXCursion?	Query peak definition
:CALCulate:MARKer:PEAK:EXCursion:STATe OFF ON 0 1	Set peak definition switch
:CALCulate:MARKer:PEAK:EXCursion:STATe?	Query peak definition switch
:CALCulate:MARKer:PEAK:THReshold <amp>	Set peak threshold
:CALCulate:MARKer:PEAK:THReshold?	Query peak threshold
:CALCulate:MARKer:PEAK:THReshold:STATe OFF ON 0 1	Set peak threshold switch
:CALCulate:MARKer:PEAK:THReshold:STATe?	Query peak threshold switch

Appendix B SCPI Command Index

:CALCulate:MARKer:PEAK:TABLE:STATe OFF ON 0 1	Set peak list switch
:CALCulate:MARKer:PEAK:TABLE:STATe?	Query peak list switch
:CALCulate:MARKer:PEAK:SORT FREQuency AMPLitude	Set peak sequence
:CALCulate:MARKer:PEAK:SORT?	Query peak sequence
:CALCulate:MARKer:PEAK:TABLE:READout ALL GTDLIne LTDLine	Set peak read-out
:CALCulate:MARKer:PEAK:TABLE:READout?	Query peak read-out
:CALCulate:MARKer[1] 2 3 4 5 6 7 8 9 10 11 12:CPSearch[:STATe] ON OFF 1 0	Set peak track on/off
:CALCulate:MARKer[1] 2 3 4 5 6 7 8 9 10 11 12:CPSearch[:STATe]?	Query peak track on/off
:CALCulate:MARKer[1] 2 3 4 5 6 7 8 9 10 11 12:PTPeak	Peak-to-peak search
:CALCulate:MARKer[1] 2 3 4 5 6 7 8 9 10 11 12:MINimum	Min Search
:CALCulate:MARKer[1] 2 3 4 5 6 7 8 9 10 11 12:MODE POSITION DELTA FIXed OFF	Set marker mode
:CALCulate:MARKer[1] 2 3 4 5 6 7 8 9 10 11 12:MODE?	Query marker mode
:CALCulate:MARKer[1] 2 3 4 5 6 7 8 9 10 11 12:X <freq>	Set marker position on X axis
:CALCulate:MARKer[1] 2 3 4 5 6 7 8 9 10 11 12:X?	Query marker position on X axis
:CALCulate:MARKer[1] 2 3 4 5 6 7 8 9 10 11 12:X:POSITION <real>	Set marker X point
:CALCulate:MARKer[1] 2 3 4 5 6 7 8 9 10 11 12:X:POSITION?	Query marker X point
:CALCulate:MARKer[1] 2 3 4 5 6 7 8 9 10 11 12:Y <real>	Set marker position on Y axis
:CALCulate:MARKer[1] 2 3 4 5 6 7 8 9 10 11 12:Y?	Query marker position on Y axis
:CALCulate:MARKer[1] 2 3 4 5 6 7 8 9 10 11 12:REFerence<integer>	Set marker reference
:CALCulate:MARKer[1] 2 3 4 5 6 7 8 9 10 11 12:REFerence?	Query marker reference
:CALCulate:MARKer[1] 2 3 4 5 6 7 8 9 10 11 12:X:READout FREQuency TIME ITIME PERiod	Marker X axis scale attribute
:CALCulate:MARKer[1] 2 3 4 5 6 7 8 9 10 11 12:X:READout?	Query marker X axis scale attribute
:CALCulate:MARKer[1] 2 3 4 5 6 7 8 9 10 11 12:X:READout:AUTO ON OFF 1 0	Marker X axis scale attribute
:CALCulate:MARKer[1] 2 3 4 5 6 7 8 9 10 11 12:X:READout:AUTO?	Query marker X axis scale attribute
:CALCulate:MARKer[1] 2 3 4 5 6 7 8 9 10 11 12:TRACe1 2 3 4 5 6	Set marker trace
:CALCulate:MARKer[1] 2 3 4 5 6 7 8 9 10 11 12:TRACe?	Query marker trace
:CALCulate:MARKer[1] 2 3 4 5 6 7 8 9 10 11 12:LINes[:STATe] OFF ON 0 1	Set marker line display on/off
:CALCulate:MARKer[1] 2 3 4 5 6 7 8 9 10 11 12:LINes[:STATe]?	Query marker line display on/off
:CALCulate:MARKer:TABLE[:STATe] OFF ON 0 1	Set marker report window on/off
:CALCulate:MARKer:TABLE[:STATe]?	Query marker report window on/off
:CALCulate:MARKer[1] 2 3 4 5 6 7 8 9 10 11 12:FCOunt[:STATe] OFF ON 0 1	Set marker count on/off

Appendix B SCPI Command Index

:CALCulate:MARKer[1] 2 3 4 5 6 7 8 9 10 11 12:FCOunt[:STATe]?	Query marker count on/off
:CALCulate:MARKer[1] 2 3 4 5 6 7 8 9 10 11 12:FCOunt:X?	Query marker count
:CALCulate:MARKer[1] 2 3 4 5 6 7 8 9 10 11 12:FCOunt:GATetim e <time>	Set marker count gate time
:CALCulate:MARKer[1] 2 3 4 5 6 7 8 9 10 11 12:FCOunt:GATetim e?	Query marker count gate time
:CALCulate:MARKer[1] 2 3 4 5 6 7 8 9 10 11 12:FCOunt:GATetim e:AUTO OFF ON 0 1	Set marker count gate time auto on/off
:CALCulate:MARKer[1] 2 3 4 5 6 7 8 9 10 11 12:FCOunt:GATetim e:AUTO?	Query marker count gate time auto on/off
:CALCulate:MARKer:COUPl e[:STATe] OFF ON 0 1	Set marker couple
:CALCulate:MARKer:COUPl e[:STATe]?	Query marker couple
:CALCulate:MARKer:AOFF	Set all markers off
:CALCulate:MARKer[1] 2 3 4 5 6 7 8 9 10 11 12:FUNCTi on NOIS e BPOW e BDENS ity OFF	Set marker function
:CALCulate:MARKer[1] 2 3 4 5 6 7 8 9 10 11 12:FUNCTi on?	Query marker function
:CALCulate:MARKer[1] 2 3 4 5 6 7 8 9 10 11 12:FUNCTi on:BAND: SPAN <freq>	Set bandwidth adjustment span
:CALCulate:MARKer[1] 2 3 4 5 6 7 8 9 10 11 12:FUNCTi on:BAND: SPAN?	Query bandwidth adjustment span
:CALCulate:MARKer[1] 2 3 4 5 6 7 8 9 10 11 12:FUNCTi on:BAND: LEFT <freq>	Set bandwidth adjustment start frequency
:CALCulate:MARKer[1] 2 3 4 5 6 7 8 9 10 11 12:FUNCTi on:BAND: LEFT?	Query bandwidth adjustment start frequency
:CALCulate:MARKer[1] 2 3 4 5 6 7 8 9 10 11 12:FUNCTi on:BAND: RIGH t <freq>	Set bandwidth adjustment stop frequency
:CALCulate:MARKer[1] 2 3 4 5 6 7 8 9 10 11 12:FUNCTi on:BAND: RIGH t?	Query bandwidth adjustment stop frequency
:CALCulate:MARKer[1] 2 3 4 5 6 7 8 9 10 11 12[:SET]:CENTer	Marker -> Center
:CALCulate:MARKer[1] 2 3 4 5 6 7 8 9 10 11 12[:SET]:STEP	Marker -> Frequency Step
:CALCulate:MARKer[1] 2 3 4 5 6 7 8 9 10 11 12[:SET]:STARt	Marker -> Start
:CALCulate:MARKer[1] 2 3 4 5 6 7 8 9 10 11 12[:SET]:STOP	Marker -> Stop
:CALCulate:MARKer[1] 2 3 4 5 6 7 8 9 10 11 12[:SET]:DELTA:SPAN	Marker Delta -> Span
:CALCulate:MARKer[1] 2 3 4 5 6 7 8 9 10 11 12[:SET]:DELTA:CENTer	Marker Delta -> Center
:CALCulate:MARKer[1] 2 3 4 5 6 7 8 9 10 11 12[:SET]:RLEVel	Marker -> Reference
:CALCulate:MATH:MODE <LINear LOGarithmic POWer>	Set trace operation method
:CALibration[:ALL]	Calibration all
:CALibration[:ALL]?	Search the current calibration state.
:CONFigure?	Measurement function

Appendix B SCPI Command Index

	query
:CONFigure:SANalyzer	Set as spectrum measurement
:CONFigure:SANalyzer:NDEFault	Enter spectrum measurement as default
:COUPlE ALL NONE	Set couple all
:DEMod AM FM PM OFF	Set audio demodulation type
:DEMod?	Query audio demodulation type
:DEMod:TIME <time>	Set audio demodulation time
:DEMod:TIME?	Query audio demodulation time
:DISPlay:WINDow[1]:ANNotation[:ALL] OFF ON 0 1	Set status area display on/off
:DISPlay:WINDow[1]:ANNotation[:ALL]?	Query status area display on/off
:DISPlay:ANNotation:FREQuency OFF ON 0 1	Set frequency information display on/off
:DISPlay:ANNotation:FREQuency?	Query frequency information display on/off
:DISPlay:WINDow[1]:TRACe:GRATicule:GRID[:STATe] OFF ON 0 1	Set grid line on/off
:DISPlay:WINDow[1]:TRACe:GRATicule:GRID[:STATe]?	Query grid line on/off
:DISPlay:WINDow[1]:TRACe:Y[:SCALe]:PDIVision <rel_ampl>	Set scale/division
:DISPlay:WINDow[1]:TRACe:Y[:SCALe]:PDIVision?	Query scale/division
:DISPlay:WINDow[1]:TRACe:Y[:SCALe]:RLEVel <real>	Set reference level
:DISPlay:WINDow[1]:TRACe:Y[:SCALe]:RLEVel?	Query reference level
:DISPlay:WINDow[1]:TRACe:Y[:SCALe]:RLEVel:OFFSet <rel_power>	Set reference level offset
:DISPlay:WINDow[1]:TRACe:Y[:SCALe]:RLEVel:OFFSet?	Query reference level offset
:DISPlay:WINDow[1]:TRACe:Y[:SCALe]:SPACing LINear LOGarithmic	Set scale type
:DISPlay:WINDow[1]:TRACe:Y[:SCALe]:SPACing?	Query scale type
:DISPlay:WINDow[1]:TRACe:Y:DLINe <ampl>	Set display line
:DISPlay:WINDow[1]:TRACe:Y:DLINe?	Query display line
:DISPlay:WINDow[1]:TRACe:Y:DLINe:STATe OFF ON 0 1	Set display line on/off
:DISPlay:WINDow[1]:TRACe:Y:DLINe:STATe?	Query display line on/off
:FETCh:SANalyzer[n]?	
:FORMat:TRACe[:DATA] ASCii INTeger32 REAL32 REAL64	Set trace data type (only for remote control)
:FORMat:TRACe[:DATA]?	Query trace data type (only for remote

Appendix B SCPI Command Index

	control)
:FORMat:BORDER NORMAl SWAPped	Set data byte sequence (only for remote control)
:FORMat:BORDER?	Query data byte sequence (only for remote control)
:HCOPy[:IMMediate]	Output the screen snapshotting on printer.
:INITiate:CONTInuous OFF ON 0 1	Set continuous on/off
:INITiate:CONTInuous?	Query continuous on/off
:INITiate:SANalyzer	Spectrum Analysis Initialize
:INITiate[:IMMediate]	Refresh now
:INITiate:PAUS	Measurement pause
:INITiate:RES	Restart measurement
:INITiate:REStart	Restart Measurement
:INPut:COUPLing AC DC	Set coupling method
:INPut:COUPLing?	Query coupling method
INPut:FILTer:YIG[:STATe] OFF ON 0 1	Set preselector bypass on/off
INPut:FILTer:YIG[:STATe]?	Query preselector bypass on/off
:MEASure:SANalyzer[n]?	Make spectrum measurement as default
:MMEMory:DATA? <file_name>	Return the file data
:MMEMory:LOAD:STATe <filename>	Call the state file
:MMEMory:STORE:SCReen <filename>	Save the state file
:MMEMory:STORE:STATe <filename>	Save the screen image
:MMEMory:STORE:TRACe:DATA TRACE1 TRACE2 TRACE3 TRACE4 TRACE5 TRACE6 ALL<filename >	Set trace data store
:MMEMory:LOAD:TRACe:DATA TRACE1 TRACE2 TRACE3 TRACE4 TRACE5 TRACE6<filename>	Trace call
:MMEMory:LOAD:CORRection 1 2 3 4 5 6, <filename>	Call amplitude correction
:MMEMory:STORE:CORRection 1 2 3 4 5 6, <filename>	Save amplitude correction
:OUTPut:AUX SIF AIF OFF	Set HIF and IF output on/off
:OUTPut:AUX?	Query HI-IF and IF Output On/Off
:OUTPut:AUX:AIF <value>	Set IF output frequency
:OUTPut:AUX:AIF?	Query IF output frequency

Appendix B SCPI Command Index

:OUTPut:AUX:LOGVideo OFF ON 0 1	Set Logarithmic Detector Output On/Off
:OUTPut:AUX:LOGVideo?	Query Logarithmic Detector Output On/Off
:OUTPut:AUX:SIF <value>	Set HIF output frequency
:OUTPut:AUX:SIF?	Query HIF output frequency
:READ:SANalyzer[n]?	
[:SENSe]:ADC:DITHer[:STATe] OFF ON HIGH	Set ADC on/off
[:SENSe]:ADC:DITHer[:STATe]?	Query ADC on/off
[:SENSe]:ADC:DITHer:AUTO[:STATe] OFF ON 0 1	Set ADC auto on/off
[:SENSe]:ADC:DITHer:AUTO[:STATe]?	Query ADC auto on/off
[:SENSe]:ADJust:LEVel	Set amplitude auto scaling
[:SENSe]:AVERAge:COUNT <integer>	Set up average frequency.
[:SENSe]:AVERAge:COUNT?	Query average count
[:SENSe]:AVERAge:CLear	Clear current average count
[:SENSe]:AVERAge:TYPE:AUTO OFF ON 0 1	Average type auto on/off
[:SENSe]:AVERAge:TYPE:AUTO?	Query average type auto on/off
[:SENSe]:AVERAge:TYPE RMS LOG SCALar	Set average type
[:SENSe]:AVERAge:TYPE?	Query average type
[:SENSe]:BANDwidth BWIDth[:RESolution] <freq>	Set resolution bandwidth
[:SENSe]:BANDwidth BWIDth[:RESolution]?	Query resolution bandwidth
[:SENSe]:BANDwidth BWIDth[:RESolution]:AUTO OFF ON 0 1	Set resolution bandwidth auto on/off
[:SENSe]:BANDwidth BWIDth[:RESolution]:AUTO?	Query resolution bandwidth auto on/off
[:SENSe]:BANDwidth BWIDth:VIDeo <freq>	Set video bandwidth
[:SENSe]:BANDwidth BWIDth:VIDeo?	Query video bandwidth
[:SENSe]:BANDwidth BWIDth:VIDeo:AUTO OFF ON 0 1	Set video bandwidth auto on/off
[:SENSe]:BANDwidth BWIDth:VIDeo:AUTO?	Query video bandwidth auto on/off
[:SENSe]:BANDwidth BWIDth:VIDeo:RATio <real>	Set VBW/RBW
[:SENSe]:BANDwidth BWIDth:VIDeo:RATio?	Query VBW/RBW
[:SENSe]:BANDwidth BWIDth:VIDeo:RATio:AUTO OFF ON 0 1	Set VBW/RBW on/off
[:SENSe]:BANDwidth BWIDth:VIDeo:RATio:AUTO?	Query VBW/RBW

Appendix B SCPI Command Index

[[:SENSe]:BANDwidth BWIDth:SHAPE GAUSSian FLATtop	Set filter type
[[:SENSe]:BANDwidth BWIDth:SHAPE?	Query filter type
[[:SENSe]:BANDwidth BWIDth:TYPE DB3 DB6	Set filter bandwidth
[[:SENSe]:BANDwidth BWIDth:TYPE?	Query filter bandwidth
[[:SENSe]:CORRection:CSET[1] 2 3 4 5 6[:STATe] ON OFF 1 0	Set current amplitude correction on/off
[[:SENSe]:CORRection:CSET[1] 2 3 4 5 6[:STATe]?	Query current amplitude correction on/off
[[:SENSe]:CORRection:CSET[1] 2 3 4 5 6:DELeTe	Delete current amplitude correction
[[:SENSe]:CORRection:CSET:ALL[:STATe] ON OFF 1 0	Apply all corrections on/off
[[:SENSe]:CORRection:CSET:ALL[:STATe]?	Query all corrections application on/off
[[:SENSe]:CORRection:CSET:ALL:DELeTe	Delete All Corrections
[[:SENSe]:CORRection:NOISe:FLOOr ON OFF 1 0	Set the noise correction switch
[[:SENSe]:CORRection:NOISe:FLOOr?	Search the noise correction switch
[[:SENSe]:DEMod:STATe:MODE INTER CONT	Set audio demodulation method
[[:SENSe]:DEMod:STATe:MODE?	Query audio demodulation method
[[:SENSe]:DETEctor:TRACe[1] 2 3 4 5 6 AVERAge NEGAtive NORMAl POSitive SAMPle QPEak EAVERage RAVERage	Set trace detector mode
[[:SENSe]:DETEctor:TRACe[1] 2 3 4 5 6?	Query trace detector mode setting
[[:SENSe]:DETEctor[:FUNCTion] NORMAl AVERAge POSitive SAMPle NEGAtive QPEak EAVERage EPOSitive MPOSitive RMS	Set trace detector mode (applicable for all traces)
[[:SENSe]:DETEctor[:FUNCTion]?	Query trace detector mode setting (applicable for all traces)
[[:SENSe]:DETEctor:TRACe[1] 2 3 4 5 6:AUTO ON OFF 1 0	Set detector mode auto on/off
[[:SENSe]:DETEctor:TRACe[1] 2 3 4 5 6:AUTO?	Query detector mode auto on/off
[[:SENSe]:DETEctor:AUTO ON OFF 1 0	Set detector mode auto on/off (for all traces)
[[:SENSe]:DETEctor:AUTO?	Query detector mode auto on/off (for all traces)
[[:SENSe]:FEED RF AREFereNce	Set input port
[[:SENSe]:FEED?	Query input port
[[:SENSe]:FEED:AREFereNce REF500 REFCOMB REF4800 OFF	Set calibration port
[[:SENSe]:FEED:AREFereNce?	Query calibration port

Appendix B SCPI Command Index

[[:SENSe]:FREQuency:TUNE:IMMediate	Initiate auto tune
[[:SENSe]:FREQuency:STARt <freq>	Set the starting frequency
[[:SENSe]:FREQuency:STARt?	Query start frequency
[[:SENSe]:FREQuency:STOP <freq>	Set the stop frequency
[[:SENSe]:FREQuency:STOP?	Query stop frequency
[[:SENSe]:FREQuency:SPAN:BANDwidth[:RESolution]:RATio <integer>	Set Span/RBW
[[:SENSe]:FREQuency:SPAN:BANDwidth[:RESolution]:RATio?	Query Span/RBW
[[:SENSe]:FREQuency:SPAN:BANDwidth[:RESolution]:RATio:AUTO OFF ON 0 1	Set Span/RBW on/off
[[:SENSe]:FREQuency:SPAN:BANDwidth[:RESolution]:RATio:AUTO?	Query Span/RBW
[[:SENSe]:FREQuency:SPAN <freq>	Set frequency span
[[:SENSe]:FREQuency:SPAN?	Query frequency span
[[:SENSe]:FREQuency:SPAN:FULL	Set full frequency span
[[:SENSe]:FREQuency:SPAN:PREVious	Query previous frequency span setting
[[:SENSe]:FREQuency:SYNTHeSis[:STATe] OFF ON 0 1	Set phase noise optimization on/off
[[:SENSe]:FREQuency:SYNTHeSis[:STATe]?	Query phase noise optimization on/off
[[:SENSe]:FREQuency:SYNTHeSis:AUTO[:STATe] OFF ON 0 1	Set phase noise optimization auto on/off
[[:SENSe]:FREQuency:SYNTHeSis:AUTO[:STATe]?	Query phase noise optimization auto on/off
[[:SENSe]:IF:GAIN:AUTO OFF ON 0 1	Set IF gain auto on/off
[[:SENSe]:IF:GAIN:AUTO?	Query IF gain auto on/off
[[:SENSe]:IF:GAIN:AUTO:LEVEL 5 0 -5 -10	Set IF auto gain level
[[:SENSe]:IF:GAIN:AUTO:LEVEL?	Query IF auto gain level
[[:SENSe]:IF:GAIN:SWEPT[:STATe] OFF ON 0 1	Set sweep IF gain on/off
[[:SENSe]:IF:GAIN:SWEPT[:STATe]?	Query sweep IF gain on/off
[[:SENSe]:IF:GAIN:SWEPT:AUTO[:STATe] OFF ON 0 1	Set sweep IF gain auto on/off
[[:SENSe]:IF:GAIN:SWEPT:AUTO[:STATe]?	Query sweep IF gain auto on/off
[[:SENSe]:IF:GAIN:FFT[:STATe] LOW HIGH	Set FFT IF gain on/off
[[:SENSe]:IF:GAIN:FFT[:STATe]?	Query FFT IF gain on/off
[[:SENSe]:IF:GAIN:FFT:AUTO[:STATe] OFF ON 0 1	Set FFT IF gain auto
[[:SENSe]:IF:GAIN:FFT:AUTO[:STATe]?	Query FFT IF gain auto
[[:SENSe]:POWER[:RF]:MW:PATH STD LNPath	Set low noise path on/off

Appendix B SCPI Command Index

[.SENSe]:POWer[:RF]:MW:PATH?	Query low noise path on/off
[.SENSe]:RF:GAIN:AUTO:RULEs RANGE	RF gain best dynamic range
[.SENSe]:RF:GAIN:AUTO:RULEs SENSITIVITY	RF gain best sensitivity
[.SENSe]:RF:GAIN:AUTO:RULEs?	Query RF gain distribution rules
[.SENSe]:RF:GAIN:AUTO[:STATe] OFF ON 0 1	Set RF gain auto on/off
[.SENSe]:RF:GAIN:AUTO[:STATe]?	Query RF gain auto on/off
[.SENSe]:SWEep:FFT:WIDTh <real>	Set FFT width
[.SENSe]:SWEep:FFT:WIDTh?	Query FFT width
[.SENSe]:SWEep:FFT:WIDTh:AUTO OFF ON 0 1	Set FFT width auto on/off
[.SENSe]:SWEep:FFT:WIDTh:AUTO?	Query FFT width auto on/off
[.SENSe]:SWEep:TIME <time>	Set the scanning time
[.SENSe]:SWEep:TIME?	Query sweep time
[.SENSe]:SWEep:TIME:AUTO OFF ON 0 1	Set sweep time on/off
[.SENSe]:SWEep:TIME:AUTO?	Query sweep time
[.SENSe]:SWEep:TIME:AUTO:RULEs NORMAl ACCuRacy SRESponse	Set sweep time rules
[.SENSe]:SWEep:TIME:AUTO:RULEs?	Query sweep time rules
[.SENSe]:SWEep:TYPE FFT SWEep	Set the scanning type
[.SENSe]:SWEep:TYPE?	Query sweep type
[.SENSe]:SWEep:TYPE:AUTO OFF ON 0 1	Set sweep type auto on/off
[.SENSe]:SWEep:TYPE:AUTO?	Query sweep type auto on/off
[.SENSe]:SWEep:TYPE:AUTO:RULEs SPEEd DRANge	Set sweep type rules
[.SENSe]:SWEep:TYPE:AUTO:RULEs?	Query sweep type rules
[.SENSe]:SWEep:TYPE:AUTO:RULEs:AUTO[:STATe] OFF ON 0 1	Set sweep type rules auto on/off
[.SENSe]:SWEep:TYPE:AUTO:RULEs:AUTO[:STATe]?	Query sweep type rules auto on/off
[.SENSe]:SWEep:POINts <integer>	Set the scanning point number
[.SENSe]:SWEep:POINts?	Query sweep points
:TRACe:COPIY TRACE1 TRACE2 TRACE3 TRACE4 TRACE5 TRACE6,TRACE1 TRACE2 TRACE3 TRACE4 TRACE5 TRACE6	Initiate trace copy
:TRACe:COPIY?	Query trace copy
:TRACe<1 2 3 4 5 6>:DISPlay[:STATe] ON OFF 0 1	Set trace display status on/off
:TRACe<1 2 3 4 5 6>:DISPlay[:STATe]?	Query trace display status on/off

Appendix B SCPI Command Index

:TRACe:PRESet:ALL	Reset All Traces
:TRACe<1 2 3 4 5 6>:TYPE WRITe AVERAge MAXHold MINHold	Set trace display mode
:TRACe<1 2 3 4 5 6>:TYPE?	Query trace display mode
:TRACe#:UPDate[:STATe] ON OFF 0 1	Set trace update state on/off
:TRACe#:UPDate[:STATe]?	Query trace update state on/off
:TRACe[:DATA]? TRACE1 TRACE2 TRACE3 TRACE4 TRACE5 TRACE6	Query trace data (only for remote control)
:UNIT:POWer DBM DBMV DBMA V W A DBUV DBUA DBUVM DBUAM DBPT DBG	Set Y axis scale unit
:UNIT:POWer?	Query Y axis scale unit
INITiate:PAUSe	Sweep pause
:INITiate:RESume	Sweep resume
[:SENSe]:FREQuency:CENTer <freq>	Set center frequency
[:SENSe]:FREQuency:CENTer?	Query center frequency
[:SENSe]:FREQuency:CENTer:STEP[:INCRement] <freq>	Set frequency step
[:SENSe]:FREQuency:CENTer:STEP[:INCRement]?	Query frequency step
[:SENSe]:FREQuency:CENTer:STEP:AUTO OFF ON 0 1	Set frequency step auto on/off
[:SENSe]:FREQuency:CENTer:STEP:AUTO?	Query frequency step auto on/off
[:SENSe]:FREQuency:OFFSet <freq>	Set frequency offset
[:SENSe]:FREQuency:OFFSet?	Query frequency offset
frequency step auto on/off	Set mechanical attenuation
[:SENSe]:POWer[:RF]:ATTenuation?	Query mechanical attenuation
[:SENSe]:POWer[:RF]:ATTenuation:AUTO OFF ON 0 1	Set mechanical attenuation auto on/off
[:SENSe]:POWer[:RF]:ATTenuation:AUTO?	Query mechanical attenuation auto on/off
[:SENSe]:POWer[:RF]:EATTenuation <rel_amp>	Set Elec Attenuation
[:SENSe]:POWer[:RF]:EATTenuation?	Query Elec Attenuation
[:SENSe]:POWer[:RF]:EATTenuation:STATe OFF ON 0 1	Set Elec Attenuator on/off
[:SENSe]:POWer[:RF]:EATTenuation:STATe?	Query Elec Attenuator on/off
[:SENSe]:POWer[:RF]:EATTenuation <rel_amp>	Set Elec Attenuator
[:SENSe]:POWer[:RF]:EATTenuation?	Query Elec Attenuator
[:SENSe]:POWer[:RF]:ATTenuation:STEP[:INCRement] 10dB 2dB	Set mechanical attenuation step
[:SENSe]:POWer[:RF]:ATTenuation:STEP[:INCRement]?	Query mechanical attenuation step
[:SENSe]:POWer[:RF]:MIXer:RANGe[:UPPer] <real>	Set maximum mixer

Appendix B SCPI Command Index

	level
[[:SENSe]:POWer[:RF]:MIXer:RANGe[:UPPer]?]	Query maximum mixer level
[[:SENSe]:POWer[:RF]:GAIN[:STATe] OFF ON 0 1]	Set pre-amplifier on/off
[[:SENSe]:POWer[:RF]:GAIN[:STATe]?]	Query pre-amplifier on/off
[[:SENSe]:ROSCillator:SOURce INTernal EXTernal]	Set frequency reference internal/external
[[:SENSe]:ROSCillator:SOURce?]	Query frequency reference internal/external
[[:SENSe]:SWEep:EGATe:HOLDoff <time>]	Set Trigger Holdoff Time
[[:SENSe]:SWEep:EGATe:HOLDoff?]	Query Trigger Holdoff Time
[[:SENSe]:SWEep:EGATe:HOLDoff:AUTO OFF ON 0 1]	Set Trigger Holdoff On/Off
[[:SENSe]:SWEep:EGATe:HOLDoff:AUTO?]	Query Trigger Holdoff On/Off
:SYSTem:CLOGging ON OFF	Set log text on/off
:SYSTem:CLOGging?	Query log text on/off
:SYSTem:COMMunicate:GPIB[:SELf]:ADDRess <integer>	set GPIB address
:SYSTem:COMMunicate:GPIB[:SELf]:ADDRess?	Query the GPIB address.
:SYSTem:ERRor[:NEXT]?	Search the current error information
:SYSTem:PRESet:USER	Change the preset mode to user preset
:SYSTem:PRESet:USER:SAVE	Save the user preset state
:TRIGger[:SEQuence]:EXTernal[1] 2:DELay <time>	Set external trigger 1 or external trigger 2 delay
:TRIGger[:SEQuence]:EXTernal[1] 2:DELay?	Query external trigger 1 or external trigger 2 delay
:TRIGger[:SEQuence]:EXTernal[1] 2:DELay:STATe OFF ON 0 1]	Set external trigger 1 or external trigger 2 delay
:TRIGger[:SEQuence]:EXTernal[1] 2:DELay:STATe?	Set external trigger 1 or external trigger 2 delay on/off
:TRIGger[:SEQuence]:EXTernal[1] 2:LEVel <level>	Set external trigger 1 or external trigger 2 level
:TRIGger[:SEQuence]:EXTernal[1] 2:LEVel?	Query external trigger 1 or external trigger 2

Appendix B SCPI Command Index

	level
:TRIGger[:SEQuence]:EXTErnal[1] 2:SLOPe POSitive NEGative	Set external trigger 1 or external trigger 2 polarity
:TRIGger[:SEQuence]:EXTErnal[1] 2:SLOPe?	Query external trigger 1 or external trigger 2 polarity
:TRIGger[:SEQuence]:FRAMe:DELay <time>	Set timer trigger delay
:TRIGger[:SEQuence]:FRAMe:DELay?	Query timer trigger delay
:TRIGger[:SEQuence]:FRAMe:DELay:STATe OFF ON 0 1	Set timer trigger delay on/off
:TRIGger[:SEQuence]:FRAMe:DELay:STATe?	Query timer trigger delay on/off
:TRIGger[:SEQuence]:FRAMe:OFFSet <time>	Set timer trigger offset
:TRIGger[:SEQuence]:FRAMe:OFFSet?	Query timer trigger offset
:TRIGger[:SEQuence]:FRAMe:PERiod <time>	Set timer trigger period
:TRIGger[:SEQuence]:FRAMe:PERiod?	Query timer trigger period
:TRIGger[:SEQuence]:FRAMe:SYNC EXTErnal1 EXTErnal2 RFBurst OFF	Select Sync Source
:TRIGger[:SEQuence]:FRAMe:SYNC?	Query sync source selection
:TRIGger[:SEQuence]:FRAMe:SYNC:HOLDoff <time>	Set sync source holdoff
:TRIGger[:SEQuence]:FRAMe:SYNC:HOLDoff?	Query sync source holdoff
:TRIGger[:SEQuence]:LINE:DELay <time>	Set power trigger delay
:TRIGger[:SEQuence]:LINE:DELay?	Query power trigger delay
:TRIGger[:SEQuence]:LINE:DELay:STATe OFF ON 0 1	Set power trigger delay on/off
:TRIGger[:SEQuence]:LINE:DELay:STATe?	Query power trigger delay on/off
:TRIGger[:SEQuence]:LINE:SLOPe POSitive NEGative	Set power trigger polarity
:TRIGger[:SEQuence]:LINE:SLOPe?	Query power trigger polarity
:TRIGger[:SEQuence]:RFBurst:DELay <time>	Set burst signal trigger delay
:TRIGger[:SEQuence]:RFBurst:DELay?	Query burst signal trigger delay
:TRIGger[:SEQuence]:RFBurst:DELay:STATe OFF ON 0 1	Set burst signal trigger delay on/off
:TRIGger[:SEQuence]:RFBurst:DELay:STATe?	Query burst signal trigger delay on/off
:TRIGger[:SEQuence]:RFBurst:LEVel:ABSolute <ampl>	Set burst signal trigger level
:TRIGger[:SEQuence]:RFBurst:LEVel:ABSolute?	Query burst signal

Appendix B SCPI Command Index

	trigger level
:TRIGger[:SEQuence]:RFBurst:SLOPe POSitive NEGative	Set burst signal trigger polarity
:TRIGger[:SEQuence]:RFBurst:SLOPe?	Query burst signal trigger polarity
:TRIGger[:SEQuence]:SOURce EXTernal1 EXTernal2 IMMEDIATE LINE FRAME RFBurst VIDeo IF ALARm LAN I/QMag IDEMod QDEMod IINPut QINPut AI/QMag	Select trigger method
:TRIGger[:SEQuence]:SOURce?	Query trigger method selection
:TRIGger[:SEQuence]:VIDeo:DELay <time>	Set video trigger delay
:TRIGger[:SEQuence]:VIDeo:DELay?	Query video trigger delay
:TRIGger[:SEQuence]:VIDeo:DELay:STATe OFF ON 0 1	Set video trigger delay
:TRIGger[:SEQuence]:VIDeo:DELay:STATe?	Query video trigger delay
:TRIGger[:SEQuence]:VIDeo:LEVel <ampl>	Set video trigger level
:TRIGger[:SEQuence]:VIDeo:LEVel?	Query video trigger level
:TRIGger[:SEQuence]:VIDeo:SLOPe POSitive NEGative	Set video trigger polarity
:TRIGger[:SEQuence]:VIDeo:SLOPe?	Query video trigger polarity

Appendix C Error Message Index

Schedule C.1 Table of Local Error Information

Error code	Key Error Field	Description of error
1	USBINITERR	Instrument keyboard initialization failed, please check hardware and driver
2	LANINIT ERR	LAN port initialization failed, please check hardware and driver
3	HARDINIT ERR	Hardware function initialization failed, please check hardware and driver
4	WINSOCKET ERR	Winsocket library initialization failed
5	SOCKETCRT ERR	SOCKET interface creation failed
6	SOCKETBAND ERR	SOCKET interface binding failed
7	LISTEN ERR	Listener interface failed
8	LINK ERR	Link creation failed
9	FMDATA ERR	FM offset data calling failed
15	CALFILE ERR	Calibration file calling failed
20	GPS INIT	GPS initialization failed
30	FACTDATA ERR	Factory commissioning status data calling failed
31	FLATNESS ERR	Flatness data calling failed
32	LOADFILE ERR	File loading failed
33	SAVEFILE ERR	File saving failed
34	LICENSE ERR	Invalid license
35	LICENSE OPEN	License opening failed
37	YTFTUNE ERR	YTF tuning data calling failed
38	YTFTRC ERR	YTF trace data calling failed
39	SAMPLL ERR	Sampling loop calling failed
40	CRET EVT	System sync event creation error
41	NO MEMRY	No dynamic allocation memory
42	SHUTDOWN FAIL	Remote instrument shutdown failed
43	SPACE LOW	Low disk space
44	CRET DIRY	Folder creation failed
45	CRET FILE	File creation failed
46	CHECK DISK	Free disk space checking failed
47	READ FILE	File reading failed
48	WRITE FILE	File writing failed
90	CALCBAND	Band parameter calculation error
100	LO ALLOT	LO allocation algorithm failed
101	FRACNLOW	Lower fractional loop lock loss
102	SAMP UPR	Upper sample loop lock loss
103	YTO CHK	YTO loop lock detect
104	OVERSTEP	Error voltage zero adjustment times beyond 15
105	CORS LOW	Coarse tuned DAC out of range of 0~255 and below 0

Appendix C Error Message Index

Schedule C.2 Table of Local Error Information (Continued 1)

Error code	Key Error Field	Description of error
106	CORS UPR	Coarse tuned DAC out of range of 0~255 and above 255
107	CORS LOW	Fined tuned DAC falls below 65 during coarse tuning, resulting in coarse tuned DAC below 0
108	CORS UPR	Fined tuned DAC increases to over 255 during coarse tuning, resulting in coarse tuned DAC above 255
109	CORS UPR	Fined tuned DAC increases to over 255 during fine tuning, resulting in coarse tuned DAC above 255
110	CORS UPR	Fined tuned DAC increases to over 191 during fine tuning, resulting in coarse tuned DAC beyond 0~255 and above 255
111	CORS LOW	Fined tuned DAC falls below 0 during fine tuning, resulting in coarse tuned DAC beyond 0~255 and above 255
112	CORS LOW	Fined tuned DAC falls below 65 during fine tuning, resulting in coarse tuned DAC beyond 0~255 and above 255
113	SAMP LOW	Lower sample loop lock loss
114	FRACNUPR	Upper fractional loop lock loss
115	LO1 FAIL	LO1 modulation failed
116	LO2 FAIL	LO2 modulation failed
201	LOAD CAL	Calibration file loading failed
202	DSP DATA	Calibration data writing into DSP failed
203	SAVE CAL	Writing or creation of file to save calibration data failed
210	GETCALTR	Calibration sweep trace acquiring during calibration failed
220	CALFLTNS	Calibration data out of limit during in-band flatness calibration
221	40MFLTNS	40 MHz in-band flatness calibration error
222	13MFLTNS	13MHz in-band flatness calibration error
223	3M FLTNS	3MHz in-band flatness calibration error
224	.1MFLTNS	100kHz in-band flatness calibration error
225	200MFLTNS	200MHz in-band flatness calibration error
226	100MFLTNS	100MHz in-band flatness calibration error
227	50MFLTNS	50MHz in-band flatness calibration error
230	200MError	200MHz bandwidth switching error calibration error
231	100MError	100MHz bandwidth switching error calibration error
232	50MError	50MHz bandwidth switching error calibration error
233	40MError	40MHz bandwidth switching error calibration error
234	20MError	20MHz bandwidth switching error calibration error
235	10MError	10MHz bandwidth switching error calibration error
236	8M Error	8MHz bandwidth switching error calibration error
237	5M Error	5MHz bandwidth switching error calibration error
238	4M Error	4MHz bandwidth switching error calibration error
239	2.5M Err	2.5MHz bandwidth switching error calibration error
240	2M Error	2MHz bandwidth switching error calibration error
241	1.6M Error	1.6MHz bandwidth switching error calibration error
242	1M Error	1MHz bandwidth switching error calibration error

Schedule C.3 Table of Local Error Information (Continued 2)

Error code	Key Error Field	Description of error
243	800kError	800kHz bandwidth switching error calibration error
244	500kError	500kHz bandwidth switching error calibration error
245	400kError	400kHz bandwidth switching error calibration error
246	250kError	250kHz bandwidth switching error calibration error
247	200kError	200kHz bandwidth switching error calibration error
248	160kError	160kHz bandwidth switching error calibration error
249	100kError	100kHz bandwidth switching error calibration error
250	80kError	80kHz bandwidth switching error calibration error
251	50kError	50kHz bandwidth switching error calibration error
252	40kError	40kHz bandwidth switching error calibration error
253	25kError	25kHz bandwidth switching error calibration error
254	20kError	20kHz bandwidth switching error calibration error
255	16kError	16kHz bandwidth switching error calibration error
256	10kError	10kHz bandwidth switching error calibration error
257	8kError	8kHz bandwidth switching error calibration error
258	5kError	5kHz bandwidth switching error calibration error
259	4kError	4kHz bandwidth switching error calibration error
260	2.5kError	2.5kHz bandwidth switching error calibration error
261	2kError	2kHz bandwidth switching error calibration error
262	1.6kError	1.6kHz bandwidth switching error calibration error
263	<=1kErr	<=1kHz bandwidth switching error calibration error
291	RF GAIN	RF variable gain calibration error
292	FLATGDAC	Flatness amplifier gain calibration error
294	NBIFGAIN	Narrowband IF variable gain calibration error
295	WBIFGAIN	Wideband IF variable gain calibration error
296	500MAMPL	Absolute amplitude error calculation error when narrowband pre-amplifier is off
297	500MAMPL	Absolute amplitude error calculation error when wideband pre-amplifier is off
298	500MAMPL	Absolute amplitude error calculation error when narrowband pre-amplifier is on
299	500MAMPL	Absolute amplitude error calculation error when wideband pre-amplifier is on
300	NB DEV	Narrowband acquisition equipment opening failed
301	NB INIT	Narrowband acquisition equipment initialization failed
302	NB FPGA	Narrowband acquisition equipment FPGA configuration failed
303	NB WRKP	Narrowband equipment operating parameter setting failed
304	FIR FILE	FIR file loading failed
305	FPGA FILE	Narrowband acquisition equipment FPGA file opening failed
306	NB EVT	Narrowband acquisition equipment driver sync event creation failed
310	NBOVERTIME	Narrowband acquisition equipment sampling overtime
311	DIRVER READ	Narrowband acquisition equipment driver reading failed
312	DIRVER WRITE	Narrowband acquisition equipment driver writing failed

Appendix C Error Message Index

Schedule C.4 Table of Local Error Information (Continued 3)

Error code	Key Error Field	Description of error
313	DRIVER DMA	Narrowband acquisition equipment driver DMA failed
315	WBOVERTIME"	Wideband acquisition equipment sampling overtime
320	WB DEV	Wideband acquisition equipment opening failed
321	WB INIT	Wideband acquisition equipment initialization failed
322	WB FPGA	Wideband acquisition equipment FPGA configuration failed
323	WB WRKP "	Wideband equipment operating parameter setting failed
325	FPGA FILE	Wideband acquisition equipment FPGA file opening failed
326	WB EVT	Wideband acquisition equipment driver sync event creation failed
331	DIRVER READ	Wideband acquisition equipment driver reading failed
332	DIRVER WRITE	Wideband acquisition equipment driver writing failed
333	DRIVER DMA	Wideband acquisition equipment driver DMA failed
340	BBS DEV	Audio acquisition equipment opening failed
341	BBS INIT	Audio acquisition equipment initialization failed
342	BBS FPGA	Audio acquisition equipment FPGA configuration failed
343	BBS WRKP	Audio equipment operating parameter setting failed
345	FPGA FILE	Audio acquisition equipment FPGA file opening failed
346	BBS EVT	Audio acquisition equipment driver sync event creation failed
350	OVERTIME	Audio acquisition equipment sampling overtime
351	DIRVER READ	Audio acquisition equipment driver reading failed
352	DIRVER WRITE	Audio acquisition equipment driver writing failed
353	DRIVER DMA	Audio acquisition equipment driver DMA failed
354	DATA LACK	Too short data length of audio acquisition equipment
360	LARGEREF	Audio board wide range reference calibration error
361	LARGEEND	Audio board wide range calibration error
362	SMALLREF	Audio board wide range reference calibration error
363	SMALLGND	Audio board wide range calibration error
370	500MAMPL	Shutdown before phase noise optimizationabsolute amplitude error calibration error!
371	500MAMPL	Clearing before phase noise optimizationabsolute amplitude error calibration error!
400	FIR TMOUT	Timeout error in continuous sweep
401	FIR RDERR	Data reading error in continuous sweep and reading points mismatch
500	NODSPDEV	Data processor opening error
501	DEV INIT	Data processor initialization error
502	DSP PARM	Data processor operating parameter setting error
503	DSPA ERR	DSPA initialization failed
504	DSPB ERR	DSPB initialization failed
505	DSPC ERR	DSPC initialization failed
506	FPGA ERR	Data processor FPGA configuration error
507	FPGA PARM	Data processor FPGA operating parameter setting error
508	FPGA FILE	Data processor FPGA file opening failed

Schedule C.5 Table of Remote control Error Information

Error code	Key Error Field	Description of error
509	DSP FILE	dsp file opening failed
510	CRET EVT	Data processor driver sync event creation failed
511	DIRVER READ	Data processor driver reading failed
512	DIRVER WRITE	Data processor driver writing failed
513	DRIVER DMA	Data processor driver DMA failed
525	DSP OVERTIME	Data processor fetching overtime
600	CMD ERR	No parameter allowed in command
601	CMD ERR	Command parameter error
602	GPIB ERR	Current mode command file damaged
603	CMD ERR	Remote command not exist
604	CMD ERR	Command not exist in current mode
605	GPIB ERR	Receiver mode command file damaged
606	GPIB ERR	Phase noise mode command file damaged
607	CMD ERR	Too much key words with number
608	CMD ERR	No number allowed in key words
610	SFP ERR	Recorder path link failed
650	GPIBINIT ERRO	GPIB initialization failed
651	REGISTER ERRO	GPIB access to registry failed
652	GPIBMEMERRO	GPIB storage initialization failed