

VNA Master™

Handheld Vector Network Analyzer + Spectrum Analyzer

MS2026C 5 kHz to 6 GHz
MS2027C 5 kHz to 15 GHz
MS2028C 5 kHz to 20 GHz
 Vector Network Analyzer

MS2036C 5 kHz to 6 GHz
MS2037C 5 kHz to 15 GHz
MS2038C 5 kHz to 20 GHz
 Vector Network Analyzer
 9 kHz to 9 GHz
 9 kHz to 15 GHz
 9 kHz to 20 GHz
 Spectrum Analyzer

The Ultimate Handheld Vector Network + Spectrum Analyzer for Cable, Antenna, and Signal Analysis Anytime, Anywhere

Introduction

High Performance Handheld S-Parameters

Anritsu introduces the MS202x/3xC VNA Master + Spectrum Analyzer, the industry's broadest frequency handheld solution to address cable, antenna, component, and signal analysis needs in the field: with frequency coverage from 5 kHz up to 20 GHz. Equally impressive, this broadband measurement tool offers the industry's first 12-term error correction algorithm in a truly handheld, battery-operated, rugged multi-function instrument. And now the MS203xC models include a powerful spectrum analyzer which multiplies user convenience by combining spectrum analysis with the VNA into a single measurement powerhouse for the harsh RF and physical environments of field test. Whether it is for spectrum monitoring, broadcast proofing, interference analysis, RF and microwave measurements, regulatory compliance, or 3G/4G and wireless data network measurements, this VNA/Spectrum Analyzer combination is the ideal instrument for making fast and reliable measurements in the field.



Performance and Functional Highlights

Vector Network Analyzer

- Broadband coverage of 5 kHz to up to 20 GHz
- True 2-path, 2-port Vector Network Analyzer
- Ultimate accuracy with 12-term error correction
- User-defined Quad Display for viewing all 4 S-Parameters
- Arbitrary data points up to 4001
- IF Bandwidth selections of 10 Hz to 100 kHz
- Directivity:
 - > 42 dB 5 kHz - 5 GHz (all models)
 - > 36 dB 5 GHz - 15 GHz (MS2027C/37C)
 - > 32 dB 15 GHz - 20 GHz (MS2028C/38C)
- Transmission Dynamic Range:
 - > 100 dB 2 MHz - 3 GHz (all models)
 - > 90 dB 3 GHz - 6 GHz (all models)
 - > 85 dB 6 GHz - 15 GHz MS2027C/37C
 - > 85 dB 6 GHz - 20 GHz MS2028C/38C
- Supports waveguide measurements
- 350 μ sec/data point sweep speed
- USB/Ethernet for PC data transfer and control
- Automate repetitive tasks via Ethernet & USB
- Field upgradable firmware
- Traces and setups limited by memory
- Portable: 10.5 lbs (4.8 kg)
- Full Speed USB Memory support
- High resolution daylight viewable TFT color display
- Time Domain option for Distance-to-Fault diagnostics
- Internal Bias Tee option
- Vector Voltmeter option
- High Accuracy Power Meter option
- Differential option (S_{d1d1} , S_{c1c1} , S_{d1c1} , and S_{c1d1})
- Secure Data Operation option
- GPS Receiver option
- Power Monitor option
- Polar Format Impedance Display
- Supports 4, 6, 8, 18, 26 GHz USB Power Sensors
- 8.4 in. Display
- Standards Compliance:
 - MIL-PRF-28800F Class 2

Block Diagram

As shown in the following block diagram, the VNA Master has a 2-port, 2-path architecture that automatically measures four S-parameters with a single connection.

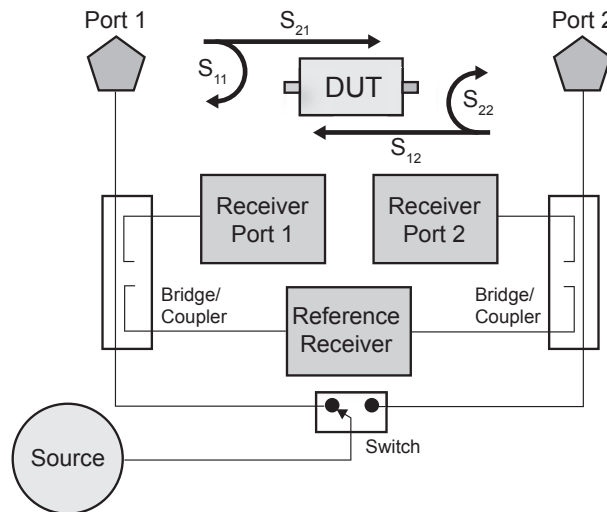

The above illustration is a simplified block diagram of VNA Master's 2-port, 2-path architecture.

Spectrum Analyzer (MS203xC models only)

- Measure: Occupied Bandwidth, Channel Power, ACPR, C/I
- Dynamic Range: > 104 dB in 1 Hz RBW
- DANL: -160 dBm in 1 Hz RBW
- Phase Noise: -100 dBc/Hz @ 10 kHz offset at 1 GHz
- Frequency Accuracy: < 25 ppb with GPS lock
- 1 Hz to 10 MHz Resolution Bandwidth (RBW)
- Traces: Normal, Max Hold, Min Hold, Average, # of Averages
- Detectors: Peak, Negative, Sample, Quasi-peak, and true RMS
- Markers: 6, each with a Delta Marker, or 1 Reference with 6 Deltas
- Limit Lines: up to 40 segments with one-button envelope creation
- Trace Save-on-Event: crossing limit line or sweep complete
- Option to automatically optimize sweep-RBW-VBW tradeoff for best possible display
- Interference Analyzer Option: Spectrogram, Signal Strength, RSSI
- Burst Detect
- Zero-span IF Output
- Gated Sweep
- GPS tagging of stored traces
- Internal Preamplifier standard
- High Accuracy Power Meter Option
- AM/FM/SSB Demodulation (audio only)

VNA Master Functional Specifications

Definitions

All specifications and characteristics apply under the following conditions, unless otherwise stated:

- After 30 minutes of warm-up time, when the instrument is in VNA Mode and left in the ON state.
- Temperature range is $23\text{ }^{\circ}\text{C} \pm 5\text{ }^{\circ}\text{C}$.
- All specifications apply when using internal reference.
- All specifications subject to change without notice. Please visit www.anritsu.com for most current data sheet.
- Typical performance is the measured performance of an average unit.
- Recommended calibration cycle is 12 months.

Frequency

VNA Frequency Range: MS2026/36C: 5 kHz to 6 GHz
 MS2027/37C: 5 kHz to 15 GHz
 MS2028/38C: 5 kHz to 20 GHz

Frequency Accuracy: $\pm 1.5\text{ ppm}$

Frequency Resolution: 1 Hz to 375 MHz, 10 Hz to 6 GHz, and 100 Hz to 20 GHz

Test Port Power

VNA Master supports selection of either High (default) or Low test port power. Changing power after calibration can degrade the calibrated performance. Typical power by bands is shown in the following table.

Frequency Range	High Port Power (dBm, typical)	Low Port Power (dBm, typical)
5 kHz to \leq 3 GHz	+3	-25
3 GHz to \leq 6 GHz	-3	-25
6 GHz to \leq 20 GHz	-3	-15

Transmission Dynamic Range

The transmission dynamic range (the difference between test port power and noise floor) using 10 Hz IF Bandwidth and High Port Power is shown in the following table.

Frequency Range	Dynamic Range (dB)
5 kHz to \leq 2 MHz	85
2 MHz to \leq 3 GHz	100
3 GHz to \leq 6 GHz	90
6 GHz to \leq 20 GHz	85

Sweep Speed

The typical sweep speed for IF Bandwidth of 100 kHz, 1001 data points, and single display is shown in the following table. The three receiver architecture will simultaneously collect S_{21} and S_{11} (or S_{12} and S_{22}) in a single sweep.

Frequency Range	Sweep Speed ($\mu\text{sec/point}$, typical)
5 kHz to 6 GHz	350
6 GHz to 20 GHz	650

High-Level Noise (S_{11} or S_{22} , Short, Power = High, IFBW = 200 Hz typical)

Magnitude	Phase
0.004 dB(rms) (5 kHz to 6 GHz)	0.040 deg (5 kHz to 6 GHz)
0.010 dB(rms) (6 GHz to 20 GHz)	0.050 deg (6 GHz to 20 GHz)

Noise Floor (Port Power - Dynamic Range)

Frequency	Noise Floor (dB, typical)
5 kHz to = 2 MHz	Port Power -85
2 MHz to = 3 GHz	Port Power -100
3 GHz to = 6 GHz	Port Power -90
6 GHz to = 20 GHz	Port Power -85

Temperature Stability (S_{11} or S_{22} , Short, $23\text{ }^{\circ}\text{C} \pm 5\text{ }^{\circ}\text{C}$, typical)

Magnitude	Phase
0.018 dB/ $^{\circ}\text{C}$ (5 kHz to 10 GHz)	0.160 deg/ $^{\circ}\text{C}$ (5 kHz to 10 GHz)
0.070 dB/ $^{\circ}\text{C}$ (10 GHz to 20 GHz)	0.800 deg/ $^{\circ}\text{C}$ (10 GHz to 20 GHz)

Reflection Tracking (S_{11} or S_{22})

Frequency	Tracking (dB, typical)
< 3 GHz	0.05
3 to 6 GHz	0.10
6 to 20 GHz	0.20

Transmission Tracking (S_{21} or S_{12})

Frequency	Tracking (dB, typical)
< 3 GHz	0.02
3 to 6 GHz	0.05
6 to 20 GHz	0.40

Source Match* (Anritsu 3652A Cal Kit)

Frequency	Match (dB, typical)
5 kHz to 1 GHz	41
1 GHz to 5 GHz	39
5 GHz to 20 GHz	31

Load Match* (Anritsu 3652A Cal Kit)

Frequency	Match (dB, typical)
5 kHz to 1 GHz	37
1 GHz to 15 GHz	34
15 GHz to 20 GHz	30

* Valid for MS20xxC, Anritsu 3652 Cal Kit, Port Power = High, No Averaging, IFBW = 1 kHz

VNA Performance Capabilities (MS202x/3xC)

Measurement Parameters	$S_{11}, S_{21}, S_{22}, S_{12}, S_{d(d1)}, S_{c(c1)}, S_{d(c1)}, S_{c(d1)}$
Number of Traces	Four: TR1, TR2, TR3, TR4
Trace Format	Single, Dual, Tri, Quad. When used with Number of Traces, overlays are possible including a Single Format with Four trace overlays.
Graph Types	Log Magnitude SWR Phase Real Imaginary Group Delay Smith Chart Inverted Smith Chart Log Mag / 2 (1-Port Cable Loss) Linear Polar Log Polar Real Impedance Imaginary Impedance
Domains	Frequency Domain, Time Domain, Distance Domain
Frequency	Start Frequency, Stop Frequency, Center Frequency, Span
Distance	Start Distance, Stop Distance
Time	Start Time, Stop Time
Frequency Sweep Type: Linear	Single Sweep, Continuous
Data Points	2 to 4001 (arbitrary setting); data points can be reduced without recalibration.
Limit Lines	Upper, Lower, 10-segmented Upper, 10-segmented Lower
Test Limits	Pass/Fail for Upper, Pass/Fail for Lower, Limit Audible Alarm
Data Averaging	Sweep-by-sweep
Smoothing	0 to 20%
IF Bandwidth	10, 20, 50, 100, 200, 500, 1 k, 2 k, 5 k, 10 k, 20 k, 50 k, 100 k (Hz)
Reference Plane	The reference planes of a calibration (or other normalization) can be changed by entering a line length. Assumes no loss, flat magnitude, linear phase, and constant impedance.
Auto Reference Plane Extension	Instead of manually entering a line length, this feature automatically adjusts phase shift from the current calibration (or other normalization) to compensate for external cables (or test fixtures). Assumes no loss, flat magnitude, linear phase, and constant impedance.
Frequency Range	Frequency range of the measurement can be narrowed within the calibration range without recalibration.
Group Delay Aperture	Defined as the frequency span over which the phase change is computed at a given frequency point. The aperture can be changed without recalibration. The minimum aperture is the frequency range divided by the number of points in calibration and can be increased to 20% of the frequency range.
Group Delay Range	< 180° of phase change within the aperture
Trace Memory	A separate memory for each trace can be used to store measurement data for later display. The trace data can be saved and recalled.
Trace Math	Complex trace math operations of subtraction, addition, multiplication, or division are provided.
Number of Markers	Eight, arbitrary assignments to any trace
Marker Types	Reference, Delta
Marker Readout Styles	Log Mag, Cable Loss (Log Mag / 2), Log Mag and Phase, Phase, Real and Imaginary, SWR, Impedance, Admittance, Normalized Impedance, Normalized Admittance, Polar Impedance, and Group Delay, Linear Mag, Linear Mag and Phase
Marker Search	Peak Search, Valley Search, Find Marker Value
Correction Models	Full 2-Port, Full S_{11} , Full S_{22} , Full S_{11} & S_{22} , Response S_{21} , Response S_{12} , Response S_{21} & S_{12} , Response S_{11} , Response S_{22} , Response S_{11} & S_{22} , One-Path Two-Port (S_{11}, S_{21}), One-Path Two-Port (S_{22}, S_{12})
Calibration Methods	Short-Open-Load-Through (SOLT), Offset-Short (SSLT), and Triple-Offset-Short (SSST)
Calibration Standards' Coefficients	Coax: N-Connector, K-Connector, 7/16, TNC, SMA, and four User Defined Waveguide: WG11A, WG12, WG13, WG14, WG15, WG16, WG17, WG18, WG20, and four User Defined
Cal Correction Toggle	On/Off
Dispersion Compensation	Waveguide correction that improves accuracy of distance-to-fault data by compensating for different wavelengths propagating at different speeds.
Impedance Conversion	Support for 50 Ω and 75 Ω are provided.
Units	Meters, Feet
Bias Tee Settings	Internal, External, Off
Timebase Reference	Internal, External (10 MHz)
File Storage Types	Measurement, Setup (with CAL), Setup (without CAL), S2P (Real/Imag), S2P (Lin Mag/Phase), S2P (Log Mag/Phase), JPEG
Ethernet Configuration	DHCP or Manual (Static); IP, Gateway, Subnet entries
Languages	English, French, German, Spanish, Chinese, Japanese, Korean, Italian, Russian, plus one User Defined

Uncertainty Curves for Round-Trip Cable Loss Measurements (1-Port)

Round-trip cable loss measurements are convenient for field personnel testing installed cable or waveguide runs. This one-port technique provides one-way data after twice traversing the cable. The following two sets of uncertainty curves, less than 6 GHz on the left and greater than 6 GHz on the right, present worst-case uncertainty by DUT Match (i.e., Log Mag) when using VNA Master for one-port cable loss measurements. As a practical tip, consider using a two-port transmission measurement technique to improve upon these one-port cable loss uncertainties.

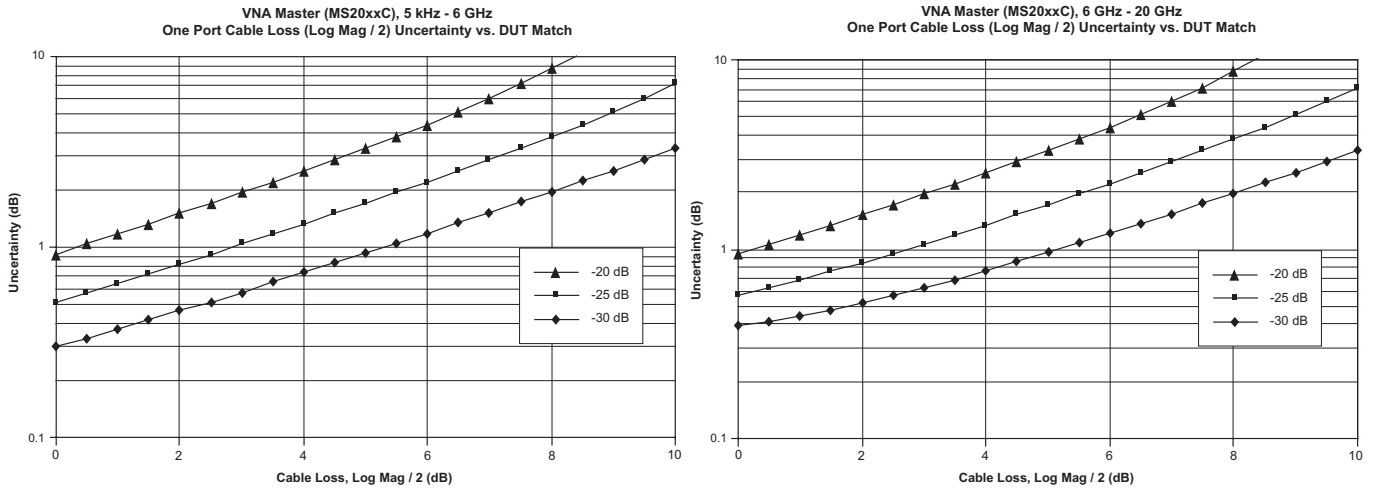

These uncertainty curves show how frequency range, DUT Match, and cable loss impact worst-case uncertainty of round-trip cable loss measurements. The uncertainty curves, separated by frequency range, are shown for DUT Match cable loss conditions of -20 dB, -25 dB, and -30 dB. For DUT Match of 30 dB and cable loss of 4 dB to 5 dB (reflection measurement of 8 dB to 10 dB) the worst-case uncertainties are approximately ± 1 dB.

High Port Power

OSLxx50 Calibration Components (N-Connectors)

Corrected System Performance and Uncertainties:
MS202x/3xC Models with 12-term SOLT calibration including
isolation using either OSLN50 & OSLNF50 or OSLK50 &
OSLKF50 Calibration Kits



Precision calibration standards come in a convenient configuration for field work.

Frequency Range (GHz)	Directivity (dB)
≤ 5	> 42
≤ 15	> 36
≤ 20*	> 32

* N Connector guaranteed to 18 GHz, typical > 18 GHz

Frequency Range (GHz)	Typical High Port Power (dBm)
≤ 3	+3
≤ 6	-3
≤ 20	-3

Measurement Uncertainties

The following graphs provide measurement uncertainty at 23 °C ± 5 °C for the above indicated connector type and calibration. Errors are worst-case contributions of residual directivity, source match, frequency response, network analyzer dynamic range, and connector repeatability. Transmission tracking, crosstalk, and physical load termination were added for two-port measurements. Isolation calibration and an IF Bandwidth of 10 Hz are used.

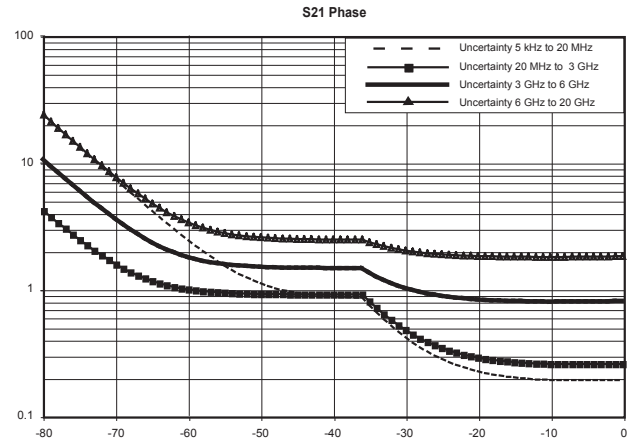
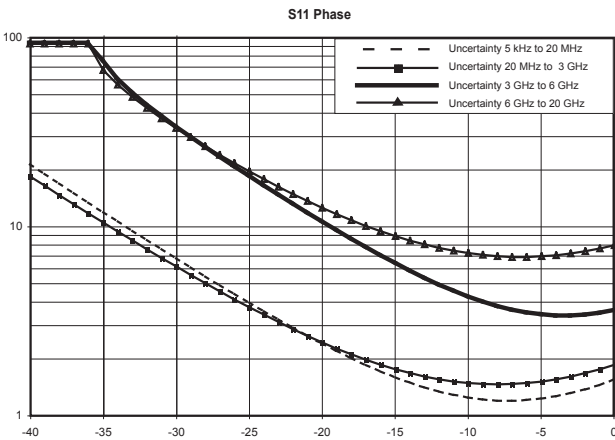
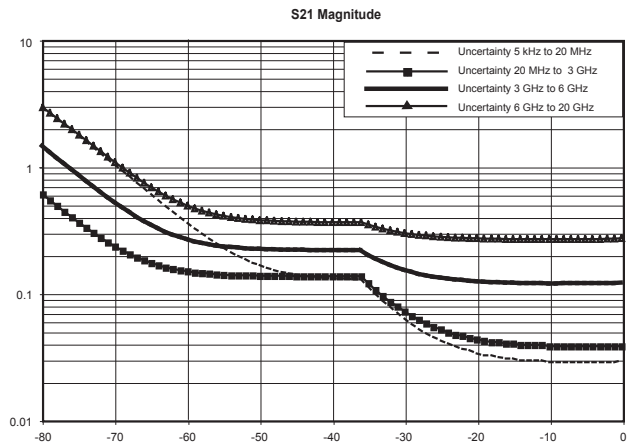
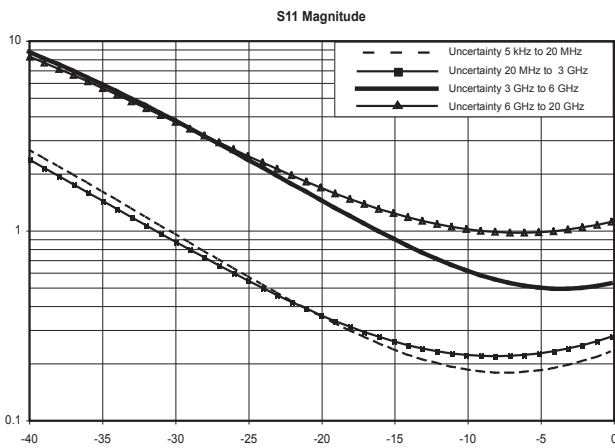

Low Port Power

OSLxx50 Calibration Components

Corrected System Performance and Uncertainties:
MS202x/3xC Models with 12-term SOLT calibration including
isolation using either OSLN50 & OSLNF50 or OSLK50 &
OSLKF50 Calibration Kits



Frequency Range (GHz)	Directivity (dB)
≤ 5	> 42
≤ 15	> 36
≤ 20*	> 32

* N Connector guaranteed to 18 GHz, typical > 18 GHz

Frequency Range (GHz)	Typical High Port Power (dBm)
≤ 3	-25
≤ 6	-25
≤ 20	-15

Measurement Uncertainties

The following graphs provide measurement uncertainty at 23 °C ± 5 °C for the above indicated connector type and calibration. Errors are worst-case contributions of residual directivity, source match, frequency response, network analyzer dynamic range, and connector repeatability. Transmission tracking, crosstalk, and physical load termination were added for two-port measurements. Isolation calibration and an IF Bandwidth of 10 Hz are used.

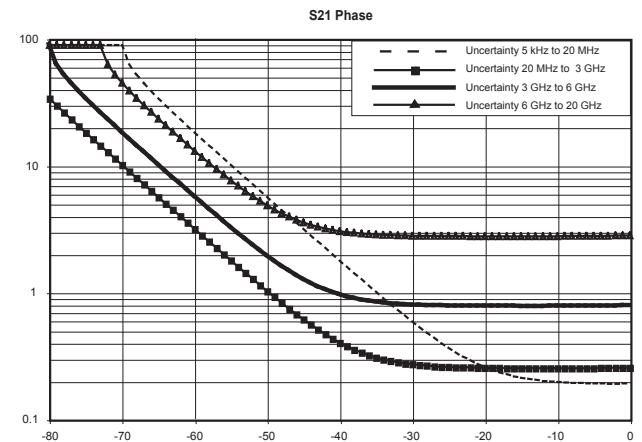
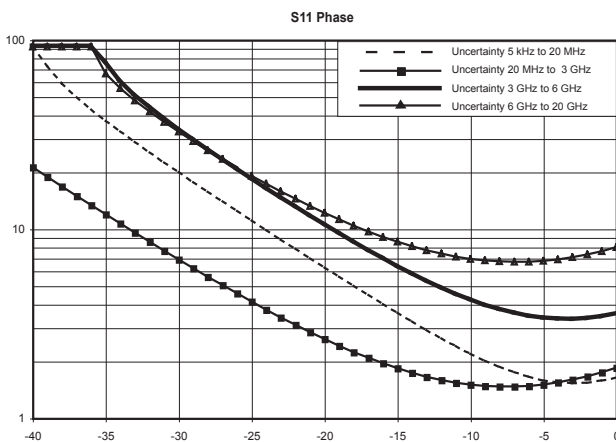
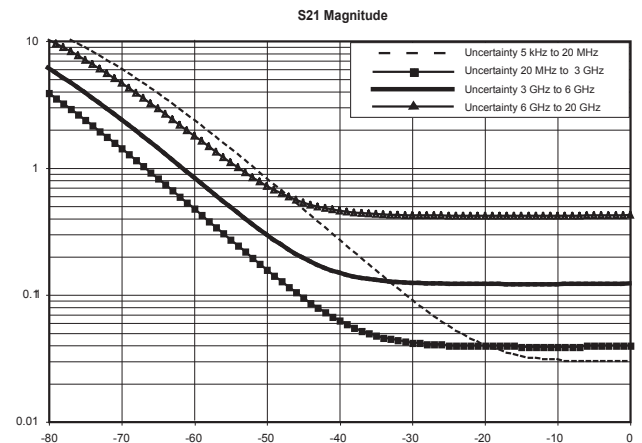
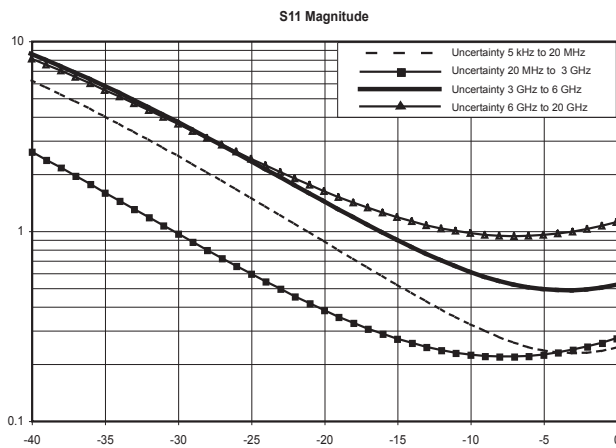

High Port Power

3652A Calibration Kit (K-Connector)

Corrected System Performance and Uncertainties:
MS202x/3xC Models with 12-term SOLT calibration including
isolation using 3652A Calibration Kit



Frequency Range (GHz)	Directivity (dB) *
≤ 5	> 34
≤ 15	> 34
≤ 20	> 34

* Directivity spec is limited to 34 dB by the 3652A Calibration Kit, not by the instrument performance.

Frequency Range (GHz)	Typical High Port Power (dBm)
≤ 3	+3
≤ 6	-3
≤ 20	-3

Measurement Uncertainties

The following graphs provide measurement uncertainty at 23 °C ± 5 °C for the above indicated connector type and calibration. Errors are worst-case contributions of residual directivity, source match, frequency response, network analyzer dynamic range, and connector repeatability. Transmission tracking, crosstalk, and physical load termination were added for two-port measurements. Isolation calibration and an IF Bandwidth of 10 Hz are used.

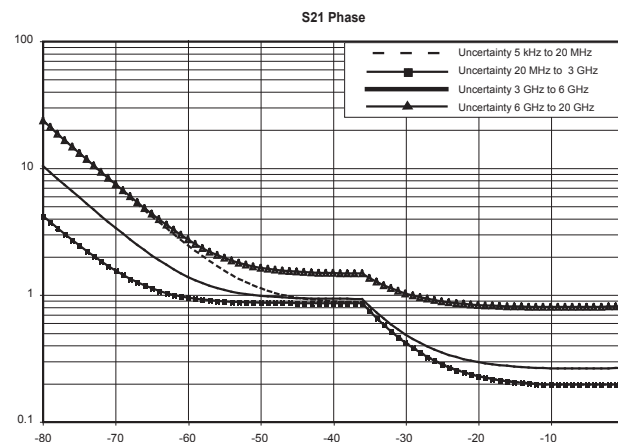
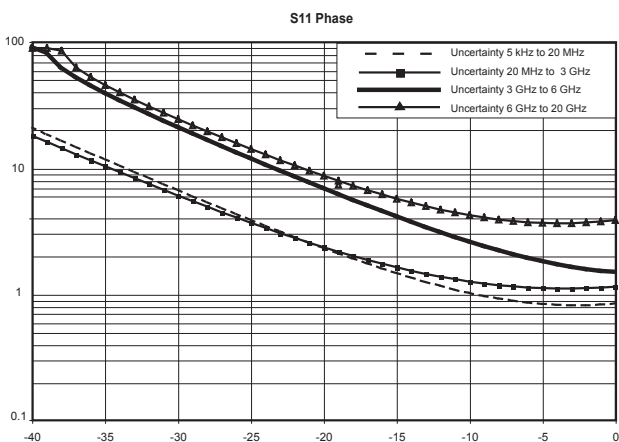
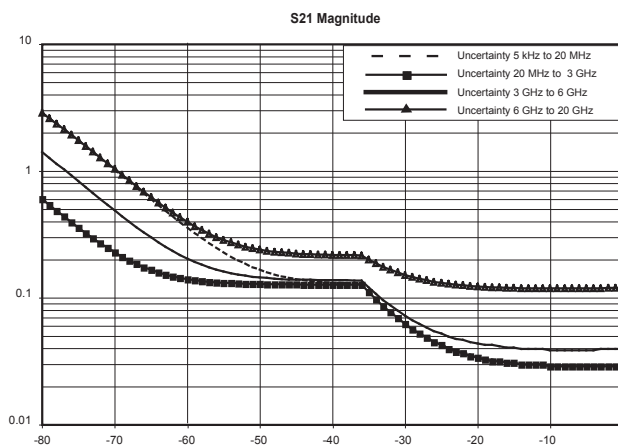
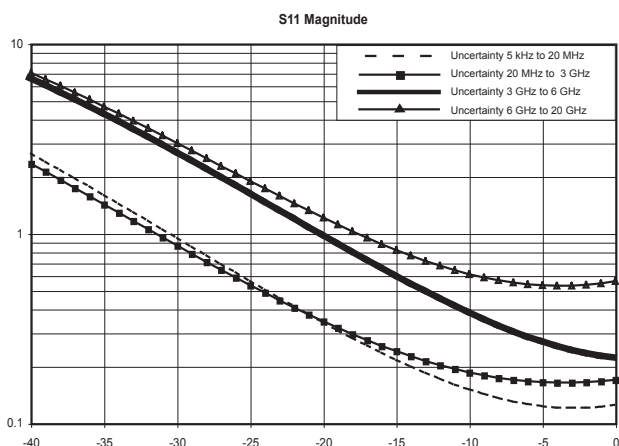

Low Port Power

3652A Calibration Kit (K-Connector)

Corrected System Performance and Uncertainties:
MS202x/3xC Models with 12-term SOLT calibration including
isolation using 3652A Calibration Kit



Frequency Range (GHz)	Directivity (dB) *
≤ 5	> 34
≤ 15	> 34
≤ 20	> 34

Frequency Range (GHz)	Typical Low Port Power (dBm)
≤ 3	-25
≤ 6	-25
≤ 20	-25

* Directivity spec is limited to 34 dB by the 3652A Calibration Kit, not by the instrument performance.

Measurement Uncertainties

The following graphs provide measurement uncertainty at $23\text{ }^{\circ}\text{C} \pm 5\text{ }^{\circ}\text{C}$ for the above indicated connector type and calibration. Errors are worse-case contributions of residual directivity, source match, frequency response, network analyzer dynamic range, and connector repeatability. Transmission tracking, crosstalk, and physical load termination were added for two-port measurements. Isolation calibration and an IF Bandwidth of 10 Hz are used.

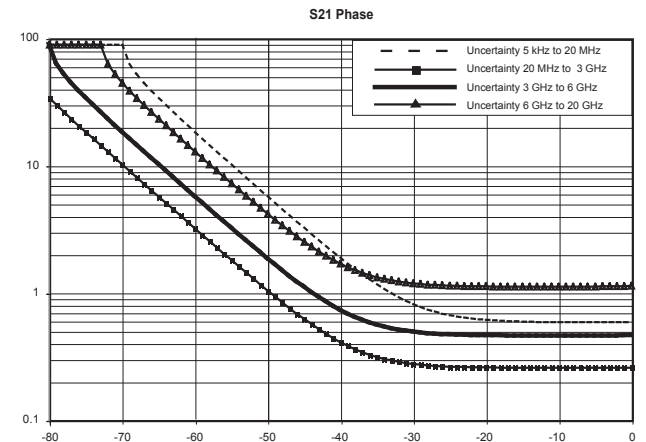
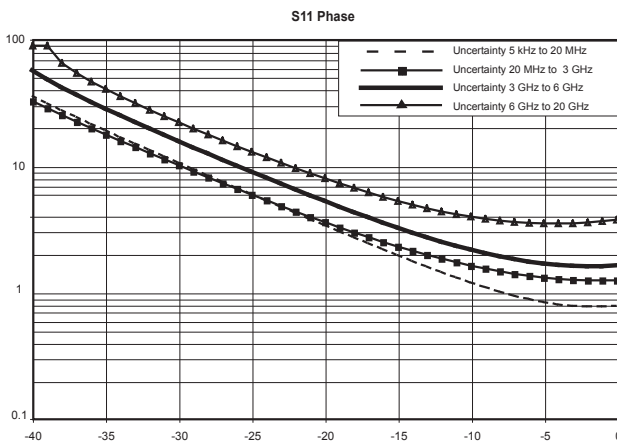
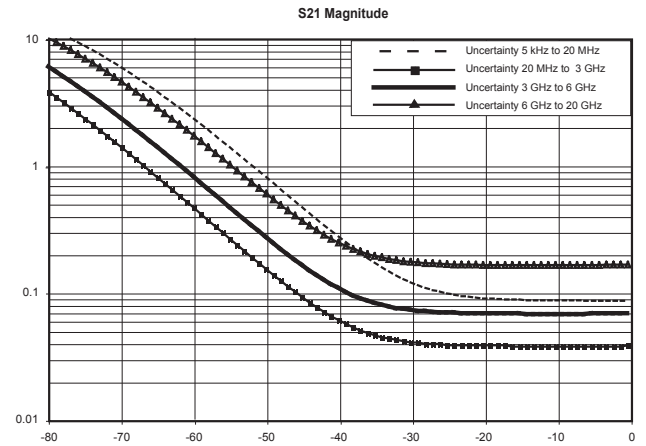
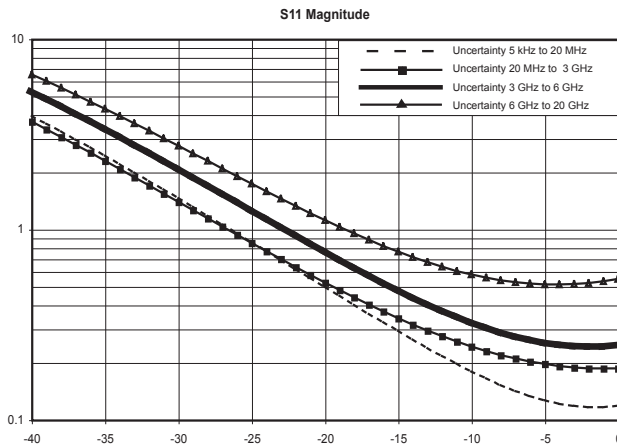

Spectrum Analyzer Functional Specifications (MS203xC models only)

Frequency	
Frequency Range	9 kHz to 6/15/20 GHz (usable to 0 Hz), Preamp 100 kHz to 6/15/20 GHz
Tuning Resolution	1 Hz
Frequency Reference	Aging: ± 1.0 ppm/10 years Accuracy: ± 0.3 ppm ($25\text{ }^{\circ}\text{C} \pm 25\text{ }^{\circ}\text{C}$) + aging
External Reference Frequencies	1, 1.2288, 1.544, 2.048, 2.4576, 4.8, 4.9152, 5, 9.8304, 10, 13, 19.6608 MHz
Frequency Span	10 Hz to 20 GHz including zero span
Sweep Time	10 μs to 600 seconds in zero span
Sweep Time Accuracy	$\pm 2\%$ in zero span
Bandwidth	
Resolution Bandwidth (RBW)	1 Hz to 10 MHz in 1–3 sequence $\pm 10\%$ (–3 dB bandwidth)
Video Bandwidth (VBW)	1 Hz to 10 MHz in 1–3 sequence (–3 dB bandwidth)
RBW with Quasi-Peak Detection	200 Hz, 9 KHz, 120 kHz (–6 dB bandwidth)
VBW with Quasi-Peak Detection	Auto VBW is On, RBW/VBW = 1
Spectral Purity	
SSB Phase Noise at 1 GHz	–100 dBc/Hz @ 10 kHz offset from carrier (–104 dBc/Hz typical) –102 dBc/Hz @ 100 kHz offset from carrier (–107 dBc/Hz typical) –107 dBc/Hz @ 1 MHz offset from carrier (–114 dBc/Hz typical) –120 dBc/Hz @ 10 MHz offset from carrier (–129 dBc/Hz typical)
Amplitude Ranges	
Dynamic Range	> 104 dB @ 2.4 GHz, 2/3 (TOI-DANL) in 1 Hz RBW
Measurement Range	DANL to +30 dBm
Display Range	1 to 15 dB/div in 1 dB steps, ten divisions displayed
Reference Level Range	–120 dBm to +30 dBm
Attenuator Resolution	0 to 65 dB, 5 dB steps
Amplitude Units	Log Scale Modes: dBm, dBV, dBmV, dB μ V Linear Scale Modes: nV, μ V, mV, V, kV, nW, μ W, mW, W, kW
Maximum Continuous Input	+30 dBm Peak, ± 50 VDC (≥ 10 dB Attn) +23 dBm Peak, ± 50 VDC (< 10 dB Attn) +13 dBm Peak, ± 50 VDC (Preamp On)
Amplitude Accuracy (single sine wave input < Ref level, and > DANL, auto attenuation), Performance Sweep mode	
20 $^{\circ}\text{C}$ to 30 $^{\circ}\text{C}$ after 30 minute warm-up	Typical: ± 0.5 dB, 100 kHz to 18 GHz Maximum: ± 1.3 dB, 100 kHz to 13 GHz Add ± 1.0 dB, 13 GHz to 18 GHz
–10 $^{\circ}\text{C}$ to 50 $^{\circ}\text{C}$ after 60 minute warm-up	Add ± 1.0 dB, 100 kHz to 18 GHz (typical)
Displayed Average Noise Level (DANL) (RMS detection, VBW/Avg type = Log., Ref Level = –20 dBm for preamp Off and –50 dBm for preamp On)	
(DANL in 1 Hz RBW, 0 dB attenuation)	Preamp Off
10 MHz to 4 GHz	–141 dBm
> 4 GHz to 9 GHz	–134 dBm
> 9 GHz to 13 GHz	–129 dBm
> 13 GHz to 20 GHz	–123 dBm
	Preamp On
10 MHz to 4 GHz	–160 dBm
> 4 GHz to 9 GHz	–156 dBm
> 9 GHz to 13 GHz	–152 dBm
> 13 GHz to 20 GHz	–145 dBm
Spurs	
Residual Spurious	Preamp Off (RF input terminated, 0 dB input attenuation) –90 dBm 9 kHz to 13 GHz, –85 dBm 13 GHz to 20 GHz
	Preamp On (RF input terminated, 0 dB input attenuation) –100 dBm 1 MHz to 20 GHz
Input-Related Spurious	(0 dB attenuation, –30 dBm input, span < 1.7 GHz) –60 dBc, –70 dBc typical

Spectrum Analyzer Functional Specifications (MS203xC models only) (continued)

Third-Order Intercept (TOI) (-20 dBm tones 100 kHz apart, -20 dBm Ref level, 0 dB input attenuation, preamp Off)

2.4 GHz	+15 dBm
50 MHz to 20 GHz	+20 dBm typical
P1dB	
< 4 GHz	+5 dBm typical
4 GHz to 20 GHz	+12 dBm typical
Second Harmonic Distortion	
50 MHz	-54 dBc
< 4 GHz	-60 dBc typical
> 4 GHz	-75 dBc typical
VSWR	
> 10 dB input attenuation < 20 GHz	1:5:1 typical

Measurements

Smart Measurements	Field Strength (uses antenna calibration tables to measure dBm/m ² or dBmV/m) Occupied Bandwidth (measures 99% to 1% power channel of a signal) Channel Power (measures the total power in a specified bandwidth) ACPR (adjacent channel power ratio) C/I (carrier-to-interference ratio) Emission Mask (recall limit lines as emission mask)
--------------------	---

Setup Parameters

Frequency	Center/Start/Stop, Span, Frequency Step, Signal Standard, Channel #
Amplitude	Reference Level (RL), Scale, Attenuation Auto/Level, RL Offset, Pre-Amp On/Off, Detection
Span	Span, Span Up/Down (1-2-5), Full Span, Zero Span, Last Span
Bandwidth	RBW, Auto RBW, VBW, Auto VBW, RBW/VBW, Span/RBW
File	Save, Recall, Copy, Delete, Directory Management
Save/Recall	Setups, Measurements, Limit Lines, Screen Shots Jpeg (save only), Save-on-Event
Save-on-Event	Crossing Limit Line, Sweep Complete, Save-then-Stop, Clear All
Delete	Selected File, All Measurements, All Mode Files, All Content
Directory Management	Sort Method (Name/Type/Date), Ascend/Descend, Internal/USB, Copy
Application Options	Impedance (50 Ω, 75 Ω, Other)

Sweep Functions

Sweep	Single/Continuous, Manual Trigger, Reset, Detection, Minimum Sweep Time, Trigger Type
Sweep Mode	Fast, Performance, No FFT, Burst Detect
Detection	Peak, RMS/Avg, Negative, Sample, Quasi-peak
Triggers	Free Run, External, Video, Delay, Level, Slope, Hysteresis, Holdoff, Force Trigger Once

Trace Functions

Traces	Up to three Traces (A, B, C), View/Blank, Write/Hold, Trace A/B/C Operations
Trace A Operations	Normal, Max Hold, Min Hold, Average, # of Averages, (always the live trace)
Trace B Operations	A→B, B↔C, Max Hold, Min Hold
Trace C Operations	A→C, B↔C, Max Hold, Min Hold, A - B→C, B - A→C, Relative Reference (dB), Scale

Marker Functions

Markers	Markers 1-6 each with a Delta Marker, or Marker 1 Reference with Six Delta Markers, Marker Table (On/Off/Large), All Markers Off
Marker Types	Style (Fixed/Tracking), Noise Marker, Frequency Counter Marker
Marker Auto-Position	Peak Search, Next Peak (Right/Left), Peak Threshold %, Set Marker to Channel, Marker Frequency to Center, Delta Marker to Span, Marker to Reference Level
Marker Table	1-6 markers frequency and amplitude plus delta markers frequency offset and amplitude

Limit Line Functions

Limit Lines	Upper/Lower, On/Off, Edit, Move, Envelope, Advanced, Limit Alarm, Default Limit
Limit Line Edit	Frequency, Amplitude, Add Point, Add Vertical, Delete Point, Next Point Left/Right
Limit Line Move	To Current Center Frequency, By dB or Hz, To Marker 1, Offset from Marker 1
Limit Line Envelope	Create Envelope, Update Amplitude, Number of Points (41), Offset, Shape Square/Slope
Limit Line Advanced	Type (Absolute/Relative), Mirror, Save/Recall

Measurement Options Specifications

Time Domain (Option 0002) (includes Distance Domain Option 0501)

The VNA Master can also display the S-parameter measurements in the time or distance domain using lowpass or bandpass processing analysis modes. The broadband frequency coverage coupled with 4001 data points means you can measure discontinuities both near and far with unprecedented clarity for a handheld tool. With this option, you can simultaneously view S-parameters in frequency, time, and distance domain to quickly identify faults in the field. Advanced features available with this option include step response, phasor impulse, gating, and frequency gated in time. The option includes computational routines that further enhance the Distance Domain results by compensating for cable loss, relative velocity of propagation, and dispersion compensation in waveguide.

Distance Domain	Round-Trip (reflection) Fault Resolution (meters):	$(0.5 \times c \times Vp) / \Delta F$; (c is speed of light = 3E8 m/s, ΔF is $F2 - F1$ in Hz)
	One-Way (transmission) Fault Resolution (meters):	$(c \times Vp) / \Delta F$; (c is speed of light = 3E8 m/s, ΔF is $F2 - F1$ in Hz)
	Horizontal Range (meters):	0 to (data points - 1) x Fault Resolution to a maximum of 3000 m (9843 ft.)
	Windowing	Rectangular, Nominal Side Lobe (NSL), Low Side Lobe (LSL), and Minimum Side Lobe (MSL)

Distance Domain (Option 0501) (not required if Option 0002 is purchased)

Distance Domain Analysis is a powerful field test tool to analyze cables for faults, including minor discontinuities that may occur due to a loose connection, corrosion, or other aging effects. By using Frequency Domain Reflectometry (FDR), the VNA Master exploits a user-specified band of full power operational frequencies (instead of DC pulses from TDR approaches) to more precisely identify cable discontinuities. The VNA Master converts S-parameters from frequency domain into distance domain on the horizontal display axis, using a mathematical computation called Inverse Fourier Transform. Connect a reflection at the opposite end of the cable and the discontinuities appear versus distance to reveal any potential maintenance issues. When access to both ends of the cable is convenient, a similar distance domain analysis is available on transmission measurements.

Option 0501 Distance Domain will improve your productivity with displays of the cable in terms of discontinuities versus distance. This readout can then be compared against previous measurements (from stored data) to determine whether any degradations have occurred since installation (or the last maintenance activity). More importantly, you will know precisely where to go to fix the problem and so minimize or prevent downtime of the system.

Power Monitor (Option 0005) (MS202xC models only) (requires external detector)

Transmitter measurements in the field are possible when using this VNA Master software mode with a separately purchased Anritsu 560 series detector. A variety of detectors are available to 50 GHz, but the popular 560-7N50B covers 10 MHz to 20 GHz with a measurement range of -50 to +20 dBm with better than 0.5 dB flatness to 18 GHz. After zeroing the detector to ensure accuracy at low power levels, the software offers intuitive operation for absolute and relative readouts in dBm or Watts.

Display Range	-80 dBm to +80 dBm (10 pW to 100 kW)
Measurement Range	-50 dBm to +20 dBm (10 nW to 40 mW)
Offset Range	0 dB to +60 dB
Resolution	0.1 dB, 0.1 xW (x = n, μ , m based on detector power)
Accuracy	± 1 dB maximum for >-40 dBm using 560-7N50B detector

Power Monitor Detectors* (Ordered separately):

Part Numbers	560-7N50B	560-7S50B
Frequency Range	0.01 to 20 GHz	0.01 to 20 GHz
Impedance	50 Ω	50 Ω
Power Range	-55 dBm to +16 dBm	-55 dBm to +16 dBm
Return Loss	15 dB, < 0.04 GHz 22 dB, < 8 GHz 17 dB, < 18 GHz 14 dB, < 20 GHz	15 dB, < 0.04 GHz 22 dB, < 8 GHz 17 dB, < 18 GHz 14 dB, < 20 GHz
Input Connector	N(m)	WSMA(m)
Frequency Response	± 0.5 dB, < 18 GHz ± 1.25 dB, < 20 GHz	± 0.5 dB, < 18 GHz ± 1.25 dB, < 20 GHz

*See www.anritsu.com for additional detectors

Secure Data Operation (Option 0007)

For highly secure data handling requirements, this software option prevents the storing of measurement setup or data information onto any internal file storage location. Instead, setup and measurement information is stored ONLY to the external USB memory location. A simple factory preset prepares the VNA Master for transportation while the USB memory remains behind in the secure environment. The VNA Master cannot be switched between secure and non-secure operation by the user once configured for secure data operation. As an additional security measure, with this option enabled, the user can choose to blank the frequency values displayed on the screen.

Bias Tee (Option 0010)

For tower mounted amplifier tests, the MS20x/3xC series with optional internal bias tees can supply both DC and RF signals on the center conductor of the cable during measurements. For frequency sweeps in excess of 2 MHz, the VNA Master can supply internal voltage control from +12 to +32 V in 0.1 V steps up to 450 mA. To extend battery life, an external power supply can substitute for the internal supply by using the external bias inputs instead. Both test ports can be configured to supply voltage via this integrated bias tees option. Bias can be directed to VNA Port 1 or Port 2.

Frequency Range	2 MHz to 6 GHz (MS20x6C) 2 MHz to 15 GHz (MS20x7C) 2 MHz to 20 GHz (MS20x8C)
Internal Voltage/Current	+12V to +32V at 450 mA steady rate
Internal Resolution	0.1V
External Voltage/Current	± 50 V at 500 mA steady rate
Bias Tee Selections	Internal, External, Off

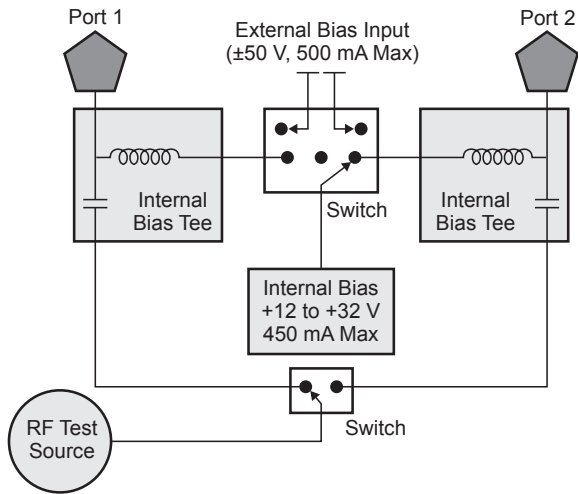

The VNA Master offers optional integrated bias tee for supplying DC plus RF to the DUT as shown in this simplified block diagram. Connectivity is also provided for external supply (instead of internal) to preserve battery consumption.

Vector Voltmeter (Option 0015)

A phased array system relies on phase matched cables for nominal performance. For this class of application, the VNA Master offers this special software mode to simplify phase matching cables at a single frequency. The similarity between the popular vector voltmeter and this software mode ensures minimal training is required to phase match cables. Operation is as simple as configuring the display for absolute or relative measurements. The easy-to-read large fonts show either reflection or transmission measurements using impedance, magnitude, or VSWR readouts. For instrument landing system (ILS) or VHF Omni-directional Range (VOR) applications, a table view improves operator efficiency when phase matching up to twelve cables. The MS20x/3xC solution is superior because the signal source is included internally, precluding the need for an external signal generator.

CW Frequency Range	5 kHz to 6 GHz (MS20x6C) 5 kHz to 15 GHz (MS20x7C) 5 kHz to 20 GHz (MS20x8C)
Measurement Display	CW, Table (Twelve Entries, Plus Reference)
Measurement Types	Return Loss, Insertion
Measurement Format	dB/VSWR/Impedance

High Accuracy Power Meter (Option 0019) requires external USB power sensor.

Conduct precise measurements of CW and digitally modulated transmitters in the field using this VNA Master software mode with a separately purchased Anritsu USB power sensor. After specifying the center frequency and zeroing the sensor to ensure accuracy at low power levels, the software offers intuitive operation for absolute and relative readouts in dBm or Watts. Option 0019 supports the USB Power Sensors in the following table.

USB Power Sensors (Ordered separately):						
	PSN50	MA24105A	MA24106A	MA24108A	MA24118A	MA24126A
Frequency Range	50 MHz to 6 GHz	350 MHz to 4 GHz	50 MHz to 6 GHz	10 MHz to 8 GHz	10 MHz to 18 GHz	10 MHz to 26.5 GHz
Description	High Accuracy RF Power Sensor	Inline Peak Power Sensor	RF USB Power Sensor	Microwave USB Power Sensor	Microwave USB Power Sensor	Microwave USB Power Sensor
Connector	Type N, male, 50 Ω	Type N, female, 50 Ω	Type N, male, 50 Ω	Type N, male, 50 Ω	Type N, male, 50 Ω	Type N, male, 50 Ω
Dynamic Range	-30 dBm to +20 dBm (0.001 mW to 100 mW)	+3 dBm to +51.76 dBm (2 mW to 150 W)	-40 dBm to +23 dBm (0.1 μW to 200 mW)	-40 dBm to +20 dBm (0.1 μW to 100 mW)	-40 dBm to +20 dBm (0.1 μW to 100 mW)	-40 dBm to +20 dBm (0.1 μW to 100 mW)
VBW	100 Hz	100 Hz	100 Hz	50 kHz	50 kHz	50 kHz
Measurand	True-RMS	True-RMS	True-RMS	True-RMS, Slot power, Burst Average Power	True-RMS, Slot power, Burst Average power	True-RMS, Slot power, Burst Average power
Measurement Uncertainty	± 0.16 dB ¹	± 0.17 dB ²	± 0.16 dB ¹	± 0.18 dB ³	± 0.18 dB ³	± 0.18 dB ³
Datasheet for Additional Specifications	11410-00414	11410-00621	11410-00424	11410-00504	11410-00504	11410-00504

- Notes:
- 1) Total RSS measurement uncertainty (0 °C to 50 °C) for power measurements of a CW signal greater than -20 dBm with zero mismatch errors
 - 2) Expanded uncertainty with K=2 for power measurements of a CW signal greater than +20 dBm with a matched load. Measurement results referenced to the input side of the sensor.
 - 3) Expanded uncertainty with K=2 for power measurements of a CW signal greater than -20 dBm with zero mismatch errors

Interference Analyzer (Option 0025) (MS203xC models only) (recommend GPS)

Measurements	Spectrum Field Strength Occupied Bandwidth Channel Power Adjacent Channel Power (ACPR) AM/FM/SSB Demodulation (Wide/Narrow FM, Upper/Lower SSB), (audio out only) Carrier-to-Interference ratio (C/I) Spectrogram (Collect data up to one week) Signal Strength (Gives visual and aural indication of signal strength) Received Signal Strength Indicator (RSSI) (collect data up to one week) Gives visual and aural indication of signal strength Signal ID (up to 12 signals) Center Frequency Bandwidth Signal Type (FM, GSM, W-CDMA, CDMA, Wi-Fi) Closest Channel Number Number of Carriers Signal-to-Noise Ratio (SNR) > 10 dB
Application Options	Impedance (50 Ω, 75 Ω, Other)

Channel Scanner (Option 0027) (MS203xC models only)

Number of Channels	1 to 20 Channels (Power Levels)
Measurements	Graph/Table, Max Hold (On/5 sec/Off), Frequency/Channel, Current/Maximum, Dual Color
Scanner	Scan Channels, Scan Frequencies, Scan Customer List, Scan Script Master™
Amplitude	Reference Level, Scale
Custom Scan	Signal Standard, Channel, # of Channels, Channel Step Size, Custom Scan
Frequency Range	150 kHz to 13 GHz
Frequency Accuracy	± 10 Hz + Time base error
Measurement Range	-110 dBm to +30 dBm
Application Options	Impedance (50 Ω, 75 Ω, Other)

GPS (Option 0031) requires external GPS antenna

Built-in GPS provides location information (latitude, longitude, altitude) and Universal Time (UT) information for storage along with trace data so you can later verify that measurements were taken at the right location. The GPS option requires a separately ordered magnet mount GPS antenna (2000-1528-R or 2000-1652-R), which are configured to mount outside on a metallic surface. Frequency accuracy is enhanced for the Spectrum Analyzer (on MS203xC models) when Options 0025 Interference Analyzer and 0027 Channel Scanner are engaged and the enhanced accuracy is maintained for up to 3 days after loss of GPS lock.

Setup	On/Off, Antenna Voltage 3.3/5.0 V, GPS Info
GPS Time/Location Indicator	Time, Latitude, Longitude, and Altitude on display Time, Latitude, Longitude, and Altitude with trace storage
GPS-Enhanced Frequency Accuracy	Active GPS lock provides < 25 ppb accuracy in Spectrum Analyzer, Channel Scanner, Interference Analyzer, and AM/FM/PM Modulation Analyzer modes
Residual Enhanced Frequency Accuracy – retained after 3 minutes of GPS lock – after antenna is disconnected	< 50 ppb for 72 hours, 0 °C to 50 °C ambient temperature
Connector	SMA, female

Balanced/Differential S-Parameters, 1-port (Option 0077)

As an alternative to a sampling oscilloscope, verifying the performance and identifying discontinuities in high-data-rate differential cables is now possible with the VNA Master. After a full two-port calibration, connect your differential cable directly to the two test ports and reveal the $S_{d_{id1}}$ performance, which is essentially differential return loss, or any of the other differential S-Parameters, $S_{c_{ic1}}$, $S_{d_{ic1}}$, or $S_{c_{id1}}$. With optional time domain, you can convert frequency sweeps to distance. This capability is especially valuable for applications in high data rate cables where balanced data formats are used to isolate noise and interference.

AM/FM/PM Demodulation Analyzer (Option 0509) (MS203xC models only)

The VNA Master + Spectrum Analyzer models comes with AM/FM/SSB audio demodulation standard. By adding Option 0509, the instrument becomes capable of measuring, analyzing, and displaying key modulation parameters of RF Spectrum, Audio Spectrum, Audio Waveform and Demodulation Summary. The RF Spectrum View displays the spectrum analyzer with carrier power, frequency, and occupied BW. Audio Spectrum shows the demodulated audio spectrum along with the Rate, RMS deviation, Pk-Pk/2 deviation, SINAD, Total Harmonic Distortion (THD), and Distortion/Total. Each demodulation also includes an Audio Waveform oscilloscope display that shows the time-domain demodulated waveform. There is a summary display that provides a display of all the RF and demodulation parameters.

VNA Master General Specifications (MS202x/3xC)

Setup Parameters

System	Status (Temperature, Battery Info, S/N, Firmware Ver, IP Address, Options Installed) Self Test, Application Self Test GPS (see Option 0031)
System Options	Name, Date and Time, Ethernet Configuration, Brightness, Volume Language (English, French, German, Spanish, Chinese, Japanese, Korean, Italian, Russian, User defined) Reset (Factory Defaults, Master Reset, Update Firmware)
File	Save, Recall, Delete, Directory Management
Save/Recall	Setups, Measurements, Screen Shots Jpeg (save only)
Delete	Selected File, All Measurements, All Mode Files, All Content
Directory Management	Sort Method (Name/Type/Date), Ascend/Descend, Internal/USB, Copy
Internal Trace/ Setup Memory	> 13,000 traces
External Trace/ Setup Memory	Limited by size of USB Flash drive
Mode Switching	Auto-Stores/Recalls most recently used Setup Parameters in the Mode

Connectors

Maximum Input (Damage Level) into Vector Network Analyzer	+23 dBm, ± 50 VDC (MS202x/3xC)
Maximum Input (Damage Level) into Spectrum Analyzer	+30 dBm, ± 50 VDC (MS203xC)
VNA Connectors	Type N female (or K female with opt 0011, MS20x8C only) VNA port (x2)
Bias Tee	Type BNC female Bias Tee port (enabled with opt 0010) (x2)
Ext Ref	Type BNC female External Reference In port
Spectrum Analyzer Connectors	Type N, female (or K female with opt 0011) (MS203xC) Type BNC female External Reference In port
GPS	SMA female (Available with opt 0031 GPS)
External Power	5.5 mm barrel connector, 12 to 14.5 VDC, < 5.0 Amps
LAN Connection	RJ48C, 10/100 Mbps, Connect to PC or LAN for Remote Access
USB Interface (2)	Type A, Connect Flash Drive and Power Sensor
USB Interface	5-pin mini-B, Connect to PC for data transfer
Headset Jack	3.5 mm barrel connector
External Trigger	BNC, female, 50 Ω, Maximum Input + 5 VDC
10 MHz Out	SMA, female, 50 Ω

Display

Size	8.4 in, daylight viewable color LCD
Resolution	800 x 600

Power

Field replaceable Li-Ion Battery (633-75: 7500 mAh)	40 Watts on battery power only
DC power from Universal 110/220V AC/DC Adapter	55 Watts running off AC/DC adaptor while charging battery
Life time charging cycles (Li-Ion Battery, 633-75)	> 300 (80% of initial capacity)
Battery Operation	3.0 hours, typical

Size and Weight

Dimensions	Height	211 mm (8.3 in)
	Width	315 mm (12.4 in)
	Depth	78 mm (3.1 in) (MS202xC) 97 mm (3.8 in) (MS203xC)
Weight, Including Battery	4.5 kg (9.9 lbs)	(MS202xC)
	4.8 kg (10.5 lbs)	(MS203xC)

Safety

Safety Class	EN 61010-1 Class 1
Product Safety	IEC 60950-1 when used with Anritsu supplied Power Supply

Environmental

MIL-PRF-28800F, Class 2 Environmental Conditions	MS202x/3xC
Temperature, operating (°C) (3.8.2.1 & 4.5.5.14)	Passed, -10 °C to 55 °C, Humidity 85%
Temperature, not operating (°C) (3.8.2.2 & 4.5.5.1)	Passed, -51 °C to 71 °C
Relative humidity (3.8.2.3 & 4.5.5.1)	Passed
Altitude, not operating (3.8.3 & 4.5.5.2)	Passed*, 4600 m
Altitude, operating (3.8.3 & 4.5.5.2)	Passed*, 4600 m
Vibration limits (3.8.4.1 & 4.5.5.3.1)	Passed
Shock, functional (3.8.5.1 & 4.5.5.4.1)	Passed
Transit Drop (3.8.5.2 & 4.5.5.4.2)	Passed
Bench handling (3.8.5.3 & 4.5.5.4.3)	Passed
Shock, high impact (3.8.5.4 & 4.5.5.4.4)	Not Required**
Salt exposure structural parts (3.8.8.2 & 4.5.6.2.2)	Not Required***

* Qualified by similarity (tested on a similar product)

** Not defined in standard; must be invoked and defined by purchase description

*** Not required for Class 2 equipment

Electromagnetic Compatibility

European Union	CE Mark, EMC Directive 89/336/EEC, 92/31/EEC, 93/68/EEC and Low Voltage Directive 73/23/EEC, 93/68/EEC
Australia and New Zealand	C-tick N274
Interference	EN 61326-1
Emissions	EN 55011
Immunity	EN 61000-4-2/-4-3/-4-4/-4-5/-4-6/-4-11

Ordering Information

MS2026C¹ VNA Master, 2-port, VNA 5 kHz to 6 GHz						MS2027C¹ VNA Master, 2-port, VNA 5 kHz to 15 GHz						MS2028C¹ VNA Master, 2-port, VNA 5 kHz to 20 GHz						MS2036C¹ VNA Master + Spectrum Analyzer, S/A 9 kHz to 9 GHz						MS2037C¹ VNA Master + Spectrum Analyzer, S/A 9 kHz to 15 GHz						MS2038C¹ VNA Master + Spectrum Analyzer, S/A 9 kHz to 20 GHz																	
Options												Description																																			
MS2026C-0002						MS2027C-0002						MS2028C-0002						MS2036C-0002						MS2037C-0002						MS2038C-0002						Time Domain (includes Option 0501 capabilities)											
MS2026C-0005						MS2027C-0005						MS2028C-0005						-						-						-						Power Monitor (requires external detector)											
MS2026C-0007						MS2027C-0007						MS2028C-0007						MS2036C-0007						MS2037C-0007						MS2038C-0007						Secure Data Operation											
MS2026C-0010						MS2027C-0010						MS2028C-0010						MS2036C-0010						MS2037C-0010						MS2038C-0010						Built-in Bias-Tee											
-						-						MS2028C-0011						-						-						MS2038C-0011						K(f) Test Port Connectors											
MS2026C-0015						MS2027C-0015						MS2028C-0015						MS2036C-0015						MS2037C-0015						MS2038C-0015						Vector Voltmeter											
MS2026C-0019						MS2027C-0019						MS2028C-0019						MS2036C-0019						MS2037C-0019						MS2038C-0019						High Accuracy Power Meter (requires external USB sensor)											
-						-						-						MS2036C-0025						MS2037C-0025						MS2038C-0025						Interference Analysis, 9 kHz to 9/15/20 GHz ²											
-						-						-						MS2036C-0027						MS2037C-0027						MS2038C-0027						Channel Scanner, 9 kHz to 9/15/20 GHz ²											
MS2026C-0031						MS2027C-0031						MS2028C-0031						MS2036C-0031						MS2037C-0031						MS2038C-0031						GPS Receiver (requires GPS antenna, 2000-1528-R or 2000-1652-R)											
MS2026C-0077						MS2027C-0077						MS2028C-0077						MS2036C-0077						MS2037C-0077						MS2038C-0077						Balanced/Differential S-Parameters, 1-port											
MS2026C-0098						MS2027C-0098						MS2028C-0098						MS2036C-0098						MS2037C-0098						MS2038C-0098						Standard Calibration (ANSI Z540-1-1994)											
MS2026C-0099						MS2027C-0099						MS2028C-0099						MS2036C-0099						MS2037C-0099						MS2038C-0099						Premium Calibration (ANSI Z540-1-1994, plus test data)											
MS2026C-0501						MS2027C-0501						MS2028C-0501						MS2036C-0501						MS2037C-0501						MS2038C-0501						Distance Domain (included in Option 0002)											
-						-						-						MS2036C-0509						MS2037C-0509						MS2038C-0509						AM/FM/PM Analyzer											

Notes: 1) Includes standard one-year warranty and Certificate of Calibration and Conformance.

2) Requires external antenna (Series 2000-xxxx Antenna, or 61532 Antenna Kit), Recommend Option 0031 GPS.

MS202x/3xC Standard Accessories

10920-00060	Handheld Instruments Documentation Disc
10580-00305	VNA Master User's Guide
2000-1685-R	Soft Carrying Case for MS202xC models
2000-1686-R	Soft Carrying Case for MS203xC models
2300-498	Master Software Tools CD ROM
633-75	Rechargeable Battery, Li-Ion, 7.5 Ah
40-187-R	AC-DC Adapter
806-141-R	Automotive Cigarette Lighter 12 V DC adapter
3-2000-1498	USB A-type to Mini USB B-type cable, 3.05 m (10 ft.)
2000-1371-R	Ethernet cable, 2.13 m (7 ft.)

Optional Accessories

Ancillary Equipment

2000-1528-R	GPS Antenna – Magnet Mount (active 3-5V) with SMA connector and 4.6 m (15 ft) extension cable
2000-1652-R	GPS Antenna – Magnet mount (active 3-5V) with SMA connector and 1 foot cable
2000-1653	Protective Screen Cover (Package of 2)
2000-1689	EMI Near Field Probe Kit
2300-517	Phase Noise Measurement Software
66864	Rack Mount Kit, Master Platform

High Accuracy Power Sensor

PSN50	High Accuracy Power Sensor, 50 MHz to 6 GHz
MA24105A	Inline Peak Power Sensor, 350 MHz to 4 GHz, True RMS
MA24106A	RF USB Power Sensor, 50 MHz to 6 GHz, True RMS
MA24108A	Microwave USB Power Sensor, 10 MHz to 8 GHz, True RMS
MA24118A	Microwave USB Power Sensor, 10 MHz to 18 GHz, True RMS
MA24126A	Microwave USB Power Sensor, 10 MHz to 26 GHz, True RMS

Power Monitor Detectors

560-7N50B	RF Detector, 0.01 to 20 GHz, Type-N(m)
560-7S50B	RF Detector, 0.01 to 20 GHz, W-SMA(m)

Detector Extender Cables

800-109	Detector Extender Cable, 7.6 m (25 ft)
800-111	Detector Extender Cable, 30.5 m (100 ft.)

K Connector Components

OSLK50	Precision integrated Open/Short/Load K(m), DC to 20 GHz, 50 Ω
OSLK50	Precision integrated Open/Short/Load K(f), DC to 20 GHz, 50 Ω
22K50	Precision K(m) Short/Open, 40 GHz
22KF50	Precision K(f) Short/Open, 40 GHz
28K50	Precision Termination, DC to 40 GHz, 50 Ω, K(m)
28KF50	Precision Termination, DC to 40 GHz, 50 Ω, K(f)
3652A	K Calibration Kit, DC to 40 GHz

N-Type Connectors

OSLN50	Precision Integrated Open/Short/Load N(m), DC to 18 GHz, 50 Ω
OSLNF50	Precision Integrated Open/Short/Load N(f), DC to 18 GHz, 50 Ω
22N50	Precision N(m) Short/Open, 18 GHz
22NF50	Precision N(f) Short/Open, 18 GHz
28N50-2	Precision Termination, DC to 18 GHz, 50 Ω, N(m)
28NF50-2	Precision Termination, DC to 18 GHz, 50 Ω, N(f)
OSLN50-1	Precision N(m) Open/Short/Load, 42 dB, 6 GHz
OSLNF50-1	Precision N(f) Open/Short/Load, 42 dB, 6 GHz
SM/PL-1	Precision N(m) Load, 42 dB, 6 GHz
SM/PLNF-1	Precision N(f) Load, 42 dB, 6 GHz

continued on next page...

Ordering Information (continued)

Phase-Stable Test Port Cables, Armored

15NNF50-1.5C	1.5 m, DC to 6 GHz, N(m) to N(f), 50 Ω
15NN50-1.5C	1.5 m, DC to 6 GHz, N(m) to N(m), 50 Ω
15NDF50-1.5C	1.5 m, DC to 6 GHz, N(m) to 7/16 DIN(f), 50 Ω
15ND50-1.5C	1.5 m, DC to 6 GHz, N(m) to 7/16 DIN(m), 50 Ω
15NNF50-3.0C	3.0 m, DC to 6 GHz, N(m) to N(f), 50 Ω
15NN50-3.0C	3.0 m, DC to 6 GHz, N(m) to N(m), 50 Ω

Directional Antennas

2000-1411-R	824 MHz to 896 MHz, N(f), 10 dBd, Yagi
2000-1412-R	885 MHz to 975 MHz, N(f), 10 dBd, Yagi
2000-1413-R	1710 MHz to 1880 MHz, N(f), 10 dBd, Yagi
2000-1414-R	1850 MHz to 1990 MHz, N(f), 9.3 dBd, Yagi
2000-1415-R	2400 MHz to 2500 MHz, N(f), 10 dBd, Yagi
2000-1416-R	1920 MHz to 2170 MHz, N(f), 10 dBd, Yagi
2000-1519-R	500 MHz to 3000 MHz, log periodic
2000-1617	600 MHz to 21000 MHz, N(f), 5-8 dBi to 12 GHz, 0-6 dBi to 21 GHz, log periodic

Portable Antennas

2000-1200-R	806 MHz to 866 MHz, SMA(m), 50 Ω
2000-1473-R	870 MHz to 960 MHz, SMA(m), 50 Ω
2000-1035-R	896 MHz to 941 MHz, SMA (m), 50 Ω (1/4 wave)
2000-1030-R	1710 MHz to 1880 MHz, SMA(m), 50 Ω (1/2 wave)
2000-1474-R	1710 MHz to 1880 MHz with knuckle elbow (1/2 wave)
2000-1031-R	1850 MHz to 1990 MHz, SMA(m), 50 Ω (1/2 wave)
2000-1475-R	1920 MHz to 1980 MHz and 2110 MHz to 2170 MHz, SMA(m), 50 Ω
2000-1032-R	2400 MHz to 2500 MHz, SMA(m), 50 Ω (1/2 wave)
2000-1361-R	2400 MHz to 2500 MHz, 5000 MHz to 6000 MHz, SMA(m), 50 Ω
2000-1616	20 MHz to 21000 MHz, N(f), 50 Ω
2000-1636-R	Antenna Kit (Consists of: 2000-1030-R, 2000-1031-R, 2000-1032-R, 2000-1200-R, 2000-1035-R, 2000-1361-R, and carrying pouch)
2000-1487	Telescopic Whip Antenna

Bandpass Filters

1030-114-R	806 MHz to 869 MHz, N(m) to SMA(f), 50 Ω
1030-109-R	824 MHz to 849 MHz, N(m) to SMA (f), 50 Ω
1030-110-R	880 MHz to 915 MHz, N(m) to SMA (f), 50 Ω
1030-105-R	890 MHz to 915 MHz, N(m) to N(f), 50 Ω
1030-111-R	1850 MHz to 1910 MHz, N(m) to SMA (f), 50 Ω
1030-106-R	1710 MHz to 1790 MHz, N(m) to N(f), 50 Ω
1030-107-R	1910 MHz to 1990 MHz, N(m) to N(f), 50 Ω
1030-112-R	2400 MHz to 2484 MHz, N(m) to SMA (f), 50 Ω
1030-155-R	2500 MHz to 2700 MHz, N(m) to N(f), 50 Ω

Adapters

1091-26-R	SMA(m) to N(m), DC to 18 GHz, 50 Ω
1091-27-R	SMA(f) to N(m), DC to 18 GHz, 50 Ω
1091-80-R	SMA(m) to N(f), DC to 18 GHz, 50 Ω
1091-81-R	SMA(f) to N(f), DC to 18 GHz, 50 Ω
1091-172-R	BNC(f) to N(m), DC to 1.3 GHz, 50 Ω
510-90-R	7/16 DIN(f) to N(m), DC to 7.5 GHz, 50 Ω
510-91-R	7/16 DIN(f) to N(f), DC to 7.5 GHz, 50 Ω
510-92-R	7/16 DIN(m) to N(m), DC to 7.5 GHz, 50 Ω
510-93-R	7/16 DIN(m) to N(f), DC to 7.5 GHz, 50 Ω
510-96-R	7/16 DIN(m) to 7/16 DIN (m), DC to 7.5 GHz, 50 Ω

510-97-R	7/16 DIN(f) to 7/16 DIN(f), DC to 7.5 GHz, 50 Ω
1091-379-R	7/16 DIN(f) to 7/16 DIN(f), DC to 6 GHz, 50 Ω , with Reinforced Grip
510-102-R	N(m) to N(m), DC to 11 GHz, 50 Ω , 90 degrees right angle

Precision Adapters

34NN50A	Precision Adapter, N(m) to N(m), DC to 18 GHz, 50 Ω
34NFN50	Precision Adapter, N(f) to N(f), DC to 18 GHz, 50 Ω
34NK50	Precision Adapter, DC to 18 GHz, N(m) to K(m), 50 Ω
34NKF50	Precision Adapter, DC to 18 GHz, N(m) to K(f), 50 Ω

Attenuators

3-1010-122	20 dB, 5 W, DC to 12.4 GHz, N(m) to N(f)
42N50-20	20 dB, 5 W, DC to 18 GHz, N(m) to N(f)
42N50A-30	30 dB, 50 W, DC to 18 GHz, N(m) to N(f)
3-1010-123	30 dB, 50 W, DC to 8.5 GHz, N(m) to N(f)
1010-127-R	30 dB, 150 W, DC to 3 GHz, N(m) to N(f)
3-1010-124	40 dB, 100 W, DC to 8.5 GHz, N(m) to N(f), Uni-directional
1010-121	40 dB, 100 W, DC to 18 GHz, N(m) to N(f), Uni-directional
1010-128-R	40 dB, 150 W, DC to 3 GHz, N(m) to N(f)

Backpack and Transit Case

67135	Anritsu Backpack (For Handheld Instrument and PC)
760-243-R	Large Transit Case with Wheels and Handle

Manuals

10580-00240	Power Meter Measurement Guide
10580-00244	Spectrum Analyzer Measurement Guide
10580-00289	VNA Measurement Guide
10580-00305	VNA Master User's Guide
10580-00306	VNA Master Programming Manual
10580-00307	VNA Master Maintenance Manual

Related Literature, Application Notes, Books

11410-00206	Time Domain for Vector Network Analyzers
11410-00214	Reflectometer Measurements – Revisited
11410-00270	What is Your Measurement Accuracy?
11410-00373	Distance-to-Fault
11410-00387	Primer on Vector Network Analysis
11410-00414	High Accuracy Power Meter, PSN50
11410-00424	USB Power Sensor MA24106A
11410-00472	Measuring Interference
11410-00476	Essentials of Vector Network Analysis
11410-00504	Microwave USB Power Sensor MA241x8A
11410-00531	Practical Tips on Making “Vector Voltmeter (VVM)” Phase Measurements using VNA Master (Opt. 15)
11410-00544	VNA Master + Spectrum Analyzer Brochure
11410-00548	VNA Master + Spectrum Analyzer Technical Data Sheet
11410-00565	Troubleshoot Wire Cable Assemblies with Frequency-Domain Reflectometry

Waveguide Calibration Components and WG/Coaxial Adapters

Recommended waveguide calibration procedure requires offset shorts and a precision load. The waveguide/coaxial adapter shown attached to test port #1, adapts the VNA Master ports to the waveguide under test.



Part Number				Frequency Range	Waveguide Type	Compatible Flanges
1/8 Offset Short	3/8 Offset Short	Precision Load	Coaxial to Universal Waveguide Adapter ^[1]			
23UM70	24UM70	26UM70	35UM70N	5.85 to 8.20 GHz	WR137, WG14	CAR70, PAR70, UAR 70, PDR70
23UM84	24UM84	26UM84	35UM84N	7.05 to 10.00 GHz	WR112, WG15	CBR84, UBR84, PBR84, PDR84
23UM100	24UM100	26UM100	35UM100N	8.20 to 12.40 GHz	WR90, WG16	CBR100, UBR100, PBR100, PDR100
23UM120	24UM120	26UM120	35UM120N	10.00 to 15.00 GHz	WR75, WG17	CBR120, UBR120, PBR120, PDR120
23UA187	24UA187	26UA187	35UA187N	3.95 to 5.85 GHz	WR187, WG12	CPR187F, CPR187G, UG-1352/U, UG-1353/U, UG-1728/U, UG-1729/U, UG-148/U, UG-149A/U
23UA137	24UA137	26UA137	35UA137N	5.85 to 8.20 GHz	WR137, WG14	CPR137F, CPR137G, UG-1356/U, UG-1357/U, UG-1732/U, UG-1733/U, UG-343B/U, UG-344/U, UG-440B/U, UG-441/U
23UA112	24UA112	26UA112	35UA112N	7.05 to 10.00 GHz	WR112, WG15	CPR112F, CPR112G, UG-1358/U, UG-1359/U, UG-1734/U, UG-1735/U, UG-52B/U, UG-51/U, UG-137B/U, UG-138/U
23UA90	24UA90	26UA90	35UA90N	8.20 to 12.40 GHz	WR90, WG16	CPR90F, CPR90G, UG-1360/U, UG-1361/U, UG-1736/U, UG-1737/U, UG-40B/U, UG-39/U, UG-135/U, UG-136B/U
23UA62	24UA62	26UA62	35UA62N	12.40 to 18.00 GHz	WR62, WG18	UG-541A/U, UG-419/U, UG-1665/U, UG1666/U
23UA42	24UA42	26UA42	35UA42K	17.00 to 26.50 GHz	WR42, WG20	UG-596A/U, UG-595/U, UG-597/U, UG-598A/U

[1] For Coaxial/Waveguide Adapter part numbers, N designates Type N and K designates K-Connector

The Master Users Group is an organization dedicated to providing training, technical support, networking opportunities and links to Master product development teams. As a member you will receive the Insite Quarterly Newsletter with user stories, measurement tips, new product news and more.

Visit us to register today: www.anritsu.com/MUG



To receive a quote to purchase a product or order accessories visit our online ordering site: www.ShopAnritsu.com

Training at Anritsu

Anritsu has designed courses to help you stay up to date with technologies important to your job.

For available training courses visit: www.anritsu.com/training

Anritsu

• United States

Anritsu Company

1155 East Collins Boulevard, Suite 100,
Richardson, TX, 75081 U.S.A.
Toll Free: 1-800-ANRITSU (267-4878)
Phone: +1-972-644-1777
Fax: +1-972-671-1877

• Canada

Anritsu Electronics Ltd.

700 Silver Seven Road, Suite 120,
Kanata, Ontario K2V 1C3, Canada
Phone: +1-613-591-2003
Fax: +1-613-591-1006

• Brazil

Anritsu Eletrônica Ltda.

Praça Amadeu Amaral, 27 - 1 Andar
01327-010 - Bela Vista - São Paulo - SP - Brazil
Phone: +55-11-3283-2511
Fax: +55-11-3288-6940

• Mexico

Anritsu Company, S.A. de C.V.

Av. Ejército Nacional No. 579 Piso 9, Col. Granada
11520 México, D.F., México
Phone: +52-55-1101-2370
Fax: +52-55-5254-3147

• United Kingdom

Anritsu EMEA Ltd.

200 Capability Green, Luton, Bedfordshire LU1 3LU, U.K.
Phone: +44-1582-433280
Fax: +44-1582-731303

• France

Anritsu S.A.

12 avenue du Québec, Batiment Iris 1-Silic 612,
91140 VILLEBON SUR YVETTE, France
Phone: +33-1-60-92-15-50
Fax: +33-1-64-46-10-65

• Germany

Anritsu GmbH

Nemetschek Haus, Konrad-Zuse-Platz 1
81829 München, Germany
Phone: +49 (0) 89 442308-0
Fax: +49 (0) 89 442308-55

• Italy

Anritsu S.r.l.

Via Elio Vittorini 129 00144 Roma Italy
Phone: +39-06-509-9711
Fax: +39-06-502-2425

• Sweden

Anritsu AB

Borgafjordsgatan 13, 164 40 KISTA, Sweden
Phone: +46-8-534-707-00
Fax: +46-8-534-707-30

• Finland

Anritsu AB

Teknobulevardi 3-5, FI-01530 Vantaa, Finland
Phone: +358-20-741-8100
Fax: +358-20-741-8111

• Denmark

Anritsu A/S (for Service Assurance)

Anritsu AB (for Test & Measurement)

Kay Fiskers Plads 9, 2300 Copenhagen S, Denmark
Phone: +45-7211-2200
Fax: +45-7211-2210

• Russia

Anritsu EMEA Ltd.

Representation Office in Russia

Tverskaya str. 16/2, bld. 1, 7th floor.
Russia, 125009, Moscow
Phone: +7-495-363-1694
Fax: +7-495-935-8962

• United Arab Emirates

Anritsu EMEA Ltd.

Dubai Liaison Office

P O Box 500413 - Dubai Internet City
Al Thuraya Building, Tower 1, Suite 701, 7th Floor
Dubai, United Arab Emirates
Phone: +971-4-3670352
Fax: +971-4-3688460

• Singapore

Anritsu Pte. Ltd.

60 Alexandra Terrace, #02-08, The Comtech (Lobby A)
Singapore 118502
Phone: +65-6282-2400
Fax: +65-6282-2533

• India

Anritsu Pte. Ltd.

India Branch Office

3rd Floor, Shri Lakshminarayan Niwas, #2726, 80 ft Road,
HAL 3rd Stage, Bangalore - 560 075, India
Phone: +91-80-4058-1300
Fax: +91-80-4058-1301

• P. R. China (Shanghai)

Anritsu (China) Co., Ltd.

Room 1715, Tower A CITY CENTER of Shanghai,
Shanghai 200051, P.R. China
Phone: +86-21-6237-0898
Fax: +86-21-6237-0899

• P. R. China (Hong Kong)

Anritsu Company Ltd.

Unit 1006-7, 10/F., Greenfield Tower, Concordia Plaza,
No. 1 Science Museum Road, Tsim Sha Tsui East,
Kowloon, Hong Kong, P. R. China
Phone: +852-2301-4980
Fax: +852-2301-3545

• Japan

Anritsu Corporation

8-5, Tamura-cho, Atsugi-shi,
Kanagawa, 243-0016 Japan
Phone: +81-46-296-1221
Fax: +81-46-296-1238

• Korea

Anritsu Corporation, Ltd.

502, 5FL H-Square N B/D, 681,
Sampyeong-dong, Bundang-gu, Seongnam-si,
Gyeonggi-do, 463-400 Korea
Phone: +82-31-696-7750
Fax: +82-31-696-7751

• Australia

Anritsu Pty Ltd.

Unit 21/270 Ferntree Gully Road,
Notting Hill, Victoria 3168, Australia
Phone: +61-3-9558-8177
Fax: +61-3-9558-8255

• Taiwan

Anritsu Company Inc.

7F, No. 316, Sec. 1, Neihu Rd., Taipei 114, Taiwan
Phone: +886-2-8751-1816
Fax: +886-2-8751-1817



Anritsu prints on recycled paper with vegetable soybean oil ink.



©Anritsu All trademarks are registered trademarks of their respective owners. Data subject to change without notice. For the most recent specifications visit: www.anritsu.com

MS20xxC VNA Master TDS
©2013 Anritsu Company, USA
All Rights Reserved



11410-00548



K