

# Векторный генератор сигналов SGT100A



Архангельск (8182)63-90-72  
Астана (7172)727-132  
Астрахань (8512)99-46-04  
Барнаул (3852)73-04-60  
Белгород (4722)40-23-64  
Брянск (4832)59-03-52  
Владивосток (423)249-28-31  
Волгоград (844)278-03-48  
Вологда (8172)26-41-59  
Воронеж (473)204-51-73  
Екатеринбург (343)384-55-89  
Иваново (4932)77-34-06

Ижевск (3412)26-03-58  
Иркутск (395)279-98-46  
Казань (843)206-01-48  
Калининград (4012)72-03-81  
Калуга (4842)92-23-67  
Кемерово (3842)65-04-62  
Киров (8332)68-02-04  
Краснодар (861)203-40-90  
Красноярск (391)204-63-61  
Курск (4712)77-13-04  
Липецк (4742)52-20-81

Киргизия (996)312-96-26-47

Магнитогорск (3519)55-03-13  
Москва (495)268-04-70  
Мурманск (8152)59-64-93  
Набережные Челны (8552)20-53-41  
Нижний Новгород (831)429-08-12  
Новокузнецк (3843)20-46-81  
Новосибирск (383)227-86-73  
Омск (3812)21-46-40  
Орел (4862)44-53-42  
Оренбург (3532)37-68-04  
Пенза (8412)22-31-16

Россия (495)268-04-70

Пермь (342)205-81-47  
Ростов-на-Дону (863)308-18-15  
Рязань (4912)46-61-64  
Самара (846)206-03-16  
Санкт-Петербург (812)309-46-40  
Саратов (845)249-38-78  
Севастополь (8692)22-31-93  
Симферополь (3652)67-13-56  
Смоленск (4812)29-41-54  
Сочи (862)225-72-31  
Ставрополь (8652)20-65-13

Казахстан (772)734-952-31

Сургут (3462)77-98-35  
Тверь (4822)63-31-35  
Томск (3822)98-41-53  
Тула (4872)74-02-29  
Тюмень (3452)66-21-18  
Ульяновск (8422)24-23-59  
Уфа (347)229-48-12  
Хабаровск (4212)92-98-04  
Челябинск (351)202-03-61  
Череповец (8202)49-02-64  
Ярославль (4852)69-52-93

# AT A GLANCE

The R&S®SGT100A is an RF vector signal generator with an integrated baseband generator. It has been optimized for use in production and automated applications. Designed as a fast and compact, space-saving solution, it provides top speed to ensure optimized throughput and fits into any test system.

The R&S®SGT100A has a clear focus on automated environments. Its main characteristics are high speed and a compact design.

The R&S®SGT100A is the first 1 HU, ½ 19" vector signal generator up to 6 GHz with an integrated baseband generator. The radio frequency chain has been optimized for fastest frequency and level switchover times. In the baseband, the multisegment waveform mode helps users quickly switch from one test signal to the next.

Though compact in size, the R&S®SGT100A has excellent RF characteristics (e.g. signal quality and level accuracy) that are on par with those of larger high-end instruments. Maximum output level, level repeatability and excellent EVM performance are key characteristics in production environments.

Thanks to its flexible customization concept, options can be easily added and configured via key codes, allowing customers to directly unlock additional functionalities and easily respond to various production requirements. Easy maintenance and a three-year calibration cycle help keep total cost of ownership to a minimum.

Equipped with a LAN, USB and PCIe interface, the R&S®SGT100A allows remote control of test equipment in automated applications.

On the front panel, LEDs indicate the generator's operating status and pushbuttons allow users to operate the basic functions. The R&S®WinIQSIM2 simulation software makes it easy to generate test signals in line with different digital standards such as LTE, IEEE802.11a or NFC and directly upload them to the R&S®SGT100A. The supplied R&S®SGMA-GUI PC software can be used for manual operation.

## Key facts

- ▶ Fastest vector signal generator with frequency and level switchover times of 240 µs (typ.) for optimized throughput in production
- ▶ Smallest standalone vector signal generator up to 6 GHz with integrated baseband generator (1 HU, ½ 19")
- ▶ Integrated baseband generator with I/Q modulation bandwidth of up to 240 MHz (in RF) supporting all advanced digital standards, including IEEE 802.11ac
- ▶ Excellent RF performance for EVM and ACLR
- ▶ Easy signal generation for digital standards such as LTE and LTE-Advanced using the R&S®WinIQSIM2 simulation software
- ▶ Ideal enhancement for the R&S®SMW200A in MIMO applications with more than two receiving antennas



# BENEFITS AND KEY FEATURES

## Optimized for use in production

- ▶ Smallest standalone vector signal generator with integrated baseband generator
- ▶ Fast frequency and level switchover to optimize production throughput
- ▶ High output level to compensate for losses in the test system
- ▶ Low power consumption for reduced heat dissipation and simplified thermal management within the system
- ▶ [page 4](#)

## The right signal performance in the right package

- ▶ Excellent modulation accuracy for large test margins
- ▶ Outstanding frequency response due to integrated baseband generator
- ▶ Low phase noise of  $-133$  dBc (typ.) at 1 GHz and 20 kHz offset (1 Hz measurement bandwidth)
- ▶ Excellent level repeatability and level linearity for outstanding reproducibility of measurements
- ▶ Optional high-performance oven-controlled crystal oscillator for easy integration into test system
- ▶ Ideal enhancement for the R&S®SMW200A in MIMO applications with more than two antennas
- ▶ Optional analog I/Q outputs enabling full-featured envelope tracking testing capabilities
- ▶ [page 6](#)

## Low cost of ownership

- ▶ Low acquisition costs
- ▶ Simple modular design for easy servicing
- ▶ Easily upgradeable at customer premises
- ▶ Waveform package as ideal production solution
- ▶ Many remote control interfaces for easy integration into the test setup
- ▶ R&S®SGMA-GUI PC software
- ▶ [page 11](#)

## Overview of R&S®SGT100A applications

	Standalone vector signal generator	Extension for R&S®SMW200A as additional RF source
Frequency range		1 MHz to 3 GHz 1 MHz to 6 GHz (with R&S®SGT-KB106)
ARB baseband generator	32 Msample memory and 60 MHz RF bandwidth (with R&S®SGT-K510)	n.a.; digital I/Q data is transferred from R&S®SMW200A (requires R&S®SGT-K18 digital interface option)
Memory	up to 1 Gsample (with R&S®SGT-K511 and R&S®SGT-K512)	n.a.
RF bandwidth	up to 240 MHz (with R&S®SGT-K521, R&S®SGT-K522 and R&S®SGT-K523 )	up to 160 MHz
Analog I/Q outputs	available with R&S®SGT-K16	n.a.

# OPTIMIZED FOR USE IN PRODUCTION

## Smallest standalone vector signal generator with integrated baseband generator

Its space-saving design makes the R&S®SGT100A ideal for use in any test system. The compact R&S®SGT100A is a complete vector signal generator with a frequency range of up to 6 GHz and an integrated high-performance baseband generator. It can generate digital RF signals with an I/Q modulation bandwidth of up to 240 MHz (in RF) and supports all common digital standards.

The large memory depth of up to 1 Gsample allows long signal sequences and can also store many different signals to minimize switchover times. The multisegment waveform mode makes it possible to switch over between up to 100 different signals within microseconds. Should other additional test signals be required, the standard solid-state drive (SSD) speeds up reloading.

## Fast frequency and level switchover to optimize production throughput

For automated tests, the time it takes to switch frequencies and levels is a key characteristic, especially when using the frequency and level to calibrate or characterize DUTs such as amplifiers. In addition to LAN and USB, the R&S®SGT100A features a PCIe interface for remote control to achieve maximum speed. To accelerate remote control command processing, the R&S®SGT100A supports fast, direct commands for the most important settings such as frequency and level. These commands enable direct access to the internal architecture, which has been optimized for maximum speed.

## High output level to compensate for losses in the test system

Though compact in size, the R&S®SGT100A achieves a maximum output level of +22 dBm (typ.). Such a high level is important in a test system to compensate for losses that arise in cabling and signal paths.

The maximum level delivered by the R&S®SGT100A can eliminate the need for an additional amplifier in the system, which saves cost and space, simplifying system calibration and ensuring unimpaired signal quality. Thanks to its high output power, the R&S®SGT100A can also be used as a modulated interferer.

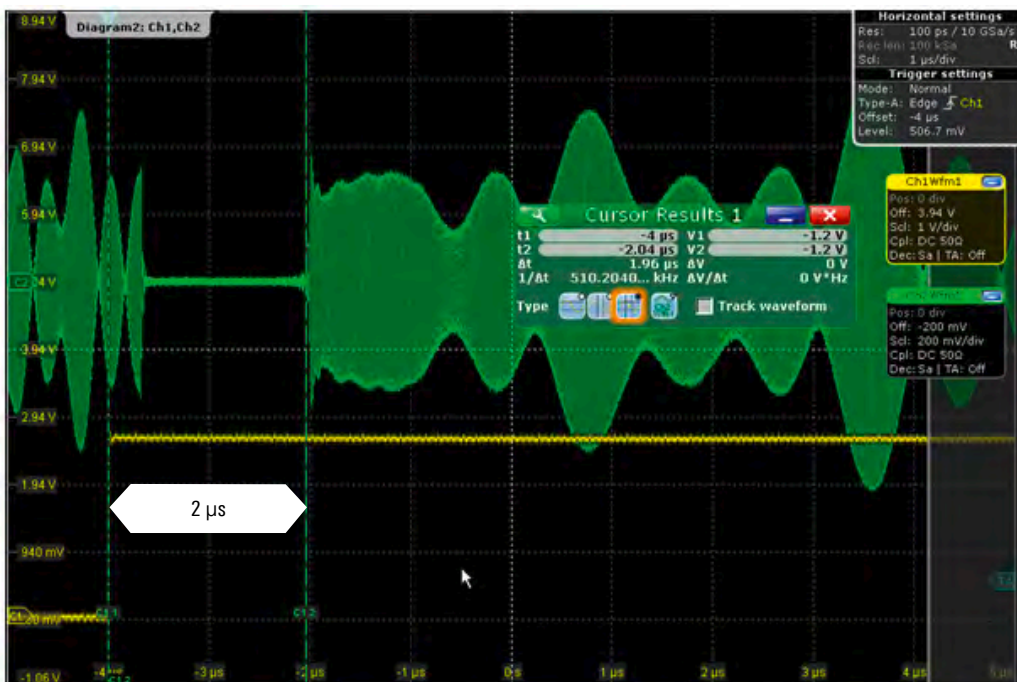

Measured delay of 2 μs for switching between signals using the multisegment waveform mode, a WCDMA test signal at 30.72 MHz sample rate

### Low power consumption for reduced heat dissipation and simplified thermal management within the system

The low 65 W power consumption cuts operating costs and reduces heat dissipation. Low heat dissipation simplifies the test system's thermal management and allows a high packing density for the generators.

Now four full-fledged vector signal generators can fit into a 2 HU, 19" space, the same space previously required for a single RF path.

Standard connectors on the rear panel allow easy integration into the test system since all the cables are routed at the back of the rack.

LEDs on the front panel indicate the current status of basic characteristics and the generator itself. Pushbuttons allow a LAN reset and also provide access to an identification aid that makes it easier to connect more than one instrument to the test software.

### Maximum available level in CW mode, setting characteristic: auto

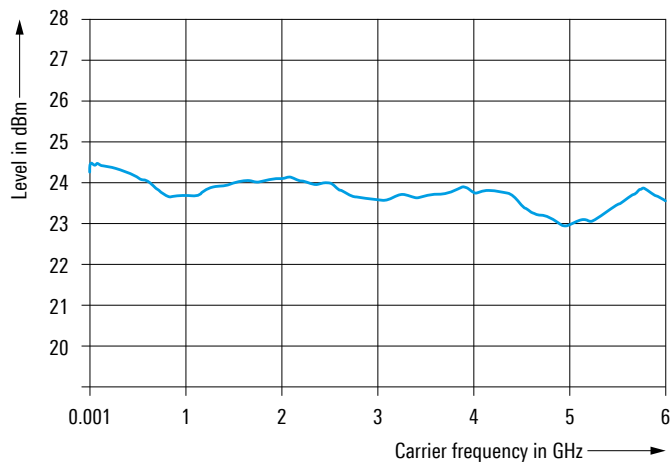

### Histogram of the level setting times via the PCIe interface

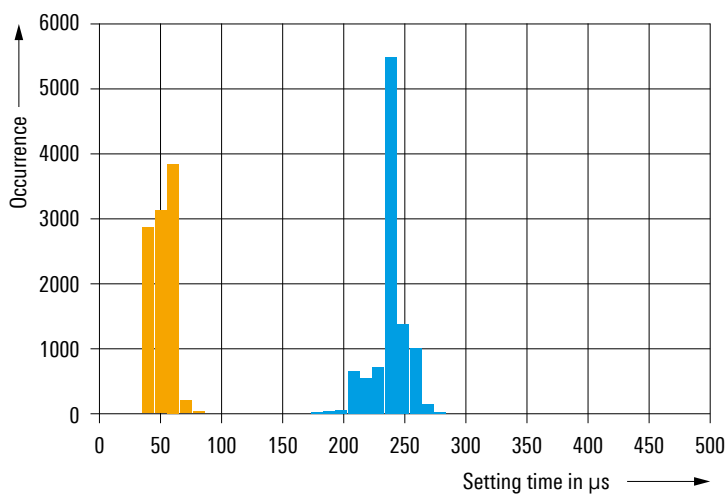

I/Q modulation from internal baseband, setting characteristic: auto

- ▶ Orange: with digital attenuation
- ▶ Blue: with arbitrary level setting

# THE RIGHT SIGNAL PERFORMANCE IN THE RIGHT PACKAGE

## Excellent modulation accuracy for large test margins

Signal performance is crucial when it comes to offering the right instrument for production applications. This is where the R&S®SGT100A excels: it achieves an extremely low error vector magnitude (EVM) of 0.4% when testing devices for compliance with IEEE802.11ac (with 160 MHz RF bandwidth and higher-order 256QAM modulation). Its performance enables larger test margins and achieves higher yields in production.

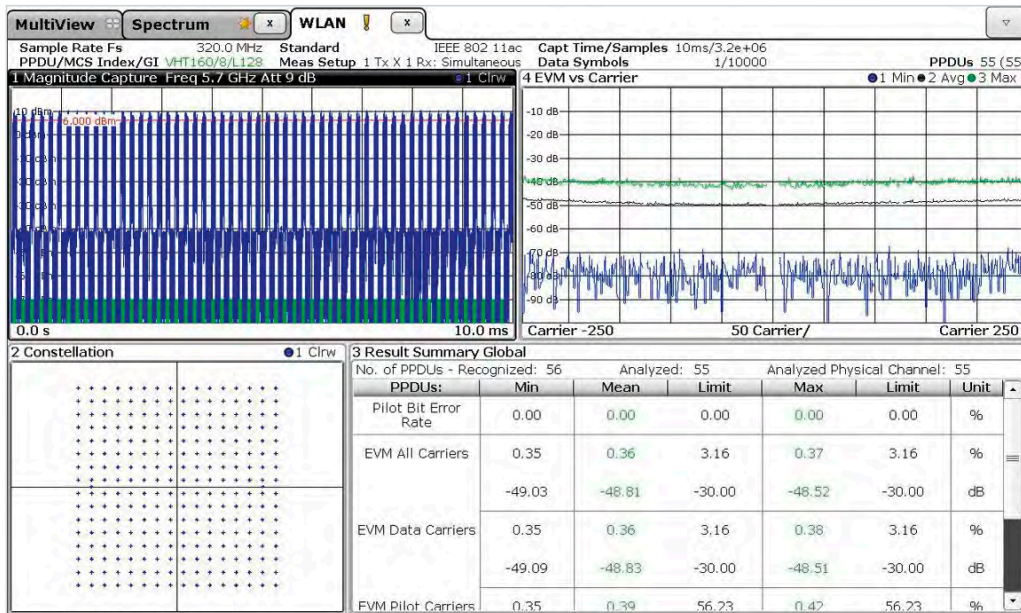

IEEE 802.11ac signals with 160 MHz bandwidth and an EVM of -48 dB

### Outstanding frequency response due to integrated baseband generator

The very flat frequency response over a bandwidth of 240 MHz makes the R&S®SGT100A flexible and ideal for a wide range of applications. A deviation of just 0.1 dB over the entire range clearly reveals why an internal baseband that is perfectly matched to the RF module is a real plus. Other features such as frequency offsets in the baseband, high signal bandwidths and LTE carrier aggregation also benefit from this linearity.

### Low phase noise of $-133$ dBc (typ.) at 1 GHz and 20 kHz offset (1 Hz measurement bandwidth)

The excellent performance of the R&S®SGT100A is due to the low phase noise because phase noise directly influences the accuracy of the constellation points of a digital modulation scheme.

Except for vector signals, low phase noise is essential for receiver tests, especially intermodulation tests, to ensure that the interfering signal is only transmitting in the intended frequency range. This is vital for a generator, which should be flexible enough to generate modulated or CW interferers and a clean LO in addition to digital signals.

### Measured frequency response across the maximum modulation bandwidth of 240 MHz at different carrier frequencies

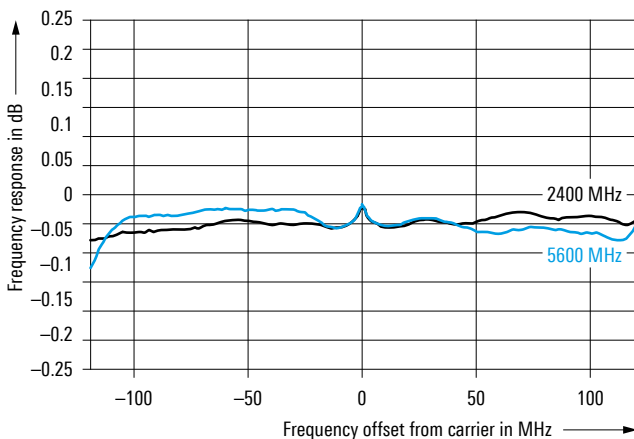

### Measured SSB phase noise with the R&S®SGT-B1 internal OCXO option

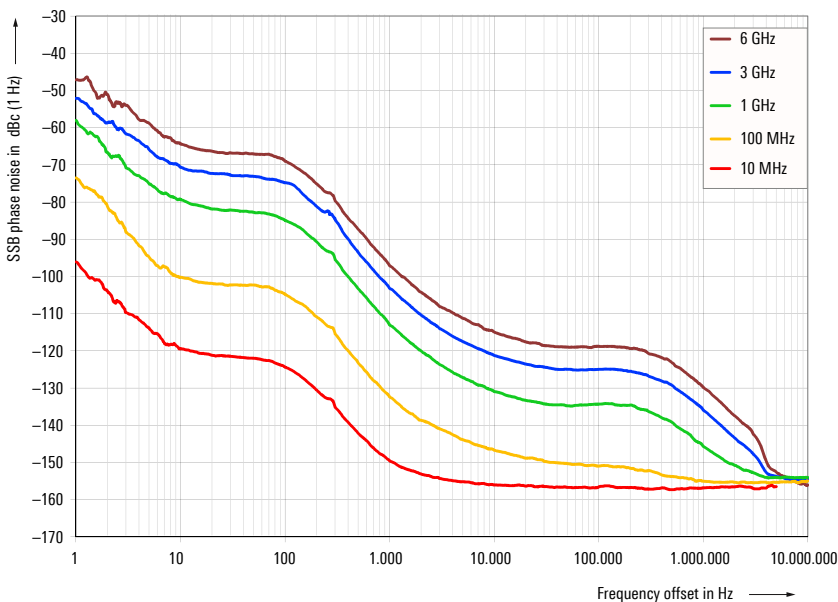

### Excellent level repeatability and level linearity for outstanding reproducibility of measurements

In production environments, the level to the DUT over the entire system is typically calibrated to take out any effects of components between the generator and the DUT. Consequently, an RF generator's level repeatability is more important than its absolute level accuracy when it comes to ensuring that a one-time calibration of the entire system remains valid for a long time in order to maximize uptime.

Level linearity is also crucial in tests with swept level (e.g. finding the 1 dB compression point in amplifiers) as the input signal fed into the DUT is swept over the entire frequency range of interest. What really matters here is precise step size, which is what the R&S®SGT100A delivers.

### Optional high-performance oven-controlled crystal oscillator for easy integration into test system

Typically, all test instruments in a system are synchronized using a 10 MHz reference. The R&S®SGT100A offers an optional high-performance oven-controlled crystal oscillator to provide a stable and precise 10 MHz reference without taking up additional rack space.

The R&S®SGT100A can also be synchronized via a 13 MHz, 100 MHz or even a 1 GHz reference frequency. A much higher reference frequency makes coupling more direct and provides higher phase stability between the RF signals. The R&S®SGT-K90 option is ideal for high-precision phase stability tests in beamforming applications, offering fixed LO-RF signal coupling between different devices.

### Measured level linearity for an internally generated LTE uplink signal at various test frequencies

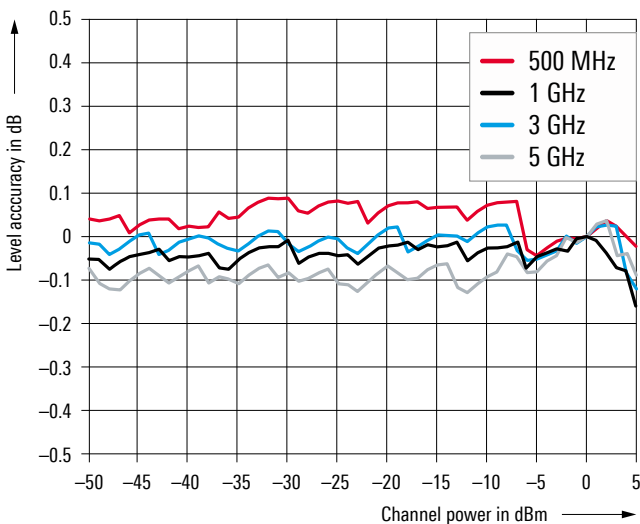



## Ideal enhancement for the R&S®SMW200A in MIMO applications with more than two antennas

Its solid performance makes the R&S®SGT100A the ideal enhancement for the high-end R&S®SMW200A vector signal generator in MIMO applications. For higher-order MIMO setups (such as 4x4 with LTE or 2x8 with TD-LTE), it is necessary to feed four or even eight signals into the input ports of a base station.

The R&S®SMW200A provides the required baseband signals and real-time fading for the MIMO channels. The R&S®SMW200A provides two RF ports, and up to six R&S®SGT100A vector RF sources can be connected to provide up to six additional ports. The instruments are connected via a digital interface to ensure top quality of all signals used for testing a base station. Such a setup requires no additional software because the R&S®SGT100A, once connected via LAN or USB, can be fully controlled from the user interface of the R&S®SMW200A.



Setup with one R&S®SMW200A and six R&S®SGT100A for 2x8 MIMO applications as used for TD-LTE

### Optional analog I/Q outputs enabling full-featured envelope tracking testing capabilities

Despite the small size, the R&S®SGT100A offers four SMB connectors on the rear of the instrument that provide the differential analog I/Q output signals with a bandwidth of up to 120 MHz.

The R&S®SGT100A is the ideal solution for power amplifier tests due to its speed, size and performance. To support the testing of envelope tracking power amplifiers (PA), an additional envelope signal synchronous to the RF signal needs to be generated.

With the future-ready R&S®SGT100A, this is an easy task since the required software options can be upgraded later

without the need for additional hardware. For full flexibility, two different configurations are offered:

Equipped with the R&S®SGT-K540 option, the R&S®SGT100A calculates the envelope signal in real-time. This unique feature offers the advantage of test time reduction since no manual calculation of the envelope waveform is required.

The second possibility, which allows the use of customer envelope waveform files, is to split the ARB into two independent digital basebands (requires R&S®SGT-K543). This approach combines two instruments into one. A vector signal generator for the RF signal and an arbitrary waveform generator for the synchronized envelope signal.

### Concept of real-time envelope tracking tests with R&S®SGT-K540

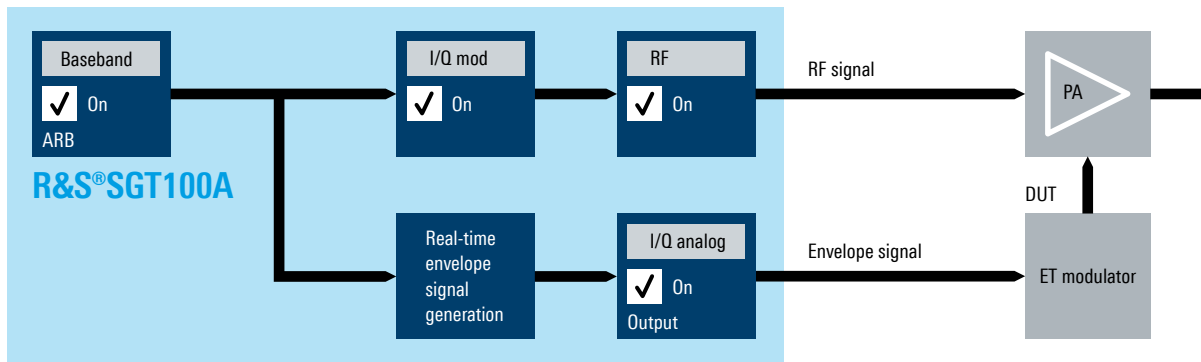

### Concept of split ARB envelope tracking tests with R&S®SGT-K543

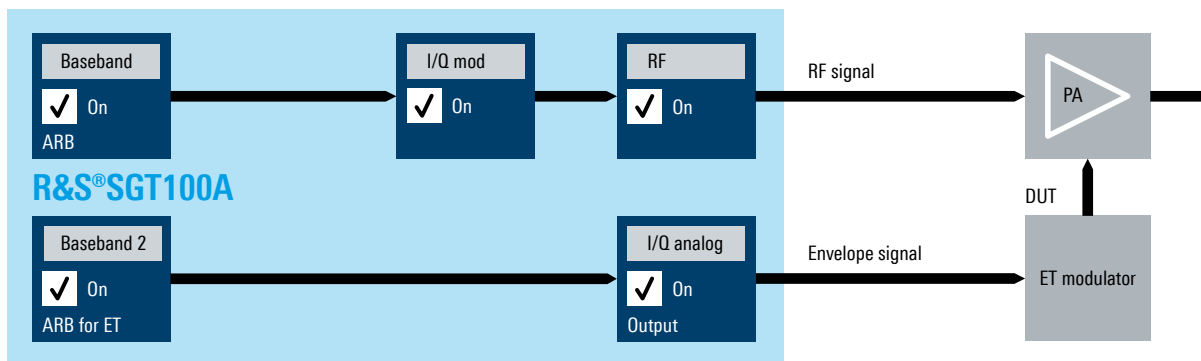

### Interfaces on the rear panel of the R&S®SGT100A



# LOW COST OF OWNERSHIP

## Low acquisition costs

The total cost of ownership incurred for a product involves many different aspects. Beyond the initial costs, the generator's low power consumption of just 65 W also saves money in two ways. First, it reduces the power bills. Second, it dissipates less heat, simplifying the test system's thermal management.

## Simple modular design for easy servicing

The R&S®SGT100A consists of just a few modules, making it easy and inexpensive to repair in the unlikely event that a problem occurs.

The built-in test supports the service process, helping to get the instrument back into operation as fast as possible.

The recommended three-year calibration interval ensures that the instrument does its job as long as possible and rarely has to be serviced, which in turn reduces the total cost of ownership.

## Easily upgradeable at customer premises

The R&S®SGT100A offers an impressively flexible customization concept with just one hardware option (the oven-controlled crystal oscillator). All other options can be easily added at the customer premises using key codes – e.g. from 3 GHz to 6 GHz<sup>1)</sup> or to a larger bandwidth. This saves cost and time and maximizes system uptime.

<sup>1)</sup> The R&S®SGT100A is calibrated up to 6 GHz at the plant. If the generator is upgraded at a later point in time, it is recommended to recalibrate it up to 6 GHz.

Inside view of the R&S®SGT100A



### Waveform package as ideal production solution

Characterizing DUTs in production often requires using test signals from a number of different standards. In addition to wireless communications standards such as GSM, 3GPP FDD and LTE, today's chipsets also support connectivity systems such as NFC, Bluetooth® or WLAN.

The waveform package is the ideal solution when it comes to inexpensively providing a signal for each standard and to licensing test signals on the R&S®SGT100A in line with these standards. A waveform package for five signals, for example, can generate one signal each for GSM, EDGE, 3GPP FDD, HSPA+ and LTE to test an amplifier.

### Many remote control interfaces for easy integration into the test setup

In addition to USB and Gigabit-LAN, the R&S®SGT100A comes with a PCIe interface for remote control as used in computers. This maximizes data throughput for remote control commands, speeds up waveform downloads and allows very short setting times for various commands, such as those used to change the level, frequency or digital signal.

### R&S®SGMA-GUI PC software

The R&S®SGMA-GUI PC software, which comes with the instrument, is used for manual operation. It can simultaneously control up to twelve R&S®SGT100A sources and also provides access to all instrument functions and settings via all interfaces.

Screenshot of the R&S®SGMA-GUI PC software for controlling up to twelve instruments

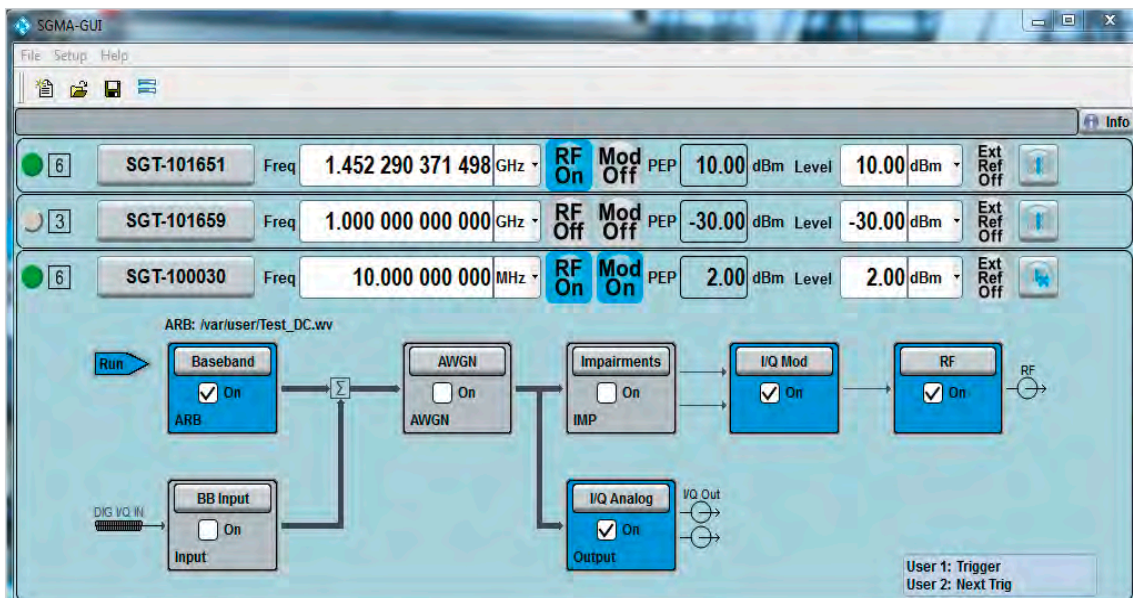

# SPECIFICATIONS IN BRIEF

Specifications in brief		
<b>Frequency</b>		
Frequency range	CW mode and I/Q mode	1 MHz to 3 GHz
	with the R&S®SGT-KB106 option	
	CW mode and I/Q mode	1 MHz to 6 GHz
Setting time	with PCIe/Ethernet remote control	< 500 µs
Input frequency for external reference	into the R&S®SGT100A	10 MHz, 13 MHz, 100 MHz, 1000 MHz
<b>Level</b>		
Specified level range		-120 dBm to +17 dBm (PEP) <sup>1)</sup>
Setting time	with PCIe/Ethernet remote control, setting characteristic: auto	< 500 µs
<b>Spectral purity</b>		
Harmonics	level ≤ 8 dBm, CW, I/Q wideband off	< -30 dBc
Nonharmonics	level > -10 dBm, offset > 10 kHz from carrier, f ≤ 1.5 GHz	< -76 dBc
Wideband noise	10 MHz carrier offset, level > 5 dBm, 1 Hz measurement bandwidth, CW	< -145 dBc
SSB phase noise	20 kHz carrier offset, 1 Hz measurement bandwidth	
	f = 1 GHz	< -126 dBc, -133 dBc (typ.)
	f = 6 GHz	< -110 dBc, -117 dBc (typ.)
<b>Pulse modulation</b>		
On/off ratio		> 80 dB
Minimum pulse width	using the integrated pulse generator	20 ns
<b>I/Q modulation</b>		
I/Q modulator bandwidth (RF)	with an external analog signal	
	100 MHz < f ≤ 2.5 GHz, I/Q wideband	20% of carrier frequency
	2.5 GHz < f ≤ 6 GHz, I/Q wideband	1 GHz
	with the integrated baseband source	60 MHz
	with the R&S®SGT-K521 option	120 MHz
	with the R&S®SGT-K521 and R&S®SGT-K522 options	160 MHz
	with the R&S®SGT-K521, R&S®SGT-K522 and R&S®SGT-K523 options	240 MHz
<b>Waveform length</b>		
	with the R&S®SGT-K511 option	1 sample to 32 Msample, in one-sample steps
	with the R&S®SGT-K511 and R&S®SGT-K512 options	1 sample to 256 Msample, in one-sample steps
	with the R&S®SGT-K511 and R&S®SGT-K512 options	1 sample to 1 Gsample, in one-sample steps
Sample resolution	equivalent to D/A converter	16 bit
ACLR	WCDMA 3GPP FDD, TM 1-64	> 68 dB, 71 dB (typ.)
<b>Waveform changeover time in multisegment waveform mode</b>		
	50 MHz clock rate (external trigger, without clock change)	5 µs (meas.)
EVM	IEEE802.11ac, 160 MHz, MCS 9	0.4% (typ.)
Supported standards with R&S®WinIQSIM2 <sup>1)</sup>	with additional options	EUTRA/LTE, LTE-Advanced, 3GPP FDD incl. HSPA/HSPA+, GSM/EDGE/EDGE Evolution, TD-SCDMA, CDMA2000®/1xEV-DO, TETRA, IEEE802.11a/b/g/n/p/ac, IEEE802.16, Bluetooth®, NFC, DVB-H/DVB-T, DAB/T-DMB, GPS, Galileo, GLONASS, BeiDou
Remote control		PCIe (single lane), Ethernet (TCP/IP) 10/100/1000BASE-T, USB 2.0
<b>General data</b>		
Power consumption		65 W (meas.)
Dimensions	W × H × D, per unit	250 mm × 52.5 mm × 401 mm (9.84 in × 2.07 in × 15.79 in); 1 HU, ½ 19" rack width
Weight	when fully equipped, per unit	4.0 kg (8.82 lb)
Recommended calibration interval	40 h/week operation in the full range of the specified environmental conditions	3 years

<sup>1)</sup> R&S®WinIQSIM2 requires an external PC.

# ORDERING INFORMATION

Designation	Type	Order No.
SGMA vector RF source, 1 MHz to 3 GHz RF, baseband hardware included	R&S®SGT100A	1419.4501.02
Including power cable and quick start guide		
<b>RF options</b>		
Frequency extension to 6 GHz	R&S®SGT-KB106	1419.5708.02
Reference oscillator OCXO	R&S®SGT-B1	1419.5608.02
Extension unit	R&S®SGT-B88	1419.8207.02
Pulse modulation	R&S®SGT-K22	1419.6279.02
Phase coherent input/output	R&S®SGT-K90	1419.6333.02
<b>Baseband options</b>		
Differential analog I/Q outputs	R&S®SGT-K16	1419.8007.02
Digital baseband connectivity	R&S®SGT-K18	1419.6240.02
ARB baseband generator, 32 Msample, 60 MHz RF bandwidth	R&S®SGT-K510	1419.7500.02
ARB memory extension to 256 Msample	R&S®SGT-K511	1419.6362.02
ARB memory extension to 1 Gsample	R&S®SGT-K512	1419.6391.02
ARB bandwidth extension to 120 MHz RF bandwidth	R&S®SGT-K521	1419.6427.02
ARB bandwidth extension to 160 MHz RF bandwidth	R&S®SGT-K522	1419.6456.02
ARB bandwidth extension to 240 MHz RF bandwidth	R&S®SGT-K523	1419.7952.02
Envelope tracking	R&S®SGT-K540	1419.7800.02
AM/AM AM/PM predistortion	R&S®SGT-K541	1419.7852.02
Envelope ARB	R&S®SGT-K543	1419.7900.02
Crest factor reduction	R&S®SGT-K548	1419.8471.02
<b>Noise generation</b>		
Additive white Gaussian noise (AWGN)	R&S®SGT-K62	1419.6304.02
<b>Digital modulation systems using R&amp;S®WinIQSIM2<sup>1)</sup></b>		
GSM/EDGE	R&S®SGT-K240	1419.5950.02
EDGE Evolution	R&S®SGT-K241	1419.6004.02
3GPP FDD	R&S®SGT-K242	1419.6056.02
GPS	R&S®SGT-K244	1419.6104.02
CDMA2000® incl. 1xEV-DV	R&S®SGT-K246	1419.6156.02
1xEV-DO Rev. A	R&S®SGT-K247	1419.6204.02
IEEE802.16	R&S®SGT-K249	1419.6504.02
TD-SCDMA	R&S®SGT-K250	1419.6556.02
TD-SCDMA enhanced BS/MS tests	R&S®SGT-K251	1419.6604.02
DVB-H	R&S®SGT-K252	1419.6656.02
DAB/T-DMB	R&S®SGT-K253	1419.6704.02
IEEE802.11a/b/g/n	R&S®SGT-K254	1419.6756.02
LTE Release 8	R&S®SGT-K255	1419.6804.02
Bluetooth® EDR	R&S®SGT-K260	1419.6856.02
Multicarrier CW signal generation	R&S®SGT-K261	1419.6904.02
Additive white Gaussian noise (AWGN)	R&S®SGT-K262	1419.6956.02
Galileo	R&S®SGT-K266	1419.7000.02
TETRA Release 2	R&S®SGT-K268	1419.7052.02
3GPP FDD HSPA/HSPA+	R&S®SGT-K283	1419.7100.02
LTE Release 9	R&S®SGT-K284	1419.7152.02
LTE Release 10	R&S®SGT-K285	1419.7200.02
IEEE802.11ac	R&S®SGT-K286	1419.7252.02
1xEV-DO Rev. B	R&S®SGT-K287	1419.7300.02
NFC A/B/F	R&S®SGT-K289	1419.7352.02
GLONASS	R&S®SGT-K294	1419.7400.02
NavIC/IRNSS	R&S®SGT-K297	1426.3388.02
Modernized GPS	R&S®SGT-K298	1419.5766.02

<sup>1)</sup> R&S®WinIQSIM2 requires an external PC.

Designation	Type	Order No.
BeiDou	R&S®SGT-K407	1419.7452.02
LTE Release 11	R&S®SGT-K412	1419.7600.02
LTE Release 12	R&S®SGT-K413	1419.8159.02
OFDM signal generation	R&S®SGT-K414	1419.8188.02
Cellular IoT Release 13	R&S®SGT-K415	1426.3607.02
DVB-S2/DVB-S2X	R&S®SGT-K416	1426.3707.02
Bluetooth® 5.0	R&S®SGT-K417	1426.3759.02
Verizon 5GTF	R&S®SGT-K418	1419.7781.02
LTE Release 13/14/15	R&S®SGT-K419	1426.3859.02
LoRa	R&S®SGT-K431	1419.7881.02
Modernized BeiDou	R&S®SGT-K432	1426.3394.02
IEEE 802.11ax	R&S®SGT-K442	1426.3807.02
Cellular IoT Release 14	R&S®SGT-K443	1419.7752.02
Cellular IoT Release 15	R&S®SGT-K446	1419.8171.02
IEEE 802.11be	R&S®SGT-K447	1419.7775.02
5G NR Release 16	R&S®SGT-K448	1419.8036.02
5G NR Release 15	R&S®SGT-K444	1419.5908.02
<b>Waveform package for signals from R&amp;S®WinIQSIM2<sup>1</sup>, R&amp;S®Pulse Sequencer and R&amp;S®Pulse Sequencer (DFS)</b>		
1 waveform	R&S®SGT-K200	1419.5850.71
5 waveforms	R&S®SGT-K200	1419.5850.72
50 waveforms	R&S®SGT-K200	1419.5850.75
<b>Digital standards using an external PC software or waveforms</b>		
Pulse sequencing	R&S®SGT-K300	1419.7652.02
Enhanced pulse sequencing	R&S®SGT-K301	1419.7700.02
Direction finding	R&S®SGT-K308	1419.7730.02
DFS signal generation	R&S®SGT-K350	1419.8107.02
<b>Recommended extras</b>		
Documentation of calibration values	R&S®DCV-2	0240.2193.18
Hardcopy manuals (in English)		1176.8674.02
19" rack adapter (for two 1 HU instruments next to each other, suitable for installation of two R&S®SGMA instruments)	R&S®ZZA-KN20	1175.3191.00
19" rack adapter (for one instrument and spacing module, without R&S®SGT-B88 option)	R&S®ZZA-KN21	1175.3204.00
19" rack adapter (for one instrument and spacing module, with R&S®SGT-B88 option)	R&S®ZZA-KN23	1175.3227.00
R&S®SGMA adapter	R&S®SGS-Z8	1416.2914.02
R&S®SGT adapter cable set	R&S®SGT-Z9	1419.8059.02

<b>Архангельск</b> (8182)63-90-72	<b>Ижевск</b> (3412)26-03-58	<b>Магнитогорск</b> (3519)55-03-13	<b>Пермь</b> (342)205-81-47	<b>Сургут</b> (3462)77-98-35
<b>Астана</b> (7172)727-132	<b>Иркутск</b> (395)279-98-46	<b>Москва</b> (495)268-04-70	<b>Ростов-на-Дону</b> (863)308-18-15	<b>Тверь</b> (4822)63-31-35
<b>Астрахань</b> (8512)99-46-04	<b>Казань</b> (843)206-01-48	<b>Мурманск</b> (8152)59-64-93	<b>Рязань</b> (4912)46-61-64	<b>Томск</b> (3822)98-41-53
<b>Барнаул</b> (3852)73-04-60	<b>Калининград</b> (4012)72-03-81	<b>Набережные Челны</b> (8552)20-53-41	<b>Самара</b> (846)206-03-16	<b>Тула</b> (4872)74-02-29
<b>Белгород</b> (4722)40-23-64	<b>Калуга</b> (4842)92-23-67	<b>Нижний Новгород</b> (831)429-08-12	<b>Санкт-Петербург</b> (812)309-46-40	<b>Тюмень</b> (3452)66-21-18
<b>Брянск</b> (4832)59-03-52	<b>Кемерово</b> (3842)65-04-62	<b>Новокузнецк</b> (3843)20-46-81	<b>Саратов</b> (845)249-38-78	<b>Ульяновск</b> (8422)24-23-59
<b>Владивосток</b> (423)249-28-31	<b>Киров</b> (8332)68-02-04	<b>Новосибирск</b> (383)227-86-73	<b>Севастополь</b> (8692)22-31-93	<b>Уфа</b> (347)229-48-12
<b>Волгоград</b> (844)278-03-48	<b>Краснодар</b> (861)203-40-90	<b>Омск</b> (3812)21-46-40	<b>Симферополь</b> (3652)67-13-56	<b>Хабаровск</b> (4212)92-98-04
<b>Вологда</b> (8172)26-41-59	<b>Красноярск</b> (391)204-63-61	<b>Орел</b> (4862)44-53-42	<b>Смоленск</b> (4812)29-41-54	<b>Челябинск</b> (351)202-03-61
<b>Воронеж</b> (473)204-51-73	<b>Курск</b> (4712)77-13-04	<b>Оренбург</b> (3532)37-68-04	<b>Сочи</b> (862)225-72-31	<b>Череповец</b> (8202)49-02-64
<b>Екатеринбург</b> (343)384-55-89	<b>Липецк</b> (4742)52-20-81	<b>Пенза</b> (8412)22-31-16	<b>Ставрополь</b> (8652)20-65-13	<b>Ярославль</b> (4852)69-52-93
<b>Иваново</b> (4932)77-34-06				

**Киргизия** (996)312-96-26-47    **Россия** (495)268-04-70    **Казахстан** (772)734-952-31