

RIGOL

Quick Guide

English

DS8000-R Series Digital Oscilloscope

Nov. 2020

RIGOL TECHNOLOGIES CO., LTD.

Guaranty and Declaration

Copyright

© 2020 **RIGOL** TECHNOLOGIES CO., LTD. All Rights Reserved.

Trademark Information

RIGOL® is the trademark of **RIGOL** TECHNOLOGIES CO., LTD.

English

Publication Number

QGA27101-1110

Software Version

00.01.01.00.00

Software upgrade might change or add product features. Please acquire the latest version of the manual from **RIGOL** website or contact **RIGOL** to upgrade the software.

Notices

- **RIGOL** products are covered by P.R.C. and foreign patents, issued and pending.
- **RIGOL** reserves the right to modify or change parts of or all the specifications and pricing policies at the company's sole decision.
- Information in this publication replaces all previously released materials.
- Information in this publication is subject to change without notice.
- **RIGOL** shall not be liable for either incidental or consequential losses in connection with the furnishing, use, or performance of this manual, as well as any information contained.
- Any part of this document is forbidden to be copied, photocopied, or rearranged without prior written approval of **RIGOL**.

Product Certification

RIGOL guarantees that this product conforms to the national and industrial standards in China as well as the ISO9001:2015 standard and the ISO14001:2015 standard. Other international standard conformance certifications are in progress.

Contact Us

If you have any problem or requirement when using our products or this manual, please contact **RIGOL**.

RIGOL

E-mail: service@rigol.com

Website: www.rigol.com

English

General Safety Summary

1. Only the exclusive power cord designed for the instrument and authorized for use within the local country could be used.
2. Ensure that the instrument is safely grounded.
3. Observe all terminal ratings.
4. Use proper overvoltage protection.
5. Do not operate without covers.
6. Do not insert objects into the air outlet.
7. Use the proper fuse.
8. Avoid circuit or wire exposure.
9. Do not operate the instrument with suspected failures.
10. Provide adequate ventilation.
11. Do not operate in wet conditions.
12. Do not operate in an explosive atmosphere.
13. Keep instrument surfaces clean and dry.
14. Prevent electrostatic impact.
15. Handle with caution.

English

Safety Notices and Symbols

Safety Notices in this Manual:



WARNING

Indicates a potentially hazardous situation or practice which, if not avoided, will result in serious injury or death.



CAUTION

Indicates a potentially hazardous situation or practice which, if not avoided, could result in damage to the product or loss of important data.

Safety Terms on the Product:

DANGER

It calls attention to an operation, if not correctly performed, could result in injury or hazard immediately.

WARNING

It calls attention to an operation, if not correctly performed, could result in potential injury or hazard.

CAUTION

It calls attention to an operation, if not correctly performed, could result in damage to the product or other devices connected to the product.

Safety Symbols on the Product:Hazardous
VoltageSafety
WarningProtective Earth
Terminal

Chassis Ground



Test Ground

English

Care and Cleaning

Care

Do not store or leave the instrument where it may be exposed to direct sunlight for long periods of time.

Cleaning

Clean the instrument regularly according to its operating conditions.

1. Disconnect the instrument from all power sources.
2. Clean the external surfaces of the instrument with a soft cloth dampened with mild detergent or water. Avoid having any water or other objects into the chassis via the heat dissipation hole. When cleaning the externally connected LCD, take care to avoid scarifying it.

**CAUTION**

To avoid damage to the instrument, do not expose it to caustic liquids.

**WARNING**

To avoid short-circuit resulting from moisture or personal injuries, ensure that the instrument is completely dry before connecting it to the power supply.

Document Overview

This manual gives you a quick review about the appearance of DS8000-R series, the user interface, and the basic operation method.

Tip

For the latest version of this manual, download it from the official website of **RIGOL** (www.rigol.com).

Format Conventions in this Manual

English

1. Key

The key on the front panel is denoted by the format of "Key Name (Bold) + Text Box" in the manual. For example, **RUN/STOP** denotes the "RUN/STOP" key.

2. Menu

The menu items are denoted by the format of "Menu Word (Bold) + Character Shading". For example, **System** denotes the "System" menu item under "**Utility**" function.

3. Operation Procedures

→ denotes the next step of operation. For example, **Utility** → **System** denotes clicking on the navigation function icon to enter the "Utility" menu first, and then clicking the **System** menu item.

4. Connector

The connectors on the front or rear panel are usually denoted by the format of "Connector Name (Bold) + Square Brackets (Bold)". For example, **[TRIG OUT]**.

Content Conventions in this Manual

DS8000-R series includes the following models. Unless otherwise specified, this manual takes DS8204-R as an example to illustrate the functions and operation methods of the DS8000-R series.

Model	Max. Analog Bandwidth	No. of Analog Channels	No. of Channels of Function/AWG
DS8104-R	1 GHz	4	1 (option)
DS8204-R	2 GHz	4	1 (option)
DS8034-R	350 MHz	4	1 (option)

The manuals of this product mainly include Quick Guide, User Guide, Programming Guide, Data Sheet, and etc. For the latest version of this manual, download it from the official website of **RIGOL** (www.rigol.com).

General Inspection

1. Inspect the packaging

If the packaging has been damaged, do not dispose the damaged packaging or cushioning materials until the shipment has been checked for completeness and has passed both electrical and mechanical tests.

The consigner or carrier shall be liable for the damage to the instrument resulting from shipment. **RIGOL** would not be responsible for free maintenance/rework or replacement of the instrument.

2. Inspect the instrument

In case of any mechanical damage, missing parts, or failure in passing the electrical and mechanical tests, contact your **RIGOL** sales representative.

3. Check the accessories

Please check the accessories according to the packing lists. If the accessories are damaged or incomplete, please contact your **RIGOL** sales representative.

Product Overview

DS8000-R series is a medium and high-end digital oscilloscope with a compact size designed on the basis of the ASIC chip (**RIGOL** self-owns its intellectual property right) and UltraVision II technical platform developed by **RIGOL**. It is compact and thin in design. It supports system integration of multiple devices, rack mount installation, and remote system operation to meet the system requirements for industrial automation test system. DS8000-R series oscilloscope has an analog bandwidth of up to 2 GHz, supporting multi-device synchronous triggering, available to be extended to 512 channels. It provides an excellent solution for users to meet their middle and high-speed requirement for the system integration test and synchronization requirement for multi-channel data acquisition.

For descriptions of the front panel, refer to Figure 1 and Table 1; for descriptions of the rear panel, refer to Figure 2 and Table 2; and for descriptions of the main interface (display screen), refer to Figure 3 and Table 3.

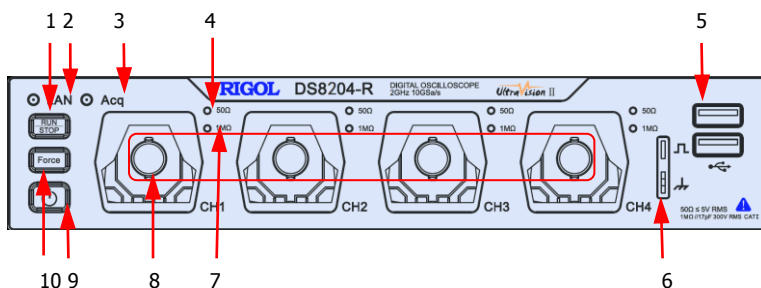

English

Figure 1 Front Panel

Table 1 Front Panel Description

No.	Description	No.	Description
1	RUN/STOP Key	2	LAN Interface Indicator
3	Acq Indicator	4	50 Ω Indicator
5	USB HOST Interface	6	Probe Compensation Signal Output Terminal/Ground Terminal
7	1 MΩ Indicator	8	Analog channel input terminals
9	Power Key	10	Force Key (used to initiate a trigger forcibly)

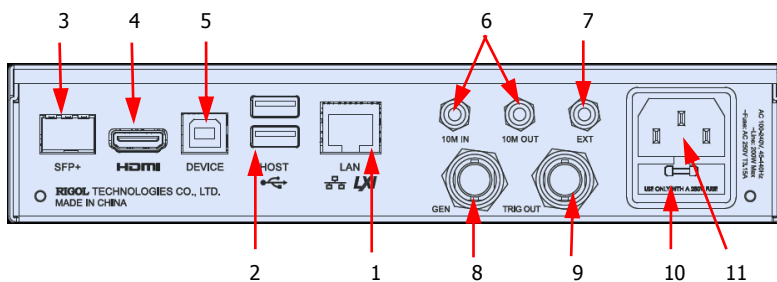

Figure 2 Rear Panel

Table 2 Rear Panel Description

No.	Description	No.	Description
1	LAN Interface	2	USB HOST Interface
3	SFP+ Interface	4	HDMI Video Output
5	USB DEVICE Interface	6	10 MHz In/Out
7	EXT TRIG	8	AWG Output Terminal
9	Trigger Out and Pass/Fail	10	Fuse
11	AC Power Cord Connector	--	--

English

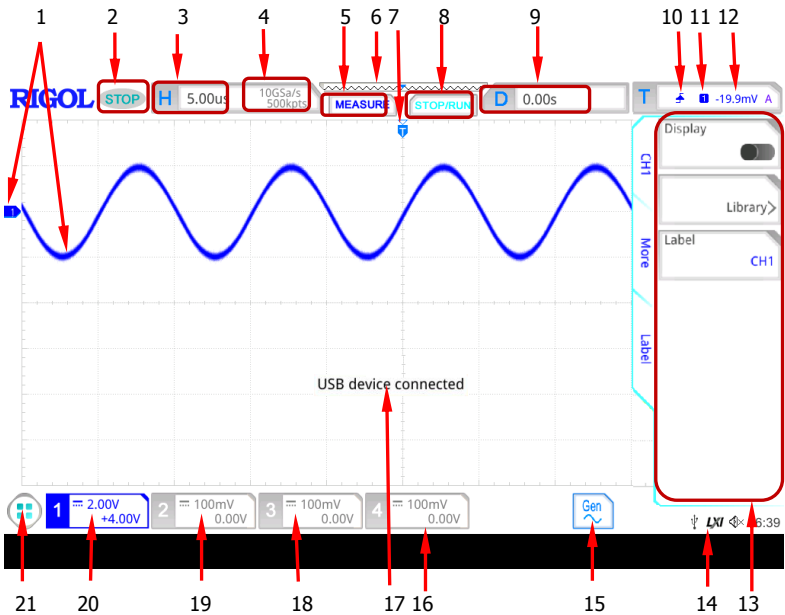

Figure 3 User Interface

Table 3 User Interface Icons

No.	Description	No.	Description
1	Analog Channel Label/Waveform	12	Trigger Level
2	Operating Status	13	Operation Menu
3	Horizontal Time Base	14	Notification Area

4	Sample Rate and Memory Depth	15	Arbitrary Waveform Generator
5	Auto Measurement Label	16	CH4 Status Label
6	Waveform Memory	17	Message Box
7	Trigger Position	18	CH3 Status Label
8	Run/Stop Label	19	CH2 Status Label
9	Horizontal Position	20	CH1 Status Label
10	Trigger Type	21	Function Navigation
11	Trigger Source	--	--

English

To Prepare for Use

To Connect to AC Power

The input AC power requirements of the oscilloscope are 100 V-240 V, 45 Hz-440 Hz. Please use the power cord provided in the accessories to connect the oscilloscope to the AC power source via the power cord connector, as shown in Figure 4.

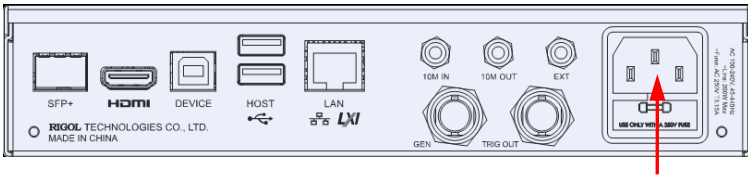

Figure 4 To Connect to AC Power

Power Cord Connector

To Connect to the Display and the Control Device

DS8000-R series does not have an LCD display or monitor. To set the parameters and view the measurement results, you need to connect it to an external control and display device. You can use the externally connected monitor, mouse, or keyboard to control the DS8000-R series oscilloscope. Also, you can use the standard Web Control software to realize remote control of the oscilloscope.

- **To connect to the display and the control device, the mouse, and the keypad board**

You can configure the parameters for the function menu, observe acquired waveforms, measurement results, and other information on the user interface through the display device (e.g. LCD, TV, projector, etc.) externally connected via the rear-panel HDMI interface. The keyboard and mouse can be connected to the oscilloscope via the USB interface. In this way, you can input values or strings with the externally connected keypad and mouse; scroll with the mouse to select the desired parameter and adjust the parameter value; drag the mouse cursor to make dragging operation on the screen.

Note:

The operations for controlling the DS8000-R series oscilloscope in this manual are, by default, described based on the externally connected mouse operation. The screen mentioned in this manual refers to the

externally connected LCD display (or monitor) that is connected via the HDMI interface.

● Web Control remote operation

Connect the oscilloscope to the network, then input the IP address of the oscilloscope into the address bar of the browser of your computer. The **RIGOL** web control interface is displayed. Click Web Control to enter the web control page. Then you can view the display of the real-time interface of oscilloscope. Through the Web Control method, you can migrant the device control and waveform analysis to the control terminals (e.g. PC, Mobile, iPad, and other smart terminals) to realize remote control of instruments.

When you first log in to the Web Control, the user name is "admin" and password is "rigol".



English

Turn-on Checkout

When the oscilloscope is connected to power, press the Power key at the lower-left corner of the front panel to start the oscilloscope. During the start-up process, the oscilloscope performs a series of self-tests. If the oscilloscope has been connected to an external display device, after the self-test, the splash screen is displayed.

Tip

Restart and Shutdown:

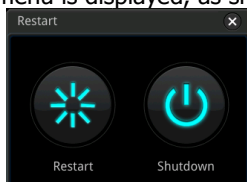

1. Operate the oscilloscope with the externally connected mouse. Click the function navigation icon  at the lower-left corner of the externally connected screen to enable the function navigation.
2. Click on the "Restart" icon , and then the "Restart" selection menu is displayed, as shown in the figure below:



3. If you click on the "Restart" icon , the oscilloscope will be powered off and then automatically restart again. If you click on the

"Shutdown" icon , the oscilloscope is powered off (you can also press the Power key at the lower-left corner of the front panel to turn off the oscilloscope).

To Set the System Language

This oscilloscope supports menus in multiple languages. You can click on the function navigation icon  to open the function navigation. Then click on the "Utility" icon  to enter the utility setting menu. Click **Language** to select the desired language.

To Connect the Probe

RIGOL provides the passive probe and the active probe (required to be purchased by yourself if necessary) for DS8000-R series. For specific probe models, please refer to DS8000-R Series Datasheet. For detailed technical information of the probes, please refer to the corresponding Probe User Guide.

Connect the passive probe:

1. Connect the BNC terminal of the probe to an analog channel input terminal of the oscilloscope on the front panel, as shown in Figure 5.
2. Connect the ground alligator clip or spring of the probe to the circuit ground terminal, and then connect the probe tip to the circuit point to be tested.

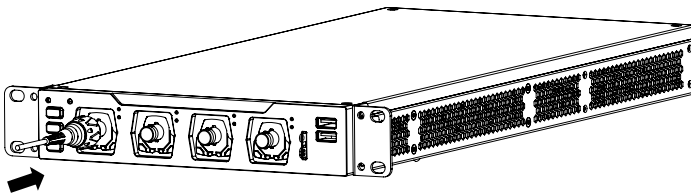

Figure 5 To Connect the Passive Probe

After you connect the passive probe, check the probe function and probe compensation adjustment before making measurements. For detailed procedures, refer to "**Function Inspection**" and "**Probe Compensation**".

Connect the active probe:

Take RP7150 (active differential probe) as an example.

1. Connect the probe head to the preamp of the active probe, as shown in Figure 6.

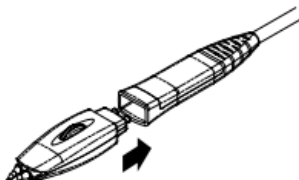

Figure 6 To Connect the Probe Head to the Preamp of the Active Probe

2. Connect the other end of the preamp to an analog channel input terminal of the oscilloscope on the front panel, as shown in Figure 7. Note that you should push the probe to the end to ensure that it is tightly connected.

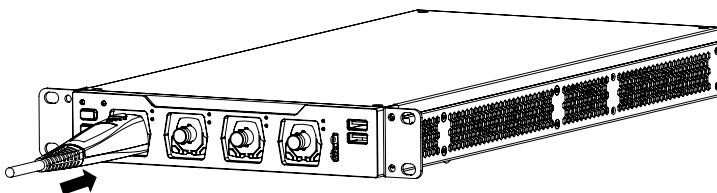



Figure 7 To Connect the Active Probe

3. Use the probe's auxiliary device to connect the probe head to the circuit under test. For details about the probes, refer to *RP7000 Series Active Probe User Guide*.

After connecting the active probe, you can perform probe calibration and offset voltage adjustment if necessary. For detailed procedures, refer to the "Active Probe" section in User Guide.

Function Inspection

1. Click on the function navigation icon  at the lower-left corner of the screen to open the function navigation. Then click on the "Storage" icon  to enter the storage and loading setting menu. Click **More** →

- Default**, then a prompt message "Restore default settings?" is displayed. Click **OK** to restore the instrument to its factory default settings.
- Connect the ground alligator clip of the probe to the "Ground Terminal" as shown in Figure 8 below.
 - Use the probe to connect the input terminal of CH1 of the oscilloscope and the "Compensation Signal Output Terminal" of the probe, as shown in Figure 8.

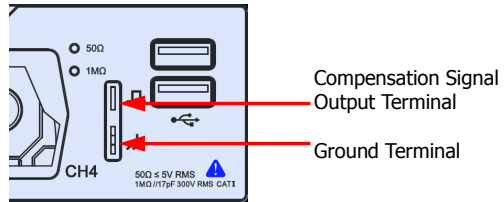

Figure 8 To Use the Compensation Signal

- Set the probe attenuation to 10X, and then click the **Auto** key in the Web Control page.
- Observe the waveform on the display. In normal condition, the square waveform as shown in Figure 9 should be displayed.



Figure 9 Square Waveform Signal

- Use the same method to test the other channels. If the square waveforms actually shown do not match that in the figure above, please perform "Probe Compensation" introduced in the next section.

**WARNING**

To avoid electric shock when using the probe, please make sure that the insulated wire of the probe is in good condition and do not touch the metallic part of the probe when the probe is connected to high voltage source.

Probe Compensation

English

When the probes are used for the first time, you should compensate the probes to make them match the input channels of the oscilloscope. Non-compensated or poorly compensated probes may cause measurement inaccuracy or errors. The probe compensation procedures are as follows:

1. Perform Step 1, 2, 3 and 4 specified in "**Function Inspection**".
2. Check the displayed waveforms and compare them with the waveforms shown in Figure 10.

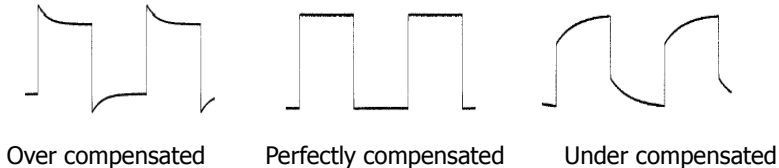



Figure 10 Probe Compensation

3. Use the probe compensation adjustment tool provided in the accessories to adjust the low-frequency compensation adjustment hole on the probe until the displayed waveform is consistent with the "Perfectly compensated" waveform shown in Figure 10.

Common Operation

Click Operation

- Click the menu displayed on the externally connected screen to operate on the menu.
- Click the function navigation icon  at the lower-left corner of the externally connected screen to enable the function navigation.
- Click the displayed numeric keypad to set the parameters.
- Click the virtual keypad to set the label name, the filename, and other character strings.

- Click the close button  at the upper-right corner of the message box to close the prompt window.
- Click other windows on the touch screen and operate on the windows.
- Double-click the left mouse button to stop the recording/playing of the waveforms or stop the self-calibration.

Drag Operation

Click to select the menu and then drag the mouse to change the position of the waveforms or the cursor on the screen.

Scroll Operation



For the menu with the icon  on it, click to select the parameter item, then scroll up and down with the mouse to adjust the parameter value. You can also set it with the pop-up numeric keypad.

For the menu with the icon , click the menu and scroll up and down with the mouse to adjust the parameter.

For example, to adjust the waveform brightness, first click on the function navigation icon  to open the function navigation. Then click on the

"Display" icon  to enter the "Display" setting menu. Click **Intensity** to adjust the intensity. The adjustable range of the intensity is from 1% to 100%. Scroll up with the mouse to increase the brightness, and scroll down with the mouse to decrease the brightness.

Rectangle Drawing

Click the function navigation icon  at the lower-left corner of the externally connected screen to open the function navigation. Then click on the "Draw rect" icon  to switch to the rectangle drawing mode. Drag the mouse cursor from upper left to lower right across the screen to draw a rectangle on the screen, and then a menu is displayed on the screen. At this time, you can click to select "Trigger zone A", "Trigger zone B", "Histogram", "Horizontal zoom in", "Vertical zoom in", or "Waveform zoom in". Drag the mouse cursor from lower right to upper left across the screen to draw a rectangle on the screen. Move your cursor away from the screen, and then a menu is displayed on the screen. At this time, you can click to select "Trigger zone A", "Trigger zone B", "Histogram", "Horizontal zoom out", "Vertical zoom out", or "Waveform zoom out".

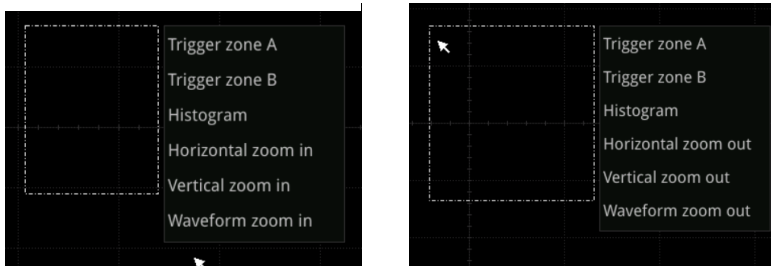



English

Figure 11 Rectangle Drawing

- Select "Trigger zone A":
 - Draw the region for Trigger zone A;
 - Open Trigger zone A:
 - Open the "Zone Trigger" menu.
- Select "Trigger zone B":
 - Draw the region for Trigger zone B;
 - Open Trigger zone B:
 - Open the "Zone Trigger" menu.
- Select "Histogram":
 - Draw the region for the histogram;
 - Open the "Histogram" menu.
- Select "Horizontal zoom in": expands the waveforms in the horizontal direction. Select "Horizontal zoom out": compresses the waveforms in the horizontal direction.
- Select "Vertical zoom in": expands the waveforms in the vertical direction. Select "Vertical zoom out": compresses the waveforms in the vertical direction.
- Select "Waveform zoom in": expands the waveforms both in the horizontal and vertical direction. Select "Waveform zoom out": compresses the waveforms both in the horizontal and vertical direction.

Tip

Click on the "Draw rect" icon to switch between the rectangle drawing and waveform operation modes.

Click on the "Draw rect" icon, if  is displayed, it indicates that the rectangle drawing mode is enabled. Click on the "Draw rect" icon, if  is displayed, it indicates that the waveform operation mode is enabled. By default, the waveform operation mode is enabled.

Note:

The menu displayed on the externally connected screen or the icon available to be enabled on the screen can all be operated by Web Control. However, Web Control does not support the following operations:

- Double-click the mouse left button to stop recording/playing of the waveforms; or stop the self-calibration.
- All the mouse dragging operation.
- All the mouse scrolling operation.
- Rectangle drawing operation.

In this manual, descriptions on menu operation through externally connected screen are illustrated in details. For details about menu operation through Web Control, we will illustrate it in relevant chapters if necessary.

Parameter Setting Method

You can set the parameters of DS8000-R series through the Web Control or the externally connected display device/mouse/keyboard. The common parameter setting method is as follows:

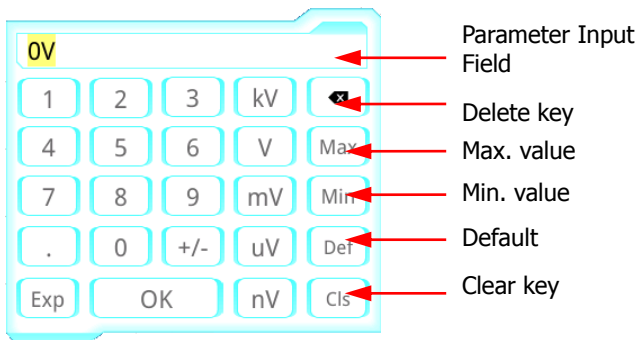

Figure 12 Numeric Keypad

In the numeric keypad, click to select the value or the unit in the numeric keypad. You can also use the externally connected keyboard to input the parameter value. After you input all the values and select the desired units, the numeric keypad is turned off automatically. This indicates that you have completed parameter setting. Besides, after you have input the values, you can also press **OK** directly to close the numeric keypad. At this time, the unit of the parameter is the default unit. In the numeric keypad, you can also perform the following operations:

- Delete the parameter value that has been input.
- Set the parameter to a maximum or minimum value (sometimes, the maximum or minimum value are the specified one for the current state).
- Set the parameter to a default value.
- Clear the parameter input field.



Tip

The above method is commonly used for the parameter settings of the oscilloscope. For other methods of parameter settings, refer to details in relevant chapters.

English

To Use the Built-in Help System

The help system of this oscilloscope provides instructions for all the function keys and their corresponding menu keys. The steps for viewing the help information are as follows:

1. Click the function navigation icon  to open the function navigation. Click the "Help" icon  to enter the "Help" menu.
2. Click **Content**, and then the help information is displayed on the screen, as shown in Figure 13. The help interface mainly consists of two sections. The left section lists "Help Options", and the right section is the "Help Display Area".

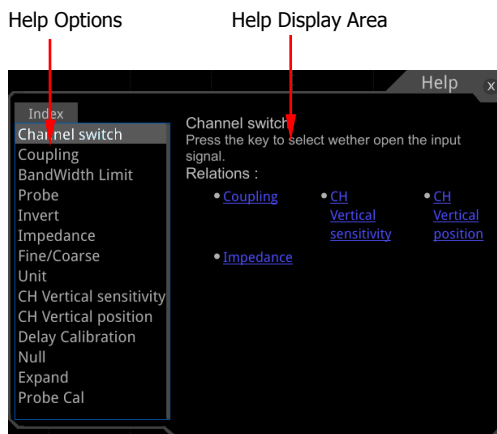

Figure 13 Help Information

After opening the help interface, you can click the desired help option to get its help information in the "Help Display Area".

Fuse Replacement

English

If you need to replace the fuse, use only the specified fuse (AC 250V, T3.15A; 5.2 mm×20 mm) and perform the following operations (as shown in Figure 14):

1. Turn off the instrument, cut off the power, and remove the power cord.
2. Use a small straight slotted screwdriver to pry out the fuse holder.
3. Take out the fuse holder.
4. Replace the old fuse with a specified fuse.
5. Install the fuse holder.

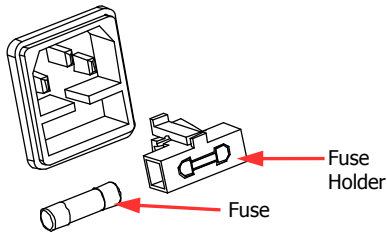

Figure 14 To Replace the Fuse



WARNING

To avoid electric shock, please ensure that the instrument has been turned off, the power source has been cut off, and the fuse to be used conforms to the fuse rating.



Remote Control

DS8000-R series digital oscilloscope can be connected to the PC via the USB, LAN, or GPIB interface to set up communication and realize remote control through the PC. The remote control can be realized by using SCPI (Standard Commands for Programmable Instruments) commands. DS8000-R series digital oscilloscope supports three ways of remote control: user-defined programming, PC software (e.g. **RIGOL** Ultra Sigma), and Web Control.

English

More Product Information

1. Obtain the device information

Click on the function navigation icon  at the lower-left corner of the screen to open the function navigation. Then click on the "Help" icon  to enter the help menu. Click **About** to obtain the information of the instrument, such as the manufacturer, model, serial number, firmware version number, and hardware version number.

2. Check the option installation status

The instrument is installed with the trial versions of the options before leaving factory. When you power on the instrument for the first time, the trial time is about 2,160 minutes. Open the "Help" menu, and then click **Option list** to view the options currently installed on the oscilloscope and their information. Click **Option setup** to install the option. For detailed setting methods, refer to descriptions in *DS8000-R User Guide*.

For more information about this instrument, refer to the relevant manuals by logging in to the official website of **RIGOL** (www.rigol.com) to download them. *DS8000-R User Guide*: introduces the functions of the instrument and the operation methods, remote control methods, possible failures and solutions in using the instrument, the technical specifications, and order information. *DS8000-R Programming Guide*: provides detailed descriptions of SCPI commands and programming examples of the instrument. *DS8000-R Datasheet*: provides the main features and technical specifications of the instrument.