

User Manual

Please read this Manual carefully before operation

Please keep this Manual along with the device



BELIEVE YOUR EYES

VIEW 810/830 Battery Tester

HIGH-PRECISION & HIGH-RESOLUTION

Content

Chapter I Overview	4
1.1 Product overview.....	4
1.2 Functional advantages and features.....	4
1.3 Instrument appearance details and description.....	6
Chapter II Measurement Method	7
2.1 Example of basic measurement.....	7
2.2 Select the measurement type.....	9
2.3 Set the measurement range.....	10
2.4 Set the sampling rate.....	11
2.5 Set the power frequency.....	11
2.6 Perform zero setting.....	13
2.7 Show the measurement result.....	13
2.8 Test abnormality output.....	14
2.9 Overflow display.....	14
Chapter III Application Measurement	15
3.1 Measurement configuration.....	15
3.2 Comparator function.....	18
3.3 Statistical operation function.....	24
3.4 System settings.....	28
3.5 Storage function.....	41
3.6 Key lock function.....	44
3.7 Key sound (Beep).....	44
3.8 Power key.....	45
3.9 Zero setting.....	45
3.10 Trig key.....	46
3.11 Local key.....	46
3.12 Clear key.....	46
3.13 ESC key.....	46
Chapter IV External Control (EXT I/O) (option)	47
4.1 Input terminal function.....	49
4.2 Output terminal function.....	49
4.3 Functional port timing.....	49
4.4 Composition of internal circuit.....	55
Chapter V Printer (option)	58
5.1 Connect the printer.....	58
5.2 Parameters settings.....	58
5.3 Print.....	59

Chapter VI Analog Output (option)	60
6.1 Connect analog output.....	60
Chapter VII Remote Control	61
7.1 Overview and characteristics.....	61
7.2 Specifications of RS-232C.....	61
7.3 Connection and setting methods.....	61
7.4 Communication method.....	62
7.5 Summary of messages.....	62
Chapter VIII Specifications	67
8.1 Specifications.....	67
8.2 Precision.....	68
8.3 General features.....	69
Chapter IX Problems and Maintenance	70
9.1 Common problems.....	70
9.2 Cleaning.....	70
Appendix	71
Appendix I AC four-terminal test method.....	71
Appendix II Synchronous Detection.....	71
Appendix III About Zero Setting.....	72
Appendix IV About the Test Line (Option).....	74

Chapter I Overview

1.1 Product Overview

VIEW 810/830 battery tester is a high-accuracy and high-resolution battery tester. It is widely used in the test of various batteries such as mobile phone lithium battery, storage battery and power battery. Using AC four-terminal test method, it can test the internal resistance and voltage of the battery more accurately. With the built-in comparator function, it can automatically judge whether the battery parameters meet the standard, so as to count the qualified rate, which is suitable for the detection and sorting of various batteries.

1.2 Functional advantages and features

1.2.1 AC 4-terminal method

AC 4-terminal method is used for impedance measurement, which will not be affected by the wiring impedance of the test line when measuring.

1.2.2 High-accuracy measurement

Resistance: $\pm 0.4\% \text{rdg.} \pm 5 \text{dgt.}$

Voltage: $\pm 0.01\% \text{rdg.} \pm 3 \text{dgt.}$

1.2.3 High resolution display

Resistance: 0.1μ

Voltage: $10\mu\text{V}$

1.2.4 Comparator function

- **Simultaneous judgment of resistance and voltage**

Independent comparing function of resistance and voltage, which can judge Hi/IN/Lo. The judgment results can be displayed on screen, buzzed and output to external I/O. The judgment results of both sides can be seen on the screen display at the same time.

- **Output of comprehensive judgment result**

For resistance and voltage, in addition to their respective judgment result, comprehensive judgment result can be output to external I/O. In this way, the comprehensive judgment result can be confirmed.

- **Two setting methods**

The following two settings can be made: the method of setting Hi/Lo according to their respective upper and lower limit absolute values and the method of setting them according to the deviation (%) of any standard value.

- **Manual comparison**

Comparison mode can be divided into manual and automatic, and the instrument defaults to automatic comparison. During manual comparison, comparator results will be output only when EXT I/O is ON. It is suitable for foot switch or PLC control and other occasions.

- **Four types of beeps**

Buzzer settings include OFF, HL, IN, BT1 and BT2. Under BT1 and BT2 modes, different beeps can be set for IN or Hi/Lo respectively.

1.2.5 Storage function

The measurement results (data) can be stored in the instrument memory or USB flash disk in csv or mat format, and the data stored in the memory can also be transferred to USB flash disk, so that the measurement results at corresponding time can be viewed at any time.

1.2.6 Statistic function

Calculate the statistical indicators according to the measured results, draw the normal distribution diagram, and observe the normal distribution of the measured results.

1.2.7 Calibration function

It is used to compensate the bias voltage or gain drift of the internal circuit of instrument to improve the test accuracy. Calibration is divided into automatic mode and manual mode, and the default is automatic mode. In automatic mode, calibration is executed every 30 minutes; in manual mode, it needs to be executed manually through EXT I/O and communication command. The measurement is suspended during calibration.

1.2.8 Analog output function

VIEW 810/830 battery tester can execute analog output of the resistance/voltage measurements, and record the change of battery resistance for a long time or evaluate the performance and quality of battery by connecting the analog output to the recorder.

1.3 Instrument Appearance Details And Description

Front



Back

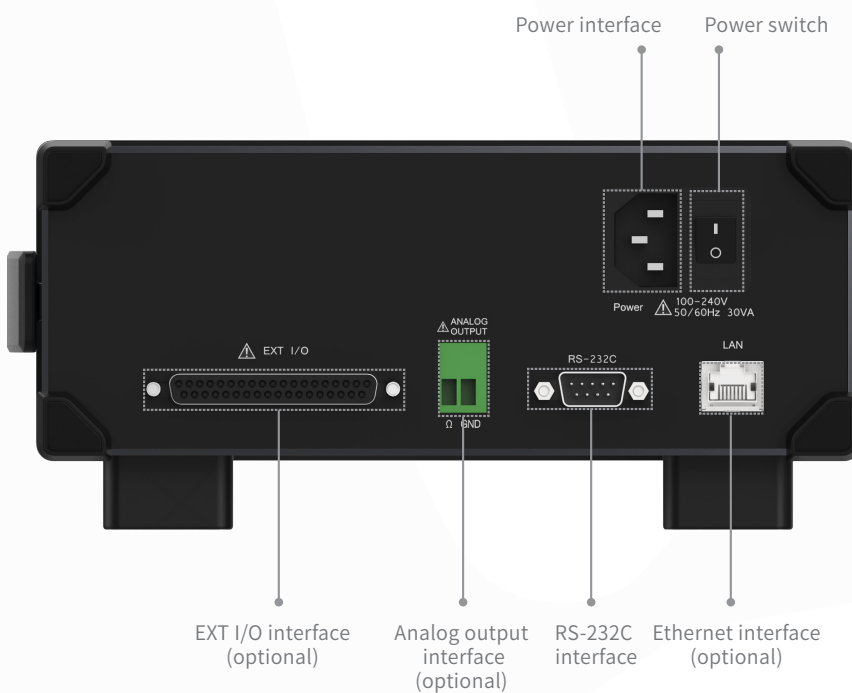

Chapter II Measurement Method

- In order to prevent electric shock accident, no short circuit at the top of test line and the line with voltage occurs.
- Do not measure the voltage of DC \pm 60V (VIEW810)and DC \pm 300V (VIEW830)or above, or measure AC voltage, AC current and DC current. Otherwise, it may cause instrument damage or personal injury accident.
- In order to prevent electric shock, please confirm the rated value of test line before measurement, and do not measure the voltage higher than the rated value.

2.1 Example of Basic Measurement

Use the following example to illustrate the measurement method.

<Example>	Measure the resistance and voltage of 30m Ω lithium-ion battery
Required items	Lithium-ion battery Test line: use BL-1002 clamp type four-terminal test line.
Measurement conditions	Measurement mode..... Ω V (resistance and voltage measurement) Range.....300m Ω range, 60V range Sampling rate..... Slow Zero setting.....Yes

The measurement steps are described as follows:

1、 Connect the test line to the instrument

2、 Set the instrument

a)Set [Ω V] measurement mode

Click [Ω V/ Ω /V] key continuously until the interface is displayed as follows to complete the setting of measurement mode.

Note : [] indicates the text displayed on the instrument screen/key, for example: [Measure].

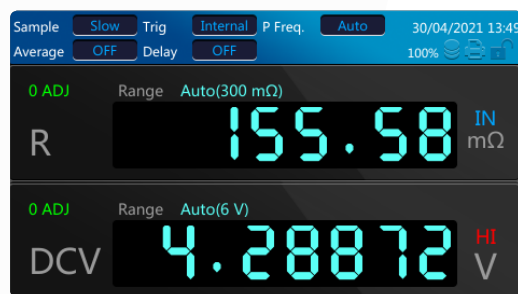

b) Set the range

i. Set the voltage range

Click [Rang (V)]-> in the key, and then the following figure will appear. Then click [F1] to select voltage range setting. Click [F1] repeatedly or up and down direction keys until the range of [60V] is highlighted. Click [Enter] key. Then the setting of voltage range is completed.

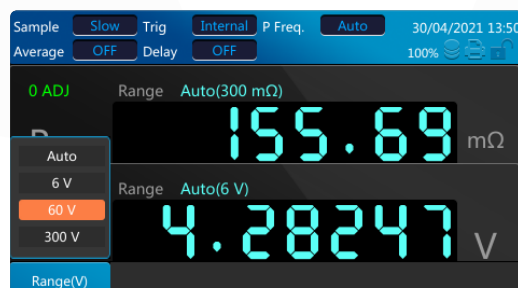

ii. Set the resistance range

Click [Rang (R)]-> in the key, and then the following figure will appear. Then click [F1] to select resistance range setting. Click [F1] repeatedly or click up and down direction keys until the range of [300mΩ] is highlighted.

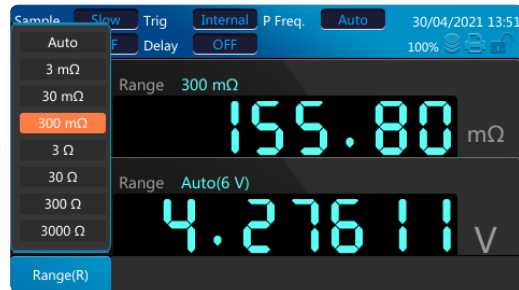

c) Set the sampling rate

Click [Measure] key, and the display image is as follows:

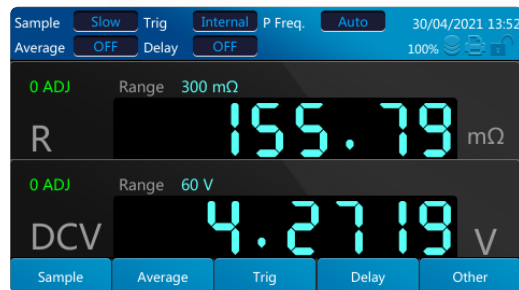

Click [F1] to select the setting of [Sampling rate], and then click [F1] until [Slow] is highlighted.

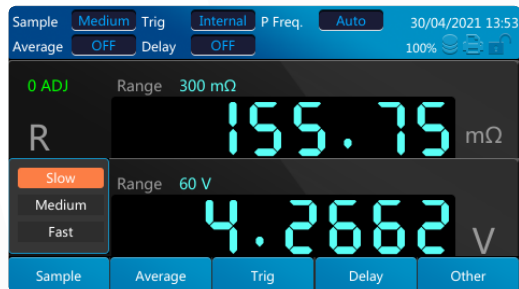

Click [Enter] to complete the setting of sampling rate.

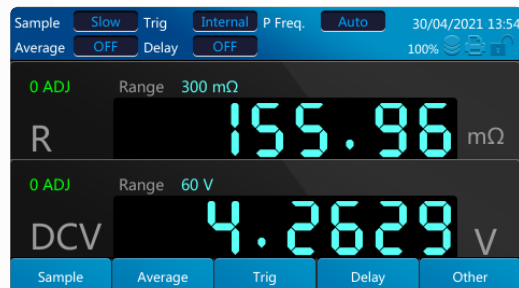

3. Perform zero setting

Refer to Section 3.9 Perform zero setting.

4. Start the measurement

- Connect the test line to battery.
- Read the resistance measurements and voltage measurements



2.2 Select the Measurement Type

Select the measurement type from ΩV (resistance and voltage measurement), Ω (resistance measurement) and V (voltage measurement).

Click [$\Omega V/\Omega/V$] key to display the screen of measurement function. The measurement type will be switched every time you click it.

ΩV measurement type (resistance • voltage measurement)

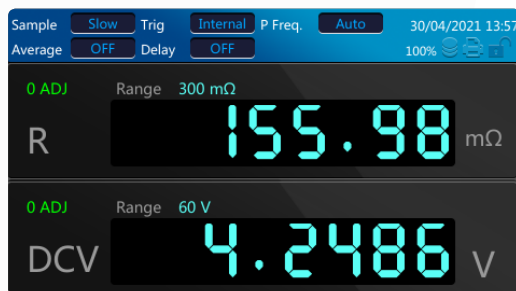

Ω measurement type (resistance measurement)

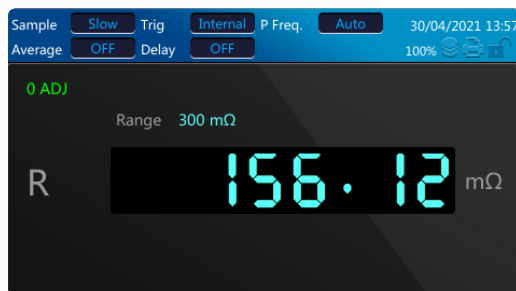

V measurement type (voltage measurement)

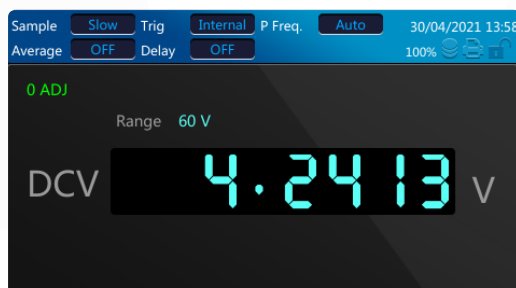

2.3 Set the Measurement Range

Set the range of resistance measurement or voltage measurement. Select resistance measurement from 8 ranges of 3mΩ~3000Ω and [Automatic], and select voltage measurement from 4 ranges of [6V], [60V], [300V] (VIEW830 only) and [Automatic].

2.3.1 Resistance range

Click [Range (R)]-> in the key, and then Figure 1 will appear. Then click [F1] to select resistance range setting. Click [F1] repeatedly or click up and down direction keys until the range of [300mΩ] is highlighted. Click [Enter] key. Then the setting of resistance range is completed.

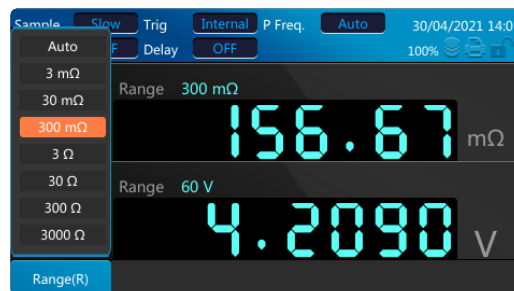

2.3.2 Voltage range

Click [Range (V)]-> in the key, and then Figure 1 will appear. Then click [F1] to select voltage range setting. Click [F1] repeatedly or click up and down direction keys until the range of [60V] is highlighted. Click [Enter] key. Then the setting of voltage range is completed.

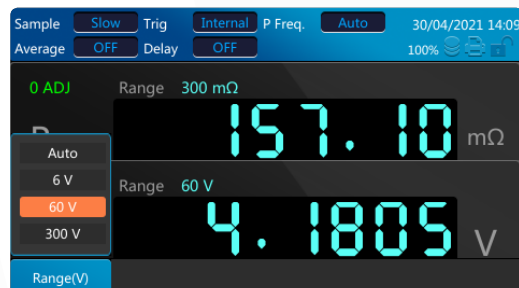

Notes :

- Automatic measuring range may become unstable because the measurements of the measured object is at the critical value of measuring range. At this time, please specify the range manually or extend the delay time.
- For accuracy, please refer to [Chapter IX Specifications]

2.4 Set the Sampling Rate

The sampling rate can be changed in three stages (fast/medium/slow). The lower the sampling rate, the higher the test accuracy.

Steps of switching sampling rate:

Click [Measure] in the key, and it will display as follows:



Click [F1] again to select the setting of [Sampling rate], which will be switched every time you click F1. Until the required sampling rate is highlighted.

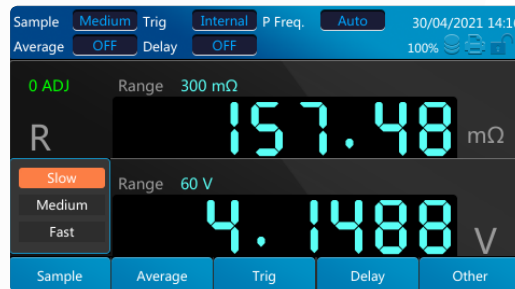

Click [Enter] key. Then the setting of sampling rate is completed.



2.5 Set the Power Frequency

In order to remove noise, it is necessary to set the power frequency of this instrument.

In the initial state, it is automatic recognition of power frequency setting (AUTO), but it can also be set manually. If the power frequency is not set correctly, the measurements will be unstable.

In case the power frequency is set to Auto, when the power supply is turned on or reset, it will automatically determine whether the frequency of power supply is 50Hz or 60Hz.

AUTO..... Automatic setting of power frequency

50 Hz..... Power frequency 50Hz

60 Hz..... Power frequency 60Hz

Setting steps:

Use an effect picture to illustrate the steps,

1、 Click [Measure] key

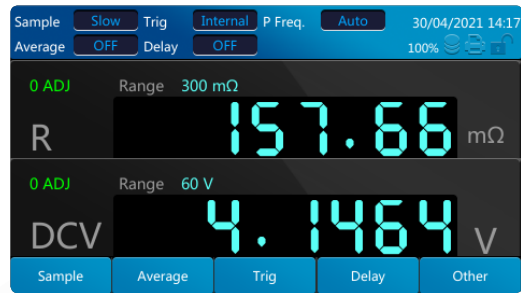

2. Click [F5] key

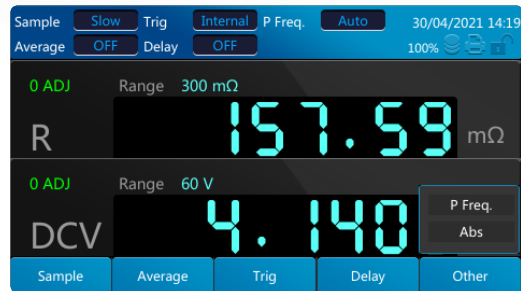

3. Click [F5] to select [Power frequency] from the menu

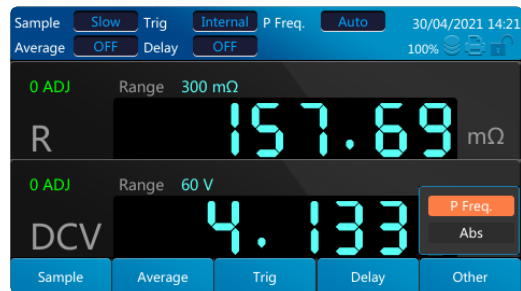

4. Click [Enter], the following interface will pop up, and press the up and down direction keys or the [F5] key to select the frequency to be selected.



5. Click [Enter], and the power frequency value in menu bar will be updated to the selected value.

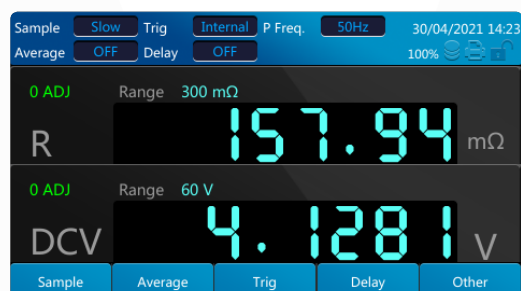

2.6 Zero Setting Result

In order to eliminate errors caused by the bias voltage of instrument itself or the measurement environment, please perform zero setting before measurement. Use [0ADJ] key to perform zero setting. Conduct short-circuit of the test line, and then press [0ADJ] key for zero setting.

2.6.1 Wiring method for zero setting

Please refer to Appendix III About zero setting.

2.6.2 Perform zero setting

Press [0 ADJ] key after short circuit of test line, and the following dialog box will pop up after zero setting is completed. If the zero setting of some range gear fails, please check whether the short circuit is correct, and then perform zero setting of keys until it succeeds.



2.6.3 Zero setting result

When the zero setting result shows that it is completed, the interface displays the zero setting result of the current range gear, and the corresponding zero setting result will change after switching the range gear.

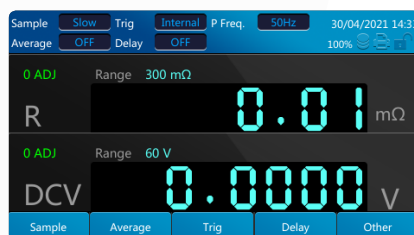

2.7 Show the Measurement Result

When [QV] function is selected, the upper section of screen displays the resistance measurements, and the lower section displays the voltage measurement.

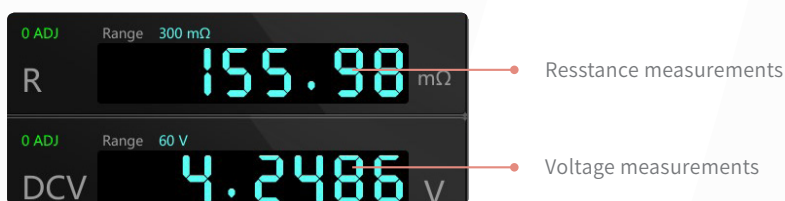

When [Q] function is selected, the measurement screen only displays the resistance measurement.



When [V] function is selected, the measurement screen only displays the voltage measurement.



2.8 Test Abnormality Output

[— — — —] is displayed on the screen when the measurement is not performed correctly.

In addition, a test abnormality signal (ERR) is output from the EXT I/O terminal.

Test abnormality is displayed in the following circumstances.

- When the test line is not connected to the test object
- When the resistance of test object is greater than the range
- <Example> When measuring 30Ω in the range of 300mΩ,
- When the probe line is broken
- When contact resistance is larger or wiring resistance is larger due to probe wear and contamination (please refer to the following table)
- When the circuit protection fuse is broken

Test abnormality and detection level

If there are resistance values (contact resistance + wiring resistance + test object resistance) between SOURCE +/- and SENSE +/- that exceed those shown in the following table, it is regarded as test abnormality.

Range	SOURCE +/-	SENSE +/-
3 mΩ	8 Ω	3 Ω
30 mΩ	8 Ω	3 Ω
300 mΩ	15 Ω	20 Ω
3 Ω	150 Ω	20 Ω
30 Ω	1.5 kΩ	200 Ω
300 Ω	6.5 kΩ	700 Ω
3000 Ω	6.5 kΩ	6.5 kΩ

- If contact resistance or wiring resistance is larger, the error of the measurement will increase.

2.9 Overflow Display

When [OF] or [-OF] is displayed on the screen, it indicates that overflow occurs.



The following is the reason for displaying such information.

Display	Causes
OF	<ul style="list-style-type: none"> • The resistance measurement exceeds 103.3% of the range • The voltage measurement exceeds the range
-OF	<ul style="list-style-type: none"> • The resistance measurement is less than -3% of the current range • The voltage measurement exceeds -100% of the range

Chapter III Application Measurement

3.1 Measurement Configuration

There are five test configurations on the measurement page: [Sampling rate], [Average value], [Trigger source], [Delay] and [Other]. The functions and setting methods of these measurement configurations are described below.

3.1.1 Sampling rate function

Please refer to Section 2.4 Set the sampling rate.

3.1.2 Average value function

Average value function refers to the function of outputting the average measurements. The deviation of the displayed value can be reduced with this function. The average times can be set to 2 ~ 16 times.

The average value function has two configurations of ON/OFF, which can turn on/off this function. The average value function is turned on by default. After the average value function is turned on, the average setting box displays the set average times, which is 2 by default.

Turn on the average value function:

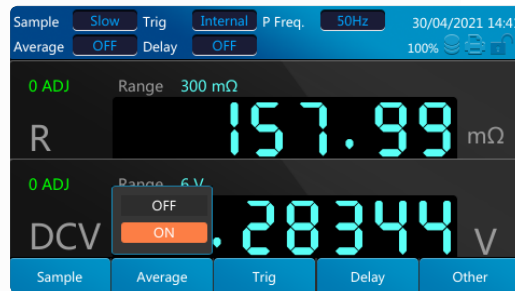

Set the average value:

When the cursor focuses on the average value setting box, numbers can be input with number keys. Click [Clear] to clear the input numbers.

When the input number is larger than the maximum value or is less than the minimum value, it is adaptive to the maximum value or the minimum value.

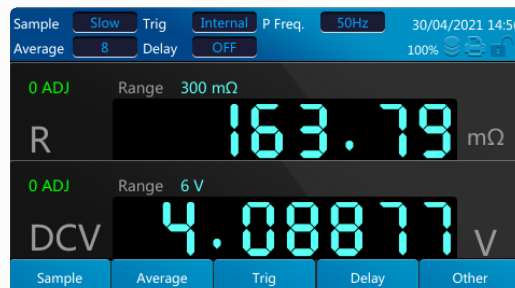

Turn off the average value function:



After being turned off, it displays as follows:



3.1.3 Trigger function

Trigger source function is used to set the trigger mode of instrument. Trigger sources include [Internal trigger], [External trigger] and [Manual trigger].

Internal trigger	Automatic trigger occurs internally (free measurement).
External trigger	Perform the measurement by externally inputting trigger signal.
Manual trigger	Perform the measurement by manually inputting trigger signal.

3.1.3.1 Trigger source switchover

Click [Measure] and [F3], and the trigger source will be switched every time you click [F3]. After the selected trigger source is highlighted, click [Enter] key and then you can see internal trigger in the input box of trigger source in the menu bar.

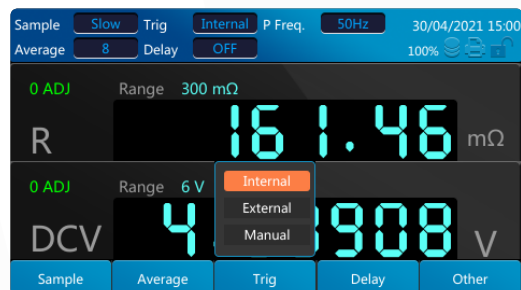

3.1.4 Delay function

Set the delay time from the input of trigger signal to the start of measurement. With this function, the measurement can be started after the measurements are stable even if the trigger signal is input just after the test object is connected. The trigger delay time can be set within the range of 0.000~9.999s with the resolution of 1ms, and the default value is 0.

Turn on the delay time, which is set to 1s:



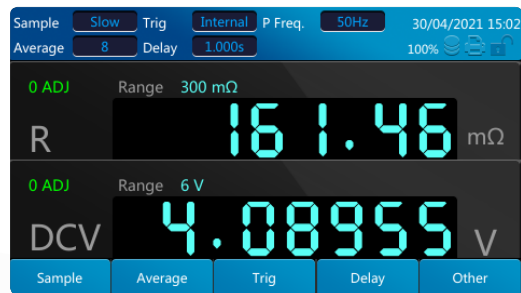

Turn off the delay time:

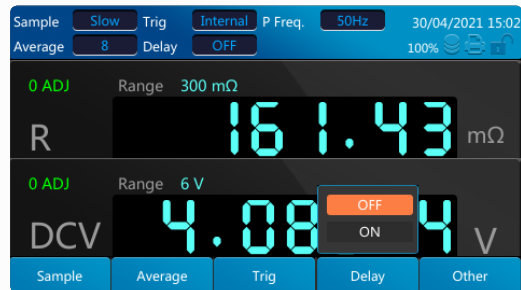

3.1.5 Other functions

3.1.5.1 Power frequency

Please refer to Section 2.5 Set the power frequency.

3.1.5.2 Absolute value judgment

Set the function of reading the absolute value of measurements. Absolute value judgment includes [ON] and [OFF], and it is [ON] by default. After this function is turned on, even if the battery polarity is reversed, it can be displayed as a positive value; if this function is turned off, the measurements are possibly to be negative, which will affect the judgment of comparison result.

Turn on the absolute value function:

Click [Measure] and [F5].

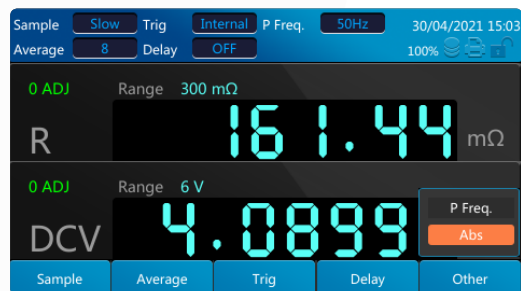

Every time you press [F5] to select absolute value judgment, click [Enter] and then click [F5] or the up and down direction keys to select [ON], as shown below:



Click [Enter] to complete the setting of turning on the absolute value.

Turn off the absolute value function:

Select [OFF] and click [Enter] to turn off the absolute value function.

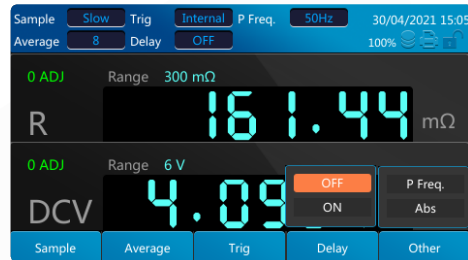

3.2 Comparator Function

The comparator function is to judge whether the measurements conform to the judgment standard by comparing the measurement with the set threshold, and to display and output the measured result.

Click [Comp] key to jump to the comparator setting page.

There are two comparison modes: automatic and manual, and it is automatic mode by default. Automatic mode: the measurement generated every time is automatically compared with the threshold value; manual mode: the external interface triggers the comparison between the current measurements and the threshold value.

The comparison method of threshold value includes setting the upper and lower limit and setting the reference value and percentage.

As a result of the comparator, in addition to page display of HI, IN, LO and PASS and buzzer sound, it can also be output through the EXT I/O terminal.

Setting process of displaying comparator function:

Enter the comparator setting screen

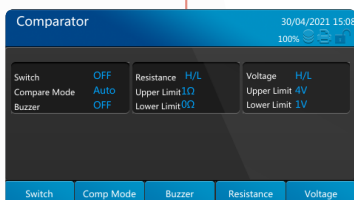

Set the buzzer

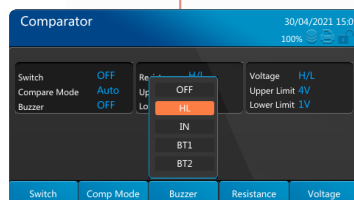

Set the comparison mode

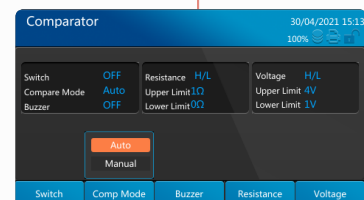

Set the comparator switch

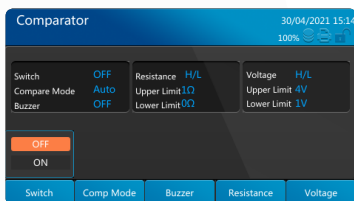

Set upper and lower limits of voltage and reference value range

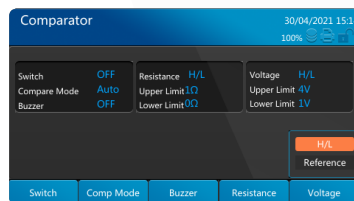

Set upper and lower limits of resistance and reference value range

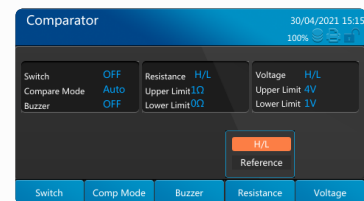

3.2.1 Comparator setting example 1 (determining according to upper and lower limits)

The following example illustrates the comparator setting method

<Example> It is expected to use the ΩV function (range of 3Ω, 60V) to set the upper and lower limits of resistance and voltage respectively, and sound a buzzer to judge when the measurements exceed the upper limit or fall below the lower limit.

Resistance: the upper limit is 200.00mΩ, and the lower limit is 50.00mΩ

Voltage: the upper limit is 10.0000V, and the lower limit is 5.0000V.

1. Set the measurement function to ΩV

2. Set the voltage range to 60V
 3. Set the resistance range to 3Ω
 4. Enter the comparator setting screen
- Click [Comp] to enter the comparator setting screen.

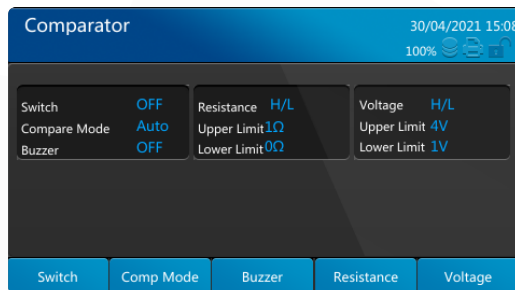

5. Set the buzzer to [HL]
- Click [F3] key, and the buzzer setting will be switched every time you click [F3] until [HL] is highlighted. Click [Enter] to complete the setting.

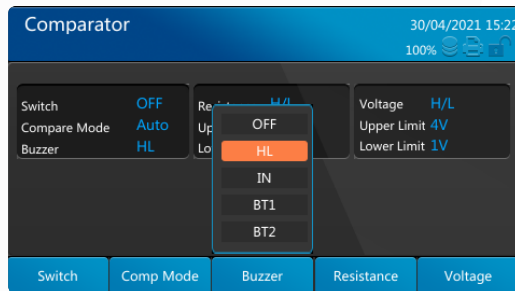

Buzzer mode	Sound type
Turn off	No sound
HL	The buzzer sounds [tick, tick, tick...] when it is in [HI] and [LO]
IN	The buzzer sounds [tick, tick] (continuous sound)
BT1	The buzzer sounds [tick, tick] (continuous sound) when it is in [IN], and [tick, tick, tick...] when it is in [HI] and [LO]
BT2	The buzzer sounds [tick] once (short sound) when it is changing from outside [IN] to [IN], and [tick, tick, tick...] when it is in [HI] and [LO]

6. Set the comparison mode to automatic
- Click [F2] key, and the comparison mode will be switched every time you click F2, until the [Automatic] mode is highlighted. Click [Enter] to complete the setting.

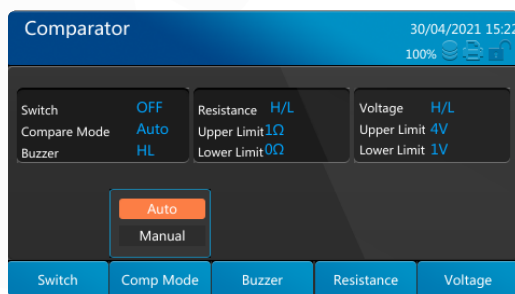

7. Set the upper and lower limits of resistance
- Click [F4] key, and the resistance mode will be switched every time you click [F4] until [Upper and lower limits] is highlighted. Click [Enter] to enter the upper and lower limits input settings.

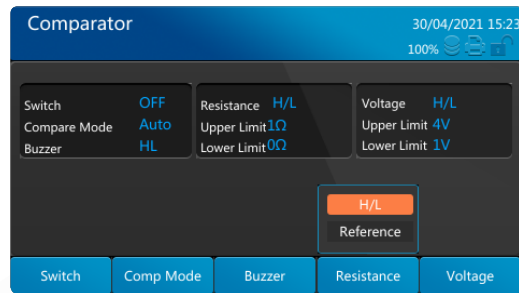

Enter [0.2] in [Upper limit], click the up and down keys to adjust to the lower limit input box, and enter [0.05]. Click [Enter] to complete the setting.

The values after setting are as follows:

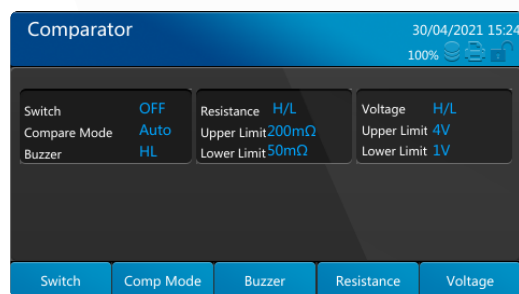

8. Set the upper and lower limits of voltage

Click [F5] key, and the voltage mode will be switched every time you click [F5] until [Upper and lower limits] is highlighted. Click [Enter] to enter the upper and lower limits input settings.

Enter [4] in upper limit, click the up and down direction keys to adjust to the lower limit input box, and enter [0]. Click [Enter] to complete the setting.

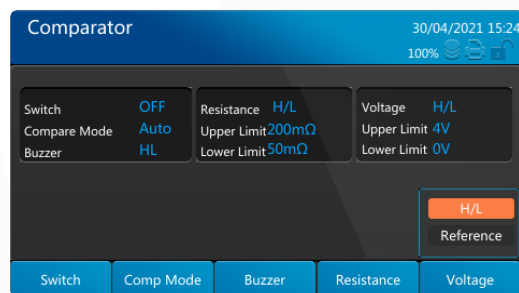

The values after setting are displayed as follows:

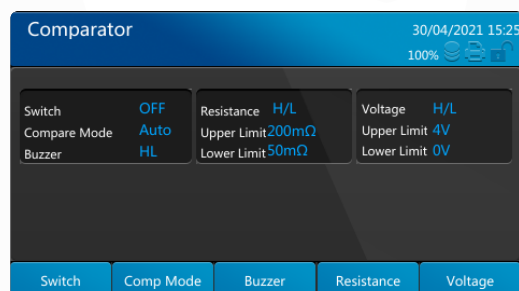

9. Turn on the comparator function

Click [F1] key, and ON/OFF will be switched every time you click [F1] until [ON] is highlighted. Click [Enter] to complete the setting.

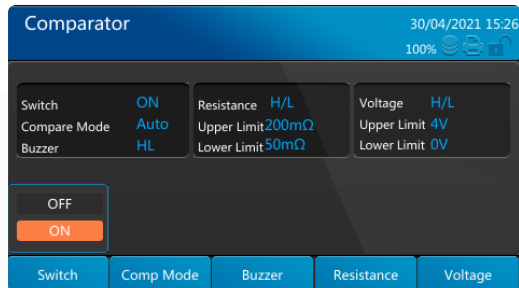

10. Return to the measurement screen

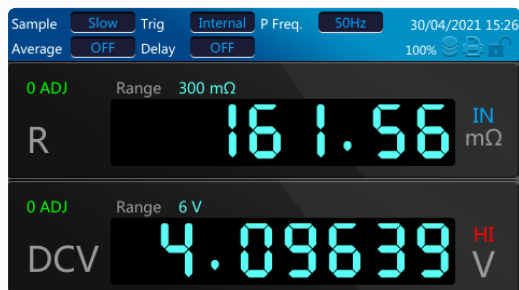

11. Connect the test object and determine the measurements

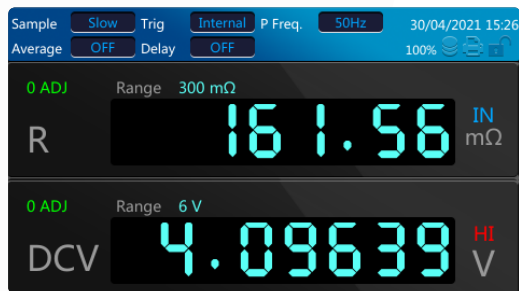

3.2.2 Comparator setting example 2 (determining according to reference value range)

The following example illustrates the comparator setting method.

<Example> It is expected to use the ΩV function (range of 300m Ω , 60V) to set the reference value and the range relative to the reference value, and sound a buzzer to judge when the measurements are within the range.

Resistance: reference value 8 Ω , percentage 5%, voltage reference value 6V, and range 5%.

1. Set the measurement function to ΩV
 2. Set the voltage range to 60V
 3. Set the resistance range to 300m Ω
 4. Enter the comparator setting screen
- Click [Comp] to enter the comparator setting screen.

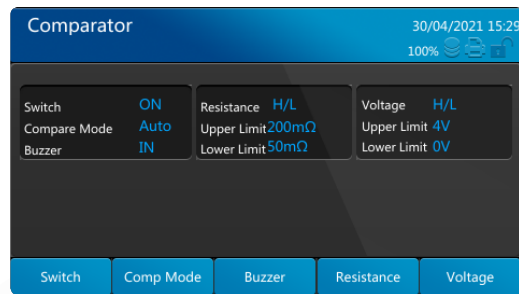

5. Set the buzzer to IN

Click [F3] key, and the buzzer setting will be switched every time you click [F3] until [IN] is highlighted. Click [Enter] to complete the setting.

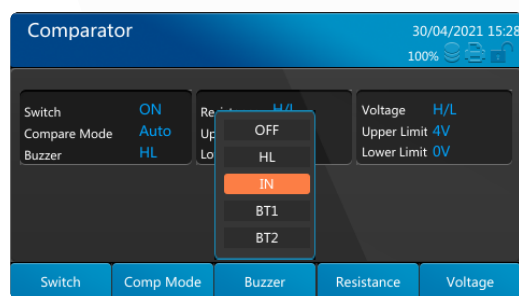

It is displayed as follows after setting:

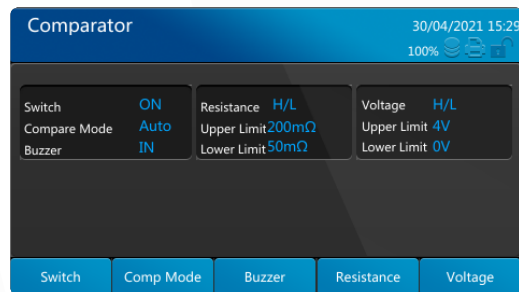

6. Set the resistance reference value

Click [F4] key, and the resistance mode will be switched every time you click [F4] until [Reference value] is highlighted. Click [Enter] to enter the reference input settings.

The range of reference value is 0~3100Ω, and that of percentage is 0.00%~99.99%.

Enter [8] in [Reference value], click the up and down direction keys to adjust to [Percentage] input box, and enter [5]. Click [Enter] to complete the setting.

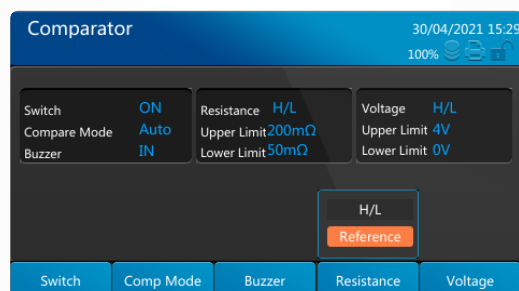

It is displayed as follows after the reference value is set:

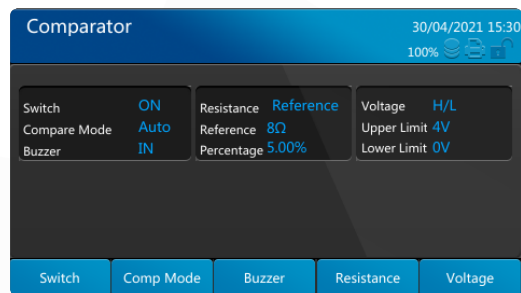

7. Set the voltage reference value

Click [F5] key to set the voltage as reference value. Click [Enter] to enter the reference value input settings.

The range of reference value is 0~310V, and that of percentage is 0.00%~99.99%.

Enter [6] in [Reference value], click the up and down arrows to adjust to [Percentage] input box, and enter [5]. Click [Enter] to complete the setting.

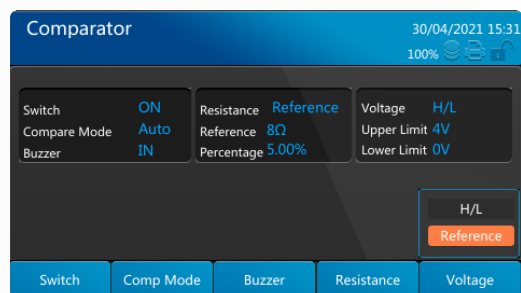

It is displayed as follows after the reference value is set:

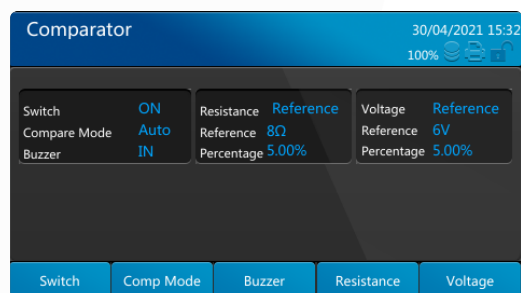

8. Set the comparison mode to automatic

Click [F2] key, and the comparison mode will be switched every time you click [F2], until the [Automatic] mode is highlighted. Click [Enter] to complete the setting.

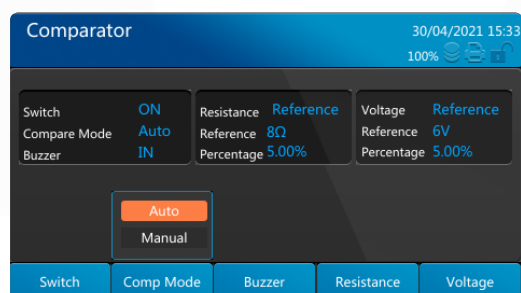

9、 Turn on the comparator function

Click [F1] key, and ON/OFF will be switched every time you click [F1] until [ON] is highlighted. Click [Enter] to complete the setting.

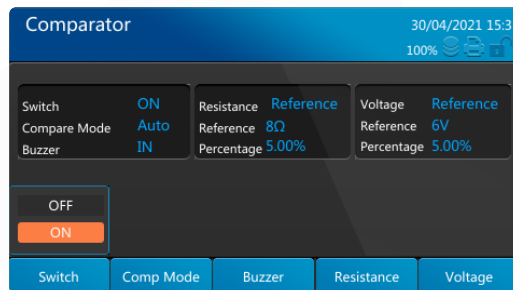

10、 Return to the measurement screen and click [Measure] key. Connect the test object and determine the measurements.

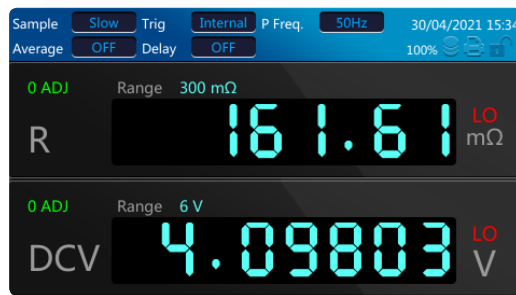

3.3 Statistical Operation Function

Click [Stat] key, and the statistics menu icon will appear on the measurement page. The functions of statistical function ON/OFF, statistics result viewing, data loading, normal distribution diagram and statistics clearing are introduced respectively as below.

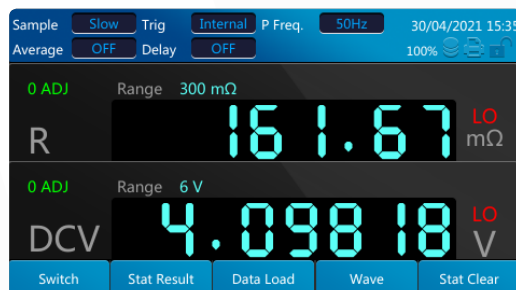

3.3.1 Statistical function ON/OFF

Click [F1] key to switch ON/OFF of statistical function, and then click [Enter] to complete the ON/OFF of statistical function.

Statistical function ON:



Statistical function OFF:

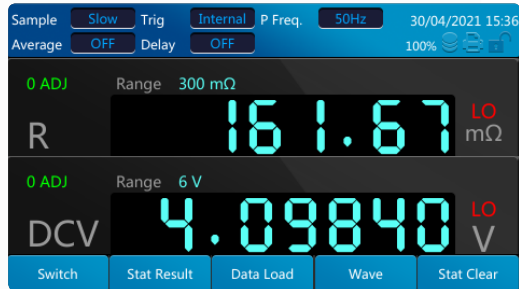

3.3.2 Statistical results

The view method of statistical results are divided into [Statistical indicators] and [Statistical list].

When statistical list is selected, it is displayed as follows:

Stat List			
No.	Resistance	Voltage	Comparisons
1	161.61mΩ	4.09828V	FAIL
2	161.60mΩ	4.09829V	FAIL
3	161.60mΩ	4.09829V	FAIL
4	161.61mΩ	4.09829V	FAIL
5	161.61mΩ	4.09828V	FAIL
6	161.61mΩ	4.09829V	FAIL
7	161.61mΩ	4.09828V	FAIL

When selecting statistical indicators, it is displayed as follows:

Stat Index		
Items	Resistance	Voltage
Average	161.63mΩ	4.09832V
Max	161.68mΩ	4.09836V
Min	161.60mΩ	4.09828V
Sn	0.0222mΩ	0.00002V
Sn-1	0.0223mΩ	0.00002V
Cp	99.999	99.9999
Cpk	0.0000	0.00000

It calculates and displays the average value, maximum value, minimum value, parent standard deviation, sampling standard deviation and process capability index for up to 1,000 measurement data.

The operational formula is as follows:

Average value	$\bar{x} = \frac{\sum x}{n}$
Parent standard deviation	$\sigma = \sqrt{\frac{\sum x^2 - n\bar{x}^2}{n}} \quad (= \sigma_n)$
Sampling standard deviation	$s = \sqrt{\frac{\sum x^2 - n\bar{x}^2}{n-1}} \quad (= \sigma_{n-1})$
Process capability index (deviation)	$Cp = \frac{Hi - Lo}{6\sigma_{n-1}}$
Process capability index (offset)	$CpK = \frac{ Hi - Lo - Hi + Lo - 2\bar{x} }{6\sigma_{n-1}}$

- In the formula, n represents the number of valid data
- Hi and Lo use the upper and lower limits of comparator.
- Process capability index refers to the capability of realizing process quality, which can be understood as [quality deviation and offset amplitude of process].

Generally, the values of Cp and CpK can be used to evaluate the process capability (as shown below):

- Cp and CpK > 1.33 Sufficient process capability
- $1.33 \geq Cp$ and $CpK > 1.00$ Appropriate process capability
- $1.00 \geq Cp$ and CpK Insufficient process capability

Notes:

- When the number of valid data (except test abnormality and $\pm OF$) is 1, the sampling standard deviation and process capability index are not displayed. When σ_{n-1} is 0, Cp and Cpk are 99.99.
- The upper limit of Cp and CpK is 99.99. When Cp and CpK is > 99.99, it is displayed as 99.99.
- CpK=0 when CpK is negative.

3.3.3 Data loading

The statistical function can load the stored data in USB flash disk, and it must be turned off before loading the data in USB flash disk.

Insert the USB flash disk, display the list of identifiable CSV files on the screen, select the file to be loaded with the up and down direction keys, and click [Enter] to load it. After loading the file, the page jumps to the homepage of statistics, the user can view the measurements and statistical indicators on the statistics page, and the loaded data overwrites the original data.

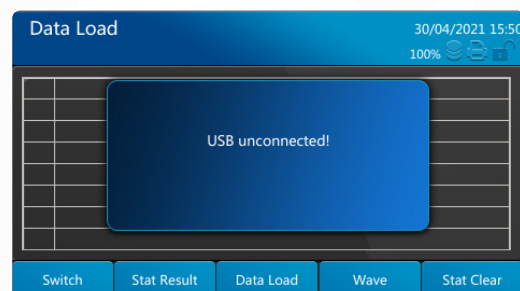

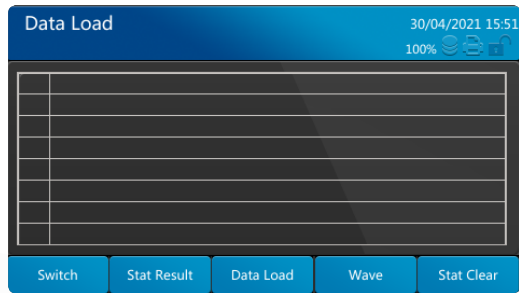

Insert the USB flash disk and identify the file.



Click [Enter] to load the data. It prompts as follows:

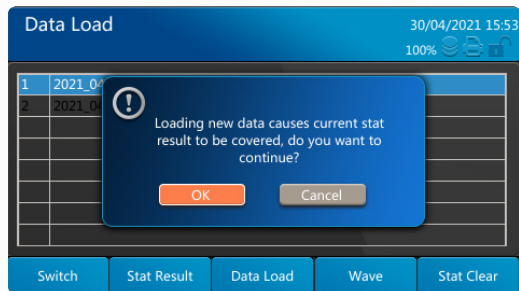

Prompt dialog box of successful loading.

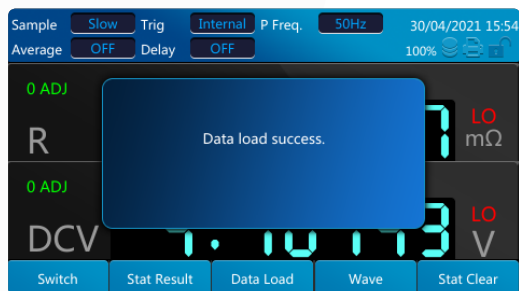

3.3.4 Normal distribution diagram

The statistical resistance and voltage measurements can be generated into a normal distribution diagram. In the main statistics interface, click [F4] to enter the normal distribution diagram interface. X represents the waveform display multiple.

When there is statistical data in the instrument, it is displayed as follows:

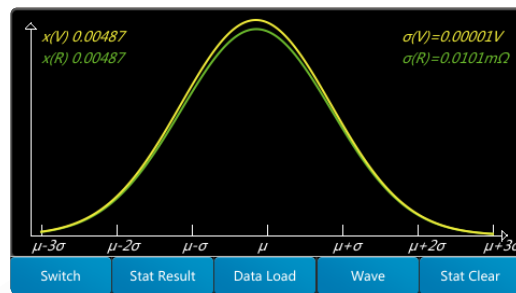

When there is no statistical data, it is displayed as follows:

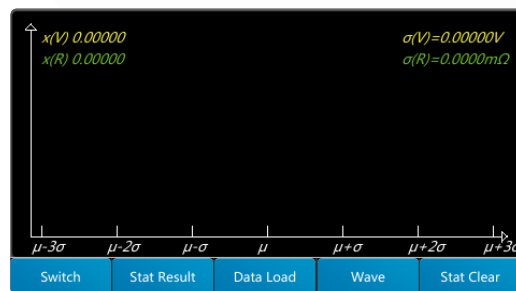

3.3.5 Statistics clearing

Clear local statistical data.

Click [F5] key to clear statistical data, select [Confirm] or [Cancel] with the left and right direction keys, and click [Enter].

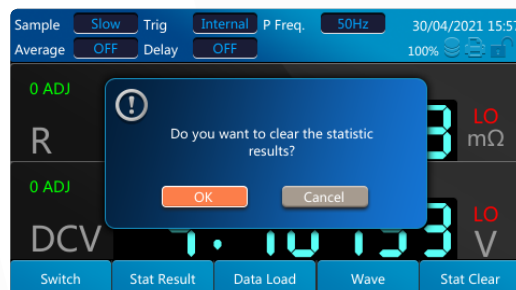

When the number of statistical packets is 1,000, clear the last statistical results and carry out the next statistics. If the number of statistical packets is less than 1,000, continue to carry out statistics following the number of statistical packets last time.

3.4 System Settings

Click [System] key to enter the system settings page. System settings include general settings, configuration settings, communication settings, print settings and other settings.

3.4.1 General settings

General settings include: measurement current pulse output, measurements output, automatic/manual calibration, ERR output asynchronization/synchronization, EOM output, etc.

Take the measurement pulse output as an example to illustrate the setting method of these general settings:

Click [F1] key, the following menu will pop up, and the sub-function settings will be switched and lit every time you click [F1] until [Measurement pulse output] is highlighted.

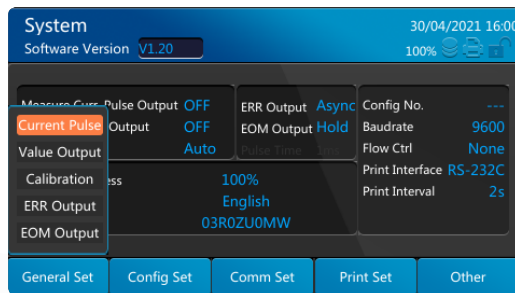

Click [Enter], the submenu will pop up, as shown in the figure below,

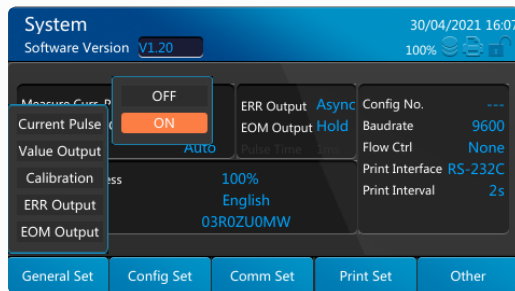

Use the up and down direction keys to select [OFF] and [ON], and finally click [Enter] to complete the settings. Click [Esc] if you want to cancel the settings.

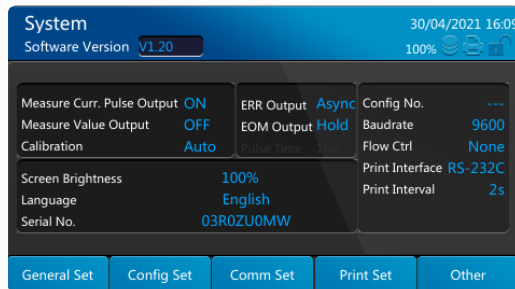

The ON/OFF of measurements output, automatic/manual calibration setting, ERR output asynchronization/synchronization, EOM output, etc. are operated according to this operation mode.

3.4.1.1 About output mode of ERR and EOM

Two output modes of ERR:

Asynchronization: asynchronous with EOM output.

Synchronization: synchronous with EOM output.

Two output modes of EOM:

Hold: hold EOM signal after the measurement is finished.

Pulse: output the established pulse after the measurement is finished.

Important notes on ERR output:

ERR output is used for outputting test abnormality state (open circuit of test line, poor contact, etc.). ERR output includes two output methods.

Synchronous with EOM output (SYNC)	When test abnormality is detected during measurement (excluding waiting trigger state, delay time and operation time), ERR output is performed with the timing sequence of EOM output (measurement end signal). ERR output LOW (ON): correct measurement cannot be made due to test abnormality. ERR output HIGH (OFF): correct measurement can be made. (OF, -OF: including when it is out of range)
Asynchronous with EOM output (ASYNC)	Output test abnormality state (connection state of test line) in real time. Asynchronous with EOM output. ERR output LOW (ON): test abnormality state (open circuit of test line, poor contact, etc.) ERR output HIGH (OFF): no abnormal connection of test line

3.4.2 Configuration settings

Configuration settings include configuration saving, configuration reading and configuration deleting.

Configuration saving	You can save user measurement configuration items, including: measurement function, resistance range, voltage range, delay, delay time, sampling rate, average value, average times, self-calibration, trigger mode, power frequency, comparator, statistical operation function, comparator's judgment of beep, and storage.
Configuration reading	You can read the configuration saved by the user previously.
Configuration deleting	You can delete the configuration saved by the user.

The operation steps of these three configurations are described respectively as follows.

3.4.2.1 Configuration saving

Click [F1] to select [Configuration saving], a dialog box will pop up, requiring the user to input the saved configuration number (the number is the minimum value of unused number by default). The input range is 1~200.

If the input number already exists, you will be prompted, and click "Confirm" to overwrite the original number configuration.

Press [Enter] key to enter the configuration number setting, and fill in the saved number in the input box, which is the minimum number that can be saved by default.

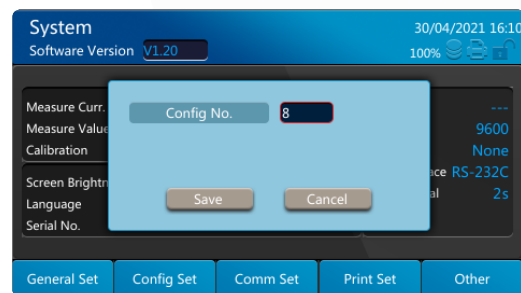

Then press [Enter] key, select [Save] to save the configuration, it will prompt [Save succeeded], and then press [Enter] key to exit the configuration saving page. Select [Cancel] key to cancel saving the configuration.

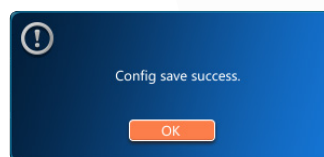

3.4.2.2 Configuration reading

Select [Configuration reading], press [Enter] to enter the dialog box of selecting configuration number, input the number of configuration file to be read, click [Enter] and the [Load] key will be lit. Then use the left and right direction keys to select [Load] or [Cancel].

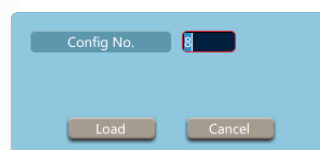

After loading successfully, it prompts as follows:

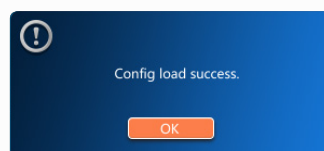

3.4.2.3 Configuration deleting

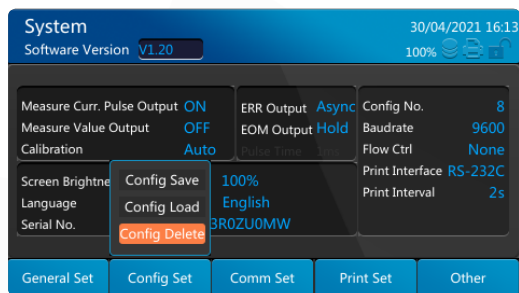

Select [Configuration deleting], the configuration number input box will pop up, fill in the configuration number to be deleted, and click [Enter],

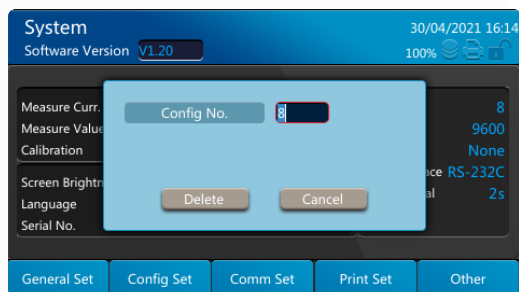

Use the left and right direction keys to select [Delete], and it will prompt as follows. Then click [Enter] key to finish deleting the configuration.

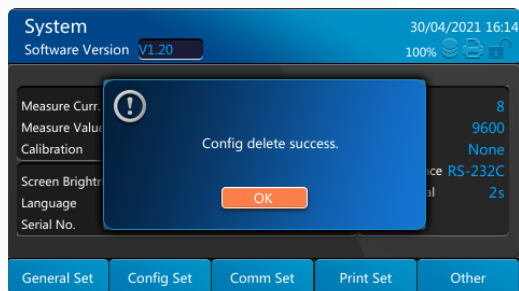

If you click [Cancel], it will exit the configuration deleting and go to the main interface of system settings.

3.4.3 Communication settings

Communication settings include the settings of [Baud rate], [Flow control] and [Network interface].

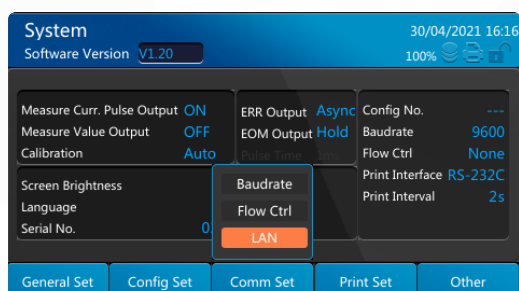

3.4.3.1 Baud rate settings

Use the up and down direction keys or [F3] key to select the baud rate to be used, and press [Enter] key to enter the settings.

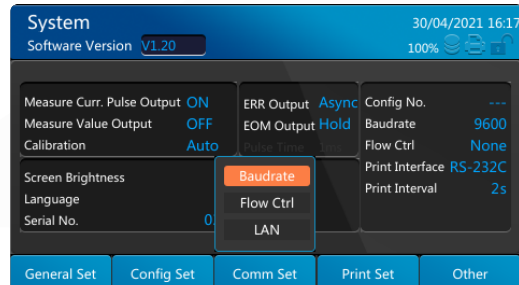

Continue to press [F3] to select the baud rate to be set.

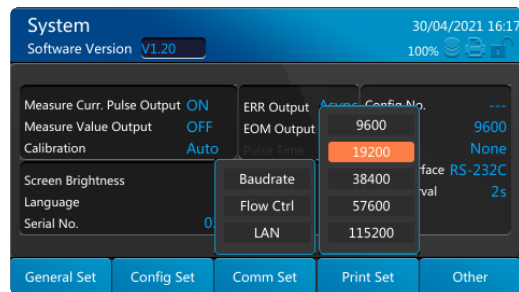

Click [Enter] to complete the setting.

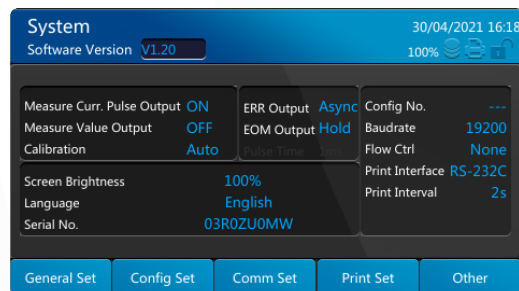

3.4.3.2 Flow control

It has NONE and XON/XOFF, and the default is NONE.

After flow control is selected, the following submenu will pop up. Press the up and down direction keys to select the required [Flow control].

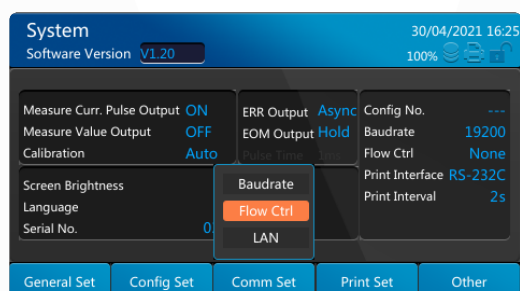

Press [Enter], the flow control submenu will pop up, and press [F3] to select the value.

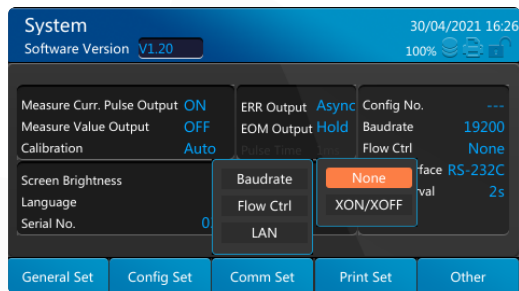

Click [Enter] to complete the setting.

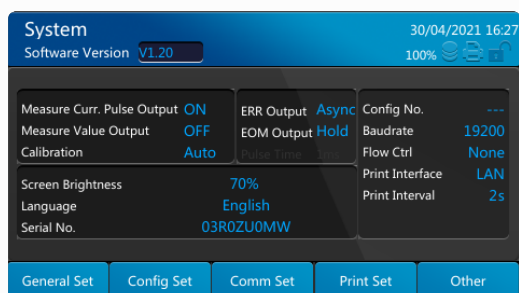

3.4.3.3 Network interface (optional)

Select the network interface and press [Enter] to enter the network interface parameter settings, including: IP mode: manual setting/DHCP, IP address, subnet mask and gateway.

Select [Manual setting] and [DHCP] by pressing the up, down, left and right keys.

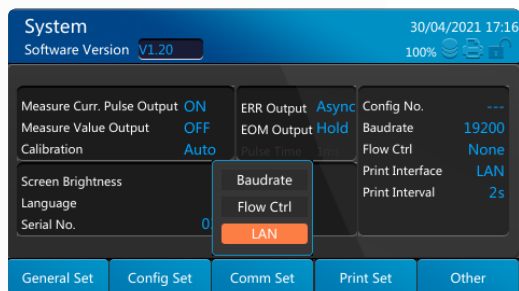

After each input box is selected by pressing the left and right keys, you can edit it by directly inputting the number keys.

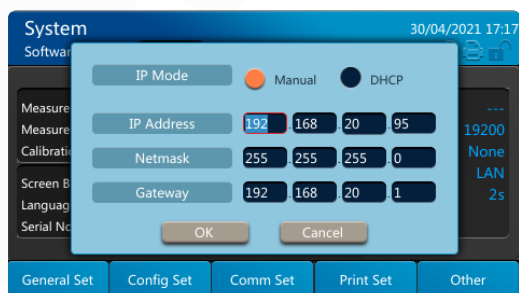

After it is set, press the up and down direction keys to select [Confirm] setting, or select [Cancel] setting, and then click [Enter] to complete the setting.

3.4.4 Print settings

Print settings can set the print interface and print interval.

The print interface can be set to USB, RS-232C and network interface. The printer models that need to be adapted include HP LaserJet P2035 (USB), HP LaserJet Pro MFP M128fp (LAN) and thermal printer (RS-232).

3.4.4.1 Print interface settings

Click [F4] to select [Print interface] and click [Enter], the following submenu will pop up:

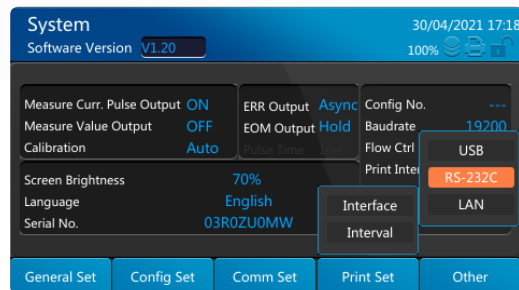

Select [USB] and click [Enter] to complete the setting of print interface as USB.

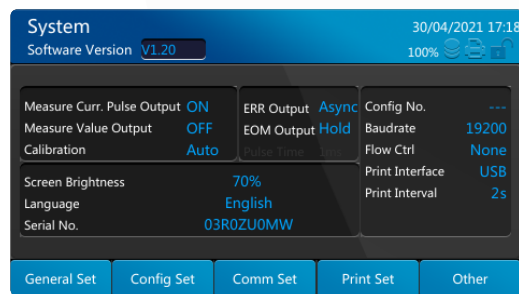

Select [RS-232C] and click [Enter] to complete the setting of print interface as RS-232C.

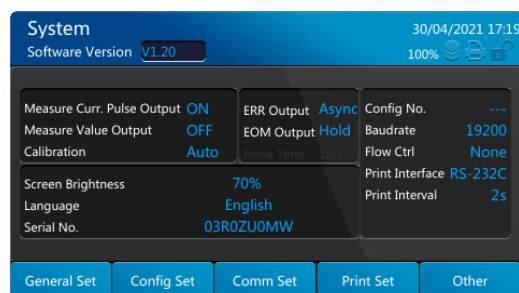

Select [Network interface] and click [Enter] key, the setting of IP address of printer will pop up, and then use the number keys and left and right direction keys.

After IP address is set, use the up and down direction keys to select and confirm, and press [Enter] to save the setting; select [Cancel] and press [Enter] to cancel the setting.



Then the setting of print interface as network interface is completed.

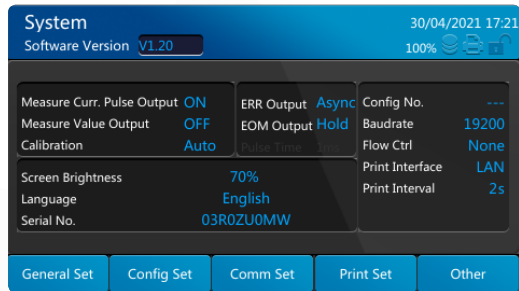

3.4.4.2 Print interval settings

The user can set the interval time for printing data in seconds. The input range is 0-3600, and the default interval is 0.

Note :

- It is manual printing when the value is 0, and one piece of data is printed every time you press [Print] key;
- It is automatic printing when the value is not 0. Press [Print] key to start automatic printing, and press [Print] key again to stop printing.
- During continuous printing, the print interval value cannot be modified

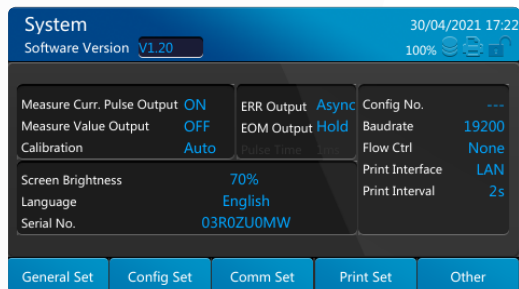
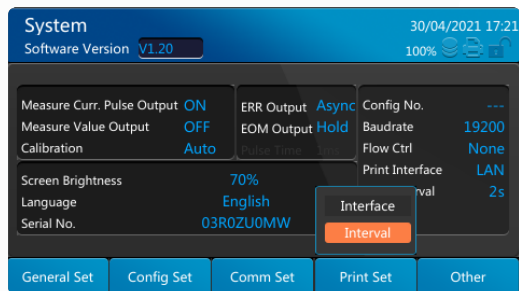

3.4.5 Other

Set [Clock], [Screen brightness], [Language], [Reset] and [Upgrade].

3.4.5.1 Clock

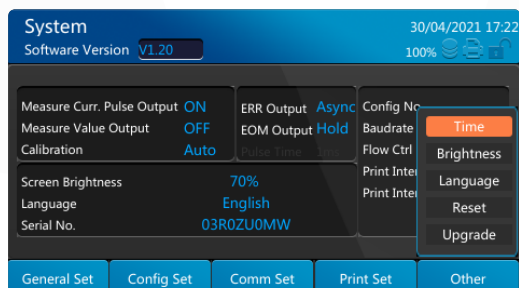

Press [F5] to select [Clock], and click [Enter], the clock setting interface will pop up:

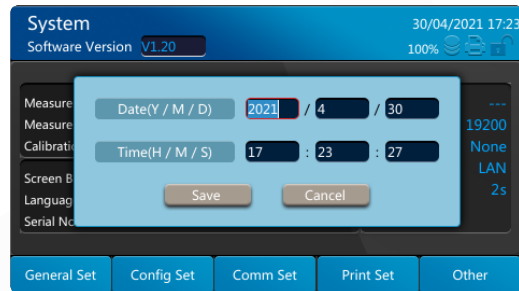

Press the left and right direction keys to switch the input box, and press the up and down direction keys to select settings or [Save] and [Cancel] keys.

After it is set, you must press [Enter] key to confirm, otherwise the setting is invalid;

Notes:

There is leap year information, the year range is 2000~2037, and the default time is 2018-01-01;

Clock setting must meet the time format (24 hours);

The time is displayed in the upper right corner

There is difference between Chinese and English dates, which is Year-Month-Date in Chinese and Date-Month-Year in English.

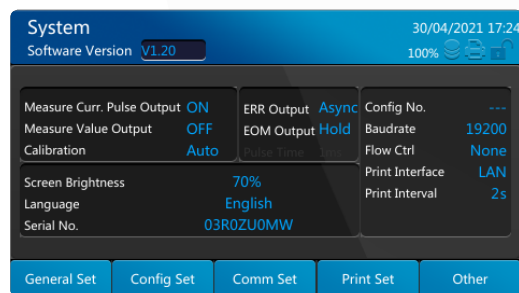

3.4.5.2 Screen brightness

Click [F5] until [Screen brightness] is selected, and click [Enter] to enter the settings.

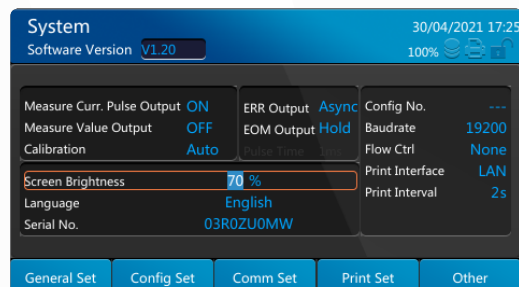

The default is 70%; the adjustment range is 0%-100%. You must press [Enter] key to take effect, otherwise the setting is invalid.

3.4.5.3 Language

Click [F5] until [Language] is selected. Press [Enter] key. Press [F5] or the up and down direction keys to select [English] in the submenu.

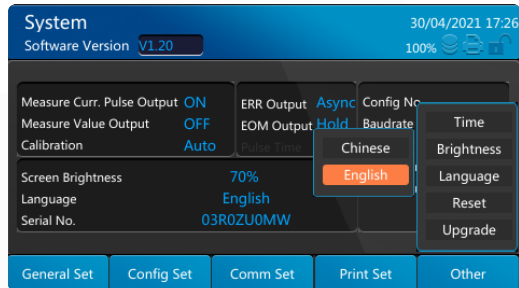

Press [Enter] key, it will prompt [Switching language], and the pop-up box will disappear automatically after successful switching. The the language switching succeeded.

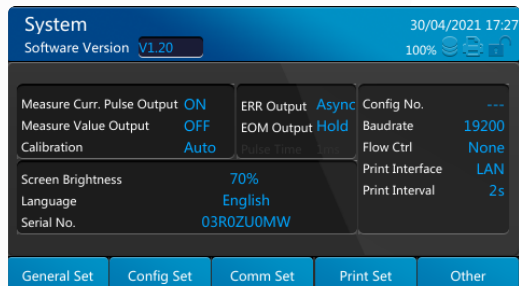
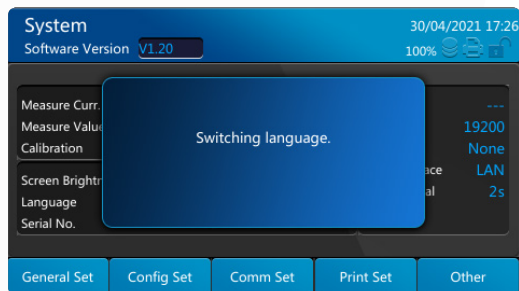

3.4.5.4 Reset

The reset function includes configuration reset and system reset.

Configuration reset: initialize the measurement conditions except the data saved in the panel to the factory state.

System reset: initialize all measurement conditions and data saved in the panel to the factory state.

Click [F5] continuously until [Reset] is selected, click [Enter] to display the following submenu, and then continue to press [F5] to select [Configuration reset] or [System reset].

Select [Configuration reset], the following dialog box will pop up:

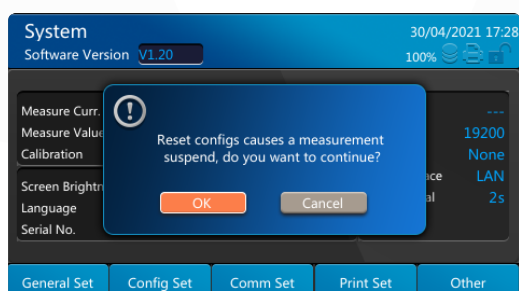

Select [System reset], the following dialog box will pop up. System reset requires clearing local memory, configuration and statistics. System reset also initializes the data saved in the panel:

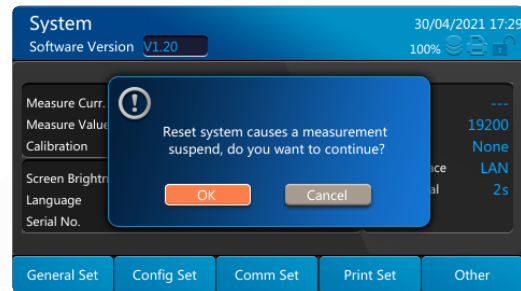

The system is reset to the initial factory settings:

Item	Initial value
Measurement function	ΩV
Resistance range	AUTO
Voltage range	AUTO
Delay	OFF
Delay time	0
Sampling rate	SLOW
Average value	ON
Average times	2
Calibration	AUTO
Trigger	INT
Power frequency	AUTO
Key sound	ON
Key locking	OFF
Comparator	OFF
Comparison mode	AUTO
Comparison way	Upper and lower limits
Upper and lower limits	0
Statistical operation function	OFF
Measurement current pulse output	OFF
Absolute value judgment function	ON
Measurements output	OFF
Beep sound judged by comparator	HL
Screen brightness	70%
ERR output mode	Async
EOM mode	Hold
Storage	OFF
Storage path	Local

Storage format	csv
Print interface	RS232
RS232 rate	9600
Flow control	NONE
Print interval	0
Configuration number	[---]

Configuration reset:

Item	Initial value
Measurement function	Ω V
Resistance range	AUTO
Voltage range	AUTO
Delay	OFF
Delay time	0
Sampling rate	SLOW
Average value	ON
Average times	2
Self-calibration	AUTO
Trigger method	INT
Power frequency	AUTO
Comparator	OFF
Statistical operation function	OFF
Beep sound judged by comparator	HL
Storage	OFF

3.4.5.5 Upgrade

Copy the upgrade package to USB flash disk and insert it into USB port. Click "Upgrade".

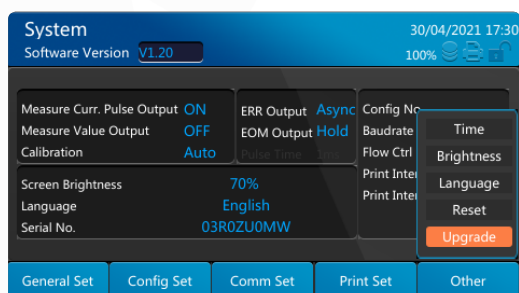

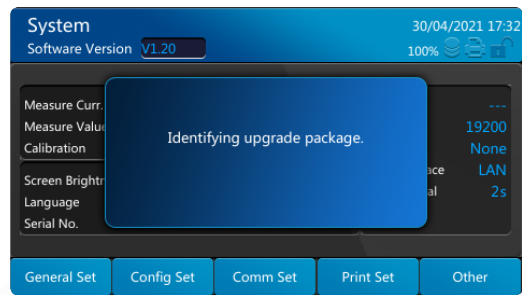

After identifying the upgrade version, it will prompt as follows:

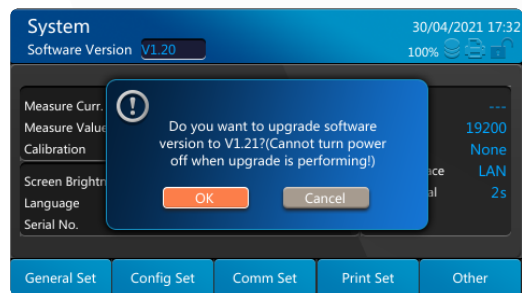

Select [Confirm] and click [Enter] to start upgrade operation.

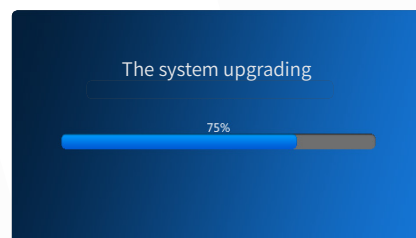
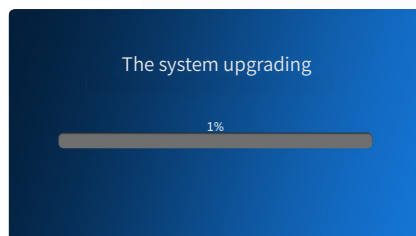

Upgrade to 100% and restart the system.

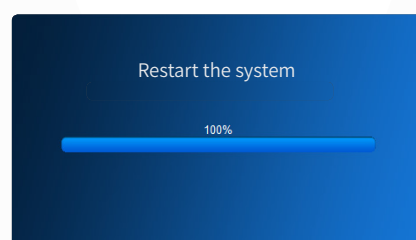

After the restart is completed, the upgrade is successful.

If it fails during upgrade process, the system will automatically roll back to the original version. If multiple attempts to upgrade failed, please check whether the upgrade package is complete or contact customer service.

3.5 Storage Function

The storage function can store the measurement data to the local internal memory or USB memory. Click [Save] key, the storage function menu will pop up. The storage functions include [Storage ON/OFF], [Storage path], [Storage format], [Storage transfer] and [Storage clear] options. The menu is as follows:



After all storage options are set, select ON and the storage settings will take effect. When the storage function is turned on, the storage settings cannot be modified.

3.5.1.1 Storage path

Storage path includes [Local] and [USB]. The default path is [Local], which can be set to [USB] path when USB is already connected. Otherwise, [USB] path cannot be selected.

Click [F2] key continuously to select [Local], and click [Enter] to complete the setting of storage path as local.



Insert the USB flash disk, click [F2X] key continuously to select [USB], and click [Enter] to complete the setting of storage path as USB.



3.5.1.2 Storage format

There are two storage formats: [.csv] and [.mat], and the default format is [.csv].

On the storage page, press [F3] continuously until [.csv] is selected, and then click [Enter] to complete the setting of storage format as [.csv].



On the storage page, press [F3] continuously until [.mat] is selected, and then click [Enter] to complete the setting of storage format as [.mat].



3.5.1.3 Storage transfer

Transfer the data stored in the internal memory of this machine to USB flash disk. USB flash disk must be inserted before storage transfer. If the USB flash disk is not inserted, it will prompt as follows:

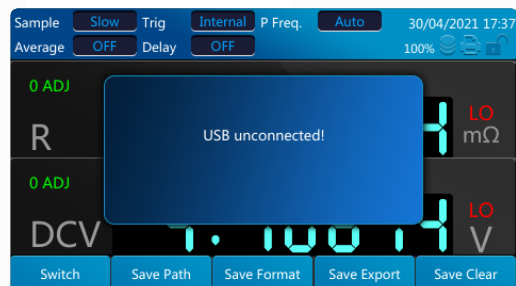

After inserting the USB flash disk, click [F4] to select data transfer format, and click [Enter] to confirm:

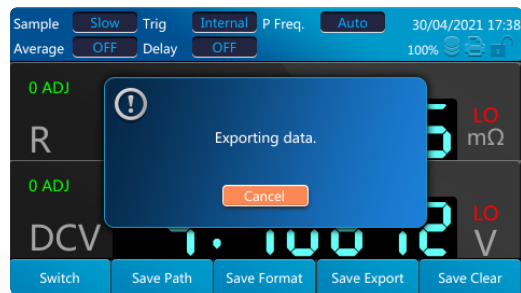

After the transfer succeeded, it will prompt [Transfer succeeded], and the prompt will disappear after 2s.

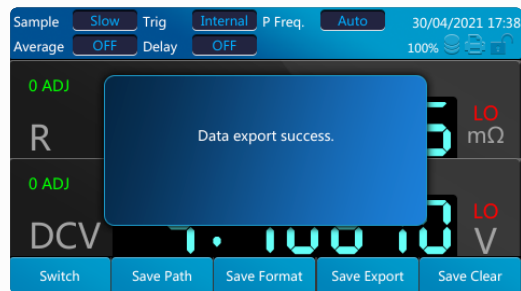

After the transfer fails, it will prompt the user [Transfer failed, please check the memory of USB flash disk]. The transfer steps of [.mat] files is the same as that of [.csv] files.

3.5.1.4 Memory clearance

Clear the data stored in the internal memory of the unit.

Click [F5] a confirmation prompt box will pop up:

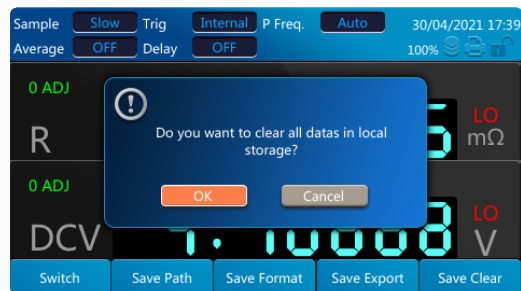

Click [Enter] to select [Confirm] or [Cancel].

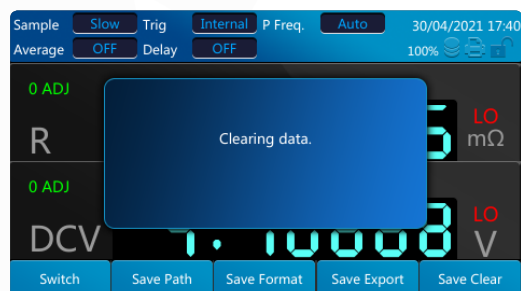

It will disappear in 2s.

3.5.1.5 Memory ON/OFF

Click [F1] to switch the memory function ON/OFF, and then click [Enter] to complete the setting of ON/OFF.



3.6 Key Lock Function

Key lock function can lock the keys, and the operating keys on the front of the host become inoperable, which can protect the setting content.

Press [Lock] key to lock the keys, and press and hold it for more than 1s to cancel the lock.

Other keys are invalid during the key lock period (except Power). After shutdown and restart, the key lock is still valid.

Press [Lock] key, and the lock on the page is shown as below:



Press and hold for more than 1s to unlock, and the interface is displayed as follows:



3.7 Key Sound (Beep)

Press the [Beep] button once to turn off the key sound, and then press it once again to turn on the key sound. There is no sound when clicking the button to turn off, but there is sound when clicking the button to turn on.

Key sound is turned on by default.

3.8 Power Key

It is colorless in the OFF state, red in the standby state and green in the ON state.
Press and hold the power key for more than 1s to power on and power off.

3.9 Zero Setting

In order to eliminate errors caused by the bias voltage of instrument itself or the measurement environment, perform zero setting before measurement.

Before testing, it is necessary to perform zero setting of the instrument. Before zero setting, use correct method to cause short circuit of the test line and perform zero setting.



Press and hold the [0 ADJ] button for more than 1s to clear the zero setting.
After zero setting, the prompt box of zero setting results for all range gears will pop up,
It will disappear after pressing "Enter" key to confirm



Notes:

- The range of zero setting is less than or equal to $\pm 1,000$ dgt of each range.
- Zero setting will be executed for all ranges.
- Even if the power supply is switched of, and the compensation value after zero setting will continue to be maintained.
- Zero setting can be executed on the 0ADJ terminal of EXT I/O.

3.10 Trig Key

Press this key for manual trigger, and the measurement will be triggered every time the key is pressed.

3.11 Local Key

Use [Local] to switch remote control to local control. During remote control, the user will be prompted as [under remote control] when operating the interface, and the prompt will disappear in 2s.

3.12 Clear Key

Use [Clear] key to clear the input.

3.13 ESC Key

Use [ESC] key to return or cancel the current operation. Cancel the input/pop-up box/submenu/menu to return to the measurement interface.

Chapter IV External Control (EXT I/O) (option)

The EXT I/O interface provides external output and external control functions. Please read the precautions when connecting.

Warning : In order to prevent electric shock and instrument failure, please observe the following instructions when connecting the wiring of EXT I/O connector.

- Please cut off the power supply of the instrument and the instrument to be connected before connecting it.
- If the wiring is disconnected during operation, it may come into contact with other conductive parts, which is very dangerous.
- Please fix the external connector reliably with screws.
- Please make proper insulation for the instrument and device connected to EXT I/O connector.

NOTES :

- Do not input voltage or current above the rated value to EXT I/O connector.
- Be sure to install freewheel diodes when using relays.
- Do not cause short circuit of ISO_5V and ISO_COM.

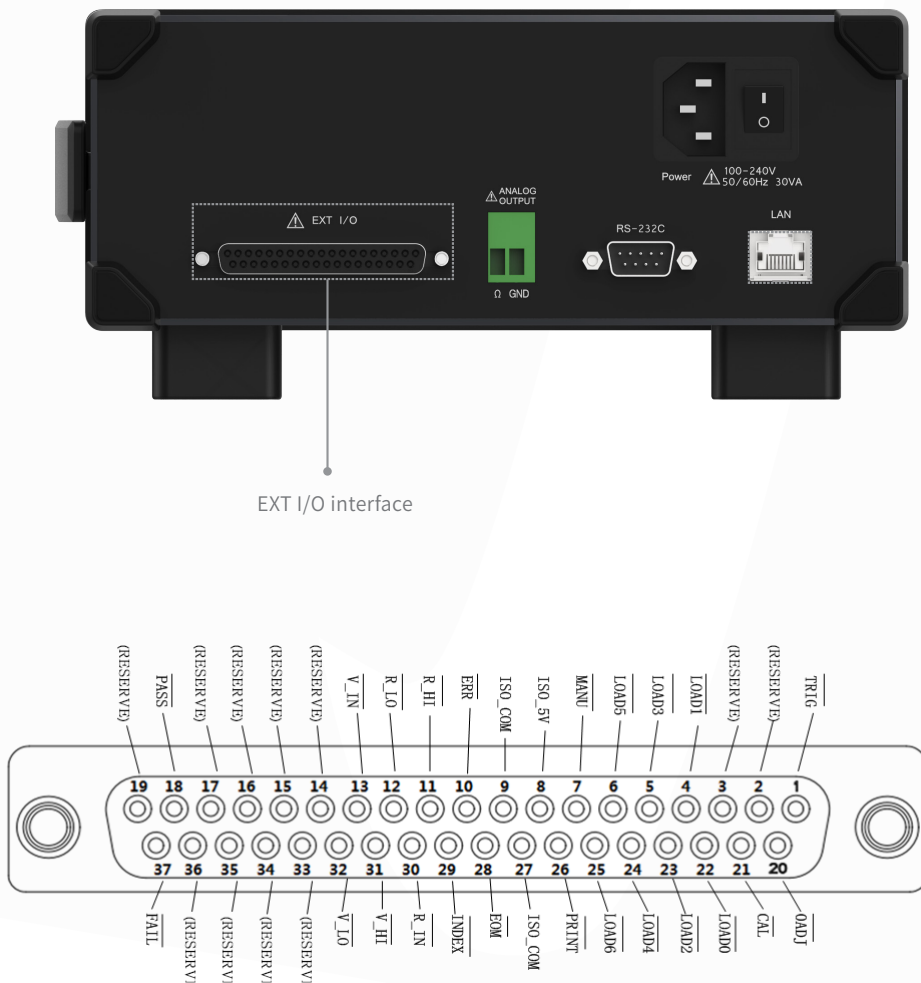

Pin No.	Signal name	I/O	Function	Logic	
1	$\overline{\text{TRIG}}$	IN	External trigger	Negative	Edge
2	(RESERVE)	IN	—	—	—
3	(RESERVE)	IN	—	—	—
4	$\overline{\text{LOAD1}}$	IN	Read the number Bit1	Negative	Level
5	$\overline{\text{LOAD3}}$	IN	Read the number Bit3	Negative	Level
6	$\overline{\text{LOAD5}}$	IN	Read the number Bit5	Negative	Level
7	$\overline{\text{MANU}}$	IN	Manual control of comparator	Negative	Level
8	ISO_5V	—	5V output of insulated power supply	—	—
9	ISO_COM	—	Common terminal of insulated power supply	—	—
10	$\overline{\text{ERR}}$	OUT	Test abnormality	Negative	Level
11	$\overline{\text{R_HI}}$	OUT	Resistance judgment result HI	Negative	Level
12	$\overline{\text{R_LO}}$	OUT	Resistance judgment result Lo	Negative	Level
13	$\overline{\text{V_IN}}$	OUT	Voltage judgment result IN	Negative	Level
14	(RESERVE)	OUT	—	—	—
15	(RESERVE)	OUT	—	—	—
16	(RESERVE)	OUT	—	—	—
17	(RESERVE)	OUT	—	—	—
18	$\overline{\text{PASS}}$	OUT	Judgment result PASS	Negative	Level
19	(RESERVE)	OUT	—	—	—
20	$\overline{\text{0ADJ}}$	IN	Zero setting	Negative	Edge
21	$\overline{\text{CAL}}$	IN	Execute self-calibration	Negative	Edge
22	$\overline{\text{LOAD0}}$	IN	Read the number Bit0	Negative	Level
23	$\overline{\text{LOAD2}}$	IN	Read the number Bit2	Negative	Level
24	$\overline{\text{LOAD4}}$	IN	Read the number Bit4	Negative	Level
25	$\overline{\text{LOAD6}}$	IN	Read the number Bit6	Negative	Level
26	$\overline{\text{PRINT}}$	IN	Measurements printing	Negative	Edge
27	ISO_COM	—	Common terminal of insulated power supply	—	—
28	$\overline{\text{EOM}}$	OUT	End of measurement	Negative	Edge
29	$\overline{\text{INDEX}}$	OUT	Measurement reference signal	Negative	Level
30	$\overline{\text{R_IN}}$	OUT	Resistance judgment result IN	Negative	Level
31	$\overline{\text{V_HI}}$	OUT	Voltage judgment result Hi	Negative	Level
32	$\overline{\text{V_LO}}$	OUT	Voltage judgment result	Negative	Level
33	(RESERVE)	OUT	—	—	—
34	(RESERVE)	OUT	—	—	—
35	(RESERVE)	OUT	—	—	—
36	(RESERVE)	OUT	—	—	—
37	$\overline{\text{FAIL}}$	OUT	Judgment result FAIL	Negative	Level

NOTES:

The housing of connector is connected to the housing (metal part) of the instrument, and is also connected (conducted) to the protective grounding terminal of power socket. Please note that it is not insulated from the grounding wire.

4.1 Input terminal function

- $\overline{\text{TRIG}}$

External trigger input. When the trigger source is set to be external and when $\overline{\text{TRIG}}$ signal changes from high level to low level, measurement is triggered once at the jumping edge. When internally triggered, the measurement cannot be triggered.

- $\overline{\text{LOAD0}}\sim\overline{\text{LOAD6}}$

It is used for the selected panel display number for the external input. After the number is selected, input $\overline{\text{TRIG}}$ signal, and the equipment reads in the configuration corresponding to the selected panel display number for measurement. If the number value does not change when $\overline{\text{TRIG}}$ is input, measurement is executed once when external trigger is executed.

- $\overline{\text{0ADJ}}$

Zero setting function controlled by external input. When the signal changes from high level to low level, the application program is triggered to execute the zero setting function once in the form of interrupt.

- $\overline{\text{PRINT}}$

Print function controlled by external input. When the signal changes from high level to low level, the application program is triggered to execute the print function once in the form of interrupt.

- $\overline{\text{CAL}}$

Calibration function controlled by external input. When the signal changes from high level to low level, the application program is triggered to execute the calibration function once in the form of interrupt.

- $\overline{\text{MANU}}$

Comparator function controlled by external input, which is high level by default. When the level changes (high to low or low to high), the application program is triggered to read the current level state in the form of interrupt. If the interrupt is generated and it is low level, the comparator function is turned on; if it is high level, the comparator function is turned off.

4.2 Output terminal function

- $\overline{\text{EOM}}$

End of measurement signal, which is divided into HOLD mode and PULSE mode. In the external trigger mode, HOLD mode keeps EOM at low level after the end of measurement and till the beginning of next measurement (when external trigger is generated) and then restores high level, while PULSE mode outputs low level pulse with a configurable width and then restores high level state; in the internal trigger mode, HOLD mode outputs low level pulse with a fixed width according to the measurement mode after the end of measurement, and then restores high level state, while PULSE mode outputs low level pulse with a configurable width and then restores high level state.

- $\overline{\text{INDEX}}$

Measurement process index signal. Output INDEX signal is at low level in waiting trigger state, delay state, self-calibration state and operation state. Output signal is at high level in range configuration state, data acquisition state and data transmission and operation state, and the test object can be removed when the signal changes from high to low level.

- $\overline{\text{ERR}}$

Measurement abnormality output signal, which is divided into two modes: synchronous output and asynchronous output. In synchronous output mode, ERR state and EOM are output synchronously, and ERR state is judged to be valid when EOM output is at low level; in asynchronous output mode, ERR state is updated in real time and has no synchronous timing relationship with EOM.

- $\overline{\text{R_HI}}$, $\overline{\text{R_IN}}$, $\overline{\text{R_LO}}$, $\overline{\text{V_HI}}$, $\overline{\text{V_IN}}$, $\overline{\text{V_LO}}$, $\overline{\text{PASS}}$, $\overline{\text{FAIL}}$

Comparator function output results. R-Hi, R-IN, R-Lo, V-Hi, V-IN and V-Lo represent the comparison results of resistance and voltage respectively. There are different judgment conditions for PASS signal according to different measurement modes. In resistance voltage mode, when the resistance comparison result is R-IN and the voltage is V-IN, PASS is at low level; in resistance mode, when the comparison result is R-IN, PASS is at low level; in voltage mode, when the comparison result is V-IN, PASS is at low level. When FAIL signal is a PASS signal, the logic shall be inverse output.

4.3 Functional port timing

4.3.1 ERR output function timing

ERR output is divided into two modes: synchronous and asynchronous. In synchronous mode, ERR state is synchronized with EOM output, i.e. ERR state is valid when EOM is at low level; in asynchronous mode, ERR state is updated in real time, and there is no fixed timing relationship with EOM or TRIG signal. The timing diagram is as shown below.

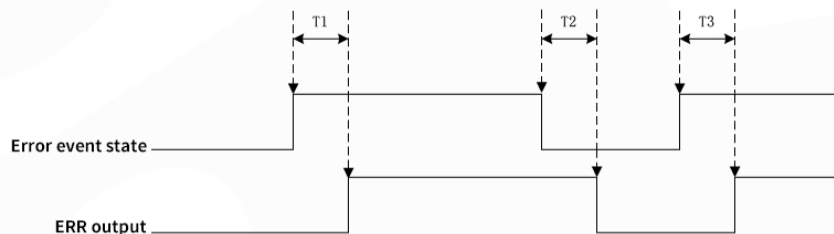

ERR asynchronous output timing

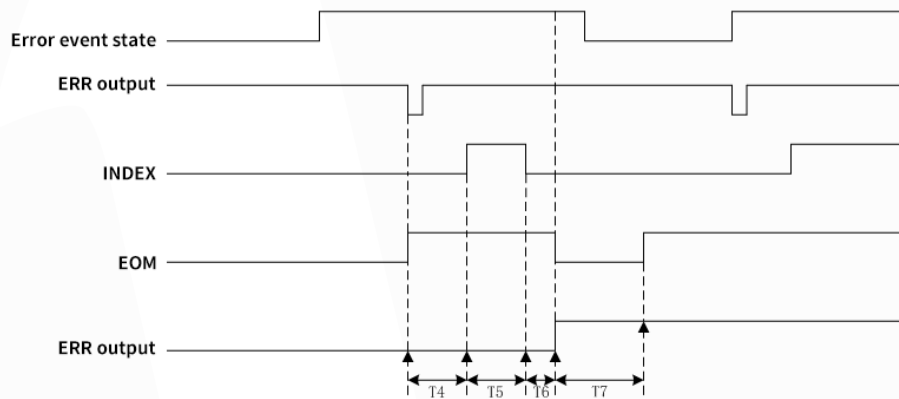

ERR synchronous output timing

In the timing diagram, T1, T2 and T3 represent that the state is output delay from error event to ERR output port in ERR asynchronous output mode. The time is introduced by the application program from responding to error event interruption to configuring ERR port output, which has been measured to be correct, and there is no time accuracy requirement; in the example, the asynchronous output timing is configured as external trigger, EOM is set to PULSE mode, T4 is trigger delay, T5 is measurement time, T6 is calculation time, and T7 is EOM pulse output width. It can be seen from the figure that the ERR output outputs the error event state in synchronization with EOM and keeps it until the EOM output is measured next time to update the error state.

4.3.2 EOM external trigger mode function timing

EOM external trigger includes external TRIG trigger and key trigger. The working mode can be set to HOLD mode and PULSE mode, and the timing is as shown in figure below.

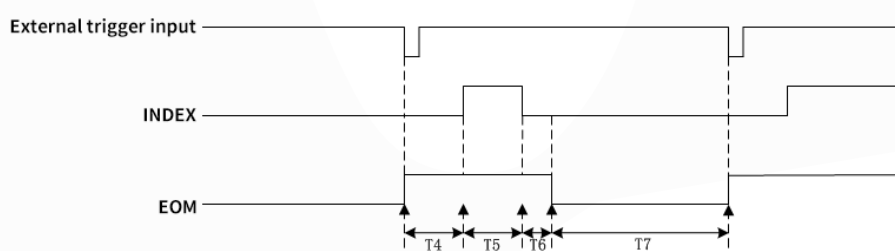

Output timing in HOLD mode

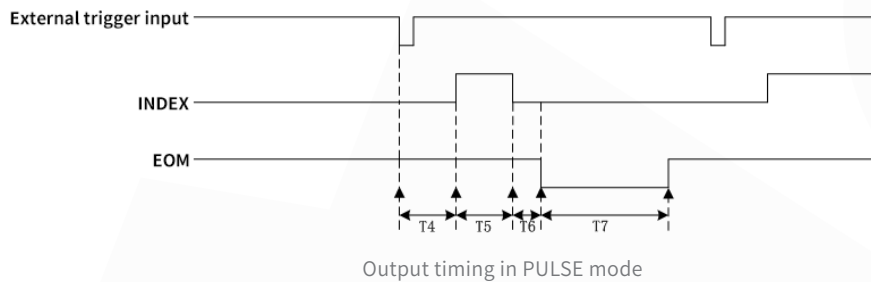

HOLD mode outputs EOM after calculation is completed and cancels EOM until the next trigger is generated; PULSE mode outputs EOM after calculation is completed, and cancels EOM after keeping the set pulse width time. Time parameters are shown in the following table.

Content	Description	Function	Measuring mode	Time
T4	Trigger delay	$\Omega V/\Omega/V$	FAST/MEDIUM/SLOW	Trigger delay setting
T5	Measurement time	Ω or V	FAST	36ms
			MEDIUM	55ms
			SLOW	240ms
		ΩV	FAST	72ms
			MEDIUM	110ms
			SLOW	372ms
T6	Computing time (sensitivity function)	$\Omega V/\Omega/V$	FAST/MEDIUM/SLOW	About 10ms
T7	EOM pulse width	$\Omega V/\Omega/V$	FAST/MEDIUM/SLOW	HOLD mode differs according to trigger interval; PULSE mode is according to user settings

4.3.3 EOM internal trigger mode function timing

The EOM internal trigger working mode can be set to HOLD mode and PULSE mode, and the timing is as shown in figure below.

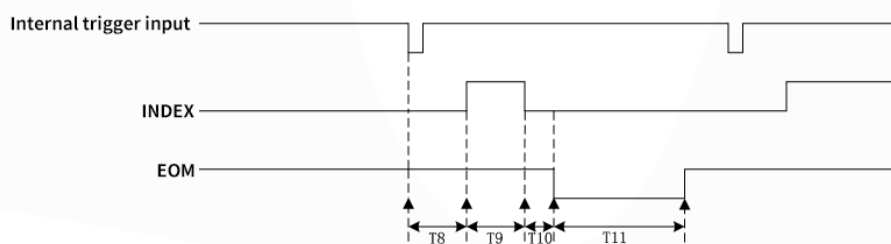

HOLD mode outputs EOM width and measurement mode after calculation is completed; PULSE mode outputs EOM after calculation is completed, and cancels EOM after keeping the set pulse width time. Time parameters are shown in the following table.

Content	Description	Function	Measuring mode	Time
T8	Trigger delay	Ω V/ Ω /V	FAST/MEDIUM/SLOW	Trigger delay setting
T9	Measurement time	Ω or V	FAST	36ms
			MEDIUM	55ms
			SLOW	240ms
		Ω V	FAST	72ms
			MEDIUM	110ms
			SLOW	372ms
T10	Computing time (sensitivity function)	Ω V/ Ω /V	FAST/MEDIUM/SLOW	About 10ms
T11	EOM pulse width	Ω V/ Ω /V	FAST	5ms in HOLD mode; PULSE mode is according to user settings
			MEDIUM	20ms/50Hz and 16ms/60Hz in HOLD mode; PULSE mode is according to user settings
			SLOW	50ms in HOLD mode;
				PULSE mode is according to user settings

NOTES: :

- I/O signal cannot be used when changing measurement conditions inside the instrument.
The EOM signal and INDEX signal are initialized to HIGH (OFF) when the power supply is turned on.
- Please fix LOAD0~LOAD6 as Hi or Lo when it is not necessary to switch measurement conditions.
- In order to avoid wrong judgment, please confirm the judgment of comparator by both the PASS and FAIL signals.

4.4 Composition of internal circuit

Input circuit

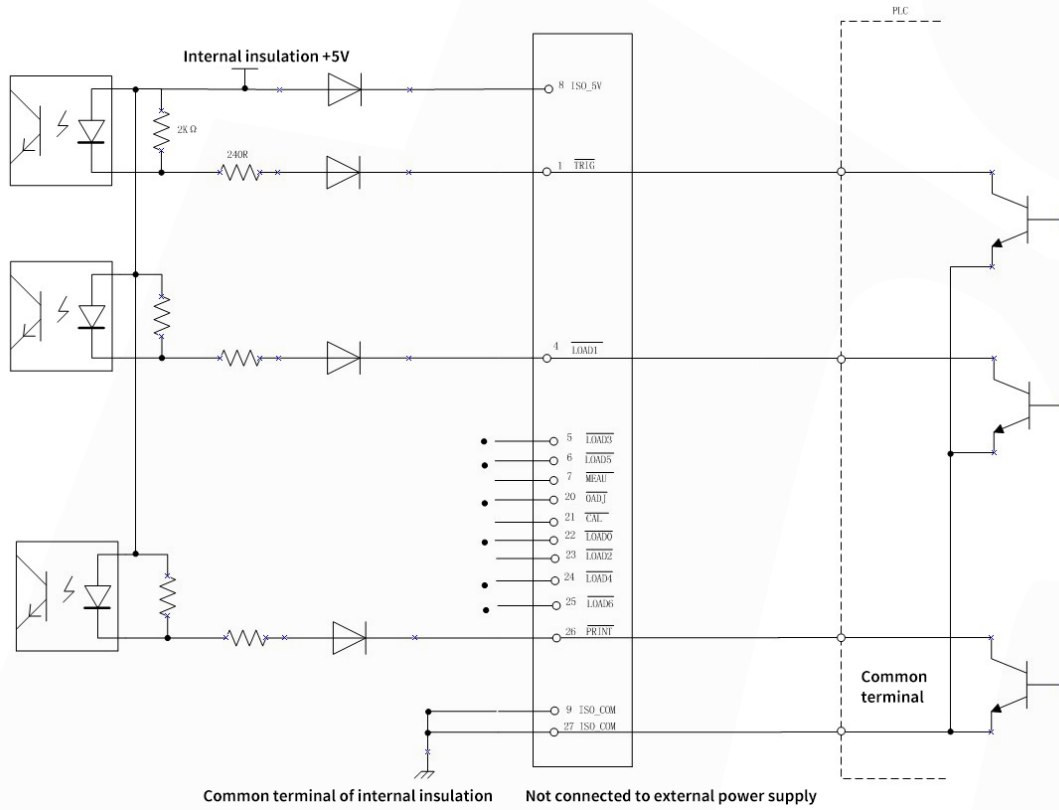

Output circuit

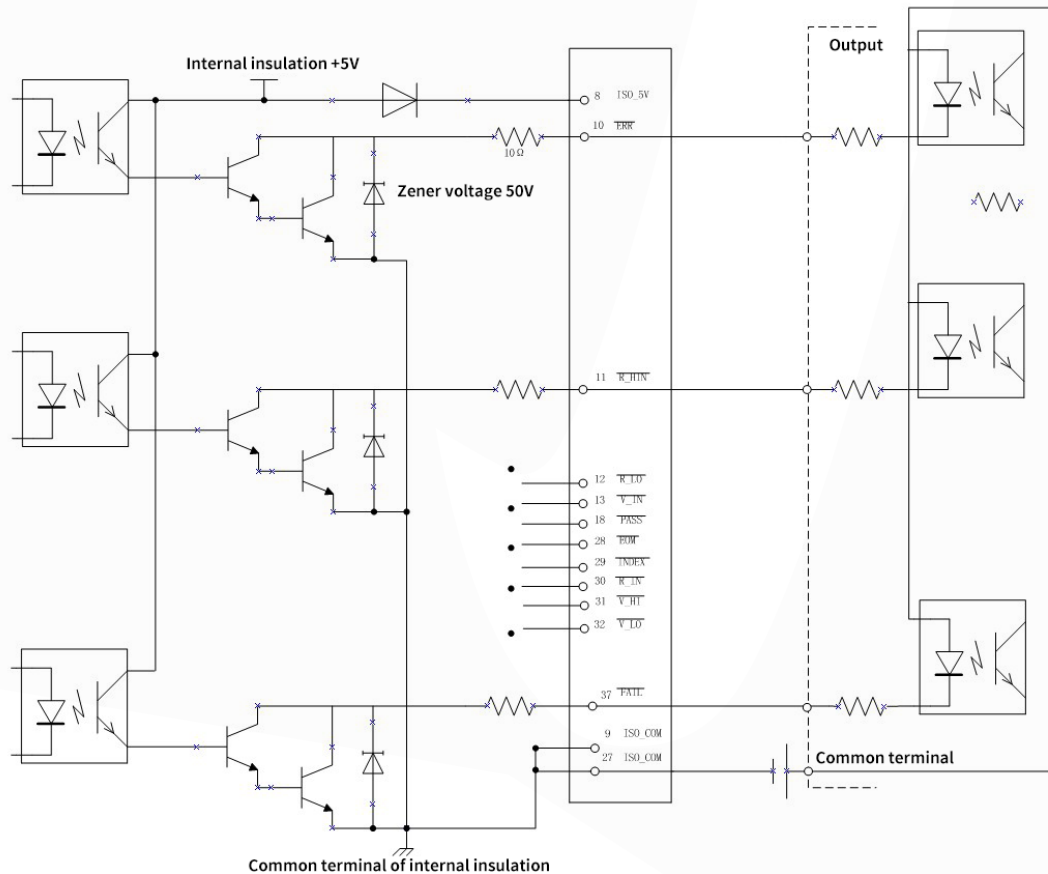

Electrical specifications

Input signal	Input format	Photocoupler insulation no-voltage node input (corresponding to consumption current output), negative logic
	Input ON voltage	Below 1V
	Input OFF voltage	OPEN or 5-30 V
	Input ON current	20mA
	Maximum applied voltage	30V
Output signal	Output format	Photocoupler insulation NPN open-collector output (consumption current), negative logic
	Maximum load voltage	30V
	Maximum Output Current	50mA/ch
	Residual voltage	1V (10mA) 1.5V(50mA)
Built-in insulated power	Output voltage	4.8-5.2V
	Maximum Output Current	1.1A
	External power input	None

Connection example

Connection example of input circuit

- Connection with switch

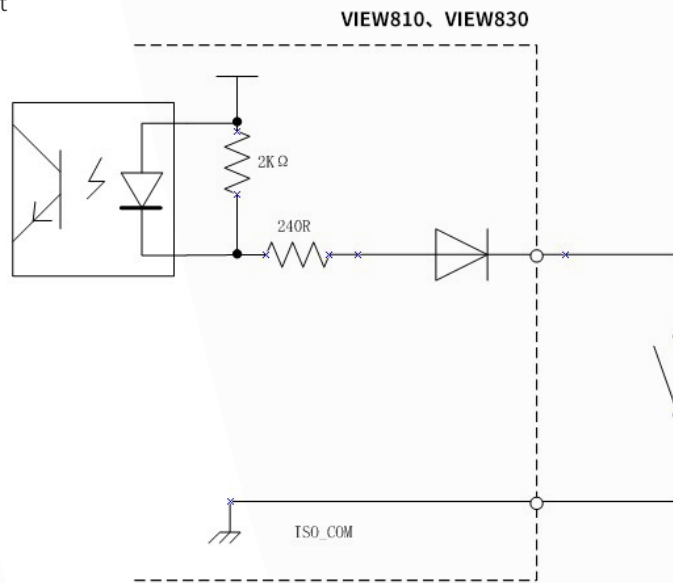

- Connection with relay

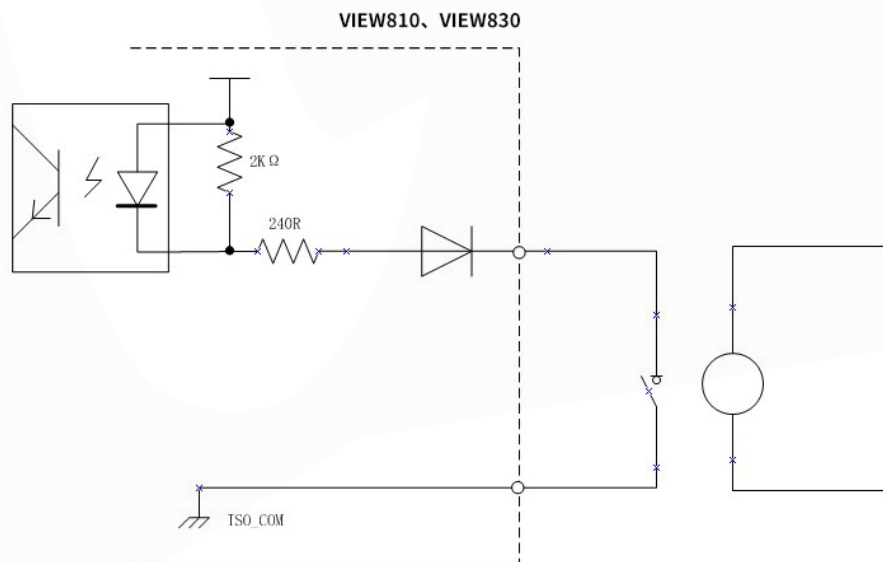

· Connection with PLC (negative common terminal output)

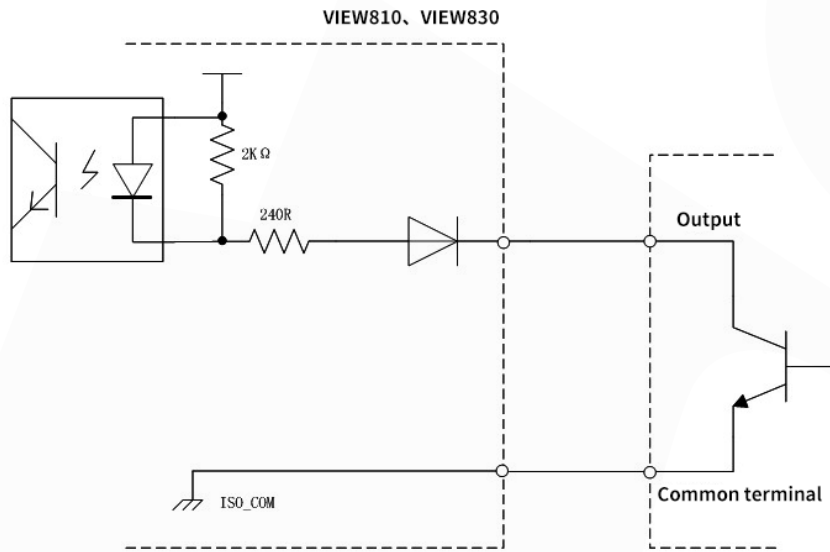

· Connection with PLC (positive common terminal output)

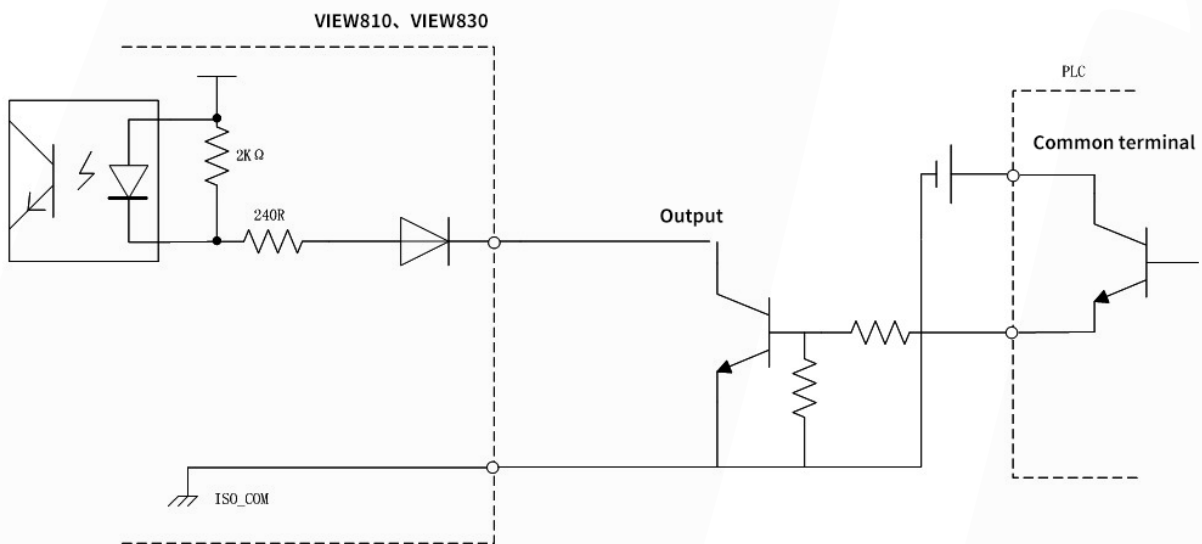

Connection example of output circuit

· Connection with relay

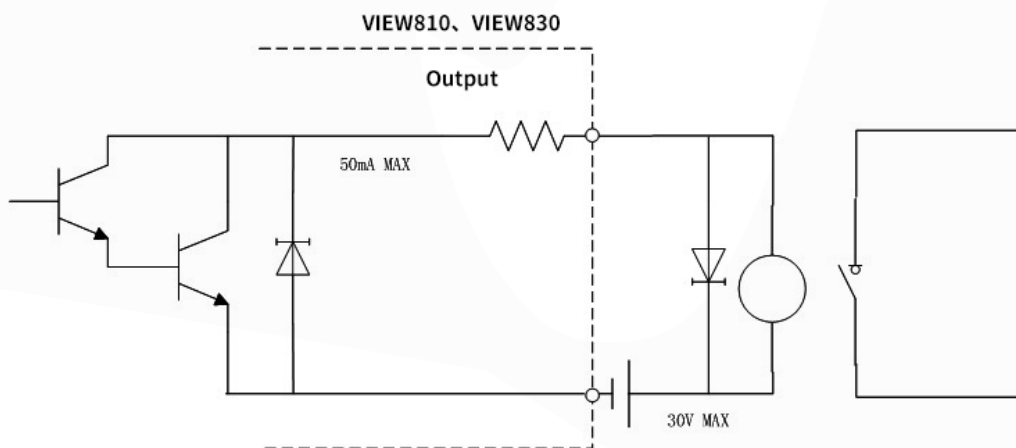

· Connection with LED

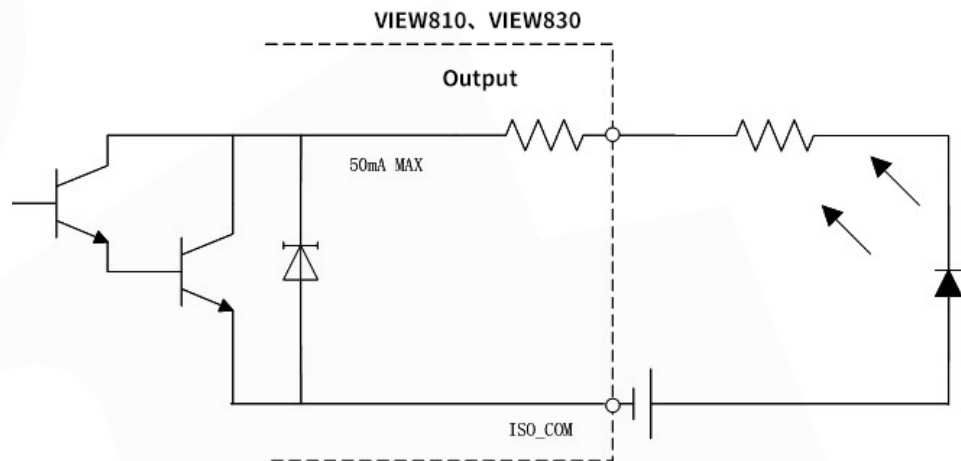

· Negative logic output

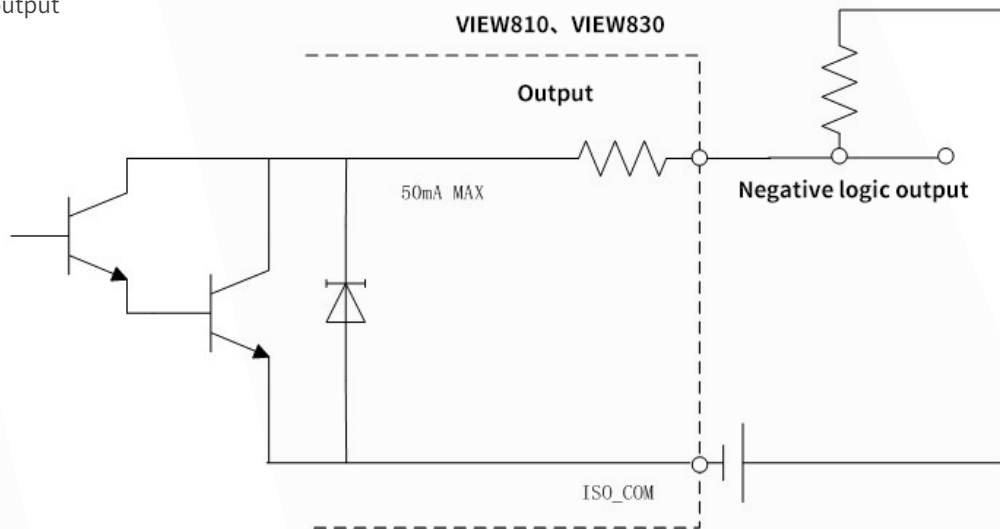

· WIRED OR

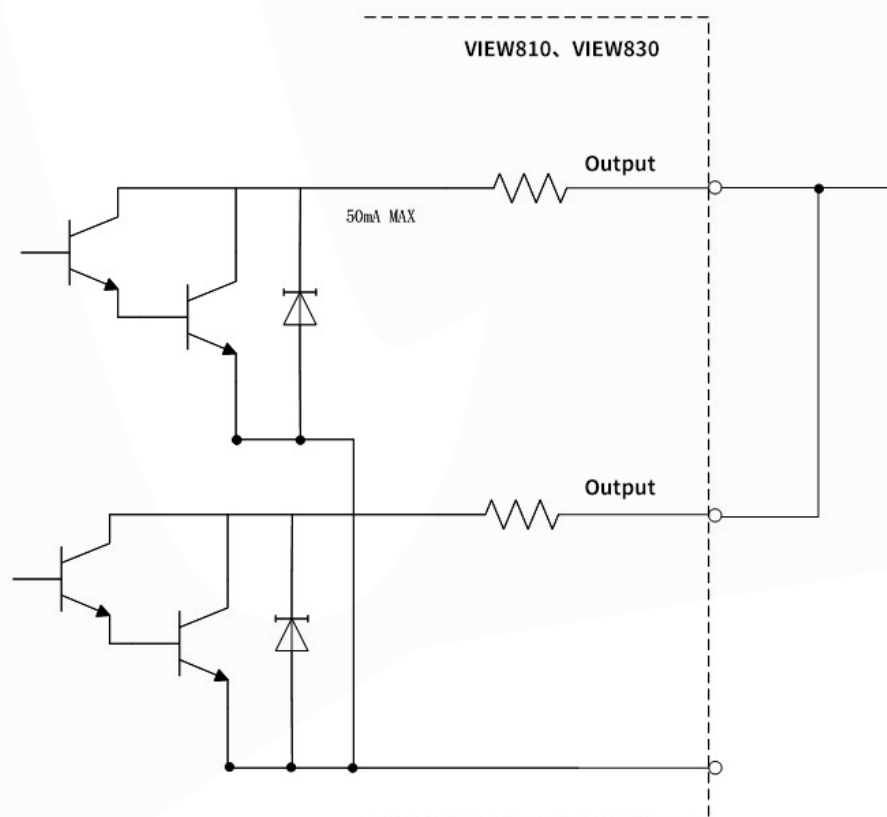

- Connection with PLC input (negative common terminal output)

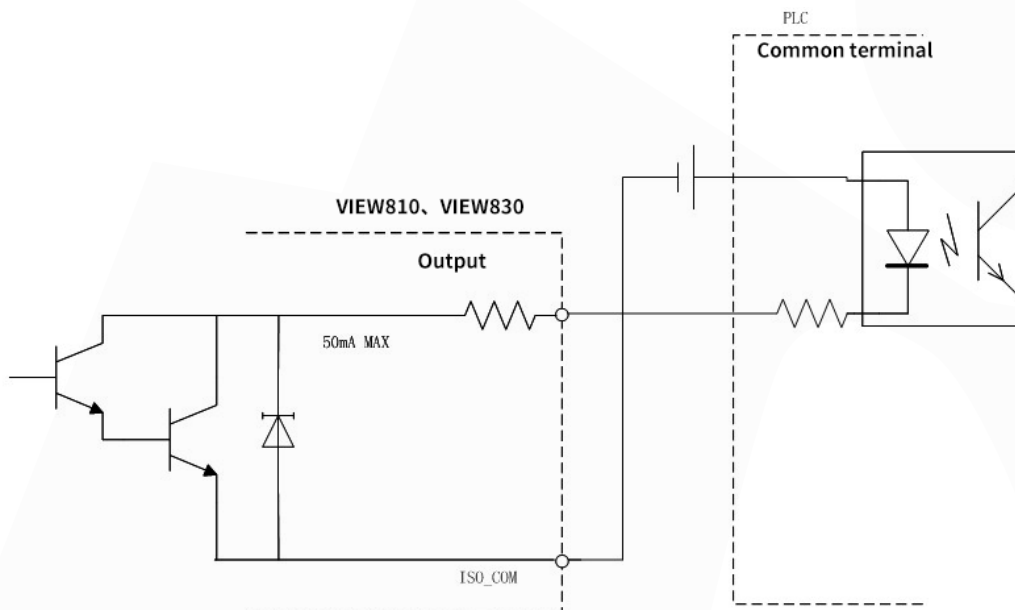

- Connection with PLC input (positive common terminal output)

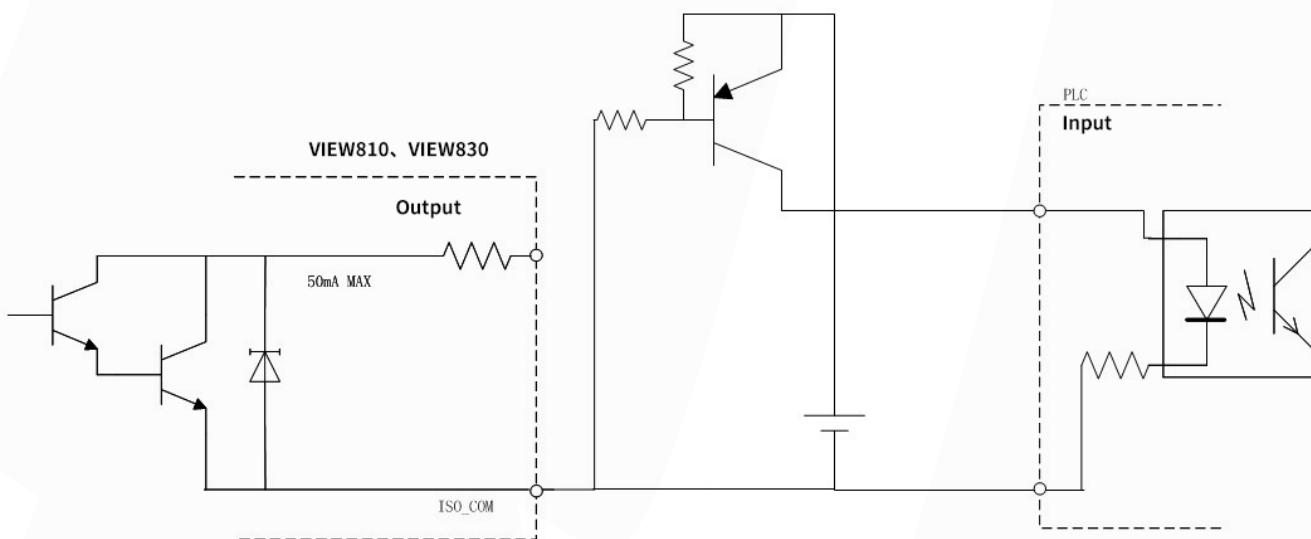

Chapter V Printer (option)

5.1 Connect the Printer

Before connecting the printer

WARNING:

Be sure to observe the following instructions when connecting the printer, otherwise it may cause electric shock or instrument failure.

- Be sure to cut off the power supply of the instrument and the printer before connecting it.
- If the connection breaks off during operation, it may come into contact with other conductive parts, which is very dangerous. Please make the connection physically.

Notes:

- Please do not print in high temperature and humid environment. Otherwise, the service life of the printer may be seriously shortened.
- Be sure to use record paper suitable for the printer. If the record paper other than specified one is used, it will not only degrade the performance, but also make it impossible to print.
- If the record paper is not aligned with the feed roll, the paper may be jammed.

Recommended printer

The printer specifications that can be connected with the instrument are shown as below. Please confirm the specifications or settings of the printer before connecting it.

- Interface.....RS-232C
- 1 line of characters.....More than 45 half-width characters
- Communication rate.....9,600bps
- Data bit.....8 bits
- Parity.....None
- Stop bit.....1 bit
- Process control.....None
- Control code..... Be possible to print plain text directly

There are three ways to connect the instrument with the printer:

- USB
- Network interface (optional)
- RS-232C

5.2 Parameters Settings

Print measurements, statistics, etc.

Notes:

- Directly printed measurement information includes: number, resistance measurement, voltage measurement and time.
- Print statistical results (statistical indicators). Statistical indicators only support manual printing. Resistance/resistance statistical results include: statistical quantity, average value, maximum value, minimum value, target quasi-deviation, sampling standard deviation, process capability index (deviation, offset), process capability index (offset), and number of comparison results (HI, LO and IN).
- Use USB and LAN interfaces to print, and adopt interval printing (continuous printing). It takes more time to print the measurements; print once every 60 pieces of data or use the print button to stop printing.
- The print icon is highlighted in the process of automatic printing. Except for the statistical indicator interface, the other interfaces print the measurement data information.

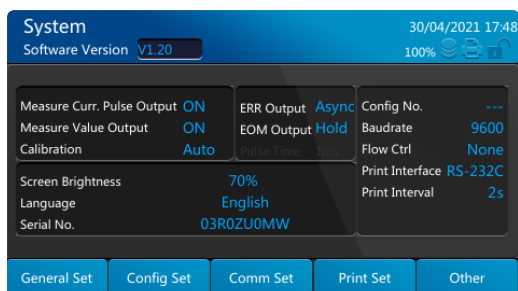

5.3 Print

1) Printing of measurements and judgment results

Press the [PRINT] key in the non-statistical indicator interface to print the number, measurements and judgment results.

- If it is intended to print after the measurement triggered externally is finished, connect the EOM signal of EXT I/O to the PRINT signal.
- If continuous printing is required for each measurement, the print interval is not 0, and the trigger source is internal trigger.

If the statistical operation function is ON and the print interval is 0, click the Print button on the statistical indicator page to print statistical indicators.

- The serial number is 1~3,000, and it will return to 1 after exceeding 3000.

2) Interval printing

The measurements can be printed automatically at certain time intervals. Set the print interval in the interface setting screen.

The setting range is 1~3,600s.

If the print interval is set to 0, the interval printing becomes OFF, and it becomes manual printing mode at the moment.

Print operation for interval printing:

- Use [PRINT] key or the signal of EXT I/O to start interval printing
- Print elapsed time (hour, minute, second) and measurements according to the set interval.
- The interval printing stops when [PRINT] key is pressed again or the PRINT signal is used.

3) Printing of statistical indicators

If the print interval is 0 and the current page is statistical indicator page, press [PRINT] key to print the statistical indicators.

Chapter VI Analog Output (option)

The analog output of resistance measurements is to record the change of resistance value by connecting the analog output quantity to the recorder.

- When connecting to the analog output terminal, please set the power supply of the instrument and the connected instrument to OFF, and connect it when the probe is removed from the test object in order to avoid electric shock and instrument failure.
- In order to avoid damaging the instrument, please do not cause short circuit of the output terminal or input voltage.

6.1 Connect Analog Output

Analog output specification

Output voltage	DC 0V ~ DC 3.1V(f.s.)
Resolution	12-bit resolution (about 1mV)
Output resistance	470Ω
Output item	Resistance measurements (display count value) OF, which is fixed at 3.1V when the test is abnormal, and fixed at 0V when it is negative
Output rate	0 count value ~ 31,000 count values→0V~3.1V
Output accuracy	Resistance test accuracy $\pm 0.2\%$ f.s. (temperature coefficient $\pm 0.02\%$ f.s./°C)
Response time	Resistance measurement response time + sampling time + 1ms

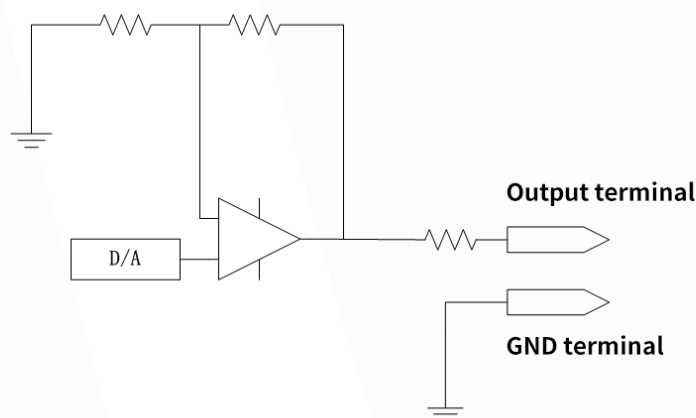

NOTES :

- Output impedance is 470Ω. Please use the connected instrument with an input impedance above 5MΩ.
- If the cable is connected, external noise may be picked up. Please use a band-pass filter on the connected instrument as required.
- Connect the GND terminal of analog output to the ground wire (metal part of housing).
- The output voltage is updated according to the sampling timing of resistance measurement.
- The recorded waveform is in a ladder shape. (Because the response of output circuit is very fast relative to the update cycle)
- Under the automatic range, the output voltage is 1/10 (or 10 times) even if the resistance value is the same due to range switching. It is recommended to use in the manual range.
- When the settings is changed (such as range switching) and the power is OFF, the output is set to 0V.

Chapter VII Remote Control

7.1 Overview and Characteristics

All functions except the power switch can be remotely controlled by RS-232C.

7.2 Specifications of RS-232C

Transmission mode	Communication method: full duplex Synchronization mode: asynchronous mode
Transmission rate	9600 bps/ 19200 bps/ 38400bps
Data length	8 bits
Parity	None
Stop bit	1 bit
Message terminator (delimiter)	When received: CR+LF, CR When sent: CR+LF
Process control	None
Electrical specifications	Input voltage level 5~15V: ON, -15~-5 V: OFF Output voltage level 5~9V: ON, -9~-5 V: OFF
Connector	Pin configuration of interface connector (D-sub9 pin male connector set screw #4-40) The input-output connector is of terminal (DTE) specification Recommended cable: <ul style="list-style-type: none"> • 9637RS-232C cable (for PC/AT compatible machine) • 9638RS-232C cable (for PC98 series)

7.3 Connection and Setting Methods

WARNING :

- When unplugging the interface connector, turn off the power of each instrument. Otherwise, it will lead to electric shock.
- Be sure to tighten the screws after connection. If the screws are not tightened, the specifications cannot be met, leading to failure.
- In order to avoid damaging to the instrument, please do not cause short circuit of connector or input voltage.

7.3.1 Connection of the connector

Please connect the RS-232C cable.

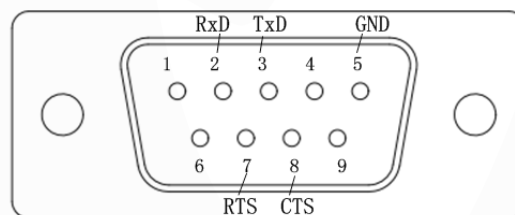

Bit number	Signal definition	Function description
1		
2	RxD	Receive data
3	TxD	Send data
4		
5	GND	Signal ground
6		
7	RTS	Request to send
8	CTS	Clear to send
9		

7.3.2 Setting of communication conditions

Please refer to 3.4.3 Communication settings.

7.4 Communication Method

In order to use the interface to control the instrument, a variety of messages are configured.

The messages include program message sent from computer to the instrument and response message sent from the instrument to computer.



Press [Local] key when remove the remote control state.

7.5 Summary of Message

Note: All commands are not case sensitive.

Commands	Data field	Description
General commands		
*IDN?	<Manufacturer name, model, 0, software version>	Query of instrument information
*RST		Instrument initialization
*TRG		Sampling requirement
Type of measurements		
:FUNction	<RV/RESistance/VOLTage>	Setting of measurement type
:FUNction?	<RV/RESistance/VOLTage>	Query of measurement function
Range		
:RESistance:RANGe	<0~3000/AUTO>	Setting of resistance range
:RESistance:RANGe?	<3.0000E-3/30.000E-3/300.00E-3/3.0000E+0/30.000E+0/300.00E+0/3.0000E+3/ AUTO>	Query of resistance range
:VOLTage:RANGe	<0~300/AUTO>	Setting of voltage range
:VOLTage:RANGe?	<6.00000E+0/60.0000E+0/300.000E+0/ AUTO>	Query of voltage range
Automatic range		
:AUTorange	<1/0/ON/OFF>	Setting of automatic range
:AUTorange?	<Resistance automatic range switch>, <Voltage automatic range switch>	Query of the setting of automatic range

Zero setting

:ADJust:CLEAr		Clear of zero setting
:ADJust?		Execution of zero setting and query of results
:ADJust		Execution of zero setting

Sampling rate

:SAMPlE:RATE	<FAST/MEDium/SLOW>	Setting of sampling rate
:SAMPlE:RATE?	<FAST/MEDium/SLOW>	Query of sampling rate

Average function

:CALCulate:AVERage:STATe	<1/0/ON/OFF>	Setting of average value function
:CALCulate:AVERage:STATe?	<ON/OFF>	Query of execution of average value function
:CALCulate:AVERage	<2~16>	Setting of average times
:CALCulate:AVERage?	<2~16>	Query of average times

Comparator

:CALCulate:LIMit:STATe	<1/0/ON/OFF>	Setting of comparator
:CALCulate:LIMit:STATe?	<ON/OFF>	Query of comparator
:CALCulate:LIMit:BEEPer	<OFF/HL/IN/BOTH1/BOTH2>	Setting of judgment buzzer of comparator
:CALCulate:LIMit:BEEPer?	<OFF/HL/IN/BOTH1/BOTH2>	Query of judgment buzzer of comparator
:CALCulate:LIMit:RESistance:MODE	<HL/REF>	Setting of resistance comparator mode
:CALCulate:LIMit:RESistance:MODE?	<HL/REF>	Query of resistance comparator mode
:CALCulate:LIMit:VOLTagE:MODE	<HL/REF>	Setting of voltage comparator mode
:CALCulate:LIMit:VOLTagE:MODE?	<HL/REF>	Query of voltage comparator mode
:CALCulate:LIMit:RESistance:UPPer	<Upper limit>	Setting of upper resistance limit
:CALCulate:LIMit:RESistance:UPPer?	<Upper limit>	Query of upper resistance limit
:CALCulate:LIMit:VOLTagE:UPPer	<Upper limit>	Setting of upper voltage limit
:CALCulate:LIMit:VOLTagE:UPPer?	<Upper limit>	Query of upper voltage limit
:CALCulate:LIMit:RESistance:LOWer	<Lower limit>	Setting of lower resistance limit
:CALCulate:LIMit:RESistance:LOWer?	<Lower limit>	Query of lower resistance limit
:CALCulate:LIMit:VOLTagE:LOWer	<Lower limit>	Setting of lower voltage limit
:CALCulate:LIMit:VOLTagE:LOWer?	<Lower limit>	Query of lower voltage limit
:CALCulate:LIMit:RESistance:REFerence	<Reference voltage>	Setting of reference voltage
:CALCulate:LIMit:RESistance:REFerence?	<Reference voltage>	Query of reference voltage
:CALCulate:LIMit:VOLTagE:REFerence	<Reference voltage>	Setting of voltage reference value
:CALCulate:LIMit:VOLTagE:REFerence?	<Reference voltage>	Query of voltage reference value
:CALCulate:LIMit:RESistance:PERCent	<Range %>	Setting of resistance range
:CALCulate:LIMit:RESistance:PERCent?	<Range %>	Query of resistance range
:CALCulate:LIMit:VOLTagE:PERCent	<Range %>	Setting of voltage range
:CALCulate:LIMit:VOLTagE:PERCent?	<Range %>	Query of voltage range
:CALCulate:LIMit:RESistance:RESult?	<HI/IN/LO/OFF/ERR/PASS>	Query of resistance judgment result
:CALCulate:LIMit:VOLTagE:RESult?	<HI/IN/LO/OFF/ERR/PASS>	Query of voltage judgment result
:CALCulate:LIMit:ABS	<1/0/ON/OFF>	Setting of absolute value judgment function of comparator

:CALCulate:LIMit:ABS?	<ON/OFF>	Query of absolute value judgment function of comparator
:CALCulate:LIMit:VOLTage:REFerence	<Reference voltage>	Setting of voltage reference value
:CALCulate:LIMit:VOLTage:REFerence?	<Reference voltage>	Query of voltage reference value
Statistic function		
:CALCulate:STATistics:STATe	<1/0//ON/OFF>	Setting of execution of statistical operation function
:CALCulate:STATistics:STATe?	<1/0//ON/OFF>	Query of execution of statistical operation function
:CALCulate:STATistics:CLEAR		Clear of statistical operation results
:CALCulate:STATistics:RESistance:NUMBer?	<Total data number>, <Valid data number>	Query of data number of resistance measurements
:CALCulate:STATistics:VOLTage:NUMBer?	<Total data number>, <Valid data number>	Query of data number of voltage measurements
:CALCulate:STATistics:RESistance:MEAN?	<Mean value>	Query of mean value of resistance measurements
:CALCulate:STATistics:VOLTage:MEAN?	<Mean value>	Query of mean value of voltage measurements
:CALCulate:STATistics:RESistance:MAXimum?	<Maximum value>, <Data number>	Query of maximum value of resistance measurements
:CALCulate:STATistics:VOLTage:MAXimum?	<Maximum value>, <Data number>	Query of maximum value of voltage measurements
:CALCulate:STATistics:RESistance:MINimum?	<Minimum value>, <Data number>	Query of minimum value of resistance measurements
:CALCulate:STATistics:VOLTage:MINimum?	<Minimum value>, <Data number>	Query of minimum value of resistance measurements
:CALCulate:STATistics:RESistance:LIMit?	<Hi number>, <IN number>, <Lo number>, <Test abnormality number>	Query of comparator judgment result of resistance measurements
:CALCulate:STATistics:VOLTage:LIMit?	<Hi number>, <IN number>, <Lo number>, <Test abnormality number>	Query of comparator judgment result of voltage measurements
:CALCulate:STATistics:RESistance:DEVIation?	< σ >, < σ -1>	Query of standard deviation value of resistance measurements
:CALCulate:STATistics:VOLTage:DEVIation?	< σ >, < σ -1>	Query of standard deviation value of voltage measurements
:CALCulate:STATistics:RESistance:CP?	<Cp>, <Cpk>	Query of process capability index of resistance measurements
:CALCulate:STATistics:VOLTage:CP?	<Cp>, <Cpk>	Query of process capability index of voltage measurements
Storage		
:MEMory:STATe	<1/0/ON/OFF>	Setting of storage function
:MEMory:STATe?	<ON/OFF>	Query of storage function
:MEMory:CLEAR		Clear of storage data
:MEMory:COUNT?		Query of storage data number
:MEMory:DATA?	[STEP]	Query of storage data
Self-calibration		
:SYSTem:CALibration		Execution of self-calibration
:SYSTem:CALibration:AUTO	<1/0/ON/OFF>	Setting of automatic self-calibration
:SYSTem:CALibration:AUTO?	<ON/OFF>	Query of automatic self-calibration
Measurement output when triggering input		
:SYSTem:DATAout	<1/0/ON/OFF>	Setting of measurement output when triggering input
:SYSTem:DATAout?	<ON/OFF>	Query of measurement output when triggering input
Key sound		

:SYSTem::BEEPer:STATe	<1/0/ON/OFF>	Setting of key sound
:SYSTem:BEEPer:STATe?	<ON/OFF>	Query of key sound
Power frequency		
:SYSTem:LFRequency	<AUTO/50/60>	Setting of power frequency
:SYSTem:LFRequency?	<AUTO/50/60>	Setting of power frequency
Key locking		
:SYSTem:KLOCK	<1/0/ON/OFF>	Setting of key locking state
:SYSTem:KLOCK?	<ON/OFF>	
EXI I/O Output		
:SYSTem:ELock	<1/0/ON/OFF>	Setting of external input terminal locking
:SYSTem:ELock?	<ON/OFF>	Query of external input terminal locking
Local		
:SYSTem:LOCAl		Setting of local state
Saving and read-in of measurement conditions		
:SYSTem:SAVE	<Table NO.>	Saving of measurement conditions
:SYSTem:LOAD	<Table NO.>	Reading of measurement conditions
:SYSTem:BACKup		Backup of measurement conditions
ERR Output		
:SYSTem:ERRor	<SYNChronous/ASYNchronous>	Setting of ERR output timing
:SYSTem:ERRor?	<SYNChronous/ASYNchronous>	Query of ERR output timing
:SYSTem:ERRor	<SYNChronous/ASYNchronous>	Setting of ERR output timing
EOM Output		
:SYSTem:EOM:MODE	<HOLD/PULSe>	Setting of EOM output mode
:SYSTem:EOM:MODE?	(<HOLD/PULSe>)	Query of EOM output mode
:SYSTem:EOM:PULSe	<Pulse width>	Setting of EOM pulse width
:SYSTem:EOM:PULSe?	<0.001~0.099>	Query of EOM pulse width
Setting of measuring current pulse output function		
:SYSTem:CURRent	<CONTInuous/PULSe>	Setting of measuring current pulse output function
:SYSTem:CURRent?	<CONTInuous/PULSe>	Query of measuring current pulse output function
Terminator		
:SYSTem:TERMinator	<0/1>	Setting of terminator
:SYSTem:TERMinator?	<0/1>	Query of terminator
System reset		
:SYSTem:RESet		Execution of reset including saved data of measurement conditions
EXT I/O		
:IO:IN?	<0~31>	EXT I/O input
Trigger		
:INITiate:CONTInuous	<1/0/ON/OFF>	Setting of continuous measurement
:INITiate:CONTInuous?	<ON/OFF>	Query of continuous measurement

:INITiate[:IMMEDIATE]		Setting of immediate trigger
Setting of trigger source		
:TRIGger:SOURce	<IMMEDIATE/EXTERNAL/MANU>	Setting of trigger source
:TRIGger:SOURce?	<IMMEDIATE/EXTERNAL/MANU>	Query of trigger source
:TRIGger:DELay:STATe	<1/0/ON/OFF>	Setting of trigger delay
:TRIGger:DELay:STATe?	<ON/OFF>	Query of trigger delay
:TRIGger:DELay	<Delay time>	Setting of trigger delay time
:TRIGger:DELay?	<0~9.999>	Query of trigger delay time
Reading of measurements		
:FETCh?	<Resistance measurement>, <Voltage measurement> Ω V <Resistance measurement> Ω function, <Voltage measurement> V function	Reading of latest measurement
:READ?	<<Resistance measurement>, <Voltage measurement> Ω V <Resistance measurement> Ω function, <Voltage measurement> V function	Measurement execution and measurement reading function

Chapter VIII Specifications

8.1 Specifications

Serial No.	Module	Base Specifications
1	Resistor	Range: 3mΩ/30mΩ/300mΩ/3Ω/30Ω/300Ω/3000Ω Measuring range: 0~3.1kΩ Minimum resolution: 0.1μΩ
2	Voltage	VIEW810 : Range: 6V/60V Measuring range: 0~60V Minimum resolution: 10μV VIEW830 : Range: 6V/60V/300V Measuring range: 0~300V Minimum resolution: 10μV
3	Rated input voltage	VIEW810 : DC±60VDC VIEW830 : DC±300VDC
4	Current frequency	1KHz
5	Input impedance	3mΩ~300mΩ 95KΩ 3Ω~3000Ω 2.3MΩ
6	Open terminal voltage	3mΩ~30Ω 25V peak 300Ω~3000Ω 10V peak
7	Test abnormality display (Contact detection)	Detection content: connection abnormality between SOURCE HIGH-LOW Connection abnormality between SENSE HIGH-LOW Display: [-----]
8	Sampling time	Sampling rate FAST/MEDIUM/SLOW (3gears)
		Sampling time
		Function Frequency FAST MEDIUM SLOW ΩV 50Hz/60Hz 40ms 80ms 320ms Ω 50Hz/60Hz 20ms 40ms 200ms V 50Hz/60Hz 20ms 40ms 200ms
9	Response time	Response time Measurement response time: about 5ms
		Total measurement time Time required for the whole measurement: sampling time + response time
10	Comparator function module	Comparator function ON/OFF (shared by resistance and voltage)
		Comparator setting Comparator mode: HIGH-LOW/REF-% Upper and lower limits: 0~3,000 (resistance)/0~300 (voltage) Reference value: 0~3,100 (resistance)/0~310 (voltage) % value: 0.000%~99.99% (% range set to +/- common) Buzzer mode: OFF/HL/IN/BT1/BT2
		Determination Judgment result: Hi/IN/Lo (resistance and voltage are determined independently) PASS/FAIL judgment: execute AND operation on the resistance judgment result and the voltage judgment result, and then execute PASS/FAIL output (EXT I/O output) Test abnormal value judgment : OF Hi judgment -OF Lo judgment Test abnormality ----- Not determined (without judgment)
11	Absolute value judgment function	In this function, even if the battery polarity is reversed, it can be compared according to the absolute value.
12	Average value function	ON/OFF, output the average measurement to reduce the deviation of displayed value, with average times of 2~16

13	Delay	Delay function	ON/OFF
		Delay time	0~9.999s
14	Self-calibration	Calibration mode	AUTO/MANU, used to compensate the bias voltage or gain drift of internal circuit of the instrument, so as to improve the self-calibration function of test accuracy
		AUTO	Once every 30 minutes, automatic execution
		MANU	Execute through EXT I/O, communication command or manually
15	Zero setting	Zero setting function	Zero setting: ON/OFF (shared by resistance and voltage) Clear of zero setting: set zeroing to OFF and clear all zeroing data
		Range of zero setting	Resistance measurement: -1,000~1,000 count values Voltage measurement: -1,000~1,000 count values (i.e., the range of zero setting is less than or equal to $\pm 1,000$ dgt.)
16	Trigger	Internal/external/manual	
17	Current output	Pulse/continuous	
18	Statistics	Statistical operation	ON/OFF/Clear
		Computation content	Total data number, valid data number, maximum value, minimum value, mean value, sampling standard deviation, parent standard deviation, process capability index, etc.
		Computation trigger	Execute statistics on the measurements through EXT I/O, keys and commands
19	Storage	ON/OFF/Clear, save the measurements to memory through EXT I/O, keys and commands, and send the stored measurements uniformly by commands.	
20	Saving and reading of measurement settings	Function	Save and read measurement settings
		Save settings	Test function, resistance range, voltage range, automatic range setting, zero setting and data, sampling rate, trigger source, delay setting, average setting, comparator setting and statistical operation setting
21	Key sound	ON/OFF	
22	Key locking	ON/OFF	
23	Reset	Settings reset/system reset	
24	Measurement output	Transmit the measurements in memory to the computer through RS-232C/LAN interface	
25	Communication interface setting	SCPI, serial port baud rate, IP Mode, port number, IP address, subnet mask, and gateway	

8.2 Precision

Accuracy guarantee conditions

Temperature and humidity range	23°C \pm 5°C, below 80%RH (no condensation)
Zero setting	After zero setting
Preheating time	More than 30 minutes
Self-calibration	Except for sampling = SLOW, self-calibration should be executed after preheating. The temperature variation after self-calibration shall be within $\pm 2^\circ\text{C}$.
Measuring condition	Measurement should be carried out in the same probe shape, configuration and measurement environment as the zero setting. During the measurement, the probe shape should be unchanged.

About accuracy

The overall error is co-determined by the reading error of measurements (rdg.) and the digital error of measuring range (dgt.).

For example: standard value: 1, measuring range: 3

It can be seen from the table below that the reading error is $\pm 0.4\%rdg.$, and the digital error is $\pm 5dgt.$,

Then, the reading error ($\pm\%rdg.$): $1 \times \pm 0.4\% = \pm 0.004$

Digital error ($\pm dgt.$): the minimum resolution of the current range is 0.0001, so $\pm 5dgt. = \pm 0.0005$

Overall error: reading error + digital error, i.e. ± 0.0045

According to the calculation, the accuracy range of the instrument is 0.9955~1.0045 relative to the standard value of 1.

Serial No.	Module	Technical indicators								
1	Current	Range	3mΩ	30mΩ	300mΩ	3Ω	30Ω	300Ω	3000Ω	
		Maximum display value	3.1000mΩ	31.000mΩ	310.00mΩ	3.1000Ω	31.000Ω	310.00Ω	3100.0Ω	
		Resolution	0.1μΩ	1μΩ	10μΩ	100μΩ	1mΩ	10mΩ	100mΩ	
		Measuring current*1	100mA	100mA	10mA	1mA	100μA	10μA	10μA	
		Measuring current frequency	1kHz±0.2Hz							
		Accuracy*2	±0.4%rdg.±5dgt. ±0.4%rdg.±10dgt. (range of 3mΩ)							
		Temperature factor	(±0.05%rdg.±0.5dgt.)/°C (0.05%rdg.±1dgt.)/°C (range of 3mΩ)							
		*1 : Error in measuring current is within ±10% *2 : Plus ±2dgt. for FAST, and plus ±2dgt. for MEDIUM. Plus ±10dgt. for FAST, and plus ±5dgt. for MEDIUM. (range of 3mΩ)								
2	Voltage	Range	6V		60V		300V (VIEW830 only)			
		Maximum display value	±6.00000V		±60.0000V		±300.000V			
		Resolution	10μV		100μV		1mV			
		Accuracy*3	±0.01%rdg.±3dgt.							
		Resolution	(±0.001%rdg.±0.3dgt.)/°C							
		*3 : Plus ±2dgt. for FAST, and plus ±2dgt. for MEDIUM.								

8.3 General Features

Temperature and humidity range for use	0°C~40°C, below 80%RH (no condensation)
Temperature and humidity range for storage	-10°C~50°C, below 80%RH (no condensation)
Temperature and humidity range for accuracy guarantee	23°C±5°C, below 80%RH (no condensation)
Accuracy guarantee range	1 year
Operation place	Indoor use, with the altitude below 2,000m
Power rating	35VA
Nominal supply voltage	AC 100V~AC 240V (10% voltage fluctuation already considered)
Rated power supply frequency	50/60Hz
Size	D306mm*W232mm*H108.5mm
Weight	About 3.12KG
Annex	Instructions CD 1 Power cord 1
Applicable standards	Safety EN61010 EMC EN61326 ClassA EN61000-3-2 EN61000-3-3

Chapter IX Problems and Maintenance

9.1 Common Problems

Problems	Inspection Item	Countermeasures
Unable to turn it on when pressing the power button for a long time	Whether the power cord is loose	Please connect the power cord.
Invalid key input	Whether it is in the key locking state	Please unlock the key. Refer to key lock function
	Whether RS-232C is used for remote control externally	Click [Local] key to switch the remote control mode to the local mode.
Unstable measurements	Use two terminals for connection	When connected with two terminals, the contact resistance of probe will affect the resistance value and may become unstable. Please make a four-terminal connection
	There is a metal part around the probe	If there is a metal part around the battery and probe to be measured, the measurements may fluctuate due to induction of eddy current. <ul style="list-style-type: none"> • Please keep as far away from metal part as possible when measuring. • Wrap the cables together to minimize the area of branches.
		<ul style="list-style-type: none"> • Wrap the cables together to minimize the area of branches • Shield the cable and connect it to ground wire
	Multiple instruments shall be used for measurement at the same time	The measurements fluctuate due to the interference between the measurement signals of each other. <ul style="list-style-type: none"> • Please use the measurement current pulse output function to stagger the measurement timing when measuring. • Please do not overlap the probes as far as possible • Do not stack the instrument when placing it
	Get too close to the front of the instrument for measurement	Noise may be picked up due to the inductive signal of circuit of the instrument, resulting in fluctuation of measurements. Please keep a distance of more than 20cm from the instrument when measuring.

9.2 Cleaning

When removing the dirt of the instrument, please use a soft cloth to dip a small amount of water or neutral detergent and then wipe it gently. Please never use gasoline, alcohol, acetone, ether, ketone, diluent, or detergent containing gasoline. Otherwise, deformation and discoloration may occur.

Appendix

Appendix I Ac Four-terminal Test Method

The instrument adopts the AC four-terminal test method, and deducts the wire resistance of wire and the contact resistance between wire and the test object in the process of measurement, so that the measurement results will be more accurate.

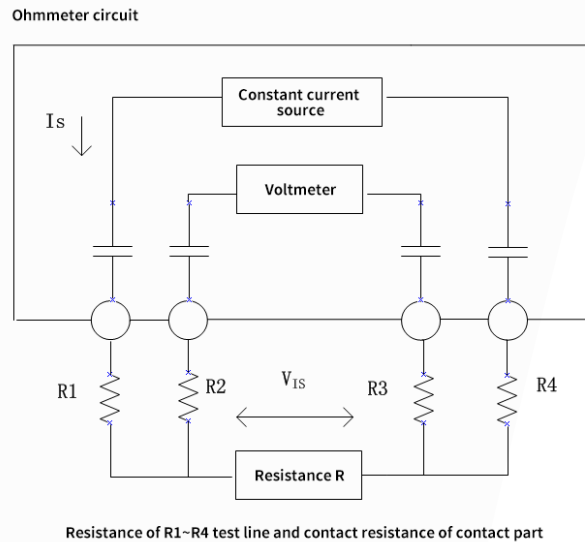

Principle of AC four-terminal measurement method: As shown in the figure, the AC current I_S is input to the measured object through the current output terminal, and the voltage drop V_{IS} generated due to the impedance of the measured object is measured on the voltage measurement terminal. At this time, the current terminal is connected to the internal high impedance voltmeter, so almost no current flows through the resistors R_2 and R_3 of wire resistance and contact resistance, thus eliminating the voltage drop on R_2 and R_3 and making the measurement results more accurate.

Appendix II Synchronous Detection

Synchronous detection method is a detection method used when extracting a signal with the same frequency component as the reference signal from a certain signal. As shown in the figure, it is composed of a multiple circuit that multiplies two signals and a low-pass filter that only outputs DC component.

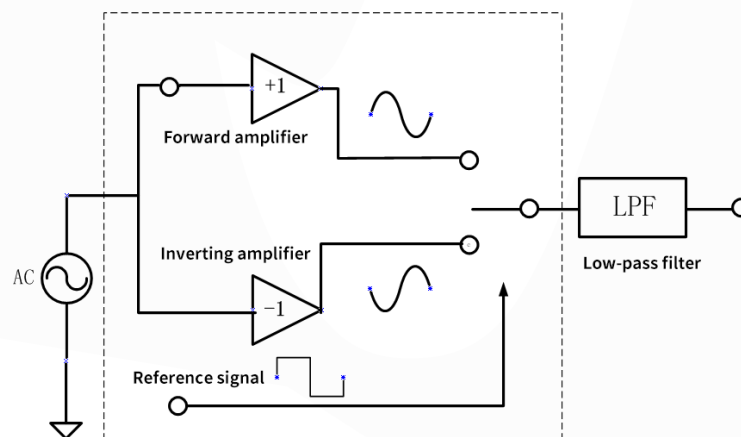

Set the AC current reference signal generated by the instrument as $V1$, and set the signal voltage for synchronous detection as $V2$, so that:

$$V1 = A \sin t$$

$$V2 = B \sin(t + \theta)$$

Where θ is the phase shift caused by $V1$ on the reactive component.

Execute synchronous detection on $V1$ and $V2$, then:

$$V1 * V2 = 1/2 AB \cos \theta - 1/2 AB \cos(2t + \theta)$$

The second part of AC component can be filtered by the LPF low-pass filter, and only the first part of DC component is output, which is proportional to the internal resistance of the battery. This test method, which has little effect on batteries, is widely used to measure all kinds of batteries.

Appendix III About Zero Setting

In order to remove the residual component caused by the bias voltage of instrument or the measurement environment, please perform zero setting before measurement, and specify the test accuracy after zero setting.

Zero setting refers to the function of subtracting the residual value when measuring 0 to adjust the zero point, so it is necessary to perform zero setting when 0 is connected. Considering that it is unrealistic to connect the measured object without resistance in reality. Therefore, zero setting is executed by establishing a state close to 0 in the actual zeroing process. If zero setting is not executed in a correct way, the correct measurements cannot be obtained.

Zero setting wiring principle

According to Ohm's law $E = I * R$, in order to establish a state close to 0, it is necessary to cause a direct short circuit between SENSE-H (red) and SENSE-L (black), and the voltage between SENSE-H and SENSE-L is approximately 0V. The specific calculation is as follows:

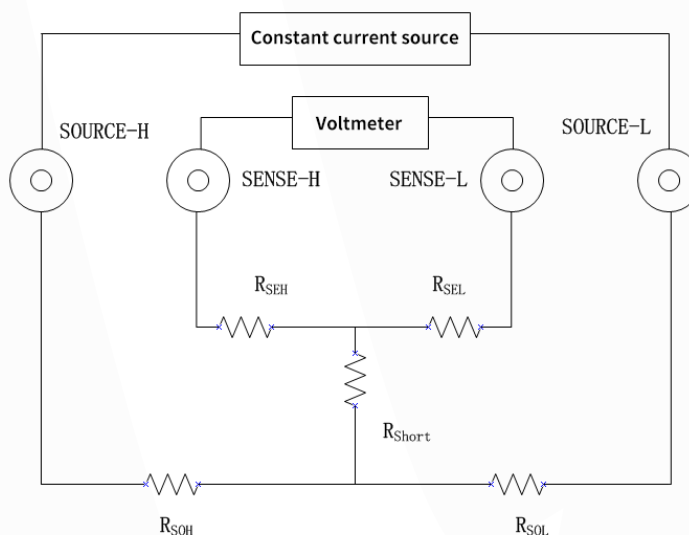

R_{SEH} and R_{SEL} are wiring resistances for SENSE-H and SENSE-L

R_{SOH} and R_{SOL} are wiring resistances for SOURCE-H and SOURCE-L

R_{Short} is short-circuit resistance

I_0 is the current flowing from SENSE-H to SENSE-L

I is the current flowing from SOURCE-H to SOURCE-L

$$\text{Then: } E = (I_0 \times R_{SEL}) + (I_0 \times R_{SEH})$$

$$= (0 \times R_{SEL}) + (0 \times R_{SEH})$$

$$= 0(V)$$

Therefore, the voltage between SENSE-H and SENSE-L can be correctly maintained at 0V by the above wiring method, so it can be properly zeroed.

(1) Zero setting using clip type test line

When using clip type test line for zero setting, please connect the test line as shown below

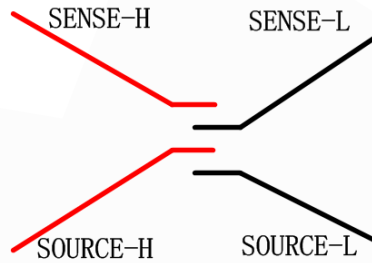

The equivalent circuit is as shown in figure below, where the voltage between SENSE-H and SENSE-L is approximately 0V.

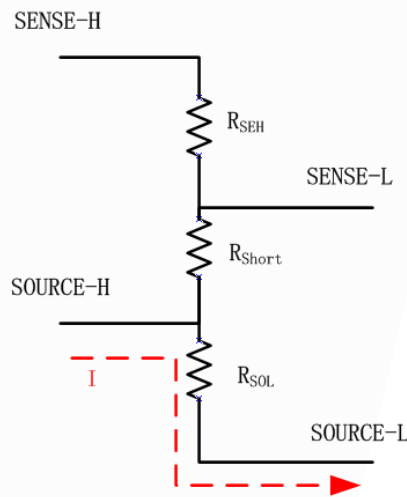

(2) Zero setting using pin type test line

When using pin type test line for zero setting, please connect the test line as shown below.

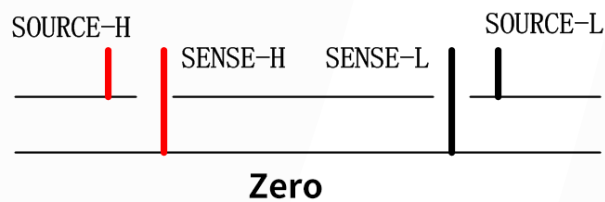

When using pin type test line for zero setting, please connect the test line as shown below.

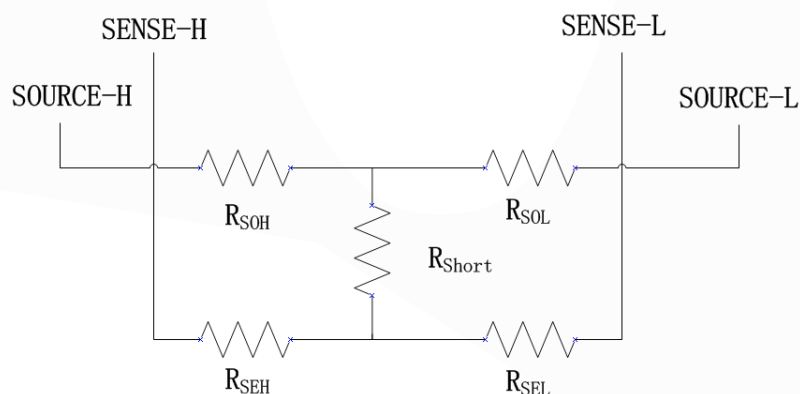

Appendix IV About the Test Line (Option)

(1) BL-1001 pin type test line (below DC 1,000V)

BL-1001 test line has parallel pins at the top and can measure the battery (pack) through stable point contact. It is most suitable for measuring battery (pack) with high voltage below DC 1,000V or high ground potential.

Please use the test lines below corresponding rated voltage.

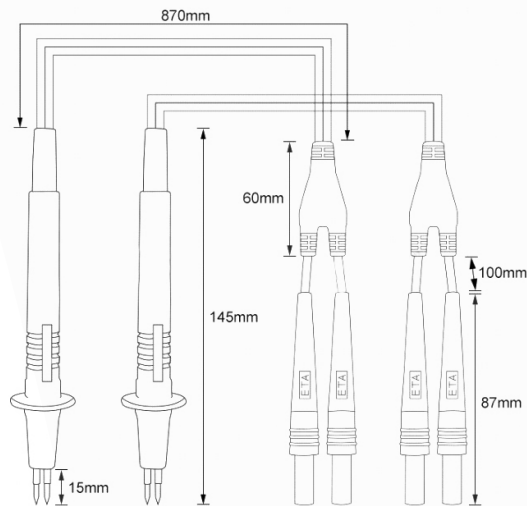

(2) BL-1002 clip type test line (below DC 60V)

BL-1002 clip type test line has a clip-on top and can execute four-terminal measurement once clipped on. It is suitable for measuring DC 60V battery (pack).

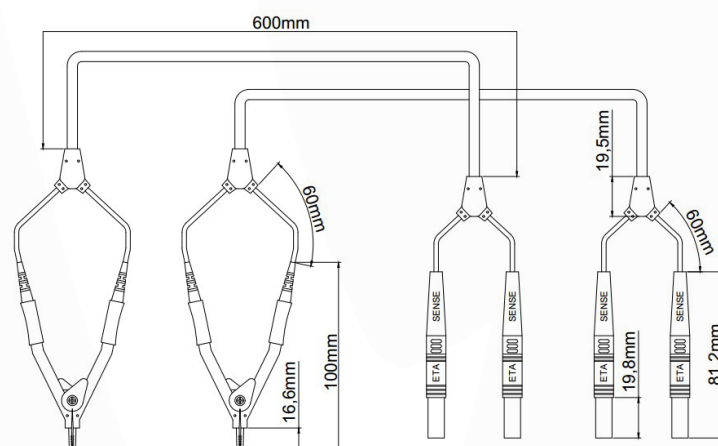

The End

* Products models and specifications are subject to change without prior notice.

